



HAL
open science

Industrial aspects of voltage management and hosting capacity of photovoltaic power generation in low voltage networks

Kalle Rauma

► **To cite this version:**

Kalle Rauma. Industrial aspects of voltage management and hosting capacity of photovoltaic power generation in low voltage networks. Electric power. Université Grenoble Alpes, 2016. English. NNT : 2016GREAT036 . tel-01345202

HAL Id: tel-01345202

<https://theses.hal.science/tel-01345202v1>

Submitted on 13 Jul 2016

HAL is a multi-disciplinary open access archive for the deposit and dissemination of scientific research documents, whether they are published or not. The documents may come from teaching and research institutions in France or abroad, or from public or private research centers.

L'archive ouverte pluridisciplinaire **HAL**, est destinée au dépôt et à la diffusion de documents scientifiques de niveau recherche, publiés ou non, émanant des établissements d'enseignement et de recherche français ou étrangers, des laboratoires publics ou privés.

THÈSE

Pour obtenir le grade de

DOCTEUR DE L'UNIVERSITÉ GRENOBLE ALPES

Spécialité : **Génie électrique**

Arrêté ministériel : 7 août 2006

Présentée par

Kalle Rauma

Thèse dirigée par **Nouredine Hadj-Saïd** et
codirigée par **Florent Cadoux**

préparée au sein du **Laboratoire de Génie Electrique de Grenoble**
dans l'**École Doctorale de Électronique, Électrotechnique, Automatique et Traitement du Signal (EEATS)**

Aspects industriels de la gestion de tension et la capacité d'accueil de la génération photovoltaïque dans les réseaux basse tension

Thèse soutenue publiquement le **29 Mars 2016**,
devant le jury composé de :

Mme Corinne ALONSO

Professeure, Université de Toulouse III Paul Sabatier, Examineur

M. Marc PETIT

Professeur, Université de l'École Supérieure d'Électricité, Rapporteur

M. Matti LEHTONEN

Professeur, Aalto University, Rapporteur

M. Guillaume ROUPIOZ

Ingénieur, Électricité Réseau Distribution France, Examineur

M. Nouredine HADJ-SAÏD

Professeur, Université Grenoble Alpes, Directeur de thèse

M. Florent CADOUX

Docteur, Titulaire de la Chaire ERDF, Co-directeur de thèse



Abstract

Grenoble Institute of Technology
Université Grenoble Alpes
Grenoble Electrical Engineering Laboratory (G2Elab)

Author: Kalle Rauma

Title: Industrial Aspects of Voltage Management and Hosting Capacity of Photovoltaic Power Generation in Low Voltage Networks

Date: March 29, 2015 **Pages:** 168

Director: Professor Nouredine Hadj-Saïd

Supervisors: Doctor Florent Cadoux

Engineer Guillaume Roupioz

In this thesis, voltage measurements provided by the advanced metering infrastructure (AMI) are used to control an on-load tap changer located at the secondary substation. The thesis presents a practical and a straightforward method of selecting the low voltage customers whose voltage measurements are used as an input to the controller of the on-load tap changer. The developed method takes into account the load and the topology of the network. Furthermore, a simple method of creating synthetic and statistically correct load curves for networks studies is presented. The created methods have been tested by using real data of low voltage networks on a common platform in the power distribution industry leading to encouraging results; a few customers per low voltage network should be monitored in order to achieve accurate voltage measurements.

This methodology is further applied to estimate the hosting capacity of photovoltaic power generation in a given low voltage network.

In the first part, the evolution of the hosting capacity by using three different types of voltage control; an on-load tap changer of five and nine tap positions and voltage control through photovoltaic power generators, is studied. The study considers two different cases for placing and sizing the photovoltaic generators in a low voltage network. The results of 38 low voltage networks are provided.

In the second part, the hosting capacities of 631 low voltage networks, located in a French metropolitan area, are analysed by using an on-load tap changer of five and an on-load tap changer of nine tap positions.

The work has been together with Électricité Réseau Distribution France (ERDF), the major French distribution system operator. All studies presented in the thesis are based on the real operational data of the company. Moreover, all studies are implemented on a platform that is widely used in the power distribution industry.

As an introductory part to low voltage networks, the thesis provides a general view about the French power system. In addition, the thesis presents a number of selected technologies considering low voltage networks that seem promising in the future.

Keywords: voltage control, low voltage network, advanced metering infrastructure, hosting capacity, photovoltaic generation

Language: English

Acknowledgements

I would like to thank Doctor Florent Cadoux for supervising my thesis and Professor Nouredine Hadj-Saïd for the support throughout the work. Especial acknowledgements to Guillaume Roupioz (ERDF) for the ideas and the inspiration that finally led to a successful accomplishment of the project. I would also like to thank Adrien Dufournet (ERDF) for the significant contribution to the practical implementation of the work.

I would like to express my gratitude to everybody at ERDF Lyon for welcoming ambience during my time at the company.

Very special thanks to Julien Bruschi and Aurel Garry for an enormous technical and non-technical support during my whole thesis and creating a friendly environment. Big thanks to Bhargav Swaminathan, Davis Montenegro, Catalin Gavriluta, Cederic Nolan, Kevin Marojahan, Lyubomir Kerachev, Julian Fernandez, Fabien Menard and everybody else who supported my work directly or indirectly, giving ideas and moral support. Also, I want to thank everybody at the G2Elab and elsewhere who are partly responsible for the successful thesis and leaving me warm memories from my years in Grenoble.

I would like to express my gratitude to Fortum Foundation for supporting my doctoral studies.

Table of Contents

Abstract	1
Acknowledgements	2
List of Symbols, Abbreviations and Nomenclature	6
1. Introduction.....	8
1.1. Background and the Motivation of the Thesis.....	8
1.2. The Principal Contributions.....	8
1.3. Organisation of the Thesis	9
2. French Power Delivery System	11
2.1. Power Transmission System.....	12
2.2. Power Distribution System.....	12
2.2.1. Medium Voltage Networks	12
2.2.2. Low Voltage Networks	15
2.3. Management of the Power System in France	22
2.4. Evolution of the Low Voltage Networks.....	22
2.4.1. Advanced Metering Infrastructure	22
2.4.2. Distributed Generation	23
2.4.3. Other Factors	24
3. Technical Prospects in Low Voltage Networks.....	25
3.1. General Preferences for the Devices in Low Voltage Networks.....	25
3.2. State Estimation by Advanced Metering Infrastructure	26
3.3. Reconfiguration by Using Power Electronics	29
3.3.1. Reconfiguration in Power Systems	29
3.3.2. Constraints and Issues Associated with Reconfiguration	31
3.3.3. Reconfiguration by Power Electronic –based Switches.....	34
3.4. Automatic Tap Changers and Voltage Regulators in Secondary Transformers.....	36
3.4.1. Mechanical and Thyristor Assisted On-load Tap Changers.....	37
3.4.2. Solid State On-Load Tap Changers.....	39
3.5. Direct Current in Low Voltage Power Distribution	40
3.5.1. Low Voltage Direct Current Technologies	42
3.5.2. Electrical Safety and Protection of the Low Voltage Direct Current Systems ..	44

3.5.3.	Benefits of the Low Voltage Direct Current Technology in Power Distribution	45
3.5.4.	Downsides of the Low Voltage Direct Current Technology.....	48
3.5.5.	Low Voltage Direct Current Technology in the Rural and Urban Environments	49
3.5.6.	Low Voltage Direct Current Distribution – Practical Setups.....	50
3.6.	Fault Location, Intelligent Substations and Applications for Condition Monitoring	54
4.	Optimal Placement of Voltage Sensors in a Low Voltage Network for On-Load Tap Changer Application	57
4.1.	Description of the Methodology and the Results	59
4.1.1.	The Number of Voltage Measurements for Automatic Online Tap Changer - Application based on the Load Data of Four Days.....	63
4.1.2.	Accuracy of the Voltage Estimation due to Loss of Measurements	65
4.1.3.	Robustness of the Methodology against Minor Changes in the Network.....	69
4.1.4.	The Creation of New Random-based Load Curves	72
4.1.5.	The Error in Voltage Measurements for Automatic Online Tap Changer - Application when the Load Data is Extent to 400 Days.....	77
4.2.	Analysis of the Results	84
4.2.1.	The Number of Voltage Measurements for Automatic Online Tap Changer - Application based on the Load Data of Four Days.....	84
4.2.2.	Accuracy of the Voltage Estimation due to Loss of Measurements	85
4.2.3.	The Robustness of the Methodology against Minor Changes in the Network... ..	85
4.2.4.	The Error in Voltage Measurements for Automatic Online Tap Changer - Application when the Load Data is Extent to 400 Days.....	85
4.3.	Discussion.....	86
4.4.	Conclusions	92
5.	The Impact of Voltage Control Technologies on the Capacity to Host Photovoltaic Power Generation in Low Voltage Networks	94
5.1.	Increasing the Hosting Capacity of Photovoltaic Power Generation by an On-Load Tap Changer at the Secondary Substation.....	94
5.1.1.	Description of the Methodology and the Results	95
5.1.2.	Analysis of the Results	120
5.1.3.	Discussion	122
5.1.4.	Conclusions	128

5.2. Increasing the Hosting Capacity of Photovoltaic Power Generation by Reactive Power Compensation	129
5.2.1. Description of the Methodology and the Results	130
5.2.2. Analysis of the Results	139
5.2.3. Discussion	143
5.2.4. Conclusions	145
6. The Estimation of the Hosting Capacity on a Large Number of Networks	147
6.1. Description of the Methodology	147
6.2. Potential Pitfalls when Applying the Methodology to Place Voltage Sensors to Estimate the Hosting Capacity	149
6.3. Results	156
6.4. Analysis of the Results	162
6.5. Discussion and Conclusions	163
7. General Conclusions and Future Work	165
7.1. Conclusions	165
7.2. Future Work	166
References	168
Annex : Résumé de thèse en français	185

List of Symbols, Abbreviations and Nomenclature

A	Ampere <i>or</i> phase A
<i>a</i>	Activated or deactivated voltage measurement
AC	Alternative current
AMI	Advanced Metering Infrastructure
CRE	Commission de Régulation de l'énergie; the French energy regulator
<i>d, x</i>	Binary variables
DC	Direct current
DPL	DIgSILENT Programming Language
EDF	Électricité de France; the major French power company
ELV	Extra low voltage
EN	European standard
ERDF	Électricité Réseau Distribution France; the major French distribution system operator
FACTS	Flexible AC Transmission Systems
GPRS	General Packet Radio Service
GTO	Gate Turn-Off Thyristors
GW	Gigawatt
HVA	High voltage A
HVB	High voltage B
IGBT	Insulated-Gate Bipolar Transistor
kV	Kilovolt
kVA	Kilovoltampere
kW	Kilowatt
L	Length
Linky	The electric energy meter used by Électricité Réseau Distribution France
LV	Low voltage
LVA	Low voltage A
LVAC	Low voltage alternative current
LVB	Low voltage B
LVDC	Low voltage direct current
m	meter
mm	Millimetre
MV	Medium voltage
N	Neutral wire
NC point	Normally closed point
NO point	Normally open point
OLTC	On-load tap changer
P	Power
PLC	Power Line Communication

PowerFactory	A power system analysis software created by DIgSILENT
PV	Photovoltaic <i>or</i> a photovoltaic generator
PVC	Polyvinyl chloride
Q	Reactive power
RTE	Réseau de transport d'électricité; the French transmission system operator
SCADA	Supervisory, Control and Data Acquisition System; a supervisory and control system used by a network operator
SD	Standard deviation
THD	Total Harmonic Distortion
TN	TN earthing system
TT	TT earthing system
TURPE	Tarifs d'utilisation des réseaux publics d'électricité; the French tariff of using the public power network
UFE	Union Française de Electricité; French electricity association
V	Volt
VA	Voltampere
XLPE	Cross linked polyethylene
Ω	Ohm

1. Introduction

A short background, motivation and the main contributions of the thesis are presented in this chapter. In addition, a brief description of the thesis can be found in this chapter.

1.1. Background and the Motivation of the Thesis

The principles of the European power distribution networks have remained relatively unchanged since the beginning of the large-scale electrification. The technological advances during the last decades in the fields of electronics, telecommunications, information and control technology permit the development of the whole power delivery system. The low voltage level is the less automated and by far the least developed part of the power distribution chain. However, certain political decisions encourage the introduction of technologies, such as distributed generation and electric vehicles, that didn't exist in the low voltage networks before. These technologies together with the load growth are creating the necessity to upgrade the existing low voltage networks to respond to the future needs. Under this pressure, many distribution system operators are more and more interested in developing their low voltage networks.

Today, many power utilities in Europe have replaced or are replacing the traditional electromechanical electricity meters by the advanced metering infrastructure. The introduction of the advanced metering infrastructure can be stated as the most important ongoing technical progress in the operation of low voltage networks. The main advantage of the advanced metering infrastructure is related to energy metering and billing, but they can provide information also for control and monitoring functions of many kinds.

The introduction of distributed power generation, mainly photovoltaic generators, creates an increasing number of voltage problems in low voltage networks. In order to avoid the problems, efficient methods of voltage control are needed. It is a great help if a distribution system operator is able to estimate the hosting capacity of the photovoltaic generation in its networks, which allows foreseeing the problems and consider them in the planning before they take place.

The main motivation of the thesis is to contribute to two relevant topics; the new uses of advanced metering infrastructure and the accommodation of distributed generation.

1.2. The Principal Contributions

Chapters “French Power Delivery System” and “Technical Prospects in Low Voltage Networks” provide a summary of the French power distribution system and a review of promising technologies in low voltage networks.

Chapter “Optimal Placement of Voltage Sensors in a Low Voltage Network for On-Load Tap Changer Application” proposes a new application for advanced metering infrastructure as a measurement input to an on-load tap changer. The chapter constructs a simple approach to place voltage measurements in a given low voltage network in order to measure the maximum and the minimum voltage in the network. Additionally, a straightforward method of using the mean load data together with the 90th percentile probability curve instead of a large amount of data from real consumption is suggested.

Chapter “The Impact of Voltage Control Technologies on the Capacity to Host Photovoltaic Power Generation in Low Voltage Networks” provides several ideas on how to assess the hosting capacity of photovoltaic power generation in low voltage networks. The hosting capacities resulting from three different solutions for voltage control are compared between each other.

Chapter “The Estimation of the Hosting Capacity on a Large Number of Networks” proves that the method of analysis presented in the two earlier chapters can be executed effectively in an automated manner on a large number of networks. In addition, concrete results of 631 low voltage networks are presented, mainly through two developed indicators.

The work presented in this thesis has been carried out in a close collaboration with the power distribution industry. Thus, it offers practical standpoints that are not always taken into account in the academic research. All results presented in this thesis are based on real operational data provided by Électricité Réseau Distribution France (ERDF).

1.3. Organisation of the Thesis

The thesis is divided into six main chapters. The contents of Chapter “French Power Delivery System” and “Technical Prospects in Low Voltage Networks” are based mainly on scientific literature, technical reports and interviews as well as discussions with relevant experts.

Chapter “French Power Delivery System” provides a general overview of the French power system and its most important ongoing evolutions. The focus of the chapter is on the low voltage networks.

In **Chapter “Technical Prospects in Low Voltage Networks”**, a review of selected novel technologies in low voltage networks is provided. Medium voltage networks are considered when regarded appropriate.

In **Chapter “Optimal Placement of Voltage Sensors in a Low Voltage Network for On-Load Tap Changer Application”**, a method of placing voltage measurements in a low voltage network is proposed and tested on 38 real networks.

Chapter “The Impact of Voltage Control Technologies on the Capacity to Host Photovoltaic Power Generation in Low Voltage Networks” develops means to assess the hosting capacity of photovoltaic power generation in a given low voltage network. The method developed in the previous chapter is applied in order to control an on-load tap changer. Additionally, the hosting capacities of 38 low voltage networks are evaluated.

Chapter “The Estimation of the Hosting Capacity on a Large Number of Networks” combines ideas developed in the two earlier chapters and applies them on 631 low voltage networks. The data gathered from those networks are further processed and conclusions based on statistics are extracted.

Chapter “General Conclusions and Future Work” resumes the fundamental outcomes and ideas of the thesis and provides suggestions for future developments of the work.

2. French Power Delivery System

This chapter presents a global view of the power system in France and some of the most important trends of evolution in the near future. It is necessary to acquire a broad view of the French power system before entering further details of the new technologies in low voltage networks. For the sake of the impossibility of covering the subject completely, the text is strongly focused on the low voltage –part of the electricity distribution network and the other parts are introduced briefly in order to give a general view of the whole power system. On the behalf of the distribution network, the text is centred on the network of Électricité Réseau Distribution France (ERDF).

A power system can be divided into three main layers: power transmission network, medium and low voltage power distribution networks. The power transmission network is a system where the bulk power is transported over long distances (hundreds or thousands of kilometres) at high voltage from large power stations to the areas of consumption, such as cities. The medium voltage power distribution network distributes electricity at medium voltage across geographically smaller areas (generally up to tens of kilometres) than the power transmission network. In turn, the low voltage distribution network delivers electricity to its customers at low voltage over short distances (generally up to one kilometre). As a rule of thumb, the lower is the level of voltage, the smaller are the transported powers in an individual line. There are customers (power consumers or producers) connected to every level of the power system. Large customers, such as a paper mill or a nuclear power plant, can be connected to the transmission network. The medium voltage level has more customers than the high voltage level, but they are minor in production or consumption.

In France, the voltage levels are classified into five voltage classes as shown in Table 1.

Table 1: Acronyms, voltage limits and common voltages used in France. Note that LVB and ELV are not used in the public distribution system.

Acronym	Voltage Limits	Common Voltages in the Power System [kV]
HVB	$> 50 \text{ kV}$	63, 90, 225, 400
HVA	$> 1 \text{ kV and } \leq 50 \text{ kV}$	5.5, 10, 15, 20, 33
LVB	$> 500 \text{ V and } \leq 1 \text{ kV}$	
LVA	$\geq 50 \text{ V and } \leq 500 \text{ V}$	0.4
ELV	$< 50 \text{ V}$	

This thesis separates the power network into three parts (the transmission, the medium voltage distribution and the low voltage distribution networks) because it is simpler than the division of Table 1. Each of these three parts of the power system is described in its own section.

The first sections of this chapter describe the abovementioned three layers of the French power system. After that a quick view of the regulatory organs is given. The last sections discuss about the most remarkable evolutions considering low voltage networks.

2.1. Power Transmission System

The French power transmission network is operated by a transmission system operator called Réseau de transport d'électricité (RTE) that is a subsidiary company of Électricité de France (EDF) [1]. The main transmission network and the interconnections with are use the voltage of 400 kV [2]. The regional transmission networks use the voltage levels of 225 kV, 90 kV and 63 kV [1].

The standard European frequency of 50 Hz (specified by the standard EN 50160) is used all over the country [3]. The transmission system has about 100300 kilometres of power lines and 2500 substations [4]. It is the largest transmission network in Europe [2]. The most of the new lines between 50 kV and 225 kV are built underground for environmental and aesthetic reasons [5]. All the major power generation units (more than 500), such as nuclear or large hydro power plants are connected to the transmission network [2]. Additionally, there are about 600 industrial customers directly connected to the transmission system [2].

The highest load peak in the French history is 102.1 GW and it was experienced in the year 2010 [6]. The annual demand for electricity is about 480 TWh per year [6]. Altogether the transmission network of France has 45 cross border interconnections divided with Great Britain, Belgium, Germany, Switzerland, Italy and Spain [7].

2.2. Power Distribution System

The electricity distribution network can be divided into the low voltage and the medium voltage networks according to their voltage level. Although these two parts of the power delivery chain have many characteristic in common, they are contemplated separately in this section. Like this, the special qualities of the low voltage networks can be emphasised and become more evident to the reader.

2.2.1. Medium Voltage Networks

Medium voltage networks are directly connected to the low voltage networks. That is why a change of circumstances in a medium voltage network affects downstream to the low voltage network and vice versa. Hence, a certain level of knowledge of the medium voltage networks is required in order to comprehend low voltage networks.

The major part of the French distribution network uses the voltage level of 20 kV, but some areas use the older 15 kV voltage level. In France, the electricity is supplied in three phases (each phase has a phase difference of 120 degrees in relation with the other two phases), through three phase wires and a neutral wire. Both, overhead lines and underground cables are used. Since the rate of failure is significantly lower when using underground cables than in case of overhead lines, underground cables are generally preferred in urban areas or when a particularly high quality of supply is pursued [8]. In the distribution networks, the number of loads correlates closely with the density of population, except in case of large industrial sites [9]. [10]

There are several types of medium voltage distribution networks; rural, urban, semi-urban, industrial networks. The rural networks, for example, are differentiated by radial topology and a small number of feeders (power lines departing from substations) outgoing from every substation. Feeders between the substations permit the operation as open loops in the most

important areas. Another important characteristic is the low number of line switches on radial feeders. This topology is to aspire a moderate quality of power with low economic investments. The number of feeders departing from a substation can vary from a few (rural areas with a low density of population) up to several tens (urban areas with a high density of population) [11]. A medium length of a distribution feeder is about 35 kilometres, so a distribution substation can feed distribution lines of several hundreds of kilometres [11]. [10]

In urban areas with a high density of population, there lies a danger that a large number of customers experience an outage in the event of a failure. This is why the urban distribution networks are constructed as open loops, but operated in a radial way. This means that there is always a backup connection to every distribution transformer. A detailed classification of medium voltage networks is out of the scope of this thesis, thus, further information about the typical topologies of French distribution networks can be found in [12]. [10]

In France, an established manner to locate the normally open line switches of the feeders is so-called $P * L$ -criterion. The idea is that the active power (P) distributed by the substation multiplied by the length of the lines (L) that connect the customers to the substations is roughly the same in all areas of distribution. In other words, in case of a failure, each area of distribution has a similar probability to lose the same amount of load. The criterion is based on the fact that the number of failures in a network has a direct correlation with the total length of the lines when all lines are of the same type. [13]

Since power distribution lines transfer large amounts of power, it is important to manage fault currents in case of an incident due to safety and power quality issues [14]. The fault currents of some types of faults are limited by connecting a transformer to the ground (called earthing or grounding) directly or through an impedance [14]. In France, the transformers in the substations are earthed so, that the earth fault currents are limited to 300 A on overhead lines and 1000 A on underground cables [10].

Generally, a distribution line is intended to be built on the shortest route possible, in order to minimise the investment costs and the operational costs (in particular, costs related to power losses). Nevertheless, this is not always possible due to geography or regulatory reasons, for instance. Usually in a power distribution network, the power flows unidirectional from the substations to the final customers. However, this situation may change in some parts of networks that possess an increasing number of distributed generation, such as photovoltaic panels or small wind turbines [15].

The power distribution networks can be radial (do not contain loops) or meshed (contains loops). Meshed networks are operated in a radial way, which means that it has points that are open the most of the time (called normally open points). A power distribution network may require changes in topology as a result of maintenance work or a fault in a power line, for instance. When the topology of the network is changed, these switches are closed and other switches (called normally closed points) are opened, so that the network maintains its radial topology. By this arrangement, the network would be meshed if all switches were closed, but it is operated radially. Figure 1 presents the idea of meshing the network by using normally open and normally closed points.

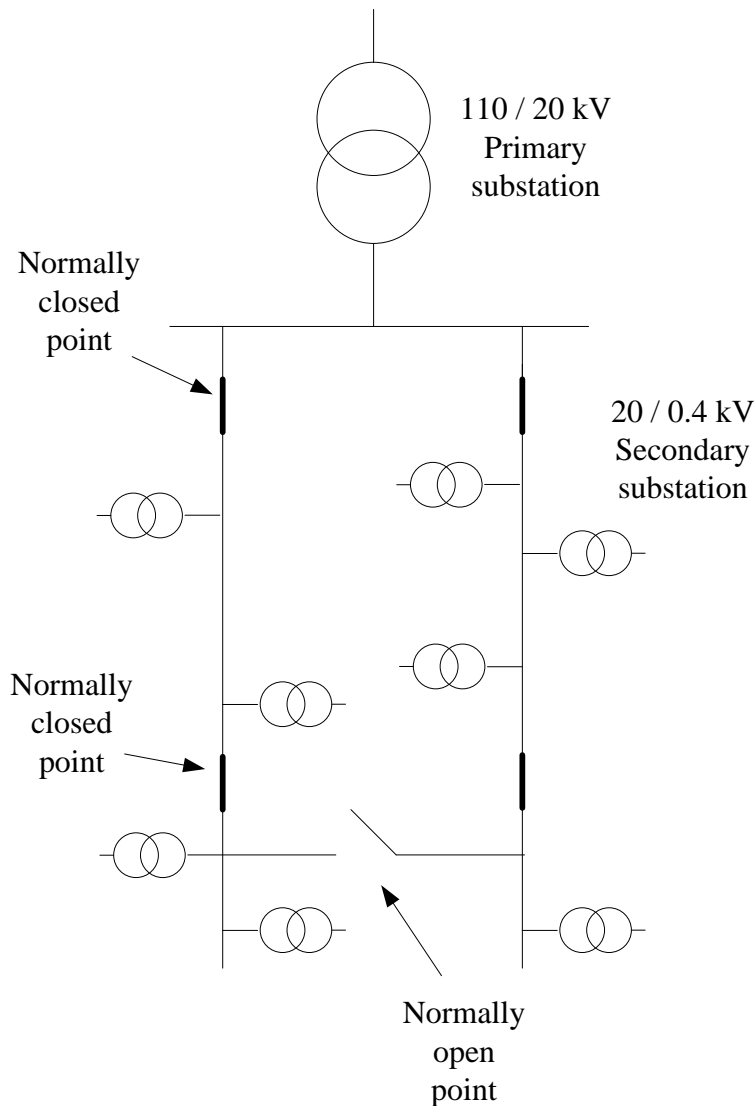

Figure 1: Two radial branches of medium voltage network that can be meshed by closing the normally open point. Normally closed points can be opened to gain more convertibility in the network. The depicted network does not represent reality because of its small size and it only shows the idea of meshing the network through reconfiguration.

The electricity to one area of distribution generally flows through one substation from the power transmission network to the power distribution network. There are lines (called tie-lines) to connect one area of distribution to another one. These tie-lines are equipped with normally open switches. For example, if a substation of one area of distribution fails, the electricity can be fed from another area to the failed area through tie-lines. By means of normally open switches, the distribution network can be seen as one interconnected network that is operated by areas.

The transformers located at the substations are provided with on-load tap changers that keep the voltage on the same level in the distribution network, even if the voltage in the transmission network fluctuated. From the viewpoint of voltage, the use of on-load tap

changers makes it possible to consider the power distribution network separately from the power transmission network.

Even if a voltage has a nominal value (20 kV or 15 kV), it is never exactly constant but fluctuates around the nominal value. The variation of the voltage can happen because of various reasons, an important one being the losses of both, active and reactive power, on the power lines. Due to these losses, there occurs a voltage drop when moving from a substation towards the end of the line [8]. In France, the voltage is allowed to vary from -10 to $+10$ per cent from its nominal value.

The current owing on a power line produces heat. The heating is directly proportional to the resistance (R) of the line and the current [8]. The current limit on a line due to the heating is called thermal limit. Exceeding this limit can cause deterioration of the dielectric and the mechanical properties of a line [8].

The voltage drop and thermal limits are the most significant issues in power distribution systems from the operational point of view. Generally speaking, the voltage drop is the dominant limit for the operation of a distribution network in rural environment and the thermal limit (as explained in Chapter 2) is more remarkable in urban systems [16].

2.2.2. Low Voltage Networks

As explained earlier, this thesis is focused on low voltage networks, thus, this section forms the most important part of this chapter. In power systems, the voltages of a maximum 1000 V for the alternative current and 1500 V for the direct current are considered as low voltage [3]. A low voltage network starts from a distribution transformer at a secondary substation and ends to the premises of an end customer. This thesis considers low voltage networks only in the electricity distribution of public utilities and does not take into account low voltage networks of more exceptional locations, such as industrial sites or ships. Figure 2 shows a three-phase scheme of a distribution transformer connected to a low voltage feeder. Additionally, Figure 3 demonstrates a simplified structure of a low voltage network in a one-phase diagram.

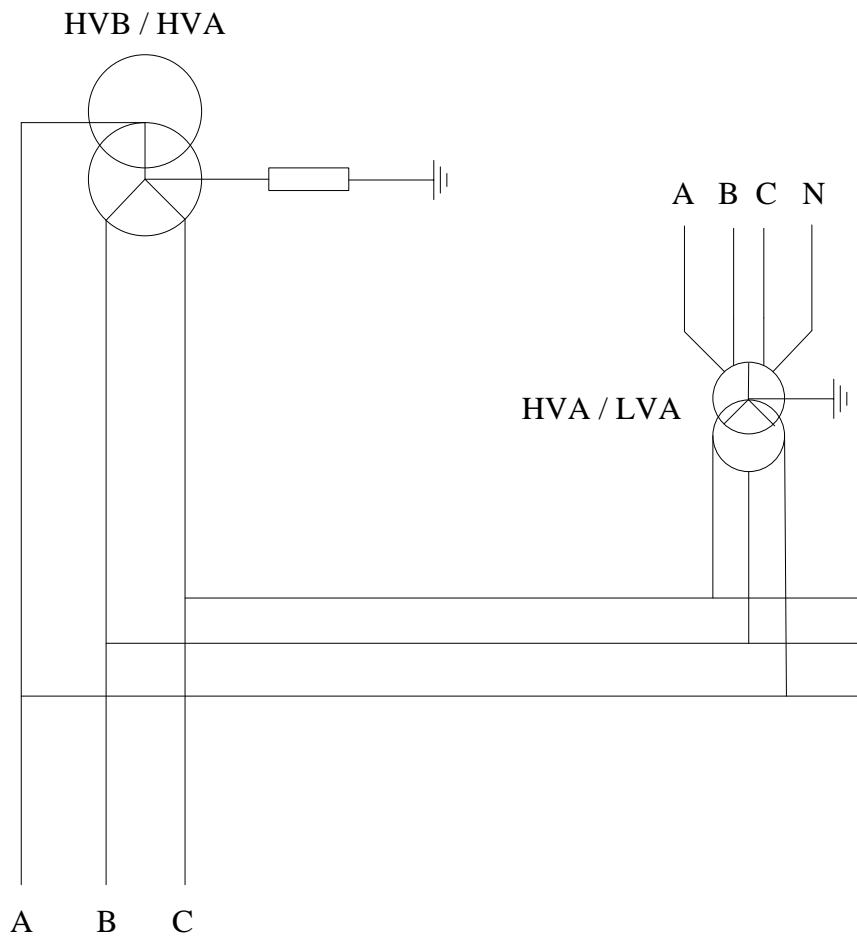

Figure 2: The layout of a distribution transformer connected to a HVB/HVA transformer. The image is modified from [15]. The letters A, B and C refer to the phase conductors and the letter N refers to the neutral conductor.

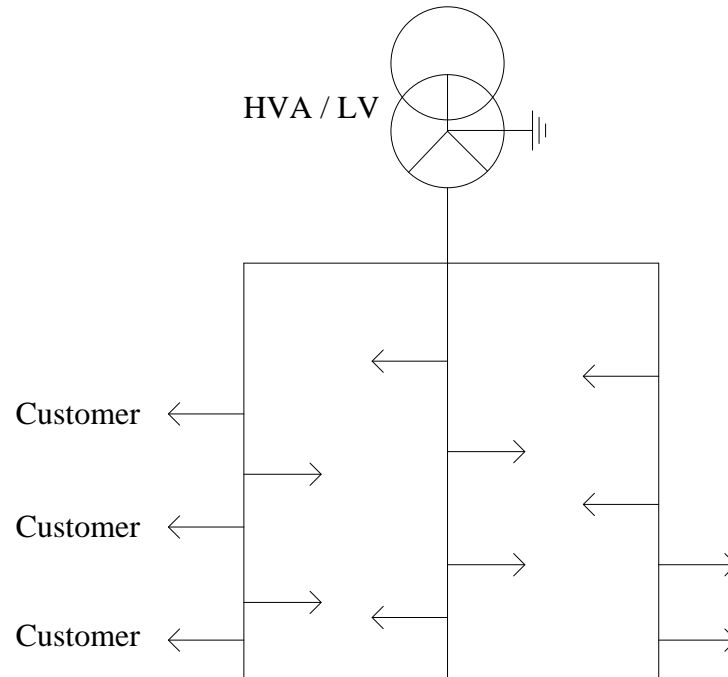

Figure 3: A single line diagram of a distribution transformer with three departing low voltage feeders. The arrows represent low voltage customers.

It should be taken into account that the majority of the customers are connected to the low voltage networks. As shown in Figure 3, a typical low voltage network is purely radial with no tie-lines or other possibilities of meshing the network. In addition, the length of the low voltage feeders is kept as short as possible. A low voltage feeder can reach from a hundred metres up to one kilometre (at its very maximum). Each secondary substation has from one to eight departing low voltage feeders. The exact structure of the low voltage networks is mainly dictated by the location of the customers and the topologies of the streets. The idea of using radial structure and short line lengths is to pursue as simple operation as possible with as low costs as possible.

In the urban and semi urban areas, mainly underground cables are used, but also overhead lines exist. All the new line installations are underground cables. In the rural areas with a low density of population, the low voltage networks can be constructed by overhead lines. In the overhead lines all phase wires can be separated or they can be bundled together. New installations may be overhead lines or underground cables. In case of overhead lines, aluminium cables with the cross sections from 70 to 150 mm² are used. Aluminium cables between 150 and 240 mm² (also 95 mm² in some cases) are used in underground feeders. [17]

Secondary substations can be pole-mounted or located in cabins or in buildings. Pole mounted secondary substations with the limited apparent power of maximum 160 kVA, where the medium voltage network consists of overhead lines. Secondary substations inside the buildings are used in cases where the apparent power is between 400 kVA and 1000 kVA. A pole mounted secondary substation has one or two outreaching low voltage feeders. The transformers with a nominal apparent power of 250 kVA have the maximum of four feeders and the transformers of more than 250 kVA have the maximum number of eight feeders. New secondary substations are built when the low voltage network meets constraints, when a relevant amount of new load or production is going to be connected to the network or when

the connected medium voltage network is placed underground (a pole mounted secondary substation is replaced by a secondary transformer inside a cabin). Distribution transformers are standard bulk products that are straightforward to be replaced [18]. The typical lifetime of a distribution transformer is about 40 years [18]. [17]

There are three different ways to connect a secondary substation to a medium voltage network. These three ways are shown in Figure 4.

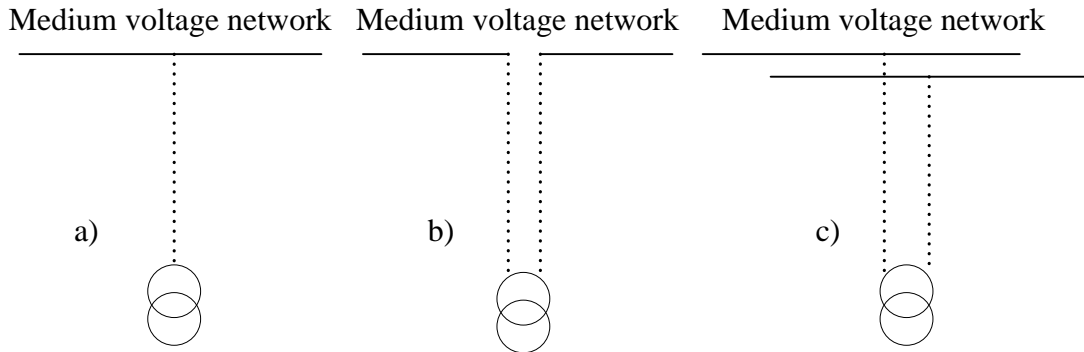

Figure 4: Three ways to connect a secondary substation to a medium voltage network [17]. The line connecting the secondary substation to an existing medium voltage network is drawn in a dotted line.

In the part a) of Figure 4, the distribution transformer is connected to the medium voltage line through a simple connection. This topology is used in rural and in semi urban areas due to its simplicity. The part b) represents the serial connection of the distribution transformer in, the medium voltage network. This type of connection is used in semi urban and urban areas, where a higher security of supply is required. This is because the low voltage network is supplied in two parts of medium voltage network. In the part c), the transformer is connected by using two parallel lines. In this way, the distribution transformer remains fed in case of a fault in one of the feeding medium voltage lines. This topology is only used in core areas of large cities. The used topology is selected according to the nominal power of the distribution transformer and the length of the connection from this transformer to the nearest medium voltage line. [17]

In the transformers, there are two different kinds of losses; winding losses and core losses. Winding losses are caused by the resistance of the windings and the core losses are due to the magnetizing of the core. Winding losses depend on the current flowing through the transformer winding and core losses are always constant when the transformer is energized. [19]

Overload causes a heating of the transformer windings due to resistive losses. The heat causes chemical changes in the oil and speeds up the ageing of the isolation, causing an accelerated loss of life [20]. In addition to overloading, there are several other electrical factors affecting the lifetime of a distribution transformer, such as unbalanced loading, non-linear loading (such as a harmonic voltage and currents), the quickly varying level of loading and reactive power [20]. The level of overloading is dependent on the outside temperature; the lower the temperature, the better is the natural cooling and the higher is the level of acceptable overloading.

The secondary substations are the most important and expensive points of the low voltage networks. In addition to the transformer, they have different medium and low voltage equipment. The exact equipment of a secondary substation depends on every case. [21]

In the French low voltage system, the earthing is carried out mainly by using TT system. The first letter indicates that the neutral wire is connected directly to the ground. The second letter means that the exposed conductive parts of the installation are connected to a local ground. The start point of the transformer is grounded directly without a resistance. The TT earthing system is demonstrated in Figure 5. [15], [22]

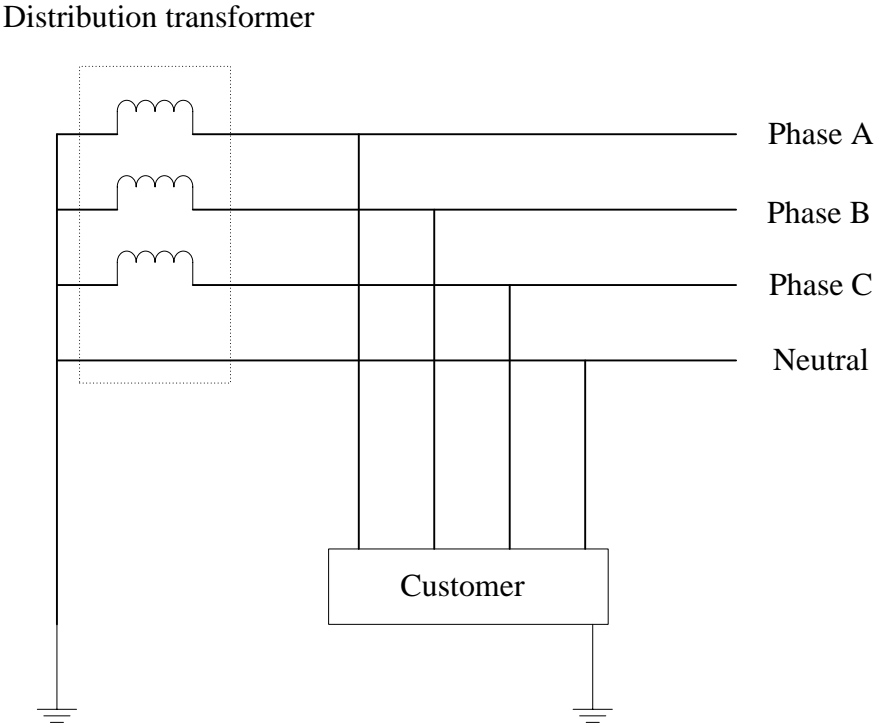

Figure 5: An illustration of TT earthing system [15].

In the low voltage systems, the protection is relatively simple. There is a circuit breaker and the related fuses at the premises of the customer. After, there are fuses at the common distribution board of the buildings. There are circuit breakers or fuses at the low voltage bus bar connections downstream from the distribution transformer. Additionally, there may be fuses upstream of the distribution transformer. The protection of the low voltage network is based principally on fuses to keep the costs low [23]. The use of relays would increase the price of protection excessively [23]. The protection of the low voltage networks is shown in Figure 6. [15]

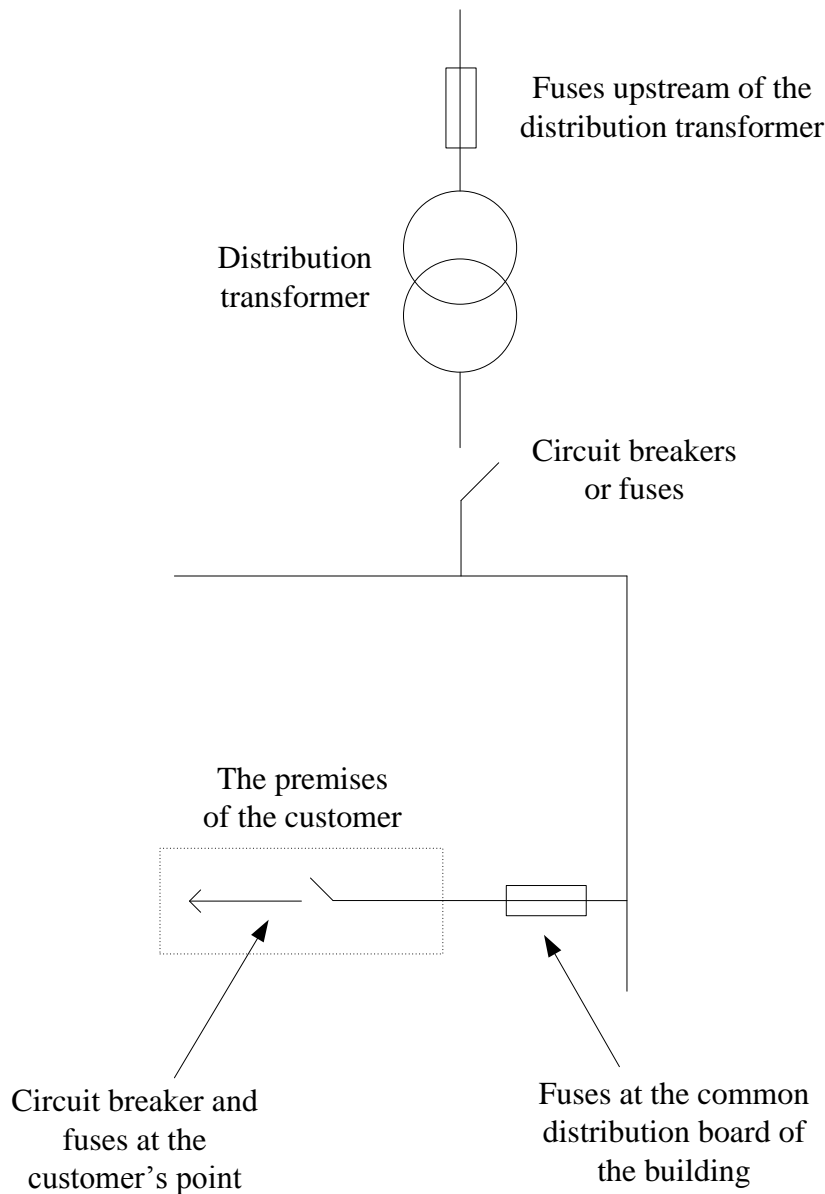

Figure 6: A simplified protection scheme of the low voltage network [15].

The most common low voltage cable used by the distribution system operator *Électricité Réseau Distribution France (ERDF)* has three phase conductors and a neutral wire inside the same cable structure. The phase conductors have the shape of a sector while the neutral wire is round and much smaller in cross section than the phase conductors. Each conductor is isolated by a layer of cross linked polyethylene (XLPE). All the conductors are stranded. The conductors are wrapped under a screen of steel tape and an external layer of polyvinyl chloride (PVC) to provide mechanical hardness. Additionally, there are several fillers to make sure that the components of the cable do not move inside the layer of steel tape. The cable used with different sizes of cross section. [24], [25]

Underground cables are buried by using the minimum depth of 65 centimetres [26]. A warning ribbon is buried 20 centimetres above the cable in order to avoid accidents due to excavations [26]. It is worth noticing that the more cables are installed near each other (located in the same enclosure or in the same trench) the lower is the permitted load capacity

of the cables. This is to maintain the operation below the thermal capacity of the cables due to the fact that the cables heat each other [17].

The more customers there are connected downstream a single point of the network, the stronger is the smoothing effect. The smoothing effect means that the more customers there are downstream of a certain point, the easier it is to forecast the load at this point in any given moment due to a smaller variation. It is easier to forecast the load of a large group of customers than a single customer. Because of different habits of living, it is unlikely that several customers use their maximum power capacity exactly at the same time. For example, if there are 20 customers in the low voltage feeder, the maximum power peak is not 20 times the maximum power drawing capacity of each customer. It would be uneconomic to size the cables and the transformers to accommodate this theoretical power peak because it is very unlikely that it happens. Instead, different smoothing coefficients are applied in order to calculate the optimum sizing of the equipment. Table 1 shows an example of the smoothing coefficients when different numbers of customers are connected downstream of the point of the network. These smoothing coefficients are applied when sizing the electric equipment in the residential areas that consist of houses [22].

Table 1: Examples of the smoothing coefficients to calculate the sizing of the network components in residential areas consisting of houses [22].

The Number of Customers Downstream	Smoothing Coefficient
2 to 4	1
5 to 9	0.78
10 to 14	0.63
15 to 19	0.53
20 to 24	0.49
25 to 29	0.46
30 to 34	0.44
34 to 39	0.42
40 to 49	0.41
more than 50	0.38

The French voltage regulation follows the European standard EN 50160 that sets the phase to phase voltage as 400 V and the voltage between one-phase and the earth is 230 V [17]. In one-phase connections, the maximum voltage is 253 V and the minimum voltage is 207 V. Likewise, in three-phase connections, phase-to-phase voltage can vary between 440 V and 360 V [17]. These limits correspond to ± 10 per cent if variation. In the standard EN 50160, average values over 10 minute intervals are calculated during one week [27]. According to the standard EN 50160, the voltage has to stay within the mentioned limits during 95 per cent of the time [28]. In line with the same standard, voltage unbalance has the maximum value of 2 per cent [29]. It is measured by using the same 10 minute intervals over one week, such as the voltage magnitude variations [29]. The same standard states the limits for several other parameters, like voltage dips, harmonic voltages and transient over voltages [29].

2.3. Management of the Power System in France

In France, the businesses of the power transmission, distribution, production and supply have to be separated. Power production and supply are open to competition. [30]

Réseau de transport d'électricité (RTE) is the national transmission system operator whose main responsibilities are the operation, maintenance and development of the transmission network. It was created in the year 2000 [31].

The electricity distribution is mostly managed by one company. Électricité Réseau Distribution France (ERDF) is a subsidiary of Électricité de France (EDF) and is by far the largest distribution system operator in the country, managing around 95 per cent of the electricity distribution networks [32]. The company was created in the year 2008 [32]. The rest five per cent is divided between 160 local operators [32]. The distribution network operators manage and operate the medium and the low voltage networks. In the early 2014, ERDF had about 7 GW of wind power capacity and about 3.8 GW of photovoltaic capacity in its system [33].

Commission de Régulation de l'Energie (CRE) is the supervising organism and the regulator of the electricity sector [34]. The major revenue for the distribution system operator (about 90 per cent) comes from a tariff called tarifs d'utilisation des réseaux publics d'électricité (TURPE). This tariff states the compensation that RTE and the distribution network operators obtain from CRE in order to cover their costs. [30]

France has a national objective of installing 25 GW of wind power capacity (where 6 GW would be off shore), 5 GW of solar power capacity and 2 GW of biomass capacity by the year 2020 [35].

2.4. Evolution of the Low Voltage Networks

This section discusses the most important ongoing evolutions as of the low voltage networks in France, even though similar progression can be seen in the major part of European countries. In the field of power systems, the dynamics of evolution are slow due to the high costs of the investments. For this reason, the topics under discussion will form the core of the technical development of low voltage networks for many years, or even decades, in the future.

2.4.1. Advanced Metering Infrastructure

Advanced metering infrastructure (AMI) makes a significant progress in the automation of the customer energy metering and billing [36]. The core feature of the advanced metering infrastructure is the ability of the electricity meters to send and receive information between the customer and the distribution system operator [37]. Automatic metering infrastructure is already or will be installed in a large part of the European countries. The exact structure and the schedule of the rollout of the meters depends on the local distribution company. The European Union has set a directive that says that 80 per cent of the customers must have an electronic meter by the end of the year 2020 [38]. In some countries, such as Sweden, Finland and The Netherlands, the public institutions have set common timetables for the installation of the electronic meters [39], [40], [41]. In France, the largest distribution system operator,

ERDF, will install electronic meters (called Linky) to its 35 million customers according to the abovementioned directive of the European Union [38].

Linky meters are installed in customer's premises where they send the meter reading data automatically to the nearest data concentrator via power line communication (PLC) [38], [42]. From the data concentrator, the information is sent to a centre of supervision of ERDF by using general packet radio service (GPRS) [43]. Similar system of communication is used by the major part of the distribution system operators in Europe [43], [44]. The communication channel of Linky system is illustrated in Figure 7.

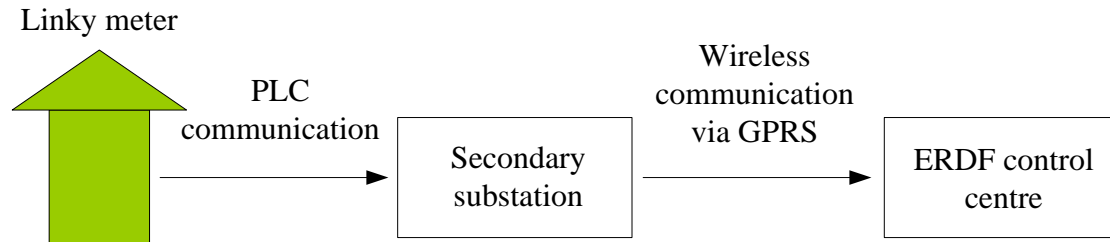

Figure 7: The communication chain of the Linky system [45].

To the power utilities, the advanced metering infrastructure provides several benefits, such as savings in the meter reading, more accurate customer profiling and help in phase balancing [46], [47]. Together with the direct benefits, advanced metering infrastructure can help to enable several advanced monitoring, control and planning functions in the distribution networks [48], [49], [50], [51], [52]. To the customers, the most important benefit of advanced metering infrastructure is a more accurate billing of electricity [38]. With the electronic meters, it is possible to carry out an exact electricity bill based on actual consumption over a predefined time period (for example once a month) rather than estimated billing that is compensated at the end of a certain time period (for example one year).

2.4.2. Distributed Generation

In the framework of this thesis, distributed generation means a small-scale power generation that is connected to the distribution network, that is, at the medium or at the low voltage level [53]. Another essential characteristic of the distributed generation is that it is not centrally managed and dispatched by power utilities, but operated by independent power producers or consumers [53]. As an exception, there may be virtual power plants that are groups of distributed generation units operated in a coordinated manner in order to form one larger unit that may be able to be dispatched. The total power generation capacity of France is about 128,7 GW where 15,5 GW (roughly 12 per cent) is installed in the electricity distribution network [54]. Nuclear power holds a dominant position (49 per cent) in of the power production of the country [54].

The fact that distributed generation units are connected to local distribution networks implies that they are located relatively near the consumption. In theory, power has to be transmitted over a short distance, which may reduce losses, increasing the energy efficiency of the whole power system [15]. This is in the case that the production of the distributed power is simultaneous with the consumption, which is not always the case. Shorter distances

may also signify a reduced need for the transmission network infrastructure, which obviously decreases the investments in the transmission network [15]. Frequently, new installations of distributed generation are based on renewable generation (such as photovoltaic, thermal solar or wind power, for example), which may result in cleaner power production. It is also easier to find sites for small generation units than larger ones [15].

For the power utilities, large amounts of distributed generation may result in deterioration of power quality, such as increasing voltage variations in the feeders [55], [56]. Reversed power flow caused by large amount of generation in the distribution network may require changes in the protection settings as a result of its contribution to the short circuit levels and possibly reversed power flow [57], [58], [59]. If the generation is not connected to all three phases, it may increase voltage and current unbalance [60]. Problems due to unbalanced load or generation can be complex and difficult to identify without an extensive monitoring system [61]. In the low voltage networks, increasing unbalance increments the level of current in the neutral wire that entails additional losses and the risk of overloading the neutral phase wire. Voltage rise is perhaps the effect that is the easiest to perceive [62]. Especially the low voltage networks with several single phase connected loads and distributed generation are of concern. In the networks of such characteristics, voltages can be seriously unbalanced [63].

Wind power is the leading power production technology connected to the distribution network. The second most important is solar power with 20 per cent of the generation and the third is combined heat and power (13 per cent). Practically all the production from the combined heat and power units are connected to the medium voltage level. On the contrary, 66 per cent of the photovoltaic production is installed in the low voltage and 34 per cent in the medium voltage level. [54]

In France, the major growth of the distributed generation is expected to in the photovoltaic and in the wind power generation, while the growth of the capacity of the other sources is not expected to be increased. During the next three years, the photovoltaic power capacity is expected to increase by 62 per cent of the capacity of today. The capacity of wind power (in distributed generation) is expected to grow nearly 83 per cent during the same period of time. Over a period of 20 years, the capacity of photovoltaic generation is anticipated to increase about 600 per cent and the capacity of wind power around 300 per cent. [54]

2.4.3. Other Factors

Load growth is one of the most vital factors to be taken into account when planning a power distribution system. In France, the consumption of electricity is sensible to the temperature variations and especially winter peak have increased significantly [5]. During the past ten years, the national peak load has increased by 33 per cent [5]. This is because of the extensive use of electric heating [5]. It has been estimated that the thermo-sensitivity of France is between 2.1 GW and 2.3 GW per each Celsius degree in the winter time [64], [33].

The expected average load growth is about 0.8 per cent per year [65]. The number of customers is not supposed to change [54].

The French electric association Union Française de Electricité (UFE) has estimated that there will be more than 9 million electric or plug-in hybrid vehicles by the year 2030 [66]. This would represent about 27 per cent of the total number of cars in the country [67].

3. Technical Prospects in Low Voltage Networks

This chapter describes technical solutions for low voltage networks that may be promising in the near future. The previous chapter covered the actual state and the most important current technical developments in the low voltage networks. In order to complement the previous chapter, this chapter discusses selected technical solutions that are not yet well established in the design of low voltage networks. Consequently, long-term operational experience of the presented technologies is not gathered in a large scale.

The technical performances of all chosen technologies presented here are tested in a laboratory or in real conditions. Albeit a technology has reached technical maturity, it does not guarantee its prosperity in economic terms. It is important to bear in mind that the economic profitability of a technology vastly depends on the environmental factors, such as the density of customers per square kilometre or the number of distributed generators in the feeder, where it is introduced. An example of this is the direct current technology in the low voltage level. Because low voltage networks are connected to the medium voltage level, medium voltage networks are discussed when necessary.

Before the different technologies are described in their own sections, the general preferences of the equipment installed in the low voltage networks are explained. The presented technologies are not necessarily actual in France, but a more global view is provided.

3.1. General Preferences for the Devices in Low Voltage Networks

Low voltage level is geographically the largest part of the network which results in a large number of heterogeneous components. This means that every component should be as economic as possible in order to avoid oversized investments. The statement leads to a situation where the quality of the products is usually poorer than the corresponding products in medium and high voltage levels, where the payback of every investment is divided by a large number of clients and higher quality of products are called for. Another important factor is that, in case of a failure, a significantly lower number of customers would be left without power supply than if the failure happened on higher voltage levels. That is why an individual failure in the low voltage network is less costly for the local distribution company in terms of “quality of service” indicators than for example in the medium voltage network. All things considered it is easy to understand that the components in the low voltage networks are not traditionally under active maintenance. After the failure, the component is changed to a new one because the maintenance is not usually economically feasible. Thus, the components should have high reliability with no maintenance.

Often, low voltage networks are situated outdoors in residential areas and are exposed to intentional and unintentional human interventions such as vandalism or accidents. This means that the components should have robust structure and high reliability. The placement in populous areas where the space is costly, especially in the cities, leads to a requirement of small dimensions by any component.

Another requirement that stands out in low voltage networks is that the repertoire of equipment should be kept as concise as possible. The more variety the selection of equipment has, the more difficult it is for an operational person to master the installation and the maintenance of all possible devices. This makes the installation more prone to errors caused by the human factor. This philosophy yields the solutions that are easy to duplicate to as many

low voltage networks as possible with as minor changes as possible. It should be added that the installation and the operation of any new equipment should not require extensive further training of the operational personnel. This is related to a prerequisite that any new device or application should be able to be incorporated seamlessly to the existing infrastructure. Strictly speaking, heavily customised technical solutions should be avoided. In this sense, there are fundamental differences among local distribution companies. It can be said that the size and the willingness of the local distribution company to try new technologies are determinant issues when experimenting new technologies.

Together with the development of electronics, information and telecommunication technologies, power utilities are looking for ways to automate the network, which means extensive harnessing of sensors and measurement equipment, even on the low voltage level, where such technologies, today, are essentially absent. In economic terms, installing a sensor serving only one purpose may not be attractive in case of the low voltage networks. Nonetheless, the situation may change if the benefits of the same device could be shared together with several functions, such as fault localisation, condition monitoring or state estimation. In this manner, the investment of the measurement device would be paid off through several applications.

At the moment, the lifetime of the software, sensors and other electronics is considerably lower than traditional power system components, such as underground cables or transformers, which means that they have to be changed one or more times during the lifetime of long living components [68]. Accepting this fact, it is important that the sensors and other components can be replaced as easily as possible if needed.

3.2. State Estimation by Advanced Metering Infrastructure

In the context of this section, state estimation refers to a mathematical method where the complete state (voltages, currents and their respective angles at every node) of a given network is computed based on the network topologic data and measurements and/or pseudo measurements. In other words, it is a method that combines a mathematical model or a network with measurements from a real network [69].

Pseudo measurements are used in cases where there are not enough measurements available to complete the state estimation process. Thus a pseudo measurement is not a real measurement but can be considered as a guess of a measurement. This guess is treated as a measurement in the computation process of the state estimation. Due to pseudo measurements, the source data of the state estimation can have a very high inaccuracy. The accuracy and the bias of the results are directly proportional to the accuracy of the source data. Hence, accurate measurements and/or pseudo measurements are vital if accurate results of the state estimation are called for. Whereas pseudo measurements can be considered as guesses of the state of the network in a certain node, they are generally much more inaccurate than actual measurements. Bearing this in mind, it can be concluded that the accuracy of state estimation is strongly dependent on the share of the pseudo measurements among all the measurement data.

State estimation is a tool used in daily operation by the transmission system operators and is designed principally to cover the needs of the operation of power transmission networks, but novel in low voltage level [70]. It provides real-time information on the system, which is a basic requirement when any control actions of a network are considered. In this light, it can be said that it provides a basis for many applications even if it is not a final application itself.

State estimation can serve applications such as the control of distributed generators, voltage control devices, demand side management or reconfiguration [71].

Since advanced metering infrastructure, such as Linky meters with the related infrastructure in France, is already or will be a part of the standard networks infrastructure in many developed countries in the near future, it is worthwhile to examine all possible applications for this technology. These new electricity meters are equipped with sensors and are able to send information for further analysis through a communication media. All the information provided by the meters is managed digitally, which makes it possible to analyse the data in a highly automatized manner. These features make them attractive explore new ways of monitoring and managing the power distribution network. If the advanced metering infrastructure is not already installed, it will be installed by any means, and therefore, every application that helps to return the investment for the power companies and improves the operation of their network is desirable. Even if the installed metering infrastructure was not prepared to be used to support state estimation, it is valuable to survey new opportunities and needs of power utilities so that they can be taken into account when upgrading the existing meters or developing the next generation of the meters.

Another positive aspect is that the meters are installed nearly all (if not all) loads in the low voltage network. This means that there is much more measurement information available than before the installation of the advanced metering infrastructure, when the available information was limited to occasional measurements (where specific information from a particular substation is wanted for a further study) mainly at the secondary substations. State estimation by advanced metering infrastructure is proven to work when the accuracy of the meters is around a few per cent [72], [73]. A reverse side of the abundant amount of data may be the difficulty of transmitting and further process all the data if it is not filtered or any other selection of the data is not made.

A factor that may deteriorate the accuracy of the state estimation on the low voltage level is the possibility of the lack of information (for example on the line types and the line lengths), if the information is not correctly updated to the database of the distribution system operator.

Despite the abundant amount of information, there are still several things to be sorted out before reliable state estimation can be applied on the low voltage level. Not all distribution system operators have a digital model of their low voltage network in their SCADA systems, which is a limiting factor for real-time applications. It should be noted that the meters are in principle energy meters and the state estimation is not within their priority applications by any chance. If any real-time applications are considered, the metering system should be ready to process the data in real time. If the processed data is available, for instance 24 hours after the measurement, it is evident that the data cannot serve applications in real-time.

One of the issues of the low voltage networks is the high variability of the loading conditions. This distinguishes the low voltage networks from the higher voltage levels. As a general rule, the higher the voltage level the larger number of customers there are downstream a single point of the network (such as a single line or a transformer). Consequently, the loading behaviour of this point is easier to predict due to the smoothing effect. This phenomenon is easy to notice by comparing the load curves of a single low voltage customer and a transmission transformer over one day. This phenomenon is illustrated in Figure 8 and in Figure 9 showing the load curve of a single load and the distribution transformer in the same network, consequently.

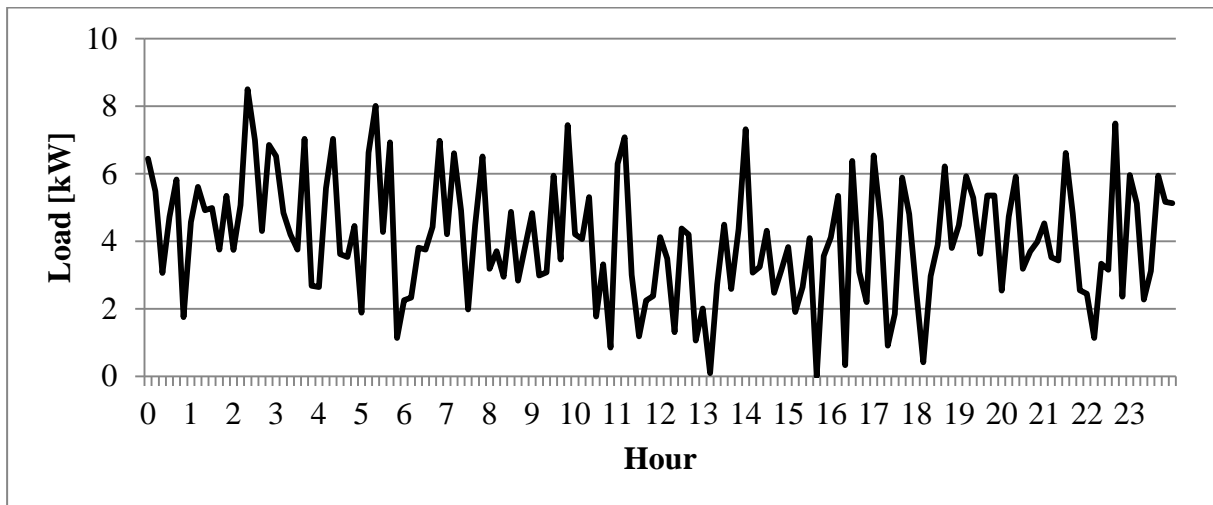

Figure 8: Load curve of a single three-phase customer in a network of 200 customers.

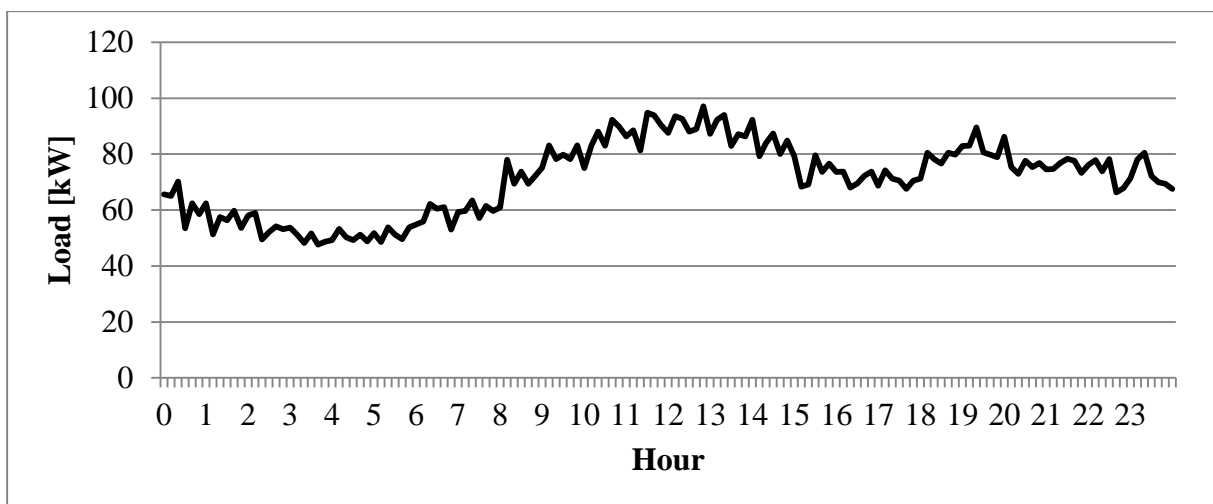

Figure 9: Load curve of a distribution transformer in a network of 200 customers.

Due to this phenomenon, the loading conditions of a low voltage network can change extremely rapidly. The state (voltages and currents) can change completely in a few seconds after a state estimation has been carried out. This means that the state estimation does not resemble the real situation (since it is a network state in the past), which raises a doubt about the reliability and the usefulness of the state estimation on the low voltage level. In practice, low voltage feeders are never perfectly balanced, which means that the unbalance in loading should be taken into account in the computation of state estimation. This is another fact that should be considered in the calculation process.

The degree of the accuracy in demand depends on the application where the state estimation is adapted. One of the interesting questions to be answered would be the minimum number of measurements (in relation with the number of customers) so that an accurate state estimation can be carried out. If the measurements of all customers were used, it could overload the data transmission and make the computation process heavy. On the other hand, if

there were too few measurements, the state estimation might not achieve the wished accuracy. Another doubt is the location of the measurements. It may be that the measurements at the beginning of the feeder are more valuable for the state estimation process than the measurements at the end of the feeder. With this view, one argument to be considered is the need of additional measurement at the secondary substation. It could be worth investing a more precise and costly measurement device at the distribution transformer if it improves the precision of the state estimates substantially. It may be that the cost of such a measurement device cannot be justified only by its utilisation for the state estimation. As previously stated it may be better if the same measurement device could serve several functions, such as the condition monitoring of the transformer.

More generally speaking, it could be valuable to know the effect of the topology on the state estimation and whether changes in the network topology makes the state estimation less robust against measurement errors. However, in practice, it is not common that the topology of a networks changes. This happens every now and then when new customers are connected to the network, for example. As a further study, it would be useful to detect the factors that make state estimation more inaccurate in some networks than in the others.

It is important to take into account that low voltage networks form the most widespread part of the electricity distribution chain. This signifies that a process of implementing state estimation on the low voltage level has to be as standardised and as automatized as possible within the same power utility. Generalised rules for implementation are a necessity. With the enormous number of low voltage feeders and customers, it is impossible to manually customise every solution to match the characteristics of every feeder perfectly. The need for automation is valid for the monitoring as well; it is impossible and unnecessary to monitor all low voltage networks by the operation personnel. What is more is that there is a wide range of different types of low voltage networks (urban, rural, semi-urban, etc.), which implies that the solution should be adaptable no matter the type or the size of the network.

All in all, it can be pointed out that it may not be useful to copy the state estimation as it is known about the transmission networks to the low voltage level as it stands. At any rate, it could be useful to redefine the state estimation so that it keeps in view the special features of the low voltage networks.

3.3. Reconfiguration by Using Power Electronics

This part discusses reconfiguration in power distribution networks. In order to understand the essence of reconfiguration, the first section explains reconfiguration as it is known in meshed transmission and distribution networks. Consequently, the second section talks about the constraints and issues related to reconfiguration. The third section extends reconfiguration to low voltage networks employing power electronic devices.

3.3.1. Reconfiguration in Power Systems

There are two kinds of reconfigurations; a planned and an unplanned one. A planned reconfiguration is an action where a normally open point (NO point) is closed and another switch in a normally closed point (NC point) is opened. The switches are closed and opened so, that the radial operation of the network is maintained. In other words, a reconfiguration

means changing the topology of the network. The change of network topology is carried out in a manner that customers do not experience any interruption of power supply. An unplanned reconfiguration is done after a fault, which means that the customers experience an outage prior to the reconfiguration. In the context of this thesis, a reconfiguration refers to the planned reconfiguration. Automatic reconfiguration refers to the reconfiguration that is carried out without immediate human intervention. On the contrary, manual reconfiguration means that the reconfiguration is carried out by the maintenance staff. Figure 10 demonstrates a simplified reconfiguration process due to a fault in a medium voltage network.

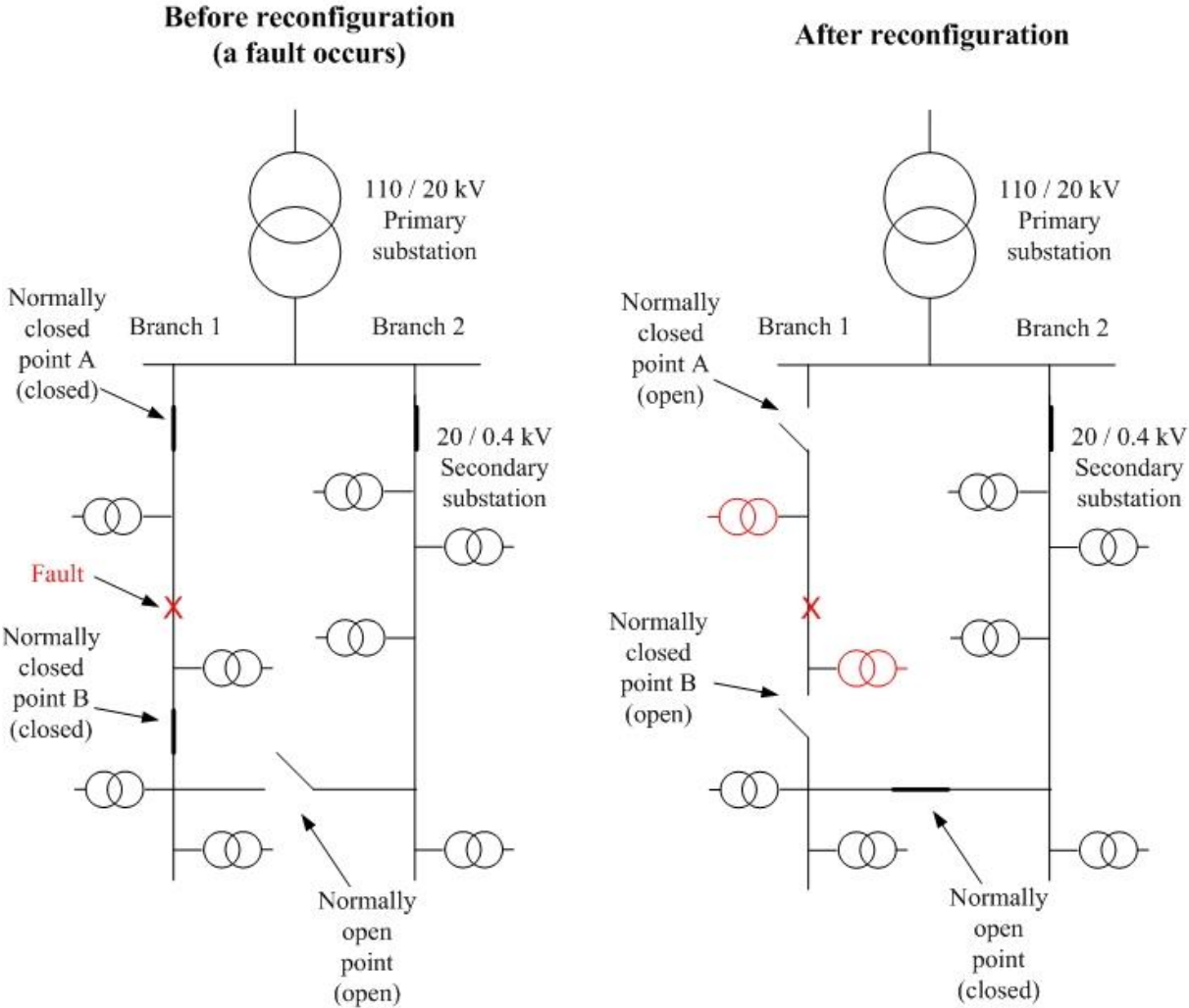

Figure 10: A simplified scheme of a reconfiguration in a medium voltage network. A fault occurs in the middle of Branch 1. Normally closed points are opened to isolate the fault and a normally open point is closed to feed the last two secondary substations of Branch 1 through a tie line. Without the possibility of reconfiguration, the two last secondary substations of Branch 1 would have left without power. The affected area (two secondary substations marked in red) has been reduced with the help of the reconfiguration process.

Changing the configuration also changes the load flow of the network. Once the load flow changes, many other characteristics of the network do as well, such as losses, voltage and current profiles on the feeders and the reliability of the network at that particular moment. In this light, it is apparent that many qualities of the network can be affected through reconfiguration. At the moment, ERDF uses a manual reconfiguration after a fault in order to restore the electricity to the customers faster while the reparation of the failed network components take place [74].

Reconfiguration can have a significant impact on the reliability of a distribution network, especially when the power needs to be restored in a post-fault situation [75], [76]. After a fault has occurred, manual reconfiguration may imply travelling of several kilometres by the maintenance crew before the fault has been identified, isolated and the power has been restored to all possible customers via secondary routes.

All the procedure requires a considerable amount of time and workforce, depending on the location and the number of faults, the mutual distances between the switching points, the landscape and the working conditions (weather, lighting, the amount of traffic on the streets). Compared against this background, it is evident that automation of the restoration function would decrease the total time of restoration and the amount of needed workforce [77]. On the other hand, this would involve a large amount of expensive distribution automation. It is found that using reconfiguration in post-fault situations can improve the quality of supply significantly and thus it the most attractive application of reconfiguration [78], [79], [80].

It is possible to reduce the level of resistive losses by finding an optimal configuration [81]. The configuration to correspond minimum losses can be found through optimal power flow calculations. In the literature, a great number of publications aspiring the minimum losses (as a principal or a secondary objective of optimisation) can be found [82], [83], [84], [85], [86], [87], [88], [89].

Reconfiguration can also help to improve the voltage profile of a feeder [90], [91], [92]. Since reconfiguration affects the load flow of the network, it can be used to balance feeders and maximise the overall loading capacity of the network [93], [94]. This has an impact on the reliability due to the fact that, in case of a fault, more load will be shed on heavily loaded feeders than on lightly balanced feeders. As a result of loading the feeders evenly, there may be a possibility that investments on network components (such as new lines or transformers) can be postponed in the future [95]. This is because load from heavily loaded feeders could be transferred to lightly loaded feeders, which may relieve the need for network reinforcement. However, this depends on the characteristics of the network (topology, type of loads, etc.) and cannot be generalized to all networks. At any rate, this aspect links the reconfiguration strongly to the asset management.

Finally, the possibility to transfer loads between primary substations, gives headroom to a distribution system operator to optimise the access fee to the power transmission network [96]. This is another fact that associates reconfiguration with mid- and long-term asset management.

3.3.2. Constraints and Issues Associated with Reconfiguration

It is important to take into account that a network has always its normal (or basic) state. This state is used as a basis for operational and safety plans. When the configuration of the network changes the changes in the operational aspects have to be taken into account. [96]

Before the execution of a reconfiguration, all the restrictions of the network have to be catered.

- The most obvious restrictions are the radial operation of the network, current capacities of the lines and transformers, voltage and thermal limits of the lines [97].
- Some parts of any distribution network are often subjects to ordinary works (such as maintenance or building of new lines). A part of the network must always be able to be locked from reconfiguration to make sure that this kind of works can be carried out safely [96].
- Additionally, it has to be taken into account that a failure of a network component can impede a planned reconfiguration procedure [96].
- The reconfiguration strategy has to comply with existing functions of distribution automation [98]. For example, if load shedding schemes are used, the load shedding procedure can be disturbed by a reconfiguration and has to be planned again [96].
- Since overloads can result in damage of equipment due to thermal limitations, loading conditions must be verified before a reconfiguration. The system has to check not only how much load can be transferred from one line to another, but also take into account possible sudden changes in loading [84].
- The protection strategy has to be adapted to meet the safety requirements at all possible configurations [99], [58]. Modern relays equipped with a microprocessor and sophisticated communication can be adjusted to changing network topologies [100].
- There can be only one author to make changes in the topology of the network in order to avoid overlapping commands of reconfiguration.
- After a reconfiguration action has been executed, the information about the new state of the network has to be distributed to all possible parties in real time [96]. The same issue has to be bear in mind, when the network is returned back to its normal topology.
- There may be situations, where the distribution network operator has to communicate with the transmission system operator in order to confirm that the transmission network is ready for the planned changes in the distribution network [96].

These demands do not call only for comprehensive internal infrastructure and strategy from the distribution system operator, but also seamless external communication between secondary parties, such as the transmission system operator or the subcontractors that are involved in the maintenance of the network.

A complicated question is whether to arrange the control of the medium voltage network locally, so that part of the network can control itself independently from the other parts of the network or globally, so that there is a central data processing point that has a control over the whole network. Moreover, there could be a mix of both of these control schemes, so that each part of the network controls itself partly independently, some of the control functions centralised to a central data processing point. Both, local and global control approaches have

their positive and negatives points. In practice, the local control would mean that the data processing point would be placed on the secondary transformers as intelligent MV/LV substations [101]. The local manner of an approach tries to avoid heavy data traffic to the centralised control body, makes the communication fast due to less communication routes and communication equipment and reduces the costs related to the communication infrastructure [102]. Despite that with the modern data processing equipment and control methodologies the local approach of a control may seem pragmatic; it has many doubts in practice, such as the reliability point of view. If a network has several switching options, it is difficult to make sure that any of these switching options cause any danger for the personnel or damage any equipment. This is why different parts of the network should interchange information between them before making a decision of a reconfiguration. Additionally, a global optimum of each section of a network may not be the global optimum of the whole network, for example, in terms of loss reduction. Thus, at least some kind of central management of reconfiguration is recommended.

Apart from the operational issues, the technical limitations have to be considered as well. Traditional vacuum interrupters are designed to withstand up to a few thousands of switching actions (depending on the model) before reaching the end of their lifetime [100]. Subsequently, the switch has to be replaced. Thereupon, it is infeasible to make frequent switching actions by mechanical interrupters [103], [104]. This is one of the strong factors why it is not economically viable to employ frequent automatic reconfiguration in loss reduction by the commercially available switches of today. Problems that involve frequent switching actions must be approached by other switch alternatives, such as power electronic - based switches.

Transient phenomena, such as over-voltages due to switching transients are associated to network configuration [105]. A modification in the network topology can lead to unexpected transitory effects if they are not anticipated, and therefore, detailed transient studies are important, notably in the areas where high quality of supply is aspired [99]. If transient studies are not performed, there is a risk that the behaviour of the grid is underestimated and reconfiguration cannot be carried out in a planned manner [99]. It should be taken into account that the number of possible configurations of the grid can be high even with a relatively low number switches and one of them may lead to an undamped transient. Moreover, the more frequent are switching actions, the higher are the risks that a network will experience switching over-voltages [106].

When a switching action is done in order to connect two feeders to each other, transient currents (also called equalizing or balancing current) occur [84]. The transient current occurs because of a voltage angle and/or magnitude difference on both sides of the switch. When the switch is closed, the voltage difference manifests itself as a transient current. This current leads to transient voltage. Before the closing of the switch, the higher the voltage difference (the amplitude or the angle difference) is on both sides of the switch, the higher the transitory effect will be [84]. The magnitude of the transient current (and the voltage) depends on the location of the switches in the network, the loading conditions and the impedance of the network [107]. An angle difference of 6 degrees may cause problems in the network [84]. The most important causes for angle differences are the phase shift in a transformer, the differences in the loadings of primary transformers (a transformer changes the angle of the voltage, depending of the power flowing through it) and the existence of large generators in the medium voltage network [104]. The phase shift is dependent on the coupling of the transformer.

In distribution networks, transients may damage (such as electronic devices) or cause an accelerated ageing of equipment (such as transformers) and increase the risk of failure in the long term, especially in case of power transformers [108], [106]. For example, a capacitance of an underground cable may form a resonance circuit with the inductance of the core of a transformer. The energy stored in the capacitance of the cable may circulate through the inductance of the transformer and lead to the saturation of the core [109]. Due to high cable capacitances, underground networks are more prone to experience ferroresonance than overhead networks [109].

3.3.3. Reconfiguration by Power Electronic –based Switches

Generally, there is a rising tendency to study the possibilities of power electronic -based (such as FACTS, Flexible AC Transmission Systems) devices to help to make the most out of the medium and low voltage networks and to avoid costly network reinforcements [110]. This has become possible along with the technological development and the decreasing costs of power electronics. A relatively new and certainly interesting approach is to add power electronic switches to the network. These devices are also called “intelligent nodes” or “soft normally-open points”. The major research effort is done on the medium voltage level, but the low voltage network seems more and more interesting due to the fact that, in the future, a large number of distributed generation will be added to the low voltage level and the cheaper unit price of power electronic converters [111]. The technology is not unknown in the area of power distribution, since power converters are used in some countries in some marginal situations to connect industrial customers for whom extremely fast switching capabilities cannot be provided by mechanical interrupters [100]. Additionally, similar converter technology is used in many distributed generators such as in wind turbines [111].

The prevailing idea is that the switches in the normally-open points of the network could be replaced by power electronic switches. These switches would be basically back-to-back converters, having a DC link in between. The technical solution is very similar used in the permanent magnet and full converter -based wind turbines and in high voltage DC links used to connect two asynchronous networks [111], [112]. The principle of a back to back converter is shown in Figure 11.

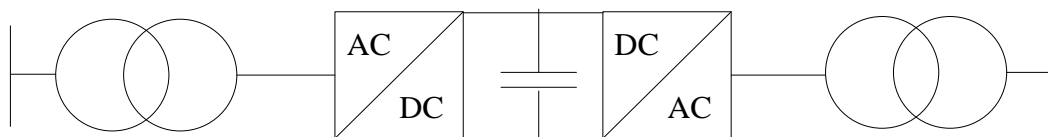

Figure 11: A simplified idea of a back-to-back converter to connect to networks to each other.

The switches are based on power converters and are able to regulate the power flow between two feeders, which makes active feeder balancing possible [113]. The name soft normally-open point derives from the fact that the switches do not only have an on and an off state, but also can adjust the power flow through them. If the converter lets the power flow through it, the network is operated as a meshed one, but if it blocks the power flow, the network is operated radially [110].

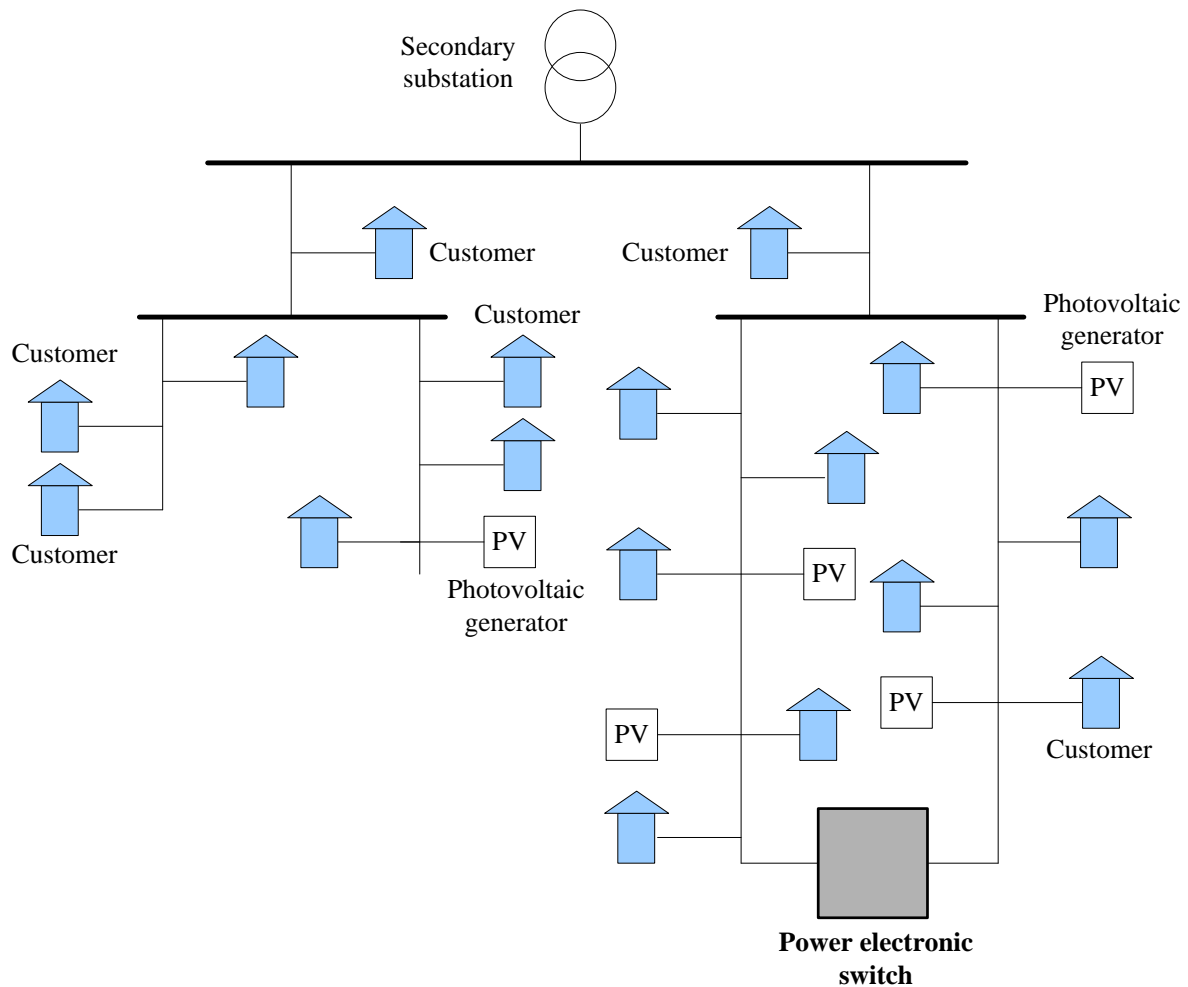

Figure 12: A power electronic switch connecting two low voltage feeders [114]. PV refers to a photovoltaic generator.

Another positive aspect is that they can regulate the reactive power independently from the active power, which means that in some cases they can be used for voltage control to prevent voltage drops, for example. Seeing that the DC links have an independent control over all phase, they can relieve voltage unbalances and harmonics of low order (although increasing the higher order ones) [114]. This in turn, may increase the power quality significantly. As in the case of high voltage networks, the DC links can connect to networks or feeders with different voltage amplitude or angle to each other [115]. If a DC link connects more than two feeders together, it is called a multi terminal link. The power electronic switches have very fast current control capabilities, which means that they do not require any changes in the existing protection equipment [116]. In case of a fault, the converters can be used to isolate the faulted areas from other feeders [117].

The optimal placement of the power electronic switch plays a significant role when justifying the investment, because it would be very expensive to replace all normally-open points by power electronic switches [117]. The more the network has distributed generation, the more attractive the power electronic switches appear [118]. This is because the more the network has distributed generation the larger are the possible voltage fluctuations in the

network. Additional benefits of converting the network even more flexible can be gained by combining and energy storage with power electronic switches [118]. The space requirement of a power electronic switch may be an issue in urban areas, since they are larger than mechanical switches [119].

The DC links have been tested successfully in the laboratory environment [110], [120]. Despite the technical potential, interviews with the experts on the topic revealed that at the moment power electronic switches can be hardly justified in a large scale penetration in economic terms at the medium voltage level [100], [121], [122]. It is likely, that power electronic switches remain as specific solutions for special purposes, such as customers that have very high demands of power quality. Although some exceptions exist; the use of power electronic switches may be economically viable for example some parts of Spain, where the resources of solar energy are abundant and an extensive number of photovoltaic panels are expected to be connected to the network [111]. One of the bottom line factors to determine whether the power electronic switches can be used to connect two or more low voltage feeders is their topology. If the ends of the feeders are not located physically near each other, it is evident that they cannot be connected by the device without significant extra cabling.

UK Power Networks is hosting a two-year project (started in January 2014) in order to test power electronic switches in its low voltage network in the cities of London and Brighton. The project has 36 test sites (of which 24 uses power electronic switches) in the abovementioned cities [123]. Two different kinds of power electronic switches are tested: dual terminal and multi terminal switches. Dual terminal switches can interchange power between two secondary substations (200 kVA of shared power capacity) and multi terminal switches between three secondary substations (400 kVA of shared capacity) [124]. The remaining 12 of the pilot sites use circuit breakers and so called Link Box devices to realise a reconfiguration [124]. These devices are on-off type switches that have two positions (on or off) and are not able to control the power flows between these two extreme configurations [124].

The project aims at finding solutions in order to realise flexible reconfiguration in the low voltage networks. The most important benefits are considered the better utilisation of the network capacity, active voltage control and the minimisation of faults [123]. The project is also considered useful to question whether the traditional type of the low voltage network architecture is the most applicable one in the future [123].

3.4. Automatic Tap Changers and Voltage Regulators in Secondary Transformers

The secondary transformers are the interconnections between the medium and the low voltage levels. They are probably the most vital and the most expensive single components in a low voltage network. Traditional tap changers are mechanical devices that are used to regulate the voltage of a transformer [125].

Transformers on the higher voltage levels are often equipped with tap changers that can be operated under loading, namely on-load tap changers. The major part of the European secondary transformers are provided with off-load tap changers [126]. The position of the tap changers of this kind can be changed only when the transformer is off line.

In the future, more flexibility to the whole power distribution network will likely be needed and therefore on-load tap changers appear as an interesting alternative for the networks where

the voltage is expected to be subjected to drastic fluctuations. In a favourable situation, a distribution system operator can increase the transfer capacity of its distribution network thanks to appropriate voltage regulation [127]. Notably, on-load tap changers can offer an appealing solution in the low voltage feeders with a high penetration of distributed generation. In a feeder of this kind, it may happen that power is desired to transfer from the low voltage feeder to the medium voltage network during the periods of high power production and low consumption. In this case, a transformer with a changeable voltage ratio is a possible way to control the power flow [128].

The on-load tap changers can be divided into three categories: mechanical tap changers, thyristor assisted tap changers and solid state tap changers [129]. The technical principles, their benefits and disadvantages are discussed in the next sections.

There are various alternatives where an on-load tap changer can measure the actual voltage of the network so that an adequate tap position can be found. The measurements can be located at the low voltage bus bar of the secondary substation and/or at the end of the feeders such as in [130] and [131] or several measurements may be placed along the feeder as in [132].

3.4.1. Mechanical and Thyristor Assisted On-load Tap Changers

In the mechanical on-load tap changers, the change of the tap is carried out by means of an electric actuator. The main advantage of the mechanical on-load tap changers is their robustness [129]. In addition, they can be well adapted to the common commercial transformer models [129]. The downsides of the mechanical on-load tap changers are related to the fact that mechanically moving parts are included in the system. This makes the system vulnerable to faults due to contact wear, the breakage of the electric actuator or weakened springs [133]. Furthermore, electric arcs strike during the change of the tap position as a result of the high current through the contacting parts [133]. These arcs contaminate the oil inside the tap changer and cause the erosion of the contactors and accelerating the ageing of the tap changer in the long run [134]. Mechanical on-load tap changers may entail high costs in the secondary transformers [129]. The sensitivity for mechanical breakdowns converts them to more maintenance intensive components than the classic secondary transformers [134]. In general, the on-load tap changers cause around 20 per cent of the transformer failures [135]. In spite of possible disadvantages, a German utility Pfalzwerke Netz AG has shown an on-load tap changer to be highly effective and cost-efficient in radial low voltage networks [136]. This is true especially when the network poses a large amount of photovoltaic power generation. Pfalzwerke Netz AG has adapted the on-load tap changer to its renewed planning principles [136].

Thyristor assisted tap changers are developed to avoid the deterioration of the tap changer due to the current through the contactors, achieving low maintenance costs and long life-time [137], [138]. The basic idea of a thyristor assisted tap changer is very similar to a mechanical tap changer, but the contact currents are conducted through thyristors instead of the main contactors [139]. This configuration cuts down the arc on the contactors. The major inconvenience of the configuration is that adding the thyristors to the tap changers leads to a more complicated structure and increments the production costs [129].

A German distribution system operator, EnBW Regional AG, has installed a 400 kVA transformer with a thyristor-assisted on-load tap changer into the low voltage network in the year 2011. The transformer is provided by Siemens AG. The transformer is installed in the

rural area with a high penetration of small scale photovoltaic power plants. The area suffers from a massive domination of photovoltaic power generation; the maximum peak of load is less than 20 per cent of the generation. Assuming that the network was sized according to the peak load, it is evident that serious voltage fluctuations are encountered in a situation of this kind. [127]

The experience gathered from the prototype installation is mainly positive and the voltage variations have been relieved. The major problem is that the control algorithm was too sensitive, which created flickering in the voltage. [127]

Figure 13 and Figure 14 illustrate a simplified structure and the operation of a thyristor assisted on-load tap changer. Figure 13 shows a thyristor assisted on-load tap changer in the steady state operation. Figure 14 illustrates the same thyristor assisted on-load tap changer in the position, where the current flows through the thyristors. In this case, there is no arc in the switch when the switch is changed from the left position to the right position.

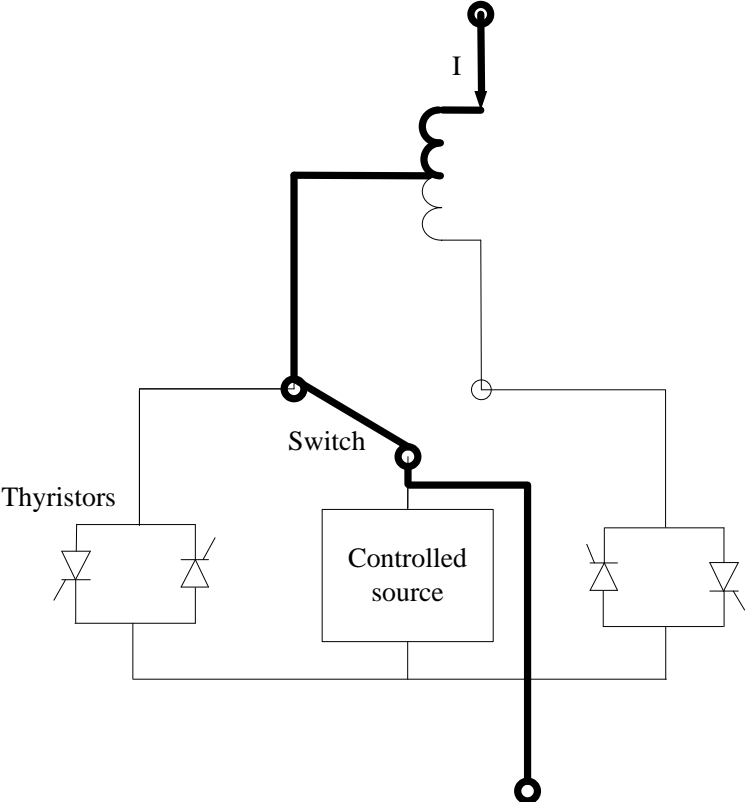

Figure 13: A thyristor assisted on-load tap changer in the steady state operation [140].

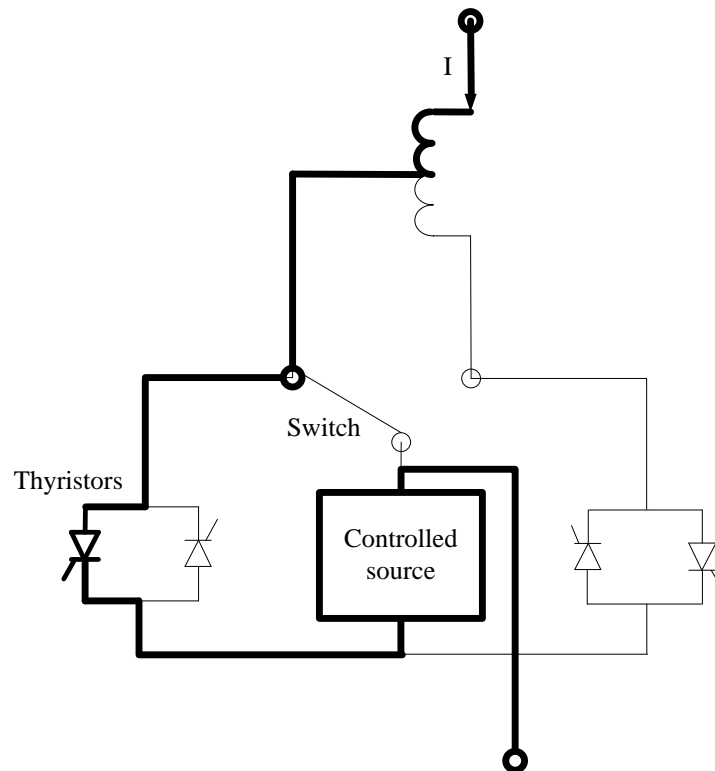

Figure 14: A thyristor assisted on-load tap changer when the current is lead through thyristors. In this state the switch can be turned from the left position to the right position without experiencing an arc [140].

3.4.2. Solid State On-Load Tap Changers

The concurrent price decrease and the technologic evolution of power electronics have provoked an emerging interest towards the inclusion of power electronic components into the secondary transformers [141]. In more general terms, transformers made of power electronics are referred to as universal transformers or power electronic transformers [141]. As the name states, the solid state tap changers do not possess mechanically moving parts as mechanical and thyristor assisted tap changers. The voltage regulation is made by power electronics. Since different semiconductor switches have distinct characteristics, the most suitable switch depends on the application. The most promising types of switches are insulated-gate bipolar transistors (IGBT), thyristors and gate turn-off thyristors (GTO) [129], [142].

The power electronic components are able to react and modify the voltage quickly, practically instantaneously. The rapidness brings new functions to power quality management, such as the compensation of voltage sags or voltage unbalances, flicker mitigation or fault current mitigation [141], [143]. For the customers, these new functions would result in the improved voltage profile and higher quality of supply [135]. Because of the lack of moving mechanical parts, the maintenance costs can be very low [143].

Operating voltages and currents form one of the technical restraints that hamper the design of solid state tap changers. In generally, the lack of robustness, and especially, over voltages due to lightning strikes are a threat to relatively sensible power electronics [144], [145]. Other drawbacks are the high switching losses and the losses in a complete conducting state, which decrease the efficiency and contribute to the overheating of the power electronics [141],

[144]. The high cost of solid state tap changers in distribution transformers is one of the most critical issues to impede their utilisation in an extensive manner [146]. Despite the obstacles, the development of solid state on-load tap changers seems promising [141]. The first solid state on-load tap changer was installed by ABB in Norway in 1986 [147]. The tap changer is able to control the three phase voltages separately.

3.4.3. Control Aspects of an On-Load Tap Changer

The control of an on-load tap changer is a crucial aspect when considering a real application [148]. Before the installation of an on-load tap changer, it is important to define the highest possible frequency of tap changes and the locations where the voltage measurements are obtained [149]. A mechanical on-load tap changer wears out quickly if the tap position is changed several times per day. In order to increase its life-time, the number of tap changes can be reduced by using a dead band or other methods [150].

The most simple approach to place the voltage measurements of an on-load tap changer is to locate them to the low voltage bus bar of the distribution transformer, as presented in [151] and in [152]. Another approach is to install more voltage sensors, for example, at the beginning, at the halfway and at the end of each feeder [153]. The voltage of the low voltage network can be measured also by using a selected set of low voltage customers who are equipped by an advanced metering infrastructure [154], [155]. There is also a possibility to control an on-load tap changer based on time [156]. This can be a satisfactory arrangement if the behaviour of the loads can be estimated or forecasted because no external voltage measurements are required.

3.5. Direct Current in Low Voltage Power Distribution

Direct current has been used in high voltage power transmission for decades, but there are increasingly growing research activities on bringing the benefits of DC to low voltage electricity distribution. Several pages of this thesis are dedicated to the concept of LVDC, because it does not consider only a single component but fundamentally transforms the traditional concept of the power distribution. The interest towards the LVDC system in a public distribution has grown globally during the last years [157], [158]. The LVDC technology is seen as a cost-effective solution to the situation, where the power distribution infrastructure is ageing and calls for major renovations in the near future [159]. At the same time, the economic regulations have tightening requirements for the reliability and the quality of supply [159]. In Finland, LVDC systems are planned to replace long and lightly loaded medium voltage branch lines and low voltage lines [159]. This avoids constructing long and expensive medium voltage branch lines and, in addition, cheaper low voltage lines can be built by using low voltage cables. This is possible, because the maximum distance that can be reached by the LVDC technology can go up to ten kilometres (due to the lower impedance in direct current than in alternative current systems), while the traditional LVAC technology can deliver power less than one kilometre without suffering a serious voltage drop [160]. In many cases, the branch line can be traced entirely on the low voltage level directly from the trunk line of the medium voltage feeder to the end customer by using the LVDC technology. The situation is shown in Figure 15 below by comparing the traditional LVAC technology and the LVDC technology.

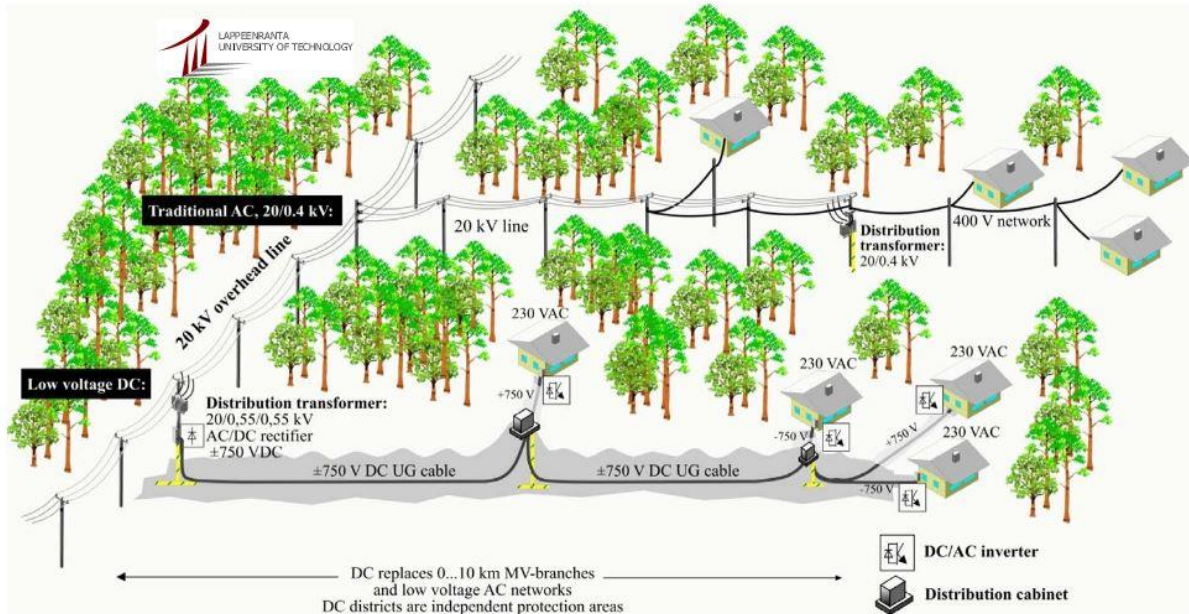

Figure 15: A concept comparison of LVAC and LVDC technologies [159]. The upper branch presents the traditional AC structure and the lower branch illustrates the LVDC structure.

The branch line that is made of LVDC technology, consists of a 20/1 kV transformer to step down the voltage from the medium voltage level to the low voltage level, an AC/DC rectifier that converts the power from AC to DC and a DC/AC inverter that makes the inversion vice versa. The DC/AC inverter can be individual for each customer (for example in case of an individual house) and it can be shared among several customers (for instance in case of a residential building with several customers). If the inverter is located in the customer premises, also the customers can have and access to the DC in addition to the AC. In this case a converter to decrease voltage to the suitable level is required. The basic concept of the energy conversion is explained in Figure 16.

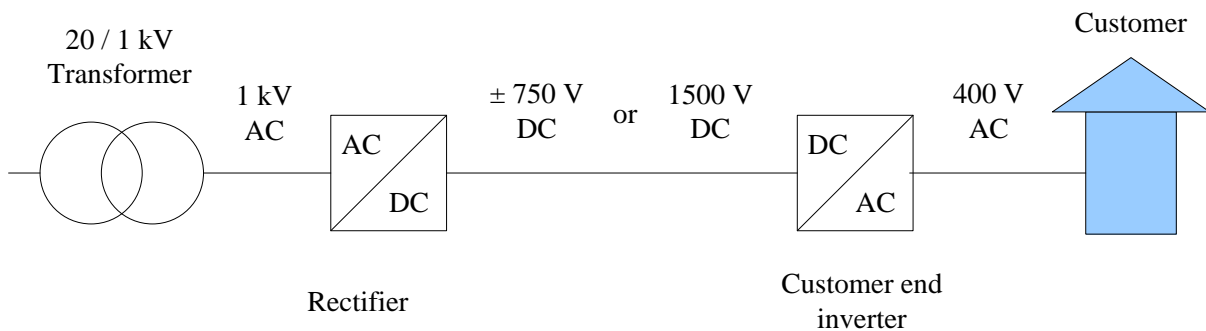

Figure 16: The principal components of an LVDC connection [159].

According to the European voltage directive 2006/95/EC, the limit of low voltage is 1 kV for the AC and 1,5 kV for the DC [161]. In the unipolar DC technologies, the maximum voltage is measured between the positive and the neutral (the potential is 0 V) wires, and in the bipolar technologies, the maximum voltage is measured between the negative and the positive conductors [161]. This directive defines the maximum voltage that can be utilized by the LVDC technology. Due to the same directive, an LVDC system can be classified as low voltage system if the AC system that feeds it, has the maximum nominal voltage of 1 kV [161]. Therefore, a 1/20 kV transformer is needed.

3.5.1. Low Voltage Direct Current Technologies

There are two major LVDC technologies, namely the unipolar and the bipolar technology [162]. In the unipolar technology, two conductors are used; the neutral wire and the positive wire. The voltage between these two conductors is 1.5 kV. The load is connected between these two wires. The transformer is fed through a transformer with the transformer ratio as 1000/800 V or 1000/920 V [163]. Those transformation ratios are chosen to make sure that the DC voltage can be kept constant even if the voltage in the medium voltage network raised 10 per cent [163]. The basic structure is on the unipolar LVDC system is shown in Figure 17. [160]

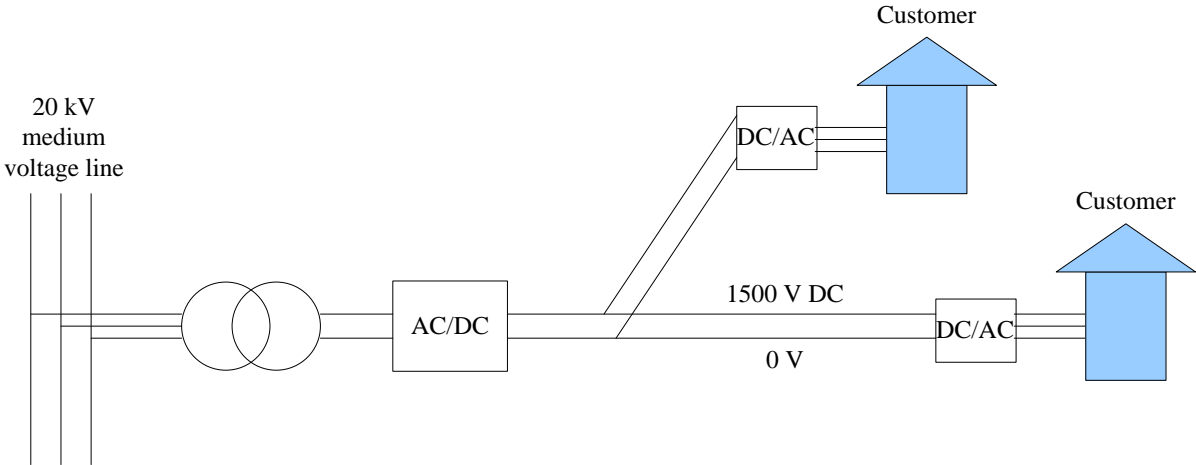

Figure 17: Unipolar LVDC technology delivering power to two customers [164].

The bipolar technology employs three wires; the positive, the neutral and the negative conductor. The positive conductor is on the level of + 750 V, the neutral is on 0 V and the negative is on the level of - 750 V. Thus, the potential difference between the negative and the positive conductors is 1.5 kV. The bipolar system can be fed through a two winding transformer and one converter. Another option is to use a three winding transformer and two converters connected in a unipolar fashion. It means that one of the converters is connected between the positive and the neutral wire while another one is connected between the negative and the neutral wire. If the converter uses pulse width modulation (PWM), the transformation ratio of the transformer is 1000/400/400. If the converter uses space vector modulation, the transformation ratio is 1000/460/460. [163]

The system of three wires makes it possible to connect a load to the network in three different ways. A customer can be connected between the negative and the positive wires, between the neutral and the positive or between the neutral and the negative wires. Another point of the bipolar technology is that it works even if one of the conductors is out of order. For example, if the negative conductor has a failure, the two other conductors can still be used to transfer half the maximum power capability of the whole line. This may improve the reliability of the bipolar technology in comparison with the unipolar technology. Another opportunity of the bipolar technology is that the three wires can be used as a trunk feeder while branches from this trunk feeder could be created by using only two wires [165]. The customers could be connected to these branch feeders. A branch line created by using the bipolar LVDC technology is presented in the Figure 18. [160]

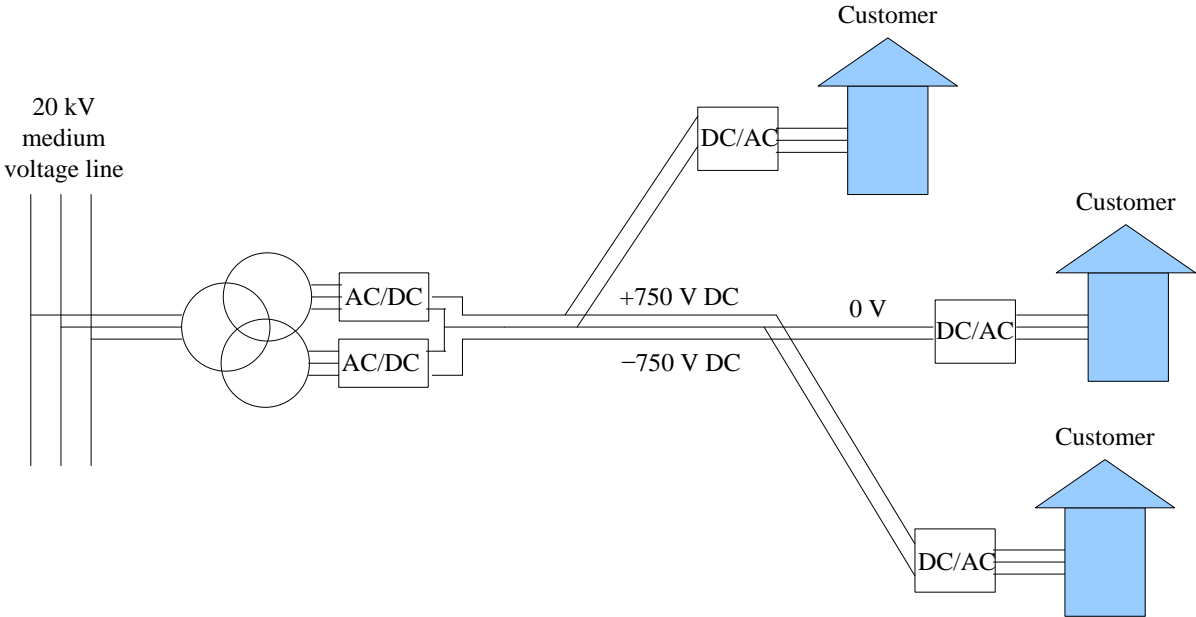

Figure 18: The structure of the bipolar LVDC technology. The customers are connected to the LVDC network through two phases. [164]

Most of the existing AC low voltage underground cables can be used on the voltage level up to 900 V by exploiting the LVDC technology [166]. Consequently, it may be cost-effective to limit the voltage to 900 V in case of unipolar technology. To that end, cheaper low voltage cables can be used instead of more expensive medium voltage cables.

The losses of the power converters system are highly dependent on their structure. The inductors used in the harmonic filters of the converters are the major cause of losses. The losses of the coil are created by hysteresis and eddy currents in the iron core in addition to the DC resistance and eddy currents in the coil windings [167]. It has been found that the three level converters are more efficient than the two level converters because the output voltage can have three different values instead of two. This leads to the fact that smaller harmonic filters (with smaller inductors) and IGBTs with lower voltage rating can be used. The efficiency of the Customer End Inverter plays a significant role in the efficiency of the whole LVDC network [168]. The overall efficiency of a LVDC network is more difficult to estimate than the efficiency of a LVAC network. This is because, in addition to the network

configuration, the total efficiency and the lifetime costs are affected by the used power electronics equipment and their control [169], [170]. It has been found out that the efficiency of the LVDC power converters could be improved substantially by changing the material of the switches, using a different configuration in the converter and supplying large variable loads, such as the electric heating, by DC [168], [171]. Along with the efficiency of the converters, the optimisation improvement of the energy efficiency of the LVDC systems in a global sense is focused on the optimisation of the voltage level, the use of battery storage systems and the use of residential DC distribution [172]. [163]

3.5.2. Electrical Safety and Protection of the Low Voltage Direct Current Systems

Because low voltage systems are situated close to households and other premises of everyday life, the electrical safety becomes one of the most important concerns from a customer's point of view. The safety has been selected as one of the major issues in the improvement of the LVDC systems [173]. In the context of this thesis, electrical safety means that the touch voltages and currents are within the limits that are not dangerous for the human safety. Since the purpose of the earthing is to prevent dangerously high contact voltages in the system, it is a crucial issue when dealing with decreasing the touch voltages and currents [174], [175].

The converters do not form a galvanic isolation between the AC and the DC sides and therefore, an LVDC system is one galvanically connected structure from the low voltage transformer to the AC network in the customer premises if no galvanic isolation transformer is used [176]. Even if the converters do not provide galvanic isolation, they can be used to decrease the values of touch voltages [173]. The most suitable earthing configuration depends on the characteristics of the LVDC system used, such as the type of the system (unipolar or bipolar), the type of the converters and the voltage level [173]. For a bipolar LVDC system, the IT earthing system (at the AC side) is considered as the best solution [177]. IT system is a neutral isolated system, where the neutral conductor is not used [174]. All the galvanic parts, such as water tubes in the customer premises are connected to the principal earthing [173]. Other earthing arrangements, such as TN earthing, may lead to hazard touch voltages when an earth fault is experienced in the system [176]. According to the study in [173], a single indirect fault does not lead to hazard touch voltages and currents if the earth resistance is more than 1 Ω . On the other hand, a double fault may bring the touch voltages to a dangerous level [173].

The same protection devices that are used in the traditional LVAC systems can be employed in the case of LVDC, but additional circuits have to be added [178]. The converters control and monitor the voltage and current and are able to detect and react on tripping very quickly [179]. The protection profits from the increased local measurements introduced by the power electronic converters [180]. Because of the short react time, the converters can be used as differential relays if the communication system does not form a bottleneck [179]. If the customer end inverters are equipped with a current limiting circuit, the overcurrent protection in the customer's side can be realised by circuit breakers. The protection of the DC line can be realised by using a similar method than in the traditional AC network [178]. Practice shows that the converters used in the LVDC technology do not have any significant issues of electromagnetic interferences [181].

3.5.3. Benefits of the Low Voltage Direct Current Technology in Power Distribution

The LVDC technology opens possibilities for significant savings in power distribution. A remarkable advantage of the LVDC technology is that a higher voltage level can be used in comparison with the traditional LVAC technology, which makes it possible to transfer more power in comparison with the LVAC technology [165]. No reactive power is transmitted through an LVDC line, so all the transferred power is active power, which releases power transmission capacity in comparison with the LVAC lines [182]. On the contrary, the same power can be transferred by using cheaper cables with smaller cross sections [165]. The same low voltage cables can be utilized in both LVDC and LVAC systems. Because the LVDC cables do not have reactive losses neither skin effect, usually a smaller voltage drop across the cable is experienced (because of smaller impedance), which in turn leads to fewer losses [162], [159]. This is because losses are related to voltage drop over a line.

The structure of a low voltage line is simpler and cheaper than the structure of a medium voltage line [160]. Because LVDC systems can cover long distances, significant savings in investments can be achieved by replacing medium voltage branch lines with low voltage DC systems. This also results in the lower number of distribution transformers [159]. The price evolution of the power converters has a strongly decreasing tendency, while the price of the metals, such as copper, is increasing in the worldwide markets, which has an influence on the price of transformers, for example [165]. The downgrade of the price of power electronics is one of the main drivers for the success of the LVDC technology [183]. The fact that it is possible to use already existing network structures in the LVDC distribution, increases fundamentally the cost-effectiveness of the technology [184]. At the same time, more power can be transferred through the power lines by using the LVDC technology than by using the LVAC technology, more distribution capacity can be got out of the already existing infrastructure [185]. As a consequence, the investment costs are highly centred on the converters instead of the whole network structure. Apart from the converters, all the components required to build an LVDC system are commercially available products [184]. It is a fact that a large part of the electricity infrastructure of the Europe is ageing and coming to the end of its lifetime in the near future [186]. For the electricity distribution system operators, it is a sound opportunity to carry out a part of the needed network replacements by using the LVDC technology.

It is also worth taking into account that low voltage cables do not require wide line corridors, such as medium voltage overhead lines because they are underground [187]. This helps to reduce the costs of the power distribution network [188]. The lack of the need of wide line corridors is a positive point from the environmental point of view, in the cases where medium voltage overhead branches are replaced by LVDC cables. Besides, this fact may facilitate the process of having permissions to build new distribution lines and make them more acceptable in the public. Replacing overhead lines by cables makes the system more weatherproof, which in turn, affects notably the network reliability [164].

The customers can be connected to any point of the LVDC line, which avoids the parallel medium and low voltage lines [189]. The savings in the lengths of the lines is demonstrated in the Figure 19. A Finnish distribution system operator Elenia Oy has estimated that it is technically possible to replace medium voltage branch lines up to eight kilometres by using the LVDC technology [190]. This is about 20 per cent of the medium voltage network of the company.

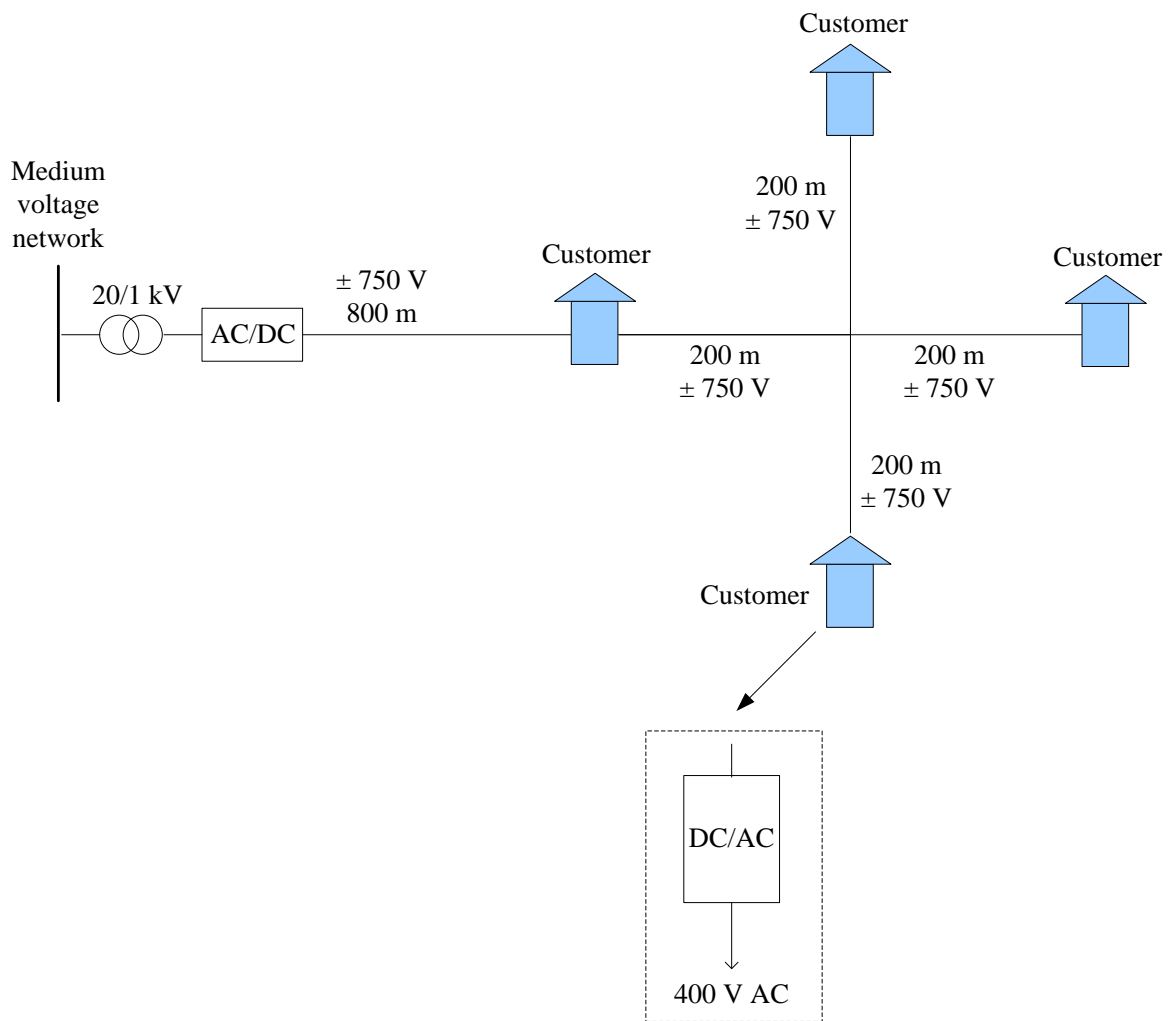
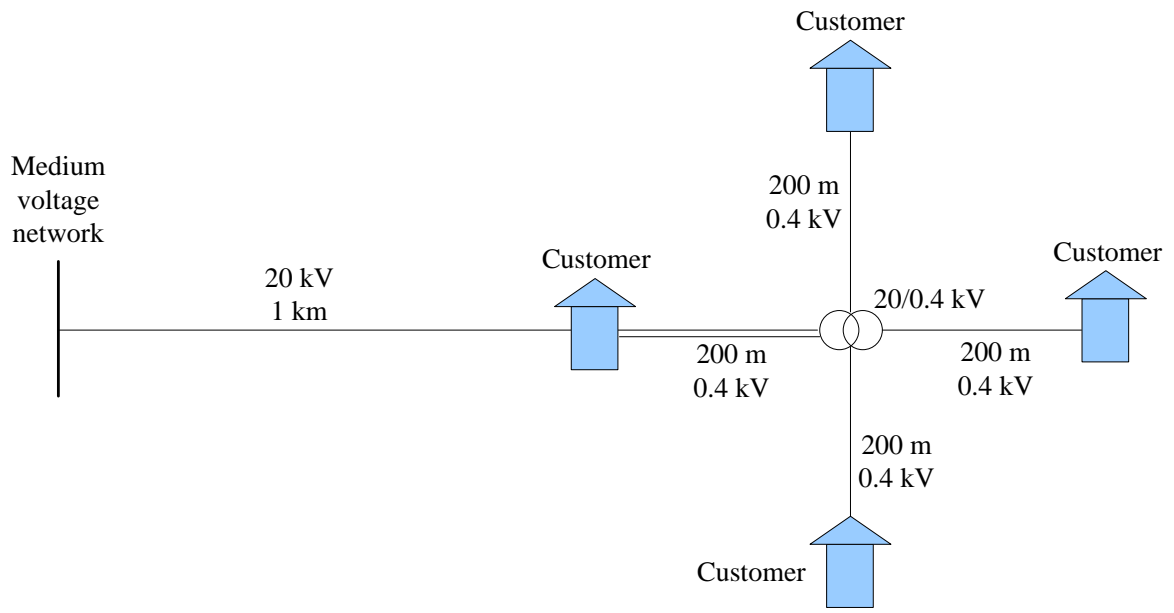

Figure 19: The scheme above demonstrates the traditional LVAC and the scheme below shows the LVDC system. It is worth noting that by using the LVDC technology, the 20 kV branch line can be significantly shorter. Also, 200 metres of the 0.4 kV cable can be eliminated. The figure is redrawn from [159].

Each LVDC branch forms its own protection area [191]. This means that the faults in one LVDC zone cannot be seen in the medium voltage network, which has important potential to increase the quality of supply [192]. For the sake of the fact that the voltage is converted by power electronics, voltage sags experienced by customers can be improved significantly because the customer end inverters can keep the voltage constant even if the voltage in the AC network fluctuated [187]. This remains true as long as the AC voltage remains high enough that the voltage of DC line can be created [187]. The DC voltage can drop severely, let's say 25 per cent, without any voltage drop on the side of the customer [193]. As a result, many problems of voltage drops are avoided [164]. By reason of the capacitance of the DC line, customers do not experience flicker due to short power cuts caused by the automatic reclosers on the medium voltage lines, through the LVDC system [194], [195]. This also corresponds to the increasingly growing demand of the increased power quality [196]. One innate benefit of using the direct current is the easiness of the possibility to add capacitor-based energy storages to further increase the power quality from short interruptions [188]. The converters in the AC/DC rectifiers provide an effective control over the harmonics by active filtering, which can lead to the improved power quality [185]. The combination of AC and DC networks can increase the voltage stability of the whole network by virtue of the fast and flexible reactive power capabilities of the power converters [197].

With a view to the future development of power distribution networks, the LVDC technology offers several possibilities. For the reason that for example solar panels produce direct current, a DC/AC converter is not needed, when connecting a distributed generator, such as a solar panel to an LVDC network [198]. This is the case of the most of the small scale distributed generation [192]. A DC/DC converter would be enough, which increases the efficiency of the system, because a DC/DC converter can be made to be more efficient than an DC/AC converter [163]. The technical easiness of connecting distributed generation is in line with the so-called “20-20-20” targets set by the European Commission in order to increase the share of renewable energies in the power production mix of Europe [199]. What is more is that the lack of a DC/AC converter may decrease the investment costs on the distributed generators, such as solar panels [200]. The same applies, for instance, for the electric vehicles chargers. What is more is that the interphase between energy storage, such as a battery, and a DC network is technically simpler than in the case of an AC network [201]. This is because there is no problem of the synchronisation of the frequency, so less components and more simple control is required [202], [200]. In an AC network, voltage unbalance may be problematic for a distribution network operator, since it results in additional losses due to increased current in the neutral conductor [47], [49]. In the future, along with the increasing number of large unbalanced loads, such as electric vehicles, the problems of voltage unbalance may increase [203]. In the unipolar LVDC technology there is no problem of voltage unbalance. In the bipolar technology, the voltage unbalance may exist if the loads on the two phases are not balanced.

With the active converters, it is possible to transfer energy in both directions. The converters are flexible in terms of control, for example the power factor can be adjusted to create reactive power when it is necessary [160]. It is a commonly admitted fact that the

distribution network operators need more visibility of their network, especially in case of low voltage networks, which have very few sensors today [48]. Power converters already contain several sensors and using these sensors to gather current and voltage information for the network operation (for example by sending it to a central SCADA system), could provide a cost effective means to gain more visibility of the network [187]. Converters could allow a high level of penetration of control and monitor hardware in the low voltage network [204]. Consecutively, this would permit to bring energy market -related services to the reach of the end customers [204]. The inverters that are located near the 20/1 kV transformers are able to gather information about the loading of the transformer [187]. In such a way, power converters could act as the links of the communication network [187]. The information could be applied in active online condition monitoring and the optimisation of the maintenance, and finally, in intelligent asset management. Despite the electric noise emitted by the power electronics, Power Line Communication is a practical and an inexpensive method of communication for LVDC networks [205]. Furthermore, power converters could provide additional information on the load behaviour, which could be helpful in the network planning [160].

For the flexibility and security reasons, there is a growing interest towards the decentralised monitoring and control of the networks [206], [207], [208]. The trend is even more radical in case of micro grids. They are conceived as totally autonomous parts of the network and capable of islanding from the main grid [209]. The benefits of the LVDC technology are culminated more in case of the micro grids than in traditional distribution networks. This is because the distributed generation and energy storages play a more significant role in a micro grid than in a distribution network of a traditional topology [185]. It has been demonstrated that LVDC could be an adequate solution for islanded networks [210].

If the customers have a direct access to DC, loss reductions could be done in the internal networks of domestic buildings by decreasing the number of AC/DC voltage conversions in the customer premises [211]. The devices that require DC voltage could be connected directly to the DC network through a DC/DC converter. The number of electronic loads using DC power is increasing constantly in the households, which means that a growing number of AC/DC transformations could be saved [185]. The interest towards DC power at households has increased during last years, which may pave way for the LVDC technology [200].

Due to the power electronics, the LVDC technology provides inherently a platform for implementing new advanced functions, such as load control, micro grid functions and the control of voltage quality [181].

3.5.4. Downsides of the Low Voltage Direct Current Technology

Employing DC in the electricity distribution entails introducing a large number of power electronic equipment into the network. Power electronic -based converters are substantially more complex systems than traditional AC network components, such as the power transformers, the cables or the circuit breakers. The increasing number of components in the distribution network can have an effect on the system reliability [187]. Although power converters of similar characteristics are widely used in the industry, for example, in the wind turbines, it is important to take into account that the life time expectation of the converters is not on the same range with the power transformers. The approximated lifetime of a power converter is between 15 and 20 years at best [187]. In addition, new components require maintenance that causes additional costs for the distribution system operator [187]. On the

other hand, there is still plenty of potential lifetime increase and lifetime costs of the components [192].

Because the converters targeted to the LVDC power distribution are still custom made products, the prices are relatively high, but expected to decrease when the LVDC technology becomes more usual in the electricity distribution business. Significant technological changes of distribution network calls for an extensive further training of the installation, maintenance and operational personnel.

If an LVDC technology is employed, a similar or better efficiency is expected from the new systems than from the traditional LVAC system. This means that the efficiency of a power converter should be higher than 98 per cent [187]. The efficiency of the converters has a key role in the economic feasibility of the LVDC systems [187], [183]. Besides, the distribution system operators are probably not willing to change their system to another one that operates with lower efficiency. Now and in the near future, a lot of effort is concentrated on cutting down the losses of LVDC systems and improving the efficiency of the converters by developing the converter topologies [204], [212].

Power converters emit harmonic pollution to the distribution network, which may cause problems if the harmonic filters are not designed properly.

One of the greatest challenges is that any distribution system operator or manufacturer does not have accumulated experience in long term and the lack of standards considering the technology [179], [171]. Before the technology can become common, further experience on the real use of LVDC systems needs to be gained. Because of the absence of the long-term practical experience, the estimation of the complete lifetime costs of the LVDC systems is difficult [213]. Despite of the potential drawbacks, the LVDC technology develops rapidly and substantial technological advances are expected to be made in the near future [184].

3.5.5. Low Voltage Direct Current Technology in the Rural and Urban Environments

By the nature of the LVDC systems, the technology is especially well applicable in the areas, where the distances are long, the network has a radial structure and the transferred powers are relatively low compared with the distance of the line. These are the areas, where the major advantages of the DC delivery stand out: cost-effective structure in contrast with the traditional medium and low voltage AC systems, low losses, the increased quality of supply and the low voltage drop. In other words, rural areas are considered as the principles sites, where the LVDC systems are the most economically suited nowadays [196]. The successful technical and the economic applicability of the LVDC technology has already been recognised in the rural areas of Scandinavia, where the technology has an important positive impact on increasing the technical performance of the low voltage network compared with the existing LVAC networks [194], [159], [204].

From the point of view of the distribution system operator, it is less risky to experiment new technologies in the networks with only a few customers, in the case that the technology does not succeed. If the technology works as expected, it can be transferred to the areas with a higher density of customers.

By taking into account the other benefits brought by the LVDC technology, such as the easy interconnectivity with distributed generation (like solar panels), energy storages (like batteries), electric vehicles, the lack of voltage unbalance problems and the possibility to save energy in the internal networks of residential buildings, the technology may become feasible in the urban or semi urban environments. The direct economic benefits of many of the

abovementioned possible boosters of the LVDC technology in the urban areas are not addressed merely to the distribution system operator, but also to the customers. Likewise, it may be difficult to quantify the exact profit of the employment of the LVDC technology for the distribution system operator, unlike in the case of a rural network. This may hinder the willingness of the distribution system operators to employ the LVDC technology in the urban and semi urban environments. On the other hand, the easy interconnectivity of new technologies to the LVDC network can create new business opportunities to the distribution system operators [196]. It is seen that the LVDC technology offers an economic way of constructing electricity distribution networks in rural areas [181].

3.5.6. Low Voltage Direct Current Distribution – Practical Setups

By the knowledge of the author, there are two real-life LVDC pilot systems utilised by the local distribution system operators in their public networks. Both of these pioneer systems are located in Finland and are developed in collaboration with universities.

3.5.6.1. The System of Suur-Savon Sähkö Oy

The LVDC system in Suomenniemi, in south east of Finland, is a collaborative project between Suur-Savon Sähkö Oy (a local distribution system operator) and Lappeenranta University of Technology. The planning of the system started in the beginning of the 2010 and the system started its continuous running in June 2012 [214], [215].

The setup consists of 100 kVA rectifying substation that is supplied by the medium voltage network through a 20/1 kV transformer, a 1.7 kilometre long underground cable, three 16 kVA customer end inverters and four customers (two of the customers share a common inverter) [194]. In addition, some hundreds of metres of LVAC cable is needed to connect the customer houses to the customer end inverters [214]. The possible peak demand of the system is 24 kW [214]. The system uses bipolar (± 750 V DC) topology. In the rectifying substation, there is a 12-pulse half controlled thyristor rectifier and a battery energy system of 30 kWh with a maximum charging power of 30 kW [216], [201]. The 20/1 kV transformer that feeds the inverters has two secondary coils, one connected in delta and the another one connected in star configuration [214]. A scheme of the installation is shown in Figure 20.

The customer end inverters are two-level inverters based on insulated-gate bipolar transistors (IGBT) [194]. They provide the electricity to the customers in three phases [216]. The customers are galvanically isolated from the LVDC network through a galvanic isolation transformer [216]. The customer end inverters are provided with LC-filters to filter out the harmonics [217].

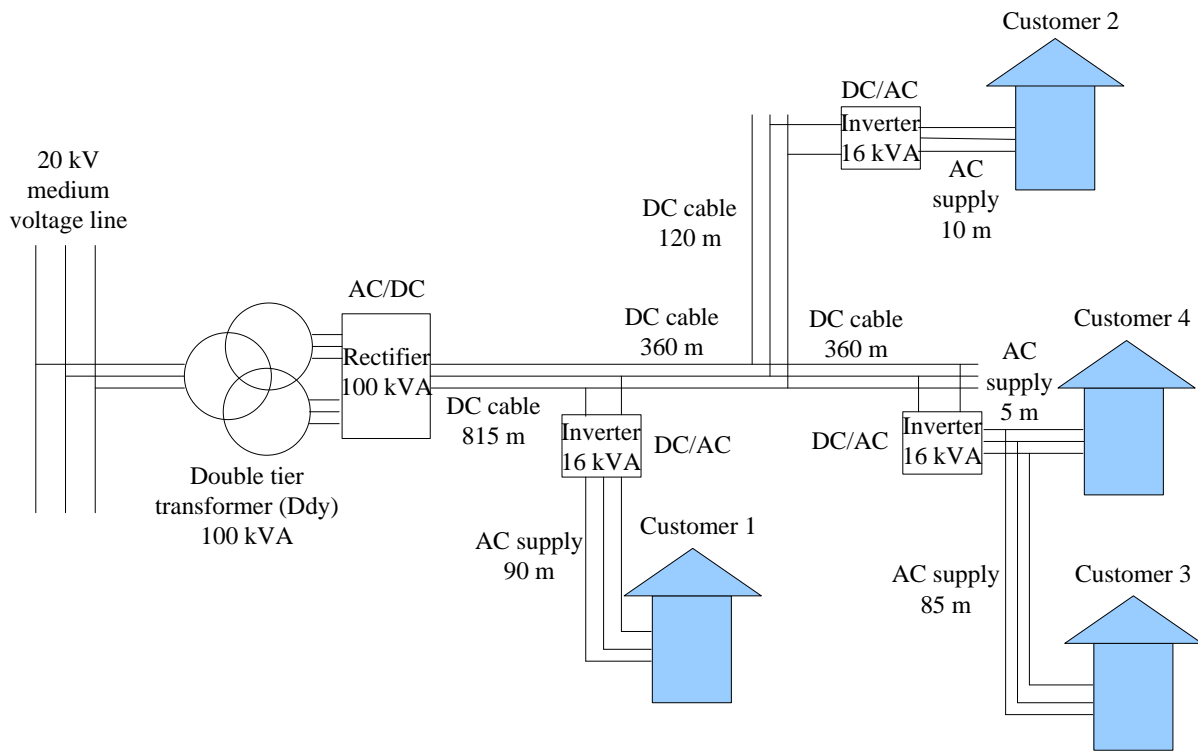

Figure 20: The scheme of the LVDC pilot system in Suomenniemi [218].

The customer end inverters and the rectifier are situated in the uninsulated cabinets in front of the customer premises [216]. They are manufactured by the Lappeenranta University of Technology [219]. Because of the lack of thermal insulation, the converters are exposed to rugged weather conditions since the temperature can range between -35 to 35 celsius degrees [194]. A cooling system maintains the temperature of the IGBT at 50 celsius degrees [194]. A web portal, both for the operational use of the distribution system operator and the research use of the university, was created to easily follow the measurements of the converters [215]. The system can also be controlled through the web portal [216]. The communication is from the rectifying substation to the customer end inverters is realised by a fibre optic cable [216].

The protection equipment of the system is commercially available. The network in the customer end is carried out by using fuses and circuit breakers. Hence, the inverter has to supply a sufficient short circuit current for these devices in case of a fault. That is provided by the Customer End Inverters. Further technical details of the system can be found, for example, in [157]. The development of the system in the near future includes the addition of an installation of photovoltaic panels, a bidirectional control of power flow and a possibility to control customer loads [220]. The topology of the pilot system in Suomenniemi is shown in Figure 21. [194]

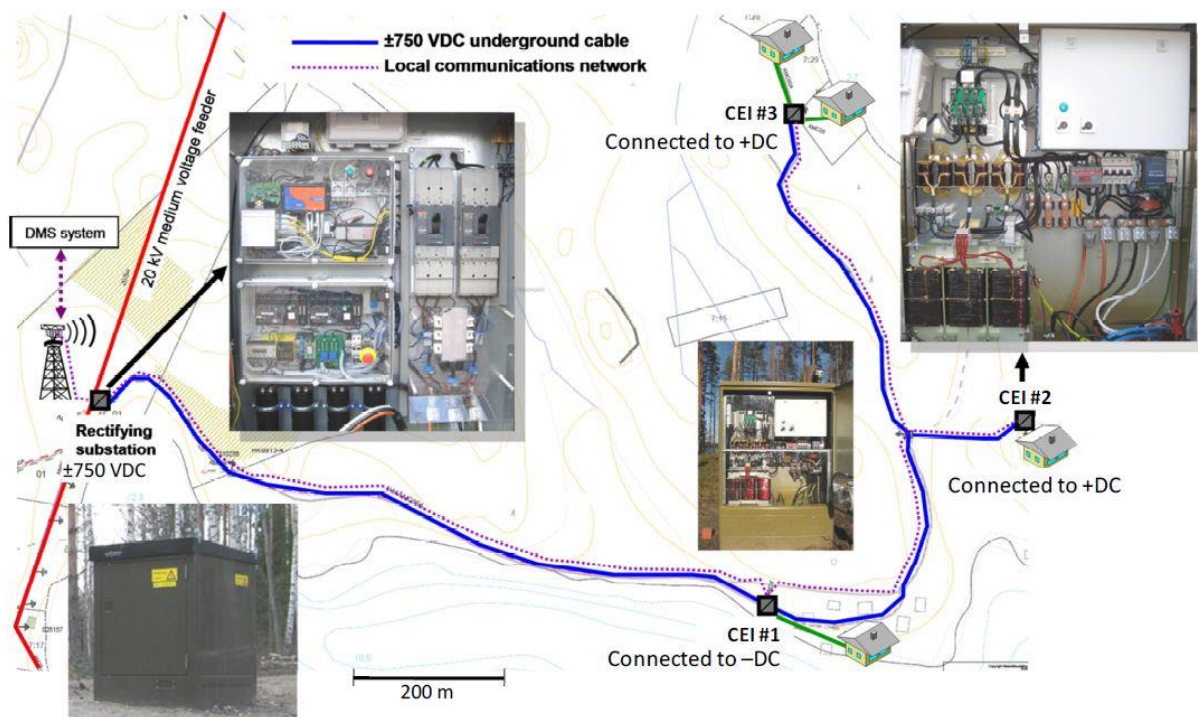

Figure 21: LVDC system in Suomenniemi [219]. CEI signifies customer end inverter.

The reported practical experiences from the system are encouraging. The quality of the voltage fulfills the standards in every situation. Short power interruptions due to autoreclosers were experienced in the medium voltage network, but the customers were not able to experience them due to the capacitance of the DC line, that works as a buffer (or energy storage) against very short interruptions. The feeding medium voltage network also experienced climatic over voltages without any significant damage in the LVDC systems. Finally, what is an essential point for the distribution system operator is that Suur-Savon Sähkö Oy has not received any customer complaints of the system. [194]

3.5.6.2. The System of Elenia Oy

Elenia Oy (the second largest distribution system operator in the country) has an LVDC system in Orivesi, south west of Finland. The project is a collaboration project with ABB Drives Oy Finland that is the manufacturer of the converters used in the project. The research and development is carried out in collaboration with the Tampere University of Technology [221]. The planning of the system started in the autumn 2008 and the construction was done in the spring 2010 [214].

Together with the functioning of the LVDC technology, one of the main objectives of the project is to discover the possibilities of the technology in micro grid applications [204]. The system is a connection between two points, that consists of a rectifier, a one kilometre long underground cable (of which about 300 metres is of underwater cable) and a converter, that has an islanding capability [204]. The system employs unipolar technology and the nominal voltage level of the underground cable is 750 V DC [220]. The customers are single households that are equipped by advanced metering infrastructure (AMI) to observe some power quality –related variables [214], [216].

There is a lake between the rectifier and the converter stations. IGBT based back-to-back converters are used in both ends of the LVDC connection. The nominal apparent power of the converters is 120 kVA and they are equipped with LCL filters. There is a possibility to bypass the converters in case of a malfunction so that direct current is not used. The converters are in hermetically isolated cabinets that are equipped with a cooling system. The customers are galvanically isolated from the DC bus by a transformer. Before the rectifier, there is a 20/0,4 kV transformer to connect the rectifier to the medium voltage network [220]. The communication is realized through a general packet radio service (GPRS) connection, so that the system can be monitored and controlled by the distribution system operator from its SCADA system. [214]

The published results of the system operation are mainly positive. The employment of the LVDC system has improved the quality of power. The variation of the voltage is less than two per cent, the flicker effect has decreased and the phase voltages in the customer's AC network are balanced. The standards for the power quality were fulfilled [214]. Short power cuts were experienced in the medium voltage distribution network due to the automatic reclosers, but they were not emanated to the customers through the LVDC system. The reactive power exchange between the medium and the low voltage networks is zero because of the active control of the rectifier. The improvement of the power quality is demonstrated in Figure 22. [216]

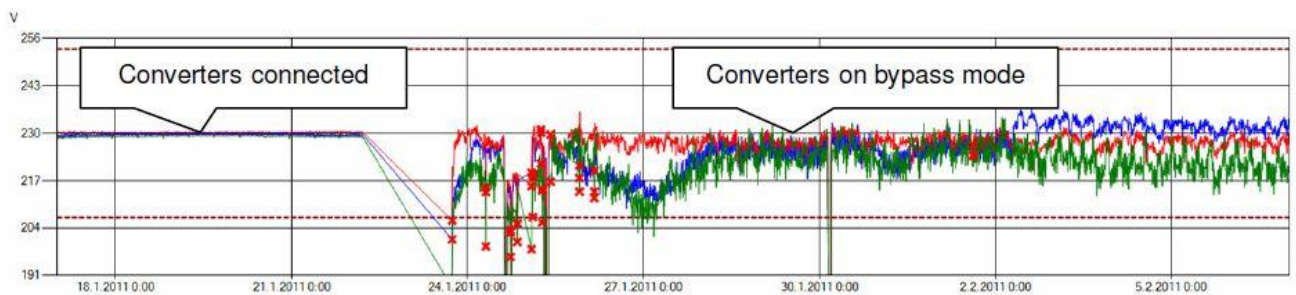

Figure 22: The phase voltages, when the converters are shifted from the connected mode to the bypass mode. The phases 1, 2 and 3 are represented by the blue, the red and the green curves in the corresponding order. [214]

The drawbacks include the relatively high losses of the converters. This is because the converters were oversized during the planning stage. Also, a noise can be heard from the cooling systems of the converter cabinets. The total harmonic distortion (THD) index at the customer's premises rose from about two per cent up to 5.4 per cent when the converters were connected. [214]

ABB Drives Oy Finland and Elenia Oy have another common unipolar point-to-point LVDC pilot project in Kylmäkoski, in Southwest Finland started in March 2014. The main purpose of the second pilot project is to create long-term experience on the system operation. For that purpose, there is a web based remote service platform that gathers statistics on the operating conditions in the intervals of one minute. Technical details, such as losses or harmonic voltages, of the pilot project can be found in [213].

3.6. Fault Location, Intelligent Substations and Applications for Condition Monitoring

Fault location by using advanced metering infrastructure is a successful application that gives clear benefits to the distribution network operators as well as customers [222]. Significant mutual benefits are gained from faster fault repairing and the shorter interruption times [222]. According to the experience, fault repairing times are not reduced only in the low voltage networks, but also in the medium voltage networks [222]. The system used by Elenia Oy is able to detect and send an alarm to the system operator as a result of occasions such as a fault between the neutral wire and ground, missing phase voltage, voltage unbalance, over or under voltage and tripping of the internal circuit breaker of the electricity meter [222], [223].

In the currently used systems, alarms cannot be sent in case of three-phase faults. This is because the communication would get congested due to the large number of alarms due to the power cuts in the medium voltage network [224]. This is understandable when there are a large number of customers downstream from the medium voltage network. The practice shows that there are only a small number of faults that cannot be detected by the electricity meters [222]. It has been stated that one of the most useful features of the recent electronic electricity meters is the possibility to upgrade the software remotely so that the meter can be reprogrammed when needed [223].

As stated earlier, low voltage networks are extremely numerous, which makes it too laborious to study them in detail manually. This is why highly automated methods of studying data from advanced metering infrastructure are demanded. A contribution to this is done in [225] where low voltage networks of Liander (the major Dutch distribution system operator) are grouped according to selected parameters, such as the length of the cables or the number of connected customers. The distribution system operator can analyse representative networks constructed based on these groups of networks instead of having to analyse all networks one by one. The same problematic is assessed in [226] that presents a study completed by using the network data of Electricity North West Limited (United Kingdom) where voltages at the bus bars, the power factors and the voltage unbalance factors are studied at 100 substations by using the 10-minute data over one year.

Around the world, there are several projects on intelligent primary and secondary substations, such as [227], [228], [229], [230], [231] and [232]. Since this thesis is focused on the low voltage networks, innovation of the secondary substations are mainly considered. The increasing amount of data from low voltage networks due to advanced metering infrastructures and possibly other sensors sets the management of the distribution networks in a situation, where it is not useful to process all the data gathered from the low voltage networks at one centralised point. It is also true that secondary substations are excellent locations for obtaining the data of the distribution network, because both, the low and the medium voltage networks are connected to them [231]. Moreover, the distribution transformer can be monitored and the electrifying of the equipment needed for network automation can be arranged in an easy manner [231].

When thinking about highly automated low voltage networks with possibilities of different controls, possibly some of the decisions can be made locally in the low voltage network while some others require a more centralised decision making. A selection process of the information originating from the low voltage network could be done at the secondary substation. Likewise, the information from the medium voltage network could be filtered through the primary substation before it goes to a centralised data centre. This would help to

avoid the saturation of communication channels and data processing equipment. Regarding the findings in the bibliography, it can be stated that substations will have an essential role as the distributed data processing centres in the future power distribution networks.

In the model that is implemented in the distribution networks of Helen Electricity Networks Ltd, the active secondary substations collect the following data:

- phase currents and voltages
- total harmonic distortion (THD) of phase voltages and phase currents
- active, reactive and apparent power
- temperature of the transformer
- load level of the transformer
- voltage sags and swells
- interruptions in voltage.

All the above mentioned data is measured by using the frequency of 10 minutes. Reports and analyses can be generated out of the measurement data. [231]

A different concept of an intelligent substation is tested in the low voltage network of Alliander [227]. This prototype not only offers measurement information, but also has control functions, power electronics and energy storage [227]. In addition for providing measurement information about the network, the additional devices are able to manage the peak load, improve power quality and reliability [227]. Other possible functions that become reality due to the automation of low voltage networks are the automatic detection of customers in every phase, the detection of non-technical losses and thefts, phase balancing due to the control of loads and photovoltaic production, control on-load tap changers and detect a blown fuse [232].

Until recently, condition monitoring has been a topic mainly in the high and medium voltage electricity networks. Condition monitoring is a key to preventive maintenance and that is why it has become more and more popular in the high and medium voltage networks [233]. Preventive maintenance decreases the number of unplanned electricity disruptions because it is possible to inform customers beforehand about the upcoming interruption [234]. Also, the possibility to bypass the fault during a planned interruption makes it possible to avoid the interruption totally [234].

If the exact historical records of the component loading are linked with the failure data, condition monitoring can be linked to sophisticated asset management. The combination of accurate loading data permits to create accurate life-time models of the components, which could help in preventive maintenance and in the end, to make proper asset renewal decisions and to convert the asset management more 'intelligent' in the medium and long term [235]. A distribution system operator could create new tools for predicting the real-time technical condition of its assets, such as different health indices or colour indicators, such as in [236], [237] and [238]. The combination of online condition monitoring and the improved asset management is many times called intelligent rating [239], [240].

Due to the decrease of the prices of sensor technologies, the applications of condition monitoring become within the reach of economic possibilities in the low voltage networks. Because the distribution transformer is the most important single component in the low voltage networks, it is naturally the first object of interest when condition monitoring is

considered. An example of an application of this kind is tested by Energias de Portugal S.A. (EDP). The system includes the following functionalities:

- detection of mechanical and thermic abnormalities in the behaviour of the transformer
- detection of partial discharges in the medium voltage side of the transformer
- alarm in case of blown fuses
- current measurement in the low voltage side
- detection of fire, flood and the malfunction of ventilation
- functions to detect theft and intrusion.

Wireless communication and the lack of the need for opening the distribution transformer make the installation relatively simple and thus, lower the price of the installation. [241]

Another interesting target of condition monitoring is the underground low voltage feeder. A replacement of an underground cable is slow and expensive and that is why it would be convenient to be able to forecast the faults before they occur. An innovative system is presented in [234]. The technology is based on measuring the resistance of the cable insulation by high frequencies. By the cause of the fact that the resistance of the insulation changes whenever it has significant changes, the upcoming faults can be detected already when the cable insulation starts to break down before the actual fault happens. When the system is installed, the frequency fingerprint of the cable is taken. The control system located at the secondary substation scans the resistance of the cable every certain period (for example once a day). After the scanning, the resistance is compared with the resistance of the healthy cable. If the frequency fingerprint has changed more than it would change due to normal ageing, it is a sign that a breakdown process of the insulation has started. The system is proved to work in laboratory conditions and it has been found that the system would be economically feasible under certain conditions in practice. [234]

The system requires a high frequency signal transmitter at the secondary substation and a receiver at the other end of the feeder. The transmitter is an additional device, but the receivers could be embedded on the already existing electricity meters. The system is an example to show that the existing advanced metering infrastructure can be used for totally different functions than they are originally designed for.

4. Optimal Placement of Voltage Sensors in a Low Voltage Network for On-Load Tap Changer Application

The previous chapters of this thesis focus on the fundamentals of the power distribution presenting the actual concept and a few future directions of the technical development. This section studies the problematic of measuring voltage in a given low voltage network in order to control an on-load tap changer at a secondary substation. Some of the presented technologies discussed in earlier chapters are applied in this one.

As a general rule of thumb, in a given low voltage network, voltage can have any value as long as it stays within the limits of the maximum and the minimum allowed voltage (see Section “Low Voltage Networks” for more information about the voltage limits). In other words, voltage is not an issue when it is within permitted bandwidth. In order to adjust the optimal level of voltage, it is crucial to know the maximum and the minimum value of voltage in the network at any time. This being the case, only the maximum and the minimum values of voltage are of interest. Thus, it is a simplified version of state estimation explained in Section “State Estimation by Advanced Metering Infrastructure”. The voltage control can be done by an on-load tap changer that takes the values of the maximum and the minimum voltage as inputs.

As mentioned in Section “Advanced Metering Infrastructure”, the modern measurement infrastructure provides a communication media between a customer and a distribution system operator control centre. That is why it is natural to consider the use of advanced metering infrastructure (AMI) and/or dedicated voltage sensors to measure the maximum and the minimum voltage in the network. The objective of this section is to find the optimal number of voltage sensors that are able to provide information sufficient enough for the on-load tap changer application. As stated earlier, when voltage sensors or measurements are referred, they can be electricity meters or additional sensors. For economic reasons, it is not of interest to install too many sensors in the networks. A highly number of sensors would also bring an unnecessary high burden for data transmission and processing. On the other hand, important voltage drops or peaks can remain unnoticed if too low a number of sensors are placed. The optimal number of sensors can be found between these two extremes.

This section is focused on the placement of voltage sensors and does not consider the technology of an on-load tap changer itself. Therefore, technical details of on-load tap changer technologies are not explained. A description of an on-load tap changer can be read in Section “Automatic Tap Changers and Voltage Regulators in Secondary Transformers”. The application of advanced metering infrastructure presented in this thesis can be regarded as an additional function for an intelligent secondary substation (see Section “Fault Location, Intelligent Substations and Applications for Condition Monitoring” for a description of an intelligent substation).

Figure 23 presents the principal idea of the function of an on-load tap changer. Before a tap change, the voltage of an (electric) path drops below the lower voltage limit. When this voltage drop is detected by the voltage sensors, the tap position is moved from one to another one so, that the voltage stays between the upper and the lower voltage limits along the whole path. In the figure the voltage profile of a path is improved by changing the tap position to avoid a violation of the lower voltage limit. The same action of a tap change could be taken in the opposite direction so that voltage is impeded from exceeding the upper limit by moving the tap position in the other direction. The same principle of control applies to voltage at any point of the network; the voltage profiles of all electrical paths have to stay between the lower and the upper voltage limits in any given node at any time.

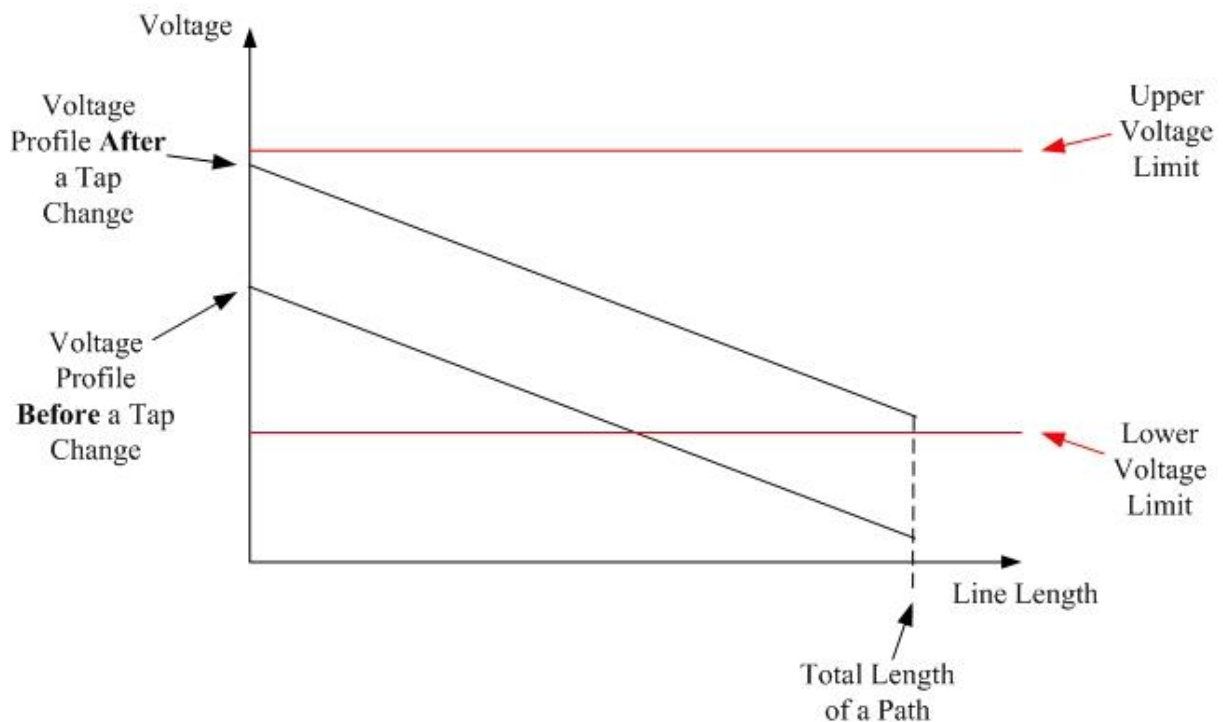

Figure 23: The principal concept of how a tap changer works. A simplified voltage profiles of the same path (or line) after and before a change in the transformer tap position. Before the change, a voltage drop violating the lower voltage limit is experienced. After the change, voltage remains within the allowed limits. It is supposed that the shape of the voltage profile does not change when the position of the tap is changed, but only shifts up vertically. The figure does not represent a realistic case, but the idea is to provide an idea about the purpose on-load tap changers.

The case of Figure 23 is a highly simplified situation and does not represent any practical case. In reality the voltage profile is not static over time, but fluctuates constantly depending upon the loading of the network. This leads to a conclusion that the optimal positions and the optimal number of sensors is highly dependent on the voltage profile of the line, which, in turn, depends highly on the load and the generation of the network.

One of the principal constraints in the design of low voltage networks is the vast extension of the low voltage networks. Since it is not advised to dedicate significant time of the design of one network, the planning process has to be as fast and as straightforward as possible. This aspect has been taken into account in the studies by automating the simulations as far as possible. One of the indirect objectives of the study is to develop a tool that could be used by ERDF in the planning of low voltage networks. ERDF uses PowerFactory as a standard tool for power system analysis. That is why the analysis is done as far as possible by using PowerFactory and the use of other analysis software is avoided. In this way, the maximum integration of the scripts for the planning processes of ERDF is aspired.

4.1. Description of the Methodology and the Results

The simulations are done by using PowerFactory (Version 15.2) by DIgSILENT Programming Language (DPL). A DPL script has been written in order to detect the locations of the voltage measurements so that the maximum and the minimum values of voltages of a given network are observed at any given moment with a sufficient accuracy by using the minimum number of measurements possible. The objective is to use the information to control an on-load tap changer of a distribution transformer so that the minimum and the maximum voltage of the whole low voltage networks are taken into account rather than measuring voltage only on the secondary side of the transformer. In this case it is more important to know the value of the maximum and minimum voltage than the location of the voltages. This is because a change in the tap position of the tap changer affects the whole low voltage network and anyway it is not possible to affect only one part of the networks, such as only one feeder, separately. It is highlighted that the final objective of the placement of voltage measurements is to use them to measure the maximum and the minimum voltage of the network at any given moment so that those measurements are close enough to the real maximum and minimum voltages.

Along this section, the “maximum voltage” and the “minimum voltage” are mentioned several times. An important remark is that the maximum and minimum values of voltage should not be confused with “over voltage” or a “voltage drop”. The extreme values of voltage may or may not exceed the allowed voltage limits, but the maximum and minimum voltage itself are not synonyms of over voltage and a voltage drop.

The algorithm to place voltage measurements in a low voltage network works as follows:

- 1) Run unbalanced load flow in 10-minute time steps over four typical days (two winter days and two summer days). Consequently, 576 load flows are executed.

Select a customer that is connected to the same terminal and the phase that experiences at least one time the maximum or the minimum voltage in any of the executed 576 load flows.

- 2) If a terminal is directly connected to at least one three-phase customer, a three-phase customer is selected instead of a single-phase customer.

To obtain the results, the algorithm is run on 38 low voltage networks from the distribution network operated by ERDF. Each network model includes the load data from four different days of the year that together cover the very different conditions of loading. Namely, the days represent

- a winter weekday,
- a winter bank holiday,
- a summer weekday,
- a summer bank holiday.

The networks are of different types and sizes, the number of customers ranging from 1 to 255. The networks form a representative set of French urban and semi-urban networks. It is important to mention that the selected winter and summer days cover the extreme loading conditions: high load and low power generation in the wintertime, and on the contrary, low load and high power generation in the summertime. It is important to consider a weekday and a bank holiday of both seasons, since these are the two main types of days in terms of load.

The networks include both one-phase and three-phase connected low voltage customers. A large part of the networks includes also distributed generation. Details of individual networks are not revealed due to confidentiality. The names of the networks, loads or any components do not correspond to their real names. The objective is to test the developed methodology by using real and representative low voltage networks. This objective is achieved through the use of the chosen networks.

The script goes through all given study cases (different days of the year) and detects all points of customer connections that measure at least once the highest or the lowest voltage in the network. It is noteworthy to mention that only the nodes where customers are connected (terminals with customer connections) are considered. For example, many times the highest voltage of a low voltage network can be found in the bus bar of the distribution transformer. Usually there are no customers connected directly to the bus bar, which means that the highest voltage, in that moment, can be measured at the nearest point of a customer connection. Usually low voltage networks are built so that there is a customer relatively near to any point of the network. Because of this, there is not much error between the highest voltage of the network and the measured highest voltage of the network. As an output, the script gives the customers where the voltages are measured so that the maximum and the minimum voltage of the low voltage network are known at any given moment over the four days. It is important to note that phase voltage refers to voltage between a phase wire and a neutral conductor in this context, not a voltage between a phase wire and the earth. This is an important remark because in reality phase-to-neutral and phase-to-ground voltage can be very different due to feeder unbalance. An example of this can be seen in Figure 24 and Figure 25. The first one presents phase-to-ground voltages and the second one phase-to-ground voltages on the same feeder at the same moment.

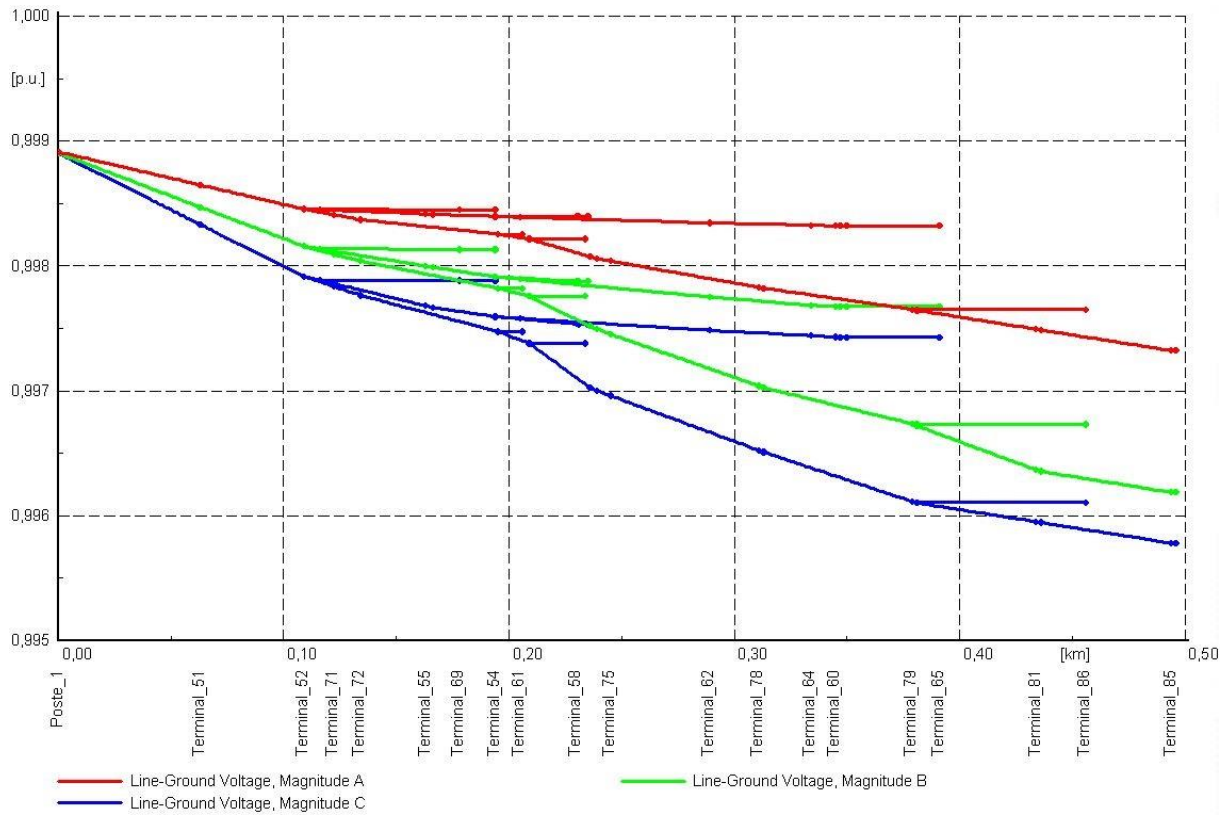

Figure 24: Voltage profiles (phase-to-ground voltage) along a feeder on a winter working day at 21h.

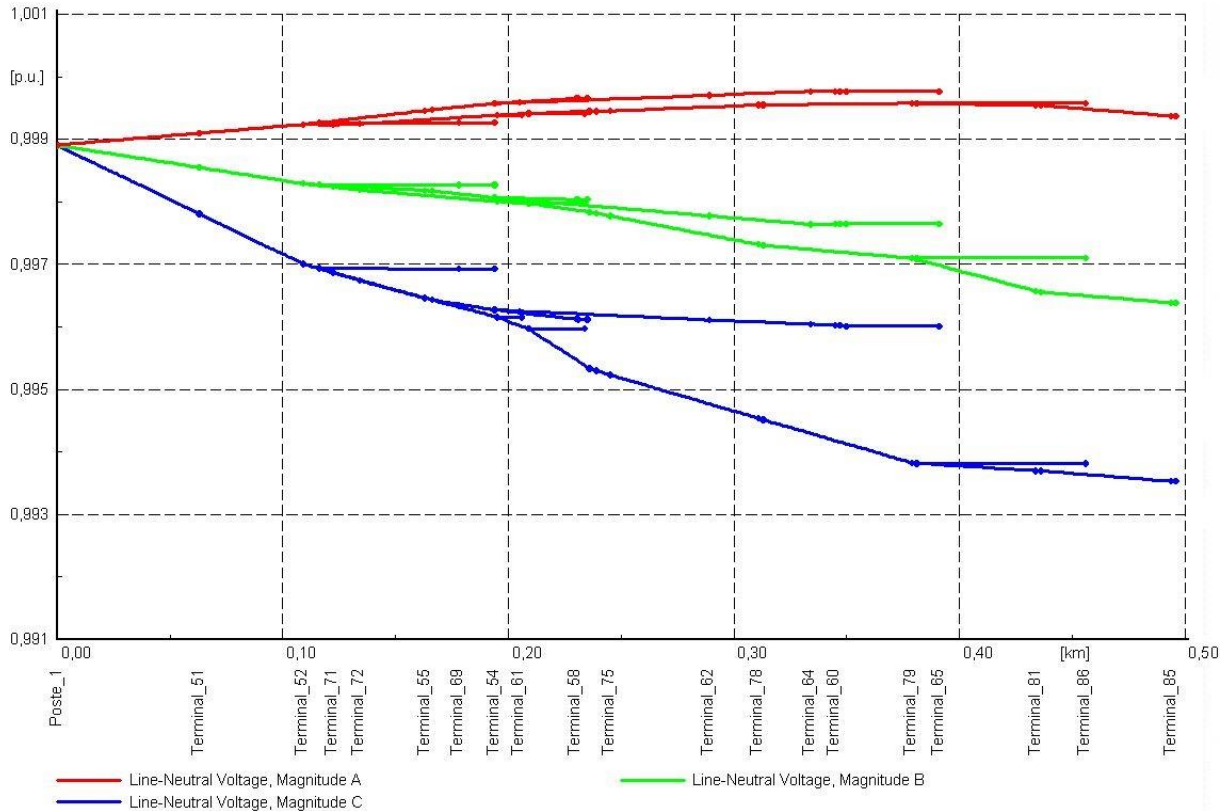

Figure 25: Voltage profiles (phase-to-neutral voltage) along a feeder on a winter working day at 21h. The feeder and the hour is the same as in Figure 24.

Due to the unbalanced nature of the low voltage networks, three-phase power flow is used. In all networks, there may be single phase and/or three-phase connected customers. It is supposed that the measurements can be placed only in the same phase as the corresponding customer. If a network terminal has both a three-phase customer and single phase customers, the measurement is placed in the location of the three-phase customer. In such a way, the voltages of all three phases can be measured by one measurement in one terminal rather than installing several voltage measurements to measure voltages in the same terminal. For example, it is more straightforward to measure the voltage of phase A, B and C at one customer than measuring the voltage of phases A, B and C in separate customers. Giving the preference to the three-phase customer reduces the total number of voltage measurement devices in some networks. Due to the high number of different possibilities in the loading, it is not obvious to find the exact placements of the voltage measurements only by knowing the network topology. That is why the loads must be considered and load flow forms an essential part of the algorithm.

It must be noted that the three-phase customers are modelled as balanced loads, even if this was not always the case. In reality, the balance of a three-phase load depends on how the phases are distributed in the load. The phases are seldom loaded equally, except if the load consists of an electrical machine that loads all three phases equally by nature.

The script runs unbalanced load flows every 10 minutes over the given four case studies, 576 load flows per network. In the load data provided by ERDF, the resolution of the load data is mostly one hour. This means that all the 10-minute time steps have the same value during the same hour. As a result, it gives the names of the loads where the voltage

measurements should be placed so that the maximum and the minimum voltage is known any given moment in the network. However, the resolution of 10 minutes is exploited when the synthetic load curves are made (later on in this thesis). The same script can be run on any given number of networks by one execution and print the results to an external file.

4.1.1. The Number of Voltage Measurements for Automatic Online Tap Changer - Application based on the Load Data of Four Days

The developed algorithm (described in Section “Description of the Methodology and the Results”) is run on the mentioned 38 low voltage networks. The name of each network, the number of customers and the number of voltage measurements suggested by the DPL script are shown in Table 2. Additionally, the number of voltage measurements divided by the number of customers in the same network is included in the table. This is to make the comparison of the results of the networks of different sizes easier. Figure 26 shows the percentage of customers to be equipped with a voltage measurement as a function of the number of customers in a low voltage network.

Table 2: The results of the DPL script run on 38 analysed low voltage networks. “The Number of Voltage Measurements to be Placed” (the third column from left) is obtained by using the algorithm developed in Section “Description of the Methodology and the Results”.

The Name of the Network	The Number of Customers	The Number of Voltage Measurements to be Placed	The Percentage of Customers to be Equipped with a Voltage Measurement
Network 1	128	7	5.5
Network 2	150	11	7.3
Network 3	140	4	2.9
Network 4	160	11	6.9
Network 5	177	10	5.6
Network 6	54	3	5.6
Network 7	92	2	2.2
Network 8	141	4	2.8
Network 9	181	8	4.4
Network 10	200	5	2.5
Network 11	47	2	4.3
Network 12	67	6	9.0
Network 13	120	7	5.8
Network 14	56	5	8.9
Network 15	104	5	4.8
Network 16	32	2	6.3
Network 17	23	5	21.7

Network 18	47	7	14.9
Network 19	67	3	4.5
Network 20	183	4	2.2
Network 21	114	5	4.4
Network 22	28	4	14.3
Network 23	61	6	9.8
Network 24	255	6	2.4
Network 25	122	5	4.1
Network 26	8	2	25.0
Network 27	1	1	100.0
Network 28	50	7	14.0
Network 29	74	3	4.1
Network 30	144	8	5.6
Network 31	231	6	2.6
Network 32	64	2	3.1
Network 33	26	3	11.5
Network 34	68	2	2.9
Network 35	284	7	2.5
Network 36	181	2	1.1
Network 37	196	2	1.0
Network 38	90	4	4.4

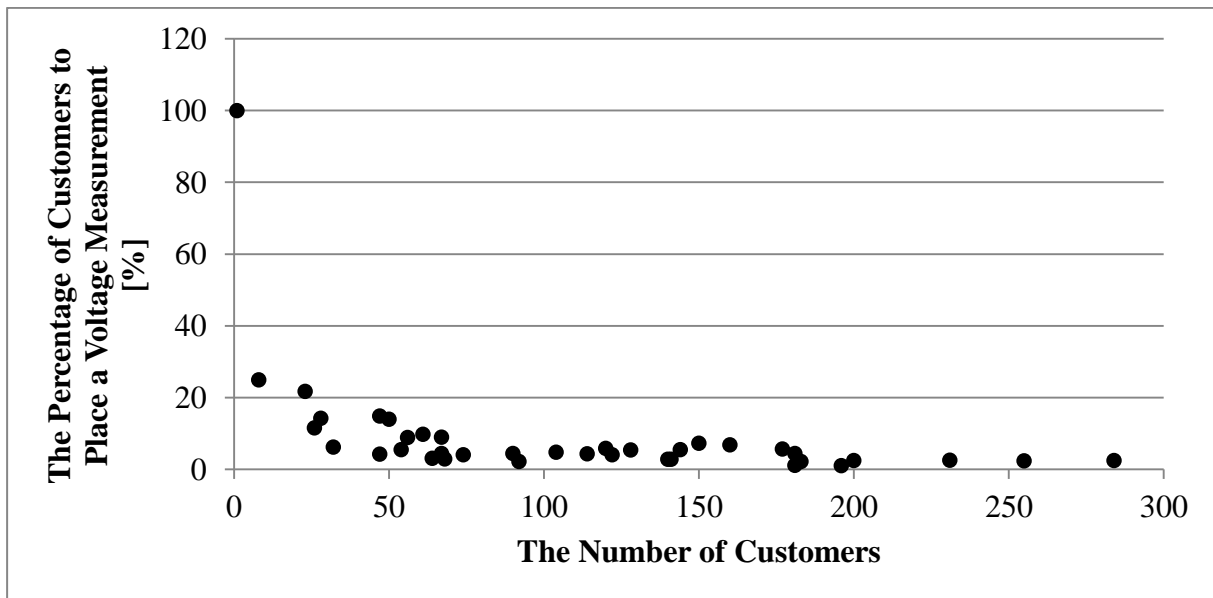

Figure 26: The percentage of customers to place a voltage sensor presented as a function of the number of customers in the low voltage network.

4.1.2. Accuracy of the Voltage Estimation due to Loss of Measurements

In this section, the impact of loss of measurements on the estimation of voltage is studied. The purpose is to study the robustness of the sensor placement if one or several voltage measurements are lost due to loss of information in the communication media or if sensors are broken. This means that, for example, if five voltage measurements should be placed in a network according to the methodology presented in Section “Description of the Methodology and the Results” and one of the five measurements is lost, how much does the error in the estimation increase. Another intention of this study is to see whether an accurate estimation of the maximum and the minimum voltage can be obtained with a lower number of voltage measurements than suggested by the abovementioned methodology. Even if the number of required voltage measurements is relatively low, it is useful to verify whether the number can be decreased. On the other hand, if the accuracy does not suffer drastically due to a loss on one or two voltage measurements, it confirms the security of the voltage measurements.

Analysis is carried out by using the voltages from the voltage measurements in 10-minute time step over four days as explained in Section “Description of the Methodology and the Results”. If the methodology to place voltage sensors gives as a result, for example, five voltage measurements and voltage measurements are placed to those locations, perfect estimations of the maximum and the minimum voltages are obtained always when the same load information is used. Thus, the error is zero at every time step. Instead of five voltage measurements, if four measurements are allowed to be placed in the network (simulates the situation that one voltage measurement fails), the locations of four voltage measurements are placed in a way that the smallest possible error is obtained. The total error is the sum between the error between the maximum phase-to-neutral voltage of the network (ΔV_α) and the maximum measured phase-to-neutral voltage summed to the error between the minimum phase-to-neutral voltage and the minimum measured phase-to-neutral voltage (ΔV_β), as presented in Figure 27. Thus, the maximum value over all total errors during all 576 time steps is searched for each network.

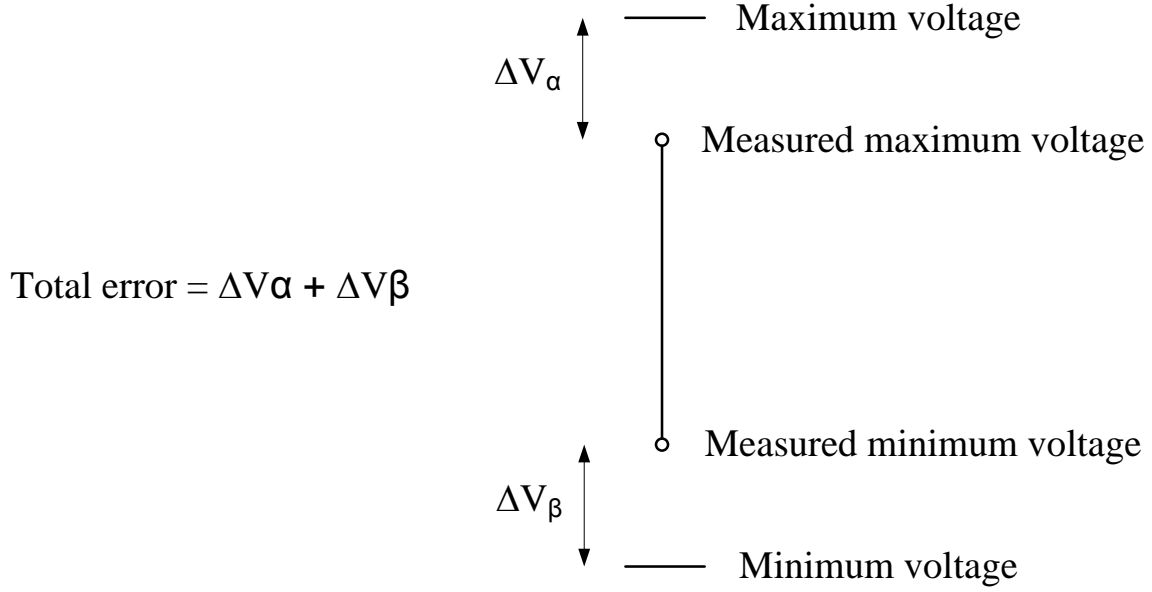

Figure 27: An illustration of how the total error is defined in the calculation.

In order to solve the problem, the measured voltages are organised in the form of a matrix so that one column corresponds the voltages of one measurement and one row (m) corresponds one time step. All time steps are organised to the same matrix so that the matrix has 576 rows and N columns (N is the total number of voltage measurements in the network). n is the number of active voltage measurements. Voltage measurements are activated and deactivated so that $n \leq N$. An active voltage measurements corresponds a successful measurement and a deactivated voltage measurement corresponds a failed measurement. If $n < N$ a combination of voltage measurements is found so that the maximum error is minimised.

Vectors of voltages V_{upper} and V_{lower} are stated as

$$V_{upper}(i) = \max_j V_{ij} \tag{1}$$

$$V_{lower}(i) = \min_j V_{ij}.$$

The objective function of the problems is formulated as follows,

$$\min_a \max_{1 \leq i \leq m} \left(V'_{lower}(i) - V_{lower}(i) + V_{upper}(i) - V'_{upper}(i) \right). \tag{2}$$

Vectors V_{upper} and V_{lower} refer to the upper and lower measurements among all voltage measurements and V'_{upper} and V'_{lower} refer to the voltages with a reduced set of voltage measurements. When $n = N$, $V_{upper} = V'_{upper}$ and $V_{lower} = V'_{lower}$. That is, when all voltage measurements are activated. $a = 1$ when the corresponding voltage measurement is activated and $a = 0$ when it is deactivated. The objective is to find the placements of the voltage measurements so that the maximum error between the upper and the lower voltages is minimised.

The constraints of the problem are,

$$\left\{ \begin{array}{l} \forall i \leq m \quad V'_{upper}(i) = \max_j a_j V_{ij} \\ \forall i \leq m \quad V'_{lower}(i) = \min_j a_j V_{ij} + (1 - a_j) * V_{upper}(i) \\ \sum_j a_j \leq n \\ V'_{lower}, V'_{upper} \in R^m, a \in \{0; 1\}^N \end{array} \right. . \quad (3)$$

The first line (from above) of Equation 3 finds the maximum voltage among all activated measurements (where $a = 1$). The second line finds the lowest voltage among the voltages with activated measurements. The purpose of the term $(1 - a_j) * V_{upper}(i)$ is to separate the values where there is no voltage measurement (and thus are zeros) from the minimum values where there are voltage measurements (higher than zero). In this way, the zeros indicating that there is no voltage measurement are not selected as minimum voltages. The third line in Equation 3 the sum of a has to be smaller or equal to the number of active voltage measurements. The fourth line defines the dimensions of the variables.

In order to be able to solve the problem, the equations are linearized. Two used linearization techniques are presented here in a general manner.

The first technique is used to linearize the product $d_3 = d_1 d_2$ of two binary variables d_1 and d_2 . This is formulated as follows [242],

$$\left\{ \begin{array}{l} d_3 \leq d_1 \\ d_3 \leq d_2 \\ d_3 \geq d_1 + d_2 - 1 \end{array} \right. . \quad (4)$$

The second technique is applied to linearize the notation of the maximum $y = \max \{x_1, x_2, x_3, \dots, x_n\}$, of the binary variables x_1, \dots, x_n . Binary variables d_1, \dots, d_n are introduced so that $d_i = 1$ if x_i is the minimum value, otherwise 0. The method is formulated as [242],

$$\begin{cases} L_i \leq x_i \leq U_i \\ y \geq x_i \\ y \leq x_i + (U_{max} - L_i)(1 - d_i) \\ \sum_i d_i = 1 \end{cases} \quad (5)$$

U_i and L_i are the upper and the lower boundaries. U_{max} is the maximum value among U_i .

From the 38 networks (also used in Section “The Number of Voltage Measurements for Automatic Online Tap Changer -Application based on the Load Data of Four Days”) 37 are used in this study. Network 27 is discarded because it has only one customer and is not interesting for this study. The optimisation is carried out by using General Algebraic Modeling System (GAMS) and Cplex solver. The sum of maximum errors at every number of active voltage measurements is presented in Figure 28. Total errors presented in the figure are the errors when estimating the maximum voltage plus the error when estimating the minimum voltage.

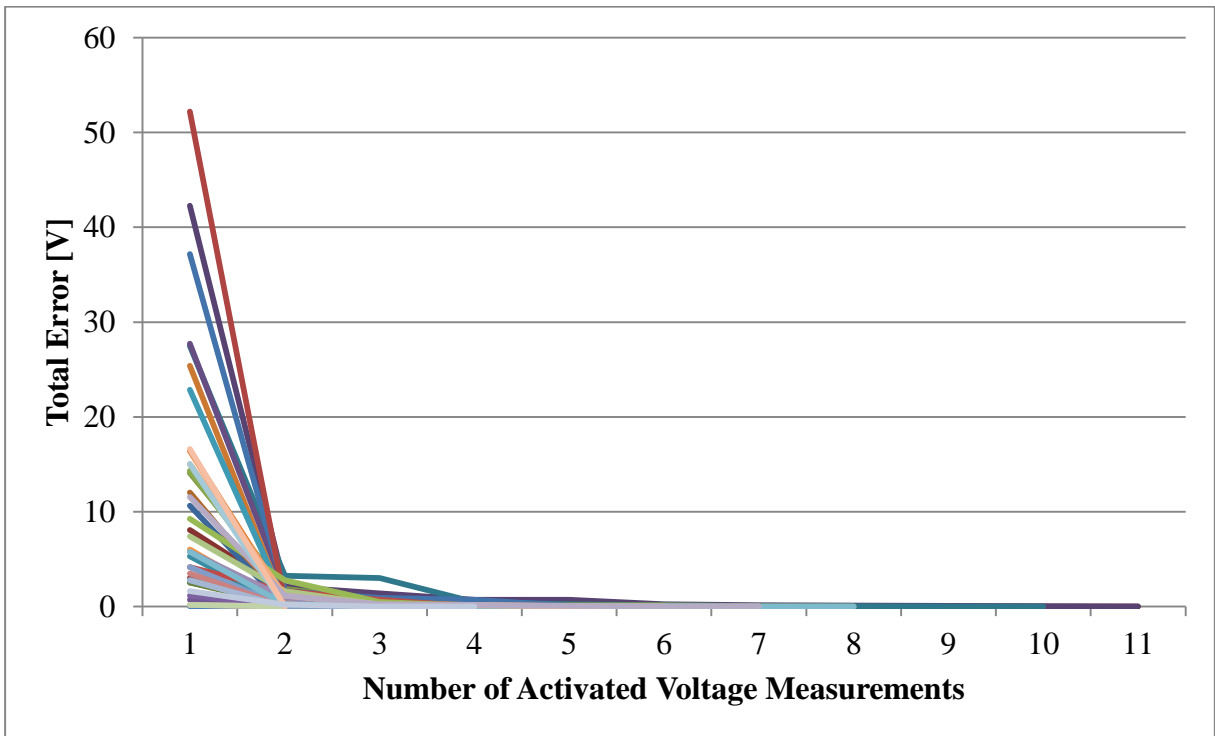

Figure 28: The total errors in all the studied networks in different number of activated voltage measurements. One curve presents one network. It should be noted that the total error is the sum between the errors when estimating the maximum and the minimum voltages.

4.1.3. Robustness of the Methodology against Minor Changes in the Network

In this section, it is studied how much the error of the voltage estimation increases when new customers and photovoltaic generators are added to the network. It should be highlighted that the idea is to add only a modest amount of customers. This is because if a network experienced significant changes, the local distribution system operator would relocate the voltage sensor in order to control an on-load tap changer. However, this may not be the case if the loading conditions change only slightly.

In this study, the previously presented 38 low voltage networks are used. The number of customers is increased by five per cent in each network. The number of added customers is estimated by calculating five per cent of the customers and rounded it to the closest integer value so that at least one new customer is added to each network. Additionally, the same number as new customers, photovoltaic generators are added to the network. All new customers are single-phase connected and have different load curves. The new photovoltaic generators are also single-phase connected and have the same output curve (assuming the same solar radiation for all photovoltaic panels). The photovoltaic generators are relatively small, having the nominal rating of 3 kVA. The terminals where the new customers and the photovoltaic generators are connected are chosen randomly as well as their phase connections. Network 27 is discarded in this study because it has only one customer. Thus, the required number of voltage measurements does not change.

The study is carried out as follows:

1. Place the voltage measurements to the network according to the methodology presented in Section “Description of the Methodology and the Results”. Note that these are the customers where voltage should be measured in order to have a perfect estimation of the minimum and the maximum value of voltage under the simulated circumstances.
2. Connect the new customers and the photovoltaic generators to the network.
3. Calculate the maximum and the minimum values of voltage in 10-minute time steps over four days between all customers (including the new customers) in the network.
4. Calculate the maximum and the minimum values of voltage in 10-minute time steps over four days among the customers obtained in Step 1.
5. Calculate the error between the maximum values of voltage in every time step in Step 3 and in Step 4. Repeat the same between the minimum values in Step 3 and in Step 4.

It may be that the optimal locations for measuring the maximum and the minimum voltages change after the connection of the new customers. If they change, an error between the real and the estimated maximum voltage occurs. The same is valid for the minimum voltage.

When five per cent of new customers are added, the required number of voltage measurements changes in 28 networks and remains unchanged in nine networks. The number of additional voltage measurements as well as the number of voltage measurements before and after the addition of the new customers and the photovoltaic generators are presented in

Table 3. In the nine networks where the number of voltage measurements does not change, the location of one voltage measurements changes in one network. In the remaining eight networks, there are no changes in the placements of the sensors, which means the in those eight networks, there is no error between the estimated and the real values of the maximum and the minimum voltage.

Table 3: The number of additional voltage measurements required after the addition of new customers and photovoltaic generators. Also the number of voltage measurements before and after the network changes. A negative value means that a lower number of voltage measurements are required after than before the changes. Note that only the networks where the total number of voltage measurements changes, are taken into account.

Network	The Number of Additional Voltage Measurements	The Number of Voltage Measurements before the Changes in the Network	The Number of Voltage Measurements after the Changes in the Network
Network 1	5	7	12
Network 2	2	11	13
Network 3	5	4	9
Network 5	8	10	18
Network 6	3	3	6
Network 7	4	2	6
Network 8	4	4	8
Network 9	3	8	11
Network 10	5	5	10
Network 12	3	6	9
Network 13	2	7	9
Network 14	3	5	8
Network 15	1	5	6
Network 16	2	2	4
Network 17	1	5	6
Network 18	2	7	9
Network 21	2	5	7
Network 23	1	6	7
Network 24	8	6	14
Network 25	2	5	7
Network 28	-1	7	6
Network 29	1	3	4

Network 30	2	8	10
Network 31	10	6	16
Network 35	5	7	12
Network 36	1	2	3
Network 37	2	2	4
Network 38	1	4	5

The errors when estimating the maximum and the minimum values of voltage are presented in Figure 29 and in Figure 30 in the form of a duration curve. These duration curves show how the error is distributed over time. 100 per cent of time is equivalent to 148 days; four days in 37 networks.

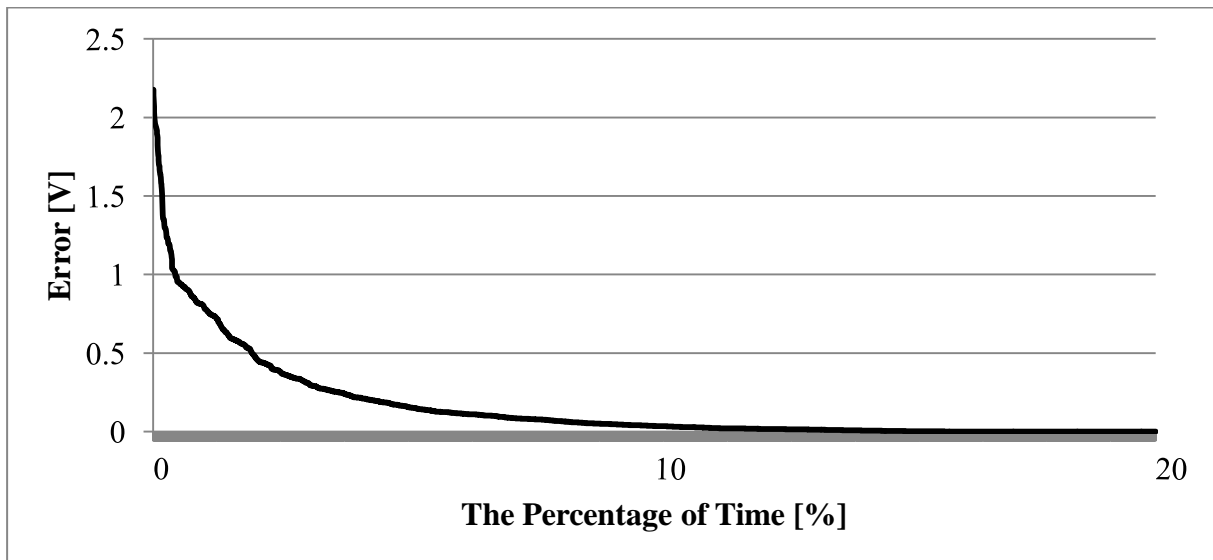

Figure 29: The error when estimating the maximum voltage. 100 % of time is equal to 148 days. In order to make the image more readable, only 20 per cent of the time frame is shown in the horizontal axis.

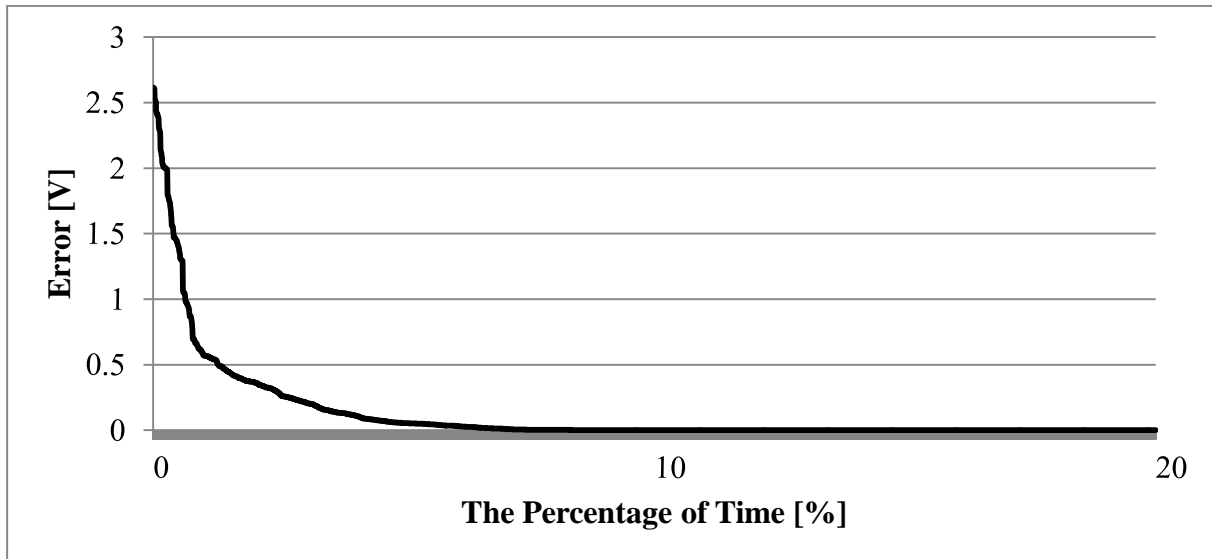

Figure 30: The error when estimating the minimum value of voltage. 100 % of time is equal to 148 days. In order to make the image more readable, only 20 per cent of the time frame is shown in the horizontal axis.

It should be noted that an error exists less than 3 V in the estimation of both, the maximum and the minimum voltage, even in the very extreme case. When estimating the maximum voltage, the mean value is 0.03 V with the standard deviation of 0.14 V. The same figures, when estimating the minimum value, are 0.02 V and 0.16 V.

4.1.4. The Creation of New Random-based Load Curves

This section explains a straightforward method to create new load curves for individual customers. The method is explained in this section and applied in Section “The Error in Voltage Measurements for Automatic Online Tap Changer -Application when the Load Data is Extent to 400 Days”. The objective of the method is not to create fully realistic but rather statistically correct load curves. This means that when the sum of the load curves is realistic when they are grouped (for example at the secondary substation) even if the individual load curves are not realistic. In this thesis, it is important to be able to test the algorithm for placing voltage sensors under as many different loading conditions as possible so that all loading conditions are within the limits of reality. That is the fact that justifies the use of this method in the thesis. As many other things developed this thesis, a great amount of importance is given to the straightforwardness and the easy applicability of the method.

The creation of the new load curves is based on the assumption that the behaviour of each load follows Gaussian probability distribution. This hypothesis comes from the industrial expertise and is not further studied within the scope of this work. Two kinds of data are used to create a new load curve:

- the 50th percentile, that is, the mean load and
- the 90th percentile.

There is a probability of 50 per cent that a load has the value of the 50th percentile (or lower) at the given moment. Likewise, a load has the value indicated by the 90th percentile as maximum in the probability of 90 per cent. As an example, if the 90th percentile is 2 kW at 14.00h, it means that there is a probability of 90 per cent that the load is 2 kW or less at 14.00h. On the contrary, there is a probability of 10 per cent that the load is more than 2 kW at 14.00h.

By using these assumptions, the mean value and the value corresponding to 90 per cent percentile in the Gaussian probability curve are known for each customer during each time step.

Based on this information, the script

1. calculates the standard deviation and
2. draws a new value for that load at that time step in a random manner according to the Gaussian probability distribution.

If the drawn value is negative at any given moment, the value of the load will be set to 0 kW at that moment. If the value drawn by the method surpasses the contracted power of the named customer, the consumption at that moment will be set at the maximum power. The problematic of creating artificial load curves based on probabilistic methods are also addressed with success in [243] and in [244].

Figure 31 and Figure 32 demonstrate the function of the method that creates random load curves. In both figures 10000 random values are generated for the same load (at the same moment) with the mean value (50 per cent percentile) of 3.54 kW, the 90 per cent percentile of 5.63 kW and the standard deviation of 1.63 kW. Figure 31 shows a histogram of the generated values in the case when no lower or upper constraints of the load value are set. Figure 32 shows the histogram in the situation where the lower and the upper constraints are set as explained earlier. The difference between the calculated and the theoretical values is slightly larger when the constraints are set (Figure 32) in comparison with the case when the constraints are not set (Figure 31). The effect of the lower constraint (0 kW) can be seen in Figure 32 as a small peak in the very left of the histogram. This is because the values that would have been negative are set to 0 kW. Despite the minor distortion of the Gaussian curve, the values are close enough in order to be realistic. A clear Gaussian form is visible in both histograms.

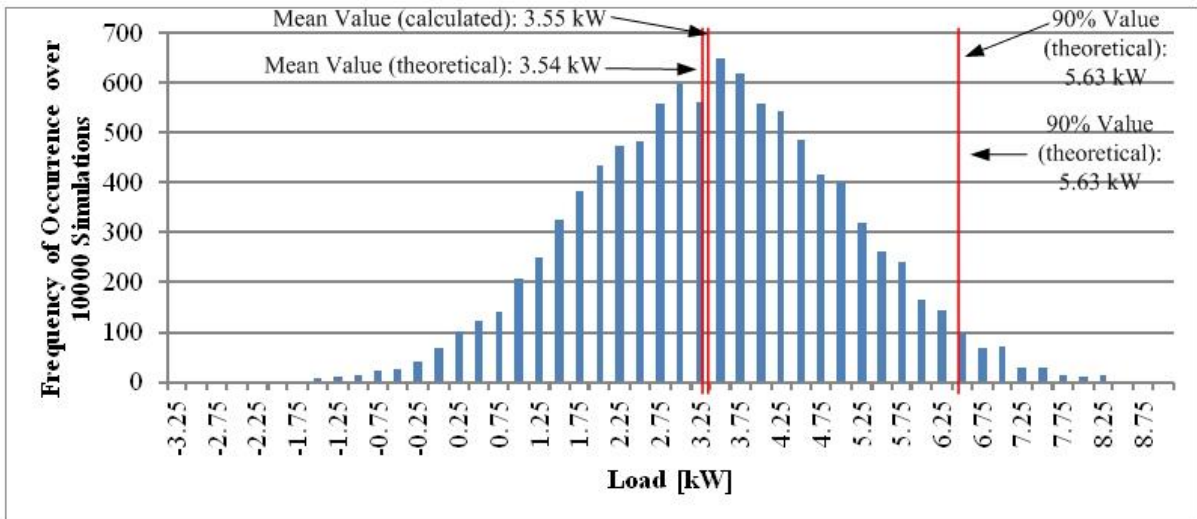

Figure 31: A histogram of random values generated according to the Gaussian distribution in the case where no lower or upper limits are set. The horizontal axis presents the value of the load and the vertical axis shows how many times the values in a certain interval occur over 10000 simulations. The theoretical values refer to the input values for the random number generator and the calculated values are the values calculated based on the output of the random number generator.

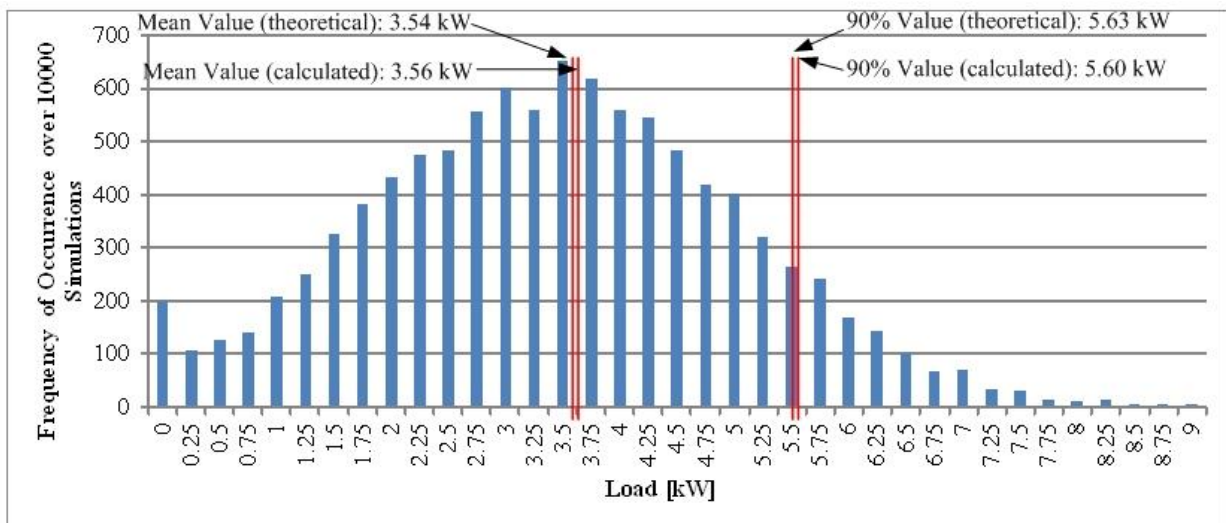

Figure 32: A histogram of random values generated according to the Gaussian distribution in the case where no lower or upper limits are set. The horizontal axis presents the value of the load and the vertical axis shows how many times the values in a certain interval occur over 10000 simulations. The theoretical values refer to the input values for the random number generator and the calculated values are the values calculated based on the output of the random number generator. The effect of the lower limit (0 kW) can be seen as accumulated values on the left hand side of the histogram.

Figure 33 shows the 90th and the 50th percentiles of one customer over one day. Figure 34 illustrates the new load curve generated by the algorithm based on two curves presented in

Figure 33. The two figures are presented separated for the sake of clarity. Finally, Figure 35 presents all curves presented in Figure 33 and in Figure 34 in one figure so that all curves can be compared easily. Figure 36 presents another example but, in this case, both the input (the 90th percentile and the 50th percentile) and the output (the random) curves of the algorithm are presented in one figure. Note that the customer of Figure 36 is different than in Figure 33, in Figure 34 and in Figure 35.

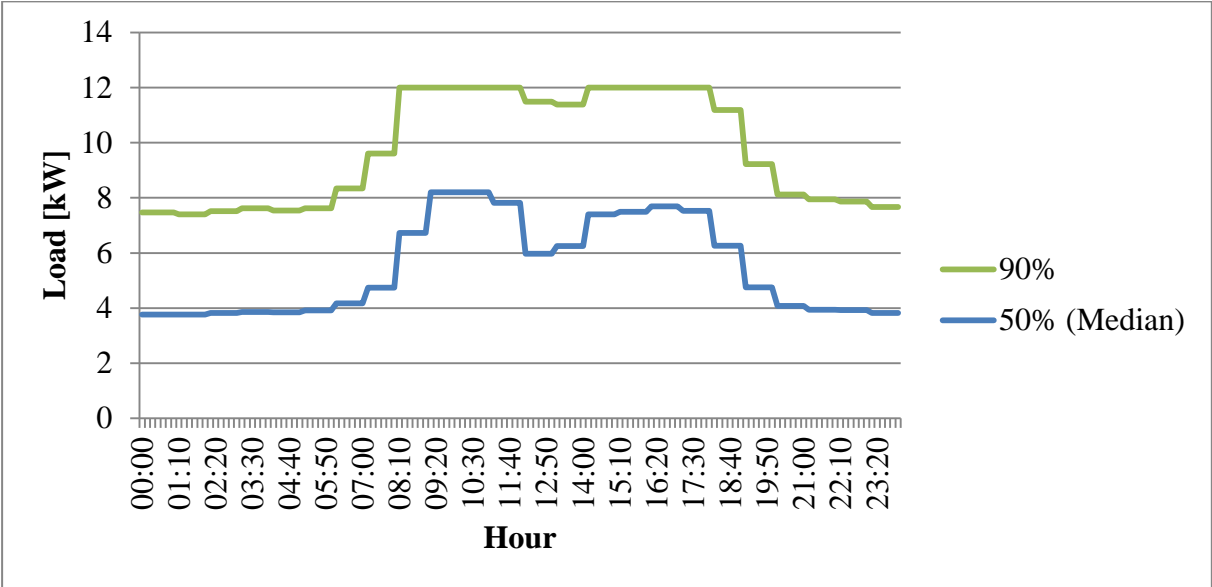

Figure 33: The curves of the 90th (the green curve) and the 50th (the blue curve) percentile of a single-phase customer during a winter working day. These curves are given as an input to the algorithm that creates a new load curve. The new load curve is illustrated in Figure 34.

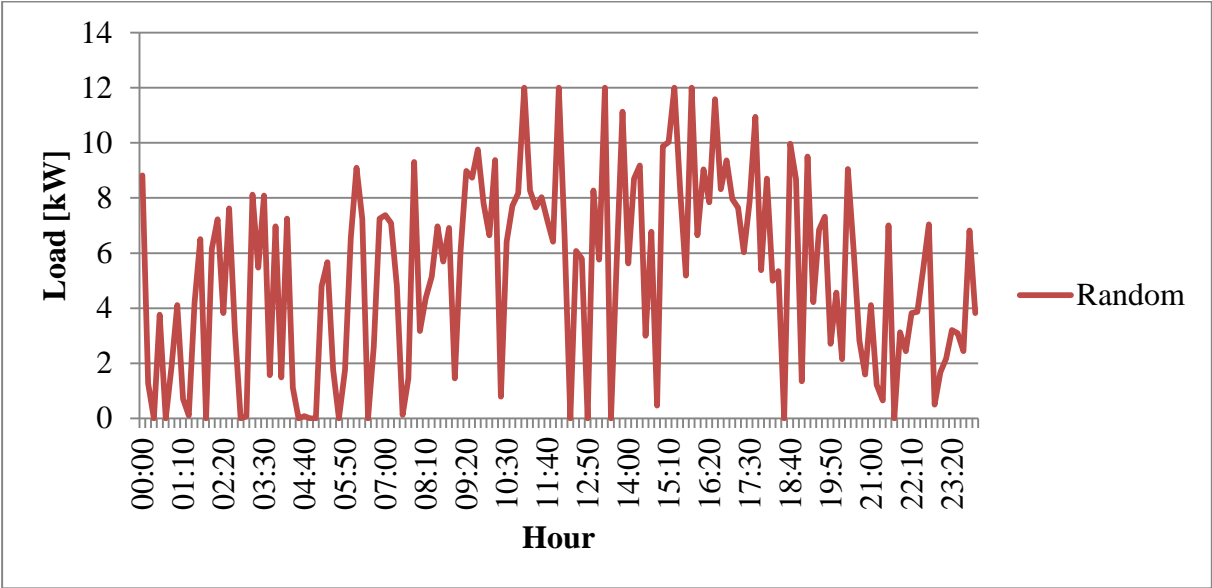

Figure 34: A new load curve generated by the algorithm based on two curves illustrated in Figure 33.

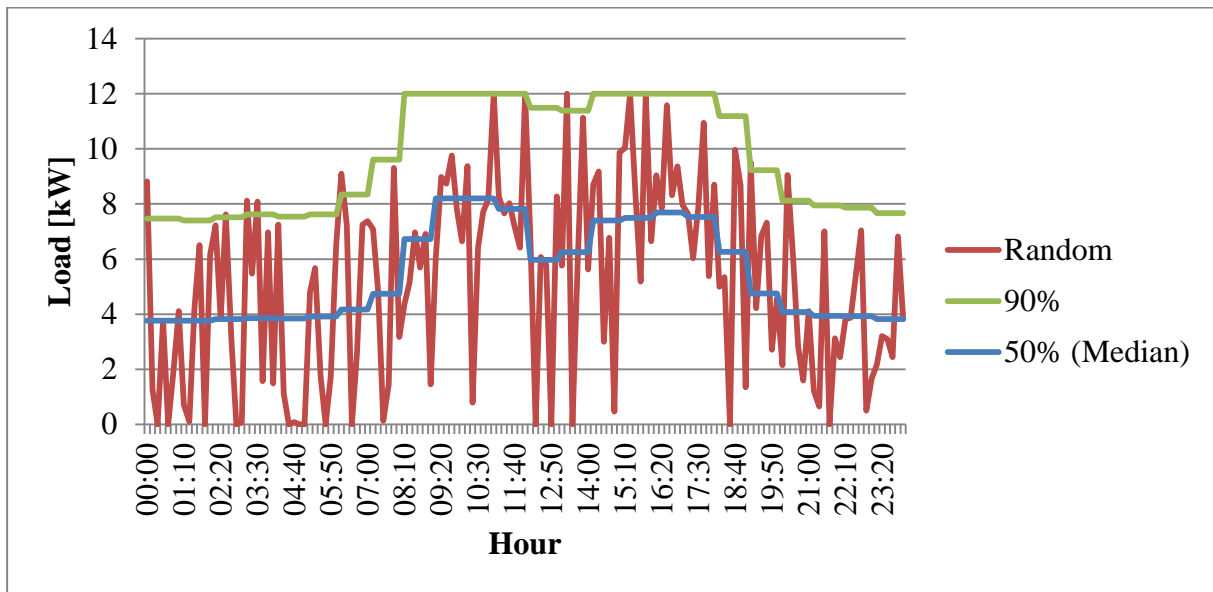

Figure 35: An example load curve generated by the algorithm. The curves 90% (the green curve) and 50% percentiles (the blue curve) are the inputs to the algorithm and the curve Random (the red curve) is the output from the algorithm. The load is a one-phase customer during a winter working day with the contracted power of 12 kW.

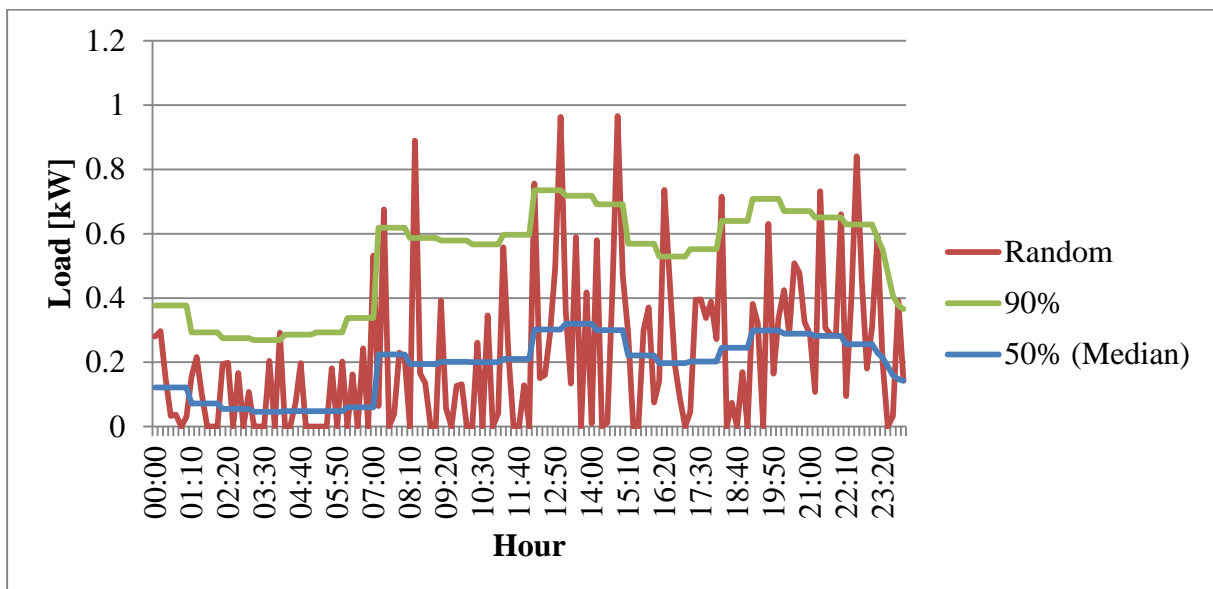

Figure 36: An example curve generated by the algorithm (the red curve) together with the 90th percentile (the green curve) and the 50th percentile (the blue curve). The load is a one-phase customer during a summer working day. The contracted power of the customer is 9 kW.

In the simulations of this thesis, the load curves of photovoltaic panels are changed by using a similar approach than in case of customers. Randomised values are drawn according to the

Gaussian curve by using the mean value and the 90 per cent percentile based on real measurements in the same city area than where the networks are located. Load curves of similar forms are used for all photovoltaic generators. This is due to the fact that all generators within the same network are located in a relatively small area, so it is justified to suppose that the solar radiation is the same for all generators.

4.1.5. The Error in Voltage Measurements for Automatic Online Tap Changer - Application when the Load Data is Extent to 400 Days

The algorithm used to create random load curves (presented in Section “The Creation of New Random-based Load Curves”) allows creating artificial but statistically realistic load curves efficiently. The used load curves of 400 days are modifications of the load curves of the four days used in Section “The Number of Voltage Measurements for Automatic Online Tap Changer -Application based on the Load Data of Four Days”. Since the load curves of 400 days are based on the load curves of four days as mentioned, among those 400 days there are four different types of days; a winter working day, a winter bank holiday, a summer working day and a summer bank holiday. Each day type is represented by 100 times, thus, there are 400 days altogether. Naturally the proportion of the days is not correct since in reality there are more working days than bank holidays. However, the main objective is to create statistically correct load curves so that it is possible to study the voltage behaviour of the network under as many different loading situations as possible under the restriction that all situations are realistic.

It should be noted that the most of the load data used in that section had a real resolution of one hour (the value of the load remains the same during one hour). On the contrary, the load data used in this section has a resolution of 10 minutes in all cases. It means that the number of different load conditions for each network is multiplied roughly by 600 (six time steps in one hour multiplied by 100 days) in comparison with the situation when using the load data with the resolution of one hour.

The voltage measurements that are placed in the networks by using four load curves for each customer as described Section “The Number of Voltage Measurements for Automatic Online Tap Changer -Application based on the Load Data of Four Days” are called benchmark voltage measurements. The maximum and the minimum values of those benchmark voltage measurements are compared with the maximum and the minimum values of voltages that can be measured at any point of customer connection (not only at the points where the benchmark measurements are located, because then there would be no error). The benchmark voltage measurements are only at selected locations meaning that every time when the maximum or the minimum value of voltage can be measured at the customer connection point that does not have a benchmark voltage measurement, there is an error between the benchmark voltage measurement and the real maximum or minimum voltage measurement. These errors are quantified in this section. As in the earlier section, voltage (or phase voltage) always refers to voltage between a phase wire and a neutral conductor.

Table 4 displays the results when the sensors placed according to four days of load data are placed according to the load data of 400 days in 38 networks. The mean values and the standard deviations of the errors are displayed.

Table 4: The mean value and the standard deviation of the error when maximum and minimum voltage are estimated in 38 networks.

	The Object to Estimate	
	Maximum Voltage	Minimum Voltage
The Mean Value of the Error [V]	0.02	0.03
The Standard Deviation of the Error [V]	0.11	0.26

The errors when estimating the maximum and the minimum voltage divided by the type of the day can be seen in Figure 37. The mean values are shown in columns and the respective standard deviations are located above the columns.

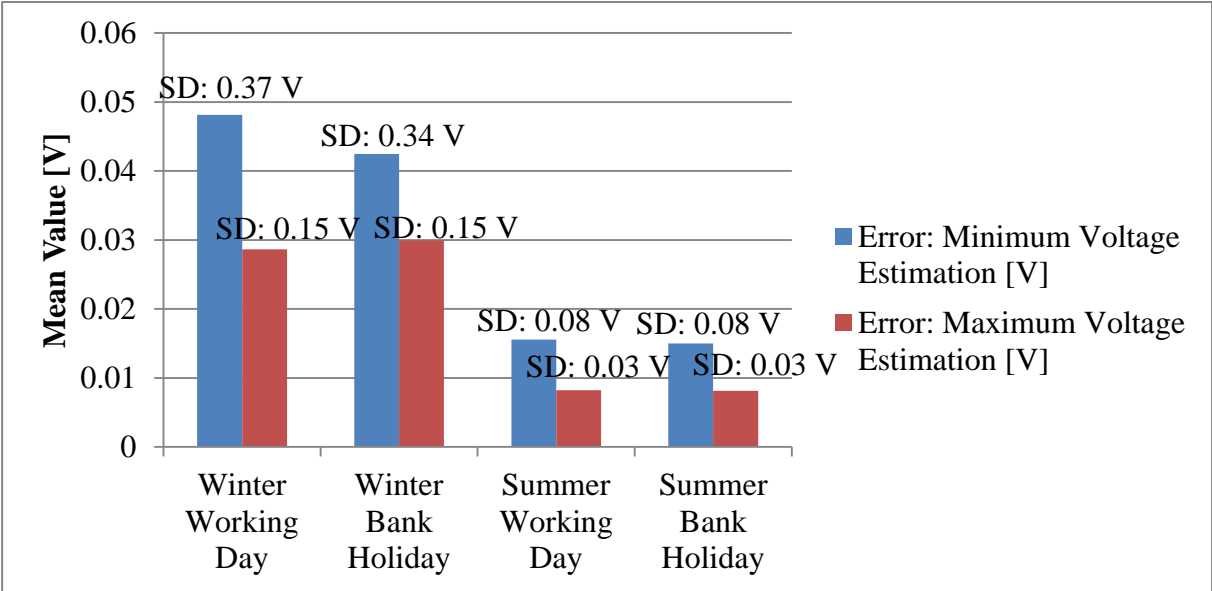

Figure 37: The mean values and the standard deviations of the errors when the maximum and the minimum voltages are estimated according to the type of the day. The abbreviation SD stands for the standard deviation.

Figure 38 presents the errors of the estimation between the networks with photovoltaic panels and the networks without photovoltaic panels. It should be noted that there are 10 networks that have photovoltaic panels and 28 networks that do not include them. Therefore, different networks are included in the two groups.

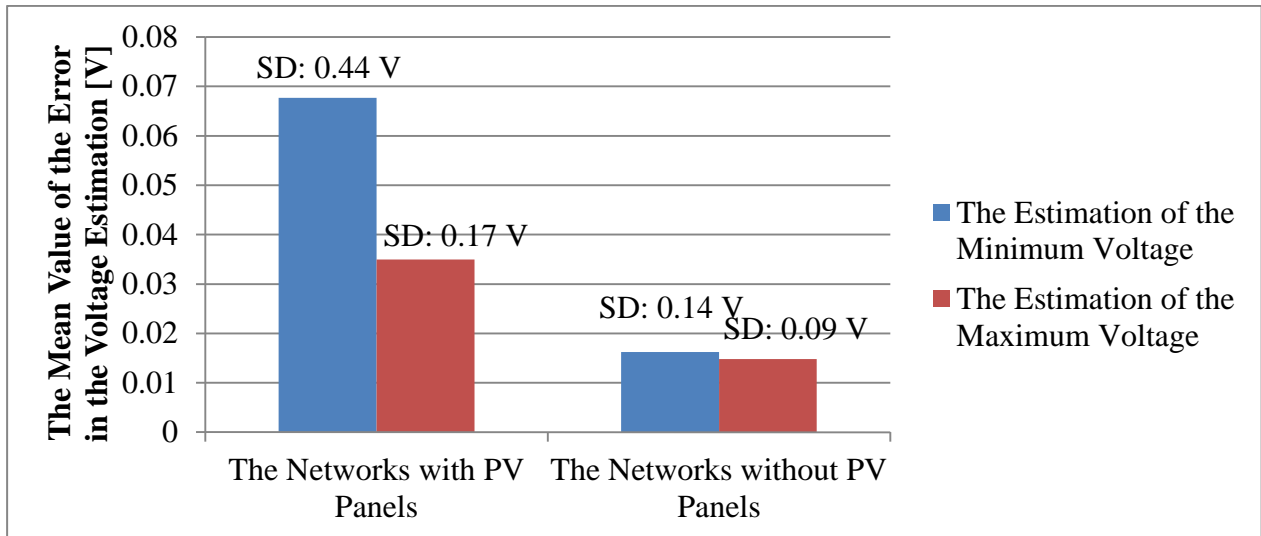

Figure 38: The errors when estimating the minimum and the maximum voltage divided by the networks with photovoltaic panels and without photovoltaic panels. The standard deviations of each case are marked on top of the columns.

4.1.5.1. An Example of Results of the Analysis on Network 10

This section presents the results of one low voltage network. The chosen network is Network 10 that is one of the 38 low voltage networks described in Section “The Number of Voltage Measurements for Automatic Online Tap Changer -Application based on the Load Data of Four Days”. Network 10 is chosen for this study because it is relatively large with its 200 customers (187 one-phase and 13 three-phase customers) and has about 2.2 kilometres of lines. It has one 400 kVA distribution transformer and one photovoltaic panel of 2.5 kVA. The results of this section are not analysed and no conclusions are drawn. This is because no general conclusions can be drawn based on the information about one network. The principal idea of this section is to show what kind of information the analysis has as an outcome. Furthermore, not all results are shown but rather different ways to organise the results of the analysis. The topology of Network 10 is shown in Figure 39, where the secondary substation is named as Poste_1.

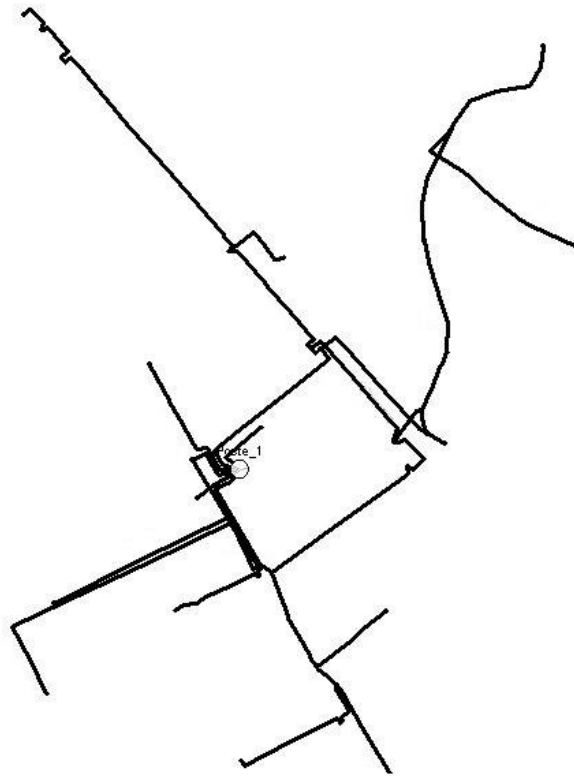

Figure 39: The topology of Network 10. The image is a screenshot from DIgSILENT PowerFactory.

Five loads are suggested as benchmark loads (the customers where the voltage measurements should be placed); Load 79, Load 162, Load 192, Load 197 and Load 200. All loads are three-phase connected except Load 192 that is connected to the phase A. The locations of the benchmark loads with their corresponding phase connections are shown in Figure 40. In other words, the benchmark loads represent the locations where the maximum or minimum voltage is met at least once when the load curves of four typical days (a “winter working day”, “winter bank holiday”, “summer working day” and “summer holiday”) are used. Figure 41 shows additional information in comparison with Figure 40 since it presents the location of the maximum and minimum voltages in the network by different colours. Additionally, Figure 41 presents the share of time of the maximum and the minimum value of voltage in each location over four days.

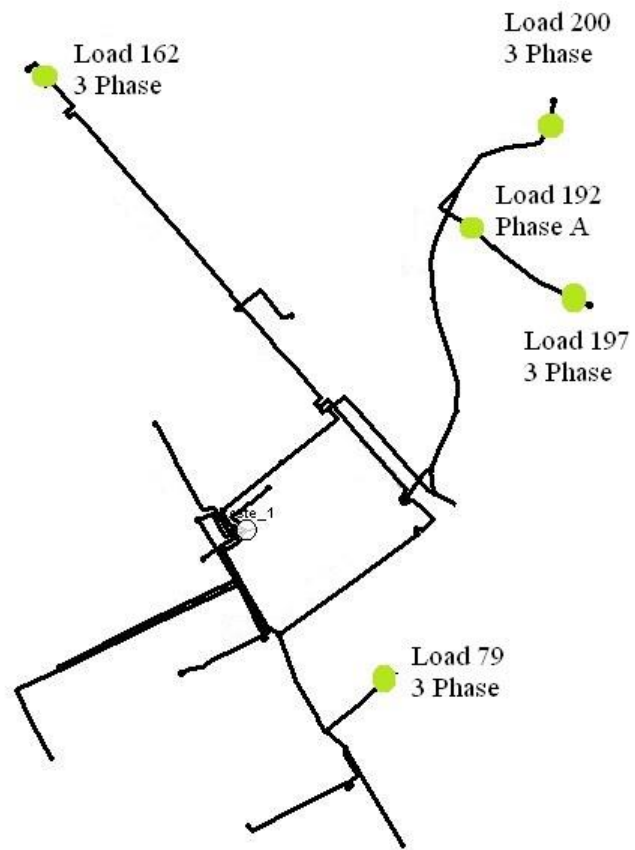

Figure 40: The locations and the phase connections of the benchmark loads. The image is a screenshot from PowerFactory with superposed locations of the benchmark loads.

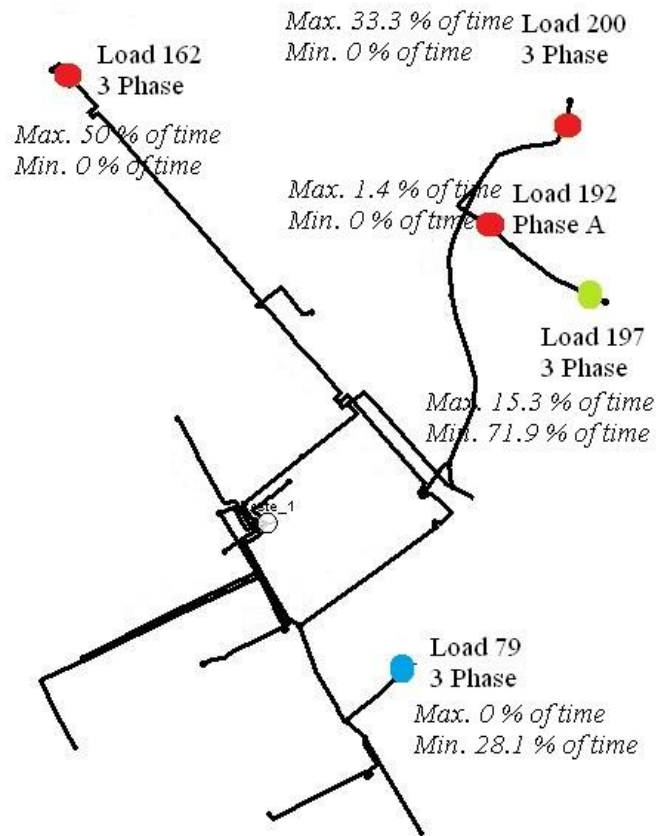

Figure 41: The distribution of the maximum and minimum values of voltage showed in the example network. The locations of the voltage sensors (based on the data of four days) are marked by points of different colours. The red points represent the locations where the maximum voltage is met at least once over all simulations. The blue point represents the location of the minimum voltage. The green colour stands for the point where both, maximum and minimum voltages, are met. The share of how many per cent of time the maximum and minimum voltages are met in each point, are marked in the figure.

There are relatively few locations of voltage sensors (five in this example). This means that there are few loads that have a dominating importance on the voltage profiles of the feeders. Even maximum voltages are met at the ends of the feeders due to unbalance. The minimum values are at the ends of the feeders due to decreasing nature of a voltage profile when moving towards the end of the feeder. The image is a screenshot from DIGSILENT PowerFactory with superposed information about the location and the duration time of the maximum and the minimum phase-to-neutral voltages.

Figure 42 shows the distribution of the error when the maximum voltage among the benchmark loads is compared with the maximum voltage among all low voltage customers. If the error is zero, it means that the maximum voltage is located at one of the benchmark loads shown in Figure 40. Figure 42 includes 400 days calculated by using 10-minute time steps. Thus, it is based on 57600 load flows. The figure gives a tangible illustration on the distribution of the error in relation with the time. It should be noted that 100 per cent of time

represents 400 days. The horizontal axis of the figure reaches until 25 per cent in order to make it easier to read.

$$error = \left| \frac{max.voltage (all LV loads) - max.voltage (benchmark loads)}{max.voltage (all LV loads)} * 100\% \right|. \tag{1}$$

Figure 43 is analogous with Figure 42 with the exception that it presents the error distribution when the minimum voltage is measured.

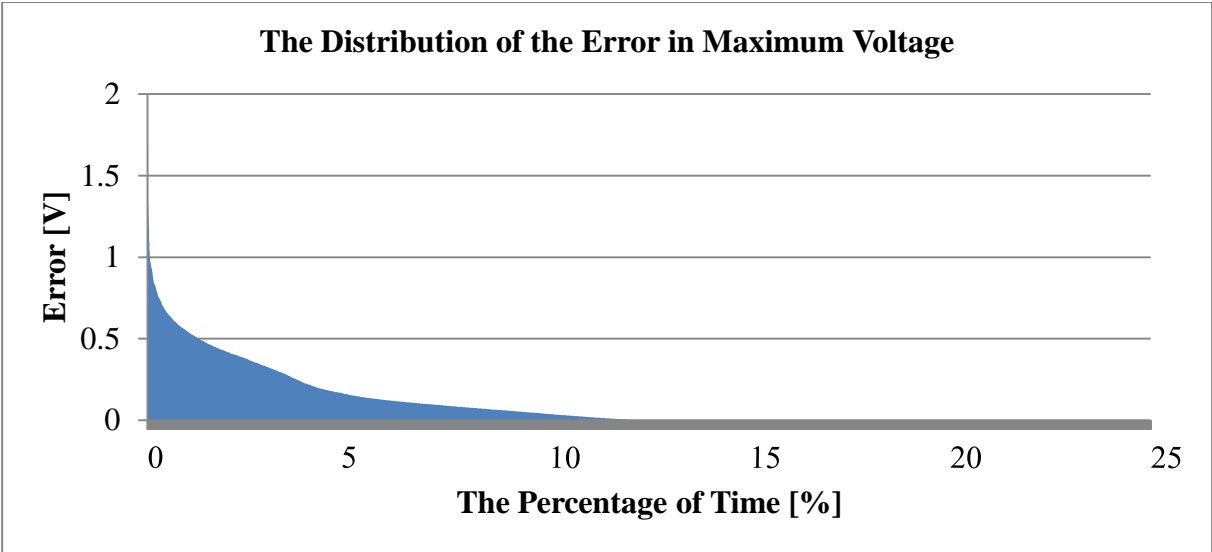

Figure 42: The distribution of the error (in volts) when measuring the maximum voltage between the benchmark load that experiences the highest voltage between all low voltage customers.

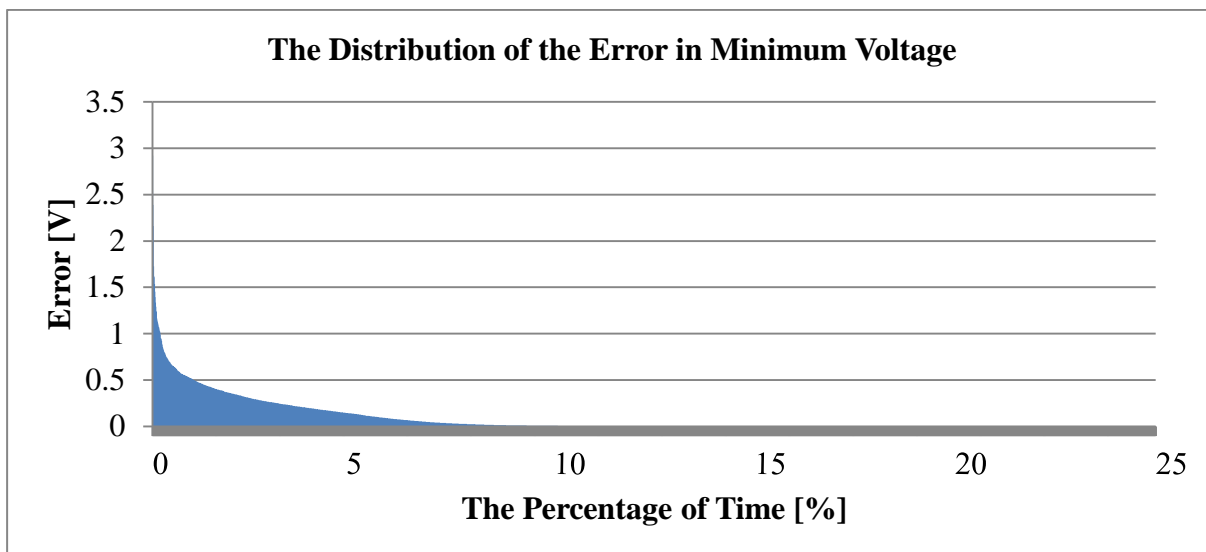

Figure 43: The distribution of the error (in volts) when measuring the minimum voltage between the benchmark load that experiences the lowest voltage between all low voltage customers.

4.2. Analysis of the Results

In this section, the results are analysed in detail. The first section considers the number of voltage measurements and the second section is focused on the error estimated when the synthetic load curves are used.

4.2.1. The Number of Voltage Measurements for Automatic Online Tap Changer -Application based on the Load Data of Four Days

Table 2 shows the number of voltage measurements in all 38 networks. On average, five customers per low voltage network should be equipped by a voltage measurement so that the minimum and the maximum are known at any time according to the used load data. Network 27 is a special case since it only has one customer. Therefore, it is not a surprise that only one sensor (100 per cent of the customers) is enough to measure the voltages. When Network 27 is not considered due to its very special structure, the maximum percentage of customers required to be equipped by voltage measurements is 21.7 per cent (Network 17) and the minimum percentage is 1 per cent (Network 37). The average percentage of customers that should be equipped with a voltage measurement is 9 per cent. If Network 27 is not considered, the value descends to 6.5 per cent. Among the networks that have more than 50 customers (29 networks), the percentage is 4.4 per cent. Likewise, for the networks that have more than 100 customers (19 networks), the value is 3.9 per cent. It is very important remark that the abovementioned average values are not weighted values. Because of this, the average value cannot be extrapolated directly to networks of all sizes. Anyway, there are significant differences between the results of different networks, which suggest that each network should be treated individually and that it is difficult to make an exact rule-of-thumb considering the number of sensors.

Figure 26 shows the relation between the number of customers in a network (x-axis) and the percentage of customers to be equipped with a voltage measurement (y-axis). It can be seen that the higher is the number of customers in a network the lower is the relative number of customers where the voltage measurements should be placed. This trend is clear until the networks of about 50 customers. The reduction of the relative number of voltage measurements does not continue in the same scale as the number of customers is higher than 50, but stays rather similar. Even though not all the networks follow this tendency this could be stated as a general trend amongst the studied networks and load curves.

4.2.2. Accuracy of the Voltage Estimation due to Loss of Measurements

It can be seen in Figure 28 that the total error (see Figure 27) in the voltage estimation has a wide range of values when only one voltage measurement is used. The total error reaches until about 52 V between the very extreme cases. When two voltage measurements are used, the total error reduces significantly. When four or more voltage measurements are used, the total error remains under 1 V in all cases.

4.2.3. The Robustness of the Methodology against Minor Changes in the Network

After the addition of five per cent of new customers in the networks, no changes in the placements of the voltage measurements are experienced in eight networks. However, changes occur in 29 networks. This number may seem a high but when considering the values of the estimation errors, it can be seen that they are low. If maximum and minimum voltage was estimated by using the measurements from the same customers as where they were estimated before the arrival of the new customers, it can be noticed that an error occurs less than 15 per cent of the time in both cases. When estimating maximum voltage, the error is about 0.4 per cent of the time more than 1 V and in the estimation of minimum voltage the error is about 0.6 per cent of the time more than 1 V.

4.2.4. The Error in Voltage Measurements for Automatic Online Tap Changer - Application when the Load Data is Extent to 400 Days

After the placement of the voltage measurements to 38 networks, the differences between the maximum values indicated by the sensors and the real maximum values are compared. The same is comparison is done to the minimum voltages. Table 4 indicates that when estimating the maximum voltage, the mean value of the error is 0.02 V and 0.03 V in case of the minimum voltage. The standard deviations are 0.11 V and 0.26 V, respectively. The very maximum value of error is 10.14 V in the maximum voltage and 17.69 V in the minimum voltage. The minimum error is 0 V in both cases. It can be seen clearly that all the above mentioned values are lower when estimating the maximum voltage than when estimating the minimum voltage.

When the errors are considered by the type of the day, in Figure 37, it is apparent that all values for both, the maximum and the minimum voltage, are higher in the winter than in the summer. The mean value of the minimum voltage is 0.048 V in the winter working days and 0.042 V in the winter bank holidays. The corresponding values for the summer are 0.016 V

and 0.015 V. The mean value of the maximum voltage is 0.029 V for the winter working days and 0.03 V for the winter bank holidays. The mean value of the error is for the maximum voltage estimation is 0.008 for both, summer working days and summer bank holidays. The errors when estimating the minimum voltage and the errors when estimating the maximum voltage are of a similar scale between each other during the winter days and during the summer days. Thus, the results can be divided into two clear groups; winter and summer. The errors during the wintertime are about three to four times higher than during the summertime. Significant differences between the working days and the bank holidays during the same season cannot be seen.

In Figure 38, it can be noticed that there is a large relative difference in the mean values and the standard deviations between the networks with and without photovoltaic panels. When the minimum voltage is estimated, the mean value in the case with photovoltaic panels is roughly four times the case without photovoltaic panels. Also, the standard deviation of the error is about three times superior in the case with photovoltaic panels than in the case without them. When the maximum voltage is estimated, the mean value in the first case is more than two times and the standard deviation slightly less than two times higher than in the latter case.

Even if the relative differences are high, the errors do not increase much in absolute terms. In the very worst case (when the minimum voltage is estimated in the networks that include photovoltaic panels), the mean value of the error is less than 0.07 V with a standard deviation of 0.44 V (Figure 38). This means that errors of several volts are rarely encountered.

It is reasonable that the presence of distributed generation increases the errors in the voltage estimation because it increases the variability of voltage near the node where it is connected. It is also logical that the errors in the estimations of the minimum voltage increase more than in the estimations of the maximum voltage. This due to the fact that the photovoltaic panels are relatively small units in the most of the cases they are not located in near the secondary transformer, where the highest voltages are found many times, which means that it is more likely that the photovoltaic panels have an increasing effect on the minimum voltage than on the maximum voltage of the network. Naturally, this increases the error more in the estimation of the minimum voltage than the maximum voltage of the low voltage network. It must be remembered that there are much more possible locations to experience the minimum voltage than the maximum voltage, at least with a low penetration rate of photovoltaic power generation. Besides the photovoltaic panels, the networks do not have any components that would increase the voltage.

4.3. Discussion

The simulations based on four different load curves per network indicate that the higher is the number of customers in a network, the lower is the number of voltage measurements per customer (the number of voltage measurements divided by the number of customers) that is needed to be installed in the network when the objective is to monitor the minimum and the maximum voltage in a network at any given moment. This is true generally until about the number of 100 customers. A larger number of networks should be needed to confirm the statement. However, this behaviour can be explained by the fact that the more customers a network has, the smaller is the impact of the load or the generation of an individual customer on voltage. It might also be the case that the networks with only tens of customers are sized closer to their limits than the networks with hundreds of customers because of the lower

expectations of growth. When the lines are sized with a small cross section, their resistance is high and the changes in loading cause more severe voltage drops than in the networks where the lines are sized with a large cross section.

Based on four load curves per customer, the percentage of customers that should be equipped with voltage measurements is relatively low, when taking into account the high variety in the loading of a single low voltage customer, since it rarely exceeds 20 per cent (three out of 38 cases) and many times stays under 10 per cent. The low number of voltage measurements means that the maximum and the minimum values of voltage are concentrated on a few locations. One reason for this is that the voltage profiles along the feeders (at least most of them) tend to have a similar form over time. This is illustrated in Figure 44 and in Figure 45.

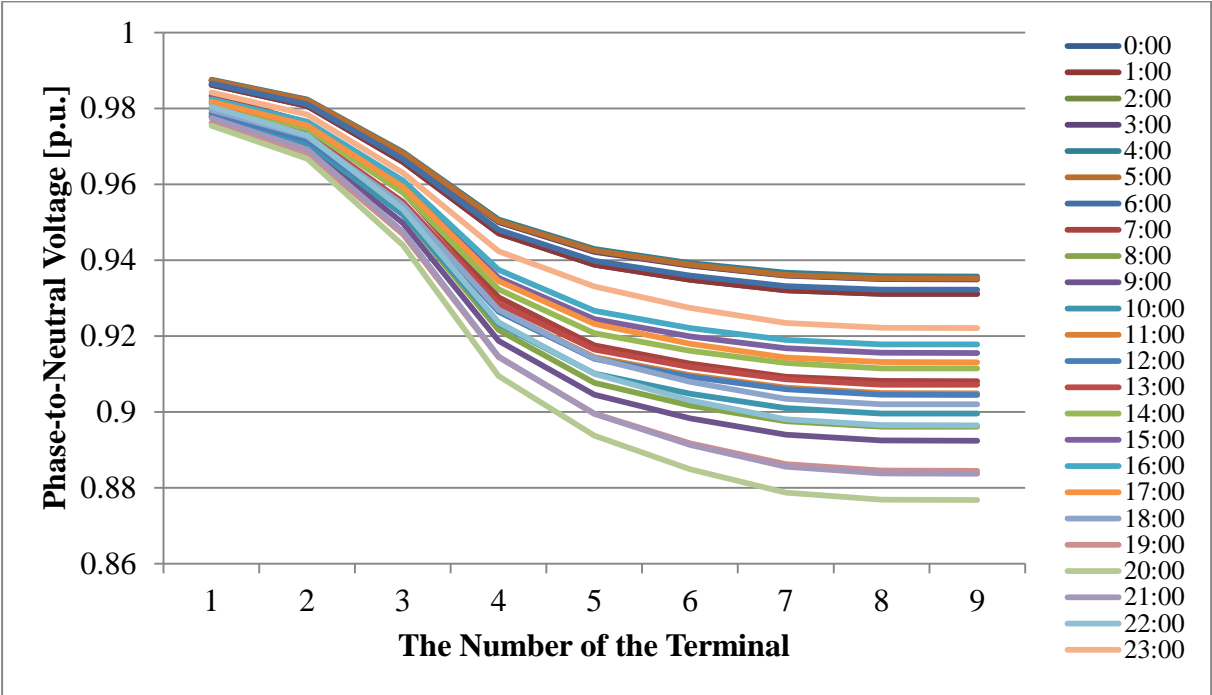

Figure 44: Voltage (phase-to-neutral) profile from the beginning (left hand side) to end of a feeder (right hand side) over 24 hours.

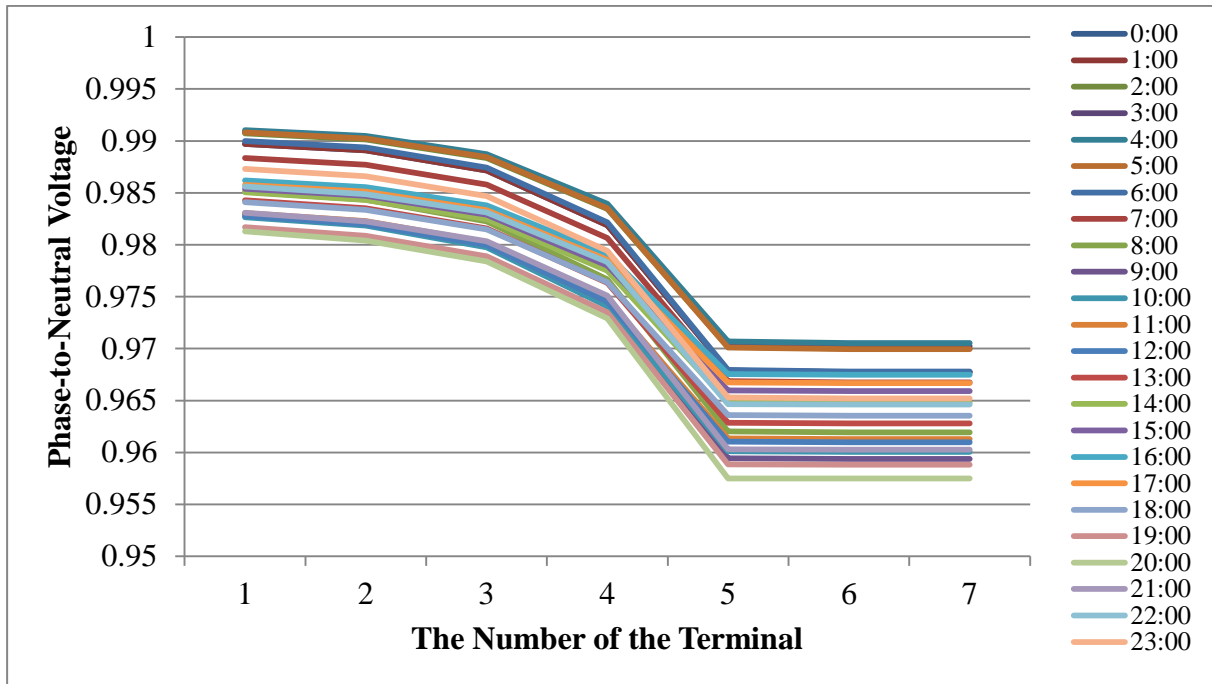

Figure 45: Voltage (phase-to-neutral) profile from the beginning (left hand side) to end of a feeder (right hand side) over 24 hours.

Additionally, there are a few loads that have a high impact on the shape of the voltage profile. Another explanation for the low number of voltage measurements is that there might be constant unbalances in some of the networks. This can be fixed by checking the phase connections of the customers and balancing the feeder again.

The number of required voltage measurements does not increase much when the networks become larger. This is because in large networks an individual customer has less impact on voltage than in networks with a few customers. Another fact is that in large networks, each terminal with customer connections has on average more connected customers per terminal than in smaller networks. Thus, large networks have relatively fewer terminals than small networks, which make it easier to find the terminals with the maximum and the minimum voltage. Also, three-phase connected customers are preferred over single-phase connected customers, in a large network, the major part of the terminals have at least one three-phase connected customer. This means that this three-phase customer is always chosen as a load where voltage is measured if the maximum of the minimum value of voltage is experienced at that terminal, while the other loads in the same terminal are not considered. This has a drastic reduction on the number of possible loads to be candidates for voltage measurements in large networks compared with small networks. All this leads to a conclusion that it is easier to estimate the locations of the voltage sensors in large than in small networks of similar topologies.

Considering placing a voltage sensor directly in the low voltage bus bar of the secondary substation would improve the estimations of the maximum voltage in many networks.

When effect of the failure of voltage measurements is studied in Section “Accuracy of the Voltage Estimation due to Loss of Measurements”, it is found that the number of voltage measurements can be further reduced in few networks and still maintain satisfying accuracy of the estimation of the extreme voltages. Thus, in these networks, a loss of one or two

measurement does not decrease the voltage estimation drastically. However, it should be kept in mind that the error is estimated by using mean load profiles. When real load curves are used, the maximum error will be higher and occasional peaks of error will occur due to the fact that real load curves are less smooth than mean profiles.

The methodology to place voltage sensors is relatively robust against small changes in the power consumption. It is not regarded meaningful to study the impact of large changes in loading because if there were important changes in a network, the distribution system operator would update the locations of the voltage measurements at any rate. Ideally a change in the location of a voltage measurement would not require human intervention, so an update of the locations of voltage measurements does not mean immense effort to the distribution system operator.

If the advanced metering infrastructure could be used for this measurement so that it wouldn't be necessary to install separate voltage sensors, the number of measurements could be manageable with an efficient communication media. On the other hand, the study does not take into account any possible dependency of the location on the hour or the season. There could be a possibility to reduce the number of measurements employed at one time by adding more real-time selectivity when choosing the placements of the voltage measurements. This means that if it known, for example, that during daytime, the extreme values of voltage are located at the beginning of the feeder and during the night time at the end of the feeder. Then the extreme values could be read at the beginning of the feeder during daytime and at the end of the feeder during night time. In opposition, it would add an additional layer in the data processing.

The reason for the low relative number of required voltage measurements is that relatively few combinations of different load curves are used in the simulations since the major part of the load data has a real frequency of one hour. To make sure whether that is the case, the same networks should be studied under higher variety of different loading conditions. Additionally, the decrease in the accuracy in case of the loss of one measurement should be studied.

An upside of the method is that it takes into account both, the topology and the loading of the network, which makes it accurate (according to the results presented in Section "The Error in Voltage Measurements for Automatic Online Tap Changer -Application when the Load Data is Extent to 400 Days"). On the other hand, the trends of loading evolve over time, which means that the locations of voltage sensors should be updated every certain period or if new construction has taken place in the network area. That is why one execution of the script that indicates the optimal locations of the voltage sensors has to be fast. If the automatic metering infrastructure was used to measure voltage, it would be possible to automate the process to locate the voltage sensors. If the load data is available from all (or nearly all) customers, the script could be launched automatically in a data centre of the distribution system operator every one to three years, for example. A list of the customers (the corresponding customer codes) where the voltage measurements should be read could be transmitted to the secondary substation. This would make sure that the locations of the meter readings are always up-to-date. If the process was done automatically, it wouldn't require direct manpower. In addition, if the procedure is not carried out often, the requirements of the data processing and transmission are not enormous.

If studies were made on a large number of networks, accurate statistics can be gathered about how many locations of voltage measurements are needed on average for networks of different sizes and types to guarantee accurate estimations of the maximum and the minimum values of voltage. In this way, a maximum number of voltage measurement points could be determined according to the size of the network. The maximum number of voltage

measurement could be used to limit the number of voltage measurements in order to avoid unnecessarily accurate estimation of voltage. Because the locations of the voltage sensors are affected by the forms of the customer load and generation curves, there could be cases where a large number of locations for the maximum and the minimum voltage are met. Highly accurate voltage estimation is not necessary because the subsequent control will be much less accurate anyway. If an accurate enough estimation is achieved, let's say, by five sensors instead of nine, significant amount of communication capacity can be saved, assuming that the reliability of communication is high.

In case that the number of voltage measurements has to be decreased, let's say due to the limitations in the communication media, the algorithm can be improved so that it counts the number of the maximum and the minimum voltages at every customer. When the frequency of the voltage readings is fixed, it is known how long time each terminal has the maximum or the minimum voltage over the simulated time, which allows to create a ranking list according to the frequentness of the maximum and the minimum voltage (or one list for the commonness of the maximum voltages and another similar one for the minimum voltages). It can be assumed that the customers who are the first in the list are more important than the ones at the end of the list. If the number of measurement locations is limited, for example to six, the first six customers in the list will be chosen (or three in the list of the maximum voltages and three in the list of the minimum voltages). If the voltage magnitude is wished to be included in the algorithm, the frequencies of the maximum and the minimum voltages can be weighted by the respective voltage magnitudes.

Since the final objective is to be able to control an on-load tap changer at the secondary substation, it is important to underline that the major concern is to know the values of the maximum and minimum voltage as accurately as it is required by the on-load tap changer at any given moment. The on-load tap changer is located at the secondary substation, which means that a change in the tap position affects all feeders equally (in case that the network has several feeders departing from the secondary substation). This leads to the conclusion that it is of secondary importance to know the exact location of the minimum or the maximum value of voltage because the actuation of the tap changer cannot improve the voltage profile merely at one point, but it affects the whole network.

When the errors in the voltage estimations are calculated in all 38 networks, it is notable that the mean values of the errors are low with a relatively small number of sensors per network. The difference between two tap positions in a mechanical tap changer is much higher than the mean value of the error. In a practical application, an error of such a scale would be acceptable. If higher accuracy is pursued, a higher number of voltage measurements per network is called for. Even if the maximum errors obtained seem high, the standard deviations show that large errors occur extremely rarely. In practice this means that they are insignificant. Slightly high voltage in low voltage networks does not interrupt the service. This means that distributing power with a voltage slightly over the limits during a short period of time may be more acceptable than building highly oversized, and thus underutilised, networks.

The errors are larger when estimating the minimum voltage than the maximum voltage. The networks have only a small number of photovoltaic panels in comparison with the number of loads. This means that there are more possible locations to experience the minimum voltage than the maximum voltage. In this light, it is natural that it is more difficult to estimate the value of the minimum voltage than the value of the maximum voltage. It should be noted that the values of the maximum errors are very high when compared with the mean values and the standard deviations. This means that the values of such a scale are met

extremely rarely and they easily give a false perception of the range of the error. The difficulty to estimate the maximum voltage can increase in the future if the number of photovoltaic generators increases, which also increases the variability in the maximum voltages.

It is sure that it would be simple to make a small error in the voltage estimation if the lines were heavily oversized and the voltage drops were insignificant. However, it is important to remark that the errors are very small in comparison with the values of the voltage drops. The minimum voltages of the network are many times close to 0.9 per unit, which means that the voltage drops over a feeder are usually more than 20 V. On the other hand, the errors of voltage estimations are usually less than 0.5 V.

During the wintertime, the power consumption is significantly higher than during the summertime, mainly due to the dominating position of electric heating. It means that the variations of the loads are higher in the winter than in the summer. Since the voltage varies according to the changing load, it is rational that the voltage level has a higher variation during the winter than during the summer.

When comparing the networks with photovoltaic power generation and with no photovoltaic panels, it is important to underline that even if the relative differences between the cases with photovoltaic panels and without them are notable, the absolute error remains still very small, much less than 1 V, in any case. However, it is not sure if the differences in the error are caused only by the photovoltaic panels and whether the networks would give the similar rates of error if the photovoltaic panels were not taken into account or if the photovoltaic generation was significant.

In the study when new customers are added to the network, the measurement errors remain extremely low. In conclusion, it can be stated that the methodology is robust against an addition of a decent amount of customers.

It should be highlighted that it is important to focus on the values errors instead of the number of voltage sensors. By considering only the number of customers before and after the network changes, it seems that the voltage estimation experiences fundamental changes even if in reality the errors remain low. This conclusion suggests that the method could be further developed in a way that a predefined level of error is accepted. The errors would be analysed when the voltage measurements are placed in the network. Only the necessary measurements (in other words, the measurements where a predefined level of error is not exceeded) would be the customers where the voltage measurements would be placed eventually. For example, if the perfect estimations of the maximum and the minimum voltages were achieved by using 12 measurements, a lower number of measurements (for example six) is used because it is observed that the error of measurements would not be superior to the predefined level of error. Evidently, this would make the execution time of the script longer but on the other hand gives a smaller number of customers where the voltage should be measured in order to control the on-load tap changer.

The method suggests the small number of voltage measurements in comparison with the total number of customers in the network. One reason for this is that there are usually several customers connected to one terminal. Many of those terminals have at least one three-phase connected customer. By measuring voltage at that customer, it is possible to know all phase-to-neutral voltages at that terminal. Evidently, this customer is chosen for the measurement. Connecting several customers to the same terminal explains partly the low number of measurements suggested by the script.

The load curves of 400 days are constructed in a manner that many different situations of loading are caused, perhaps even more than in the real-life. This is convenient for the study

due to the fact that if the errors are within acceptable limits during the study, they won't exceed the limits of acceptance in reality. The method is tested on urban and semi urban networks. In practice, voltage problems are more common in rural networks where the relative variation of load is higher than in the urban areas. Because of this, it would be worth testing the method on networks where on-load tap changers are likely to be installed.

The system should be robust against failures and should work even in case of a reading failure, a breakdown of a meter or a loss of information in a data transmission, for example. It is important to remember that the placement of the voltage sensors relies highly on the loading of the network. If the loading conditions change, the optimal locations of the sensors change as well. This means that the robustness of the system has to be confirmed each time when the voltage sensors are replaced. This should be verified by further studies on the robustness of the methodology. Before a real application, possible technical constraints related with the data transmission, such as the rate of error in the transferred data, should be studied thoroughly.

The error analysis shows that the load profiles (mean load curves) can effectively replace large amounts of historical data from the advanced metering infrastructure in certain applications with only a small error. This finding is a relief to the future studies because it is impractical to handle large amounts of past data and because gathered data from an automatic metering infrastructure is typically stored in the billing database that may not be easily accessible for planning engineers.

An enormous advantage of the method is that it is developed completely in DIGSILENT PowerFactory software that is widely used in the power distribution industry. This implies that the method does not have to be adapted to another software before its use in the industry. Because the method is based on power flows, it takes automatically into account both, the topology and the loading conditions of the network.

An important aspect to be taken into account when developing a script is that it should be easy to use for the end users, for example, for the network planning engineers. Furthermore, the functions of the script should be as simple as possible. When the end users understand the functions of the script (so that it is not only a black box) it may be that the script will be better accepted in the daily use. Additionally the end users can contribute more effectively in the further development of the script by introducing their own ideas. In order to achieve this, the methodology behind the script has to be simple enough so that a lot of time is not required to understand how the script works. The usability of the script can be improved for example by adding an intuitive graphical user interface. The script should be directly available in the side bar of the planning tool, for example PowerFactory, with a descriptive icon. For the further development, the script could have a free box for commentaries and notes so that an end user can note the ideas immediately when they occur. Later, these ideas are delivered to the script developers.

4.4. Conclusions

The study validates the fact that the levels of error are low when estimating the maximum and the minimum value of voltage based on the predefined locations of voltage measurements. Of course this statement is based on the assumption that the use of the synthetic load curves represents reality with a sufficient accuracy. According to the study, the voltage measurements can be placed in a low voltage network by using the mean load profiles of the customers. Photovoltaic panels increase the errors in the voltage estimation. However, the

errors remain at low levels even if the networks included small amount of photovoltaic panels.

The voltage estimations are more accurate when estimating the maximum than the minimum voltage. This is because of the fact that the values of minimum voltage have more variability than the ones of maximum voltage mainly due to higher peaks of consumption in the wintertime. Again, by the cause of higher peaks of consumption during the wintertime than in the summertime, the estimation errors are between three and four times higher during the winter than in the summertime. If the networks had a high penetration of photovoltaic power generation, the estimation of maximum voltage would have more variability and thus, there would be more error in the estimation of the maximum voltage. The method is relatively robust against modest changes in the loading conditions.

According to the error analysis, the method for sensor placement is straightforward and robust. It is implemented in the DlgSILENT PowerFactory software that is common in the power distribution industry. This means that the scripts can be applied easily in practice. What is more is that the method itself does not include complex mathematics, which makes it easy to understand.

Before applying voltage measurements as suggested by the methodology, simulations should be run over a larger number of different kinds of networks, including rural networks, in order to make sure that the voltage measurements will be placed in proper locations.

5. The Impact of Voltage Control Technologies on the Capacity to Host Photovoltaic Power Generation in Low Voltage Networks

In this chapter, the impact of two different voltage control technologies on the hosting capacity of photovoltaic power generation is investigated. Namely, an on-load tap changer at a secondary substation and a reactive power control of the photovoltaic generators. The work presented in this chapter applies the method of placing the voltage measurements developed in the previous chapter. When an on-load tap changer is studied, two different kinds of technologies are considered; one with five tap positions and another one with nine tap positions. More information about on-load tap changers can be found in Section “Automatic Tap Changers and Voltage Regulators in Secondary Transformers”. In this thesis, the term hosting capacity means the ability of a given low voltage network to accommodate photovoltaic power generation up to a point when the first constraint (over voltage or overloading of a line of a transformer, in our case) appears. If an amount of photovoltaic power generation that is less than its hosting capacity is added to the network, no constraint is expected to appear. Sometimes in this thesis the “hosting capacity” is clarified as the “hosting capacity of photovoltaic power generation” or as the “capacity to host photovoltaic power generation” so that the reader remembers that the only type of distributed generation considered in this thesis is the photovoltaic power.

The investigation about the on-load tap changer is presented in the first part and the work about the reactive power control by the photovoltaic generators is presented in the second part. Additionally, a short comparison between the two mentioned technologies can be found in the latter part. Both sections form their own entity with separate parts of discussion and conclusions.

5.1. Increasing the Hosting Capacity of Photovoltaic Power Generation by an On-Load Tap Changer at the Secondary Substation

The objective of this section is to analyse the hosting capacity of photovoltaic generation in low voltage networks and the impact of an on-load tap changer at the secondary substation on it. Every low voltage network has a limited hosting capacity that depends on the load conditions as well as the sizing of the components and the topology of the network. An excess of this limit manifests itself as an over voltage, a voltage drop (a voltage constraint) or an overloading of a line or a transformer (a current constraint). In the networks, where the hosting capacity is limited by voltage, an on-load tap changer can provide additional flexibility for the network and increase the hosting capacity of photovoltaic generation.

While photovoltaic power generation becomes more and more common in low voltage networks, the question of how much photovoltaic power generation can be accommodated within a low voltage network, is becoming crucial. The exact locations, the sizes and the phase connections of the photovoltaic generators cannot be foreseen, but on the other hand, the network should be planned in a way that constraints won't be met for a given objective. Thus, an essential question is how to choose the abovementioned parameters for the photovoltaic power generation of the future in a given network. Two different approaches to size the photovoltaic generators and to choose their phase connections are presented in this section. In both ways, photovoltaic generators are connected to every customer terminal in the network, but the sizes and the phase connections are different. It is important to demonstrate the differences due to these two approaches so that the reader is aware of the importance of

the size and the phase connections of photovoltaic generators. The details of both methodologies are explained in their own subsections.

5.1.1. Description of the Methodology and the Results

As mentioned earlier, it is not possible to know exactly where the photovoltaic power generators will be installed in the future, the following methodology is adopted:

- A photovoltaic generator is connected to every customer node in the low voltage network.
- All photovoltaic generators are connected in a three-phase manner.
- The rated power of all these generators is raised simultaneously through continuous method until a constraint is met.

Altogether, this methodology is expected to yield a rather optimistic view of the hosting capacity, for the following reasons.

- Firstly, spreading generators all over the network with identical growth of their rated power is more favourable to increase the hosting capacity than if some generators are large and installed in “bad” locations such as the end of long feeders (and less favourable of course, than if large generators are grouped near secondary substation).
- Secondly; three-phase generators will probably lead to a higher hosting capacity than single-phase connected generators. This is because the power is injected to the network evenly between three phases. If single-phase connected generators are used, voltage may rise in one phase more than in the other ones, possibly leading to a voltage constraint. In this case, it may be that the network could withstand more distributed power generation if the power injections were balanced between the phases. It may be that if single-phase connected generators (that are connected to the network in an unbalanced way) are used instead of three-phase connected ones, it is more likely to meet a voltage constraint.

All photovoltaic generators have the same profile of power production that is an average production curve of July in the same urban area where the networks are located. The simulation is carried out during a summer working day between 11.30h and 14h by using 10-minute time steps. This time frame is considered sufficient because the intention of the simulation is to study the impact of photovoltaic generators. It would not be meaningful to run the simulation during night time when the photovoltaic generators do not produce power and, thus, the constraints caused by power production in the network cannot be detected.

In the first step the profile of each photovoltaic generator is reduced to a small value and an unbalanced load flow is executed every 10 minutes over the abovementioned time frame. After the execution of each load flow, voltage and current constraints are monitored. Namely, the loading of every line and the distribution transformer as well as voltage at every point of customer connection is measured. If no current or voltage constraints are encountered, the amount of photovoltaic power generation is increased and the load flows over the named time

frame are executed again. If no constraints are met, the power generation is increased even more. The same process is repeated until a constraint is found. The load profiles of the photovoltaic generators are increased by using a fixed step.

The same simulations are carried out by using the same networks without an on-load tap changer and with two different types of on-load tap changers. In the simulations where an on-load tap changer is used, the voltage control is based on the voltage measurements obtained by using the advanced metering infrastructure from predefined customers as described in Section “Optimal Placement of Voltage Sensors in a Low Voltage Network for On-Load Tap Changer Application”. As mentioned previously, two types of on-load tap changer-fitted transformers are tested; one with five tap positions and another one with nine tap positions. In the transformer with five tap positions, the position 3 is the neutral one and in the transformer with nine tap positions, the position 5 is the neutral position. In both transformers, a change in the tap position increases or reduces voltage by 1.75 per cent. The on-load tap changer is controlled so that it changes the tap position automatically when phase-to-neutral voltage in any of the points of measurement exceeds the limits of ± 10 per cent of the nominal voltage. Once the tap position is changed, it is done so that the tap moves as far from the current position as possible without violating the voltage limits. This is done in order to anticipate the evolution of voltage. As an example, before midday voltage increases due to the increasing production from photovoltaic generators, the tap position is moved directly from the position 6 to the position 8 (in order to decrease voltage in the network) (if the voltage conditions permit) without changing it first from the position 6 to the position 7 and then from the position 7 to the position 8 after some time. If both, the maximum and the minimum, voltage limits are violated the tap position is not changed in order to not aggravate an already exceeded voltage limit. In this case, a voltage constraint has been reached and the simulations will be finished.

As mentioned above, two different types of on-load tap changers are tested; one with five tap positions and another one with nine tap positions. At the beginning of each simulation, the tap is set one position above its neutral position (the position 4 in the five-position transformer and the position 6 in the nine-position transformer). The voltage profile tends to be decreasing when moving from the distribution transformer towards the end of the feeder. Normally the tap position is set so that the voltage at the secondary substation is as close to the upper voltage limit as possible in order to use the permitted voltage range as efficiently as possible. If the networks had a high amount of photovoltaic power generation, the tap positions would have to be considered again in order to not to exceed the upper voltage limit on a sunny day.

The nominal voltage of the medium voltage network is 20 kV but the HV/MV tap changer is set to maintain 21 kV (+5% over the nominal value) on the secondary side of the HV/MV transformer.

As in Section “Optimal Placement of Voltage Sensors in a Low Voltage Network for On-Load Tap Changer Application”, the simulations are done in DIGSILENT PowerFactory (version 15.2) software by scripts done in DPL programming. Additionally, the same 38 low voltage networks are used in this study. To achieve the easy usability of the DPL scripts, they are done so that the simulations of all networks are carried out by one execution of the main script and the results are saved into an Excel-file.

5.1.1.1. Comparison of the Ways to Connect and Size Photovoltaic Generators in the Method of the Estimation of Hosting Capacity

When investigating hosting capacity, two different methodologies to connect and size the photovoltaic generators are used. These methods are described here below.

Only three-phase connected photovoltaic generators:

During the first iteration of the algorithm to estimate hosting capacity, there is one three-phase connected photovoltaic generator in every node of the network with a customer connection. The rated capacity of each photovoltaic generator is 1 kW. Before the second iteration, an additional generator of 1 kW is added in parallel with every existing generator. This is continued until a constraint is found.

Having only one 1 kW rated photovoltaic generator connected to three phases is not realistic but adding small generators in parallel is a straightforward way to increase the photovoltaic power generation in the network. The power generation curves of the photovoltaic panels remain the same throughout the simulation. During every iteration, the simulation is realised between 11.30h and 14.00h in time steps of ten minutes. This is done in order to reduce the total simulation time.

Single-phase and three-phase connected photovoltaic generators:

As in the previous method, one photovoltaic generator is connected to every customer node in the given low voltage network. Differently to the previous method, 90 per cent of the photovoltaic generators are single-phase and 10 per cent of them are three-phase connected. This proportion corresponds roughly the real proportion of photovoltaic generators in French low voltage networks. The single-phase connected generators have an initial rated capacity of 1 kW and the three-phase connected generators 10 kW. The locations of the three- and single-phase generators are decided in a random manner.

Before running the actual algorithm to estimate the hosting capacity of the network, the single-phase generators are connected to a randomly chosen phase so that all phases have the same probability to be chosen. This approach is not fully realistic but it leads to a relatively balanced connections. On the other hand, the connections are never chosen so that the rated power of photovoltaic generation is equal in all phases, except if all generators are three-phase connected. Without a doubt, the objective of a distribution system operator is to maintain the feeders balanced as possible but in reality perfect balancing is difficult.

Before every iteration of the method, the generation curve of the photovoltaic generators is increased by five per cent. This five per cent fixed step is calculated based on the initial value during the first iteration. The forms of the power production curves of all photovoltaic generators remain the same during the whole simulation. As in the earlier case, the simulation is carried out between 11.30h and 14.00h in time steps of ten minutes.

Here, the results of the two different methods to size and connect photovoltaic generators are shown. These methods are used when hosting capacity of a low voltage network is estimated. It is important to show and discuss about the differences because the two approaches give different results. The purpose of this section is to clearly illustrate the differences in order to

see how the decisions about the sizing and the phase connection affect the value of the hosting capacity in each network. The values of the hosting capacity are divided by the maximum load of the network. In this context “maximum load of the network” refers to the sum of all loads (active powers of the loads) at the moment when it is at its maximum. Thus, the losses in the network are not considered. Network 27 is discarded in this case because it is an extremely special case. The hosting capacity divided by the maximum loading of the network is shown in Figure 46. In these results, voltage control of any kind is applied. The maximum load of the network is calculated as a sum of all loads, thus, the losses are not taken into account.

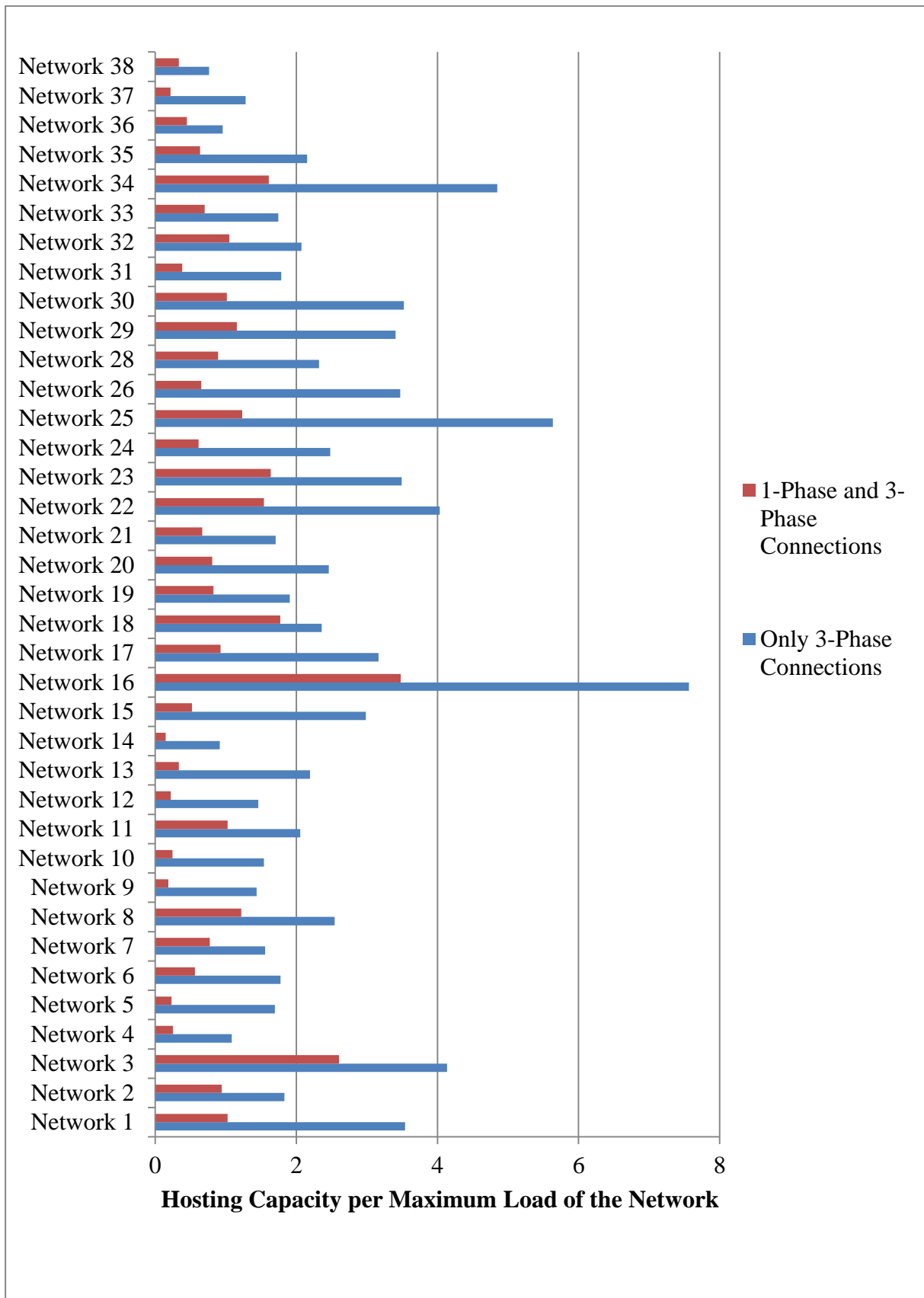

Figure 46: Hosting capacity divided by the maximum loading of the network. The two strategies to size and connect the photovoltaic generators are compared. No voltage

control is applied. It is important to underline that the hosting capacity of photovoltaic generation (the sum of powers produced by the photovoltaic generators at the moment of the constraint) is used, not the installed capacity.

It can be seen clearly in Figure 46, what is the impact of choosing the size and the phase connections of photovoltaic generators when estimating the hosting capacity of an individual network. The differences between the two used approaches can be extremely large, such as in Networks 9, 10, 12 and 13, for example, or relatively small, such as in Networks 18 and 36. When all photovoltaic generators are connected to three phases, the mean value of the hosting capacity per maximum loading is 2.5 and in the case of mixed connections it is 0.9.

5.1.1.2. The Hosting Capacity of Photovoltaic Power Production with and without an On-Load Tap Changer: All Photovoltaic Generators Connected to Three Phases

The photovoltaic power generators are placed in the networks according to the methodology described in Section “Description of the Methodology and the Results”. Table 5 presents the results at the moment when a constraint appears. The on-load tap changer is not employed in this case. Namely, the total power produced by the photovoltaic panels, the installed photovoltaic power generation capacity (the sum of the rated capacities), the maximum loading of the network by the voltage sensors and the type of the constraint. As mentioned, all values in the table are during the moment when the named constraint occurs (see the rightmost column). The column “Generation” refers to the capacity of the network to host photovoltaic power generation and “Installed Generation Capacity” refers the hosting capacity when the efficiency of the photovoltaic generators is taken into account (the sum of the rated capacities of all photovoltaic generators). The efficiency of the photovoltaic generators is based on the measured average efficiencies in the same urban area than where the low voltage networks are located.

Table 5: The power produced by the photovoltaic generators, the installed photovoltaic power generation capacity (because the power produced by a photovoltaic generator is not the same as its rated capacity), the maximum (peak) load of the network, generation per maximum load and the type of the occurred constraint are presented. Note that the maximum load is the real peak load of the network, not the installed rated load. All values are measured at the moment of the constraint. On-load tap changer is not used.

The Name of the Network	Generation [kW]	Installed Generation Capacity [kW]	The Maximum Load of the Network [kW]	Generation per Maximum Load [%]	The Type of the Constraint
Network 1	678	1190	192	353	Current (transformer)
Network 2	272	495	149	183	Current (transformer)
Network 3	427	750	103	415	Current (transformer)

Network 4	311	545	286	109	Voltage
Network 5	500	909	295	169	Voltage
Network 6	182	330	102	178	Current (transformer)
Network 7	376	660	241	156	Current (line)
Network 8	270	492	106	255	Current (transformer)
Network 9	357	627	249	143	Voltage
Network 10	482	846	313	154	Current (line)
Network 11	481	844	234	206	Current (line)
Network 12	351	638	240	146	Voltage
Network 13	264	479	120	220	Voltage
Network 14	188	342	205	92	Voltage
Network 15	614	1078	206	298	Voltage
Network 16	262	460	35	749	Current (transformer)
Network 17	268	470	85	315	Current (transformer)
Network 18	264	480	112	236	Current (transformer)
Network 19	421	738	221	190	Current (transformer)
Network 20	700	1272	285	246	Current (transformer)
Network 21	175	318	102	172	Current (transformer)
Network 22	420	736	104	404	Current (transformer)
Network 23	646	1175	185	349	Current (line)
Network 24	436	793	176	248	Current (transformer)
Network 25	674	1183	120	562	Current (transformer)
Network 26	275	483	79	348	Current (transformer)
Network 27	452	793	0	–	Current (line)
Network 28	426	775	184	232	Current (transformer)

Network 29	866	1519	254	341	Current (line)
Network 30	431	783	122	353	Current (transformer)
Network 31	444	807	248	179	Current (transformer)
Network 32	418	734	202	207	Current (transformer)
Network 33	445	780	255	175	Current (transformer)
Network 34	640	1122	132	485	Current (line)
Network 35	886	1554	411	216	Current (line)
Network 36	455	799	476	96	Current (transformer)
Network 37	267	485	208	128	Voltage
Network 38	457	802	599	76	Current (transformer)

The results of the simulations with an on-load tap changer that has five tap positions are showed in Table 6. As in Table 5, the photovoltaic power generation, the installed photovoltaic power generation capacity, the maximum loading of the network and the type of the constraint, at the moment when the constraint occurs, are presented.

Table 6: The power produced by the PV generators, the installed photovoltaic power generation capacity, the maximum load of the network, power generation per maximum load and the type of the occurred constraint are presented. All values are measured at the moment of the constraint. An on-load tap changer with five positions is used.

The Name of the Network	Generation [kW]	Installed Generation Capacity [kW]	The Maximum Load of the Network [kW]	Generation per Maximum Load [%]	The Type of the Constraint
Network 1	678	1190	192	353	Current (transformer)
Network 2	272	495	149	183	Current (transformer)
Network 3	427	750	103	415	Current (transformer)
Network 4	376	685	286	131	Current (line)

Network 5	684	1244	295	232	Current (transformer)
Network 6	182	330	102	178	Current (transformer)
Network 7	376	660	241	156	Current (line)
Network 8	270	492	106	255	Current (transformer)
Network 9	409	744	249	164	Current (line)
Network 10	482	846	313	154	Current (line)
Network 11	481	844	234	206	Current (line)
Network 12	451	821	240	188	Current (transformer)
Network 13	274	498	120	228	Current (transformer)
Network 14	272	495	205	133	Current (transformer)
Network 15	673	1224	206	327	Current (transformer), Voltage
Network 16	262	460	35	749	Current (transformer)
Network 17	268	470	85	315	Current (transformer)
Network 18	264	480	112	236	Current (transformer)
Network 19	421	738	221	190	Current (transformer)
Network 20	700	1272	285	246	Current (transformer)
Network 21	175	318	102	172	Current (transformer)
Network 22	420	736	104	404	Current (transformer)
Network 23	646	1175	185	349	Current (line)
Network 24	436	793	176	248	Current (transformer)
Network 25	674	1183	120	562	Current (transformer)
Network 26	275	483	79	348	Current (transformer)
Network 27	452	793	0	–	Current (line)

Network 28	426	775	184	232	Current (transformer)
Network 29	866	1519	254	341	Current (line)
Network 30	431	783	122	353	Current (transformer)
Network 31	444	807	248	179	Current (transformer)
Network 32	418	734	202	207	Current (transformer)
Network 33	445	780	255	175	Current (transformer)
Network 34	640	1122	132	485	Current (line)
Network 35	886	1554	411	216	Current (line)
Network 36	455	799	476	96	Current (transformer)
Network 37	428	779	208	206	Current (transformer)
Network 38	457	802	599	76	Current (transformer)

Table 7 presents the photovoltaic generation, the installed photovoltaic power generation capacity, the maximum loading of the network, power generation (from the photovoltaic generators) per maximum load and the type of the constraint when an on-load tap changer is employed in every network.

Table 7: The power produced by the photovoltaic generators, the installed photovoltaic power generation capacity, the maximum load of the network, power generation per maximum load and the type of the occurred constraint are presented. All values are measured at the moment of the constraint. The on-load tap changer of nine tap positions is used.

The Name of the Network	Generation [kW]	Installed Generation Capacity [kW]	The Maximum Load of the Network [kW]	Generation per Maximum Load [%]	The Type of the Constraint
Network 1	678	1190	192	353	Current (transformer)
Network 2	272	495	149	183	Current (transformer)
Network 3	427	750	103	415	Current (transformer)
Network 4	376	685	286	132	Current (line)

Network 5	684	1244	295	232	Current (transformer)
Network 6	182	330	102	178	Current (transformer)
Network 7	376	660	241	156	Current (line)
Network 8	270	492	106	255	Current (transformer)
Network 9	409	744	249	164	Current (line)
Network 10	482	846	313	154	Current (line)
Network 11	481	844	234	206	Current (line)
Network 12	451	821	240	188	Current (transformer)
Network 13	274	498	120	228	Current (transformer)
Network 14	272	495	205	133	Current (transformer)
Network 15	673	1224	206	327	Current (transformer), Voltage
Network 16	262	460	35	749	Current (transformer)
Network 17	268	470	85	315	Current (transformer)
Network 18	264	480	112	236	Current (transformer)
Network 19	421	738	221	190	Current (transformer)
Network 20	700	1272	285	246	Current (transformer)
Network 21	175	318	102	172	Current (transformer)
Network 22	420	736	104	404	Current (transformer)
Network 23	646	1175	185	349	Current (line)
Network 24	436	793	176	248	Current (transformer)
Network 25	674	1183	120	562	Current (transformer)
Network 26	275	483	79	348	Current (transformer)
Network 27	452	793	0	–	Current (line)

Network 28	426	775	184	232	Current (transformer)
Network 29	866	1519	254	341	Current (line)
Network 30	431	783	122	353	Current (transformer)
Network 31	444	807	248	179	Current (transformer)
Network 32	418	734	202	207	Current (transformer)
Network 33	445	780	255	175	Current (transformer)
Network 34	640	1122	132	485	Current (line)
Network 35	886	1554	411	216	Current (line)
Network 36	455	799	476	96	Current (transformer)
Network 37	428	779	208	206	Current (transformer)
Network 38	457	802	599	76	Current (transformer)

Table 8 presents the total increment, the increment per customer of the hosting capacity and the hosting capacity per peak load in all networks where an increase of the hosting capacity of photovoltaic power generation occurs when an on-load tap changer is used. It is important to notice that the installed capacity is considered, except in the rightmost column. The case with no on-load tap changer is taken as a basis of the comparison. The networks that do not increase their hosting capacity of photovoltaic power generation are the ones that are limited by current if they are not equipped by on-load tap changer.

Table 8: The total increment of the hosting capacity, the increment of the hosting capacity per customer and the hosting capacity per peak loading in the networks that increase their hosting capacity of photovoltaic power generation if the on-load tap changer of five or nine tap positions is used. The results are compared with the case that no on-load tap changer is used.

The Name of the Network	The Total Increment of the Hosting Capacity (Rated Capacity) of the PV Generation [kW]	The Increment of the Hosting Capacity (Rated Capacity) of the PV Generation per Customer [kW]	The Hosting Capacity of the PV Generation Divided by the Peak Load
Network 4	140	0.9	1.3
Network 5	335	1.9	2.3
Network 9	117	0.6	1.6

Network 12	183	2.7	1.9
Network 13	19	0.2	2.3
Network 14	153	2.7	1.3
Network 15	146	1.4	3.3
Network 37	294	1.5	2.1

The hosting capacities (installed capacity) of the photovoltaic power generation in all studied networks and in all cases, no on-load tap changer, the on-load tap changer of five and nine tap positions, are presented in Figure 47.

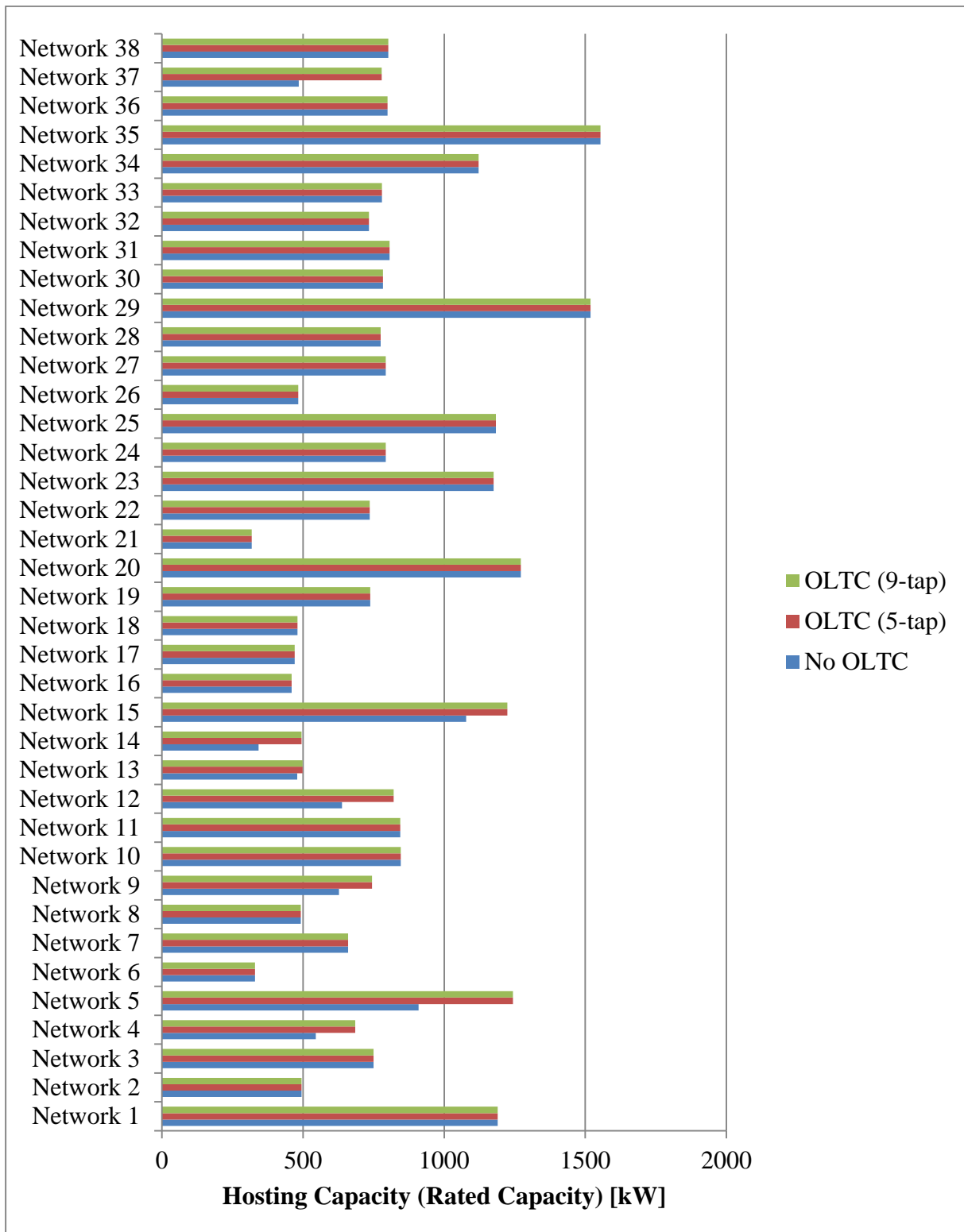

Figure 47: The hosting capacity (rated capacity) to accommodate photovoltaic power generation in all studied 38 networks.

The hosting capacities (installed capacity) per customer in the networks where the hosting capacity is increased when using the on-load tap changer are illustrated in Figure 48. The other networks are not shown in order to make the presentation more compact.

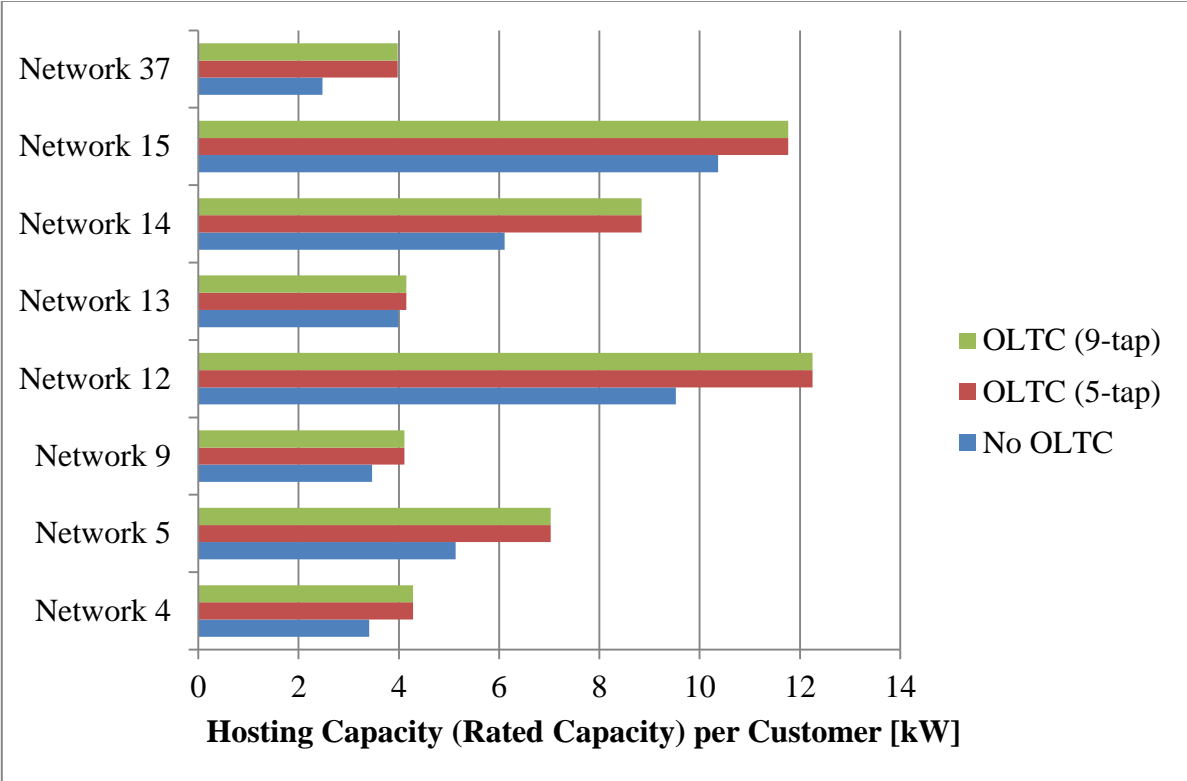

Figure 48: The hosting capacity (rated capacity) per customer in the networks that increase the hosting capacity of photovoltaic power generation when an on-load tap changer is used. The difference with Figure 47 is that the rated capacity is divided by the number of customers in the corresponding network.

5.1.1.3. The Hosting Capacity of Photovoltaic Power Production with and without an On-Load Tap Changer: Single- and Three-Phase Connected Photovoltaic Generators (Mixed Types of Phase Connections)

In this part, the methodology of estimating the hosting capacity is similar to the one presented in Section “Description of the Methodology and the Results” but all photovoltaic generators do not have the same nominal rating and are not three-phase connected. In addition, the output of the photovoltaic generators is increased in a slightly different manner.

The same types of on-load tap changers are used as in the simulations in Section “The Hosting Capacity of Photovoltaic Power Production with and without an On-Load Tap Changer: All Photovoltaic Generators Connected to Three Phases”. Also the same control principle of the on-load tap changers is used.

The results in the case when no on-load tap changer is used are shown in Table 9. The photovoltaic power generation and the installed generation capacity at the moment when the

constraint occurs are presented. Also the maximum loading of the network and the type of the constraint are displayed.

Table 9: The power generation by the photovoltaic panels at the moment when the constraint occurs and the installed generation capacity in each network together with the maximum load of the network, power generation per maximum load and the type of the constraint is presented. In this case, an on-load tap changer is not used.

The Name of the Network	Generation [kW]	Installed Generation Capacity [kW]	The Maximum Load of the Network [kW]	Generation per Maximum Load [%]	The Type of the Constraint
Network 1	196	344	192	102	Voltage
Network 2	140	246	149	94	Current (transformer)
Network 3	269	473	103	261	Voltage
Network 4	73	132	286	26	Voltage
Network 5	68	123	295	24	Voltage
Network 6	58	105	102	57	Voltage
Network 7	187	327	241	78	Voltage
Network 8	130	228	106	123	Current (transformer)
Network 9	47	85	249	19	Voltage
Network 10	77	140	313	25	Voltage
Network 11	240	421	234	103	Current (line)
Network 12	53	97	240	22	Voltage
Network 13	40	73	120	33	Voltage
Network 14	30	55	205	15	Voltage
Network 15	107	188	206	52	Voltage
Network 16	121	212	35	346	Current (transformer)
Network 17	79	138	85	93	Voltage
Network 18	198	360	112	177	Current (transformer)
Network 19	182	320	221	82	Current (transformer)
Network 20	230	404	285	81	Voltage
Network 21	68	124	102	67	Voltage
Network 22	160	281	104	154	Current (line)
Network 23	303	531	185	164	Current (line)
Network 24	108	190	176	61	Voltage
Network 25	148	259	120	123	Voltage
Network 26	52	91	79	66	Voltage

Network 27	151	265	0	–	Current (line)
Network 28	164	287	184	89	Voltage
Network 29	294	516	254	116	Voltage
Network 30	124	218	122	102	Voltage
Network 31	95	173	248	38	Voltage
Network 32	212	372	202	105	Current (line)
Network 33	179	314	255	70	Current (transformer)
Network 34	212	373	132	161	Current (line)
Network 35	262	459	411	64	Voltage
Network 36	214	375	476	45	Current (transformer)
Network 37	45	82	208	22	Voltage
Network 38	200	351	599	33	Current (transformer)

Similar as in Table 9, the results in the cases where an on-load tap changer of five tap positions and of nine tap positions are used, are presented in Table 10 and in Table 11, respectively.

Table 10: The results in the case where on on-load tap changer of five tap positions is used are presented. The photovoltaic power generation at the moment of the constraint, the installed generation capacity, the maximum load of the network, power generation per maximum load and the type of the constraint are presented.

The Name of the Network	Generation [kW]	Installed Capacity [kW]	The Maximum Load of the Network [kW]	Generation per Maximum Load [%]	The Type of the Constraint
Network 1	342	600	192	178	Current (line)
Network 2	140	246	149	94	Current (transformer)
Network 3	383	671	103	372	Current (transformer)
Network 4	131	238	286	46	Voltage
Network 5	124	226	295	42	Voltage
Network 6	92	168	102	90	Current (transformer)
Network 7	196	343	241	81	Current (line)
Network 8	130	228	106	123	Current (transformer)
Network 9	85	149	249	34	Voltage
Network 10	140	245	313	45	Voltage
Network 11	240	421	234	103	Current (line)

Network 12	97	176	240	40	Voltage
Network 13	72	126	120	60	Voltage
Network 14	53	97	205	26	Voltage
Network 15	194	341	206	94	Voltage
Network 16	121	212	35	346	Current (transformer)
Network 17	90	165	85	106	Current (line)
Network 18	198	360	112	177	Current (transformer)
Network 19	182	320	221	82	Current (transformer)
Network 20	314	551	285	110	Current (line)
Network 21	68	124	102	67	Current (transformer)
Network 22	160	281	104	154	Current (line)
Network 23	303	531	185	164	Current (line)
Network 24	199	349	176	113	Voltage
Network 25	271	475	120	226	Voltage
Network 26	95	166	79	120	Voltage
Network 27	151	265	0	–	Current (line)
Network 28	175	307	184	95	Current (line)
Network 29	422	740	254	166	Current (line)
Network 30	157	285	122	129	Current (line)
Network 31	168	306	248	68	Current (line)
Network 32	212	372	202	105	Current (line)
Network 33	179	314	255	70	Current (transformer)
Network 34	212	373	132	161	Current (line)
Network 35	297	522	411	72	Current (line)
Network 36	214	375	476	45	Current (transformer)
Network 37	82	149	208	39	Voltage
Network 38	200	351	599	33	Current (transformer)

Table 11: The results in the case when an on-load tap changer of nine tap positions is used are displayed. The photovoltaic power generation at the moment of the constraint, the installed generation capacity, the maximum loading of the network, power generation per maximum load and the type of the constraint are shown.

The Name of the Network	Generation [kW]	Installed Generation Capacity [kW]	The Maximum Load of the Network	Generation per Maximum Load [%]	The Type of the Constraint
Network 1	342	600	192	178	Current (line)
Network 2	140	246	149	94	Current (transformer)
Network 3	383	671	103	372	Current (transformer)
Network 4	149	272	286	52	Voltage
Network 5	143	261	295	48	Voltage
Network 6	92	168	102	90	Current (transformer)
Network 7	196	343	241	81	Current (line)
Network 8	130	228	106	123	Current (transformer)
Network 9	97	177	249	39	Voltage
Network 10	164	298	313	52	Voltage
Network 11	240	421	234	103	Current (line)
Network 12	112	197	240	47	Voltage
Network 13	82	144	120	68	Voltage
Network 14	61	111	205	30	Voltage
Network 15	246	432	206	119	Voltage
Network 16	121	212	35	346	Current (transformer)
Network 17	90	165	85	106	Current (line)
Network 18	198	360	112	177	Current (transformer)
Network 19	182	320	221	82	Current (transformer)
Network 20	314	551	285	110	Current (line)
Network 21	68	124	102	67	Current (transformer)
Network 22	160	281	104	154	Current (line)
Network 23	303	531	185	164	Current (line)
Network 24	228	415	176	130	Voltage
Network 25	312	568	120	260	Voltage
Network 26	109	192	79	138	Voltage
Network 27	151	265	0	–	Current (line)

Network 28	175	307	184	95	Current (line)
Network 29	422	740	254	166	Current (line)
Network 30	157	285	122	129	Current (line)
Network 31	168	306	248	68	Current (line)
Network 32	212	372	202	105	Current (line)
Network 33	179	314	255	70	Current (transformer)
Network 34	212	373	132	161	Current (line)
Network 35	297	522	411	72	Current (line)
Network 36	214	375	476	45	Current (transformer)
Network 37	93	163	208	45	Voltage
Network 38	200	351	599	33	Current (transformer)

The installed hosting capacities in all 38 networks in all studied cases; with no on-load tap changer and with on-load tap changers with five and with nine tap positions are displayed in Figure 49.

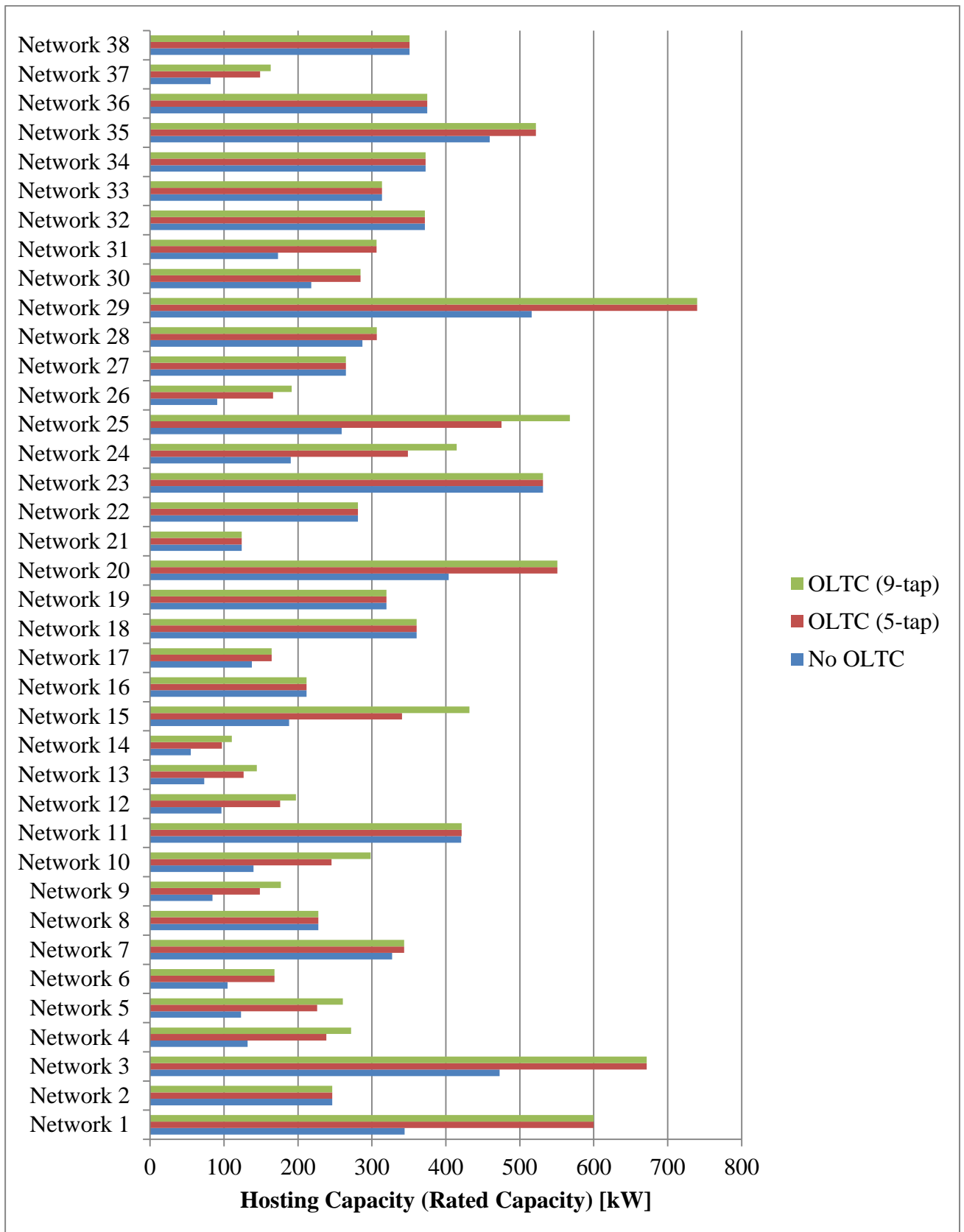

Figure 49: The hosting capacities of the 38 networks with no on-load tap changer, with the on-load tap changer of five tap positions and with the one of nine tap positions.

The hosting capacities per customer in the networks that increase their hosting capacity when the on-load tap changer of five or nine tap positions is used (in comparison with the case that no on-load tap changer is employed) are illustrated in Figure 50.

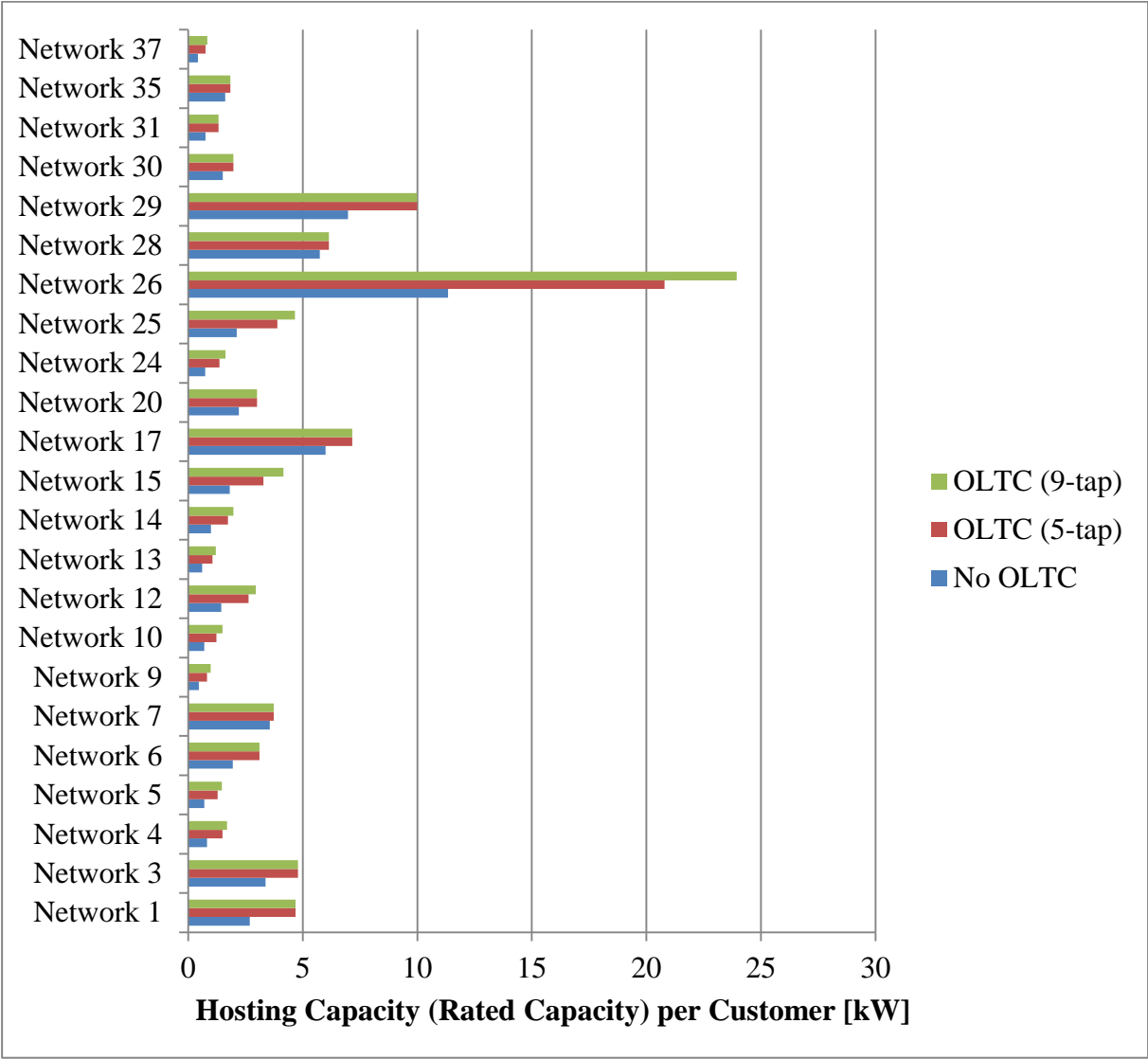

Figure 50: The hosting capacities per customer of the networks that increase their hosting capacity when an on-load tap changer (with nine or with five tap positions) is used.

5.1.1.4. Comparison: All Photovoltaic Generators Connected to Three Phases versus 90% of the Generators One-Phase and 10% Three-Phase Connected

In this section, the results between two studied cases are compared; all photovoltaic generators are connected in a three-phase manner (Section “The Hosting Capacity of Photovoltaic Power Production with and without an On-Load Tap Changer: All Photovoltaic Generators Connected to Three Phases”) and mixed connection types (90 per cent connected

to a single phase and 10 per cent connected to three phases) (Section “The Hosting Capacity of Photovoltaic Power Production with and without an On-Load Tap Changer: Single- and Three-Phase Connected Photovoltaic Generators (Mixed Types of Phase Connections)”). Only the hosting capacities (rated capacities) of the networks where the hosting capacity is increased in both studied cases when an on-load tap changer is used. The hosting capacities in the case when no on-load tap changer is used are shown in Figure 51 and the results of the case when the on-load tap changer of nine tap positions is used are presented in Figure 52. The cases where the on-load tap changer with five tap positions is used are not shown in order to reduce the space of the presentation and make the figures easier to read.

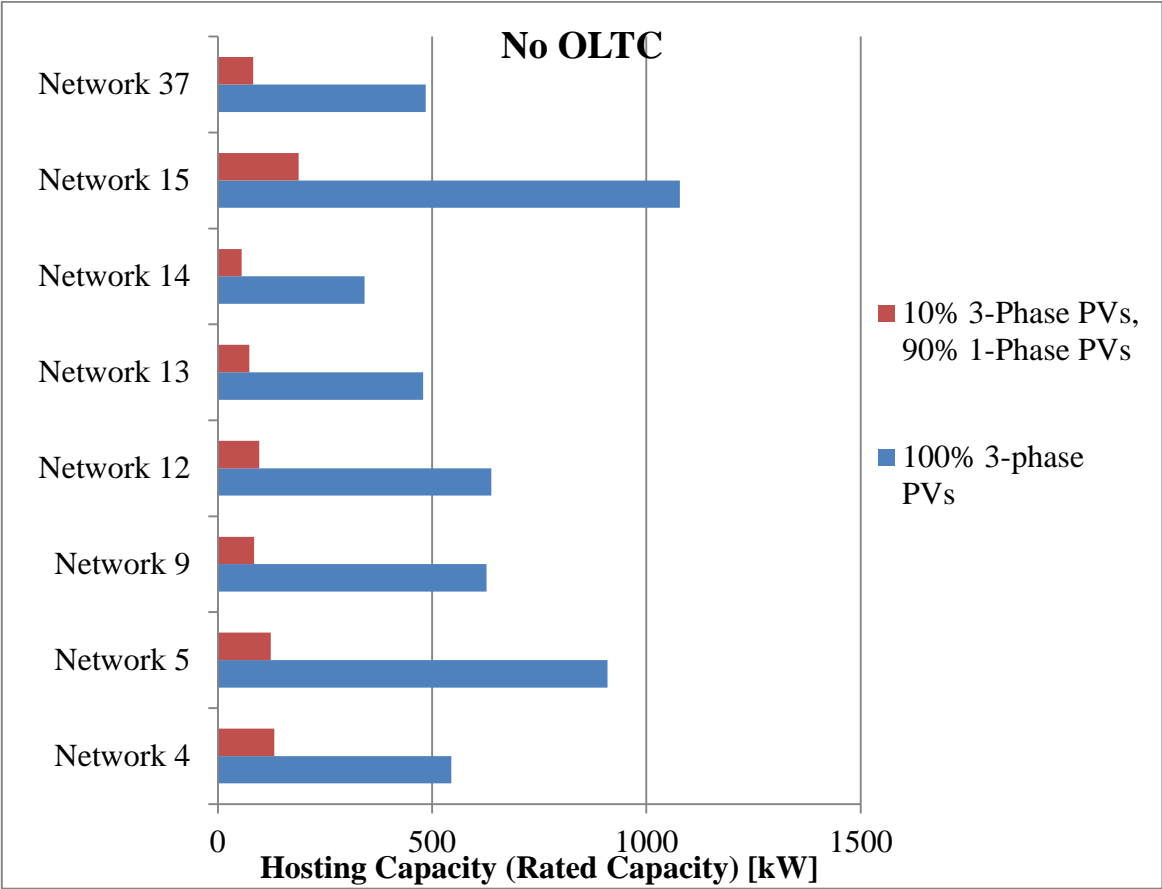

Figure 51: The hosting capacity (rated capacity) of the photovoltaic power generation in the networks where the hosting capacity is increased in both studied cases (only three-phase connected generator and both: single-phase and three-phase connected generators) when no on-load tap changer is used.

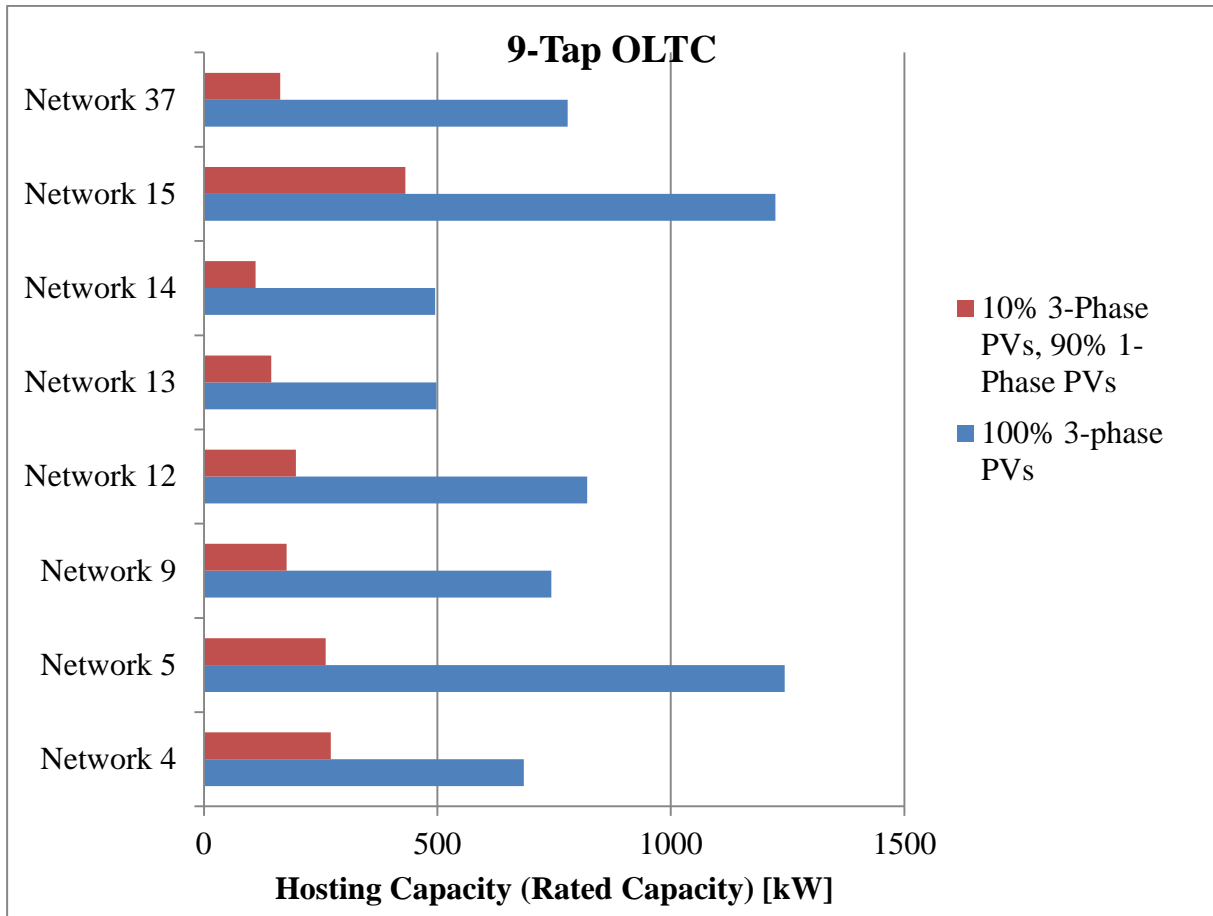

Figure 52: The hosting capacity (rated capacity) of the photovoltaic power generation in the networks where the hosting capacity is increased in both studied cases (only three-phase connected generator and both: single-phase and three-phase connected generators) when the on-load tap changer with nine tap positions is used.

5.1.1.5. Application of Monte Carlo –Method in the Estimation of Hosting Capacity for Photovoltaic Power Generation

This section studies the application of Monte Carlo –method in order to estimate the hosting capacity for photovoltaic power generation. The objective is to see whether an approach based on the Monte Carlo –method can improve the estimation of the hosting capacity. As a basis, the same methodology is used as in Section “Description of the Methodology and the Results”. In this case, an on-load tap changer is not used. The difference is that the random variables in three phases. These are:

- the number of fictive photovoltaic generators in a network,
- the locations of the fictive photovoltaic generators and
- the proportion of single- and three-phase photovoltaic generators in a network.

Firstly, the number of photovoltaic generators is drawn randomly according to the uniform distribution so that the minimum number of photovoltaic generators is one and the maximum number of the photovoltaic generators is the number of terminals that are connected to at least one customer. Secondly, the fictive photovoltaic generators are placed in the networks in a random manner. Finally, the proportion of the single- and the three-phase generators is drawn randomly according to the uniform distribution so that this proportion varies from 10 to 90 per cent. The rest of the generators are three-phase connected photovoltaic generators. Apart from these modifications, the simulation is similar as presented in Section “The Hosting Capacity of Photovoltaic Power Production with and without an On-Load Tap Changer: Single- and Three-Phase Connected Photovoltaic Generators (Mixed Types of Phase Connections)”. For the study, Network 10 (among the networks used in earlier sections) is analysed.

Figure 53 illustrates the hosting capacity of 120 cases on Network 10. The values are organised in the descending order so that the leftmost value is the highest one. The mean value is marked in the red column.

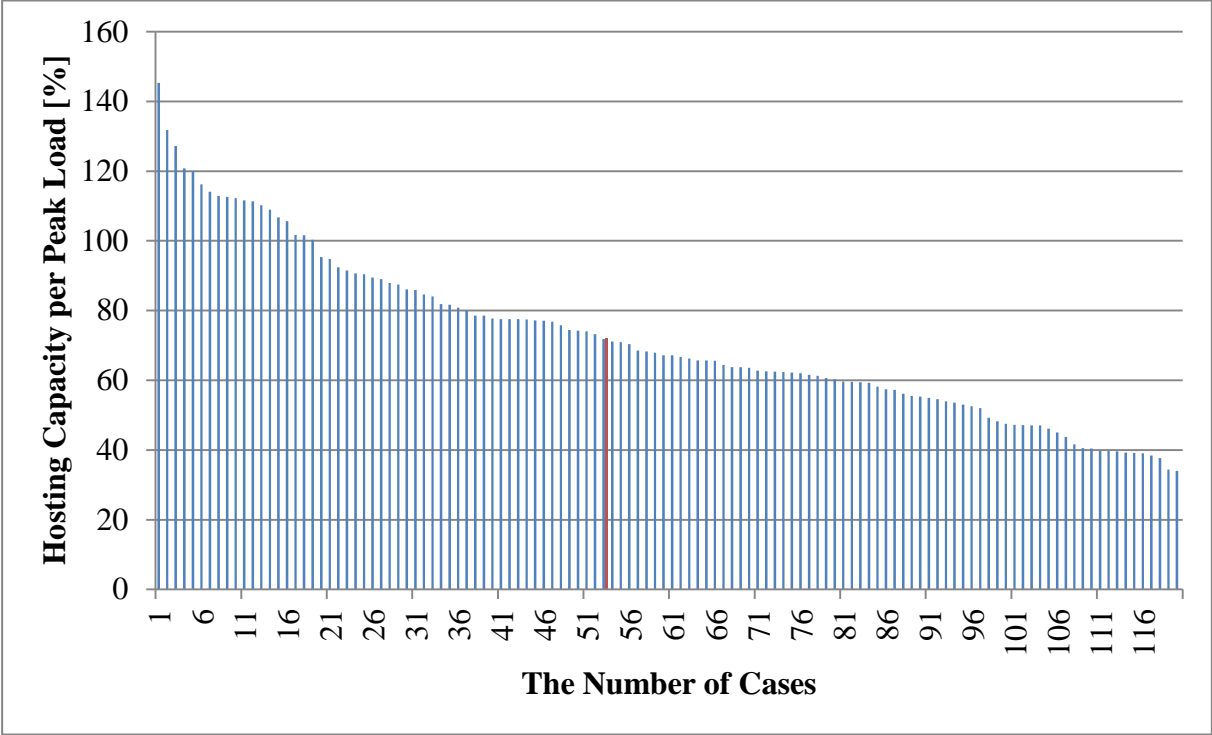

Figure 53: Hosting capacity for photovoltaic power generation in Network 10. The values are organised in the descending order. The red column represents the mean value of the hosting capacity. An on-load tap changer is not used.

The lowest value of the hosting capacity for photovoltaic power generation is 34 per cent and the highest value 145 per cent of the peak load. The mean value is 72 per cent. In eight out of 120 cases, the network is constrained by the current in a line. In the rest of the cases, the network is constrained by voltage.

5.1.2. Analysis of the Results

The results of the simulations are analysed in this section. Thereafter, a short comparison of the results of two used approaches is carried out.

5.1.2.1. The Hosting Capacity of Photovoltaic Power Production with and without an On-Load Tap Changer: All Photovoltaic Generators are Three-Phase Connected

When the on-load tap changers are not used, eight networks are constrained by voltage and the rest of the networks are restrained by current in a line or in a transformer. This means that there is a possibility to increase the hosting capacity of the photovoltaic power generation in those eight networks by installing an on-load tap changer. The average value of photovoltaic generation is 434 kW and the average value of the installed capacity is 771 kW (installed capacity is the sum of the rated capacities of all photovoltaic generators in the network) between all 38 networks. The average value of the photovoltaic generation per customer is 18.0 kW and 6.2 kW except for Network 27 (Network 27 has only one customer). The average value of photovoltaic generation capacity is 31.6 kW when Network 27 is included and 11.0 kW when Network 27 is not included.

When all 38 networks are equipped by the on-load tap changers with five tap positions, an increase in the hosting capacity of photovoltaic power generation can be seen in eight networks (4, 5, 9, 12, 13, 14 and 37) (Table 5). Those networks are constrained by voltage if the on-load tap changers are not used. Network 15 has both, a voltage constraint and a current constraint in the transformer. This is because the limits of the voltage and the current constraints are closer to each other than the size of one step when increasing the amount of photovoltaic power generation between the simulations. Among those eight networks that increase their hosting capacity, the average amount of installed photovoltaic power generation capacity increases 173 kW from 638 kW to 811 kW when the on-load tap changers of five positions are used instead of the option that no on-load tap changer is used. The average value of the increment per customer is about 1.5 kW. The minimum increment is 0.16 kW per customer (Network 13) and the maximum increase is 2.73 kW per customer (Network 14). When the on-load tap changers of five positions are used, the networks that are voltage constrained without an on-load tap changer, become current constrained. This means that the hosting capacity of the network cannot be increased by installing a tap changer with a larger range of voltage adjustment (a higher number of tap positions). This is confirmed by the simulation where the on-load tap changers of nine tap positions are used. The results are exactly the same (Table 6 and Table 7). In other words, using an on-load tap changer of nine positions does not increase the hosting capacity more than an on-load tap changer of five positions under the studied circumstances.

There are significant differences in how much a low voltage network can gain in hosting capacity by using an on-load tap changer among the eight networks that increase the hosting capacity (Figure 48). The smallest gain in installed capacity per customer is 0.2 kW (Network 13) and the largest one 2.7 is kW (Network 14).

5.1.2.2. The Hosting Capacity of Photovoltaic Power Production with and without an On-Load Tap Changer: Mixed Connection Types

In the cases where an on-load tap changer is not employed, the hosting capacity of photovoltaic power generation is limited by voltage in 24 out of 38 networks and limited by current constraints in 14 networks. If an on-load tap changer of five or nine position is used, the number of voltage limited networks reduced from 24 to 12. If no on-load tap changer is used, the mean value of the hosting capacity among all networks is 145 kW (Table 9) and becomes 181 kW (Table 10) if the 5-position on-load tap changer is used and increases further to 188 kW (Table 11) if the on-load tap changer of 9 tap positions is used. The average values of the rated capacities of photovoltaic generations are 256 kW, 320 kW and 333 kW, respectively. The on-load tap changer with nine tap positions does not reduce the number of networks constrained by voltage when compared with the on-load tap changer with five positions. On the other hand the on-load tap changer with nine tap positions further increases the hosting capacity in some networks that benefit from the on-load tap changer with five tap positions.

5.1.2.3. Comparison of the Results: All Photovoltaic Generators Three-Phase Connected versus Mixed Connection Types

There are clear differences between the two approaches to size the photovoltaic generators and choose their phase connections. Generally, when all generators used in the study are three-phase connected photovoltaic generators, the hosting capacities are higher. Also, fewer networks are constrained by voltage than in the study where mixed types of connections are used.

When only the networks that increase the hosting capacity (in both cases; with only three-phase connected generators and mixed connections) are considered and the case when no on-load tap changer is used, it can be seen that the hosting capacities are about four to seven times higher when only three-phase connected generators are used than in the case with mixed types of connections (Figure 51). If the on-load tap changer of nine tap positions is used, this ratio (the difference between the case of only three-phase connected generators and the case of mixed types of phase connections) is from three to five (Figure 52).

In the study when only three-phase connected photovoltaic generators are used, no difference in the hosting capacity is noticed if five or nine position tap changers are used (Figure 47). On the other hand, differences can be found when mixed types of connections are used (Figure 50).

5.1.2.4. Application of Monte Carlo –Method in the Estimation of Hosting Capacity for Photovoltaic Power Generation

When the method of estimating the hosting capacity for photovoltaic power generation is carried out 120 times on the same network, the values of relative hosting capacity (hosting capacity divided by the peak load) range from 34 per cent to 145 per cent, the average value being 72 per cent. The values obtained from Monte Carlo simulations prove that the hosting capacity obtained in Section “The Hosting Capacity of Photovoltaic Power Production with and without an On-Load Tap Changer: Single- and Three-Phase Connected Photovoltaic Generators (Mixed Types of Phase Connections)”, that is 25 per cent, represents a pessimistic estimation. On the other hand, the value obtained in Section “The Hosting Capacity of Photovoltaic Power Production with and without an On-Load Tap Changer: All Photovoltaic

Generators Connected to Three Phases”, that is 154 per cent, is an optimistic estimation of the hosting capacity.

In order to take the most out of the essence of the Monte Carlo -method, it has to be run at least several tens or hundreds of times. So many runs are required so that a decent coverage of the output results is achieved. If it takes, for example, five minutes to execute the script one time on one network, it means that a simulation of several hours or even days should be used to acquire solid results. This is a long time invested in one low voltage network.

5.1.3. Discussion

When using the proposed strategy to choose the phase connection of the photovoltaic generators, in general, the hosting capacity of the photovoltaic power generation is several times higher than the maximum value of the average load of that network even without an on-load tap changer. However, according to the results, an on-load tap changer is an efficient way to increase the hosting capacity in low voltage networks where a voltage constraint poses a bottleneck.

The hosting capacity of photovoltaic power generation divided by the number of customers is a simple indicator that takes into account the size of the network. However, it does not take into account the loading of the network. Low voltage networks are sized according to the maximum estimated loading. That is why it is interesting to link the hosting capacity to the sizing of the network by dividing it by the maximum loading. The proportional indicators of this kind offer better picture of the hosting capacity that permit the comparison of networks with each other.

In the studies, the hosting capacity is studied only over a typical summer day, even though the hosting capacity is higher during the winter than during the summertime due to the high loading of the network. On the other hand, solar irradiation is weaker during the winter than during the summer so it is evident that lower production of photovoltaic power is expected. If the hosting capacity was estimated according to the values of winter loading and photovoltaic production, problems would be expected in the summer when the networks are lightly loaded and the photovoltaic power production is high. Only one day is considered in order to make the algorithm as fast as possible. Choosing a summer day is a safer option because if constraints are not met during the summer day, it is not likely to experience constraints during a winter day. In this light, using also a winter day for the estimation of the hosting capacity would not provide useful supplementary information. If more information is required, hosting capacity divided by the light loading conditions can be used to estimate the difference between the difference between the “optimistic” (low load per hosting capacity) and the “pessimistic” (high load per hosting capacity) ratios of hosting capacity per load.

It is logical that the placement and the phase connection of the photovoltaic generators have a significant impact on the resulting hosting capacity of the network. For example, the limits of the hosting capacity are met much faster (due to over voltage) if all photovoltaic generators are connected to the phase A instead of connecting them evenly between phases A, B and C. This is because of the fact that if the power is fed to one phase, voltage increases much more than if the same amount of power was injected to three phases, where it would divide equally between three phases. As demonstrated by the studies, the difference in the hosting capacity of the network can be several times higher when the photovoltaic generators are three-phase connected (and located evenly in the network and sized equally) in comparison with the case that most of them are connected to one phase.

As a general rule, the further a single line is located from a secondary substation, the smaller cross section and smaller transmission capacity it has. The lines with the smallest cross sections are located at the ends of the feeders where the loading is relatively light. It is reasonable that these locations have low hosting capacities.

When a planning for the future is done, there is no one way to choose the locations, the sizes and the phase connections of the photovoltaic generators because in reality it is impossible to foresee these exactly in any network. A fact is that every different configuration of the phase connections of photovoltaic panels results in slightly different voltage profiles in the feeders and thus, different values of the hosting capacity. This is why it is difficult to estimate an exact value for the hosting capacity. It can be stated that a voltage constraint is a soft constraint; a voltage constraint means that the hosting capacity of the network can be increased without the need for reinforcement if voltage is controlled properly. If the network doesn't have any device that can adjust the voltage in the location of the constraint, a reinforcement has to be done. Additionally, minor and short-term over voltages or voltage drops do not cause a significant damage in the network and do not interrupt the power delivery through a blown fuse. A current constraint is a hard constraint because the hosting capacity can be increased only by reinforcing the network.

A voltage constraint is less expensive to treat for a distribution system operator than a current constraint. There are several technical solutions to relieve bottlenecks formed by voltage constraints, such as a retrofitted on-load tap changer, an autotransformer or a voltage controller based on power electronics. These technologies are relatively cheap because they don't require the replacement of the existing components before the end of their lifetime, but are added in the network as it is. Some of these solutions can be moved to another destination if a reinforcement takes place in the network and the voltage controlling component turns out to be unnecessary.

In the made studies, the hosting capacity is the limit where the first constraint is met. It is not studied how much photovoltaic power generation has to be increased so that the next constraint will appear (if the output power from the photovoltaic power generators is further increased). This would be interesting to know, especially in case of a voltage constraint. If the first bottleneck is a voltage constraint and a notable amount of power generation can be added to the network before the appearance of the first current constraint (the margin between these two limits is large), an investment in a voltage controller may be appealing. The larger is the margin, the more network capacity is to be exploited.

Removing a current constraint is likely to be more expensive than removing a voltage constraint as a result of the fact that substantial component, a line or a transformer, has to be replaced. Another fact to consider is that the network components are sized for unidirectional power flow. For example, the largest cross sections of the lines can be found at the beginning of the feeders. In the second line of the feeder has a slightly smaller cross section because some of the power is delivered to the customers at the very beginning of the feeder, which means that there is less power flow in the second line of the feeder (as presented in Figure 54). When moving from the beginning towards the end of the feeder, the cross sections of the lines become smaller. This is based on the fact that all customers are not situated at the end of the feeder, but rather more or less uniformly along it. Because of this design, the current capacities of different line sections are slightly decreasing towards the end of the feeder but, in overall, rather close to each other. This means that if one line section is renewed, the hosting capacity cannot increase much before an appearance of a new current constraint. That is why several limitations should be considered.

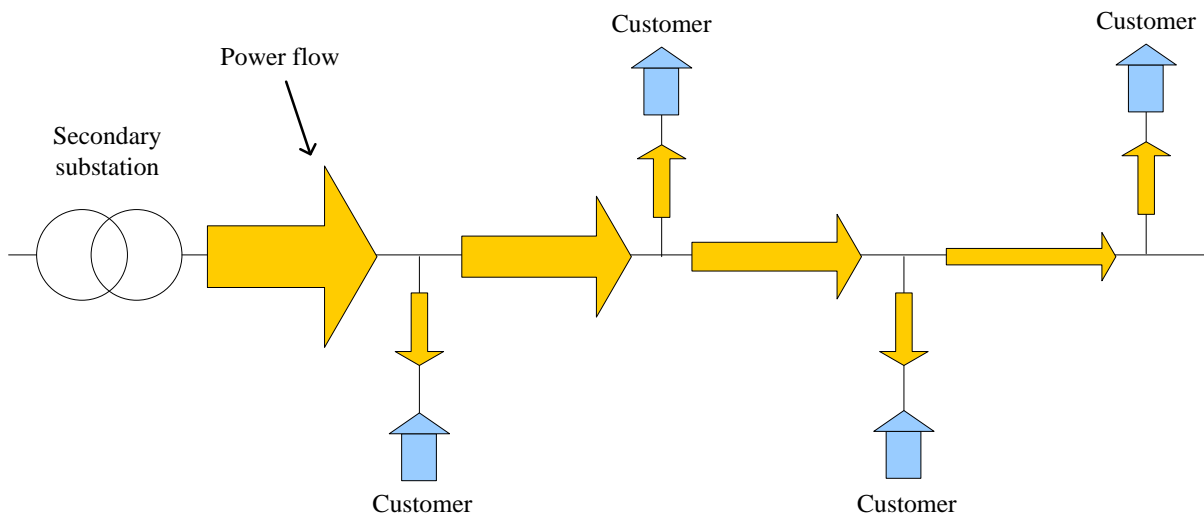

Figure 54: An illustration of one-way power flow from the secondary substation towards the end of the feeder. The thicker the arrow is, the stronger is the power flow. The lines of the feeder are sized according to the power flow (the thickness of the arrow). Thus, the cross-section of the line is smaller at the end (on the right side) than at the beginning of the feeder (on the left side).

Another matter is that not only the power generation affects the hosting capacity but also the consumption. If the consumption cannot be known exactly, it is impossible to obtain an accurate value for the hosting capacity. In real-life, not all customers install photovoltaic generators and not all photovoltaic generators are of the same size. This study presents only two ways of placing and choosing the phase connections of the photovoltaic generators, but it would be useful to consider different strategies and compare them with each other.

For instance, one possible strategy could be to choose the phase connection so that every single-phase photovoltaic generator is connected to a phase that has the lowest installed capacity of photovoltaic generation among all three phases. Another simpler way would be to choose the phase connection purely randomly, which would guarantee that roughly the same number of photovoltaic generators is connected to each phase. In order to find as realistic a method as possible, different methods should be compared with data from real low voltage networks (whenever the required data is available) that suffer from voltage problems due to photovoltaic power generation.

Even if every single low voltage network is different, it is likely that common tendencies about the size and the placement can be found if a statistical work on a large number of networks was carried out. These characteristics could be used to create general schemes of locating and sizing photovoltaic generators. There could be for example, a pessimistic, an average and an optimistic scenario.

Another kind of approach could be to consider only the worst case scenario. Most probably this would be to place a large virtual photovoltaic generator (or several small generators in parallel) far from the secondary substation (at the end of a feeder with only few customers) and connecting it to one phase. Without a doubt, this supposition would not be realistic, but at least it would be a safe approach, giving a large margin because the estimated hosting capacity is not going to be surpassed in practice.

A more elaborated strategy is to use Monte Carlo approach, but it requires a large number of simulations, which would be timely inefficient. The method used in this work aims at obtaining average results without having to run the number of simulation that a Monte Carlo approach would require. Nevertheless, since finding an accurately realistic method of placing the photovoltaic generators, to size them and to choose their phase connections are not among the main themes of this work the results should be treated in terms of directional or average results rather than as exact ones. Before estimating the hosting capacity, a trade-off between the accuracy of the estimation and the time of execution of the method must be made. Also, the final utility of the data has to be taken into account. It does not bring additional benefit to know the hosting capacity exactly because the exact number and the location of photovoltaic generators are not known anyway. On the other hand, it is more useful to know the order of magnitude of the hosting capacity so that approximate estimations can be done.

One advantage of including Monte Carlo –techniques to the estimation of hosting capacity is that extreme situations considering hosting capacity can be determined. The hosting capacities can be classified, for example, as “pessimistic” and “optimistic” values. This cannot be done if only one scenario is used. However, within the framework of this thesis, an average estimation of the hosting capacities can be done even without Monte Carlo – techniques. That is why Monte Carlo –techniques are not further used or developed in this thesis.

The work targets at benchmarking approximations of the hosting capacities of low voltage networks when on-load tap changers are used and are not used. This is only one standpoint to consider when thinking of investing in an on-load tap changer. Before being able to acquire a comprehensive view about whether an on-load tap changer should be applied, with how many tap positions and what kind of tap control should be applied, a study consisting of several consecutive steady-state calculations over a long period of time should be made. This is the way to obtain a more complete view on the function of an on-load tap changer. According to the results of this work, the more tap positions there are, the larger is the available voltage range and the more photovoltaic generation a given network can withstand without meeting technical constraints. However, the increment of the hosting capacity may not be the most substantial argument for choosing the technology used in the on-load tap changer. Because every tap change wears out the tap changer, it is important to choose a control method that responds to the needs of the network, but also minimises the number of tap changes in order to obtain the maximum possible lifetime for the component. Because an on-load tap changer increases or reduces voltage in the whole low voltage network, it is ideal in the networks where voltage fluctuates more or less equally in the whole feeder and does not have local voltage peaks.

The results based on the previous chapter show that the minimum and the maximum values of voltage can be captured correctly. However, theoretically a feeder can have significant voltage peaks (or drops) that cannot be detected by voltage measurements, if the locations of the voltage measurements are not updated after the addition of new photovoltaic generators. In this case the use of an on-load tap changer can make the situation even worse if the voltage profile of the whole feeder is elevated when the peak has already exceeded the upper voltage limit. This is illustrated in Figure 55. Of course the scenario contains a supposition that a generator that causes the voltage peak does not have a voltage control of any kind. Local voltage variations can be an issue in long feeders.

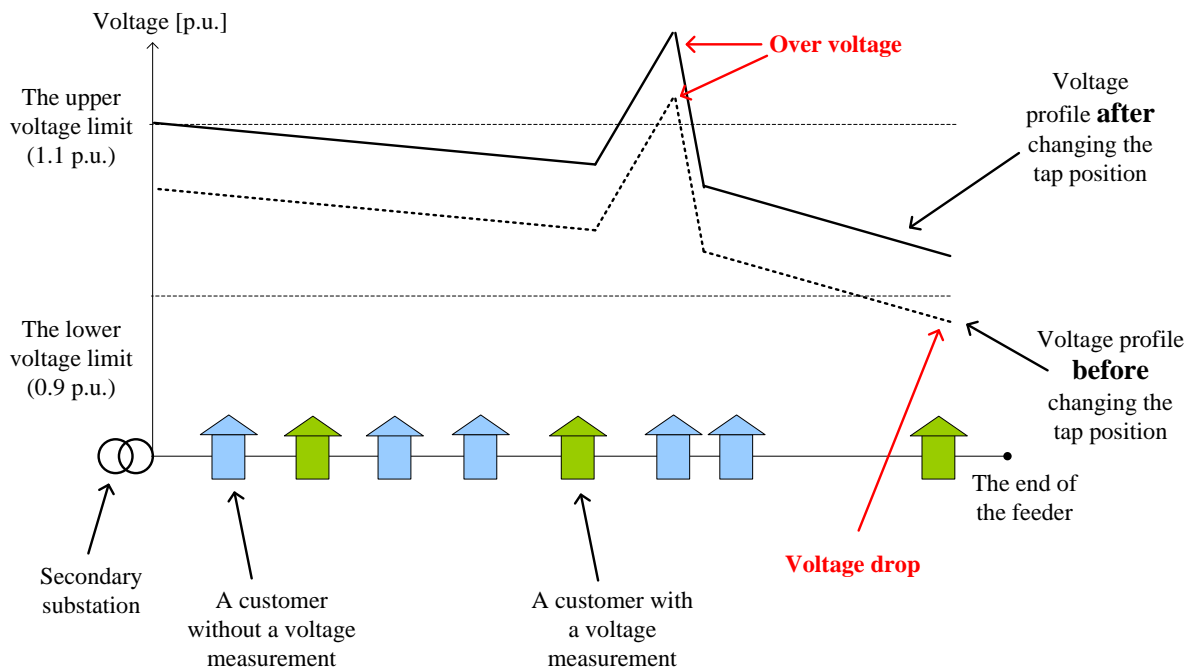

Figure 55: Voltage profile of a feeder before and after a change in a tap position by the on-load tap changer. Three of eight customers are equipped by a voltage measurement in order to control the on-load tap changer. Before the change in the tap position, the last (the rightmost) customer experiences a voltage drop. After the tap change, the sixth customer (from the left) experiences an over voltage because it is not equipped by a voltage measurement. The purpose of the figure is to support the idea presented in the text and not to be exactly realistic.

A high concentration of photovoltaic generators in one low voltage distribution network or in one feeder, that is a relatively small area, can cause high and fast local voltage variation due to passing clouds. Since an on-load tap changer is a mechanical device that can wear out quickly in a frequent use, it cannot be used to solve the voltage problems of such a short time scale. Also, the response time of an on-load tap changer cannot be extremely high due to its mechanical structure. The problems of this kind should be addressed by an apparatus with a fast response time and non-mechanical components, such as power electronic converters. If a network is demanding with large voltage variations, one idea could be to use solid state transformer. As discussed in Section “Solid State On-Load Tap Changers”, a solid state transformer has a capability to contribute to the power quality in a very short time range. Nevertheless, a transformer is the most expensive single component in a low voltage network. That is why the decision should be well justified.

If the hosting capacity of a network is wanted to know for the planning purposes, it should be taken into account that there are many other uncertainties involved in planning. The longer is the time frame, the more uncertainties are likely to be involved. With this in mind, it may not make a difference in practice whether the exact value of the hosting capacity is known, or only a rough approximation. More generally, if there are several factors affecting the hosting capacity, it may not be useful to invest a lot of time in order to achieve a precise estimate of the location of the photovoltaic generators if all the rest of the affecting factors have only vague estimations, which would not improve the global estimation significantly.

The study does not consider the impact of the on-load tap changer on the medium voltage network. This problem should be covered before the actual implementation in order to make sure that voltage problems of the low voltage networks are not transferred upstream to a medium voltage network. A transformer is not a “wall” between the medium and the low voltage level, which means that changes in voltage, such as a voltage drop, in a low voltage network can be experienced on the medium voltage level. Because medium voltage networks have several low voltage networks in their downstream, the voltage fluctuations due to the operation of on-load tap changers sum on the medium voltage level.

The methodology of finding the hosting capacity of photovoltaic power generation is straightforward and can be realised in the PowerFactory environment. In this way, the calculations can be executed in a highly automated manner. Depending on the size of each increment of power generation, results can be obtained quickly. This means that a high number of networks can be analysed in a short time.

All studied networks are located in urban or semi urban areas. Each low voltage network is studied separately, which means that their mutual locations of the networks are not taken into account. Considering the geographical locations of the networks means that possibilities of applying reconfiguration can be found, as discussed in Section “Reconfiguration by Power Electronic –based Switches”. Meshing networks or building networks that can be meshed by switches could provide a feasible solution in certain areas to flatten the voltage profile of the feeder.

If rural networks were considered in addition to urban and semi-urban networks, probably a larger number of low voltage networks with voltage constraints would have been found. In addition, the installation of distributed generation is more likely to occur in the rural areas than in the urban areas. This is due to the fact that in rural areas people tend to live in individual houses instead of apartments where distributed generation, such as photovoltaic panels, can be installed easily with less space limitations. In rural areas where the medium voltage network has to be renewed, it could be interesting to carry out a study about the possibilities of LVDC and compare it with the actual system. Networks where this can be economically sound could be found in rural areas as stated in Section “Benefits of the Low Voltage Direct Current Technology in Power Distribution”. In this case, also the medium voltage network has to be considered because the major savings of the LVDC systems come from the shorter medium voltage lines.

The decision of installation of an on-load tap changer is made by the local distribution system operator. On the other hand, the installation of photovoltaic generators is based on the decision of individual customers, which is highly affected by the regulations, the tariffs and the predominating trends. Even if a customer should ask the distribution system operator an authorisation to connect his generator into the public network, the distribution system operator has a responsibility to allow the customers small-scale generation to be connected to the network. For a distribution system operator, it can be difficult to foresee the evolution of the photovoltaic generation, including the need for an on-load tap changer, on a local level over several years. This is where more flexible and easy-to-install solutions are seen as interesting alternatives.

As discussed in this section earlier, low voltage feeders are usually sized so that the cross section becomes smaller when moving from the beginning towards the end of the feeder. Thus, the hosting capacity at the end of the feeder is lower than at the beginning of it. In a very extreme case, if a high concentration of photovoltaic power generation is located at the end of the feeder and the power flow becomes inversed (from the end towards the beginning

of the feeder), the feeders may be sized so that they are capable of transmitting high power flow in both directions, which may be expensive.

5.1.4. Conclusions

A simple and straightforward method of studying the hosting capacity of photovoltaic power generation is presented. The procedure is programmed in PowerFactory software and tested on 38 real low voltage networks based on real data. The method is used to find the limits of how much photovoltaic power generation can be introduced in a single low voltage network without violating the technical voltage or current constraints. In addition, it permits the comparison of different types of tap changers. A concrete indicator that allows comparing different sizes of networks is the increment of the hosting capacity divided by the maximum network load.

An on-load tap changer can help to gain a significant amount of flexibility in a low voltage network but a large gain is not self-evident. However, more hosting capacity of photovoltaic power production is not gained in all tested networks. As a rule-of-thumb, an on-load tap changer increases the hosting capacity about 1 kW per customer in the networks limited by voltage.

The hosting capacity of a low voltage network can be estimated in several different ways. The results of two approaches are presented in this work, both of them providing rather different outcomes. It is important to note that when only three-phase connected photovoltaic generators are used, the hosting capacities are higher than when three- and single-phase connected photovoltaic generators are used. Additionally, a lower number of networks are constrained by voltage. In one study, the results indicate that there are no additional benefits of using an on-load tap changer with nine tap positions instead of one with five tap positions in the studied networks. This underlines the importance to study the usefulness of the type of the on-load tap changer. If a nine-position on-load tap changer is chosen instead of a five-position one, the cost-benefit advantages of the choice should be studied carefully because the advantages are not evident in all networks.

Monte Carlo –based techniques are able to provide slightly more information on the networks when several simulations are done. However, the computational resources to achieve this are extremely high. This is useful only, if the network is an object of a detailed analysis, thus, it is not the case in operational use.

5.2. Increasing the Hosting Capacity of Photovoltaic Power Generation by Reactive Power Compensation

This section studies the possibility of increasing the hosting capacity of photovoltaic power generation by controlling voltage through the power converters of the photovoltaic generators. The approach to the problem is similar as in Section “Increasing the Hosting Capacity of Photovoltaic Power Generation by an On-Load Tap Changer” but instead of controlling voltage by on-load tap changers, voltage is controlled by the power converters of the photovoltaic generators. Again, all simulations are done in PowerFactory software and the same 38 low voltage networks, as presented in Section “Optimal Placement of Voltage Sensors in a Low Voltage Network for On-Load Tap Changer Application”, are used. As mentioned in Section “Distributed Generation”, the number of photovoltaic generators connected to low voltage networks increases quickly, which means that the application presented in this Section could have an increasing number of possibilities.

The study uses the fact that the modern power converters can adjust their generation of reactive power within the limits of their rating. A research done in [245] results that the hosting capacity can be increased by the voltage control of the photovoltaic generators. However, the methodology of the study is different and the study is limited only to one low voltage feeder of 70 customers. In the study of this section the voltage control of the photovoltaic generators is considered to be the only solution to increase the hosting capacity of the low voltage networks, thus, the on-load tap changer is not regarded. Even though the hosting capacity could be increased in some networks by using both solutions; the on-load tap changer and the voltage control in the photovoltaic generators.

In this study, the photovoltaic generators are controlled by using a reactive power control [246]. A considerable advantage of controlling voltage by the converters of the photovoltaic generators is that voltage is controlled at every node, where a generator is connected, not only at the secondary substation, as in the case of an on-load tap changer. A drawback of controlling voltage by adjusting reactive power is that it may not have a strong effect in low voltage networks since low voltage lines are mostly of resistive type on the contrary to high voltage transmission lines, for example. Other drawbacks are, for example, the converter losses and a possible “hunting effect” between the inverters, if no common coordination is used between them. In this study, voltage is controlled by a droop control with a dead band. The droop control with a dead band means that the control does not operate when voltage is between the upper and the lower limit of the dead band. If voltage is lower than the lower dead band, the photovoltaic generator increases the production of reactive power to the network in order to increase voltage. On the contrary, if voltage surpasses the upper dead band, the photovoltaic generator absorbs reactive power from the network. The voltage-reactive power characteristic of the reactive power voltage control with a dead band is illustrated in Figure 56.

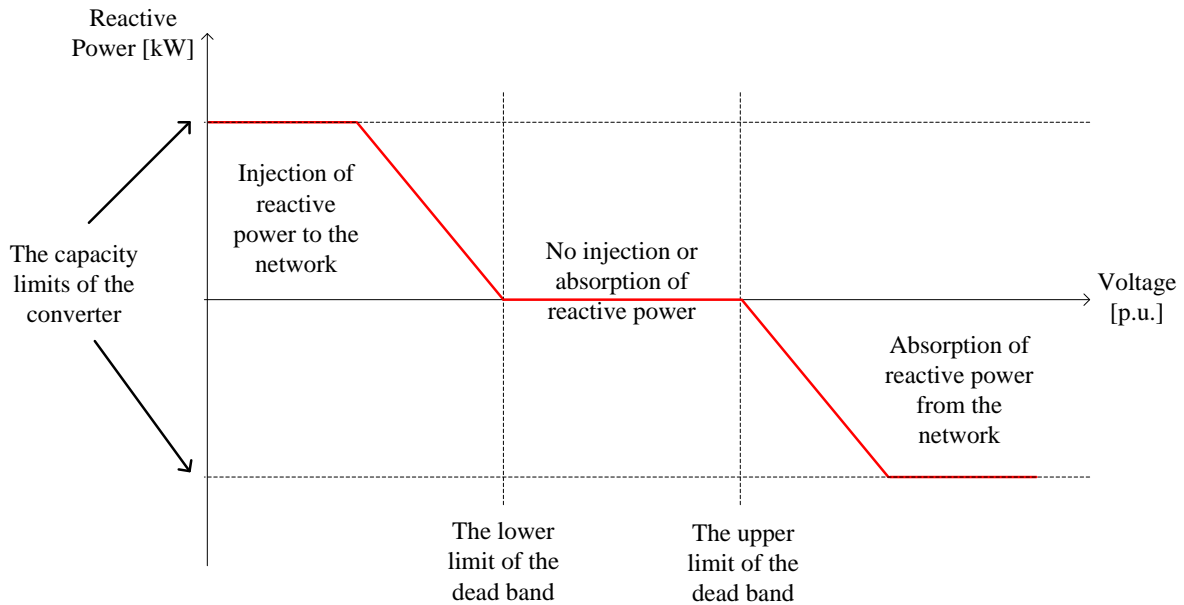

Figure 56: The ideal concept of the reactive power voltage controller with a dead band. In the illustration, it is supposed that curve has the same form at all levels of output power.

Voltage is measured at the point where the photovoltaic generator is connected. The upper limit of the dead band is set to 1.09 per unit and the lower limit to 0.91 per unit. The dead band is narrower than the allowed voltage limits (0.9 per unit to 1.1 per unit) so that the voltage control starts to react before violating the voltage limits of the network. The converter of the photovoltaic generator can change the reactive power freely within the range of its power rating. The droop is set at 1 per cent. This means, for example, that the converter starts generating reactive power when voltage is 0.91 per unit. The production of reactive power increases linearly if voltage drops below 0.91 per unit. The converter produces reactive power of its maximum capacity when voltage is at 0.9 per unit that is the limit of voltage violation.

5.2.1. Description of the Methodology and the Results

The methodology and the results of the simulations in two cases are presented in this section. The final objective is to investigate the impact of the voltage control on behalf of the photovoltaic generators on the hosting capacity. The simulations follow the same procedure than the simulations in Section “Increasing the Hosting Capacity of Photovoltaic Power Generation by an On-Load Tap Changer” (except that voltage is controlled in a different manner). Two different cases are investigated. The first case is where all photovoltaic generators connected to three phases and the second case is where there are three- and single-phase photovoltaic generators connected to the low voltage networks. The difference in comparison with Section “Description of the Methodology and the Results” is that voltage is controlled by the converters of the photovoltaic generators instead of on-load tap changers.

Hosting capacity is estimated according to the following methodology:

- A photovoltaic generator is connected to every customer node in the low voltage network.
- All photovoltaic generators are connected in a three-phase manner.
- The rated power of all these generators is raised simultaneously through continuous method until a constraint is met.

Details and further discussion about the methodology can be found in Section “Description of the Methodology and the Results”. In order to save space, the description of the whole methodology is not repeated here. As already, the simulations are repeated for two abovementioned cases. The results are presented in subsections below.

5.2.1.1. The Hosting Capacity of Photovoltaic Power Production with Voltage Controlled Photovoltaic Generators: All Photovoltaic Generators Connected to Three Phases

In this section, all photovoltaic generators are connected to three phases. The simulation is similar as in Section “The Hosting Capacity of Photovoltaic Power Production with and without an On-Load Tap Changer: All Photovoltaic Generators Connected to Three Phases” except the fact that voltage is controlled by the converters of the photovoltaic generators and an on-load tap changer is not used.

The power generation, the installed generation capacity, the maximum load of the network at the moment of the constraint and the type of the constraint are presented in Table 12.

Table 12: The generation by the photovoltaic panels, the installed generation capacity, the maximum load of the network, power generation per maximum load and the type of the constraint are presented at the moment when the constraint occurs. In this case, only three-phase connected photovoltaic generators are used.

The Name of the Network	Generation [kW]	Installed Generation Capacity [kW]	The Maximum Load of the Network [kW]	Generation per Maximum Load [%]	The Type of the Constraint
Network 1	678	1190	192	353	Current (transformer)
Network 2	272	495	149	183	Current (transformer)
Network 3	427	750	103	415	Current (transformer)
Network 4	376	685	286	131	Current (line)
Network 5	688	1252	295	233	Current (transformer)

Network 6	182	330	102	178	Current (transformer)
Network 7	376	660	241	156	Current (line)
Network 8	270	492	106	255	Current (transformer)
Network 9	409	744	249	164	Current (line)
Network 10	482	846	313	154	Current (line)
Network 11	481	844	234	206	Current (line)
Network 12	451	821	240	188	Current (transformer)
Network 13	274	498	120	228	Current (transformer)
Network 14	223	406	205	109	Voltage
Network 15	673	1224	206	327	Current (transformer)
Network 16	262	460	35	749	Current (transformer)
Network 17	268	470	85	315	Current (transformer)
Network 18	264	480	112	236	Current (transformer)
Network 19	421	738	221	190	Current (transformer)
Network 20	700	1272	285	246	Current (transformer)
Network 21	175	318	102	172	Current (transformer)
Network 22	420	736	104	404	Current (transformer)
Network 23	646	1175	185	349	Current (line)
Network 24	436	793	176	248	Current (transformer)
Network 25	674	1183	120	562	Current (transformer)
Network 26	275	483	79	348	Current (transformer)
Network 27	452	793	0	–	Current (line)
Network 28	426	775	184	232	Current (transformer)
Network 29	866	1519	254	341	Current (line)

Network 30	431	783	122	353	Current (transformer)
Network 31	444	807	248	179	Current (transformer)
Network 32	418	734	202	207	Current (transformer)
Network 33	445	780	255	175	Current (transformer)
Network 34	640	1122	132	485	Current (line)
Network 35	886	1554	411	216	Current (line)
Network 36	455	799	476	96	Current (transformer)
Network 37	300	545	208	144	Voltage
Network 38	457	802	599	76	Current (transformer)

Figure 57 shows the hosting capacity (rated capacity) of the networks that increase the hosting capacity if voltage control is used in photovoltaic generators in comparison with the case that no voltage control is used at all. It is important to note that the hosting capacities in Case “No Voltage Control” are the same that can be found in Section “The Hosting Capacity of Photovoltaic Power Production with and without an On-Load Tap Changer: All Photovoltaic Generators Connected to Three Phases”.

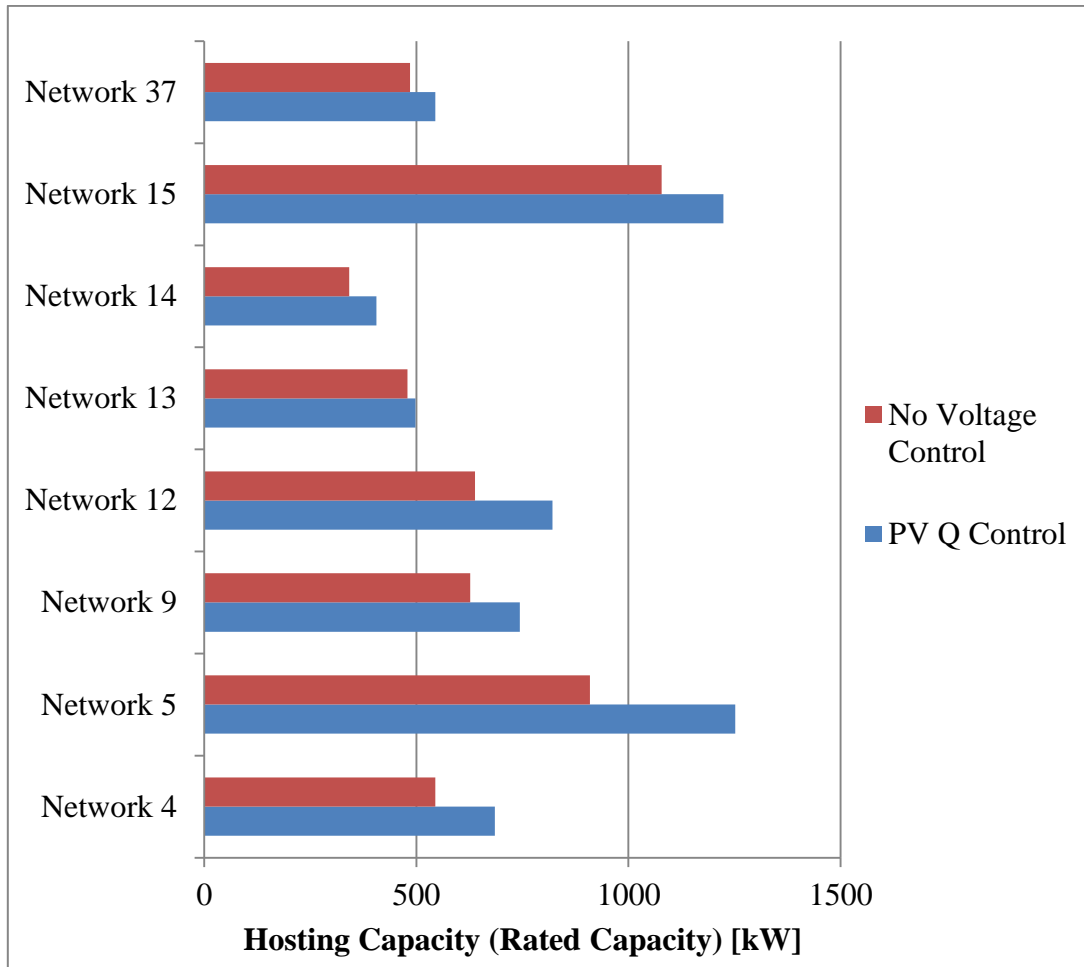

Figure 57: The hosting capacities of photovoltaic power generation in the low voltage networks where the hosting capacity increases when the reactive control in the photovoltaic generators (PV Q Control) is used. The networks where the hosting capacity is not increased are not considered.

The hosting capacities (installed capacity) of photovoltaic power production per customer in Network 4, 5, 9, 12, 13, 14, 15 and 37 are presented in Figure 58. The networks presented in the figure are the ones that increase their hosting capacity when a voltage control in the photovoltaic generators is used.

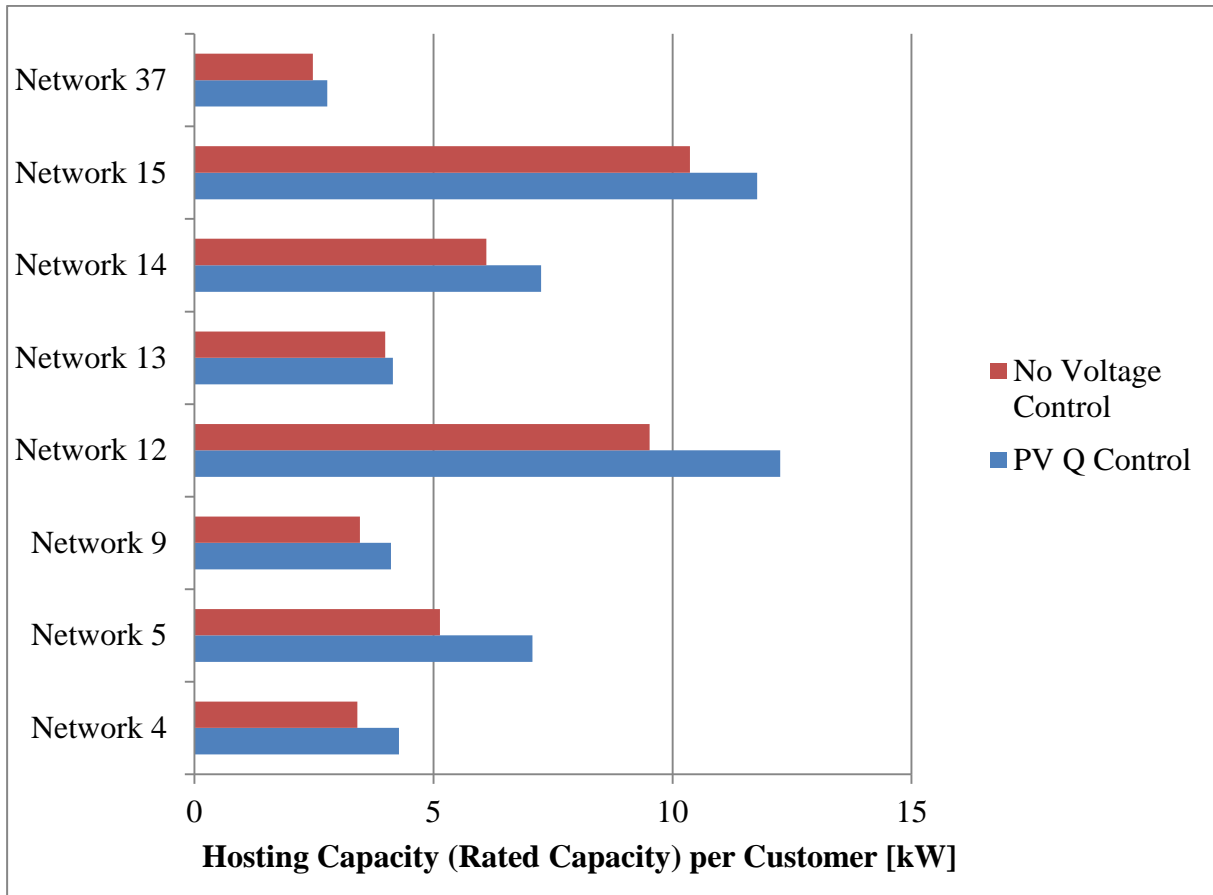

Figure 58: Hosting capacity (rated capacity) per customer in the networks that increase the hosting capacity when a voltage control in the photovoltaic generators is used (PV Q Control). The hosting capacities are compared with the networks that do not possess a voltage control.

5.2.1.2. The Hosting Capacity of Photovoltaic Power Production with Voltage Controlled Photovoltaic Generators: Single- and Three-Phase Connected Photovoltaic Generators (Mixed Types of Phase Connections)

In this section, the same study is carried out as in Section “The Hosting Capacity of Photovoltaic Power Production with Voltage Controlled Photovoltaic Generators”, except the fact that the nameplate capacities and the phase connections of the photovoltaic generators are chosen as in Section “The Hosting Capacity of Photovoltaic Power Production with and without an On-Load Tap Changer: Single- and Three-Phase Connected Photovoltaic Generators (Mixed Types of Phase Connections)”. That is to say that 90 per cent of the photovoltaic generators are connected to one phase and 10 per cent of them are connected to three phases. An on-load tap changer is not used in this study. The photovoltaic power generation, the installed generation capacity, the maximum load of the network and the type of the constraint are presented in Table 13. It should be noted that in the table, the generation refers to the hosting capacity and the installed generation capacity means the installed hosting capacity.

Table 13: The photovoltaic power generation (the hosting capacity) (the second column from right), the installed generation (installed hosting capacity) (the third column from right), the maximum loading of the network, power generation per maximum load and the type of the constraint when the mixed types of connections in photovoltaic generators are used. It should be noted that the difference between “Generation” and “Installed Generation Capacity” is that the first is the actual power generation from the photovoltaic generators and the second one is the installed (nameplate) capacity of the photovoltaic generators.

The Name of the Network	Generation [kW]	Installed Generation Capacity [kW]	The Maximum Load of the Network [kW]	Generation per Maximum Load [%]	The Type of the Constraint
Network 1	196	344	192	102	Voltage
Network 2	140	246	149	94	Current (transformer)
Network 3	328	576	103	94	Voltage
Network 4	74	135	286	318	Voltage
Network 5	108	190	295	37	Voltage
Network 6	86	151	102	84	Current (transformer)
Network 7	194	340	241	80	Current (line)
Network 8	130	228	106	123	Current (transformer)
Network 9	72	131	249	29	Voltage
Network 10	79	143	313	25	Voltage
Network 11	240	421	234	103	Current (line)
Network 12	55	99	240	23	Voltage
Network 13	66	120	120	55	Voltage
Network 14	49	89	205	24	Voltage
Network 15	148	259	206	72	Voltage
Network 16	121	212	35	346	Current (transformer)
Network 17	91	159	85	107	Current (line)
Network 18	198	360	112	177	Current (transformer)
Network 19	182	320	221	82	Current (transformer)
Network	301	528	285	106	Current (line)

20					
Network 21	69	121	102	68	Current (transformer)
Network 22	160	281	104	154	Current (line)
Network 23	303	531	185	164	Current (line)
Network 24	140	246	176	80	Voltage
Network 25	193	338	120	161	Voltage
Network 26	74	129	79	94	Voltage
Network 27	151	265	0	–	Current (line)
Network 28	173	304	184	94	Current (line)
Network 29	319	560	254	126	Voltage
Network 30	154	270	122	126	Current (line)
Network 31	163	285	248	66	Current (line)
Network 32	212	372	202	105	Current (line)
Network 33	179	314	255	70	Current (transformer)
Network 34	212	373	132	161	Current (line)
Network 35	293	514	411	71	Current (line)
Network 36	214	375	476	45	Current (transformer)
Network 37	72	126	208	35	Voltage
Network 38	200	351	599	33	Current (transformer)

The hosting capacities of the networks where the hosting capacity is increased when reactive power control is implemented in the photovoltaic generators are shown in Figure 59.

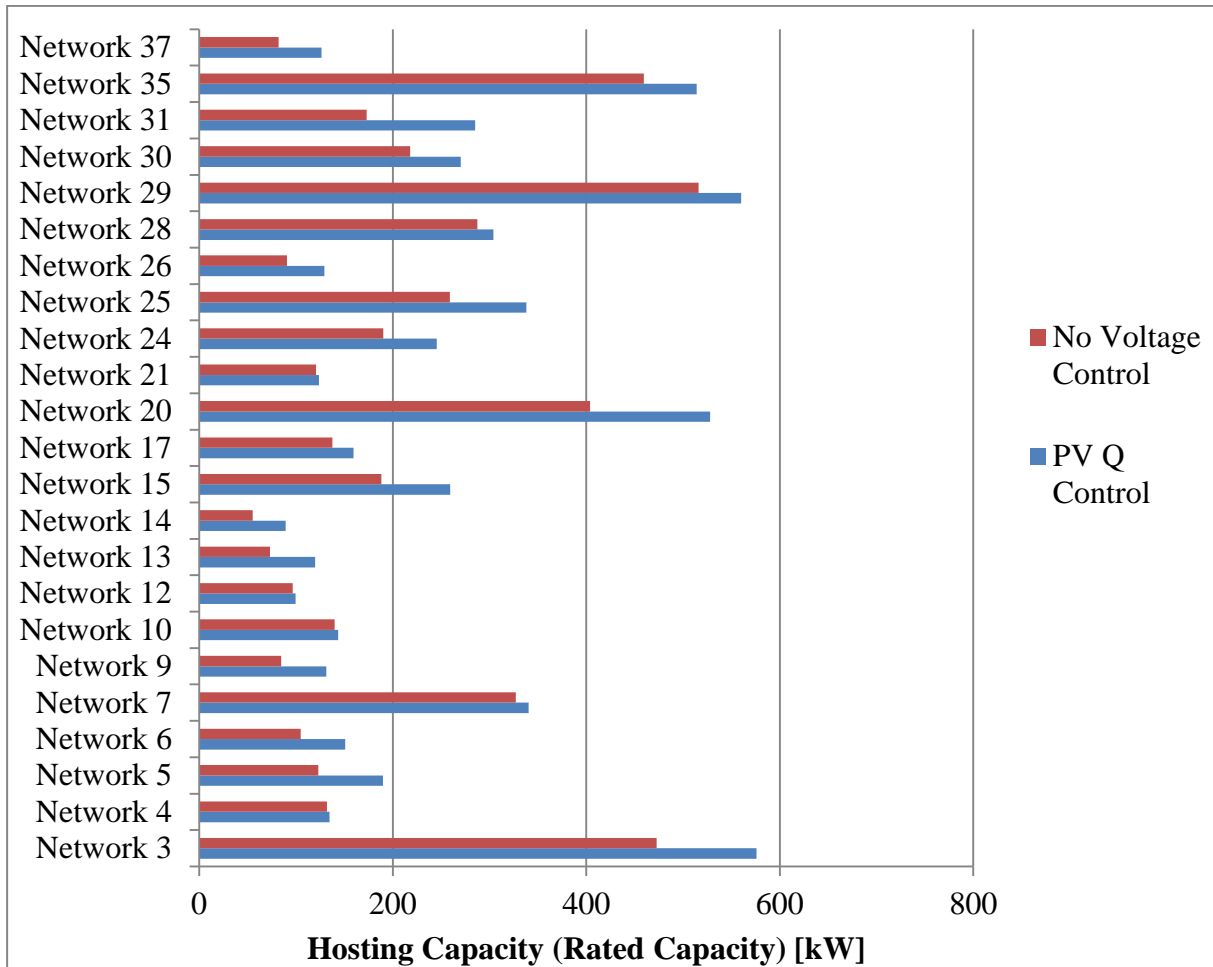

Figure 59: The hosting capacities of the networks when the reactive power control is applied in the photovoltaic generators (PV Q Control). The results are compared with the case that no voltage control is applied. The networks where the hosting capacity is not increased are omitted.

The hosting capacities of the networks per customer in the networks that increase their hosting capacity when the voltage control is used are shown in Figure 60.

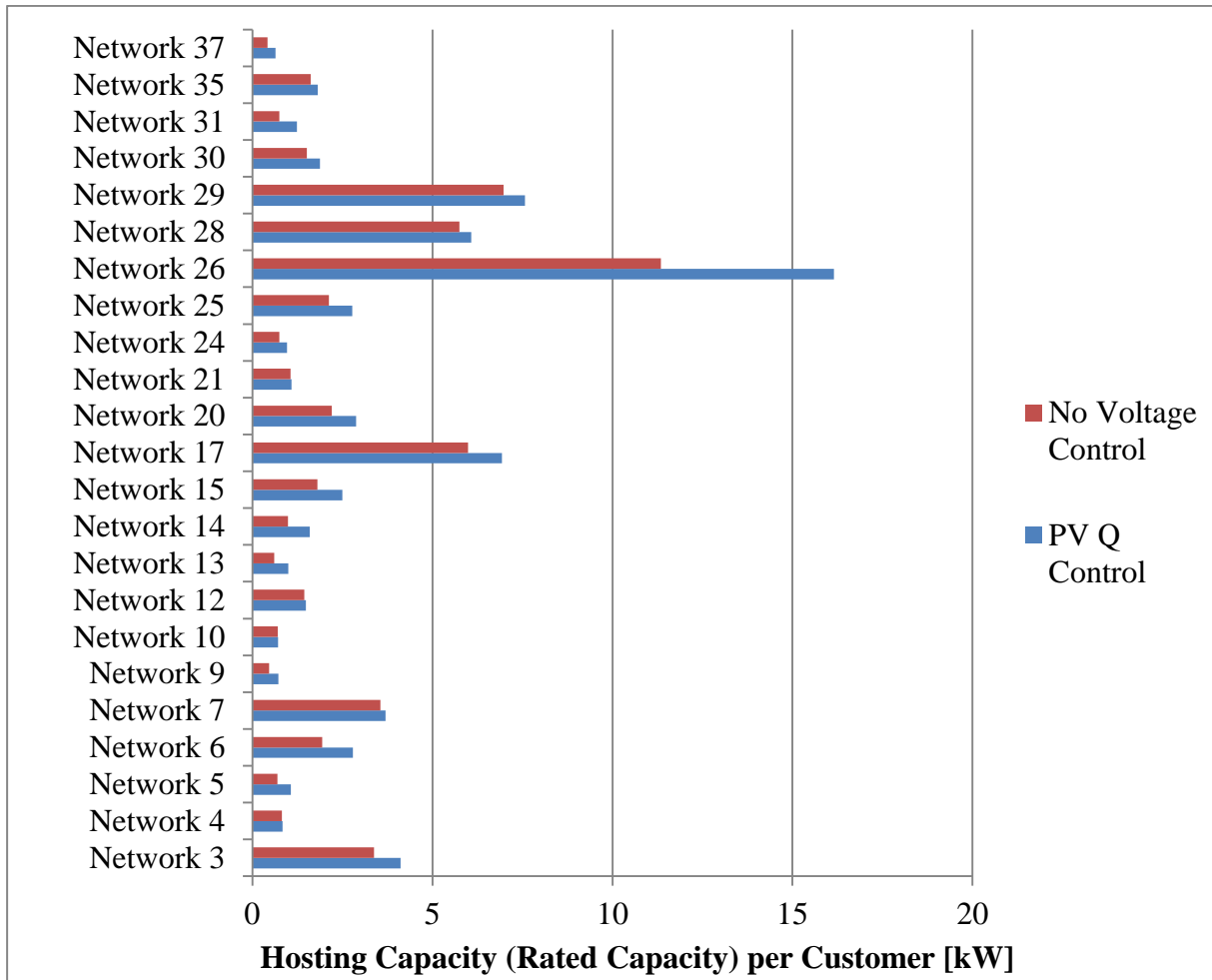

Figure 60: The hosting capacity (rated capacity of photovoltaic power generation) per customer in the networks that increase their hosting capacity when the voltage control is used in the photovoltaic generators (PV Q Control).

5.2.2. Analysis of the Results

This section presents the analysis of the results that is organised in a following manner; first the results of the approach where only three-phase connected photovoltaic generators are used and then the case where single- and three-phase connected photovoltaic generators are applied. Following, the performances of the on-load tap changer technologies are compared with the performance of the voltage control by the photovoltaic generators. Lastly, the different approaches to size and connect the photovoltaic generators in order to assess the hosting capacity are compared. In all sections, the analyses are preserved short and only the most remarkable results are commented.

5.2.2.1. The Hosting Capacity of Photovoltaic Power Production with Voltage Controlled Photovoltaic Generators: All Photovoltaic Generators Connected to Three Phases

In this case, all photovoltaic generators are connected to three phases and voltage is controlled only by the photovoltaic generators. From 38 studied networks, two networks (Network 14

and Network 37) are constrained by voltage and the 36 remaining networks are constrained by current in a transformer or in a line. If the voltage control was not used, the results would be similar to the ones in Table 5 in Section “Increasing the Hosting Capacity of Photovoltaic Power Generation by an On-Load Tap Changer”. The studies between the results of Table 5 and Table 12 are that in the latter one, the photovoltaic generators are used for voltage control. When the voltage control is used, the number of voltage constrained networks reduces from eight to two. This means that when the voltage control by the photovoltaic panels is applied, six networks reach the limit of their hosting capacity and become current constrained. In two of the eight networks that are limited by voltage when the on-load tap changers are not used, the limit of the hosting capacity is not reached by the voltage control of the photovoltaic generators. This means that two networks could possibly accommodate more photovoltaic power generation if the method of voltage control was more efficient.

5.2.2.2. The Hosting Capacity of Photovoltaic Power Production with Voltage Controlled Photovoltaic Generators: Single- and Three-Phase Connected Photovoltaic Generators (Mixed Types of Phase Connections)

In this case, 90 per cent of the photovoltaic generators are single-phase connected and 10 per cent three-phase connected. When the 90 per cent of the photovoltaic generators are connected to one phase and 10 per cent of them are connected to three phases, 23 out of 38 networks increase the hosting capacity. It can be seen in Figure 59 and in Figure 60 that even if the hosting capacity is increased, the average increment is not extremely high. Concretely, the average increase in the hosting capacity (installed capacity of photovoltaic generation) is 47 kW in total and 0.4 kW per customer. This represents an increment of about 23 per cent in comparison with the case that no voltage control is employed.

5.2.2.3. Comparison of Voltage Control Technologies

In this section, the hosting capacities of both technologies of voltage control (the on-load tap changer and voltage control by the converters of the photovoltaic generators) are compared with each other. Even though the results are already presented in individual sections, they are presented here in order to make the comparison straightforward. The results of both cases, three-phase connected photovoltaic generators and mixed phase connection, are presented separately. In order to make the section more concise, only the networks where the hosting capacity is increased by any of the used voltage control technologies are presented in the figures. Figure 61 shows the results in the case when only 3-phase connected PV generators are used and Figure 62 presents the results when the mixed phase connections are used. In Figure 61, the hosting capacities are shown. Both types of on-load tap changers (5-tap and 9-tap) are illustrated by the same bar because the results are the same (in those networks).

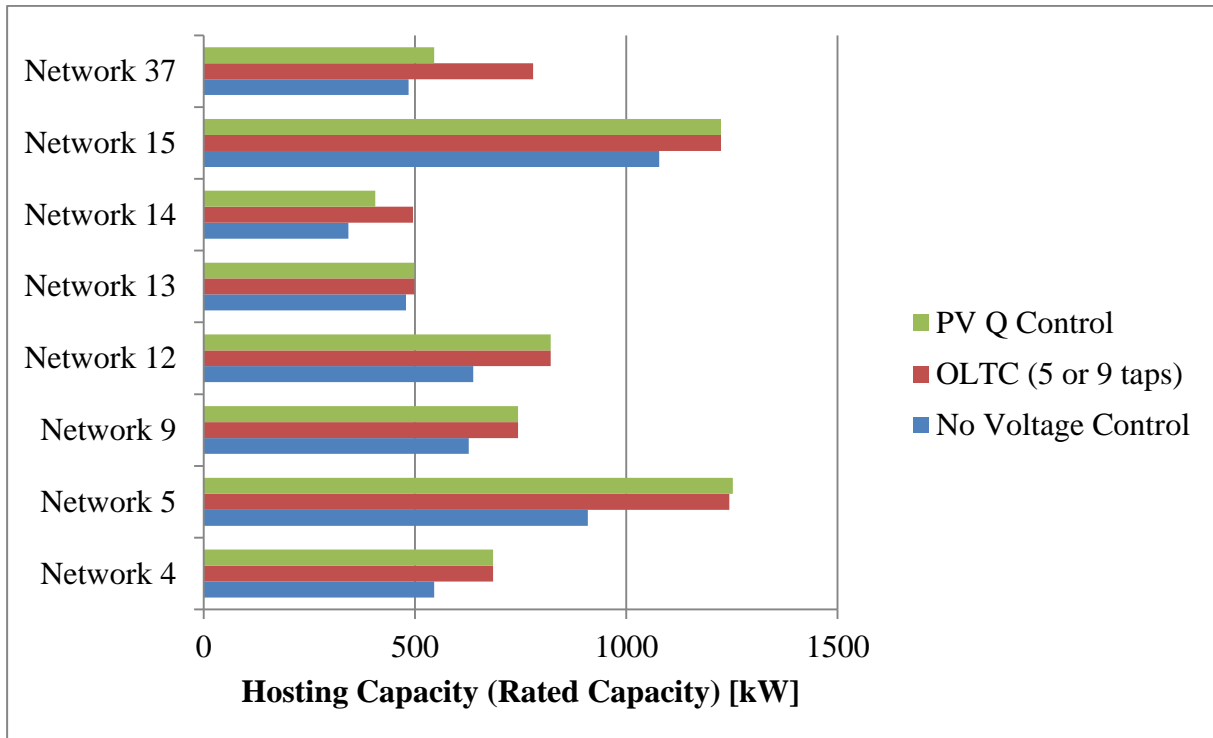

Figure 61: The hosting capacities (rated capacity) in the networks when all photovoltaic generators are connected to three phases. OLTC refers to an on-load tap changer and PV Q control to voltage control by photovoltaic generators. Only the networks where the hosting capacity is increased by voltage control of photovoltaic generators are illustrated.

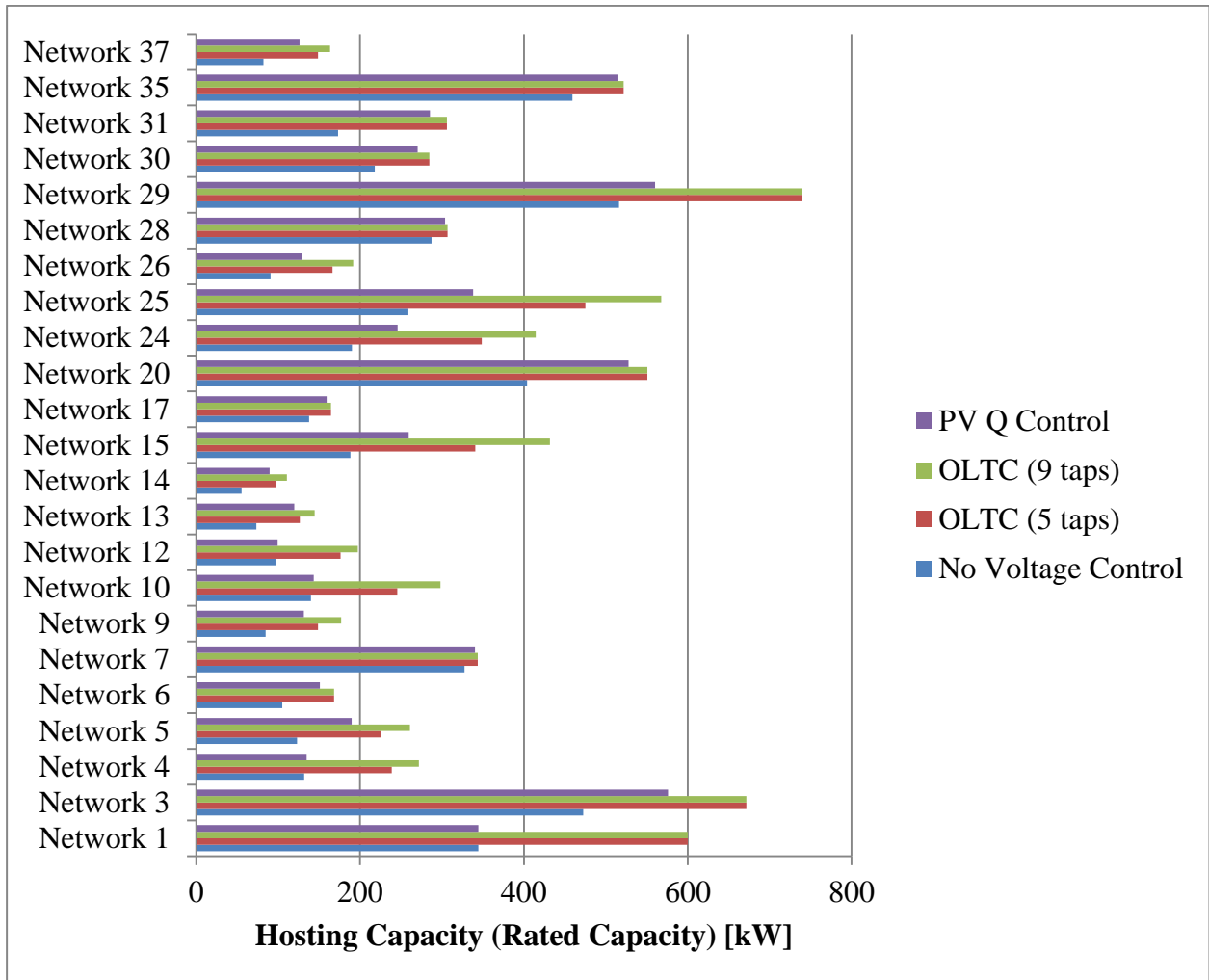

Figure 62: The hosting capacities (rated capacity) in the networks when the mixed connections of photovoltaic generators are used. OLTC refers to an on-load tap changer and PV Q control to voltage control by photovoltaic generators.

When only three-phase connected photovoltaic generators are used, an on-load tap changer (five or nine tap positions) results in higher hosting capacity than a reactive power voltage control in the photovoltaic generators in two networks. In one network, a slightly higher hosting capacity is obtained by using the voltage control in the photovoltaic generators than an on-load tap changer at the secondary substation. In case of mixed types of connections an on-load tap changer results in higher or similar hosting capacity than the voltage control in the photovoltaic generators in all studied networks.

In the case when only three-phase connected photovoltaic generators are used (in Figure 61), the average hosting capacity of photovoltaic power generation is 811 kW if an on-load tap changer is employed and 772 kW when the reactive power control in the photovoltaic generators is applied. When the mixed types of connections are used (in Figure 62), the same figures are 321 kW / 343 kW (an on-load tap changer with five / nine tap positions) and 263 kW (voltage control in the photovoltaic generators), respectively.

5.2.3. Discussion

In general it can be said that the on-load tap changers bring more flexibility to the network (higher hosting capacity) than the used reactive power control in the photovoltaic generators. This is because low voltage lines are mostly resistive, so reactive power control does not change the voltage as much as an on-load tap changer. Also, it may be true that slightly higher hosting capacities could be gained by using different kind of voltage control or simply adjusting the value of the droop and the limits of the dead band. Anyway, the focus of this work is not to go into a deep analysis of generator control, so those options are not taken into consideration.

In the part of this work, where all photovoltaic generators are connected in a three-phase manner, power fed in the network is divided evenly between three phases and voltage does not rise in one phase more than in the other two. That is to say that more power can be injected into the network before a voltage constraint in that point is met. This assumption does not match exactly with the reality since the major part of the photovoltaic panels in low voltage networks are single-phase connected. On the contrary, the largest units (that have a stronger individual impact on voltage than a small one single-phase connected unit) are three-phase connected even if they are fewer in numbers. When only three-phase connected generators are used, a higher value the hosting capacity is obtained than by using single-phase connected generators. Besides, it is more likely to obtain a result that the network is current-limited rather than voltage-limited. The photovoltaic generators are divided evenly along the network, which also decreases the probability to form sharp and local voltage peaks in the network.

When only three-phase connected photovoltaic generators are connected to a network, the hosting capacity is more than double in comparison with the case when single- and three-phase connected generators are used. In the latter case, when power injected in the network is connected unevenly between the phases, which leads to a voltage constraint. This is why any of the used voltage controls (the five-tap or the nine-tap tap changer or the reactive power control in the photovoltaic generators) has an impact on the hosting capacity in a larger number of networks when single- and three-phase connected generators are used than when only three-phase connected ones are used.

Because the two different approaches to size the photovoltaic generators and to choose their phase connections indicate substantially different results, it is safer to choose the approach that results in a lower value of the estimated hosting capacity because it is not over-optimistic. Therefore, it is difficult to obtain a false estimation of the hosting capacity that leads to undesirable surprises. When the strategy of mixed phase connections is used (90 per cent of the photovoltaic generators single-phase connected and 10 per cent of them three-phase connected), an amount close to the maximum loading of the network of photovoltaic power generation can be connected to the networks on average (90 per cent of the maximum load). This figure is somewhat high considering that it is unlikely that all customers are willing to install photovoltaic generators, at least in the near future, apart from some exceptional areas.

The cables have four conductors (three phase wires and one neutral wire), which means that it should be bear in mind that a current limit doesn't mean that all phase wires are overloaded. Due to the unbalanced loading, only one of the four wires is overloaded and consequently, the whole cable has to be replaced.

As discussed earlier, in order to make the results more realistic, a statistical study made by using a Monte Carlo approach could be made to determine a factor for the hosting capacity

for the networks of different sizes so that the results obtained by employing the approach used in this study are compatible with the reality. As mentioned earlier, Monte Carlo –based analyses are time-consuming and not suitable for studying each network individually. In opposition, the advantage of the methodology used in this study is its straightforwardness and fastness. It could be beneficial to combine both methods; first to determine the abovementioned factor on a set of networks by using a Monte Carlo –based method and then use the method presented in this work to determine the actual hosting capacity. Afterwards, the obtained hosting capacity could be multiplied by the factor acquired from the Monte Carlo –based method.

An advantage of voltage control by photovoltaic generators over an on-load tap changer is that photovoltaic generators are most usually placed in different locations of the network, but an on-load tap changer is usually located at the beginning of the feeders. In this way, the photovoltaic generators may respond better to local voltage drops or peaks whereas an on-load tap changer changes voltage at the beginning of the feeder. Additionally, an on-load tap changer does not offer a possibility to control voltage only in one feeder such as a photovoltaic generator. In this way, photovoltaic generators can be seen as local voltage regulators that are placed along the feeders. From this viewpoint, photovoltaic generators could offer different kind of voltage control than on-load tap changers. This could be useful especially in long feeders where the voltage profile can experience significant fluctuations when moving from the beginning towards the end of the feeder. In an extreme situation (for example, a long feeder with a significant amount of distributed generation), if the difference between the lowest and the highest values of voltage are larger than the control range of an on-load tap changer, voltage cannot be even controlled by an on-load tap changer. Since the photovoltaic generators use only local measurements, their measurement scheme is simple and no separate communication infrastructure is needed. Another advantage is that the power converter of a generator has fast dynamics as opposed to a mechanical on-load tap changer. A response time of a power electronics converter is in the range of milliseconds or tens of milliseconds, which can contribute to the power quality in the phenomena that are in a short time frame. Furthermore, the voltage control of photovoltaic generators does not suffer from mechanical wear as an on-load tap changer. A combination of an on-load tap changer with voltage control by photovoltaic generators would complement each other if a network has a significant amount of distributed generation. This would possible reduce the number of tap changing actions and increase the life-time of the tap changer. In this way, a tap changer of a shorter voltage range would be needed.

If any voltage control is applied in the photovoltaic generators, it must be made sure that the voltage control methods are of the same type or at least compatible with each other to avoid any kind of unfavourable behaviour, such as controllers “competing” with each other or with an on-load tap changer. Also the parameters of the controllers have to be set so that effects of this kind do not occur.

From the economic point of view the use of photovoltaic generators is relatively simple for the distribution system operator if it doesn’t have to interact with the control; if the voltage control is built-in inside the generators and the customers pay the costs of the generators, there are no actions needed from the side of the local distribution system operator. In this light, a distribution system operator receives “carefree” and cheap units of voltage control that are connected in the network anyway and the voltage control would be only an additional benefit. Contrarily, an on-load tap changer is relatively significant investment. On the other hand, the distribution system operator must manage the voltage control of photovoltaic

generators at some stage in order to avoid any detrimental impact on the medium voltage network.

In the future, the photovoltaic generators of individual customers might benefit from the advanced metering infrastructure. If there is a communication media connecting the distribution system operator and the electricity meter, this could be expanded by a local communication path between the electricity meter and the converter of the photovoltaic generator.

If the photovoltaic generators are owned by individual customers, the voltage control on behalf of the distribution system operator might lead to legal questions. It would be advantageous for the distribution system operator to be able to make use of the control capabilities of the converters in the photovoltaic generators, but the tariffs and other possible legal aspects must be adapted to this in a way that it would not cause any additional discomfort to the customers.

In some networks that have an extremely high penetration of distributed generation, it could be useful to maximise the capacity of voltage control and use both methods of voltage control; an on-load tap changer and a voltage control in the distributed generators. This could work only as a special solution in carefully chosen networks because in many networks, the limits of the hosting capacity are met already by using only one method for voltage control. This means that in many networks this would not be useful. The difficulty of applying two different types of voltage controls would be the coordination between them and avoid the situation where, for example, the on-load tap changer increases voltage while the photovoltaic generators decrease it. An efficient control method would mean a communication media between the secondary substation and the distributed generators, which could imply high costs.

Voltage control by photovoltaic generators could have a possibility to provide different kind (faster and more local) of voltage support than on-load tap changers. The two methods of voltage control are not directly comparable due to their different nature. However, the combination of voltage control by the photovoltaic generation and an on-load tap changer could be profitable in long networks with a high penetration of distributed generation that otherwise would suffer from complex voltage profiles with several local peaks of over voltage and voltage drop. With this combination, the photovoltaic generators would reduce the stress from the on-load tap changer.

Whatever is the technical solution, the final decision is habitually based on the estimated economic performance. In addition to the technical estimations, it is also difficult to evaluate the economic performance based on the fact that the regulation affecting the payback time of the component may change several times during its lifetime. In general, new economic possibilities should be studied always when creating new technical solutions. It should be also kept in mind that different highly customised solutions in the same network area should be avoided as remarked in Section “General Preferences for the Devices in Low Voltage Networks”.

5.2.4. Conclusions

This section analyses the hosting capacities of the low voltage networks if a voltage droop control with a dead band is used to control voltage in the photovoltaic generators. The performance of the named voltage control is compared with the voltage control through on-load tap changers. The study is made by using real urban and semi-urban low voltage

networks from the same metropolitan area. According to the results, the voltage control by the photovoltaic generators does not increase the hosting capacity as much as an on-load tap changer in low voltage networks. Without any kind of voltage control, eight of the studied networks are limited by voltage. This means that there may be a possibility to increase their hosting capacity by an adequate voltage control. The used voltage control manages to increase the hosting capacity in six of those eight networks until a current constraint is met. Thus, the voltage control is not enough to achieve the maximum hosting capacity in two of the eight networks.

The method used in this study provides optimistic results to the hosting capacity. There could be a difference in the hosting capacity between the reality and results of the study because most of the photovoltaic generators in low voltage networks are single-phase and not three-phase connected. This problem could be overcome by studying corrective factors for different types of low voltage networks by advanced (that usually means more time-consuming) methods and applying the corrective factors to the method presented in this work.

If voltage control by the photovoltaic generators does not entail significant additional costs to the distribution system operator, voltage control is a practical and an economic method of increasing the hosting capacity and mitigating voltage problems from the viewpoint of the distribution system operator.

6. The Estimation of the Hosting Capacity on a Large Number of Networks

In this chapter, a large number of networks are studied by using the methodology presented in Chapters “Optimal Placement of Voltage Sensors in a Low Voltage Network for On-Load Tap Changer Application” and “The Impact of Voltage Control Technologies on the Capacity to Host Photovoltaic Power Generation in Low Voltage Networks”.

The purpose of this chapter is to show that the methodology to place voltage measurements and use them to control an on-load tap changer is practical and that it can be used to study a large number of networks in an automated manner. Also, one of the major interests is to generate statistical data in order to make general conclusions. This data permits discovering suitable indicators to present the essential data in a compact form. Along with these objectives, this chapter forms a natural continuation to the previous chapters. In order to understand the results, the abovementioned two previous chapters should be read before this chapter.

The studies are performed by using 631 real low voltage networks from the same metropolitan area. 38 previously studied networks are not included in the abovementioned 631 networks. As in the previous chapters, the database includes the complete network and load data. The simulations are carried out on three study cases; no on-load tap changer, an on-load tap changer with five tap positions and an on-load tap changer with nine tap positions. On-load tap changers are selected to be the only method of voltage control because it is the most realistic one from the point of view of the distribution system operator. In addition, an on-load tap changer results in higher hosting capacity than voltage control by using photovoltaic generators in Chapter “The Impact of Voltage Control Technologies on the Capacity to Host Photovoltaic Power Generation in Low Voltage Networks”. When calculating the hosting capacities of photovoltaic generation in each network, the photovoltaic generators are connected as described in Section “The Hosting Capacity of Photovoltaic Power Production with Voltage Controlled Photovoltaic Generators: Single- and Three-Phase Connected Photovoltaic Generators (Mixed Types of Phase Connections)”.

As mentioned, the study uses the same methodologies that are already presented in previous chapters. That is why the methodologies are not presented again in detail, but only the most important parts are recapitulated. After presenting the methodology, possible pitfalls are presented and discussed. Subsequently, the analysis of the results and the conclusions are presented.

6.1. Description of the Methodology

In this section, the essential parts of the used methodologies are presented. The whole process is divided into two main parts.

- 1) The methodology to place voltage sensors: This is a method of choosing the low voltage customers in order to control an on-load tap changer at the secondary substation. The details of the method are presented in Chapter “Optimal Placement of Voltage Sensors in a Low Voltage Network for On-Load Tap Changer Application”.
- 2) The methodology to estimate hosting capacity for photovoltaic power generation of a low voltage network: This method finds an estimation for the hosting capacity in a given network. On-load tap changers are controlled based on the voltage

measurements from the customers that are chosen according to 1). The method is presented in Chapter “The Impact of Voltage Control Technologies on the Capacity to Host Photovoltaic Power Generation in Low Voltage Networks”.

Firstly, the sensors (in order to control the on-load tap changers) are placed in the network according to the following methodology.

- 1) Run unbalanced load flow in 10-minute time steps over four typical days (two winter days and two summer days).

Select a customer that is connected to the same terminal and the phase that experiences at least one time the maximum or the minimum voltage in any of the executed 576 load flows.

- 2) If a terminal is directly connected to at least one three-phase customer, a three-phase customer is selected instead of a single-phase customer.

It is crucial to note that, in this context, placing a voltage measurement means selecting a customer whose AMI measurements (of voltage) are used to control the on-load tap changer. It does not mean installing dedicated voltage sensors in the network (even though it could be applied also for that). If an on-load tap changer is not used, the voltage measurements of the network are not used either. This is because there is no on-load tap changer to be controlled.

Secondly, the hosting capacity is estimated according to the following methodology:

- 1) A photovoltaic generator is connected to every customer node in the low voltage network. 90 per cent of the photovoltaic generators are single-phase and 10 per cent of them are three-phase connected. The single-phase connected generators have an initial rated capacity of 1 kW and the three-phase connected generators 10 kW. The locations of the three- and single-phase generators are decided in a random manner. The phase connections of the single-phase generators are chosen randomly.
- 2) An unbalanced load flow is run in 10-minute time steps over a typical summer day from 11.30h to 14.00h. The simulation is finished when a voltage or a current constraint (in the secondary transformer or a line) is experienced.
- 3) Before every iteration of the method, the generation curve of the photovoltaic generators is increased by five per cent. This five per cent fixed step is calculated based on the initial value during the first iteration. Otherwise, the forms of the power production curves of all photovoltaic generators remain the same during the whole simulation.

An overview of how the two parts are combined together is illustrated in Figure 63.

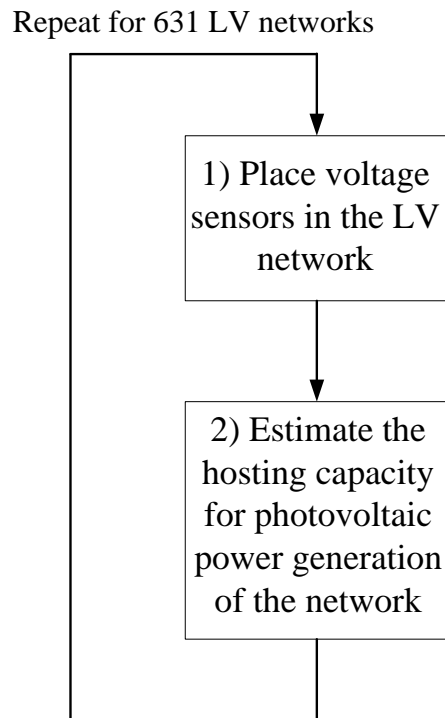

Figure 63: An overview of the combination of methodologies to place the voltage sensors and to estimate the hosting capacity for photovoltaic power generation.

The whole process is repeated in three cases; no-on load tap changer, an on-load tap changer with five tap positions and an on-load tap changer with nine tap positions. In the case when no on-load tap changer is used, Part 1) of Figure 63 is ignored. Before starting Part 2), the tap position of the on-load tap changer is set to +1.75 per cent. That means the position 4 in case of an on-load tap changer with 5 tap position and the position 6 in case of an on-load tap changer with 9 tap positions.

6.2. Potential Pitfalls when Applying the Methodology to Place Voltage Sensors to Estimate the Hosting Capacity

This section presents possible sources of misleading results when controlling an on-load tap changer. It is important to understand the fundamental reasons that may lead to unexpected outcomes from the algorithm. This is crucial not only for avoiding erroneous conclusions but also important for the further development of the methodology. These inaccuracies are present in the results (see Section “Results”) and therefore, are clarified.

Voltage sensors are placed in each low voltage network before the hosting capacity is estimated, as presented in the previous section. A simplified example of the idea how the voltage measurements are placed is presented in Figure 64.

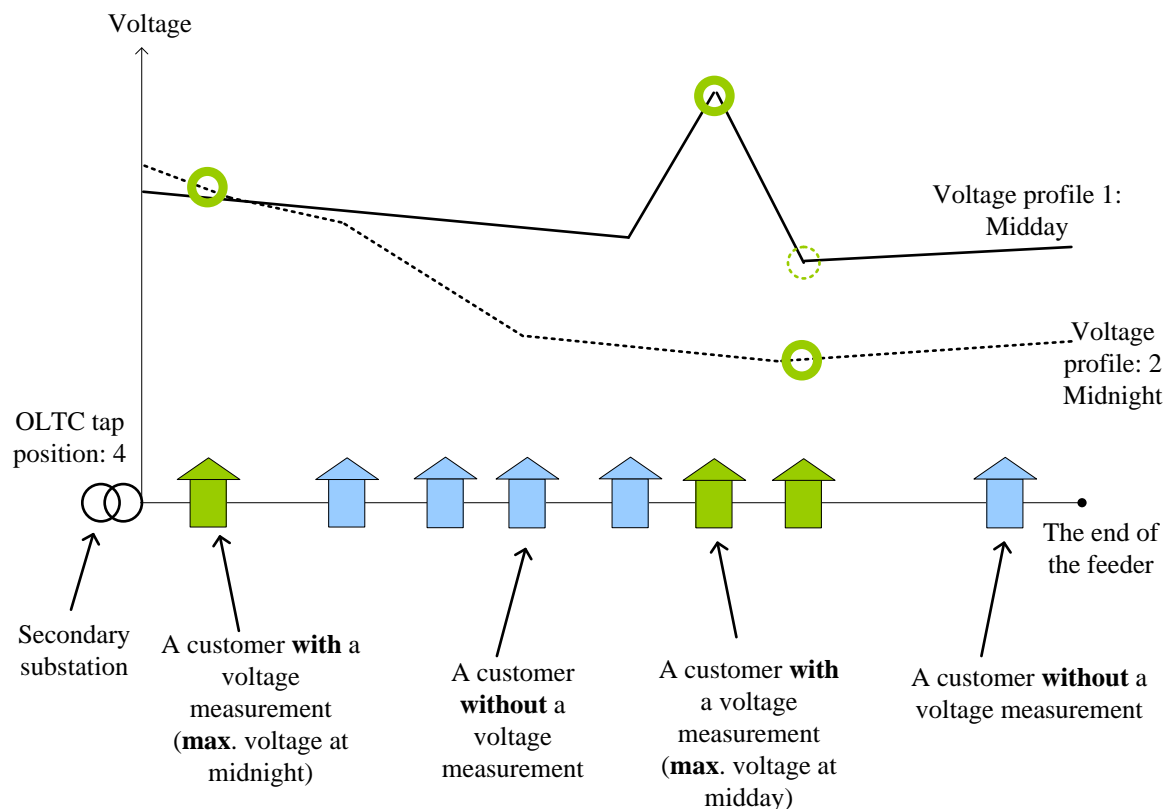

Figure 64: The idea of how the voltage measurements are placed. The voltage measurements are placed in all locations with a maximum or a minimum voltage. In order to make the figure easy to understand, only two different voltage profiles are shown; midday and midnight. Three voltage measurements are placed (three green circles): one in the location with the maximum voltage during the midnight (the leftmost green circle), one in the location with the maximum voltage during the midday (the green circle in the middle) and one in the location with the minimum voltage during both, midday and midnight. The green dashed line above the rightmost green circle shows that the minimum voltage of both voltage profiles is located at the same customer. The tap position of the on-load tap changer is in four. The purpose of the figure is to illustrate the general idea, thus it is not realistic.

This means that the fictive photovoltaic power generators (that are used to estimate the hosting capacity) are not taken into account when voltage sensors are placed in the network. Generally, as the outcome of the algorithm, there are less voltage measurements than low voltage terminals in a given network. Thus, there are low voltage terminals connected to a photovoltaic generator but not to a customer equipped with a voltage measurement. When the hosting capacity is estimated, a constraint is met when the penetration of the photovoltaic power generation is high enough to cause a voltage or a current constraint. The lack of voltage measurement among terminals means that there is not always a voltage measurement at the terminal where the maximum voltage is experienced. This leads to the situation where a voltage constraint is met but any of the placed measurements is not capable of detecting it. When the extreme voltage it is not detected by the voltage measurements, the tap of the on-load tap changer cannot be changed to relieve the voltage constraint. In this way, the hosting capacity of the network cannot be increased even if there was still available voltage range (the

tap is not in an extreme position) in the on-load tap changer in order to relieve the voltage constraint. This is illustrated in Figure 65.

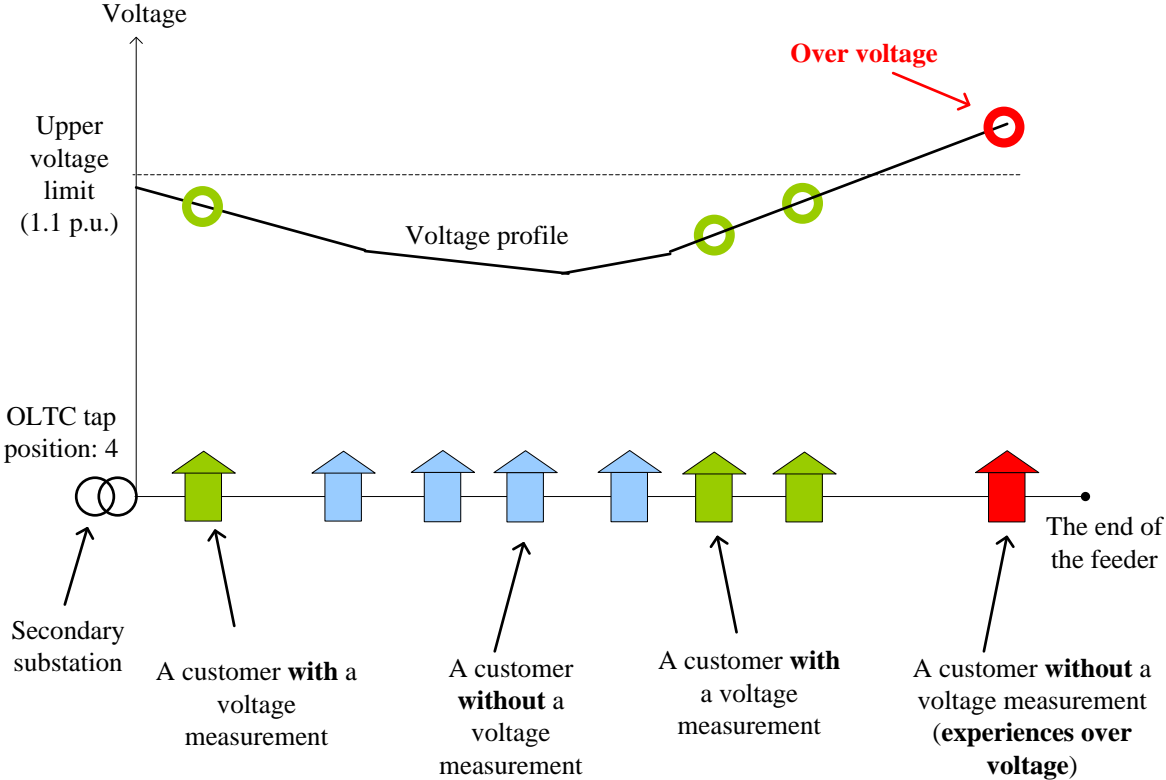

Figure 65: Voltage measurements are placed in the network as illustrated in Figure 64 (the voltage measurements are marked in green circles). The voltage profile changes in comparison with Figure 64 due to changing habits on power consumption. The rightmost customer (marked in red) is not equipped with a voltage measurement, thus over voltage (marked in a red circle) is not detected by the on-load tap changer and does not change the tap position in order to relieve the voltage constraint (maintains the tap position in four as in Figure 64).

This issue can be solved by considering the photovoltaic generators already in the phase when the voltage sensors are placed in the network. This would result in a higher number of voltage sensors in the network.

An example of a network with 145 customers is described here. The peak load of the network is 550 kW.

If no on-load tap changer is used and the off-load tap position is set in the neutral position, the hosting capacity of the network is 315 kW (according to the methodology explained in the previous section). The hosting capacity of the network is limited by a voltage constraint. At the moment when the voltage constraint occurs, the maximum phase-to-neutral voltage in the network is 1.1004 per unit that is found at Terminal 34.

Before executing the method in order to find the hosting capacity, the voltage measurements are located to the low voltage network according to the method of finding the

customers whose voltage measurements are used to control the on-load tap changer. The voltage measurements are placed at three customers; one three-phase customer and two single-phase customers. The named measurements (and the customers) are located at Terminal 48 (A-to-neutral, B-to-neutral and C-to-neutral), Terminal 4 (C-to-neutral) and Terminal 5 (B-to-neutral). When the same network is equipped by an on-load tap changer with five tap positions and the tap position is set to four (+1.75 per cent) at the beginning of the method (for estimating the hosting capacity), the hosting capacity is limited to 261 kW.

In the case of the on-load tap changer, the tap position is set in +1.75 per cent, which leads to a voltage drop. However, this voltage drop is not experienced when no on-load tap changer is used because the tap position is in the neutral position (1.75 per cent lower than in the case when an on-load tap changer is used).

Due to the voltage drop, the on-load tap changer moves down and decreases voltage. During the method of estimating the hosting capacity, photovoltaic power production is increased step by step. Because the placement of the voltage measurements does not take into account the increasing voltage due to the increasing power output from the photovoltaic power generators, it does not detect the maximum phase-to-neutral voltage in the network. Thus, the on-load tap changer does not move upwards and a voltage constraint is experienced.

At the moment, when the constraint occurs, the maximum phase-to-neutral voltage in the network is 1.1001 per unit, experienced at Terminal 34 (B-to-neutral). The maximum phase-to-neutral voltages at the terminals captured by the voltage measurements are 1.07 per unit (Terminal 48; C-to-neutral), 1.05 per unit (Terminal 4; B-to-neutral) and 1.06 per unit (Terminal 5; B-to-neutral). Thus, the maximum phase-to-neutral voltage detected by the voltage sensors is thus 1.07 per unit that is shown in Figure 66,

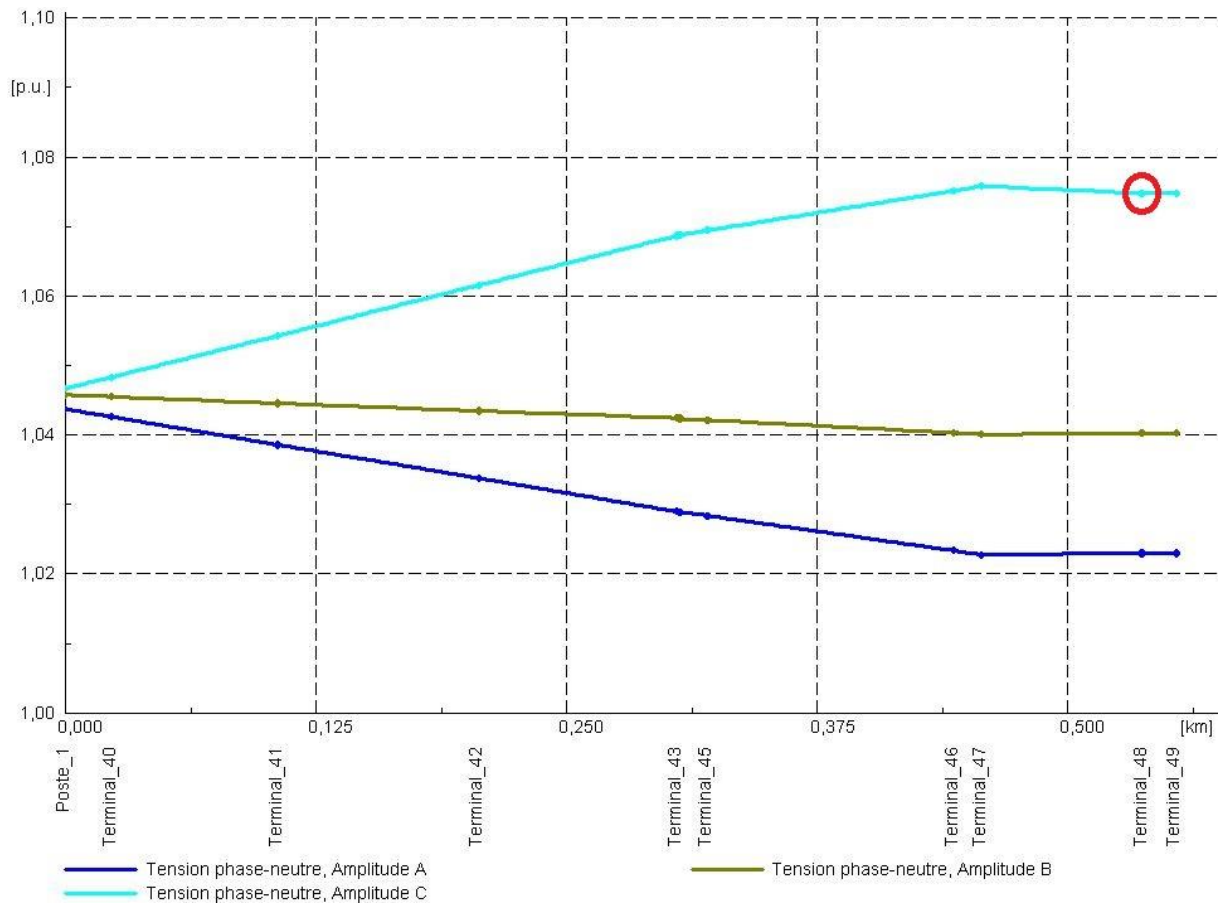

Figure 66: Voltage profiles (phase-to-neutral voltage) along the feeder at the moment when the voltage constraint occurs. The highest measured phase-to-neutral voltage of the network is in this feeder. The highest measured phase-to-neutral voltage is marked by a red circle. The voltage sensor that measures the highest phase-to-neutral voltage is located at Terminal 48 (see the horizontal axis).

while the maximum phase-to-neutral voltage in the network is 1.100 per unit, as illustrated in Figure 67.

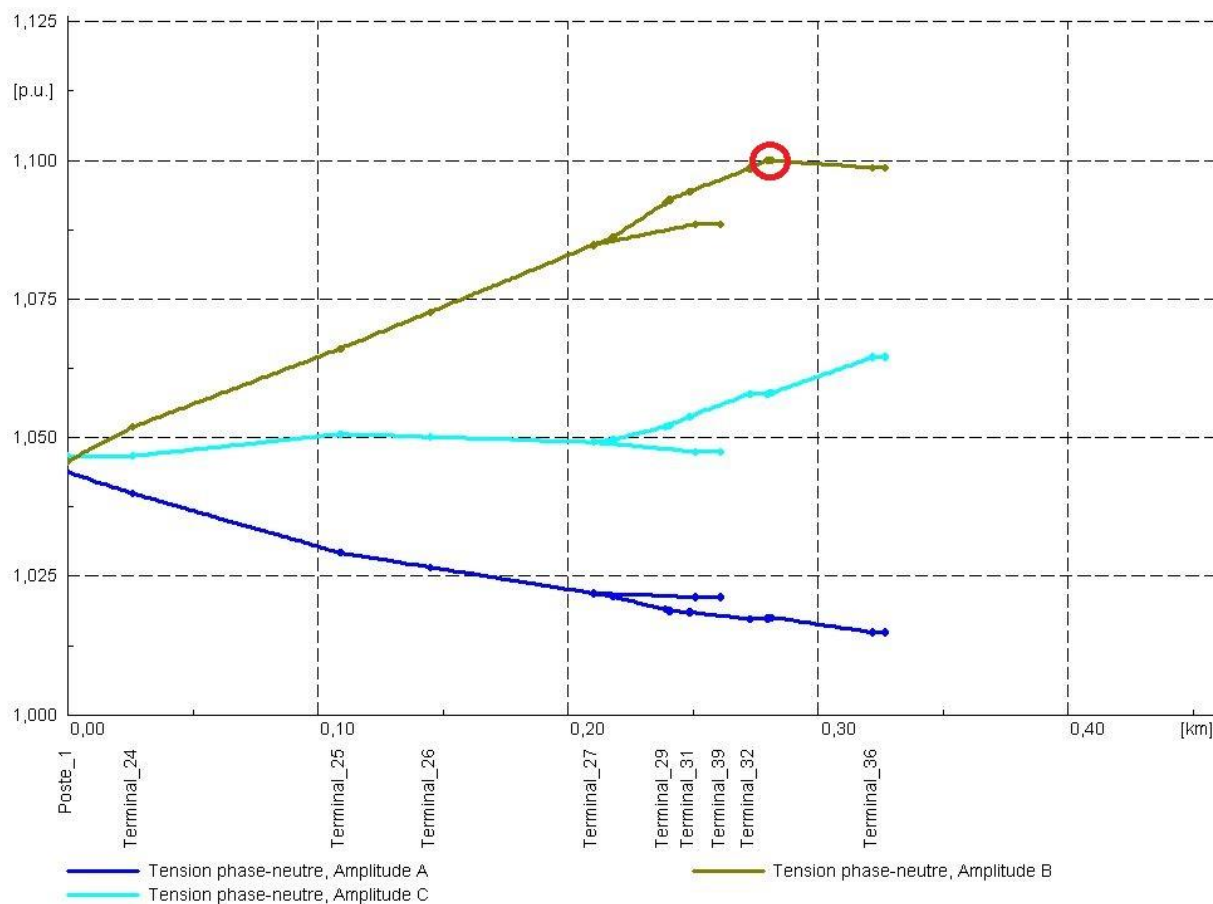

Figure 67: Voltage (phase-to-neutral voltage) profiles along the feeder at the moment when the voltage constraint occurs. The highest experienced phase-to-neutral voltage is located in this feeder. The highest experienced phase-to-neutral voltage is marked by a red circle. It is located at Terminal 34 (cannot be seen in the horizontal axis).

During the method for estimating the hosting capacity, the on-load tap changer does not change the tap position because voltages at the terminals where the voltage measurements are located do not exceed 1.1 per unit. The voltage peak at Terminal 34 remains unnoticed. It should be noticed that the maximum and the maximum detected phase-to-neutral voltages are located in different feeders.

In this case, hosting capacity can be increased by placing one voltage measurement at Terminal 34 because it would allow the on-load tap changer to change the tap position. Terminal 34 has a customer connected to Phase B, so this arrangement is possible. The same results are obtained when an on-load tap changer with nine tap positions is used.

As mentioned earlier, when an on-load tap changer is used, the tap is set +1.75 per cent higher than when no on-load tap changer (with five or with nine tap positions) is used. This leads to a problem where a voltage drop is experienced only when an on-load tap changer is used but does not lead to a voltage drop when an on-load tap changer is not used. A positioning of the voltage measurements when an over voltage is detected is illustrated in a simplified example in Figure 68.

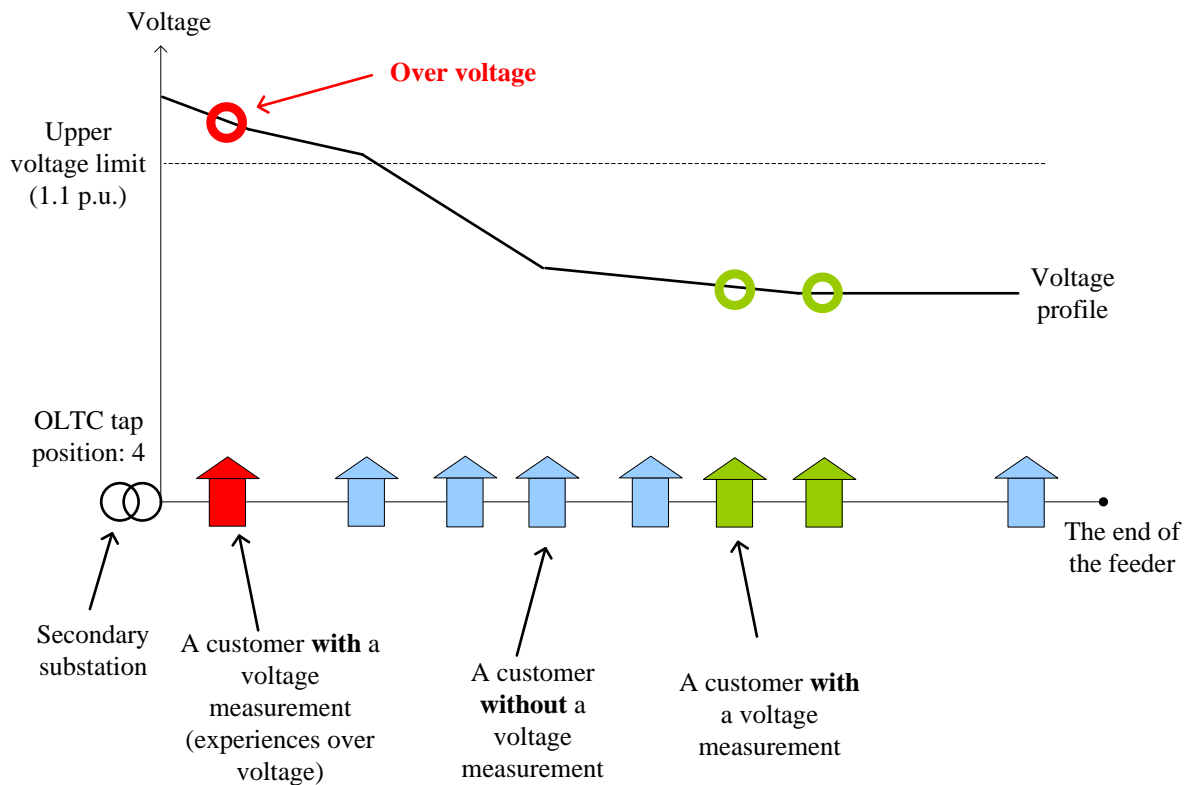

Figure 68: A voltage constraint (marked by a red circle) is detected at the leftmost customer (marked in red). See the upper voltage limit marked in a dashed line. The on-load tap changer is in the position four. The voltage constraint is detected by the on-load tap changer that will decrease voltage. The circles (green and the red one) represent voltages measured by the on-load tap changer.

At the moment, when the voltage drop is experienced, the tap position is moved downwards as low as possible without evoking a voltage constraint in the form of high voltage. However, since current constraints are not taken into account when the on-load tap changer is controlled, setting the tap position lower may lead to a current constraint in a line or in a transformer due to increasing current. This situation is demonstrated in Figure 69.

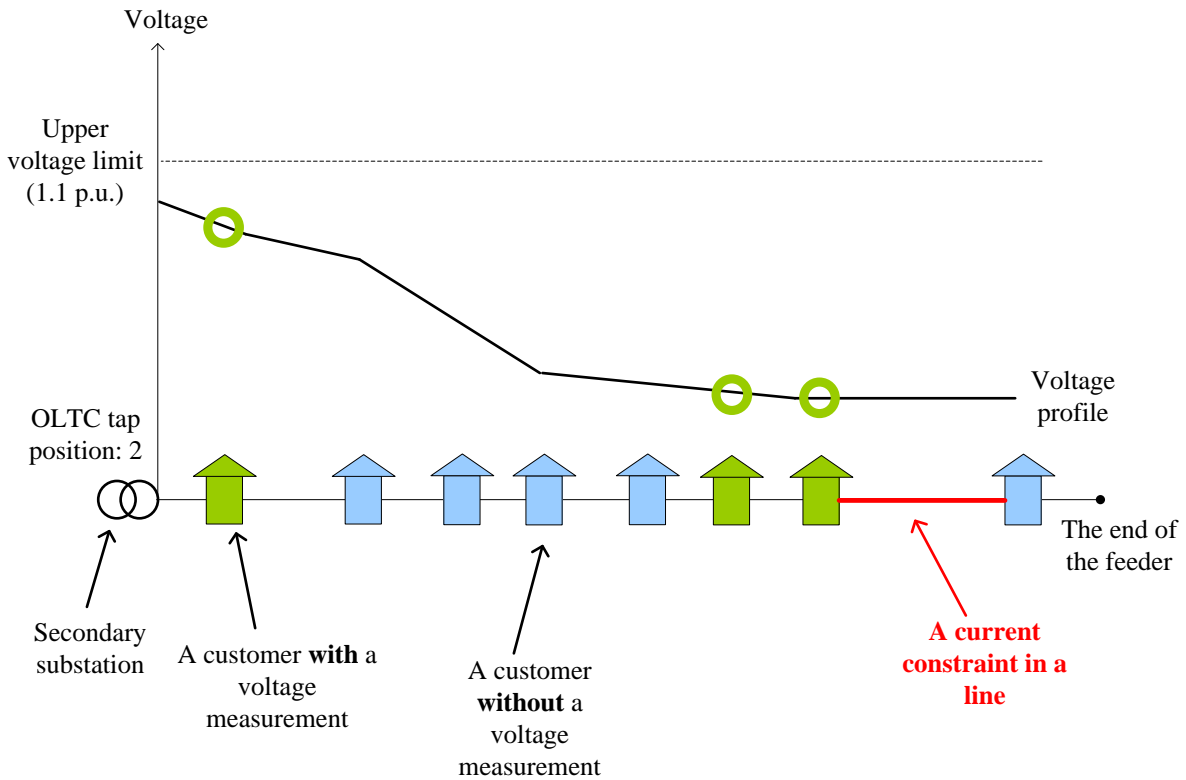

Figure 69: The voltage constraint presented in Figure 68 is relieved by moving the tap position of the on-load tap changer from four to two. However, increasing current provokes a current constraint between the two rightmost customers (marked in the red line).

The on-load tap changer is used for correcting voltage and it is not used in case of a current constraint. In the method of estimating hosting capacity, if both, a voltage and a current constraint (in a line or in the secondary transformer) are experienced with the same amount of penetration of photovoltaic power generation, the constraint is registered as a current constraint and the tap position is not changed. However, as a result of the small step size of increment in the output of photovoltaic power generation, experiencing a voltage and a current constraint during the same step is extremely rare.

In the calculation of load flow, the maximum accepted error in the power flows at the nodes is set to 0.1 VA. Hosting capacity is calculated as a sum of consumed powers at all loads, which means that the error in the hosting capacity can be several times higher than the accepted error in the maximum accepted error at the loads.

6.3. Results

As stated previously, 631 low voltage networks are studied in this section. The size of the networks ranges from one to 446 customers, the average size being 128 customers. In order to have a clear idea of the size of the networks, Figure 70 illustrates the number of the customers and the number of voltage measurements in those networks.

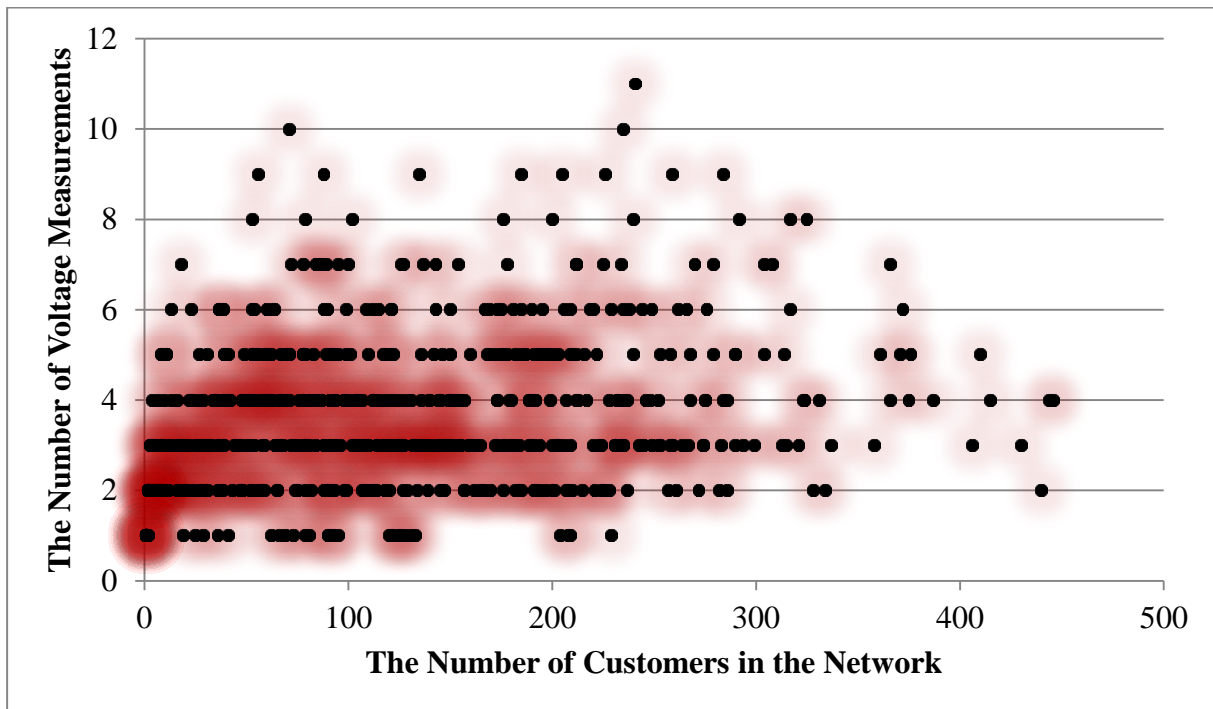

Figure 70: The number of customers and the number of required voltage measurements in the studied networks. The red surrounding each mark helps to visualise the density of the measurement points.

The number of customers in the network as a function of the share (in per cents) of the customers where voltage should be measured is illustrated in Figure 71.

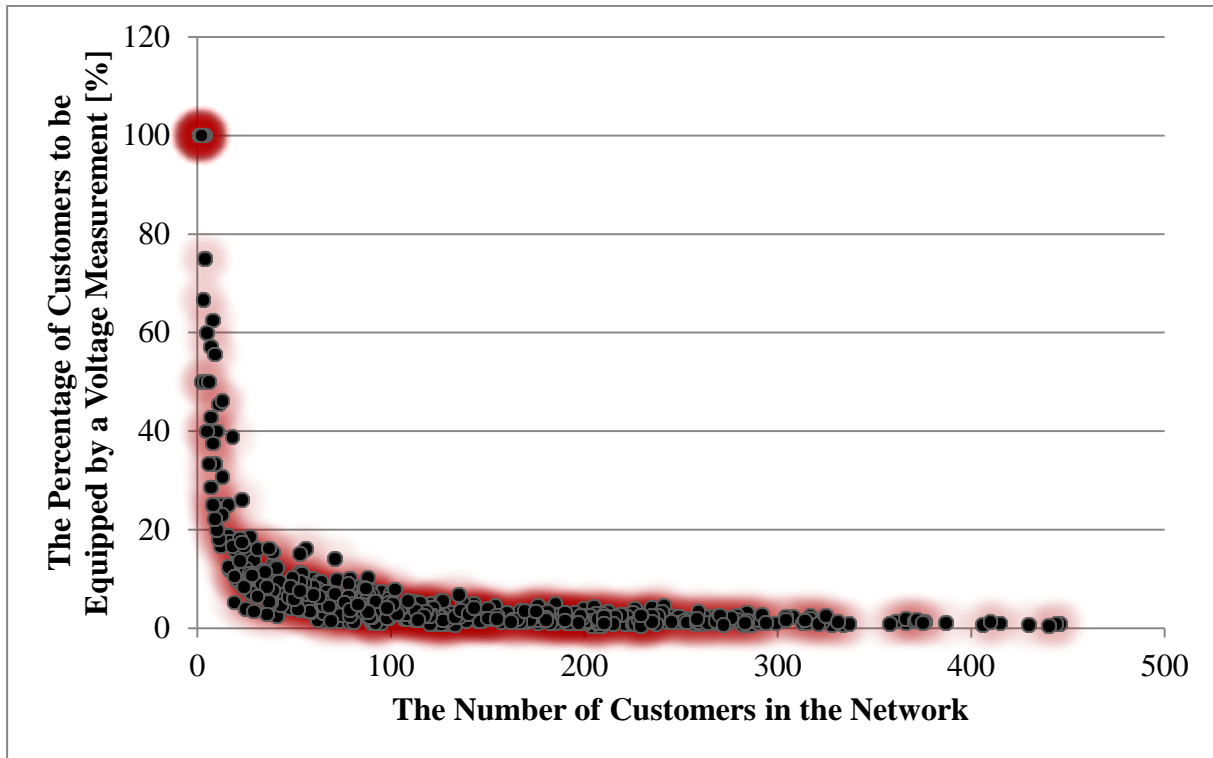

Figure 71: The number of customers in the network as a function of the share of customers to be equipped by a voltage measurement.

As presented in Figure 70, the minimum number of voltage sensors is one and the maximum is 11. On average, four voltage measurements are needed in order to provide the aspired level of accuracy for the estimation of the maximum and the minimum voltage values. The average share of customers that should be provided by a voltage measurement is 11 per cent.

The shares of the different types of constraints are shown in three studied cases respectively: no on-load tap changer, the on-load tap changer of five tap positions and the on-load tap changer of nine tap positions.

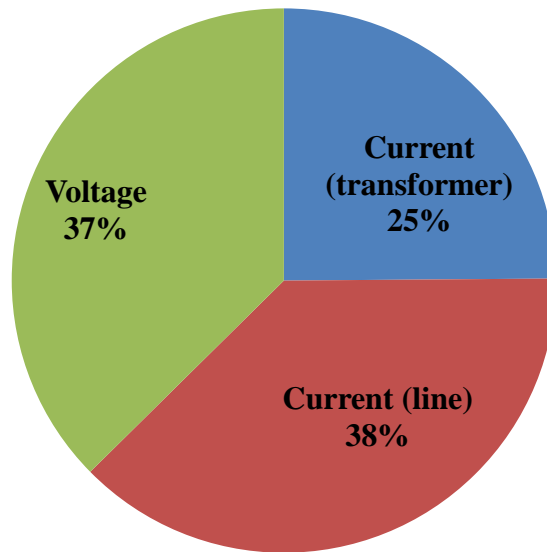

Figure 72: The share of the types of the constraints when no on-load tap changer is used.

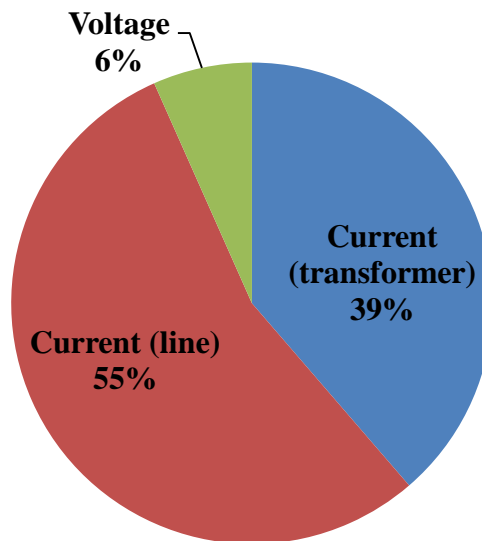

Figure 73: The share of the types of the constraints when the on-load tap changer of five tap positions is used.

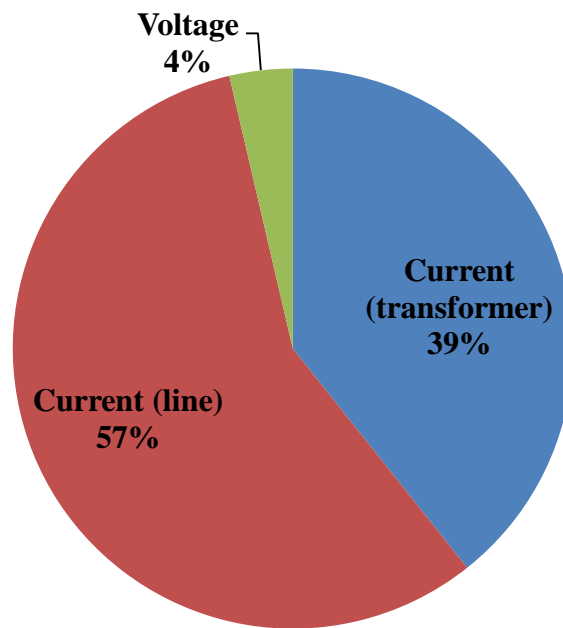

Figure 74: The share of the types of the constraints when the on-load tap changer of nine tap positions is used.

Hosting capacities per peak loads (in per cents) are illustrated in a box-and-whisker diagram in Figure 75. It should be noted that only the networks where the hosting capacity for photovoltaic power generation is increased when an on-load tap changer is used, are included the figure.

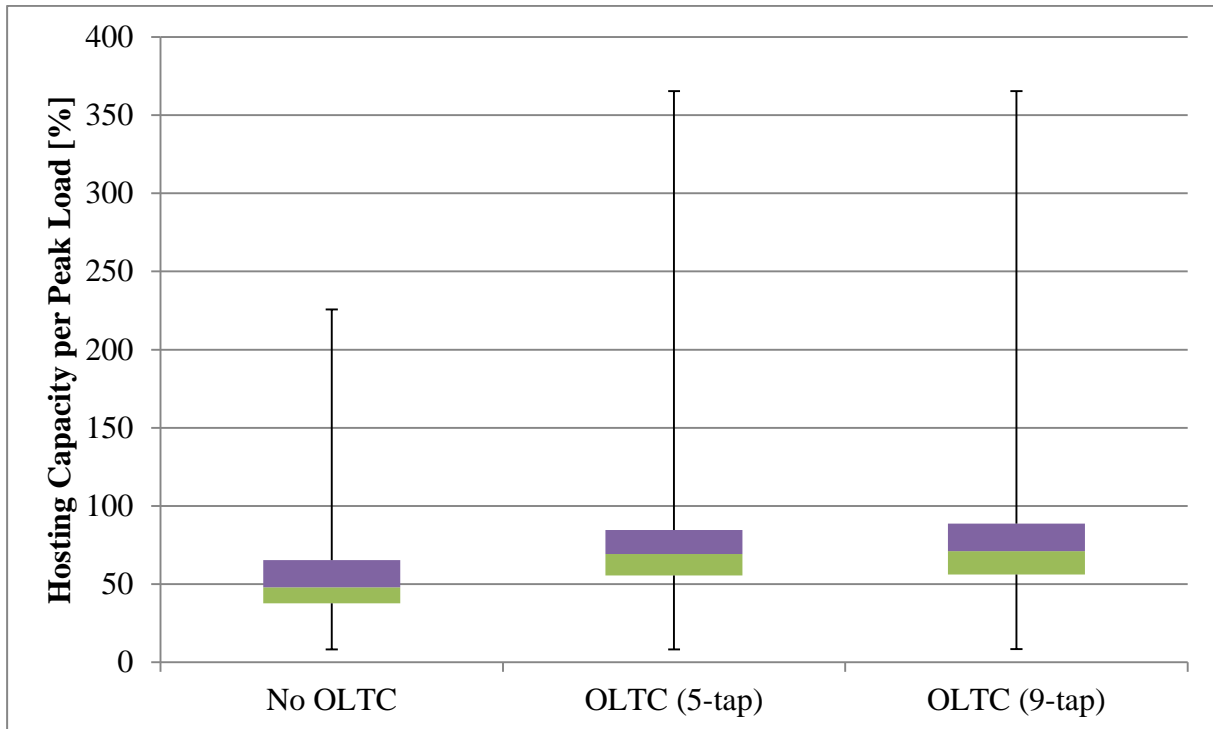

Figure 75: Hosting capacity for photovoltaic power generation per peak load. The three studied cases are presented; no on-load tap changer, the on-load tap changer with five tap positions and the on-load tap changer with nine tap positions. Only the networks where hosting capacity is increased by using an on-load tap changer are considered. The median value can be seen as the intersection between the green and the purple boxes. The purple box represents the upper 25 per cent (from the median) of the networks and the green box represents the lower 25 per cent (from the median) of the networks. Thus 50 per cent of the networks are within the purple or the green boxes and 50 per cent of the networks are within the whiskers.

In order to have a clear idea of the medium values of the hosting capacity per peak load, Figure 76 presents them as a histogram. Such as in Figure 75, only the networks where hosting capacity is increase through the use of an on-load tap changer are included in the figure.

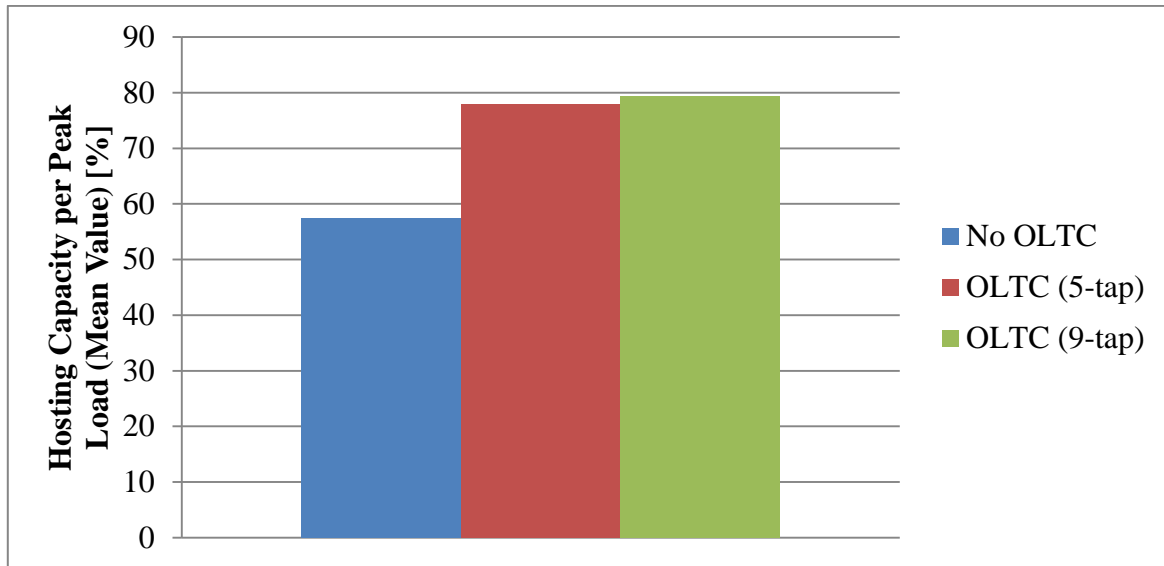

Figure 76: The mean values of the hosting capacity per peak load. Only the networks where hosting capacity for photovoltaic power generation is increased are considered.

6.4. Analysis of the Results

As illustrated in Figure 70, a relatively small number of voltage measurements are needed to control the on-load tap changer. According to the results, there is a correlation between the number of customers in a network and a percentage of customers where voltage measurements should be measured (Figure 71). Within the networks with less than 40 customers, a high variation in the share of voltage measurements can be found in comparison with the networks that have between 200 and 300 customers, for example.

When no on-load tap changer is used, 37 per cent of the networks are constrained by voltage. The rest of the networks are limited by current in a line or in a transformer. When an on-load tap changer is applied, the hosting capacity is limited by voltage in only four to six per cent of the networks depending on the number of tap positions (see Figure 73 and Figure 74).

The hosting capacities per peak load of three studied cases are presented in Figure 75. The differences between the cases can be clearly seen in this plot. In the 50 per cent of the networks closest to the median value (the purple box and the green box) the hosting capacity cannot be increased significantly. When no on-load tap changer is used, the median (hosting capacity per peak load) is 48 per cent. When the on-load tap changer with five tap positions is used, the median is 69 per cent and 71 per cent when the on-load tap changer with nine tap positions is used. On the other hand, there is a set of networks that experience a considerable increment in the hosting capacity when the on-load tap changer or five or nine tap positions is used (see the two rightmost boxplots in the figure). This can be seen as an extending range of the values in the upper quartiles (the whiskers above the purple boxes).

During the method of estimating the hosting capacity, the range of the on-load tap changers is used only to increase voltage and not to decrease it. That is why the lower quartiles (the whiskers below the green boxes) do not increase significantly (in Figure 75).

In the average values of hosting capacity per peak load (Figure 76), it can be seen that hosting capacity is increased by 37 per cent when comparing between the case “No OLTC” with the case “OLTC (5-tap)”. Additionally, the hosting capacity per peak load is further

increased to 38 per cent when comparing the cases “No OLTC” with the case “OLTC (9-tap)”.

6.5. Discussion and Conclusions

The required number of voltage measurements is low, considering that it is four on average. The hosting capacity can be increased only in about one third of the networks. When only the networks where the possibility to increment the hosting capacity is significant in practice are considered, the number of networks is substantially smaller. With a view to the fact that the major part of the networks do not increase their hosting capacity (or increase it only slightly) through the use of an on-load tap changer, it should be studied carefully whether to install an on-load tap changer or not.

The methodology to place voltage measurements in a low voltage network in order to control an on-load tap changer is straightforward and takes into account only the current state of the network without any future scenarios. This methodology is used in the estimation of hosting capacity for photovoltaic power generation. When the voltage measurements are placed in the network, any information of the future locations of the photovoltaic generators is not available. This fact being considered, the placement of the voltage measurements performs well because the number of voltage constrained networks is reduced significantly, however, it doesn't guarantee optimal locations under extremely high penetration of photovoltaic power generation. In reality, low voltage networks evolve over time, which means that the locations of the voltage measurements must be updated over certain time periods.

Among the networks that remain voltage constrained even when an on-load tap changer is used, it is not clear if they stay voltage constrained because the range of the on-load tap changer is not wide enough or if the voltage measurements do not detect the highest phase-to-neutral voltage in the network (as explained in Section “Potential Pitfalls when Applying the Methodology to Place Voltage Sensors to Estimate the Hosting Capacity”). This should be taken into account in the further development of the method for estimating hosting capacity. An important rationale of this is that it is better not to use an on-load tap changer than use it if it is not sure that the corresponding voltage measurements are placed in an adequate manner.

Another valuable conclusion is that when the hosting capacity of a low voltage network is studied, the way how the on-load tap changer is controlled must be taken into account. A perfect control cannot be taken for granted. For example, if it is supposed that the extreme voltages of the network are always known with a perfect accuracy when controlling the on-load tap changer and this is not the case, unrealistic values for the hosting capacity are obtained. Consequently, these hosting capacities cannot be reached in practice. All things considered, it is not useful to estimate the increase of the hosting capacity by an on-load tap changer if the hosting capacity cannot be fully exploited.

The increments in the hosting capacity can be stated to be moderate in general, which leads to a conclusion that it may not be feasible to install an on-load tap changer only with a view to increase the hosting capacity. Even if the percentage of the networks where the hosting capacity can be increased significantly does not seem noticeably high, it should be kept in mind that one per cent of the networks equals to about 7000 low voltage networks in the territory of ERDF. This means that even a few per cent means tens of thousands of networks.

In summary, this decision would require further research from the economic standpoint, which is out of the scope of this thesis. An important remark is that there is no or there is a

very limited difference between the performance of the on-load tap changer with five and nine tap positions. In almost all networks, the range of the one with five tap positions is wide enough to remove voltage limitations. Both indicators, hosting capacity per peak load and installed hosting capacity per customer, show almost identical results. Both indicators are valuable. The most important benefit from the indicators is that they enable the comparison of networks with each other.

An important fact to be regarded is that the studied networks are from the same metropolitan area, which means that the results cannot be directly extrapolated to the rest of France without further studies. On the other hand, these results offer a relatively comprehensive view of one metropolitan area.

7. General Conclusions and Future Work

This chapter presents brief overall conclusions of this thesis and ideas for future developments. More detailed conclusions can be read in the dedicated chapters.

7.1. Conclusions

As a result of many changes in the consumption and the generation of electricity, there are actual needs to introduce new ideas how to build and operate low voltage networks. Today, the installation of advanced metering infrastructure is the most important current technical development in the sector of low voltage networks. There are several promising technical solutions, such as on-load tap changer or direct current distribution (mainly in rural areas), but one of the main problems are the lack of standards and long-term practical experience. These deficiencies may not convince power utilities to trial them even if similar technologies were used for other industrial applications. Investments of such a size are expensive for the electricity distribution utilities, meaning that high level of security for the investments is called for. Advanced metering infrastructure can provide measurements for many other applications, such as the control of an on-load tap changer. That is why discovering further usage of advanced metering infrastructure is interesting from the viewpoint of the utility. The results of this thesis show that an on-load tap changer can be controlled accurately with a relatively small number of voltage measurements in the low voltage network.

If no real historical data from electricity meters is available, synthetic load curves based on the mean value and the 90th percentile can efficiently substitute real load curves in certain applications. A real application for the use of the synthetic load curves is shown in this thesis.

There is no one “fixed” hosting capacity in a network, but it depends on how it is estimated. The resulting hosting capacities are different depending on the method of assessment. Thus, using one scenario of placing photovoltaic power generators gives one value for the hosting capacity. When in-depth information of the hosting capacity is required, for example, for research purposes, a method based on several different scenarios of placing and sizing the photovoltaic power generators must be used. Monte Carlo –based techniques are applicable for this purpose. However, the computational costs are the most notable drawback.

When estimating the hosting capacity of photovoltaic generation in a given low voltage network, selecting the size and the phase connection of the photovoltaic generators is one of the most crucial questions. The hosting capacity per network peak load and installed hosting capacity per customer are useful indicators that make the information proportional and several networks can be compared with each other.

If the impact of an on-load tap changer on the hosting capacity is assessed, the control of the on-load tap changer must be included as an integrated part of the study in order to have a realistic estimation of the hosting capacity. Besides, there is no sense in estimating hosting capacity if it cannot be fully exploited. When an on-load tap changer is controlled based on AMI measurements, the locations of the measurements should be updated every certain period. If the on-load tap changer is not controlled in an adequate manner, it is better not to use an on-load tap changer than using it.

According to the presented results obtained by studying 631 real low voltage networks, an on-load tap changer can be an efficient method for increasing the capacity to host photovoltaic power generation in a reduced set of networks, but it should not be used as a

self-evident tool to increase the hosting capacity. Put in other way, an on-load tap changer is an efficient way to control voltage because it usually removes the voltage constraint but a new constraint is posed by the thermal limit of a cable or a transformer. An on-load tap changer of nine tap positions does not usually result in a higher hosting capacity than an on-load tap changer of five tap positions.

Because of the enormous number of low voltage networks, all of them cannot be analysed separately, a network by a network, but new uniform and well-tested methods are required so that networks can be analysed in masses. For a distribution system operator, it is important to obtain a comprehensive view about the state of its low voltage networks to support the economic decisions. The possibility to combine data from the advanced metering infrastructure as well as the topological data on one platform opens a wide range of opportunities to analyse large numbers of low voltage networks in an automated manner. This information is highly valuable in planning and in asset management. In the work presented in this thesis, efficient algorithms are implemented directly on a platform that is widely used in the power distribution industry, which facilitates their practical use.

7.2. Future Work

The work carried out in the framework of this thesis uncovered many issues but, understandably, all relevant questions cannot be solved by the cause of limited time. Even if the methodologies and scripts presented in this thesis show encouraging results, further studies are required in order to guarantee the applicability in the real environment. A technical question of this kind is, for example, the optimal interval for updating the locations of voltage measurements.

It can be assumed that voltage control can be more feasible in rural networks that are typically longer and more prone to voltage problems than urban and semi-urban networks. This should be verified by repeating the studies by using rural networks.

This thesis has a focus on the hosting capacity without taking into account the dynamics of the operation. Especially it would be interesting in case of an on-load tap changer in order to be able to select the most appropriate control methodology and estimate the operational lifetime of the on-load tap changer. It is crucial to take into account the impact of the operation of multiple parallel low voltage networks on the medium voltage network to which they are connected. This would make sure that the problems of low voltage networks are eliminated and not transmitted to the medium voltage network.

In the estimation of the hosting capacity, only the first constraint to be experienced is taken into account. It could be useful to consider more than one constraint while increasing photovoltaic power generation. If the first constraint is a voltage constraint, it could be estimated how much margin there is from the first voltage constraint to the first current constraint if voltage was controlled in an ideal way so that no voltage constraint occurs. The results of this thesis show that the hosting capacity can be increased more in some networks than in the other ones. It would be interesting to realise in-depth analysis in order to find out the common characteristics between the networks where the hosting capacity can be increased essentially.

Before any ideas presented in this thesis will be taken into practice, comprehensive economic estimations should be carried out. The decision making process, for example about whether an on-load tap changer should be installed, has to be straightforward because a significant amount of time cannot be invested in the design on a single low voltage network.

That is why simple rules-of-thumb should be created taking into account both, the technical and the economic aspects at least to some extent.

More efficient methods of estimating the hosting capacities could be created so that more low voltage networks could be studied in a shorter time. The scripts used in the studies are purely based on the execution of computer code. Before their use in the industry, they should be equipped by a graphical user interface in order to make them more accessible to the end users. Additionally, an automatic graphical visualisation of the results would be helpful to make the results easy to perceive.

References

- [1] Réseau de transport d'électricité (RTE), "RTE - The French Transmission System Operator."
- [2] Réseau de transport d'électricité (RTE), "RTE - Electricity Transport Network Operator," La Défense, 2011.
- [3] R. Calvas, "Les perturbations électriques en BT," Grenoble, 2001.
- [4] Y. Hassaine and P. Panciatici, "Experiences and practices on State Estimation in RTE (French Transmission System Operator)," *Power and Energy Society General Meeting - Conversion and Delivery of Electrical Energy in the 21st Century, 2008 IEEE*. pp. 1–5, 2008.
- [5] S. Henry, P. Panciatici, and A. Parisot, "Going Green: Transmission Grids as Enablers of the Transition to a Low-Carbon European Economy," *Power Energy Mag. IEEE*, vol. 12, no. 2, pp. 26–35, 2014.
- [6] Réseau de transport d'électricité (RTE), "RTE - Bilan électrique 2012," La Défense, 2013.
- [7] B. Mallem and B. Marinescu, "Dynamic Equivalent of Neighbor Power System for Day-Ahead Stability Studies," in *Innovative Smart Grid Technologies Conference Europe (ISGT Europe), 2010 IEEE PES*, 2010, pp. 1–6.
- [8] E. Lakervi and J. Partanen, *Sähköjaketekniikka*, 2nd ed. Gaudeamus Helsinki University Press, 2009.
- [9] A. A. Diallo and C. Chaudet, "An Alternate Topology Generator for Joint Study of Power Grids and Communication Networks," *Lect. Notes Comput. Sci.*, vol. 6027, pp. 50–61, 2010.
- [10] R. Tellier and G. Gallet, "French distribution systems: basic features and practices," *Gener. Transm. Distrib. IEE Proc. C*, vol. 133, no. 7, pp. 377–383, 1986.
- [11] Électricité Réseau Distribution France (ERDF), "Description physique du réseau public," 2008.
- [12] M.-C. Alvarez-Hérault, "Architectures des réseaux de distribution du futur en présence de production décentralisée," 2009.
- [13] M.-C. Alvarez-Hérault, D. Picault, R. Caire, B. Raison, N. Hadjsaid, and W. Bienia, "A Novel Hybrid Network Architecture to Increase DG Insertion in Electrical Distribution Systems," *Power Syst. IEEE Trans.*, vol. 26, no. 2, pp. 905–914, 2011.
- [14] O. Siirto, M. Loukkalahti, M. Hyvärinen, P. Heine, and M. Lehtonen, "Neutral Point Treatment and Earth Fault Suppression," in *Electric Power Quality and Supply Reliability Conference (PQ), 2012*, 2012, pp. 1–6.
- [15] N. Hajsaid and J.-C. Sabonnadière, *Electrical Distribution Networks*. John Wiley & Sons, 2011.
- [16] N. Hadjsaid, M. Alvarez-Hérault, R. Caire, B. Raison, J. Descloux, and W. Bienia, "Novel architectures and operation modes of distribution network to increase DG

- integration,” in *Power and Energy Society General Meeting, 2010 IEEE*, 2010, pp. 1–6.
- [17] Électricité Réseau Distribution France (ERDF), “Principes d’étude et de développement du réseau pour le raccordement des clients consommateurs et producteurs BT,” Paris, 2011.
- [18] J. Pylvanainen, M. Kauppinen, and P. Verho, “Studies to Utilise Calculational Condition Information and AMR Measurements for Transformer Condition Assessment,” in *Electricity Distribution - Part 1, 2009. CIRED 2009. 20th International Conference and Exhibition on*, 2009, pp. 1–4.
- [19] A. Kytölä, “Pienihäviöinen muuntaja on energiatehokas,” *ABB Power Magazine*, 2011.
- [20] V. Huurinainen, “Lifespan Analysis of a Distribution Transformer,” Tampere University of Applied Sciences, 2006.
- [21] Électricité Réseau Distribution France (ERDF), “Guide pratique a l’usage et maîtrise d’ouvrage de construction - Réalisation de postes HTA/BT de distribution publique,” 2009.
- [22] “Guide pratique a l’usage de la maîtrise d’ouvrage de construction - Réseaux et branchements basse tension souterrains en lotissement,” 2012.
- [23] J. Karppanen, “Sähköntuotannon pienjänniteverkkoon liittäminen – määräykset ja sähköturvallisuus,” Lappeenranta University of Technology, 2012.
- [24] Y. Brument, J.-L. Fau, C. Guillaume, and P. Williams, “Low voltage mains cables : Working towards a common optimised design for both ERDF and EDF Energy,” in *Electricity Distribution - Part 1, 2009. CIRED 2009. 20th International Conference and Exhibition on*, 2009, pp. 1–4.
- [25] Prysmian, “Torsade aérienne de branchement NF C 33-209,” 2012.
- [26] Électricité Réseau Distribution France (ERDF), “Guide pratique a l’usage de la maîtrise d’ouvrage de construction,” 2012.
- [27] M. Domagk, J. Meyer, G. Eberl, and T. Darda, “Influence of aggregation intervals on power quality assessment according to EN 50160,” in *Electricity Distribution (CIRED 2013), 22nd International Conference and Exhibition on*, 2013, pp. 1–4.
- [28] C. Masetti, “Revision of European Standard EN 50160 on power quality: Reasons and solutions,” in *Harmonics and Quality of Power (ICHQP), 2010 14th International Conference on*, 2010, pp. 1–7.
- [29] C. D. Association, “Power Quality Application Guide: Voltage Disturbances Standard EN 50160,” Wroclaw, 2004.
- [30] Électricité Réseau Distribution France (ERDF), “ERDF - Electricity Market,” 2014. [Online]. Available: http://www.erdf.fr/Electricity_market.
- [31] J.-M. Tesson, “Mission: Reliability,” *Power and Energy Magazine, IEEE*, vol. 6, no. 1, pp. 42–48, 2008.
- [32] M. Farsi, M. Filippini, M.-A. Plagnet, and R. Saplacan, “The Economies of Scale in the French Power Distribution Utilities,” in *Energy Market (EEM), 2010 7th International*

- Conference on the European*, 2010, pp. 1–7.
- [33] D. Bui and M. De Possesse, “Big Data Contribution to the Management of the French Distribution Network,” in *CIREC Workshop 2014*, 2014.
- [34] L. Wautier, “Forecasting the Congestion Costs of the French Transmission Network,” Royal Institute of Technology (KTH), 2013.
- [35] P. Bornard and T. Veyrenc, “Grid development in France and in Europe: The new paradigm,” in *Power & Energy Society General Meeting, 2009. PES '09. IEEE*, 2009, pp. 1–3.
- [36] F. Bouhafs, M. Mackay, and M. Merabti, “Links to the Future: Communication Requirements and Challenges in the Smart Grid,” *Power Energy Mag. IEEE*, vol. 10, no. 1, pp. 24–32, 2012.
- [37] M. M. Rahman and A. Mto, “Technologies required for efficient operation of a smart meter network,” in *Industrial Electronics and Applications (ICIEA), 2011 6th IEEE Conference on*, 2011, pp. 809–814.
- [38] Électricité Réseau Distribution France (ERDF), “Linky, comment ça marche?,” Paris, 2012.
- [39] S. Renner, M. Albu, H. Van Elburg, C. Heinemann, L. Penttinen, and H. Saele, “European Smart Metering Landscape Report,” Vienna, 2011.
- [40] J. Söderbom, “Overview of the Swedish Smart Grid Community,” 2013.
- [41] M. Pekkarinen and A. Rajala, “Valtioneuvoston asetus sähkötoimitusten selvityksestä ja mittauksesta,” Helsinki, 2009.
- [42] Électricité Réseau Distribution France (ERDF), “Spécifications du profil CPL Linky,” 2009.
- [43] E. Cerqueira, P. Blandin, and O. Devaux, “Using AMI for network monitoring and control: New equipment as a step towards a smart grid implementation,” in *CIREC 2011*, 2011.
- [44] S. Repo, D. Della Giustina, G. Ravera, L. Cremaschini, S. Zanini, J. M. Selga, and P. Jarventausta, “Use case analysis of real-time low voltage network management,” in *Innovative Smart Grid Technologies (ISGT Europe), 2011 2nd IEEE PES International Conference and Exhibition on*, 2011, pp. 1–8.
- [45] Électricité Réseau Distribution France (ERDF), “Linky, le compteur nouvelle génération,” 2014. .
- [46] J. Duplex, S. Gosswiller, and S. Fagnoni, “A better knowledge of electricity consumption for residential customers through the linky smart meter,” in *CIREC 2013*, 2013.
- [47] G. Antoine, L. De Alvaro, and G. Roupioz, “Large scale phase balancing of LV networks using the amm infrastructure,” in *CIREC 2011*, 2011.
- [48] O. Devaux, P. Bredillet, F. Gorgette, and C. Auneau, “Optimizing distribution operation, control and development by using AMM data and infrastructure,” in *CIREC 2009*, 2009.

- [49] G. Roupioz, X. Robe, and F. Gorgette, "First use of smart grid data in distribution network planning," in *CIREC 2013*, 2013.
- [50] S. Repo, S. Lu, T. Poho, D. Della Giustina, G. Ravera, J. M. Selga, and F. Alvarez-Cuevas Figuerola, "Active distribution network concept for distributed management of low voltage network," *Innov. Smart Grid Technol. Eur. (ISGT Eur. 2013 4th IEEE/PES)*, pp. 1–5, 2013.
- [51] A. Safdarian, M. Fotuhi-Firuzabad, and M. Lehtonen, "Benefits of Demand Response on Operation of Distribution Networks: A Case Study," *Syst. Journal, IEEE*, vol. PP, no. 99, pp. 1–9, 2014.
- [52] P. Valtonen, S. Honkapuro, and J. Partanen, "Impacts of smart grids on electricity retail business," in *CIREC 2011*, 2011.
- [53] R. van Gerwen, "Power Quality and Utilisation Guide: Distributed Generation and Renewables," 2006.
- [54] H. Schuster, J. Kellermann, T. Bongers, V. Gomez Oñate, and R. Hermes, "Development of methodologies and tools for new and evolving DSO roles for efficient DRES integration in distribution networks," Aachen, 2014.
- [55] V. A. Evangelopoulos and P. S. Georgilakis, "Optimal distributed generation placement under uncertainties based on point estimate method embedded genetic algorithm," *Gener. Transm. Distrib. IET*, vol. 8, no. 3, pp. 389–400, 2014.
- [56] A. R. Di Fazio, G. Fusco, and M. Russo, "Decentralized Control of Distributed Generation for Voltage Profile Optimization in Smart Feeders," *Smart Grid, IEEE Trans.*, vol. 4, no. 3, pp. 1586–1596, 2013.
- [57] P. P. Barker and R. W. De Mello, "Determining the impact of distributed generation on power systems. I. Radial distribution systems," in *Power Engineering Society Summer Meeting, 2000. IEEE*, 2000, vol. 3, pp. 1645–1656 vol. 3.
- [58] P.-C. Chen, R. Salcedo, Q. Zhu, F. de Leon, D. Czarkowski, Z.-P. Jiang, V. Spitsa, Z. Zabar, and R. E. Usef, "Analysis of Voltage Profile Problems Due to the Penetration of Distributed Generation in Low-Voltage Secondary Distribution Networks," *Power Deliv. IEEE Trans.*, vol. 27, no. 4, pp. 2020–2028, 2012.
- [59] H. Laaksonen, "Advanced Islanding Detection Functionality for Future Electricity Distribution Networks," *Power Delivery, IEEE Transactions on*, vol. 28, no. 4, pp. 2056–2064, 2013.
- [60] P. Juanuwattanakul and M. A. S. Masoum, "Increasing distributed generation penetration in multiphase distribution networks considering grid losses, maximum loading factor and bus voltage limits," *Gener. Transm. Distrib. IET*, vol. 6, no. 12, pp. 1262–1271, 2012.
- [61] P. D. F. Ferreira, P. M. S. Carvalho, L. A. F. M. Ferreira, and M. D. Ilic, "Distributed Energy Resources Integration Challenges in Low-Voltage Networks: Voltage Control Limitations and Risk of Cascading," *Sustain. Energy, IEEE Trans.*, vol. 4, no. 1, pp. 82–88, 2013.
- [62] G. Mokhtari, A. Ghosh, G. Nourbakhsh, and G. Ledwich, "Smart Robust Resources Control in LV Network to Deal With Voltage Rise Issue," *Sustain. Energy, IEEE*

- Trans.*, vol. 4, no. 4, pp. 1043–1050, 2013.
- [63] P. M. S. Carvalho, L. A. M. Ferreira, and J. J. E. Santana, “Single-Phase Generation Headroom in Low-Voltage Distribution Networks Under Reduced Circuit Characterization,” *Power Syst. IEEE Trans.*, vol. PP, no. 99, pp. 1–6, 2014.
 - [64] M. Doquet, C. Fourment, and J. Roudergues, “Generation and Transmission Adequacy of Large Interconnected Power Systems: A contribution to the renewal of Monte-Carlo approaches,” in *PowerTech, 2011 IEEE Trondheim*, 2011, pp. 1–6.
 - [65] P. Loevenbruck and A. Sacre, “Impact of Distributed Generation on Losses, Draw Off Costs from Transmission Network and Investments of the French Distribution Network Operator ERDF,” in *Electricity Distribution - Part 1, 2009. CIRED 2009. 20th International Conference and Exhibition on*, 2009, pp. 1–4.
 - [66] C. Salon, O. Huet, and F. Blanc, “How DSO Could Facilitate System Optimization in New Market Mechanisms for Distributed Resources,” in *Electricity Distribution (CIRED 2013), 22nd International Conference and Exhibition on*, 2013, pp. 1–4.
 - [67] Shell, “Shell Passenger Car Scenarios up to 2030 - Facts, Trends and Options for Sustainable Auto-Mobility,” 2009.
 - [68] E. Tonne, J. A. Foosnaes, and T. Pynten, “Power System Planning in Distribution Networks Today and in the Future with Smart Grids,” in *Electricity Distribution (CIRED 2013), 22nd International Conference and Exhibition on*, 2013, pp. 1–4.
 - [69] D. A. Haughton and G. T. Heydt, “A Linear State Estimation Formulation for Smart Distribution Systems,” *Power Syst. IEEE Trans.*, vol. 28, no. 2, pp. 1187–1195, 2013.
 - [70] A. Abdel-Majeed and M. Braun, “Low voltage system state estimation using smart meters,” in *Universities Power Engineering Conference (UPEC), 2012 47th International*, 2012, pp. 1–6.
 - [71] A. Mutanen, “Distribution Network State Estimation,” 2012.
 - [72] A. Abdel-Majeed, S. Tenbohlen, D. Schollhorn, and M. Braun, “Meter Placement for Low Voltage System State Estimation with Distributed Generation,” in *Electricity Distribution (CIRED 2013), 22nd International Conference and Exhibition on*, 2013, pp. 1–4.
 - [73] A. Mutanen, S. Repo, P. Jarventausta, A. Lof, and D. Della Giustina, “Testing low voltage network state estimation in RTDS environment,” in *Innovative Smart Grid Technologies Europe (ISGT EUROPE), 2013 4th IEEE/PES*, 2013, pp. 1–5.
 - [74] S. Grenard, O. Devaux, O. Carre, and O. Huet, “Power Steering: Advanced Distribution Applications for Operations,” *IEEE Power and Energy Magazine*, 2011.
 - [75] S.-I. Lim, S.-J. Lee, M.-S. Choi, D.-J. Lim, and B.-N. Ha, “Service Restoration Methodology for Multiple Fault Case in Distribution Systems,” *Power Syst. IEEE Trans.*, vol. 21, no. 4, pp. 1638–1644, 2006.
 - [76] D. Shirmohammadi, “Service Restoration in Distribution Networks via Network Reconfiguration,” *Power Deliv. IEEE Trans.*, vol. 7, no. 2, pp. 952–958, 1992.
 - [77] J. Baker and M. Meisinger, “Experience with a Distributed-Intelligence, Self-Healing Solution for Medium-Voltage Feeders on the Isle of Wight,” in *Innovative Smart Grid*

- Technologies (ISGT Europe), 2011 2nd IEEE PES International Conference and Exhibition on*, 2011, pp. 1–4.
- [78] A. Rodriguez-Calvo, P. Frias, J. Reneses, C. Mateo, L. del Rio, and S. Banales, “Mejora de la calidad del suministro electrico mediante centros de transformacion inteligentes,” *An. Mec. y Electr.*, vol. Julio-Agos, pp. 11 – 17, 2012.
- [79] F. Echavarren, “private communication.” Madrid, 2013.
- [80] X. Mamo, S. Mallet, T. Coste, and S. Grenard, “Distribution automation: The cornerstone for Smart Grid development strategy,” in *Power & Energy Society General Meeting, 2009. PES '09. IEEE*, 2009, pp. 1–6.
- [81] M. Oddi, F. Gorgette, and G. Roupioz, “ERDF Experience in Reducing Network Losses,” in *Electricity Distribution - Part 1, 2009. CIRED 2009. 20th International Conference and Exhibition on*, 2009, pp. 1–5.
- [82] S. Civanlar, J. J. Grainger, H. Yin, and S. S. H. Lee, “Distribution feeder reconfiguration for loss reduction,” *Power Deliv. IEEE Trans.*, vol. 3, no. 3, pp. 1217–1223, 1988.
- [83] E. Lopez, H. Opazo, L. Garcia, and P. Bastard, “Online reconfiguration considering variability demand: applications to real networks,” *Power Syst. IEEE Trans.*, vol. 19, no. 1, pp. 549–553, 2004.
- [84] F. De Groot, A. Geschiere, and R. Korver, “Support System for Safe Switching in Medium Voltage Grids by Real Time Prediction of Equalizing Currents,” in *Electricity Distribution - Part 1, 2009. CIRED 2009. 20th International Conference and Exhibition on*, 2009, pp. 1–4.
- [85] Y.-T. Hsiao and C.-Y. Chien, “Multiobjective Optimal Feeder Reconfiguration,” *Gener. Transm. Distrib. IEE Proceedings-*, vol. 148, no. 4, pp. 333–336, 2001.
- [86] I. Roytelman, V. Melnik, S. S. H. Lee, and R. L. Lugtu, “Multi-objective feeder reconfiguration by distribution management system,” *Power Syst. IEEE Trans.*, vol. 11, no. 2, pp. 661–667, 1996.
- [87] F. Scenna, D. Anaut, L. I. Passoni, and G. J. Meschino, “Reconfiguration of Electrical Networks by an Ant Colony Optimization Algorithm,” *Lat. Am. Trans. IEEE (Revista IEEE Am. Lat.)*, vol. 11, no. 1, pp. 538–544, 2013.
- [88] H. Salazar, R. Gallego, and R. Romero, “Artificial Neural Networks and Clustering Techniques Applied in the Reconfiguration of Distribution Systems,” *Power Deliv. IEEE Trans.*, vol. 21, no. 3, pp. 1735–1742, 2006.
- [89] E. Romero Ramos, A. Gómez Expósito, J. Riquelme Santos, and F. Llorens Iborra, “Path-Based Distribution Network Modeling: Application to Reconfiguration for Loss Reduction,” *IEEE Trans. Power Syst.*, vol. May, pp. 556 – 564, 2005.
- [90] S. Grenard and O. Carre, “Optimal short term operational planning for distribution networks,” in *Integration of Renewables into the Distribution Grid, CIRED 2012 Workshop*, 2012, pp. 1–4.
- [91] B. Amanulla, S. Chakrabarti, and S. N. Singh, “Reconfiguration of Power Distribution Systems Considering Reliability and Power Loss,” *Power Deliv. IEEE Trans.*, vol. 27,

- no. 2, pp. 918–926, 2012.
- [92] S. Bahadoorsingh, J. V Milanovic, Y. Zhang, C. P. Gupta, and J. Dragovic, “Minimization of Voltage Sag Costs by Optimal Reconfiguration of Distribution Network Using Genetic Algorithms,” *Power Deliv. IEEE Trans.*, vol. 22, no. 4, pp. 2271–2278, 2007.
- [93] B. Venkatesh, R. Ranjan, and H. B. Gooi, “Optimal Reconfiguration of Radial Distribution Systems to Maximize Loadability,” *Power Syst. IEEE Trans.*, vol. 19, no. 1, pp. 260–266, 2004.
- [94] M. A. Kashem, V. Ganapathy, and G. B. Jasmon, “Network reconfiguration for load balancing in distribution networks,” *Gener. Transm. Distrib. IEE Proceedings-*, vol. 146, no. 6, pp. 563–567, 1999.
- [95] A. Berman and N. Markushevich, “Analysis of Three-Phase Parallel Distribution Feeders Fed from Different Substations,” in *Transmission and Distribution Conference and Exposition, 2010 IEEE PES*, 2010, pp. 1–8.
- [96] T. Janssen, “Cost Control to the Access Fee to the Transmission Grid for the Distribution Network Operator,” Kungliga Tekniska Högskolan (KTH), 2010.
- [97] A. Y. Abdelaziz, R. A. Osama, and S. M. El-Khodary, “Reconfiguration of distribution systems for loss reduction using the hyper-cube ant colony optimisation algorithm,” *Gener. Transm. Distrib. IET*, vol. 6, no. 2, pp. 176–187, 2012.
- [98] Q. Zhou, D. Shirmohammadi, and W.-H. E. Liu, “Distribution Feeder Reconfiguration for Operation Cost Reduction,” *Power Syst. IEEE Trans.*, vol. 12, no. 2, pp. 730–735, 1997.
- [99] V. Spitsa, X. Ran, R. Salcedo, J. F. Martinez, R. E. Uosef, F. de Leon, D. Czarkowski, and Z. Zabar, “On the Transient Behavior of Large-Scale Distribution Networks During Automatic Feeder Reconfiguration,” *Smart Grid, IEEE Trans.*, vol. 3, no. 2, pp. 887–896, 2012.
- [100] M. Meisinger, “private communication.” Swansea, 2013.
- [101] A. Rodriguez-Calvo, P. Frias, J. Reneses, and C. Mateo, “Optimal Degree of Smart Transformer Substations in Distribution Networks for Reliability Improvement,” in *Innovative Smart Grid Technologies (ISGT Europe), 2012 3rd IEEE PES International Conference and Exhibition on*, 2012, pp. 1–7.
- [102] D. Elizalde, D. Staszkesky, and M. Meisinger, “Use of Distributed Intelligence for Reliability Improvement Using Minimum Available Distribution Assets,” in *Transmission & Distribution Conference and Exposition: Latin America, 2006. TDC '06. IEEE/PES*, 2006, pp. 1–6.
- [103] A. González, “private communication.” Madrid, 2013.
- [104] R. J. W. De Groot, J. Morren, and J. G. Slootweg, “Investigation of Simultaneity in Distribution Networks for the Assessment of DA Feasibility,” in *Universities Power Engineering Conference (UPEC), 2012 47th International*, 2012, pp. 1–6.
- [105] L. B. Viena, F. A. Moreira, N. R. Ferreira, A. C. De Castro, and N. C. De Jesus, “Analysis and Application of Transformer Models in the ATP Program for the Study of

- Ferroresonance,” in *Transmission and Distribution Conference and Exposition: Latin America (T&D-LA), 2010 IEEE/PES*, 2010, pp. 738–744.
- [106] J. Furgal, M. Florkowski, M. Fulczyk, P. Kys, M. Ostrogorska, and W. Piasecki, “Influence of Serial Choke on Damping of Switching Transients in Distribution Transformers,” in *High Voltage Engineering and Application (ICHVE), 2010 International Conference on*, 2010, pp. 592–595.
- [107] F. Provoost and P. van Oirsouw, “Software Tools to Facilitate Advanced Network Operation,” in *Future Power Systems, 2005 International Conference on*, 2005, p. 6 pp.–6.
- [108] M. Aro and J. Elovaara, *Suurjännitetekniikka*. Espoo: Otatieta, 2003.
- [109] R. Zhang, T. Byrne, D. Jones, and Z. Wang, “A Technical experience during network asset replacement: Investigating cable and transformer switching interactions,” in *CIGRE Workshop*, 2010.
- [110] R. de Graaff, J. Duarte, W. Kling, and P. Vaessen, “Intelligent Nodes in distribution systems - Transition from radial to meshed operation,” in *Electricity Distribution - Part 1, 2009. CIGRE 2009. 20th International Conference and Exhibition on*, 2009, pp. 1–4.
- [111] E. Romero Ramos and J. M. Maza Ortega, “private communication.” Seville, 2013.
- [112] R. De Graaff, J. Myrzik, W. Kling, and J. Enslin, “Intelligent nodes in distribution systems - Operating concept,” in *CIGRE 2007*, 2007.
- [113] R. A. A. De Graaff, J. M. A. Myrzik, W. L. Kling, and J. H. R. Enslin, “Intelligent Nodes in Distribution Systems - Optimizing Steady State Settings,” in *Power Tech, 2007 IEEE Lausanne*, 2007, pp. 391–395.
- [114] E. Romero-Ramos, A. Gomez-Exposito, A. Marano-Marcolini, J. M. Maza-Ortega, and J. L. Martinez-Ramos, “Assessing the loadability of active distribution networks in the presence of DC controllable links,” *Generation, Transmission & Distribution, IET*, vol. 5, no. 11. pp. 1105–1113, 2011.
- [115] A. Gomez-Exposito, “Enlaces inteligentes para redes de distribución en media tensión.” Catedra Endesa, Seville, 2011.
- [116] A. Marano-Marcolini, E. Romero-Ramos, A. Gomez-Exposito, J. M. Maza-Ortega, and J. L. Martinez-Ramos, “Enhancing the integration of renewable sources in distribution systems using DC-links,” in *Sustainable Alternative Energy (SAE), 2009 IEEE PES/IAS Conference on*, 2009, pp. 1–5.
- [117] J. M. Bloemink and T. C. Green, “Increasing Distributed Generation Penetration using Soft Normally-Open Points,” in *Power and Energy Society General Meeting, 2010 IEEE*, 2010, pp. 1–8.
- [118] J. M. Bloemink and T. C. Green, “Increasing Photovoltaic Penetration with Local Energy Storage and Soft Normally-Open Points,” in *Power and Energy Society General Meeting, 2011 IEEE*, 2011, pp. 1–8.
- [119] B. O. Brewin, S. C. E. Jupe, M. G. Bartlett, K. T. Jackson, and C. Hanmer, “New Technologies for Low Voltage Distribution Networks,” in *Innovative Smart Grid Technologies (ISGT Europe), 2011 2nd IEEE PES International Conference and*

Exhibition on, 2011, pp. 1–8.

- [120] M. Barragan, J. M. Mauricio, A. Marano, M. Nieves, J. Churio, J. M. Maza-Ortega, E. Romero, and A. Gomez, “Operational benefits of multiterminal DC-links in active distribution networks,” in *Power and Energy Society General Meeting, 2012 IEEE*, 2012, pp. 1–6.
- [121] R. De Groot, “private communication.” Eindhoven, 2013.
- [122] R. De Graaff, “private communication.” Arnhem, 2013.
- [123] UK Power Networks, “Flexible Urban Networks Low Voltage,” London, 2014.
- [124] J. Gooding, “Low Carbon Networks Fund Full Submission Pro-forma Project Section 1: Project Summary,” London, 2014.
- [125] A. Kramer and J. Ruff, “Transformers for phase angle regulation considering the selection of on-load tap-changers,” *Power Delivery, IEEE Transactions on*, vol. 13, no. 2, pp. 518–525, 1998.
- [126] D. Monroy-Berjillos, A. Gomez-Exposito, and A. Bachiller-Soler, “A Lab Setup Illustrating Thyristor-Assisted Under-Load Tap Changers,” *Power Syst. IEEE Trans.*, vol. 25, no. 3, pp. 1203–1210, 2010.
- [127] C. Korner, M. Hennig, K. Handt, and R. Schmid, “Gaining experience with a regulated distribution transformer in a smart grid environment,” in *Integration of Renewables into the Distribution Grid, CIRED 2012 Workshop*, 2012, pp. 1–4.
- [128] G. Hipszki, R. Schmid, R. Maier, K. Handt, and G. Buchgraber, “Distribution transformers - Ready for the smart grid,” in *CIRED 2011*, 2011.
- [129] E. Martinez, I. Fernandez, and J. M. Canales, “Thyristor based solid state tap changer for distribution transformers,” in *Electronics, Control, Measurement, Signals and their application to Mechatronics (ECMSM), 2013 IEEE 11th International Workshop of*, 2013, pp. 1–5.
- [130] A. Procopiou, C. Long, and L. Ochoa, “Voltage Control in LV Networks: An Initial Investigation,” in *IEEE PES Innovative Smart Grid Technologies Conference Europe*, 2014.
- [131] A. Navarro-Espinosa and L. Ochoa, “Increasing the PV Hosting Capacity of LV Networks: OLTC-Fitted Transformers vs. Reinforcements,” in *IEEE/PES Innovative Smart Grid Technologies ISGT 2015*, 2015.
- [132] P. Kadurek, J. F. G. Cobben, and W. Kling, “Smart MV/LV Transformer for Future Grids,” in *International Symposium on Power Electronics, Electrical Drives, Automation and Motion*, 2010.
- [133] P. Kang and D. Birtwhistle, “Condition monitoring of power transformer on-load tap-changers. II. Detection of ageing from vibration signatures,” *Gener. Transm. Distrib. IEE Proceedings-*, vol. 148, no. 4, pp. 307–311, 2001.
- [134] R. Shuttleworth, X. Tian, C. Fan, and A. Power, “New tap changing scheme,” *Electr. Power Appl. IEE Proc. -*, vol. 143, no. 1, pp. 108–112, 1996.
- [135] D. Monroy, A. Gomez-Exposito, and E. Romero-Ramos, “Improving the Voltage

- Regulation of Secondary Feeders by Applying Solid-State Tap Changers to MV/LV Transformers,” in *Electrical Power Quality and Utilisation, 2007. EPQU 2007. 9th International Conference on*, 2007, pp. 1–6.
- [136] P. Hauffe, C. Wendel, M. Arnold, and W. Wellssow, “Techno-Economic Assessment of Planning Principles for Low Voltage Grids in the Presence of Massive Distributed PV Generation,” in *CIREN 2015*, 2015.
- [137] J. H. Harlow, H. Jiang, R. Shuttleworth, B. A. T. Al Zahawi, X. Tian, and A. Power, “Discussion of ‘Fast response GTO assisted novel tap changer’ and closure,” *Power Deliv. IEEE Trans.*, vol. 16, no. 4, pp. 826–827, 2001.
- [138] G. R. C. Mouli, P. Bauer, T. Wijekoon, A. Panosyan, and E. M. Barthlein, “Design of a Power-Electronic-Assisted OLTC for Grid Voltage Regulation,” *IEEE Trans. Power Deliv.*, vol. 30, no. 3, pp. 1086–1095, 2015.
- [139] G. H. Cooke and K. T. Williams, “New thyristor assisted diverter switch for on load transformer tap changers,” *Electr. Power Appl. IEE Proc. B*, vol. 139, no. 6, pp. 507–511, 1992.
- [140] D. J. Rogers, T. C. Green, and R. W. Silversides, “A Low-Wear Onload Tap Changer Diverter Switch for Frequent Voltage Control on Distribution Networks,” *IEEE Trans. Power Deliv.*, vol. 29, no. 2, pp. 860–869, 2014.
- [141] X. She, A. Q. Huang, and R. Burgos, “Review of Solid-State Transformer Technologies and Their Application in Power Distribution Systems,” *Emerg. Sel. Top. Power Electron. IEEE J.*, vol. 1, no. 3, pp. 186–198, 2013.
- [142] F. Q. Yousef-Zai and D. O’Kelly, “Solid-state on-load transformer tap changer,” in *Electric Power Applications, IEE Proceedings -*, 1996, vol. 143, no. 6, pp. 481–491.
- [143] J. Faiz and B. Siahkolah, “Implementation of a low-power electronic tap-changer in transformers,” *Electr. Power Appl. IET*, vol. 2, no. 6, pp. 362–373, 2008.
- [144] A. Gomez-Exposito and D. Monroy Berjillos, “Solid-State Tap Changers: New Configurations and Applications,” *Power Deliv. IEEE Trans.*, vol. 22, no. 4, pp. 2228–2235, 2007.
- [145] R. Kabiri, D. G. Holmes, B. P. McGrath, and L. G. Meegahapola, “LV Grid Voltage Regulation Using Transformer Electronic Tap Changing, With PV Inverter Reactive Power Injection,” *IEEE J. Emerg. Sel. Top. Power Electron.*, vol. 3, no. 4, pp. 1182–1192, 2015.
- [146] J. Faiz and B. Siahkolah, “Optimal configurations for taps of windings and power electronic switches in electronic tap-changers,” *Generation, Transmission and Distribution, IEE Proceedings-*, vol. 149, no. 5, pp. 517–524, 2002.
- [147] T. Larsson, R. Innanen, and G. Norstrom, “Static Electronic Tap-Changer for fast phase voltage control,” in *Electric Machines and Drives Conference Record, 1997. IEEE International*, 1997, pp. TC3/4.1–TC3/4.3.
- [148] R. Schwalbe, H. Brunner, M. Stifter, A. Abart, E. Traxler, M. Radauer, and W. Niederhuemer, “DG-Demonet Smart LV Grid - Increasing Hosting Capacity of LV Grids by Extended Planning and Voltage Control,” in *Smart Electric Distribution Systems and Technologies (EDST), 2015 International Symposium on*, 2015, pp. 63–

- [149] A. T. Procopiou, C. Long, and L. F. Ochoa, "On the Effects of Monitoring and Control Settings on Voltage Control in PV-Rich LV Networks," in *Power & Energy Society General Meeting, 2015 IEEE*, 2015, pp. 1–5.
- [150] L. F. M. Gevaert, T. L. Vandoorn, C. Deckmyn, J. Van de Vyver, and L. Vandevelde, "OLTC Selection and Switching Reduction in Multiple-Feeder LV Distribution Networks," in *2015 International Conference on Renewable Energy Research and Applications (ICRERA)*, 2015, pp. 562–566.
- [151] A. Einfalt, F. Zeilinger, R. Scwalbe, B. Bletterie, and S. Kadam, "Controlling Active Low Voltage Distribution Grids with Minimum Efforts on Costs and Engineering," in *Annual Conference of the IEEE Industrial Electronics Society*, 2013.
- [152] D. Geibel, T. Degner, A. Seibel, T. Bolo, C. Tschendel, M. Pfalzgraf, K. Boldt, P. Muller, F. Sutter, and T. Hug, "Active, intelligent low voltage networks - Concept, realisation and field test results," in *Electricity Distribution (CIRED 2013), 22nd International Conference and Exhibition on*, 2013, pp. 1–4.
- [153] C. Long, A. T. Procopiou, L. F. Ochoa, G. Bryson, and D. Randles, "Performance of OLTC-Based Control Strategies for LV Networks with Photovoltaics," in *Power & Energy Society General Meeting, 2015 IEEE*, 2015, pp. 1–5.
- [154] R. Scwalbe, A. Einfalt, M. Heidl, A. Abart, M. Radauer, and H. Brunner, "DG - DEMONET Smart LV Grid – Robust Control Architecture to Increase DG Hosting Capacity," in *CIRED 2015*, 2015.
- [155] K. N. Bangash, M. E. A. Farrag, and A. H. Osman, "Smart Control of On Load Tap Changer Deployed in Low Voltage Distribution Network," in *Electric Power and Energy Conversion Systems (EPECS), 2015 4th International Conference on*, 2015, pp. 1–6.
- [156] C. Long and L. F. Ochoa, "Voltage Control of PV-Rich LV Networks: OLTC-Fitted Transformer and Capacitor Banks," *IEEE Trans. Power Syst.*, vol. PP, no. 99, pp. 1–10, 2015.
- [157] P. Nuutinen, P. Peltoniemi, T. Kaipia, P. Salonen, and P. Silventoinen, "Commissioning Inspection of an LVDC Distribution Network," in *Nordic Conference on Electricity Distribution System Management and Development (NORDAC)2012*, 2012.
- [158] A. Agustoni, E. Borioli, M. Brenna, G. Simioli, E. Tironi, and G. Ubezio, "LV DC distribution network with distributed energy resources: Analysis of possible structures," in *Electricity Distribution, 2005. CIRED 2005. 18th International Conference and Exhibition on*, 2005, pp. 1–5.
- [159] J. Lassila, T. Kaipia, J. Haakana, J. Partanen, and K. Koivuranta, "Potential and strategic role of power electronics in electricity distribution systems," in *Electricity Distribution - Part 1, 2009. CIRED 2009. 20th International Conference and Exhibition on*, 2009, pp. 1–5.
- [160] J. Rekola, "Kolmitasoiset suuntaajat tasasähköjäljälussa," Tampere University of Technology, 2009.

- [161] T. Vornanen, "Tehoelektroniikkaa sisältävien sähkönjakeluverkkojen simulointi PSCAD-ympäristössä," Tampere University of Technology, 2009.
- [162] J. Partanen, J. Pyrhönen, P. Silventoinen, M. Niemelä, J. Lassila, T. Kaipia, P. Salonen, P. Peltoniemi, P. Nuutinen, A. Lana, J. Haakana, A. Pinomaa, H. Makkonen, V. Voutilainen, P. Paajanen, P. Järventausta, H. Tuusa, T. Suntio, K. Kannus, K. Lahti, A. Nikander, A. Mäkinen, J. Alahuhtala, T. Suntila, L. Nousiainen, J. Rekola, and T. Vornanen, "Tehoelektroniikka sähkönjakelussa - Pienjännitteinen tasasähkönjakelu," Lappeenranta, 2010.
- [163] J. Rekola, A. Virtanen, J. Jokipii, and H. Tuusa, "Comparison of Converter Losses in an LVDC Distribution," in *IECON 2012 - 38th Annual Conference on IEEE Industrial Electronics Society*, 2012, pp. 1240–1245.
- [164] A. Pinomaa, J. Ahola, and A. Kosonen, "PLC Concept for LVDC Distribution Systems," *Commun. Mag. IEEE*, vol. 49, no. 12, pp. 55–63, 2011.
- [165] L. Kumpulainen, H. Laaksonen, R. Komulainen, A. Martikainen, M. Lehtonen, P. Heine, A. Silvast, P. Imris, J. Partanen, J. Lassila, T. Kaipia, S. Viljanen, P. Järventausta, P. Verho, K. Kivikko, K. Kauhaniemi, H. Lagland, and H. Saaristo, "Verkkovisio 2030 - Jakelu- ja alueverkkojen teknologiavisio," Espoo, 2006.
- [166] P. Salonen, "Tasasähkön hyödyntämismahdollisuudet sähkönjakelussa," Lappeenranta University of Technology, 2006.
- [167] R. Erickson and D. Maksimovic, *Fundamentals of Power Electronics*, 2nd ed. 2001.
- [168] A. Lana, A. Mattsson, P. Nuutinen, P. Peltoniemi, T. Kaipia, A. Kosonen, L. Aarniovuori, and J. Partanen, "On Low-Voltage DC Network Customer-End Inverter Energy Efficiency," *Smart Grid, IEEE Trans.*, vol. 5, no. 6, pp. 2709–2717, 2014.
- [169] J. Rekola, J. Jokipii, and T. Suntio, "Effect of Network Configuration and Load Profile on Efficiency of LVDC Distribution Network," in *Power Electronics and Applications (EPE'14-ECCE Europe), 2014 16th European Conference on*, 2014, pp. 1–10.
- [170] A. Mattsson, P. Nuutinen, T. Kaipia, P. Peltoniemi, P. Silventoinen, and J. Partanen, "Implementation of a Modular Customer-End Inverter for a Low Voltage DC Distribution Network," in *Power Electronics and Applications (EPE'14-ECCE Europe), 2014 16th European Conference on*, 2014, pp. 1–10.
- [171] J. Rekola and H. Tuusa, "Efficiency of Converters and Amorphous Core AC-filters in an LVDC Distribution," *Appl. Power Electron. Conf. Expo. (APEC), 2014 Twenty-Ninth Annu. IEEE*, pp. 1827–1834, 2014.
- [172] A. Lana, P. Nuutinen, T. Kaipia, A. Mattsson, J. Karppanen, P. Peltoniemi, and J. Partanen, "Prospects of Development of LVDC Electricity Distribution System Energy Efficiency," in *CIREN 2015*, 2015.
- [173] P. Salonen, A. Lana, T. Kaipia, P. Nuutinen, and J. Partanen, "Electrical safety in LVDC distribution system," in *CIREN 2011*, 2011.
- [174] N. Löf, "Pienjänniteverkon automaattoratkaisuiden kehitysnäkymät," Tampere University of Technology, 2009.
- [175] "IEEE Recommended Practice for Electrical Safety in Industrial and Commercial

- Power Systems,” *IEEE Std 3007.3-2012*, pp. 1–82, 2012.
- [176] P. Salonen, T. Kaipia, P. Nuutinen, P. Peltoniemi, and J. Partanen, “A Study of LVDC Distribution System Grounding,” in *Nordic Conference on Electricity Distribution System Management and Development (NORDAC) 2008*, 2008.
- [177] M. Brenna, F. Iannone, and D. Zaninelli, “Electrical Safety Analysis in Low Voltage Systems with Electronic Power Converters,” in *Power Engineering Society General Meeting, 2005. IEEE*, 2005, pp. 2462–2468 Vol. 3.
- [178] P. Salonen, P. Nuutinen, P. Peltoniemi, and J. Partanen, “LVDC Distribution System Protection - Solutions, Implementation and Measurements,” in *Power Electronics and Applications, 2009. EPE '09. 13th European Conference on*, 2009, pp. 1–10.
- [179] J. Karppanen, T. Kaipia, A. Lana, P. Peltoniemi, P. Nuutinen, A. Pinomaa, A. Mattsson, and J. Partanen, “Considerations on impacts of DER interconnection on LVDC distribution system engineering,” in *CIGRE Workshop 2014*, 2014.
- [180] A. A. S. Emhemed and G. M. Burt, “An Advanced Protection Scheme for Enabling an LVDC Last Mile Distribution Network,” *Smart Grid, IEEE Trans.*, vol. 5, no. 5, pp. 2602–2609, 2014.
- [181] P. Nuutinen, A. Pinomaa, J.-P. Strom, T. Kaipia, and P. Silventoinen, “On Common-Mode and RF EMI in a Low-Voltage DC Distribution Network,” *Smart Grid, IEEE Trans.*, vol. PP, no. 99, p. 1, 2014.
- [182] M. Brenna, G. C. Lazaroiu, and E. Tironi, “High Power Quality and DG Integrated Low Voltage DC Distribution System,” in *Power Engineering Society General Meeting, 2006. IEEE*, 2006, p. 6 pp.
- [183] P. Järventausta, P. Verho, J. Partanen, and D. Kronman, “Finnish smart grids - A migration from version one to the next generation,” in *CIGRE 2011*, 2011.
- [184] T. Kaipia, “private communication.” Lappeenranta, 2013.
- [185] P. Waeckerlé, “Potential of using Low Voltage Direct Current in local distribution network to improve the overall efficiency,” The Royal Institute of Technology (KTH), 2011.
- [186] “Technology report - Electricity infrastructure,” 2009.
- [187] V. Voutilainen, “Tasasähköjakelelu käyttöpotentiaalin määrittäminen,” Lappeenranta University of Technology, 2007.
- [188] P. Nuutinen, T. Kaipia, P. Peltoniemi, A. Lana, A. Pinomaa, A. Mattsson, P. Silventoinen, J. Partanen, J. Lohjala, and M. Matikainen, “Research Site for Low-Voltage Direct Current Distribution in a Utility Network - Structure, Functions, and Operation,” *Smart Grid, IEEE Transactions on*, vol. PP, no. 99, p. 1, 2014.
- [189] J. Lassila, “Strategic Development of Electricity Distribution Networks – Concepts and Methods,” Lappeenranta University of Technology, 2009.
- [190] T. Hakala, T. Lahdeaho, and P. Jarventausta, “Low Voltage DC Distribution - Utilization Potential in a Large Distribution Network Company,” *Power Deliv. IEEE Trans.*, vol. PP, no. 99, p. 1, 2015.

- [191] T. Kaipia, P. Peltoniemi, J. Lassila, P. Salonen, and J. Partanen, "Impact of low voltage DC system on reliability of electricity distribution," in *Electricity Distribution - Part 1, 2009. CIRED 2009. 20th International Conference and Exhibition on*, 2009, pp. 1–4.
- [192] T. Kaipia, J. Karppanen, A. Mattsson, A. Lana, P. Nuutinen, P. Peltoniemi, P. Salonen, J. Partanen, J. Lohjala, W. Chae, and K. Juyong, "A system engineering approach to low voltage DC distribution," in *CIRED 2013*, 2013.
- [193] P. Salonen, T. Kaipia, P. Nuutinen, P. Peltoniemi, and J. Partanen, "An LVDC Distribution System Concept," in *Nordic Workshop on Power and Industrial Electronics (NORPIE) 2008*, 2008.
- [194] P. Nuutinen, T. Kaipia, P. Peltoniemi, A. Lana, A. Pinomaa, P. Salonen, J. Partanen, J. Lohjala, and M. Matikainen, "Experiences from use of an LVDC system in public electricity distribution," in *CIRED 2013*, 2013.
- [195] T. Hakala, P. Järventausta, and T. Lähdeaho, "The utilization potential of LVDC distribution," in *CIRED 2013*, 2013.
- [196] T. Kylkisalo and R. Alanen, "Tasajännite taajaman sähköjaketussa ja mikroverkoissa," Espoo, 2007.
- [197] D. Salomonsson, "Modeling, Control and Protection of Low-Voltage DC Microgrids," Royal Institute of Technology (KTH), 2008.
- [198] J. Han, Y.-S. Oh, G.-H. Gwon, D.-U. Kim, C.-H. Kim, and K.-W. Park, "A Study on the Fault Characteristics of Line Fault in LVDC Distribution System," in *Developments in Power System Protection (DPSP 2014), 12th IET International Conference on*, 2014, pp. 1–5.
- [199] "Analysis of options to move beyond 20 % greenhouse gas emission reductions and assessing the risk of carbon leakage," Brussels, 2010.
- [200] T. Dragicevic, J. C. Vasquez, J. M. Guerrero, and D. Skrlec, "Advanced LVDC Electrical Power Architectures and Microgrids: A step toward a new generation of power distribution networks.," *Electrif. Mag. IEEE*, vol. 2, no. 1, pp. 54–65, 2014.
- [201] P. Nuutinen, A. Lana, T. Kaipia, A. Mattsson, A. Pinomaa, P. Peltoniemi, J. Karppanen, J. Partanen, P. Silventoinen, and M. Matikainen, "Implementing a Battery Energy Storage System with a Converterless Direct Connection to an LVDC Distribution Network," in *CIRED 2015*, 2015.
- [202] H. Kakigano, Y. Miura, and T. Ise, "Low-Voltage Bipolar-Type DC Microgrid for Super High Quality Distribution," *Power Electron. IEEE Trans.*, vol. 25, no. 12, pp. 3066–3075, 2010.
- [203] P. Papadopoulos, S. Skarvelis-Kazakos, I. Grau, L. M. Cipcigan, and N. Jenkins, "Electric vehicles' impact on british distribution networks," *Electr. Syst. Transp. IET*, vol. 2, no. 3, pp. 91–102, 2012.
- [204] O. Gulich, "Smart Grids and Energy Markets R&D Program - Annual public report," Helsinki, 2013.
- [205] A. Pinomaa, J. Ahola, A. Kosonen, and P. Nuutinen, "Power Line Communication Network for a Customer-End AC Grid in an LVDC Distribution System," in *Smart*

- Grid Communications (SmartGridComm), 2014 IEEE International Conference on*, 2014, pp. 224–229.
- [206] S. Ruj and A. Nayak, “A Decentralized Security Framework for Data Aggregation and Access Control in Smart Grids,” *Smart Grid, IEEE Trans.*, vol. 4, no. 1, pp. 196–205, 2013.
- [207] A. A. Aquino-Lugo and T. Overbye, “Agent Technologies for Control Applications in the Power Grid,” in *System Sciences (HICSS), 2010 43rd Hawaii International Conference on*, 2010, pp. 1–10.
- [208] C.-H. Lo and N. Ansari, “Decentralized Controls and Communications for Autonomous Distribution Networks in Smart Grid,” *Smart Grid, IEEE Transactions on*, vol. 4, no. 1, pp. 66–77, 2013.
- [209] A. Kahrobaeian and Y. A.-R. I. Mohamed, “Interactive Distributed Generation Interface for Flexible Micro-Grid Operation in Smart Distribution Systems,” *Sustain. Energy, IEEE Trans.*, vol. 3, no. 2, pp. 295–305, 2012.
- [210] A. Narayanan, P. Peltoniemi, T. Kaipia, and J. Partanen, “Energy Management System for LVDC Island Networks,” in *Power Electronics and Applications (EPE'14-ECCE Europe), 2014 16th European Conference on*, 2014, pp. 1–10.
- [211] P. Paajanen, T. Kaipia, and J. Partanen, “DC supply of low-voltage electricity appliances in residential buildings,” in *Electricity Distribution - Part 1, 2009. CIREN 2009. 20th International Conference and Exhibition on*, 2009, pp. 1–4.
- [212] T. Kaipia, P. Peltoniemi, A. Lana, A. Mattsson, J. Partanen, J. Rekola, and H. Tuusa, “Development of LVDC Technology,” in *SGEM Unconference 2013*, 2013.
- [213] T. Hakala, T. Lähdeaho, and R. Komsu, “LVDC Pilot Implementation in Public Distribution Network,” in *CIREN 2015*, 2015.
- [214] V. Naakka, “Reliability and Economy Analysis of the LVDC Distribution System,” Tampere University of Technology, 2011.
- [215] A. Lana, “Future grid infrastructure - Field tests of LVDC distribution,” in *CLEEN Summit 2013*, 2013.
- [216] J. Rekola, “DC distribution and power electronics applications in smart grids,” 2012.
- [217] A. Khramov, “Converter supply transformer for LVDC distribution system,” Lappeenranta University of Technology, 2009.
- [218] T. Kaipia, “Power electronics in electricity distribution and LVDC – Proof of concepts,” in *CLEEN Summit 2011*, 2011.
- [219] P. Nuutinen, T. Kaipia, J. Partanen, P. Peltoniemi, P. Salonen, L. Andrey, J. Lohjala, M. Matikainen, A. Nieminen, and M. Karhinen, “Field Test Platform for LVDC Distribution,” in *Nordic Conference on Electricity Distribution System Management and Development (NORDAC) 2012*, 2012.
- [220] P. Nuutinen, A. Lana, A. Pinomaa, P. Peltoniemi, T. Kaipia, A. Mattsson, J. Partanen, J. Lohjala, M. Matikainen, A. Nieminen, T. Lähdeaho, and R. Komsu, “LVDC Research Platforms and Field Tests,” in *SGEM Unconference 2013*, 2013.

- [221] T. Hakala, "The utilization potential of LVDC distribution in the LNI distribution network," Tampere University of Technology, 2012.
- [222] S. Antila, J. Kuru, and V. Maksimainen, "Integration of AMM functionality into operating systems of electricity distribution company for LV network fault management," in *CIREC 2011*, 2011.
- [223] A. Mäkinen, M. Pikkarainen, P. Pakonen, P. Järventausta, M. Kauppinen, M. Sohlman, H. Valkonen, and J. Aalto, "Neutral Fault Management in LV Network Operation Supported by AMR System," in *CIREC 2013*, 2013.
- [224] N. Löf, M. Pikkarainen, S. Repo, and P. Järventausta, "Utilizing Smart Meters in LV Network Management," in *CIREC 2011*, 2011.
- [225] M. Nijhuis, M. Gibescu, and S. Cobbe, "Clustering of Low Voltage Feeders from a Network Planning Perspective," in *CIREC 2015*, 2015.
- [226] A. Navarro-Espinosa, T. Gozel, L. Ochoa, R. Shaw, and D. Randles, "Data Analysis of LV Networks: Key Parameters from One Year of Monitoring Over Hundreds of UK LV Feeders," in *CIREC 2015*, 2015.
- [227] E. C. W. de Jong and P. T. M. Vaessen, "European experiences with an intelligent substation intended for smart distribution networks," in *Power Engineering Society Conference and Exposition in Africa (PowerAfrica), 2012 IEEE*, 2012, pp. 1–5.
- [228] P. Vinter, "DONG Energy - Towards the intelligent utility network," in *CIREC Seminar 2008: SmartGrids for Distribution*, 2008.
- [229] A. Madureira, J. Pecos Lopes, A. Carrapatoso, and N. Silva, "The new role of substations in distribution network management," in *CIREC 2009*, 2009.
- [230] J. Heckel, "Smart substation and feeder automation for a smart distribution grid," in *CIREC 2009*, 2009.
- [231] L. Kumpulainen, S. Pettissalo, P. Trygg, K. Malmberg, M. Loukkalahti, and M. Hyvarinen, "Improved Monitoring and Control of Distribution Network by Smart MV/LV Substations," in *Innovative Smart Grid Technologies (ISGT Europe), 2011 2nd IEEE PES International Conference and Exhibition on*, 2011, pp. 1–6.
- [232] P. Pipet, P. Deschamp, and J. Wild, "LV Monitoring in the Transformer Substation, New Technology Rises to the Challenge," in *PowerTech (POWERTECH), 2013 IEEE Grenoble*, 2013, pp. 1–6.
- [233] G. A. Taylor, M. R. Irving, N. Nusrat, R. Liao, and S. Panchadcharam, "Smart distribution network operation: Emerging techniques and standards," in *Power and Energy Society General Meeting, 2011 IEEE*, 2011, pp. 1–6.
- [234] A. Ylä-Outinen, "Techno-economic Feasibility of Novel On-Line Condition Monitoring Methods in Low Voltage Distribution Networks," Lappeenranta University of Technology, 2012.
- [235] G. Strbac, N. Jenkins, T. Green, and D. Pudjianto, "Review of Innovative Network Concepts," 2006.
- [236] B. Puluhen, E. Dorison, V. Murin, and R. Tambrun, "Health index: A technical indicator of underground network reliability," in *CIREC 2011*, 2011.

- [237] R. Wakelen, "Improvements in the management of asset health," in *Asset Management Conference 2012, IET & IAM*, 2012, pp. 1–6.
- [238] A. O. Eggen and B. I. Langdal, "Large-Scale Utility Asset Management," in *Electricity Distribution, 2005. CIRED 2005. 18th International Conference and Exhibition on*, 2005, pp. 1–4.
- [239] J. Cheema, A. Clark, J. Kilimnik, C. Pavlovski, D. Redman, and M. Vu, "Intelligent Rating Systems for the Smart Grid," in *WCECS 2010*, 2010.
- [240] J. Cheema, A. Clark, J. Kilimnik, C. Pavlovski, D. Redman, and M. Vu, "Towards Smart Grid Dynamic Ratings," in *American Institute of Physics Conference 2010*, 2010.
- [241] F. Cardoso, M. Cordeiro, N. Rocha, L. Oliveira, and S. Faria, "Using Wireless Sensors in the Remote Condition Monitoring of Secondary Distribution Substations," in *CIRED Workshop 2014*, 2014.
- [242] FICO, "MIP Formulations and Linearizations," 2014.
- [243] M. Nijhuis, B. Vonk, M. Gibescu, S. Cobbe, and J. Sloopweg, "Assessment of Probabilistic Methods for Simulating Household Load Patterns in Distribution Grids," in *CIRED 2015*, 2015.
- [244] Z. Brettschneider, R. Hanus, and Z. Muller, "A Probabilistic Approach to Power Flow Analysis," in *CIRED 2015*, 2015.
- [245] A. Ballanti, F. Pilo, A. Navarro-Espinosa, and L. Ochoa, "Assessing the Benefits of PV Var Absorption on the Hosting Capacity of LV Feeders," in *IEEE PES Innovative Smart Grid Technologies Conference Europe*, 2013.
- [246] DIgSILENT GmbH, "Technical Reference Documentation - Static Generator," Gomaringen, 2014.

Annex : Résumé de thèse en français

Aspects industriels de la gestion de tension et la capacité d'accueil de la génération photovoltaïque dans les réseaux basse tension

Dans cette thèse, les mesures de tension fournies par l'infrastructure de comptage avancé (Advanced Metering Infrastructure, AMI) sont utilisées pour contrôler un régulateur en charge situé au poste de transformation HTA/BT. La thèse présente une méthode simple permettant de sélectionner les clients basse tension pour lesquels les mesures de tension sont utilisées pour contrôler un régulateur en charge. La méthodologie tient compte de la charge et de la topologie du réseau. En outre, une méthode simple pour créer des courbes réalistes et statistiquement correctes pour les études de réseaux est présentée. Les méthodes créées ont été testées en utilisant des données réelles de réseaux basse tension sur un logiciel très utilisé dans le secteur de la distribution d'électricité et ont conduit à des résultats encourageants; quelques clients par réseau basse tension doivent être surveillés afin d'estimer avec une grande précision où se situent les extrêmes de tension sur le réseau.

Cette méthodologie est également utilisée pour estimer la capacité d'accueil de génération d'énergie photovoltaïque dans les réseaux basse tension.

Dans la première partie, l'évolution de la capacité d'accueil a été estimée, en utilisant trois types de contrôle de tension différents; un régulateur en charge de cinq et neuf prises et le contrôle de la tension, via les générateurs photovoltaïques, sont étudiés. L'étude considère deux cas différents pour le placement et le dimensionnement des générateurs photovoltaïques dans un réseau basse tension. Les résultats sur 38 réseaux basse tension sont fournis.

Dans la deuxième partie, les capacités d'accueil de 631 réseaux basse tension, situés dans une région métropolitaine française, sont analysés en utilisant un régulateur en charge de cinq et neuf prises.

Le travail a été réalisé en collaboration avec Électricité Réseau Distribution France (ERDF), le principal opérateur du réseau de distribution français. Toutes les études présentées dans la thèse reposent sur des données réelles en fonctionnement normal. En outre, toutes les études sont mises en œuvre sur un logiciel largement utilisé dans l'industrie de la distribution d'énergie.

En introduction, la thèse fournit une vue générale sur le système électrique français. De plus, la thèse présente un certain nombre de technologies sélectionnées qui semblent prometteuses pour le futur des réseaux basse tension.

Placement optimal des capteurs de tension dans les réseaux basse tension pour l'utilisation d'un régulateur en charge automatisé

Cette section étudie la problématique de la mesure de la tension dans un réseau basse tension, afin de contrôler un régulateur en charge dans un poste de transformation. L'infrastructure de mesure moderne offre un support de communication entre un client et un centre système de distribution de commande de l'opérateur. Pour ça il est naturel de considérer l'utilisation de l'infrastructure avancée de comptage (AMI) et / ou des capteurs de tension dédiés pour mesurer le maximum et le minimum de tension dans le réseau. L'objectif de cette section est de trouver le nombre optimal de capteurs de tension qui sont en mesure de fournir suffisamment d'informations pour l'application du régulateur en charge. Les capteurs de tension

ou de mesures peuvent être soit des compteurs d'électricité intelligents, soit des capteurs supplémentaires installés pour mesurer la tension. Pour des raisons économiques, il n'y a pas d'intérêt à installer un trop grand nombre de capteurs dans les réseaux. Un très grand nombre de capteurs serait également un lourd fardeau pour la transmission et le traitement des données. D'autre part, les chutes ou les pics de tension les plus significatifs peuvent passer inaperçus si le nombre de capteurs placés est trop faible. Le nombre optimal de capteurs se situe entre ces deux extrêmes.

L'une des principales contraintes dans la conception des réseaux de basse tension est leur grand nombre. Ainsi il est nécessaire que le processus de planification soit aussi rapide et aussi simple que possible. Cet aspect a été pris en compte dans les études en automatisant les simulations dans la mesure du possible. L'un des objectifs indirects de l'étude est de développer un outil qui pourrait être utilisé par ERDF dans la planification des réseaux de basse tension. ERDF utilise PowerFactory comme outil standard pour l'analyse du système d'alimentation. C'est la raison pour laquelle l'analyse est effectuée, dans la mesure du possible, en utilisant PowerFactory. De cette manière, les programmes ont été écrits dans une optique d'intégration maximale dans le processus de planification d'ERDF.

L'étude valide le fait que les niveaux d'erreur sont faibles lorsque les valeurs maximales et minimales de la tension sont estimées sur la base des emplacements prédéfinis de mesures de tension. Bien entendu, cette conclusion repose sur l'hypothèse selon laquelle les courbes de charge utilisées représentent la réalité avec une précision suffisante. D'après cette étude, l'emplacement optimal des capteurs de tension dans un réseau basse tension peut être estimé correctement en utilisant des profils de charge moyens. La présence de panneaux photovoltaïques augmente les erreurs dans l'estimation des extrema de tension. Cependant, ces erreurs restent à des niveaux faibles, pour un faible taux de pénétration de production photovoltaïque.

Les estimations de tension sont plus précises lors de l'estimation de la tension maximale que lors de celle de la tension minimale. Cela s'explique par le fait que les valeurs de tension minimale ont plus de variabilité que les maximales, principalement car les pics de consommation au cours de l'hiver ont des amplitudes plus importantes que les pics de production en été, ce qui entraîne des erreurs d'estimation qui sont trois à quatre fois plus élevées en hiver. Si les réseaux avaient un taux de pénétration élevé de production photovoltaïque, l'estimation de la tension maximale aurait plus de variabilité et il y aurait donc plus d'erreur dans l'estimation de la tension maximale. La méthode est relativement robuste vis-à-vis de l'incertitude sur le profil réel de charge d'un client.

Selon l'analyse d'erreur, le procédé de mise en place du capteur est simple et robuste. Il est implémenté dans le logiciel DIGSILENT PowerFactory. Cela signifie que les scripts peuvent être utilisés tels quel par des chargés de planification.

Avant d'appliquer les mesures de tension tel que suggéré par la méthodologie, les simulations doivent être exécutés sur un échantillon de réseaux plus important, incluant notamment des réseaux ruraux, afin de confirmer les résultats obtenus sur l'échantillon plus faible utilisé dans cette étude.

L'impact des technologies de contrôle de tension sur la capacité d'accueil de génération photovoltaïque dans les réseaux basse tension

Dans cette partie, on étudie l'impact de deux technologies de contrôle de tension différentes sur la capacité d'accueil de la production d'énergie photovoltaïque ; un régleur en charge placé dans le poste de transformation et un contrôle de la puissance réactive des générateurs photovoltaïques. Les travaux présentés dans ce chapitre utilisent la méthode présentée dans le chapitre précédent. Quand un régleur en charge est étudié, deux types de technologies sont considérées; une avec cinq positions de prise et une autre avec neuf positions de prise.

Une méthode simple et directe pour estimer la capacité d'accueil de la production d'électricité photovoltaïque est présentée. La procédure est programmée dans le logiciel PowerFactory et testée sur 38 réseaux basse tension. La méthode est utilisée pour trouver les limites de la quantité de la production d'électricité photovoltaïque qui peut être raccordée sur un seul réseau de basse tension sans violer les contraintes de tension. En outre, il permet de comparer les différents types de régulateurs en charge. Un indicateur qui permet de comparer les différentes tailles des réseaux est l'augmentation de la capacité d'accueil divisée par la charge maximale du réseau. Un régulateur en charge peut offrir une quantité importante de flexibilité dans un réseau basse tension. Cependant, la capacité d'accueil de la production d'électricité photovoltaïque n'est pas systématiquement augmentée sur l'ensemble des réseaux testés. De manière empirique, un régulateur en charge augmente la capacité d'accueil d'environ 1 kW par client dans les réseaux dimensionnés par les contraintes de tension.

La capacité d'accueil d'un réseau basse tension peut être estimée de différentes manières. Les résultats de deux approches sont présentés dans cette thèse, et donnent des résultats assez différents. Il est important de noter que lorsque les générateurs photovoltaïques sont connectés en triphasé, les capacités d'accueil sont plus élevées que lorsque l'on connecte des générateurs photovoltaïques en monophasé. En outre, les réseaux sont contraints par la tension, représentent une minorité de l'échantillon considéré. Dans une étude, les résultats indiquent qu'il n'y a pas d'avantages à utiliser un régulateur en charge avec neuf positions de prise plutôt que cinq. Cela souligne l'importance d'étudier l'utilité du type de régulateur en charge. Si un régulateur en charge de neuf positions est choisi à la place d'un régulateur en charge de cinq, les coûts du choix doivent être étudiés attentivement, car les avantages ne sont pas évidents dans tous les réseaux.

Les techniques Monte Carlo peuvent donner plus d'informations sur les réseaux lorsque plusieurs simulations sont effectuées. Cependant, les ressources de calcul sont extrêmement élevées. Ceci est utile uniquement si le réseau fait l'objet d'une analyse détaillée, ce qui n'est en général pas le cas dans une utilisation opérationnelle.

L'estimation de la capacité d'accueil sur un grand nombre de réseaux

Le but de cette partie est de montrer que la méthode de placement des capteurs de tension, et l'utilisation des mesures afin de contrôler un régulateur en charge, est pratique et peut être utilisée pour étudier un grand nombre de réseaux de manière automatisée. En outre, l'un des intérêts majeurs est de produire des données statistiques afin de tirer des conclusions générales. Ces données permettent de définir les indicateurs appropriés pour présenter les données essentielles sous une forme compacte. Parallèlement à ces objectifs, cette partie constitue un prolongement naturel des parties précédentes.

Les études sont réalisées à l'aide de 631 réseaux de tension réels faibles de la même région métropolitaine. Les 38 réseaux étudiés précédemment ne sont pas inclus dans les 631 réseaux mentionnés ci-dessus. Comme dans les chapitres précédents, la base de données comprend les données de réseau et de charge. Les simulations sont effectuées sur trois études de cas; pas de régulateur en charge, un régulateur en charge avec cinq positions de prise et un régulateur en charge avec neuf positions de prise. Les régulateurs en charge sont choisis pour être la seule méthode de contrôle de la tension, ce qui est le plus réaliste du point de vue de l'opérateur de réseau de distribution.

Le nombre requis de mesures de tension est faible, étant donné qu'il est de quatre en moyenne. La capacité d'accueil ne peut être augmentée que dans environ un tiers des réseaux. Lorsque seuls les réseaux qui offrent une perspective d'augmentation significative de la capacité d'accueil sont pris en compte, la proportion diminue encore sensiblement. Sachant que la majeure partie des réseaux n'offrent pas ou peu de perspectives d'augmentation de leur capacité d'accueil, grâce à l'utilisation d'un régulateur en charge, la question de l'installation d'un régulateur doit être étudiée avec soin.

La méthodologie de placer les mesures de tension dans un réseau basse tension afin de contrôler un régulateur en charge est simple et ne prend en compte que l'état actuel du réseau sans scénarios futurs. Cette méthode est utilisée dans l'estimation de la capacité d'accueil pour la production d'énergie photovoltaïque. Lorsque les capteurs de tension sont placés dans le réseau, toutes les informations des futurs emplacements des générateurs photovoltaïques ne sont pas disponibles. La mise en place des mesures de tension fonctionne bien parce que le nombre de réseaux contraint par la tension est réduit de manière significative, cependant, elle ne garantit pas des emplacements optimaux sous très haute pénétration de la production d'énergie photovoltaïque. En réalité, les réseaux basse tension évoluent avec le temps, ce qui signifie que les emplacements des mesures de tension doivent être mises à jour régulièrement.

Parmi les réseaux qui restent limités par les contraintes de tension, même après l'installation d'un régulateur en charge, on ne sait pas si le facteur limitant est l'amplitude du régulateur en charge ou si les mesures de tension ne sont pas suffisantes pour détecter les extrema. Ceci doit être pris en compte dans la poursuite du développement de la méthode d'estimation de la capacité d'accueil. Une raison importante est qu'il est préférable de ne pas utiliser un régulateur en charge si il n'est pas sûr que les capteurs de tension utilisés sont placés de manière adéquate.

Une autre conclusion importante est que, lorsque la capacité d'accueil d'un réseau basse tension est étudiée, la manière dont le régulateur en charge est contrôlé doit être prise en compte. Un contrôle parfait ne peut pas être tenu pour acquis. Par exemple, si on suppose que les tensions extrêmes du réseau sont toujours connues avec une précision parfaite lors du contrôle du régulateur en charge, ce qui est très optimiste, des valeurs irréalistes pour la capacité d'accueil sont obtenues. Par conséquent, ces capacités d'accueil ne peuvent être atteintes dans la pratique. Tout bien considéré, il est inutile d'estimer l'augmentation de la capacité d'accueil par un régulateur en charge si celle-ci ne peut pas être pleinement exploitée.

Les augmentations de la capacité d'accueil peuvent être qualifiées comme modérées de manière générale, ce qui conduit à la conclusion que généralement l'installation d'un régulateur en charge ne doit pas être motivée uniquement par le fait d'augmenter la capacité d'accueil. Même si le pourcentage des réseaux où la capacité d'accueil peut être augmentée de manière significative ne semble pas sensiblement élevé, il convient de garder à l'esprit que un pour cent des réseaux est égale à environ 7000 réseaux basse tension sur le territoire de ERDF.

En résumé, cette décision nécessiterait davantage de recherche du point de vue économique, ce qui est hors de la portée de cette thèse. Une remarque importante est qu'il n'y a pas ou peu de différence entre les performances du régleur en charge avec cinq et neuf positions de prise. Dans presque tous les réseaux, un régleur avec cinq positions de prise est suffisant pour supprimer les limitations de tension. Les deux indicateurs, la capacité d'accueil par la charge de pointe et la capacité installée par client hébergement, montrent des résultats presque identiques. Ces deux indicateurs sont importants. L'avantage le plus important de ces indicateurs est qu'ils permettent la comparaison des réseaux.