



HAL
open science

Autoimmune phenomena pathogenesis in chronic lymphocytic leukemia: the role of ZAP-70

Dana Ghergus

► **To cite this version:**

Dana Ghergus. Autoimmune phenomena pathogenesis in chronic lymphocytic leukemia: the role of ZAP-70. Immunology. Université de Strasbourg, 2015. English. NNT : 2015STRAJ034 . tel-01363969

HAL Id: tel-01363969

<https://theses.hal.science/tel-01363969v1>

Submitted on 12 Sep 2016

HAL is a multi-disciplinary open access archive for the deposit and dissemination of scientific research documents, whether they are published or not. The documents may come from teaching and research institutions in France or abroad, or from public or private research centers.

L'archive ouverte pluridisciplinaire **HAL**, est destinée au dépôt et à la diffusion de documents scientifiques de niveau recherche, publiés ou non, émanant des établissements d'enseignement et de recherche français ou étrangers, des laboratoires publics ou privés.

UNIVERSITE DE STRASBOURG
ÉCOLE DOCTORALE DES SCIENCES DE LA VIE ET DE LA SANTÉ (ED 414)
Unité de recherche CNRS UPR 3572

THÈSE présentée par :

Dana GHERGUS

soutenue le 10 Septembre 2015

pour obtenir le grade de: **Docteur de l'Université de Strasbourg**

Discipline: **Immunologie**

Mécanismes physiopathologiques des manifestations auto-immunes au cours de la leucémie lymphoïde chronique : rôle de ZAP-70

THÈSE dirigée par:

M. le Professeur Thierry MARTIN

CNRS UPR 3572, Institut de Biologie Moléculaire et Cellulaire, Faculté de Médecine, Université de Strasbourg

RAPPORTEURS :

M. le Professeur Luc MOUTHON

INSERM U1016, Institut Cochin, Faculté de Médecine, Université Paris-Descartes

M. le Professeur Bernard BONNOTTE

INSERM UMR 1098, Faculté de Médecine, Université de Bourgogne

EXAMINATEUR INTERNE :

M. le Professeur Raoul HERBRECHT

Service d'Hématologie et d'Oncologie, CHU Strasbourg, Faculté de Médecine, Université de Strasbourg

To my father

REMERCIEMENTS

A Monsieur le Professeur **Thierry MARTIN**. Je vous remercie de m'avoir donné la chance d'intégrer votre équipe et de m'avoir fait profiter d'un environnement scientifique exceptionnel. Je vous suis extrêmement reconnaissante du temps que vous m'avez accordé tout au long de ma thèse.

Aux Messieurs les Professeurs **Bernard BONNOTTE** et **Luc MOUTHON** pour m'avoir fait l'honneur d'évaluer ce travail.

A Monsieur le Professeur **Raoul HERBRECHT**. Je vous remercie pour avoir accepté d'évaluer ce travail et surtout pour votre grande disponibilité et pour le temps que vous m'avez accordé tout au long de cette collaboration.

Un grand Merci à Monsieur le Docteur **Bernard DRENOU** pour ses bons conseils techniques et dans la rédaction du manuscrit. Je vous remercie surtout pour vos qualités humaines exceptionnelles et vos encouragements. Merci pour « m'avoir aidé à m'échapper de la prison » et pour m'avoir initié dans le monde fascinant de l'hématologie.

Merci à Madame le Professeur **Sylviane MULLER** pour m'avoir accueilli dans son laboratoire.

Merci aux Professeurs **Jean-Louis PASQUALI**, **Pauline SOULAS-SPRAUEL** et **Anne-Sophie KORGANOW** pour l'encadrement dans la rigueur scientifique et vos bons conseils. Merci Pauline pour ton amitié et pour l'exemple que tu as été pour moi.

Merci à toute l'équipe de **l'UPR 9021 -> 3572** pour le climat sympathique dans lequel elle m'a permis de travailler.

Je remercie toutes les personnes formidables de notre petite **équipe de l'IPCB** qui m'ont aidé, soutenu et encouragé.

Merci tout particulièrement à **Anne-Marie** pour toute l'aide que tu as apporté à ce travail, pour ton expertise technique, tes conseils et ton expérience. Merci pour m'avoir montré toutes les petites astuces qui font réussir les expériences difficiles. J'espère qu'on va se revoir aux concerts quand je serai de passage à Strasbourg.

Merci **Anne** pour ta bonne humeur, ton amitié et ton soutien ! Et surtout pour tes super photos et ton english-touch !! Merci **Sylvia** pour ton amitié et pour avoir toujours su détendre l'atmosphère au labo. Merci **Aurélie** pour ta bonne humeur et ta disponibilité.

Merci à mes collègues qui m'ont aidé, supporté et qui se sont moqués des mes maladresses en français... Merci à **Julie** et à **Jean-Nicolas** qui m'ont guidé pendant mes premières années de thèse. **Sophie**, j'ai bien apprécié ton amitié et ton support pour le travail de weekend au labo. **Léa**, merci pour ta gentillesse et pour ton talent à organiser des fêtes. **Mickael**, bon courage pour la suite et ne stresse pas trop ! Merci aussi à **Delphine**, pour ton sourire toujours présent, à **Vincent**, pour tes blagues racistes (j'espère que tu trouveras bientôt une autre victime), à **Aurélien**, pour ton humour et tes chansons un peu de vieille mode... et merci aussi à **Sandra** et les autres étudiants qui ont travaillé dans notre labo.

Merci **Hélène** pour notre amitié, pour les encouragements et pour les films qu'on a vu ensemble ! **Pierre**, merci pour tes bons conseils scientifiques et artistiques, et pour les mille-feuilles !

Je tiens à remercier aussi à **Laurent VALLAT** pour les discussions et son expertise pendant les team-meetings. A **Isabelle MENDEL** et à **Arnaud DUPUIS** de l'EFS pour tester nos monoclonaux et pour leurs conseils.

Merci également à **Claudine** de l'IGBMC, toujours disponible pour les longs et minutieux tri en cellule unique.

Merci à **Eric MEFFRE** de l'Université de Yale pour nous avoir partagé leur savoir-faire dans la production des monoclonaux (merci à Jean-Nicolas et à Sophie pour l'intermédiaire).

Je remercie à toute l'équipe du **Service d'Hématologie de CHU de Strasbourg** qui m'a permis d'avoir une bonne série de patients. Merci aussi au **Professeur Laurent MAUVIEUX** et à ses collaborateurs du **Laboratoire d'hématologie de CHU de Strasbourg** pour les échantillons fournis et leur disponibilité.

Un très grand Merci à toute l'équipe du **Service d'Hématologie Clinique et du Laboratoire d'Hématologie de GHR de Mulhouse** pour votre chaleureux accueil et votre soutien. Merci aux Docteurs **EISENMANN**, **ARKAM** et **OJEDA** pour m'avoir fourni des patients et pour votre compréhension de mon travail à mi-temps dans le service. Merci à **Agathe**, **Inès**, **Loria** et **Valérie** ! J'apprécie beaucoup votre amitié, vos conseils, votre disponibilité. Merci à toutes l'équipe de soignants et techniciens des deux services pour votre gentillesse et vos encouragements.

Je tiens à remercier tous ceux qui m'ont formé des solides bases de pensée scientifique et médicale à l'Université de Médecine et Pharmacie « Gr. T. Popa » de Iasi, en Roumanie. Un grand Merci à Monsieur le Professeur **Eugen CARASEVICI** qui m'a initié dans le domaine de l'immunologie et au Professeur **Bogdan Dragos GRIGORIU** qui m'a encouragé à faire de la recherche.

Merci surtout à tous **les patients** qui ont été d'accord à participer cette étude et à la **Ligue contre le cancer** qui a financé une grande partie de ce travail.

A tous **mes amis** qui m'ont toujours soutenu et aidé. Merci surtout à **Raluca**, qui a connu tous les moments difficiles que j'ai vécu pendant cette période et qui a toujours su m'écouter et me conseiller et qui a eu la patience de corriger toutes les erreurs d'anglais du manuscrit.

Un grand merci à **mes parents** qui m'ont insufflé l'amour pour la médecine et la recherche, à ma sœur et à mon frère.

RÉSUMÉ

La leucémie lymphoïde chronique (LLC) est une lymphoprolifération maligne caractérisée par l'accumulation progressive de lymphocytes B matures. La LLC est particulièrement associée à une dérégulation du système immunitaire qui favorise le développement des fréquents phénomènes auto-immuns, ciblés contre les cellules sanguines, comme l'anémie hémolytique auto-immune et le purpura thrombopénique immunologique. L'expression aberrante de ZAP-70 dans la LLC est un important facteur pronostique, probablement due à son rôle dans l'augmentation de la signalisation par le BCR. Les mécanismes responsables de l'auto-immunité dans la LLC, manifestés par l'apparition des IgG polyclonaux pathogéniques sécrétés par les lymphocytes B non-malins, sont loin d'être connus.

Ici, nous décrivons pour la première fois une nouvelle population lymphocytaire B qui exprime ZAP-70. Les cellules B normales ZAP-70⁺ ne semble pas appartenir à une sous-population lymphocytaire B particulière, et elles n'ont pas un phénotype activé. L'expression de ZAP-70 dans les cellules B naïves suggère que ce phénomène est précoce dans le développement de cellules B, et qui probablement est antérieur à la transformation. En plus, nous avons trouvé une bonne corrélation pour le niveau d'expression de ZAP-70 entre les cellules B normales et les B de LLC.

En plus, nous avons trouvé un pourcentage élevé des cellules B normales ZAP-70⁺ dans tous les cas de cytopénie auto-immune associée à la LLC, dans notre série de patients. Les B ZAP-70⁺ pourraient être directement responsables des cytopénies auto-immunes ou elles pourraient entraîner une auto-réactivité en général. L'analyse des anticorps monoclonaux prévenant de ces cellules, synthétisés pendant ce travail, va probablement répondre à cette question. Une deuxième stratégie pour détecter les B qui sont à la fois auto-réactives et ZAP-70⁺ a été développée. Les conséquences fonctionnelles de l'expression aberrante de ZAP-70 dans les LyB sur la pathogénèse de l'auto-immunité et de la lymphoprolifération vont être mieux caractérisée dans un modèle de souris transgénique pour ZAP-70 développé dans ce projet.

Les résultats présentés dans ce travail ouvrent des nouvelles perspectives dans la compréhension du développement lymphocytaire B et de la pathogénèse des phénomènes auto-immunes et de la transformation néoplasique.

Mots clé : leucémie lymphoïde chronique, cytopénie auto-immune, ZAP-70, lymphocyte B.

ABSTRACT

Chronic lymphocytic leukemia (CLL) is a lymphoproliferative malignancy characterized by the progressive clonal accumulation of mature-appearing B cells. CLL has the particularity of a dysregulated immune system that favors the development of autoimmune phenomena, which have a high incidence, predominantly directed against blood cells, like autoimmune hemolytic anemia (AIHA) and immune thrombocytopenia (ITP). Abnormal expression of ZAP-70 in CLL cells is an important prognostic factor, probably through increased BCR signaling. The mechanisms that lead to autoimmunity in CLL, which result in the pathogenic polyclonal IgG autoantibodies secreted by non-malignant cells, are far from being understood.

In this work we described a novel B cell population that expresses ZAP-70 that has not been described before. ZAP-70⁺ normal B cells do not seem to belong to a certain subset of B cells, nor seem to have an activated phenotype. The presence of ZAP-70 in the naïve B cell subset suggests that this is an early process in the B cell development, which probably occurs before malignant transformation. Moreover, we found a good correlation in the level of ZAP-70 expression, between normal B cells and CLL B cells.

Importantly, we found a percentage of ZAP-70⁺ normal B cells in all AIC-associated CLL patients. ZAP-70⁺ B cells could be directly responsible for AIC, or could determine a general increase in autoimmune reactivity. Monoclonal antibodies synthesized from these cells will probably answer this question. A second strategy designed to detect autoantigen-reactive B cells that are at the same time ZAP-70⁺ in flow cytometry is under way. The functional consequences on autoimmunity or lymphoproliferation of aberrant expression of ZAP-70 in B cells will be studied in more detail in a conditional ZAP-70 KI mouse model, designed in this project.

The results presented in this work open new perspectives in the comprehension of B cell development and the physiopathology of autoimmunity and malignant transformation.

Keywords: chronic lymphocytic leukemia, autoimmune cytopenia, ZAP-70, B cells.

Abbreviations

AAE	acquired angioedema
Ab	antibody
ACE	antigen-capture ELISA
ADAM29	a disintegrin and metalloproteinase 29
Ag	antigen
AIC	autoimmune cytopenia
AIG	autoimmune granulocytopenia
AIHA	autoimmune hemolytic anemia
APC	antigen presenting cell
ATM	ataxia telangiectasia-mutated
APRIL	a proliferation-inducing ligand
BAFF	B-cell activating factor
BCL2	B-cell lymphoma 2
BCR	B-cell receptor
BIRC3	baculoviral IAP repeat containing 3
BLNK	B cell linker protein
BMSC	bone marrow stromal cells
Breg	regulatory B-cell
BSA	bovine serum albumin
Btk	Bruton tyrosine kinase
CAD	cold agglutinins disease
CART	chimeric antigen receptor therapy
c-Cbl	c-Casitas B-lineage lymphoma
cDNA	complementary DNA
CDR	complementarity-determining region
CIP	calf intestine alkaline phosphatase
CLL	chronic lymphocytic leukemia
CTLA4	cytotoxic T-lymphocyte-associated protein 4
DAG	diacylglycerol
DAT	direct antiglobulin test (direct Coombs test)
DMEM	Dulbecco's Modified Eagle's Medium
DNA	deoxyribonucleic acid
dsDNA	double-stranded DNA
EBV	Epstein-Barr virus
EDTA	ethylenediaminetetraacetic acid
ELISA	enzyme-linked immunosorbent assay
ES	embryonic stem cell
F	fludarabine
FACS	fluorescence activated cell sorting
FC	fludarabine-cyclophosphamide
FCIA	flow cytometry immunobead array
FCS	fetal calf serum
FISH	fluorescence in situ hybridization
FOXP3	forkhead box P3
FR	framework region
FS	forward scattering
FVD	Fixable Viability Dye
GC	germinal center

GEF	guanine-nucleotide exchange factor
GEP	gene expression profiling
GP	glycoprotein
HCDR ₃	heavy chain Ig complementarity-determining region 3
HBV	hepatitis B virus
HCMV	human cytomegalovirus
HCV	hepatitis C virus
HEK	human embryonic kidney cells
HIV	human immunodeficiency virus
HSC	hematopoietic stem cell
IGHV	immunoglobulin heavy variable (genes)
IHC	immunohistochemistry
IL	interleukin
IPEX	immunodysregulation polyendocrinopathy enteropathy X-linked syndrome
IP ₃	inositol triphosphate
ITAM	immunoreceptor tyrosine-based activation motif
ITP	immune thrombocytopenia
IWCLL	international workshop on CLL
KI	knocked-in
KIR	killer cell immunoglobulin-like receptor
LAT	linker for activation of T-cell
Lck	lymphocyte-specific protein tyrosine kinase
LDH	lactate dehydrogenase
LPL	lipoprotein lipase
mAb	monoclonal antibody
MACE	modified antigen-capture ELISA
MAG	myelin associated glycoprotein
MAIPA	monoclonal antibody immobilization of platelet Ag
MAPK	mitogen-activated protein kinase
MBL	monoclonal B cell lymphocytosis
M-CLL	mutated IGHV CLL
MFI	median fluorescence intensity
miR	micro RNA (miRNA)
MMP-9	matrix metalloproteinase-9
mRNA	messenger RNA
MRD	minimal residual disease
MyD88	myeloid differentiation primary response gene 88
MZ B cell	marginal zone B cell
NCBI	National Center for Biotechnology Information
NF-κB	nuclear factor-kappaB
NGS	next-generation sequencing
NK	natural killer cell
NLC	nurse-like cell
OD	optic density
OS	overall survival
PBMC	peripheral blood mononuclear cell
PBS	phosphate-buffered saline
PCR	polymerase chain reaction
PFS	progression-free survival
PIP ₂	phosphatidylinositol (4,5) diphosphate

PI3K	phosphoinositide 3-kinase
PLC	phospholipase C
PLL	prolymphocytic leukemia
PNP	paraneoplastic pemphigus
PTPN22	protein tyrosine phosphatase, non-receptor type 22
SH2	Src homology 2 domain
SLP-76	SH2 domain containing leucocyte protein of 76 kDa
SPRCA	solid-phase red blood cell adherence
PRCA	pure red cell aplasia
PSIFT	platelet suspension immunofluorescence test
qPCR	quantitative real-time PCR
RBC	red blood cell
RCD	rituximab, cyclophosphamide, dexamethasone
R-CVP	rituximab, cyclophosphamide, vincristine, prednisone
RF	reading frame
RFC	rituximab, fludarabine, cyclophosphamide
RhAG	Rhesus-associated glycoprotein
RMH	Royal Marsden Hospital
RNA	ribonucleic acid
RNP	ribonucleoprotein
RPMI	Roswell Park Memorial Institute medium
SCID	severe combined immunodeficiency
scPCR	single cell PCR
SF3B1	splicing factor 3b subunit 1
SHM	somatic hypermutation
SLE	systemic lupus erythematosus
SLL	small lymphocytic leukemia
SS	side scattering
Syk	spleen tyrosine kinase
TCL1	T-cell leukemia/lymphoma 1
TCR	T-cell receptor
TFH	T follicular helper cell
Th	T helper cell
TK	tyrosine kinase
TNF	tumor necrosis factor
TOF	time of flight
Treg	regulatory T-cell
TZK	truncated ZAP kinase
U-CLL	unmutated IGHV CLL
VCAM-1	vascular cell adhesion molecule
vWF	von Willebrand factor
WB	Western blotting
ZAP-70	zeta-associated protein 70kDa

CHAPTER I. INTRODUCTION 21

1. CHRONIC LYMPHOCYTIC LEUKEMIA	23
1.1. DEFINITIONS.....	23
1.2. EPIDEMIOLOGY.....	24
1.3. DIAGNOSIS.....	25
1.3.1. Clinical manifestations	25
1.3.2. Laboratory findings	25
1.4. PATHOGENESIS.....	29
1.4.1. The normal counterpart of CLL cells.....	29
➤ CD5+ B cells / human B1 cells	29
➤ Antigen-experienced, “memory-like” B cells	30
➤ Marginal zone (MZ) B cells	30
➤ Self-reactive, “anergized” B cells.....	32
➤ Hematopoietic stem cells (HSC) in CLL.....	34
1.4.2. Monoclonal B cell lymphocytosis (MBL) as a CLL precursor	34
1.4.3. BCR signaling in CLL.....	34
➤ BCR signaling in normal B cells	35
➤ IGHV mutational status and BCR signaling	37
➤ BCR stereotypy and (auto)antigen stimulation in CLL	39
1.4.4. Defective apoptosis and CLL kinetics	42
1.4.5. CLL microenvironment.....	42
1.4.6. Genetic and epigenetic features of CLL.....	44
➤ Deletions in 13q	44
➤ Deletion of 11q	45
➤ Trisomy 12	45
➤ Deletion of 17p	46
➤ Complex karyotype	46
➤ Whole exome sequencing data in CLL	46
➤ Epigenetic features of CLL	49
1.5. STAGING AND PROGNOSTIC FACTORS.....	51
1.5.1. Clinical stage according to Binet and Rai	52
1.5.2. Markers of tumor burden	53
1.5.3. Serological markers.....	54
1.5.4. IGHV mutational status	54
1.5.5. ZAP-70 as a prognostic factor in CLL.....	56
1.5.6. CD38 expression	61
1.5.7. CD49d	62
1.5.8. LPL expression.....	62
1.5.9. Genetic prognostic factors.....	62
1.5.10. Minimal residual disease as a prognostic factor in CLL	64
1.6. TREATMENT.....	65
1.7. COMPLICATIONS.....	67
2. AUTOIMMUNE PHENOMENA IN CLL.....	69
4.1. EPIDEMIOLOGIC DATA.....	69

4.2. DIAGNOSIS.....	71
2.2.1. Autoimmune hemolytic anemia (AIHA)	71
➤ Direct antiglobulin test (DAT; i.e. direct Coombs test)	72
2.2.2. Immune thrombocytopenia (ITP)	73
➤ Detection of anti-platelets antibodies	74
2.2.3. Autoimmune pure red cell aplasia (PRCA).....	77
2.2.4. Autoimmune granulocytopenia (AIG)	77
➤ Detection of anti-neutrophil antibodies	78
4.3. PATHOGENESIS.....	78
2.3.1. Overview of autoimmune mechanisms in general.....	78
2.3.2. Autoantibodies in CLL-associated autoimmune cytopenia (AIC).....	82
2.3.3. Antigens in AHAI and ITP.....	84
2.3.4. Role of normal B cells in AIC.....	87
2.3.5. Role of T cells in AIC	88
2.3.6. Role of leukemic cells in AIC	89
2.3.7. Treatment-related AIC in CLL	91
4.4. PROGNOSTIC SIGNIFICANCE AND RISK FACTORS FOR AIC	92
4.5. TREATMENT.....	95
3. ZAP-70.....	97
3.1. ZAP-70 STRUCTURE AND SIGNALING PATHWAYS THROUGH ZAP-70 IN T CELLS.....	97
➤ ZAP-70 in NK cells	101
3.2. ZAP-70 EXPRESSION IN CLL CELLS AND ASSOCIATED SURVIVAL ADVANTAGES.....	102
➤ ZAP-70 expression detection methods	102
➤ ZAP-70 expression enhances BCR signaling in CLL cells	103
➤ Survival advantages of ZAP-70 expression in CLL cells.....	106
➤ ZAP-70 expression in other lymphoid malignancies	106
3.3. ZAP-70 EXPRESSION IN NORMAL B CELLS.....	107
3.4. ZAP-70 AND AUTO-IMMUNITY.....	109
 CHAPTER 2. PROJECT	 113
➤ Premises	115
➤ Hypothesized conclusions to demonstrate	116
 CHAPTER 3. PATIENTS AND METHODS.....	 119
 CHAPTER 4. RESULTS.....	 135
4.1. A FRACTION OF NORMAL B CELLS FROM CLL PATIENTS EXPRESS ZAP-70	137
➤ Characteristics of analyzed CLL patients	144
➤ ZAP-70 mRNA expression in qPCR.....	146
➤ Confirmation of ZAP-70 mRNA expression by normal B cells from ZAP-70+ CLL patients in single cell RT-PCR (scPCR)	148
4.2. THERE IS A GOOD CORRELATION BETWEEN THE EXPRESSION LEVELS OF ZAP-70 OF MALIGNANT AND NORMAL B CELLS IN THE SAME CLL PATIENT.....	151
➤ T cells from CLL patients express higher levels of ZAP-70 than controls.....	153

➤ Search for a serum factor in CLL patients that could increase ZAP-70 level in all lymphocytes.....	154
4.3. THERE IS A GOOD CORRELATION BETWEEN THE EXPRESSION LEVEL OF ZAP-70 IN NORMAL B CELLS AND THE PRESENCE OF AUTOIMMUNE PHENOMENA IN PATIENTS WITH CLL	157
4.4. FURTHER CHARACTERIZATION OF ZAP-70+ NORMAL B CELLS FROM CLL PATIENTS	161
➤ ZAP-70+ normal B cells do not belong to a specific B cell subset.....	161
➤ Search for activation markers in ZAP-70+ normal B cells.....	165
➤ Ig V gene sequence analysis of ZAP-70+ and ZAP-70- B cell amplified by scPCR.....	166
4.5. ARE ZAP-70+ B CELLS AUTOACTIVE?.....	173
➤ Monoclonal antibody production from ZAP-70+ normal B cells	173
➤ Search of autoreactive ZAP-70+ normal B cells by flow cytometry	176
4.6. COULD THE EXPRESSION OF ZAP-70 IN B CELLS INDUCE AUTOACTIVITY OR MALIGNANT TRANSFORMATION?.....	181
CHAPTER 5. DISCUSSIONS AND PERSPECTIVES.....	183
BIBLIOGRAPHY.....	221

FIGURES:

Figure 1. Microscopic features of CLL.....	26
Figure 2. Use of immunophenotyping in differential diagnosis of mature B cell neoplasms.....	28
Figure 3. Maturation of B lymphocytes, focusing on issues relevant to the possible precursors of CLL cells.....	31
Figure 4. Tolerance mechanisms possible involved in CLL pathogenesis.....	33
Figure 5. BCR signaling in normal B cells.....	36
Figure 6. Heterogeneous versus stereotyped BCR in CLL with major subsets.....	40
Figure 7. CLL microenvironment.....	43
Figure 8. Cluster diagram of CLL patients and genetic parameters.....	48
Figure 9. Evolution and growth of our understanding of CLL heterogeneity over time.....	51
Figure 10. Kaplan-Meier survival curve comparing CLL patients with M and UM IGHV.....	55
Figure 11. Hierarchical clustering of gene expression levels that most strongly discriminate between M-CLL and UM-CLL.....	56

Figure 12. Flow cytometric method used to quantify the expression of ZAP-70 in CLL cells.....	57
Figure 13. Kaplan-Meier estimates of probability of progression and of probability of survival among patients with stage A CLL, according to the level of ZAP-70 expression.....	58
Figure 14. Relationship between ZAP-70 expression, IGHV mutational status, and the time from diagnosis to initial treatment.....	60
Figure 15. Observed overall survival of CLL patients compared with the expected overall survival in the matched general population.....	63
Figure 16. Value of MRD negative status in combination with clinical response	64
Figure 17. Targeting of BCR signaling as a therapeutic strategy in CLL.....	66
Figure 18. Three different antigen-capture ELISAs for platelet antibody detection and identification.....	75
Figure 19. Protein beads array assay for platelet antibody detection.....	76
Figure 20. Model of Rhesus proteins in the red blood cell membrane.....	85
Figure 21. Platelet glycoproteins (GP) structure, GPIa/IIa, GPIIb/IIIa, GPIb/IX.....	86
Figure 22. The predictive value of AIHA and of a positive DAT on overall survival and progression free survival in CLL.....	93
Figure 23. Time to autoimmune cytopenia from CLL diagnosis according to ZAP-70 expression in CLL patients.....	94
Figure 24. Overall survival according to occurrence of AIC and ZAP-70 expression.....	95
Figure 25. T cell receptor complex.....	97
Figure 26. Schematical representation of ZAP-70.....	98
Figure 27. ZAP-70 docking and activation.....	99
Figure 28. Model for the activation of ZAP-70 following ITAM binding.....	99
Figure 29. Strategy to clone and express monoclonal antibodies from ZAP-70 ⁺ B cells.....	128
Figure 30. Zap70 mouse coding sequence cloning into CTV vector.....	133
Figure 31. CTVZAP addnotated vector, used to generate conditional Zap70 KI mice.....	134
Figure 32. Gating strategy of normal and CLL B cells for ZAP-70 phenotyping.....	138
Figure 33. Example of two CLL cases: a ZAP-70 ⁺ CLL, and a ZAP-70 ⁻ CLL.....	139
Figure 34. ZAP-70 ⁺ normal B cells express a high level of surface light chains and are polyclonal.....	140
Figure 35. Normal B cells from CLL patients express high levels of ZAP-70 compared to normal subjects.....	142
Figure 36. ZAP-70 expression in CD19 ⁺ CD5 ⁺ cells from CLL patients as compared to normal subjects.....	142

Figure 37. MFI of ZAP-70-PE in CD5 ⁻ and CD5 ⁺ B cells from CLL patients versus controls.....	143
Figure 38. CD19 ⁺ CD5 ⁺ highly purified cells from CLL patients express a significant higher level of ZAP-70 mRNA as compared with CD19 ⁺ CD5 ⁺ cells from healthy controls.....	146
Figure 39. Normal CD19 ⁺ CD5 ⁻ B cells from CLL patients express more ZAP-70 mRNA than the same subset of cells isolated from normal subjects.....	147
Figure 40. Example of two normal B cells (CD19 ⁺ CD5 ⁻) from a ZAP-70 ⁺ CLL patient in which transcripts of IgH, Igλ, Igk and ZAP-70 were studied at single cell level.....	149
Figure 41. ZAP-70 ⁺ normal B cells amplified for Ig genes as single cells from the same patient are polyclonal.....	149
Figure 42. Correlations between the expression levels of ZAP-70 in malignant and normal B cells in CLL patients.....	151
Figure 43. Correlation in the expression levels of ZAP-70 between normal or malignant B cells and T cells in CLL patients.....	152
Figure 44. T cells from CLL patients express higher levels of ZAP-70 than normal subjects...	153
Figure 45. In vitro culture experimental design, in search for a serum factor in CLL ZAP-70 ⁺ patient that could increase ZAP-70 expression in all lymphocyte populations.....	154
Figure 46. Culture of control, ZAP-70 ⁺ CLL and ZAP-70 ⁻ CLL PBMC with RPMI enriched with serum from a normal subject or a ZAP-70 ⁺ CLL case.....	155
Figure 47. Correlation between ZAP-70 expression level in normal B cells and the presence of autoimmunity in CLL patients.....	158
Figure 48. In CLL patients with AIC, the level of ZAP-70 in normal B cells is not different as compared with the level in normal B cells from ZAP-70 ⁺ CLL without AI.....	159
Figure 49. ZAP-70 ⁺ normal B cells do not belong to a certain B cell subset.....	162
Figure 50. Correlation between the percentage of each subset of B cells in ZAP-70 ⁺ and ZAP-70 ⁻ B cell population in each patient exemplified for naïve and switched memory cells.....	163
Figure 51. CD27 expression in ZAP-70 ⁺ vs. ZAP-70 ⁻ normal B cells.....	164
Figure 52. Percentage of CD21 ^{low} in ZAP-70 ⁺ vs. ZAP-70 ⁻ normal B cells.....	164
Figure 53. Percentage of CD27 ⁺ CD43 ⁺ CD70 ⁻ cells in ZAP-70 ⁺ vs. ZAP-70 ⁻ normal B cells	165
Figure 54. MFI for CD86-PerCPCy5.5 in ZAP-70 ⁺ vs. ZAP-70 ⁻ normal B cells.....	166
Figure 55. ELISA reactivity testing of mAb produced from single normal B cells cloned from ZAP-70 ⁺ CLL and autoimmune cytopenia patients.....	175
Figure 56. GPIIb/IIIa-AF647 staining of healthy subject PBMC.....	177
Figure 57. GPIIb/IIIa and ZAP-70 flow cytometric staining of normal and CLL B cells from a ZAP-70 ⁺ CLL patient with ITP.....	178
Figure 59. Previewed crossbreeding of Zap70 loxP mice with Mb1-Cre and CD21-Cre mice..	182

TABLES:

Table 1. RMH (Matutes) scoring system.....27

Table 2. BCR signaling in CLL B cells compared with normal B cells.....37

Table 3. Subsets of CLL cases with stereotyped BCRs.....41

Table 4. MicroRNA signature associated with prognostic factors (ZAP-70 expression and IGHV mutations) and disease progression in patients with CLL.....50

Table 5. Rai classification system.....52

Table 6. Binet classification system.....53

Table 7. Prognostic value of ZAP-70 expression59

Table 8. Case series of autoimmune cytopenias in CLL.....70

Table 9. Primer sequences used for Ig gene PCR amplification in nested PCR.....125

Table 10. ZAP-70 expression determined in flow cytometry for 63 CLL patients.....145

Table 11. Autoimmune phenomena associated with CLL cases.....157

Table 12. Sequence data from single cell sorted B cells from 4 patients with ZAP-70+ CLL and AIC.....168

CHAPTER I. INTRODUCTION

1. CHRONIC LYMPHOCYTIC LEUKEMIA

1.1. DEFINITIONS

Chronic lymphocytic leukemia (CLL) is a lymphoproliferative malignancy characterized by the progressive clonal accumulation of mature-appearing B lymphocytes in the peripheral blood, bone marrow, lymph nodes and spleen (Swerdlow, International Agency for Research on Cancer., and World Health Organization. 2008). The diagnosis of CLL requires the presence of at least 5×10^9 monoclonal B lymphocytes/L (5000/ μ L) in the peripheral blood with a characteristic immunophenotype (CD19⁺, CD5⁺, CD23⁺, CD20^{low}, CD79b^{low}, sIg^{low}).

The World Health Organization classification of hematopoietic neoplasias describes *small lymphocytic lymphoma (SLL)* as the same entity as CLL, with the same tissue morphology and immunophenotype, the only distinguishable character being the absence of leukemic appearance (< 5000 monoclonal B cells/ μ L in peripheral blood). The diagnosis of SLL requires the presence of lymphadenopathy, splenomegaly and/or other tissue involvement by an infiltrate characteristic of CLL, proven by a histopathologic biopsy (Campo et al. 2011).

In the absence of lymphadenopathy or splenomegaly, the incidental detection of fewer than 5000 monoclonal B lymphocytes/ μ L is defined as *monoclonal B lymphocytosis (MBL)*. MBL is an asymptomatic hematologic condition in persons who do not have CLL, other B lymphoproliferative disorders, or underlying conditions such as infectious and autoimmune diseases (Marti et al. 2005).

The CLL cells found in the blood smear are characteristically small, mature lymphocytes with a narrow border of cytoplasm and a dense nucleus lacking discernible nucleoli and having partially aggregated chromatin. These cells may be found admixed with larger, atypical cells with prominent nucleoli (prolymphocytes), which may count up to 55% of the blood lymphocytes. The forms with more than 10% of prolymphocytes (but less than 55%) are called *atypical CLL* (Hallek et al. 2008). Finding prolymphocytes in excess of this percentage would favor a diagnosis of *prolymphocytic leukemia (PLL)*, which is a distinct entity, usually CD5⁺, described by Galton (Melo, Catovsky, and Galton 1987).

1.2. EPIDEMIOLOGY

CLL is the most common leukemia in the Western world, occurring predominantly in elderly people, with a median age at diagnosis of 72 years. The incidence rate is 2-6 cases per 100000 persons per year, increasing with age, reaching 12,8 cases/100000 at the age of 65. The risk of dying from disease-specific causes increases with age, but even for patients diagnosed with CLL before the age of 50, the median life expectancy diminishes from 31,2 years in age-matched control subjects to 13,3 years (Abrisqueta et al. 2009; Hoffman 2013). The total CLL/SLL incidence rate (IR) is significantly higher among males (IR 7,04) in comparison to females (IR 3,72). The male predominance is significantly greater for CLL with an incidence rate ratio (IRR) of 1,98 than for SLL (IRR 1,67) (Dores et al. 2007). CLL is more common in Caucasians than in blacks and Asians. The low incidence in Asians persists even in those subjects who migrated in the Occident, implying a possible genetic predisposition. Up to 10% of CLL patients have a first- or second-degree relative with CLL and an even higher frequency if we consider MBL.

Relatives of CLL patients also appear to have a higher frequency of other lymphoproliferative disorders. Although an association with familial autoimmune diseases was suggested in the past, a recent, very large case-control population study did not find such a correlation, with the exception of pernicious anemia (Landgren et al. 2006).

1.3. DIAGNOSIS

1.3.1. Clinical manifestations

Most of the patients are asymptomatic at diagnosis, which is made on a lymphocytosis identified in routine blood tests evaluation. Some patients may present with fatigue, dyspnea (due to anemia or cytokines from cancer cells), early satiety (from spleen enlargement), hepatomegaly, palpable lymph nodes, petechiae or other hemorrhagic signs (due to thrombocytopenia). Recurrent infections as a consequence of acquired immunodeficiency are also a common presentation, especially herpes zoster infection. Rarely, there is an infiltration of other organs, like skin, kidney, lung or pleural space. Unusual symptoms, generally associated with Richter transformation are night sweats, fever and weight loss.

1.3.2. Laboratory findings

In the peripheral blood the diagnosis requires hyperlymphocytosis ($> 5000/\mu\text{L}$, usually around $20000/\mu\text{L}$, occasionally $> 400000/\mu\text{L}$). It can be associated with anemia, thrombocytopenia or neutropenia as a consequence of advanced disease or of autoimmune phenomena. The blood smear shows lymphocytes with mature appearance and characteristic artefactual damaged cells as a result of their fragility, named “smudge cells” or “Gumprecht shadows”.

A bone marrow aspiration or biopsy is not usually required for diagnosis. It can help, however, search for factors that might contribute to cytopenias (anemia, thrombocytopenia) that could be related or not to CLL infiltration of the marrow. Typically, more than 30% of the nucleated cells in the aspirate are lymphoid. Before the era of new prognostic markers, the marrow biopsy used to provide prognostic features as nodular (favorable), interstitial (intermediate) or diffuse (unfavorable) infiltration.

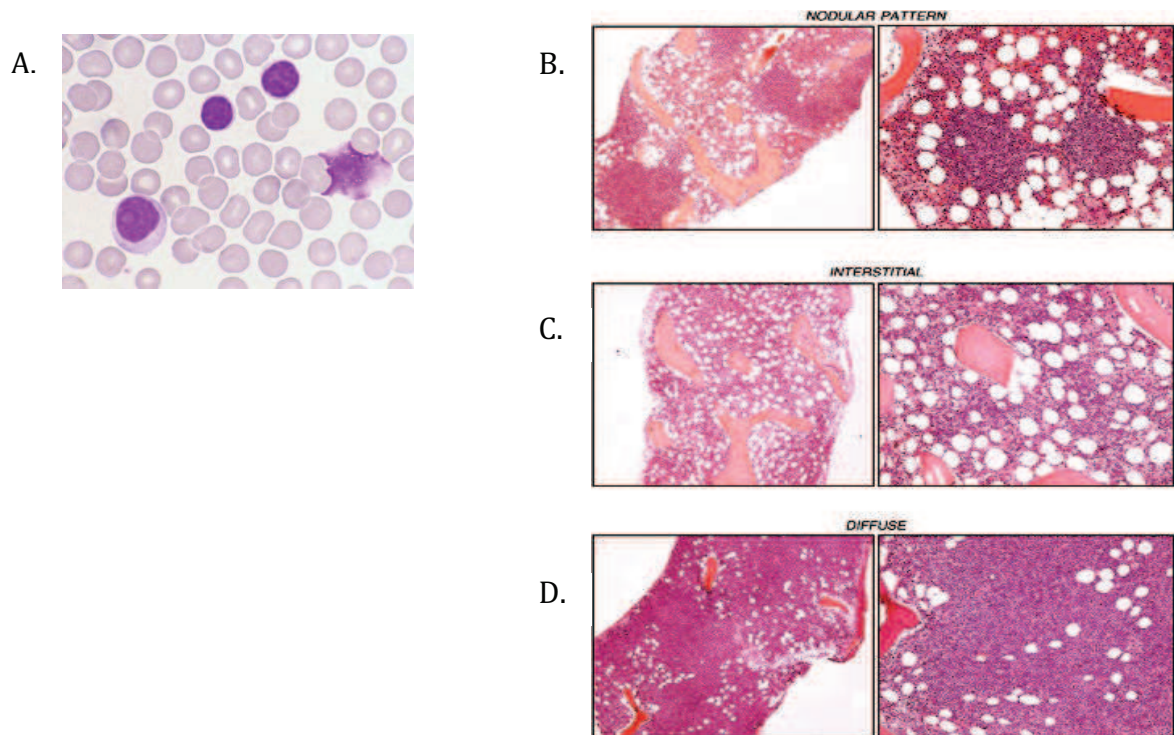

Figure 1. Microscopic features of CLL: A. Peripheral blood smear showing 2 typical B CLL cells, a prolymphocyte and a Grumprecht shadow. B., C. and D. Patterns of marrow involvement (Tkachuk, Hirschmann, and Wintrobe 2007).

Lymph node biopsy, rarely required, shows effacement of the architecture with a pseudofollicular pattern with pale areas containing large cells, in a dark background of small cells, named *proliferation centers*.

The positive diagnosis of CLL relies on immunophenotypic confirmation, which is now mandatory. Specifically, CLL express a variety of B cell markers, including CD19⁺, CD23⁺, CD20^{low}, CD79b^{low}, sIg^{low} and the pan-T cell marker CD5⁺. k or λ restriction is always present, establishing the monoclonality, although sIg expression may be so diminished that light chain restriction can be difficult to determine. The flow cytometry characterization also permits to differentiate between CLL and other mature cell lymphoproliferations as shown in Figure 2. For example, *de novo* PLL B cells do not express CD5 and have a higher level of CD20 and sIg. Mantle cell lymphoma expresses CD5, but not CD23 in the majority of cases. There is an immunophenotype score that permits to differentiate between these diseases, called RMH (Royal Marsden Hospital) or Matutes score (Table 1). A score of 4 or 5 is required for a confirmation of CLL. Only 5% of CLL

have a Matutes of 3, and a score below 3 excludes a CLL diagnosis. Transformation of CLL to either secondary PLL or local large cell lymphoma (Richter transformation) is often associated with immunophenotypic drift, where CD5 is lost and FMC7 expression is acquired.

RMH (Matutes) scoring system		
Marker	1 point	0 points
CD5	Positive (1)	Negative (0)
CD23	Positive (1)	Negative (0)
CD79b/CD22	Weak (1)	Strong (0)
FMC7	Negative (1)	Positive (0)
sIg	Weak (1)	Strong (0)

Table 1. RMH (or Matutes) scoring system (Matutes et al. 1994). CD79b is used since the publication of Moreau et al. to optimize the scoring system (Moreau et al. 1997).

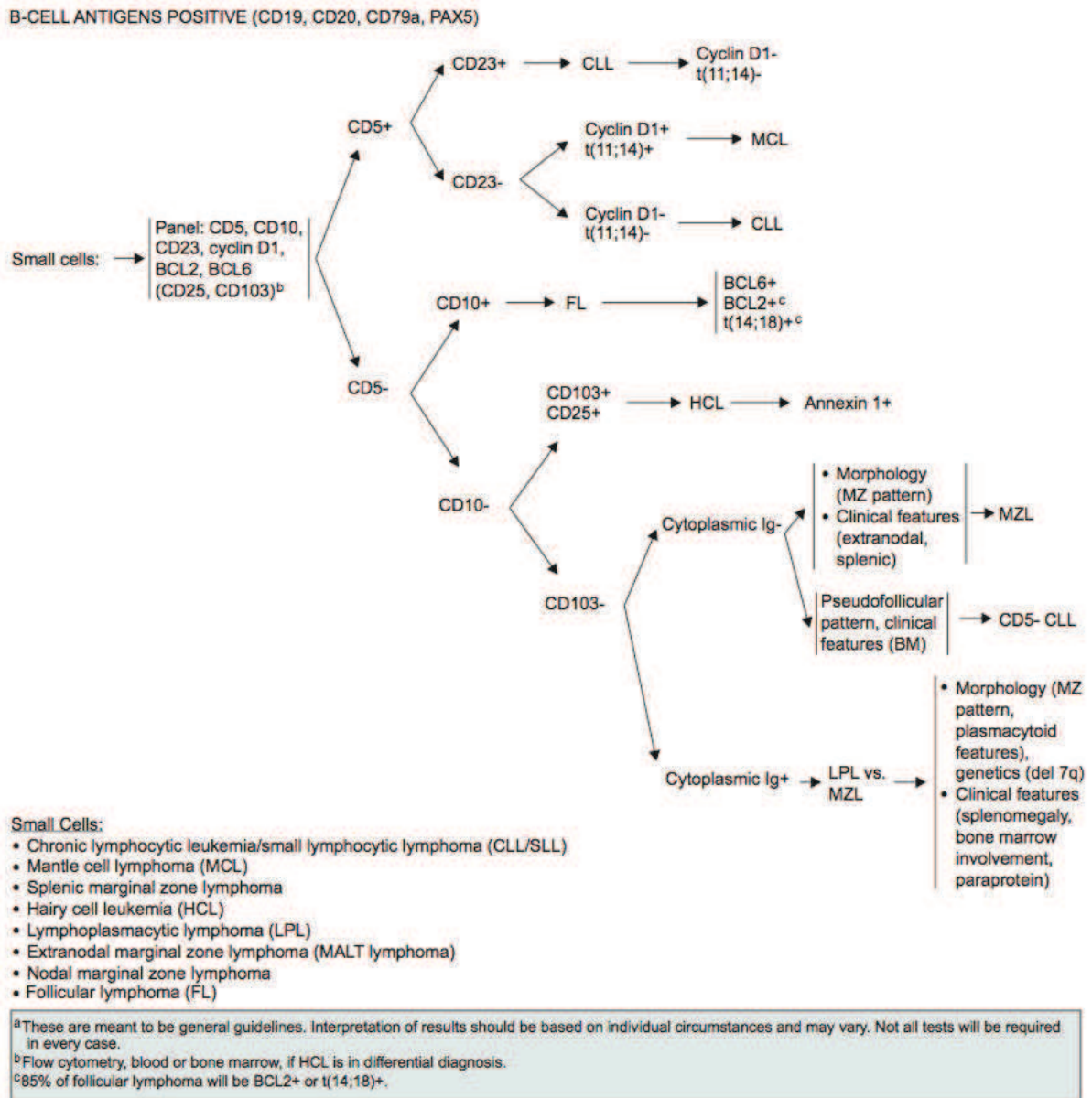

Figure 2. Use of immunophenotyping in differential diagnosis of mature B cell neoplasms (Zelenetz et al. 2010).

1.4. PATHOGENESIS

The complexity of the biology of CLL has become increasingly apparent as the knowledge of the basic science expanded. Still, CLL remains an enigmatic disease, although the first clinical description was published over 150 years ago. The main questions that remain to resolve are:

- the normal cell of origin from which CLL is derived
- the role of B cell receptor (BCR) signaling in CLL pathogenesis
- the existence and relevance of infectious or self antigens that may drive B cell clone

1.4.1. The normal counterpart of CLL cells

Several cell types have been suggested as giving rise to CLL. The phenotypic profile of CLL is different from any normal B cell subset: CD19⁺, CD5⁺, CD23⁺ and low levels of surface Ig. CLL clones use either mutated or unmutated IGHV genes, which distinguishes two subgroups of patients with distinct clinical outcomes (Hamblin et al. 1999; Damle et al. 1999). This fact gave rise to the hypothesis that these two groups originate from different cell types with distinct differentiation and antigen encounter histories, consistent with a *2-cell origin model*. On the other hand, the gene expression profiling (GEP) of these 2 groups reveals a homogenous phenotype, related to memory B cells, with only few differences, consistent with *one-cell origin model* (Klein et al. 2001).

➤ **CD5+ B cells / human B1 cells**

Originally, it was thought that CLL derives from CD5⁺ B cells, because CLL invariably expresses CD5 antigen and because mouse CD5⁺ B cells tend to outgrow as a monoclonal population in old mice (Förster, Gu, and Rajewsky 1988), have self-replenishing features and a propensity to spontaneously produce autoreactive antibodies (Thorsten Zenz et al. 2010). Recently, the human B1 cell subset has been phenotypically described as CD20⁺CD27⁺CD43⁺CD70⁻, these cells having the 3 fundamental functions of mouse B1

cells: spontaneous IgM secretion, efficient T cell stimulation and tonic intracellular signaling (Griffin, Holodick, and Rothstein 2011). These newly described human B1 cells are very similar to unmutated B cell subset of CLL, as both are CD20⁺CD27⁺CD43⁺CD70⁻, express unmutated IGHV, and most of B1 cells are CD5⁺, like CLL cells. More recent transcriptomic (GEP) studies of CLL cells show similarities to circulating CD5⁺ B cells, but not to cordon blood CD5⁺ B cells (Seifert et al. 2012). The arguments against the hypothesis that B1 cells are the origin of CLL are that half of CLL express mutated IGHV, that CD5⁺ cells from normal adults do not have stereotyped IGHV, and that CD5 is not a stable marker, as it can be induced upon activation of peripheral B cells.

➤ **Antigen-experienced, “memory-like” B cells**

Relatively unique antigen-binding sites with specific antigen-binding features strongly suggest that CLL cells are antigen-experienced, resembling memory B cells. In IGHV mutated CLL (M-CLL), cells could be similar to “classic memory B cells”, generated either by a typical GC reaction or by a response outside GC that induces mutations. Figure 3 shows the actual view on B cell development with important implications on possible precursors of CLL. Note that IgM⁺IgD⁺CD27⁺ B cells could be post-GC (Seifert and Kuppers 2009), even though not class-switched, and that antigen-experienced, but T-independent, non-GC, B cells could result in IGHV-mutated (Toellner et al. 2002), class-switched B cells (William 2002). Both of these could be possible CLL cells precursors. In IGHV unmutated CLL (U-CLL), cells could be viewed as antigen-experienced, “memory-like” cells, that, at one of several stages in B cell maturation, failed to change their antigen combining sites despite repeated stimulation (Chiorazzi and Ferrarini 2010). Recurrent stereotypy in Ig repertoire, also, is in favor of such antigen driven hypothesis.

➤ **Marginal zone (MZ) B cells**

To reconcile the two-cell origin model (supported by BCR findings) and the one-cell origin model (supported by gene expression data) a unifying theory has been proposed in which both U-CLL and M-CLL derive from MZ B cells. MZ cells can respond to both T-independent and T-dependent antigens, can express both unmutated and mutated BCR, and can display activation phenotypes after antigen encounter. The argument against this hypothesis is that MZ cells are IgM^{hi}CD5⁻CD23⁻, unlike CLL cells.

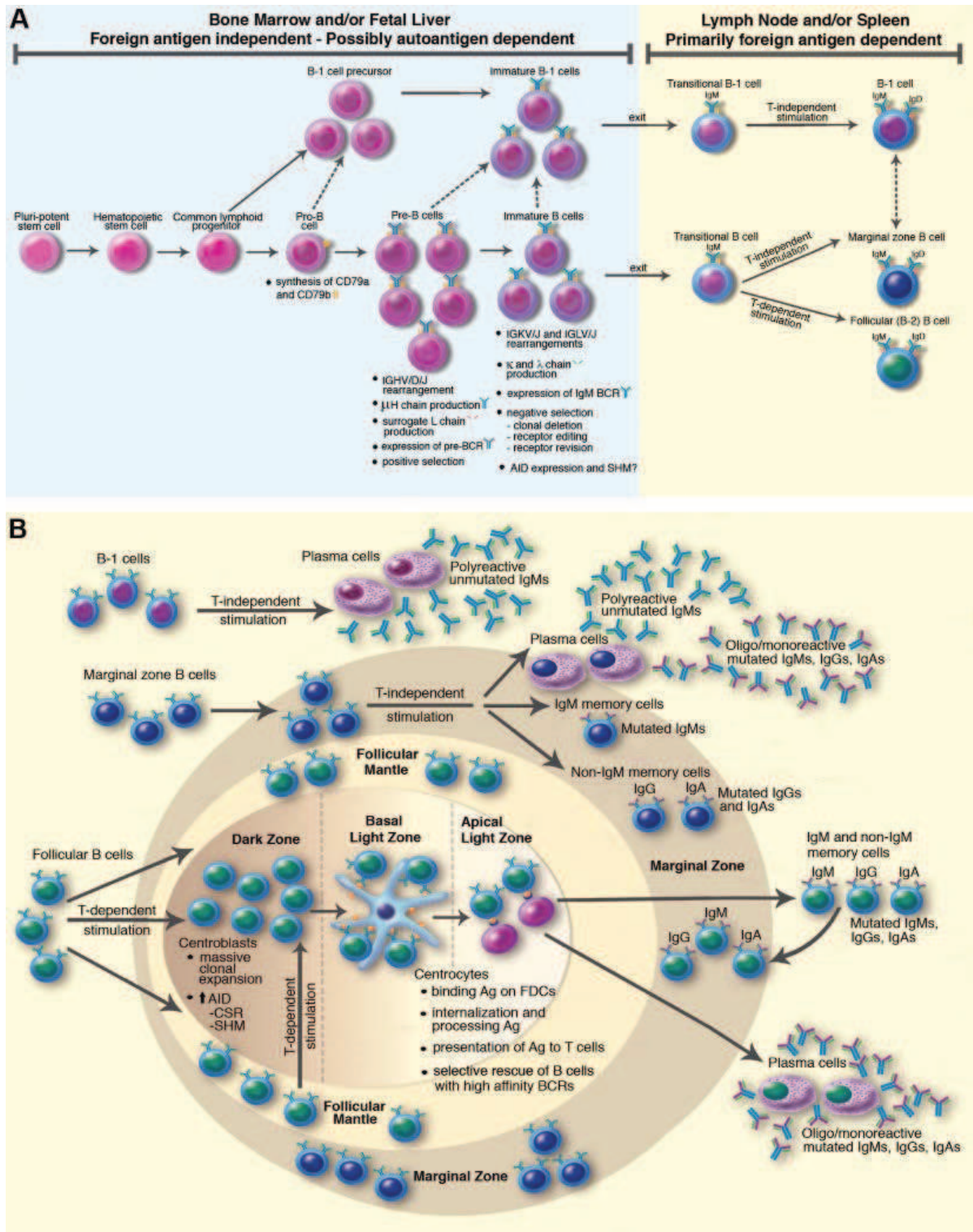

Figure 3. Maturation of B lymphocytes, focusing on issues relevant to the possible precursors of CLL cells (Chiorazzi and Ferrarini 2010).

➤ Self-reactive, “anergized” B cells

Recently, Garcia-Munoz et al. (García-Muñoz, Galiacho, and Llorente 2012; García-Muñoz and Llorente 2014) proposed the *Burnet's “forbidden clone” theory* for CLL, in which CLL cells originate from a coordinated normal immunologic tolerance mechanism aimed to destroy self-reactive B cells. Additional genetic damage induced by tolerance mechanisms may immortalize self-reactive B cells and transform them into leukemia. Importantly, U-CLL and M-CLL cells derive from self-reactive B lymphocytes, despite the fact that they express different antibody reactivity (Hervé et al. 2005). This has been demonstrated when mutated, non-autoreactive CLL autoantibody sequences were reverted in vitro to their germline counterparts that encoded polyreactive and autoreactive antibodies, just like UM-CLL. Moreover, CLL cells can express BCR that recognize their own BCR and have an autonomous signaling capacity, similar to the pre-B-cell receptor (pre-BCR) expressed in pre-B lymphocytes (Minden et al. 2012; Köhler et al. 2008).

These self-reactive or auto-reactive “forbidden” cells are persistently under check by tolerance mechanisms. There is evidence that CLL cells are in constant receptor-editing (Hadzidimitriou et al. 2008), some of them lack allelic exclusion (Rassenti and Kipps 1997), express low levels of surface Ig and a molecular signature of anergy (Muzio et al. 2008). Despite tolerance mechanisms, these new “edited anergized” lymphocytes continue with their differentiation and can, on specific stimulation, proliferate excessively.

An important checkpoint in peripheral tolerance is the entry into the T-dependent, long-term memory compartment (Figure 4). The feature of self and polyreactivity of U-CLL cells suggests that these cells are excluded from GC entry. On the other hand, M-CLL cells may represent U-CLL cells that could manage to enter the GC and correct their self-reactivity by somatic hypermutation (SHM) (Hervé et al. 2005).

Another hypothesis is that CD5 expression in CLL might be related to the control of autoimmunity, as the repetitive BCR stimulation of normal B cells leads to anergy and CD5 expression (Gary-Gouy et al. 2000; Hippen, Tze, and Behrens 2000). CD5 could protect from autoimmunity through inhibition of early BCR signaling (Gary-Gouy et al. 2002), maintain tolerance in anergic B cells and could induce the secretion of IL-10 (Gary-Gouy 2002). The autocrine secretion of IL-10 represents also a survival factor for CLL cells. Another argument for CD5 as an important factor in CLL progression and development is

the immunophenotypic drift with the loss of CD5, when CLL progress towards a more aggressive disease (increased number of prolymphocytes or Richter syndrome).

The mechanisms meant to increase diversity and to escape tolerance, like somatic hypermutation and receptor editing, could generate double-stranded DNA breaks that could favor mutations, deletions and translocations with a possible clonal evolution towards malignancy.

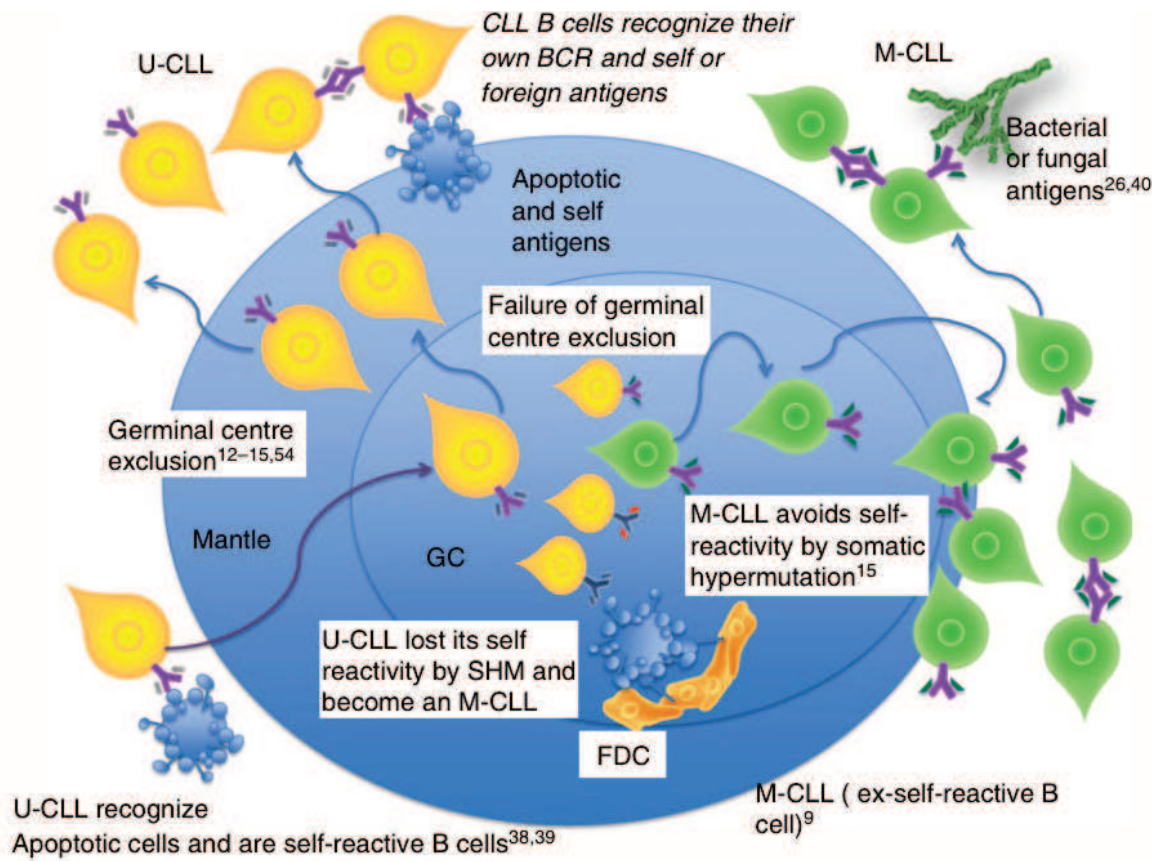

Figure 4. Tolerance mechanisms in the germinal center possible involved in CLL pathogenesis.

➤ Hematopoietic stem cells (HSC) in CLL

The actual WHO classification (Swerdlow, International Agency for Research on Cancer., and World Health Organization. 2008) of hematopoietic malignancies is according to the presumed cell of origin, categorizing two main groups: acute, precursor-cell derived and chronic, mature-cell derived diseases. According to this classification CLL was defined as a mature-cell derived leukemia. This was recently challenged by xenogeneic transplantation studies where HSC isolated from CLL patients developed into monoclonal or oligoclonal B cell lymphoproliferation, resembling CLL. The B cells that developed in such xenografts did not express the same IGHV, perhaps due to selection by different (auto)antigens present in human, but not in mouse, but expressed the same IGHV mutational status as the corresponding CLL clone (Kikushige et al. 2011). This is the first demonstration that the oncologic process begins at the stem cell level in CLL.

1.4.2. Monoclonal B cell lymphocytosis (MBL) as a CLL precursor

MBL is found in approximately 3% of normal persons and their frequency is significantly increased (13,5%) in relatives of CLL patients (Rawstron 2002; Goldin et al. 2010). MBL represents a very interesting condition for the study of CLL pathogenesis, as CLL is always preceded by an MBL state, as demonstrated by a large prospective study (Landgren et al. 2009).

1.4.3. BCR signaling in CLL

The signaling pathways activated upon antigen-BCR interaction involve activation signaling cascades that culminate in the activation of transcription factors that determine the proliferation and differentiation of B cells.

➤ **BCR signaling in normal B cells**

In normal B cells, cross-linking of surface Ig by antigen activates the receptor-associated Src-family protein tyrosine kinases Blk, Fyn and Lyn. The receptor-associated kinases phosphorylate the ITAMs (immunoreceptor tyrosine-based activation motifs) in the receptor complex, which bind and activate the cytosolic protein kinase Syk. Syk then phosphorylates other targets, including the adaptor protein BLNK, which helps to recruit Tec kinases that in turn phosphorylate and activate the enzyme PLC- γ . PLC- γ cleaves the membrane phospholipid PIP₂ into IP₃ and DAG, thus initiating two of the three main signaling pathways to the nucleus. IP₃ releases Ca²⁺ from intracellular and extracellular sources, and Ca²⁺-dependent enzymes are activated, whereas DAG activates protein kinase C with the help of Ca²⁺. The third main signaling pathway is initiated by guanine-nucleotide exchange factors (GEFs) that become associated with the receptor and activate small GTP-binding proteins such as Ras. These in turn trigger protein kinase cascades (MAP kinase cascades) that lead to the activation of MAP kinases that move into the nucleus and phosphorylate proteins that regulate gene transcription. The normal BCR activation pathway is described in Figure 5 (Murphy, Walport, and Janeway 2012).

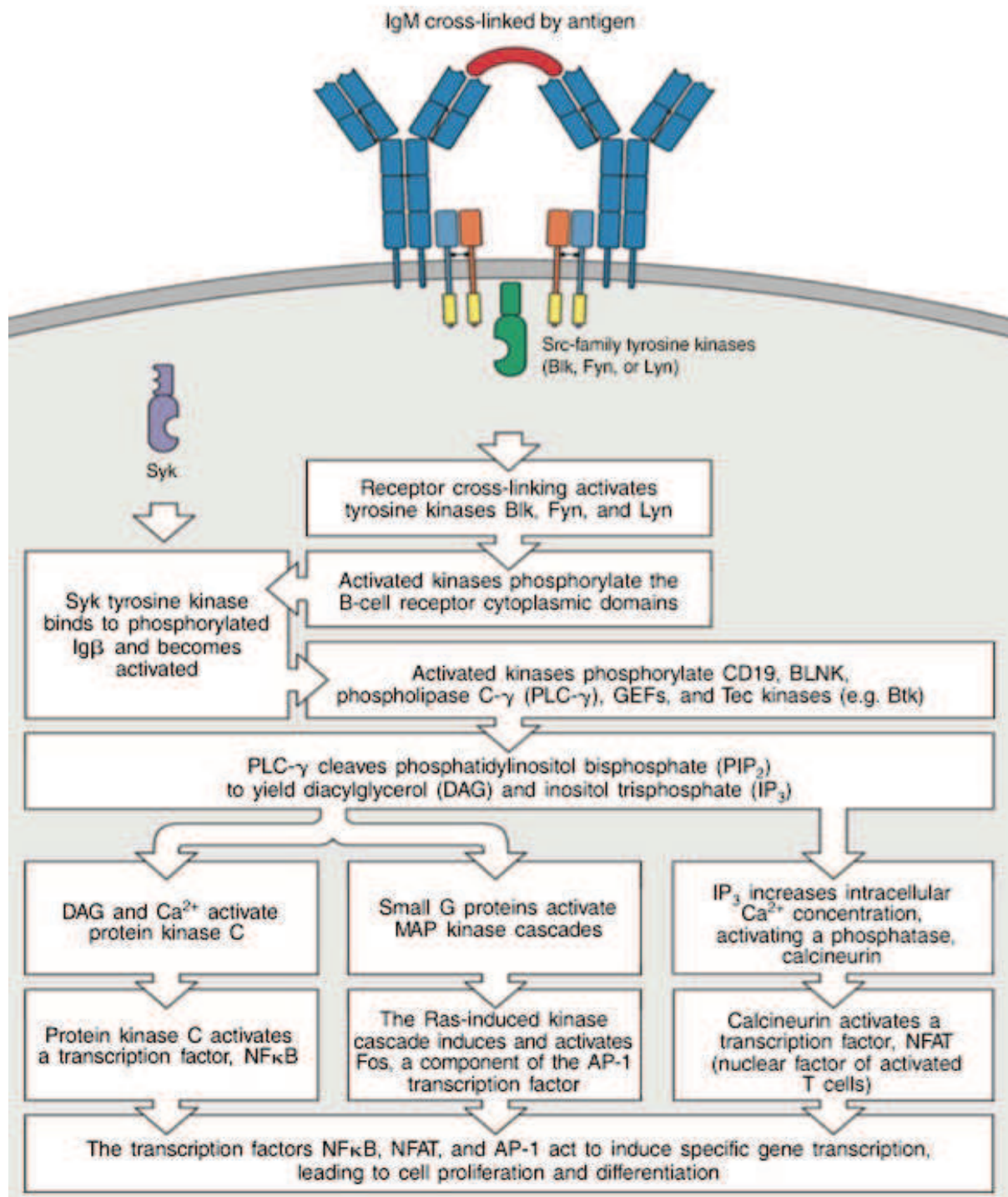

Figure 5. BCR signaling in normal B cells (Murphy, Walport, and Janeway 2012).

CLL has distinct BCR signaling compared with normal B cells, that is characterized by low-level IgM expression, variable response to antigen stimulation and tonic activation of antiapoptotic signaling pathways, as indicated in Table 2.

Characteristic	CLL cells
slg expression	Low
CD79b expression	Low
Response to antigen stimulation	Variable
Syk/Lyn/Btk expression	Elevated
PI3K p110 δ expression	Normal
PI3K kinase activity	Elevated
Calcium flux	Variable/generally low

Table 2. BCR signaling in CLL B cells compared with normal B cells (Woyach, Johnson, and Byrd 2012).

➤ **IGHV mutational status and BCR signaling**

CLL that have mutated IGHV (M-CLL) genes can be differentiated from those that have unmutated IGHV (UM-CLL) genes, the two groups following different clinical course, with patients that have UM-CLL having a poorer survival (Damle et al. 1999; Hamblin et al. 1999). IGHV genes with at least 98% similarity with germline sequences define UM-CLL and genes with less than 98% homology define the M-CLL subset.

In an attempt to identify surrogate genes associated with UM-CLL, ZAP-70 overexpression was identified (Rosenwald et al. 2001). The majority of UM-CLLs has ZAP-70 overexpression and demonstrates evidence of Syk activation and other essential BCR downstream activation signals after ligation of surface IgM. In contrast, generally all M-CLLs lack significant ZAP-70 expression.

In CLL cells, BCR signaling responses are heterogeneous. Generally we can identify 2 subsets: one that appears to be essentially unresponsive to anti-IgM ligation in vitro, more common among M-CLL and one in which there is a relatively persistent activation of ERK1/2 after anti-IgM, more common among U-CLL (Lanham et al. 2003). Specifically,

80% of cases with U-CLL showed increased global tyrosine phosphorylation following IgM ligation, whereas only 20% of M-CLL responded. Non-responsiveness to anti-IgM can be circumvented by ligation of IgD or the BCR-associated molecule CD79a (Ig α). These results suggest that multiple mechanisms underlie non-responsiveness to anti-IgM in CLL and that retained responsiveness to anti-IgM contributes to the poor prognosis associated with U-CLL. Heterogeneity in signaling responses also exists within the malignant clone.

Lack of signaling responsiveness is associated with a failure to induce Syk phosphorylation, a very early event in signalosome formation implying that a key regulatory step must exist at or close to the level of receptor. Syk activation may indirectly be enhanced by ZAP-70. BCR signaling capacity in CLL also correlates with ZAP-70 expression and signaling can be augmented by ZAP-70 overexpression (Chen 2002a; L. Chen et al. 2008; Gobessi et al. 2007).

Recently, PI3K/Akt pathway aberrant constitutive activation has been demonstrated to have an important role in CLL survival (Ringshausen 2002; Herman et al. 2010). Btk pathway is also amplified in CLL and leads to prosurvival signals through its effect on PI3K, PLC- γ and NF- κ B (Herman et al. 2014).

Importantly, signaling responses can be enhanced in CLL cells by incubation with immobilized, rather than soluble, anti-IgM antibodies (Petlickovski et al. 2005). Thus, responses in vivo are likely to be dependent on both the features of CLL cell and the interacting antigen (soluble versus tissue bound or macromolecular).

Antigen-independent BCR and pre-BCR signaling is termed *tonic signaling*. This concept was first proposed based on findings that the pre-BCR signals even though it does not contain a conventional ligand-binding site. Tonic signals are transmitted via the phosphorylated ITAM motifs of Ig α and Ig β (Monroe 2006). There was recently shown that, in contrast to other B cell neoplasias, CLL BCRs induce antigen-independent cell-autonomous signaling, which is dependent on the heavy-chain complementarity-determining region 3 (HCDR3) and an internal epitope of the BCR (Minden et al. 2012). Indeed, transferring HCDR3 of a CLL-derived BCR provides autonomous signaling capacity to a non-autonomously active BCR, whereas mutations in the internal epitope abolish this capacity. These findings identify a new process whereby CLL HCDR3 interact with epitopes within the same or adjacent BCRs, these internal epitopes being localized in the

FR2 (framework region 2) of IGHV.

➤ **BCR stereotypy and (auto)antigen stimulation in CLL**

The analysis of the Ig genes in CLL provided the first indications for a possible role of antigens (Ag) in selecting the CLL progenitor cells, through the discovery of a biased IGHV repertoire, different from normal B cells. There is a remarkable BCR similarity detected in unrelated and geographically distinct CLL cases, which is not demonstrated in other B cell malignancies in which an antigenic stimulation is demonstrated. *Stereotypy* is the observation of near complete sequence homology of the HCDR3 and is associated with adverse risk independently of IGHV mutational status, although it is more commonly observed among U-CLL (40% of stereotypy) than M-CLL (10%). The first example is provided by the cases expressing IGHV3-21 gene with a remarkably short and characteristic CDR3. These patients have a bad outcome regardless of the percentage of IGHV somatic mutation (Ghia 2005). Another provocative example is that of two different subsets of CLL using the IGHV1-69 gene, but forming two different HCDR3 regions, hence potentially recognizing two unrelated antigens. These two subsets, both with unmutated IGHVs, behave at a clinical level in rather opposite ways, with patients belonging to the subset that uses IGHV1-69/IGHD2-2/IGHJ6 showing a rather short survival (94 months) as compared to the other subgroup that uses IGHV1-69/IGHD3-10/IGHJ6, where the median survival time is not reached after an identical follow-up of 71 months (K. Stamatopoulos et al. 2007).

The criteria used to define subsets with homologous HCDR3 includes: usage of the same IGHV/D/J germline genes, usage of the same IGHD gene reading frame and HCDR3 amino acids identity of 60% or more (Messmer 2004). The recent revised criteria also include: HCDR3 length, known to be a critical determinant of the structure of the Ag recognition loop and the exact location of the shared pattern within HCDR3 region, given the evidence that the positioning of certain aminoacids may affect Ig structure stabilization (Agathangelidis et al. 2012). A recent very large study examined over 7500 IGHV sequences from CLL patients and found a stereotyped BCR in 30% of these sequences (Agathangelidis et al. 2012).

A limited number of major subsets account for a sizeable proportion of the CLL Ig

repertoire as exemplified in Figure 6. The main characteristics of the major subsets are described in detail in Table 3, as identified by another study on sequences from 916 CLL patients (K. Stamatopoulos et al. 2007).

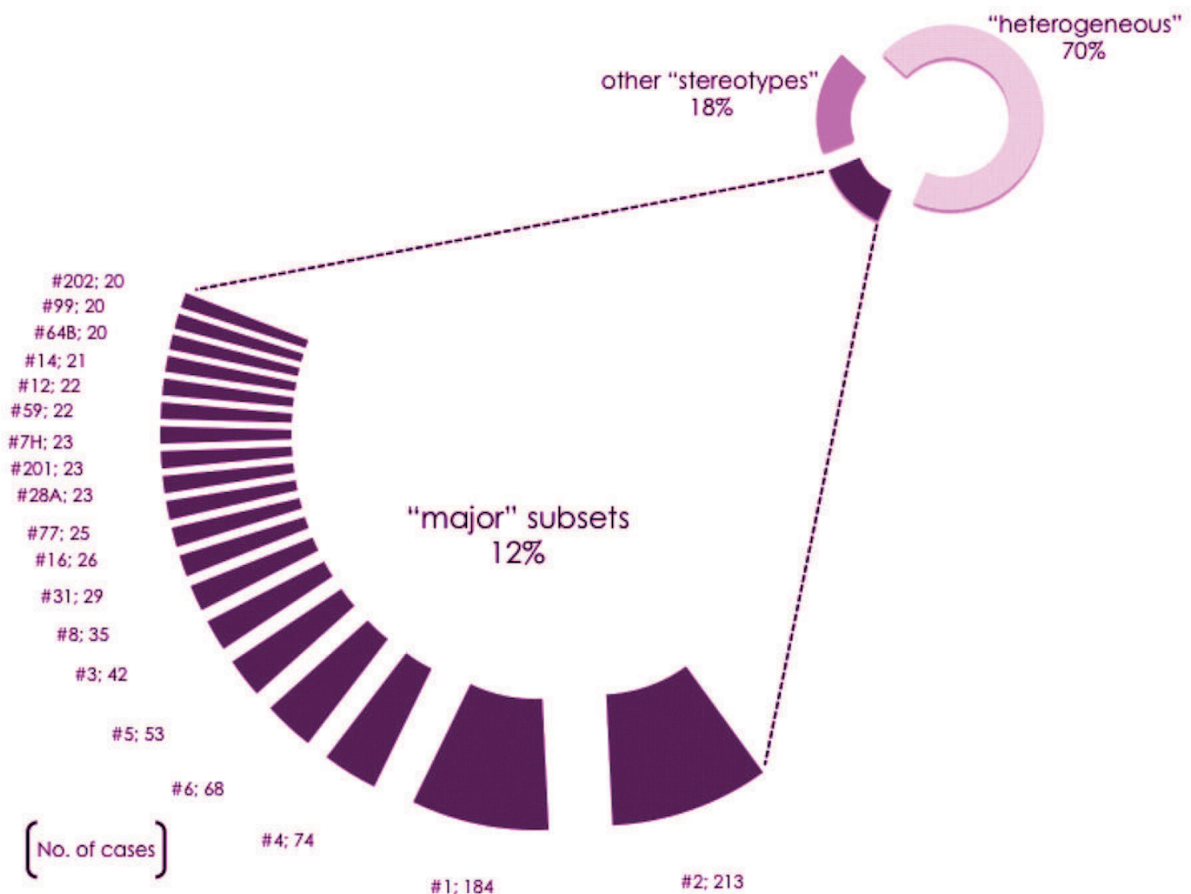

Figure 6. Heterogeneous versus stereotyped BCR in CLL with major subsets (Agathangelidis et al. 2012).

Besides BCR stereotypy, which refers only to HCDR3, in CLL there is also a remarkable high frequency of certain associations between CDR3 of heavy and CDR3 of light chains. For example all heavy chains in subset no. 1 associated with IGKV1-39/1D-39 k light chains with stereotyped CDR3 (K. Stamatopoulos et al. 2007).

Set	N	IGHV gene†	IGHD gene‡ (reading frame)	IGHJ gene§	Average Intra-subset homology¶	IGKV/IGLV gene (no. cases with indicated gene/total no. cases with available data)
Confirmed subsets						
1*	20	IGHV1-18 (4), IGHV1-2 (4), IGHV1-3 (8), IGHV5-a (3)	IGHD6-19 (3)	IGHJ4	71.2	IGKV1-39/IGKV1D-39 (15/15)
2*	18	IGHV3-21 (16), IGHV3-11 (1), IGHV3-48 (1)	ND	IGHJ6	85.2	IGLV3-21 (15/17)
3*	12	IGHV1-69 (9), IGHV1-2 (1), IGHV1-8 (1), IGHV4-34 (1)	IGHD2-2 (3)	IGHJ6	82.2	IGKV1-39/IGKV1D-39 (3/9), IGV3-11 (3/9)
4*	13	IGHV4-34	IGHD5-5 (1)/D4-17 (3)	IGHJ6	75.4	IGLV2-30 (11/11)
5*	10	IGHV1-69	IGHD3-10 (3)	IGHJ6	78.3	IGKV1-33/IGKV1D-33 (2/7), IGLV3-21 (2/7)
6*	8	IGHV1-69	IGHD3-16 (2)	IGHJ3	92.3	IGKV3-20 (6/8)
7*	8	IGHV1-69	IGHD3-3 (2)	IGHJ6	64.8	IGLV3-9 (2/6)
8*	7	IGHV4-39	IGHD6-13 (1)	IGHJ5	69.9	IGKV1-39/IGKV1D-39 (6/7)
9	7	IGHV1-69 (4), IGHV3-21 (1), IGHV3-23 (1), IGHV3-30 (1)	IGHD3-3 (3)	IGHJ6	76.4	diverse
10	5	IGHV4-39 (4), IGHV2-5 (1)	IGHD2-2 (2)	IGHJ6	74.4	IGLV1-40 (2/5), IGLV1-51 (2/5)
11	4	IGHV4-34 (3), IGHV4-59 (1)	IGHD3-10 (2)	IGHJ4	68.3	IGKV3-20 (2/2)
12	4	IGHV1-2 (3), IGHV1-46 (1)	IGHD3-22 (2)	IGHJ4	76.1	IGKV3-15 (3/3)
13	3	IGHV4-59	IGHD2-15 (2)	IGHJ2	90.7	IGKV3-20 (3/3)
14	3	IGHV4-4	IGHD2-21 (2)	IGHJ4	76.7	diverse
15	3	IGHV1-69	IGHD5-24 (1)	IGHJ3	74.5	IGKV3-20 (2/2)
16	3	IGHV4-34	IGHD2-15 (2)	IGHJ6	70.8	diverse
17	3	IGHV3-23 (1), IGHV3-33 (1), IGHV3-7 (1)	IGHD4-23 (2)	IGHJ4	77.1	diverse
18	3	IGHV3-23 (1), IGHV3-48 (1), IGHV3-11 (1)	IGHD4-23 (2)	IGHJ3	84.6	NA
19	3	IGHV1-69 (2), IGHV3-74 (1)	IGHD3-9 (2)	IGHJ4	65.1	NA
20	3	IGHV3-53	ND	IGHJ4	60.6	IGLV3-21 (3/3)
21	3	IGHV3-11 (1), IGHV3-23 (2)	IGHD3-3 (2)	IGHJ6	64.3	IGLV1-44/47 (2/2)
22	3	IGHV3-23 (1), IGHV3-21 (1), IGHV3-11 (1)	IGHD3-3 (2)	IGHJ6	76.2	NA
23	3	IGHV3-30 (1), IGHV3-15 (1), IGHV3-66 (1)	IGHD3-9 (1)	IGHJ6	71.2	diverse
24	3	IGHV1-2 (2), IGHV4-4 (1)	IGHD2-2 (2)	IGHJ6	70.4	diverse
25	3	IGHV1-8 (1), IGHV3-11 (2)	IGHD3-3 (1)	IGHJ6	70.8	diverse
26	3	IGHV4-b (1), IGHV1-69 (1), IGHV3-66 (1)	IGHD6-13 (1)	IGHJ6	80	NA

Table 3. Subsets of CLL cases with stereotyped BCRs (the asterisks denote previously published subsets (K. Stamatopoulos et al. 2007)).

The majority of U-CLL express low-affinity BCRs that are polyreactive, recognizing self or non-self antigens, like “natural antibodies”, such as DNA, LPS, insulin, apoptotic cells, oxidized LDL and the cytoskeletal antigens myosin and vimentin (Hervé et al. 2005; Catera et al. 2008; Chu et al. 2008). In contrast, M-CLL BCRs are generally not polyreactive. Some stereotyped M-CLL could have a rheumatoid factor activity, recognizing the Fc-tail of IgG (Kostareli et al. 2012; Hoogeboom et al. 2012). A recently described subset can recognize exogenous antigens presents in yeasts and filamentous fungi, β -(1,6)-glucan (Hoogeboom et al. 2013).

1.4.4. Defective apoptosis and CLL kinetics

Conventionally, CLL is a disease of primarily defective apoptosis and passive accumulation of tumor cells. This view is supported by the observation that the great majority of peripheral circulating CLL cells is arrested in G0 or early G1 phase of cell cycle and has overexpression of antiapoptotic proteins, including Bcl-2 and Mcl-1. NF- κ B and PI3K/AKT pathways are constitutively activated in CLL and this leads to the transcription and overexpression of key antiapoptotic proteins.

The model of primarily defective apoptosis has been challenged recently by heavy-water experiments that have shown that CLL contains a small fraction of actively proliferating cell, with approximately 2% of cells newly generated each day. Subsequent studies underlined the intraclonal heterogeneity with a cell fraction that has a greater proliferation rate and CD38⁺, ZAP70⁺, Ki67⁺ and telomerase positive markers (Damle et al. 2007; Calissano et al. 2009). Though lymphocytes in the peripheral blood are predominantly resting, specific structures in the lymph nodes and bone marrow, known as proliferation centers, replenish the CLL population (Burger 2011). The “new” CLL cells have a distinct immunophenotype: CD5^{hi}CXCR4^{low}, whereas “resting” CLL cells are CD5^{low}CXCR4^{hi}, hence the hypothesis that upregulation of CXCR4 promotes reentry into the tumor environment, where the cells receive prosurvival signals, proliferate, and afterwards downregulate CXCR4 and are released back to peripheral blood (Lanasa 2010).

1.4.5. CLL microenvironment

The tumor microenvironment describes an admixture of malignant cells with host immune cells, stromal elements and vascular cells that create a niche wherein signals can be transmitted through antigen presentation, cell-cell interactions and paracrine signaling. The importance of the microenvironment in CLL is underlined by the fact that most CLL cells rapidly undergo apoptosis when they are removed from patients. Adding a number of cytokines or other cell types to the CLL cell culture can prevent this process. Bone marrow

stromal cells (BMSCs), which provide attachment sites and growth factors to hematopoietic precursors, were the first cells characterized to support CLL development. Another cell type that can attract and protect CLL cells from apoptosis is the nurse-like cell (NLC), a CD14⁺ mononuclear cell, abundant in the secondary lymphoid organs in CLL patients (Burger et al. 2000). NLCs express the chemokines CXCL12 and CXCL13, whereas BMSC predominantly express CXCL12, as described in Figure 7. Integrins, particularly VLA-4 (CD49d), expressed on the surface of CLL cells contribute to cell-cell adhesion through their respective ligands on stromal cells, VCAM-1 and fibronectin. NLCs also express the TNF family members BAFF and APRIL, providing survival signals to CLL.

CD31, expressed on NLCs, represents an interaction partner for CD38⁺ CLL cells which leads to tyrosine phosphorylation of ZAP-70 and intracellular signaling (Deaglio et al. 2005).

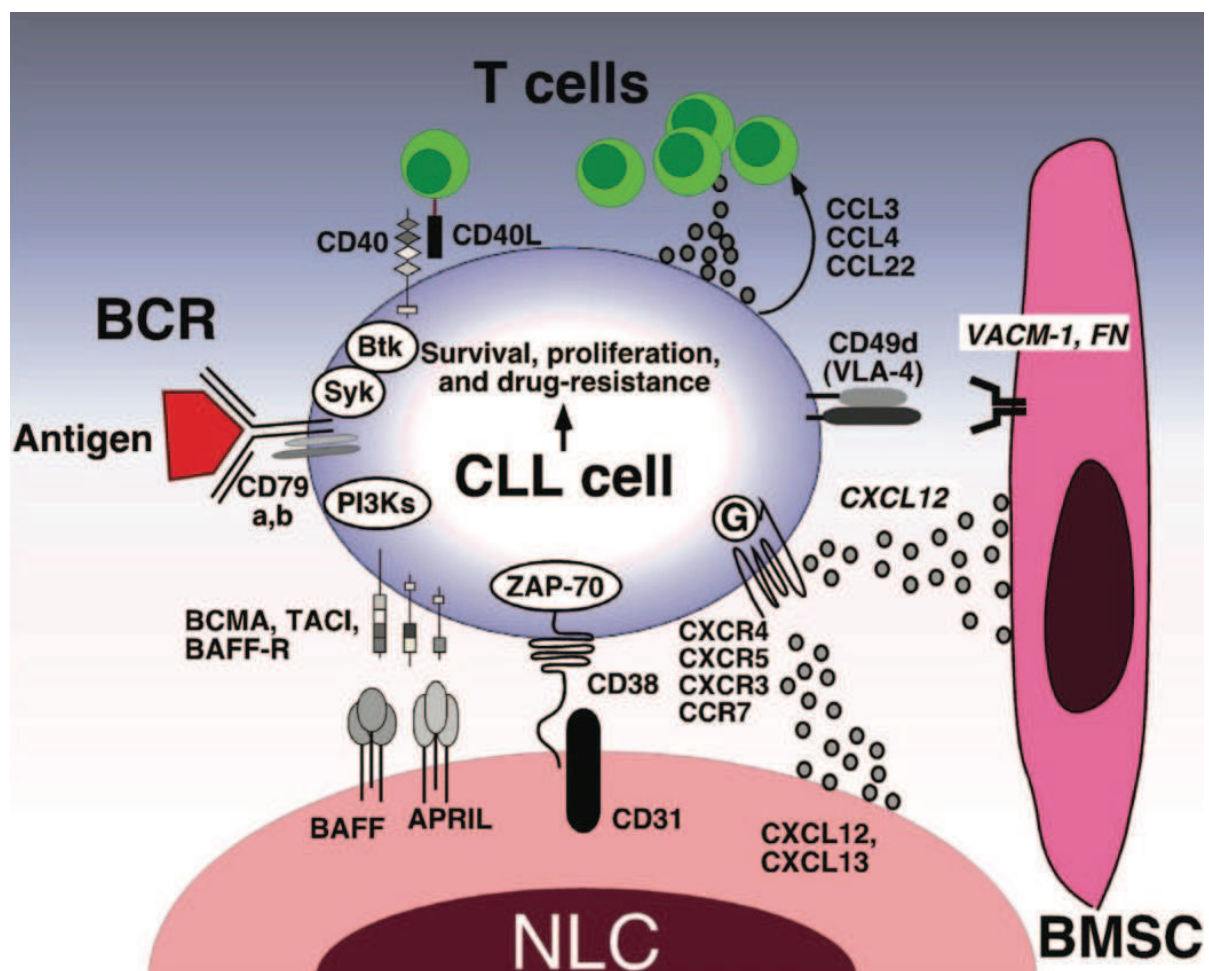

Figure 7. CLL microenvironment (Burger 2011).

T cells represent another important actor in CLL microenvironment. In untreated patients, the overall number of circulating T cells is increased (Markey et al. 1986), although oligoclonal in both CD4 and CD8 compartment. T cells can stimulate CLL cells through the interaction of CD40 and CD40L, and this stimulus synergizes with BCR signaling. In proliferation centers, activated CD4⁺ T cells colocalize with proliferating CD38⁺ CLL cells, suggesting that T cells subpopulations promote the expansion of the CLL clone (Patten et al. 2008). CLL cells also induce phenotypical changes in T cells, the most prominent of which is a defective and reduced formation of the immunological synapse, a dysfunction that can be reversed with the immunomodulatory drug lenalidomide (Ramsay et al. 2008).

1.4.6. Genetic and epigenetic features of CLL

In CLL, standard metaphase cytogenetic studies have been hindered by the inability to effectively induce proliferation of tumor cells in vitro. Nevertheless, recently improved culture methods (using CD40L or CpG oligonucleotide with IL-2 stimulation) and the use of fluorescence in situ hybridization (FISH), which does require isolation of dividing cells, detected chromosomal abnormalities in more than 80% of CLL cases (Dicker et al. 2006). No single genetic abnormality responsible for CLL development has been identified. Instead, the disease is characterized by a variety of affected chromosomal regions, with prognostic significance.

➤ Deletions in 13q

Loss of 13q14.3 is the most common chromosome aberration in CLL, with a prevalence of 40-60% (Van Bockstaele, Verhasselt, and Philippé 2009). In contrast to other recurrent aberrations, 13q14 deletions may be heterozygous (mono-allelic in 76% of cases) or homozygous (bi-allelic in 24% of cases) (Rodríguez-Vicente, Díaz, and Hernández-Rivas 2013). No inactivation of candidate genes by mutation has been demonstrated, but a complex epigenetic regulatory tumor suppressor mechanism that would control the expression of the

entire region has been proposed (Mertens et al. 2006). Croce and coworkers (Calin et al. 2002) were the first to show that 13q14 deletion in CLL is associated with downregulation of miR-15a and miR-16-1. This was the first link between miRNAs and cancer. Both miR-15a and miR-16-1 deletion accelerates the proliferation of both human and mouse B cells by modulating the expression of genes controlling the cell cycle progression, suggesting a direct pathogenic role in CLL (Klein et al. 2010).

➤ **Deletion of 11q**

Although rare in early-stage disease, approximately one-quarter of patients with advanced CLL have 11q23 deletions. Patients with 11q23 deletions are generally younger, have more B-symptoms, a more aggressive disease and extensive lymphadenopathy (Döhner et al. 1997). The minimal consensus region in bands 11q22.3-q23.1 harbors the ataxia telangiectasia-mutated (ATM) gene in almost all cases. The ATM protein kinase is a central component of the DNA damage pathway and mediates cellular responses to DNA double-strand breaks. ATM activates cell cycle check-points, can induce apoptosis in response to DNA breaks and functions directly in the DNA double-strand breaks by maintaining DNA ends in repair complexes. ATM deficiency leads to ataxia-telangiectasia, which is characterized by extreme sensitivity to irradiation, genomic instability and a predisposition to lymphoid malignancies (Lavin 2008).

➤ **Trisomy 12**

Trisomy 12 is among the most frequent aberrations in CLL, occurring in 10-20% of cases. It has long been associated with early progression, but although the progression-free survival (PFS) may be short, overall survival (OS) is favorable. This feature is explained by the fact that cases with trisomy 12 rarely show TP53 mutations and rarely acquire these over time (T. Zenz et al. 2010). Trisomy 12 is associated with an atypical morphology and immunophenotype (Matutes et al. 1996), but the critical genes involved in this chromosomal aberration remain unknown.

➤ **Deletion of 17p**

Deletion of 17p is found in 3-8% of patients who are naïve to treatment, although higher occurrences of up to 30% is reported in advanced, relapsed cases (Döhner et al. 2000). Although the 17p deletion usually encompasses most of the short arm of chromosome 17p, the deletion always includes band 17p13, where the tumor suppressor TP53 (which encodes p53) is located. Among CLL cases that have monoallelic 17p13 deletions, the majority show mutations in the remaining TP53 allele (Zenz et al. 2008). The tumor suppressor p53 plays an essential role in inducing apoptosis or cell cycle arrest after DNA damage. Therapy with fludarabine and alkylating agents is based on a p53-dependent mechanism, which could explain why patients with 17p deletions or inactivating mutations of TP53 are refractory to such chemotherapy. This chromosomal aberration is associated with a very aggressive clinical course, with lower PFS, lack of response to therapy or short response duration and short OS.

➤ **Complex karyotype**

Although CLL is characterized by a relatively stable genome and most CLL cases appear to carry few genomic aberrations, a high number of copy number alterations (over 3 per patient), termed genomic complexity, is detected in 20% of cases (Rodríguez-Vicente, Díaz, and Hernández-Rivas 2013). New chromosomal abnormalities can be acquired by the CLL clone during the course of disease, defining the concept of “clonal evolution”.

➤ **Whole exome sequencing data in CLL**

Recently, whole exome sequencing studies revealed recurrent genetic lesions that affect genes implicated in different biological pathways of potential pathogenic relevance for CLL (Fabbri et al. 2011; Puente et al. 2011; Wang et al. 2011; Quesada et al. 2011). These genes include NOTCH1, SF3B1, BIRC3 and MYD88.

Mutational activation of NOTCH1 was first described in T cell acute lymphoblastic leukemia, where it accounts for more than 50%. In CLL NOTCH1 mutations occur in 10% of cases at diagnosis, with a higher frequency in advanced disease. This mutation is associated with poor prognosis, with unmutated IGHV and with trisomy 12. NOTCH1 encodes a ligand-dependent transcription factor that regulates cell growth control.

Mutations in the splicing factor 3b subunit 1 (SF3B1) were found in approximately 10% of CLL cases at diagnosis, but are more frequent in later stages, predicting a poorer prognosis and associating with other markers of poor prognosis, like ZAP-70. SF3B1 is a major component of both minor and major type of spliceosomes and regulates the alternative splicing program of genes controlling cell cycle progression and apoptosis. Although selectively restricted to CLL across the spectrum of B cell neoplasias, this type of mutation is highly recurrent in myelodysplastic syndromes (Hahn and Scott 2012).

Inactivating mutations in BIRC3 have also been reported in 24% of fludarabine-refractory CLLs, although rare (4%) in CLL cases at diagnosis (Rossi et al. 2012). Patients with a molecular lesion of BIRC3 have a constitutive activation of noncanonical NF- κ B pathway, BIRC3 being a negative regulator of this pathway. Mutations in BIRC3 appear to be specific for CLL and for splenic marginal-zone lymphomas (Rossi et al. 2011).

Whole exome sequencing studies revealed mutations in several other genes in CLL, albeit at low frequencies. Of these, MyD88 is mutated in 3-5% of CLL cases at diagnosis, is associated with mutations in the IGHV region and is also implicated in other B cell malignancies.

The complex association between gene mutations, genomic aberrations and IGHV mutational status was recently analyzed in a large study of 573 patients of CLL8 German study group, represented in Figure 8 (Stilgenbauer et al. 2014).

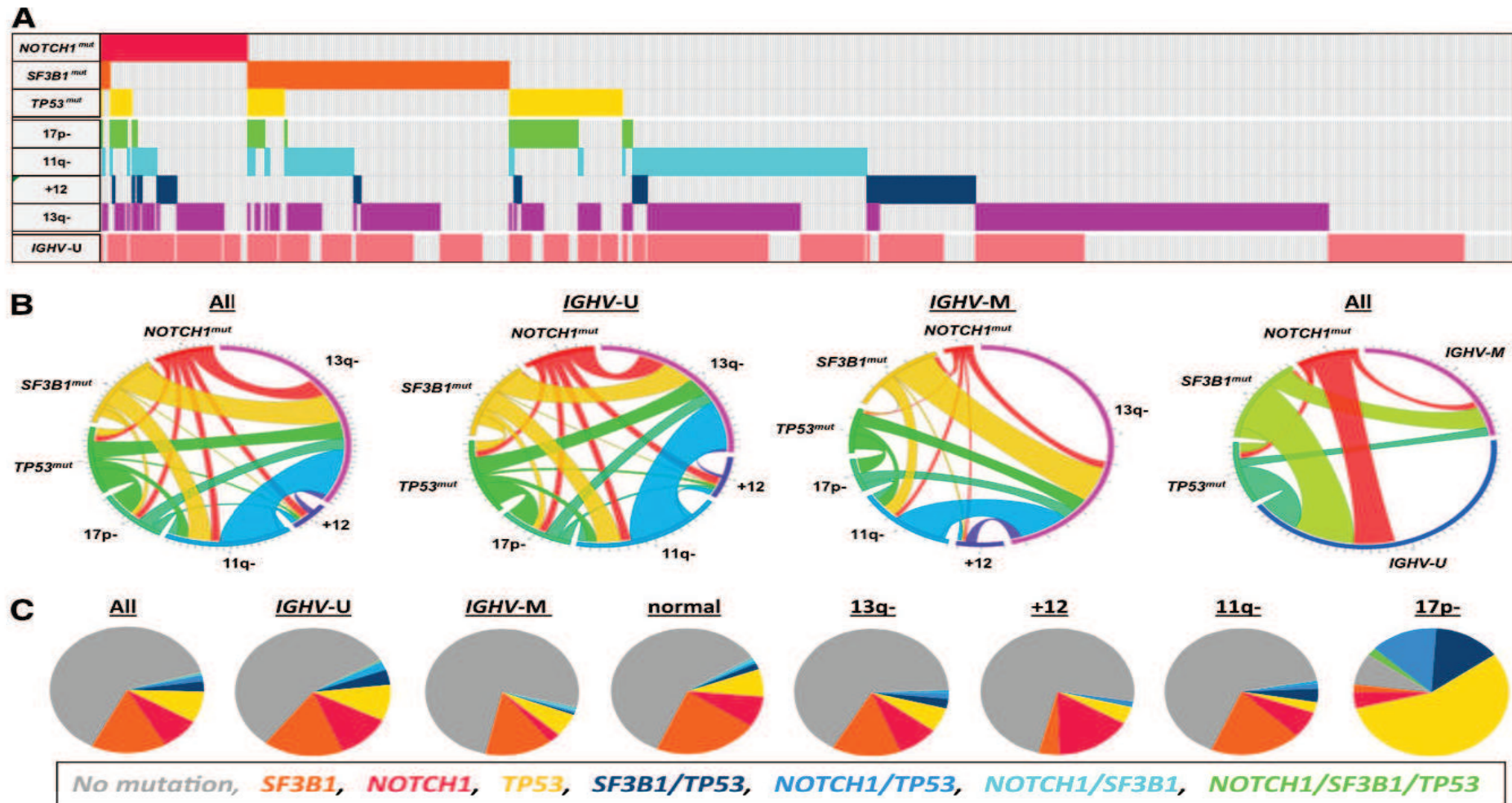

Figure 8. (A) Cluster diagram of patients (columns) and genetic parameters (rows). White boxes indicate patients without gene mutation, without aberrations (“normal FISH” group), or with mutated IGHV. (B) Circle diagrams of the pairwise co-occurrence of genomic aberrations with mutations for all patients (left), for IGHV subgroups (middle 2 panels), and of the pairwise co-occurrence of IGHV status with mutations (right). The length of the arc corresponds to the frequency of the marker alone plus its pairwise occurrence, whereas the width of the ribbon corresponds to the proportion of co-occurrence with the second marker. (C) Pie charts illustrating the occurrence and co-occurrence of mutations in all patients (left) and in subgroups defined by IGHV status and genomic aberrations (other panels). Mutations in TP53, NOTCH1, SF3B1, and combinations of mutations are indicated by the color code given at the bottom (Stilgenbauer et al. 2014).

➤ Epigenetic features of CLL

Aberrant epigenome modifications contribute to the pathogenesis of CLL. These modifications are the result of a combinatorial contribution of changes in DNA methylation, histone modifications and non-coding RNA.

DNA from CLL patients is globally hypomethylated when compared with DNA from peripheral blood mononuclear cells from healthy individuals (Wahlfors et al. 1992; Kulis et al. 2012). However, in CLL the expression of tumor suppressor genes is commonly silenced by regional hypermethylation of gene promoters. Gene-specific hypomethylation events have also been described in CLL, for example hypomethylation of BCL2 and of T cell leukemia/lymphoma 1 (TCL1) (Hanada et al. 1993; Yuille et al. 2001). Interestingly, the expression levels of ZAP-70 correlate closely with the methylation of specific CpG islands in the gene (Corcoran et al. 2005; Claus et al. 2012; Claus et al. 2014). Overall, DNA methylation scores have been indicated as strong independent predictors of CLL progression, and differences in global methylation profiles between prognostic subsets of CLL have been reported (Yu et al. 2007; Kanduri et al. 2010).

MicroRNAs (miRNAs or miR) are non-coding RNA molecules (≈ 22 nucleotides) that have the capacity for simultaneous regulation of tens to hundreds of genes through direct targeting of the untranslated regions. The first description of a miRNA associated with cancer was reported in CLL in 2002, being followed by several different miRNA associated with CLL. These miRNA signatures could act as surrogate prognostic biomarkers in CLL, as the expression levels of these miRNAs correlate with previously established prognostic markers such as IGHV mutation status or ZAP-70, as indicated in Table 4 (Calin et al. 2005).

Signature Component	MicroRNA Component	Chromosomal Location	P Value	Level of Expression in Group 1†	Putative Targets‡	Comment§
1	<i>miR-15a</i>	13q14.3	0.02	High	<i>BCL2, CNOT6L, USP15, PAFAH1B1, ESRRG</i>	Cluster <i>miR-15a-miR-16-1</i> Deleted in CLL and prostate carcinoma ¹⁰
2	<i>miR-195</i>	17p13	0.02	High	<i>BCL2, CNOT6L, USP15, PAFAH1B1, ESRRG</i>	Deleted in hepatocellular carcinoma
3	<i>miR-221</i>	Xp11.3	0.01	High	<i>HECTD2, CDKN1B, NOVA1, ZFPM2, PHF2</i>	Cluster <i>miR-221-miR-222</i>
4	<i>miR-23b</i>	9q22.1	0.009	High	<i>FNBP1L, WTAP, PDE4B, SATB1, SEMA6D</i>	Cluster <i>miR-24-1-miR-23b</i> FRA 9D; deleted in urothelial carcinoma ¹³
5	<i>miR-155</i>	21q21	0.009	High	<i>ZNF537, PICALM, RREB1, BDNF, QKI</i>	Amplified in a child with Burkitt's lymphoma ¹⁶
6	<i>miR-223</i>	Xq12-13.3	0.007	Low	<i>PTBP2, SYNCRIP, WTAP, FBXW7, QKI</i>	Expression normally restricted to myeloid lineage ²³
7	<i>miR-29a-2</i>	7q32	0.004	Low	NA	Cluster <i>miR-29a-2-miR-29b-1</i> FRA7H; deleted in prostate carcinoma ¹³
8	<i>miR-24-1</i>	9q22.1	0.003	High	<i>TOP1, FLJ45187, RSBN1L, RAP2C, PRPF4B</i>	Cluster <i>miR-24-1-miR-23b</i> FRA 9D; deleted in urothelial carcinoma ¹³
9	<i>miR-29b-2</i>	1q32.2-32.3	<0.001	Low	NA	
10	<i>miR-146</i>	5q34	<0.001	High	<i>NOVA1, NFE2L1, C1orf16, ABL2, ZFYVE1</i>	
11	<i>miR-16-1</i>	13q14.3	<0.001	High	<i>BCL2, CNOT6L, USP15, PAFAH1B1, ESRRG</i>	Cluster <i>miR-15a-miR-16-1</i> Deleted in CLL and prostate carcinoma ¹⁰
12	<i>miR-16-2</i>	3q26.1	<0.001	High	Same as for <i>miR-16-1</i>	Identical to <i>miR-16-1</i>
13	<i>miR-29c</i>	1q32.2-32.3	<0.001	Low	NA	

* All the members of the signature are mature microRNAs. NA denotes not available, and FRA fragile site.

† Group 1 includes patients with unmutated *IgV_H* and high expression of ZAP-70, both of which are predictors of poor prognosis.

‡ The top five putative targets identified with use of TargetScan at <http://genes.mit.edu/targetscan>²² were included.

§ Specific gene names are available at www.ncbi.nlm.nih.gov/entrez.

Table 4. MicroRNA signature associated with prognostic factors (ZAP-70 expression and IGHV mutations) and disease progression in patients with CLL (NA denoted not available; FRA fragile sites) (Calin et al. 2005).

The introduction of next-generation sequencing (NGS) has led to a breathtaking exponential increase of the knowledge of the molecular underpinnings of the CLL over the past three years, as shown in Figure 9 (Gruber and Wu 2014).

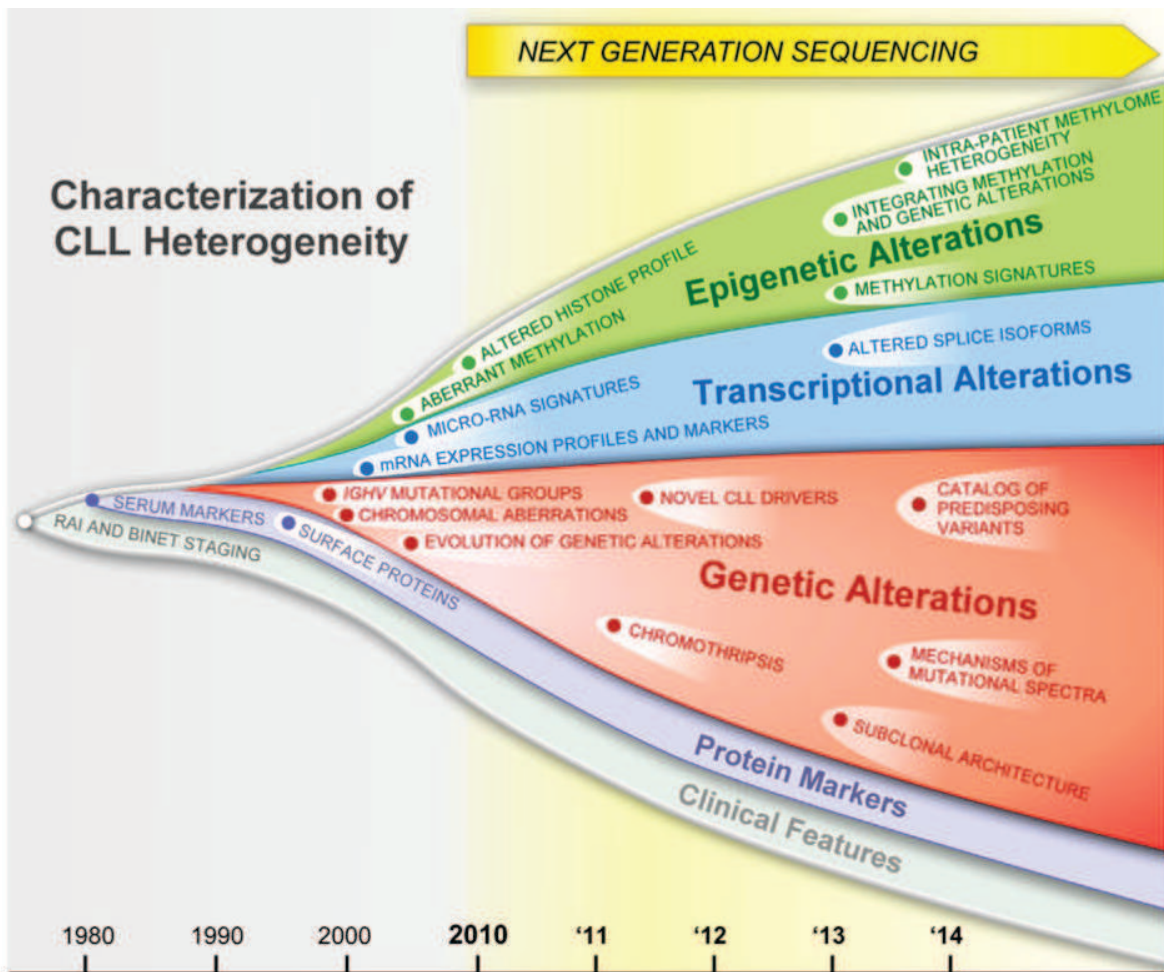

Figure 9. Evolution and growth of our understanding of CLL heterogeneity over time (Gruber and Wu 2014).

1.5. STAGING AND PROGNOSTIC FACTORS

CLL is a disease with a very heterogeneous evolution. Cases with symptomatic, advanced disease, associating medullary insufficiency signs could have an overall survival of less than 2 years, and other cases can be stable and asymptomatic for over 20 years. Based upon the lack of survival advantage observed to date with early treatment, therapy for CLL is not initiated until symptoms or clinical signs develop. Over the recent years, highly effective and potentially curative approaches such as combination of immune and chemotherapy, targeted molecular therapy and allogeneic stem cell transplantation have been

developed in CLL. Hence, it is very important to identify CLL patients who are more likely to require aggressive intervention or who are more likely to respond to a given therapy. To this effect, molecular and cellular markers have been described to stratify patients to different treatment options.

1.5.1. Clinical stage according to Binet and Rai

Historically, the staging for patients with CLL has been based on only physical examination and complete blood count. Bone marrow examination is not mandatory at diagnostic, but is especially indicated in cases with cytopenia of uncertain origin. Two staging systems are used for classifying CLL patients in risk groups and for assessing the indication for treatment.

The Rai system, proposed in 1975, is based upon a hierarchical grouping in 5 stages of disease manifestations of blood, enlarged lymph nodes, spleen and liver, and bone marrow failure (anemia and thrombocytopenia) (Rai et al. 1975).

Rai classification system			
Stage	Description	Median survival (months)	Risk status (Modified Rai)
0	Blood lymphocytosis and >40% of bone marrow involvement	> 150	Low
I	Stage 0 with lymphadenopathy	100	Intermediate
II	Stage 0-I with splenomegaly, hepatomegaly, or both	70	Intermediate
III	Stage 0-II with anemia (Hb <11g/dl)	20	High
IV	Stage 0-III with thrombocytopenia (platelets <100000/ μ l)	20	High

Table 5. Rai classification system.

In 1981 Binet and coworkers proposed the Binet classification system with 3 stages (A, B, C), which takes into account five potential sites of involvement: cervical, axillary and inguinal lymph nodes (whether unilateral or bilateral, each area is counted as one), spleen and liver. It recognizes that the form with predominant splenic involvement has a better prognosis that initially recognized in the Rai system, and that the presence of anemia or thrombocytopenia has the same prognostic impact (Binet et al. 1981). None of these two classifications makes the difference between autoimmune cytopenia and that by bone marrow infiltration.

Binet classification system			
Stage	Description	Median survival (months)	Risk status
A	Hemoglobin ≥ 10 g/dl and platelets $\geq 100000/\mu\text{l}$ and < 3 nodal areas	> 120	Low
B	Hemoglobin ≥ 10 g/dl and platelets $\geq 100000/\mu\text{l}$ and ≥ 3 nodal areas	60	Intermediate
C	Hemoglobin < 10 g/dl and/or platelets $< 100000/\mu\text{l}$ and any number of involved nodal areas	32	High

Table 6. Binet classification system.

1.5.2. Markers of tumor burden

Apart from the clinical staging systems, other easily assessable parameters of disease activity and tumor burden have also been shown to be of prognostic significance. High lymphocyte counts and the bone marrow infiltration pattern are associated with disease activity. Patients whose absolute lymphocyte counts double (the lymphocyte doubling time) in less than one year often have a worse clinical course than those whose clone accumulates less quickly (O'Brien and Gribben 2008).

1.5.3. Serological markers

Elevated LDH levels and β 2-microglobulin have been shown to have significant prognostic value in lymphoma and myeloma and correlates with disease burden in CLL. Thymidine kinase (TK) is an enzyme involved in the salvage pathway of DNA synthesis and correlates with proliferative activity. Elevated TK levels predict disease progression in CLL. CD23 is one of the immunophenotypic hallmark of CLL and is a multifunctional molecule, acting as a low-affinity receptor for IgE, as an adhesion molecule by its ability to promote T-B interaction and as a membrane-bound cytokine that can be cleaved to generate soluble fragments with cytokine properties, and as a marker of cellular activation, particularly for B cells. Soluble CD23 (sCD23) levels at initial diagnosis were linked with disease progression in early stage CLL (Sarfati et al. 1996).

1.5.4. IGHV mutational status

The initial supposition that CLL represents a homogenous disease with a similar immunophenotype was for the first time questioned by the fact that about 50% of CLL clones exhibit somatic mutations of their immunoglobulin genes, suggesting that some of CLL clones can arise from post-germinal center B cells (Schroeder and Dighiero 1994; Fais et al. 1998).

The term IGHV is used because only the heavy chain variable genes are sequenced in routine to assess the mutational status of a CLL, although the light chain variable genes are also mutated in IGHV mutated cases. European research initiative on CLL (ERICLL) published recommendations on how to perform and interpret IGHV mutation analysis in CLL to avoid discrepancies between laboratories (Ghia et al. 2007; Langerak et al. 2011). IGHV genes with at least 98% similarity with germline sequences define U-CLL and genes with less than 98% homology define the M-CLL subset. The percentage of identity is calculated based on the ratio between the number of nucleotide differences (mutations within the IGHV region) of the IGHV-D-J rearranged sequence and the length in nucleotides of the most homologous germline IGHV gene, from the first codon of FR1 to the last codon of CDR3.

Two papers published at the same time first assessed the prognostic value of mutational status of IGHV (Hamblin et al. 1999; Damle et al. 1999). This was confirmed by several other studies and assessed as the reference prognostic value for subsequently described prognostic factors. Survival is significantly worse for patients with U-CLL, irrespective of clinical stage. Median survival for Binet stage A patients with U-CLL was 95 months compared with 293 months for patients with M-CLL, as in Figure 10. The 98% sequence homology cut-off that is typically used to define this separation is arbitrary, and “gray-zone cases” (for example, those that have a IGHV homology of 97-98%) seem to have an intermediate prognosis (Hamblin, Davis, and Oscier 2008).

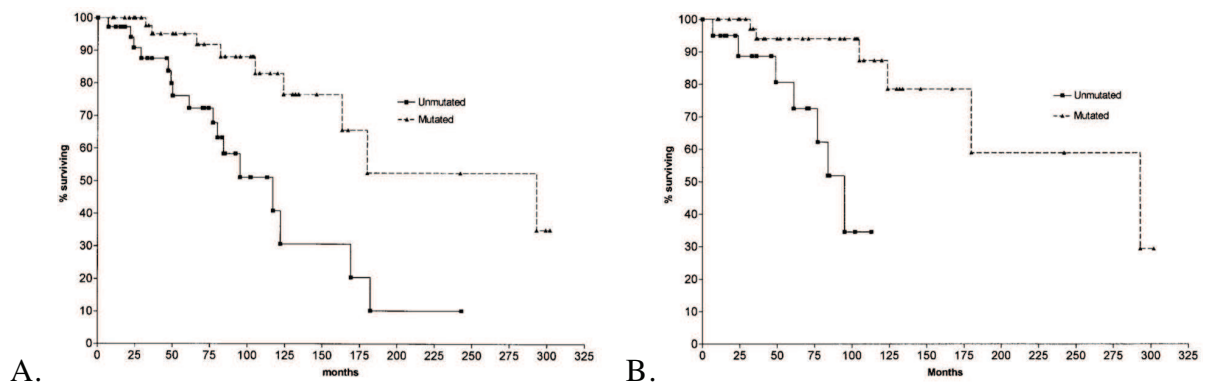

Figure 10. Kaplan-Meier survival curve comparing 84 CLL patients with mutated and unmutated IGHV. A: all CLL patients with mixed clinical stages. B: only Binet stage A patients (Hamblin et al. 1999).

Furthermore, the presence or absence of IGHV mutations in CLL cells correlates with the use of specific VH genes as well as certain characteristics of VH-D-JH and VL-JL rearrangements identified in these cells. For example, VH1-69 is generally found in U-CLL, whereas VH3-07 and VH4-34 often contain somatic mutations (Schroeder and Dighiero 1994; Fais et al. 1998). There is one important exception, however, for patients expressing the VH3-21 gene, who present a poor prognosis, irrespective of their mutational status of IGHV (Thorsélius et al. 2006).

The determination of IGHV mutational status is laborious, expensive and time-consuming, rendering this method difficult to implement in routine hematological

laboratory. Therefore many efforts have been made to identify possible surrogate markers with the same prognostic value as the mutational status.

1.5.5. ZAP-70 as a prognostic factor in CLL

In order to identify possible surrogate markers for the IGHV mutational status, comparative micro-array experiments were performed on M-CLL and U-CLL (Rosenwald et al. 2001). Surprisingly, a common gene expression signature was found for the two groups, but, nevertheless, the expression of hundreds of genes was different between them. The most differentially expressed gene between CLL subtypes was the gene encoding the zeta-associated protein of 70 kDa (ZAP-70), which is normally expressed in T cells and NK cells. The hierarchical clustering of genes that most strongly discriminate between M-CLL and U-CLL subtypes is revealed in Figure 11.

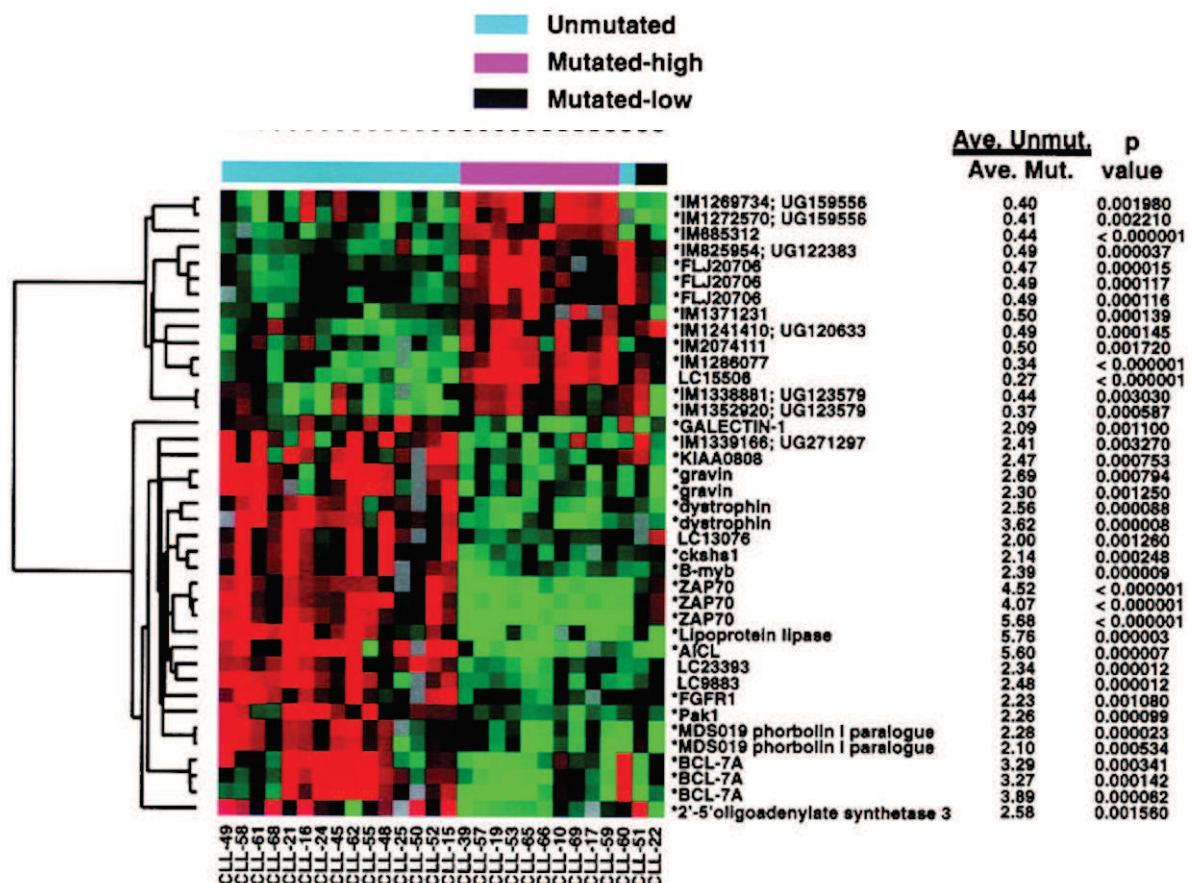

Figure 11. Hierarchical clustering of gene expression levels that most strongly discriminate between M-CLL and UM-CLL. Also shown for each gene is the ratio of mean expression of the gene in UM-CLL versus M-CLL samples (Rosenwald et al. 2001).

The same authors suggested two ZAP-70 assays for potential clinical applications, based on real-time PCR and on immunohistochemistry (Wiestner et al. 2003). In practice however, flow cytometry turned out to be the preferred technique for assessing ZAP-70 expression in CLL cells. Crespo et al. were the first to describe the method and they have also established a threshold for the positivity of ZAP-70 in CLL cells of 20%, stating that 98% of T cells and NK cells were positive for ZAP-70 (Crespo et al. 2003). The method used to quantify the percentage of CLL cells expressing ZAP-70 is shown in Figure 12. This study also stated that the level of ZAP-70 expression doesn't vary over time in the evolution of CLL disease.

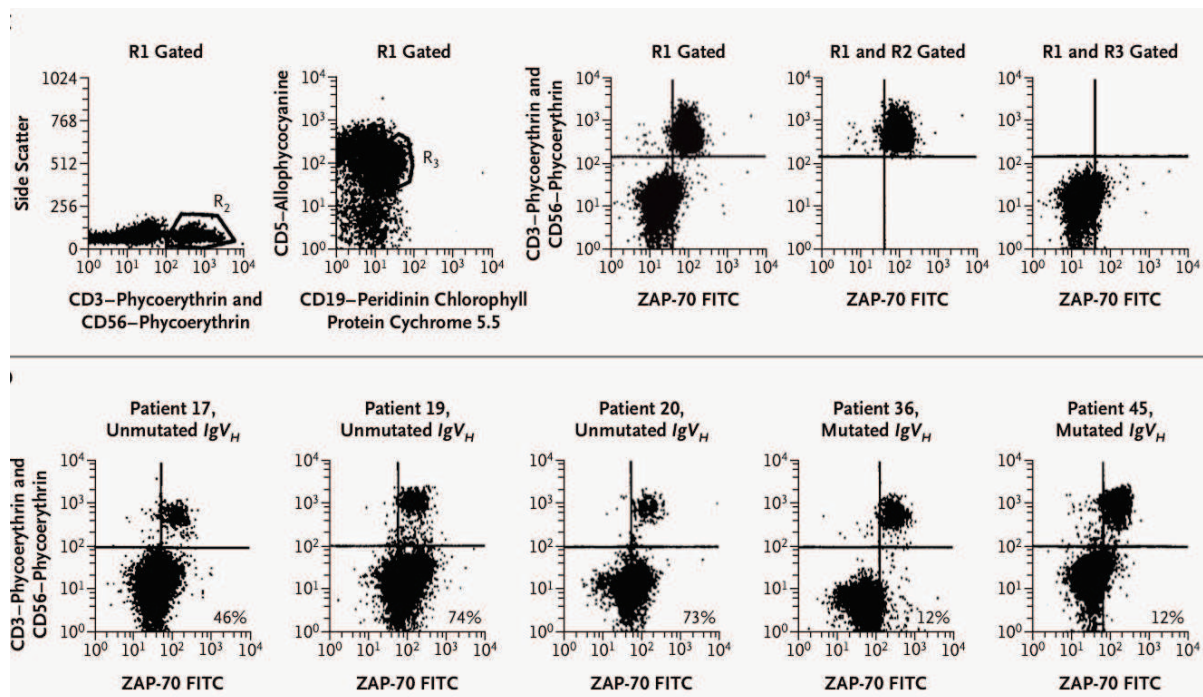

Figure 12. Flow cytometric method used to quantify the expression of ZAP-70 in CLL cells. R1 gate is drawn around lymphocytes in forward and side scatter of lysed blood. The upper panel shows the method used to quantify the expression of ZAP-70 in CLL cells. R2 represents T and NK cells (CD3+ CD56+) and R3 gate represents CLL cells (CD19+ CD5+). The lower panel shows the level of ZAP-70 expression of 5 cases of CLL with their IGHV mutational status (Crespo et al. 2003).

In Binet stage A patients, high expression of ZAP-70 is associated with a high probability of progression and a shorter overall survival, as shown in Figure 13.

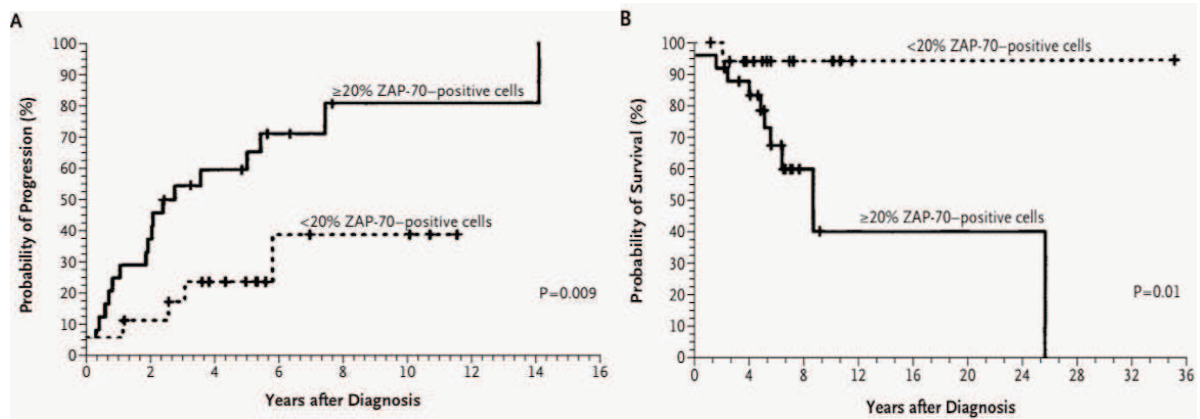

Figure 13. Kaplan-Meier estimates of probability of progression (panel A) and of probability of survival (panel B) among patients with stage A CLL, according to the level of ZAP-70 expression. The median time to progression among 26 patients with high ZAP-70 expression (20% or more) was 29 months, whereas it was not reached in 18 patients with low ZAP-70 expression ($< 20\%$) (Crespo et al. 2003).

Several other studies have confirmed the prognostic power of ZAP-70, as well as the association between IGHV mutational status and ZAP-70 expression. An overview of these studies is presented in Table 7 (Van Bockstaele, Verhasselt, and Philippé 2009; Wiestner et al. 2003; Crespo et al. 2003; Dürig et al. 2003; Orchard et al. 2004; Rassenti et al. 2004; Laurenti et al. 2005; Opezzo et al. 2005; Schroers et al. 2005; Catherwood et al. 2006; Del Principe 2006; Hus 2006; Krober 2006; Van Bockstaele, Janssens, et al. 2006; Vener et al. 2006; Arena et al. 2007; Muñoz et al. 2007; Van Bockstaele, Pede, et al. 2006; B. Stamatopoulos et al. 2007; Zanotti et al. 2007).

Reference	n	Method	Cutoff value	Prognostic value (survival)	Association with mutation status			Association with other prognostic parameters
					Overall (%)	PPV (%)	NPV (%)	
Wiestner et al.	107	Micro-array	(optimal)	Yes (TFS)	93	86	96	del13q, tris12, del11q
Wiestner et al.	43	IHC (2F3.2)	NA	ND	86	71	100	ND
Crespo et al.	56	FC (2F3.2)	20%	Yes (PFS, OS)	95	100	88	CD38
Dürig et al.	39	qPCR (GPDH)	Ratio = 0.13	Yes (TFS, OS)	ND	ND	ND	LDH, sTK, CD38, β 2-M, bone marrow histology, need for treatment
Dürig et al.	67	FC (1E7.2)	20%	Yes (TFS, OS)	ND	ND	ND	LDH, sTK, CD38, β 2-M, bone marrow histology, need for treatment
Orchard et al.	167	FC (2F3.2)	10%	Yes (OS)	92	88	94	CD38
Rassenti et al.	307	FC (1E7.2)	20%	Yes (TFS)	77	83	72	ND
Kim et al.	60	WB (29, tubulin)	Ratio = 1	No (OS)	ND	ND	ND	Stage
Carreras et al.	52	IHC (2F3.2)	NA	Yes (OS, PFS)	92	94	86	ND
Del Giudice et al.	201	FC (2F3.2)	20%	Yes (TFS)	ND	ND	ND	Stage, morphology, CD38, tris12, del6q, del13q
Gibbs et al.	33	2F3.2	20%	ND	91	82	91	ND
Laurenti et al.	92	qPCR (Syk)	Ratio = 0.25	Yes (TFS)	86	79	90	ND
Laurenti et al.	73	FC (1E7.2)	20%	ND	71	57	80	ND
Oppezzo et al.	93	FC (2F3.2)	20%	Yes (EFS)	85	77	92	LPL/ADAM29 ratio
Schroers et al.	252	FC (2F3.2)	20%	Yes (TFS)	ND	ND	ND	CD38, stage, LDH, sTK, β 2-M, auto-immune complications
Catherwood et al.	42	qPCR (18s)	(optimal)	ND	93	89	96	ND
Del Principe et al.	140	FC (1E7.2)	20%	Yes (PFS, OS)	80	60	93	Stage, karyotype, CD38, sCD23, bulky lymphadenopathy, β 2-M, LDT
Hus et al.	156	FC (2F3.2)	20%	Yes (EFS)	ND	ND	ND	LC, LDH, CD38, stage
Kröber et al.	148	FC (2F3.2)	20%	Yes (OS, TFS)	75	81	68	Karyotype
Van Bockstaele et al.	53	FC (2F3.2)	D = 0.84	ND	77	81	75	ND
Van Bockstaele et al.	53	FC (2F3.2)	11%	ND	77	74	81	ND
Van Bockstaele et al.	53	qPCR (PBGD, ABL)	(optimal)	ND	83	74	100	ND
Vener et al.	108	IHC (2F3.2)	NA	Yes (TFS)	ND	ND	ND	karyotype, LDT, stage, need for treatment
D'Arena et al.	157	FC (1E7.2)	20%	Yes (TFS)	ND	ND	ND	CD38
Muñoz et al.	53	FC (2F3.2)	20%	ND	70	71	68	ND
Van Bockstaele et al.	57	FC (2F3.2)	15%	Yes (OS)	79	79	79	LPL
Van Bockstaele et al.	57	qPCR (PBGD, ABL)	(optimal)	No (OS)	84	76	96	LPL
Stamatopoulos et al.	105	qPCR (PPIA)	(optimal)	Yes (OS, TFS)	86	83	88	LPL, CD38, stage
Stamatopoulos et al.	91	FC (1E7.2)	20%	Yes (OS, TFS)	78	79	78	LPL, CD38
Zanotti et al.	156	IHC (2F3.2)	NA	Yes (PFS, OS)	80	75	84	CD38, stage, bone marrow histology, LDH, β 2-M, LDT

PPV, positive predictive value; NPV, negative predictive value.

IHC, immunohistochemistry (antibody); FC, flow cytometry (antibody); qPCR, quantitative PCR (reference gene); WB, western blot (antibody).

NA, not applicable; ND, not determined.

OS, overall survival; PFS, progression free survival; EFS, event free survival; TFS, treatment free survival.

LDH, lactate dehydrogenase; sTK, serum thymidine kinase; β 2-M, β 2-microglobulin; LDT, lymphocyte doubling time; sCD23, serum CD23; LC, lymphocyte count.

Table 7. Prognostic value of ZAP-70 expression.

Importantly, increased expression of ZAP-70 by CLL cells is a stronger predictor of the need for treatment than the presence of an unmutated IGHV genes, as depicted in Figure 14 (Rassenti et al. 2004). In general, discordant cases show an intermediate prognosis, with ZAP-70 positive M-CLL having a generally worse prognosis than ZAP-70 negative U-CLL group.

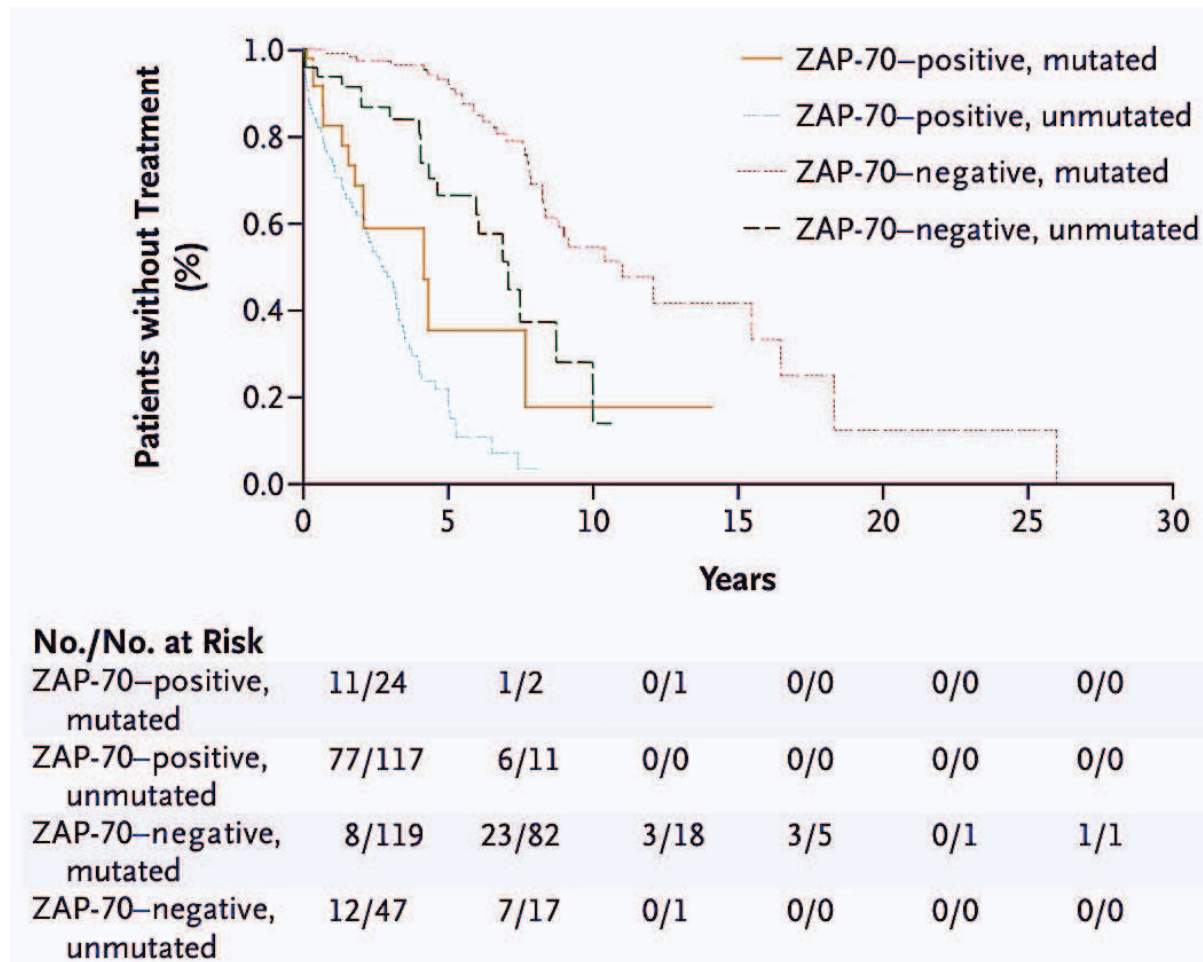

Figure 14. Relationship between ZAP-70 expression, IGHV mutational status, and the time from diagnosis to initial treatment. Kaplan-Meier curves depict the proportion of untreated patients with CLL according to the time since diagnosis (Rassenti et al. 2004).

The lack of a standardized consensus method for determination of ZAP-70 is the main bottleneck for the implementation of this parameter in clinical routine. Protein detection is preferred to mRNA detection methods from the functional point of view. Also,

since T and NK cells express high levels of ZAP-70, the quantitative real-time PCR (qPCR) and western blot techniques need highly purified CLL cells. Flow cytometry overcomes these difficulties and allows the simultaneous evaluation of ZAP-70 protein expression in CLL cells and in normal lymphocyte subsets. Although flow cytometry is generally accepted as the method of choice, several methodological aspects require standardization, such as the nature of the sample, the selection of ZAP-70 antibody (clone and labeling, direct or indirect), the choice of fluorochrome, the use of different fixation and permeabilization reagents and the method of analysis and expressing the results (percentage over a cutoff value, ratio of fluorescence, choice of reference lymphocyte population, isotopic control). In CLL, ZAP-70 expression shows a continuous spectrum, making difficult to establish a clear-cut distinction between ZAP-70 positive and negative patients.

A very recent study validated a ZAP-70 methylation assay at a certain nucleotide position that could be used in clinical routine for assessing ZAP-70 expression profile (Claus et al. 2014).

1.5.6. CD38 expression

CD38 expression identifies two subgroups in CLL, based on the percentage of CD38⁺ cells within the leukemic clone. In the majority of studies, the threshold is established at $\geq 30\%$ of CD38⁺ cells. The association between CD38 positivity and IGHV mutational status is not as good as the ZAP-70 expression, but CD38 can be considered an independent prognostic factor in CLL. The two subgroups of patients defined by the CD38 expression differ significantly in overall survival and in time to first treatment. Cell surface CD38 has a pivotal role in initiating and modulating a series of input signals from the microenvironment and is an indicator of the potential and actual degree of cellular activation of the clone. CD38⁺ fractions of CLL clones are enriched in cells expressing Ki-67 and ZAP-70 (Damle et al. 2002). The study of the signaling pathway activated upon CD38 ligation with an agonistic mAb highlighted that there is a direct functional link between CD38 and ZAP-70 with the surface receptor phosphorylating the kinase and that it is a functional dependency of CD38 on ZAP-70 (Deaglio et al. 2007).

1.5.7. CD49d

CLL cells with high levels of CD49d ($\geq 30\%$) are correlated with shorter survival. CD49d is a α -integrin subunit ($\alpha 4$) that can pair with CD29 (the $\beta 1$ subunit) to form a complete integrin ($\alpha 4\beta 1$) that binds fibronectin and VCAM-1. A large macromolecular complex comprising CD49d, CD38, CD44v and MMP-9 has been identified in U-CLL clones, bringing these prognostic markers into a presumptive biologic network (Buggins et al. 2011; Zucchetto et al. 2009). CD49d is overexpressed by almost all trisomy 12 CLLs and these overexpression is regulated by a methylation-dependent mechanism (Zucchetto et al. 2013).

1.5.8. LPL expression

Lipoprotein lipase (LPL) gene expression can be another surrogate marker for the IGHV mutational status in CLL. The ratio of LPL and ADAM29 (a disintegrin and metalloproteinase 29) mRNA expression showed 90% concordance with mutational status (Opezzo et al. 2005). Since LPL expression is low to absent in other blood cell types, its expression can be measured by quantitative PCR methods on peripheral blood mononuclear cells (PBMC) or even on lysed whole blood samples (Van Bockstaele, Pede, et al. 2006). LPL expression can have a functional role in CLL biology, because LPL positive and negative CLL subgroups have a distinct gene expression profile and the differentially expressed genes are mainly involved in fatty acid metabolism and cell plasticity (Bilban et al. 2006). Importantly, LPL was shown to be induced by stimulation of BCR, and the LPL inhibitor, orlistat, was able to induce apoptosis in CLL cells, suggesting an important role in CLL pathogenesis (Pallasch et al. 2008).

1.5.9. Genetic prognostic factors

Cytogenetic lesions identified by FISH as well as new mutational defects identified by next generation sequencing represent very important prognostic factors in CLL. As

recently proposed, by integrating mutational and cytogenetic analyses into a comprehensive and dynamic algorithm, we can obtain an improved prognostication model as we can see in Figure 15 (Rossi et al. 2013). This model proposes a four-subgroup classification of CLL cases:

1. high-risk, harboring TP53 and/or BIRC3 abnormalities (10-year survival: 29%)
2. intermediate-risk, harboring NOTCH1 and/or SF3B1 mutations and/or del11q (10-year survival: 37%)
3. low-risk, harboring trisomy 12 or a normal genetics (10-year survival: 57%)
4. very low-risk, harboring del13q only (10-year survival: 69,3%).

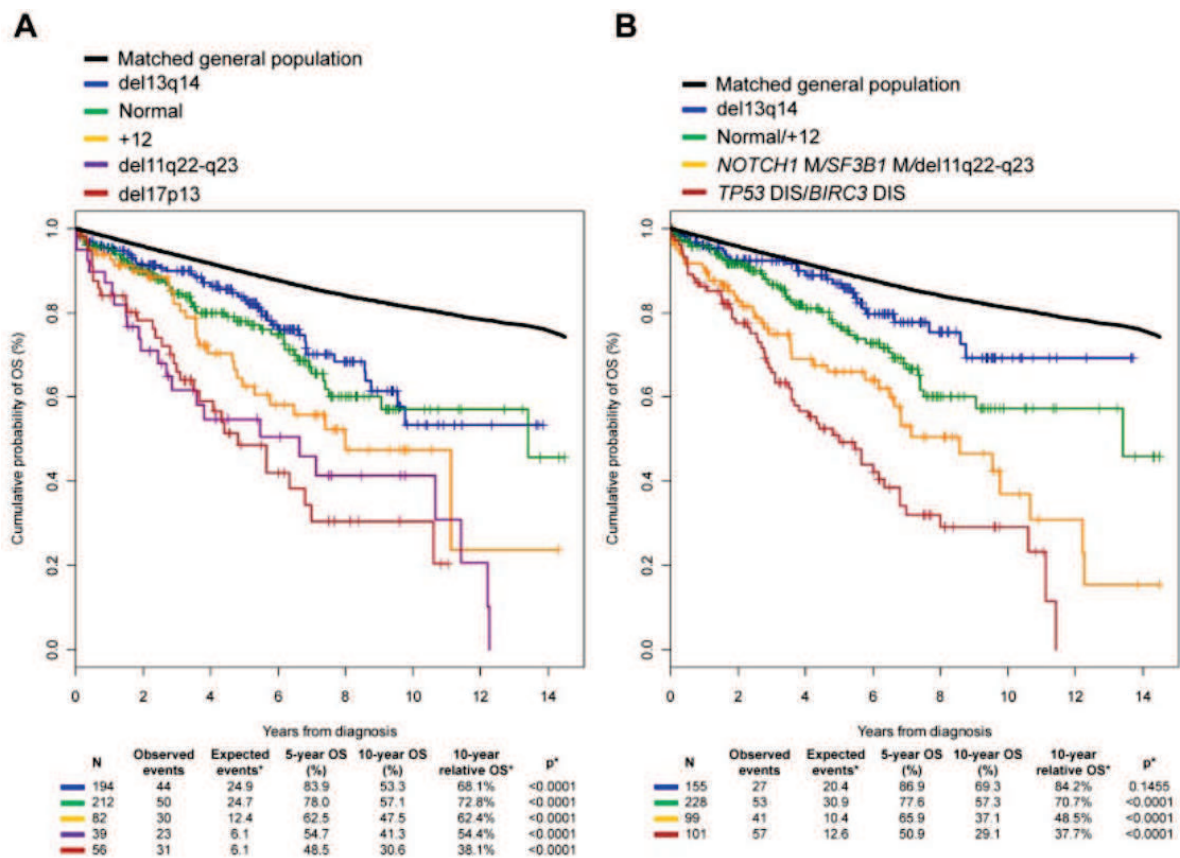

Figure 15. Observed overall survival of CLL patients compared with the expected overall survival in the matched general population. A: overall survival of CLL patients according to the FISH cytogenetic model. B: integrated mutation and cytogenetic model for the same patients (Rossi et al. 2013).

1.5.10. Minimal residual disease as a prognostic factor in CLL

Minimal residual disease (MRD) determined by different methods after the end of treatment cure represents a powerful prognostic factor in the evolution of the disease, although not used in routine clinical practice (Figure 16). MRD can be determined by allele-specific oligonucleotide IgH real-time quantitative PCR, which is generally accepted as the most sensitive technique, or by 8-color flow cytometry (FC), which have been recently demonstrated as a good reflection of the first (Raponi et al. 2014). Of note, quantification of MRD in peripheral blood or in bone marrow gives concordant results.

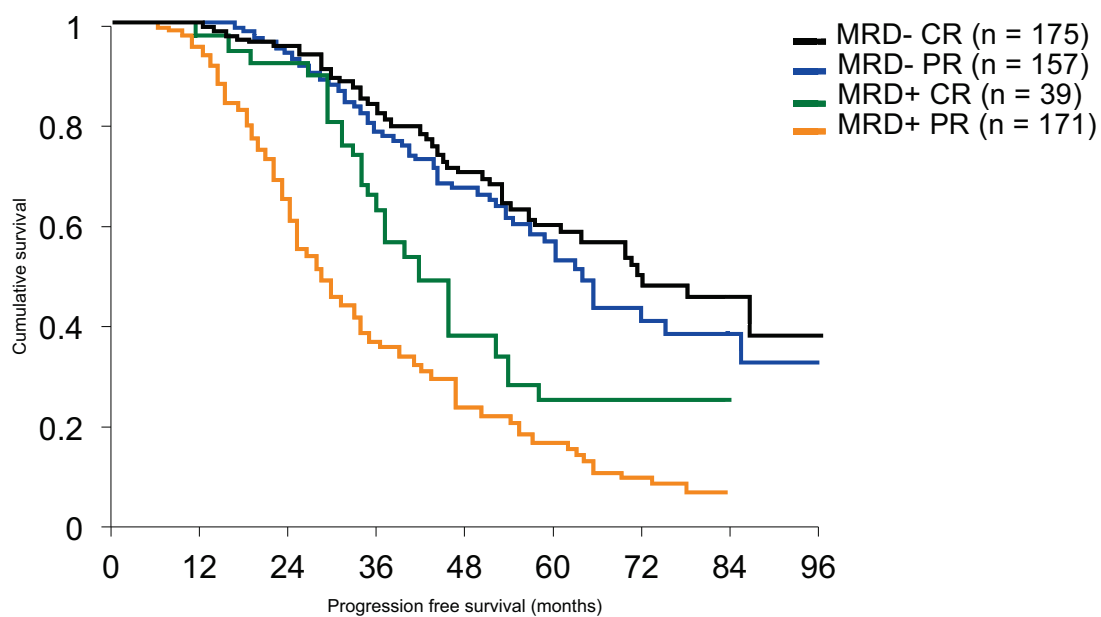

Figure 16. Value of minimal residual disease (MRD) negative status in combination with clinical response (CR = complete response; PR = partial response) two months after the end of therapy (Kovacs, Eichhorst, and Hallek 2014).

1.6. TREATMENT

Some patients with CLL have a normal life span and never require therapy, while others have a rapidly fatal disease despite therapy. In general, asymptomatic, early-stage (Binet A) patients should be monitored without therapy, regardless of prognostic markers. Early studies confirmed that the use of alkylating agents in patients with early-stage disease does not prolong survival (Trialists' Collaborative Group 1999). Still, the potential benefit of early intervention of new anti-leukemia drugs, alone or in combination, requires further study. Patients with Binet stage B and C usually require the initiation of treatment. Nevertheless, it is important to consider disease progression before assessing therapy initiation, because in some rapid progressive stage A cases a therapy is indicated and it can be delayed in some other stable, asymptomatic B stage cases. An ongoing phase III clinical trial (GCLLSG in cooperation with FCGCLL CLL7) is comparing early with delayed treatment (with Rituximab, Cyclophosphamide, Fludarabine, e.g. RFC) in Binet stage A CLL patients with high risk of progression.

The standard treatment consists of a combination of an anti-CD20 antibody and a chemotherapy agent (immuno-chemotherapy). The various combinations of the two are defined by the patient's age and comorbidities. For young and "fit" patients the combination of rituximab (an anti-CD20 monoclonal antibody), fludarabine (a purine analog agent) and cyclophosphamide (an alkylating agent) is the standard treatment. For aged, "unfit" patients less toxic regimens can be proposed, like rituximab and bendamustine or chlorambucil and an anti-CD20.

Currently, the only biologic markers taken into account in treatment decisions are del(11q) and del(17p) or TP53 mutation. Patients with 11q deletions have short progression-free survival (PFS) with traditional alkylating agents, which can be overcome by chemo-immunotherapy (Ghielmini et al. 2013). On the other hand, remission rates, PFS and OS of patients with del(17p) or TP53 mutations are poor, because CLL cells harboring these genetic lesions are resistant to alkylating agents and to purine analogs. For this type of patients early allogeneic stem cell transplantation or an anti-CD52 (alemtuzumab) monoclonal antibody treatment could be proposed. However, new TK inhibitors, such as ibrutinib and idelalisib, are usually preferred.

In second-line treatment, for relapsed or refractory cases, therapeutic choices are less consensual. As a general rule, the frontline therapy can be repeated if the duration of the first remission exceeds 24 months. In patients relapsing within 24 months of treatment or in del(17p) CLL the initial treatment should be changed. For this type of patients there are an increasing number of new molecules in clinical development, targeting a specific molecular or a signaling abnormality. Because the BCR signaling pathway has a predominant role in CLL pathogenesis, a very promising approach is to target this pathway, as exemplified in Figure 17. Some of these new agents are inhibitors of tyrosine kinase, like ibrutinib, idelalisib (CAL-101), or inducers of apoptosis, like ABT-199 (Bcl-2 inhibitor), or monoclonal antibodies with direct cytotoxic effect, like obinutuzumab (GA-101). Finally, CART-19 currently elicits the greatest enthusiasm in clinical trials, bridging malignant B cells to the antitumor effector T cells. To optimize the immunological synapse, lenalidomide is currently tested as a maintenance therapy, since it induces flare reaction when used as a first-line treatment (Ferrajoli et al. 2008; Chen et al. 2011).

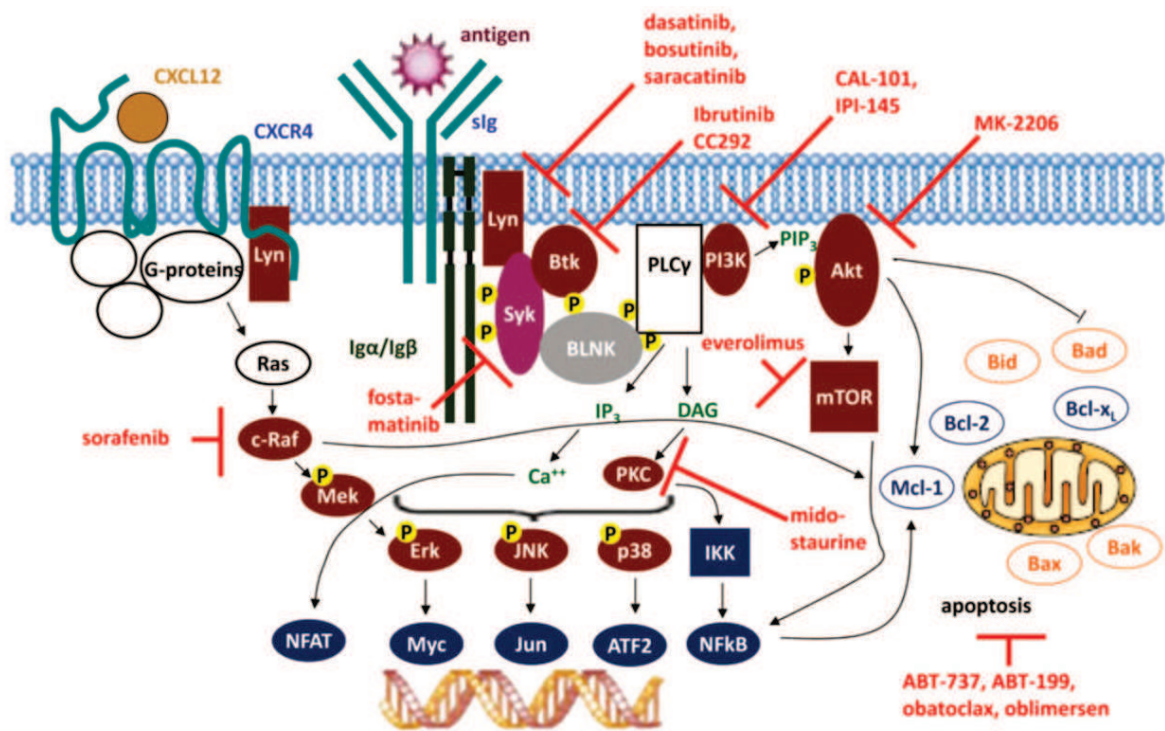

Figure 17. Targeting of BCR signaling as a therapeutic strategy in CLL. Red symbols and letters indicate new possible therapeutics (Hallek 2013).

1.7. COMPLICATIONS

The highly variable clinical course of CLL may be further complicated by infections, medullary insufficiency, autoimmune phenomena and further malignant processes as transformation into a more aggressive lymphoproliferation, the Richter syndrome.

The infections represent a major cause of morbidity in CLL patients and are the most important cause of mortality in clinical studies. The causes are multiple, including on one hand disease-related immune deficiency (hypogammaglobulinemia, B and T cells defects, cytopenias due to medullary insufficiency and to autoimmune phenomena), and on the other hand therapy-related immune deficiency. The most frequent infections are bacterial (staphylococcus, pneumococcus and haemophilus) and viral (herpes, herpes zoster), the opportunistic infections being more rare (candidiasis, pneumocytosis), except during treatment with fludarabine (pneumocystis) or anti-CD52 antibody (fungal infections) (Lepretre et al. 2012).

The medullary insufficiency signs are anemia, thrombocytopenia and neutropenia that can be aggravated by therapy.

Richter's syndrome refers to the secondary development of a focal aggressive lymphoproliferative disorder, typically diffuse-large B cell lymphoma (DLBCL), in a patient with preexisting CLL. Recent studies have suggested that the development of Richter syndrome may be related to the evolution of an abnormal clone, unrelated to the underlying CLL clone. The risk of Richter transformation is associated with advanced clinical stage at diagnosis, high-risk FISH, unmutated IGHV, and expression of ZAP-70 and CD38. It is also associated with stereotyped BCRs, but an initial association with IGHV4-39 was not confirmed in subsequent studies (Parikh et al. 2013). This complication is characterized by sudden onset of B symptoms (fever, night sweats, weight loss) and rapidly progressive lymphadenopathies at any anatomic site. The treatment consists of immunochemotherapy regimens similar to that of diffuse large B cell lymphoma and the prognosis is very poor in the literature.

CLL is associated also with secondary malignancies, like epithelial cancers. This may be attributable to disease-associated immune dysfunction, to frequent infectious complications and to carcinogenic side effects of chemotherapeutic agents.

Patients with CLL have a great predisposition to develop autoimmune complications, especially directed against hematological antigens. This will be discussed in more details in the next chapter.

2. AUTOIMMUNE PHENOMENA IN CLL

Patients with CLL have a dysregulated immune system that favors the autoimmune phenomena. Autoimmunity can occur at any time in the CLL evolution, and can even associate with the pre-leukemic monoclonal B cell lymphocytosis (MBL). The responsible mechanisms for this association are still unclear and represent an important area of research, because of the etiology and prognostic implications.

Autoimmunity is predominantly directed against blood cells, leading to autoimmune cytopenias (AIC), although other self-targets have also been described.

Most autoimmune phenomena observed in the course of CLL are hematological: autoimmune hemolytic anemia with warm-antibodies (AIHA), immune thrombocytopenia (ITP, also known as immune thrombocytopenic purpura), pure red cell aplasia (PRCA) and autoimmune granulocytopenia (AIG). AIHA and ITP are relatively frequent, whereas PRCA and AIG are very rare. Other very rare autoimmune manifestations described in CLL are: cold agglutinins disease (CAD; hemolytic anemia with cold-antibodies), paraneoplastic pemphigus (PNP), acquired angioedema (AAE) and anti-myelin associated glycoprotein neuropathy (anti-MAG neuropathy).

4.1. EPIDEMIOLOGIC DATA

The incidence of autoimmune cytopenia accompanying CLL is quite different in studies published so far, with a decreased incidence in the more recent studies. In the old series, near to 25% of CLL cases were complicated with autoimmune cytopenias (Hamblin 2006). In the more recent studies the proportion of CLL patients presenting with autoimmune cytopenia varies between 4,3% and 9,7% (Mauro et al. 2000; Zent et al. 2008; Moreno et al. 2010a; Borthakur et al. 2007; Dearden et al. 2008). This difference could be explained by the fact that initial studies were made in reference centers with selection of more aggressive diseases, by the fact that the diagnosis criteria were not very well defined

and especially by the treatment received by these patients, who can favor or not the autoimmunity (see later).

AIHA is the most frequent autoimmune phenomena in CLL, usually associating a positive direct Coombs test (i.e. direct antiglobulin test, DAT), followed by ITP. Sometimes only a “serological autoimmunity” can be present in association with CLL, defined only by serological markers of autoimmunity (most frequently a positive DAT) without clinical apparent manifestations. Inversely, CLL represents the main cause of AIHA, and a peripheral blood immunophenotypical description in research for CLL or MBL is recommended in the initial workup.

Table 8 describes the main case series in the literature about autoimmune cytopenias in CLL, with the emphasis of autoimmunity on the general outcome of CLL and the associated risk factors (Hodgson et al. 2011).

Author, Date	Population	Number of patients, time interval	Outcome	Clinical/biological correlates
Hamblin 1986 ⁵	195 patients from a single institution	19 of 195 (9.7%), 1972-1985 15 AIHA 4 ITP	Not reported	Not reported
Kyasa 2000 ²⁴	132 patients from a single primary care system	12 of 132 (9.1%), 1989-2001 6 AIHA 5 ITP 1 PRCA	OS not different to CLL patients without autoimmune complications	Not reported
Mauro 2000 ¹²	1,203 patients from a single institution	52 of 1,203 (4.3%), 1986-1996	OS not different in DAT positive anemic CLL and DAT negative non-anemic CLL patients	High WCC, advanced age, male gender, active CLL
Barcellini 2006 ¹⁷	3,150 patients from the GIEMA group, 17 institutions	194 of 3,150 (6.2%), unspecified time interval 129 AIHA 35 ITP	Not reported	AIHA associated with advanced stage active CLL, old age
Duek 2006 ²⁵	National CLL registry of 964 patients	63 of 964 (6.55%), 1971-2006 55 DAT pos at diagnosis 9 ITP or Evans	Not reported	High B2M, high CD38
Visco 2008 ¹⁸	1,278 patients from 3 institutions	64 of 1,278 (5%) ITP, 1996-2004 47 AIHA 28 DAT pos only	OS worse in CLL patients with ITP than those who never develop ITP. OS of patients with thrombocytopenia at diagnosis significantly worse than non-thrombocytopenic CLL regardless of etiology	High WCC, unmutated <i>IgVH</i> gene, high Zap70
Zent 2008, 2009 ^{13,26}	1,750 patients from a single institution	75 of 1,750 (4.5%), 1995-2004 41 AIHA 35 ITP 9 PRCA 3 AIG	OS not different to CLL patients who never develop cytopenia. OS since cytopenia was superior in patients with immune cytopenia compared to cytopenia due to bone marrow failure	Male gender, unmutated <i>IgVH</i> gene, high Zap70, poor risk cytogenetics
Moreno 2010 ¹⁵	961 patients from a single institution	70 of 960 (7%), 1980-2008 49 AIHA 20 ITP 1 Evans	OS not different to CLL patients who never develop AID. OS of immune cytopenia at presentation superior to OS of stage C at presentation	High WCC, high LDT, high B2M, high CD38

AIHA: autoimmune hemolytic anemia; ITP: immune thrombocytopenia; PRCA: pure red cell aplasia; DAT: direct anti-globulin test; OS: overall survival; WCC: white cell count; LDT: lymphocyte doubling time; B2M: beta 2 microglobulin; IgVH: immunoglobulin heavy chain variable region.

Table 8. Case series of autoimmune cytopenias in CLL. ⁵ (Hamblin, Oscier, and Young 1986), ²⁴ (Kyasa et al. 2003), ¹² (Mauro et al. 2000), ¹⁷ (Barcellini et al. 2006), ²⁵ (Duek et al. 2006), ¹⁸ (Visco et al. 2008), ^{13,26} (Zent et al. 2008; Zent and Shanafelt 2009), ¹⁵ (Moreno et al. 2010a).

The effect that AIC have on CLL evolution differs in various studies, from a poorer prognosis to a better prognosis, and is difficult to establish because AIC are associated with other poor prognostic factors in CLL, like unmutated IGHV and high expression of ZAP-70. If we consider CLL cases at diagnosis, patients with autoimmune phenomena have an important risk of evolution. But, if we consider only stage C Binet CLL cases, “immune stage C” cases have a more favorable prognosis than “CLL-related bone marrow failure stage C” cases.

4.2. DIAGNOSIS

A high degree of suspicion is necessary to diagnose autoimmunity as a cause of cytopenia in CLL. The multiple possible causes of cytopenia in CLL (bone marrow failure, hypersplenism, chemotherapy, sepsis, autoimmunity) and the possibility of two or more causes occurring simultaneously require careful clinical judgment in the management of these patients. A bone marrow examination is particularly important to differentiate between the causes of cytopenia.

2.2.1. Autoimmune hemolytic anemia (AIHA)

The diagnosis of AIHA is confirmed in the presence of all of the following criteria (Visco et al. 2014):

1. Hb levels \leq 11 g/dl, in the absence of any cytotoxic treatment in the preceding month
2. One or more laboratory signs of hemolysis (increased unconjugated bilirubin, elevated lactate dehydrogenase, reduced haptoglobin)
3. Either reticulocytosis or a positive DAT.

The diagnosis remains difficult, because reticulocytosis can be absent in the context of bone marrow infiltration. Also, the signs of hemolysis could be difficult to assess: elevated lactate dehydrogenase (LDH) may be related to disease progression, haptoglobin

may be influenced by underlying inflammation and some AIHA may have a normal unconjugated bilirubin level.

➤ **Direct antiglobulin test (DAT; i.e. direct Coombs test)**

Coombs utilized DAT for the first time in 1945 for detection of incomplete antibodies of Rh system, that didn't determine spontaneous agglutination (hence "incomplete"). The test is used to determine these antibodies or complement proteins that are bound to the surface of RBC, and responsible for the RBC destruction. In blood samples, RBC are first washed to remove the patient's plasma components, and then incubated with an anti human globulin, the Coombs reagent, that can determine the visualization of the aggregation of RBC. DAT tests utilize as antiglobulin reactive anti-IgG and anti-C3d (anti-IgA is not utilized in routine, but can be added to the test in cases with an important clinical suspicion and negativity of the first two serums).

IgM anti-RBC fix the complement more efficiently than other isotypes and can be detected by an anti-C3d reactive. Once IgM activate the complement, they are very easily eluted from the surface of RBC at body temperature, being difficult to detect in a DAT test.

In some cases, at lower temperatures, anti-RBC IgM can agglutinate spontaneously, due to their high avidity. These types of antibodies are named *cold-agglutinins*, or cold antibodies and are mainly targeted to antigens belonging to I/i system.

Even though DAT represents the most important and useful diagnostic tool, DAT negative AIHA have been documented in CLL, as well as in 1 - 10% of patients with primary AIHA (Kamesaki, Toyotsuji, and Kajii 2013). DAT negative AIHA are the consequence of IgA anti-RBC, or of antibodies with low affinity, or of an IgG with a low concentration, below the test threshold (about 400 molecules per erythrocyte) or of an elution from the RBC surface (in this case the antibody can be found in the serum). More sensitive tests are read in microcolumns or solid-phase DAT tests.

More sophisticated techniques (enzyme-linked and radiolabeled tests, flow cytometry and mitogen-stimulated DAT) are not available in routine in the majority of laboratories. These can detect up to 30 to 40 molecules of anti-RBC autoantibodies. In particular, the

mitogen-stimulated DAT has been proposed as a functional method able to detect anti-RBC antibodies in AIHA associated to CLL, in which a near six-fold frequency was found in comparison with standard DAT test (Barcellini et al. 2002).

2.2.2. Immune thrombocytopenia (ITP)

Autoimmunity is not the first cause of thrombocytopenia in CLL patients, which is more frequently determined by bone marrow failure secondary to tumor infiltration, by hypersplenism or by treatment-related toxicity. Moreover, the lack of a sufficiently sensitive and specific autoantibody test, able to parallel the performance of DAT for RBC, represents a major limitation in the interpretation of thrombocytopenia in CLL.

The following criteria have been proposed in order to make a diagnosis of CLL related ITP (Visco et al. 2014):

1. Rapid fall (at least half of the initial level and below 100 000/ μ L) of the platelet count that is otherwise unexplained (e.g. not drug- induced)
2. Normal or augmented number of megakaryocytes in the bone marrow
3. No or limited (not palpable) splenomegaly
4. No cytotoxic treatment in the last month
5. Exclusion of other causes of thrombocytopenia

So, in CLL the diagnosis of ITP is an exclusion diagnosis. Nevertheless, an isolated and severe thrombocytopenia in these patients is more characteristic of an autoimmune origin. When related to disease progression, thrombocytopenia is generally accompanied by anemia, which often precedes it. Response to corticosteroid treatment or lack of response to platelet transfusion can also represent arguments to autoimmune origin of thrombocytopenia.

ITP can be associated with AIHA, defining Evans syndrome.

➤ Detection of anti-platelets antibodies

The development of suitable tests for detection of anti-platelet antibody has been difficult. Homotypic platelet – platelet interaction via cell surface receptors and their ligands causes non-specific agglutination after centrifugation, thereby preventing the application of standard RBC agglutination test in this case. In addition, isolation and preparation of platelets for testing results in elevated cell surface immunoglobulin levels that significantly reduces assay sensitivity and specificity.

The most commonly identified antigenic targets of anti-platelet antibodies are platelet glycoproteins GPIIb/IIIa, GPIb/IX and GPIa/IIa (McMillan 2000). The epitopes are mainly nonlinear, located on intact glycoprotein complex (Fujisawa, Tani, and McMillan 1993). There are several detection methods for anti-platelet antibodies, like (Curtis and McFarland 2009):

- *Assays using intact platelets:*

- Platelet suspension immunofluorescence test (PSIFT), a flow cytometric method where the patient's plasma is incubated with platelets, and the interaction revealed with an anti-human IgG labeled F(ab').
- Solid-phase red blood cell adherence (SPRCA), a method where intact target platelets adherents to a round-bottom well are incubated with patient's serum, and then washed. A positive test results when the indicator, composed of IgG-coated RBC, after centrifugation, forms a "carpet" spread over the bottom of the well, and not forming a tight button at the well bottom (negative test). A variant of this test utilizes anti-human Ig-coated latex beads as an indicator.

- *Antigen-capture assays:*

- Antigen-capture ELISA (ACE). The principle of antigen-capture assays is to adhere individual platelet glycoproteins (e.g. GPIIb/IIIa) to a solid spurt (microtiter plate well) for detection of platelet-specific antibodies. These techniques are exemplified in Figure 18.
- Modified antigen-capture ELISA (MACE)
- Monoclonal antibody immobilization of platelet antigens (MAIPA), which is the actual standard for anti-platelet antibody detection. In this technique,

platelets are first incubated with serum and washed, but then incubated with monoclonal antibody and washed again, followed by detergent lysis. GP-antibody complexes are captured from the lysate by anti-mouse IgG polyclonal antibodies adherent to the well of a microplate. A flow cytometry version of the MAIPA has been reported, in which a small bead instead of a microplate well is used as a solid support for monoclonal antibody capture of GP.

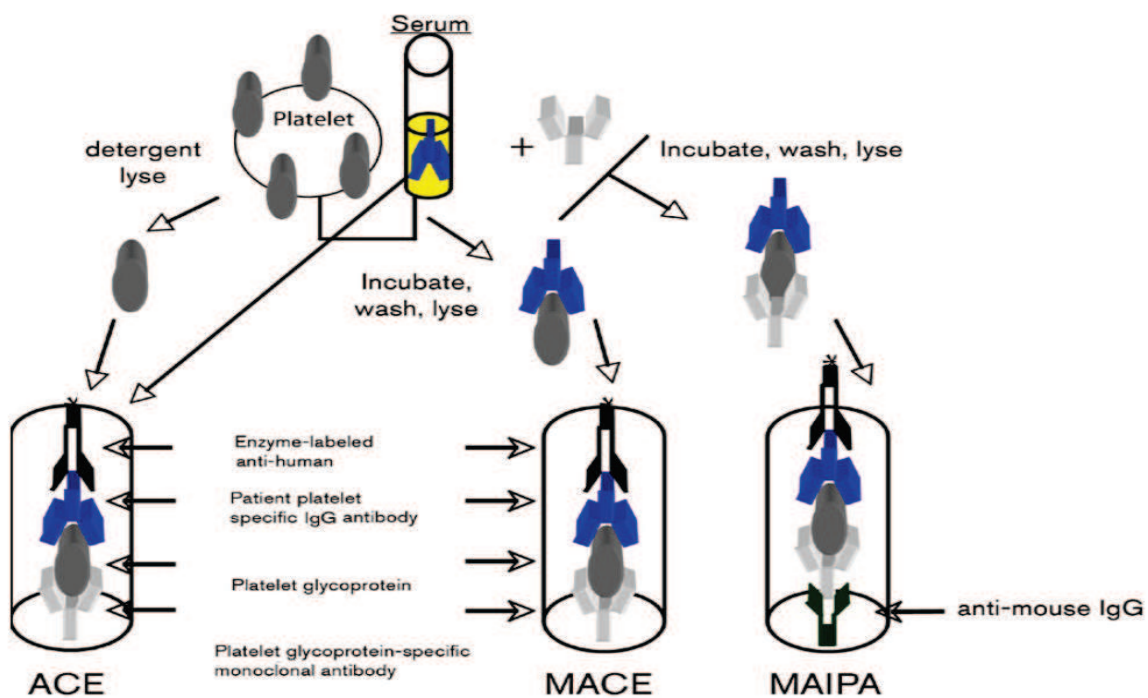

Figure 18. Three different antigen-capture ELISAs for platelet antibody detection and identification: antigen-capture ELISA (ACE), modified ACE (MACE), and monoclonal antibody immobilization of platelet antigens (MAIPA) (Curtis and McFarland 2009).

- *Protein bead arrays*, in which individual platelet GPs are attached to polystyrene microbeads and then incubated with patient's serum, washed, and then incubated with a PE-labeled anti-human IgG. The fluorescence is analyzed on a Luminex instrument (Figure 19). A variant of this method can be used in a flow cytometry, with GPs attached to PE-labeled beads.

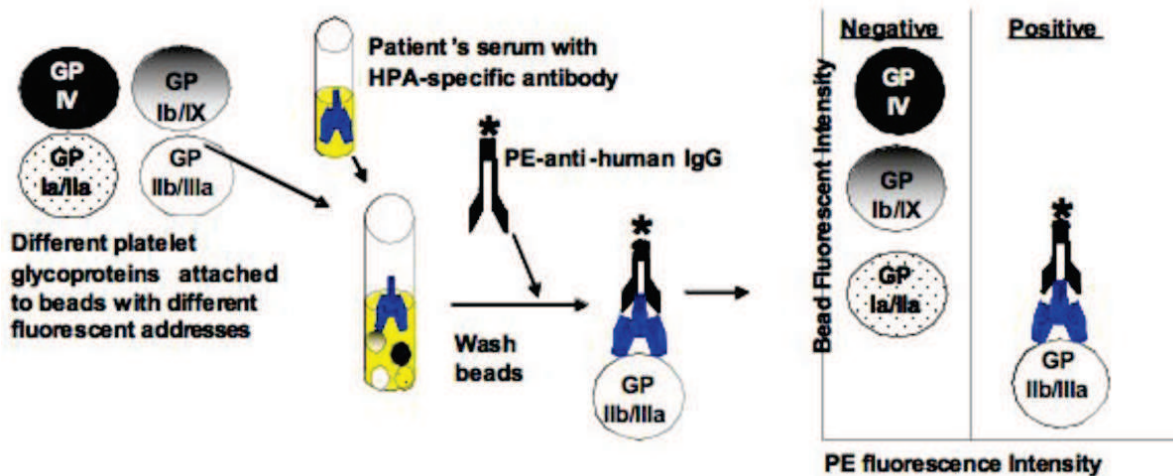

Figure 19. Protein beads array assay for platelet antibody detection and identification using microbeads coated with different GPs. Antibodies against a specific GP are detected with a labeled anti-human IgG by fluorescence detection (Curtis and McFarland 2009).

A very low sensitivity of only 45% to 60% is the major problem of these tests (McMillan 2003), as well as a low specificity. Possible explanations for the low sensitivity include rapid clearance of serum by antibody-bound platelet destruction in the spleen, tightly bound anti-platelet antibodies difficult to dissociate or the presence of other isotypes than that detected in the tests. Platelet antigens can also react in a non-specific way with natural antibodies or with other proteins in the serum.

- *Flow cytometric immunobead array (FCIA)* is a recent developed technique in which the detector monoclonal antibody is coated on the surface of polystyrene microbeads, with different fluorescence intensities. This technique is used to measure a variety of proteins in biological samples. It has been recently developed for detection of platelets antibodies (He et al. 2013). In this assay, the platelet lysate, which contains anti-platelet antibodies, is incubated with different types of monoclonal antibody labeled beads (that target platelet antigens like: GPIb, GPIIb, GPIIIa, GPIX, P-selectin). This method detects the antibodies on the platelet surface, not in the serum. The FCIA, utilizing the 5 mentioned antibodies in the same test, has a better sensitivity and accuracy than the MAIPA assay (96% vs. 44% in sensitivity; 80,9% vs. 64,7% in accuracy).

2.2.3. Autoimmune pure red cell aplasia (PRCA)

The diagnosis of secondary PRCA should be considered in any patient with severe anemia and reticulocytopenia. The following criteria can be utilized for diagnosis, though there is no consensus (Arena et al. 2013):

1. Severe normochromic normocytic anemia
2. Reticulocytopenia
3. Erythroid precursors $\leq 1\%$ in the bone marrow cells
4. No parvovirus B19 infection by PCR, or EBV, HIV, HBV, HCV infection
5. DAT negativity
6. No presence of hemolysis (normal haptoglobin, unconjugated bilirubin, LDH)
7. More than 4 to 8 weeks from the last chemotherapy administration

Definite diagnosis relies on bone marrow biopsy that shows selective red cell aplasia with virtual total absence of erythroid precursors.

2.2.4. Autoimmune granulocytopenia (AIG)

AIG occurs rarely in CLL, and should be suspected in patients with isolated neutropenia and no other apparent cause. AIG criteria still remain elusive and AIG can be considered a diagnosis of exclusion:

1. Persistent and “unexplained” neutropenia
2. Normo/hypercellular bone marrow with late maturation arrest of the granulocytes
3. Presence of anti-neutrophil antibodies
4. More than 4 to 8 weeks from the last chemotherapy administration

It is important to exclude any other cause of secondary neutropenia, like autoimmune diseases, congenital or acquired immune defects, and large granular lymphocyte leukemia (LGL) that could be concomitant to CLL.

➤ Detection of anti-neutrophil antibodies

The direct anti-neutrophil antibody test is characterized by limited discriminating power and is not standardized yet, being affected by high false positive rate. Conversely, indirect anti-neutrophil antibody test seems more precise and more reproducible. Repeating several times the test or searching for IgG and IgM autoantibodies can improve the sensitivity of the test (Ito et al. 2011).

4.3. PATHOGENESIS

Patients with CLL have a dysregulated immune system that favors the development of autoimmune disorders. The mechanisms that lead to autoimmunity in CLL are far from being understood and research on the subject represents an important area for the understanding of immune interaction between malignancy and autoimmunity. For yet unclear reasons, in CLL this process primarily target blood cells and cause cytopenia.

CLL associated autoimmune cytopenias (AIC) are usually mediated by IgG and rarely IgM autoantibodies that coat RBC, platelets and granulocytes, thus promoting their accelerated clearance, through phagocytosis by splenic macrophages or Kupffer cells, and/or by complement-mediated lysis, a typical example of type II hypersensitivity reaction.

In addition to autoreactive antibodies, several other immune mediated mechanisms have been described that may interfere with blood cells production, such as direct inhibition of erythropoiesis or megacaryocytopoiesis by cytotoxic T-cells and NK cells, also secreting inhibitory cytokines.

2.3.1. Overview of autoimmune mechanisms in general

Major barriers to understanding the mechanisms of autoimmunity come from genetic and phenotypic complexity of these diseases. It comes also from the difficulty in defining early events of these diseases, due to long intervals between initiating events and

development of diagnostic phenotype. This is an important issue, because there are probably different pathogenic mechanisms, which intervene in different phases of the disease progression. In systemic lupus erythematosus (SLE), for example, there are two groups of autoantibodies: those that precede the diagnosis of SLE by several years (like antinuclear antibodies and anti-Ro and anti-La antibodies) and those that occur about the time of onset of symptoms (like anti-Sm, anti-RNP or to a lesser extent anti-DNA) (Arbuckle et al. 2003).

Development of autoimmune diseases occurs in four phases (Rosen 2008):

1. **Susceptibility phase:** acts before disease onset and can be either inherited or acquired (in many cases both), permanent or transient. Susceptibility to autoimmunity represents an integrated threshold involving genes that regulate various immune pathways, upon which environmental events act. It includes:

- a. Incomplete tolerance induction of T and B cells

The autoreactive cells are removed at two checkpoints: in the primary lymphoid organs (central tolerance) and in the periphery, once they have attained the maturation state or just before it (peripheral tolerance).

Three mechanisms intervene at the first checkpoint for self-tolerance: clonal deletion, anergy and receptor editing. How tolerance is established at the second checkpoint in the periphery is not clear, but both positive and negative selection mechanisms have been proposed.

- b. Altered immune signaling thresholds in T cells and in B cells (e.g., CTLA4 polymorphisms, PTPN22 polymorphisms)

There are several conditions that may influence the immune response towards a more immunogenic or tolerogenic state, like: the stage of lymphocyte maturity at the moment of antigen encounter, the engagement of costimulatory receptors, the degree and stability of receptor clustering by antigen and a prior exposure to the antigen (Jun and Goodnow 2003).

BCR signaling strength and the physical nature of the self-antigen (soluble vs. membrane-bound) are important determinants in the choice between editing, deletion, and anergy.

A number of genes that regulate BCR signaling thresholds, like signal transducers, coreceptors and cytokines, have been implicated in the

pathogenesis of autoimmune phenomena. If the signaling potential of the BCR is affected, for example by PTPN22 mutations or CD19 overexpression, the autoreactive B cells will not be efficiently deleted (Menard et al. 2011; Inaoki et al. 1997). Also, there have been demonstrated in multiple animal models, that lowering the threshold of activation of BCR favors autoimmune manifestations (Pritchard and Smith 2003; Nitschke 2009).

- c. Impaired clearance and tolerance induction by apoptotic cells (e.g., deficiency of C1q, C4, MFG-E8, Mer)
 - d. Impaired production of regulatory cells (especially Treg, e.g., FOXP3 mutations causing immune dysregulation, polyendocrinopathy, enteropathy, X-linked (IPEX) syndrome)
2. **Initiation phase**, just before onset of clinical disease, requires presentation to T cells of supra-threshold concentrations of autoantigens (Ag) with structures not previously tolerized by the host, in a favorable context like infection, malignancy or exposure to adjuvants. It includes:
- a. Mechanisms that can alter antigen processing to reveal cryptic epitopes:
 - i. Modification of Ag processing through high-affinity binding to ligands or antibodies. Several studies have demonstrated that antigen processing can be dramatically altered when the antigen binds with high affinity to a ligand or antibody. So, a single bound antibody could simultaneously enhance the presentation of one T-cell epitope by more than 10-fold, while strongly suppressing the presentation of a different T-cell epitope (Simitsek et al. 1995)
 - ii. Distinct proteolytic machinery in the thymus and periphery or differential modification of proteolytic activity (Manoury et al. 2002)
 - iii. Novel proteolytic events not present in the normal antigen-presenting cell (APC) pathways (e.g., novel cleavage in different microenvironments, during cell death or damage or inflammation)
 - iv. Modification of Ag structure which modifies its processing by APC, generally through post-translational modifications (phosphorylation,

proteolytic cleavage, ubiquitination, transglutamination, citrullination, isoaspartyl modifications) (Doyle and Mamula 2005)

- v. Novel forms of Ag generated by mutation, truncation, or splicing (especially in a context of high incidence of somatic mutations as cancer)
- b. Antigen mimicry mechanisms. Initiation of an immune response to a foreign antigen may generate a cross-reactive antibody (Ab) response that also recognizes self-protein. Although the Ab cross-reacts with self-molecules, the T cells that drive this response are generally directed to the foreign antigen, at least initially. Therefore, this type of autoimmunity tends to be self-limited, unless there is an effective presentation of cryptic self-epitopes to autoreactive T cells, favored by activated cross-reactive B cells.

3. Propagation phase

- a. Acquisition of adjuvant properties by disease specific autoantigens (especially through TLRs activated by immune complexes, which amplify the immune response when simultaneously activation of BCRs or of FcγR occurs). Once initiated, specific responses that precipitate or drive the localized autoimmune reaction may diversify to comprise additional specificities (determinant spreading).
 - b. Increased autoantigen expression in the target tissue (mediated by local immune reaction with cytokine stress)
 - c. Immune effector pathways generate or expose autoantigens, which further drives the immune response
4. **Regulation/resolution phase.** In many cases, during disease propagation, immunoregulatory pathways are also activated, which may result in natural inhibition of clinical disease over time, but a permanent resolution is very rarely the case.

2.3.2. Autoantibodies in CLL-associated autoimmune cytopenia (AIC)

About 90% of AIC are due to polyclonal high-affinity IgG antibodies produced by non-malignant B cells (Hamblin, Oscier, and Young 1986).

Malignant CLL clone may also produce autoantibodies, usually poly-reactive IgM, that can be responsible for AIC in about 10% of cases (Strati and Caligaris-Cappio 2011). This is especially the case of cold-agglutinin disease (CAD) due to monoclonal IgM (associating nearly always kappa light chains) directed against RBC antigen I/i.

The pathogenic role of autoantibodies is well demonstrated, by several arguments:

- In patients with AIHA, transfused RBCs lacking the antigen targeted by patient's autoantibodies generally survive normally, in contrast to the shortened survival of the patient's own RBCs (Mollison 1959; Packman 2008).
- Cases of neonatal hemolysis have been described in newborns, resulting from the passage of IgG anti-RBC autoantibodies from a mother with AIHA to the fetus, via the placenta (Chaplin et al. 1973).
- In individual patients, an inverse relationship exist between the quantity of RBC-bound IgG antibodies and RBC survival time (Rosse 1971).
- In ITP, a transferrable plasma factor caused thrombocytopenia in healthy volunteers (Harrington et al. 1951).

Autoantibodies in AIHA can be classified "warm" or "cold" –reactive, according to the temperature reactivity of the Ab. They can bind to their antigens at core body temperature (warm, IgG type), or at lower temperature (cold, IgM type) in the peripheral circulation or *ex vivo*. Some AIHA cases are classified as "mixed", since they have both warm and cold autoantibodies.

IgG and IgM also differ in their ability to bind the complement, and this affects their mechanism of cell clearance from the peripheral blood.

Most RBC clearance occurs in the spleen, but sequestration in the liver occurs in the presence of large quantities of RBC-bound IgG, or the concurrent presence of complement proteins (Schreiber and Frank 1972).

Erythrocyte-bound IgG become attached to the Fc receptors of splenic macrophages, which may engulf entire or a part of the RBC or release cytotoxic enzymes that digest RBC membrane (antibody-dependent cell-mediated cytotoxicity, ADCC). RBCs escaping from this encounter lose more membrane than cytoplasm and become spherical to compensate for the change in their surface-to-volume ratio, the presence of spherocytes being one of the characteristic signs of hemolysis. If IgG have initiated complement activation on the cell surface, phagocytosis in the spleen will be augmented by complement receptors.

Due to its pentameric structure, IgM is a much more effective activator of complement. In this case, the main mechanism of hemolysis, which is intravascular, is by the classical activation of complement by immune complexes formed at the RBC surface, and can be especially triggered by cold temperatures in peripheral circulation. However, if the IgM elutes from the RBC as it returns to body core temperature, the complement reaction diminishes, and its components remains on the surface of RBC but do not cause intravascular hemolysis. Instead, they are cleared by hepato-splenic macrophages with complement-binding sites.

In a similar mode, in ITP, the platelets are removed from circulation by anti-platelets antibodies, which are subsequently cleared in reticulo-endothelial system through Fc γ R receptors (Fc γ R). The Fc γ R system is composed of activating (e.g., Fc γ RI, Fc γ RIIa, Fc γ RIII) and inhibitory (e.g., Fc γ RIIb) receptors and a disturb balance between these receptors has been describe in the pathogenesis of ITP (Asahi et al. 2008; Liu et al. 2011). Anti-platelets antibodies can serve also to fix complement, and complement-mediated immunity may lead to platelet destruction (Najaoui et al. 2012; Peerschke et al. 2010).

In addition, autoantibodies in ITP may target megakaryocytes and interfere with their growth and function (Usuki et al. 1986; Takahashi, Sekine, and Nakatake 1999). Also, in mouse models, anti-platelet antibodies have a direct apoptotic effect on thrombocytes, through a caspase-dependent mechanism (Piguet and Vesin 2002; Leytin et al. 2006).

2.3.3. Antigens in AHAI and ITP

Autoantibodies from AIHA patients typically bind to all the common types of human RBCs used in test panels by blood banks, but these antibodies are not “nonspecific”. Rather the autoantibodies from a given patient bind specifically to one or more antigens which are common to almost all human RBCs, so called “public antigens” (Packman 2008).

The most common targets in human AIHA, recognized in over 70% of cases, are the Rh proteins. These autoantibodies react with all human RBCs except those with the rare Rh^{null} phenotype, which completely lack expression of the Rh complex. The major target of the Rh-related autoantibodies is a 32- to 34-kDa nonglycosylated polypeptide lacking on Rh^{null} RBCs. Anti-Rh autoantibodies usually have anti-e, anti-E, anti-c or anti-C (or, more rarely, anti-D) specificity (Barker et al. 1992; Leddy et al. 1993). These autoantibodies are collectively designated as Rh related.

The RhD and RhCE genes are structural homologs and result from a duplication of a common gene ancestor. They encode transmembrane proteins, specific for RBC, of over 400 residues in length, that transverse RBC membrane 12 times. These proteins are not glycosylated, nor phosphorylated, but are expressed on the surface of RBC as part of a complex with an Rh-associated glycoprotein (RhAG). The Rh system, which is composed of 51 antigens, is highly immunogenic. The RhD protein only differs from the common form of the RhCE protein by about 35 amino acids. In RhCE gene two polymorphisms are the main cause of allelic antigens: the S103P substitution (generating the C or c antigen, respectively), and the P226A substitution (generating the E or e antigen, respectively) (Flegel 2011; Van Kim, Colin, and Cartron 2006; Dean 2005). Figure 20 exemplifies the structure of Rh protein, with some of the main polymorphisms.

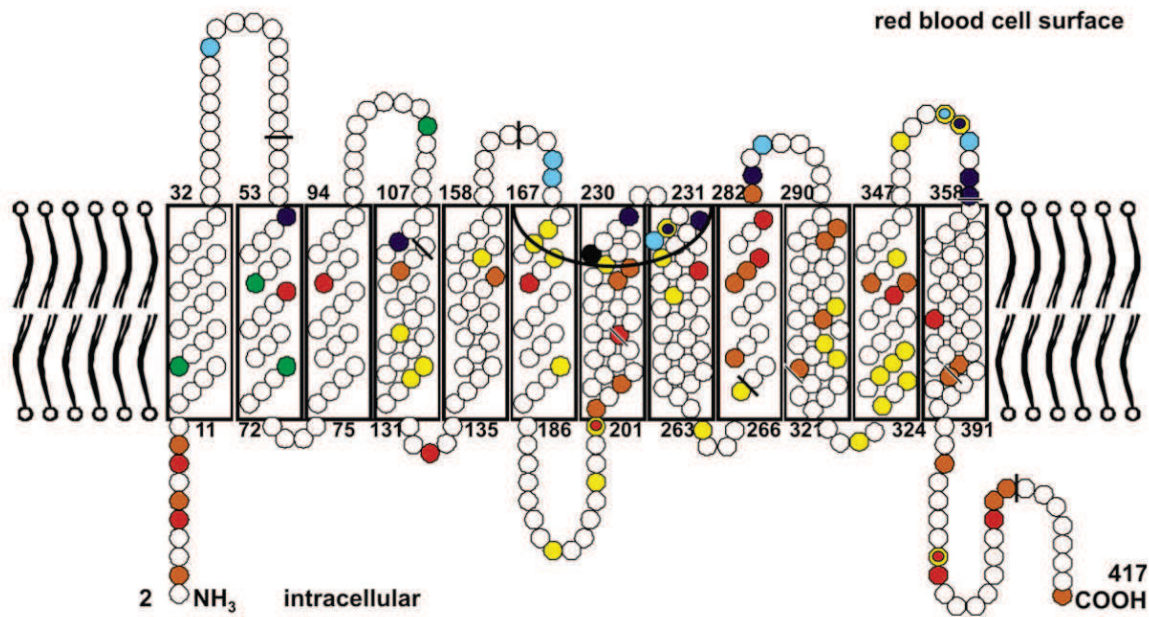

Figure 20. Model of Rhesus proteins in the red blood cell membrane. Mature proteins in the membrane lack the first amino acid. The amino acid substitutions that distinguish the RhCE from the RhD protein are marked in yellow, with the 4 amino acids that code for the C antigen in green and the one that codes for the E antigen in black. The single amino acids substitutions, which code for partial D are in blue, and those that code for weak D are in red. The extracellular Rh vestibule is depicted by the inverted black arc and bordered in part by amino acids of loops 3 and 4. The nine exon boundaries in the RHD cDNA, as reflected in the amino acid sequence, are indicated by black bars (Flegel 2011).

Autoantibodies with other specificities than Rh proteins that are produced in a minority of patients, designated as non-Rh related, react against the glycoporphins, which are heavily glycosylated RBC membrane proteins, or against the RBC anion channel protein, Band 3. Careful studies using RBCs of appropriate antigen-deficient phenotype has also allowed identification of autoantibody specificity for public blood group antigens outside the Rh system including anti-Wr^b (Issitt et al. 1976), anti-En^a (Bell and Zwicker 1978), anti-LW (Celano and Levine 1967), anti-U (Marsh, Reid, and Scott 1972), anti-Ge (Shulman et al. 1990), anti-Sc1 (Owen et al. 1992), or antibodies to Kell blood group antigens (Marsh et al. 1979).

In ITP, autoantibodies are most often directed against platelet glycoproteins GPIIb/IIIa, GPIb/IX and GPIa/IIa (McMillan 2000). The majority of these molecules belong

to the integrin superfamily, which are expressed on a variety of cells (Curtis and McFarland 2014). In alloimmune platelet disorders, human platelet alloantigens (HPAs) have been described, which represent single nucleotide polymorphisms (SNPs), localized on the main platelet glycoproteins, but for the moment, there is no clinical correspondence with autoantigens in ITP. Figure 21 describes the principal glycoproteins on platelets and CD109 with their corresponding HPAs.

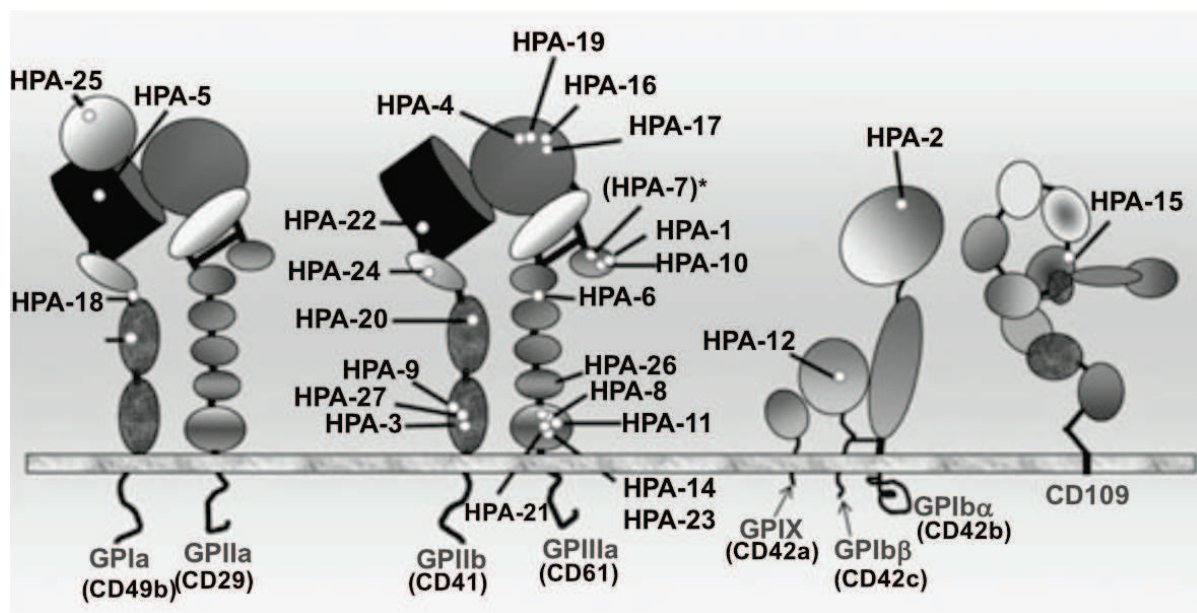

Figure 21. Platelet glycoproteins (GP) structure, GPIa/IIa, GPIIb/IIIa, GPIb/IX and CD109 and the predicted locations of the 27 different human platelet alloantigens (HPAs) biallelic groups they express (Curtis and McFarland 2014).

The GPIIb/IIIa complex corresponds to CD41/CD61 (or integrin $\alpha_{IIb}\beta_3$) and is the receptor for ligand molecules like fibrinogen, vitronectin, fibronectin and von Willebrand factor (vWF), participating in the clot formation. This heterodimer is calcium-dependent, and it dissociates in the presence of calcium chelators, like EDTA. In resting platelets, GPIIb/IIIa exists in a low-affinity state and does not bind its ligands. During platelet activation, a conformational change results in the exposure of the binding site for a variety of ligands, most notably fibrinogen, which allows firm adhesion to the extracellular matrix and aggregation (Coller and Shattil 2008). In 1982, van Leeuwen et al. reported that many antibodies eluates from ITP platelets would bind to normal platelets, but not to

thrombasthenic platelets, which are known to have reduced GPIIb/IIIa (Van Leeuwen et al. 1982). Mapping studies suggest that they target specific and distinct epitopes (Tsubakio et al. 1987), which are mainly nonlinear, dependent on the presence of cations, located on intact glycoprotein complex (Fujisawa, Tani, and McMillan 1993), although the most antigens are located on GPIIb than on GPIIIa (McMillan, Lopez-Dee, and Loftus 2001).

The GPIb/IX complex binds vWF, mediating platelet adhesion to sites on injured blood vessels. It is composed of a beta chain (GPIb-beta, CD42c) disulphide linked to an alpha chain (GPIb-alpha, CD42b) that associates non-covalently to GPIX (CD42a). The majority of GPIb/IX molecules on the platelet surface are associated with GPV (CD42d)(Curtis and McFarland 2014).

GPIa/IIa complex (CD49b/CD29, also named VLA-2, or $\alpha_2\beta_1$ integrin) represents a major collagen receptor on platelets.

Some of the most important linear epitopes described are: PVVWKN on GPIIb molecule, and TKEQTTFFP on GPIb molecule (Bowditch et al. 1996; He et al. 1995).

One of the possible targets of autoantibodies can be also the thrombopoietin (TPO) receptor (c-Mpl), already described in secondary ITP to systemic lupus erythematosus (SLE) (Kuwana et al. 2002; Kuwana 2009).

2.3.4. Role of normal B cells in AIC

Although pathogenic autoantibodies in CLL-associated AIC may very rarely be made by CLL clone, they are generally synthesized by normal bystander B cells. They are polyclonal, κ and λ , and are of different isotype that of clonal B cells.

Moreover, the onset of autoimmunity is not correlated with the overall leukemia burden, even in MBL being associated with autoimmune cytopenia (Rawstron and Hillmen 2010; Shanafelt et al. 2009), and immunosuppressive therapy may result in clinical remission of pathologic autoimmunity without affecting the CLL clone.

These “normal” autoimmune B cells have been demonstrated in the circulation of CLL patients by J. Kipps group, in an experiment of engraftment of peripheral blood mononuclear cells (PBMC) from CLL patients into SCID mice. Leukemia cells (which represent 97% of grafted PBMC in this experiment) injected into the peritoneal cavity of these animals may survive for several weeks in vivo. Eight to 16 weeks after receiving the graft, some of SCID mice develop human IgG autoantibodies to human RBCs. Soon thereafter, these animals develop lethal human B cell tumors, that are CD5⁻, have genomic EBV DNA and resemble EBV-associated lymphoproliferation noted in SCID mice reconstituted with normal human PBMC (Kobayashi et al. 1992). Similar to the pathogenic autoantibodies that develop in patients with CLL, the human IgG anti-erythrocyte autoantibodies of such reconstituted mice apparently are produced by circulating bystander B cells that are not clonally related to the transferred CLL population (Kipps and Carson 1993).

Increased levels of circulating B cells excreting anti-GPIIb/IIIa antibodies in ITP patients were recently reported (Chen et al. 2012). In ITP, there is an increased number of B cells lining the sinusoids of the red pulp of the spleen, suggesting a direct immunological attack on platelets (Olsson et al. 2012). Defects in the selection of the B cell repertoire have been described in ITP, and can be an important mechanism in the development of autoreactive cells. Certain VH genes are over-represented, with a high restriction to VH6 gene family associated with a high level of somatic mutations in the VH6 gene (Roark et al. 2002; van Dijk-Hård et al. 1999).

In chronic ITP non-splenectomized patients a role of Breg was recently suggested, where the percentage of CD19⁺CD24^{hi}CD38^{hi} Breg are reduced in peripheral circulation, associating an impaired functionality and low IL-10 levels (Li et al. 2012)

2.3.5. Role of T cells in AIC

T cells are an important factor in the pathogenesis of AIC. Autoantibodies are usually isotype-switched and harbor somatic mutations, consistent with a T-dependent mechanism (Roark et al. 2002).

Rh autoantigen-specific effector Th cells that have been activated *in vivo* can be demonstrated in the peripheral blood and/or spleen from all patients with anti-Rh autoantibodies, but from very few healthy donors (Barker et al. 1997).

In vitro studies suggest that cytotoxic T cells from ITP patients may have a direct lytic effect on platelets. CD8⁺ T cells from patients with active ITP, but undetectable platelet autoantibodies, bound to platelets *in vitro* and this caused direct platelet lysis (Olsson et al. 2003). The pathogenic role of CD8⁺ T cells has been also demonstrated in ITP patients who did not respond to B cell depletion therapy by rituximab (Audia et al. 2011; Audia et al. 2013).

In ITP, the cytokine profile is reported to be in favor of a Th1 activation (Panitsas et al. 2004) with a low number of Treg (Sakakura et al. 2007) and upregulation of Th17 response (Zhang et al. 2009). In AIHA, a low number of Treg is described (Ling et al. 2007), and RBC-specific Treg have been demonstrated in these patients (Ward et al. 2008). Still, the exact role of Treg in AIC is unclear, especially in the context of CLL, where Treg are rather increased (Arena et al. 2011), their expansion being directly induced by CLL clone, via CD27-CD70 interaction (Jak et al. 2009).

T follicular helper cells (TFH) also have a role in the pathogenesis of ITP, with an elevated number of TFH in the germinal centers of secondary follicles in ITP spleens, associated with elevated percentages of anti-platelet autoantibodies secreting plasma cells (Audia et al. 2014).

2.3.6. Role of leukemic cells in AIC

In only 10% of cases the autoantibodies responsible for AIC are synthesized by leukemic clone, this being the cases of CAD, due to monoclonal IgM.

CLL cells have the capacity to present antigens to Th cells, which in turn help non-malignant self-reactive B cells produce autoantibodies. This mechanism has been demonstrated in two experiments where CLL B cells function as efficient APC for the main antigens in AIHA, Rh proteins and erythrocyte protein band 3 (Hall 2005; Galletti et al.

2008). The antigen presentation by CLL cells is favored in advanced stages of disease, where the spleen is infiltrated with malignant CLL cells, in close proximity with antigens from damaged RBCs (Mauro et al. 2000).

Malignant cells from patients with CLL subsequently developing AIHA present nine down-regulated (i.e. miR-19a, miR-20a, miR-29c, miR-146b-5p, miR-186, miR-223, miR-324-3p, miR-484 and miR-660) miRNAs. Interestingly, two of these miRNAs (i.e. miR-20a and miR-146b-5p) are involved in autoimmune phenomena, and one (i.e. miR-146b-5p) in both autoimmunity and CLL. Furthermore, miR-146b-5p modulates CD80, a molecule associated with the B-T-cell synapse and with restoration of the antigen presenting cell capacity of CLL cells (Ferrer et al. 2013).

A possible link between CLL and AIC is through B cell activator factor (BAFF) and a proliferation-inducing ligand (APRIL) expression, two members of the tumor necrosis factor family, which are crucial for B cell development and survival (Ferrer et al. 2009). High levels of both molecules have been associated with autoimmune diseases, notably AIHA and ITP. In CLL cells, high levels of intracellular BAFF and APRIL were described, associated with adverse prognostic factors as ZAP-70 and CD38 (Bojarska-Junak et al. 2009). Still, a direct relation between high levels of BAFF and APRIL in CLL and the development of AIC is not demonstrated.

Associations between AIC and stereotyped BCRs represent other arguments for a role of leukemic cells in the development of AIC. Visco et al. demonstrated a significant association between AIC and UM-CLL and stereotyped HCDR3. The more frequent stereotyped HCDR3 subsets were #1 (IGHV1-5-7/IGHD6-19/IGHJ4; 16 of 16 unmutated) and #7 (IGHV1-69 or IGHV3-30/IGHD3-3/IGHJ6; 13 of 13 unmutated), both being significantly more represented among patients developing ITP ($p = 0.003$ and $p = 0.001$, respectively). Moreover, restricting the analysis to unmutated patients, subset #7 confirmed its independent significant association with the occurrence of ITP ($p = 0.013$) (Visco et al. 2012). A potential correlation between AIHA and subset #3 (IGHV1-69 and IGHV4-30/IGHD2-2/IGHJ6) was reported, although not confirmed in a multivariate analysis, and an inverse relation with subset #4 (IGHV4-34), in which none of the patients developed AIHA (Maura et al. 2013). In an early report a high prevalence of DFWSGY pattern of HCDR3 was found in AIHA CLL patients (Efremov et al. 1996).

2.3.7. Treatment-related AIC in CLL

Several therapies used in the management of CLL can trigger AIC. The most frequent cases of drug-triggered AIC are the consequence of purine analogs, especially fludarabine (or cladribine, or pentostatin), but also alkylating agents.

There are several series of cases that report an association between fludarabine treatment and AIHA in CLL patients with a frequency between 5% and 22% (Di Raimondo et al. 1993; Myint et al. 1995; Gonzalez et al. 1998). A large prospective study of 777 CLL patients examined the prognostic impact of AIHA or a positive DAT test for patients who were randomized to chlorambucil, fludarabine (F) or fludarabine plus cyclophosphamide (FC). Patients receiving chlorambucil or fludarabine monotherapy were 3 times more likely to develop AIHA than those receiving the FC, in favor for a protective role of FC combination therapy. They also demonstrated that DAT negativity was a strong predictor (>90%) for not developing AIHA after therapy, and that fludarabine can exacerbate the hemolysis in AIHA patients with 4 deaths from autoimmune hemolysis in the study, after first-line treatment with fludarabine (Dearden et al. 2008). Nevertheless, fludarabine-associated AIHA still remains a subject of debate, because two other studies comparing F vs FC did not report a significant association between fludarabine and AIHA, but these studies were much more limited in the number of patients (Eichhorst et al. 2006; Flinn et al. 2007).

Purine analogs can induce the expression of CD40L (CD154) *in vitro*, on PBMC culture from CLL patients with AIC, but in a lesser degree in patients without AIC (Citores et al. 2010). These data are in favor for a trigger role of therapy in patients that already have an autoimmune process ongoing, related to suppression of CD4⁺ T cells, with a decrease of Treg after fludarabine treatment (Beyer 2005). This hypothesis is supported also by reports of ITP as a complication of fludarabine treatment (Leach et al. 2000).

Bendamustine, which has a singular mechanism of action, with properties of both an alkylating agent and of a purine analog compound, can also trigger AIHA (Ghergus and Drénou 2013).

4.4. PROGNOSTIC SIGNIFICANCE AND RISK FACTORS FOR AIC

It is difficult to assess the prognostic significance of autoimmunity in CLL, independently of conventional prognosis factors, because autoimmune phenomena in CLL are clearly related to other adverse prognostic factors. To this contributes also the complex interplay between treatment, treatment-associated cytopenia and the tumor response to treatment, and the inconsistency of the way overall survival is measured in different studies (whether from CLL diagnosis, which can be several years before the onset of AIC, or from the time of AIC onset).

In a recent study, the patients with AIC (stage C “immune”) have been associated with a better outcome than those in whom cytopenia was due to bone marrow failure (stage C “infiltrative”) (Moreno et al. 2010b). Another study, focused on AIC diagnosed at CLL presentation, reported that patients with stage C “immune” had significantly worse overall survival than stage A patients, but not different from stage B (Visco et al. 2013).

Dearden et al. assessed the prognostic effect of a positive DAT and/or AIHA in patients with CLL treated for the first time, at the moment of treatment initiation. A positive DAT predicted a poorer response to treatment and together with AIHA was associated with a lower overall survival, as you can see in Figure 22 (Dearden et al. 2008).

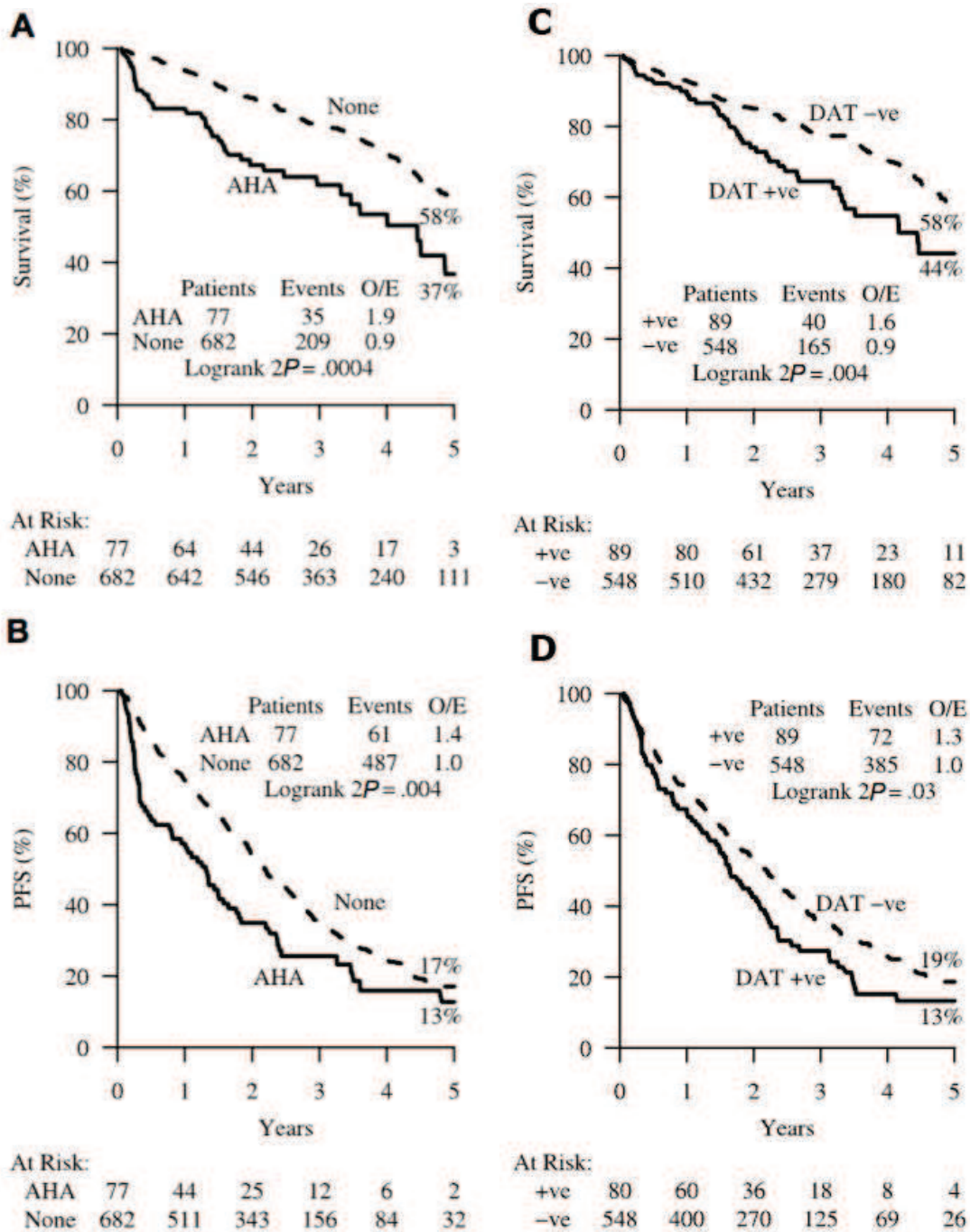

Figure 22. The predictive value of AIHA (A and B) and of a positive DAT (C and D) on overall survival (A and C) and progression free survival (PFS) (B and D) for 777 patients necessitating first line treatment (Dearden et al. 2008).

The inferior outcome of patients with autoimmune phenomena in CLL can be explained by a greater susceptibility for infections due to immunosuppressive treatment, or by cardiovascular or bleeding complications due to AIC, but it is more probably a clinical

reflection of CLL clone aggressiveness. Evidence that both AIHA and ITP are associated with other bad prognosis factors, like: age, male sex, advanced stage, high lymphocyte count, unmutated IGHV, ZAP-70, CD38, unfavorable cytogenetic lesions, supports the later hypothesis (Mauro et al. 2000; Visco et al. 2007; Maura et al. 2013; Moreno et al. 2010b; Zanotti et al. 2010).

The study that demonstrated for the first time an association between AIC and ZAP-70 analyzed retrospectively data from 290 patients, in whom the expression of ZAP-70 was realized by immunohistochemistry (IHC) on bone marrow biopsies (Zanotti et al. 2010). 16% of CLL patients developed AIC over a long follow-up period. IHC expression of ZAP-70 correlated with flow cytometry method on PBMC for 88% of cases. For a subset of patients the mutational status of IGHV was also determined. In this study ZAP-70 expression was the most discriminative parameter between CLL patients with or without AIC ($p < 0,0001$), with 80% of AIC patients being ZAP-70⁺ en IHC. The discriminative power of IGHV mutational status was lesser than ZAP-70, with a $p = 0,026$, in the context in which IGHV status was evaluated in only 136 of 290 patients. The two ZAP-70/IGHV discordant patients who developed AIC were both ZAP-70⁺/IGHV mutated. The 7-years projected cumulative incidence of AIC in ZAP-70 positive patients was 30% vs. 4% of ZAP-70 negatives (Figure 23).

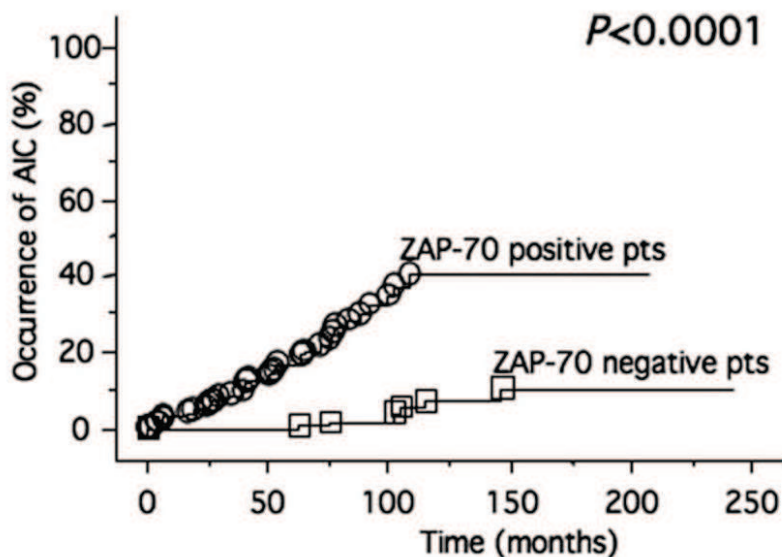

Figure 23. Time to autoimmune cytopenia from CLL diagnosis according to ZAP-70 expression in 290 patients (Zanotti et al. 2010).

In addition, the occurrence of AIC demonstrated an adverse impact on survival in ZAP-70⁺ patients (Figure 24), suggesting that AIC could worsen the adverse impact of this prognostic marker by a more severe immune imbalance or by immunosuppressive treatment. Notably, in this study, among ZAP-70⁺ group of patients, the percentage of ZAP-70 positivity was not evaluated in relation with AIC occurrence.

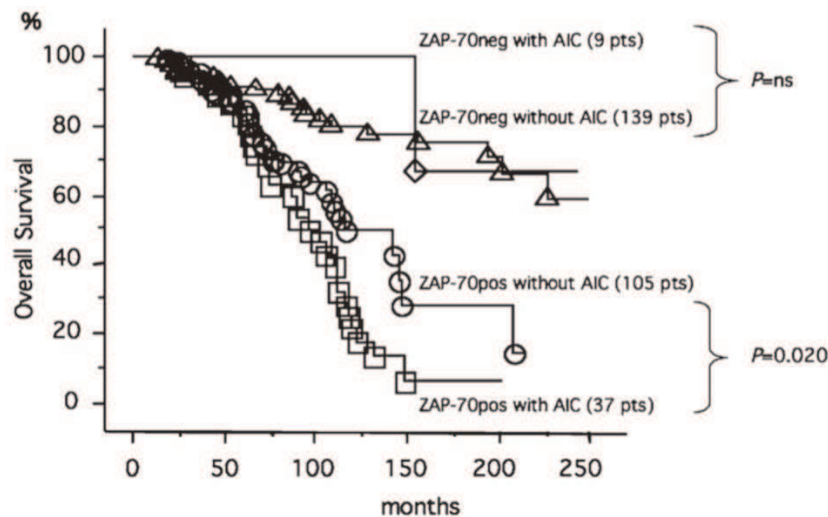

Figure 24. Overall survival according to occurrence of AIC and ZAP-70 expression (Zanotti et al. 2010).

These results were confirmed by a second study, reporting as association between ZAP-70 expression and the occurrence of AIC (Moreno et al. 2010b).

4.5. TREATMENT

No prospective randomized trials are available to guide the management of CLL-associated AIC. Moreover, autoimmune phenomena are usually excluded from clinical trial, and the majority of information comes from retrospective studies. It has been proposed that autoimmune phenomena complicating CLL may be classified into two groups: simple autoimmunity (occurring in patients with stable disease), and complex autoimmunity (if there is concomitant CLL progression) (Kaufman and Rai 2010). Patients with isolated AIC should be managed as indicated for patients with primary forms of autoimmune cytopenia. Simple-refractory autoimmunity and complex autoimmunity will require CLL-specific treatment.

According to IWCLL guidelines (Hallek et al. 2008), patients with isolated AIC should be treated with glucocorticoids, as the first line therapy. Second line options include: single agent rituximab, intravenous immunoglobulins, and immunosuppressive therapy with agents like azathioprine, cyclosporine A, and low-dose cyclophosphamide. Although a good option for primary AIC, splenectomy may worsen immunodeficiency and risk of infections in CLL patients, and should be reserved to highly selected cases (Visco et al. 2014).

For refractory cases, immune-chemotherapy treatment is indicated. The most two indicated options of rituximab plus chemotherapy combinations are: RCD (rituximab, cyclophosphamide, dexamethasone) and R-CVP (rituximab, cyclophosphamide, vincristine, prednisone). Fludarabine-associated regimens, like RFC, are not indicated in cases with active autoimmune phenomena, although there are some data suggesting that RFC treatment do not increase the risk of autoimmune cytopenia (Borthakur et al. 2007).

As BCR signaling has an important role in autoimmune phenomena, it will be interesting to study the effects of the new BCR-signaling inhibitory agents on CLL-associated autoimmunity.

3. ZAP-70

3.1. ZAP-70 STRUCTURE AND SIGNALING PATHWAYS THROUGH ZAP-70 IN T CELLS

ZAP-70 is a protein tyrosine kinase of 70 kDa, initially described in 1992 by Weiss group, as a ζ chain-associated protein, mainly expressed in T cells (Chan et al. 1992). ζ chain forms a homodimer at the cell surface, and together with CD3 heterodimers $\delta\epsilon$ and $\gamma\epsilon$ and TCR (T cell receptor) α and β chains, forms the TCR signaling complex, as seen in Figure 25. Signaling from TCR is initiated by tyrosine phosphorylation within cytoplasmic regions in the CD3 ϵ , δ , γ and ζ chains called immunoreceptor tyrosine-based activation motifs (ITAMs). Each ITAM contains two tyrosine residues (two YXXL/I motifs separated by about 6 to 9 amino acids) that, when phosphorylated, become particularly efficient in recruiting signaling proteins that contain two tandem SH2 domains.

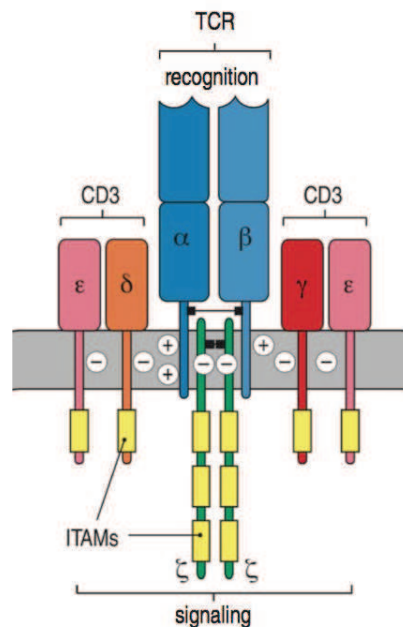

Figure 25. T cell receptor complex (Murphy, Walport, and Janeway 2012).

ZAP-70 is a 619 amino acids long protein, encoded by a gene located on chromosome 2 at 2q12 locus (chromosome 1 in mice) (Chan et al. 1992). ZAP-70 is a member of the spleen tyrosine kinase (Syk) family of kinases, with a specific structure. It is composed of two tandem SH2 domains that are separated by a linker region, termed interdomain A, and a carboxi-terminal kinase domain, separated by the SH2 domains by another linker region, named interdomain B (Figure 26). The other Syk family member is Syk kinase, which share 73% sequence homology with ZAP-70, is widely expressed in different cell types of hematopoietic origin (B cells, some T cells, myeloid cells and platelets), and has an important role in BCR proximal signaling.

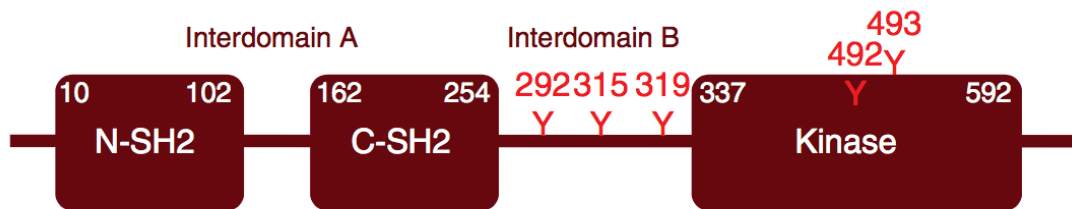

Figure 26. Schematical representation of ZAP-70 (Fischer et al. 2010).

In quiescent T cells, ZAP-70 is a cytosolic protein, and it is recruited at the plasma membrane following TCR stimulation. Upon TCR engagement, CD4 or CD8 –associated Lck is brought into proximity of the TCR complex and phosphorylates their ITAMs. ZAP-70 is then recruited by binding of the two SH2 domains to the doubly phosphorylated ITAMs of ζ chains (Figure 27). Active ZAP-70 subsequently phosphorylates LAT and SLP-76, which function as scaffolds to recruit many other signaling molecules and lead to T cell activation, proliferation and differentiation.

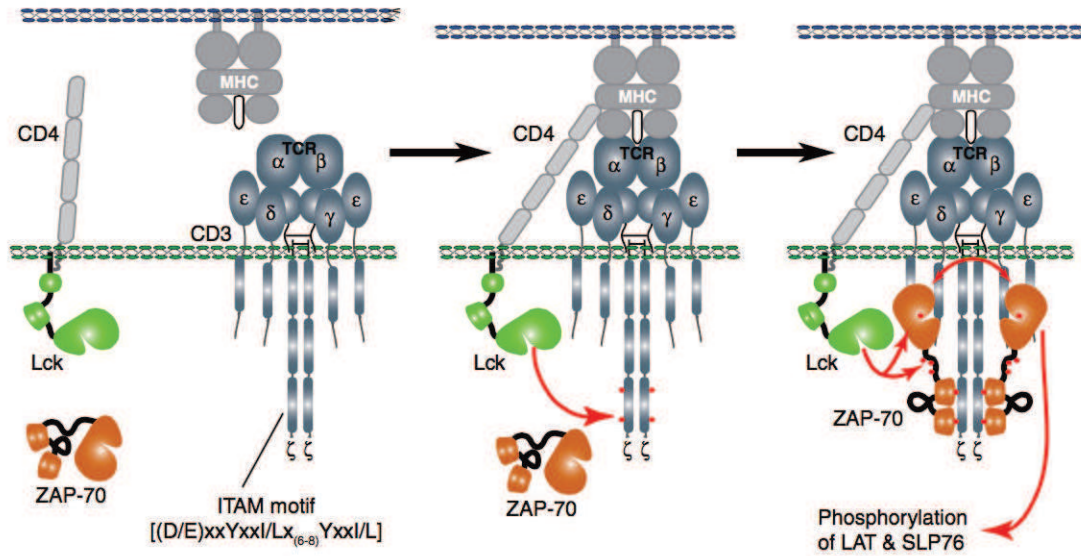

Figure 27. ZAP-70 docking and activation (Wang et al. 2010).

The two SH2 domains do not function independently, and the interaction between them is important for specific recognition of the phospho-ITAMs (Ottinger, Botfield, and Shoelson 1998). Docking of ZAP-70 to the plasma membrane, where it is activated by Lck-mediated phosphorylation, is also necessary to relieve an auto-inhibited conformation, through exposure of tyrosines in interdomain B, that are phosphorylated by Lck, as seen in Figure 28.

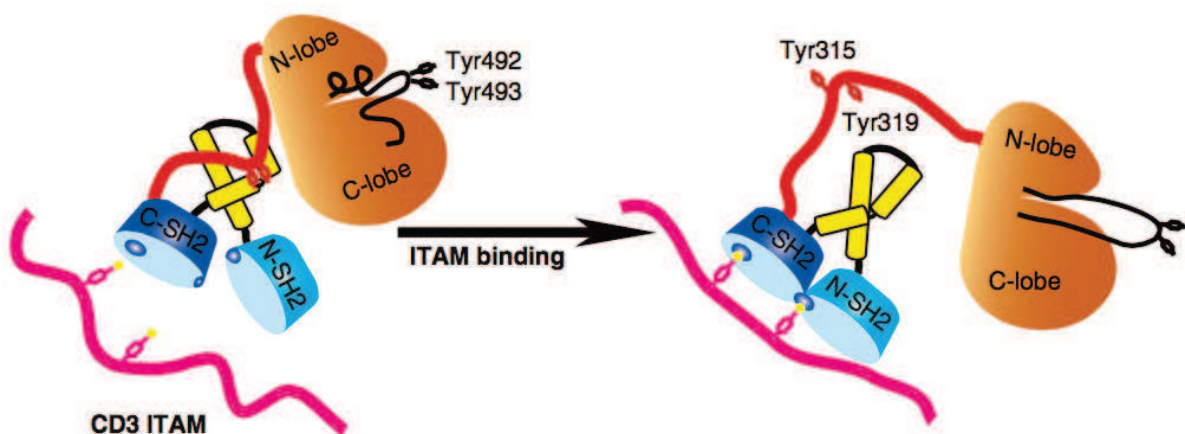

Figure 28. Model for the activation of ZAP-70 following ITAM binding (Wang et al. 2010).

Interdomain B contains 3 tyrosine residues (Y292, Y315, Y319) important in TCR activation and regulation. Y292 can bind the ubiquitin ligase c-Cbl (Lupher et al. 1997; Magnan et al. 2001), and controls both ζ chain ubiquitination (Wang et al. 2001) and TCR downmodulation (Davanture et al. 2005). So, Y292 plays a role in attenuation of TCR signaling, by limiting the duration of residence of the activated TCR at the cell surface. On the other hand, phosphorylation of Y315 residue enhances ZAP-70 function, resulting in TCR-induced actin network remodeling and cell adhesion (Goda et al. 2004; Sasahara et al. 2002). Y319 is an important positive regulator of ZAP-70 signaling, mutations at this site being associated with diminished PLC γ phosphorylation with a deficient Ca²⁺ mobilization and IL-2 secretion (Di Bartolo et al. 1999; Williams et al. 1999). The hydroxyls of the Y315 and Y319 allow for more conformational flexibility and control the auto-inhibitory conformation (Deindl et al. 2009). Regulation of ZAP-70 kinase activity is dependent on these tyrosine residues; mutation of both Y315 and Y319 to phenylalanine renders the kinase inactive, but, in contrast, mutation of these same to alanine results in increased basal kinase activity (Brdicka et al. 2005). Deletion of the entire interdomain B induces a reduction in ZAP-70 kinase activity, but do not affect the ability of ZAP-70 to bind to the TCR (Zhao et al. 1999). The kinase domain contains two tyrosines that can regulate kinase activity itself. Phosphorylation of Y493 has been shown to up-regulate ZAP-70 activity and, in contrast, phosphorylation of Y492 seems to negative regulate ZAP-70 activity (Chan et al. 1995; Wange et al. 1995).

A single ZAP-70 isoform has been described, which lacked the SH2 domains and a part of interdomain B, named truncated ZAP kinase (TZK). TZK, unlike ZAP-70, is expressed sooner, at pre-TCR⁺ stage, and function as a kinase not associated with TCR (Kuroyama et al. 2004).

The cell surface recruitment and phosphorylation of ZAP-70 determines the phosphorylation of two scaffold proteins without enzymatic activity, LAP and SLP-76, which bind in return other proteins, driving the spatial organization of signaling complexes. One of the main consequence of ZAP-70 signaling is increased intracellular free Ca²⁺ concentration (Meinl et al. 2000). Also, defective activation of mitogen-activated protein kinases (MAPK) Erk1 and Erk2 have been reported in thymocytes of ZAP-70 deficient mice and CD4⁺ T cells from ZAP-70 deficient patients (Meinl et al. 2001).

ZAP-70 controls cytoskeleton modifications, adhesion and mobility of T cells, and

also, correct formation of immunological synapse (Blanchard, Di Bartolo, and Hivroz 2002; Ticchioni et al. 2002).

ZAP-70 has an important role in thymocyte development and both positive and negative selection in thymus. Mice lacking ZAP-70 have been shown to develop neither CD4 nor CD8 single positive cells, the development being arrested at double-positive stage (Negishi et al. 1995). In mice lacking both ZAP-70 and Syk, the development of thymocytes was arrested after the expression of pre-TCR and the thymocytes were unable to become CD4⁺CD8⁺ (Cheng et al. 1997). In ZAP-70 deficient patients, a distinct phenotype of human severe combined immunodeficiency is present, in which only CD8⁺ T cells are absent, CD4⁺ T cells being present in the periphery, but inefficient in transducing signals via their TCRs (Arpaia et al. 1994; Elder et al. 1994). Initial T cell development, in this case, is partially rescued by Syk kinase. These patients have normal numbers of B cells, associating sometimes a hypergammaglobulinemia. Negative selection also require ZAP-70 activity, ZAP-70 deficient thymocytes escaping deletion by peptide antigens (Negishi et al. 1995).

Although phosphorylation/dephosphorylation processes mainly regulate ZAP-70 function, gene expression regulation has not yet been studied in different steps of T cell activation.

In B cells from CLL, ZAP-70 mRNA correlates with protein expression. ZAP-70 expression is probably controlled by a promoter region recently described in B CLL cells and in cell lines, which is characterized by particular histone modifications and DNA methylation profiles that facilitate the activation of transcription in ZAP-70⁺ B cells (Amin et al. 2012). The hypomethylation of certain CpG dinucleotides in the promoter region of ZAP-70 is well correlated with ZAP-70 mRNA and protein, and could be used as a feasible marker in clinical routine (Chantepie et al. 2010; Claus et al. 2012).

➤ **ZAP-70 in NK cells**

NK cells express both ZAP-70 and Syk kinases, which associate with transmembrane molecules with ITAM motifs, such as CD3 ζ chain or Fc ϵ RI γ , in the signaling machinery of CD16 (Fc γ RIIIA) or DAP12 in the signaling machinery of KIR receptors (Bryceson et al.

2006). These kinases, although probably redundant in these cells, are not essential for NK development and function, although necessary to signal through CD16 (Colucci et al. 2002; Colucci et al. 1999).

3.2. ZAP-70 EXPRESSION IN CLL CELLS AND ASSOCIATED SURVIVAL ADVANTAGES

➤ ZAP-70 expression detection methods

The first time that ZAP-70 expression was described in CLL cells was in micro-array experiments designed to look for a surrogate marker discriminating between M-CLL and UM-CLL subsets (Rosenwald et al. 2001). Subsequently, Crespo et al. demonstrated the prognostic role of ZAP-70 protein expression in immunohistochemistry, Western blotting and flow cytometry (Crespo et al. 2003). The expression of ZAP-70 in a B cell lineage derived leukemic cells was unexpected, for what was considered a T (or NK) lineage specific gene.

The best detection method for ZAP-70 in CLL is still in debate. The expression of ZAP-70 can be assessed by different techniques, such as Western blotting (WB), quantitative RT-PCR (qPCR), immunohistochemistry (IHC), and flow cytometry.

Flow cytometry is the most utilized, but it lacks standardization concerning the method and the expression of results in comparison to a control. One method defines a CLL sample as positive if at least 20% of CLL cells have a signal exceeding that of an isotype-matched negative control antibody. The second method utilizes the expression of ZAP-70 in normal T or NK cells as positive control. This second method, which has been largely used lately, has been recently challenged by the demonstration that ZAP-70 is also overexpressed in T cells from CLL patients. Moreover, its level is correlated with that of ZAP-70 in CLL B cells (Herishanu et al. 2005). Thus the B/T or T/B ratio on ZAP-70 expression is not representative, the expression level of ZAP-70 in CLL B cells being more reliable on an

external control (isotypic control or normal cells from a normal subject), than on an internal positive or negative control (represented by cells from the same patient).

There are different commercialized monoclonal antibodies anti-ZAP-70 conjugated with fluorochromes, the most reliable being SBZAP and 1E7.2 clone.

Real-time quantitative PCR (qPCR) is a sensitive and accurate method for ZAP-70 mRNA which proved to be an independent and a powerful prognostic factor in CLL. qPCR-measured ZAP-70 is strongly associated with mutational status, prevails over mutational status in discordant cases, and clearly tends to prevail in cases of discordance with flow cytometry-measured ZAP-70. Disadvantages of qPCR are the lack of standardization, different housekeeping genes being used to report the results, and the necessity of highly purified cells by flow cytometry sorting.

Of note, the level of ZAP-70 expression in CLL B cells does not change over time in disease evolution (Crespo et al. 2003; Orchard et al. 2004), thus an unique determination is sufficient. Moreover, the level of ZAP-70 doesn't seem to differ between different tissues (peripheral blood, marrow or lymph nodes) for the same patient (Orchard et al. 2004; Rassenti et al. 2004), although some studies contradict this (Boelens, Philippé, and Offner 2007).

The sequencing analysis of several tyrosine kinases in CLL, including ZAP-70 and Syk, did not retrieve any somatic mutation that could explain their overexpression or their more readily activation (Brown et al. 2008; Philippen et al. 2010).

➤ **ZAP-70 expression enhances BCR signaling in CLL cells**

Although high ZAP-70 expression correlates with poor prognosis in CLL, the precise role of this PTK in CLL is unclear. Prior studies indicated that ZAP-70 could reconstitute BCR signaling in Syk-deficient B cells (Kong et al. 1995). Inversely, Syk could partially restore TCR signaling in ZAP-70 deficient patients (Toyabe et al. 2001).

Ligation of the BCR with an anti- μ F(ab') on CLL cells that express ZAP-70 induce significantly greater tyrosine phosphorylation of cytosolic proteins, including p72^{Syk}, than do ZAP-70 negative cells. Moreover, following treatment with anti- μ , ZAP-70 underwent

tyrosine phosphorylation and became associated with surface μ and CD79b, in immunoprecipitation studies (Chen 2002b).

Previous studies found that CLL cells with unmutated IGHV had greater increase in the levels of tyrosine-phosphorylated proteins following IgM crosslinking than did M-CLL cells (Lanham et al. 2003). Importantly, rare cases of CLL with mutated IGHV and ZAP-70⁺ cells, also experience higher levels of tyrosine phosphorylation following BCR ligation, arguing to a more important role of ZAP-70, comparing to IGHV mutational status, in BCR signaling (Chen 2002b). A direct role of ZAP-70 in enhancing IgM signaling in CLL was demonstrated by transduction studies of ZAP-70⁻ CLL cells, the majority with mutated IGHV, with an adenovirus vector encoding ZAP-70. These CLL transfected cells induced significantly greater levels of phosphorylated p72^{Syk}, BLNK, PLC γ , and greater intracellular Ca²⁺ influx upon IgM ligation, than did similarly stimulated, noninfected CLL cells or CLL cells infected with a control adenovirus (Chen 2005).

It appears that a certain level of ZAP-70 protein is required to affect anti- μ signaling, exceeding levels above this threshold do not apparently enhance the phosphorylation of Syk or the downstream proteins (Chen 2005). This is also true on clinical level: patients with intermediate level of ZAP-70 in CLL cells have the same risk of aggressive disease as those with high ZAP-70 levels (Rassenti et al. 2004).

The increase in BCR signaling by ZAP-70 is unexpected, given that ZAP-70 has been shown to have an approximately 100 times lower intrinsic enzymatic activity than Syk in vitro and that the majority of CLL cells express ZAP-70 at lower levels than Syk (Latour, Chow, and Veillette 1996; Laurenti et al. 2005).

It has been shown that ZAP-70 is not phosphorylated at Y319, nor at Y493 in CLL B cells, important sites for ZAP-70 activation, which are strongly phosphorylated in antigen-stimulated T cells. ZAP-70 is inefficiently phosphorylated on the activating tyrosine residues, even when it is overexpressed 3-fold higher than Syk in BJAB B cell lines. The inefficacy of ZAP-70 activating phosphorylation may be explained by the competition with Syk on BCR ITAMs, which can be a limiting step in activation. It can also be a result of inadequate folding and spatial orientation of ZAP-70 in CLL cells that differs from that in T cells, as demonstrated by the fact that ZAP-70 can associate with chaperone protein Hsp90 in CLL B cells but not in T cells (Castro 2005). It cannot be explained by the absence of

Lck, a T cells specific kinase, which is also aberrantly expressed in CLL cells (Majolini et al. 1998). ZAP-70 may function as an adaptor protein, and associates with PI3K, c-Cbl, Cbl-b and Shc. It induces stronger and prolonged activation of Syk, ERK and Akt kinases, probably by regulating the rate of BCR internalization, which is lowered in ZAP-70 transfected BJAB cells (Gobessi et al. 2007).

Cell transduction experiments with an adenovirus containing ZAP-70, a mutated form of ZAP-70 without kinase activity, and an empty virus, confirmed that ZAP-70 enhance IgM signaling in CLL cells, independent of its kinase activity. In the same experiments the authors studied the possibility that ZAP-70 may enhance BCR signaling indirectly, by competing with activated p72^{Syk} for binding c-Cbl, an E3 ubiquitin ligase which signals for PTK degradation, thus prolonging the half-life of activated Syk. They concluded that competition for c-Cbl-directed proteolytic degradation is unlikely to account for the capacity of ZAP-70 to enhance BCR signaling, because ZAP-70⁻ CLL cells transfected with a mutant form of ZAP-70 at position 292, which abrogates the possibility to interact with c-Cbl, also have enhanced BCR signaling. On the contrary, the two SH2 domains are necessary for ZAP-70 to have an effect on CLL BCR signaling, as they permit the docking at the ITAMs (Liguang Chen et al. 2008).

It has been previously reported that a kinase-defective ZAP-70 mutant is able to recruit Lck to the TCR ζ chain, promoting ITAM phosphorylation by Lck in double positive thymocytes, in which only low levels of Lck are available (Ashe et al. 1999). As CLL cells are characterized by lower surface expression of IgM and CD79b than normal B cells, it is possible that ZAP-70 could facilitate the assembly of BCR complexes through special proximity. Thus, ZAP-70 could induce translocation of BCR into lipid rafts upon IgM ligation, facilitating the signaling, as demonstrated by a study where translocation of BCRs into lipid rafts was possible in IGHV unmutated, but not in mutated CLL BCRs (Allsup et al. 2005).

It is worth notice that the effect of ZAP-70 overexpression in normal B cells is totally unknown, as it hasn't been studied before.

➤ Survival advantages of ZAP-70 expression in CLL cells

A positive correlation has been demonstrated between ZAP-70 positivity and the level of expression of CCR7, a molecule known to regulate trafficking of normal B, T and dendritic cells to lymph nodes. The level of CCR7 is upregulated on the surface of circulating CLL B cells as compared to that of normal B cells, this increase correlating with clinical stage, but not with IGHV mutational status or CD38 expression (Till et al. 2002; Ghobrial et al. 2004). Through this enhanced expression of CCR7, ZAP-70⁺ CLL cells respond more readily in vitro than ZAP-70⁻ CLL cells and normal B cells, to their ligands, CCL19 and CCL21 (Richardson 2006), favoring an increase chemotaxis and F-actin polymerization, thus the entry in the proliferation centers.

In addition, ZAP-70⁺ CLL cells exhibit sustained ERK phosphorylation following stimulation with CXCL12, a survival factor produced by stromal cells. Following coculture with nurse-like cells, the survival of ZAP-70⁺ but not ZAP-70⁻ CLL cells was significantly enhanced by the addition of CXCL12, an effect that is partially blocked by a MEK inhibitor (Richardson 2006). In ZAP-70 transfected cells lines, enhanced BCR signaling after IgM ligation increased CCR7 expression via ERK1/2, increasing the response and migration toward CCL21 (Calpe et al. 2011).

CLL cells with UM-IGHV and ZAP-70⁺ have a greater capacity to respond to external microenvironmental stimuli, including those transduced through Toll-like receptor 9 (TLR9), via a not well characterized mechanism which implies the proto-oncogene MYC and a miRNA, miR-17 (Bomben et al. 2012).

➤ ZAP-70 expression in other lymphoid malignancies

ZAP-70 aberrant expression is not entirely limited to CLL. Near 600 cases of other lymphoid malignancies were analyzed in flow cytometry or immunohistochemistry in 3 large studies. ZAP-70 positivity was more common in B-acute lymphoblastic leukemia (B-ALL; 37% - 57%) (Crespo et al. 2006; Chiaretti et al. 2006), Burkitt lymphoma (8% - 31%), and mantle cell lymphomas (11%). Of note, in B-ALL cases, high ZAP-70 expression is correlated with CD38 positivity and with the abnormal presence of other TCR signaling

components, like Lck and LAT. There was non-significant expression of ZAP-70 in follicular lymphomas, diffuse large B cell lymphoma or marginal zone lymphomas or in Hodgkin's disease (Admirand et al. 2010; Carreras et al. 2005). Another study found ZAP-70 expression in all B cell malignancies, including mantle cell lymphoma and multiple myeloma (Scielzo et al. 2006). In T or NK cell origin malignancies ZAP-70 is by no means positive in all entities, but the aberrant loss of ZAP-70, although more frequent in high grade lymphomas, has no prognostic information at the time (Sup et al. 2004; Admirand et al. 2010).

3.3. ZAP-70 EXPRESSION IN NORMAL B CELLS

ZAP-70 is a tyrosine kinase classically described as expressed exclusively in T and NK cells. Controversy data began to emerge, when an unexpected requirement for ZAP-70 in pre-B cell development in mice was described. In the absence of Syk, B cell development in the mouse is only partially blocked at the pro-B to pre-B cell transition, suggesting the existence of a Syk-independent pre-BCR signaling pathway. Mice both mutant in Syk and ZAP-70 show a complete block at the pro-B cell stage. Although in the absence of Syk IgM⁺IgD⁻ immature B cell are still detected, albeit in low numbers, in ZAP^{-/-}Syk^{-/-} no IgM⁺ cells could be detected. In these cells, pro-B cells were present in elevated numbers, whereas no pre-B cells could be detected at all (Schweighoffer et al. 2003).

The arrest of B cell development at pro-B cell stage was not due to a failure to rearrange heavy chain genes, to synthesize μ chains, or to a failure to assemble a complete pre-BCR, as all those processes turn to well function in ZAP^{-/-}Syk^{-/-} mice. This arrest is the consequence of a defective pre-BCR signaling, as demonstrated by failure of Ig heavy chain allelic exclusion, known to require a pre-BCR signal. A substantial proportion of ZAP^{-/-}Syk^{-/-} pro-B cells express two different functional heavy chains, violating the principle of allelic exclusion.

Furthermore, in Syk deficient-only mice, despite ZAP-70 activity, immature B cells are blocked at positive selection, and no IgD⁺ B cell is detected in periphery. This is overcome by ZAP-70 overexpression, by transduction with a ZAP-70 containing virus. So, ZAP-70 has the ability to substitute for Syk to transduce BCR signals leading to the positive

selection of immature B cells into the recirculating follicular pool, but normally does not do so because it is expressed at a low level (Fallah-Arani et al. 2008).

In wild type mice, ZAP-70 was detected by immunoblot in pro-B, pre-B, and splenic B cells (Schweighoffer et al. 2003).

In normal human B cell development the expression of ZAP-70 is still a matter of debate.

In one study, ZAP-70 could be detected in pro/pre B cells in bone marrow from normal subjects. Thus the expression of ZAP-70 was higher in CD19⁺CD10⁺ or CD19⁺CD34⁺ human cells, than in mature B cells (CD19⁺CD34⁻CD10⁻), in flow cytometry and in Western blotting. On the contrary, ZAP-70 was negative in mature B cells from normal tonsils in this study. Thus, in line with the above, the authors hypothesized that ZAP-70 expression in near 50% of cases of B-ALL could be a consequence of malignancy development from a cell of origin (pro/pre B cell) already expressing ZAP-70 (Crespo et al. 2006).

Nolz et al. detected ZAP-70 in freshly isolated B cells from spleen and tonsil, but not from peripheral blood. ZAP-70⁺ B cells displayed an activated phenotype, with higher level of CD38, than ZAP-70⁻ B cells. ZAP-70⁺ B cells consisted of both surface IgM⁺ and IgG⁺ cells, expressed a variable level of CD5, and expressed somewhat higher levels of CD27 than did ZAP-70⁻ B cells. These cells did not express CD138, suggesting that they are not plasma cells (Nolz et al. 2005).

Another study found ZAP-70 expression also in tonsillar B cells, which had activation characteristics, such as a larger cell volume, or the presence of activation markers as CD38, CD27 and CD71. Noteworthy, there was no correlation between ZAP-70 and CD5 positivity, suggesting that ZAP-70 expression is not merely a characteristic of CD5⁺ cells, like in CLL (Cutrona et al. 2006).

On the other hand, Scielzo et al. postulated that ZAP-70 is expressed by all normal B cell subsets, not only by certain subpopulations, though at different levels. They showed that all three purified subsets of human tonsil B cells (naïve, CD19⁺CD38⁻IgD⁺; germinal center, CD19⁺CD38⁺IgD⁻; memory, CD19⁺CD38⁻IgD⁻) expressed ZAP-70 at similar levels, being about three times less than the level in CD3⁺ T cells, and five times more than that in peripheral B cells, which, in turn, are nevertheless positive for ZAP-70 (Scielzo et al. 2006).

This study utilized as negative control CD15⁺ granulocytes and CD14⁺ monocytes that were strictly negative for ZAP-70.

ZAP-70 expression in B cells could be induced by stimulation of peripheral blood or tonsil B cells with CD40L + IL-10, IL-4 and IL-6, with IL-15 + CpG ODN 2006, or with anti-IgM (Scielzo et al. 2006). A more recent study confirmed that ZAP-70 expression could be induced after stimulation through TLR9 with CpG DNA, and moreover, TLR-9 stimulated B cells resemble CLL B cells, in regard to CD5, CD23, CD25 and heat shock protein 90 (Hsp-90) expression (Scielzo et al. 2006; Bekeredjian-Ding et al. 2008).

The expression of ZAP-70 in normal B cells remains a controversy. ZAP-70 could have a redundant role, in addition to Syk, in B cell development. Their expression could be limited to early developmental B cells. Although there are several studies implying that ZAP-70 could be expressed at pro-B and pre-B cell stage of development, these cells are not well characterized. Another possibility suggested by these studies is that ZAP-70 could be an inducible molecule, upon activation, as certain B cells subtypes from tonsils with activated traits express it.

Altogether, none of the above studies found detectable ZAP-70 in peripheral B cells apart Scielzo's study, in which ZAP-70 level was extremely low (five times less than in tonsil B cell, which was three times less than in T cells, i.e. 15 times less than in T cell).

3.4. ZAP-70 AND AUTO-IMMUNITY

ZAP-70 is classically associated with autoimmune phenotypes due to T cell abnormalities. Such examples of T-cell mediated autoimmunity are SKG model and ZAP-70^{mrd/mrt} mouse model.

Sakaguchi et al. characterized SKG model in mice carrying a missense mutation in the ZAP-70 gene (W163C in C-terminal SH2 domain), which develop chronic arthritis, resembling human rheumatoid arthritis. This mutation precludes binding of ZAP-70 to the ζ

chain, leading to defective TCR signaling with impaired positive and negative selection of T cells (Sakaguchi et al. 2003). ZAP-70^{mrd/mrt} mouse model resulted from crossing two different strains with hypomorphic ZAP-70 mutations, *murdock (mrd)* and *mrtless (mrt)*. These mice had abnormal Treg development, production of anti-DNA antibodies and hyper-IgE (Siggs et al. 2007). In human autoimmune disease, one study reported that the level of ZAP-70 protein in T lymphocytes was associated with disease activity in systemic lupus erythematosus (Januchowski et al. 2007).

The relation between ZAP-70 expression in B cells and the occurrence of autoimmunity was suspected only by one group that looked for a bio-marker of B cell activation in rheumatoid arthritis (RA). They demonstrated that ZAP-70 expression in synovial fluid B cells obtained from RA patients was increased compared to synovial fluid B cells from osteoarthritis (OA) patients, although this was only true concerning the protein level, and not mRNA. In the same patients the level of ZAP-70 in peripheral blood B cells did not differ between RA and OA patients, suggesting a rather local accumulation of pathological B cells to the site of injury in RA patients. Moreover, the percentage of ZAP-70 positive B cells was related to the levels of IL-6, BAFF, and autoantibodies in synovial fluid, suggesting a relation to synovial inflammation. In *in vitro* culture, ZAP-70⁺ B cells from synovial fluid were less prone to spontaneous apoptosis than ZAP-70⁻ cells from the same patient (Tolusso et al. 2009). This initial study was infirmed by a second study from the same group, in which there was no difference between the level of expression of ZAP-70 in B cells from synovial fluid or from peripheral blood between RA and non-RA patients, rendering the first study less credible (Michelutti et al. 2011).

Another very ingenious study tried to compare differential kinase fitness between Syk and ZAP-70, *in vivo*. They studied kinase exchange in mice, which carry Zap-70 cDNA knock-in controlled by intrinsic Syk promoter, by inserting Zap-70 cDNA into the first coding exon of Syk. This disrupts wild-type Syk expression, and replaces it by ZAP-70 expression, under the control of Syk promoter. Syk^{Zap-70/Zap-70} BCR responded with diminished phosphotyrosine and Ca²⁺ responses, when compared with wild type mice. The alteration in BCR signaling in Syk^{Zap-70/Zap-70} B cells resulted in preferential development and survival of marginal zone B cells and the predisposition to auto-immunity, causing the generation of anti-insulin autoantibodies and age-related glomerulonephritis (Königsberger et al. 2012). The hypothesized mechanism of autoantibody production in these mice is

through attenuated BCR signaling, allowing for the positive selection of autoreactive and polyreactive B cell clones. Another possible explanation is that $\text{Syk}^{\text{Zap-70/Zap-70}}$ B cells survive preferentially in the pool of marginal zone cell, who were reported to harbor autoreactive specificities (Ekland et al. 2004). It is worth noting that these mice did not developed antinuclear antibodies, suggesting that negative central control selection towards particulate antigens is still intact, and that germinal center response is to some extent compromised in its ability to generate high-affinity antibodies in $\text{Syk}^{\text{Zap-70/Zap-70}}$ mice.

In conclusion, the role of B cell expressing ZAP-70 in the development of autoimmune phenomena, although suspected via the increased BCR signaling in these cells, is largely unknown.

CHAPTER 2. PROJECT

Our project logic argument, modeled after an Aristotel's syllogism, is composed of several premises, from which a conclusion can be deduced, that we will experimentally demonstrate.

➤ **Premises**

Chronic lymphocytic leukemia (CLL) is a lymphoproliferative malignancy characterized by the progressive clonal accumulation of mature-appearing B cells. In the pathogenesis of CLL, the main questions that remain to be resolved are: the normal cell of origin from which CLL is derived, the role of B cell receptor (BCR) signaling in CLL pathogenesis, and the possible role of infectious or self antigens in the arising and the proliferation of B cell clone.

In the group of lymphoproliferative diseases, CLL has the particularity of a dysregulated immune system that favors the development of autoimmune disorders. The incidence of autoimmune phenomena accompanying CLL is quite high, varying between 10 to 25% of cases. Autoimmunity is predominantly directed against blood cells, leading to autoimmune cytopenias (AIC), like autoimmune hemolytic anemia (AIHA) and immune thrombocytopenia (ITP).

Autoimmunity can occur at any time in the CLL evolution, and can even associate with the pre-leukemic monoclonal B cell lymphocytosis (MBL). The mechanisms that lead to autoimmunity in CLL are far from being understood and research on the subject is important for the understanding of the immune interaction between malignancy and autoimmunity.

Nevertheless, the great majority of pathogenic autoantibodies in CLL-associated autoimmune cytopenia, which are polyclonal IgG, are not produced by leukemic clone, but synthesized by normal¹ bystander B cells.

Additionally, accordingly to the only study before ours, there is a good correlation between ZAP-70 expression by CLL cells and the occurrence of autoimmune phenomena. ZAP-70 is the most discriminative parameter between CLL patients with or without AIC ($p < 0,0001$), with 80% of AIC patients being ZAP-70⁺ (Zanotti et al. 2010).

ZAP-70, initially described as an important molecule in surface receptor signaling in T and NK cells, has been found to be an important prognostic factor in CLL. ZAP-70⁺ CLL cells show survival advantages, acquired mainly through enhanced BCR signaling.

Classically, normal B cells do not express ZAP-70, although recent studies have given rise to a controversy. It seems to be necessary in the mouse B cell development, from the pro-B to pre-B transition (Schweighoffer et al. 2003). In humans, ZAP-70 has been described in some B cell subsets from tonsils, or in B cells with an activated phenotype (Crespo et al. 2006; Nolz et al. 2005; Cutrona et al. 2006; Scielzo et al. 2006). Moreover, there are data suggesting that ZAP-70 can be induced in B cells, after stimulation (Scielzo et al. 2006; Bekeredjian-Ding et al. 2008).

➤ **Hypothesized conclusions to demonstrate**

Our first hypothesis is that ZAP-70 expression in B cells from patients with CLL is not restricted to malignant cells as a consequence of neoplastic transformation, but could rather be an earlier phenomenon, which could predispose to malignancy.

As increased BCR signaling can favor autoimmunity, our second hypothesis is that ZAP-70, through increased BCR signaling, could induce tolerance breakdown in non-malignant B cells, being responsible for autoimmune phenomena.

¹ The non-malignant B cells are referred in the following as “normal B cells” as opposed to malignant B cells, even though they can be auto-reactive (not normal)

To test our hypothesis we addressed the following questions:

1. Do normal B cells from CLL patients express ZAP-70?
2. Is there a correlation in the expression level of ZAP-70 between malignant and normal B cells?
3. Is there a correlation between the expression level of ZAP-70 in normal B cell and autoimmune phenomena?
4. Are ZAP-70⁺ B cells autoreactive?

Moreover, in order to find whether ZAP-70 abnormal expression in B cells can favor autoreactivity in general, or whether it predisposes to malignant transformation, a ZAP-70 knock-in mouse that will conditionally express ZAP-70 from certain B cell stages of development was designed.

CHAPTER 3. PATIENTS AND METHODS

Patients

Samples used in this study were all peripheral blood specimens obtained from patients diagnosed with CLL, after a written consent, or from volunteer normal subjects or buffy coats from blood donors, used as control. Patient samples were obtained from two clinical hematology services, in Strasbourg and Mulhouse. At first, the study included all new available cases of CLL, regardless of ZAP-70 status, IGHV mutational status or clinical associated particularities, later focusing only on patients presenting with CLL and associated autoimmune cytopenia. Preferred samples were obtained from patients not previously intensely treated, especially without anti-CD20 treatment in the last 6 months, to avoid severe lymphopenia, especially for normal B cells.

Mononuclear cells from peripheral blood samples were isolated by Ficoll-Hypaque gradient (PAA), and cryopreserved before analysis.

Flow cytometry analysis

First, a viability staining was performed in all cells with Fixable Viability Dye eFluor 780 (eBioscience) that can be used on permeabilized cells.

Surface staining was performed on samples with a mixture of CD19-PE-Cy7, CD3-APC, λ -FITC, IgM-FITC, CD70-FITC, CD86-PerCPCy5.5, CD27-PerCPCy5.5, CD38-PerCPCy5.5, CD21-APC, CD43-APC (BD Pharmingen), CD5-ECD (Beckman Coulter), kappa-biotin (eBioscience), IgD-biotin (eBioscience), monoclonal antibodies. A streptavidin-APC was used as secondary antibody.

Intracellular ZAP-70 staining was performed with anti-ZAP-70-PE (1E7.2) (BD Bioscience) after a previous incubation with 2 ml of Lysing solution (BD Bioscience) for fixation and permeabilisation, as indicated by manufacturer. A CLL sample was typed as ZAP-70 positive if at least 20% of CLL cells were positive for ZAP-70, comparing to the staining with an isotype control-PE antibody (BD Bioscience).

Cells were read using Gallios flow cytometer (Beckman Coulter), the analyzed using Kaluza flow analysis software 1.2 (Beckman Coulter).

qPCR analysis of ZAP-70 mRNA expression

We measured ZAP-70 mRNA levels in fluorescence activated cell sorting (FACS) purified cells, after a surface staining as described in the flow cytometry analysis. Total RNA was isolated from purified CD19⁺CD5⁺, CD19⁺CD5⁻ and CD3⁺ viable cells, from CLL samples and controls, using RNeasy mini (for samples of at least 0,5 x 10⁶ cells) or RNeasy micro (for samples of less than 0,5 x 10⁶ cells) Kit (Qiagen). A reverse transcription reaction was performed using High-capacity cDNA Reverse Transcription Kit (Applied Biosystems) with random hexamers. A pre-amplification assay using TaqMan PreAmp Master Mix Kit (Applied Biosystems) was performed before real-time quantitative PCR (qPCR). For qPCR TaqMan probes for ZAP-70 (ref. no. Hs 00896347_m1), and for 3 housekeeping genes (HPRT1, Hs 01003267_m1; ACT1 β , Hs 99999903_m1; 18S, Hs 99999901_S1) were utilized, all from Applied Biosystems. Each sample was amplified in triplicate in a StepOnePlus real-time PCR machine (Applied Biosystems). mRNA levels were calculated with StepOne v2.1 software (Applied Biosystem), using the comparative cycle threshold method, and normalized to the endogenous control gene. After a previous analysis of C_T variability in normal and pathological B cells, HPRT1 was chosen for its best stability. Each subset of cell, after an internal normalization to his own HPRT1 expression, was then referenced to the expression of ZAP-70 in normal subject's T cells (CD3⁺ cells).

PBMC in vitro culture

Cryopreserved PBMC from a CLL ZAP-70⁻, a CLL ZAP-70⁺ case and a normal subject were incubated for 24h and 48h with a CLL or normal serum-enriched culture media (RPMI). After thawing, 1 x 10⁶ PBMC cells per well were incubated with a serum-enriched media, containing RPMI with increasing concentrations (10%, 25%, 50%) of decompartmented serum from a ZAP-70⁺ CLL patient or from a normal subject, as control. After 24h or 48h of culture, cells were recovered from culture media, and then stained with monoclonal antibody for flow cytometry on cell surface and intracellular, as described on flow cytometry analysis. ZAP-70 expression was compared to that of an isotype control, and to that of the same cells not previously cultured (freshly thawed PBMC).

In vitro stimulation of normal PBMC

Two ml of 1×10^6 /ml of thawed, cryopreserved PBMC from healthy subjects were incubated for 48h or 72h with RPMI medium with 10 μ g/ml gentamicin, supplemented with 10% heat-inactivated fetal calf serum (FCS), as control. For stimulation, two mixes were added to the culture media: 1): CD40L at 1 μ g/ml (R&D Systems) + IL-4 10ng/ml (R&D Systems) + IL-21 50ng/ml (PrepoTech) + anti-IgM 20 μ g/ml (Jackson); or 2): CD40L at 1 μ g/ml (R&D Systems) + IL-4 10ng/ml (R&D Systems) + IL-21 50ng/ml (PrepoTech) + anti-IgM 20 μ g/ml (Jackson) + CpG (ODN 2006) 2,5 mM (Invivogen). The cells were recovered from culture media after 48h and 72h of culture, and then stained with monoclonal antibody for flow cytometry on cell surface and intracellular, as described on flow cytometry analysis. ZAP-70 expression was compared to that of an isotype control, and to that of the same cells not previously cultured (freshly thawed PBMC).

Single cell reverse-transcription PCR (scPCR)

scPCR was used to reverse-transcribe and amplify at the same time mRNA for rearranged Ig heavy and light chains and ZAP-70 mRNA from a single cell. This method permit to study at single cell level immunoglobulin repertoire from B cells expressing ZAP-70, and to clone these Ig rearranged genes to produce monoclonal antibodies.

For Ig genes, the method was adapted after scPCR method utilized in Meffre's laboratory in Yale University, published by Tiller et al. (Tiller et al. 2008).

For ZAP-70 mRNA, the method of reverse-transcription and amplification at single cell level was designed and realized for the first time in this project.

Single B cells were isolated by florescence activated cell sorting (FACS) in 96 wells plate after a surface staining with monoclonal antibodies, as described in flow cytometry method. Sorted cells on dry well plates, were then sealed with an aluminum seal, and immediately placed on dry ice before storage at -80°C.

cDNA was synthesized directly in each well from total single cell RNA, without a previous RNA extraction step. The reaction was carried out in a total volume of 20 μ l per well in the original 96-well sorting plate. A mix of 140ng of random hexamer primer (pd(N)6) (Takara) and of 1 μ l of 10 μ M ZAP-70 gene-specific reverse primer (LIP 568,

designed in our laboratory), 0,5 µl of 100mM DTT (Invitrogen, SuperScript III kit), 0,7µl of 10% NP40 Surfact-Amps (thermo Scientific), and 16U of RNase out (Invitrogen) and H₂O was first added each well, vortexed and then placed at 65°C for 1 minute, then on ice. A second mix was then added containing 5X first-strand buffer (Invitrogen, SuperScript III kit), 1µl of 10mM dNTP mix (Clontech), 1µl of 100mM DTT (Invitrogen, SuperScript III kit), 20U of RNase out (Invitrogen), H₂O and 160U of SuperScript III RT (Invitrogen). Reverse transcription was performed at 42°C for 5 min, 25°C for 10 min, 50°C for 55 min and 94°C for 5 min.

ZAP-70 transcript is much more difficult to reverse transcribe and amplify than Ig gene transcripts, probably because the level of ZAP-70 mRNA is much lesser than Ig mRNA in B cells. To overcome this difficulty, reverse transcription was performed on one hand with random hexamers to amplify total RNA and on the other hand with gene specific primer for ZAP-70 (the reverse primer utilized in the following PCR1 reaction).

The gene-specific primers for ZAP-70 were designed with Vector NTI, in ZAP-70 mRNA isoform 1 (NM_001079.3 NCBI ref.):

- PCR1 forward CCCTTCTTCTACGGCAGCATCTCGCGT (LIP 567),
- PCR1 reverse AAAGTTGGTGCCCTCGGGAATGCAGTA (LIP 568),
- PCR2 forward ATGTGCGCTTCCACCACTTTCCCAT (LIP 569),
- PCR2 reverse TTGGCTGATGAGGTAGTGGTACACCGT (LIP 570).

The primers for IgH, Igλ, and Igk were the same as those published by Tiller et al. (Tiller et al. 2008), as seen in Table 9. In the first PCR, the forward primers were a mix of specific primers located in the leader region, and the reverse primers were specific for constant regions (mix of C_μ CH1 and C_δ CH1 for IgH μ and δ, C_λ for Igλ light chain, and C_k for Igk light chain). In the second, nested, PCR forward primers were specifically located in framework region (FWR) 1, and the reverse primers were located in J genes (for IgH and Igk), or in constant regions (for Igλ). The second PCR primers contained restriction sites, which could permit subsequently digestion and ligation into vectors.

IgH	Sense	Antisense	quantity (ul)	quantity (ul)	
First PCR	5' L-VH1	ACAGGTGCCACTCCAGGTGCAG	20	GGAAATTCACAGGACGA	
	5' L-VH2	CTGCAACCGGTGTACATTTGCCATCCGGATGACCCAGTC	5	GGAAAGGTGTGCACGCCCGCTGGTC	
	5' L-VH3	AAGGTGCCAGTGTARGTCCAG	50		
	5' L-VH4/6	CCAGATGGGTCCCTGCCAGGTGCAG	25		
	5' L-VH5	CAAGAGTCTGTTCCAGGTGCAG	5		
Second PCR	5' Agel VH1/5	CTGCAACCGGTGTACAT TCCGAGGTGCAGCTGGTGCAG	25	TCCGAAAGT CGACCGCT GAGGACACGGTGCAG	
	5' Agel VH3	CTGCAACCGGTGTACAT TCGAGGTGCAGCTGGTGCAG	40	TCCGAAAGT CGACCGCT GAGGACACGGTGCAG	
	5' Agel VH4	CTGCAACCGGTGTACAT TCCAGGTGCAGCTGCAGGAG	25	TCCGAAAGT CGACCGCT GAGGACACGGTGCAG	
	5' Agel VH3-23	CTGCAACCGGTGTACAT TCGAGGTGCAGCTGGTGCAG	5		
	5' Agel VH4-34	CTGCAACCGGTGTACAT TCCAGGTGCAGCTGCAGCAGTG	5		
IgL	Sense			Antisense	
	5' L Vλ.1	GGTCTGGGCCCAAGTCTGTGGTG	30	30	CACCAGTGTGGCCCTTGTGGCTTG
	5' L Vλ.2	GGTCTGGGCCCAAGTCTGGCCCTG	30		
	5' L Vλ.3	GCTCTGTGACCTCCTATGAGCTG	25		
	5' L Vλ.4/5	GCTCTCTCSCAGCYTGTGCTG	5		
	5' L Vλ.6	GTTCTTGGCCAAATTTATGCTG	5		
	5' L Vλ.7	GGTCCAATTCYAGGCTGTGGTG	5		
	5' L Vλ.8	GAGTGGATTCAGACTGTGGTG	5		
Second PCR	5' Agel Vλ.1	CTGCTACCGGTTCTGGCCCAAGTCTGTGCTGAC KCAG	30	30	CTCCTACTCGAGGGYGGGAA CAGAGTG
	5' Agel Vλ.2	CTGCTACCGGTTCTGGCCCAAGTCTGGCCCTGAC TGACAG	30		
	5' Agel Vλ.3	CTGCTACCGGTTCTGGACCTCCTATGAGCTGAC WCAG	25		
	5' Agel Vλ.4/5	CTGCTACCGGTTCTCTCSCAGCYTGTGCTGAC TCA	5		
	5' Agel Vλ.6	CTGCTACCGGTTCTGGCCAAATTTATGCTGAC TGACAG	5		
	5' Agel Vλ.7/8	CTGCTACCGGTTCCAATTCYAGR CTGTGGTGCAG	5		
	5' Agel Vλ.3-19	CTGCTACCGGTTCTGTGACCTCTTCTC T	5		
	Sense				Antisense
First PCR	5' L Vκ.1/2	ATGAGSTCCCYGCTCAGCTGCTGG	50	CCAGATTCAACTGCTCATCAGA	
	5' L Vκ.3	CTCTTCTCTGCTACTCTGGTCCGAG	40		
	5' L Vκ.4	AATTCCTGTGCTGGATCTGTG	10		
	5' Agel Vκ. 1-5	CTGCAACCGGTTGTACAT TCGACATCCAGATGACCCAGTC	25	25	GCCACCGTACGTTT GATYTCACCTTGGTC
Second PCR	5' Agel Vκ. 1-9	TTGTGCTGCAACCGGTTGTACAT TCGACATCCAGTTCACCCAGTCT	15	15	GCCACCGTACGTTT GATATCCACTTGGTC
	5' Agel Vκ. 1D-43	CTGCAACCGGTTGTACAT TGGCCATCCGGATGACCCAGTC	5	5	GCCACCGTACGTTT TAATCTCCAGTCGTGTC
	5' Agel Vκ. 2-24	CTGCAACCGGTTGTACAT GGGGATATTTGATGACCCAGAC	5		
	5' Agel Vκ. 2-28	CTGCAACCGGTTGTACAT GGGGATATTTGATGACCTCAGTC	10		
	5' Agel Vκ. 3-11	TTGTGCTGCAACCGGTTGTACAT TCGAAAATTC	10		
	5' Agel Vκ. 3-15	CTGCAACCGGTTGTACAT TCGAAAATTTGATGACCCAGTC	10		
	5' Agel Vκ. 3-20	TTGTGCTGCAACCGGTTGTACAT TCGAAAATTTGATGACCCAGTCT	10		
	5' Agel Vκ. 4-1	CTGCAACCGGTTGTACAT TCGGACATCGTGTGACCCAGTC	10		
Other/ Primers	5' Pan Vκ	ATGACCCAGWCTCCACBYCWCCCTG			GTTCCGGGGAAGTAGTCTTGAC
	5' AbSense (screening)	GCCTTCGTTAGAACCGCGCTAC			

Table 9. Primer sequences used for Ig gene PCR amplification in nested PCR. Bold letters represent restriction sites.

IgH, Ig λ , Igk and ZAP-70 gene transcripts were amplified independently by nested PCR starting from 4 μ l of cDNA for Ig or from 6 μ l of cDNA for ZAP-70, as template. All PCR reactions were performed in a total volume of 42 μ l per well containing 1 μ l of each primer (at 10 μ M), 1 μ l of 10mM dNTP mix (Clontech), 2,2 U of HotStarTaq (Qiagen) with 10x PCR Buffer (HotStarTaq kit, Qiagen). All PCR2 reactions were performed with 4 μ l for Ig, respectively 6 μ l for ZAP-70 of PCR1 product. PCR reaction was performed, after an initial time at 94°C for 5 min, for 50 cycles at 94°C for 30 sec, 57°C (PCR1) or 59°C (PCR2) for 30 sec, 72°C for 55 sec (PCR1) or 72°C for 45 sec (PCR2). The reaction was finished after a final elongation time at 72°C for 7 min, and then the PCR products were placed on ice. The presence of amplified gene transcripts were then verified in agarose gel electrophoresis.

Sequence analysis

Second PCR products were purified with Wizard SV Gel and PCR Clean-Up System (Promega) according to the manufacturer's instructions and sequenced with the respective forward and reverse primers used in PCR2, by GATC Biotech services. Before analysis, each forward and respective reverse sequence was aligned in Vector NTI software (Life Technologies). ZAP-70 sequence was analyzed by NCBI BLAST (<http://blast.ncbi.nlm.nih.gov/Blast.cgi>), to confirm human ZAP-70 isoform 1 (NM_001079.3) specificity of amplified sequence. Each Ig gene, VH, V λ , and Vk, was analyzed by IgBLAST comparison with IMGT Ig gene database (<http://www.ncbi.nlm.nih.gov/igblast/>) and by IMGT/V-QUEST (http://www.imgt.org/IMGT_vquest/vquest?livret=0&Option=humanIg), to identify germline V(D)J gene segments with highest identity. Complementary determining region (CDR) 3 length and the number of positively (histidine (H), arginine (R), lysine (K)) and negatively (aspartate (D), glutamate (E)) charged amino acids were determined as indicated in IgBLAST. IgH chain D genes and D reading frames (RF) were identified following the criteria of Corbett et al. (Corbett et al. 1997).

Expression vector cloning

Purified PCR2 products were digested with the respective restriction enzymes AgeI, Sall, XhoI and BsiWI (all from NEB) according to the manufacturer's instructions. Digested purified PCR2 products were then purified with QIA quick kit (Qiagen), before ligation into human Ig γ 1, Igk and Ig λ expression vectors.

The human Ig γ 1, Igk and Ig λ expression vectors were kindly provided by E. Meffre's laboratory in Yale University. They contain a murine Ig gene signal peptide sequence (GenBank accession no. DQ407610), and a multiple cloning site upstream of the human Ig γ 1, Igk and Ig λ constant regions. Transcription is under the influence of the human cytomegalovirus (HCMV) promoter, and clones can be selected based on resistance to ampicillin. The vectors were digested with the respective restriction enzymes AgeI, Sall, XhoI and BsiWI (all from NEB), purified with QIA quick kit (Qiagen), then dephosphorylated with calf intestine alkaline phosphatase (CIP) (Roche), according to the manufacturer's instructions, before re-purifying as above.

Ligation of \approx 110 ng (3 μ l) of each digested and purified PCR2 product into \approx 60 ng of linearized vector was realized with T4 DNA ligase (NEB) in a total volume of 10 μ l, for 1h at room temperature (RT).

75 μ l of competent E. coli bacteria were transformed with the entire ligation product by thermal shock at 42°C. After overnight culture, the colonies were screened by PCR using a screening forward primer (5' Absense, as seen in Table 9) and as reverse, 3'IgG1 int primer for IgH, and the respective reverse PCR2 primers for light chains.

Plasmid DNA was isolated from selected colonies after a previous over-night culture in LB medium with 50 μ l/ml ampicillin with QIAprep Miniprep kit (Qiagen), then sequenced to confirm identity with the original PCR product, then used in the subsequent experiments.

Single cell FACS sorting

RT (with random hexamers and ZAP-70 specific primer) — ZAP-70 (+) or ZAP-70 (-)

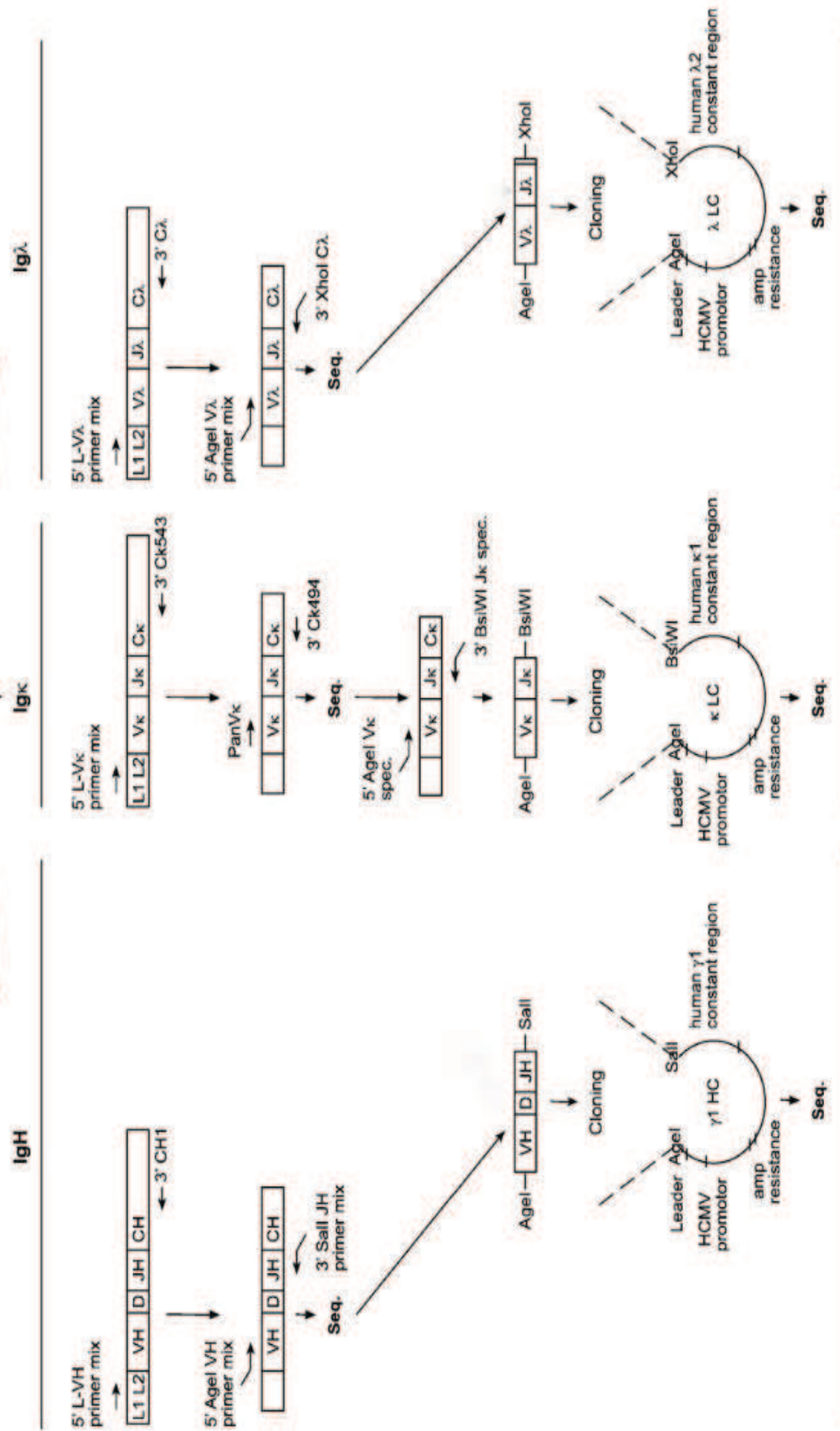

Figure 29. Strategy to clone and express human monoclonal antibodies from ZAP-70⁺ B cells (adapted from Tiller et al. (Tiller et al. 2008)). ZAP-70 gene and Ig heavy (IgH) and light (IgL) chain genes were amplified by nested RT-PCR from single cell cDNA generated by amplification with random hexamers (and ZAP-70 specific primer). PCR1 used forward primers specific for leader region and reverse primers specific for the respective IgH, Ig λ and Igk constant region. Nested PCR2 used forward primers specific for FWR1 and reverse primers specific for IgH, Ig λ and Igk J genes or constant regions. PCR2 primers contained restriction sites, which permitted ligation and cloning into eukaryotic expression vectors containing constant regions of respective human Ig γ 1, Igk and Ig λ chains. The co-transfection of a heavy and its corresponding light chain into HEK293 cell line permitted the production of monoclonal antibodies from these cells.

Generation of recombinant monoclonal antibodies from single ZAP-70⁺ normal B cells

Human embryonic kidney (HEK) 293 (ATCC, no. CRL-1573) cells were cultured under standard conditions in Dulbecco's Modified Eagle's Medium (DMEM; Lonza) supplemented with 10% heat-inactivated fetal calf serum (FCS), 1mM sodium pyruvate, 100 U/ml penicillin, 100 μ g/ml streptomycin and 0,25 μ g/ml amphotericin B.

Transfection was realized in exponentially growing cells at 80% confluence, in a medium where fetal calf serum were replaced by an Ig free medium, like 1% Nutridoma-SP (Roche). Transfection was realized with branched polyethylenimine (PEI; Sigma) transfection agent. Equal amounts of IgH and corresponding IgL (k or λ) expression vector DNA were mixed in 1 ml of sterile water and 1 ml of 300 mM NaCl, before drop-wise adding 140 μ l of 0,45 mg/ml PEI. After 10 min incubation period, the mix was distributed in the culture dish, and the supernatants were harvested after 7 to 10 days of culture.

Monoclonal antibodies were then tested directly from culture supernatants or after purification with Melon Gel Moloclonal IgG Purification kit (Life technologies), according to the manufacturer's instructions.

Monoclonal antibody quantification and testing by ELISA

Monoclonal antibodies from culture supernatants were quantified by ELISA in wells coated for 1h at 37°C with anti human IgG. After washing and saturation with PBS and 1% BSA, incubation with supernatants was realized for 2h at 37°C. Afterwards, the wells were incubated with an anti-IgG-peroxidase, and then developed with OPD substrate. Absorbance was measured at 490nm. Total IgG monoclonal antibodies were quantified by comparison with a standard curve. The light chains were semi-quantitatively measured with the same standard curve, by revealing with a secondary anti-k or anti- λ peroxidase antibody.

For anti-dsDNA reactivity, the supernatants were tested in wells coated with calf dsDNA (100ng/ml in 7,5 pH Tris-HCl buffer, Sigma) and then digested with S1 nuclease (0,001U/ μ l in sodium acetate buffer, Promega). The wells were then saturated with PBS-BSA 1%, washed, and then incubated with tested supernatants over night at room temperature. A SLE serum with known anti-dsDNA antibodies represented the positive control, and the negative control was represented by culture medium. The anti-dsDNA antibodies were revealed with an anti-IgG-peroxidase antibody, developed with OPD substrate.

The supernatants were also tested towards other autoantigens, like actin and thyroglobulin, in antigen-coated wells: actin 10 μ g/ml (Sigma, in carbonate-bicarbonate buffer) and thyroglobulin 50 μ g/ml (Sigma, in carbonate-bicarbonate buffer). Then the wells were incubated with supernatants and controls, as above, and the reaction was revealed with an anti-IgG-peroxidase as above.

Monoclonal antibody testing by direct anti-globulin test and by MAIPA test

The culture supernatants containing mAb cloned from single normal B cells from ZAP-70⁺ CLL associating autoimmune cytopenia were tested for reactivity towards red blood cells (RBS) by an indirect anti-globulin (IAT) test and towards platelets by a monoclonal antibody immobilization of platelet antigens (MAIPA) test. These two tests were performed at Etablissement Français du Sang de Strasbourg (EFS Strasbourg) by Dr. Isabelle Mendel (for DAT test) and by Dr. Arnaud Dupuis (for MAIPA test).

Flow cytometric identification of self-reactive B cells to glycoprotein IIb/IIIa in immune thrombocytopenia

Fluorochrome labeling of purified protein

Purified glycoprotein GPIIb/IIIa from human platelets (Enzyme Research Laboratories, ref. no. GP2b3a) was labeled with AF647 (Alexa Fluor[®] 647 Monoclonal Antibody Labeling Kit, Invitrogen), according to the manufacturer's instructions. Briefly, 100µg of GPIIb/IIIa (initially in 20mM Tris-HCl/0.1 M NaCl/ 0.1% Triton X-100/1 mM CaCl₂/0.05Na₃/50% glycerol/pH 7.4 buffer) was dialyzed against PBS at a concentration of 1mg/ml, alkalized by adding one-tenth volume of 1 M sodium bicarbonate, then transferred to the dye vial. The protein-dye mix was incubated for 1 hour at room temperature by gently mixing the vial every 10-15 minutes. The labeled protein was then purified by dialyzing against 20 mM Tris-HCl/0.1 M NaCl buffer over night at 4°C. The final concentration of labeled protein was of 0.38 mg/ml.

Flow cytometric analysis of glycoprotein IIb/IIIa staining

After thawing, or after thawing and enrichment for CLL sample, mononuclear cells were washed twice in TCB buffer (Tris 20mM pH 7.4/ NaCl 100mM/ CaCl₂ 1mM/BSA 0.5%). 1x10⁶ cells in 80µl of TCB buffer were first incubated for 45 minutes at 4°C with 50µl of GPIIb/IIIa-AF647, pre-diluted at 1/800. The other surface staining markers were added 15 minutes prior to incubation end, as mentioned in above flow cytometry analysis subchapter. Then an intracellular ZAP-70-PE staining was performed as above mentioned. After incubation cells were washed in TCB buffer than analyzed on Gallios cytometer (Beckman Coulter) using Kaluza software (Beckman Coulter). The control for staining with GPIIb/IIIa consisted in the inhibition of the Fab (fragment antigen binding) portion of surface immunoglobulins (Ig) by an anti-human IgG-Fab antibody (Bethyl Laboratories). For each sample, a control reaction tube was prepared with 1x10⁶ cells in 80µl of TCB buffer incubated for 30 minutes at room temperature with 50µl anti-Fab antibody diluted at 1/50, then washed once with TCB buffer. After incubation with anti-Fab, the control cells were incubated with GPIIb/IIIa-AF647 and the other surface and intracellular markers like the test tube.

Flow cytometric identification assay design of self-reactive B cells to RhCE protein in AIHA patients

Eight peptides, corresponding to the six extracellular loops on the RBC surface, with two variants for the second and the fourth loop, with one amino acid difference, were designed and synthesized in our laboratory. The amino acid sequence of RhCE protein was the reference RhcE protein on UniProt (ref. UniProt P18577; <http://www.uniprot.org/uniprot/P18577>) that was confirmed by that on NCBI (Rhce protein NP_065231.3; http://www.ncbi.nlm.nih.gov/protein/NP_065231.3). The peptides were as follow:

DG1: C - THYDASLEDQKGL

DG2C: FLSQFPSGKVVITLFSIRLA - C

DG2c: FLSQFPPGKVVITLFSIRLA - C

DG3: C - PKGTEDNDQRAT

DG4E: C - VNSPLLRSPIQRKNA

DG4e: C - VNSALLRSPIQRKNA

DG5: K - GTSCHLIPS

DG6: C - VSVVTAISGSSL

The peptides were synthesized in our laboratory by Dr. Olivier Chaloin with the help of Dr. Pierre Eftekhari.

At one end of the synthesized peptides a cysteine (C) or a lysine (K) were added that served as a binding site to a subsequent labeling to a biotin molecule, that would serve as a detection marker in flow cytometry.

For cysteine marked peptides a biotiny labeling was realized with EZ-Link Maleimide-PEG₂-Biotin kit (Thermo Scientific), according to the manufacturer's instructions. After labeling the biotin-linked peptides were re-purified by HPLC.

Generation of transgenic conditional KI mouse for Zap70 by homologous recombination transgenesis in mouse embryonic stem cells

Mouse Zap70 gene was cloned from splenic T lymphocytes, by cDNA synthesis with Zap70-specific primer (GCCACATGCAGCCTCGGCCACCTGTTC). The first PCR used the following primers: forward ATGCCCGATCCCGCGGGCGCACCTGCCATTC and reverse GCCACATGCAGCCTCGGCCACCTGTTC). The second PCR used specific primers to insert the restriction sites for digestion with AscI: forward ATT GG CGCGCC TCATACGCCACCATGCCCGATCCCGCGG and reverse ATTGGCGCGCCTCA GCCACATGCAGCCTCG.

The sequence obtained was identical to that of CCDS (consensus coding DNA sequence) sequence on NCBI (ref. 14888.1; <http://www.ncbi.nlm.nih.gov/CCDS/CcidsBrowse.cgi?REQUEST=GENEID&DATA=22637>). The amplified sequence was inserted in the CTV vector (Xiao cell 2007 17923094) by digestion with AscI. This permitted the insertion of Zap70 coding sequence preceded by a CAG promoter and a *loxP* Neo-STOP cassette into mouse ROSA26 locus, which is ubiquitously expressed. An IRES-EGFP cassette flanked by *frt* sequences placed between Zap70 gene and the polyA signal permits the detection of cells in which the deletion of Neo-STOP cassette was assessed, representing a good reporter for the hyperexpression of Zap70 (Figure 30). A Kozak sequence between *loxP* site and the first ATG of the coding sequence will permit an increase in translation of interest protein.

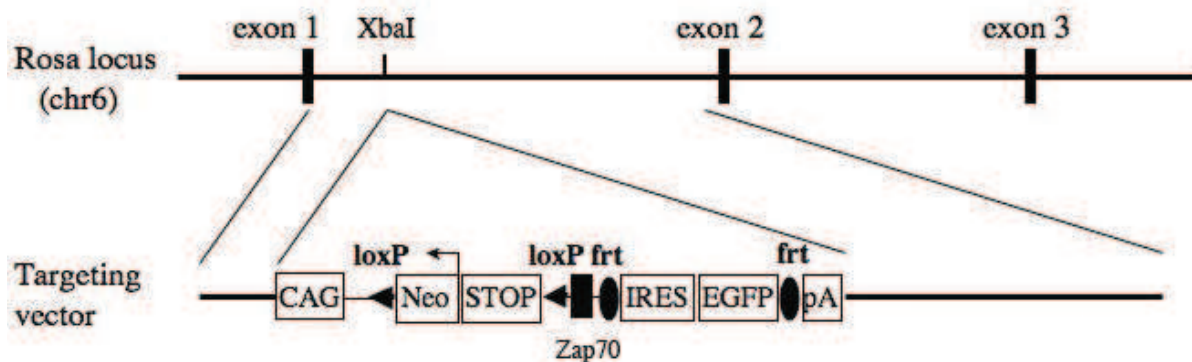

Figure 30. Zap70 mouse coding sequence cloning into CTV vector construct that will permit in insertion of conditionally expressed gene into mouse ROSA26 locus (see text).

After Zap70 cloning into CTV vector, the later was integrally sequenced, and a non-mutated cloned was selected. The final addnotated vector, containing 1857 bp Zap70 CDS (CTVZAP vector), is represented in Figure 31.

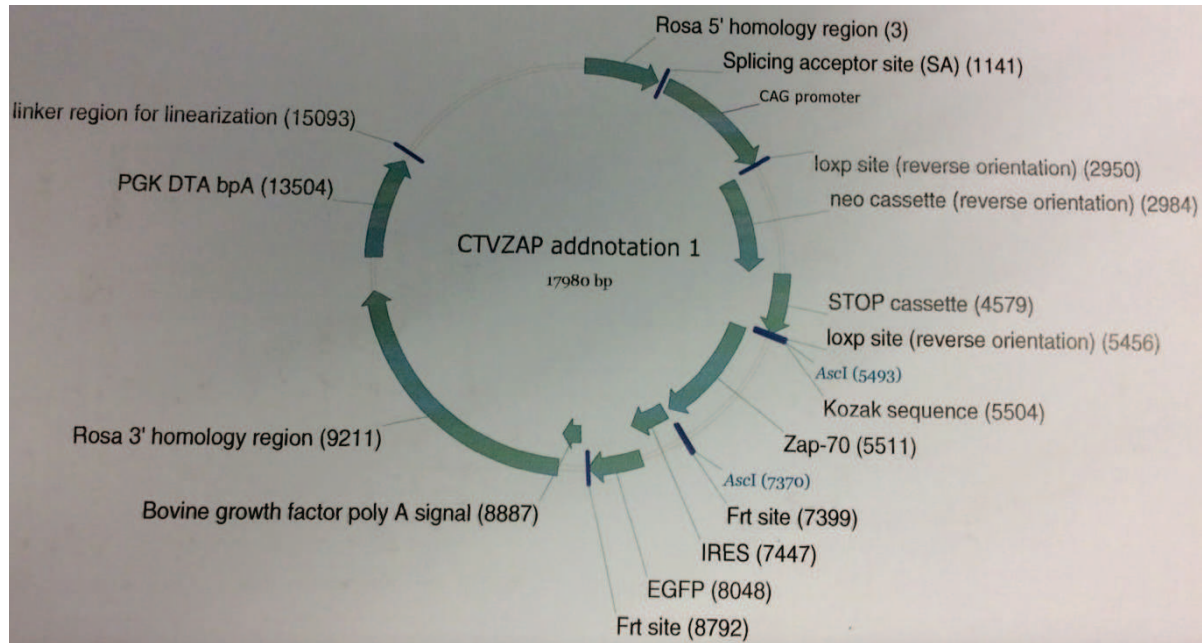

Figure 31. CTVZAP addnotated vector, used to generate conditional Zap70 KI mice by homologous recombination into embryonic stem cells of Zap70 loxP into Rosa site.

Mice were generated at Institut Clinique de la Souris (ICS) of Strasbourg. After previous homologous recombination steps of CTVZAP vector into ROSA26 locus in embryonic stem cells (ES), the selected ES cells were subsequently injected into C57BL/6N blastocysts and maintained in a pure C57BL/6N background. Mice carrying the floxed KI Zap70 gene are now available in our laboratory for further crossbreeding with Cre-mice. We will crossbreed the Zap70 loxP mice with Mb1-Cre mice that will result in the overexpression of Zap70 gene from the pro/pre-B cell stage, and with CD21-Cre mice that will result in the overexpression of Zap70 only in mature B cells. The two Cre mice, Mb1-Cre and CD21-Cre are available and already used in our labs.

CHAPTER 4. RESULTS

4.1. A FRACTION OF NORMAL B CELLS FROM CLL PATIENTS EXPRESS ZAP-70

ZAP-70 protein was determined in flow cytometry in PBMC from 63 CLL patients, in CLL cells and in normal CD19⁺CD5⁻ normal B cells. As ZAP-70 staining method in flow cytometry is not a yet standardized, we analyzed ZAP-70 expression by two methods, to reduce the possibility of false staining.

Firstly, we expressed ZAP-70 as percentage of ZAP-70⁺ cells above an isotype control cut-off (establish as no more than 0,5% of cells are positive). CLL B cells are then classify as ZAP-70 positive if they have at least 20% of leukemic clone expressing ZAP-70.

A second way of rendering ZAP-70 expression was done as a median fluorescence intensity (MFI) of anti-ZAP-70-PE monoclonal antibody staining. In the second method, we verified that MFI of isotypic control had always a low and constant value in all experiments. A cut-off value of MFI for CLL classification in ZAP-70 positive or negative is difficult to establish, as this is a highly variable characteristic, especially from an experiment to another, and can be used rather as a ratio of MFI to an internal control population, than as an independent value. Altogether, the establishment of a cut-off value between ZAP-70 positive and negative CLL cases was not the aim of our project: firstly, because we were interested in ZAP-70 expression in normal B cells, in which ZAP-70 expression cannot be expressed according to the same criteria as CLL cells, which, in turn, the expression is also differently expressed as compared with T cells; secondly, because even in CLL B cells ZAP-70 expression is not bimodal, but a continuous expression, the cut-off value being arbitrarily placed in the middle of CLL population; and thirdly, because the cut-off value of 20% in CLL cases was placed to a more clinical prognostic aim, than to delineate the presence from the absence of ZAP-70 protein (this is well exemplified by CLL cases with 18-19% of ZAP-70⁺ CLL cells, that are officially classified as “negative”, but in fact are of more of gray zone).

ZAP-70 MFI expressed as a ratio to an internal control population (like T cells, or normal B cells, for example, from the same patient), as well as ZAP-70 expressed as a percentage of positive cells reported to an internal positive control population, like T cells,

do not represent reliable methods, because ZAP-70 can vary in other internal subpopulations, like normal B cells and T cells, as we demonstrate in subchapter 4.2.

To avoid false positive staining, a very strict gating strategy was applied. First, lymphocytes were gated in a side scattering (SS) vs. forward scattering (FS) window. Next, doublets were excluded in a time of flight (TOF) window. Afterwards, only viable cells were selected, i.e. which were negative for Fixable Viability Dye (FVD). The gating strategy employed in our study is exemplified in Figure 32.

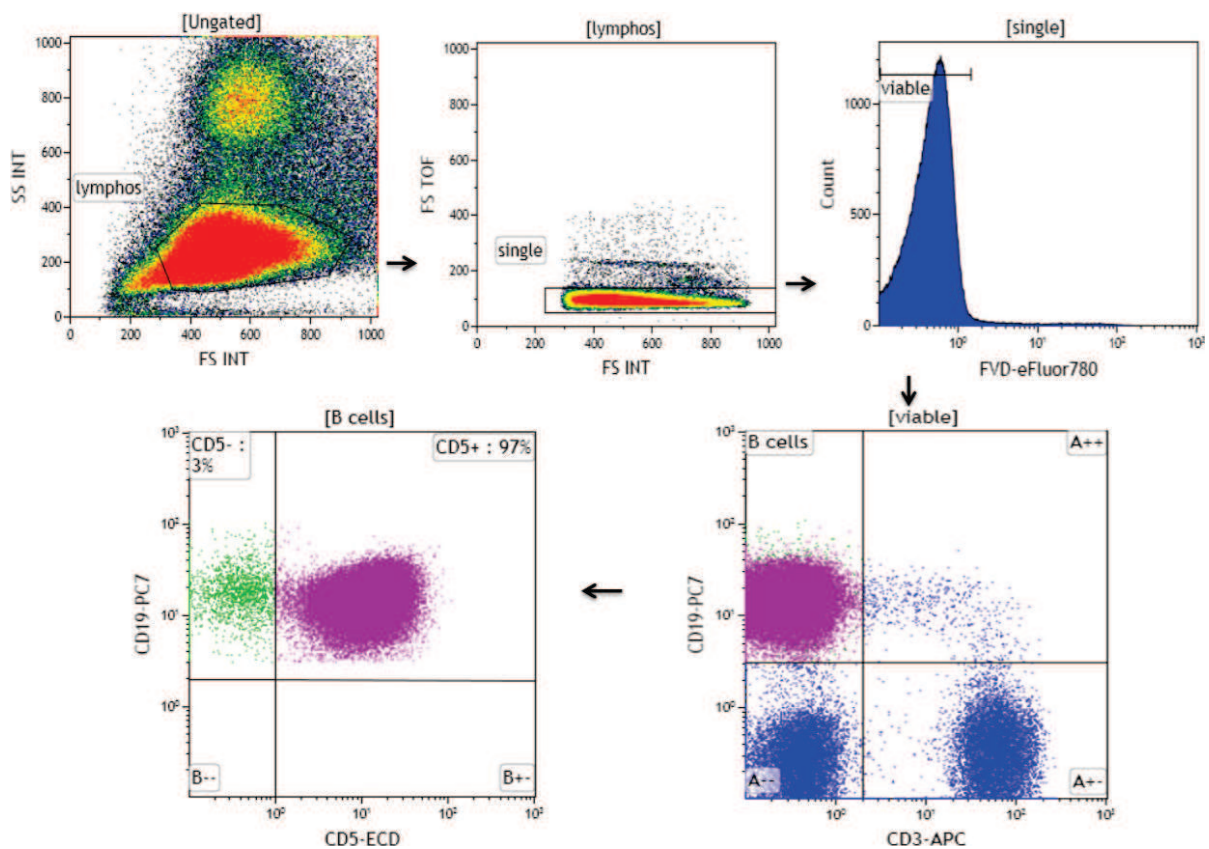

Figure 32. Gating strategy of normal and CLL B cells for ZAP-70 phenotyping. Lymphocytes (Lymphos) were gated in a side scattering (SS) vs. forward scattering (FS) window, then doublets were excluded in a time of flight (TOF) window. Afterwards, only viable cells were selected, in a window that excluded the doublets (single), which were negative for Fixable Viability Dye (FVD). CD19⁺ B cells were then gated in the viable cell window (viable) vs. CD3⁺ cells, which were then classified in CD5⁻ or CD5⁺ B cells.

Importantly, we found that a certain percentage of normal B cells from CLL patients express ZAP-70, as shown in Figure 33.

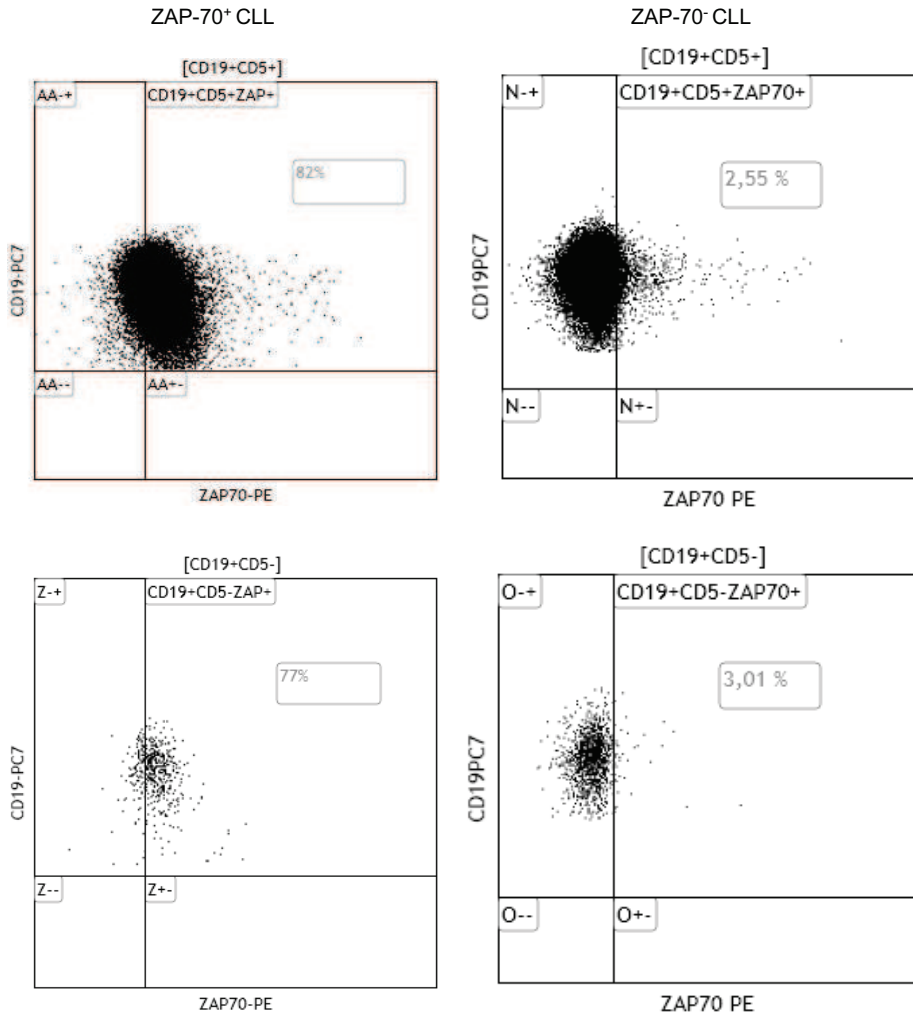

Figure 33. Example of two CLL cases: a ZAP-70⁺ CLL in the left side, and a ZAP-70⁻ CLL in the right side. In the upper cases CLL B cells were gated, showing in the left site a typical ZAP-70⁺ CLL case, in which 82% of cells express ZAP-70, and in the right side a ZAP-70⁻ CLL case, in which 2,55% of CLL cells express ZAP-70. In the bottom cases, normal B cells from the same patients were gated, showing that normal B cells from the ZAP-70⁺ CLL patient express ZAP-70.

We wondered whether these ZAP-70 expressing normal B cells could represent a contamination of normal B cells with a contingent of CLL clone that would have lost CD5 expression. This is mostly unlikely, because ZAP-70⁺ normal B cells express a high level of CD19 (MFI of CD19 10,26 for CD19⁺CD5⁻ cells, as compared to 6,51 for CD19⁺CD5⁺ cells) and a high level of surface light chain (not like CLL clone B cells) (Figure 34. A), and, most importantly, are polyclonal as they express a normal k/λ light chain ratio (Figure 34. B).

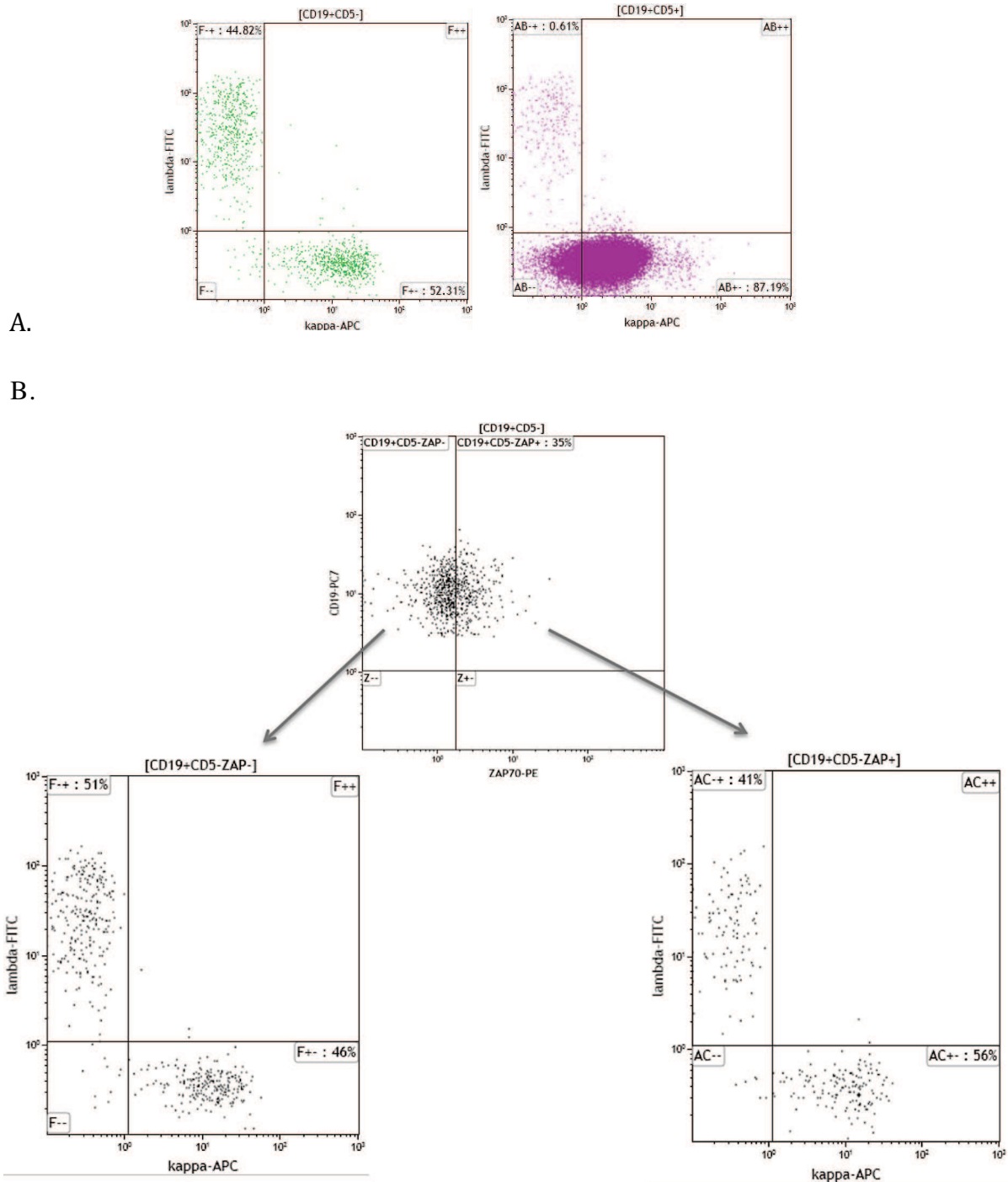

Figure 34. ZAP-70 expressing normal B cells don't represent a contamination of normal B cells with CLL clone, as they express a high level of surface light chains and are polyclonal. **A:** Levels of light chain expression in CLL clone (CD19⁺CD5⁺ cells) and in normal B cells (CD19⁺CD5⁻ cells) from the same patient. In this example the CLL cell express k monoclonal B cells with a low surface light chains (right case), as compared to normal B cells (left case). **B:** ZAP-70⁺ normal B cells are polyclonal. In the upper case CD19⁺CD5⁻ B cells are gated in a CD19 vs. ZAP-70 window. The cut-off value for ZAP-70-PE was established according to isotypic control (data not shown). As shown in the bottom cases, ZAP-70⁻ (left) as well as ZAP-70⁺ normal B cells are polyclonal as they have normal k/ λ light chain ratios (0,9 in ZAP-70⁻ and 1,3 in ZAP-70⁺, respectively), as compared to abnormal k/ λ ratio in CLL cells (at 88, for the same patient, data not shown).

The polyclonality of these cells was definitively proven by the molecular analysis of clonal level in Ig heavy and light chain sequenced rearranged genes amplified from ZAP-70⁺ normal B cells (see chapter 4.4).

We analyzed ZAP-70 expression in 63 CLL patients with enough residual normal B cells to permit statistical analysis and in 36 normal subjects. Expression of ZAP-70 in CLL B cells, normal B cells and T cells was compared to an isotype control antibody. In each experiment a sample from a normal subject was used as a control.

As we looked at normal B cells from CLL patients in general, we observed that they expressed much more ZAP-70 than normal B cells from non-leukemic subjects.

% of ZAP-70+ normal B cells from CLL patients and controls

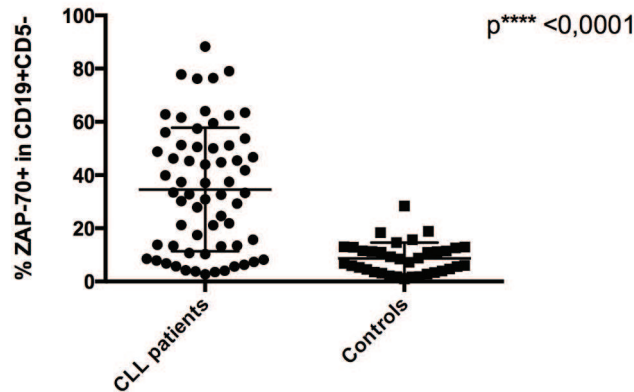

Figure 35. Normal B cells from CLL patients express high levels of ZAP-70 compared to normal subjects. The results are expressed as percentage of ZAP-70+ cells from a total of CD19+CD5- normal B cells (Mann-Whitney test).

As it was expected, CD19+CD5+ CLL clone expressed more ZAP-70 than CD19+CD5+ peripheral blood cells from normal subjects (Figure 36).

% of ZAP-70+ in CD5+ B cells from CLL patients and controls

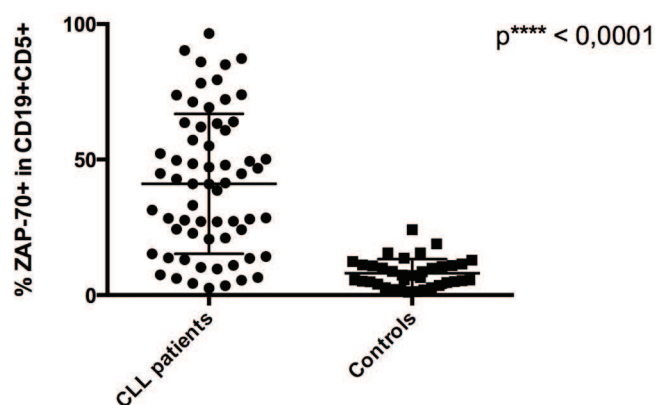
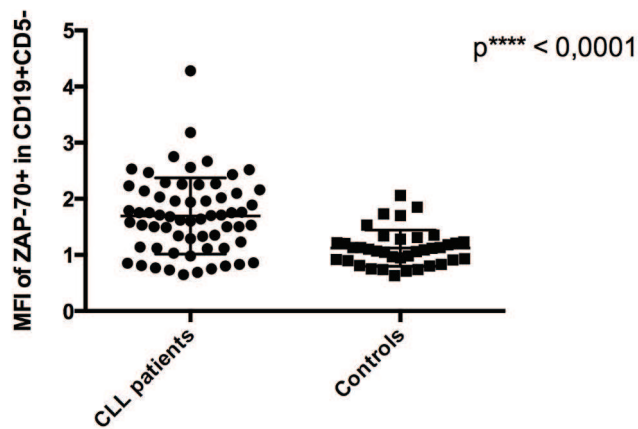

Figure 36. ZAP-70 expression in CD19+CD5+ cells from CLL patients as compared to normal subjects (Mann-Whitney test).

In addition, the expression was also expressed as median fluorescence intensity (MFI) for each of the above subpopulations. When we analyzed ZAP-70 expression, not according to a percentage of positive cells over an isotype control, but to the more independently parameter like MFI, we found similar results (Figure 37). Notably, normal B cells from CLL patients expressed a higher MFI of ZAP-70-PE than B cells from normal subjects, measured in the same experiment. This was also true, as expected for CLL B cells, as compared with CD19⁺CD5⁺ B cells from controls.

MFI of ZAP-70 in normal B cells from CLL patients and controls



A.

MFI of ZAP-70 in CD5+ B cells from CLL patients and controls

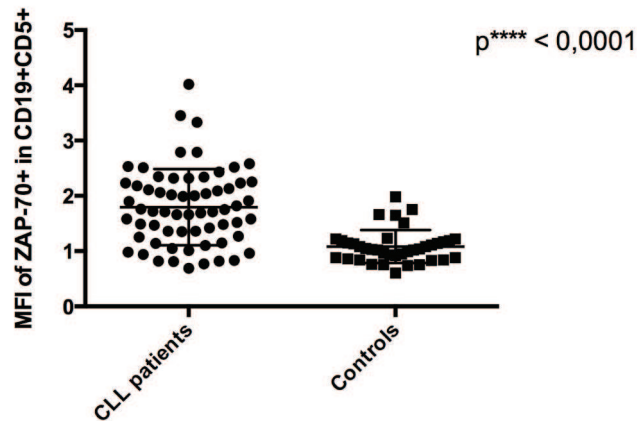

B.

Figure 37. Median fluorescence intensity (MFI) of ZAP-70-PE in CD5⁻ (A) and CD5⁺ B cells (B) from CLL patients versus controls (Mann Whitney test).

➤ **Characteristics of analyzed CLL patients**

Table 10 describes the features of a total of 63 patients tested, among which 47 (74,6%) were ZAP-70 positive and 16 (25,4%) negative.

IGHV mutation status data were available for 33 patients, among which 17 were mutated (M; 51,5%) and 16 unmutated (UM; 48,5%). The mutational status was concordant with ZAP-70 positivity in 25 out of 33 cases (75,8% concordance), values also described in previous studies. Among 16 UM cases 15 were ZAP-70⁺ (93% concordance). On the other hand, among 17 M cases only 10 were ZAP-70⁻ (58,8% concordance).

CLL clone sequencing data, available only for 24 patients, did not permit a statistical analysis concerning a possible association between ZAP-70 positivity or mutational status and a particular IGHV sequence in CLL cells in this study.

Cytogenetic data were available for 39 patients (61,9%). Patients with at least two chromosomal aberrations or complex karyotypes were all in ZAP-70⁺ group, as well as all of patients with 17p deletions. This confirms the data in the literature that describes an association between ZAP-70 positivity with other unfavorable prognostic factors.

Name	MFI ZAP test			% of ZAP+ cells above isotype CTRL		ZAP	IGVH	CLL Sequence	Genetics
	CD3+	CD19+CD5+	CD19+CD5-	CD19+ ZAP70+					
				% CD19+ CD5+	% CD19+ CD5-				
DIE	3,49	2,53	1,5	86,04	39,85	pos	UM	VH3-15	
LUD	3,45	2,52	2,16	96,58	88,31	pos	M	VH4-34	N
PER	5,7	3,45	2,52	62,06	32,6	pos	UM	VH3-33	del13q+del17p
CUR	4,63	2,23	2,53	31,37	44,77	pos			N
MAR	3,81	2,11	2,03	47,97	46,67	pos			del13q
HAE	2,81	1,01	0,8	27,13	10,29	pos	UM		del13q
STO	4,38	1,1	0,75	38,66	8,18	pos	UM		complex
KIS	5,65	2,32	2,67	28,25	43,92	pos			
HEY	3,02	2,02	1,89	44,76	37,42	pos			N
ARM	4,04	2,34	2,02	42,79	32,82	pos			del17p
MUL	3,42	1,99	1,58	41,35	27,87	pos	UM	VH2-5	N
WIT	2,77	1,58	2,25	27,01	51,3	pos			del17p + del6q
VOG	3,79	1,66	1,7	22,78	21,21	pos			del13q
LEH	4,2	2,18	1,94	63,6	50	pos			
KLL	3,79	1,75	1,49	48,48	33,46	pos			del14q
BIN	2,59	1,49	1,23	24,3	21,91	pos	UM	VH4-39	tri 12
FAG	3,55	1,35	1,34	28,06	30,24	pos			tri 12 + t(18;22)
HAT	4,39	1,27	1,35	20,66	29,29	pos			N
BEU	3,16	1,69	1,71	44,88	45,31	pos			del13q+del 11q
ZOU	4,07	2,51	2,47	79,49	79,07	pos	UM	VH3-49	
SAC	3,69	1,72	1,75	33,1	33,25	pos			
BER	3,51	1,14	1,12	47,19	45,49	pos	M	VH4-59	
KIR	3,51	1,76	1,62	71,27	62,81	pos	M	VH3-23	
FUH	3,24	1,48	1,33	50,11	37,08	pos	UM	VH1-8	del14q
VON	3,25	1,91	1,5	78,18	51,13	pos	UM	VH3-30	del13q
LAHD	2,99	1,71	1,5	63,3	46,19	pos	M	VH3-7	
BRO	4,45	2,09	1,64	27,65	13,34	pos	UM	VH3-66	del13q
GIN	3,7	2,13	1,71	46,8	21,12	pos	UM	VH3-30	del13q
GHE	4,86	2,79	2,27	87,33	64,08	pos	UM	VH1-69/VH6-1	N
RAM	4,37	2,23	2,56	52,23	61,6	pos			del13q
KRA	4,27	2,43	2,14	72,21	59,47	pos			
SUL	4,37	2,79	2,29	69,18	48,8	pos			
COU	2,79	2,04	1,75	60,78	50,57	pos			N
REI	5,27	4,02	3,18	85,08	56,06	pos			complex
PFI	4,63	3,33	2,75	90,26	77,76	pos			
BIE	3,85	1,15	0,77	27,23	4,24	pos	UM		t(6q;13q)
FRJ€	4,1	1,36	0,98	24,16	4,03	pos	UM		
FOE	3,59	1,71	1,68	63,94	63,43	pos			
GOE	2,33	1,47	1,53	28,44	30,84	pos			
DEL SO	5,56	2,58	2,26	57,2	41,76	pos			del14q
KAE	5,29	2,35	2,43	49,35	53,67	pos			
DAU	4,86	1,82	1,75	40,98	37,34	pos			del13q + del 2p
SCH	2,86	1,66	1,79	73,93	76,42	pos	M	VH3-74	N
TIS	2,63	1,36	1,96	49,73	62,43	pos	M		
BIT	2,57	1,52	1,29	41,05	24,6	pos	UM	VH1-69	del13q + TP53+
AFI	3,48	2,25	4,28	55,04	76,19	pos	M	VH3-21	N
GRU	6,56	2,06	1,76	73,78	57,45	pos			
REU	3,27	0,81	0,65	9,6	8,5	neg	M	VH3-43	del13q
KLE	1,84	0,69	0,73	6,49	5,69	neg	M	VH1-2	
LAH	2,87	0,98	1,12	4,31	7,85	neg			
HEI	2,71	1,25	1,11	14,19	5,65	neg	M	VH3-48	
HOR	4,98	2,32	2,23	13,01	13,18	neg	M	VH3-21	
JEA	5,03	2	2,1	13,67	17,48	neg	M	VH1-69	del13q
MIE	3,74	1,9	1,96	10,18	13,47	neg	M	VH4-34	del13q
BOH	3,15	0,82	0,83	6,15	6,26	neg	M		del13q
ULL	5,92	0,96	0,86	19,02	7,37	neg			N
FRI(T)	2,83	0,83	0,69	13,52	3,81	neg	UM		tri 12
FIS	3,74	0,77	0,81	2,55	2,72	neg	M		del13q
ULM	4,91	0,82	0,85	3,47	3,53	neg	M		
ROE	2,81	1,05	1,14	10,98	13,83	neg			N
FERN	6,11	1,42	1,6	7,47	10,71	neg	M	VH3-74	tri 19
BRI	2,71	0,94	1,03	5,49	6,8	neg			
CHA	3,21	1,58	1,53	15,21	15,73	neg			

Table 10. ZAP-70 expression determined in flow cytometry for 63 CLL patients. The analysis was expressed by two methods: as median fluorescence intensity (MFI) and as percentage of ZAP-70⁺ cells above an isotype control cut-off (establish as no more than 0,5% of cells are positive). CLL B cells are then classify as ZAP-70 positive if they have at least 20% of leukemic clone expressing ZAP-70. The last two colons detail available cytogenetic and molecular characteristics.

➤ **ZAP-70 mRNA expression in qPCR**

We clearly demonstrated that a significant percentage of normal B cells from CLL patients express ZAP-70 protein, determined in flow cytometry. Afterwards, we wanted to know whether this overexpression of ZAP-70 in normal B cells is also found at the mRNA level.

To this aim, we analyzed mRNA expression by qPCR, as detailed in patients and methods chapter, in highly purified cells, from CLL patients and normal subjects.

First, we validated our qPCR method by comparing CD19⁺CD5⁺ cells from 9 patients with ZAP-70⁺ CLL and 4 normal subjects. We demonstrated that CLL cells express significant levels of ZAP-70 mRNA, whereas CD19⁺CD5⁺ cells from healthy controls do not (Figure 38).

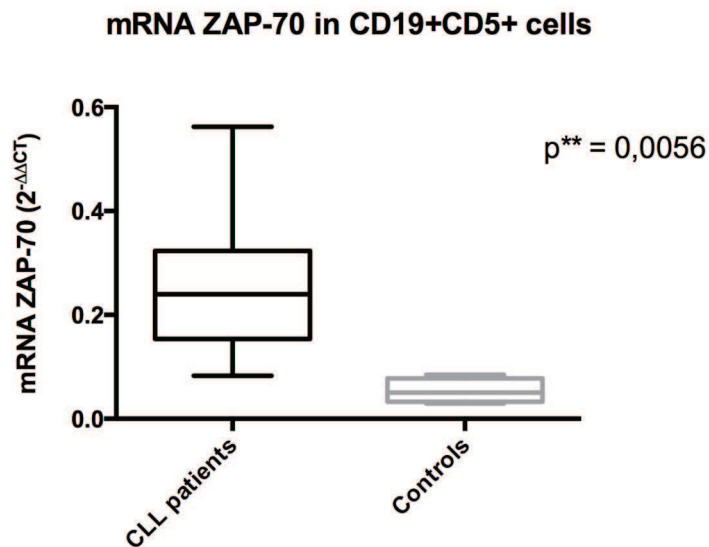

Figure 38. CD19⁺CD5⁺ highly purified cells from CLL patients express a significant higher level of ZAP-70 mRNA as compared with CD19⁺CD5⁺ cells from healthy controls. The data were expressed as 2^{-ΔΔCT}, the expression level of ZAP-70 being normalized to that of HPRT1 house keeping gene and to the level of ZAP-70 mRNA expression in normal T cells.

As we demonstrated at the protein level, by flow cytometry, we found a higher level of ZAP-70 mRNA in normal B cells from CLL patients than in normal CD5⁻ B cells from healthy subjects, although the difference was not significant. As this technique requires a minimum number of sorted cells, and as, additionally, normal residual B cells in CLL patients are very rare (near 0,01% to 0,1% of total lymphocytes), this could only be done for 5 CLL patients (samples with CTs of ZAP-70 and/or HPRT1 house keeping gene at more than 30,9 were eliminated from the analysis). This could, at least partially, explain the non-significant level.

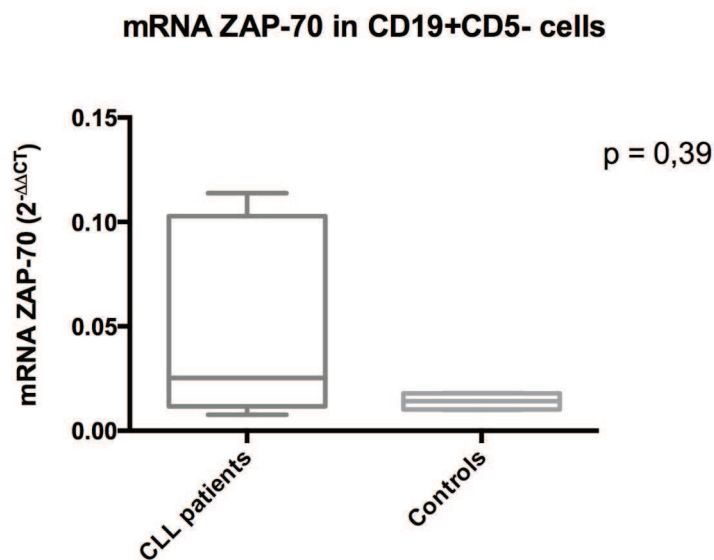

Figure 39. Normal CD19⁺CD5⁻ B cells from CLL patients express more ZAP-70 mRNA than the same subset of cells isolated from normal subjects. Expression level of ZAP-70 was normalized to that of HPRT1 house keeping gene and to the level of ZAP-70 mRNA expression in normal T cells.

➤ **Confirmation of ZAP-70 mRNA expression by normal B cells from ZAP-70⁺ CLL patients in single cell RT-PCR (scPCR)**

We designed a scPCR method for amplification of ZAP-70 gene transcript at single cell level, on FACS sorted normal B cells, as described in methods chapter. This technique was designed for the description of the Ig repertoire and for monoclonal antibody production from the ZAP-70⁺ normal B cells that we have described. These cells cannot be sorted on the ZAP-70 expression on cytometry, because ZAP-70 is an intracellular marker that needs a previous fixation and permeabilization procedures, before staining. Fixation and permeabilisation techniques use paraformaldehyde, which intercalates with nucleic acids and inhibits subsequent PCR reactions if they are not previously treated with special buffers at particular temperature conditions that revert formaldehyde modifications on RNA or DNA. Pretreatment kits are designed for large quantities of nucleic acids, but are not sensitive enough to be used on single cells. Single cell adaptation of such RNA extraction kits and strategies design for fixed cells (RNeasy PPFE Kit, Qiagen) were experimented, but remained unsuccessful.

To confirm ZAP-70 gene transcript amplification in single cells, normal B cells (CD19⁺CD5⁻) from 5 ZAP-70⁺ CLL patients were FACS sorted as single cells after surface staining on 96 well plate. Direct cDNA synthesis and its subsequent PCR nested amplification was realized as described in methods chapter.

After agarose gel electrophoresis of second PCR products we found that in each patient a proportion of normal B cells indeed actively transcribe ZAP-70 gene. Examples are illustrated in Figure 40.

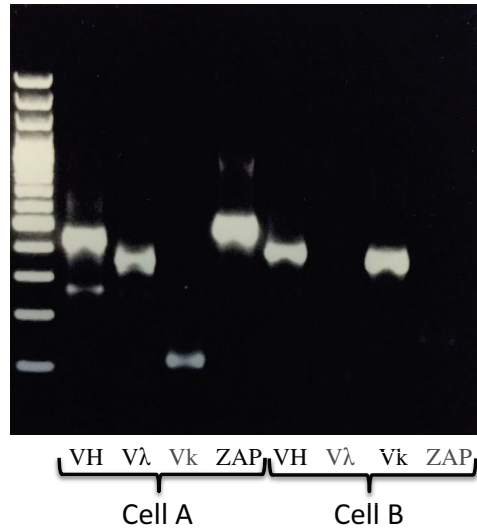

Figure 40. Example of two normal B cells ($CD19^+CD5^-$) from a $ZAP-70^+$ CLL patient in which transcripts of IgH, Ig λ , Igk and ZAP-70 were studied at single cell level. Cell A exemplifies a ZAP-70 expressing normal B cell, which also expresses positive transcripts of rearranged IgH and Ig λ variable region genes. By contrast, cell B does not express ZAP-70 mRNA.

It is worth noting that these experiments further support that $ZAP-70^+$ normal B cells are mostly polyclonal, as Igk and Ig λ rearranged V genes were equally amplified (Figure 41).

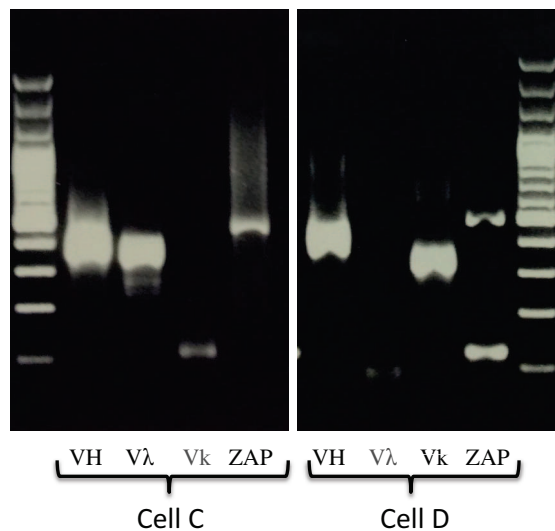

Figure 41. $ZAP-70^+$ normal B cells from the same patient are polyclonal, as exemplified here: C and D cells are both $CD19^+CD5^-$ B cells, from the same patient. They are both mRNA ZAP-70 positive, but are not from the same clone, because they express different light chain Ig (λ in cell C, and k in cell D).

Sequencing of PCR products confirmed ZAP-70 mRNA amplification and the polyclonal nature of ZAP-70⁺ normal B cells different from the malignant clone (see paragraph 4.4 for further details).

This is the first time that a reverse-transcription scPCR successfully detects ZAP-70 at single cell level.

Moreover, this is the first time that ZAP-70 mRNA can be detected in single normal B cells, at the same time as Ig heavy and light chain transcripts. This technique can be used to molecularly describe at single cell level the characteristics of ZAP-70⁺ B cells, like the sequences of rearranged Ig genes and to produce monoclonal antibodies (mAb) expressed by ZAP-70⁺ B cells.

4.2. THERE IS A GOOD CORRELATION BETWEEN THE EXPRESSION LEVELS OF ZAP-70 OF MALIGNANT AND NORMAL B CELLS IN THE SAME CLL PATIENT

We observed a surprising evident correlation in the level of ZAP-70 expression, between normal B cells and CLL B cells. This was true when we analyzed the correlation as a percentage of positive cells, as well as a MFI (Figure 42).

Correlation of ZAP-70 level in normal and CLL B cells

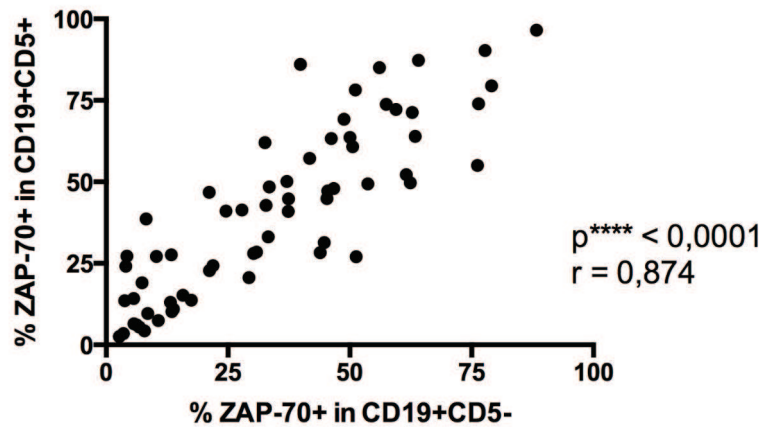

A.

Correlation of ZAP-70 level in normal and CLL B cells

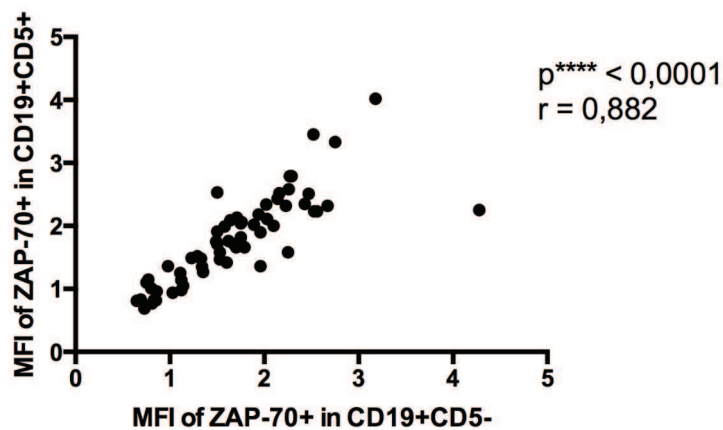

B.

Figure 42. Correlations between the expression levels of ZAP-70 in malignant and normal B cells in CLL patients, expressed as percentage of positive cells above an isotypic control (A) and as MFI (B) (Spearman statistical test).

Moreover, there is a correlation, although not so evident as the one between normal and malignant B cells, between the levels of ZAP-70 expression in T cells and normal or CLL B cells, from the same patient (Figure 43).

Correlation of ZAP-70 level in normal B cells and in T cells

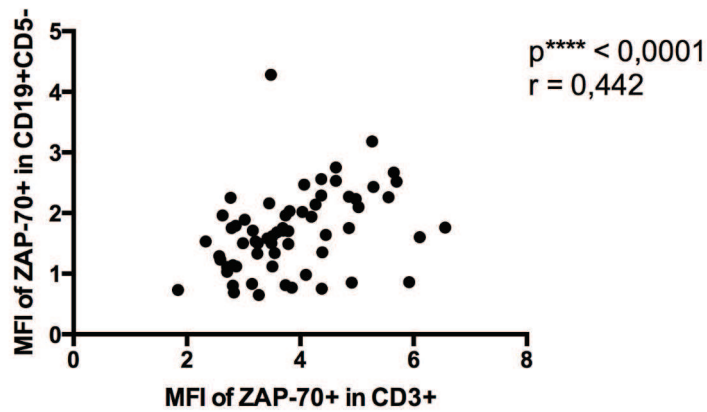

A.

Correlation of ZAP-70 level in CLL B cells and T cells

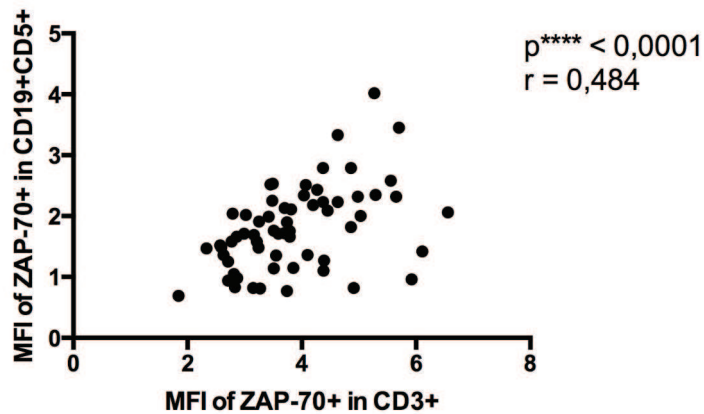

B.

Figure 43. Correlation in the expression level of ZAP-70 between normal (A) or malignant (B) B cells and T cells in CLL patients, express as and as MFI (Spearman statistical test).

➤ **T cells from CLL patients express higher levels of ZAP-70 than controls**

Interestingly, there was also a significant higher expression of ZAP-70 in T cells from CLL patients than in controls (Figure 44). A group, working on the standardization of ZAP-70 flow cytometric techniques in routine ZAP-70 status determination, only recently published similar data (Rizzo et al. 2013). The increase of ZAP-70 expression in T cells from CLL patients confirms that Zap-70 expression in CLL B cells evaluation, as a ratio to T cells from the same patient is not of reliable.

MFI of ZAP-70 in T cells from CLL patients and controls

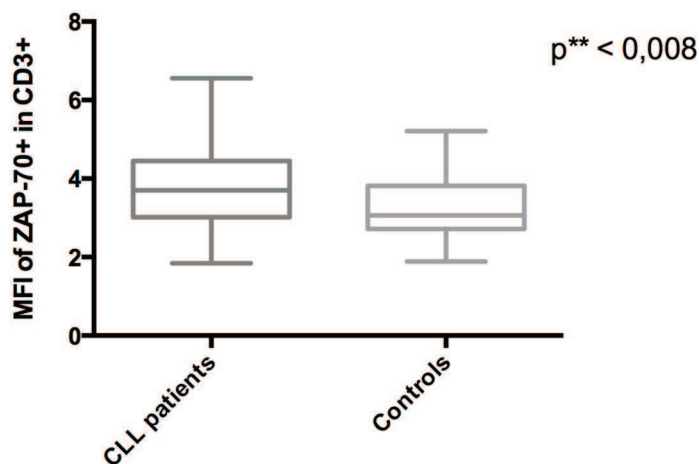

Figure 44. T cells from CLL patients express higher levels of ZAP-70 than normal subjects (Mann Whitney test).

➤ **Search for a serum factor in CLL patients that could increase ZAP-70 level in all lymphocytes**

Given the fact that we described increased levels of ZAP-70 in all lymphocyte populations studied, e. g. CLL B cells, normal B cells and T cells, in ZAP-70⁺ CLL samples, we questioned whether there was a serum factor in CLL patients that could explain this fact.

For this purpose, we designed an in vitro culture of peripheral blood mononuclear cells (PBMC) from controls or CLL patients (ZAP-70⁺ and ZAP-70⁻) with serum from a ZAP-70⁺ CLL patient. Media culture contained increasing concentration of serum-enriched RPMI (10%, 25%, 50%), and the cell were recovered at 24h and 48h of culture. As a control we used on one hand PBMC from a normal subject, and on the other hand we used serum-enriched media with increasing concentrations from a normal subject, as seen in Figure 45.

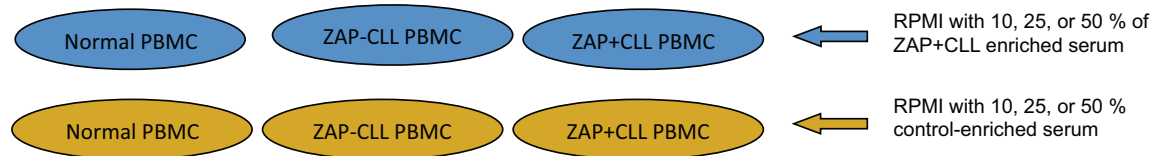

Figure 45. In vitro culture experimental design, in search of a serum factor in CLL ZAP-70⁺ patient that could increase ZAP-70 expression in all lymphocyte populations. Normal PBMC, ZAP-70⁻ and ZAP-70⁺ CLL PBMC were incubated for 24h and 48h with RPMI enriched with 10%, 25% or 50% serum from a ZAP-70⁺ CLL case, or from normal subject, as control.

The results showed that, control or ZAP-70⁻ CLL PBMC do not increase their level of ZAP-70 expression after 24h or 48h of culture with a ZAP-70⁺ CLL serum (Figure 46).

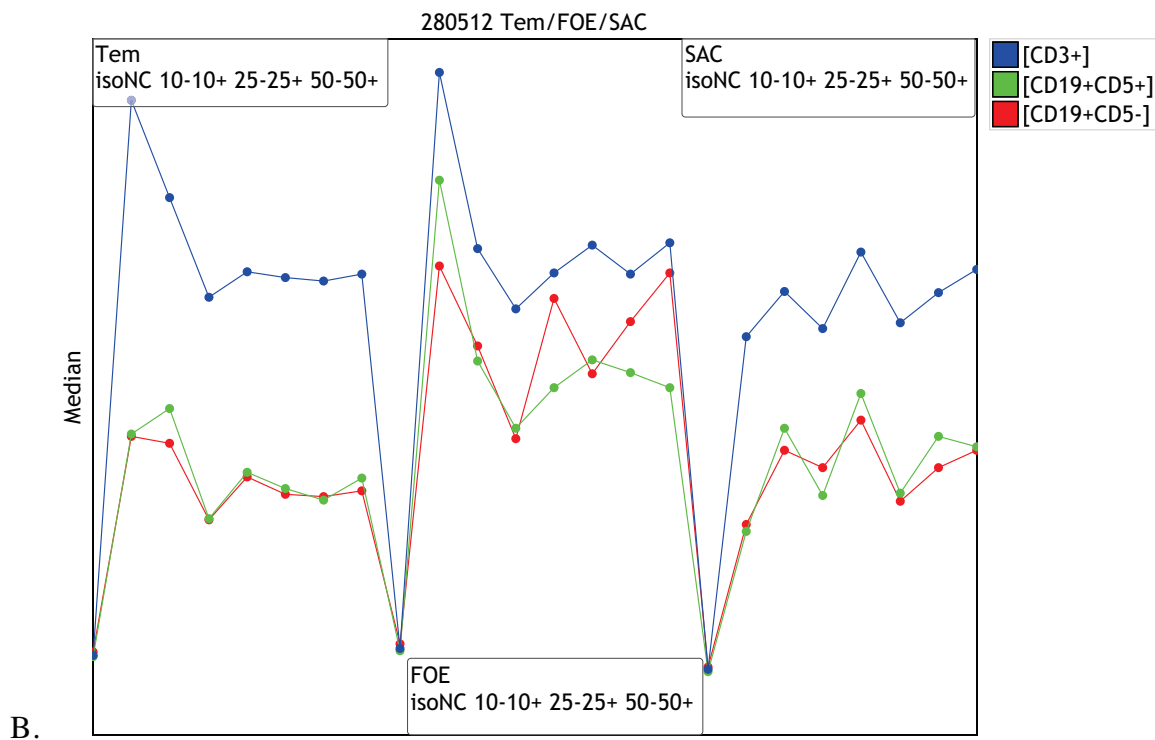
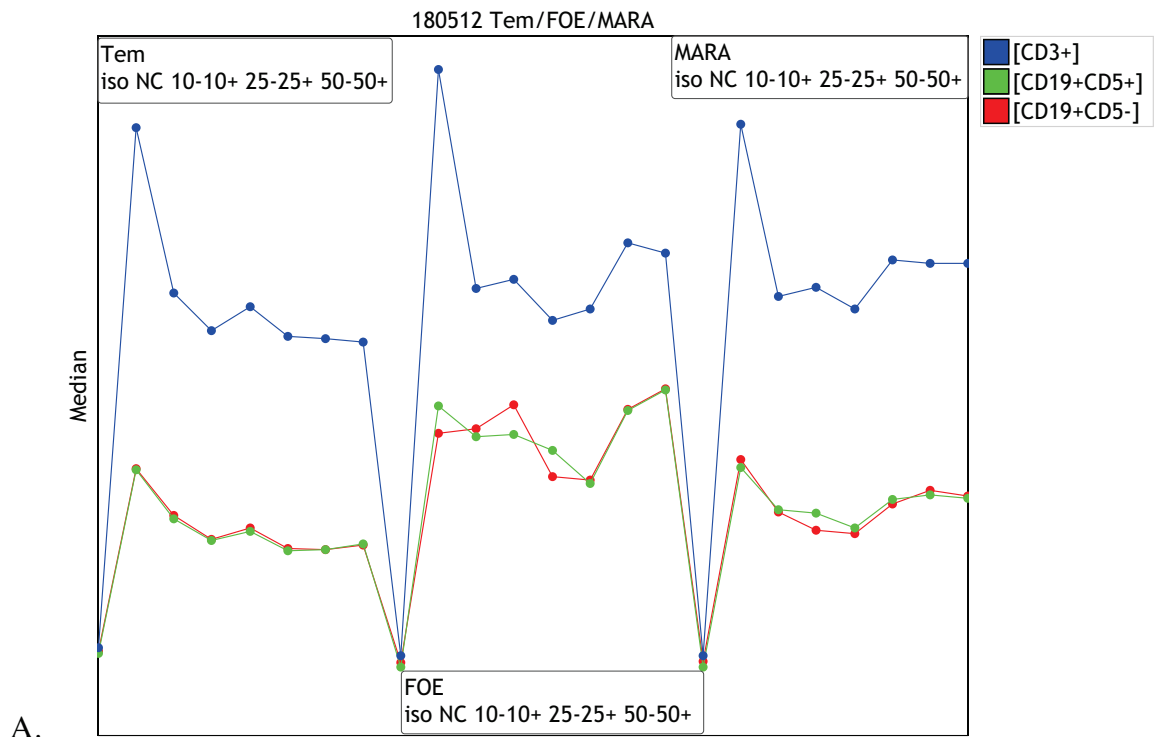

Figure 46. 24h (A) and 48h (B) culture of control (Tem), ZAP-70⁺ CLL (FOE) and ZAP-70⁻ CLL (MARA, and SAC) PBMC with RPMI enriched with 10%, 25%, 50% serum from normal subject (-) or ZAP-70⁺ (+) CLL case. ZAP-70 expression was expressed as median fluorescence intensity (median). Iso i.e. isotypic control, and NC i.e. non- cultivated were utilized as control for ZAP-70 expression. We noticed no constant increase in ZAP-70 level in T cells (blue), CD5⁺ B cells (green) or CD5⁻ B cells (red) after incubation with ZAP-70⁺ serum as compared with a normal serum.

We can deduce that increased ZAP-70 expression in peripheral blood lymphocytes from CLL patients is probably not an extrinsic, serum-induced characteristic, but a rather intrinsic trait of these cells (The possibility that increased ZAP-70 expression could be induced by an extrinsic cellular interaction with stromal cells, for example, has not yet studied). As this elevated expression is not limited to malignant transformed cells (i.e. CLL cells), but rather a more general characteristic, one can reasonably imagine that this characteristic preexist to malignant transformation and could even play a role in it. In other words, ZAP-70 expression in CLL B cells is not an abnormal consequence of malignant transformation, but could be at the origin of malignancy.

4.3. THERE IS A GOOD CORRELATION BETWEEN THE EXPRESSION LEVEL OF ZAP-70 IN NORMAL B CELLS AND THE PRESENCE OF AUTOIMMUNE PHENOMENA IN PATIENTS WITH CLL

In our study all of autoimmune cytopenia occurred in patients with ZAP-70⁺ CLL. This confirmed the literature data, as Zanotti et al. showed, that there is a good correlation between autoimmune phenomena in CLL and ZAP-70 expression by clonal CLL cells (Zanotti et al. 2010).

19 patients presented typical CLL-associated autoimmune cytopenia, like AIHA, ITP, or Evans syndrome, as described in Table 11. In addition, two patients in our series presented atypical CLL-associated auto-immunity, namely a vasculitic purpura with positive rheumatoid factor and an Sjögren syndrome. The two were diagnosed before CLL onset, and are probably independent associations, not in relation with CLL-induced immune imbalance.

No	Name	ZAP	BINET	AIHA	DAT	ITP	Anti-platelet Ab	Other AI
1	DIE	pos	Ci	YES	POS IgG, C3d	NO	0	NO
2	LUD	pos	Ci	YES	POS IgG	YES	NEG	NO
3	PER	pos	Ci	NO	POS IgG	YES	NEG	NO
4	CUR	pos	Ci	YES	NEG	YES	NEG ELISA	NO
5	MAR	pos	Ci	NO	POS C3d	YES	NEG ELISA	NO
6	HAE	pos	Ci	NO	0	YES	0	NO
7	STO	pos	Ci	YES	POS C3d	NO	0	NO
8	KIS	pos	Ci	YES	POS IgG	NO	0	NO
9	HEY	pos	Ci	NO	POS IgG	YES	NEG	ANA + 1/160
10	ARM	pos	Ci	YES	POS IgG, C3d	YES	NEG ELISA	NO
11	MUL	pos	Ci	NO	NEG	YES	0	NO
12	WIT	pos	Ci	YES	POS IgG	NO	0	NO
13	VOG	pos	Ci	YES	0	YES	0	auto-immune hepatitis
14	LEH	pos	Ci	YES	POS IgG, C3d	YES	0	NO
15	KLL	pos	Ci	YES	POS IgG, C3d	YES	0	NO
16	BIN	pos	Ci	NO	NEG	YES	NEG	NO
17	FAG	pos	Ci	YES	NEG	NO	0	cryo type 2; APLS
18	HAT	pos	Ci	YES	POS IgG, C3d	NO	0	NO
19	BEU	pos	Ci	YES	POS IgG	NO	0	NO
20	ZOU	pos	A	NO	NEG	NO	0	vasculitic purpura, RhF+
21	SAC	pos	A	NO	0	NO	0	Sjogren syndrome

Table 11. Autoimmune phenomena (AI) associated with CLL cases. All of patients with AI presented a ZAP-70⁺ CLL, and were classified in Binet stage C (Ci = immunological stage C). AIHA = autoimmune hemolytic anemia, DAT = direct anti-globulin test, ITP = immune thrombocytopenia, ANA = anti-nuclear antibody, APLS = anti-phospholipid syndrome, RhF= rheumatoid factor.

As it is well known that AI cytopenias in CLL patients are the result of normal B cells secreting polyclonal antibodies, and not the consequence of the CLL clone, we looked to see whether there was also an association between AI and the level of ZAP-70 in normal B cells.

In Figure 47 we demonstrated a good correlation between the expression level of ZAP-70 in normal B cells and the presence of AI, as compared with normal B cells and ZAP-70⁻ CLL.

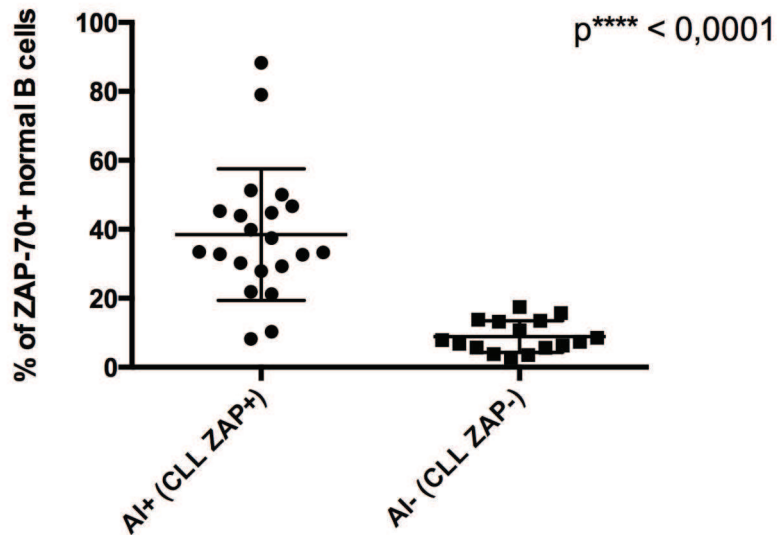

Figure 47. Correlation between ZAP-70 expression level in normal B cells and the presence of autoimmunity (AI+) in CLL patients, as compared to the level of ZAP-70 in CLL ZAP-70⁻ (CLL ZAP-) patients without autoimmunity (AI-).

On the other hand, when we compared the expression levels of ZAP-70 between CLL ZAP-70⁺ patients with or without autoimmune phenomena, we didn't find a significant difference, as seen in Figure 48.

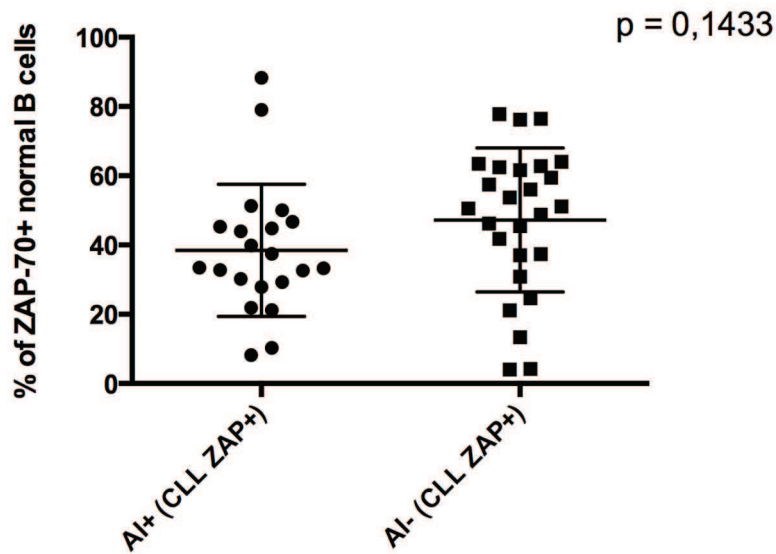

Figure 48. In CLL patients with autoimmune phenomena (AI+), the level of ZAP-70 in normal B cells is not significantly different as compared with the level in normal B cells from ZAP-70⁺ CLL without AI (AI-).

This is in favor of a rather on/off effect of ZAP-70 on B cells, as only its presence is significantly associated with autoimmunity. In ZAP-70 positive pool of patients the presence of autoimmunity was not associated with higher level of ZAP-70, as compared with ZAP-70 positive patients without autoimmunity. The fact that only a certain level of ZAP-70 protein is necessary to increase BCR signaling was previously demonstrated for CLL clones (Chen 2005). Exceeding levels above this threshold do not enhance phosphorylation of downstream proteins. Moreover, this is also true on clinical level, where patients with intermediate level of ZAP-70 in CLL cells have the same risk of aggressive disease as those with high ZAP-70 levels (Rassenti et al. 2004).

So, we clearly demonstrated that the advent of autoimmune phenomena in CLL is associated with the expression of ZAP-70 by clonal CLL cells as well as by normal residual B cells.

4.4. FURTHER CHARACTERIZATION OF ZAP-70⁺ NORMAL B CELLS FROM CLL PATIENTS

To summarize, we demonstrated that a fraction of normal B cells from ZAP-70⁺ CLL patients express ZAP-70 at significant levels, as compared with healthy controls, and that these cells do not belong to the CLL clone, as they are CD5⁻, have higher CD19 and sIg levels and are polyclonal, with a normal k/λ light chain ratio.

We then tried to characterize these ZAP-70⁺ B cells, wondering whether they belong to a certain B subset, have certain activation traits, or whether they have particular Ig rearranged sequences.

➤ ZAP-70⁺ normal B cells do not belong to a specific B cell subset

Firstly, we characterized in detail, the phenotype of ZAP-70⁺ normal B cells in flow cytometry. In ZAP-70⁺ CLL samples, normal CD5⁻, ZAP-70⁺ or ZAP-70⁻ B cells were studied in different B cell subsets: naïve (IgM⁺ IgD⁺CD27⁻), switched memory (IgM⁻IgD⁻CD27⁺), non-switched memory (IgM⁺IgD⁻CD27⁺), memory CD27⁻ (IgM⁻ IgD⁻CD27⁻), anergic (IgM⁻IgD⁺CD27⁻) and MZ (IgM⁺IgD⁺CD27⁺) B cells. We found that ZAP-70⁺ and ZAP-70⁻ normal B cells from CLL patients were equally distributed in these different B cell subsets, as you can see in Figure 49.

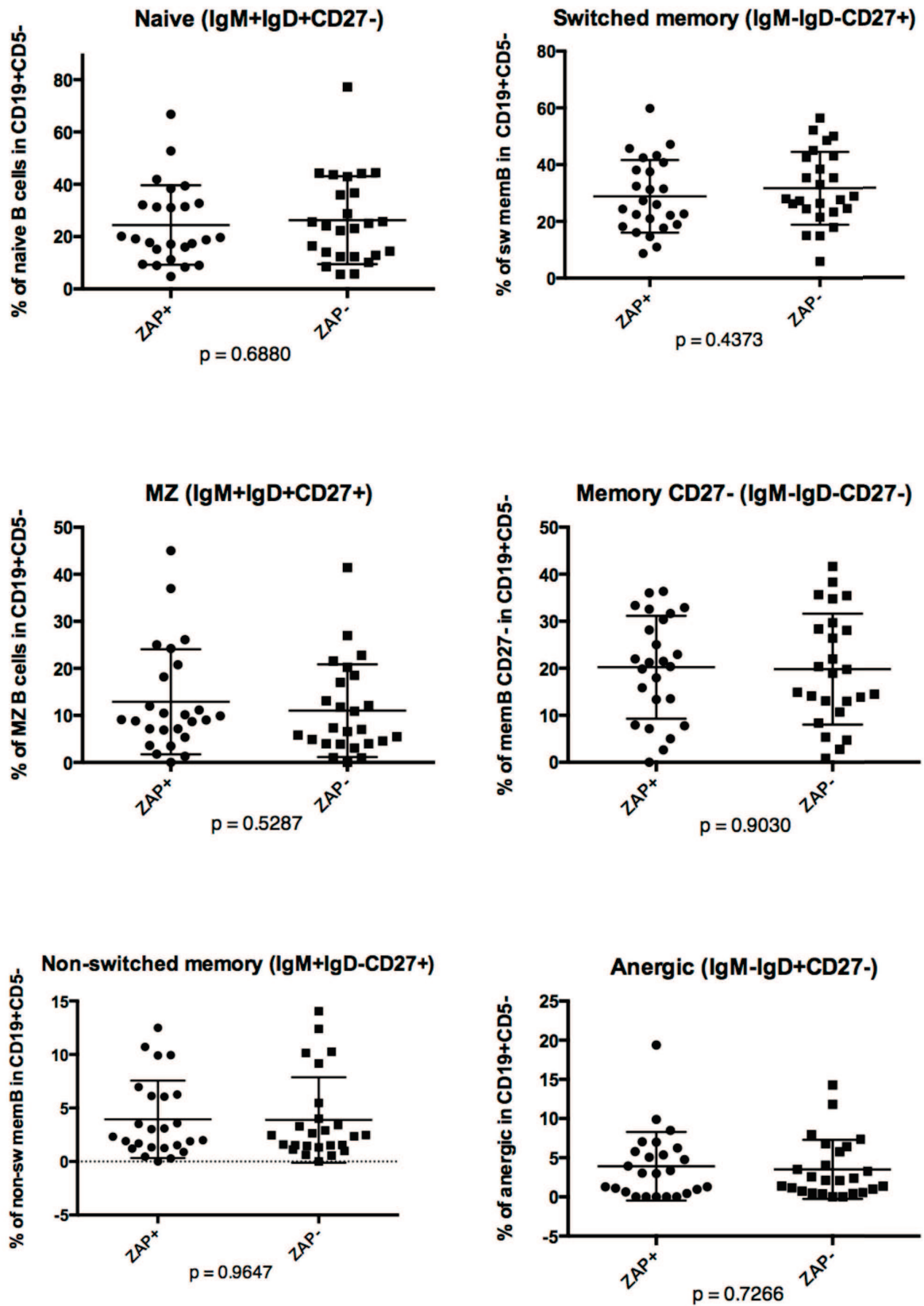

Figure 49. ZAP-70⁺ normal B cells do not belong to a certain B cell subset. Different B cell subsets have the same percentage in ZAP-70 positive and negative B cells (unpaired t test).

If we pair the ZAP-70⁺ with the corresponding ZAP-70⁻ B cell population for each patient, we observed a significant correlation between the percentage of ZAP-70⁺ and ZAP-70⁻ cells in each subset of B cells. In Figure 50 we exemplified this correlation for naïve and switched memory B cells in each patient.

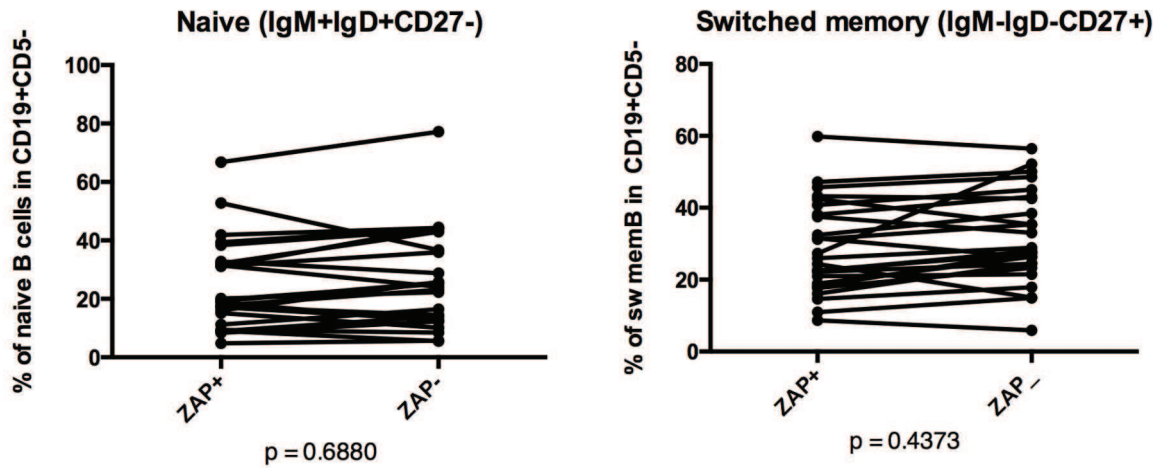

Figure 50. Correlation between the percentage of each subset of B cells in ZAP-70⁺ and ZAP-70⁻ B cell population in each patient exemplified for naïve and switched memory cells. (The correlation index was significant: 0,915 for naïve cells and 0,864 for switched memory B cells).

When we analyzed separately the expression of CD27 in ZAP-70⁺ as compared with ZAP-70⁻ normal B cells from CLL patients, we found that there was no difference in the memory markers between these two types of cells, as seen in Figure 51.

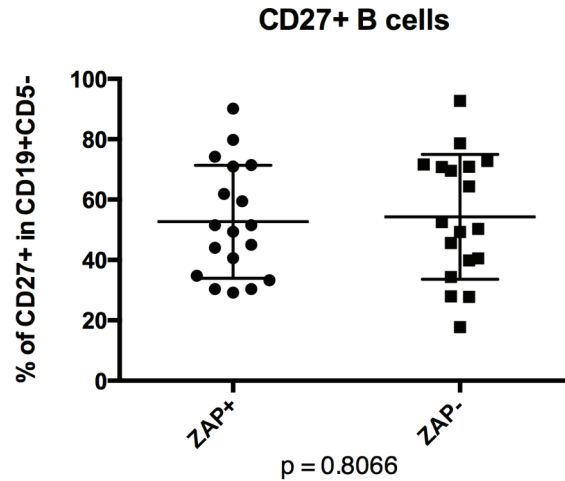

Figure 51. CD27 expression in ZAP-70⁺ vs. ZAP-70⁻ normal CD19⁺CD5⁻ B cells from CLL patients in flow cytometry (unpaired t test).

Afterwards, we wondered whether ZAP-70⁺ normal B cells show characteristics of autoimmune-prone B cells, like low expression of CD21, but there was no significant difference between ZAP-70 positive or negative normal B cells (Figure 52).

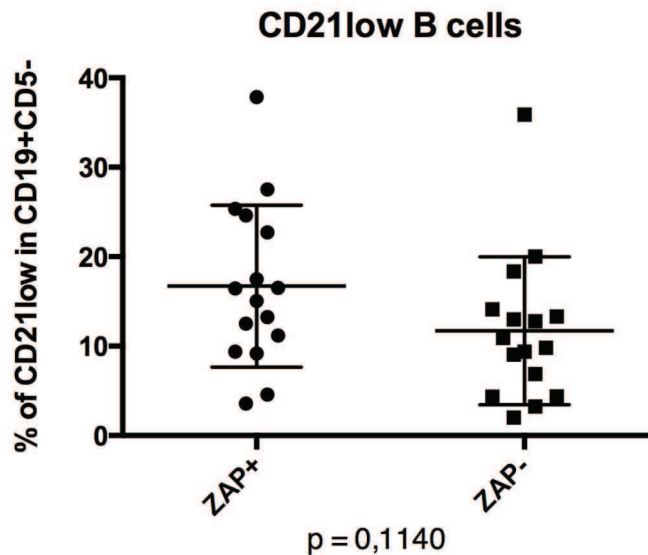

Figure 52. Percentage of CD21^{low} in ZAP-70⁺ vs. ZAP-70⁻ normal CD19⁺CD5⁻ B cells from CLL patients in flow cytometry (unpaired t test).

As the initial hypothesis that CLL cells derive from the equivalent of “human B1 cells”, and as recently these cells were described in humans as CD20⁺CD27⁺CD43⁺CD70⁻ cells, that can be either CD5⁺ or CD5⁻ (Griffin, Holodick, and Rothstein 2011), we wonder whether this type of cell can be the one that express ZAP-70. This question was all the more interesting since “human B1 cells” exhibit tonic BCR signaling and express polyreactive and autoreactive antibodies, which could explain the autoimmunity. The argument against a role of “human B1 cells” in autoimmune cytopenia in CLL patients is that they do not switch to pathogenic IgG. When we analyzed the percentage of this type of subpopulation in ZAP-70⁺ and ZAP-70⁻, we did not find any significant difference (Figure 53).

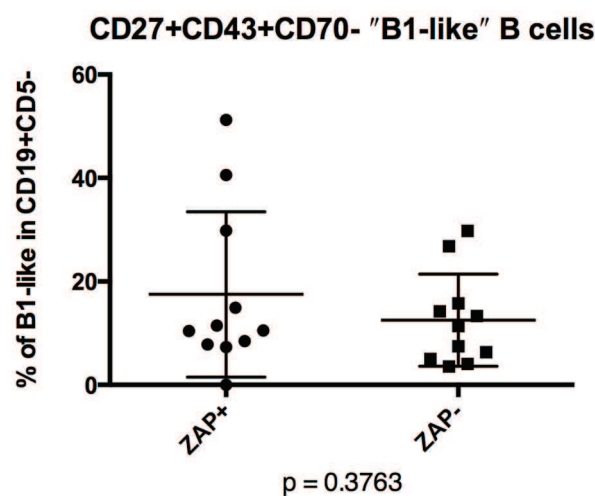

Figure 53. Percentage of CD27⁺CD43⁺CD70⁻ cells in ZAP-70⁺ vs. ZAP-70⁻ normal CD19⁺CD5⁻ B cells from CLL patients in flow cytometry (unpaired t test).

➤ **Search for activation markers in ZAP-70⁺ normal B cells**

Since two studies suggested that ZAP-70 could be induced in normal B cells by activation, we looked for activation markers that could differentiate ZAP-70⁺ from ZAP-70⁻ normal B. Although there seems to be a tendency towards a higher MFI of CD86 for ZAP-70⁺ cells, the difference was not significant in the level of expression of CD86 (Figure 54). In our opinion, for each type of cells, the observed difference in the MFI of CD86 is most probably biologically non-significant, since, in stimulation experiments, the activated cells express a much higher levels of CD86. Finally, since in each patient, ZAP-70 expression

involves all the B cell subsets, it is unlikely that this expression could be linked to B cell activation.

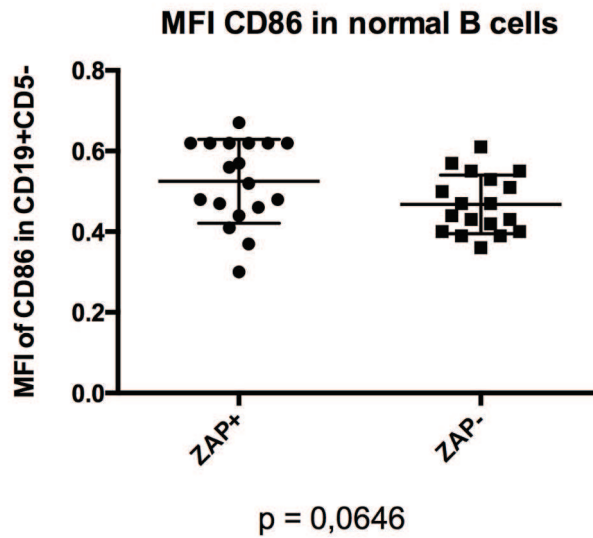

Figure 54. Median fluorescence intensity (MFI) for CD86-PerCPCy5.5 in ZAP-70⁺ vs. ZAP-70⁻ normal CD19⁺CD5⁻ B cells from CLL patients (unpaired t test).

Considering the literature data, we also looked for an increase in ZAP-70 expression in healthy subjects PBMC, stimulated for 48h and 72h through the BCR (anti-IgM mAb) and with anti-CD40, Il-4 and IL-21, or with all of these and CpG DNA. Although we observed a significant elevation of activation markers, like CD86, in stimulated cells, we did not observed any increase in ZAP-70 expression in these cells (data not presented).

➤ **Ig V gene sequence analysis of ZAP-70⁺ and ZAP-70⁻ B cell amplified by scPCR**

Single normal B cells CD19⁺CD5⁻ from 5 patients with ZAP-70⁺ CLL and autoimmune cytopenia (AIC) (3 Evans syndromes, 1 AIHA and 1 ITP), were isolated by FACS. A reverse transcription reaction was performed for each cell, with a mix of random hexamers and a ZAP-70 specific primer. This later was added to increase the sensibility for ZAP-70 mRNA amplification. Then a nested PCR was performed, as indicated in methods chapter, for ZAP-70 and IgH, Igλ, and Igk rearranged genes. As mentioned earlier, this

strategy was chosen because ZAP-70 labeling (or more specifically cell permeabilisation for ZAP-70 labeling) inhibited the single cell PCR reaction.

Firstly, scPCR confirmed that some normal B cells from ZAP-70⁺ CLL patients express ZAP-70, and that these cells seem to be polyclonal, as they express κ and λ light chains in a normal ratio, as seen in Figure 34.

From the 5 CLL and AIC patients, 217 CD19⁺CD5⁻ isolated cells were studied. From each single cell mRNA was reverse-transcribed, and then amplified concerning IgH, IgL (light), and ZAP-70 genes. From a total of 217 cells, the amplification of a PCR2 product, with an expected size, for a heavy and for a light chain for each cell was obtained for 108 cells, which means a yield of 49,7%. The other near 50% of cells (i.e. 109 cells) were eliminated from the analysis because only the heavy or only the light chains, or neither of them, were amplified. These can be explained by the low sensitivity of scPCR and probably because the experiments were done largely with frozen cells.

From a total of 108 single B cells for which a valid heavy and a valid light chain were amplified, 21 cells were ZAP-70⁺, which represents 19,4% of cells. For the first two patients the initial yield was of only 5,2%. Afterwards, we re-sorted the normal B cells from the same patients, amplifying the CD19⁺CD5⁻IgD⁻, aiming to amplify more specifically the B cells that were more prone to be responsible for autoimmune phenomena, i.e. those that were isotype-switched. This new sorting permitted an increased yield in amplifying ZAP-70 mRNA reaching 20%. This increase in ZAP-70 yield cannot be explained by a real enrichment of ZAP-70⁺ cells in the CD19⁺CD5⁻IgD⁻ compartment since in flow cytometry experiments ZAP-70⁺ normal B cells were equally shared by switched and non-switched cells. This could be, at least partially, explained by more freshly sorted cells, as the period between FACS sorting and scPCR amplification was shorter. In addition, it is possible that we only amplified by scPCR the cells that have the highest expression of ZAP-70 (ZAP-70^{hi}). In other words, we cannot conclude that a unique cell is ZAP-70⁻ if the PCR is negative (they are more probably ZAP-70^{low/neg}). We need to keep this in mind when comparing mAbs from ZAP-70⁺ and ZAP-70⁻ cells in the same patient.

In Table 12 sequence data from 32 single B cells from 4 patients with ZAP-70⁺ CLL and AIC are shown. The sequences in red originate from malignant CLL clone, and the sequences in black are all from normal sorted B cells.

B cells		Ig HEAVY chain										Ig LIGHT chain						ZAP
VH	D	RF	JH	(-)	CDR3(aa)	(+)	Length	Mut	AA mut	homology	Vk/A	Jk/A	CDR3(aa)	Length	Mut	AA mut	homology	
LUD CLL	2-6	3-3	6*03	4	ARIRARFLEWLAEWELRYLPYYMYMDV	4	27	0	0	100%								
LUD28 VH VK	4-30-4	3-22	2	4*02	2	ARGRIQRDSSGAYFDY	3	16	0	100.00%	k	1-5	2	QQYNSYYSS	8	0	0	100%
LUD29 VH VK	4-34	6-19	2	4*02	0	ARSLSYSSGWPLY	1	14	0	100%	k	4-1	1	QQYYSTPPT	9	0	0	100%
LUD40 VH VL	1-20; 1-1	2	4*02	3	AKENWNDGGHFDY	2	13	10	1	95.90%	A	2-11	3	CSWAGSWV	8	8	5	97.20%
LUD34 VH VK	4-4	2-2	3	6*03	1	ASQVPAAYYYMDV	0	15	3	98.70%	k	2-28	2	MQALQTPYS	9	1	0	99.50%
LUD30 VH VL	3-3	2	6*03	3	AKDGSLYDFWWSGLSYYMYMDV	1	22	0	0	100%	A	/	/	/				neg
BEU7 VH VK	4-34	3-9	2	4*02	1	ARGPERYLITGYPPFWA	2	17	6	97.80%	k	4-1	3	QQYYSTPFT	9	3	1	99.30%
BEU21 VH VL	3-48	3-22; 2-2	2	4*02	3	ARETYYYDSSDYLPAGADF	1	20	13	95.50%	A	3-1	1*01	CQAWDNSTYV	9	20	12	93%
HIT CLL VH VK	4-39	3-16	3	6*02	1	ARGGVGLVSYGYYYGMDV	1	19	1	99.70%	k	3-20	1	QQYGSRRKT	9	4	3	97.80%
HIT2 VH VL	3-30	1-26	3	4*02	1	AKVPRVGASTPLYFDY	2	18	21	93.50%	A	2-14	1	SSYTSSSTWV	10	11	10	95.90%
HIT6 VH VK	3-23	1-26	3	4*02	2	ASDVGTVGATYDFD	0	14	6	97.90%	k	1-5	4	QHYKTYSLT	9	8	6	97.20%
HIT7 VH VK	3-23	3-3	1	4*02	3	AKEEILEWLLVY	1	12	8	97.30%	k	3-20	2	QQYGSPPPLYT	11	6	3	98%
HIT22 VH VK	3-48	2-15	2	6*02	1	ARAGYLSYYGIDV	1	14	8	97.30%	k	2-28	1/2	MQALQTPRT	9	9	4	97%
HIT32 VH VK	3-48	2-15	2	6*02	1	ARAGYLSYYGIDV	1	14	8	97.30%	k	2-28	1/2	MQALQTPRT	9	9	4	97%
HIT35 VH VK	4-61	6-13; 3-10	2	5*02	1	ARGSTWFDP	1	9	9	97.00%	k	1-39	1	QQS'NTPRT	9	5	5	98.20%
HIT8 VH VK	4-61	6-13; 3-10	2	5*02	1	ARGSTWFDP	1	9	8	97.60%	k	1-39	1	QQS'NTPRT	9	6	6	97.80%
HIT41 VH VK	3-48	6-19	2	4*02	2	ARVERYSSGWAGYFDY	2	16	0	100.0%	k	3-20	2	QQYGSPPPLYT	10	6	3	98%
HIT31 VH VK	4-39	3-16	3	6*02	1	ARGGVGLVSYGYYYGMDV	1	19	4	99%	k	1-39	4	QQSYSPPLYT	9	12	7	96%
HIT21 VH VK	4-39	3-16	3	6*02	1	ARGGVGLVSYGYYYGMDV	1	19	2	99.30%	k	3-20	1	QQYGSRRKT	9	2	2	97%
HIT33 VH VK	4-39	3-16	3	6*02	1	ARGGVGLVSYGYYYGMDV	1	19	4	99%	k	3-20	1	QQYGSRRKT	9	4	3	98%
HIT39 VH VK	4-39	3-16	3	6*02	1	ARGGVGLVSYGYYYGMDV	1	19	4	99.0%	k	3-20	1	QQYGSRRKT	9	6	3	98%
HIT30 VH VK	4-39	3-16	3	A	1	ARGGVGLVSYGYYYGMDV	1	19	3	99%	k	3-20	1	QQYGSRRKT	9	6	3	99%
HIT40 VH VK	4-39	3-16	3	6*02	1	ARGGVGLVSYGYYYGMDV	1	19	4	99.0%	k	3-20	1	QQYGSRRKT	9	6	3	98%
HIT34 VH VL VK	4-39	3-16	3	6*02	1	ARGGVGLVSYGYYYGMDV	1	19	1	99.7%	k	3-20	1	QQYGSRRKT	9	6	3	98%
HIT34 VH VL VK	4-39	3-16	3	6*02	1	ARGGVGLVSYGYYYGMDV	1	19	1	99.7%	A	1-44	2	ASWDDSLNGVV	11	11	6	96.3%
HIT37 VH VK	4-34; 4-55	?				/					k	3-11	1	QQRSNWPPWT	10	6	3	98.00%
HIT38 VH VK	1-69	3-10; no	3	6*02	2	AREGLALGYHTLDV	2	15	22	92.90%	k	1-33	1	/				neg
HIT27 VH VL	3-30	3-9	1	6*02	2	ARVYHGLRYFDWLSPSYYGMDV	2	24	1	99.65%	A			/				pos
KLJ20 VH VL	1-69	2-2	3	6*02	4	ARDGDVVVPAAVFGGVIDYYYGMDV	1	26	4	98.60%	A			/				pos
KLJ4 VH VL	1-69	2-2	3	6*02	4	ARDGDVVVPAAVFGGVIDYYYGMDV	1	26	1	99.60%	A			/				pos
KLJ6 VH VK	3-53	3-10; 2-2	/	6*02	2	AGDPGLPNGMDV	0	12	17	94.20%	k	3-20	1	QQFGDSPPWT	10	18	12	93.60%
KLJ5 VH VL	1-69	2-2	3	6*02	4	ARDGDVVVPAAVFGGVIDYYYGMDV	1	26	2	99.70%	A			/				pos
KLJ15 VH VK	1-69	2-2	/			/					k	4-1	1	QQYYSTPPT	9	3	1	99%

Table 12. Sequence data from 32 single cell sorted B cells from 4 patients with ZAP-70⁺ CLL and AIC. The first column represents the name of the cell, then the data concerning the sequence of heavy chain are notated: VH gene, D and the reading frame of D gene (RF), JH gene, the CDR3 sequence and the number of negatively (-) and positively (+) charged amino acids in the CDR3, the length of CDR3 in number of amino acids, the nucleotide mutations (Mut) and the amino acids mutations (AA mut) in the CDR3 as compared to germline sequences, and the percentage of homology with germline sequence. Then the sequence data of each corresponding light chain are notated: k or λ, the V and J rearranged genes, the CDR3 sequence, their length in amino acids, the nucleotide mutations and amino acids mutations, and the percentage of homology with the germline sequence. The last column represents the sequence confirmation of ZAP-70 positivity, as PCR2 products that were positive for ZAP-70 were purified and sequenced, and found 100% in line with human ZAP-70 transcript variant 1 (NM_001079.3; NCBI database). The cells in red text correspond to IgH/L sequences that are similar to that of the CLL clone (see text). The cases colored in red exemplify ZAP-70⁺ normal B cells that have a valid sequence for the heavy and the light chains. The cases colored in green exemplify ZAP-70⁻ normal B cell with no amplification of ZAP-70, and with a valid Ig sequence for heavy and light chains.

In Table 12 we clearly demonstrate at molecular level that normal B cells from ZAP-70⁺ CLL patients can express ZAP-70 and that these cells are polyclonal and often different from the CLL clone. We can see that these cells often express totally different V_HD_HJ_H and V_LJ_L rearranged Ig genes, that can be somatically mutated or not.

At this time, the small number of Ig sequenced genes analyzed does not permit a statistical analysis of CDR3 length or amino acid charge content between ZAP-70⁺ normal B cell, ZAP-70⁻ normal B cells and CLL B cells. Nevertheless, we can suggest that CDR3 from clonal CLL cells tend to be longer than that of normal B cells. This is in line with the hypothesis that clonal CLL cells originate from autoreactive B cells, that have undergone receptor editing (García-Muñoz, Galiacho, and Llorente 2012), including VH replacement, that could explain longer CDR3 (Zhang, Burrows, and Cooper 2004). One example, that could sustain this hypothesis, is HIT 7 cell that expresses the same light chain as the CLL

clone, but a different and shorter CDR3. It could be a hypothetically autoreactive, ZAP-70⁺ B cell, from which the CLL clone have emerged by receptor editing through VH replacement. Another example of receptor editing that could be at the origin of CLL clone, which involves the more classical editing on the light chain (and not the rarely described editing on heavy chain), is HIT 31 cell that has a different light chain as compared with CLL clone.

Additionally, it seems that there is no strong bias in terms of VH/VL usage. Some V regions are mutated others not, which is in line with the fact that ZAP-70⁺ B cells encompass naïve and memory cells.

Interestingly some cells have the same rearranged IgH/L genes than the malignant clone (see for instance HIT 31, 21, 33, 39, 30, 40, 34). Several explanations can be proposed for this observation: 1) these cells could represent malignant cells that have lost CD5 expression; 2) more interestingly they could represent pre-malignant cells. If true, this could suggest that Zap-70 expression may indeed play a role in the neoplastic transformation. Comparing somatic mutations between the malignant clone and normal B cells with same IgH/L genes may help to differentiate between these hypotheses. In these sequences, there seems to be no difference or a few more mutations in CD5⁻ cells than in the CLL clone. For example some of these cells (HIT 31, 21, 33, 39, 30, 40) have 1, 2 or 3 more mutations as compared to CLL clone, all situated in FR1 region, and all included the mutation present in the CLL cells (on the other hand HIT 34 and the CLL clone have the exactly the same sequence). These observations cannot exclude that the cells with the same rearranged IgV sequences belong to the malignant clone, but they can also testify for a common precursor.

Another potential clonal relationship between some ZAP-70⁺ normal B cells and the malignant cells is exemplified by HIT31 cell. HIT31 cell shares its heavy chain with the CLL cells but has different Ig light rearranged genes (Vk1-39/Jk4 vs. Vk3-20/Jk1). This suggests that HIT31 and the CLL clone have split off by receptor editing at some point before transformation. Knowing that the BCR V regions are implicated in the transformation/proliferation of CLL cells, these observations open fascinating perspectives of study. On the other hand, as there is at this time only one such type of cell, we cannot completely rule out a contamination of PCR2 product with the malignant clone. We clearly need more data to study the molecular events that could have occurred between some normal ZAP-70⁺ cells and the malignant ones.

Concerning ZAP-70⁺ normal B cells, they seem pretty different from one another, for the limited sequences available for the moment, to suggest any ontogenic relationship between them.

In summary, sequence analysis confirm that patients with ZAP-70⁺ CLL frequently have CD5⁻ B cells that express ZAP-70 but have the features of normal B cells.

4.5. ARE ZAP-70⁺ B CELLS AUTOREACTIVE?

This chapter addresses two issues:

1. Are ZAP-70⁺ B cells enriched in autoimmune cells?
2. Do B cells producing autoantibodies responsible for autoimmune cytopenias originate from this pool?

To respond to these questions, two strategies were developed. The first one consists in the production of monoclonal antibodies expressed by ZAP-70⁺ normal B cells, and the study of their reactivity towards auto-antigens. The second strategy consists in the study of ZAP-70⁺ B cells by flow cytometry using labeled purified autoantigens involved in AIHA and ITP.

➤ **Monoclonal antibody production from ZAP-70⁺ normal B cells**

For this experiments we used single cells sorted in FACS from three patients with CLL and AIC (two Evans syndromes and one AIHA).

Purified PCR2 products amplified by RT-scPCR from 7 ZAP-70⁺ single normal B cells and from 2 ZAP-70⁻ single normal B cells from ZAP-70⁺ CLL patients with autoimmune cytopenia were digested and inserted in the human Ig γ 1, Igk and Ig λ corresponding expression vectors, as mentioned in methods chapter. The cloned vectors were transfected into human embryonic kidney (HEK) 293 cells, and cultured for 7 to 10 days. The quantity of total IgG and were determined by ELISA in collected supernatants, without a previous purification. The total IgG quantity in supernatants was between 1,3 and 3,4 μ g/ml of approximately 15ml of culture medium. We also verified the correct assembly of light chains by a semi-quantitative sandwich ELISA determination, in which the wells were coated with an anti-huIgG antibody and bound Ab were revealed with an anti-light chain (k or λ) antibody.

The supernatants containing mAb cloned from single normal B cells from ZAP-70⁺ CLL with autoimmune cytopenia were tested for their reactivity towards red blood cells, platelets and towards common autoantigens, like dsDNA, thyroglobulin and actin.

The supernatants containing mAb were tested in an indirect anti-globulin (IAT) test for anti-RBC reactivity, by incubation with a series of known specificities RBC. The reactivity towards platelets was tested, using a MAIPA test, by incubation of culture supernatants containing mAb with typed platelets. These two tests were performed at the EFS of Strasbourg. From a total of 9 mAbs produced, 7 mAbs were tested in IAT and MAIPA: 2 from ZAP-70⁻ B cells from a patient with CLL-associated Evans syndrome, and 5 from ZAP-70⁺ B cells (4 from CLL-associated Evans syndrome patients and one from CLL-associated AIHA patient). All the tested mAbs were found negative. These negative results do not exclude the possibility that ZAP-70⁺ normal B cells from CLL patients could be responsible for the autoimmune reactivity, because on one hand only a few mAb have been tested for the moment, and on the other hand the low concentrations of the mAb in non-purified culture supernatants could be under the cutoff of positivity of these tests. The IAT and MAIPA tests that we used have been developed for clinical routine analysis and their sensitivities for mAb are not really known. The sensibility will be improved by increasing the number of mAb produced and by purifying and concentrating them from the culture media.

The mAb produced from single normal B cells from CLL patients with autoimmunity were more largely tested towards common autoantigens to see whether these cells have a tendency towards autoreactivity in general. In this regard, the mAb were tested by ELISA for anti-dsDNA, anti-actin and anti-thyroglobulin reactivity. They all have been found negative (in several dilutions, and as pure), although some low non-significant reactivity was detected for some of them. The reactivity of tested mAb was compared with a negative control sample (culture media) and with a positive control (known positive serums from patients that we use in our labs, at dilutions situated at the linear portion of the ELISA curve).

Although all the tested mAb were negative in comparison with the positive control serum, we tried to compare the low reactivity of these mAb (used pure) between that of ZAP-70⁺ and ZAP-70⁻ B cells, in the hypothesis that maybe the mAb are too diluted in culture media to have a significant reactivity by comparison to positive control and or that

their affinities are low. In Figure 55 the 7 mAb from ZAP-70⁺ normal B cells were compared to two mAb cloned from ZAP-70⁻ normal B cells, all from ZAP-70⁺ CLL associating autoimmune cytopenia in ELISA towards anti-dsDNA, anti-thyroglobulin and anti-actin. The reactivity was expressed as a ratio of optic density (OD) between tested mAb OD and the positive control from which the OD of negative control was previous subtracted. All the mAb tested were negative as compared with the positive control (that have a relative positive ratio of 1). We found that for some of the mAb originating from ZAP-70⁺ cells there was some reactivity towards autoantigens, although this reactivity was very low as compared with the positive control (0,01 to 0,1 of relative positive ration, i. e. 1 - 10% of the reactivity of positive control). To note, for mAb originating from ZAP-70⁻ cells the reactivity was at 0, i.e. equal of that of negative control.

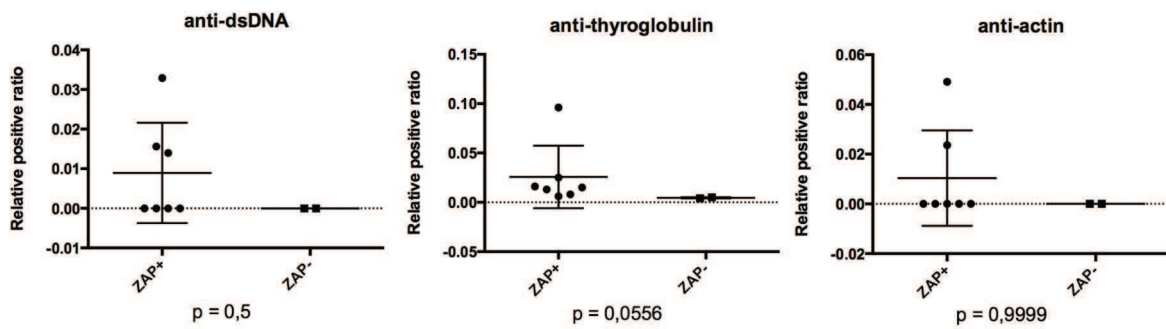

Figure 55. ELISA reactivity testing of mAb produced from single normal B cells cloned from ZAP-70⁺ CLL and autoimmune cytopenia patients, towards common autoantigens: anti-dsDNA, anti-thyroglobulin, anti-actin. 7 mAb from ZAP-70⁺ normal B cells were compared to two mAb cloned from ZAP-70⁻ normal B cells. The x-axis values are expressed as a ratio of optic density (OD) between tested mAb and the positive control, from which the OD of negative control was previous subtracted (the relative positive ratio of positive control is 1).

In conclusion, we produced 9 mAb from single normal B cells from ZAP-70⁺ CLL and autoimmune cytopenia patients, 7 from ZAP-70⁺ and 2 from ZAP-70⁻ B cells. This limited number of mAb proved not to be autoreactive, when tested towards RBC and

platelets. Some of them may bind with low affinity to common autoantigens, like dsDNA, actin or thyroglobulin. We also intend to test them on other autoantigens, including nuclear binding on Hep2 cells. We emphasize that tested mAb were not purified, and hence not concentrated, previous to testing. On the other hand, we have to produce more mAb to increase the sensibility, because only a limited percentage of ZAP-70⁺ B cells could be autoreactive. It is most probably the case for cells responsible for AIHA and ITP.

➤ **Search of autoreactive ZAP-70⁺ normal B cells by flow cytometry**

The second strategy is to look for autoreactive ZAP-70⁺ B cells by flow cytometry. We designed two methods by which B cells could at the same time be evaluated for ZAP-70 expression and for specific binding to purified autoantigens through their BCR. The flow cytometric techniques to detect B cell specific BCR for certain antigens are difficult issues because of the high risk of non-specific binding. We have already successfully used these type of staining in our laboratory, to detect B cells that are specific for phospholipids (Lieby et al. 2001). One of the methods is designed for detection of self-reactive B cells to glycoprotein IIb/IIIa in ITP-associated CLL patients, the other is designed to detect self-reactive B cells to peptides of RhCE in AIHA-associated CLL patients.

Flow cytometric identification assay of self-reactive B cells to glycoprotein IIb/IIIa

Glycoprotein (GP) IIb/IIIa is one of the most commonly identified antigen targets of anti-platelets antibodies in ITP. The epitopes are mainly non-linear, located on intact glycoprotein complex (Fujisawa, Tani, and McMillan 1993), hence the importance of using complete heterodimer protein.

Purified GPIIb/IIIa from human platelets was first labeled with AF647 fluorochrome, and then purified in an adapted buffer, as mentioned in methods chapter. Cryopreserved and freshly Ficoll isolated PBMC from healthy subjects, ITP patients, and ITP-associated CLL

patients were incubated with GPIIb/IIIa-AF647 labeled protein, before staining for surface markers and intracellular ZAP-70 staining. For each sample a control reaction tube was prepared which was previously incubated with an anti-Fab antibody that would specifically inhibit the antigen-binding site of surface BCR on tested B cells. The cells previously incubated with anti-Fab antibody were secondly incubated with GPIIb/IIIa-AF647, and with other surface and intracellular markers.

The main problem with this GPIIb/IIIa antigen staining is that there is a non-specific staining of normal B cells, observed for the healthy control. This is noticed only for B cells, and not for non-B mononuclear cells, and moreover, it is inhibited by anti-Fab antibody. This strongly suggests that this staining is the consequence of polyreactive surface IgM, which bind non-specifically GPIIb/IIIa (Figure 56). For the setting of the experiment, 5 healthy subjects were tested along with 3 primary ITP patients, in which similar staining were observed.

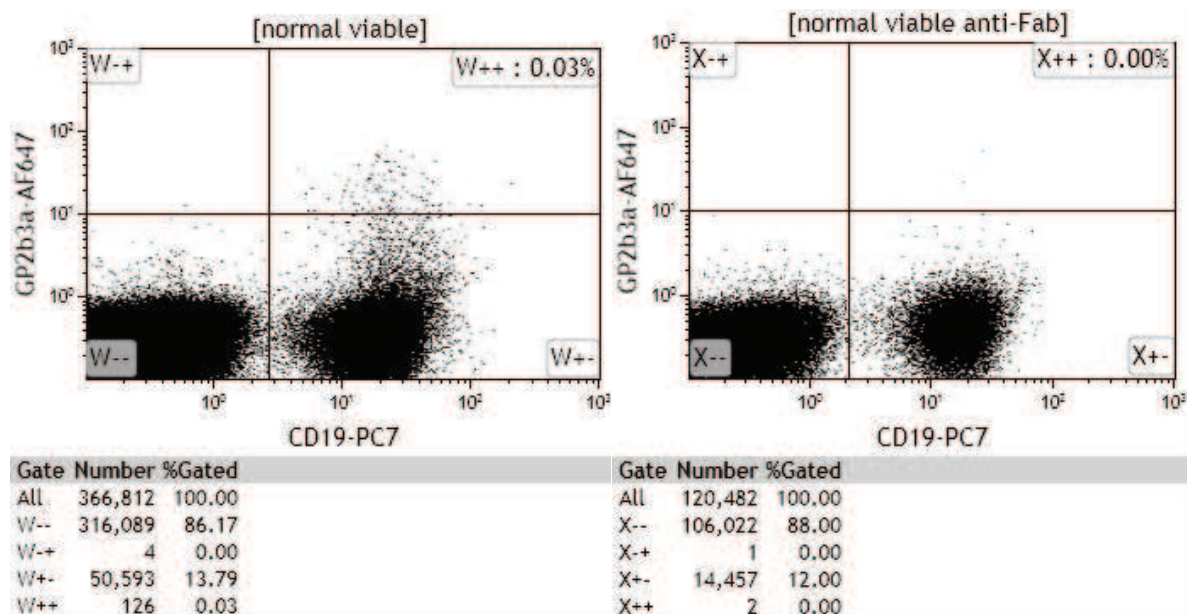

Figure 56. GPIIb/IIIa-AF647 staining of healthy subject PBMC (left case). The cutoff for GPIIb/IIIa positivity was established on Fab inhibited B cells, previously incubated with an anti-Fab antibody (right case), to assure the specificity of GPIIb/IIIa ligation on surface BCR, and not on other non-specific surface molecules.

We anyway analyzed one CLL patient with associated ITP. The anti-platelets antibodies for this patient were negative, as it is the case for the majority of ITP patients, because of a low sensitivity of this test, as we detailed in the introduction chapter on ITP diagnosis. In our experiment we observed that the GPIIb/IIIa positive B cells were almost all in normal B cell population. The CLL clone did not react with GPIIb/IIIa which further support the conclusion that the binding detected on some B cells from healthy subjects is due to a limited set of low affinity BCRs. Some staining was detected for normal B cells with a possible enrichment for ZAP-70⁺ cells (1,8% vs. 0,5% in ZAP-70⁻ cells), but given the low number of cells no conclusion can be drawn (Figure 57). Similar experiments will be performed after negative selection of CD5⁺ B cells to permit the analysis of a greater number of CD5⁻ B cells.

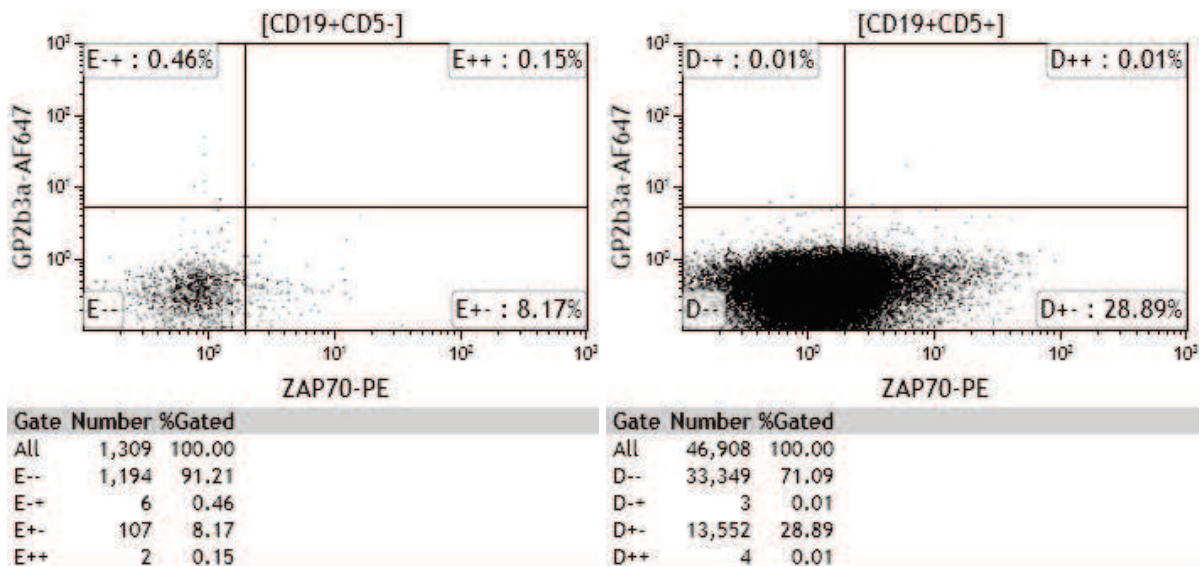

Figure 57. GPIIb/IIIa and ZAP-70 flow cytometric staining of normal (left) and CLL (right) B cells from a ZAP-70⁺ CLL patient with ITP. The cutoff value of ZAP-70-PE was established in relation with an isotypic control antibody, and the cut-off value of GPIIb/IIIa-AF647 was established as compared with the inhibited staining after a pre-incubation with an anti-Fab antibody (see methods chapter).

Nevertheless, we cannot conclude for the moment that GPIIb/IIIa staining of normal B cells is specific, because there is a high proportion of normal B lymphocytes in healthy subjects that bind through their BCR, but probably in a non-specific manner GPIIb/IIIa. Our antigen-specific GPIIb/IIIa staining methods needs further improvement, if possible, before we used it to clearly identify the pathogenic autoreactive B cells.

Flow cytometric assay design of self-reactive B cells to RhCE protein

RhCE and RhD represent the main target antigens of autoantibodies against RBC in AIHA. We initially searched for recombinant whole protein that could be fluorochrome labeled for the use in flow cytometry, as we did for GPIIb/IIIa in ITP patients. Unfortunately, such protein is not available on the market, neither as a recombinant protein, nor as a RBC-isolated protein. On the other hand, RhD and RhCE, which have a very similar sequence, have 12 transmembrane spanning segments, implying a high hydrophobic sequence, that would be difficult to dissolve in buffers compatible with flow cytometry staining (Figure 20).

The most frequent autoantibodies found in serums from AIHA patients are anti-C and anti-e Ab. One of the most antigenic sites on RhCE protein is located on the second extracellular loop, the difference between C and c antigens being only a single amino acid difference at position 103: Ser for C antigen, and Pro for c antigen. The second major antigenic region of this protein is located in the fourth extracellular loop, which forms an extracellular vestibule, as seen in Figure 44. This region defines two different antigens: E and e, the difference being also a single amino acid substitution at position 226: Pro for E, and Ala for e antigen.

Based on these particularities of targeted antigens on the surface of RhCE protein, we hypothesized that the extracellular loop peptides represent the main target of autoantibodies in AIHA. Considering this, we designed and synthesized 8 peptides, corresponding to each of the extracellular loop in RhCE protein, with two peptides for the second and the fourth loop, corresponding to the two possible antigens at these sites (C or c, and E or e). Designed peptides are as follows:

DG1: C - THYDASLEDQKGL

DG2C: FLSQFPSGKVVITLFSIRLA - C

DG2c: FLSQFPPGKVVITLFSIRLA - C

DG3: C - PKGTEDNDQRAT

DG4E: C - VNSPLLRSPIQRKNA

DG4e: C - VNSALLRSPIQRKNA

DG5: K - GTSCHLIPS

DG6: C - VSVVTAISGSSL

At one end of the synthesized peptide a cysteine (C) or a lysine (K) were added that serves as a binding site to a biotin molecule, for fluorochrome detection in flow cytometry. A portion of these peptides was labeled with a biotin molecule, and are ready to be used in flow cytometry experiments. The biotin-labeled peptides, being low molecular weight molecules are ideally fitted for antigen-reactive search of B cells, as they are less likely to bind non-specifically to other surface molecules. The flow cytometry technique using these marked peptides will soon be set in our laboratory. If it works, this unique technique of detection of self-reactive B cells in AIHA will be of great interest in characterizing the autoreactive B cells in AIHA in general, not only in CLL- associated AIHA.

Additionally, another use of the designed RhCE peptides is to permit the detection of free serum autoantibodies in AIHA patients and to study the reactivity of the mAb synthesized in our project. Firstly, the reactivity of these peptides with autoantibodies from AIHA patients with known specificity will be validated in an ELISA test, in which the wells will be coated with RhCE peptides, and then incubated with positive serums. After the validation of the ELISA, the peptides will be used in ELISA to study the specificities of mAb produced from ZAP-70⁺ single normal B cell, as previous described.

In conclusion, at this time, our two designed strategies, do not allow to draw conclusion regarding the specificities of ZAP-70⁺ B cells and their potential involvement in autoimmune manifestations associated with CLL. The first strategy, consisting in producing mAb from single normal ZAP-70⁺ B cells needs more in depth experiments. Firstly, the already tested mAb need a previous purification and concentration before re-testing against autoantigens, as the supernatants concentrations are pretty low, hence probably not enough as regarded to the cutoff value of autoantigen testing methods. Secondly, more mAb need to be produced, because even if ZAP-70 expression in B cells predisposes to autoimmune reactivity, this does not imply that all the ZAP-70⁺ normal B cells are autoreactive.

4.6. COULD THE EXPRESSION OF ZAP-70 IN B CELLS INDUCE AUTOREACTIVITY OR MALIGNANT TRANSFORMATION?

To address this question, we designed a transgenic mouse model that will conditionally express ZAP-70 in their B cells, at different maturational stages.

For this purpose, the entire mouse *Zap70* cDNA was cloned from splenic T lymphocytes, and inserted in the CTV vector (Xiao cell 2007 17923094). This permitted the insertion of *Zap70* coding sequence preceded by a CAG promoter and a *loxP* Neo-STOP cassette into mouse ROSA26 locus, which is ubiquitously expressed. An IRES-EGFP cassette flanked by *frt* sequences placed between *Zap70* gene and the polyA signal permits the detection of cells in which the deletion of Neo-STOP cassette was assessed, representing a good reporter for the overexpression of *Zap70* (Figure 30).

Mice were generated at Institut Clinique de la Souris (ICS) of Strasbourg. After previous homologous recombination steps of CTVZAP vector into ROSA26 locus in embryonic stem cells (ES), the selected ES cells were subsequently injected into C57BL/6N blastocysts and maintained in a pure C57BL/6N background. Mice carrying the floxed KI *Zap70* gene are now available in our laboratory for further crossbreeding with Cre-mice.

We will crossbreed the *Zap70* *loxP* mice with Mb1-Cre mice that will result in the overexpression of *Zap70* gene from the pro/pre-B cell stage, and with CD21-Cre mice that will result in the overexpression of *Zap70* only in mature B cells (Figure 59).

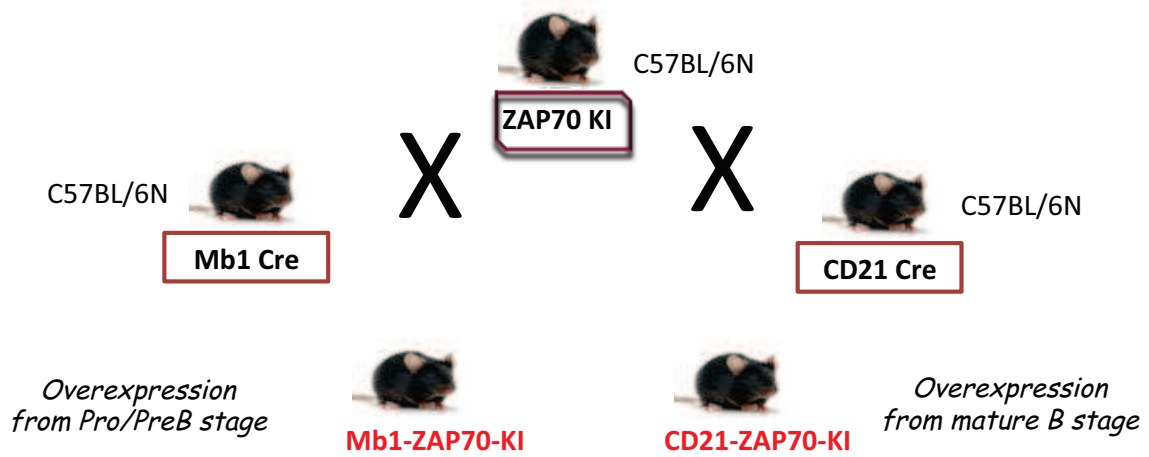

Figure 59. Previewed crossbreeding of *Zap70* loxP mice with Mb1-Cre and CD21-Cre mice, which would result in the conditional overexpression of *Zap70* in B cells from the pro/pre-B stage (Mb1-Cre) or only in mature B cells (CD21-Cre).

CHAPTER 5. DISCUSSIONS AND PERSPECTIVES

The primary result presented in this thesis is that a certain percentage of normal B cells from ZAP-70⁺ CLL patients express ZAP-70, as compared to normal B cells from healthy subjects.

This was clearly demonstrated by flow cytometry, by two ways of expressing results, as a percentage of positive cells compared to an isotypic control and as MFI values. To avoid false positive staining, a very strict gating strategy was applied, in which doublets and dead cells were excluded. We also excluded samples of patients in which a low CD5 expression (which sometimes characterize CLL cells) did not permit a clear distinction between CD5⁻, non-clonal B cells, and CD5⁺ CLL cells. We analyzed ZAP-70 expression in 63 CLL patients with enough residual normal B cells to permit statistical analysis and in 36 normal subjects. Expression of ZAP-70 in CLL B cells, normal B cells and T cells was compared to an isotype control antibody.

The presence of ZAP-70 mRNA in normal B cells from ZAP-70⁺ CLL patients was confirmed at single cell level by RT-scPCR. ZAP-70 transcripts amplified from single cell were then sequenced, and found 100% identical with the sequence previously described in T cells. This is in line with the literature data indicating that ZAP-70 does not present any mutation in CLL B cells, as compared with original sequence. Additionally, we confirmed that ZAP-70 mRNA amplified in normal B cells is that of the classical isoform1, and not that of the recently described truncated form, named truncated ZAP kinase (TZK) which lacked the SH2 domains and a part of interdomain B (Kuroyama et al. 2004).

Importantly, this is the first time that a reverse-transcription scPCR successfully detects ZAP-70 at single cell level. Moreover, we were the first to detect ZAP-70 mRNA in single normal B cells, at the same time as Ig heavy and light chain rearranged genes. This technique can be used to molecularly dissect at single cell level the characteristics of ZAP-70⁺ B cells, like the sequences of rearranged Ig genes or other deregulated genes.

In qPCR experiments we also demonstrated that there is a higher level of ZAP-70 mRNA in normal B cells from CLL patients than in normal CD5⁻ B cells from healthy subjects, although the difference was not significant. The non-significant statistical data between the two populations is mainly due to the low number of analyzed samples, this technique requiring a minimal number of highly purified cells, normal residual B cells in CLL patients being very rare.

We clearly demonstrated at several levels (cellular and molecular) that ZAP-70 expressing normal B cells do not represent a contamination of normal B cells with a contingent of CLL clone that would have lost CD5 expression. At the cellular level, we showed that ZAP-70 expressing normal B cells are CD19^{hi} and express a high level of sIg, as compared to CLL clone that is CD19^{low}sIg^{low}. In addition they are CD5⁻, and, most importantly, they are polyclonal, as they express a normal k/λ light chain ratio.

At the molecular level, Igk and Igλ rearranged V genes were equally amplified, along with ZAP-70 transcript. Moreover, ZAP-70⁺ normal B cells often express totally different V_HD_HJ_H and V_LJ_L rearranged Ig genes, from that of CLL clone, definitely demonstrating the polyclonality of these cells.

*

Interestingly, ZAP-70⁺ normal B cells seem pretty different from one another in the V_HD_HJ_H and V_LJ_L rearranged Ig genes, indicating that there is no clonal relationship between them. Moreover, they are equally somatically mutated and unmutated, suggesting that this is not a mere characteristic of only antigen-experienced, post-germinal center, B cells, but rather a more general trait.

This is further demonstrated by the fact that ZAP-70⁺ normal B cells do not belong to a certain subset of B cells. When ZAP-70⁺ and ZAP-70⁻ normal B cells from ZAP-70⁺ CLL patients were compared, we observed no difference between them in the distribution to different B cell subsets. In particular, normal ZAP-70⁺ B cells were distributed both in the naïve and in the switched memory B compartments. When we analyzed separately the expression of CD27 in ZAP-70⁺ as compared with ZAP-70⁻ normal B cells from CLL patients, we found that there was no difference in the memory markers between these two types of cells.

*

The presence of ZAP-70 in the naïve B cell subset, suggests that this is an early process in the B cell development, which probably occurs before malignant transformation. To analyze in more depth the moment when this abnormal expression occurs in the ontogeny

of B cells, we intend to look for ZAP-70 in earlier developmental stages in the bone marrow in CLL patients, from pro-B cells to mature B cells. This analysis is one of the planned perspectives of our project, but it is hindered by the fact that bone marrow examinations are rarely necessary in CLL patients.

Nevertheless, the data presented in this project, suggest that abnormal ZAP-70 expression in B cells is rather an early phenomenon, that seems to arrive at least at naïve B cell stage, and continue to be expressed at all B cell developmental levels. The persistence of ZAP-70 expression up to the plasma cells stage would be also interesting to study.

*

Another important issue is to see if ZAP-70 expression in normal B cells is a characteristic of CLL patients or not.

Classically, normal B cells do not express ZAP-70, although recent studies have given rise to a controversy, when an unexpected requirement for ZAP-70 in pre-B cell development in mice was described. In the absence of Syk, B cell development in the mouse is only partially blocked at the pro-B to pre-B cell transition, whereas mice both mutant in Syk and ZAP-70 show a complete block at the pro-B cell stage. This arrest is the consequence of a defective pre-BCR signaling, as demonstrated by failure of Ig heavy chain allelic exclusion, known to require a pre-BCR signal (Schweighoffer et al. 2003). In the same study, ZAP-70 was detected by immunoblot in pro-B, pre-B, and splenic B cells from wild-type mice, but not in peripheral blood B cells.

In humans, three studies that looked for ZAP-70 expression in normal B cells from healthy subjects did not find any expression in peripheral blood B cells, although they described ZAP-70 expression in some subsets of B cells from tonsils or spleen B cells with activation characteristics (such as a larger cell volume, or the presence of activation markers such as CD38, CD27 and CD71), or in pro- to pre-B cell stage in the bone marrow (Nolz et al. 2005; Crespo et al. 2006; Cutrona et al. 2006). The only study that suggested the possibility that ZAP-70 could be expressed by peripheral blood B cells, showed in Western blot and flow cytometry, that these cells expressed ZAP-70 at very low level, being five time lower than that of tonsil B cell, which is already three time less than that in T cells (Scielzo

et al. 2006). By contrast, our study demonstrates for the first time that normal B cells from peripheral blood of CLL patients may express ZAP-70 at levels similar to those in T cells.

As ZAP-70 expression could not be detected in peripheral B cells from healthy subjects, as previous studies and our own testing have shown, this seems rather to be a characteristic of CLL patients, especially a characteristic of ZAP-70⁺ CLL patients.

Another possibility is that ZAP-70 expression in B normal cells could be induced by stimulation through different signaling pathway, as suggested by two studies, in which ZAP-70 expression could be induced by stimulation of peripheral blood or tonsil B cells with CD40L + IL-10, IL-4 and IL-6, with IL-15 + CpG ODN, or with anti-IgM (Scielzo et al. 2006; Bekeredjian-Ding et al. 2008). In our study, we also stimulated normal PBMC for 48h and 72h with anti-IgM, anti-CD40, IL-4 and IL-21, or with all of these and CpG DNA. Although we observed a significant elevation of activation markers, like CD86, in stimulated cells, we did not observe any increase in ZAP-70 expression. Our data are in favor of a rather *à priori* (intrinsic), non-induced trait, than a *à posteriori* (extrinsic), inducible one.

Whatever explains these discrepancies, it is unlikely that ZAP-70 expression by some normal B cells in patients with CLL reflects an activated phenotype. Indeed, these cells do not show other activation features (such as increased level of CD86 expression) and many of them have a naïve phenotype.

One problematic issue that needs to be discussed here, is that in our observations in ZAP-70⁺ CLL patients, ZAP-70 expression is not only elevated in some normal B cells, in CLL cell, but it is also elevated in T cells. This observation, recently confirmed by another team, made us wonder whether this could be the reflection of an extrinsic, environmental factor that could increase ZAP-70 expression in all lymphocytes. To test for this hypothesis PBMC from a healthy subject or a ZAP-70⁻ CLL case were incubated with ZAP-70⁺ CLL serum, in search for a serum factor that could be responsible for the general increase in ZAP-70 expression. After 24h and 48h of incubation, there was no increase in the ZAP-70 level in tested cells. So, although this experiment is very simple, it is unlikely that a serum factor in ZAP-70⁺ CLL patients could responsible for this phenomenon.

An alternative way of environmental influence, which was not tested in our work, is through cellular interactions with other cell types or with stroma. The importance of the microenvironment in CLL is underlined by the fact that most CLL cells rapidly undergo

apoptosis when they are removed from patients. Moreover, increased ZAP-70 phosphorylation has been demonstrated in CD38⁺ CLL cells that interact with secondary lymphoid organ environmental nurse-like cells (NLC) through CD31 ligand (Deaglio et al. 2007). This possibility remains to be tested in our laboratory, for instance in culture experiments in which normal or ZAP-70⁻ PBMC will be incubated with CD31⁺ NLC or with stromal cells from the bone marrow from ZAP-70⁺ CLL patients.

*

It is current knowledge now that the expression of ZAP-70 in CLL cells is not an on/off process but rather a continuum. We found a striking correlation in the expression level of ZAP-70 between normal B cells and CLL cells from the same patient. Moreover, the expression of ZAP-70 in normal B cells is not bimodal, with cells that are clearly ZAP-70⁻ or ZAP-70⁺. It has continuum appearance, really resembling the expression of ZAP-70 in CLL B cells.

Together with the fact that ZAP-70 is already expressed at the naïve stage of normal B cells these data indicate that ZAP-70 expression is an early phenomenon and that it clearly precedes malignant transformation. This indeed is highly interesting because it opens the possibility that abnormal expression of ZAP-70 may have a role in the malignant transformation through, for instance, the facilitation of BCR signaling, inducing increased proliferation and survival. The role of BCR signaling in the pathogenesis of CLL is well demonstrated nowadays, emphasized by the spectacular efficacy of BCR signaling inhibitors, like ibrutinib or idelalisib, used in the treatment of CLL, even in cases with very bad prognostic factors.

Concerning the responsiveness to anti-IgM ligation, CLL cases are classified in two types: in UM-CLL, which has aggressive behavior, there is an increase in tyrosine phosphorylation following BCR ligation, as compared to M-CLL type in which there is no response to BCR ligation and that has a more indolent progression. One of the main differences that also distinguishes these two types of disease is the expression of ZAP-70 in UM-CLL types of cells, further arguing for the role of ZAP-70 in the BCR signaling and implicitly disease aggression.

In the same order of line, the recently described behavior of CLL BCR as pre-BCR, which have antigen-independent tonic signaling (Minden et al. 2012) together with the fact that ZAP-70 has been demonstrated to have a role in the pre-BCR signaling, is in favor of a role of ZAP-70 in the ontogeny of malignant B cells. As it is well known that allelic exclusion require a correct pre-BCR signaling, the fact that CLL clones frequently fail allelic exclusion is in favor of an abnormal signaling through pre-BCR in CLL patients (Rassenti and Kipps 1997). This mechanism is not yet clear, because if ZAP-70 increases pre-BCR signaling, this could not determine a failure in allelic exclusion. It will be interesting to study if the failure in allelic exclusion is not mostly limited to mutated, ZAP-70⁻ cases.

*

Another way of testing the relationship between ZAP-70 and malignant transformation, to determine whether it is a pre-malignant state or an anomaly induced by malignant transformation, is to look at ZAP-70 expression in normal B cells from monoclonal B cell lymphocytosis (MBL), which can be a premalignant state. ZAP-70 expression in MBL cells was already demonstrated, although not yet defined as a significant prognostic maker (Rossi et al. 2009). It will be very interesting to look for ZAP-70 expression in normal B cells from this type of patients, a high expression pleading in favor of a malignancy predisposing factor of ZAP-70.

A clonal relationship between ZAP-70⁺ normal B cells and the CLL clone was one of the most important questions of interest in our work. Firstly because we feared that ZAP-70⁺ normal B cells could represent a contaminating contingent of CLL clone, hence the importance of demonstrating that the two subpopulations have a really distinctive phenotype and molecular characteristics, as we previously discussed. Secondly, because, for understanding the malignant transformation process it is of primordial importance to see whether there is a clonal relation between these cells.

The contamination possibility was eliminated for most of the cases as previously discussed.

The possibility that CLL clone could derive from ZAP-70⁺ normal B cells is suggested by several observations. Firstly, we can imagine that the CLL clone gained some mutation advantages for survival and proliferation, in a receptor editing process from

autoreactive ZAP-70⁺ B cells. This is suggested by the presence of longer CDR3 regions in CLL clone, as compared to non-malignant cells, characteristic of B cells that have undergone receptor edition, including VH replacement (García-Muñoz, Galiacho, and Llorente 2012; Zhang, Burrows, and Cooper 2004). Several ZAP-70⁺ normal B cells that differ from CLL clone only by the light or the heavy chain indeed suggest receptor editing processes. Knowing that the BCR V regions are implicated in the transformation/proliferation of CLL cells, these observations open fascinating perspectives of study.

Additionally, there are several normal cells that have the same V_HD_HJ_H and V_LJ_L sequences as the clonal CLL cells, differing by only 2 or 3 additionally mutations. In such situations, the probabilities that the cells did not derive from a unique ancestor are infinitesimal. However, at this stage, it is not possible to rule out the possibility that these “normal” cells come from the CLL clone, having been selected in the CD5⁻ compartment by contamination, rather a reflection from a common precursor. This is argued by the fact that the mutations are in the FR1 region, not probably reflecting a clonal evolution, but rather mutations induced by the PCR reaction.

In the search of a clonal relationship between CLL cells and ZAP-70⁺ normal B cells, and as the initial hypothesis that CLL cells derive from the equivalent of “human B1 cells”, we verified if recently described CD20⁺CD27⁺CD43⁺CD70⁻ cells (Griffin, Holodick, and Rothstein 2011) are more frequent in the ZAP-70⁺ normal B cells, that in ZAP-70⁻ ones, but this wasn't the case.

Given the fact that, for the moment, only limited number of cells have been amplified from the ZAP-70⁺ population of normal B cells, a clear conclusion concerning the clonal relationships between CLL clone and these cells cannot be drawn. We clearly need more data to study the molecular events that could have occurred between some normal ZAP-70⁺ cells and the malignant ones.

Our present work will permit a more thorough study of the potential role of ZAP-70 overexpression on malignant transformation through increased BCR signaling. This will be done in conditionally transgenic mice that will overexpress ZAP-70 in their B cells at different developmental stages. The mice will be studied for the possible development of lymphoproliferative disease, for the possible particularities of B cell development induced by ZAP-70 overexpression, and for the level of *in vivo*, steady state, activation markers in B

cells. The influence of ZAP-70 overexpression on BCR signaling will be studied *in vitro* by stimulation experiments, comparing ZAP-70⁺ B cells with B cells from control mice. Moreover, transcriptome modifications induced by B cells stimulation through BCR-dependent or independent stimuli will be studied in collaboration with Dr. Laurent Vallat.

*

Since several genetically modified mice have shown that BCR sensitization may induce tolerance breaks and favor autoimmunity (Pritchard and Smith 2003; Nitschke 2009) we hypothesized that ZAP-70 expression in normal B cells may play a role in the autoimmune phenomena that frequently occur in CLL patients. In this view, a first logical question is whether autoimmunity in CLL is a feature of ZAP-70⁺ CLL.

Zanotti et al. suggested the possible relation between ZAP-70 expression in clonal CLL cells and the occurrence of autoimmune phenomena in CLL patients (Zanotti et al. 2010). In this study they have analyzed 290 CLL patients. Autoimmune cytopenia (AIC) occurred in 16% of cases, i.e. 46 cases. ZAP-70 expression was the most discriminative parameter between CLL patients with or without AIC ($p < 0,0001$), with 80% of AIC patients being ZAP-70⁺ detected by immunohistochemistry in bone marrow biopsies.

In our study, we firstly studied ZAP-70 in normal B cells from CLL non-selected cases, to see whether it is a characteristic of all CLL patients or only of ZAP-70⁺ CLL cases. Afterward, we looked at the ZAP-70 expression, in a more targeted way, in the autoimmunity-associated cases of CLL. Totally, we analyzed 19 cases with AIC-associated CLL, which represent an important value, taking into account the rarity of such cases and that some of the cases had to be eliminated from the analysis because of the very low, non-analyzable, number of residual normal B cells, due to advanced disease or to previous B cell-targeting treatment (Rituximab).

Notably, all of autoimmunity-associated CLL cases in our series were ZAP-70⁺ CLL cases, confirming the data of Zanotti et al. In the context of this observation, and as suggested by our logical syllogism presented in the project chapter (AIC in CLL patients are the consequence of IgG polyclonal autoantibody secreted by normal B cell; and that ZAP-70 could increase BCR signaling, known to favor tolerance break-down) we looked for the expression of ZAP-70 in normal B cells from these patients.

Importantly, we found that a percentage of normal B cells from all AIC-associated CLL patients express ZAP-70, like CLL clones.

When we compared the expression levels of ZAP-70 in normal B cells between CLL ZAP-70⁺ patients with or without autoimmune phenomena, we didn't find a significant difference. In ZAP-70 positive pool of patients the presence of autoimmunity was not associated with higher level of ZAP-70, as compared to ZAP-70 positive patients without autoimmunity. This is in favor of a rather on/off effect of ZAP-70 on B cells, as only its presence could be significantly associated with autoimmunity. It is in line with literature suggestions that only a certain level of ZAP-70 protein is necessary to increase BCR signaling (Chen 2005), and that exceeding levels above this threshold do not enhance phosphorylation of downstream proteins. Moreover, on clinical level, patients with intermediate level of ZAP-70 in CLL cells have the same risk of aggressive disease as those with high ZAP-70 levels (Rassenti et al. 2004).

To further study the potential role of ZAP-70 expression in B cell autoimmunity, two different issues need to be addressed: 1) are normal ZAP-70⁺ B cells enriched in autoreactive cells? 2) are autoreactive cells responsible for the secretion of pathogenic autoantibodies belong to the ZAP-70⁺ normal B cell pool?

To test whether ZAP-70⁺ normal B cells are enriched in autoreactive cells, we have to study the reactivity of ZAP-70⁺ normal B cells against common autoantigens (autoantigens commonly recognized by natural autoAbs, and/or by autoAbs in the most frequent autoimmune diseases). For this, we amplified the variable regions of Ig from ZAP-70⁺ normal B cells and produced monoclonal antibodies. As we could not sort the cells in function of ZAP-70 expression before RT-scPCR, we also had to amplify at single cell level ZAP-70. At the moment, we have 9 monoclonal antibodies available (7 from ZAP-70⁺ normal B cells, and 2 from ZAP-70⁻ cells). We plan to test them against ssDNA, dsDNA, thyroglobulin, actin and insulin by ELISA as well as for their global reactivity for nuclear antigens by immunofluorescence on Hep2 cells. They were tested in an IAT and MAIPA tests for reactivity against RBC and respectively platelets, and found negative. At this time only ELISA for reactivity against anti-dsDNA, anti-actin, and anti-thyroglobulin were performed. Some of mAb from ZAP-70⁺ cells had some low reactivity for these antigens by comparison with two from ZAP-70⁻ cells. We have to mention that the mAb were only tested for the moment directly from the culture supernatants, without a previous purification and

concentration, which will be done shortly. Additionally, the number of mAbs has to be significantly increased to allow statistically analysis.

Initially we planned to compare mAb from ZAP-70⁺ normal B cells with ZAP-70⁻ normal B cells, from the same patient. Noteworthy, there is one aspect in comparing ZAP-70⁺ and ZAP-70⁻ normal B cells from the same ZAP-70⁺ CLL patients that have to be emphasized. We cannot be sure that all ZAP-70⁻ normal B cells determined by RT-scPCR, are really ZAP-70⁻, because this technique is probably not sensitive enough to detect low levels of ZAP-70 mRNA. So, the ZAP-70⁻ cell could be ZAP-70^{low/neg} and only ZAP-70^{hi} cells probably represent ZAP-70⁺ cells. Depending on the results obtained from ZAP-70⁺ cells we will need to compare them with normal B cells from ZAP-70⁻ CLL patients and with literature data from healthy subjects (Wardemann et al. 2003).

The second issue is to determine whether autoreactive B cells responsible for AIC are indeed ZAP-70⁺.

The first strategy is to analyze the reactivities of mAbs produced. From a total of 9 mAbs produced, 7 mAbs were tested in IAT and MAIPA for their reactivity against RBC and respectively platelets: 2 from ZAP-70⁻ B cells (from a CLL-associated Evans syndrome) and 5 from ZAP-70⁺ B cells (4 from CLL-associated Evans syndrome patients and one from CLL-associated AIHA patient). All the tested mAbs were found negative in IAT and MAIPA tests. The limitations are the same as mentioned before (low concentrations, unpurified mAbs).

The second strategy that we designed was to detect ZAP-70⁺, autoreactive B cells by flow cytometry. We designed two methods by which B cells could at the same time be evaluated for ZAP-70 expression and for specific binding to purified autoantigens through their BCR. One of the methods was designed for detection of self-reactive B cells to glycoprotein IIb/IIIa in ITP-associated CLL patients, the other to detect self-reactive B cells to peptides of RhCE in AIHA-associated CLL patients.

For the GPIIb/IIIa antigen staining we encountered a problem that could be difficult to overcome, namely, there is some staining of normal B cells from healthy subjects that is inhibited by anti-Fab antibody. The same observations were noted for 5 different controls. In addition, peripheral B cells from patients with ITP are not distinguishable by their numbers or their MFI. This strongly suggests that this staining is the consequence of some

polyreactive surface IgM, which bind to GPIIb/IIIa, rendering this technique inappropriate to use in our project.

For the second method, designed to detect autoreactive cells in AIHA patients, used synthesized peptides from RhCE protein, the target of autoantibodies in AIHA. We designed and synthesized 8 peptides, corresponding to each of the extracellular loop in RhCE protein, with two peptides for the second and the fourth loop, corresponding to the two antigens at these sites (C/c antigen and E/e antigen). These peptides are already labeled with biotin, and will be tested for their interaction with B cells from patients with AIHA by flow cytometry. If it works, this unique technique of detection of self-reactive B cells in AIHA will be of great interest in characterizing the autoreactive B cells in AIHA in general, not only in CLL-associated AIHA. Additionally, another use of the designed RhCE peptides will be to set up ELISA to study the reactivity of our mAbs and possibly also more generally the detection of free serum autoantibodies in AIHA patients. In conclusion, at this time, our two designed strategies, do not allow to draw a conclusion regarding the specificities of ZAP-70⁺ B cells and their potential involvement in autoimmune manifestations associated with CLL.

This is due mainly because there is a major problem of sensitivity, as autoreactive B cells are rare entities, in general. More ZAP-70⁺ normal B cells reactivities have to be analyzed by mAb produced from these cells.

Moreover, as in typical primary autoimmune diseases, the autoreactive cells are represented by a very low percentage of B cells in peripheral blood (Lieby 2004). Additionally, in CLL patients, normal non-malignant B cells are rare (between 0,01 to 0,1% of total B cells). This is also true for our second strategy, designed to detect double positive normal B cells for ZAP-70 and for a fluorochrome-linked autoantigen that has the difficult task of searching for very rare cells. If we could optimize this second strategy designed to detect autoreactive B cells in ITP and AIHA CLL patients, we could use it for FACS single cell sorting the autoreactive B cells, subsequently RT-PCR amplify their IgV rearranged genes and ZAP-70 mRNA, in order to produce large quantities of mAb.

The association between AIC in CLL patients and the presence of ZAP-70⁺ normal B cells and CLL B cells could be also explained through a more general immune deregulation, that could favor the occurrence of autoimmunity. This could be the result of increased

antigen presentation by non-autoreactive B cell to T cells, and subsequently increased T cell help for autoreactive B cells. This is also suggested by increased ZAP-70 expression in T cells from ZAP-70⁺ CLL patients, which could be more readily activated. Another possible explanation to more frequent autoreactive B cells in ZAP-70⁺ CLL patients is through a more inflammatory microenvironment determining the survival of autoreactive clones. This is especially suggested by the fact that the autoimmunity in CLL patients is always targeted toward blood antigens, like RBS or platelets, suggesting that the process is initially triggered in the bone marrow environment.

*

Finally, our work suggests that it will be interesting to study the level of ZAP-70 expression in B cells in systemic autoimmune diseases, like SLE.

The relation between ZAP-70 expression in B cells and the occurrence of autoimmunity was suspected only by one group who looked for a bio-marker of B cell activation in rheumatoid arthritis (RA). They demonstrated that ZAP-70 expression in synovial fluid B cells obtained from RA patients was increased as compared to synovial fluid B cells from osteoarthritis patients, although this was only true concerning the protein level, whereas mRNA remained poorly detectable. In the same patients the level of ZAP-70 in peripheral blood B cells did not differ between RA and OA patients (Tolusso et al. 2009). This initial study was rather challenged by a second study from the same group, in which there was no difference between the level of expression of ZAP-70 in B cells from synovial fluid or from peripheral blood between RA and non-RA patients (Michelutti et al. 2011).

In our laboratory, preliminary studies in SLE patients demonstrated increased ZAP-70 mRNA by qPCR in B cells from a patient with active SLE (data not published).

*

Conclusion

In this work we described a novel B cell population that expresses ZAP-70 that has not been described before. ZAP-70⁺ normal B cells do not seem to belong to a certain subset of B cells. However their characteristics are yet to be defined.

The presence of ZAP-70 in the naïve B cell subset, demonstrated in this work, suggests that this is an early process in the B cell development, which probably occurs before malignant transformation. Taken into account the role of ZAP-70 in disease aggression, ZAP-70⁺ normal B cells could be at the origin of CLL clone.

Importantly, we found a percentage of ZAP-70⁺ normal B cells in all AIC-associated CLL patients. ZAP-70⁺ B cells could be directly responsible for AIC, or could determine a general increase in autoimmune reactivity. Monoclonal antibodies synthesized from these cells, whose reactivities have to be further tested against AIHA and ITP specific antigen, and against common autoantigens will probably answer this question. A second strategy designed to detect autoantigen-reactive B cells that are at the same time ZAP-70⁺ in flow cytometry needs more fine tuning.

At the moment, this new B cell subpopulation has only been described in ZAP-70⁺ CLL patients, but through their possible effect on BCR signaling, it could also have a role in autoimmune diseases in general.

The functional consequences of aberrant expression of ZAP-70 in B cells will be studied in more detail by the analysis of conditional ZAP-70 KI mice, for the development of autoimmune manifestations and/or lymphoproliferative disease.

The results presented in this work open new perspectives in the comprehension of B cell development and the physiopathology of autoimmunity and malignant transformation.

CHAPITRE 2. PROJET

L'argumentaire de notre projet, comme un syllogisme d'Aristotele, est composé de plusieurs prémisses, desquelles une conclusion pourra être déduite, et qui va être ensuite démontée expérimentalement.

Prémisses

La leucémie lymphoïde chronique (CLL) est une maladie lymphoproliférative, caractérisée par l'accumulation clonale progressive de lymphocytes B (LyB) matures. Dans la pathogenèse de la CLL, les principaux problèmes à résoudre sont : la cellule normale qui est à l'origine du clone CLL, le rôle de la signalisation par le BCR dans la pathogenèse de la CLL, et le possible rôle des antigènes infectieux et du soi dans l'apparition et la prolifération du clone B.

Dans le groupe des maladies lymphoprolifératives, CLL est particulièrement associée à un système immunitaire dérégulé qui favorise le développement des manifestations auto-immunes. L'incidence des manifestations auto-immunes accompagnant la CLL est assez élevée, variant de 10 à 25% des cas. L'autoimmunité est notamment dirigée contre les cellules sanguines, déterminant l'apparition des cytopénies auto-immunes, comme l'anémie hémolytique auto-immune (AIHA) et le purpura thrombopénique immun (ITP).

Les manifestations auto-immunes peuvent apparaître à tout moment dans l'évolution de la CLL, et pourraient être aussi associées aux états pre-leucémiques, comme la lymphocytose monoclonale B. Les mécanismes responsables des manifestations auto-immunes dans la CLL ne sont pas connus, et la recherche dans ce domaine est importante pour la compréhension de l'interaction immune entre la malignité et l'auto-immunité.

Pourtant, la grande majorité des anticorps pathogéniques dans les cytopénies auto-immunes associées à la CLL ne sont pas produits par le clone leucémique, ils sont synthétisés par les cellules B normales résiduelles.

En plus, il y a une bonne corrélation entre l'expression de ZAP-70 par le clone leucémique et l'occurrence des manifestations auto-immunes (Zanotti et al., 2010).

ZAP-70, une protéine initialement décrite comme ayant un important rôle dans la signalisation des récepteurs de surface dans les lymphocytes T et NK, a été retrouvée comme un facteur pronostic important dans la CLL. Les cellules de CLL ZAP-70⁺ ont une survie prolongée, grâce à une signalisation augmentée du BCR.

Classiquement, les lymphocytes B normales n'expriment pas ZAP-70. Néanmoins, des études récentes sont venues développer une controverse. ZAP-70 pourrait être nécessaire dans le développement lymphocytaire B chez la souris, dans la transition du stade pro-B au stade pre-B (Schweighoffer et al., 2003). Chez l'homme, l'expression de ZAP-70 a été décrite dans certaines sous-populations lymphocytaires B dans les amygdales, ou dans des cellules B montrant un phénotype d'activation (Crespo et al 2006; Nolz et al 2005; Cutrona et al 2006; Scielzo et al 2006). En plus, l'expression de ZAP-70 pourrait être induite dans les lymphocytes B après stimulation (Scielzo et al 2006; Bekeredjian-Ding et al., 2008).

Hypothèses à démontrer

Notre première hypothèse est que l'expression de ZAP-70 dans les LyB chez les patients ayant une CLL n'est pas limitée au clone leucémique. Au contraire elle pourrait être un phénomène précoce qui prédispose à la transformation maligne.

Comme l'augmentation de la signalisation par le BCR favorise l'auto-immunité, notre deuxième hypothèse est que ZAP-70, par une signalisation BCR augmentée, pourrait induire la rupture de tolérance dans les LyB non-malines, responsable des phénomènes auto-immuns.

Pour tester nos hypothèses, nous avons adressé les questions suivantes :

1. ZAP-70 est-elle exprimée par les LyB normaux de patients atteints de CLL ?
2. Existe-t-il une corrélation entre l'expression de ZAP-70 dans les LyB malins et dans les LyB normaux ?
3. Existe-t-il une corrélation entre l'expression de ZAP-70 dans les LyB normaux et la survenue d'une cytopénie auto-immune ?
4. Les lymphocytes B normaux exprimant ZAP-70 sont-ils auto-réactifs ?

En plus, pour déterminer si l'expression anormale de ZAP-70 dans les LyB pourrait favoriser l'auto-réactivité en général ou pourrait prédisposer à la transformation maligne, nous avons désigné une souris knock-in qui va surexprimer d'une façon conditionnelle ZAP-70 dans les différents stades de maturation LyB.

CHAPITRE 5. DISCUSSIONS ET PERSPECTIVES

Le résultat principal présenté dans cette thèse est qu'un certain pourcentage de LyB normaux provenant des patients ayant une CLL ZAP-70⁺ exprime ZAP-70, par rapport au LyB normaux de témoins sains.

Nous avons clairement démontré cela en cytométrie de flux, par deux façons différentes d'expression des résultats, comme pourcentage de cellules positives par rapport à un contrôle isotypique, et comme des valeurs MFI (intensité de fluorescence médiane). Pour éviter un marquage false positif, une stratégie stricte de fenêtrage a été utilisée, avec exclusion des doublets et des cellules mortes. Nous avons aussi éliminé les échantillons dans lesquels une l'expression faible de CD5 (qui peut rarement caractériser le clone de CLL) ne pourrait pas bien distinguer entre les LyB non-malins (CD5⁻) et les LyB de CLL (CD5⁺ faible). Nous avons analysé l'expression de ZAP-70 chez 63 patients atteints de CLL qui présentaient un nombre suffisamment de LyB résiduels afin de permettre une analyse statistique. Les 63 patients ont été comparés avec 36 sujets normaux. L'expression de ZAP-70 dans les LyB de CLL, dans les LyB normaux et dans les LyT a été rapportée à un contrôle isotypique.

La présence de mRNA de ZAP-70 dans les LyB normaux des patients CLL a été confirmée au niveau de cellule unique, par RT-scPCR. Les transcrits amplifiés d'une cellule unique ont été ensuite séquencés, montrant une identité à 100% avec la séquence décrite précédemment dans les LyT. Ceci est en accord avec les données de la littérature qui montrent que ZAP-70 ne présente pas de mutations dans les LyB de CLL, par rapport à la séquence d'origine. Nous avons ainsi montré que le mRNA de ZAP-70 amplifié à partir des LyB normaux est bien celui de l'isoforme 1 classique et non de l'isoforme tronqué, récemment décrite, nommé TZK (truncated ZAP kinase), qui manquait de domaine SH2, et une partie de l'interdomaine B (Kuroyama et al., 2004).

Surtout, cela est la première fois quand ZAP-70 mRNA est détecté au niveau de cellule unique, par une méthode de RT-scPCR. En plus, nous sommes les premiers à amplifier mRNA de ZAP-70 dans un LyB unique, dans le même temps que les gènes réarrangés des chaînes lourdes et légères des Ig. Cette technique pourrait être utilisée pour la caractérisation au niveau moléculaire de ces LyB normaux ZAP-70⁺, comme les séquences des gènes réarrangés des Ig ou d'autres gènes dérégulés.

Nous avons aussi démontré en qPCR que les LyB normaux de patients CLL expriment un niveau plus élevé de mRNA de ZAP-70 par rapport aux LyB CD5⁻ des sujets sains, même si la différence n'est pas significative de point de vue statistique. Ce fait n'est probablement pas significatif due au nombre réduit d'échantillons analysés, cette technique nécessitant un nombre minimal de cellules hautement purifiées, difficilement à attendre à cause de la rareté des LyB résiduels chez ces patients.

Le fait que les LyB normaux ZAP-70⁺ ne représentent pas une contamination des cellules normales par les LyB de CLL qui ont perdu le CD5 a été démontré à plusieurs niveaux.

Nous avons clairement démontré à plusieurs niveaux (cellulaires et moléculaires) que ZAP-70 exprimant lymphocytes B normaux ne représentent pas une contamination de cellules B normales avec un contingent du clone CLL qui aurait perdu l'expression CD5. Au niveau cellulaire, nous avons montré que les LyB normaux ZAP-70⁺ sont CD19^{hi} et expriment un niveau élevé de sIg, par rapport au clone CLL qui est CD19^{low} sIg^{low}. En outre, ils sont CD5⁻, et, surtout, ils sont polyclonaux, car ils expriment un rapport normal de chaînes légères k / λ.

Au niveau moléculaire, les régions variables réarrangées Igk et Igλ ont été amplifiées également, avec le transcrite ZAP-70. De plus, les cellules B normales ZAP-70⁺ expriment souvent des gènes réarrangés V_HD_HJ_H et V_LJ_L totalement différentes du clone de CLL, ce qui démontre nettement la polyclonalité de ces cellules.

*

Fait intéressant, les cellules B normales ZAP-70⁺ semblent assez différentes les unes des autres dans le réarrangement V_HD_HJ_H et V_LJ_L, ce qui indique qu'il n'y a pas de relation clonale entre elles. En outre, ils sont également somatiquement mutés ou non mutés, ce qui suggère que ce ne est pas seulement une caractéristique des LyB post-germinales qui ont rencontré l'antigène, mais plutôt un trait plus général.

Ceci est également démontré par le fait que les LyB normaux ZAP-70⁺ ne font pas partie d'une certaine sous-population de LyB. Lorsque les LyB normaux ZAP-70⁻ et ZAP-70⁺ prévenant de patients CLL ZAP-70⁺ ont été comparés, on a observé aucune différence entre eux dans la distribution de différents sous-populations de cellules B. En particulier, les LyB ZAP-70⁺ appartient à la fois au compartiment B naïf et au compartiment B mémoire. Lorsque nous avons analysé séparément l'expression de CD27 dans les LyB normaux ZAP-70⁺ par comparaison avec les LyB normaux ZAP-70⁻ de patients atteints de CLL, nous avons trouvé qu'il n'y avait aucune différence dans les marqueurs de mémoire entre ces deux types de cellules.

*

La présence de ZAP-70 dans la sous-population de lymphocytes B naïfs, suggère que ce processus est tôt dans le développement des lymphocytes B, qui se produit probablement avant la transformation maligne. Pour analyser plus en profondeur le moment où cette expression anormale se produit dans l'ontogenèse des cellules B, nous avons l'intention de chercher l'expression de ZAP-70 dans les premiers stades de développement LyB de la moelle osseuse chez les patients atteints de CLL, à partir de cellules pro-B aux cellules B matures. Cette analyse est une des perspectives prévues de notre projet, mais il est entravé par le fait que les examens de la moelle osseuse sont rarement nécessaires chez les patients atteints de CLL.

Néanmoins, les données présentées dans ce projet, suggèrent que l'expression aberrante de ZAP-70 dans des cellules B est plutôt un phénomène précoce, qui semble arriver au moins au stade des lymphocytes B naïfs, et continue d'être exprimée à tous

les niveaux de développement des cellules B. La persistance de l'expression de ZAP-70 jusqu'à l'étape des cellules plasmocytaires serait également intéressante d'étudier.

*

Une autre question importante est de voir si l'expression de ZAP-70 dans des cellules B normales est une caractéristique des patients atteints de CLL ou non.

Classiquement, les cellules B normales n'expriment pas ZAP-70, bien que des études récentes ont donné lieu à une controverse, quand une nécessité inattendue pour ZAP-70 a été décrite dans le développement des cellules pré-B chez la souris. En l'absence de Syk, le développement des cellules B chez la souris est seulement partiellement bloqué au stade de transition de pro-B au pré-B, alors que les souris déficientes à la fois dans Syk et ZAP-70 montrent un blocage complet au stade de cellules pro-B. Cet arrêt complet est la conséquence d'une signalisation pré-BCR défectueuse, comme en témoigne l'échec de l'exclusion allélique de la chaîne lourde, connu pour exiger un signal pré-BCR (Schweighoffer et al., 2003). Dans la même étude, ZAP-70 a été détectée par immunoblot dans les pro-B, pré-B et les cellules B spléniques de souris non-mutées, mais pas dans les cellules B du sang périphérique.

Chez l'homme, trois études qui ont regardé l'expression de ZAP-70 dans des LyB normaux de sujets sains n'ont pas trouvé une expression dans les cellules B du sang périphérique, même si elles décrivent un bas niveau d'expression de ZAP-70 dans certaines sous-populations LyB des amygdales ou de la rate B avec un phénotype activé (par exemple un volume cellulaire de plus grande taille, ou la présence de marqueurs d'activation tels que CD38, CD27 et CD71), ou dans les stades pro- et pré-B du développement B de la moelle osseuse (Nolz et al 2005; Crespo et al. 2006; Cutrona et al 2006). La seule étude qui a suggéré la possibilité que ZAP-70 peut être exprimé par les cellules B du sang périphérique, montré en Western blot et en cytométrie en flux, que ces cellules expriment ZAP-70 à très faible niveau, en étant cinq fois plus faible que celui des LyB des amygdales, qui est déjà trois fois inférieure à celui des cellules T (Scielzo et al., 2006). En revanche, notre étude met en évidence pour la première fois

que les cellules B normales du sang périphérique de patients atteints de CLL peuvent exprimer ZAP-70 à des niveaux similaires à ceux dans les cellules T.

Comme l'expression de ZAP-70 n'a pas pu être détectée dans les cellules B périphériques de sujets sains, comme les études antérieures et nos propres tests ont montré, cela semble plutôt être une caractéristique des patients atteints de CLL, en particulier une caractéristique des patients CLL ZAP-70⁺.

Une autre possibilité est que l'expression de ZAP-70 dans les cellules B normales pourrait être induite par la stimulation de différentes voies de signalisation, tel que suggéré par deux études, dans lesquelles l'expression de ZAP-70 pourrait être induite par la stimulation des LyB du sang périphérique ou d'amygdales avec CD40L + IL-10, IL-4 et IL-6, IL-15 + CpG ODN, ou avec anti-IgM (Scielzo et al 2006; Bekeredjian-Ding et al, 2008). Dans notre étude, nous avons également stimulé des PBMC normales pour 48h et 72h avec de l'anti-IgM, anti-CD40, IL-4 et IL-21, ou avec tout cela et l'ADN CpG. Bien que nous ayons observé une élévation significative des marqueurs d'activation, comme CD86, dans les cellules stimulées, nous n'avons pas constaté aucune augmentation de l'expression de ZAP-70. Nos données sont en faveur d'un trait intrinsèque, non-induit, plutôt qu'un trait extrinsèque, inductible.

Quel que soit l'explication de ces différences, il est peu probable que l'expression de ZAP-70 par des cellules B normales chez les patients atteints de CLL reflète un phénotype activé. En effet, ces cellules ne présentent pas d'autres fonctions d'activation (telles que l'augmentation du niveau d'expression de CD86) et beaucoup d'entre eux ont un phénotype naïf.

Une problématique qui doit être discutée ici, est que dans nos observations de patients CLL ZAP-70⁺, l'expression de ZAP-70 est non seulement élevée dans certains LyB normaux, dans les cellules de CLL, mais il est également élevée dans les cellules T. Cette observation, récemment confirmée par une autre équipe, nous a déterminé de nous demander si cela pourrait être le reflet d'un facteur environnemental, extrinsèque, qui pourrait augmenter ZAP-70 dans tous les lymphocytes. Pour tester cette hypothèse, des PBMC d'un sujet sain ou d'un cas de CLL ZAP-70⁻ ont été incubés avec du sérum de CLL ZAP-70⁺, à la recherche d'un facteur sérique qui pourrait être responsable de l'augmentation générale de l'expression de ZAP-70. Après 24h et 48h

d'incubation, il n'y avait pas d'augmentation du niveau ZAP-70 dans les cellules testées. Ainsi, bien que cette expérience soit très simple, il est peu probable qu'un facteur sérique pourrait responsable de ce phénomène chez les patients CLL ZAP-70⁺.

Une autre possibilité de l'influence de l'environnement, qui n'a pas été testé dans notre travail, est à travers des interactions cellulaires avec d'autres types de cellules ou avec le stroma. L'importance du microenvironnement dans CLL est soulignée par le fait que la plupart des cellules CLL sont soumises à l'apoptose rapidement quand elles sont ex vivo. En outre, l'augmentation de la phosphorylation de ZAP-70 a été démontrée dans les cellules CD38⁺ de CLL qui interagissent avec les cellules CD31⁺ des organes lymphoïdes secondaires comme les NLC (nurse-like cells)(Deaglio et al., 2007). Cette possibilité reste à être testé dans notre laboratoire, par exemple dans des expériences de culture dans lesquelles des PBMC normales ou PMBC de CLL ZAP-70⁻ seront incubées avec CD31⁺ NLC ou avec des cellules stromales de la moelle osseuse de patients CLL ZAP-70⁺.

*

Il est actuellement couramment connu que l'expression de ZAP-70 dans les cellules CLL n'est pas un processus on/off, mais plutôt un continuum. Nous avons trouvé une corrélation frappante dans le niveau d'expression de ZAP-70 entre les cellules B normales et les cellules de CLL du même patient. En plus, l'expression de ZAP-70 dans les cellules B normales n'est pas bimodale, avec des cellules qui sont clairement ZAP-70⁻ ou ZAP-70⁺. Elle a l'apparence d'un continuum, ressemblant vraiment à l'expression de ZAP-70 dans les cellules de CLL.

Avec le fait que ZAP-70 est déjà exprimé au stade naïf de cellules B normales, ces données indiquent que l'expression de ZAP-70 est un phénomène précoce et qu'il précède clairement transformation maligne. Ceci est en effet très intéressant car il ouvre la possibilité que l'expression anormale de ZAP-70 pourrait jouer un rôle dans la transformation maligne à travers, par exemple, la facilitation de la signalisation BCR, induisant une prolifération et une survie accrue. Le rôle de la signalisation BCR dans la

pathogénèse de la CLL est bien démontré aujourd'hui, soulignée par l'efficacité spectaculaire des inhibiteurs de la signalisation du BCR, comme l'ibrutinib ou l'idélalisib, utilisés dans le traitement de la CLL, même dans les cas avec de très mauvais facteurs pronostiques.

En ce qui concerne la réponse à la stimulation par l'anti-IgM, les cas de CLL sont classés en deux types: les UM-CLL, qui ont un comportement agressif, avec une augmentation de la phosphorylation des tyrosines après la stimulation par le BCR, et les M-CLL dans lesquels il n'y a pas de réponse suite à la stimulation par le BCR et qui ont une évolution plus indolente. Une des principales différences qui distinguent également ces deux types de maladie est l'expression de ZAP-70 par le LyB de CLL dans les types UM-CLL, soulignant le rôle probable de ZAP-70 dans la signalisation BCR et implicitement dans l'agressivité de la maladie.

Dans le même ordre d'idées, le comportement récemment décrit des BCR de CLL comme pré-BCR, qui ont une signalisation tonique, indépendante de l'antigène (Minden et al. 2012) ensemble avec le fait que ZAP-70 pourrait avoir un rôle dans la signalisation pré-BCR, est en faveur d'un rôle de ZAP-70 dans l'ontogénèse des cellules B malignes. Comme il est bien connu que l'exclusion allélique nécessite une signalisation pré-BCR correcte, le fait que les clones de CLL manquent souvent l'exclusion allélique est en faveur d'une signalisation anormale du pré-BCR chez les patients atteints de LLC (Rassenti et Kipps 1997). Ce mécanisme n'est pas encore clair, parce que si ZAP-70 augmente la signalisation par le pré-BCR, cela ne pourrait pas déterminer un échec dans l'exclusion allélique. Il sera intéressant d'étudier si l'absence de l'exclusion allélique n'est pas la plupart du temps limitée aux cas mutés, ZAP-70:

*

Une autre façon de tester la relation entre l'expression aberrante de ZAP-70 dans les LyB et la transformation maligne, pour déterminer si elle est un état pré-malin ou une anomalie induite *à posteriori* par la transformation maligne, est de regarder l'expression de ZAP-70 dans des cellules B normales dans les cas lymphocytose monoclonale B (MBL). L'expression de ZAP-70 dans des cellules de MBL a déjà été démontrée, bien que pas encore défini comme un facteur pronostique (Rossi et al., 2009). Il sera très intéressant de chercher l'expression de ZAP-70 dans des cellules B normales de ce type de patients, une expression élevée pourrait plaider en faveur d'un rôle prédisposant à la malignité de ZAP-70.

La relation clonale entre les cellules B normales ZAP-70⁺ et le clone de CLL est l'une des questions les plus importantes de notre travail. Tout d'abord parce que nous craignons que les cellules B normales ZAP-70⁺ pourraient représenter un contingent contaminant du clone CLL, d'où l'importance de démontrer que les deux sous-populations ont un phénotype et des caractéristiques moléculaires très différents, comme nous l'avons déjà discuté. Deuxièmement, parce que, pour comprendre le processus de transformation maligne, il est d'une importance primordiale d'établir la relation clonale entre ces cellules.

La possibilité de contamination a été éliminée de la plupart des cas, comme discuté précédemment.

La possibilité que le clone CLL pourrait provenir de cellules B normales ZAP-70⁺ est suggérée par plusieurs observations. Tout d'abord, nous pouvons imaginer que le clone CLL ait gagné des avantages mutationnels de survie et de prolifération, dans le processus d'édition des récepteurs de cellules auto-réactives ZAP-70⁺ B. Ceci est suggéré par la présence de longues régions CDR3 dans le clone CLL, par rapport à des cellules non malignes, caractéristique des cellules B qui ont subi l'édition du récepteur, y compris le remplacement du VH (Garcia-Munoz, Galiacho, et Llorente 2012; Zhang, Burrows, et Cooper 2004). Plusieurs cellules B normales ZAP-70⁺ qui diffèrent de CLL clone seulement par la chaîne lourde ou légère suggèrent en effet des processus d'édition du récepteur. Sachant que les régions BCR V sont impliqués dans la transformation / prolifération des cellules CLL, ces observations ouvrent des perspectives l'étude fascinantes.

Parmi les cellules dont les gènes réarrangés des Ig ont été amplifiés, il existe plusieurs cellules normales qui ont les mêmes séquences $V_H D_H J_H$ et $V_L J_L$ que les cellules CLL, différant par seulement 2 ou 3 mutations. Dans de telles situations, les probabilités que les cellules ne dérivent pas d'un ancêtre unique, sont infinitésimales. Toutefois, à ce stade, il est impossible d'exclure la possibilité que ces cellules «normales» proviennent du clone de CLL, ayant été sélectionnées dans le compartiment $CD5^-$ par contamination. Ceci est soutenu par le fait que les mutations sont dans la région FR1, ce qui ne reflète probablement pas une évolution clonale, mais plutôt des mutations induites par la réaction de PCR.

A la recherche d'une relation clonale entre les cellules de LLC et les cellules B normales $ZAP-70^+$, et vue l'hypothèse de départ que les cellules CLL dérivent de l'équivalent de «cellules B1 humaines», nous avons vérifié si les cellules $CD20^+ CD27^+ CD43^+ CD70^-$ récemment décrites (Griffin, Holodick, et Rothstein 2011) sont plus fréquentes dans les cellules B normales $ZAP-70^+$, que dans ceux $ZAP-70^-$, mais ce ne fut pas le cas.

Compte tenu du fait que, pour le moment, seulement un nombre limité de cellules ont été amplifiées à partir de la population de cellules B normales $ZAP-70^+$, une conclusion claire concernant la relation clonale entre le clone CLL et ces cellules ne peut pas être encore tirée. Nous avons besoin de plus de données pour étudier les événements moléculaires qui auraient pu se produire entre certaines cellules normales $ZAP-70^+$ et celles malines.

Notre travail va permettre une étude plus approfondie du rôle potentiel de la surexpression de $ZAP-70$ dans la transformation maligne, par l'augmentation de la signalisation du BCR. Cela se fera dans les souris transgéniques conditionnelles qui surexprimeront $ZAP-70$ dans leurs LyB à différents stades de développement. La souris sera étudiée pour le développement possible des lymphoproliférations, et à la recherche des possibles particularités du développement B induites par $ZAP-70$, ainsi que pour le niveau d'activation *in vivo* et les marqueurs d'activation de ces cellules B. L'influence de la surexpression de $ZAP-70$ sur la signalisation BCR sera étudiée par des expériences de stimulation *in vitro*, en comparant les LyB $ZAP-70^+$ avec des LyB de

souris témoins. En plus, les modifications du transcriptome induites par la stimulation des cellules B par des stimuli BCR-dépendants ou indépendants seront étudiées en collaboration avec le Dr Laurent Vallat.

*

Comme plusieurs modèles de souris ont montré que la sensibilisation du BCR peut induire des ruptures de tolérance et favoriser l'auto-immunité (Pritchard et Smith, 2003; Nitschke 2009), nous avons émis l'hypothèse que l'expression de ZAP-70 dans des LyB normaux pourrait jouer un rôle dans les phénomènes auto-immuns qui sont fréquents chez les patients CLL. En vue de cette perspective, une première question est de savoir si l'auto-immunité dans la CLL est une caractéristique de CLL ZAP-70⁺.

Zanotti et al. ont suggéré la possible relation entre l'expression de ZAP-70 dans les cellules clonales de CLL et l'apparition de phénomènes auto-immunes chez des patients atteints de CLL (Zanotti et al., 2010). Dans cette étude, les auteurs ont analysé 290 patients atteints de CLL. Les cytopénies auto-immunes (AIC) ont apparu dans 16% des cas, soit 46 cas. L'expression de ZAP-70 était le paramètre le plus discriminant entre les patients atteints de CLL avec ou sans AIC ($p < 0,0001$), avec 80% des patients AIC étant ZAP-70⁺ détectée par immunohistochimie dans les biopsies de moelle osseuse.

Dans notre étude, nous avons tout d'abord étudié ZAP-70 dans les cellules B normales des cas de CLL non-sélectionnés, pour voir si elle est une caractéristique de tous les patients atteints de CLL ou seulement des cas de CLL ZAP-70⁺. Ensuite, nous avons examiné l'expression de ZAP-70, d'une manière plus ciblée, dans les cas d'auto-immunité associée à la CLL. Au total, nous avons analysé 19 cas de AIC associé à une CLL, qui représentent une valeur importante, compte tenu de la rareté de ces cas et du fait que certains des cas ont dû être éliminés de l'analyse en raison du très faible, non analysable, nombre des cellules B normales résiduelles, en raison de la maladie avancée ou à un traitement antérieur ciblant les cellules B (Rituximab).

Remarquablement, tous les cas d'auto-immunité associée à la CLL dans notre série étaient des cas de CLL ZAP-70⁺, confirmant les données de Zanotti et al. Dans le contexte de cette observation, et comme suggéré par notre syllogisme logique présenté dans le chapitre projet (AIC chez les patients atteints de LLC sont la conséquence d'auto-anticorps IgG polyclonaux sécrétés par les cellules B normales ; et ZAP-70 pourrait augmenter la signalisation BCR, connu pour favoriser la rupture de tolérance) nous avons cherché l'expression de ZAP-70 dans les cellules B normales de ces patients.

Plus important, nous avons constaté qu'un pourcentage de cellules B normales de tous les patients atteints de AIC associés à la CLL exprime ZAP-70, comme les clones de CLL.

Lorsque nous avons comparé les niveaux d'expression de ZAP-70 dans les cellules B normales entre les patients CLL ZAP-70⁺ avec ou sans phénomènes auto-immuns, nous n'avons pas trouvé une différence significative. Dans le groupe de CLL ZAP-70⁺, la présence d'auto-immunité n'a pas été associée à un plus haut niveau de ZAP-70, par rapport aux patients CLL ZAP-70⁺ sans l'auto-immunité. Ceci est en faveur d'un effet on/off de ZAP-70 sur les cellules B, car seulement sa présence est significativement associée à l'auto-immunité. Ceci est en accord avec les suggestions de la littérature que seulement un certain niveau de la protéine ZAP-70 est nécessaire pour augmenter la signalisation du BCR (Chen, 2005), et que les niveaux dépassant ce seuil n'augmente pas la phosphorylation des protéines en aval. En outre, sur le plan clinique, les patients atteints de CLL avec un niveau intermédiaire de ZAP-70 dans les cellules de CLL ont le même risque de maladie agressive que ceux ayant un niveau élevé de ZAP-70 (Rassenti et al, 2004).

Pour étudier plus en détail le rôle potentiel de l'expression de ZAP-70 dans des cellules B dans l'auto-immunité, deux questions différentes doivent être abordés: 1) les cellules B normales ZAP-70⁺ sont-elles enrichies en cellules auto-réactives? 2) les cellules auto-réactives responsables de la sécrétion d'auto-anticorps pathogènes appartiennent-elles au groupe des cellules B normales ZAP-70⁺?

Pour tester si les cellules B normales ZAP-70⁺ sont enrichies en cellules auto-réactives, nous avons à étudier la réactivité des cellules B normales ZAP-70⁺ contre des auto-antigènes communs (auto-antigènes communément reconnu par les auto-Ac naturels, et / ou par auto-Ac présents dans les plus fréquentes maladies auto-immunes). Pour cela, nous avons amplifié les régions variables des Ig de cellules B normales ZAP-70⁺, et nous avons produit les anticorps monoclonaux à partir de ces cellules. Comme nous ne pouvons pas trier les cellules en fonction de l'expression de ZAP-70 avant la RT-scPCR, nous avons du également amplifier mRNA de ZAP-70 au niveau de cellule unique. À l'heure actuelle, nous avons 9 anticorps monoclonaux disponibles (7 synthétisés à partir de cellules B normales ZAP-70⁺, et 2 de cellules ZAP-70⁻). Nous prévoyons de les tester contre le DNA simple brin, le DNA double brin, la thyroglobuline, l'actine et l'insuline par ELISA ainsi que pour leur réactivité globale contre les antigènes nucléaires par immunofluorescence sur des cellules Hep2. Les monoclonaux ont été testés dans un test de IAT et de MAIPA pour leur réactivité contre les RBC et respectivement les plaquettes, qui se sont révélés négatifs. A ce moment seulement les ELISA pour la réactivité contre l'anti-DNAdb, anti-actine, anti-thyroglobuline ont été réalisées. Certains de mAb de cellules ZAP-70⁺ montraient une faible réactivité contre ces antigènes par rapport avec deux mAb de cellules ZAP-70⁻, pourtant à un niveau non-significatif. Nous devons mentionner que pour l'instant les mAb ont été seulement testé directement à partir des surnageants de culture, sans une purification et une concentration préalable, ce qui sera fait prochainement. En outre, le nombre de mAb doit être augmentée de façon significative pour permettre une analyse statistique.

Initialement nous avions prévu de comparer les mAb de cellules B normales ZAP-70⁺ avec ceux de cellules B normales ZAP-70⁻, chez le même patient. Il convient de noter qu' il y a un aspect qui doit être souligné dans la comparaison entre les cellules B normales ZAP-70⁺ et ZAP-70⁻ du même patient CLL ZAP-70⁺. Nous ne pouvons pas être sûr que toutes les cellules B normales ZAP-70⁻ déterminées par RT-scPCR, sont vraiment ZAP-70⁻, parce que cette technique n'est probablement pas assez sensible pour détecter de faibles niveaux de mRNA de ZAP-70. Ainsi, la cellule ZAP-70⁻ pourrait être ZAP-70^{faible/neg} et seulement les cellules ZAP-70^{fort} représentent probablement les cellules ZAP-70⁺. Selon les résultats obtenus à partir de cellules ZAP-70⁺, nous aurons

besoin de les comparer avec des cellules B normales de patients atteints de LLC ZAP-70⁻ et avec des données de sujets sains de la littérature (Wardemann et al, 2003).

La deuxième question est de déterminer si les cellules B auto-réactives responsables des cytopénies auto-immunes sont en effet ZAP-70⁺.

La première stratégie consiste à analyser les réactivités des mAb produits. Sur un total de 9 mAb produits, 7 mAb ont été testés dans les tests de IAT et MAIPA pour leur réactivité contre les RBC et respectivement plaquettes: 2 des cellules B ZAP-70⁻ (à partir des cellules d'un patient ayant un syndrome d'Evans associé à une CLL) et 5 des LyB ZAP-70⁺ (4 à partir des cellules d'un patients avec un syndrome d'Evans associé à une CLL et une d'un patient AIHA associée à une CLL). Tous les mAb testés ont été trouvés négatifs en IAT et MAIPA. Les limitations sont les mêmes que mentionné précédemment : faibles concentrations de mAbs non purifiés.

La deuxième stratégie que nous avons conçue était de détecter les cellules B auto-réactives ZAP-70⁺, par cytométrie de flux. Nous avons conçu deux méthodes par lesquelles les cellules B pourraient en même temps être évalués pour l'expression de ZAP-70 et pour la liaison à des auto-antigènes purifiés par leur BCR spécifique. L'un des procédés a été conçu pour la détection de cellules B auto-réactives contre la glycoprotéine IIb/IIIa chez les patients atteints de ITP associé à une CLL, l'autre pour détecter les cellules B auto-réactives contre les peptides RhCE chez les patients atteints d'une AIHA associée la une CLL.

Pour la méthode utilisant l'antigène GPIIb/IIIa, nous avons rencontré un problème qui pourrait être difficile à surmonter, car il y a un pourcentage des cellules B normales de sujets sains qui réagit avec la GPIIb/IIIa, et cette réaction est en plus inhibée par l'anticorps anti-Fab. Les mêmes observations ont été notées pour 5 contrôles différents. En plus, les cellules B périphériques provenant des patients atteints de ITP ne se distinguent pas par leur nombre ou par leur MFI. Cela suggère fortement que ce marquage est la conséquence de la liaison des IgM polyréactifs de surface avec la GPIIb/IIIa, rendant cette technique inutilisable dans notre projet.

Pour la deuxième méthode, conçue pour détecter des cellules auto-réactives chez les patients avec AIHA, nous avons utilisé des peptides de synthèse de la protéine RhCE, la cible des auto-anticorps dans l'AIHA. Nous avons conçu et synthétisé 8 peptides, correspondant à chacune de la boucle extracellulaire de la protéine RhCE, avec deux peptides pour la deuxième et la quatrième, correspondant aux deux antigènes dans ces sites (antigène C/c et l'antigène e/E). Ces peptides sont déjà marqués avec la biotine, et seront testés pour leur interaction avec les cellules B de patients atteints d'AIHA par cytométrie de flux. Si cela fonctionne, cette technique unique de détection des cellules B auto-réactives dans l'AIHA sera d'un grand intérêt dans la caractérisation des lymphocytes B auto-réactifs dans AIHA en général, pas seulement dans l'AIHA associée à la CLL. Par ailleurs, une autre utilisation des peptides RhCE conçus sera de mettre en place des ELISA pour étudier la réactivité de nos mAb et peut-être aussi plus généralement pour la détection d'auto-anticorps sériques libres chez les patients ayant une AIHA. En conclusion, en ce moment, nos deux stratégies conçues, ne permettent pas de tirer une conclusion concernant les spécificités des cellules B ZAP-70⁺ et leur implication potentielle dans les manifestations auto-immunes associées à la CLL.

Cela est dû principalement à un problème majeur de sensibilité, car les cellules B auto-réactives sont des entités très rares en général. La réactivité de cellules B normales ZAP-70⁺ doit être analysé plus en profondeur par l'analyse de plus de mAb produits à partir de ces cellules.

En plus, comme dans les maladies auto-immunes primaires typiques, les cellules auto-réactives sont représentés par un très faible pourcentage des cellules B dans le sang périphérique (Lieby 2004). En outre, chez les patients atteints de CLL, les cellules B normales non malignes sont rares (entre 0,01 et 0,1% des cellules totales B). Cela est également vrai pour notre deuxième stratégie, conçue pour détecter les cellules B normales doublement positives pour ZAP-70 et pour un auto-antigène lié à un fluorochrome, qui a la tâche difficile de la recherche de cellules très rares. Si nous pouvions optimiser cette deuxième stratégie visant à détecter les cellules B auto-réactives chez les patients ITP et AIHA associés à une CLL, nous pourrions l'utiliser pour le tri en cellule unique par FACS des cellules B auto-réactifs, ensuite amplifier

leurs mRNA des gènes IGV réarrangés et de ZAP-70 par RT-scPCR, afin de produire de grandes quantités de mAb.

L'association entre AIC chez les patients atteints de CLL et la présence de des cellules B normales et les cellules B de CLL ZAP-70⁺ pourrait également être expliqué par une dérégulation immunitaire plus générale, qui pourrait favoriser l'apparition d'auto-immunité. Cela pourrait être le résultat de l'augmentation de la présentation de l'antigène par les cellules B non auto-réactives aux cellules T, et par la suite une augmentation de l'aide des cellules T pour cellules B auto-réactives. Ceci est également suggéré par l'augmentation de l'expression de ZAP-70 dans les cellules T de patients CLL ZAP-70⁺, qui pourraient être plus facilement activées. Une autre explication possible pour la fréquence plus élevée des cellules B auto-réactives chez les patients CLL ZAP-70⁺ est par un microenvironnement plus inflammatoire, facilitant la survie des clones auto-réactifs. Ceci est particulièrement suggéré par le fait que l'auto-immunité chez les patients atteints de CLL est toujours ciblée vers les antigènes sanguins, comme les plaquettes ou les RBC, ce qui suggère que le processus est probablement déclenché initialement dans l'environnement de la moelle osseuse.

*

Enfin, notre travail suggère qu'il sera intéressant d'étudier le niveau d'expression de ZAP-70 dans les LyB dans les maladies auto-immunes systémiques, comme le SLE.

La relation entre l'expression de ZAP-70 dans les LyB et la survenue de l'auto-immunité a été soupçonnée uniquement par un groupe qui a recherché un marqueur d'activation des LyB dans la polyarthrite rhumatoïde (RA). Ils ont démontré que l'expression de ZAP-70 dans les cellules B de liquide synovial provenant de patients atteints de RA était augmentée par rapport aux cellules B de liquide synovial de patients souffrant d'arthrose, bien que cela était seulement vrai en ce qui concerne le niveau de la protéine, tandis que le mRNA est resté mal caractérisé. Dans les mêmes patients le niveau de ZAP-70 dans les cellules du sang périphérique B ne différait pas

entre les patients avec RA et les patients arthrosiques (Tolusso et al., 2009). Cette première étude a été plutôt contesté par une deuxième étude dans le même groupe, dans lequel il n'y avait pas de différence entre le niveau d'expression de ZAP-70 dans les cellules B à partir du liquide synovial ou du sang périphérique entre les patients RA et ceux non atteints de RA (Michelutti et al., 2011).

Dans notre laboratoire, des études préliminaires ont démontré chez les patients lupiques un niveau augmenté de mRNA de ZAP-70 par qPCR dans les cellules B d'un patient avec SLE actif (données non publiées).

*

Conclusion

Dans ce travail, nous avons décrit une nouvelle population de cellules B normales qui exprime ZAP-70 qui n'a pas été décrit auparavant. Les LyB normales ZAP-70⁺ ne semblent pas appartenir à une certaine sous-population de LyB. Toutefois, leurs caractéristiques sont encore à définir.

L'expression de ZAP-70 dans la sous-population de cellules B naïves, démontré dans ce travail, suggère que ce processus est précoce dans le développement des cellules B, qui se produit probablement avant la transformation maligne. Vu le rôle de ZAP-70 dans l'agression de la maladie, les cellules B normales ZAP-70⁺ pourrait être à l'origine du clone CLL.

En plus, nous avons trouvé un pourcentage de cellules B normales ZAP-70⁺ chez tous les patients atteints de AIC associée à une LLC. Les LyB ZAP-70⁺ pourraient être directement responsables de l'AIC, ou pourraient déterminer une augmentation générale de la réactivité auto-immune. Les anticorps monoclonaux synthétisés à partir de ces cellules, dont les réactivités doivent encore être testé contre les antigènes spécifiques d'AIHA et d'IPT, et contre des auto-antigènes communs, vont probablement répondre à cette question. Une deuxième stratégie visant à détecter les cellules B auto-réactives qui sont dans le même temps ZAP-70⁺ en cytométrie doit être plus mise au point.

À l'heure actuelle, cette nouvelle sous-population de cellules B a été seulement décrite chez les patients CLL ZAP-70⁺, mais vu leur effet possible sur la signalisation de BCR, elles pourraient également avoir un rôle dans les maladies auto-immunes en général.

Les conséquences fonctionnelles de l'expression aberrante de ZAP-70 dans les cellules B seront étudiées plus en détail par l'analyse de souris ZAP-70 KI conditionnelles, pour le développement des manifestations auto-immunes et/ou des maladies lymphoprolifératives.

Les résultats présentés dans ce travail ouvrent de nouvelles perspectives dans la compréhension du développement des lymphocytes B et la physiopathologie de l'auto-immunité et de la transformation maligne.

BIBLIOGRAPHY

Abrisqueta, P., A. Pereira, C. Rozman, et al.

2009 Improving Survival in Patients with Chronic Lymphocytic Leukemia (1980-2008): The Hospital Clinic of Barcelona Experience. *Blood* 114(10): 2044–2050.

Admirand, Joan H, Ronald J Knoblock, Kevin R Coombes, et al.

2010 Immunohistochemical Detection of ZAP70 in Chronic Lymphocytic Leukemia Predicts Immunoglobulin Heavy Chain Gene Mutation Status and Time to Progression. *Modern Pathology* 23(11): 1518–1523.

Agathangelidis, Andreas, Nikos Darzentas, Anastasia Hadzidimitriou, et al.

2012 Stereotyped B-Cell Receptors in One-Third of Chronic Lymphocytic Leukemia: A Molecular Classification with Implications for Targeted Therapies. *Blood* 119(19): 4467–4475.

Allsup, D. J., A. S. Kamiguti, K. Lin, et al.

2005 B-Cell Receptor Translocation to Lipid Rafts and Associated Signaling Differ between Prognostically Important Subgroups of Chronic Lymphocytic Leukemia. *Cancer Research* 65(16): 7328–7337.

Amin, S., M. Walsh, C. Wilson, et al.

2012 Cross-Talk between DNA Methylation and Active Histone Modifications Regulates Aberrant Expression of ZAP70 in CLL. *Journal of Cellular and Molecular Medicine* 16(9): 2074–2084.

Arbuckle, Melissa R., Micah T. McClain, Mark V. Rubertone, et al.

2003 Development of Autoantibodies before the Clinical Onset of Systemic Lupus Erythematosus. *New England Journal of Medicine* 349(16): 1526–1533.

D'Arena, Giovanni, Roberto Guariglia, Francesco La Rocca, et al.

2013 Autoimmune Cytopenias in Chronic Lymphocytic Leukemia. *Clinical and Developmental Immunology* 2013: 1–8.

D'Arena, Giovanni, Luca Laurenti, Maria Marta Minervini, et al.

2011 Regulatory T-Cell Number Is Increased in Chronic Lymphocytic Leukemia Patients and Correlates with Progressive Disease. *Leukemia Research* 35(3): 363–368.

D'Arena, Giovanni, Michela Tarnani, Carlo Rumi, et al.

2007 Prognostic Significance of Combined Analysis of ZAP-70 and CD38 in Chronic Lymphocytic Leukemia. *American Journal of Hematology* 82(9): 787–791.

Arpaia, E., M. Shahar, H. Dadi, A. Cohen, and C. M. Roifman
1994 Defective T Cell Receptor Signaling and CD8+ Thymic Selection in Humans Lacking Zap-70 Kinase. *Cell* 76(5): 947–958.

Asahi, Atsuko, Tetsuya Nishimoto, Yuka Okazaki, et al.
2008 Helicobacter Pylori Eradication Shifts Monocyte Fcγ Receptor Balance toward Inhibitory FcγRIIB in Immune Thrombocytopenic Purpura Patients. *Journal of Clinical Investigation*. <http://www.jci.org/articles/view/34496>, accessed April 22, 2015.

Ashe, J. M., D. L. Wiest, R. Abe, and A. Singer
1999 ZAP-70 Protein Promotes Tyrosine Phosphorylation of T Cell Receptor Signaling Motifs (ITAMs) in Immature CD4(+)8(+) Thymocytes with Limiting p56(lck). *The Journal of Experimental Medicine* 189(7): 1163–1168.

Audia, S., M. Samson, J. Guy, et al.
2011 Immunologic Effects of Rituximab on the Human Spleen in Immune Thrombocytopenia. *Blood* 118(16): 4394–4400.

Audia, Sylvain, Marzia Rossato, Kim Santegoets, et al.
2014 Splenic TFH Expansion Participates in B-Cell Differentiation and Antiplatelet-Antibody Production during Immune Thrombocytopenia. *Blood* 124(18): 2858–2866.

Audia, Sylvain, Maxime Samson, Matthieu Mahévas, et al.
2013 Preferential Splenic CD8+ T-Cell Activation in Rituximab-Nonresponder Patients with Immune Thrombocytopenia. *Blood* 122(14): 2477–2486.

Barcellini, W., S. Capalbo, R. M. Agostinelli, et al.
2006 Relationship between Autoimmune Phenomena and Disease Stage and Therapy in B-Cell Chronic Lymphocytic Leukemia. *Haematologica* 91(12): 1689–1692.

Barcellini, W., R. Montesano, G. Clerici, et al.
2002 In Vitro Production of Anti-RBC Antibodies and Cytokines in Chronic Lymphocytic Leukemia. *American Journal of Hematology* 71(3): 177–183.

Barker, R. N., K. M. Casswell, M. E. Reid, R. J. Sokol, and C. J. Elson
1992 Identification of Autoantigens in Autoimmune Haemolytic Anaemia by a Non-Radioisotope Immunoprecipitation Method. *British Journal of Haematology* 82(1): 126–132.

Barker, Robert N., Andrew M. Hall, Graham R. Standen, Jeff Jones, and Christopher J. Elson

1997 Identification of T-Cell Epitopes on the Rhesus Polypeptides in Autoimmune Hemolytic Anemia. *Blood* 90(7): 2701–2715.

Di Bartolo, Vincenzo, Dominique Mège, Valérie Germain, et al.

1999 Tyrosine 319, a Newly Identified Phosphorylation Site of ZAP-70, Plays a Critical Role in T Cell Antigen Receptor Signaling. *Journal of Biological Chemistry* 274(10): 6285–6294.

Bekeredjian-Ding, I., A. Doster, M. Schiller, et al.

2008 TLR9-Activating DNA up-Regulates ZAP70 via Sustained PKB Induction in IgM+ B Cells. *The Journal of Immunology* 181(12): 8267–8277.

Bell, C. A., and H. Zwicker

1978 Further Studies on the Relationship of Anti-Ena and Anti-Wrb in Warm Autoimmune Hemolytic Anemia. *Transfusion* 18(5): 572–575.

Beyer, M.

2005 Reduced Frequencies and Suppressive Function of CD4+CD25hi Regulatory T Cells in Patients with Chronic Lymphocytic Leukemia after Therapy with Fludarabine. *Blood* 106(6): 2018–2025.

Bilban, Martin, Daniel Heintel, Theresa Scharl, et al.

2006 Deregulated Expression of Fat and Muscle Genes in B-Cell Chronic Lymphocytic Leukemia with High Lipoprotein Lipase Expression. *Leukemia* 20(6): 1080–1088.

Binet, J. L., A. Auquier, G. Dighiero, et al.

1981 A New Prognostic Classification of Chronic Lymphocytic Leukemia Derived from a Multivariate Survival Analysis. *Cancer* 48(1): 198–206.

Blanchard, Nicolas, Vincenzo Di Bartolo, and Claire Hivroz

2002 In the Immune Synapse, ZAP-70 Controls T Cell Polarization and Recruitment of Signaling Proteins but Not Formation of the Synaptic Pattern. *Immunity* 17(4): 389–399.

Van Bockstaele, Femke, Bruno Verhasselt, and Jan Philippé

2009 Prognostic Markers in Chronic Lymphocytic Leukemia: A Comprehensive Review. *Blood Reviews* 23(1): 25–47.

Van Bockstaele, F., A. Janssens, A. Piette, et al.

2006 Kolmogorov–Smirnov Statistical Test for Analysis of ZAP-70 Expression in B-CLL, Compared with Quantitative PCR and IgVH Mutation Status. *Cytometry Part B: Clinical Cytometry* 70(4): 302–308.

Van Bockstaele, F., V. Pede, A. Janssens, et al.

2006 Lipoprotein Lipase mRNA Expression in Whole Blood Is a Prognostic Marker in B Cell Chronic Lymphocytic Leukemia. *Clinical Chemistry* 53(2): 204–212.

Boelens, Jerina, Jan Philippé, and Fritz Offner

2007 B-CLL Cells from Lymph Nodes Express Higher ZAP-70 Levels than B-CLL Cells from Peripheral Blood. *Leukemia Research* 31(5): 719–720.

Bojarska-Junak, Agnieszka, Iwona Hus, Sylwia Chocholska, et al.

2009 BAFF and APRIL Expression in B-Cell Chronic Lymphocytic Leukemia: Correlation with Biological and Clinical Features. *Leukemia Research* 33(10): 1319–1327.

Bomben, R, S Gobessi, M Dal Bo, et al.

2012 The miR-17~92 Family Regulates the Response to Toll-like Receptor 9 Triggering of CLL Cells with Unmutated IGHV Genes. *Leukemia* 26(7): 1584–1593.

Borthakur, Gautam, Susan O'Brien, William G. Wierda, et al.

2007 Immune Anaemias in Patients with Chronic Lymphocytic Leukaemia Treated with Fludarabine, Cyclophosphamide and Rituximab ? Incidence and Predictors. *British Journal of Haematology* 136(6): 800–805.

Bowditch, R. D., P. Tani, K. C. Fong, and R. McMillan

1996 Characterization of Autoantigenic Epitopes on Platelet Glycoprotein IIb/IIIa Using Random Peptide Libraries. *Blood* 88(12): 4579–4584.

Brdicka, Tomas, Theresa A. Kadlecck, Jeroen P. Roose, Alexander W. Pastuszak, and Arthur Weiss

2005 Intramolecular Regulatory Switch in ZAP-70: Analogy with Receptor Tyrosine Kinases. *Molecular and Cellular Biology* 25(12): 4924–4933.

Brown, J. R., R. L. Levine, C. Thompson, et al.

2008 Systematic Genomic Screen for Tyrosine Kinase Mutations in CLL. *Leukemia* 22(10): 1966–1969.

Bryceson, Yenan T., Michael E. March, Hans-Gustaf Ljunggren, and Eric O. Long
2006 Activation, Coactivation, and Costimulation of Resting Human Natural Killer Cells. *Immunological Reviews* 214: 73–91.

Buggins, Andrea G. S., Ana Levi, Satyen Gohil, et al.
2011 Evidence for a Macromolecular Complex in Poor Prognosis CLL That Contains CD38, CD49d, CD44 and MMP-9: A Complex in CLL That Contains CD38, CD49d, CD44 and MMP-9. *British Journal of Haematology* 154(2): 216–222.

Burger, Jan A.
2011 Nurture versus Nature: The Microenvironment in Chronic Lymphocytic Leukemia. *ASH Education Program Book 2011*(1): 96–103.

Burger, Jan A., Nobuhiro Tsukada, Meike Burger, et al.
2000 Blood-Derived Nurse-like Cells Protect Chronic Lymphocytic Leukemia B Cells from Spontaneous Apoptosis through Stromal Cell-derived Factor-1. *Blood* 96(8): 2655–2663.

Calin, G. A., M. Ferracin, A. Cimmino, et al.
2005 A MicroRNA Signature Associated with Prognosis and Progression in Chronic Lymphocytic Leukemia. *New England Journal of Medicine* 353(17): 1793–1801.

Calin, George Adrian, Calin Dan Dumitru, Masayoshi Shimizu, et al.
2002 Frequent Deletions and down-Regulation of Micro-RNA Genes miR15 and miR16 at 13q14 in Chronic Lymphocytic Leukemia. *Proceedings of the National Academy of Sciences* 99(24): 15524–15529.

Calissano, Carlo, Rajendra N. Damle, Gregory Hayes, et al.
2009 In Vivo Intraclonal and Interclonal Kinetic Heterogeneity in B-Cell Chronic Lymphocytic Leukemia. *Blood* 114(23): 4832–4842.

Calpe, E., C. Codony, M. J. Baptista, et al.
2011 ZAP-70 Enhances Migration of Malignant B Lymphocytes toward CCL21 by Inducing CCR7 Expression via IgM-ERK1/2 Activation. *Blood* 118(16): 4401–4410.

Campo, E., S. H. Swerdlow, N. L. Harris, et al.
2011 The 2008 WHO Classification of Lymphoid Neoplasms and beyond: Evolving Concepts and Practical Applications. *Blood* 117(19): 5019–5032.

Carreras, Joaquim, Neus Villamor, Lluís Colomo, et al.
2005 Immunohistochemical Analysis of ZAP-70 Expression in B-Cell Lymphoid Neoplasms. *The Journal of Pathology* 205(4): 507–513.

Castro, J. E.

2005 ZAP-70 Is a Novel Conditional Heat Shock Protein 90 (Hsp90) Client: Inhibition of Hsp90 Leads to ZAP-70 Degradation, Apoptosis, and Impaired Signaling in Chronic Lymphocytic Leukemia. *Blood* 106(7): 2506–2512.

Catera, Rosa, Gregg J. Silverman, Katerina Hatzi, et al.

2008 Chronic Lymphocytic Leukemia Cells Recognize Conserved Epitopes Associated with Apoptosis and Oxidation. *Molecular Medicine* 14(11-12): 665.

Catherwood, Mark A., Christine Matthews, Roberta Niblock, et al.

2006 ZAP-70 mRNA Quantification in B-Cell Chronic Lymphocytic Leukaemia. *European Journal of Haematology* 76(4): 294–298.

Celano, M. J., and P. Levine

1967 Anti-LW Specificity in Autoimmune Acquired Hemolytic Anemia. *Transfusion* 7(4): 265–268.

Chan, A. C., M. Dalton, R. Johnson, et al.

1995 Activation of ZAP-70 Kinase Activity by Phosphorylation of Tyrosine 493 Is Required for Lymphocyte Antigen Receptor Function. *The EMBO Journal* 14(11): 2499.

Chan, A. C., M. Iwashima, C. W. Turck, and A. Weiss

1992 ZAP-70: A 70 Kd Protein-Tyrosine Kinase That Associates with the TCR Zeta Chain. *Cell* 71(4): 649–662.

Chantepie, Sylvain P, Dominique Vaur, Christoph Grunau, et al.

2010 ZAP-70 intron1 DNA Methylation Status: Determination by Pyrosequencing in B Chronic Lymphocytic Leukemia. *Leukemia Research* 34(6): 800–808.

Chaplin, H., R. Cohen, G. Bloomberg, et al.

1973 Pregnancy and Idiopathic Autoimmune Haemolytic Anaemia: A Prospective Study during 6 Months Gestation and 3 Months Post-Partum. *British Journal of Haematology* 24(2): 219–229.

Chen, C. I., P. L. Bergsagel, H. Paul, et al.

2011 Single-Agent Lenalidomide in the Treatment of Previously Untreated Chronic Lymphocytic Leukemia. *Journal of Clinical Oncology* 29(9): 1175–1181.

Cheng, Alec M., Izumi Negishi, Steven J. Anderson, et al.

1997 The Syk and ZAP-70 SH2-Containing Tyrosine Kinases Are Implicated in Pre-T Cell Receptor Signaling. *Proceedings of the National Academy of Sciences* 94(18): 9797–9801.

Chen, Jian-fang, Lin-hua Yang, Li-xian Chang, Jian-jun Feng, and Jun-qing Liu
2012 The Clinical Significance of Circulating B Cells Secreting Anti-Glycoprotein IIb/IIIa Antibody and Platelet Glycoprotein IIb/IIIa in Patients with Primary Immune Thrombocytopenia. *Hematology (Amsterdam, Netherlands)* 17(5): 283–290.

Chen, L.

2002a Expression of ZAP-70 Is Associated with Increased B-Cell Receptor Signaling in Chronic Lymphocytic Leukemia. *Blood* 100(13): 4609–4614.

2002b Expression of ZAP-70 Is Associated with Increased B-Cell Receptor Signaling in Chronic Lymphocytic Leukemia. *Blood* 100(13): 4609–4614.

2005 ZAP-70 Directly Enhances IgM Signaling in Chronic Lymphocytic Leukemia. *Blood* 105(5): 2036–2041.

Chen, L., L. Huynh, J. Apgar, et al.

2008 ZAP-70 Enhances IgM Signaling Independent of Its Kinase Activity in Chronic Lymphocytic Leukemia. *Blood* 111(5): 2685–2692.

Chen, Liguang, Lang Huynh, John Apgar, et al.

2008 ZAP-70 Enhances IgM Signaling Independent of Its Kinase Activity in Chronic Lymphocytic Leukemia. *Blood* 111(5): 2685–2692.

Chiaretti, Sabina, Anna Guarini, Maria Stefania De Propriis, et al.

2006 ZAP-70 Expression in Acute Lymphoblastic Leukemia: Association with the E2A/PBX1 Rearrangement and the Pre-B Stage of Differentiation and Prognostic Implications. *Blood* 107(1): 197–204.

Chiorazzi, N., and M. Ferrarini

2010 Cellular Origin(s) of Chronic Lymphocytic Leukemia: Cautionary Notes and Additional Considerations and Possibilities. *Blood* 117(6): 1781–1791.

Chu, Charles C., Rosa Cattera, Katerina Hatzi, et al.

2008 Chronic Lymphocytic Leukemia Antibodies with a Common Stereotypic Rearrangement Recognize Nonmuscle Myosin Heavy Chain IIA. *Blood* 112(13): 5122–5129.

Citores, Maria Jesus, Raquel Castejon, Mercedes Villarreal, et al.

2010 CD154 Expression Triggered by Purine Analogues in Vitro: Correlation with Treatment Response and Autoimmune Events in Chronic Lymphocytic Leukemia. *Experimental Hematology* 38(3): 165–173.

Claus, R., D. M. Lucas, A. S. Ruppert, et al.
2014 Validation of ZAP-70 Methylation and Its Relative Significance in Predicting Outcome in Chronic Lymphocytic Leukemia. *Blood* 124(1): 42–48.

Claus, R., D. M. Lucas, S. Stilgenbauer, et al.
2012 Quantitative DNA Methylation Analysis Identifies a Single CpG Dinucleotide Important for ZAP-70 Expression and Predictive of Prognosis in Chronic Lymphocytic Leukemia. *Journal of Clinical Oncology* 30(20): 2483–2491.

Coller, Barry S., and Sanford J. Shattil
2008 The GPIIb/IIIa (integrin α IIb β 3) Odyssey: A Technology-Driven Saga of a Receptor with Twists, Turns, and Even a Bend. *Blood* 112(8): 3011–3025.

Colucci, Francesco, Edina Schweighoffer, Elena Tomasello, et al.
2002 Natural Cytotoxicity Uncoupled from the Syk and ZAP-70 Intracellular Kinases. *Nature Immunology* 3(3): 288–294.

Colucci, F., M. Turner, E. Schweighoffer, et al.
1999 Redundant Role of the Syk Protein Tyrosine Kinase in Mouse NK Cell Differentiation. *Journal of Immunology* (Baltimore, Md.: 1950) 163(4): 1769–1774.

Corbett, S. J., I. M. Tomlinson, E. L. Sonnhammer, D. Buck, and G. Winter
1997 Sequence of the Human Immunoglobulin Diversity (D) Segment Locus: A Systematic Analysis Provides No Evidence for the Use of DIR Segments, Inverted D Segments, “Minor” D Segments or D-D Recombination. *Journal of Molecular Biology* 270(4): 587–597.

Corcoran, Martin, Anton Parker, Jenny Orchard, et al.
2005 ZAP-70 Methylation Status Is Associated with ZAP-70 Expression Status in Chronic Lymphocytic Leukemia. *Haematologica* 90(8): 1078–1088.

Crespo, Marta, Francesc Bosch, Neus Villamor, et al.
2003 ZAP-70 Expression as a Surrogate for Immunoglobulin-Variable-Region Mutations in Chronic Lymphocytic Leukemia. *The New England Journal of Medicine* 348(18): 1764–1775.

Crespo, Marta, Neus Villamor, Eva Giné, et al.
2006 ZAP-70 Expression in Normal Pro/pre B Cells, Mature B Cells, and in B-Cell Acute Lymphoblastic Leukemia. *Clinical Cancer Research* 12(3): 726–734.

Curtis, B R, and J G McFarland
2009 Detection and Identification of Platelet Antibodies and Antigens in the Clinical Laboratory. *Immunohematology / American Red Cross* 25(3): 125–135.

Curtis, B. R., and J. G. McFarland
2014 Human Platelet Antigens - 2013. *Vox Sanguinis* 106(2): 93–102.

Cutrona, Giovanna, Monica Colombo, Serena Matis, et al.
2006 B Lymphocytes in Humans Express ZAP-70 When Activated in Vivo. *European Journal of Immunology* 36(3): 558–569.

Damle, Rajendra N., Fabio Ghiotto, Angelo Valetto, et al.
2002 B-Cell Chronic Lymphocytic Leukemia Cells Express a Surface Membrane Phenotype of Activated, Antigen-Experienced B Lymphocytes Presented in Part at the 42nd Annual Meeting of the American Society of Hematology, December 1-5, 2000, San Francisco, CA. *Blood* 99(11): 4087–4093.

Damle, Rajendra N., Tarun Wasil, Franco Fais, et al.
1999 Ig V Gene Mutation Status and CD38 Expression as Novel Prognostic Indicators in Chronic Lymphocytic Leukemia. *Blood* 94(6): 1840–1847.

Damle, R. N., S. Temburni, C. Calissano, et al.
2007 CD38 Expression Labels an Activated Subset within Chronic Lymphocytic Leukemia Clones Enriched in Proliferating B Cells. *Blood* 110(9): 3352–3359.

Davantage, S., J. Leignadier, P. Milani, et al.
2005 Selective Defect in Antigen-Induced TCR Internalization at the Immune Synapse of CD8 T Cells Bearing the ZAP-70(Y292F) Mutation. *The Journal of Immunology* 175(5): 3140–3149.

Deaglio, Silvia, Tiziana Vaisitti, Luciana Bergui, et al.
2005 CD38 and CD100 Lead a Network of Surface Receptors Relaying Positive Signals for B-CLL Growth and Survival. *Blood* 105(8): 3042–3050.

Deaglio, S., T. Vaisitti, S. Aydin, et al.
2007 CD38 and ZAP-70 Are Functionally Linked and Mark CLL Cells with High Migratory Potential. *Blood* 110(12): 4012–4021.

Dean, Laura
2005 The Rh Blood Group. <http://www.ncbi.nlm.nih.gov/books/NBK2269/>, accessed May 20, 2014.

Dearden, C., R. Wade, M. Else, et al.
2008 The Prognostic Significance of a Positive Direct Antiglobulin Test in Chronic Lymphocytic Leukemia: A Beneficial Effect of the Combination of Fludarabine and Cyclophosphamide on the Incidence of Hemolytic Anemia. *Blood* 111(4): 1820–1826.

Deindl, Sebastian, Theresa A. Kadlecik, Xiaoxian Cao, John Kuriyan, and Arthur Weiss
2009 Stability of an Autoinhibitory Interface in the Structure of the Tyrosine Kinase ZAP-70 Impacts T Cell Receptor Response. *Proceedings of the National Academy of Sciences of the United States of America* 106(49): 20699–20704.

Dicker, F., S. Schnittger, T. Haferlach, W. Kern, and C. Schoch
2006 Immunostimulatory Oligonucleotide-Induced Metaphase Cytogenetics Detect Chromosomal Aberrations in 80% of CLL Patients: A Study of 132 CLL Cases with Correlation to FISH, IgVH Status, and CD38 Expression. *Blood* 108(9): 3152–3160.

van Dijk-Hård, Iris, Sari Feld, Dan Holmberg, and Inger Lundkvist
1999 Increased Utilization of the VH6 Gene Family in Patients with Autoimmune Idiopathic Thrombocytopenic Purpura. *Journal of Autoimmunity* 12(1): 57–63.

Döhner, Hartmut, Stephan Stilgenbauer, Michael R. James, et al.
1997 11q Deletions Identify a New Subset of B-Cell Chronic Lymphocytic Leukemia Characterized by Extensive Nodal Involvement and Inferior Prognosis. *Blood* 89(7): 2516–2522.

Döhner, H., S. Stilgenbauer, A. Benner, et al.
2000 Genomic Aberrations and Survival in Chronic Lymphocytic Leukemia. *New England Journal of Medicine* 343(26): 1910–1916.

Dores, Graça M., William F. Anderson, Rochelle E. Curtis, et al.
2007 Chronic Lymphocytic Leukaemia and Small Lymphocytic Lymphoma: Overview of the Descriptive Epidemiology. *British Journal of Haematology* 139(5): 809–819.

Doyle, Hester A., and Mark J. Mamula
2005 Posttranslational Modifications of Self-Antigens. *Annals of the New York Academy of Sciences* 1050(1): 1–9.

Duek, Adrian, Lev Shvidel, Andre Braester, and Alain Berrebi
2006 Clinical and Immunologic Aspects of B Chronic Lymphocytic Leukemia Associated with Autoimmune Disorders. *Women* 561(403): 403.

Dürig, J, H Nüchel, M Cremer, et al.
2003 ZAP-70 Expression Is a Prognostic Factor in Chronic Lymphocytic Leukemia. *Leukemia* 17(12): 2426–2434.

Efremov, Dimitar G., M. Ivanovski, N. Siljanovski, et al.
1996 Restricted Immunoglobulin VH Region Repertoire in Chronic Lymphocytic Leukemia Patients with Autoimmune Hemolytic Anemia. *Blood* 87(9): 3869–3876.

Eichhorst, Barbara F., Raymonde Busch, Georg Hopfinger, et al.
2006 Fludarabine plus Cyclophosphamide versus Fludarabine Alone in First-Line Therapy of Younger Patients with Chronic Lymphocytic Leukemia. *Blood* 107(3): 885–891.

Ekland, E. H., R. Forster, M. Lipp, and J. G. Cyster
2004 Requirements for Follicular Exclusion and Competitive Elimination of Autoantigen-Binding B Cells. *The Journal of Immunology* 172(8): 4700–4708.

Elder, M. E., D. Lin, J. Clever, et al.
1994 Human Severe Combined Immunodeficiency due to a Defect in ZAP-70, a T Cell Tyrosine Kinase. *Science (New York, N.Y.)* 264(5165): 1596–1599.

Fabbri, G., S. Rasi, D. Rossi, et al.
2011 Analysis of the Chronic Lymphocytic Leukemia Coding Genome: Role of NOTCH1 Mutational Activation. *The Journal of Experimental Medicine* 208(7): 1389–1401.

Fais, F, F Ghiotto, S Hashimoto, et al.
1998 Chronic Lymphocytic Leukemia B Cells Express Restricted Sets of Mutated and Unmutated Antigen Receptors. *Journal of Clinical Investigation* 102(8): 1515–1525.

Fallah-Arani, Farnaz, Edina Schweighoffer, Lesley Vanes, and Victor L. J. Tybulewicz
2008 Redundant Role for Zap70 in B Cell Development and Activation. *European Journal of Immunology* 38(6): 1721–1733.

Ferrajoli, A., B.-N. Lee, E. J. Schlette, et al.
2008 Lenalidomide Induces Complete and Partial Remissions in Patients with Relapsed and Refractory Chronic Lymphocytic Leukemia. *Blood* 111(11): 5291–5297.

Ferrer, Gerardo, Kate Hodgson, Emili Montserrat, and Carol Moreno
2009 B Cell Activator Factor and a Proliferation-Inducing Ligand at the Cross-Road of Chronic Lymphocytic Leukemia and Autoimmunity. *Leukemia & Lymphoma* 50(7): 1075–1082.

- Ferrer, Gerardo, Alfons Navarro, Kate Hodgson, et al.
2013 MicroRNA Expression in Chronic Lymphocytic Leukemia Developing Autoimmune Hemolytic Anemia. *Leukemia & Lymphoma* 54(9): 2016–2022.
- Fischer, Alain, Capucine Picard, Karine Chemin, et al.
2010 ZAP70: A Master Regulator of Adaptive Immunity. *Seminars in Immunopathology* 32(2): 107–116.
- Flegel, Willy A.
2011 Molecular Genetics and Clinical Applications for RH. *Transfusion and Apheresis Science* 44(1): 81–91.
- Flinn, I. W., D. S. Neuberg, M. R. Grever, et al.
2007 Phase III Trial of Fludarabine Plus Cyclophosphamide Compared With Fludarabine for Patients With Previously Untreated Chronic Lymphocytic Leukemia: US Intergroup Trial E2997. *Journal of Clinical Oncology* 25(7): 793–798.
- Förster, I., H. Gu, and K. Rajewsky
1988 Germline Antibody V Regions as Determinants of Clonal Persistence and Malignant Growth in the B Cell Compartment. *The EMBO Journal* 7(12): 3693.
- Fujisawa, K., P. Tani, and R. McMillan
1993 Platelet-Associated Antibody to Glycoprotein IIb/IIIa from Chronic Immune Thrombocytopenic Purpura Patients Often Binds to Divalent Cation-Dependent Antigens. *Blood* 81(5): 1284–1289.
- Galletti, Jeremías, Cristian Cañones, Pablo Morande, et al.
2008 Chronic Lymphocytic Leukemia Cells Bind and Present the Erythrocyte Protein Band 3: Possible Role as Initiators of Autoimmune Hemolytic Anemia. *The Journal of Immunology* 181(5): 3674–3683.
- García-Muñoz, Ricardo, Verónica Roldan Galiacho, and Luis Llorente
2012 Immunological Aspects in Chronic Lymphocytic Leukemia (CLL) Development. *Annals of Hematology* 91(7): 981–996.
- García-Muñoz, Ricardo, and Luis Llorente
2014 Chronic Lymphocytic Leukaemia: Could Immunological Tolerance Mechanisms Be the Origin of Lymphoid Neoplasms? *Immunology* 142(4): 536–550.
- Gary-Gouy, H.
2002 Human CD5 Promotes B-Cell Survival through Stimulation of Autocrine IL-10 Production. *Blood* 100(13): 4537–4543.

Gary-Gouy, H  l  ne, Pierre Bruhns, Christian Schmitt, et al.
2000 The Pseudo-Immunoreceptor Tyrosine-Based Activation Motif of CD5 Mediates Its Inhibitory Action on B-Cell Receptor Signaling. *Journal of Biological Chemistry* 275(1): 548–556.

Gary-Gouy, H., J. Harriague, A. Dalloul, E. Donnadieu, and G. Bismuth
2002 CD5-Negative Regulation of B Cell Receptor Signaling Pathways Originates from Tyrosine Residue Y429 Outside an Immunoreceptor Tyrosine-Based Inhibitory Motif. *The Journal of Immunology* 168(1): 232–239.

Ghergus, D, and B Dr  nou
2013 An  mie H  molytique Auto-Immune Induite Par La Bendamustine Dans Deux Cas de Leuc  mie Lymphoide Chronique. *H  matologie, SFH* 19(2): 92–93.

Ghia, P.
2005 Geographic Patterns and Pathogenetic Implications of IGHV Gene Usage in Chronic Lymphocytic Leukemia: The Lesson of the IGHV3-21 Gene. *Blood* 105(4): 1678–1685.

Ghia, P, K Stamatopoulos, C Belessi, et al.
2007 ERIC Recommendations on IGHV Gene Mutational Status Analysis in Chronic Lymphocytic Leukemia. *Leukemia* 21(1): 1–3.

Ghielmini, M., U. Vitolo, E. Kimby, et al.
2013 ESMO Guidelines Consensus Conference on Malignant Lymphoma 2011 Part 1: Diffuse Large B-Cell Lymphoma (DLBCL), Follicular Lymphoma (FL) and Chronic Lymphocytic Leukemia (CLL). *Annals of Oncology* 24(3): 561–576.

Ghobrial, Irene M., Nancy D. Bone, Mary J. Stenson, et al.
2004 Expression of the Chemokine Receptors CXCR4 and CCR7 and Disease Progression in B-Cell Chronic Lymphocytic Leukemia/ Small Lymphocytic Lymphoma. *Mayo Clinic Proceedings* 79(3): 318–325.

Gobessi, S., L. Laurenti, P. G. Longo, et al.
2007 ZAP-70 Enhances B-Cell-Receptor Signaling despite Absent or Inefficient Tyrosine Kinase Activation in Chronic Lymphocytic Leukemia and Lymphoma B Cells. *Blood* 109(5): 2032–2039.

Goda, S., A. C. Quale, M. L. Woods, A. Felthausen, and Y. Shimizu
2004 Control of TCR-Mediated Activation of α 1 Integrins by the ZAP-70 Tyrosine Kinase Interdomain B Region and the Linker for Activation of T Cells Adapter Protein. *The Journal of Immunology* 172(9): 5379–5387.

Goldin, Lynn R., Mark C. Lanasa, Susan L. Slager, et al.
2010 Common Occurrence of Monoclonal B-Cell Lymphocytosis among Members of High-Risk CLL Families: MBL among Members of High Risk CLL Families. *British Journal of Haematology* 151(2): 152–158.

Gonzalez, H., V. Leblond, N. Azar, et al.
1998 Severe Autoimmune Hemolytic Anemia in Eight Patients Treated with Fludarabine. *Hematology and Cell Therapy* 40(3): 113–118.

Griffin, D. O., N. E. Holodick, and T. L. Rothstein
2011 Human B1 Cells in Umbilical Cord and Adult Peripheral Blood Express the Novel Phenotype CD20+ CD27+ CD43+ CD70-. *The Journal of Experimental Medicine* 208(1): 67–80.

Gruber, Michaela, and Catherine J. Wu
2014 Evolving Understanding of the CLL Genome. *Seminars in Hematology* 51(3): 177–187.

Hadzidimitriou, A., N. Darzentas, F. Murray, et al.
2008 Evidence for the Significant Role of Immunoglobulin Light Chains in Antigen Recognition and Selection in Chronic Lymphocytic Leukemia. *Blood* 113(2): 403–411.

Hahn, Christopher N., and Hamish S. Scott
2012 Spliceosome Mutations in Hematopoietic Malignancies. *Nature Genetics* 44(1): 9–10.

Hall, A. M.
2005 Rh Autoantigen Presentation to Helper T Cells in Chronic Lymphocytic Leukemia by Malignant B Cells. *Blood* 105(5): 2007–2015.

Hallek, M.
2013 Signaling the End of Chronic Lymphocytic Leukemia: New Frontline Treatment Strategies. *Blood* 122(23): 3723–3734.

Hallek, M., B. D. Cheson, D. Catovsky, et al.
2008 Guidelines for the Diagnosis and Treatment of Chronic Lymphocytic Leukemia: A Report from the International Workshop on Chronic Lymphocytic Leukemia Updating the National Cancer Institute-Working Group 1996 Guidelines. *Blood* 111(12): 5446–5456.

- Hamblin, Terry J.
2006 Autoimmune Complications of Chronic Lymphocytic Leukemia. *Seminars in Oncology* 33(2): 230–239.
- Hamblin, Terry J., Zadie A. Davis, and David G. Oscier
2008 Determination of How Many Immunoglobulin Variable Region Heavy Chain Mutations Are Allowable in Unmutated Chronic Lymphocytic Leukaemia – Long-Term Follow up of Patients with Different Percentages of Mutations. *British Journal of Haematology* 140(3): 320–323.
- Hamblin, Terry J., Zadie Davis, Anne Gardiner, David G. Oscier, and Freda K. Stevenson
1999 Unmutated Ig VH Genes Are Associated with a More Aggressive Form of Chronic Lymphocytic Leukemia. *Blood* 94(6): 1848–1854.
- Hamblin, T. J., D. G. Oscier, and B. J. Young
1986 Autoimmunity in Chronic Lymphocytic Leukaemia. *Journal of Clinical Pathology* 39(7): 713–716.
- Hanada, Motoi, Domenico Delia, Antonella Aiello, Edward Stadtmauer, and John C. Reed
1993 Bcl-2 Gene Hypomethylation and High-Level Expression in B-Cell Chronic Lymphocytic Leukemia. *Blood* 82(6): 1820–1828.
- Harrington, W. J., V. Minnich, J. W. Hollingsworth, and C. V. Moore
1951 Demonstration of a Thrombocytopenic Factor in the Blood of Patients with Thrombocytopenic Purpura. *The Journal of Laboratory and Clinical Medicine* 38(1): 1–10.
- Herishanu, Y, S Kay, O Rogowski, et al.
2005 T-Cell ZAP-70 Overexpression in Chronic Lymphocytic Leukemia (CLL) Correlates with CLL Cell ZAP-70 Levels, Clinical Stage and Disease Progression. *Leukemia* 19(7): 1289–1291.
- Herman, Sarah EM, Rashida Z. Mustafa, Jennifer A. Gyamfi, et al.
2014 Ibrutinib Inhibits B-Cell Receptor and NF- κ B Signaling and Reduces Tumor Proliferation in Tissue-Resident Cells of Patients with Chronic Lymphocytic Leukemia. *Blood*: blood–2014.
- Herman, S. E. M., A. L. Gordon, A. J. Wagner, et al.
2010 Phosphatidylinositol 3-Kinase- Inhibitor CAL-101 Shows Promising Preclinical Activity in Chronic Lymphocytic Leukemia by Antagonizing Intrinsic and Extrinsic Cellular Survival Signals. *Blood* 116(12): 2078–2088.

He, R., D. M. Reid, C. E. Jones, and N. R. Shulman
1995 Extracellular Epitopes of Platelet Glycoprotein Ib Alpha Reactive with. *Blood* 86(10): 3789–3796.

Hervé, M., K. Xu, Y. S. Ng, et al.
2005 Unmutated and Mutated Chronic Lymphocytic Leukemias Derive from Self-Reactive B Cell Precursors despite Expressing Different Antibody Reactivity. *J Clin Invest* 115(6): 1636–43.

He, Yang, Yun-xiao Zhao, Ming-qing Zhu, Qingyu Wu, and Chang-geng Ruan
2013 Detection of Autoantibodies against Platelet Glycoproteins in Patients with Immune Thrombocytopenic Purpura by Flow Cytometric Immunobead Array. *Clinica Chimica Acta* 415: 176–180.

Hippen, K. L., L. E. Tze, and T. W. Behrens
2000 CD5 Maintains Tolerance in Anergic B Cells. *The Journal of Experimental Medicine* 191(5): 883–890.

Hodgson, K., G. Ferrer, E. Montserrat, and C. Moreno
2011 Chronic Lymphocytic Leukemia and Autoimmunity: A Systematic Review. *Haematologica* 96(5): 752–761.

Hoffman, Ronald
2013 *Hematology Basic Principles and Practice*. Philadelphia, PA: Saunders/Elsevier.
<http://www.clinicalkey.com/dura/browse/bookChapter/3-s2.0-C20100668751>,
accessed November 20, 2014.

Hoogeboom, R., K. P. M. van Kessel, F. Hochstenbach, et al.
2013 A Mutated B Cell Chronic Lymphocytic Leukemia Subset That Recognizes and Responds to Fungi. *Journal of Experimental Medicine* 210(1): 59–70.

Hoogeboom, R, T A Wormhoudt, M R Schipperus, et al.
2012 A Novel Chronic Lymphocytic Leukemia Subset Expressing Mutated IGHV3-7-Encoded Rheumatoid Factor B-Cell Receptors That Are Functionally Proficient. *Leukemia* 27(3): 738–740.

Hus, I.
2006 The Clinical Significance of ZAP-70 and CD38 Expression in B-Cell Chronic Lymphocytic Leukaemia. *Annals of Oncology* 17(4): 683–690.

Inaoki, Makoto, Shinichi Sato, Bennett C. Weintraub, Christopher C. Goodnow, and Thomas F. Tedder

1997 CD19-Regulated Signaling Thresholds Control Peripheral Tolerance and Autoantibody Production in B Lymphocytes. *The Journal of Experimental Medicine* 186(11): 1923–1931.

Issitt, P. D., B. G. Pavone, D. Goldfinger, et al.

1976 Anti-Wrb, and Other Autoantibodies Responsible for Positive Direct Antiglobulin Tests in 150 Individuals. *British Journal of Haematology* 34(1): 5–17.

Ito, Taichi, Shoichiro Taniuchi, Shoji Tsuji, et al.

2011 Diagnosis of Autoimmune Neutropenia by Neutrophil-Bound IgG and IgM Antibodies. *Journal of Pediatric Hematology/oncology* 33(7): 552–555.

Jak, Margot, Rogier Mous, Ester B. M. Remmerswaal, et al.

2009 Enhanced Formation and Survival of CD4+ CD25hi Foxp3+ T-Cells in Chronic Lymphocytic Leukemia. *Leukemia & Lymphoma* 50(5): 788–801.

Januchowski, Radosław, Mariusz Wudarski, Hanna Chwalińska-Sadowska, and Paweł P. Jagodzinski

2007 Prevalence of ZAP-70, LAT, SLP-76, and DNA Methyltransferase 1 Expression in CD4+ T Cells of Patients with Systemic Lupus Erythematosus. *Clinical Rheumatology* 27(1): 21–27.

Jun, Jesse E, and Christopher C Goodnow

2003 Scaffolding of Antigen Receptors for Immunogenic versus Tolerogenic Signaling. *Nature Immunology* 4(11): 1057–1064.

Kamesaki, Toyomi, Tomonori Toyotsuji, and Eiji Kajii

2013 Characterization of Direct Antiglobulin Test-Negative Autoimmune Hemolytic Anemia: A Study of 154 Cases. *American Journal of Hematology* 88(2): 93–96.

Kanduri, M., N. Cahill, H. Goransson, et al.

2010 Differential Genome-Wide Array-Based Methylation Profiles in Prognostic Subsets of Chronic Lymphocytic Leukemia. *Blood* 115(2): 296–305.

Kaufman, Matthew, and Kanti Rai

2010 The Challenge of Treating Complex Autoimmune Cytopenias in Chronic Lymphocytic Leukemia. *Leukemia & Lymphoma* 51(4): 574–575.

Kikushige, Yoshikane, Fumihiko Ishikawa, Toshihiro Miyamoto, et al.
2011 Self-Renewing Hematopoietic Stem Cell Is the Primary Target in Pathogenesis of Human Chronic Lymphocytic Leukemia. *Cancer Cell* 20(2): 246–259.

Van Kim, Caroline Le, Yves Colin, and Jean-Pierre Cartron
2006 Rh Proteins: Key Structural and Functional Components of the Red Cell Membrane. *Blood Reviews* 20(2): 93–110.

Kipps, T. J., and D. A. Carson
1993 Autoantibodies in Chronic Lymphocytic Leukemia and Related Systemic Autoimmune Diseases. *Blood* 81(10): 2475–2487.

Klein, Ulf, Marie Lia, Marta Crespo, et al.
2010 The DLEU2/miR-15a/16-1 Cluster Controls B Cell Proliferation and Its Deletion Leads to Chronic Lymphocytic Leukemia. *Cancer Cell* 17(1): 28–40.

Klein, U., Y. Tu, G. A. Stolovitzky, et al.
2001 Gene Expression Profiling of B Cell Chronic Lymphocytic Leukemia Reveals a Homogeneous Phenotype Related to Memory B Cells. *The Journal of Experimental Medicine* 194(11): 1625–1638.

Kobayashi, R., G. Picchio, M. Kirven, et al.
1992 Transfer of Human Chronic Lymphocytic Leukemia to Mice with Severe Combined Immune Deficiency. *Leukemia Research* 16(10): 1013–1023.

Köhler, Fabian, Eva Hug, Cathrin Eschbach, et al.
2008 Autoreactive B Cell Receptors Mimic Autonomous Pre-B Cell Receptor Signaling and Induce Proliferation of Early B Cells. *Immunity* 29(6): 912–921.

Kong, G. H., J. Y. Bu, T. Kurosaki, A. S. Shaw, and A. C. Chan
1995 Reconstitution of Syk Function by the ZAP-70 Protein Tyrosine Kinase. *Immunity* 2(5): 485–492.

Königsberger, Sebastian, Jan Prodöhl, David Stegner, et al.
2012 Altered BCR Signalling Quality Predisposes to Autoimmune Disease and a Pre-Diabetic State. *The EMBO Journal* 31(15): 3363–3374.

Kostareli, E., M. Gounari, A. Janus, et al.
2012 Antigen Receptor Stereotypy across B-Cell Lymphoproliferations: The Case of IGHV4-59/IGKV3-20 Receptors with Rheumatoid Factor Activity. *Leukemia* 26(5): 1127–1131.

Kovacs, G, B Eichhorst, and M Hallek

2014 Value of Minimal Residual Disease (MRD) Negative Status at Response Evaluation in Chronic Lymphocytic Leukemia : Combined Analysis of Two Phase III Studies of the German CLL Study Group (GCLLSG). Paper presented at the ASH, San Francisco, December 6.

<https://ash.confex.com/ash/2014/webprogram/Paper69949.html>, accessed March 1, 2015.

Krober, A.

2006 Additional Genetic High-Risk Features Such As 11q Deletion, 17p Deletion, and V3-21 Usage Characterize Discordance of ZAP-70 and VH Mutation Status in Chronic Lymphocytic Leukemia. *Journal of Clinical Oncology* 24(6): 969–975.

Kulis, Marta, Simon Heath, Marina Bibikova, et al.

2012 Epigenomic Analysis Detects Widespread Gene-Body DNA Hypomethylation in Chronic Lymphocytic Leukemia. *Nature Genetics* 44(11): 1236–1242.

Kuroyama, Hiroyuki, Tohru Ikeda, Michiyuki Kasai, et al.

2004 Identification of a Novel Isoform of ZAP-70, Truncated ZAP Kinase. *Biochemical and Biophysical Research Communications* 315(4): 935–941.

Kuwana, Masataka

2009 Autoantibodies to Platelets: Roles in Thrombocytopenia. *Inflammation and Regeneration* 29(1): 40–46.

Kuwana, Masataka, Yuka Okazaki, Mikio Kajihara, et al.

2002 Autoantibody to c-Mpl (thrombopoietin Receptor) in Systemic Lupus Erythematosus: Relationship to Thrombocytopenia with Megakaryocytic Hypoplasia. *Arthritis & Rheumatism* 46(8): 2148–2159.

Kyasa, Mouhammed J., Rudolph S. Parrish, Steven A. Schichman, and Clive S. Zent

2003 Autoimmune Cytopenia Does Not Predict Poor Prognosis in Chronic Lymphocytic Leukemia/small Lymphocytic Lymphoma. *American Journal of Hematology* 74(1): 1–8.

Lanasa, Mark C.

2010 Novel Insights into the Biology of CLL. *ASH Education Program Book* 2010(1): 70–76.

Landgren, O., E. A. Engels, N. E. Caporaso, et al.

2006 Patterns of Autoimmunity and Subsequent Chronic Lymphocytic Leukemia in Nordic Countries. *Blood* 108(1): 292–296.

Landgren, Ola, Maher Albitar, Wanlong Ma, et al.
2009 B-Cell Clones as Early Markers for Chronic Lymphocytic Leukemia. *New England Journal of Medicine* 360(7): 659–667.

Langerak, A. W., F. Davi, P. Ghia, et al.
2011 Immunoglobulin Sequence Analysis and Prognostication in CLL: Guidelines from the ERIC Review Board for Reliable Interpretation of Problematic Cases. *Leukemia* 25(6): 979–984.

Lanham, Stuart, Terry Hamblin, David Oscier, et al.
2003 Differential Signaling via Surface IgM Is Associated with VH Gene Mutational Status and CD38 Expression in Chronic Lymphocytic Leukemia. *Blood* 101(3): 1087–1093.

Latour, Sylvain, Lionel ML Chow, and André Veillette
1996 Differential Intrinsic Enzymatic Activity of Syk and Zap-70 Protein-Tyrosine Kinases. *Journal of Biological Chemistry* 271(37): 22782–22790.

Laurenti, Luca, Aleksandar Petlickovski, Carlo Rumi, et al.
2005 Comparison of ZAP-70/Syk mRNA Levels with Immunoglobulin Heavy-Chain Gene Mutation Status and Disease Progression in Chronic Lymphocytic Leukemia. *Haematologica* 90(11): 1533–1540.

Lavin, Martin F.
2008 Ataxia-Telangiectasia: From a Rare Disorder to a Paradigm for Cell Signalling and Cancer. *Nature Reviews Molecular Cell Biology* 9(10): 759–769.

Leach, M., R. M. Parsons, J. T. Reilly, and D. A. Winfield
2000 Autoimmune Thrombocytopenia: A Complication of Fludarabine Therapy in Lymphoproliferative Disorders. *Clinical & Laboratory Haematology* 22(3): 175–178.

Leddy, J. P., J. L. Falany, G. E. Kissel, S. T. Passador, and S. I. Rosenfeld
1993 Erythrocyte Membrane Proteins Reactive with Human (warm-Reacting) Anti-Red Cell Autoantibodies. *Journal of Clinical Investigation* 91(4): 1672.

Van Leeuwen, E. F., J. T. Van Der Ven, C. P. Engelfriet, and A. E. Von Dem Borne
1982 Specificity of Autoantibodies in Autoimmune Thrombocytopenia. *Blood* 59(1): 23–26.

Lepretre, Stephane, Therese Aurrant, Beatrice Mahé, et al.
2012 Excess Mortality after Treatment with Fludarabine and Cyclophosphamide in

Combination with Alemtuzumab in Previously Untreated Patients with Chronic Lymphocytic Leukemia in a Randomized Phase 3 Trial. *Blood* 119(22): 5104–5110.

Leytin, Valery, Sergiy Mykhaylov, Alison F. Starkey, et al.

2006 Intravenous Immunoglobulin Inhibits Anti-Glycoprotein IIb-Induced Platelet Apoptosis in a Murine Model of Immune Thrombocytopenia. *British Journal of Haematology* 0(0): 060207074859002.

Lieby, P.

2004 Pathogenic Antiphospholipid Antibody: An Antigen-Selected Needle in a Haystack. *Blood* 104(6): 1711–1715.

Lieby, P., A. Soley, H. Levallois, et al.

2001 The Clonal Analysis of Anticardiolipin Antibodies in a Single Patient with Primary Antiphospholipid Syndrome Reveals an Extreme Antibody Heterogeneity. *Blood* 97(12): 3820–3828.

Ling, Yun, Xiangshan Cao, Ziqiang Yu, and Changgeng Ruan

2007 Circulating Dendritic Cells Subsets and CD4 + Foxp3 + Regulatory T Cells in Adult Patients with Chronic ITP before and after Treatment with High-Dose Dexamethasone. *European Journal of Haematology* 79(4): 310–316.

Liu, X.-g., S.-h. Ma, J.-z. Sun, et al.

2011 High-Dose Dexamethasone Shifts the Balance of Stimulatory and Inhibitory Fc Receptors on Monocytes in Patients with Primary Immune Thrombocytopenia. *Blood* 117(6): 2061–2069.

Li, X., H. Zhong, W. Bao, et al.

2012 Defective Regulatory B-Cell Compartment in Patients with Immune Thrombocytopenia. *Blood* 120(16): 3318–3325.

Lupher, Mark L., Zhou Songyang, Steven E. Shoelson, Lewis C. Cantley, and Hamid Band

1997 The Cbl Phosphotyrosine-Binding Domain Selects a D (N/D) XpY Motif and Binds to the Tyr292 Negative Regulatory Phosphorylation Site of ZAP-70. *Journal of Biological Chemistry* 272(52): 33140–33144.

Magnan, Antoine, Vincenzo Di Bartolo, Anne-Marie Mura, et al.

2001 T Cell Development and T Cell Responses in Mice with Mutations Affecting Tyrosines 292 or 315 of the ZAP-70 Protein Tyrosine Kinase. *The Journal of Experimental Medicine* 194(4): 491–506.

Majolini, M. Bernardetta, Mario M. D'elios, Piero Galieni, et al.
1998 Expression of the T-Cell-specific Tyrosine Kinase Lck in Normal B-1 Cells and in Chronic Lymphocytic Leukemia B Cells. *Blood* 91(9): 3390–3396.

Manoury, Bénédicte, Daniela Mazzeo, Lars Fugger, et al.
2002 Destructive Processing by Asparagine Endopeptidase Limits Presentation of a Dominant T Cell Epitope in MBP. *Nature Immunology* 3(2): 169–174.

Markey, G. M., H. D. Alexander, A. N. Agnew, et al.
1986 Enumeration of Absolute Numbers of T Lymphocyte Subsets in B-Chronic Lymphocytic Leukaemia Using an Immunoperoxidase Technique: Relation to Clinical Stage. *British Journal of Haematology* 62(2): 257–273.

Marsh, W. Laurence, Ragnhild Øyen, Edith Alicea, Meredith Linter, and Susan Horton
1979 Autoimmune Hemolytic Anemia and the Kell Blood Groups. *American Journal of Hematology* 7(2): 155–162.

Marsh, W. L., M. E. Reid, and E. P. Scott
1972 Autoantibodies of U Blood Group Specificity in Autoimmune Hemolytic Anaemia. *British Journal of Haematology* 22(5): 625–629.

Marti, Gerald E., Andy C. Rawstron, Paolo Ghia, et al.
2005 Diagnostic Criteria for Monoclonal B-Cell Lymphocytosis. *British Journal of Haematology* 130(3): 325–332.

Matutes, E., D. Oscier, J. Garcia-Marco, et al.
1996 Trisomy 12 Defines a Group of CLL with Atypical Morphology: Correlation between Cytogenetic, Clinical and Laboratory Features in 544 Patients. *British Journal of Haematology* 92(2): 382–388.

Matutes, E., K. Owusu-Ankomah, R. Morilla, et al.
1994 The Immunological Profile of B-Cell Disorders and Proposal of a Scoring System for the Diagnosis of CLL. *Leukemia* 8(10): 1640–1645.

Maura, Francesco, Carlo Visco, Erika Falisi, et al.
2013 B-Cell Receptor Configuration and Adverse Cytogenetics Are Associated with Autoimmune Hemolytic Anemia in Chronic Lymphocytic Leukemia. *American Journal of Hematology* 88(1): 32–36.

Mauro, F. R., R. Foa, R. Cerretti, et al.
2000 Autoimmune Hemolytic Anemia in Chronic Lymphocytic Leukemia: Clinical, Therapeutic, and Prognostic Features. *Blood* 95(9): 2786–2792.

McMillan, R

2000 The Pathogenesis of Chronic Immune (idiopathic) Thrombocytopenic Purpura. *Seminars in Hematology* 37(1 Suppl 1): 5–9.

McMillan, R., J. Lopez-Dee, and J. C. Loftus

2001 Autoantibodies to alpha(IIb)beta(3) in Patients with Chronic Immune Thrombocytopenic Purpura Bind Primarily to Epitopes on alpha(IIb). *Blood* 97(7): 2171–2172.

McMillan, Robert

2003 Antiplatelet Antibodies in Chronic Adult Immune Thrombocytopenic Purpura: Assays and Epitopes. *Journal of Pediatric Hematology/oncology* 25 Suppl 1: S57–61.

Meinl, E., T. Derfuss, R. Pirzer, et al.

2001 Herpesvirus Saimiri Replaces ZAP-70 for CD3- and CD2-Mediated T Cell Activation. *Journal of Biological Chemistry* 276(40): 36902–36908.

Meinl, E., D. Lengenfelder, N. Blank, et al.

2000 Differential Requirement of ZAP-70 for CD2-Mediated Activation Pathways of Mature Human T Cells. *The Journal of Immunology* 165(7): 3578–3583.

Melo, J. V., D. Catovsky, and D. A. Galton

1987 Chronic Lymphocytic Leukemia and Prolymphocytic Leukemia: A Clinicopathological Reappraisal. *Blood Cells* 12(2): 339–353.

Menard, Laurence, David Saadoun, Isabelle Isnardi, et al.

2011 The PTPN22 Allele Encoding an R620W Variant Interferes with the Removal of Developing Autoreactive B Cells in Humans. *Journal of Clinical Investigation* 121(9): 3635–3644.

Mertens, Daniel, Stephan Wolf, Cordula Tschuch, et al.

2006 Allelic Silencing at the Tumor-Suppressor Locus 13q14.3 Suggests an Epigenetic Tumor-Suppressor Mechanism. *Proceedings of the National Academy of Sciences* 103(20): 7741–7746.

Messmer, B. T.

2004 Multiple Distinct Sets of Stereotyped Antigen Receptors Indicate a Role for Antigen in Promoting Chronic Lymphocytic Leukemia. *Journal of Experimental Medicine* 200(4): 519–525.

Michelutti, Alessandro, Elisa Gremese, Francesca Morassi, et al.
2011 B-Cell Subsets in the Joint Compartments of Seropositive and Seronegative Rheumatoid Arthritis (RA) and No-RA Arthritides Express Memory Markers and ZAP70 and Characterize the Aggregate Pattern Irrespective of the Autoantibody Status. *Molecular Medicine* 17(9-10): 901.

Minden, Marcus Dühren-von, Rudolf Übelhart, Dunja Schneider, et al.
2012 Chronic Lymphocytic Leukaemia Is Driven by Antigen-Independent Cell-Autonomous Signalling. *Nature* 489(7415): 309–312.

Mollison, P. L.
1959 Measurement of Survival and Destruction of Red Cells in Haemolytic Syndromes. *British Medical Bulletin* 15(1): 59–66.

Monroe, John G.
2006 ITAM-Mediated Tonic Signalling through Pre-BCR and BCR Complexes. *Nature Reviews Immunology* 6(4): 283–294.

Moreau, E. J., E. Matutes, R. P. A'Hern, et al.
1997 Improvement of the Chronic Lymphocytic Leukemia Scoring System with the Monoclonal Antibody SN8 (CD79b). *American Journal of Clinical Pathology* 108(4): 378–382.

Moreno, C., K. Hodgson, G. Ferrer, et al.
2010a Autoimmune Cytopenia in Chronic Lymphocytic Leukemia: Prevalence, Clinical Associations, and Prognostic Significance. *Blood* 116(23): 4771–4776.

2010b Autoimmune Cytopenia in Chronic Lymphocytic Leukemia: Prevalence, Clinical Associations, and Prognostic Significance. *Blood* 116(23): 4771–4776.

Muñoz, Luz, Adriana Lasa, Maria T. Carricondo, et al.
2007 Comparative Analysis of ZAP-70 Expression and Ig VH Mutational Status in B-Cell Chronic Lymphocytic Leukemia. *Cytometry Part B: Clinical Cytometry* 72B(2): 96–102.

Murphy, Kenneth Travers, Paul, Mark Walport, and Charles Janeway
2012 *Janeway's Immunobiology*. New York: Garland Science.

Muzio, Marta, Benedetta Apollonio, Cristina Scielzo, et al.
2008 Constitutive Activation of Distinct BCR-Signaling Pathways in a Subset of CLL Patients: A Molecular Signature of Anergy. *Blood* 112(1): 188–195.

Myint, H., J. A. Copplestone, J. Orchard, et al.
1995 Fludarabine-Related Autoimmune Haemolytic Anaemia in Patients with Chronic Lymphocytic Leukaemia. *British Journal of Haematology* 91(2): 341–344.

Najaoui, Abderrahim, Tamam Bakchoul, Johanna Stoy, et al.
2012 Autoantibody-Mediated Complement Activation on Platelets Is a Common Finding in Patients with Immune Thrombocytopenic Purpura (ITP): Complement Activation in ITP. *European Journal of Haematology* 88(2): 167–174.

Negishi, I., N. Motoyama, K. Nakayama, et al.
1995 Essential Role for ZAP-70 in Both Positive and Negative Selection of Thymocytes. *Nature* 376(6539): 435–438.

Nitschke, Lars
2009 CD22 and Siglec-G: B-Cell Inhibitory Receptors with Distinct Functions. *Immunological Reviews* 230(1): 128–143.

Nolz, J C, R C Tschumper, B T Pittner, et al.
2005 ZAP-70 Is Expressed by a Subset of Normal Human B-Lymphocytes Displaying an Activated Phenotype. *Leukemia* 19(6): 1018–1024.

O'Brien, Susan, and John Gribben, eds.
2008 *Chronic Lymphocytic Leukemia*. New York: Informa Healthcare.

Olsson, Bob, Per-Ola Andersson, Margareta Jernås, et al.
2003 T-Cell-Mediated Cytotoxicity toward Platelets in Chronic Idiopathic Thrombocytopenic Purpura. *Nature Medicine* 9(9): 1123–1124.

Olsson, Bob, Börje Ridell, Margareta Jernås, and Hans Wadenvik
2012 Increased Number of B-Cells in the Red Pulp of the Spleen in ITP. *Annals of Hematology* 91(2): 271–277.

Oppezzo, Pablo, Yuri Vasconcelos, Catherine Settegrana, et al.
2005 The LPL/ADAM29 Expression Ratio Is a Novel Prognosis Indicator in Chronic Lymphocytic Leukemia. *Blood* 106(2): 650–657.

Orchard, Jenny A., Rachel E. Ibbotson, Zandie Davis, et al.
2004 ZAP-70 Expression and Prognosis in Chronic Lymphocytic Leukaemia. *The Lancet* 363(9403): 105–111.

Ottinger, Elizabeth A., Martyn C. Botfield, and Steven E. Shoelson
1998 Tandem SH2 Domains Confer High Specificity in Tyrosine Kinase Signaling. *Journal of Biological Chemistry* 273(2): 729–735.

Owen, I., V. Chowdhury, M. E. Reid, et al.
1992 Autoimmune Hemolytic Anemia Associated with Anti-Sc1. *Transfusion* 32(2): 173–176.

Packman, Charles H.
2008 Hemolytic Anemia due to Warm Autoantibodies. *Blood Reviews* 22(1): 17–31.

Pallasch, C. P., J. Schwamb, S. Königs, et al.
2008 Targeting Lipid Metabolism by the Lipoprotein Lipase Inhibitor Orlistat Results in Apoptosis of B-Cell Chronic Lymphocytic Leukemia Cells. *Leukemia* 22(3): 585–592.

Panitsas, Fotios P., Maria Theodoropoulou, Alexandra Kouraklis, et al.
2004 Adult Chronic Idiopathic Thrombocytopenic Purpura (ITP) Is the Manifestation of a Type-1 Polarized Immune Response. *Blood* 103(7): 2645–2647.

Parikh, Sameer A., Kari G. Rabe, Timothy G. Call, et al.
2013 Diffuse Large B-Cell Lymphoma (Richter Syndrome) in Patients with Chronic Lymphocytic Leukaemia (CLL): A Cohort Study of Newly Diagnosed Patients. *British Journal of Haematology* 162(6): 774–782.

Patten, Piers EM, Andrea GS Buggins, Julie Richards, et al.
2008 CD38 Expression in Chronic Lymphocytic Leukemia Is Regulated by the Tumor Microenvironment. *Blood* 111(10): 5173–5181.

Peerschke, Ellinor I. B., Biree Andemariam, Wei Yin, and James B. Bussel
2010 Complement Activation on Platelets Correlates with a Decrease in Circulating Immature Platelets in Patients with Immune Thrombocytopenic Purpura. *British Journal of Haematology* 148(4): 638–645.

Petlickovski, Aleksandar, Luca Laurenti, Xiaoping Li, et al.
2005 Sustained Signaling through the B-Cell Receptor Induces Mcl-1 and Promotes Survival of Chronic Lymphocytic Leukemia B Cells. *Blood* 105(12): 4820–4827.

Philippen, Angela, Susanne Diener, Thorsten Zenz, et al.
2010 SYK Carries No Activating Point Mutations in Patients with Chronic Lymphocytic Leukaemia (CLL). *British Journal of Haematology* 150(5): 633–636.

Piguet, Pierre F., and Christian Vesin
2002 Modulation of Platelet Caspases and Life-Span by Anti-Platelet Antibodies in Mice. *European Journal of Haematology* 68(5): 253–261.

Del Principe, M. I.
2006 Clinical Significance of ZAP-70 Protein Expression in B-Cell Chronic Lymphocytic Leukemia. *Blood* 108(3): 853–861.

Pritchard, Nicholas R., and Kenneth GC Smith
2003 B Cell Inhibitory Receptors and Autoimmunity. *Immunology* 108(3): 263–273.

Puente, Xose S., Magda Pinyol, Víctor Quesada, et al.
2011 Whole-Genome Sequencing Identifies Recurrent Mutations in Chronic Lymphocytic Leukaemia. *Nature* 475(7354): 101–105.

Quesada, Víctor, Laura Conde, Neus Villamor, et al.
2011 Exome Sequencing Identifies Recurrent Mutations of the Splicing Factor SF3B1 Gene in Chronic Lymphocytic Leukemia. *Nature Genetics* 44(1): 47–52.

Rai, K. R., A. Sawitsky, E. P. Cronkite, et al.
1975 Clinical Staging of Chronic Lymphocytic Leukemia. *Blood* 46(2): 219–234.

Di Raimondo, F., R. Giustolisi, E. Cacciola, et al.
1993 Autoimmune Hemolytic Anemia in Chronic Lymphocytic Leukemia Patients Treated with Fludarabine. *Leukemia & Lymphoma* 11(1-2): 63–68.

Ramsay, Alan G., Amy J. Johnson, Abigail M. Lee, et al.
2008 Chronic Lymphocytic Leukemia T Cells Show Impaired Immunological Synapse Formation That Can Be Reversed with an Immunomodulating Drug. *Journal of Clinical Investigation*. <http://www.jci.org/articles/view/35017>, accessed May 9, 2014.

Raponi, Sara, Irene Della Starza, Maria S. De Propriis, et al.
2014 Minimal Residual Disease Monitoring in Chronic Lymphocytic Leukaemia Patients. A Comparative Analysis of Flow Cytometry and ASO IgH RQ-PCR. *British Journal of Haematology* 166(3): 360–368.

Rassenti, Laura Z., Lang Huynh, Tracy L. Toy, et al.
2004 ZAP-70 Compared with Immunoglobulin Heavy-Chain Gene Mutation Status as a Predictor of Disease Progression in Chronic Lymphocytic Leukemia. *New England Journal of Medicine* 351(9): 893–901.

Rassenti, Laura Z., and Thomas J. Kipps

1997 Lack of Allelic Exclusion in B Cell Chronic Lymphocytic Leukemia. *The Journal of Experimental Medicine* 185(8): 1435–1446.

Rawstron, A. C.

2002 Inherited Predisposition to CLL Is Detectable as Subclinical Monoclonal B-Lymphocyte Expansion. *Blood* 100(7): 2289–2290.

Rawstron, Andy C., and Peter Hillmen

2010 Clinical and Diagnostic Implications of Monoclonal B-Cell Lymphocytosis. *Best Practice & Research Clinical Haematology* 23(1): 61–69.

Richardson, S. J.

2006 ZAP-70 Expression Is Associated with Enhanced Ability to Respond to Migratory and Survival Signals in B-Cell Chronic Lymphocytic Leukemia (B-CLL). *Blood* 107(9): 3584–3592.

Ringshausen, I.

2002 Constitutively Activated Phosphatidylinositol-3 Kinase (PI-3K) Is Involved in the Defect of Apoptosis in B-CLL: Association with Protein Kinase Cdelta. *Blood* 100(10): 3741–3748.

Rizzo, David, Gaëlle Bouvier, Ibtissam Youlyouz-Marfak, et al.

2013 T/B Ratio Does Not Reflect Levels of ZAP70 Expression in Clonal CLL B-Cells due to ZAP70 Overexpression in Patient T-Cells. *Cytometry Part B: Clinical Cytometry* 84B(2): 125–132.

Roark, Jessica H., James B. Bussel, Douglas B. Cines, and Don L. Siegel

2002 Genetic Analysis of Autoantibodies in Idiopathic Thrombocytopenic Purpura Reveals Evidence of Clonal Expansion and Somatic Mutation. *Blood* 100(4): 1388–1398.

Rodríguez-Vicente, Ana E., Marcos González Díaz, and Jesús M. Hernández-Rivas

2013 Chronic Lymphocytic Leukemia: A Clinical and Molecular Heterogenous Disease. *Cancer Genetics* 206(3): 49–62.

Rosen, Antony

2008 *Clinical Immunology: Principles and Practice : Expert Consult with Updates*, vol. Mechanisms of autoimmunity. Philadelphia, PA: Mosby, Elsevier.

- Rosenwald, Andreas, Ash A. Alizadeh, George Widhopf, et al.
2001 Relation of Gene Expression Phenotype to Immunoglobulin Mutation Genotype in B Cell Chronic Lymphocytic Leukemia. *The Journal of Experimental Medicine* 194(11): 1639–1648.
- Rosse, Wendell F.
1971 Quantitative Immunology of Immune Hemolytic Anemia. *Journal of Clinical Investigation* 50(4): 727–733.
- Rossi, Davide, Marco Fangazio, Silvia Rasi, et al.
2012 Disruption of BIRC3 Associates with Fludarabine Chemorefractoriness in TP53 Wild-Type Chronic Lymphocytic Leukemia. *Blood* 119(12): 2854–2862.
- Rossi, Davide, Silvia Rasi, Valeria Spina, et al.
2013 Integrated Mutational and Cytogenetic Analysis Identifies New Prognostic Subgroups in Chronic Lymphocytic Leukemia. *Blood* 121(8): 1403–1412.
- Rossi, Davide, Elisa Sozzi, Alessia Puma, et al.
2009 The Prognosis of Clinical Monoclonal B Cell Lymphocytosis Differs from Prognosis of Rai 0 Chronic Lymphocytic Leukaemia and Is Recapitulated by Biological Risk Factors. *British Journal of Haematology* 146(1): 64–75.
- Rossi, D., S. Deaglio, D. Dominguez-Sola, et al.
2011 Alteration of BIRC3 and Multiple Other NF- B Pathway Genes in Splenic Marginal Zone Lymphoma. *Blood* 118(18): 4930–4934.
- Sakaguchi, Noriko, Takeshi Takahashi, Hiroshi Hata, et al.
2003 Altered Thymic T-Cell Selection due to a Mutation of the ZAP-70 Gene Causes Autoimmune Arthritis in Mice. *Nature* 426(6965): 454–460.
- Sakakura, Miho, Hideo Wada, Isao Tawara, et al.
2007 Reduced Cd4+ Cd25+ T Cells in Patients with Idiopathic Thrombocytopenic Purpura. *Thrombosis Research* 120(2): 187–193.
- Sarfati, M., S. Chevret, C. Chastang, et al.
1996 Prognostic Importance of Serum Soluble CD23 Level in Chronic Lymphocytic Leukemia. *Blood* 88(11): 4259–4264.
- Sasahara, Yoji, Rima Rachid, Michael J. Byrne, et al.
2002 Mechanism of Recruitment of WASP to the Immunological Synapse and of Its Activation Following TCR Ligation. *Molecular Cell* 10(6): 1269–1281.

Schreiber, Aland D., and Michael M. Frank
1972 Role of Antibody and Complement in the Immune Clearance and Destruction of Erythrocytes I. IN VIVO EFFECTS OF IgG AND IgM COMPLEMENT-FIXING SITES. *Journal of Clinical Investigation* 51(3): 575–582.

Schroeder, Harry W., and Guillermo Dighiero
1994 The Pathogenesis of Chronic Lymphocytic Leukemia: Analysis of the Antibody Repertoire. *Immunology Today* 15(6): 288–294.

Schroers, R, F Griesinger, L Trümper, et al.
2005 Combined Analysis of ZAP-70 and CD38 Expression as a Predictor of Disease Progression in B-Cell Chronic Lymphocytic Leukemia. *Leukemia* 19(5): 750–758.

Schweighoffer, Edina, Lesley Vanes, Anne Mathiot, Tetsuya Nakamura, and Victor LJ Tybulewicz
2003 Unexpected Requirement for ZAP-70 in Pre-B Cell Development and Allelic Exclusion. *Immunity* 18(4): 523–533.

Scielzo, C., A. Camporeale, M. Geuna, et al.
2006 ZAP-70 Is Expressed by Normal and Malignant Human B-Cell Subsets of Different Maturational Stage. *Leukemia* 20(4): 689–695.

Seifert, M., and R. Kuppers
2009 Molecular Footprints of a Germinal Center Derivation of Human IgM+(IgD+)CD27+ B Cells and the Dynamics of Memory B Cell Generation. *Journal of Experimental Medicine* 206(12): 2659–2669.

Seifert, M., L. Sellmann, J. Bloehdorn, et al.
2012 Cellular Origin and Pathophysiology of Chronic Lymphocytic Leukemia. *Journal of Experimental Medicine*. <http://www.jem.org/cgi/doi/10.1084/jem.20120833>, accessed November 2, 2012.

Shanafelt, T. D., N. E. Kay, K. G. Rabe, et al.
2009 Brief Report: Natural History of Individuals With Clinically Recognized Monoclonal B-Cell Lymphocytosis Compared With Patients With Rai 0 Chronic Lymphocytic Leukemia. *Journal of Clinical Oncology* 27(24): 3959–3963.

Shulman, Ira A., Virginia Vengelen-Tyler, Joseph C. Thompson, Janice M. Nelson, and David CT Chen
1990 Autoanti-Ge Associated with Severe Autoimmune Hemolytic Anemia. *Vox Sanguinis* 59(4): 232–234.

Siggs, Owen M., Lisa A. Miosge, Adèle L. Yates, et al.
2007 Opposing Functions of the T Cell Receptor Kinase ZAP-70 in Immunity and Tolerance Differentially Titrate in Response to Nucleotide Substitutions. *Immunity* 27(6): 912–926.

Simitsek, Phaedra D., David G. Campbell, Antonio Lanzavecchia, Neil Fairweather, and Colin Watts
1995 Modulation of Antigen Processing by Bound Antibodies Can Boost or Suppress Class II Major Histocompatibility Complex Presentation of Different T Cell Determinants. *The Journal of Experimental Medicine* 181(6): 1957–1963.

Stamatopoulos, B., N. Meuleman, B. Haibe-Kains, et al.
2007 Quantification of ZAP70 mRNA in B Cells by Real-Time PCR Is a Powerful Prognostic Factor in Chronic Lymphocytic Leukemia. *Clinical Chemistry* 53(10): 1757–1766.

Stamatopoulos, K., C. Belessi, C. Moreno, et al.
2007 Over 20% of Patients with Chronic Lymphocytic Leukemia Carry Stereotyped Receptors: Pathogenetic Implications and Clinical Correlations. *Blood* 109(1): 259–270.

Stilgenbauer, Stephan, Andrea Schnaiter, Peter Paschka, et al.
2014 Gene Mutations and Treatment Outcome in Chronic Lymphocytic Leukemia: Results from the CLL8 Trial. *Blood* 123(21): 3247–3254.

Strati, Paolo, and Federico Caligaris-Cappio
2011 A Matter of Debate in Chronic Lymphocytic Leukemia: Is the Occurrence of Autoimmune Disorders an Indicator of Chronic Lymphocytic Leukemia Therapy? *Current Opinion in Oncology* 23(5): 455–460.

Sup, Stephen J., Rana Domiati-Saad, Todd W. Kelley, et al.
2004 ZAP-70 Expression in B-Cell Hematologic Malignancy Is Not Limited to CLL/SLL. *American Journal of Clinical Pathology* 122(4): 582–587.

Swerdlow, Steven H., International Agency for Research on Cancer., and World Health Organization.
2008 WHO Classification of Tumours of Haematopoietic and Lymphoid Tissues. Lyon, France: International Agency for Research on Cancer.

Takahashi, Ryo, Nariko Sekine, and Toshihiko Nakatake
1999 Influence of Monoclonal Antiplatelet Glycoprotein Antibodies on in Vitro Human Megakaryocyte Colony Formation and Proplatelet Formation. *Blood* 93(6): 1951–1958.

- Thorsélius, Mia, Alexander Kröber, Fiona Murray, et al.
2006 Strikingly Homologous Immunoglobulin Gene Rearrangements and Poor Outcome in VH3-21-Using Chronic Lymphocytic Leukemia Patients Independent of Geographic Origin and Mutational Status. *Blood* 107(7): 2889–2894.
- Ticchioni, Michel, Céline Charvet, Nelly Noraz, et al.
2002 Signaling through ZAP-70 Is Required for CXCL12-Mediated T-Cell Transendothelial Migration. *Blood* 99(9): 3111–3118.
- Tiller, Thomas, Eric Meffre, Sergey Yurasov, et al.
2008 Efficient Generation of Monoclonal Antibodies from Single Human B Cells by Single Cell RT-PCR and Expression Vector Cloning. *Journal of Immunological Methods* 329(1-2): 112–124.
- Till, Kathleen J., Ke Lin, Mirko Zuzel, and John C. Cawley
2002 The Chemokine Receptor CCR7 and alpha4 Integrin Are Important for Migration of Chronic Lymphocytic Leukemia Cells into Lymph Nodes. *Blood* 99(8): 2977–2984.
- Tkachuk, Douglas C., Jan V. Hirschmann, and Maxwell Myer Wintrobe, eds.
2007 *Wintrobe's Atlas of Clinical Hematology*. Philadelphia, PA: Wolters Kluwer Health/Lippincott Williams & Wilkins.
- Toellner, Kai-Michael, William E. Jenkinson, Dale R. Taylor, et al.
2002 Low-Level Hypermutation in T Cell-independent Germinal Centers Compared with High Mutation Rates Associated with T Cell-dependent Germinal Centers. *The Journal of Experimental Medicine* 195(3): 383–389.
- Tolusso, Barbara, Maria De Santis, Silvia Bosello, et al.
2009 Synovial B Cells of Rheumatoid Arthritis Express ZAP-70 Which Increases the Survival and Correlates with the Inflammatory and Autoimmune Phenotype. *Clinical Immunology* 131(1): 98–108.
- Toyabe, Shin-ichi, Akihiro Watanabe, Waka Harada, Tamaki Karasawa, and Makoto Uchiyama
2001 Specific Immunoglobulin E Responses in ZAP-70-Deficient Patients Are Mediated by Syk-Dependent T-Cell Receptor Signalling. *Immunology* 103(2): 164–171.
- Trialists' CollaborativeGroup, C. L. L.
1999 Chemotherapeutic Options in Chronic Lymphocytic Leukemia: A Meta-Analysis of the Randomized Trials. *Journal of the National Cancer Institute* 91(10): 861–868.

Tsubakio, T., P. Tani, V. L. Woods, and R. McMillan
1987 Autoantibodies against Platelet GPIIb/IIIa in Chronic ITP React with Different Epitopes. *British Journal of Haematology* 67(3): 345–348.

Usuki, Y., M. Kohsaki, K. Nagai, Y. Ohe, and H. Hara
1986 Complement-Dependent Cytotoxic Factor to Megakaryocyte Progenitors in Sera from Patients with Idiopathic Thrombocytopenic Purpura. *International Journal of Cell Cloning* 4(6): 447–463.

Vener, Claudia, Umberto Gianelli, Agostino Cortelezzi, et al.
2006 ZAP-70 Immunoreactivity Is a Prognostic Marker of Disease Progression in Chronic Lymphocytic Leukemia. *Leukemia & Lymphoma* 47(2): 245–251.

Visco, Carlo, Wilma Barcellini, Francesco Maura, et al.
2014 Autoimmune Cytopenias in Chronic Lymphocytic Leukemia: Autoimmune Cytopenias in CLL. *American Journal of Hematology* 89(11): 1055–1062.

Visco, Carlo, Agostino Cortelezzi, Francesca Moretta, et al.
2013 Autoimmune Cytopenias in Chronic Lymphocytic Leukemia at Disease Presentation in the Modern Treatment Era: Is Stage C Always Stage C? *Leukemia & Lymphoma*: 1–5.

Visco, C., I. Giaretta, M. Ruggeri, et al.
2007 Un-Mutated IgVH in Chronic Lymphocytic Leukemia Is Associated with a Higher Risk of Immune Thrombocytopenia. *Leukemia* 21(5): 1092–1093.

Visco, C., F. Maura, G. Tuana, et al.
2012 Immune Thrombocytopenia in Patients with Chronic Lymphocytic Leukemia Is Associated with Stereotyped B-Cell Receptors. *Clinical Cancer Research* 18(7): 1870–1878.

Visco, C., M. Ruggeri, M. L. Evangelista, et al.
2008 Impact of Immune Thrombocytopenia on the Clinical Course of Chronic Lymphocytic Leukemia. *Blood* 111(3): 1110–1116.

Wahlfors, J., H. Hiltunen, K. Heinonen, et al.
1992 Genomic Hypomethylation in Human Chronic Lymphocytic Leukemia. *BLOOD-NEW YORK*- 80: 2074–2074.

Wange, R. L., R. Guitián, N. Isakov, et al.
1995 Activating and Inhibitory Mutations in Adjacent Tyrosines in the Kinase Domain of ZAP-70. *The Journal of Biological Chemistry* 270(32): 18730–18733.

Wang, H., T. A. Kadlecsek, B. B. Au-Yeung, et al.
2010 ZAP-70: An Essential Kinase in T-Cell Signaling. *Cold Spring Harbor Perspectives in Biology* 2(5): a002279–a002279.

Wang, H.-Y., Y. Altman, D. Fang, et al.
2001 Cbl Promotes Ubiquitination of the T Cell Receptor through an Adaptor Function of Zap-70. *Journal of Biological Chemistry* 276(28): 26004–26011.

Wang, L., M. S. Lawrence, Y. Wan, et al.
2011 SF3B1 and Other Novel Cancer Genes in Chronic Lymphocytic Leukemia. *New England Journal of Medicine*.

Wardemann, Hedda, Sergey Yurasov, Anne Schaefer, et al.
2003 Predominant Autoantibody Production by Early Human B Cell Precursors. *Science (New York, N.Y.)* 301(5638): 1374–1377.

Ward, Frank J., Andrew M. Hall, Lindsay S. Cairns, et al.
2008 Clonal Regulatory T Cells Specific for a Red Blood Cell Autoantigen in Human Autoimmune Hemolytic Anemia. *Blood* 111(2): 680–687.

Wiestner, A., A. Rosenwald, T. S. Barry, et al.
2003 ZAP-70 Expression Identifies a Chronic Lymphocytic Leukemia Subtype with Unmutated Immunoglobulin Genes, Inferior Clinical Outcome, and Distinct Gene Expression Profile. *Blood* 101(12): 4944–4951.

William, J.
2002 Evolution of Autoantibody Responses via Somatic Hypermutation Outside of Germinal Centers. *Science* 297(5589): 2066–2070.

Williams, Brandi L., Brenda J. Irvin, Shari L. Sutor, et al.
1999 Phosphorylation of Tyr319 in ZAP-70 Is Required for T-Cell Antigen Receptor-Dependent Phospholipase C- γ 1 and Ras Activation. *The EMBO Journal* 18(7): 1832–1844.

Woyach, J. A., A. J. Johnson, and J. C. Byrd
2012 The B-Cell Receptor Signaling Pathway as a Therapeutic Target in CLL. *Blood* 120(6): 1175–1184.

Yuille, Martin R., Alison Condie, Elaine M. Stone, et al.
2001 TCL1 Is Activated by Chromosomal Rearrangement or by Hypomethylation. *Genes, Chromosomes and Cancer* 30(4): 336–341.

Yu, Margaret K., Hector Bergonia, Aniko Szabo, and John D. Phillips
2007 Progressive Disease in Chronic Lymphocytic Leukemia Is Correlated with the DNA Methylation Index. *Leukemia Research* 31(6): 773–777.

Zanotti, Roberta, Achille Ambrosetti, Maurizio Lestani, et al.
2007 ZAP-70 Expression, as Detected by Immunohistochemistry on Bone Marrow Biopsies from Early-Phase CLL Patients, Is a Strong Adverse Prognostic Factor. *Leukemia* 21(1): 102–109.

Zanotti, Roberta, Francesco Frattini, Paolo Ghia, et al.
2010 ZAP-70 Expression Is Associated with Increased Risk of Autoimmune Cytopenias in CLL Patients. *American Journal of Hematology* 85(7): 494–498.

Zelenetz, Andrew D, Jeremy S Abramson, Ranjana H Advani, et al.
2010 NCCN Clinical Practice Guidelines in Oncology: Non-Hodgkin's Lymphomas. *Journal of the National Comprehensive Cancer Network: JNCCN* 8(3): 288–334.

Zent, Clive S., Wei Ding, Susan M. Schwager, et al.
2008 The Prognostic Significance of Cytopenia in Chronic Lymphocytic Leukaemia/small Lymphocytic Lymphoma. *British Journal of Haematology* 141(5): 615–621.

Zent, Clive S., and Tait Shanafelt
2009 Management of Autoimmune Cytopenia Complicating Chronic Lymphocytic Leukemia. *Leukemia & Lymphoma* 50(6): 863–864.

Zenz, Thorsten, Alexander Kröber, Katrin Scherer, et al.
2008 Monoallelic TP53 Inactivation Is Associated with Poor Prognosis in Chronic Lymphocytic Leukemia: Results from a Detailed Genetic Characterization with Long-Term Follow-Up. *Blood* 112(8): 3322–3329.

Zenz, Thorsten, Daniel Mertens, Ralf Küppers, Hartmut Döhner, and Stephan Stilgenbauer
2010 From Pathogenesis to Treatment of Chronic Lymphocytic Leukaemia. *Nature Reviews Cancer*. <http://www.nature.com/doifinder/10.1038/nrc2764>, accessed March 9, 2013.

Zenz, T., D. Vollmer, M. Trbusek, et al.
2010 TP53 Mutation Profile in Chronic Lymphocytic Leukemia: Evidence for a Disease Specific Profile from a Comprehensive Analysis of 268 Mutations. *Leukemia* 24(12): 2072–2079.

Zhang, Jingbo, Daoxin Ma, Xiaojuan Zhu, et al.
2009 Elevated Profile of Th17, Th1 and Tc1 Cells in Patients with Immune Thrombocytopenic Purpura. *Haematologica* 94(9): 1326–1329.

Zhang, Zhixin, Peter D. Burrows, and Max D. Cooper
2004 The Molecular Basis and Biological Significance of VH Replacement. *Immunological Reviews* 197(1): 231–242.

Zhao, Qihong, Brandi L. Williams, Robert T. Abraham, and Arthur Weiss
1999 Interdomain B in ZAP-70 Regulates but Is Not Required for ZAP-70 Signaling Function in Lymphocytes. *Molecular and Cellular Biology* 19(1): 948–956.

Zucchetto, A., D. Benedetti, C. Tripodo, et al.
2009 CD38/CD31, the CCL3 and CCL4 Chemokines, and CD49d/Vascular Cell Adhesion Molecule-1 Are Interchained by Sequential Events Sustaining Chronic Lymphocytic Leukemia Cell Survival. *Cancer Research* 69(9): 4001–4009.

Zucchetto, A., C. Caldana, D. Benedetti, et al.
2013 CD49d Is Overexpressed by Trisomy 12 Chronic Lymphocytic Leukemia Cells: Evidence for a Methylation-Dependent Regulation Mechanism. *Blood* 122(19): 3317–3321.

*Eu nu strivesc corola de minuni a lumii
și nu ucid
cu mintea tainele, ce le-ntâlnesc
în calea mea...
eu cu lumina mea sporesc a lumii taină –
și tot ce-i neînțeles
se schimbă-n neînțelesuri și mai mari...*

(Lucian BLAGA, “*Poemele luminii*”, 1919)

*I do not crush the world's corolla made of wonders
and never slay
through reason, the mysteries I meet
along my way...
I increase the world's enigma, with my light –
and what is hard to grasp
will change into even harder puzzling senses...*

(Lucian BLAGA, “*Poems of light*”, 1919)

*Je ne foule pas la corolle de merveilles du monde
et je n'assassine point
de mes raisonnements les mystères que je croise
sur mon chemin...
moi avec ma lumière, j'amplifie le mystère du monde –
et tout l'incompris
se transforme en énigmes plus grandes encore...*

(Lucian BLAGA, "Poèmes de la lumière", 1919)

MÉCANISMES PHYSIOPATHOLOGIQUES DES MANIFESTATIONS AUTO-IMMUNES AU COURS DE LA LEUCÉMIE LYMPHOÏDE CHRONIQUE: RÔLE DE ZAP-70

La leucémie lymphoïde chronique (LLC) est particulièrement associée aux cytopénies auto-immunes (AIC). L'expression de ZAP-70 dans la LLC est un facteur pronostique, due à une forte signalisation par le BCR. Nous décrivons une nouvelle population B normale (LyBn) qui exprime ZAP-70. Ces LyBn ZAP-70⁺ ne semble pas appartenir à une sous-population LyB particulière, et elles n'ont pas un phénotype activé. L'expression de ZAP-70 dans les LyB naïves suggère que ce phénomène est précoce. Il y a une bonne corrélation dans le niveau de ZAP-70 entre les LyBn et les LyB de LLC. Les LyBn ZAP-70⁺ ont été retrouvés dans tous les cas de AIC associée à la LLC. L'analyse des anticorps monoclonaux prévenant de LyB ZAP-70⁺ et des souris ZAP-70 KI, réalisés pendant ce travail, définiront les conséquences de la surexpression de ZAP-70 dans les LyB dans la pathogénèse de l'auto-immunité et de la lymphoprolifération.

Mots clé: leucémie lymphoïde chronique, cytopénie auto-immune, ZAP-70, lymphocyte B.

Chronic lymphocytic leukemia (CLL) is particularly associated with autoimmune cytopenia (AIC). The expression of ZAP-70 in CLL cells is a prognostic factor, through increased BCR signaling. We described a novel normal B cell population (LyBn) that expresses ZAP-70. ZAP-70⁺ LyBn do not seem to belong to a certain subset of B cells, nor seem to have an activated phenotype. The presence of ZAP-70 in the naïve B cell subset suggests that this is an early process, which probably occurs before malignant transformation. There is a good correlation in the level of ZAP-70 expression, between normal B cells and CLL B cells. We found a significant percentage of ZAP-70⁺ LyBn in all AIC-associated CLLs. Analysis of monoclonal antibodies and of conditional ZAP-70 KI mouse model synthesized in this work will clarify the consequences of aberrant ZAP-70 expression in B cells on autoimmunity and lymphoproliferation.

Keywords: chronic lymphocytic leukemia, autoimmune cytopenia, ZAP-70, B cells.