



**HAL**  
open science

# Design and configuration of sustainable dynamic cellular manufacturing systems

Farzad Niakan

► **To cite this version:**

Farzad Niakan. Design and configuration of sustainable dynamic cellular manufacturing systems. Chemical and Process Engineering. INSA de Lyon, 2015. English. NNT: 2015ISAL0123. tel-01368427

**HAL Id: tel-01368427**

**<https://theses.hal.science/tel-01368427>**

Submitted on 19 Sep 2016

**HAL** is a multi-disciplinary open access archive for the deposit and dissemination of scientific research documents, whether they are published or not. The documents may come from teaching and research institutions in France or abroad, or from public or private research centers.

L'archive ouverte pluridisciplinaire **HAL**, est destinée au dépôt et à la diffusion de documents scientifiques de niveau recherche, publiés ou non, émanant des établissements d'enseignement et de recherche français ou étrangers, des laboratoires publics ou privés.

N° d'ordre 2015ISAL0123  
Année 2015

Thèse

## **Design and Configuration of Sustainable Dynamic Cellular Manufacturing Systems**

### **Présentée devant**

L'Institut national des sciences appliquées de Lyon

### **Pour Obtenir**

Le grade de docteur

### **École doctorale**

École doctorale Informatique et Mathématique

### **Par**

Farzad Niakan  
(B.Sc ; M.Sc.)

Soutenue le 07/12/2015 devant la commission d'examen

### **Jury**

Gülgün Alpan-Gaujal	Maître de conférences HDR à Grenoble-INP, France	Rapporteur
Saeed Zolfaghari	Professeur à l'Université Ryerson, Canada	Rapporteur
Damien Trentesaux	Professeur à l'Université de Valenciennes, France	Examineur
André Thomas	Professeur à l'Université de Lorraine, France	Examineur
Valérie Botta-Genoulaz	Professeur à INSA de Lyon, France	Directeur de thèse
Armand Baboli	Maître de conférences HDR à INSA de Lyon, France	Co-directeur de thèse
Thierry Moyaux	Maître de conférences, INSA de Lyon, France	Co-encadrant de thèse

Laboratoire de recherche :  
DISP, Décision et Information pour les Systèmes de Production

## **Abstract**

The most recent revolution in industry (Industrial Revolution 4.0) requires increased flexibility, agility and efficiency in the use of production equipment. Dynamic Cellular Manufacturing System (DCMS) is one of the best production systems to meet such requirements. In addition, the increasing importance of sustainable development forces manufacturers and managers to take account of the environmental and social issues in the design and configuration of manufacturing systems. This thesis focuses on the sustainable configuration of DCMS by proposing three mathematical models. The main challenge of this study is to (i) choose appropriate social and environmental criteria, (ii) integrate them in mathematical models, and (iii) study the impact of these criteria on the configuration of DCMS.

The first model is bi-objective in order to make a trade-off between social (job opportunity, potential machine hazards, etc.) and economic (various costs related to cell formation) criteria. To get closer to real-life situations, some parameters such as demand, machine-related costs and time capacity of the machines are considered as uncertain. To solve this problem, a robust optimization method is applied to cope with this uncertainty.

In our second model all dimensions of sustainable development are taken into account in our new bi-objective mathematical model. The first objective function models economic criteria (costs) and the second one environmental aspects (production waste), while some constraints represent social issues (mainly Daily Noise Dosage because of computational complexity). Due to the NP-hardness of the problem, a new innovative approach called NSGA II-MOSA is proposed. This approach merges an efficient hybrid meta-heuristic based on the Non-dominated Sorting Genetic Algorithm (NSGA-II), with Multi-Objective Simulated Annealing (MOSA). In this model, an important attempt is made to reduce the complexity of the mathematical model and to propose an innovative resolution approach.

Next, our last model has three objective functions, one for each of the environmental, social and economic issues. In order to be close to real life, some parameters of the model are expressed in terms of fuzzy value. We propose a hybridized possibilistic method to deal with uncertainty and an interactive fuzzy approach is considered to solve an auxiliary crisp multi-objective model in order to find trade-off solutions.

Finally, the last part of the thesis studies the possibility to apply the three proposed models to the industry thanks to an easier method. A novel optimization-simulation approach is introduced to deal with the configuration of DCMS: (i) the optimization phase operates as scenario fraction method in order to reduce the number of alternative configurations by focusing on

strategic and tactical levels. (ii) Next, a simulation tool investigates the operational level by studying the performance of each alternative and the interaction between several components of the cells.

**Keywords:** *Dynamic Cellular Manufacturing System; Cell Formation; Sustainability; Corporate Social Responsibility; Multi-Objective Optimization; Simulation*

## Résumé

La révolution la plus récente dans l'industrie (révolution industrielle 4.0) nécessite une plus grande flexibilité, agilité et efficacité dans l'utilisation des équipements de production. Le système manufacturier cellulaire dynamique (DCMS) est l'un des meilleurs systèmes de production qui répondent à ces exigences. En outre, l'importance croissante du développement durable force les fabricants et les gestionnaires à prendre en compte les enjeux environnementaux et sociaux dans la conception et la configuration des systèmes de fabrication. Cette thèse porte sur la configuration durable des DCMS en proposant trois modèles mathématiques. Le plus grand challenge de cette étude est (i) de choisir des critères sociaux et environnementaux appropriés, (ii) de les intégrer dans des modèles mathématiques et (iii) d'étudier l'impact de ces critères sur la configuration des DCMS.

Le premier modèle est bi-objectif afin de faire un compromis entre des critères sociaux (offres d'emplois, risques de la machine, etc.) et économiques (divers coûts liés à la formation des cellules). Pour être plus proche de situations de la vie réelle, certains paramètres tels que la demande, les coûts liés aux machines et la capacité des machines sont considérés comme incertains. Pour résoudre ce problème, une méthode d'optimisation robuste est appliquée pour faire face à cette incertitude.

Dans notre deuxième modèle, toutes les dimensions du développement durable sont prises en compte dans un nouveau modèle mathématique bi-objectif. La première fonction objectif modélise des critères économiques (coûts) et la seconde des aspects environnementaux (gaspillages de production), tandis que certaines contraintes représentent des questions sociales (principalement le Daily Noise à cause de la complexité de calcul). En raison de la NP-difficulté du problème, une approche novatrice appelée NSGA II-MOSA est proposée. Cette approche combine une méta-heuristique hybride efficace basée sur l'algorithme génétique tri non-dominé (NSGA-II) avec un recuit simulé multi-objectif (MOSA). Dans cette thèse, une importante tentative est faite pour réduire la complexité du modèle mathématique et proposer une approche de résolution innovante.

Ensuite, notre dernier modèle a trois fonctions objectif, une pour chacun des enjeux environnementaux, sociaux et économiques. Afin d'être proche de la vie réelle, certains paramètres du modèle sont exprimés en termes de valeur floue. Nous proposons une méthode possibiliste hybride pour faire face à l'incertitude et une approche floue interactive est considérée pour résoudre un modèle multi-objectif déterministe pour des solutions de compromis.

Enfin, la dernière partie de la thèse étudie la possibilité d'appliquer les trois modèles proposés à l'industrie grâce à une méthode plus facile. Une approche

d'optimisation-simulation innovante est introduite pour faire face à la configuration de DCMS : (i) La phase d'optimisation fonctionne comme méthode de fractionnement de scénarii pour réduire le nombre de configurations alternatives en se concentrant sur les niveaux stratégique et tactique. (ii) Ensuite, un outil de simulation détaille le niveau opérationnel en étudiant la performance de chaque alternative et les interactions entre plusieurs composants de cellules.

**Mots-clés:** *Dynamique Système de Fabrication Cellulaire; Cellule Formation; Développement Durable; Responsabilité Sociale des Entreprises; Optimisation Multi-Objectif; Simulation*

*Dedicated to*

*My parents for their endless support and  
unconditional love*

# Table of contents

<b>1</b>	<b>Introduction, problem statement and literature review .....</b>	<b>2</b>
1.1	Introduction .....	2
1.2	Literature review.....	6
1.3	Problem statement .....	20
1.4	Contribution and novelty.....	20
1.5	Conclusion .....	22
<b>2</b>	<b>A bi-objective mathematical model for dynamic cell formation under uncertainty considering social criteria .....</b>	<b>24</b>
2.1	Motivation .....	24
2.2	Problem formulation .....	25
2.3	Robust counterpart mathematical model.....	31
2.4	NSGA-II algorithm.....	36
2.5	Computational results .....	39
2.6	Conclusion .....	45
<b>3</b>	<b>A bi-objective mathematical model for dynamic cell formation considering social and environmental issues and worker assignment. 48</b>	
3.1	Motivation .....	48
3.2	Problem formulation .....	50
3.3	Hybrid NSGA II-MOSA algorithm .....	57
3.4	Computational results .....	66
3.5	Conclusion .....	74
<b>4</b>	<b>Multi-objective model for the configuration of sustainable dynamic cellular manufacturing system; a possibilistic approach.....</b>	<b>76</b>
4.1	Motivation .....	76
4.2	Problem formulation .....	77
4.3	Solution approach .....	84
4.4	Experimental results.....	91
4.5	Conclusion .....	97
<b>5</b>	<b>A tentative approach to make applicable optimization method for industrial case.....</b>	<b>99</b>
5.1	Motivation .....	99
5.2	Solution approach .....	99
5.3	Computational results .....	103
5.4	Conclusion .....	108
<b>6</b>	<b>Conclusion and directions of future research .....</b>	<b>110</b>



<b>References.....</b>	<b>114</b>
<b>Appendix A: Notations .....</b>	<b>123</b>
<b>Appendix B: Abbreviations .....</b>	<b>127</b>
<b>Appendix C: List of Figures and Tables .....</b>	<b>129</b>
<b>Appendix D: Résumé étendu en français.....</b>	<b>131</b>
1 Introduction .....	131
2 Revue de la littérature .....	132
3 Un modèle bi-objectif de configuration de cellules manufacturières sous incertitudes considérant des critères économiques et sociaux.....	135
4 Un modèle bi-objectif de configuration de cellules manufacturières dynamiques et d’affectation des opérateurs considérant des critères économiques, environnementaux et sociaux .....	139
5 Un modèle multi-objectif de configuration de cellules manufacturières dynamiques durables.....	144
6 Vers une approche d'optimisation-simulation pour la configuration de DCMS.....	148
7 Conclusion et perspectives .....	150

# 1

## **Introduction, problem statement and literature review**

- 1.1 Introduction
- 1.2 Literature review
  - 1.2.1 Literature review on static cellular manufacturing system
  - 1.2.2 Literature review on dynamic cellular manufacturing system
  - 1.2.3 Literature review on simulation in cellular manufacturing system
  - 1.2.4 Synthesis
- 1.3 Problem statement
- 1.4 Contribution and novelty
  - 1.4.1 First model
  - 1.4.2 Second model
  - 1.4.3 Third model
  - 1.4.4 Tentative optimization-simulation approach
- 1.5 Conclusion

# 1 Introduction, problem statement and literature review

## 1.1 Introduction

Increasing of competitive global marketplace makes intensive pressure for manufacturing companies. This makes different challenges for the managers such as time-to-market, product life-cycles, and diverse customer needs. The major goal of manufacturing system is to deliver the products to the customer quickly which leads to a decrease in the production cost and an increase in the quality of products. In addition, the system should be able to respond quickly to change in product design and/or product demand without major investment. The traditional manufacturing system, such as flow shops and job shops have less capability to satisfy these kind of requirements.

In job shops, as one of common manufacturing system, the configuration are designed to achieve maximum flexibility that is suitable for the wide variety of products with small lot sizes. Therefore, the manufactured products in job shops usually need different operations and various operation sequences. The specification of the job shop (high variety of products with small lot sizes) defines the types of machines and the configuration of system. In this kind of system, machines are often arranged in each shops according to the nature of skills and technological processes: for example drill equipment in Drilling department, milling machines in another department. (Figure 1.1)

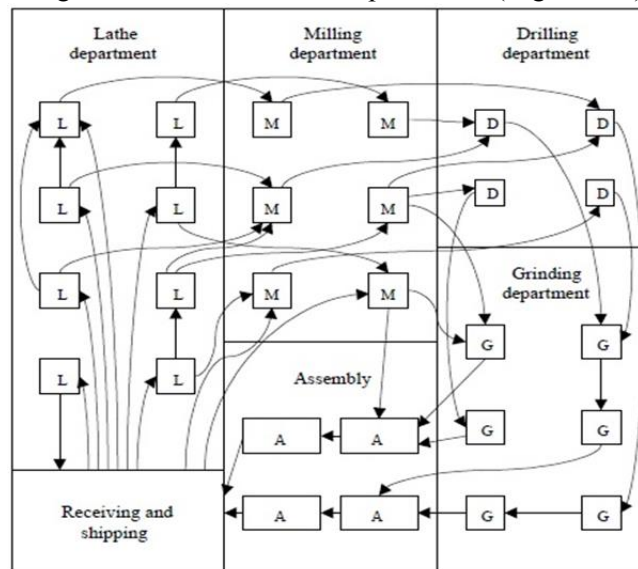


Figure 1.1 Material flow in job shop manufacturing system [1]

In job shops, products spend about 95% of their time in unproductive activity; much of the time is spent for waiting in queue and the remaining 5% of time is split between setup and processing [2]. This means that the part after finishing the process in a department, must usually travel a long distance (sometimes the entire layout) to reach next department or stage, as shown in Figure 1.1. Therefore, long production times, high levels of in-process inventory, high production costs and low production rates are the major limitations of this kind of system.

In contrast to job shops, flow shop (Figure 1.2) are mainly designed for mass production with high production rates and low costs. In this system, the flow of products in the plant is unidirectional, and all the products use the machines in the same order. The equipment are arranged according to the sequence of operation for each product while the order of sequence is fixed during the production. To achieve high production rates, specialized machines and equipment are utilized while these machines are usually expensive so to justify the high investment of machines, a large volume of the product must be produced. The main restriction of this system is the low flexibility to produce new products.

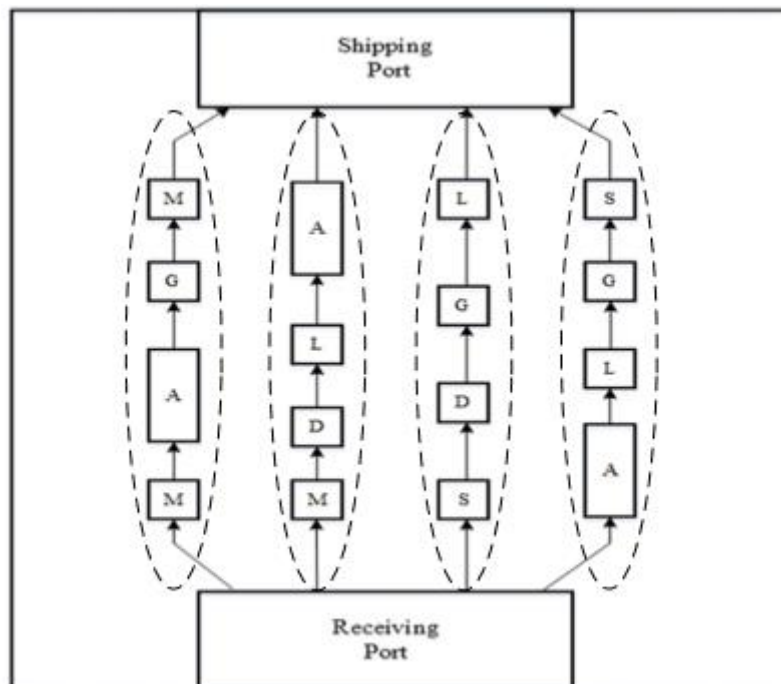


Figure 1.2 Material flow in flow shops manufacturing system

As indicated above, since manufacturing systems often need to be reconfigured in response to variations in product and demand, job shop and flow shop could not meet today's production requirements. As alternative solution, Cellular

Manufacturing System (CMS) can be applied. CMS based on Group Technology (GT), attempts to classify parts and machines in order to regroup machines in cells and parts in families of part. This action is known as Cell Formation Problem (CFP). This classification is based on the similarities in the process requirements of each part and geometry of them. Using this kind of system can take advantages as reduction of Work-In-Process (WIP), flow time and space utilization, while also improving production planning and control (Figure 1.3). Therefore, CMS is implemented to produce medium-volume/medium-variety more economically than job shop and flow shop.

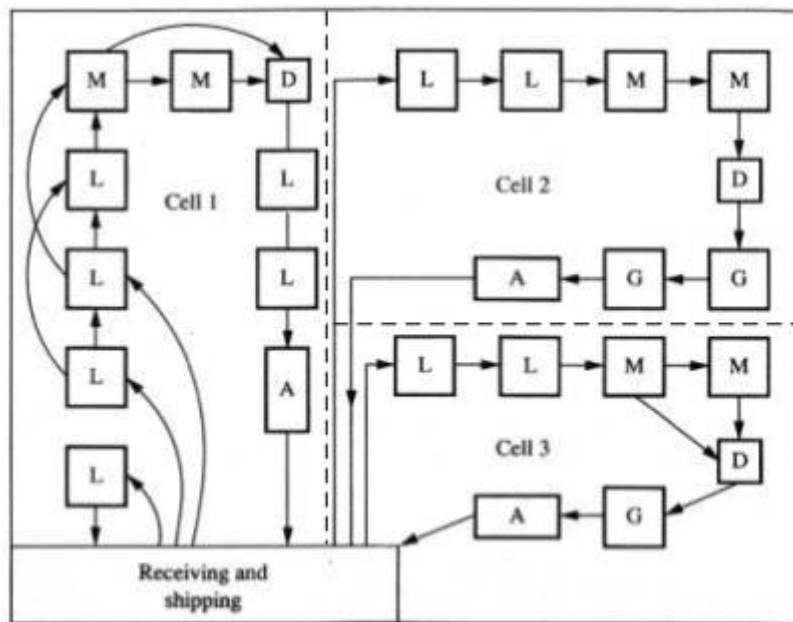


Figure 1.3 Material flow in cellular manufacturing system (CMS)

Traditional CMS is called as static cellular manufacturing system, because in this system, the main assumption concern less variation of demand (constant demand) and cells are configured for one period. Shorter product life-cycles, higher variety of product, unpredictable demand, shorter delivery times and others dynamic conditions require more frequent reconfiguration of cells. In order to maintain a high level of performance, the configuration of cells have to be restudied from one period to the others, because optimal cells formed in one period might not be optimal for the other periods. This reconfiguration of part families and machine grouping may include either relocation of machines between cells or change in the number of cells. Moreover, with regard to the matters enumerated and based on extracted from new revolution concept, named Industry 4.0 [3], the production system must have high level of flexibility and agility. Dynamic Cellular Manufacturing System (DCMS) (see Figure 1.4) is one of the solution and can be applied to achieve this aim. In this

system, depending on variation of the demand, part families and machine groups at each period must be restudied. This concept is close to multi-period CMS, it has some differences [4]. For more explanation, multi-period CMS just considers new production planning without relocation of machines while in DCMS, the configuration of cells (machine and part family) can be changed. Researchers during previous decades have addressed various issues concerning CMS and DCMS problem. These include Cell Formation Problem (CFP) and cell design or configuration. The CFP concerns an optimal grouping of the given machines and parts into cells while cell design or configuration consider more issues such as the layout design, the operator allocation, *etc.*

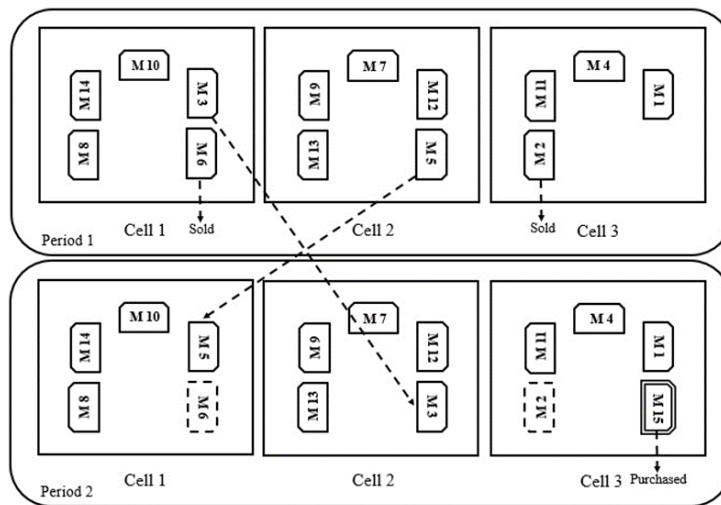


Figure 1.4 A schematic view of Dynamic Cellular Manufacturing System (DCMS)

From another point of view, the importance of sustainability and pressures of communities, government and non-government organizations forced managers and manufacturers to consider environmental and social criteria in addition of economic aspect. The United Nations World Commission on Environment and Development WCED in 1987 [5] gave a well-known definition about sustainable development. By this definition “*sustainable development is development that meets the needs of the present without compromising the ability of future generations to meet their own needs*” [5]. Based on the analysis of given definition, meeting current and future depends on how well we balance economic, social and environmental aspect in our current decisions. According to the above reasons, sustainability becomes as most attractive research domain by researcher in recent years and there is an increasing amount of literature about that. However, despite of importance of considering sustainability, only small number of areas, such as supply chain management, have been involved this aspect in their decisions.

## 1.2 Literature review

Shorter product life-cycles, higher product variety, unpredictable demand, and shorter delivery times force manufacturers and researchers to find a system which can be adapted/responded to such changes and uncertainties quickly. Therefore, cellular manufacturing system have received a great deal of attention in the recent years.

In this section, we review the relevant literature in three main classes; the first one concerns static (traditional) cellular manufacturing system, the second one concerns dynamic cellular manufacturing system and finally the application of simulation tools in cellular manufacturing.

The presentation of research work in next sections is based on their publication date, showing the progress in these matters

### 1.2.1 Literature review on static cellular manufacturing system

According to previous study about static cellular manufacturing system, the literature body is categorized into two sections; cell formation and layout design and cell formation.

#### 1.2.1.1 Cell formation

Cell formation is the first phase in CMS configuration, which defines the group of parts and machines according to the similarities in the process and geometry and then assign group of parts to the cells. There are many studies on cell formation from 1972 [6]. We present in this section some of the important research contributions.

Before 1997, research works mainly focused on cell formation using different information and data and tried to optimize one objective (cost or profit). The authors often use mathematical approach and exact method or heuristics to find the best cell formation. Regarding the complexity of system, proposed method could be only applied on small size problem.

Lee *et al.* [7] proposed to use a meta-heuristic and they developed a genetic algorithm (GA) for cell formation problem while production volume, alternate routings and process sequences are considered. Vakharia and Chang [8] proposed two metaheuristic method for forming machine cells and compared them. The proposed methods search the feasible solution based on simulated annealing and Tabu search algorithms. HSu and Su [9] integrated simulated annealing and GA as an hybrid method which is concluded by a better resolution in cell formation problem. Their method decreases inter/intra-cell movement and some machine-related cost as objective function. Nair and Narendran [10] proposed an algorithm with 8 phases for cell formation problem. In this research, the clustering of machines and components are done

based on production sequence data. Sofianopoulou [11] formulated a mathematical model in cell formation problem. Then, two simulated annealing meta-heuristics are implemented to solve it.

Baykasoglu [12] formulated a non-linear integer program for cell formation. His model decreases several important objectives such as part dissimilarity, cell load imbalance and extra capacity requirements. A cooperative game theoretic approach is implemented to solve the mathematical model. Mak and Wang [13] proposed a model for virtual cell formation problem while minimizing the total travel distance of parts. In addition, a conventional GA method is developed for solving proposed model. Yin and Yusuda [14] integrate some important concepts such as alternative process routes, operation sequence, operation time, production volume of parts, machine capacity, machine investment cost and machine overload cost in cell formation problem. Moreover, two-stage heuristic algorithm was developed as solving approach. Das *et al.* [15] solved a multi-objective model to form cells and define process route. Their goals make a trade-off between minimization of related cost and maximization of reliability. Simulated annealing method was implemented to solve the model. Schaller [16] proposed a model to design or redesign cells formation. Afterward, they solved their model by a multiple heuristics procedure and evaluated it by lower bounding methods. Tavakkoli-Moghaddam *et al.* [17] presented a model to form production cells and scheduling process simultaneously. The objective function of the model is the minimization of several features such as, set up cost, makespan, intra-cellular movement and tardiness. The authors also developed a scatter search algorithm to cope with the complexity of the problem. Mahdavi *et al.* [18] proposed a mathematical model to carry out cell formation by cubic incidence matrix of machine-part-worker. Hamedi *et al.* [19] present a multi-objective model for virtual manufacturing cell formation while cost optimization and machine load have been studied as objectives and Dual-Resource (machine and worker) constraint are considered. Chattopadhyay *et al.* [20] addressed a cell formation approach, called self-organizing map. The approach has good efficiency to solve large cell formation data set problems by hierarchical procedure.

As conclusion for this section, most recent papers focus on the efficiency of resolution approaches for large scale problem by using metaheuristic and hybrid methods. There is some multi objective research, but most papers try to optimize economic criteria. Finally, the older paper focus on inter cell movement but the recent research try to take into account inter and intra cell movements.



### 1.2.1.2 Layout design and cell formation

Dimopoulos and Zalzala [21] presented the cell layout configuration through the several stages such as (i) machine selection and job assignment (ii) assigning each machine to the cells (iii) defining of layout for each cell (iv) defining of whole layout by considering all cells, and (v) design of transportation system. Ho and Moodie [22] presented a linear programming model and design cells and flow paths by a search algorithm. Salum [23] focus on decreasing the lead time of manufactured part in configuration of cell layout. Akturk and Turkcan [24] proposed a mixed integer programming model for cell formation and intra-cell layout. In the proposed model, they considered various important concepts such as alternative route, production volumes, processing times, operation sequences, cell size, utilization and profit level. Lee and Chiang [25] addressed an integrated cell clustering-layout problem while machine cells located alongside the bi-directional linear flow layout to minimize inter-cell flow cost. A three-phase algorithm, based on the cut tree network, is developed to solve the problem. Furthermore, Lee and Chiang [26] developed a genetic-based algorithm with optimal partition approach to solve the joint problem.

Chaieb and Korbaa [27] introduced a model for intra-cell layout problem to optimize distances between machines and total transportation time. The authors also applied various approach such as enumerative algorithm and CPLEX to solve the problem. Al-Mubarak *et al.* [28] proposed a Focused Cellular Manufacturing (FCM) as layout scheme which configures cells and machines by end-items. The results demonstrate the superiority of FCM scheme comparing job shop and flow shop because of batching process. Solimanpur *et al.* [29] formulated a mathematical model for inter-cell layout problem as a Quadratic Assignment Problem (QAP). They solved the model by developing an ant colony algorithm. Kim *et al.* [30] presented an integer programming model to minimize inter-cell movements and workload imbalances. Chan *et al.* [31] addressed a two-stage approach for cell formation and layout problem. In the first stage, their mathematical model create several cells by grouping machines and parts to the families. In the second stage, intercellular movement is minimized by consideration of operation sequence, which is obtained by another mathematical model. Since the mathematical models are formulated as QAP problem and have high complexity, a GA is applied to solve them. Filho and Tiberti [32] presented a new GA to solve cell design problem. The proposed algorithm is based on group encoding which is presented as a contribution by the authors. They also applied new cross over and mutation operator to find solutions. Hicks [33] proposed a GA for a set of entire manufacturing cell. The authors used a case study data to show the efficiency of proposed algorithm.

Ioannou [34] addressed a method to convert pure functional manufacturing shops into hybrid production systems which includes both cellular and functional areas. In this method, first intra-cell layout is determined then the cells are placed, and sequences are implemented in the department simultaneously by an integer programming formulation. The objective of the mathematical model is the net benefit maximization. Wu *et al.* [35] developed a hierarchical GA for cell formation and layout design. The correlated fitness functions and group mutation operator are the main contribution of proposed algorithm to reach better solution. Wu *et al.* [36] formulated a mathematical model to integrate cell formation, layout design and group scheduling as three important decisions in CMS. Due to complexity of the proposed model, they implemented a hybrid GA as solving approach. Tavakkoli-Moghaddam *et al.* [37] presented a model for layout design in CMS while the demands are stochastic. The objective function of their model is the minimization of both inter/intra-cell movement cost. Mahdavi and Mahadevan [38] proposed an algorithm to define cell formation and layout design simultaneously. They prove the efficiency of algorithm by comparing the result with some other studies in the literature. Ahi *et al.* [39] proposed the multiple attribute decision making (MADM) concept and a two-stage method to define cell formation and intra-cell layout. They also compared obtained results with well-known approaches that are presented in literature.

Ariaifar and Ismail [40] developed a mathematical model for facility layout problem in CMS while inter/intra cell movements are minimized. The simulated annealing algorithm is also implemented to cope with the complexity of model. Satoglu and Suresh [41] proposed a goal programming model for the design of hybrid CMS. In this approach, three important phases are elaborated; (i) Pareto analysis for demand volumes and volatility, (ii) cell formation and create a residual functional layout, and (iii) worker allocation, which is done, based on capability of workers. The proposed model is also tested by real case data. Paydar *et al.* [42] proposed a mathematical model to simultaneously solve cell formation and machine layout. This model is formulated based on “multiple departures single destination multiple travelling salesman problem”. Simulated annealing algorithm is applied to solve the problem. Ghezavati and Saidi-Mehrabad [43] proposed a mixed integer model to design CMS while some parameters such as processing time, part demand, product mix and inter-arrival time have uncertain nature. In order to cope with this uncertainty, a stochastic programming approach is developed and transforms the uncertain model to a crisp one. To increase the efficiency of their model, authors applied queue system in the model and optimized it by queuing theory.

Chang *et al.* [44] addressed the concepts of cell formation, cell layout and intracellular machine sequence in design of CMS. Therefore, a two-stage model

is formulated to integrate these concepts with alternative process routings, operation sequences, and production volume. A novel Tabu search algorithm is developed to solve this model. Nouri and Hong [45] developed a new evolutionary algorithm for cell formation and layout design which is called Bacteria Foraging Optimization (BFO) algorithm. Izui *et al.* [46] presented a multi-objective model for design of CMS with robots. Total motion time (min) robots, layout area (min) and manipulability for each task (max) are considered as objective function then a multi-objective GA is implemented to reach optimal Pareto frontiers. Azab and Naderi [47] integrated the production schedule and process plan for design of CMS while the multitasking machines are considered. The authors solved proposed model by a new variable neighborhood search algorithms. Egilmez *et al.* [48] developed three models to form manufacturing cells and to allocate workers simultaneously. They considered demand and operation time as uncertain parameters and developed four-phase hierarchical methodology to optimize the worker skill levels, product-cell formations and individual worker assignment for a specified risk level. The proposed model is also applied on a real case.

Mohammadi and Forghani [49] addressed a cell formation and layout problem while some important design features such as alternative processing routings, operation sequences, processing times and capacity of machines are considered. To deal with NP-hardness of problem, a GA method is implemented. Shiyas and Madhusudanan Pillai [50] formulated a model making a trade-off between the heterogeneity of cells in term of amount of machines per cell and the inter-cell moves as two conflicting objectives in CMS. They also developed a heuristic to assign parts, and integrated it into GA method. Brown [51] studied about exceptional elements in CMS to decrease the bottlenecks in production process. The author also consider machine duplication and subcontracting to avoid violations.

As a conclusion, most studies focus on traditional cost optimization, but recent works involve other objectives as heterogeneity of cells, assigned area to each cell, etc. Using various evolutionary algorithms becomes common solving approaches. However, GA and simulated annealing are more used by researchers comparing other algorithms. Considering uncertain parameters allows being close to real cases, and is also becoming very popular in recent researches. Finally, we observe a new tendency concerning the simultaneous consideration of cell formation and layout of each cell as well as workers assignment and skill level. However, to the best of our knowledge, there is still no research considering sustainable criteria in cell formation and layout problem.

### 1.2.2 Literature review on dynamic cellular manufacturing system

In this section, a review of literature on dynamic cellular manufacturing systems (DCMS) is presented. We have investigated studies with regard to several aspects such as objectives, problem-solving approaches, parts movement (inter/intra cell), and the nature of applied parameters (deterministic, stochastic, etc.).

Rheault *et al.* [52] were the first to introduce the concept of dynamic environment in the cell formation problem. Chen and Cao [53] proposed a mathematical model for a DCMS to minimize the total cost, including: inter-cell material handling, inventory costs, and setting up of manufacturing cells. These authors also developed a Tabu Search (TS) method to obtain a sound solution and show the efficiency of their model. Next, these authors [54] generated a robust system configuration by integrating cell formation and part allocation. They also proposed a two-stage TS method to find the optimal or near optimal solutions. Tavakkoli-Moghaddam *et al.* [55] presented a nonlinear integer model in DCMS with consideration of machine capacity limitation, machine replication, and inter-cell movements that perform in batches. They used constant and variable costs as well as reconfiguration and inter-cell movement costs to formulate their objective function. These authors solved their models by several traditional meta-heuristics comprising GA, TS and SA, and then compared solutions obtained by means of each method to define the best algorithm. Tavakkoli-Moghaddam *et al.* [56] applied a new Memetic Algorithm (MA) to solve their DCMS model. Defersha and Chen [57] formulated a new comprehensive model containing dynamic cell configuration, alternative routings, lot splitting, sequence of operations and workload balancing. They also considered machine adjacency and cell-size capacity as constraints in their proposed model. Moreover, Defersha and Chen [58] also proposed a two-phase GA-based heuristic to solve DCMS with alternative routings. Saidi-mehrabad and Safaei [59] developed a non-linear integer mathematical model for DCFP by minimizing material handling cost. The authors also applied neural approach based on mean field theory as solving approach. Tavakkoli-Moghaddam *et al.* [60] proposed linear mix-integer programming for DCFP while part demands are fuzzy number. They developed a novel GA to deal with complexity of the model. Safaei *et al.* [61],[62] presented a DCMS mathematical model with uncertain circumstances, assuming fuzzy demand and fuzzy machine availability. They solved their mixed-integer programming model by developing fuzzy programming to determine optimal cell configuration with maximum satisfaction of the fuzzy objective and constraints. Safaei *et al.* [63] proposed a mixed-integer programming model in DCMS with consideration batch of inter/intra-cell material handling, sequence

of operations, alternative process plans and machine replication. In this study, the authors minimized machine variable/constant costs, inter/intra-cell movements and reconfiguration costs as an objective function. They used a hybrid meta-heuristic called MFA-SA (Mean Field Annealing-Simulated Annealing) to solve the proposed model and showed its efficiency by comparing with classical SA.

Defesha and Chen [64] integrated DCMS with production lot sizing, and formulated a mathematical model to minimize both production and quality-related costs, such as operation costs, setup costs and inventory costs. They solved it by a linear programming embedded GA. In another study [65] they developed a parallel GA approach for DCFP. Tavakkoli-Moghaddam *et al.* [66] presented an integer-linear programming in DCFP while minimize the inter-cell movement and machine costs simultaneously. Due to the NP hardness of the problem a SA method is developed. Ahkioon *et al.* [67] formulated a mixed integer mathematical model in DCMS by considering routing flexibility. In other words, they made a trade-off between increased flexibility and the imposed additional cost of part routings. Aryanezhad *et al.* [68] proposed a model to transact with a Simultaneous Dynamic Cell Formation and Worker assignment Problem (SDCWP). The objective function of their model has two components: production costs, such as inter-cell material handling costs and machine costs in the planning horizon; and human issues consisting of hiring costs, firing costs, training costs and salaries.

Safaei and Tavakkoli-Moghaddam [69] developed a mathematical model to integrate cell formation and subcontracted production planning in DCMS. In this study, the authors made a trade-off between production and outsourcing costs in the reconfiguration of system. Ahkioon *et al.* [70] proposed a mathematical model in CFP under dynamic condition while some new features such as alternate process routings and lot splitting are considered. Aramoon Bajestani *et al.* [71] formulated a multi-objective mathematical model in DCMS and minimized the sum of various costs and the total cell load variation simultaneously. They obtained a locally Pareto-optimal frontier by using a new Multi-Objective Scatter Search (MOSS) method. Wang *et al.* [72] presented a non-linear mixed integer program to model a DCSM with three conflicting objectives (machine relocation cost, the utilization rate of machine capacity, and the total number of inter-cell moves over the entire planning horizon). Deljoo *et al.* [73] improved previous models presented in the literature by correcting some essential errors which weakened the efficiency of the model.

Mahdavi *et al.* [74] proposed an integer non-linear programming in DCMS with consideration of worker aspects such as worker assignment, alternative workers, available time of workers, hiring and firing costs and wages. They utilized holding and backordering costs in their model as an inventory aspect to

make it more realistic. Javadian *et al.* [75] presented a multi-objective problem of cellular manufacturing systems in dynamic and deterministic production environments to minimize total cell load variation and the sum of the miscellaneous costs (machine costs, inter/intra-cellular material handling, back orders, inventory holding and subcontracting) simultaneously. A Non-Dominated Sorting Genetic Algorithm (NSGA-II) method was developed to obtain optimal Pareto-frontier. Rafiee *et al.* [76] integrated DCMS and inventory lot sizing problems by formulating a comprehensive mathematical model. The proposed model was considered with several design factors, such as machine procurement, cell reconfiguration, preventive and corrective maintenance, intra/inter-cell material handling, subcontracting, inventory cost, and defective parts replacement costs. Saxena and Jain [77] developed a mixed-integer nonlinear programming model to merge machine breakdown effects and DCMS by incorporating reliability modeling. The proposed model seeks to minimize the following: intra/inter-cell movement costs and machine procurement costs, machine variable/constant costs, production costs, part holding costs, subcontracting and reconfiguration costs, and machine repair costs such as production time loss cost due to machine breakdown. Kia *et al.* [78] proposed a new mixed-integer non-linear programming model for DCMS by integrating three major decisions in the design of a CMS (cell formation, group layout and group scheduling) and developed an efficient SA method to solve their model. The objective function of this model is minimizing total costs of intra/inter-cell movement, machine relocation, machine procurement, machine overhead and machine processing.

Rafiei and Ghodsi [79] presented a bi-objective problem of DCMS considering worker-related issues. Their proposed model seeks to (i) minimize various costs including machine procurement relocation, machine variable, inter/intra-cell movement, overtime and worker shifting as a first objective, and (ii) to maximize worker utilization as second objective. They proposed a hybridization of the ant-colony optimization algorithm with GA to solve their model. Saidi-Mehrabad *et al.* [80] proposed a mathematical model to integrate production planning and worker assignment. This model minimizes the costs of maintenance and overheads, system reconfiguration, backorder and inventory holding, training, and salaries. Kia *et al.* [81] formulated a multi objective mathematical model in DCMS by integrating cell formation and group layout decisions. They tried to make a trade-off between the total configuration cost and the imbalance of workload among cells as two conflict objectives. Fan and Feng [82] proposed a new concept as quasi-dynamic cell formation to design DCMS. They also consider salary of the worker as an objective of their model as well as configuration cost. Majazi-Dalfard [83] developed a new nonlinear integer programming model, into which he incorporated effects of distance in

the material flow as an important factor of decision making. In this study, he applied a new simulated annealing embedded in branch-and-cut to solve the proposed problem.

Shirazi *et al.* [84] presented a multi-objective mixed integer model by integrating cell formation, group layout and production planning decision. Total configuration cost and imbalance of workload are minimized as two objective functions of model. Kia *et al.* [85] formulated a mathematical model for multi-floor DCMS design as a new contribution in cell formation and group layout decision for multi-floor factories. They also designed a GA for the proposed problem and demonstrates its efficiency by comparing the obtain solution with CPLEX. Javadi *et al.* [86] developed a mathematical model to minimize the total costs of rearrangement and inter/intra-cell movements. They also proposed a hybrid of an electro-magnetism-like (EM-like) algorithm and a GA method as a solution approach. Aghajani *et al.* [87] presented a multi-objective model for dynamic cell formation where the demand is probabilistic. The proposed model consisted of three conflict objectives: reconfiguration cost, penalty cost of machine underutilization, and system failure rate. The authors also solved the model by developing a NSGA-II algorithm and comparing the result with the  $\epsilon$ -constraint method to show its efficiency.

Bootaki *et al.* [88] presented a bi-objective model in robust design of DCMS, with a fuzzy and random demand. The objective function of model is the minimization of inter-cell movements while machine and worker utilizations are maximized. A new goal programming method named 'Percentage Multi-Choice Goal Programming' is also proposed to verify the model. Paydar and Saidi-Mehrabad [89] formulated a bi-objective model to integrate cell formation and supply chain (procurement, production and distribution) planning which decreases distribution and procurement costs and increases the customer response rate. They applied revised multi-choice goal programming to solve a case study example and to find a compromise solution. Deep and Singh [90] proposed a comprehensive mathematical model in the design of a DCMS, considering multiple process plans for parts, and alternative process routes for each plan. These authors proposed a GA based on heuristics to cope with the complexity of a problem.

As conclusion, as for previous section, recent research work tends more and more to use (or to develop) several evolutionary algorithms to solve the problem. NSGA-II, SA, TS and new hybrid meta-heuristics are used more than other algorithms. Multi objective optimization for quantitative criteria as cost, load variation, imbalance workloads, worker utilization, etc. are proposed, mainly in recent works. Dynamic aspect in cell formation is mainly considered by uncertain parameters in time capacity and demand, and modeled by probabilistic or fuzzy approach. As for previous sections, to the best of our

knowledge, there is still no research considering sustainable criteria in DCMS design.

### 1.2.3 Literature review on simulation in cellular manufacturing system

On the other hand there are numerous studies about the design and analysis of manufacturing system specially CMS by computer simulation which is present as an efficient and flexible tool in manufacturing context. In this thesis, we only present the most important studies in this area. Ertay and Ruan [91] studied on worker assignment in CMS based on data envelopment analysis (DEA) and simulation approach. Siemiatkowski and Przybylski [92] studied on multi-stage CMS configuration, they identified the alternative process flow by computer simulation approach. Pitchuka *et al.* [93] introduced a simulation based approach to define part and machine family in CMS. They also used queuing theory to obtain queue times for the system. Ranaiefar *et al.* [94] used computer simulation to define the material flow in CMS by considering company's development plan and production capacity. Azadeh *et al.* [95] proposed a new simulation procedure for operator allocation in CMS. They applied an integrated fuzzy data analysis to define better layout and configuration. Moreover, Azadeh and Anvari [96] addressed a decision making model for operator allocations by computer simulation. In order to find best solution, they integrated DEA, principle component analysis (PCA) and numerical taxonomy approach. Neto and Filho [97] proposed a multi-objective mathematical modeling in CMS and obtained a Pareto frontier by a GA method. The authors defined the value of each objectives for each candidate by running a discrete-event simulation. Egilmez *et al.* [98] addressed model in CMS under uncertain condition. They validated the result of their mathematical model via simulation. Baykasoglu and Gorkemli [99] proposed an agent based simulation clustering algorithm for DCFP. They investigated performance of their algorithm by several heuristics, meta-heuristics and optimization-based algorithms. Renna and Ambrico [100] developed a model for reconfiguration and scheduling in DCMS. They assumed demands to be probabilistic in discrete probability scenarios. The authors also applied a simulation environment to test the proposed method compared to the manufacturing system without reconfiguration.

As conclusion, simulation approaches are not very popular in cell formation and DCMS design. However, utilization of simulation approach had slowly in recent research. Table 1.1 shows the classification of previous study about DCMS.



#### 1.2.4 Synthesis

Based on this literature review and Table 1.1, we observed that most of the studied criteria in previous research work are mainly economic rather than social or environmental. In other word, environmental and social issues were generally neglected in the literature body of CMS and DCMS design. To the best of our knowledge, there is no research that considers sustainability in configuration of DCMS. The most of previous studies considered sustainability in the supply chain network and they did not consider it particularly in each stage of chain (supplier, manufacturer, etc.). Although some researches in supply chain configuration or network design do take sustainable issues into account. As an example, Carter and Jennings [101] were the first to incorporate the concept of the Corporate Social Responsibility (CSR) into the supply chain. Cruz and Wakolbinger [102] and Cruz and Liu [103] studied the role of social responsibility on the supply chain and network design.

**Table 1.1** Classification of literature about DCMS

Author	Year	Applied Method	Data Essence	Solving Method	Objective	Movement Aspect	Inventory	Worker Assignment	Worker Aspect	Lot Splitting	Alternative Routing
Rheault <i>et al.</i> [52]	1995	<i>Scheduling framework</i>	<i>Certain</i>	<i>heuristic</i>	<i>Configuration cost</i>	<i>inter-cell</i>					
Chen & Cao [53]	2004	<i>mathematical modeling</i>	<i>Certain</i>	<i>Meta-heuristic (TS)</i>	<i>Configuration cost</i>	<i>inter-cell</i>	<i>Yes (level)</i>				
Chen & Cao [54]	2005	<i>Mathematical modeling</i>	<i>Probabilistic</i>	<i>Meta-heuristic (TS)</i>	<i>Configuration cost</i>	<i>inter-cell</i>	<i>Yes</i>				
Tavakkoli-Moghaddam <i>et al.</i> [55]	2005	<i>mathematical modeling</i>	<i>Certain</i>	<i>Meta-heuristic (GA,TS,SA)</i>	<i>Configuration cost</i>	<i>inter-cell</i>					
Tavakkoli-Moghaddam <i>et al.</i> [56]	2005	<i>Mathematical modeling</i>	<i>Certain</i>	<i>Meta-heuristic (MA)</i>	<i>Configuration cost</i>	<i>inter-cell</i>					
Defersha & Chen [58]	2006	<i>Mathematical modeling</i>	<i>Certain</i>	<i>Meta-heuristic (GA based heuristic)</i>	<i>Configuration cost</i>	<i>inter-cell</i>					
Defersha & Chen [57]	2006	<i>Mathematical modeling</i>	<i>Certain</i>	<i>Exact (LINGO)</i>	<i>Configuration cost</i>	<i>inter-cell</i>				<i>Yes</i>	<i>Yes</i>
Saidi-Mehrabad & Safaei [59]	2007	<i>Mathematical modeling</i>	<i>Certain</i>	<i>Neural approach based on mean filed theory</i>	<i>Configuration cost</i>	<i>inter-cell</i>					
Tavakkoli-Moghaddam <i>et al.</i> [60]	2007	<i>Mathematical modeling</i>	<i>Fuzzy</i>	<i>Meta-heuristic (GA)</i>	<i>Configuration cost</i>	<i>inter-cell</i>					
Defersha & Chen [64]	2008	<i>Mathematical modeling</i>	<i>Certain</i>	<i>Meta-heuristic (GA)</i>	<i>Configuration cost</i>	<i>inter-cell</i>					
Defersha & Chen [65]	2008	<i>Mathematical modeling</i>	<i>Certain</i>	<i>Meta-heuristic ( Parallel GA)</i>	<i>Configuration cost</i>	<i>inter-cell</i>					
Tavakkoli-Moghaddam <i>et al.</i> [66]	2008	<i>Mathematical modeling</i>	<i>Certain</i>	<i>Meta-heuristic (SA)</i>	<i>Configuration cost</i>	<i>inter-cell</i>					
Ahkioon <i>et al.</i> [67]	2008	<i>mathematical modeling</i>	<i>Certain</i>		<i>Configuration cost &amp; Routing flexibility</i>	<i>inter-cell</i>					<i>Yes</i>
Safaei <i>et al.</i> [63]	2008	<i>Mathematical modeling</i>	<i>Certain</i>	<i>Hybrid of MFA-SA</i>	<i>Configuration cost</i>	<i>inter-cell /intra-cell</i>					

**Table 1.1** Classification of literature about DCMS

Author	Year	Applied Method	Data Essence	Solving Method	Objective	Movement Aspect	Inventory	Worker Assignment	Worker Aspect	Lot Splitting	Alternative Routing
Safaei <i>et al.</i> [62],[61]	2008	Mathematical modeling	Fuzzy	Fuzzy based approach (LINGO)	Configuration cost	inter-cell /intra-cell					
Ahkioon <i>et al.</i> [70]	2009	Mathematical modeling	Certain	B&C (CPLEX)	Configuration cost	inter-cell /intra-cell				Yes	Yes
Aramoon Bajestani <i>et al.</i> [71]	2009	Mathematical modeling	Certain	Meta-heuristic (MOSS)	(2), Configuration cost & Load variation	inter-cell					
Safaei & Tavakkoli-Moghaddam [69]	2009	Mathematical modeling	Certain	B&B (LINGO)	Configuration cost	inter-cell /intra-cell					
Aryanezhad <i>et al.</i> [68]	2009	Mathematical modeling	Certain	Exact (LINGO)	Configuration cost	inter-cell		Yes	Yes		
Wang <i>et al.</i> [72]	2009	Mathematical modeling	Certain	Meta-heuristic (Scatter search)	Machine relocation cost & utilization rate & inter-cell movement	inter-cell					
Deljoo <i>et al.</i> [73]	2010	Mathematical modeling	Certain	Meta-heuristic (GA)	Configuration cost	inter-cell					
Mahdavi <i>et al.</i> [74]	2010	Mathematical modeling	Certain	Exact (LINGO)	Configuration & Inventory cost	inter-cell	Yes	Yes	Yes		
Rafiee <i>et al.</i> [76]	2011	Mathematical modeling	Certain	Meta-heuristic (PSO)	Configuration cost	inter-cell /intra-cell				Yes	Yes
Javadian <i>et al.</i> [75]	2011	Mathematical modeling	Certain	Meta-heuristic (NSGA-II)	Configuration cost & Cell load variation	inter-cell /intra-cell	Yes				
Saxena & Jain [77]	2011	Mathematical modeling	Certain	Exact (LINGO)	Configuration cost	inter-cell /intra-cell					Yes
Kia <i>et al.</i> [78]	2012	Mathematical modeling	Certain	Meta-heuristic (GA)	Configuration cost	inter-cell /intra-cell				Yes	
Saidi-Mehrabad <i>et al.</i> [80]	2013	Mathematical modeling	Certain	B&B (LINGO)	Production planning & Inventory cost		Yes		Yes		

**Table 1.1** Classification of literature about DCMS

Author	Year	Applied Method	Data Essence	Solving Method	Objective	Movement Aspect	Inventory	Worker Assignment	Worker Aspect	Lot Splitting	Alternative Routing
Majazi Dalfard [83]	2013	Mathematical modeling	Certain	SA embedded in B&C	Configuration cost	inter-cell /intra-cell					
Rafiei & Ghodsi [79]	2013	Mathematical modeling	Certain	Hybrid of ACO-GA	(2), Configuration cost & worker utilization	inter-cell /intra-cell			Yes		
Kia <i>et al.</i> [81]	2013	Mathematical modeling	Certain	Exact ( $\epsilon$ -constraint)	(2), Configuration cost & Load variation	inter-cell /intra-cell				Yes	
Fan & Feng [82]	2013	Mathematical modeling	Certain	Meta-heuristic (GA)	Configuration & worker cost	inter-cell /intra-cell			Yes		
Aghajani <i>et al.</i> [87]	2014	Mathematical modeling	Probabilistic	Meta-heuristic (NSGA-II)	(3), Configuration & subcontracting cost	inter-cell					
Shirazi <i>et al.</i> [84]	2014	Mathematical modeling	Certain	Meta-heuristic (AMOS)	(2), Configuration cost & Imbalance of workload	inter-cell /intra-cell	Yes				Yes
Baykasoglu & Gorkemli [99]	2014	Agent based Simulation method	Probabilistic	Simulation	Configuration cost	inter-cell /intra-cell					
Javadi <i>et al.</i> [86]	2014	Mathematical modeling	Certain	Hybrid of (EM-Like-GA)	Configuration cost	inter-cell /intra-cell					
Paydar <i>et al.</i> [89]	2014	Mathematical modeling	Possibilistic (Fuzzy)	Exact (LINGO)	(2), Procurement, holding, delivery cost & grouping efficacy	inter-cell /intra-cell	Yes				
Kia <i>et al.</i> [85]	2014	Mathematical modeling	Certain	Meta-heuristic (GA)	Configuration cost	inter-cell /intra-cell/ inter-floor					
Bootaki <i>et al.</i> [88]	2014	Mathematical modeling	Fuzzy	Exact (LINGO)	(2), Inter-cell moves & worker utilization	inter-cell /intra-cell		Yes			
Deep & Singh [90]	2015	Mathematical modeling	Certain	Meta-heuristic (GA)	Configuration cost	inter-cell /intra-cell					

Another gap in literature concerns uncertain parameters. Regarding the complexity of cell formation problem, most research works assume the parameters as certain and worked only on one period. Some authors consider cell formation for multi-product in multi periods, but they assume that there is a forecast or predefined quantity of each product in each period. Only a little research works considered the uncertainties in demand and capacity of machines. To the best of our knowledge, there is no research that consider the uncertainties in price, cost, etc.

### **1.3 Problem statement**

The motivation of this research is to develop new methods that can capture accurately and realistically several important characteristics of the DCMS configuration problem, which have not been well addressed, as:

- Investigation on dynamic configuration of cellular manufacturing under uncertain parameters, as demand, time, capacity, cost, price, etc.
- Investigation on integration of social and environmental criteria in addition to classical economic criteria.
- Investigation on mathematical modeling of sustainable DCMS and development of new optimization and simulation methods.

Knowing that the main aim of this thesis is to develop a DCMS by considering sustainable criteria, following research questions must be answered:

- How to integrate sustainable issues in the configuration of DCMS and how to make a tradeoff between economic, social and environmental aspects?
- How to develop resolution approach to deal with uncertain parameters of the problem?
- How to develop new solving approaches to find solutions with better performance in calculation time and quality of solution?
- How to gather optimization and simulation approach to analyze the solution and decisions on strategic, tactic, operational and real time levels?

### **1.4 Contribution and novelty**

This thesis extends the previous research in the design of DCMS by considering the sustainable issues (economic, social, and environmental). To achieve these objectives, we developed three mathematical models. In this section, the specificities, contributions and innovations of each model are presented.

#### 1.4.1 First model

The first model (Chapter 2) focus on the configuration of DCMS under uncertainties in demand, capacity of machine and cost. This model considers not only several economic criteria in its first objective, but also tries to optimize some social criteria. A robust optimization method is proposed to solve this bi-objective mathematical model. The main contributions of this model are listed as follows:

- Considering social issues such as “job opportunity” and “potential machine hazard” as a specific objective in the configuration of DCMS.
- Formulate mathematical model to make trade-off between relevant costs as economical aspects and social issues.
- Some parameters such as demand, machine related costs and machine time capacity are considered to be uncertain, allowing to be closer to real-life situations.
- Robust counterpart has been developed to cope with uncertain parameters (robust optimization).
- Non-dominated sorting genetic algorithm (NSGA II) has been designed to deal with the complexity and the NP-hardness of model.

#### 1.4.2 Second model

Second model (Chapter 3) takes into account all dimensions of the sustainable development. Economic and environmental criteria have been considered as objective while social issues are represented as constraints. In addition to DCMS configuration, this model concerns worker assignment according to their skills. In this way, the main contributions of this model are:

- Consideration of production waste as an environmental issue in design of DCMS.
- Consideration of Daily Noise Dosage (DND) and training procedure for worker as two social issues.
- Consideration of skill-based worker assignment approach in the configuration of DCMS.
- Development of a new hybrid meta-heuristic, composed by two well-known methods, NSGA II and Multi Objective Simulated Annealing (MOSA), for sustainable configuration of DCMS.

#### 1.4.3 Third model

The last model (Chapter 4) also addressed the sustainable configuration of DCMS. The main difference between this model and the previous one concerns

on the one hand its mathematical modeling of three sustainable aspects as separated objectives and on the other hand, the specific attention paid to the type of workers (local versus non-local works). The main contribution can be listed as follows:

- Formulation of a multi-objective sustainable model in configuration of DCMS and possibility to make a trade-off between economic, social and environmental issues.
- Consideration of two types of workers (local and non-local) with different hiring and firing cost and different social impact.
- Consideration of demand, machine related costs and machine time capacity as fuzzy values.
- Development of a hybridized possibilistic method to cope with uncertainty of the model.
- Interactive fuzzy approach to solve an auxiliary crisp multi-objective model and compromised solutions.

#### 1.4.4 Tentative optimization-simulation approach

In order to investigate some operational level performance, a simulation approach is used (Chapter 5). The main aim is to integrate optimization and simulation models to analyze the performance of the system.

Data Envelopment Analysis (DEA) as multi-criteria decision-making method is performed to rank several configuration scenarios or alternative configuration, obtained by optimization step.

### 1.5 Conclusion

In this chapter, first a brief introduction of various type of manufacturing systems, advantages and disadvantages of them are explained. Then, the related literature of CMS and DMCS is reviewed and analyzed to extract the research gaps for future directions. Finally, the problem statement and research contribution of the thesis are discussed.

The remainder of this thesis is organized as follows. Chapter 2 focuses on integration of social issues in design and configuration of DCMS with uncertain parameters. Chapter 3 expresses the conducted study on possibilities of formulating bi-objective model for sustainable DCMS and develop efficient hybrid method to solve the model. Chapter 4 elaborates multi-objective mathematical model for sustainable DCMS design. Chapter 5 addresses optimization-simulation approach in order to investigate the performance of the DCMS configurations and finally chapter 6 summarizes results and concludes with future research opportunities.

# 2

## **A bi-objective mathematical model for dynamic cell formation under uncertainty considering social criteria**

- 2.1 Motivation
- 2.2 Problem formulation
  - 2.2.1 Problem assumptions
  - 2.2.2 Notations
  - 2.2.3 Mathematical formulation
  - 2.2.4 Linearization
- 2.3 Robust counterpart mathematical model
- 2.4 NSGA-II algorithm
- 2.5 Computational results
- 2.6 Conclusion



## 2 A bi-objective mathematical model for dynamic cell formation under uncertainty considering social criteria

### 2.1 Motivation

As mentioned in Chapter 1, to remain competitive on the marketplace, manufacturers and producers are forced to increase the reactivity, the flexibility and the agility of their manufacturing systems. Dynamic Cellular Manufacturing Systems (DCMS) are one of the well-known production systems, allowing to achieve these objectives. In addition, pressure from NGOs, social communities and the media are currently prompting researchers and firms to take into account Corporate Social Responsibility (CSR). CSR concerns the effect of corporate activities on different social entities, such as environment preservation, human rights, occupational safety, etc. According to our literature review, social criteria is one of the neglected issues in the literature body of DCMS. In this chapter, an attempt has been made to integrate social issues in the configuration of DCMS.

The research presented in this chapter contributes to the existent literature in two ways.

First, a bi-objective mathematical model is formulated to integrate the relative costs of DCMS and social issues. In other words, the proposed model tries to make a trade-off between economic and social criteria and to define the best configuration of CMS in each period.

Due to high levels of interaction between human and manufacturing environments, social issues are particularly important. Among these issues, stress due to job loss [104] and occupational injuries [105] caused by ergonomic problems are the most common. There are many social criteria in production system configuration and it is too difficult to develop an exhaustive model. In this study, an attempt has been made to choose social measures in such a way that they are closely related to the DCMS decisions. This consideration has an important impact in the DCMS configuration. However, mathematical modeling of social criteria is not easy because of their qualitative aspect and interdependency of these criteria. Therefore, for a better modeling of these criteria, a multidisciplinary research work is necessary. Aware of this difficulty, our effort goes to develop the model for some independent social criteria and to have the possibility for integration of new criteria. To this end, in the proposed model, the focus is put on two quantitative social issues, as the number of job

opportunities created and the number of potential hazards of machines. These social issues have been extracted according to the social accountability standards (SAI 8000 [106], ISO 26000 [107]) and ergonomic guideline (GRI [108], NIOSH [109]). For this aim, the second objective of proposed model focuses on these issues.

The second contribution of this work is to deal with several uncertainties as demand, machine availability and machine costs. For this aim, a robust counterpart has been developed. It may seem easier to use the deterministic parameter in a DCMS configuration, but in the real world, many parameters must be considered as uncertain. Moreover, a feasible solution could not be found for most deterministic problems of DCMS. These considerations may slightly affect the economic performance of a system, but they allow us to approach reality and above all to have a feasible solution under different kinds and levels of uncertainty.

Due to the complexity of the DCMS problem (NP Hard) [110] and in order to deal with the uncertainty of parameters and to obtain robust optimal solutions, one of the most common meta-heuristic methods, the NSGA-II algorithm, has been selected. The biggest challenge is to design this meta-heuristic method for DCMS problems. Finally, several numerical experiments allow us to validate the performance of a robust counterpart of the proposed model by sensitivity analysis of uncertainty levels.

## **2.2 Problem formulation**

The first objective function of the model is to minimize some of the costs, including machine fixed and variable costs, inter-cell movement costs, intra-cell movement costs, machine procurement costs, machine relocation costs and workers' wages. The second objective function is to optimize the social issues of the problem by maximizing job opportunities and minimizing potential machine hazards for worker during the planning phase.

The first social measure represents the variation of job opportunities created due to the hiring and firing of worker [106],[107] resulting from the buying and selling of machines from one period to another.

The second measure, which reflects the average fraction of potential hazards of each machine [108],[111]. It shows how much injury, illness and damage each machine causes for workers. The latter measure is taken into account through a parameter called "average fraction of potential machine hazard". This average fraction is a continuous number between 0 (the most safe) and 1 (the most dangerous) and is defined by the decision maker using a safety checklist, talking to workers, reviewing the manufacturer's information, and checking the injury and incident reports of each machine. Because of the differences in the

units of the two considered social measures, normalized weighting method is applied. The aggregation of these normalized value with weighting factors not only represents the importance of each measure but also decreases the computational complexity of evaluating each solution with social aspects [112],[113]. Other assumptions used for formulating the mathematical model are presented as follows.

### 2.2.1 Problem assumptions

It is noteworthy that assumptions are categorized into two part: general assumptions, which are shared with other proposed models in next chapters, and specific assumptions that are applicable for the model in each chapter. The general and specific assumptions are presented as follows:

#### *General assumptions*

- Each part has an operation sequence and must be processed according to the sequence, which is extracted from the route sheet parts.
- The fixed cost of each machine is independent of the assigned workload. This cost is considered for each machine whether or not it is used in the planning horizon, and includes the costs of total maintenance and overhead services.
- The variable cost of each machine includes the operation cost and depends on the workload assigned to each machine.
- Each machine type can process several operations. In other words, each processing of parts can be performed on different machine types with various processing times.
- The upper and lower bound of the cell size is known and fixed in all periods.
- The inter-intra movements of parts are performed in batches with different sizes and the related cost of this movement is dependent on the distance traveled. For decreasing the complexity of the problem we assume that the distance between two cells (inter) is the same, and that for each cell, the distance between two machines (intra) is the same. Furthermore, the dimensions of all machine types are supposed to be equal.

#### *Specific assumptions*

- The demand of each part type in each period is an uncertain parameter.
- The capability of each machine for processing parts is known. The time capacity (availability) of each machine is also an uncertain parameter.

- The fixed and variable costs of machine are considered as an uncertain parameter.
- The machine purchasing and selling costs in each period are considered as an uncertain value and include machine prices and freight charges, which means that movement costs between the place of storage and that of installation are not considered.
- The relocation cost (installation, un-installation, shifting) of each machine type between two periods is an uncertain parameter.
- The worker leveling rule (hiring – firing) in each period allows the decision maker to change the worker level to at most a certain percentage ( $\lambda_h$ ) of the worker level in the previous period.

### 2.2.2 Notations

As for assumptions the general notation, commonly used in all models, are presented in this section and the specific ones, related to a model, in each chapter.

#### *General Sets*

$p$	index for part types ( $p = 1, \dots, P$ )
$c$	index for manufacturing cells ( $c = 1, \dots, C$ )
$m$	index for machine types ( $m = 1, \dots, M$ )
$j$	index for operation of parts type $p$ ( $j = 1, \dots, O_p$ )
$h$	index for number of periods ( $h = 1, \dots, H$ )

#### *General Parameters*

$P$	number of part type
$H$	number of periods
$O_p$	number of operations for part type $p$
$C$	maximum number of cells (assumes given)
$M$	number of machine types
$D_{p,h}$	demand for part $p$ in period $h$
$B_p^{inter}$	batch size for inter-cell movement of part $p$
$B_p^{intra}$	batch size for intra-cell movement of part $p$
$\gamma_p^{inter}$	inter-cell movement cost per batch
$\gamma_p^{intra}$	intra-cell movement cost per batch. It is assumed that
	$\forall p (\gamma_p^{intra} / B_p^{intra}) < (\gamma_p^{inter} / B_p^{inter})$

$T_{m,h}$	time-capacity of machine type $m$ in period $h$
$UB$	maximum cell size
$LB$	minimum cell size
$t_{j,p,m}$	time required to process operation $j$ of part $p$ on machine type $m$
$a_{j,p,m}$	1, if operation $j$ of part $p$ can be done on machine type $m$ ; 0 otherwise

### *Specific Parameters*

$\alpha_{m,h}$	fixed cost of machine type $m$ in period $h$
$\beta_{m,h}$	variable cost of machine type $m$ in period $h$ per unit of time
$\delta_{m,h}$	relocation cost of machine type $m$ in period $h$
$L_m$	number of workers required for machine type $m$
$\varphi_{m,h}$	purchasing cost of machine type $m$ in period $h$
$\omega_{m,h}$	marginal revenue from selling machine type $m$ in period $h$
$S_m$	average fraction of potentially hazardous of machine type $m$
$\theta_{hd}$	normalized weighting factor of total number of potential machine's hazard
$\theta_{jo}$	normalized weighting factor of total number of job opportunities created
$\lambda_h$	maximum percentage of worker leveling variation in period $h$
$sa_{m,h}^L$	salary of worker working on machine type $m$ in period $h$

### *General Variables*

$N_{m,c,h}$	number of machine type $m$ assigned to cell $c$ at the beginning of period $h$
$K_{m,c,h}^+$	number of machine type $m$ added to cell $c$ at the beginning of period $h$
$K_{m,c,h}^-$	number of machine type $m$ removed from cell $c$ at the beginning of period $h$
$I_{m,h}^+$	number of machine type $m$ purchased at the beginning of period $h$
$I_{m,h}^-$	number of machine type $m$ sold at the beginning of period $h$

$x_{j,p,m,c,h}$  1, if operation  $j$  of part type  $p$  is performed in cell  $c$  in period  $h$  by machine type  $m$ ; 0 otherwise

### Specific Variables

$hi_h$  number of workers hired in period  $h$

$fi_h$  number of worker fired in period  $h$

### 2.2.3 Mathematical formulation

$$\begin{aligned}
 \text{Min } Z_1 = & \sum_{h=1}^H \sum_{m=1}^M \sum_{c=1}^C \alpha_{m,h} N_{m,c,h} + \sum_{h=1}^H \sum_{m=1}^M \sum_{c=1}^C \sum_{p=1}^P \sum_{j=1}^{O_p} \beta_{m,h} D_{p,h} t_{j,p,m} x_{j,p,m,c,h} \\
 & + \frac{1}{2} \sum_{h=1}^H \sum_{p=1}^P \gamma_p^{inter} \left[ \frac{D_{ph}}{B_p^{inter}} \left| \sum_{j=1}^{O_p-1} \sum_{c=1}^C \left| \sum_{m=1}^M x_{(j+1),p,m,c,h} - \sum_{m=1}^M x_{j,p,m,c,h} \right| \right. \right. \\
 & \left. \left. + \frac{1}{2} \sum_{j=1}^{O_p-1} \sum_{c=1}^C \left[ \gamma_p^{intra} \left[ \frac{D_{ph}}{B_p^{intra}} \right] \times \left( \sum_{m=1}^M \left| x_{(j+1),p,m,c,h} - x_{j,p,m,c,h} \right| - \left| \sum_{m=1}^M x_{(j+1),p,m,c,h} - \sum_{m=1}^M x_{j,p,m,c,h} \right| \right) \right] \right] \quad (2-1) \\
 & + \sum_{h=1}^H \sum_{m=1}^M \sum_{c=1}^C N_{m,c,h} L_m Sa_m^L + \frac{1}{2} \sum_{h=1}^H \sum_{m=1}^M \sum_{c=1}^C \delta_{m,h} (K_{m,c,h}^+ + K_{m,c,h}^-) \\
 & + \sum_{h=1}^H \sum_{m=1}^M I_{m,h}^+ \varphi_{m,h} - \sum_{h=1}^H \sum_{m=1}^M I_{m,h}^- \omega_{m,h}
 \end{aligned}$$

$$\text{Max } Z_2 = \theta_{jo} \left( \sum_{h=1}^H hi_h - \sum_{h=1}^H fi_h \right) - \theta_{hd} \left( \sum_{h=1}^H \sum_{m=1}^M \sum_{c=1}^C N_{m,c,h} S_m \right) \quad (2-2)$$

S.t.

$$\sum_{c=1}^C \sum_{m=1}^M a_{j,p,m} x_{j,p,m,c,h} = 1 \quad \forall j, p, h \quad (2-3)$$

$$x_{j,p,m,c,h} \leq a_{j,p,m} \quad \forall j, p, c, m, h \quad (2-4)$$

$$\sum_{p=1}^P \sum_{j=1}^{O_p} D_{p,h} t_{j,p,m} x_{j,p,m,c,h} \leq T_{m,h} N_{m,c,h} \quad \forall m, c, h \quad (2-5)$$

$$N_{m,c,(h-1)} + K_{m,c,h}^+ - K_{m,c,h}^- = N_{m,c,h} \quad \forall m, c, h \quad (2-6)$$

$$\sum_{c=1}^C N_{m,c,(h-1)} + I_{m,h}^+ - I_{m,h}^- = \sum_{c=1}^C N_{m,c,h} \quad \forall m, h \quad (2-7)$$

$$\sum_{m=1}^M N_{m,c,h} \leq UB \quad \forall c,h \quad (2-8)$$

$$\sum_{m=1}^M N_{m,c,h} \geq LB \quad \forall c,h \quad (2-9)$$

$$\sum_{m=1}^M I_{m,h}^+ L_m \leq hi_h \quad \forall h \quad (2-10)$$

$$\sum_{m=1}^M I_{m,h}^- L_m \leq fi_h \quad \forall h \quad (2-11)$$

$$\left| \sum_{m=1}^M [(I_{m,h}^+ - I_{m,h}^-) L_m] \right| \leq \left( \sum_{m=1}^M \left( \sum_{c=1}^C N_{m,c,(h-1)} \right) L_m \right) \lambda_h \quad \forall h \quad (2-12)$$

$$x_{j,p,m,c,h} \in \{0,1\}, \quad (2-13)$$

$$N_{m,c,h}, K_{m,c,h}^+, K_{m,c,h}^-, I_{m,h}^+, I_{m,h}^-, hi_h, fi_h \geq 0 \text{ and integer}$$

The objective function (2-1) represents the minimizing of total costs, that includes eight terms: the first term relates to the machine fixed costs; the second term represents variable machine costs; the third term relates to the part's inter-cell movement costs; the fourth term represents the part's intra-cell movement costs; the fifth term includes wages or salaries; the sixth term represents machine relocation costs; the seventh term includes machine procurement costs; and the eighth term relates to revenue from selling the machine.

The objective function (2-2) maximizes the social aspects of DCMS configuration during the planning horizon that includes maximizing job opportunities and minimizing potential machines hazards.

Constraint (2-3) ensures that each operation of a part is assigned to just one machine and one cell. Constraint (2-4) guarantees that the process of each part is assigned to the appropriate machines. Constraint (2-5) ensures that the time capacity of each machine is not exceeded. Constraints (2-6) and (2-7) ensure that in each planning period the number of machines is balanced. Constraints (2-8) and (2-9) determine the maximum and minimum cell sizes according to the defined upper and lower bound. Constraints (2-10) and (2-11) calculate the number of workers that are respectively hired and fired. Constraint (2-12) guarantees maximum worker leveling variation in each period. Constraint (2-13) defines non-negativity, binary and integer necessities of decision variables.

#### 2.2.4 Linearization

The third and fourth terms of equation (2-1) in the proposed model make it a nonlinear equation. In order to transform it to a linear equation for the third

term, two non-negative variables,  $z_{j,p,c,h}^1$  and  $z_{j,p,c,h}^2$  are added and then the third term is rewritten as follows:

$$\frac{1}{2} \sum_{h=1}^H \sum_{p=1}^P \gamma^{inter} \left[ \frac{D_{ph}}{B_p^{inter}} \right] \sum_{j=1}^{O_p-1} \sum_{c=1}^C (z_{j,p,c,h}^1 + z_{j,p,c,h}^2) \quad (2-14)$$

Then following constraint must be added to the proposed model:

$$z_{j,p,c,h}^1 - z_{j,p,c,h}^2 = \sum_{m=1}^M x_{(j+1),p,m,c,h} - \sum_{m=1}^M x_{j,p,m,c,h} \quad \forall j, p, c, h \quad (2-15)$$

Similarity, to linearize the fourth term of equation (2-1),  $y_{j,p,m,c,h}^1$  and  $y_{j,p,m,c,h}^2$  are introduced as two non-negative variables, the fourth term of the objective function is therefore rewritable as follows:

$$\frac{1}{2} \sum_{h=1}^H \sum_{p=1}^P \gamma^{inter} \left[ \frac{D_{ph}}{B_p^{inter}} \right] \sum_{j=1}^{O_p-1} \sum_{c=1}^C \left( \sum_{m=1}^M (y_{j,p,m,c,h}^1 + y_{j,p,m,c,h}^2) - (z_{j,p,c,h}^1 + z_{j,p,c,h}^2) \right) \quad (2-16)$$

And also following constraint must be added to the proposed model.

$$y_{jpmch}^1 - y_{jpmch}^2 = x_{(j+1)pmch} - x_{jpmch} \quad \forall j, p, m, c, h \quad (2-17)$$

Equation (2-12) is the other case in which the proposed mathematical model is nonlinear. Hence, for linearization, instead of equation (2-12), equation (2-18) and (2-19) are added to the original model as follows:

$$\sum_{m=1}^M \left[ (I_{m,h}^+ - I_{m,h}^-) L_m \right] \leq \left( \sum_{m=1}^M \left( \sum_{c=1}^C N_{m,c,(h-1)} \right) L_m \right) \lambda_h \quad \forall h \quad (2-18)$$

$$\sum_{m=1}^M \left[ (I_{m,h}^- - I_{m,h}^+) L_m \right] \leq \left( \sum_{m=1}^M \left( \sum_{c=1}^C N_{m,c,(h-1)} \right) L_m \right) \lambda_h \quad \forall h \quad (2-19)$$

### 2.3 Robust counterpart mathematical model

In this section, we provide a quick description of the principles of robust optimization. Consider the following linear program (LP):

$$\begin{aligned} & \min \quad cx \\ & \text{s.t.} \\ & \quad Ax \geq b \end{aligned} \quad (2-20)$$

Where  $x \in \mathfrak{R}^n$  is the vector of decision variables,  $b \in \mathfrak{R}^m$  is the right-hand side parameter vector,  $c \in \mathfrak{R}^n$  is the vector of objective function coefficients, and  $A \in \mathfrak{R}^{m \times n}$ , with elements  $a_{ij}$ , is the constraint coefficient matrix.

In a typical problem like (LP),  $c$ ,  $A$  and  $b$  are assumed to be deterministic and optimal solution is obtained according to deterministic circumstances. Some of the data parameters are considered as uncertain in the Robust Optimization (RO) approach, yet they lie within a set that expresses limits on the uncertainty. The foregoing uncertainty set subsequently defines the limits on uncertainty



that a solution will be immunized against. That is, solution  $x$  deals with any possible uncertainty lying within the set. In the robust optimization approach, the (LP) is transformed into a robust counterpart by replacing each constraint that has uncertain coefficients with a constraint that reflects the incorporation of the uncertainty set. Let  $\tilde{c}_j$ ,  $\tilde{a}_{ij}$  and  $\tilde{b}_i$  denote, as an uncertain entry in the objective function coefficients, constraint coefficient and right-hand side parameters, respectively. In the proposed model, each of the uncertain parameters is assumed to vary in a specified closed, bounded box [114],[115],[116].

The general form of this box can be defined as follows:

$$u_{Box} = \left\{ \mathcal{G} \in \mathfrak{R}^n : \left| \mathcal{G}_t - \overline{\mathcal{G}}_t \right| \leq \rho \zeta_t, t = 1, 2, \dots, n \right\} \quad (2-21)$$

Where  $\overline{\mathcal{G}}_t$  is the normal value of  $\mathcal{G}_t$  as the  $t$  th parameter of vector  $\mathcal{G}$ , and where the positive number  $\zeta_t$  represents the “uncertainty scale” and  $\rho > 0$  is the “uncertainty level”. A particular case of interest is  $\zeta_t = \overline{\mathcal{G}}_t$ , which corresponds to a simple case where the box contains  $\mathcal{G}_t$ , whose relative deviation from the nominal data is up to  $\rho$ .

According to the above description, the robust counterpart of the LP model (2-22) can be stated as equations (2-23) to (2-26):

Mathematical model:

$$\begin{aligned} & \min \quad \tilde{c}x + dy \\ & s.t. \\ & \quad \tilde{a}x \geq b \\ & \quad ey \geq \tilde{f} \\ & \quad x, y \in \{0,1\} \end{aligned} \quad (2-22)$$

Robust counterpart mathematical model:

$$\min \quad z \quad (2-23)$$

$$s.t. \quad \tilde{c}_j x_j + dy \leq z \quad \forall \tilde{c}_j \in u_{Box}^c \quad (2-24)$$

$$\tilde{a}_{ij} x_j \geq b_j \quad \forall \tilde{a}_{ij} \in u_{Box}^a \quad (2-25)$$

$$e_i y \geq \tilde{f}_i \quad \forall \tilde{f}_i \in u_{Box}^f \quad (2-26)$$

$$x, y \in \{0,1\}$$

Ben-Tal *et al.* [115] demonstrate that in a closed bounded box, the robust counterpart problem can be converted to a tractable equivalent model where  $u_{Box}$  is replaced by a finite set  $u_{ext}$  consisting of the extreme points of  $u_{Box}$ . To represent the tractable form of the robust mathematical model, equations (2-23) to (2-26) should be converted to their tractable equivalents. For equation (2-24) we have:

$$\begin{aligned} \tilde{c}_j x &\leq z - dy, \\ \forall \tilde{c}_j \in u_{Box}^c \mid u_{Box}^c &= \left\{ \tilde{c}_j \in \mathfrak{R}^{n_c} : |\tilde{c}_j - \bar{c}_j| \leq \rho_c \zeta_j^c, j = 1, 2, \dots, n_c \right\} \end{aligned} \quad (2-27)$$

The left-hand side of equation (2-27) contains the vector of uncertain parameters, while all parameters of the right-hand side are certain. Thus, the tractable form of the above semi-infinite inequality could be written as follows:

$$\begin{aligned} \sum_j (\bar{c}_j x_j + \eta_j) &\leq z - dy, \\ \rho_c \zeta_j^c x_j &\leq \eta_j, \quad \forall j \in \{1, 2, \dots, n_c\}, \\ \rho_c \zeta_j^c x_j &\leq -\eta_j, \quad \forall j \in \{1, 2, \dots, n_c\}, \end{aligned} \quad (2-28)$$

For a constraint  $i$ ,  $\sum_{j=1}^n \tilde{a}_{ij} x_j \geq b_i$ , we only need to augment the left-hand side of the equation to reflect the uncertainty set in the formulation. Formally, in the augmented constraint we require, for a given solution  $x$ , that [117],[118]:

$$\min_{\tilde{a} \in u_{Box}^a} \left\{ \sum_{j=1}^n \tilde{a}_{ij} x_j \right\} \geq b_i \quad (2-29)$$

or

$$\min_{\tilde{a}_{ij} : |\tilde{a}_{ij} - \bar{a}_{ij}| \leq \rho_a \zeta_{ij}^a} \left\{ \sum_{j=1}^n \tilde{a}_{ij} x_j \right\} \geq b_i \quad (2-30)$$

Given the structure of  $u_{Box}$ , the optimal solution of the optimization on the left-hand side is:

$$\sum_{j=1}^n \bar{a}_{ij} x_j - \rho_a \sum_{j=1}^n \zeta_{ij}^a |x_j| \geq b_i \quad (2-31)$$

Which can be reformulated as:

$$\sum_{j=1}^n \bar{a}_{ij} x_j - \rho_a \sum_{j=1}^n \zeta_{ij}^a t_j \geq b_i \quad (2-32)$$

$$-t_j \leq x_j \leq t_j \quad \forall j (1, 2, \dots, n) \quad (2-33)$$

Similarly, for inequality (2-26) we have:

$$\begin{aligned} e_i y &\geq \tilde{f}_i, \quad \forall i \in \{1, 2, \dots, n_f\}, \\ \forall \tilde{f}_i \in u_{Box}^f \mid u_{Box}^f &= \left\{ \tilde{f}_i \in \mathfrak{R}^{n_f} : |\tilde{f}_i - \bar{f}_i| \leq \rho_f \zeta_i^f, i = 1, 2, \dots, n_f \right\} \end{aligned} \quad (2-34)$$

Thus, it can be rewritten as follows:

$$e_i y \geq \bar{f}_i + \rho_f \zeta_i^f, \quad \forall i \in \{1, 2, \dots, n_f\} \quad (2-35)$$

According to the above explanation, for developing the robust counterpart of the proposed model, the related machine costs include fixed costs ( $\alpha_{m,h}$ ), variable costs ( $\beta_{m,h}$ ), relocation costs ( $\delta_{m,h}$ ), purchasing costs ( $\varphi_{m,h}$ ), and sales

revenue ( $\omega_{mh}$ ), which are assumed to be uncertain. The other parameters, such as demand of each part ( $D_{p,h}$ ) and time capacity of machines, ( $T_{m,h}$ ) are also of an uncertain nature. Hence, the robust counterpart of the presented DCMS model with uncertain parameters given by box sets is equivalent to the following:

$$\text{Min } Z_1 \quad (2-36)$$

$$\text{Max } Z_2 = \theta_{jo} \left( \sum_{h=1}^H h i_h - \sum_{h=1}^H f i_h \right) - \theta_{hd} \left( \sum_{h=1}^H \sum_{m=1}^M \sum_{c=1}^C N_{m,c,h} S_m \right) \quad (2-37)$$

S.t.

$$\begin{aligned} Z_1 \geq & \sum_{h=1}^H \sum_{m=1}^M \sum_{c=1}^C (\bar{\alpha}_{m,h} N_{m,c,h} + \eta_{m,h}^\alpha) \\ & + \sum_{h=1}^H \sum_{m=1}^M \sum_{c=1}^C \sum_{p=1}^P \sum_{j=1}^{O_p} (\bar{\beta}_{p,h} \bar{D}_{p,h} t_{j,p,m} x_{j,p,m,c,h} + \eta_{p,h}^D + \eta_{p,h}^\beta) \\ & + \frac{1}{2} \sum_{h=1}^H \sum_{p=1}^P \gamma_p^{inter} \left[ \frac{\bar{D}_{ph}}{B_p^{inter}} \right] \sum_{j=1}^{O_p-1} \sum_{c=1}^C (z_{j,p,c,h}^1 + z_{j,p,c,h}^2) + \eta_{p,h}^D \\ & + \frac{1}{2} \sum_{h=1}^H \sum_{p=1}^P \left[ \gamma_p^{intra} \left[ \frac{\bar{D}_{ph}}{B_p^{intra}} \right] \times \right. \\ & \left. \sum_{j=1}^{O_p-1} \sum_{c=1}^C \left( \sum_{m=1}^M (y_{j,p,m,c,h}^1 + y_{j,p,m,c,h}^2) - (z_{j,p,c,h}^1 + z_{j,p,c,h}^2) \right) \right] + \eta_{p,h}^D \quad (2-38) \\ & + \sum_{h=1}^H \sum_{m=1}^M \sum_{c=1}^C N_{m,c,h} L_m S a_{m,h}^L \\ & + \frac{1}{2} \sum_{h=1}^H \sum_{m=1}^M \sum_{c=1}^C (\bar{\delta}_{m,h} (K_{m,c,h}^+ + K_{m,c,h}^-) + \eta_{m,h}^\delta) \\ & + \sum_{h=1}^H \sum_{m=1}^M (I_{m,h}^+ \bar{\varphi}_{m,h} + \eta_{m,h}^\varphi) - \sum_{h=1}^H \sum_{m=1}^M (I_{m,h}^- \bar{\omega}_{m,h} + \eta_{m,h}^\omega) \end{aligned}$$

$$\sum_{c=1}^C \sum_{m=1}^M a_{j,p,m} x_{j,p,m,c,h} = 1 \quad \forall j, p, h \quad (2-39)$$

$$x_{j,p,m,c,h} \leq a_{j,p,m} \quad \forall j, p, c, m, h \quad (2-40)$$

$$\begin{aligned} & \sum_{p=1}^P \sum_{j=1}^{O_p} \bar{D}_{p,h} t_{j,p,m} x_{j,p,m,c,h} + \rho_D \sum_{p=1}^P \sum_{j=1}^{O_p} \zeta_{p,h}^D x_{j,p,m,c,h} \\ & \leq \bar{T}_{m,h} N_{m,c,h} + \rho_T \zeta_{m,h}^T N_{m,c,h} \quad \forall m, c, h \quad (2-41) \end{aligned}$$

$$N_{m,c,(h-1)} + K_{m,c,h}^+ - K_{m,c,h}^- = N_{m,c,h} \quad \forall m,c,h \quad (2-42)$$

$$\sum_{c=1}^C N_{m,c,(h-1)} + I_{m,h}^+ - I_{m,h}^- = \sum_{c=1}^C N_{m,c,h} \quad \forall m,h \quad (2-43)$$

$$\sum_{m=1}^M N_{m,c,h} \leq UB \quad \forall c,h \quad (2-44)$$

$$\sum_{m=1}^M N_{m,c,h} \geq LB \quad \forall c,h \quad (2-45)$$

$$\sum_{m=1}^M I_{m,h}^+ L_m \leq hi_h \quad \forall h \quad (2-46)$$

$$\sum_{m=1}^M I_{m,h}^- L_m \leq fi_h \quad \forall h \quad (2-47)$$

$$\sum_{m=1}^M [(I_{m,h}^+ - I_{m,h}^-) L_m] \leq \left( \sum_{m=1}^M \left( \sum_{c=1}^C N_{m,c,(h-1)} \right) L_m \right) \lambda_h \quad \forall h \quad (2-48)$$

$$\sum_{m=1}^M [(I_{m,h}^- - I_{m,h}^+) L_m] \leq \left( \sum_{m=1}^M \left( \sum_{c=1}^C N_{m,c,(h-1)} \right) L_m \right) \lambda_h \quad \forall h \quad (2-49)$$

$$\rho_\alpha \zeta_{m,h}^\alpha N_{m,c,h} \leq \eta_{m,h}^\alpha \quad \forall m,c,h \quad (2-50)$$

$$\rho_\alpha \zeta_{m,h}^\alpha N_{m,c,h} \geq -\eta_{m,h}^\alpha \quad \forall m,c,h \quad (2-51)$$

$$\rho_\beta \zeta_{p,h}^\beta x_{j,p,m,c,h} \leq \eta_{p,h}^\beta \quad \forall j,p,m,c,h \quad (2-52)$$

$$\rho_\beta \zeta_{p,h}^\beta x_{j,p,m,c,h} \geq -\eta_{p,h}^\beta \quad \forall j,p,m,c,h \quad (2-53)$$

$$\rho_D \zeta_{p,h}^D x_{j,p,m,c,h} \leq \eta_{p,h}^D \quad \forall j,p,m,c,h \quad (2-54)$$

$$\rho_D \zeta_{p,h}^D x_{j,p,m,c,h} \geq -\eta_{p,h}^D \quad \forall j,p,m,c,h \quad (2-55)$$

$$\rho_D \zeta_{p,h}^D z_{j,p,c,h}^1 \leq \eta_{p,h}^D \quad \forall j,p,m,c,h \quad (2-56)$$

$$\rho_D \zeta_{p,h}^D z_{j,p,c,h}^1 \geq -\eta_{p,h}^D \quad \forall j,p,m,c,h \quad (2-57)$$

$$\rho_D \zeta_{p,h}^D z_{j,p,c,h}^2 \leq \eta_{p,h}^D \quad \forall j,p,m,c,h \quad (2-58)$$

$$\rho_D \zeta_{p,h}^D z_{j,p,c,h}^2 \geq -\eta_{p,h}^D \quad \forall j,p,m,c,h \quad (2-59)$$

$$\rho_D \zeta_{p,h}^D y_{j,p,m,c,h}^1 \leq \eta_{p,h}^D \quad \forall j,p,m,c,h \quad (2-60)$$

$$\rho_D \zeta_{p,h}^D y_{j,p,m,c,h}^1 \geq -\eta_{p,h}^D \quad \forall j,p,m,c,h \quad (2-61)$$

$$\rho_D \zeta_{p,h}^D y_{j,p,m,c,h}^2 \leq \eta_{p,h}^D \quad \forall j,p,m,c,h \quad (2-62)$$

$$\rho_D \zeta_{p,h}^D y_{j,p,m,c,h}^2 \geq -\eta_{p,h}^D \quad \forall j,p,m,c,h \quad (2-63)$$

$$\rho_\delta \zeta_{m,h}^\delta K_{m,c,h}^+ \leq \eta_{m,h}^\delta \quad \forall m,c,h \quad (2-64)$$

$$\rho_\delta \zeta_{m,h}^\delta K_{m,c,h}^+ \geq -\eta_{m,h}^\delta \quad \forall m,c,h \quad (2-65)$$

$$\rho_{\delta} \zeta_{m,h}^{\delta} K_{m,c,h}^{-} \leq \eta_{m,h}^{\delta} \quad \forall m,c,h \quad (2-67)$$

$$\rho_{\delta} \zeta_{m,h}^{\delta} K_{m,c,h}^{-} \geq -\eta_{m,h}^{\delta} \quad \forall m,c,h \quad (2-68)$$

$$\rho_{\varphi} \zeta_{m,h}^{\varphi} I_{m,h}^{+} \leq \eta_{m,h}^{\varphi} \quad \forall m,h \quad (2-69)$$

$$\rho_{\varphi} \zeta_{m,h}^{\varphi} I_{m,h}^{+} \geq -\eta_{m,h}^{\varphi} \quad \forall m,h \quad (2-70)$$

$$\rho_{\omega} \zeta_{m,h}^{\omega} I_{m,h}^{-} \leq \eta_{m,h}^{\omega} \quad \forall m,h \quad (2-71)$$

$$\rho_{\omega} \zeta_{m,h}^{\omega} I_{m,h}^{-} \geq -\eta_{m,h}^{\omega} \quad \forall m,h \quad (2-72)$$

$$z_{j,p,c,h}^1 - z_{j,p,c,h}^2 = \sum_{m=1}^M x_{(j+1),p,m,c,h} - \sum_{m=1}^M x_{j,p,m,c,h} \quad \forall j,p,c,h \quad (2-73)$$

$$y_{j,p,m,c,h}^1 - y_{j,p,m,c,h}^2 = x_{(j+1),p,m,c,h} - x_{j,p,m,c,h} \quad \forall j,p,m,c,h \quad (2-74)$$

$$x_{j,p,m,c,h} \in \{0,1\},$$

$$N_{m,c,h}, K_{m,c,h}^{+}, K_{m,c,h}^{-}, I_{m,h}^{+}, I_{m,h}^{-}, hi_h, fi_h \geq 0 \text{ and integer} \quad (2-75)$$

$$z_{j,p,c,h}^1, z_{j,p,c,h}^2, y_{j,p,m,c,h}^1, y_{j,p,m,c,h}^2 \geq 0$$

$$\eta_{m,h}^{\alpha}, \eta_{p,h}^{\beta}, \eta_{p,h}^D, \eta_{m,h}^{\delta}, \eta_{m,h}^{\varphi}, \eta_{m,h}^{\omega} \geq 0$$

## 2.4 NSGA-II algorithm

Numerous methods have been developed to deal with multi-objective problems. Some of them define an integrated objective function based on all objective functions (*e.g.*, weighted sum method) and reach an optimal or near-optimal result. However, it is noteworthy that, the exact resolution approach could be used for small size of problem, because of important calculation time. Other methods aim to find a set of solutions named Pareto solutions. The Optimal Pareto set involves a number of solutions, none of which can completely dominate other Pareto solutions. Non-Dominated Sorting Genetic Algorithm II (NSGA-II) is a meta-heuristic, which belongs to evolutionary algorithms and is a commonly used method when there is a problem with more than one goal.

This method, first proposed by Deb *et al.* [119], finds a near-optimal Pareto set. In fact, an initial population is randomly generated and then, for a given number of iterations, new solutions are obtained from existing solutions, per iteration, through crossover and mutation. Employing a crossover operator, two parents are chosen and they produce two new children by combining their characteristics. It should be mentioned that a binary tournament selection process does parents' selection. In this process, two members are randomly selected and the winner can stay as a parent in our parent set. This is done 2N times to choose N parents. In a mutation operation, a member is selected randomly and is changed in some respects.

Here, members of a population are compared with each other in relation to two criteria: rank and crowding distance. Members are sorted and ranked. Consequently, the solutions of a same rank cannot dominate each other; this means that if two members of the same rank are selected, neither of them is better in all objective functions. On the other hand, crowding distance is a criterion, which investigates the diversity of solutions, and high crowding distance is preferred. Of course, crowding distance is a criterion measured for members of a specific rank. Equation (2-76) explains the way in which crowding distances are measured.

In the equation,  $d_i$  is the crowding distance of solution  $i$  where  $f_i^r$  represents the  $r^{th}$  objective function value of the  $i^{th}$  solution, and  $f_{\min}^r$  and  $f_{\max}^r$  are minimum and maximum values of the  $r^{th}$  objective function, respectively. The crowding distance of the first and last points, the points that have optimum value in at least one objective, is moreover assumed to be infinite.

$$d_i = \sum_r \frac{f_{i+1}^r - f_{i-1}^r}{f_{\max}^r - f_{\min}^r} \quad (2-76)$$

It is noteworthy initial solutions of the algorithm are generated randomly. The NSGA-II algorithm has four vital parameters, which should be appropriately tuned before using them to find best results:

- Number of members in a population ( $NPop$ )
- Number of iterations to find best results ( $MaxIt$ )
- Crossover rate ( $CrR$ )
- Mutation rate ( $MuR$ )

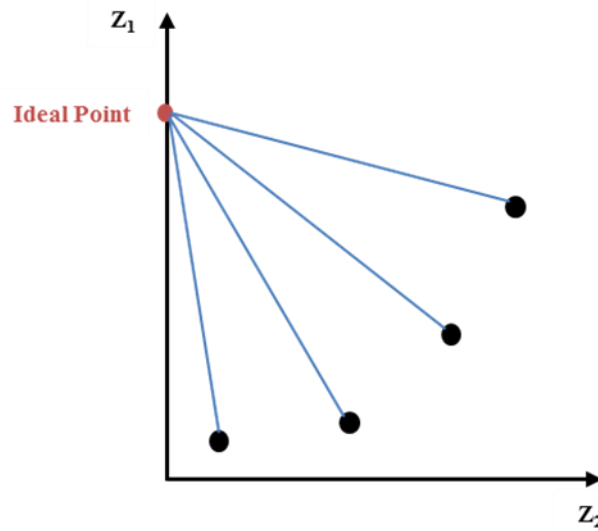
As a result, a Taguchi design [120] is employed to set a suitable level for the parameters. Here, we assume three different levels for each parameter:

- $NPop$ : 40, 60 and 80
- $MaxIt$ : 20, 50 and 100
- $CrR$ : 0.2 (20%), 0.5 and 0.8
- $MuR$ : 0.1 (10%), 0.2 and 0.3

A response should furthermore be defined for the Taguchi design. Spacing Metric (SM) is a metric used to evaluate Pareto results and is measured by equation (2-77) where  $d_i^o$  represents the Euclidian distance between two consecutive points (*i.e.*, points  $i$  and  $i+1$ ),  $\bar{d}$  is their average, and  $N$  is the number of members in final non-dominated solutions. An algorithm with more SM is preferred.

$$SM = \frac{\sum_{i=1}^{N-1} |\bar{d} - d_i^o|}{(N-1)\bar{d}} \quad (2-77)$$

Distance to an ideal point (D2P) is another metric which calculates the average Euclidian distance of the Pareto results from an ideal point in the space (*e.g.*, Figure 2.1). Of course, the ideal point is selected by decision maker. In this study the utopia point is considered as an ideal point.



**Figure 2.1** Distance of Pareto solutions from an ideal point

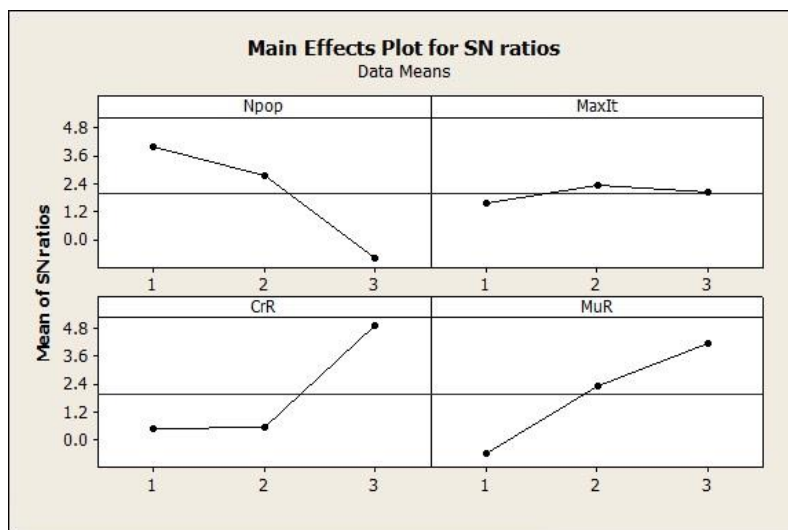
Computational time is also an important criterion of this method. As a result, the table of the Taguchi design is done with Minitab software (version 16), and best levels of parameters are selected as represented in Tables 2.1 and 2.2 and Figure 2.2. Table 2.1 displays responses in the experiments. Regarding the same importance of three responses, normalization is used to convert all values to a number in the range [0, 1]. Based on these experiments, Figure 2.2 serves as a graphic tool to choose the best levels for the considered parameters. In fact, level 1 of *NPop*, i.e. 40, level 2 of *MaxIt*, i.e. 50, level 3 of *CrR*, i.e. 0.8, and level 3 of *MuR*, i.e. 0.3, have been determined as best levels for the parameters.

**Table 2.1** Experiments of the Taguchi design

Experiment	Coded levels				Uncoded levels			
	<i>Npop</i>	<i>MaxIt</i>	<i>CrR</i>	<i>MuR</i>	<i>Npop</i>	<i>MaxIt</i>	<i>CrR</i>	<i>MuR</i>
1	1	1	1	1	40	20	0.2	0.1
2	1	2	2	2	40	50	0.5	0.2
3	1	3	3	3	40	100	0.8	0.3
4	2	1	2	3	60	20	0.5	0.3
5	2	2	3	1	60	50	0.8	0.1
6	2	3	1	2	60	100	0.2	0.2
7	3	1	3	2	80	20	0.8	0.2
8	3	2	1	3	80	50	0.2	0.3
9	3	3	2	1	80	100	0.5	0.1

**Table 2.2** Obtained responses of Taguchi experiments

Experiments	Real values			Normalized values		
	SM	D2P	Time (s)	SM	D2P	Time (s)
1	0.921	10003360428	34.167	0.431	1	0
2	0.897	9996648391	209.943	0.373	0.636	0.118
3	1.069	9994073131	673.243	0.805	0.496	0.43
4	1.058	9995545657	198.928	0.778	0.576	0.111
5	0.777	9988679715	552.402	0.07	0.204	0.349
6	0.785	9996204858	425.263	0.088	0.612	0.263
7	0.757	9990439112	500.821	0.019	0.299	0.314
8	1.146	9986893557	515.639	1	0.107	0.324
9	0.75	9984924763	1520.5	0	0	1



**Figure 2.2** Signal to noise ratio from Taguchi experiments

## 2.5 Computational results

Some numeric examples have to be generated in order to evaluate the performance of the proposed robust mathematical model. Three sets of examples are therefore generated, based on the pattern in Table 2.3, in different sizes named S1, S2 and S3, respectively, shown in Table 2.4. On the other hand, the uncertainty levels for all parameters are the same (*i.e.*  $\rho_\alpha = \rho_\beta = \rho_D = \rho_\delta = \rho_\phi = \rho_\omega$ ) and take three different values: 0.25, 0.50 and 0.75. On each uncertainty level, five problems are derived from S1, S2 and S3



with different amounts of uncertain data, subject to their range of deviation from nominal levels. This action is taken into account to simulate five different possible states of a case and to solve all of them, in order to assess the performance of the proposed models. This operation could actually be called realization. All deterministic and robust problems are solved by the NSGA-II algorithm, using Matlab software (version 2012a) on a Core 2 Duo Notebook, 2.67 GHz with 4 GB RAM. Some of these patterns are taken from Safaei *et al.* [63], while others are generated for our problem.

**Table 2.3** Pattern of sample generation

Parameter	Generation pattern	Parameter	Generation pattern
$D_{p,h}$	$\sim$ Uniform (100, 1000)	$UB$	4
$B_p^{inter}$	$\sim$ Uniform (10, 50)	$LB$	1
$B_p^{intra}$	$B_p^{inter} / 5$	$L_m$	$\sim$ Uniform (1, 8)
$\gamma_p^{inter}$	$\sim$ Uniform (1, 30)	$\varphi_{m,h}$	$\sim$ Uniform (1000, 5000)
$\gamma_p^{intra}$	$\sim$ Uniform (1, 30)	$\omega_{m,h}$	$\sim$ Uniform (0, 1) $\times \varphi_{mh}$
$\alpha_{m,h}$	$\sim$ Uniform (1000, 2000)	$S_m$	$\sim$ Uniform (0, 1)
$\beta_{m,h}$	$\sim$ Uniform (1, 10)	$\lambda_h$	$\sim$ Uniform (0, 1)
$\delta_{m,h}$	$\alpha_{mh} / 2$	$s\alpha_{m,h}^L$	$\sim$ Uniform (50, 75)
$T_{m,h}$	$\sim$ Uniform (1, 5)	$t_{j,p,m}$	$\sim$ Uniform (1, 10)

\* Time in hours

**Table 2.4** Different sizes of problems

	S1	S2	S3
$ O_p  \times  P  \times  M  \times  C  \times  H $	$3 \times 3 \times 4 \times 3 \times 2$	$6 \times 6 \times 7 \times 5 \times 4$	$8 \times 8 \times 9 \times 6 \times 5$

A set of solutions, called Pareto results, is predictably obtained after running NSGA-II. A Pareto set, as mentioned above, involves a number of non-dominated solutions. This means that each result is better than at least one other result in the Pareto set, considering an objective function, and is worse than that, considering another objective function. In all Pareto sets of bi-objective problems, there are two important points: one with an optimum level for one objective, and one with an optimum level for another objective. Tables 2.5 and 2.6 report the best solutions obtained for Z1 and Z2, respectively.

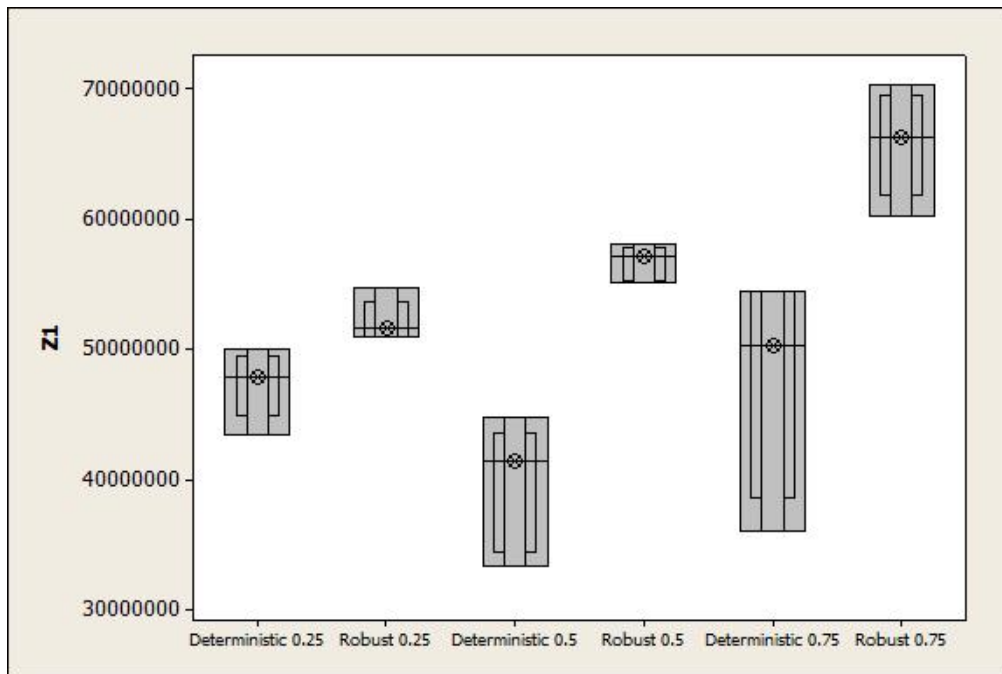
**Table 2.5** Objective functions value with best Z1 in final Pareto results

		Deterministic		Robust		
		Z <sub>1</sub>	Z <sub>2</sub>	Z <sub>1</sub>	Z <sub>2</sub>	
$\rho = 0.25$	S1	1	2660152	9.30	3869829	11.58
		2	2817647	10.17	3958172	12.47
		3	2590974	8.79	3809776	10.04
		4	3328184	11.57	4151874	13.73
		5	3227828	10.31	4079282	11.64
	S2	1	48897145	19.61	51645075	24.44
		2	47929235	23.57	50985008	25.96
		3	43446370	16.82	51015775	25.67
		4	46511082	18.21	54762120	23.17
		5	50124192	22.80	52640809	24.36
	S3	1	Infeasible	Infeasible	133682132	30.80
		2	Infeasible	Infeasible	129053558	29.90
		3	Infeasible	Infeasible	139439767	30.07
		4	131126369	29.33	133304621	30.95
		5	125392597	27.64	129728057	29.39
$\rho = 0.50$	S1	1	3233609	9.18	5281690	11.36
		2	2984265	11.30	5025683	12.76
		3	3483557	9.85	5353713	12.09
		4	3194290	12.29	5231658	13.34
		5	2943472	9.44	5049565	11.62
	S2	1	33447984	21.77	58145649	25.86
		2	41522784	25.35	57491017	28.19
		3	44879080	18.64	57229791	27.97
		4	42390396	20.08	55506873	25.54
		5	35466965	19.59	55233404	26.78
	S3	1	Infeasible	Infeasible	141158769	32.91
		2	138828320	26.73	143221613	31.98
		3	Infeasible	Infeasible	144363247	32.61
		4	141310553	29.08	144875053	32.94
		5	134058112	28.29	140746973	31.14
$\rho = 0.75$	S1	1	3103390	10.71	6209219	13.76
		2	3556638	12.87	6372328	14.41
		3	3699606	11.47	6397338	14.05
		4	3944940	12.26	6521649	14.97
		5	3342342	11.63	6345644	13.07
	S2	1	54402305	23.13	68658804	26.28
		2	Infeasible	Infeasible	63567388	28.69
		3	54493461	20.48	66275691	27.06
		4	36131037	21.73	60240167	26.64
		5	46308242	22.14	70419317	27.80
	S3	1	Infeasible	Infeasible	162653028	32.75
		2	Infeasible	Infeasible	161786934	32.24
		3	Infeasible	Infeasible	160016398	33.35
		4	Infeasible	Infeasible	164223733	33.52
		5	Infeasible	Infeasible	159613662	32.01

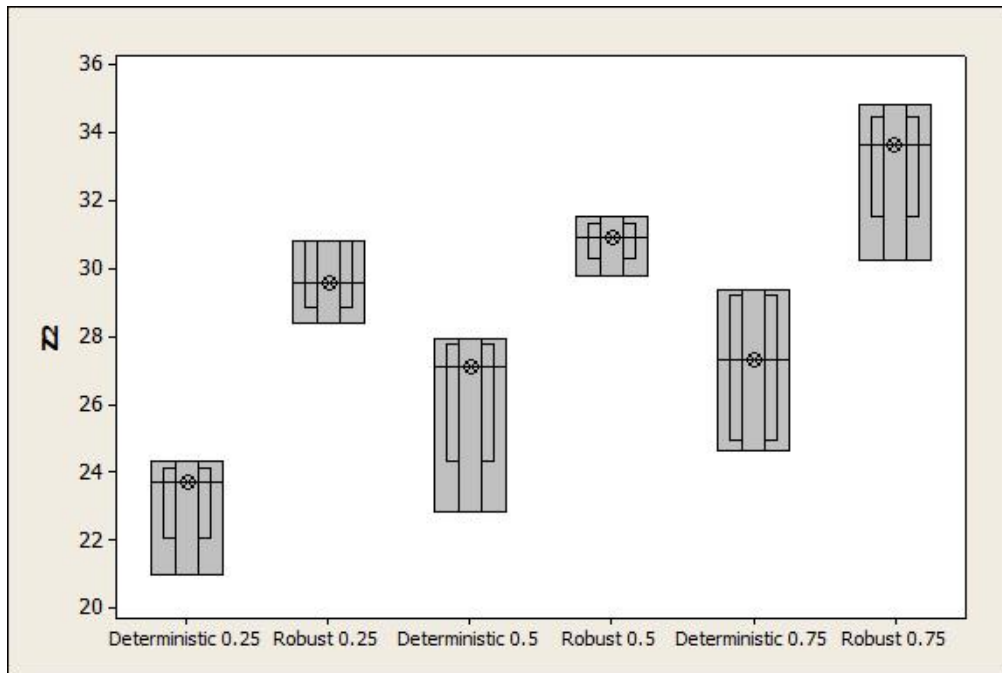
**Table 2.6** Objective functions value with best Z2 in final Pareto results

		Deterministic		Robust		
		Z <sub>1</sub>	Z <sub>2</sub>	Z <sub>1</sub>	Z <sub>2</sub>	
$\rho = 0.25$	S1	1	5554496	12.41	6559327	15.16
		2	5608261	13.09	6615716	15.47
		3	5366828	11.72	6427405	14.88
		4	5920855	13.87	6795080	15.93
		5	5856379	13.28	6704907	15.11
	S2	1	77909945	23.73	79277216	29.59
		2	77111769	23.14	84780634	30.81
		3	66841834	21.01	72011777	29.32
		4	75987696	23.98	81542885	30.84
		5	67570578	24.36	63376426	28.43
	S3	1	Infeasible	Infeasible	188016979	36.15
		2	Infeasible	Infeasible	186232042	35.96
		3	Infeasible	Infeasible	189777164	36.07
		4	179781896	35.78	187776447	36.83
		5	172087733	33.37	186878868	35.71
$\rho = 0.50$	S1	1	6147074	11.97	7862448	14.22
		2	5735765	13.16	7650407	15.83
		3	6344049	12.38	7933251	14.79
		4	6295541	14.04	7824441	15.96
		5	5996903	12.84	7733181	15.07
	S2	1	74385260	27.67	85857450	30.85
		2	67801284	25.85	93747777	31.53
		3	71363586	27.95	82361564	29.81
		4	64996306	22.86	83582232	30.92
		5	64455603	27.11	89842826	31.12
	S3	1	Infeasible	Infeasible	192315126	37.43
		2	183139967	33.14	193541829	36.62
		3	Infeasible	Infeasible	194277386	37.15
		4	189048329	35.22	196250678	37.48
		5	180198052	34.67	192121899	36.33
$\rho = 0.75$	S1	1	6525453	12.76	76394726	15.72
		2	6319703	14.53	7761483	16.04
		3	6814392	13.65	7937980	16.38
		4	7039242	14.24	8184947	16.74
		5	6612239	13.90	7763060	15.46
	S2	1	72335438	28.71	87826886	32.85
		2	Infeasible	Infeasible	100359058	33.66
		3	86370933	25.96	96011762	34.17
		4	62184179	24.67	81592600	30.27
		5	86072371	29.41	110391114	34.82
	S3	1	Infeasible	Infeasible	204630224	37.21
		2	Infeasible	Infeasible	203832468	36.94
		3	Infeasible	Infeasible	201999065	38.43
		4	Infeasible	Infeasible	206310318	38.76
		5	Infeasible	Infeasible	201836404	36.48

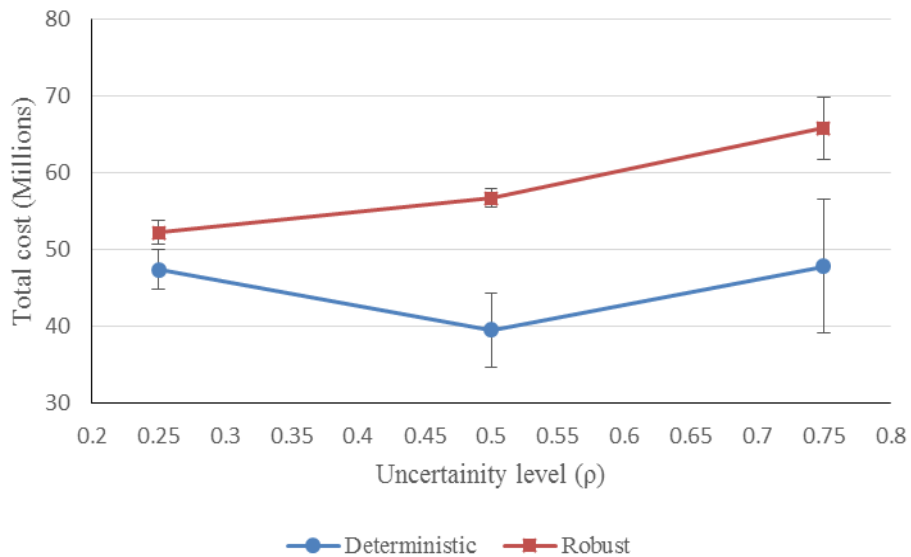
Figures 2.3 and 2.4 illustrate the difference between the robust and deterministic models in the second size, S2. Each block presents the mean (horizontal line in the middle), the median (x in the circle on the middle horizontal line), the standard deviation (internal rectangle), and the max and min value of the objective function (external rectangle). The results demonstrate that the proposed robust model is worse than the deterministic model because in robust optimization all uncertain parameters are considered as worst cases in practice, in order to obtain lower risks and to limit loss as far as possible. The robust model is able to reach appropriate solutions in all sizes and at all considered levels of uncertainty, while the deterministic model is probably unfeasible when the level of uncertainty is increased (feasibility robustness). Moreover, the deterministic model could find better solutions than the robust one when, with the latter, the first objective function is more important and the second objective function is well maximized. However, based on figures 2.3 to 2.6, we find that the results of the robust model have higher values of the objective function but a lower standard deviation in comparison with the deterministic model in all uncertainty levels (optimality robustness). In other words, low standard deviation of robust results is another reason to demonstrate the efficiency of the proposed model. In fact, as Figures 2.3 to 2.6 show, there are six comparisons between deterministic and robust results, by which it could be found that most comparisons represent the lower deviation of robust results.



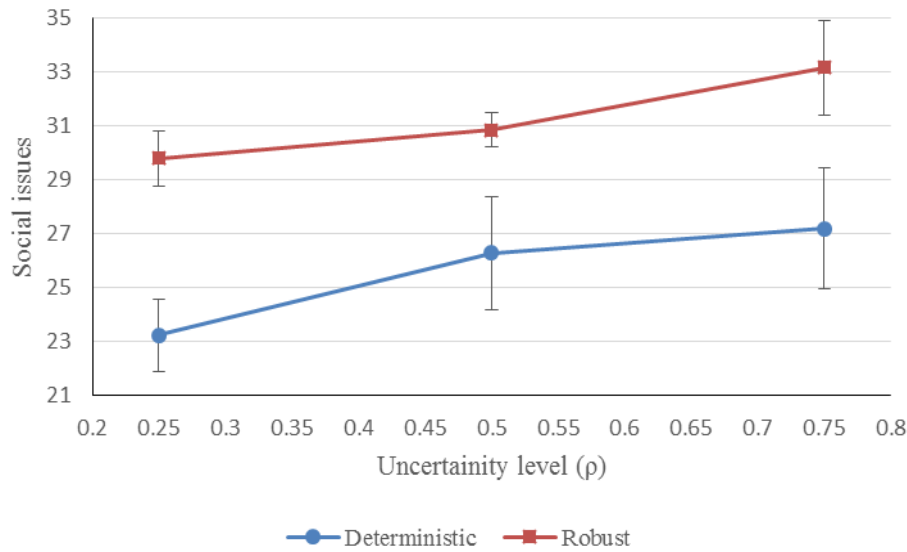
**Figure 2.3** Best results of Z1 for S2



**Figure 2.4** Best results of Z2 for S2



**Figure 2.5** Mean and standard deviation of first Objective function values (Z1)



**Figure 2.6** Mean and standard deviation of second Objective function values (Z2)

Table 2.7 shows the computational times of the solved problems. It is worth mentioning that the robust model contains more constraints, decision variables and parameters. It is therefore expected that computational times in a meta-heuristic algorithm will be longer in the robust model than in the deterministic model.

**Table 2.7** Computational times (Second)

	$\rho = 0.25$		$\rho = 0.50$		$\rho = 0.75$	
	Deterministic	Robust	Deterministic	Robust	Deterministic	Robust
S1	2.845	5.377	2.851	5.66	2.836	5.808
S2	72.143	127.145	71.831	125.077	72.356	124.255
S3	368.323	614.43	352.78	617.599	-	607.002

## 2.6 Conclusion

This chapter addresses a new model for DCMS configuration problem by adding some social issues, and introduces a new robust optimization model for dealing with uncertain parameters that are neglected in the literature.

A bi-objective mathematical model is developed, in which the first objective function minimizes related costs of problems, including machine and worker costs. The social aspect, consisting of job opportunities and occupational safety, is maximized by the second objective function. In the proposed model, in order to reduce its complexity, we take into account only two social criteria, even

though this model is able to integrate more criteria, such as job severity, occupational diseases, and worker days lost due to injury, in the second objective function.

In order to increase the capability of the proposed model to deal with uncertain data such as machine costs, demand for parts, and machine time capacity, a robust optimization approach is presented. A number of examples are generated and solved by employing a Non-Dominated Sorting Genetic Algorithm (NSGA-II). In our study, three test problems were examined in different states of uncertainty, which means that each of the based examples was used to generate various problems under uncertain parameters. The results illustrate the supremacy of the robust model in the handling of uncertain parameters and in the robustness of relevant solutions in comparison with the deterministic model. By a way of explanation, in contrast to the deterministic model, the robust model could obtain suitable solutions for all levels of uncertainty. Moreover, the results demonstrate the low deviation of the robust model in comparison with the deterministic one.

# 3

## **A bi-objective mathematical model for dynamic cell formation considering social and environmental issues and considering worker assignment**

- 3.1 Motivation
- 3.2 Problem formulation
  - 3.2.1 Problem assumptions
  - 3.2.2 Notations
  - 3.2.3 Mathematical formulation
  - 3.2.4 Linearization
- 3.3 Hybrid NSGA II-MOSA algorithm
- 3.4 Computational results
- 3.5 Conclusion



# 3 A bi-objective mathematical model for dynamic cell formation considering social and environmental issues and worker assignment

## 3.1 Motivation

In chapter 2, we presented a new model for configuration of DCMS, based on the trade-off between traditional economic criteria and social issues. Due to the pressures of communities, government and non-governmental organizations, managers and manufacturers force to consider environmental issues as well as social criteria. Therefore, in this chapter, we present a new mathematical model for configuration of DCMS by compromising between the total costs and environmental issues. The first objective of our model is associated with economic criteria, such as machine fixed and variable costs, inter/intra-cell movement costs, machine procurement, installation and relocation costs, and finally, hiring, firing and training costs of workers.

In order to be closer to reality, we assume that some costs, as hiring, firing, and training costs for each skill can vary from one period to another. Therefore, the model has to determine the best period for hiring, firing and training of workers, allowing to be more reactive and flexible. This kind of strategy can be very important in cost optimization and in workers' motivation.

The industrial sector is considered to be one of the major sources of pollution in the world. A large part of this pollution is produced by material waste, water pollution, and heat and Greenhouse Gas (GHG) emissions. Global warming, world pollution and ozone layer depletion force managers and manufacturers to improve the efficiency of their production systems, in order to decrease these forms of waste. This efficiency depends on the characteristics and age of the manufacturing equipment. The selection of equipment configuration or reconfiguration of systems are therefore one of the most important decision problems in reducing production waste.

In view of the importance of environmental criteria, the second objective focuses on waste minimization. In this way, several kinds of waste, such as CO<sub>2</sub> emissions, energy loss, raw material scrap, water pollution, etc., are considered. All wastes have been converted to one aggregated parameter, enabling the addition of other kinds of waste.

Workers are continuously exposed to noise hazards in manufacturing environments in which many machines work simultaneously, generating a significant level of noise overall. According to Leigh and Miller [121], in their review of job-related illness data from the Bureau of Labor Statistics, hearing loss accounts for the most lost days compared to any other occupational illness and concerns more than 300 occupations. Danial *et al.* [122] found that workers' compensation claims in Washington State regarding annual disability settlements for hearing-related problems was close to \$22.8 million. From the point of view of human costs, occupational noise exposure not only causes social and psychological disorders for workers, but also these workers suffer from increased fatigue during shift work. Niebel and Freivalds [123] indicate that intermittent broadband noise can result in productivity decreases and greater employee fatigue, due to annoyance and distraction.

Considerable effort has been devoted to controlling noise levels in workshops. Generally, there are various means to control industrial noise, such as proper design, maintenance, lubrication and alignment of machines, moving machines away from other workers, using barriers or shields in order to reflect high frequency noise, wearing hearing protection devices such as earplugs or earmuffs, etc. Moreover, job reassignment and reduction of daily exposure times to high noise levels based on corresponding standards through dynamic cell formation, production planning and work force assignment can be applied in addition to the above-mentioned protective and preventive actions [124],[125]. Tharmmaphornphilas *et al.* [126] provided a single-objective optimization model to minimize the maximum daily noise exposure among workers. Then, they ran a computer simulation model and compared the resulting schedules to those used in sawmill. Aryanezhad *et al.* [105] proposed a multi-objective integer programming model to reduce the costs, noise exposure index and lower-back pain index for a single-period job-rotation schedule problem. They considered different skill levels as well as different job categories.

Therefore, regarding the noise regulation, the worker assignment in the presented model is based on the maximum noise exposure per day, called as Daily Noise Dosage (DND). With regard to hearing loss, the National Institute of Occupational Safety and Health (NIOSH) [109] claimed that job rotation scheduling could be used as an effective means to control and reduce daily noise exposure. The Occupational Safety and Health Administration (OSHA) [127] as well as NIOSH [111] have provided threshold limit values for daily combined noise exposure levels, which represent conditions for permissible noise levels workers can be exposed to constantly.

Regarding the complexity of the model, only Daily Noise Dosage (DND) as social aspect have been taken into account as constraint. However, other social constraints can be integrated to this model.

Finally, another contribution has been provided regarding the resolution approach. Firstly, because of the complexity of model, it is necessary to linearize it. Secondly, due to its NP-hardness of problem [110], we develop a new hybrid meta-heuristic algorithm, composed by two well-known methods, *viz.*, NSGA II and MOSA. This algorithm combines the Non-dominated Sorting Genetic Algorithm (NSGA II) and Multi-objective Simulated Annealing (MOSA) to solve this problem. In order to increase the performance of the algorithm, six vital parameters by Number of Members of Population, Number of Iterations, Crossover Rate, Mutation Rate, Cooling Rate and Power Value, have been identified and tuned. Then Taguchi design is used as a Design of Experiment (DOE) method to set the appropriate levels of these parameters. The proposed algorithm has been applied on 10 test problems with different size.

Several demonstrations show the efficiency and performance of this hybrid meta-heuristic, compared to the application of each of them, separately.

### 3.2 Problem formulation

This section introduces the new bi-objective mathematical model where the first objective function minimizes various costs while the second one optimizes environmental aspects.

In order to reflect the waste of each machine while processing every operation, several types of waste have been considered in second objective. This consideration can include various features, such as energy waste, chemical waste, raw material waste, GHG emissions, etc. Knowing that the units of these features are different, several aggregation methods (*e.g.*, normalized weighting method [112], AHP method [128], etc.) can be applied to transform these features into a single parameter, called as machine waste for each operation. The waste for each operation of each machine can then be calculated as follows:

$$w_{j,m} = \alpha_1 \cdot (w_{energy}) + \alpha_2 \cdot (w_{chemical}) + \alpha_3 \cdot (w_{raw\ material}) + \alpha_4 \cdot (w_{GHG\ emission}) \quad (3-1)$$

Where  $\alpha_i$  are the normalized weights of each kind of waste. In proposed model, other environmental issues can also have an important impact on manufacturing systems. For example, the wasted energy (energy loss transformed into heat) for each operation on each machine may be estimated from the energy label (*i.e.*, efficiency ranked *A+*, *A*, *C*, etc.) and power (*i.e.*, energy consumption), provided by the manufacturer of this machine. This calculation is as follows:

$$power = \frac{E}{t} \quad (3-2)$$

Where  $E$  is the amount of energy consumed to do the operation and  $t$  is the time taken, since we have:

$$E = \text{useful energy} + \text{energy loss} \quad (3-3)$$

$$Efficiency = \frac{\text{useful energy}}{E} \quad (3-4)$$

### 3.2.1 Problem assumptions

In addition to the general assumptions presented in chapter 2 (page 25), the specific assumptions of this model are presented as follows:

- The demand of each type of part in each period is known and constant.
- The time capacity of each machine for processing parts is known and constant.
- The worker assignment is done according to the worker's skill level and the machine's skill level category. As each machine type is categorized with a level, each machine level needs the worker to have the corresponding skill level. For example, the worker assigned to a level-2 machine must him- or herself have a skill level 2 at least (a worker with skill level 2 can work with a level-2 or a level-1 machine, but a worker with skill level 1 can work only with a level-1 machine).
- The workers at each skill level can be upgraded to the higher level by a training process, which is modeled as a training cost.
- The machine purchasing and selling costs are known and constant in each period. These costs include machine prices and freight charges, which means that removal costs between the place of storage and that of installation are not considered.
- The relocation cost (un-installation, shifting and reinstallation) of each machine type between two periods is known and remains constant.

### 3.2.2 Notations

In addition to general notations, presented in chapter 2 (pages 26, 27), the specific notations of the model are presented as follows:

#### *Specific Sets*

- $s$  index for number of shifts per period ( $s = 1, 2, \dots, S$ )
- $d$  index for number of days per period ( $d = 1, 2, \dots, D$ )
- $l$  index for number of worker ( $l = 1, 2, \dots, NL$ )
- $k, k'$  index for level of machine ( $1, 2, \dots, ML$ )

$\alpha, \beta$  index for level of worker (1, 2, ...,  $\psi$ )

*Specific Parameters*

$S$	number of shifts per period
$D$	number of days per period
$NL$	number of workers
$ML$	number of machine levels
$\psi$	number of worker levels
$\lambda_m$	fixed cost of machine type $m$ per period
$\eta_m$	variable cost of machine type $m$ for each unit time
$\delta_m$	relocation cost of machine type $m$
$\varphi_m$	cost of purchase machine type $m$
$\omega_m$	marginal revenue from selling machine type $m$
$\bar{L}_k$	the combined noise level (dBA) measured at machine level $k$
$w_{j,m}$	total amount of waste of machine type $m$ to process each operation $j$
$UG_{\alpha,\beta}$	1, if training from skill level $\alpha$ to skill level $\beta$ is possible, 0 otherwise
$MTL_{m,k}$	1, if machine of type $m$ belongs to machine level $k$ , 0 otherwise
$WP_{\alpha,k}$	1, if working of a worker with skill level $\alpha$ on machine level $k$ is possible, 0 otherwise
$h_{\alpha,h}$	cost of hiring a worker with skill level $\alpha$ in period $h$
$C_{\alpha,\beta,h}$	training cost of each $\alpha$ -level worker for skill level $\beta$ in period $h$
$S_{\alpha,h}$	salary of each $\alpha$ -level worker in period $h$
$NL_m$	Number of workers needed for machine type $m$
$F_{\alpha,h}$	firing cost of each $\alpha$ -level worker in period $h$
$ALT$	available working time per worker in a working day
$t_s$	Time duration for each shift $s$
$BN$	an arbitrary big number

*Specific Variables*

$x'_{l,\alpha,k,h,s}$	1, if worker $l$ with skill level $\alpha$ is assigned to machine level $k$ in period $h$ and shift $s$ ; 0 otherwise
$EL_{\alpha,k,h}$	number of existing workers with skill level $\alpha$ who are assigned to machine level $k$ in period $h$

$HL_{\alpha,k,h}$	number of hired workers with skill level $\alpha$ who are assigned to machine level $k$ in period $h$
$FL_{\alpha,k,h}$	number of fired workers with skill level $\alpha$ who are assigned to machine level $k$ in period $h$
$TL_{\alpha,\beta,k,k',h}$	number of $\alpha$ -level workers who were working with machine level $k$ in period $h-1$ , and are upgraded by training to higher skill level $\beta$ and are assigned to machine level $k'$ in period $h$
$y_{\alpha,k',h}$	an auxiliary binary variable

*Note:*

$$EL_{\alpha,h,k} = \sum_{l=1}^L \sum_{s=1}^S x'_{l,\alpha,k,h,s} \quad \forall \alpha, k, h \quad (3-5)$$

### 3.2.3 Mathematical formulation

Once the sets, parameters and variables have been defined, the dynamic cell formation model with cost minimization, waste minimization and Daily Noise Dosage (DND) consideration is formulated as follows:

$$\begin{aligned}
 \text{Min } Z_1 = & \sum_{h=1}^H \sum_{m=1}^M \sum_{c=1}^C \lambda_m \times N_{m,c,h} \\
 & + \sum_{h=1}^H \sum_{m=1}^M \sum_{c=1}^C \sum_{p=1}^P \sum_{j=1}^{O_p} \eta_m \times D_{ph} \times t_{j,p,m} \times x_{j,p,m,c,h} \\
 & + \frac{1}{2} \times \sum_{h=1}^H \sum_{p=1}^P \gamma_p^{inter} \times \left[ \frac{D_{ph}}{B_p^{inter}} \right] \times \sum_{j=1}^{O_p-1} \sum_{c=1}^C \left| \sum_{m=1}^M x_{(j+1)p,m,c,h} - \sum_{m=1}^M x_{j,p,m,c,h} \right| \\
 & + \frac{1}{2} \times \sum_{h=1}^H \sum_{p=1}^P \left[ \gamma_p^{intra} \times \left[ \frac{D_{ph}}{B_p^{intra}} \right] \right. \\
 & \left. \times \sum_{j=1}^{O_p-1} \sum_{c=1}^C \left( \sum_{m=1}^M \left( \left| x_{(j+1)p,m,c,h} - x_{j,p,m,c,h} \right| - \right. \right. \right. \\
 & \left. \left. \left. \times \sum_{m=1}^M \left( \left| \sum_{m=1}^M x_{(j+1)p,m,c,h} - \sum_{m=1}^M x_{j,p,m,c,h} \right| \right) \right) \right) \right] \quad (3-6) \\
 & + \frac{1}{2} \times \sum_{h=1}^H \sum_{m=1}^M \sum_{c=1}^C \delta_m \times (K_{m,c,h}^+ + K_{m,c,h}^-) \\
 & + \sum_{h=1}^H \sum_{m=1}^M I_{m,h}^+ \times \varphi_m - \sum_{h=1}^H \sum_{m=1}^M I_{m,h}^- \times \omega_m \\
 & + \sum_{h=1}^H \sum_{\alpha=1}^{\psi} \sum_{k=1}^{ML} h_{\alpha,h} \times HL_{\alpha,k,h} + \sum_{h=1}^H \sum_{\alpha=1}^{\psi} \sum_{\beta>\alpha}^{\psi} \sum_{k=1}^{ML} \sum_{k'=1}^{ML} C_{\alpha,\beta,h} \times TL_{\alpha,\beta,k,k',h} \\
 & + \sum_{h=1}^H \sum_{\alpha=1}^{\psi} \sum_{k=1}^{ML} S_{\alpha,h} \times \left( \sum_{l=1}^L \sum_{s=1}^S x'_{l,\alpha,k,h,s} \right) + \sum_{h=1}^H \sum_{\alpha=1}^{\psi} \sum_{k=1}^{ML} F_{\alpha,h} \times FL_{\alpha,k,h}
 \end{aligned}$$

$$\text{Min } Z_2 = \sum_{h=1}^H \sum_{m=1}^M \sum_{c=1}^C \sum_{j=1}^{O_p} N_{m,c,h} \times w_{j,m} \times x_{j,p,m,c,h} \quad (3-7)$$

S.t.

$$\sum_{c=1}^C \sum_{m=1}^M a_{j,p,m} \times x_{j,p,m,c,h} = 1 \quad \forall j, p, h \quad (3-8)$$

$$x_{j,p,m,c,h} \leq a_{j,p,m} \quad \forall j, p, c, m, h \quad (3-9)$$

$$\sum_{p=1}^P \sum_{j=1}^{O_p} D_{p,h} \times t_{j,p,m} \times x_{j,p,m,c,h} \leq T_{m,h} \times N_{m,c,h} \quad \forall m, c, h \quad (3-10)$$

$$N_{m,c,(h-1)} + K_{m,c,h}^+ - K_{m,c,h}^- = N_{m,c,h} \quad \forall m, c, h \quad (3-11)$$

$$\sum_{c=1}^C N_{m,c,(h-1)} + I_{m,h}^+ - I_{m,h}^- = \sum_{c=1}^C N_{m,c,h} \quad \forall m, h \quad (3-12)$$

$$\sum_{m=1}^M N_{m,c,h} \leq UB \quad \forall c, h \quad (3-13)$$

$$\sum_{m=1}^M N_{m,c,h} \geq LB \quad \forall c,h \quad (3-14)$$

$$\sum_{k=1}^{ML} \sum_{\alpha=1}^{\psi} x'_{l,\alpha,k,h,s} \leq 1 \quad \forall l,h,s \quad (3-15)$$

$$\sum_{l=1}^{NL} \sum_{\alpha=1}^{\psi} x'_{l,\alpha,k,h,s} \geq NL_K \quad \forall k,h,s \quad (3-16)$$

$$x'_{l,\alpha,k,h,s} \leq WP_{\alpha,k} \quad \forall l,\alpha,k,h,s \quad (3-17)$$

$$\begin{aligned} \sum_{l=1}^{NL} \sum_{s=1}^S x'_{l,\alpha,k,h,s} &= \sum_{l=1}^{NL} \sum_{s=1}^S x'_{l,\alpha,k,(h-1),s} + HL_{\alpha,k,h} - FL_{\alpha,k,h} \\ &+ \sum_{v=1}^{\psi} \sum_{k'=1}^{ML} (TL_{v,\alpha,k',k,h} - TL_{\alpha,v,k,k',h}) \end{aligned} \quad \forall \alpha,h,k \quad (3-18)$$

$$\begin{aligned} ALT \times \sum_{\alpha=1}^{\psi} \sum_{l=1}^{NL} \sum_{s=1}^S x'_{l,\alpha,k,h,s} &\geq \\ \sum_{c=1}^C \sum_{m=1}^M (N_{m,c,h} \times T_{m,h} \times MTL_{m,k} \times NL_m) &\end{aligned} \quad \forall h,k \quad (3-19)$$

$$FL_{\alpha,k,h} \leq BN \times WP_{\alpha,k} \quad \forall \alpha,k,h \quad (3-20)$$

$$HL_{\alpha,k,h} \leq BN \times WP_{\alpha,k} \quad \forall \alpha,h,k \quad (3-21)$$

$$TL_{\alpha,v,k,k',h} \leq BN \times WP_{\alpha,k} \quad \forall v,\alpha,k,k',h \quad (3-22)$$

$$TL_{\alpha,v,k,k',h} \leq BN \times WP_{v,k'} \quad \forall v,\alpha,k,k',h \quad (3-23)$$

$$TL_{\alpha,v,k,k',h} \leq BN \times UG_{v,\alpha} \quad \forall v,\alpha,k,k',h \quad (3-24)$$

$$\sum_{v>\alpha}^{\psi} \sum_{k'=1}^{ML} TL_{\alpha,v,k,k',h} + FL_{\alpha,k,h} \leq EL_{\alpha,k,(h-1)} \quad \forall \alpha,k,h \quad (3-25)$$

$$\sum_{v=1}^{\psi} \sum_{k=1}^{ML} TL_{v,\alpha,k,k',h} \leq BN \times y_{\alpha,k',h} \quad \forall \alpha,k',h \quad (3-26)$$

$$FL_{\alpha,k',h} \leq BN \times (1 - y_{\alpha,k',h}) \quad \forall \alpha,k',h \quad (3-27)$$

$$12.5 \times \left[ \sum_{s=3d-2}^{3d} \sum_{k=1}^{ML} x'_{l,\alpha,k,h,s} \times t_s \times 2^{\frac{\bar{L}_k - 90}{5}} \right] \leq 100 \quad \forall l,\alpha,h,d \quad (3-28)$$

$$\begin{aligned} N_{m,c,h}, K_{m,c,h}^+, K_{m,c,h}^-, I_{m,h}^+, I_{m,h}^-, EL_{\alpha,k,h,r} &\geq 0 \\ HL_{\alpha,k,h,r}, FL_{\alpha,k,h,r}, TL_{\alpha,\beta,k,k',h,r} &\geq 0 \end{aligned} \quad (3-29)$$

and integer



$$x_{j,p,m,c,h}, x'_{l,\alpha,k,h,s,r}, y_{\alpha,k',h,r} \in \{0,1\}$$

In this mathematical model, an effort has been put into making trade-offs between economic and environmental factors, while the social aspects are considered as constraints.

The first objective (Equation 3-6) includes machine fixed cost, machine variable costs, inter-cell movement costs, intra-cell movement costs, machine relocation costs, purchasing and selling of machines, as well as hiring, training, salary and firing costs.

The second objective function (Equation 3-7) considers minimization of the total production waste amount resulting from machines. As noted in the previous section, this amount is an aggregate value of several kinds of waste. Based on the precision level defined by decision makers, several aggregation methods such as the normalized weighting method [112], the AHP method [128], etc. can be applied.

To decrease the complexity of the model, social issues are considered as constraints (constraint 3-28), and we focus on restriction of the maximum daily noise exposure level (DND) in worker's assignment. According to the standard released by NIOSH [111] and OSHA [127], the combination of exposure level ( $L_k$ ) in duration of  $t_s$  for each person should be less than 100 dBA.

Equations (3-8) and (3-9) ensure that parts are processed according to plan and to required processes. The time capacity of planning periods is controlled by constraints in Equation (3-10). Constraints (3-11) and (3-12) mainly consider the dynamic balance between consecutive periods in terms of, respectively, number of machines assigned to each cell, and number of machines purchased or sold (procurement cost) for each machine type. Constraints (3-13) and (3-14) define the maximum number of machines per cell. Equation (3-15) indicates that each worker has only one skill level and should be assigned to only one machine skill level. Constraint (3-16) ensures that enough workers are available for each skill level of machine at each period and shift. Constraint (3-17) applies the rules regarding the skill levels of workers who can work with machines with certain skill levels. Constraint (3-18) is the dynamic worker balance equation according to the hiring, firing and training of workers at each skill level and in each period. Constraint (3-18) guarantees that total required worker in each period is satisfied by using hiring, firing or training. Constraint (3-19) ensures that sufficient numbers of workers are available to operate machines for each cell and machine type. Equations (3-20) to (3-24) ensure that firing, hiring and training are allowed when they are logically possible according to predefined rules (described in assumptions). The constraint in equation (3-25) ensures that the process of the firing the worker with skill-level  $k$  and training of workers from level  $k$  to a higher level in each period must be less than current worker with the same level ( $k$ ) in previous period. Finally,

Equations (3-26) and (3-27) stipulate that firing newly trained workers for skill level  $\alpha$  is not allowed. Inequation (3-29) determines the variables to be binary or integer.

### 3.2.4 Linearization

As in Chapter 2, the third and fourth terms of equation (3-6) in the proposed model make it nonlinear. Therefore, to transform it to the linear one for the third term, two non-negative variables  $z_{j,p,c,h}^1$  and  $z_{j,p,c,h}^2$  are introduced and the third term is rewritable as follows:

$$\frac{1}{2} \times \sum_{h=1}^H \sum_{p=1}^P \gamma^{\text{inter}} \times \left[ \frac{D_{ph}}{B_p^{\text{inter}}} \right] \times \sum_{j=1}^{O_p-1} \sum_{c=1}^C (z_{j,p,c,h}^1 + z_{j,p,c,h}^2) \quad (3-29)$$

Then following constraint must be added to the proposed model.

$$z_{j,p,c,h}^1 - z_{j,p,c,h}^2 = \sum_{m=1}^M x_{(j+1),p,m,c,h} - \sum_{m=1}^M x_{j,p,m,c,h} \quad \forall j,p,c,h \quad (3-30)$$

Similarly, to linearize the fourth term of the equation (3-6),  $y_{j,p,m,c,h}^1$  and  $y_{j,p,m,c,h}^2$ , two non-negative variables, are introduced. The fourth term of the objective function can therefore be rewritten as follows:

$$\frac{1}{2} \times \sum_{h=1}^H \sum_{p=1}^P \gamma^{\text{intra}} \times \left[ \frac{D_{ph}}{B_p^{\text{intra}}} \right] \times \sum_{j=1}^{O_p-1} \sum_{c=1}^C \left( \sum_{m=1}^M (y_{j,p,m,c,h}^1 + y_{j,p,m,c,h}^2) - (z_{j,p,c,h}^1 + z_{j,p,c,h}^2) \right) \quad (3-31)$$

In addition, following constraint must be added to the proposed model.

$$y_{j,p,m,c,h}^1 - y_{j,p,m,c,h}^2 = x_{(j+1),p,m,c,h} - x_{j,p,m,c,h} \quad \forall j,p,m,c,h \quad (3-32)$$

Finally, the multiple integer and binary variables equation (3-7) made them nonlinear. It can be linearized as follows:

$$\text{Min } Z_2 = \sum_{h=1}^H \sum_{m=1}^M \sum_{c=1}^C \sum_{j=1}^{O_p} N_{m,c,h} \times w_{j,m} \quad (3-33)$$

$$\frac{x_{j,p,m,c,h}}{BN} \leq N_{m,c,h} \leq x_{j,p,m,c,h} \times BN \quad \forall j,p,m,c,h \quad (3-34)$$

## 3.3 Hybrid NSGA II-MOSA algorithm

According to the previous studies, CFP has been mentioned as an NP-hard optimization problem [110], [79]. In order to cope with the complexity of the proposed mathematical model, a new hybrid of a non-dominated sorting genetic algorithm and a multi-objective simulated annealing (NSGA II-MOSA) is now proposed.

As explained in chapter 2, Non-dominated sorting genetic algorithm II (NSGA II) is an evolutionary algorithm commonly used in problems with more than one objective. With this method proposed by Deb *et al.* [119] we obtain a near-optimal Pareto frontier. The mechanism of generation and changing of the population in NSGA II are the same as in GA. In fact, primary solutions are generated randomly and in each iteration new solutions are selected from the primary solutions (solution of previous iteration) and from solutions that are produced by crossover and mutation operations. In crossover operations, new solutions are produced by a combination of two parents that are selected by a binary tournament selection process. When in mutation, new solutions are generated by changing the characteristics of a member that is selected randomly. After these operations, each solution is compared with others by two indicators: rank and crowding distance. The members of the population are sorted according to their rank: solutions in rank 1 are not dominated, and solutions in rank  $R+1$  are only dominated by solutions in rank  $R$ . Since solutions with a same rank cannot dominate each other, they are compared by calculating their crowding distance (Equation (2-76)), and a high value of crowding distance is preferred.

Next, the Pareto frontier ( $N$  solutions) obtained from NSGA-II is used as input for MOSA [129], which includes the concept of archives to trade off the solutions. Thus, in the proposed algorithm, we have two sets of solutions: representative solutions (RP) and archive of Pareto solutions (AP). These solutions are changed in each iteration and belong to representative solutions. Of course, in the first iteration of this algorithm, RP solutions are included in the Pareto solutions that are transmitted from NSGA-II, and the archive of Pareto solutions are sets of optimal Pareto solutions at the beginning of the algorithm. They are the same as RP.

In each iteration of MOSA, by applying a change operator (cooling process), each RP solution will be changed due to the creation of neighborhood solutions. Afterwards, this algorithm compares the new solution with the current one, and if the former is dominated by the latter, it will be added to the other solutions in AP as first rank. Otherwise, AP remains the same as in the previous iteration and also with  $\alpha$  probability, the new solution is reported as RP or with probability  $1-\alpha$ , and the current solution is reported as RP. This procedure is repeated until the stopping criteria are satisfied ( $it=MaxIt$ ). In each iteration of the proposed algorithm, an annealing schedule is selected to systematically decrease the temperature as the algorithm proceeds. As the temperature decreases, the algorithm reduces the extent of its search to converge to a minimum (see Figure 3.1). The mechanisms of decreasing temperature,  $\alpha$  and  $MaxIt$ , are computed according to the following functions:

$$T_{it} = \beta \times T_{it-1} \quad (3-35)$$

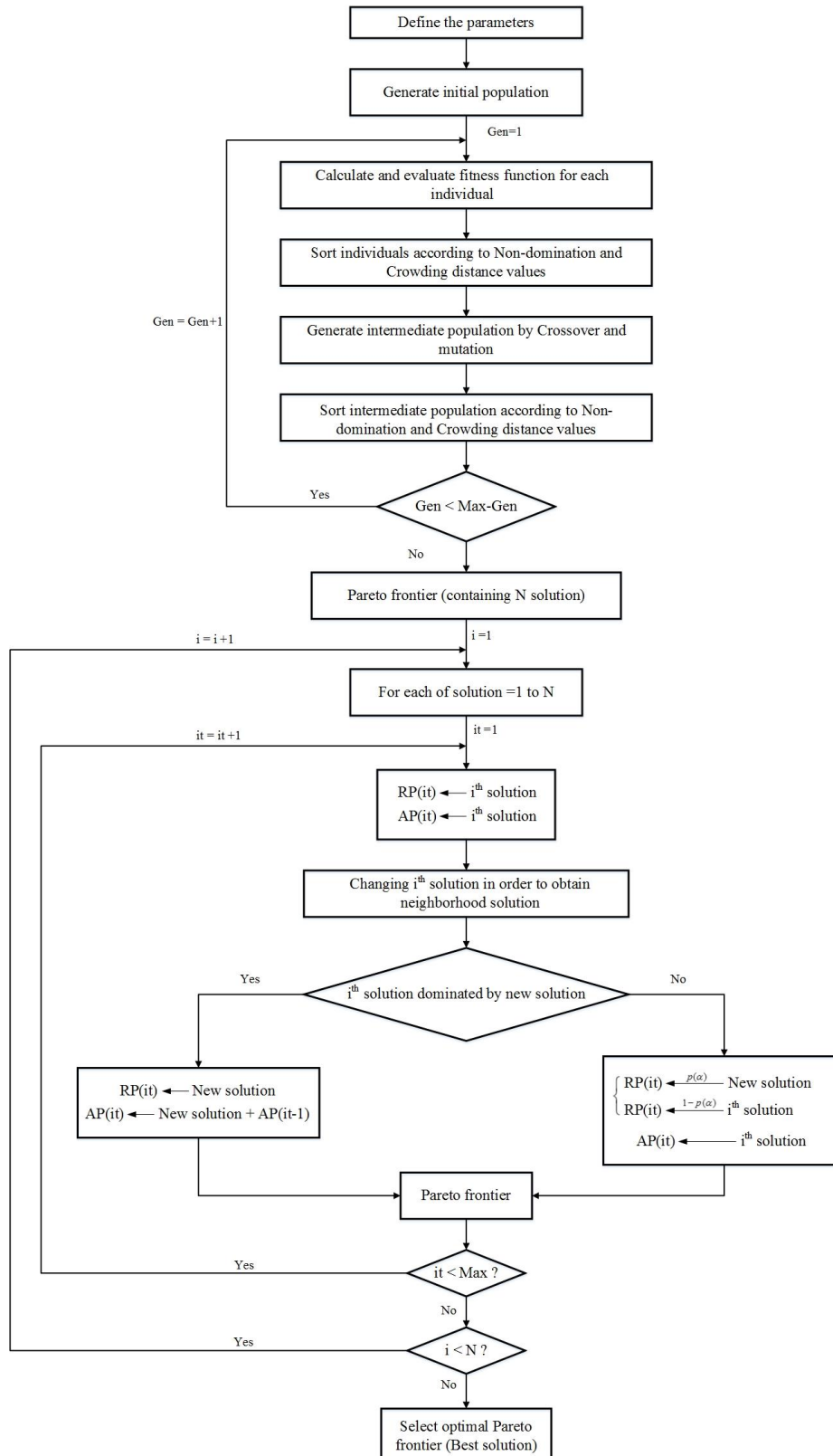
$$T_0 = C_1^{RP} + C_2^{RP} \quad (3-36)$$

$$T_f = T_0 \times 10^{-\gamma} \quad (3-37)$$

$$\alpha = e^{-[(C_1^{new} + C_2^{new}) - (C_1^{RP} + C_2^{RP})] / T_{it}} \quad (3-38)$$

$$Maxit = [(\log(T_f / T_0) / \log \beta)] \quad (3-39)$$

Where  $C_1$  and  $C_2$  represent the values of first and second objective functions respectively,  $\beta$  is the cooling rate,  $T_f$  is the final temperature,  $T_0$  is the initial temperature and  $T_{it}$  is the temperature in each iteration.



**Figure 3.1** The flow chart of Hybrid NSGA II-MOSA

The structure of the solutions (Figure 3.2) comprises 10 matrices as follows:

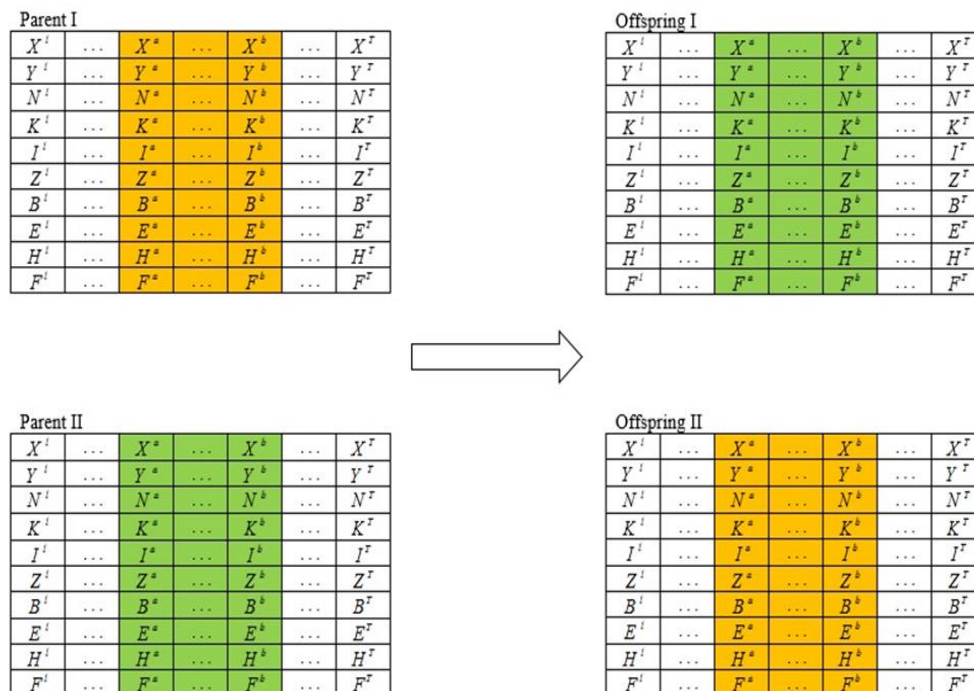
- Matrix  $[X]_{p \times r}^h$  consists of genes relating to the assignment of the part operations to the machines in period  $h$  while  $r$  is equal to  $\max_i^p \{O_i\}$ . The elements of the matrix  $[X]$  are ascertained according to the  $a_{j,p,m}$ .
- Matrix  $[Y]_{p \times r}^h$  consists of genes signifying the assignment of part operations to the machines.
- Matrix  $[N]_{m \times c}^h$  consists of genes belonging to the number of available machines in each cell in period  $h$ . The value of  $N_{m,c,h}$  can be infeasible due to lower and upper bounds on the cell size. Therefore, an amendatory strategy is used to eliminate it.
- Matrix  $[K]_{m \times c}^h$  includes the gene related to the machines moving into or out of each cell. It is noteworthy that the value of the elements in this matrix can be negative.
- Matrix  $[I]_{m \times c}^h$  consists of the gene signifying the number of machine procurement (selling and buying). The elements of this matrix can also be negative.
- Matrix  $[Z]_{l \times g}^h$  consists of genes relating to the assignment of the worker skill-level to the machine skill-level in period  $h$ , while  $g$  is equal to  $\max_{i \in l} \{\psi_i\}$ . The elements of matrix  $[Z]$  are ascertained according to the  $WP_{\alpha,k}$ .
- Matrix  $[B]_{l \times g}^h$  consists of genes signifying the assignment of worker skill-level to the shifts. The element of matrix  $[B]$  is generated by uniform distribution  $U(1,s)$ .
- Matrix  $[E]_{\alpha \times k}^h$  consists of genes which indicate the number of assigned workers with specific skill-levels to the specific machine skill-level in period  $h$ .
- Matrix  $[H]_{\alpha \times k}^h$  consists of genes which indicate the number of workers who are hired in period  $h$ .
- Matrix  $[F]_{\alpha \times k}^h$  consists of genes relating to the number of workers who are fired in period  $h$ .

In this study, the standard two-point crossover point is applied which are generated randomly. Each parent categorize to the three segment by crossover operator. The places of the middle segments are exchanged and produce the offspring. This procedure is demonstrated in figure 3.3.

Three different mutation methods are implemented as mutation operators; single mutation, multi mutation, and inversion mutation. For example, for the single mutation a part operation is selected randomly and assigned to the different machines that can be processed. The selected operation or the skill-level of the worker is chosen and assigned to another machine skill-level which can be assigned. Similarly, for the multi-mutation operator, a part is randomly picked by single mutation on all the operations. Finally, the inversion mutation is performed as an inversion of the sequence of cells which carry out the part operations.

$X^1$	$X^2$	...	$X^T$
$Y^1$	$Y^2$	...	$Y^T$
$N^1$	$N^2$	...	$N^T$
$K^1$	$K^2$	...	$K^T$
$I^1$	$I^2$	...	$I^T$
$Z^1$	$Z^2$	...	$Z^T$
$B^1$	$B^2$	...	$B^T$
$E^1$	$E^2$	...	$E^T$
$H^1$	$H^2$	...	$H^T$
$F^1$	$F^2$	...	$F^T$

**Figure 3.2** Chromosome structure



**Figure 3.3** Crossover operator

In order to increase the performance of our NSGA II-MOSA hybrid algorithm and to find the best results, we consider six vital parameters of NSGA II-MOSA, which should be carefully tuned:

- Number of members in a population (*NPop*)
- Number of iterations to find best results (*MaxIt*)
- Crossover rate (*CrR*)
- Mutation rate (*MuR*)
- Cooling rate (*Beta*)
- The power value to calculate  $T_f$  (*Gamma*)

Like previously, a Taguchi design is used as a Design of Experiment (DOE) method to set the appropriate levels for the parameters of the algorithm. We thus define three levels for each parameter after an extensive analysis on proposed algorithm (Table 3.1).

**Table 3.1** Design parameters and their levels

Level	Npop	Maxit	CrR	MuR	Beta	Gamma
1	40	40	0.6	0.2	0.5	4
2	60	60	0.7	0.3	0.6	6
3	80	80	0.8	0.5	0.8	9

In order to apply the Taguchi method, we consider three factors: Spacing Metric (SM), Distance to an ideal Point (D2P), and time. SM is a metric to define the quality of Pareto distribution in the objective space (uniformity). This metric is calculated by equation (3-40) which is reminder of Equation (2-77) in previous chapter.

$$SM = \frac{\sum_{i=1}^{N-1} |\bar{d} - d_i^o|}{(N-1)\bar{d}} \quad (3-40)$$

Where  $d_i^o$  represents the Euclidian distance between two consecutive points (*i.e.*, points  $i$  and  $i+1$ ),  $\bar{d}$  is their average and  $N$  is number of members in final non-dominated solutions.

In this chapter, also D2P (as explained in chapter 2) is used as another metric for parameter setting. Finally, the computational time is another important metric to evaluate the performance of the algorithm. The Taguchi method arranges a matrix experiment with 27 trials (6 factors, 3 levels) according to the orthogonal array (Tables 3.2 and 3.3) and responses, which are assigned to own trial. Regarding the same importance of three responses, normalization is used to convert all values to the same unit between 0 and 1. Finally, evaluation of the Taguchi method leads to a figure (Figure 3.4) as a graphic tool to show the single to noise ratio of each factor, in order to compare and select the best level for each factor. Analysis of the single to noise ratio shows that level 2 of *NPop*, *i.e.* 60, level 2 of *MaxIt*, *i.e.* 60, level 3 of *CrR*, *i.e.* 0.8, level 1 of *MuR*, *i.e.* 0.2, level 3 of *Beta*, *i.e.* 0.8 and level 3 of *Gamma*, *i.e.* 9 are better in comparison with other levels.

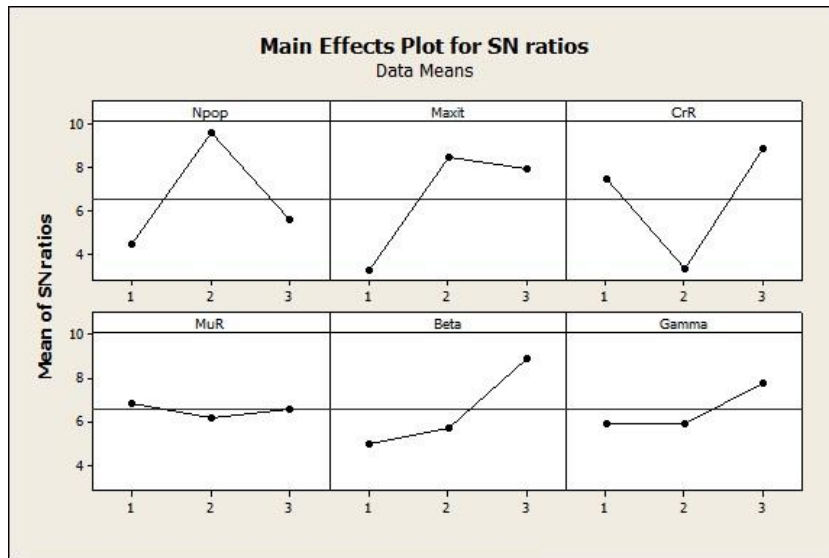


**Table 3.2** Experiments of the Taguchi design

Experiment	Coded levels						Uncoded levels					
	Npop	MaxIt	CrR	MuR	Betta	Gamma	Npop	MaxIt	CrR	MuR	Betta	Gamma
1	1	1	1	1	1	1	40	40	0.6	0.2	0.5	4
2	1	1	1	1	2	2	40	40	0.6	0.2	0.6	6
3	1	1	1	1	3	3	40	40	0.6	0.2	0.8	9
4	1	2	2	2	1	1	40	60	0.7	0.3	0.5	4
5	1	2	2	2	2	2	40	60	0.7	0.3	0.6	6
6	1	2	2	2	3	3	40	60	0.7	0.3	0.8	9
7	1	3	3	3	1	1	40	80	0.8	0.5	0.5	4
8	1	3	3	3	2	2	40	80	0.8	0.5	0.6	6
9	1	3	3	3	3	3	40	80	0.8	0.5	0.8	9
10	2	1	2	3	1	2	60	40	0.7	0.5	0.5	6
11	2	1	2	3	2	3	60	40	0.7	0.5	0.6	9
12	2	1	2	3	3	1	60	40	0.7	0.5	0.8	4
13	2	2	3	1	1	2	60	60	0.8	0.2	0.5	6
14	2	2	3	1	2	3	60	60	0.8	0.2	0.6	9
15	2	2	3	1	3	1	60	60	0.8	0.2	0.8	4
16	2	3	1	2	1	2	60	80	0.6	0.3	0.5	6
17	2	3	1	2	2	3	60	80	0.6	0.3	0.6	9
18	2	3	1	2	3	1	60	80	0.6	0.3	0.8	4
19	3	1	3	2	1	3	80	40	0.8	0.3	0.5	9
20	3	1	3	2	2	1	80	40	0.8	0.3	0.6	4
21	3	1	3	2	3	2	80	40	0.8	0.3	0.8	6
22	3	2	1	3	1	3	80	60	0.6	0.5	0.5	9
23	3	2	1	3	2	1	80	60	0.6	0.5	0.6	4
24	3	2	1	3	3	2	80	60	0.6	0.5	0.8	6
25	3	3	2	1	1	3	80	80	0.7	0.2	0.5	9
26	3	3	2	1	2	1	80	80	0.7	0.2	0.6	4
27	3	3	2	1	3	2	80	80	0.7	0.2	0.8	6

**Table 3.3** Obtained responses of Taguchi experiments

Experiment	Real values			Normalized values		
	<i>SM</i>	<i>D2P</i>	<i>Time (s)</i>	<i>SM</i>	<i>D2P</i>	<i>Time (s)</i>
1	0.96	9856311461	95.721	0.33	1	0
2	0.898	9849087854	384.664	0.218	0.603	0.188
3	0.976	9849240930	374.385	0.361	0.611	0.182
4	0.855	9847247539	329.3	0.138	0.501	0.152
5	0.902	9848788998	320.591	0.224	0.586	0.147
6	0.926	9849694602	375.654	0.269	0.636	0.182
7	0.794	9846722913	342.594	0.025	0.472	0.161
8	0.936	9847418495	490.943	0.286	0.511	0.258
9	1.015	9844046495	657.696	0.431	0.325	0.366
10	0.79	9848607506	693.207	0.019	0.576	0.389
11	1.218	9846532268	542.632	0.805	0.462	0.291
12	0.79	9844541622	615.439	0.019	0.352	0.339
13	0.983	9847793810	490.943	0.373	0.531	0.258
14	1.126	9846514025	859.899	0.636	0.461	0.498
15	1.121	9848928222	854.176	0.626	0.594	0.494
16	1.117	9847036921	702.092	0.619	0.49	0.395
17	0.815	9844307254	817.025	0.064	0.339	0.47
18	1.112	9847155861	1040.691	0.61	0.496	0.616
19	0.78	9845330988	838.718	0	0.396	0.484
20	0.855	9844046495	961.288	0.138	0.325	0.564
21	1.203	9844359598	807.762	0.778	0.342	0.464
22	1.097	9843917974	736.749	0.584	0.318	0.418
23	1.146	9842901511	774.448	0.673	0.262	0.442
24	1.08	9843253296	1099.165	0.552	0.282	0.654
25	1.117	9843573373	859.899	0.62	0.299	0.498
26	1.324	9840078095	1160.35	1	0.107	0.694
27	1.093	9838137219	1630.514	0.575	0	1



**Figure 3.4** Signal to noise ratio from Taguchi experiments

### 3.4 Computational results

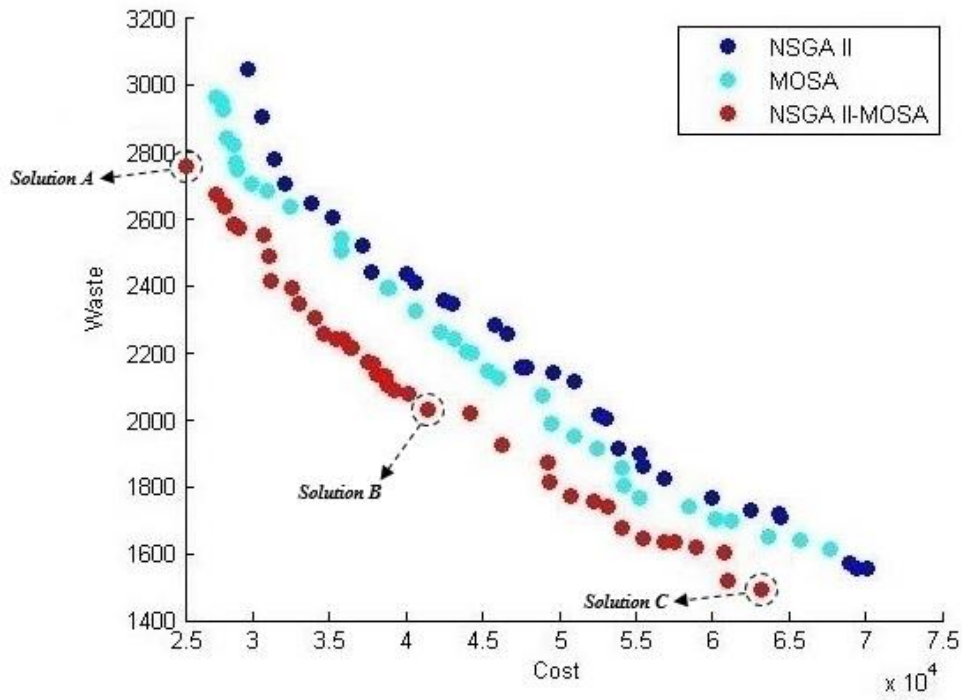
In order to evaluate feasibility and applicability of presented model, ten sets of samples (Table 3.4) are randomly generated based on the pattern which is given in Table 3-5. Afterward generated problems are solved by using NSGA II, MOSA and NSGA II-MOSA on a computer with Intel Core i5 CPU 2.27GHz and 4 GB RAM. Both presented algorithms are developed by using Matlab R2012a. The resulted Pareto optimal solutions from NSGA II-MOSA, NSGA II and MOSA for problems 3, 5, 7, 10 are demonstrated in separate Figures 3.5 to 3.8. within the optimal Pareto frontier for problem 4, three solutions (solution A: solution with best cost or first point of Pareto, solution B: a solution from middle of Pareto, solution C: solution with minimum waste or last point of Pareto). The cell configuration and workers pattern in the planning horizons of this example for selected solutions are depicted respectively in Figures 3.9 to 3.11. To show efficiency of NSGA II-MOSA as hybrid method, the obtained results (Pareto-optimal Frontiers) of each method are compared by using some comparison metrics which are presented in the next section.

**Table 3.4** Dimension of test problems

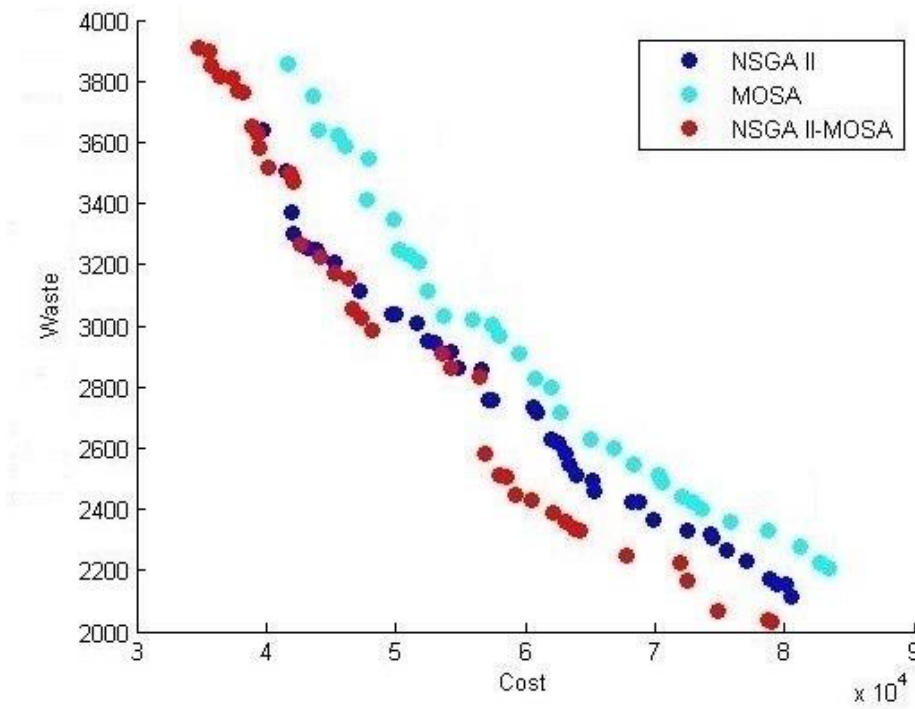
Problem No	Number of							
	Machine skill level	Worker skill level	Cell	Part type	Machine type	Operation	Period	Shift
P1	2	2	3	4	4	3	2	2
P2	2	3	3	4	5	3	2	2
P3	3	3	4	6	6	5	3	2
P4	3	4	4	7	7	5	3	2
P5	3	4	5	8	7	6	4	2
P6	4	4	6	9	8	7	3	3
P7	4	4	7	9	8	8	3	3
P8	6	5	7	10	9	9	4	3
P9	5	6	8	12	10	10	4	3
P10	6	6	12	18	16	12	5	3

**Table 3.5** Pattern of data generation

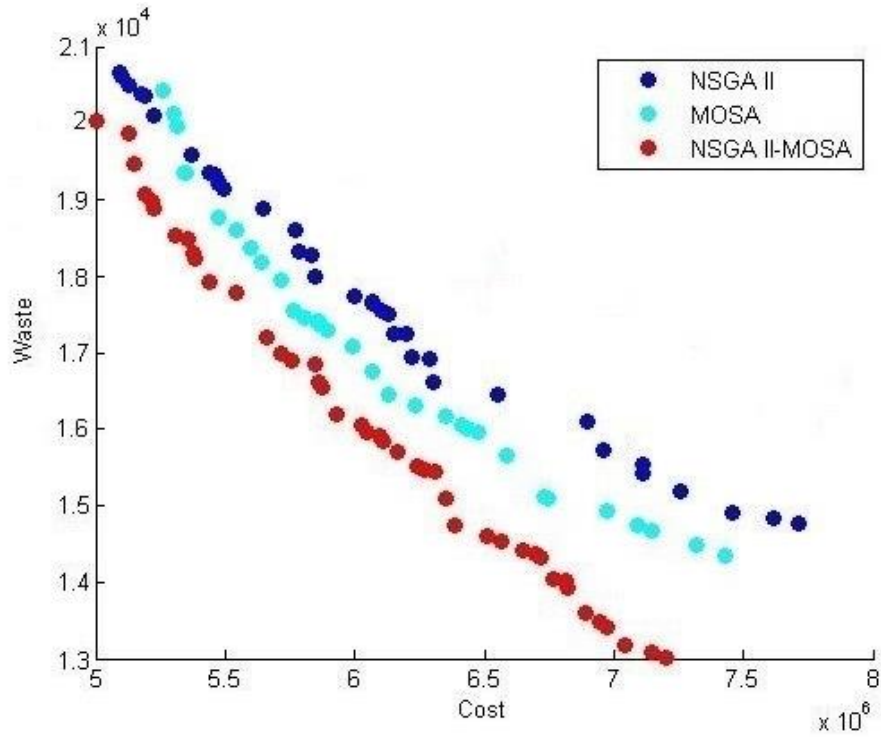
Parameter	Generation pattern	Parameter	Generation pattern
$D_{ph}$	$\sim$ Uniform (50, 100)	$\omega_m$	$\sim$ Uniform (0, 1) $\times \varphi_m$
$B_p^{inter}$	$\sim$ Uniform (10, 50)	$\bar{L}_k$	$\sim$ Uniform (65, 85)
$B_p^{intra}$	$B_p^{inter} / 5$	$w_{p,m}$	$\sim$ Uniform (200, 300)
$\gamma_p^{inter}$	$\sim$ Uniform (100, 300)	$t_{j,p,m}$	$\sim$ Uniform (1, 10)
$\gamma_p^{intra}$	$\sim$ Uniform (100, 300)	$h_{\alpha,h}$	$\sim$ Uniform (200, 400)
$\lambda_m$	$\sim$ Uniform (500, 800)	$C_{\alpha,\beta,h}$	$\sim$ Uniform (100, 200)
$\eta_m$	$\sim$ Uniform (100, 200)	$F_{\alpha,h}$	$\sim$ Uniform (300, 500)
$\delta_m$	$\alpha_{mh} / 2$	$S_{\alpha,h}$	$\sim$ Uniform (500, 700)
$T_{m,h}$	$\sim$ Uniform (1, 5)	$NL_m$	$\sim$ Uniform (1, 4)
$UB$	6	$ALT$	$\sim$ Uniform (6, 8)
$LB$	2	$ts$	$\sim$ Uniform (4, 6)
$\varphi_m$	$\sim$ Uniform (3000, 5000)		



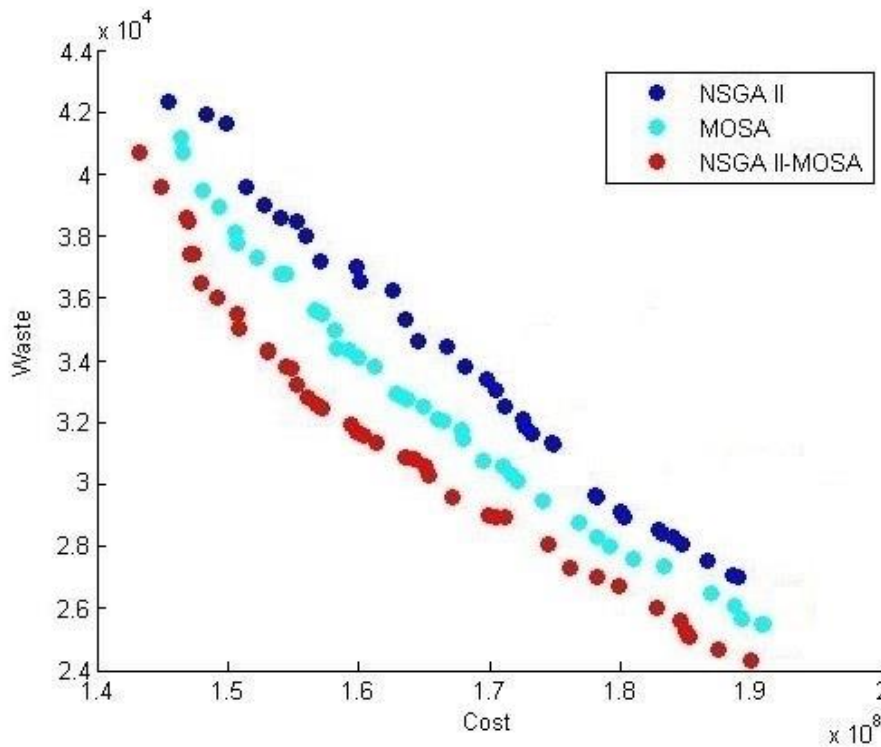
**Figure 3.5** Optimal Pareto solutions for problem 3



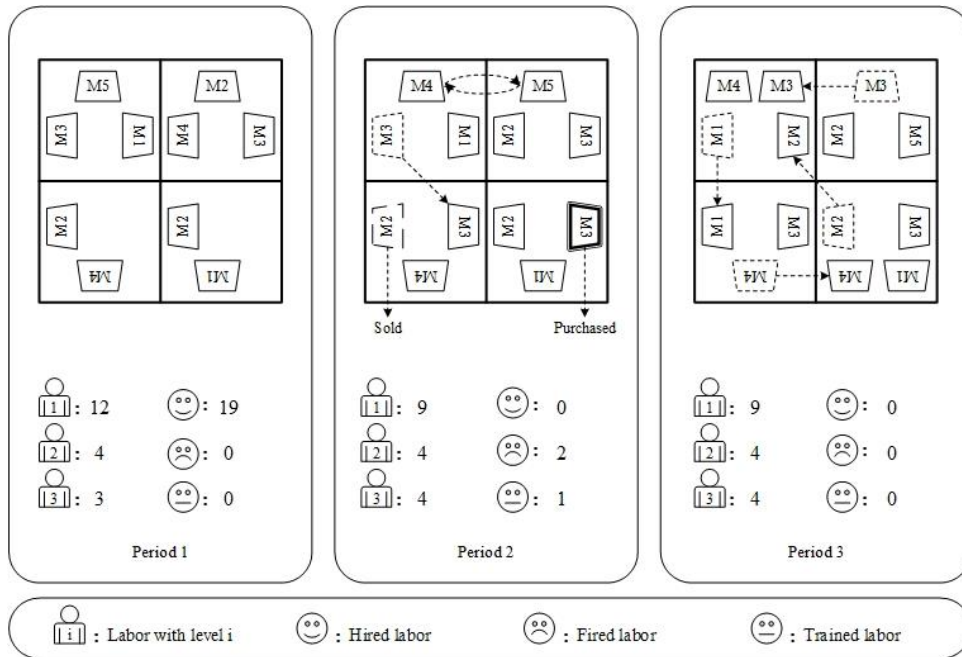
**Figure 3.6** Optimal Pareto solutions for problem 5



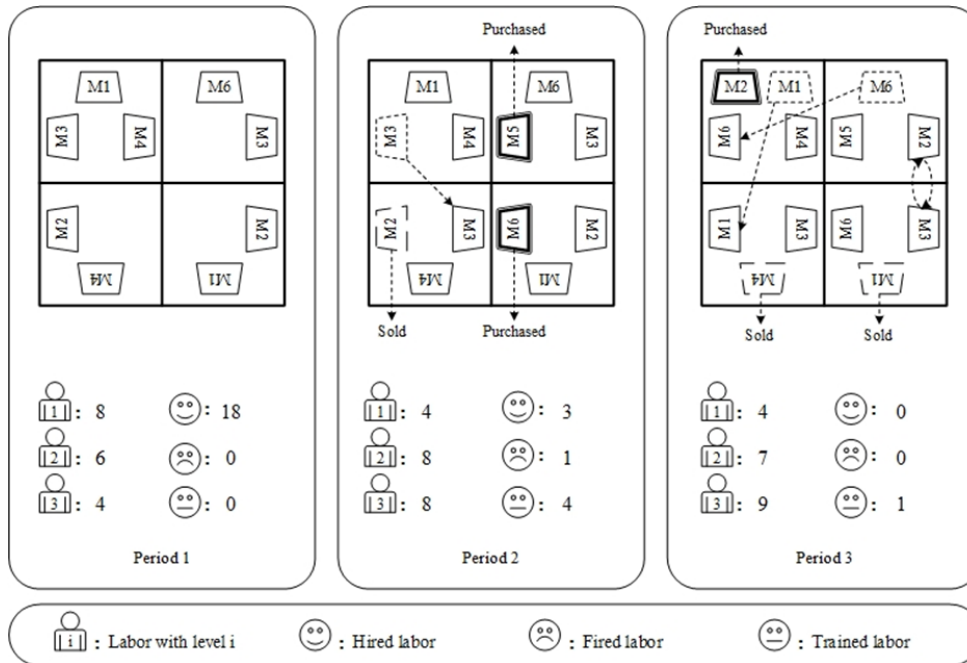
**Figure 3.7** Optimal Pareto solutions for problem 7



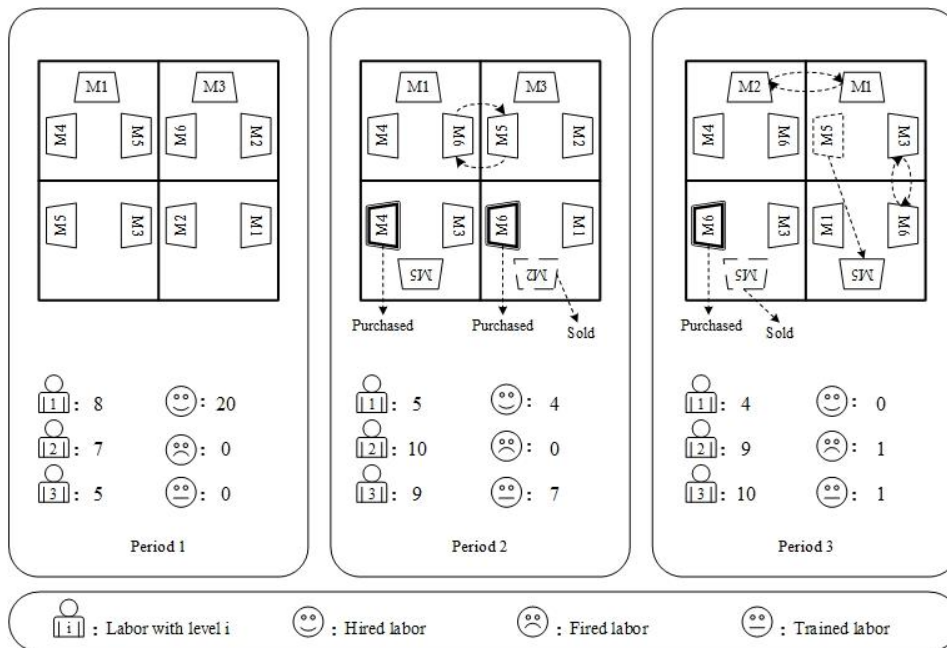
**Figure 3.8** Optimal Pareto solutions for problem 10



**Figure 3.9** Cell configuration and worker pattern for solution A in problem 3



**Figure 3.10** Cell configuration and worker pattern for solution B in problem 3



**Figure 3.11** Cell configuration and worker pattern for solution C in problem 3

Considering the cell configuration on different solutions of problem 3, Figures 3.9 to 3.11 illustrate that a large number of type 5 and 6 machines are relocated in the configuration of solution C (solution with minimum waste), that these machines are more expensive but more efficient in decreasing waste. By contrast, in the configuration of solution A (solution with minimum cost), only machine 5 is relocated and there is no machine 6 on the planning horizon. To validate, compare and measure the performance of the proposed NSGA II-MOSA hybrid, three comparison metrics are considered (Table 3.6):

- *Quality Metric (QM)*: This metric allows us to measure the ratio of non-dominated solutions obtained by each algorithm by putting together all their Pareto solutions. It reports the ratio of solutions related to each algorithm in final non-dominated solutions [71].
- *Spacing Metric (SM)*: As mentioned in the previous section, this metric measures the uniformity of the spread of Pareto solutions, which is calculated by equation (3-40). The algorithm with a lower value of *SM* is preferred [130].
- *Diversification Metric (DiM)*: This metric measures the spread of a Pareto solution set. The algorithm with a higher value of *DiM* is preferred [131]. Its function is defined as follows:

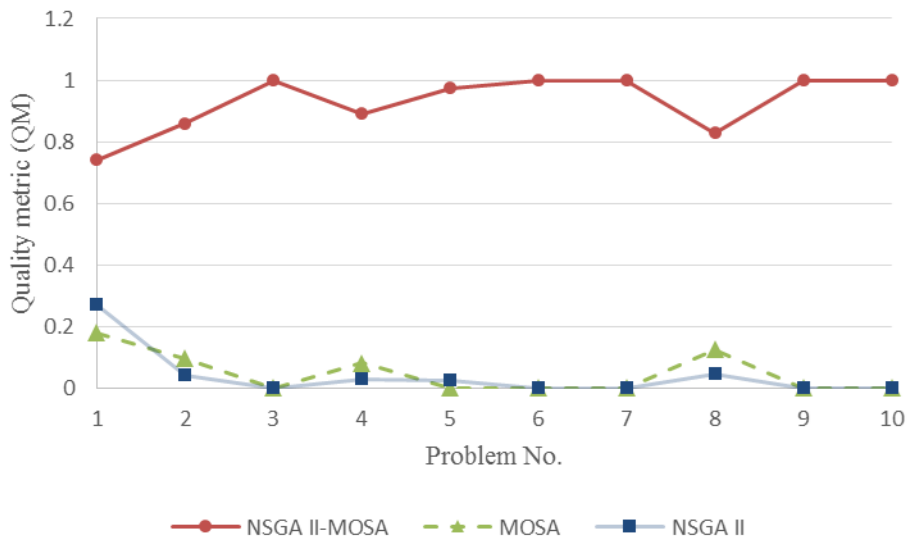


$$DiM = \sqrt{\left(\frac{\max f_i^1 - \min f_i^1}{f_{\max}^{1,total} - f_{\min}^{1,total}}\right)^2 + \left(\frac{\max f_i^2 - \min f_i^2}{f_{\max}^{2,total} - f_{\min}^{2,total}}\right)^2} \quad (3-41)$$

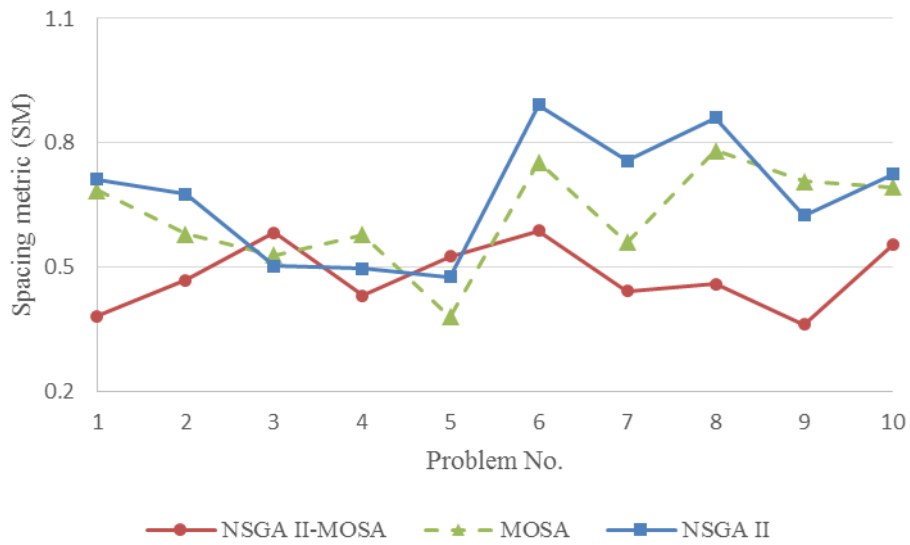
where  $f_{\max}^{i,total}$  and  $f_{\min}^{i,total}$  are the maximum and minimum values of each fitness function among all the dominated solutions obtained by the algorithms, respectively.

**Table 3.6** Comparison Metrics

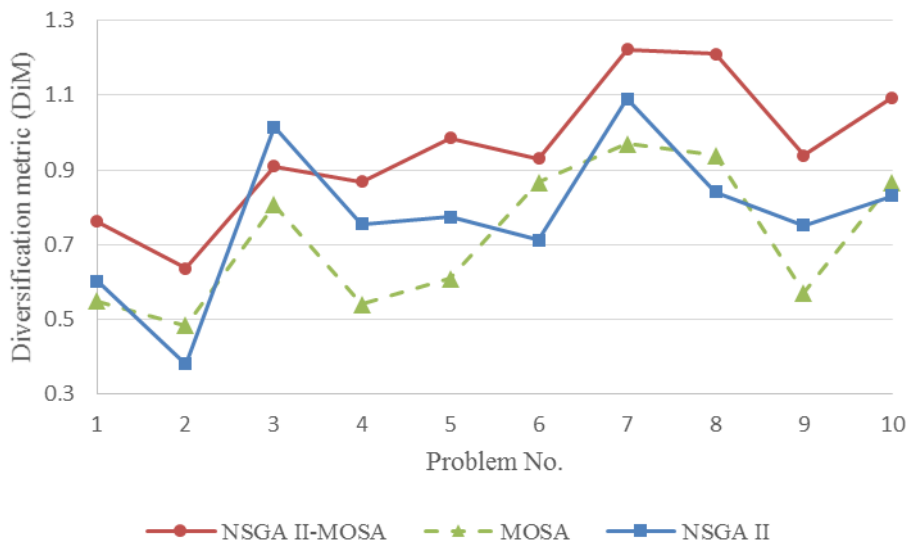
Problem No	Quality Metric (QM)			Spacing Metric (SM)			Diversity Metric (DiM)		
	NSGAI-MOSA	MOSA	NSGAI	NSGAI-MOSA	MOSA	NSGAI	NSGAI-MOSA	MOSA	NSGAI
P1	0.74	0.18	0.27	0.382	0.685	0.712	0.761	0.548	0.602
P2	0.86	0.097	0.043	0.468	0.58	0.676	0.636	0.483	0.38
P3	1	0	0	0.583	0.529	0.503	0.91	0.806	1.014
P4	0.89	0.081	0.029	0.432	0.578	0.496	0.868	0.539	0.755
P5	0.975	0	0.025	0.526	0.381	0.477	0.986	0.609	0.774
P6	1	0	0	0.588	0.753	0.891	0.93	0.867	0.711
P7	1	0	0	0.443	0.56	0.757	1.222	0.97	1.09
P8	0.828	0.125	0.047	0.459	0.782	0.86	1.21	0.939	0.841
P9	1	0	0	0.362	0.707	0.625	0.939	0.57	0.752
P10	1	0	0	0.554	0.693	0.724	1.094	0.866	0.83



**Figure 3.12** Comparison of Quality Metrics (QM) for three meta-heuristics

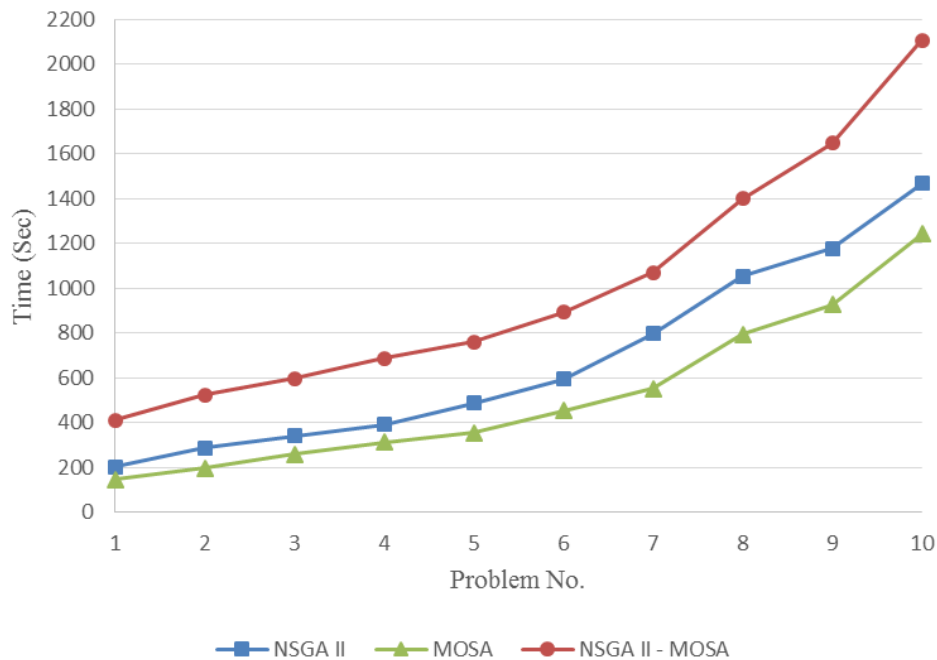


**Figure 3.13** Comparison of Spacing Metrics (SM) for three meta-heuristics



**Figure 3.14** Comparison of Diversification Metrics (DiM) for three meta-heuristics

As shown in Table 3.6 and Figures 3.12 to 3.14, the proposed hybrid NSGA II-MOSA has a better performance compared to NSGA II and MOSA taken separately. In other words, the hybrid NSGA II-MOSA hybrid algorithm can achieve the largest number of Pareto optimal solutions with better quality than NSGA II. Moreover, the average values of diversification and spacing metrics (Figures 3.13 and 3.14) of our hybrid algorithm have most of the time greater and lower values, respectively, in comparison with NSGA II and MOSA taken separately (*i.e.*, optimal Pareto solutions obtained by hybrid NSGA II-MOSA have more uniformity and diversity, respectively.)



**Figure 3.15** Computational time of two algorithms for ten test problems

Figure 3.15 shows that the proposed hybrid NSGA II-MOSA algorithm takes only 50% more calculation time in average compared to NSGA II and MOSA. However, a part of this increase must be considered as warming up time (setup time), and this additional calculation time can be justified by a better quality solution.

### 3.5 Conclusion

This chapter addresses the issues of dynamic cell formation and worker assignment by considering economic, environmental and social aspects simultaneously. This consideration is largely overlooked in the literature on DCMS. A bi-objective mathematical model is developed, in which the first objective function minimizes the relevant costs of these issues, including machine and worker costs. The total production waste is minimized by the second objective function, and the maximum amount of Daily Noise Dosage (DND) for every worker is controlled by the constraint. In order to deal with the complexity of the problem and find a better solution, we develop a hybrid NSGA II-MOSA algorithm. We then compare its performance in terms of capability and reliability in several test problems with two conventional evolutionary algorithms (NSGA II and MOSA) on different metrics. The results demonstrate the supremacy of our hybrid algorithm over both NSGA II and MOSA.

# 4

## **Multi-objective model for the configuration of sustainable dynamic cellular manufacturing system; a possibilistic approach**

- 4.1 Motivation
- 4.2 Problem formulation
  - 4.2.1 Problem assumptions
  - 4.2.2 Notations
  - 4.2.3 Mathematical formulation
  - 4.2.4 Linearization
- 4.3 Solution approach
  - 4.3.1 The auxiliary crisp multi-objective model
  - 4.3.2 The fuzzy solution approach
- 4.4 Experimental results
- 4.5 Conclusion

## 4 Multi-objective model for the configuration of sustainable dynamic cellular manufacturing system; a possibilistic approach

In the previous two chapters (Chapter 2 and 3), we investigated on the trade-off between social and environmental issues with total cost. We proposed two bi-objective mathematical models allowing studying economic criteria as first objective and environmental and social aspects as second objective. Even if the second model takes into account all aspects of sustainable development, one (social aspect) is considered as constraint. It is noteworthy that, due to the complexity of DCMS configuration, it is not always necessary to consider the three dimensions of sustainable development as objective and sometimes a simpler model can allow finding a good solution more quickly. In this chapter, in order to consider all dimensions of the sustainable development as objectives, a multi-objective mathematical model is developed to reach compromise between different aspects of sustainability in configuration of DCMS.

### 4.1 Motivation

As presented in the literature review in Chapter 1, to the best of our knowledge, sustainable development is the one of overlooked issues in configuration of DCMS. Moreover, real life condition is one of the issues that attract more attentions in recent studies. In this way, the consideration of several kinds of uncertainty and the approaches to model them need a deeper attention.

In order to respond these gaps, a multi-objective model is developed to trade-off economic, social and environmental aspects as three separate objective functions. It is noteworthy that in addition to all contributions developed for models in Chapter 2 and 3, new considerations as the type of the worker (local, non-local) in the hiring and firing decision is proposed.

Furthermore, to closely approximate real-life situations, some parameters, such as demand, machine related costs and machine time capacity are considered to be uncertain. Due to lack of knowledge about uncertain parameters, the pattern of triangular fuzzy value is used as possibilistic distribution. A two-phase possibilistic approach is implemented for solving the problem. Firstly, to deal with the uncertainty of proposed model, hybridized possibilistic method is developed to transform the model into the equivalent auxiliary crisp one. Then

an interactive fuzzy approach is applied to solve and find the compromised solution.

## **4.2 Problem formulation**

As previously explained, a multi-objective model is proposed for the configuration of DCMS. The first objective minimizes related costs such as fixed and variable costs of machines, inter-cell and intra-cell movement costs, machine procurement costs, machine relocation costs, hiring, firing, training and salaries of workers. The second objective maximizes the social criteria, such as increasing of job opportunities, decreasing of potential machines hazards for workers over the planning horizon. The third objective represents environmental criteria, modeled by an aggregate criterion representing total production waste caused by machines.

Because of the complex nature and interdependencies of social criteria, it is too difficult to model and measure them. This study selects and extracts social issues from ISO 26000 [107] and GRI 2011 [108] (credible sustainability reporting frameworks) that are closely related to DCMS and can be simplified to be calculable in the mathematical model.

As a result, we select (i) the number of job opportunities created, (ii) the number of potential hazards of machines as social issues and (iii) the total waste of machines (production waste) as environmental measures. The first social issue is represented by the variation of job opportunities, changed due to the hiring and firing of workers. For this issue, the proposed model tries to promote local workers more than non-local ones. The second social issue measures the average fraction of potential hazards of each machine according to ergonomic criteria. This is the number of injuries, illnesses and damages of each machine for workers. This value is a continuous number between 0 (safest) and 1 (utmost dangerous) and can be selected by the decision maker. For this objective, decision maker can use a safety checklist, discuss with workers, review the manufacturer's information, and check the injury and incident reports of each machine. Due to the different nature of measuring units of the considered social criteria, a normalized weighted sum method is applied [112], [113]. Finally, as third objective several wastes have been involved which reflect the waste of each machine to process each operation. This measure may include several wastes by an aggregation method, which is explained in the previous chapter.

### 4.2.1 Problem assumptions

In addition to the general assumptions presented in Chapter 2 (page 25), the specific assumptions of the model are presented as follows:

- The demand of each part in each period is uncertain and fuzzy number.
- The capability of each machine for processing parts is known. The time capacity of each machine is modeled by a fuzzy value.
- The fixed and variable costs of machines are assumed as fuzzy value in each period.
- The machine purchasing and selling costs in each period are considered as fuzzy values and include machine prices and freight charges. This means that the removal costs between the places of storage and installation are not considered.
- The relocation cost of each type of machines between two periods is assumed as a constant parameter.

### 4.2.2 Notations

In addition to the general notations, presented in chapter 2 (pages 26, 27), the specific notations of the model are presented as follows:

#### *Specific Sets*

$s$	index for number of shifts per period ( $s = 1, 2, \dots, S$ )
$d$	index for number of days per period ( $d = 1, 2, \dots, D$ )
$l$	index for number of workers ( $l = 1, 2, \dots, NL$ )
$r$	index for type of workers ( $r = 1, 2, \dots, R$ )
$k, k'$	index for level of machine ( $1, 2, \dots, ML$ )
$\alpha, \beta$	index for level of worker ( $1, 2, \dots, \psi$ )

#### *Specific Parameters*

$S$	number of shifts per period
$D$	number of days per period
$NL$	number of workers
$R$	number of types of workers
$ML$	number of machine levels
$\psi$	number of worker levels
$\tilde{\lambda}_{m,h}$	fixed cost of machine type $m$ in period $h$
$\tilde{\eta}_{j,m,h}$	variable cost of machine type $m$ to process operation $j$ in period $h$
$\delta_m$	relocation cost of machine type $m$
$\tilde{\varphi}_{m,h}$	cost of purchase machine type $m$ in period $h$
$\tilde{\omega}_{m,h}$	marginal revenue from selling machine type $m$ in period $h$
$\bar{L}_k$	combined noise level (dBA) measured at machine level $k$

$W_{j,m}$	total amount of waste of machine type $m$ to process operation $j$
$UG_{\alpha,\beta}$	1, if training from skill level $\alpha$ to skill level $\beta$ is possible, 0 otherwise
$MTL_{m,k}$	1, if machine of type $m$ belongs to machine level $k$ , 0 otherwise
$WP_{\alpha,k}$	1, if working of a worker with skill level $\alpha$ on machine level $k$ is possible, 0 otherwise
$H_{\alpha,h,r}$	cost of hiring a worker with skill level $\alpha$ and type of $r$ in period $h$
$C_{\alpha,\beta,h,r}$	training cost of each $\alpha$ -level worker for skill level $\beta$ for worker type $r$ in period $h$
$S_{\alpha,h,r}$	salary of each $\alpha$ -level worker and type of $r$ in period $h$
$NL_k$	number of workers needed for machine level $k$
$HZ_m$	average fraction of potential hazards of machine type $m$
$F_{\alpha,h,r}$	firing cost of each $\alpha$ -level worker and type of $r$ in period $h$
$ALT$	available working time per worker in a working day
$t_s$	time duration for each shift $s$
$BN$	an arbitrary big number

#### Specific Variables

$x'_{l,\alpha,k,h,s,r}$	1, if worker $l$ with type $r$ skill level $\alpha$ is assigned to machine level $k$ in period $h$ and shift $s$ ; 0 otherwise
$EL_{\alpha,k,h,r}$	number of existing worker type $r$ with skill level $\alpha$ who are assigned to machine level $k$ in period $h$
$HL_{\alpha,k,h,r}$	number of hired workers type $r$ with skill level $\alpha$ who are assigned to machine level $k$ in period $h$
$FL_{\alpha,k,h,r}$	number of fired workers type $r$ with skill level $\alpha$ who are assigned to machine level $k$ in period $h$
$TL_{\alpha,\beta,k,k',h,r}$	number of $\alpha$ -level workers type $r$ who were working with machine level $k$ in period $h-1$ , and are upgraded by training to higher skill level $\beta$ and are assigned to machine level $k'$ in period $h$
$y_{\alpha,k',h,r}$	an auxiliary binary variable

Note:

$$EL_{\alpha,k,h,r} = \sum_{l=1}^L \sum_{s=1}^S x'_{l,\alpha,k,h,s,r} \quad \forall \alpha,k,h,r \quad (4-1)$$

### 4.2.3 Mathematical formulation

According to the assumption and objectives presented in the previous section, this problem is formulated as follows:



$$\begin{aligned}
 \text{Min } Z_1 = & \sum_{h=1}^H \sum_{m=1}^M \sum_{c=1}^C \tilde{\lambda}_{m,h} \times N_{m,c,h} \\
 & + \sum_{h=1}^H \sum_{m=1}^M \sum_{c=1}^C \sum_{p=1}^P \sum_{j=1}^{O_p} \tilde{\eta}_{j,m,h} \times \tilde{D}_{p,h} \times t_{j,p,m} \times x_{j,p,m,c,h} \\
 & + \left[ \frac{1}{2} \times \sum_{h=1}^H \sum_{p=1}^P \gamma_p^{inter} \times \left[ \frac{\tilde{D}_{p,h}}{B_p^{inter}} \right] \right. \\
 & \left. \times \sum_{j=1}^{O_p-1} \sum_{c=1}^C \left| \sum_{m=1}^M x_{(j+1)p,m,c,h} - \sum_{m=1}^M x_{j,p,m,c,h} \right| \right] \\
 & + \frac{1}{2} \times \sum_{h=1}^H \sum_{p=1}^P \left[ \gamma_p^{intra} \times \left[ \frac{\tilde{D}_{p,h}}{B_p^{intra}} \right] \times \right. \\
 & \left. \sum_{j=1}^{O_p-1} \sum_{c=1}^C \left( \sum_{m=1}^M |x_{(j+1)p,m,c,h} - x_{j,p,m,c,h}| - \sum_{m=1}^M x_{(j+1)p,m,c,h} + \sum_{m=1}^M x_{j,p,m,c,h} \right) \right] \quad (4-2)
 \end{aligned}$$

$$\begin{aligned}
 & + \frac{1}{2} \times \sum_{h=1}^H \sum_{m=1}^M \sum_{c=1}^C \delta_m \times (K_{m,c,h}^+ + K_{m,c,h}^-) \\
 & + \sum_{h=1}^H \sum_{m=1}^M I_{m,h}^+ \times \tilde{\varphi}_{m,h} - \sum_{h=1}^H \sum_{m=1}^M I_{m,h}^- \times \tilde{\omega}_{m,h} \\
 & + \sum_{h=1}^H \sum_{\alpha=1}^{\psi} \sum_{k=1}^{ML} \sum_{r=1}^R H_{\alpha,h,r} \times HL_{\alpha,k,h,r} \\
 & + \sum_{h=1}^H \sum_{\alpha=1}^{\psi} \sum_{\beta>\alpha}^{\psi} \sum_{k=1}^{ML} \sum_{k'=1}^{ML} \sum_{r=1}^R C_{\alpha,\beta,h,r} \times TL_{\alpha,\beta,k,k',h,r} \\
 & + \sum_{h=1}^H \sum_{\alpha=1}^{\psi} \sum_{k=1}^{ML} S_{\alpha,h,r} \times \left( \sum_{l=1}^L \sum_{s=1}^S x'_{l,\alpha,k,h,s} \right) \\
 & + \sum_{h=1}^H \sum_{\alpha=1}^{\psi} \sum_{k=1}^{ML} \sum_{r=1}^R F_{\alpha,h,r} \times FL_{\alpha,k,h,r}
 \end{aligned}$$

$$\begin{aligned}
 \text{Max } Z_2 = & \theta_{jo} \left( \sum_{h=1}^H \sum_{\alpha=1}^{\psi} \sum_{k=1}^{ML} \sum_{r=1}^R HL_{\alpha,k,h,r} - \sum_{h=1}^H \sum_{\alpha=1}^{\psi} \sum_{k=1}^{ML} \sum_{r=1}^R FL_{\alpha,k,h,r} \right) \\
 & - \theta_{hd} \left( \sum_{h=1}^H \sum_{m=1}^M \sum_{c=1}^C N_{m,c,h} \times HZ_m \right) \quad (4-3)
 \end{aligned}$$

$$\text{Min } Z_3 = \sum_{h=1}^H \sum_{m=1}^M \sum_{c=1}^C \sum_{j=1}^{O_p} N_{m,c,h} \times W_{j,m} \times x_{j,p,m,c,h} \quad (4-4)$$

Subject to:

$$\sum_{c=1}^C \sum_{m=1}^M a_{j,p,m} \times x_{j,p,m,c,h} = 1 \quad \forall j,p,h \quad (4-5)$$

$$x_{j,p,m,c,h} \leq a_{j,p,m} \quad \forall j,p,m,c,h \quad (4-6)$$

$$\sum_{p=1}^P \sum_{j=1}^{O_p} \tilde{D}_{p,h} \times t_{j,p,m} \times x_{j,p,m,c,h} \leq \tilde{T}_{m,h} \times N_{m,c,h} \quad \forall m,c,h \quad (4-7)$$

$$N_{m,c,(h-1)} + K_{m,c,h}^+ - K_{m,c,h}^- = N_{m,c,h} \quad \forall m,c,h \quad (4-8)$$

$$\sum_{c=1}^C N_{m,c,(h-1)} + I_{m,h}^+ - I_{m,h}^- = \sum_{c=1}^C N_{m,c,h} \quad \forall m,h \quad (4-9)$$

$$\sum_{m=1}^M N_{m,c,h} \leq UB \quad \forall c,h \quad (4-10)$$

$$\sum_{m=1}^M N_{m,c,h} \geq LB \quad \forall c,h \quad (4-11)$$

$$\sum_{k=1}^{ML} \sum_{\alpha=1}^{\psi} \sum_{r=1}^R x'_{l,\alpha,k,h,s,r} \leq 1 \quad \forall l,h,s \quad (4-12)$$

$$\sum_{l=1}^{NL} \sum_{\alpha=1}^{\psi} \sum_{r=1}^R x'_{l,\alpha,k,h,s,r} \geq NL_k \quad \forall k,h,s \quad (4-13)$$

$$x'_{l,\alpha,k,h,s,r} \leq WP_{\alpha,k} \quad \forall l,\alpha,k,h,s,r \quad (4-14)$$

$$\begin{aligned} \sum_{l=1}^{NL} \sum_{s=1}^S x'_{l,\alpha,k,h,s,r} &= \sum_{l=1}^{NL} \sum_{s=1}^S x'_{l,\alpha,k,(h-1),s,r} + HL_{\alpha,k,h,r} \\ &- FL_{\alpha,k,h,r} + \sum_{v=1}^{\psi} \sum_{k'=1}^{ML} (TL_{v,\alpha,k',k,h,r} - TL_{\alpha,v,k,k',h,r}) \end{aligned} \quad \forall \alpha,h,k,r \quad (4-15)$$

$$\begin{aligned} ALT \times \sum_{\alpha=1}^{\psi} \sum_{l=1}^{NL} \sum_{s=1}^S \sum_{r=1}^R x'_{l,\alpha,k,h,s,r} &\geq \\ &\sum_{c=1}^C \sum_{m=1}^M (N_{m,c,h} \times T_{m,h} \times MTL_{m,k} \times NL_m) \end{aligned} \quad \forall h,k \quad (4-16)$$

$$FL_{\alpha,k,h,r} \leq BN \times WP_{\alpha,k} \quad \forall \alpha,h,k,r \quad (4-17)$$

$$HL_{\alpha,k,h,r} \leq BN \times WP_{\alpha,k} \quad \forall \alpha,h,k,r \quad (4-18)$$

$$TL_{\alpha,v,k,k',h,r} \leq BN \times WP_{\alpha,k} \quad \forall v,\alpha,k,k',h,r \quad (4-19)$$

$$TL_{\alpha,v,k,k',h,r} \leq BN \times WP_{v,k'} \quad \forall v,\alpha,k,k',h,r \quad (4-20)$$

$$TL_{\alpha,v,k,k',h,r} \leq BN \times UG_{v,\alpha} \quad \forall v,\alpha,k,k',h,r \quad (4-21)$$

$$\sum_{v>\alpha}^{\psi} \sum_{k'=1}^{ML} TL_{\alpha,v,k,k',h,r} + FL_{\alpha,k,h,r} \leq EL_{\alpha,k,(h-1),r} \quad \forall \alpha, k, h, r \quad (4-22)$$

$$\sum_{v=1}^{\psi} \sum_{k=1}^{ML} TL_{v,\alpha,k,k',h,r} \leq BN \times y_{\alpha,k',h,r} \quad \forall \alpha, k', h, r \quad (4-23)$$

$$FL_{\alpha,k',h,r} \leq BN \times (1 - y_{\alpha,k',h,r}) \quad \forall \alpha, k', h, r \quad (4-24)$$

$$12.5 \times \left[ \sum_{s=3d-2}^{3d} \sum_{k=1}^{ML} x'_{l,\alpha,k,h,s,r} \times t_s \times 2^{\left(\frac{\bar{L}_k - 90}{5}\right)} \right] \leq 100 \quad \forall l, \alpha, h, d, r \quad (4-25)$$

$$N_{m,c,h}, K_{m,c,h}^+, K_{m,c,h}^-, I_{m,h}^+, I_{m,h}^-, EL_{\alpha,k,h,r}, HL_{\alpha,k,h,r}, FL_{\alpha,k,h,r}, TL_{\alpha,\beta,k,k',h,r} \geq 0, \text{ integer} \quad (4-26)$$

$$x_{j,p,m,c,h}, x'_{l,\alpha,k,h,s,r}, y_{\alpha,k',h,r} \in \{0,1\}$$

In this mathematical model, an effort has been put on making trade-off between economic, environmental and social aspect. The first objective function tries to minimize total cost by considering machine fixed and variable costs, inter-cell and intra-cell movement costs, machine relocation cost, purchasing and selling costs, as well as hiring and firing, training and salary costs of worker (Eq. 4-2). Second objective maximizes the social issues of DCMS over the planning horizon, which includes the maximization of job opportunities and minimization of the potential hazards of machines (Eq. 4-3). Furthermore, a restriction of maximum worker daily noise exposure level is formulated as constraint (4-25). According to the National Institute of Occupational Safety and Health (NIOSH) [111], [109] and Occupational Safety and Health Administration (OSHA) [127] of the U.S. Department of Labor, the combination of exposure level ( $\bar{L}_k$ ) in duration of  $t_s$  for each person should be less than 100 *dBA*. Finally, the third objective function considers minimization of the total production waste amount resulting from machines (Eq. 4-4). As presented in the previous section, production waste can be calculated by aggregation method.

Equations (4-5) and (4-6) ensure that parts are processed according to the planning and required processes. Time capacity of planning periods is controlled by constraints in Equation (4-7). Equations (4-8) and (4-9) consider dynamic balance between consecutive periods in terms of respectively number of assigned machines to each cell and number of purchased or sold machines for each machine type. Equations (4-10) and (4-11) limit the size of cells. Equation (4-12) indicates that each worker has a unique skill level and should be assigned to a unique machine level. Constraint (4-13) ensures that enough number of workers are available for each machine level at each period and shift. Constraint (4-14) applies the rules for assignment of workers regarding skill

levels requested for each machine. Constraint (4-15) is the dynamic worker balance equation and indicates that the number of  $\alpha$ -level workers assigned to machine level  $k$  is equal to the number of  $\alpha$ -level workers in previous period plus the number of  $\alpha$ -level workers hired or trained, minus the number of workers with the same characteristics who are fired or upgraded for upper skill levels. In addition, Constraint (4-15) guarantees that total demand in each period is satisfied, using hiring, firing or training. Constraint (4-16) ensures that sufficient number of workers are available in order to operate machines for each cell. Equations (4-17) to (4-21) ensure that firing, hiring and training are allowed when they are logically possible according to predefined rules. The constraint in Equation (4-22) guarantees that the total number of  $\alpha$ -level workers, assigned to machine level  $k$  in period  $h-1$  and fired or trained for upper skill levels must be less than or equal to the number of workers with the same skill level in previous period. Firing the newly trained workers is not allowed by constraints (4-23) and (4-24). Equation (4-26) determines the variables to be binary or integer.

#### 4.2.4 Linearization

The third and fourth terms of equations (4-2) in the proposed model make it as a nonlinear equation. In order to convert it to the linear one as two previous Chapter, two non-negative variables  $z_{j,p,c,h}^1$  and  $z_{j,p,c,h}^2$  are assumed therefore third term is rewritable as follows:

$$\frac{1}{2} \times \sum_{h=1}^H \sum_{p=1}^P \gamma^{inter} \times \left[ \frac{\tilde{D}_{ph}}{B_p^{inter}} \right] \times \sum_{j=1}^{O_p-1} \sum_{c=1}^C (z_{j,p,c,h}^1 + z_{j,p,c,h}^2) \quad (4-27)$$

Then following constraint must be added to the proposed model.

$$z_{j,p,c,h}^1 - z_{j,p,c,h}^2 = \sum_{m=1}^M x_{(j+1),p,m,c,h} - \sum_{m=1}^M x_{j,p,m,c,h} \quad \forall j,p,c,h \quad (4-28)$$

Similarly, to linearize the fourth term of Equation (4-2),  $y_{j,p,m,c,h}^1$  and  $y_{j,p,m,c,h}^2$  as two non-negative variables are presented, the fourth term of objective function is changed as follows:

$$\frac{1}{2} \times \sum_{h=1}^H \sum_{p=1}^P \gamma^{intra} \times \left[ \frac{\tilde{D}_{ph}}{B_p^{intra}} \right] \times \sum_{j=1}^{O_p-1} \sum_{c=1}^C \left( \sum_{m=1}^M (y_{j,p,m,c,h}^1 + y_{j,p,m,c,h}^2) - (z_{j,p,c,h}^1 + z_{j,p,c,h}^2) \right) \quad (4-29)$$

Also following constraint must be added to the proposed model.

$$y_{j,p,m,c,h}^1 - y_{j,p,m,c,h}^2 = x_{(j+1),p,m,c,h} - x_{j,p,m,c,h} \quad \forall j,p,m,c,h \quad (4-30)$$

Finally, the multiple integer and binary variables equation (4-4) make them nonlinear. It can be linearized as follows:

$$\text{Min } Z_3 = \sum_{h=1}^H \sum_{m=1}^M \sum_{c=1}^C \sum_{j=1}^{O_p} N_{m,c,h} \times w_{j,m} \quad (4-31)$$

$$\frac{x_{j,p,m,c,h}}{BN} \leq N_{m,c,h} \leq x_{j,p,m,c,h} \times BN \quad \forall j, p, m, c, h \quad (4-32)$$

### 4.3 Solution approach

To solve the present multi-objective model, a two-phase approach is developed. In the first phase, by hybridizing two possibilistic methods, [132], [133] the equivalent auxiliary crisp model is obtained. In the second phase, an efficient fuzzy multi-objective method, *i.e.*, Torabi and Hassini (TH) [134] is applied to solve the auxiliary crisp multi-objective programming model and finds the optimized solution.

#### 4.3.1 The auxiliary crisp multi-objective model

According to the above explanation, the main model is converted to the equivalent crisp model in the first phase. There are several methods in the literature to present imprecise coefficients in possibilistic models, see [135], [136], [137], and [138]. An efficient hybridized possibilistic method by Jimenez *et al.* [132] and Parra *et al.* [133] is developed here to transform the present model into the auxiliary crisp multi-objective integer linear programming model (MOILP). With this method, the expected interval and expected value is defined for a fuzzy number, as first presented by Heilpern [139], Jimenez [135], Yager [140], and Dubios and Prade [141], respectively.

If  $\tilde{n}$  is a triangular fuzzy number ( $\tilde{n} = (n^p, n^m, n^o)$ , where  $n^p$  is estimated as the most pessimistic value,  $n^m$  is estimated as the most likely value, and  $n^o$  is estimated as the optimistic value of  $\tilde{n}$ ), the membership function  $\mu_{\tilde{n}}$  will be defined as:

$$\mu_{\tilde{n}}(x) = \begin{cases} f_n(x) = \frac{x - n^p}{n^m - n^p} & \text{if } n^p \leq x \leq n^m \\ 1 & \text{if } x = n^m \\ g_n(x) = \frac{n^o - x}{n^o - n^m} & \text{if } n^m \leq x \leq n^o \\ 0 & \text{if } x \leq n^p, x \geq n^o \end{cases} \quad (4-33)$$

The Expected Interval (EI) and Expected Value (EV) of  $\tilde{n}$  can be calculated [135] as follows:

$$EI(\tilde{n}) = [E_1^n, E_2^n] \quad (4-34)$$

$$= \left[ \int_0^1 f_n^{-1}(x) dx, \int_0^1 g_n^{-1}(x) dx \right] = \left[ \frac{1}{2}(n^p + n^m), \frac{1}{2}(n^m + n^o) \right]$$

$$EV(\tilde{n}) = \frac{E_1^n + E_2^n}{2} = \frac{n^p + 2n^m + n^o}{4} \quad (4-35)$$

Equations (4-34) and (4-35) are usable for a trapezoidal fuzzy number, as well. As [135], for any pair of fuzzy numbers  $\tilde{a}$  and  $\tilde{b}$ , the degree in which  $\tilde{a}$  is bigger than  $\tilde{b}$  is introduced in Equation (4-36):

$$\mu_M(\tilde{a}, \tilde{b}) = \begin{cases} 0 & \text{if } E_2^a - E_1^b < 0 \\ \frac{E_2^a - E_1^b}{E_2^a - E_1^b - (E_1^a - E_2^b)} & \text{if } 0 \in [E_1^a - E_2^b, E_2^a - E_1^b] \\ 1 & \text{if } E_1^a - E_2^b > 0 \end{cases} \quad (4-36)$$

If  $\mu_M(\tilde{a}, \tilde{b}) \geq \alpha$ , it implies that  $\tilde{a}$  is greater or equal to  $\tilde{b}$  at least a degree of preference  $\alpha$ , which will be denoted by  $\tilde{a} \geq_\alpha \tilde{b}$ .

On the other hand, according to the definition presented by Parra *et al.* [133], for any pair of fuzzy number  $\tilde{a}$  and  $\tilde{b}$ , when  $\tilde{a}$  and  $\tilde{b}$  are indifferent in a degree of  $\alpha$ , the following relationships hold simultaneously:

$$\tilde{a} \geq_{\alpha/2} \tilde{b}, \quad \tilde{a} \leq_{\alpha/2} \tilde{b}. \quad (4-37)$$

Equation (4-37) can be rewritten as follows:

$$\frac{\alpha}{2} \leq \mu_M(\tilde{a}, \tilde{b}) \leq 1 - \frac{\alpha}{2} \quad (4-38)$$

Now, assume the following mathematical model in which  $\tilde{c} = (\tilde{c}_1, \tilde{c}_2, \dots, \tilde{c}_n)$ ,  $\tilde{a} = [\tilde{a}_{ij}]_{s \times n}$  and  $\tilde{b} = (\tilde{b}_1, \tilde{b}_2, \dots, \tilde{b}_s)^t$  are trapezoidal or triangular fuzzy numbers:

$$\min \quad z = \tilde{c}^t x$$

s.t.

$$\tilde{a}_{ij} x \geq \tilde{b}_i \quad \forall i = 1, \dots, k, \quad j = 1, \dots, n \quad (4-39)$$

$$\tilde{a}_{ij} x = \tilde{b}_i \quad \forall i = k + 1, \dots, s, \quad j = 1, \dots, n$$

$$x \geq 0$$

If  $\min_{i=1, \dots, s} \{ \mu_M(\tilde{a}_i x, \tilde{b}_i) \} = \alpha$ , where  $\tilde{a}_i = (\tilde{a}_{i1}, \tilde{a}_{i2}, \dots, \tilde{a}_{in})$ ,  $x \in \mathfrak{R}^n$  (decision vector) will be feasible in a degree of  $\alpha$  [132]. According to Equations (4-36), (4-37) and (4-38), constraints  $\tilde{a}_i x \geq \tilde{b}_i$  and  $\tilde{a}_i x = \tilde{b}_i$  can be rewritten as:

$$\frac{E_2^{a_i x} - E_1^{b_i}}{E_2^{a_i x} - E_1^{a_i x} + E_2^{b_i} - E_1^{b_i}} \geq \alpha \quad \forall i = 1, \dots, k \quad (4-40)$$

$$\frac{\alpha}{2} \leq \frac{E_2^{a_i x} - E_1^{b_i}}{E_2^{a_i x} - E_1^{a_i x} + E_2^{b_i} - E_1^{b_i}} \leq 1 - \frac{\alpha}{2} \quad \forall i = k+1, \dots, s \quad (4-41)$$

Then, these equations are equivalent to:

$$\left[ (1-\alpha)E_2^{a_i} + \alpha E_1^{a_i} \right] x \geq \alpha E_2^{b_i} + (1-\alpha)E_1^{b_i} \quad \forall i = 1, \dots, k \quad (4-42)$$

$$\left[ \left(1 - \frac{\alpha}{2}\right)E_2^{a_i} + \frac{\alpha}{2} E_1^{a_i} \right] x \geq \frac{\alpha}{2} E_2^{b_i} + \left(1 - \frac{\alpha}{2}\right)E_1^{b_i} \quad \forall i = k+1, \dots, s \quad (4-43)$$

$$\left[ \frac{\alpha}{2} E_2^{a_i} + \left(1 - \frac{\alpha}{2}\right)E_1^{a_i} \right] x \leq \left(1 - \frac{\alpha}{2}\right)E_2^{b_i} + \frac{\alpha}{2} E_1^{b_i} \quad \forall i = k+1, \dots, s$$

According to the ranking method which is presented by Jimenez [135], when vector  $x$  is presented as a feasible vector, then the vector  $x^0$  can be presented as an optimal solution at least in degree  $1/2$ , as opposed to vector  $x$  for model (4-39), if it is verified for all  $\tilde{c}^t x \geq_{1/2} \tilde{c} x^0$ . Therefore, the previous equation can be expressed:

$$\frac{E_2^{c^t x} - E_1^{c^t x}}{2} \geq \frac{E_2^{c^t x^0} + E_1^{c^t x^0}}{2} \quad (4-44)$$

Finally, according to above explanation of expected value and expected interval, model (4-39) can be transformed into an equivalent crisp  $\alpha$ -parametric linear model as follows:

$$\min \quad EV(\tilde{c})x$$

*s.t.*

$$\begin{aligned} \left[ (1-\alpha)E_2^{a_i} + \alpha E_1^{a_i} \right] x &\geq \alpha E_2^{b_i} + (1-\alpha)E_1^{b_i} & \forall i = 1, \dots, k \\ \left[ \left(1 - \frac{\alpha}{2}\right)E_2^{a_i} + \frac{\alpha}{2} E_1^{a_i} \right] x &\geq \frac{\alpha}{2} E_2^{b_i} + \left(1 - \frac{\alpha}{2}\right)E_1^{b_i} & \forall i = k+1, \dots, s \\ \left[ \frac{\alpha}{2} E_2^{a_i} + \left(1 - \frac{\alpha}{2}\right)E_1^{a_i} \right] x &\leq \left(1 - \frac{\alpha}{2}\right)E_2^{b_i} + \frac{\alpha}{2} E_1^{b_i} & \forall i = k+1, \dots, s \\ x &\geq 0 \end{aligned} \quad (4-45)$$

Therefore, the main model will be transformed into the equivalent auxiliary crisp multi-objective model as follows:

$$\begin{aligned}
 \text{Min } f_1 = & \sum_{h=1}^H \sum_{m=1}^M \sum_{c=1}^C \left( \frac{\lambda_{m,h}^p + \lambda_{m,h}^m + \lambda_{m,h}^o}{4} \right) \times N_{m,c,h} + \\
 & + \sum_{h=1}^H \sum_{m=1}^M \sum_{c=1}^C \sum_{p=1}^P \sum_{j=1}^{O_p} \left[ \left( \frac{\eta_{j,m,h}^p + \eta_{j,m,h}^m + \eta_{j,m,h}^o}{4} \right) \times \right. \\
 & \left. \left( \frac{D_{p,h}^p + D_{p,h}^m + D_{p,h}^o}{4} \right) \times t_{j,p,m} \times x_{j,p,m,c,h} \right] \\
 & + \frac{1}{2} \times \sum_{h=1}^H \sum_{p=1}^P \left[ \gamma_p^{\text{inter}} \times \left| \frac{D_{p,h}^p + D_{p,h}^m + D_{p,h}^o}{4B_p^{\text{inter}}} \right| \times \right. \\
 & \left. \sum_{j=1}^{O_p-1} \sum_{c=1}^C (z_{j,p,c,h}^1 + z_{j,p,c,h}^2) \right] \\
 & + \frac{1}{2} \times \sum_{h=1}^H \sum_{p=1}^P \left[ \gamma_p^{\text{intra}} \times \left| \frac{D_{p,h}^p + D_{p,h}^m + D_{p,h}^o}{4B_p^{\text{intra}}} \right| \times \right. \\
 & \left. \sum_{j=1}^{O_p-1} \sum_{c=1}^C \left( \sum_{m=1}^M (y_{j,p,m,c,h}^1 + y_{j,p,m,c,h}^2) \right) \right. \\
 & \left. \left( -z_{j,p,c,h}^1 + z_{j,p,c,h}^1 \right) \right] \tag{4-46}
 \end{aligned}$$

$$\begin{aligned}
 & + \frac{1}{2} \times \sum_{h=1}^H \sum_{m=1}^M \sum_{c=1}^C \delta_m \times (K_{m,c,h}^+ + K_{m,c,h}^-) \\
 & + \sum_{h=1}^H \sum_{m=1}^M I_{m,h}^+ \times \left( \frac{\varphi_{m,h}^p + \varphi_{m,h}^m + \varphi_{m,h}^o}{4} \right) \\
 & - \sum_{h=1}^H \sum_{m=1}^M I_{m,h}^- \times \left( \frac{\omega_{m,h}^p + \omega_{m,h}^m + \omega_{m,h}^o}{4} \right) \\
 & + \sum_{h=1}^H \sum_{\alpha=1}^{\psi} \sum_{k=1}^{ML} \sum_{r=1}^R H_{\alpha,h,r} \times HL_{\alpha,k,h,r} \\
 & + \sum_{h=1}^H \sum_{\alpha=1}^{\psi} \sum_{\beta > \alpha}^{\psi} \sum_{k=1}^{ML} \sum_{k'=1}^{ML} \sum_{r=1}^R C_{\alpha,\beta,h,r} \times TL_{\alpha,\beta,k,k',h,r} \\
 & + \sum_{h=1}^H \sum_{\alpha=1}^{\psi} \sum_{k=1}^{ML} S_{\alpha,h,r} \times \left( \sum_{l=1}^L \sum_{s=1}^S x'_{l,\alpha,k,h,s} \right) \\
 & + \sum_{h=1}^H \sum_{\alpha=1}^{\psi} \sum_{k=1}^{ML} \sum_{r=1}^R F_{\alpha,h,r} \times FL_{\alpha,k,h,r} \\
 \text{Max } f_2 = & \theta_{jo} \left( \sum_{h=1}^H \sum_{\alpha=1}^{\psi} \sum_{k=1}^{ML} \sum_{r=1}^R HL_{\alpha,k,h,r} - \sum_{h=1}^H \sum_{\alpha=1}^{\psi} \sum_{k=1}^{ML} \sum_{r=1}^R FL_{\alpha,k,h,r} \right) \\
 & - \theta_{hd} \left( \sum_{h=1}^H \sum_{m=1}^M \sum_{c=1}^C N_{m,c,h} \times HZ_m \right) \tag{4-47}
 \end{aligned}$$



$$\text{Min } f_3 = \sum_{h=1}^H \sum_{m=1}^M \sum_{c=1}^C \sum_{j=1}^{O_p} N_{m,c,h} \times W_{j,m} \quad (4-48)$$

Subject to:

$$\sum_{c=1}^C \sum_{m=1}^M a_{j,p,m} \times x_{j,p,m,c,h} = 1 \quad \forall j, p, h \quad (4-49)$$

$$x_{j,p,m,c,h} \leq a_{j,p,m} \quad \forall j, p, c, m, h \quad (4-50)$$

$$\sum_{p=1}^P \sum_{j=1}^{O_p} \left[ \alpha \times \frac{D_{p,h}^m + D_{p,h}^o}{2} + (1-\alpha) \times \frac{D_{p,h}^p + D_{p,h}^m}{2} \right] \times x_{j,p,m} \times x_{j,p,m,c,h} \leq \left[ \alpha \times \frac{T_{m,h}^m + T_{m,h}^o}{2} + (1-\alpha) \times \frac{T_{m,h}^p + T_{m,h}^m}{2} \right] \times N_{m,c,h} \quad \forall m, c, h \quad (4-51)$$

$$N_{m,c,(h-1)} + K_{m,c,h}^+ - K_{m,c,h}^- = N_{m,c,h} \quad \forall m, c, h \quad (4-52)$$

$$\sum_{c=1}^C N_{m,c,(h-1)} + I_{m,h}^+ - I_{m,h}^- = \sum_{c=1}^C N_{m,c,h} \quad \forall m, h \quad (4-53)$$

$$\sum_{m=1}^M N_{m,c,h} \leq UB \quad \forall c, h \quad (4-54)$$

$$\sum_{m=1}^M N_{m,c,h} \geq LB \quad \forall c, h \quad (4-55)$$

$$\sum_{k=1}^{ML} \sum_{\alpha=1}^{\psi} \sum_{r=1}^R x'_{l,\alpha,k,h,s,r} \leq 1 \quad \forall l, h, s \quad (4-56)$$

$$\sum_{l=1}^{NL} \sum_{\alpha=1}^{\psi} \sum_{r=1}^R x'_{l,\alpha,k,h,s,r} \geq NL_k \quad \forall k, h, s \quad (4-57)$$

$$x'_{l,\alpha,k,h,s,r} \leq WP_{\alpha,k} \quad \forall l, \alpha, k, h, s, r \quad (4-58)$$

$$\sum_{l=1}^{NL} \sum_{s=1}^S x'_{l,\alpha,k,h,s,r} = \sum_{l=1}^{NL} \sum_{s=1}^S x'_{l,\alpha,k,(h-1),s,r} + HL_{\alpha,k,h,r} - FL_{\alpha,k,h,r} + \sum_{v=1}^{\psi} \sum_{k'=1}^{ML} (TL_{v,\alpha,k',k,h,r} - TL_{\alpha,v,k,k',h,r}) \quad \forall \alpha, h, k, r \quad (4-59)$$

$$ALT \times \sum_{\alpha=1}^{\psi} \sum_{l=1}^{NL} \sum_{s=1}^S \sum_{r=1}^R x'_{l,\alpha,k,h,s,r} \geq \sum_{c=1}^C \sum_{m=1}^M (N_{m,c,h} \times T_{m,h} \times MTL_{m,k} \times NL_m) \quad \forall h, k \quad (4-60)$$

$$FL_{\alpha,k,h,r} \leq BN \times WP_{\alpha,k} \quad \forall \alpha, h, k, r \quad (4-61)$$

$$HL_{\alpha,k,h,r} \leq BN \times WP_{\alpha,k} \quad \forall \alpha, h, k, r \quad (4-62)$$

$$TL_{\alpha,v,k,k',h,r} \leq BN \times WP_{\alpha,k} \quad \forall v, \alpha, k, k', h, r \quad (4-63)$$

$$TL_{\alpha,v,k,k',h,r} \leq BN \times WP_{v,k'} \quad \forall v, \alpha, k, k', h, r \quad (4-64)$$

$$TL_{\alpha,v,k,k',h,r} \leq BN \times UG_{v,\alpha} \quad \forall v, \alpha, k, k', h, r \quad (4-65)$$

$$\sum_{v>\alpha}^{\psi} \sum_{k'=1}^{ML} TL_{\alpha,v,k,k',h,r} + FL_{\alpha,k,h,r} \leq EL_{\alpha,k,(h-1),r} \quad \forall \alpha, k, h, r \quad (4-66)$$

$$\sum_{v=1}^{\psi} \sum_{k=1}^{ML} TL_{v,\alpha,k,k',h,r} \leq BN \times y_{\alpha,k',h,r} \quad \forall \alpha, k', h, r \quad (4-67)$$

$$FL_{\alpha,k',h,r} \leq BN \times (1 - y_{\alpha,k',h,r}) \quad \forall \alpha, k', h, r \quad (4-68)$$

$$12.5 \times \left[ \sum_{s=3d-2}^{3d} \sum_{k=1}^{ML} x'_{l,\alpha,k,h,s,r} \times t_s \times 2^{\left(\frac{\bar{L}_k - 90}{5}\right)} \right] \leq 100 \quad \forall l, \alpha, h, d, r \quad (4-69)$$

$$z_{j,p,c,h}^1 - z_{j,p,c,h}^2 = \sum_{m=1}^M x_{(j+1)p,m,c,h} - \sum_{m=1}^M x_{j,p,m,c,h} \quad \forall j, p, c, h \quad (4-70)$$

$$y_{j,p,m,c,h}^1 - y_{j,p,m,c,h}^2 = x_{(j+1)p,m,c,h} - x_{j,p,m,c,h} \quad \forall j, p, m, c, h \quad (4-71)$$

$$\frac{x_{j,p,m,c,h}}{BN} \leq N_{m,c,h} \leq x_{j,p,m,c,h} \times BN \quad \forall j, p, m, c, h \quad (4-72)$$

$$N_{m,c,h}, K_{m,c,h}^+, K_{m,c,h}^-, I_{m,h}^+, I_{m,h}^-, EL_{\alpha,k,h,r}, HL_{\alpha,k,h,r}, FL_{\alpha,k,h,r}, TL_{\alpha,\beta,k,k',h,r} \geq 0, \text{ integer} \quad (4-73)$$

$$x_{j,p,m,c,h}, x'_{l,\alpha,k,h,s,r}, y_{\alpha,k',h,r} \in \{0,1\}$$

### 4.3.2 The fuzzy solution approach

There are various methods to solve multi-objective linear programming (MOLP) problems. However, fuzzy programming approach is applied by a large number of researchers. This approach allows to maximize the satisfaction degree for each objective function. The main advantage of this approach is that it helps the decision maker to obtain an efficient solution according to his/her preference, or the relative importance of each objective. Zimmermann [142] was the first person to propose a fuzzy approach for solving a MOLP by the max-min approach. However, the solutions yielded by max-min approach are not unique and efficient [137]. Therefore, Lai *et al.* [137] proposed an augmented min-max approach to remove this deficiency. Recently, Selim and

Ozkarahan [143] proposed a new approach, according to a modification in the aggregation functions suggested by Werners [144].

In this study, the TH (Torabi-Hassini) [134] method is applied to find an optimized, efficient solution as follows:

- *Step 1:* Define the possibility distribution (triangular or trapezoidal) for ambiguous parameters and formulate the multi-objective possibilistic mixed-integer linear programming for the DCMS configuration problem.
- *Step 2:* Transform fuzzy constraints to crisp ones by defining a minimum acceptable feasibility degree of  $\alpha$ , and convert the original fuzzy objectives into crisp ones according to the expected values of the ambiguous parameters.
- *Step 3:* Specify the  $\beta$ -positive ideal solution ( $\beta$ -PIS) and the  $\beta$ -negative ideal solution ( $\beta$ -NIS) for each objective function.  $(Y_1^{\beta-PIS}, x_1^{\beta-PIS})$ ,  $(Y_2^{\beta-PIS}, x_2^{\beta-PIS})$  and  $(Y_3^{\beta-PIS}, x_3^{\beta-PIS})$  could be obtained as  $\beta$ -positive ideal solutions by solving the crisp multi-objective mixed-integer linear programming (MOMILP) model for each objective function. Then, related  $\beta$ -negative ideal solutions could be estimated thus:

$$Y_1^{\beta-NIS} = \max \{Y_1(x_2^{\beta-PIS}), Y_1(x_3^{\beta-PIS})\} \quad (4-74)$$

$$Y_2^{\beta-NIS} = \max \{Y_2(x_1^{\beta-PIS}), Y_2(x_3^{\beta-PIS})\} \quad (4-75)$$

$$Y_3^{\beta-NIS} = \max \{Y_3(x_1^{\beta-PIS}), Y_3(x_2^{\beta-PIS})\} \quad (4-76)$$

- *Step 4:* Linear membership objective functions are presented as follows:

$$\mu_1(x) = \begin{cases} 1 & \text{if } Y_1 < Y_1^{\beta-PIS} \\ \frac{Y_1^{\beta-NIS} - Y_1}{Y_1^{\beta-NIS} - Y_1^{\beta-PIS}} & \text{if } Y_1^{\beta-PIS} \leq Y_1 \leq Y_1^{\beta-NIS} \\ 0 & \text{if } Y_1 > Y_1^{\beta-NIS} \end{cases} \quad (4-77)$$

$$\mu_2(x) = \begin{cases} 0 & \text{if } Y_2 < Y_2^{\beta-PIS} \\ \frac{Y_2 - Y_2^{\beta-PIS}}{Y_2^{\beta-NIS} - Y_2^{\beta-PIS}} & \text{if } Y_2^{\beta-PIS} \leq Y_2 \leq Y_2^{\beta-NIS} \\ 1 & \text{if } Y_2 > Y_2^{\beta-NIS} \end{cases} \quad (4-78)$$

$$\mu_3(x) = \begin{cases} 1 & \text{if } Y_3 < Y_3^{\beta-PIS} \\ \frac{Y_3^{\beta-NIS} - Y_3}{Y_3^{\beta-NIS} - Y_3^{\beta-PIS}} & \text{if } Y_3^{\beta-PIS} \leq Y_3 \leq Y_3^{\beta-NIS} \\ 0 & \text{if } Y_3 > Y_3^{\beta-NIS} \end{cases} \quad (4-79)$$

- *Step 5:* The equivalent crisp MOMILP will transform into a single objective MILP by the TH aggregation method. The aggregation function is presented as follows:

$$\begin{aligned} \max \quad & \lambda(x) = \gamma\lambda_0 + (1-\gamma)\sum_h \theta_h \mu_h(x) \\ \text{s.t.} \quad & \lambda_0 \leq \mu_h(x), \quad h=1,2,3 \\ & x \in F(x), \quad \lambda_0 \text{ and } \lambda \in [0,1] \end{aligned} \quad (4-80)$$

where  $\mu_h(x)$  denotes the satisfaction degree of the  $h$  th objective function for vector  $x$ , and also  $\lambda_0$  defines the lower bound of the satisfaction degree for objectives ( $\lambda_0 = \min_h \{\mu_h(x)\}$ ). Moreover,  $\theta_h$  represents the relative importance, which is defined by the decision maker according to his/her preference, that  $\sum_h \theta_h = 1$ ,  $\theta_h > 0$ . Moreover,  $\gamma$  determines the coefficient of compensation for each objective, which can be unbalanced (more attention is paid to the objective function with high relative importance), and balances all objective the optimized solution.

- *Step6:* Determine  $\theta_h$  (relative importance) and  $\gamma$  (coefficient of compensation), then solve proposed auxiliary MILP model (4-80). According to his/her preference, decision maker is able to change the values of  $\alpha$ ,  $\gamma$  and  $\theta_h$  in order to obtain the optimized and efficient solution.

#### 4.4 Experimental results

To verify feasibility and performance of the proposed model and solution approach, four test problems with different sizes (Table 4.1) are generated. Table 4.2 shows the generation pattern of the parameters. Some of these patterns are taken from Safaei *et al.* [63], while others are generated for our problem. The triangular fuzzy parameter is produced according to the presented method by Lai and Hwang [137]. In this method, the value of three prominent points of fuzzy membership is produced based on the presented pattern in Table 4.2, when the most likely value is considered equivalent to the crisp value. The pessimistic and optimistic values are then calculated by the following equations:

$$\begin{aligned} n^o &= (1 + d_1)n^m \\ n^p &= (1 - d_2)n^m \end{aligned} \quad (d_1, d_2) \sim \text{Uniform}(0.2, 0.8)$$

**Table 4.1** The Size of test problems

Problem	Number of								
	Machine skill level	Worker skill level	Cell	Part type	Machine type	Operation	Period	Shift	Worker type
P1	1	2	3	2	3	3	2	1	2
P2	2	2	4	3	4	4	2	1	2
P3	2	3	4	7	6	5	3	2	2
P4	3	3	5	7	7	6	4	2	2

**Table 4.2** Generation pattern of the parameters

Parameter	Generation pattern	Parameter	Generation pattern
$D_{ph}$	$\sim$ Uniform (50, 100)	$\omega_m$	$\sim$ Uniform (0, 1) $\times \varphi_m$
$B_p^{inter}$	$\sim$ Uniform (10, 50)	$\bar{L}_k$	$\sim$ Uniform (65, 85)
$B_p^{int ra}$	$B_p^{inter} / 5$	$w_{j,m}$	$\sim$ Uniform (200, 300)
$\gamma_p^{inter}$	$\sim$ Uniform (100, 300)	$t_{j,p,m}$	$\sim$ Uniform (1, 10)
$\gamma_p^{int ra}$	$\sim$ Uniform (100, 300)	$H_{\alpha,h,r}$	$\sim$ Uniform (200, 400)
$\lambda_m$	$\sim$ Uniform (500, 800)	$C_{\alpha,\beta,h,r}$	$\sim$ Uniform (100, 200)
$\eta_{j,m}$	$\sim$ Uniform (100, 200)	$F_{\alpha,h,r}$	$\sim$ Uniform (300, 500)
$\delta_m$	$\lambda_m / 2$	$S_{\alpha,h,r}$	$\sim$ Uniform (500, 700)
$T_{m,h}$	$\sim$ Uniform (1, 5)	$NL_m$	$\sim$ Uniform (1, 4)
$UB$	4	$HZ_m$	$\sim$ Uniform (0, 1)
$LB$	2	$ALT$	$\sim$ Uniform (6, 8)
$\varphi_m$	$\sim$ Uniform (3000, 5000)	$t_s$	$\sim$ Uniform (4, 6)

The relative importance ( $\theta = (\theta_1, \theta_2, \theta_3)$ ) for the objectives of this problem are defined according to the Analytical Hierarchy Process (AHP) [145] as one of the Multi Criteria Decision Making techniques. Accordingly, the relative importance is set as  $\theta_2 > \theta_1 > \theta_3$  and  $\theta = (0.35, 0.5, 0.15)$ . In the first step, all the numerical examples are solved with different  $\alpha$  levels, where low value of 0.4 is considered for  $\gamma$ . Since the second objective (social issues) has higher

relative importance, the low value is set for  $\gamma$  so as to yield unbalanced solutions. It is noteworthy that to consider the randomness effect, 5 instances are generated for each problem and the average results of them are reported in Table 4.3.

The possibilistic model is programmed in optimization software GAMS 23.5, Solver CPLEX and tested for all computational example on a notebook by Pentium Corei5, 2.27 GHZ with 4.0 GB RAM. The mean optimality gap is less than 5% for all sizes of the test problems.

**Table 4.3** Results based on  $\alpha$ -level variations

Problem No.	$\alpha$ -level	$Y_1$	$Y_2$	$Y_3$	$\mu(Y_1)$	$\mu(Y_2)$	$\mu(Y_3)$	CPU time (s)
1	0.5	25512	13.83	1346	0.94	0.97	0.93	671.2
	0.6	25843	12.18	1497	0.93	0.96	0.92	708.1
	0.7	26471	11.72	1403	0.92	0.96	0.88	649.9
	0.8	26052	11.36	1531	0.92	0.87	0.94	683.2
	0.9	27367	10.21	1784	0.91	0.93	0.90	712.8
	1	28109	9.88	1609	0.87	0.94	0.89	718.3
2	0.5	39347	18.86	2326	0.94	0.96	0.98	985.9
	0.6	40916	18.24	2494	0.94	0.95	0.91	978.2
	0.7	40293	17.62	2377	0.93	0.95	0.91	963.4
	0.8	41311	17.08	2441	0.90	0.95	0.92	991.7
	0.9	41674	16.75	2547	0.92	0.91	0.90	987.1
	1	42381	15.97	2501	0.92	0.92	0.93	993.9
3	0.5	68579	24.55	4174	0.95	0.98	0.92	1837.2
	0.6	68812	23.94	4037	0.95	0.98	0.91	1846.5
	0.7	70668	23.08	4298	0.86	0.97	0.90	1804.6
	0.8	71827	22.61	4631	0.90	0.95	0.94	1862.1
	0.9	71933	22.47	4362	0.90	0.95	0.94	1879.4
	1	72961	21.19	4679	0.91	0.95	0.88	1871.1
4	0.5	143496	28.39	5926	0.93	0.98	0.90	2693.7
	0.6	142143	28.11	6138	0.91	0.96	0.87	2751.3
	0.7	143947	27.70	6043	0.90	0.96	0.91	2673.6
	0.8	145712	27.46	6197	0.90	0.94	0.92	2668.8
	0.9	146483	26.92	6266	0.87	0.93	0.90	2713.1
	1	150391	26.08	6281	0.92	0.93	0.88	2784.3

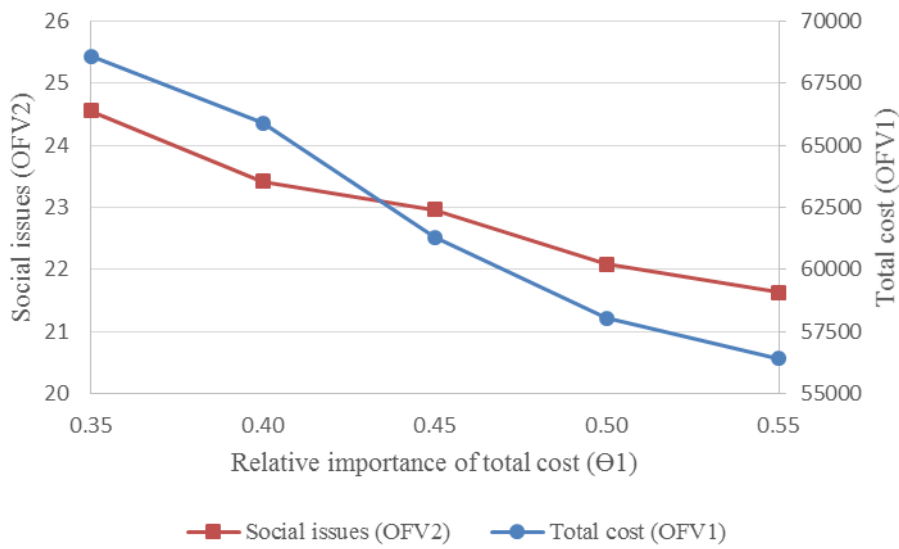
To define the effect of the parameters on the proposed model, several sensitivity analyses are carried out. Every sensitivity analysis is performed for problem No.3,  $\theta = (0.35, 0.5, 0.15)$ ,  $\alpha = 0.5$  and  $\gamma = 0.4$ . In order to investigate the sensitivity of TH method against  $\gamma$  variations, an analysis is performed and

shown in Table 4.4. The result of this analysis shows that setting a higher value for  $\gamma$  leads to reach balanced solution and higher lower bound for satisfaction degree of the objectives ( $\lambda_0$ ). On the other hand, the lower value of  $\gamma$  yields unbalanced solutions. This means better solution is reached for objective function with higher satisfaction degree.

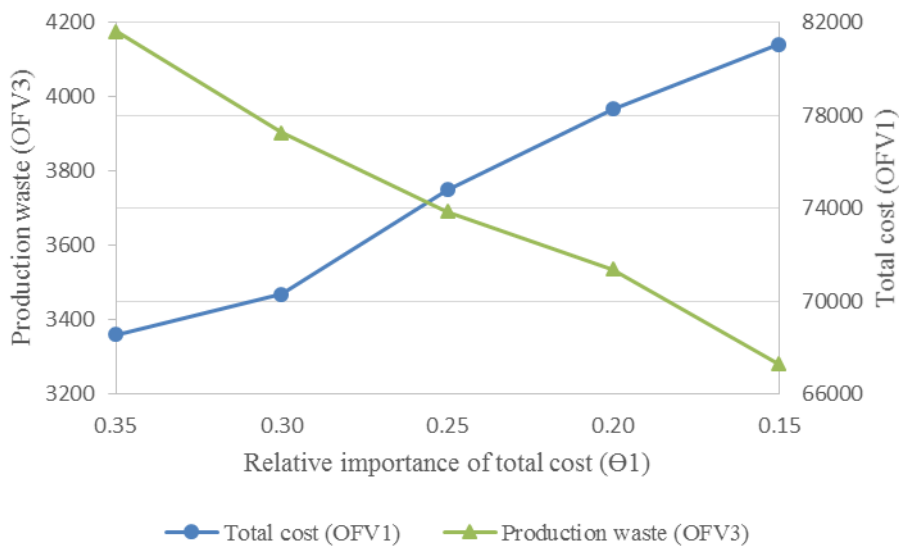
**Table 4.4** Sensitivity analysis on  $\gamma$ -value

Problem No.	$\alpha$ -level	$\gamma$ -value	$Y_1$	$Y_2$	$Y_3$	$\mu(Y_1)$	$\mu(Y_2)$	$\mu(Y_3)$
1	0.9	0.1-0.3	28225	14.18	1803	0.89	0.96	0.84
		0.4,0.5	27367	10.21	1784	0.91	0.93	0.90
		0.6-0.9	26449	9.67	1537	0.91	0.85	0.90
2	0.9	0.1, 0.2	42261	18.76	2586	0.90	0.94	0.84
		0.3, 0.4	41674	16.75	2547	0.92	0.91	0.90
		0.5	41195	15.24	2463	0.92	0.90	0.89
		0.6-0.9	39417	15.24	2311	0.78	0.81	0.90
3	0.9	0.1, 0.2	72714	24.83	4709	0.89	0.96	0.85
		0.3-0.5	71933	22.47	4362	0.90	0.95	0.94
		0.6-0.8	70851	22.03	4124	0.93	0.90	0.87
		0.9	70216	21.43	4076	0.93	0.88	0.90
4	0.9	0.1, 0.2	148113	28.26	6327	0.90	0.96	0.81
		0.3-0.5	146483	26.92	6266	0.87	0.93	0.90
		0.6, 0.7	144135	26.31	6034	0.85	0.89	0.88
		0.8, 0.9	143717	25.79	5983	0.88	0.87	0.91

The second analysis represents the impact of relative importance variation on the objective function values. This analysis is done in two ways; first, we investigate the variation of total cost value (OFV1) and social issues (OFV2) against an increase in the relative importance of cost ( $\theta_1$ ), while the relative importance for production waste ( $\theta_3$ ) is fixed and equal to 0.15 (Figure 4.1). Then, we repeat the same procedure for the variation of total cost value (OFV1) and production waste (OFV2) against a decrease in the relative importance of cost ( $\theta_1$ ), while the relative importance for social issues ( $\theta_2$ ) is fixed and equal to 0.5 (Figure 4.2).



**Figure 4.1** The impact of relative importance  $\theta_1$  on total cost and social issues

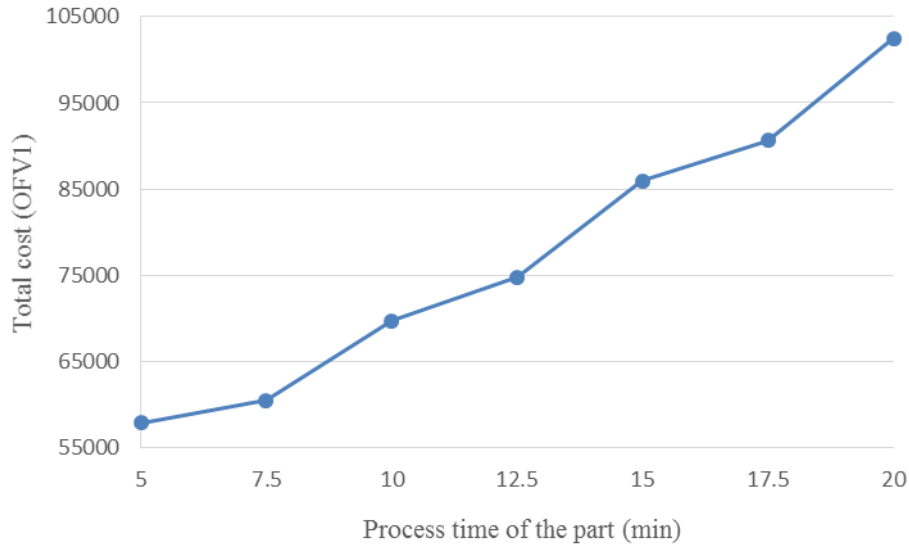


**Figure 4.2** The impact of relative importance  $\theta_1$  on total cost and waste

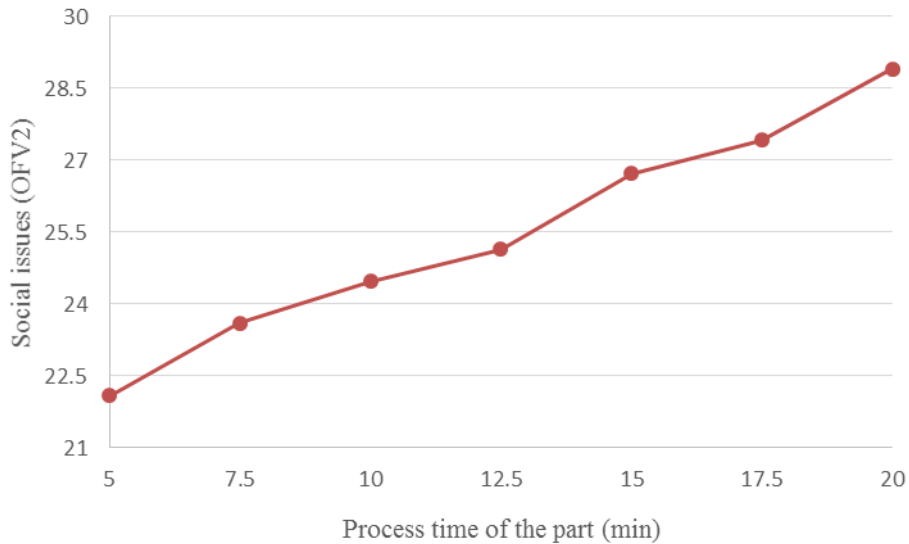
Figure 4.1 shows that when the relative importance of total cost increases from 0.35 to 0.55, we observe 18% decrease of total cost and 12% decrease in amount of social issues. According to Figure 4.2, a decrease in relative importance of total cost from 0.35 to 0.15 leads to 15% increase in total while amount of production waste is decreased by 21%.



The third analysis is related to the impact of the process time variation in total cost and social issues. As shown in Figures 4.3 and 4.4, total cost (from OFV1) increase by increasing the process time. This is because when the process time of the operation increases, the model attempts to increase the number of machines to satisfy the demand which also causes an increase of the hiring of the workers and second objective function (OFV2).



**Figure 4.3** The impact of process time of the part on total cost



**Figure 4.4** The impact of process time of the part on social issues

## **4.5 Conclusion**

In this chapter, a multi-objective model is presented for sustainable DCMS configuration. The first objective function minimizes total cost, the second one concerns social issues, and finally, the third objective minimizes the amount of production waste produced in the manufacturing process. Furthermore, a restriction is placed as social issue to control the maximum of daily noise exposure level for each worker.

Due to high degree of uncertainty in real-life condition, the capability of the model is increased by considering uncertain parameters with respect to demand, machine time capacity, and related machine costs. Therefore, a possibilistic fuzzy approach was developed to transform the fuzzy mathematical model to an equivalent auxiliary crisp model, and then an efficient fuzzy approach was applied to find compromised solutions according to the decision maker's priorities. The results and the analysis indicate the strength of the proposed solving approach in handling uncertain parameters. Moreover, the analysis illustrates the efficiency of the proposed method to reach balanced and unbalanced solutions according to the preference of decision maker, which increases flexibility of our approach to choose the preferred compromise solution.

# 5

## **A tentative approach to make applicable optimization method for industrial case**

- 5.1 Motivation
- 5.2 Solution approach
  - 5.2.1 Phase 1: Optimization
  - 5.2.2 Phase 2: Simulation
  - 5.2.3 Data Envelopment Analysis (DEA)
- 5.3 Computational results
- 5.4 Conclusion

# 5 A tentative approach to make applicable optimization method for industrial case

## 5.1 Motivation

In the previous chapters, three mathematical models have been proposed to study the sustainability aspects in the design and the configuration of DCMS using optimization methods. However, using an optimization approach in industry remains very difficult and infrequent, mainly due to the complexity of the modeling and the resolution of big size problems. Based on the results and analysis of the obtained solutions by the optimization approach, as well as the simplicity and efficiency of simulation tools for real case problems, a tentative optimization-simulation approach is introduced.

This approach is made of two phases:

- (i) the optimization phase operates as scenario fraction method in order to reduce the number of alternatives for the configuration of DCMS by only focusing on strategic and tactical levels.
- (ii) in second phase, a simulation tool investigates the operational level problem by studying the performance of each alternative and the interaction between several components of the cells.

The proposed mathematical model in Chapter 4 is applied for the optimization phase therefore the social and environmental issues are the same as explained in section 4.3. As a result, we study the number of job opportunities created and the number of potential hazards caused by machines as social issues and several kinds of wastes (CO<sub>2</sub> emission, energy loss, scrap of raw materials, water pollution, etc.) as environmental measure.

## 5.2 Solution approach

In this study, a two-phase simulation-optimization approach is developed to find a set of solutions and rank them based on Data Envelopment Analysis (DEA) method. In the following, each phase of the proposed approach is described.

### 5.2.1 Phase 1: Optimization

According to the previous chapters, DCMS configuration problem has been mentioned as an NP-hard optimization problem. In order to deal with the complexity of the model, hybrid of a non-dominated sorting genetic algorithm

and a multi-objective simulated annealing (NSGA II-MOSA) is applied which is detailed in Chapter 3. The optimal Pareto frontier as output of this phase is used as input of second phase (simulation).

### 5.2.2 Phase 2: Simulation

Computer simulation is one of appropriate approaches to investigate the dynamic behavior of the system according to input data, scenario analysis and predicting problem. The simulation tools allow better dealing with the uncertainty phenomena, specifically on the operational level of production systems. By these tools, it is easier to analyze the performance of the system with respect to its complexity. These specific features make the simulation as one of popular tools in the configuration of production and manufacturing systems and provide tangible information about the system for the managers. The configuration of manufacturing systems, particularly cell formation problems, have a lot of variables and heterogeneity in their search space. Therefore, mathematical optimization approach may not be sufficient to analyze and measure the performance of the system on all decision levels.

In this phase, a discrete event simulation model is performed for each set of Pareto solutions, which is obtained from the optimization phase. In other words, each solution from the Pareto frontier can be considered as a single scenario. Accordingly, the optimization phase operates as a scenario fraction method in order to reduce the number of total scenarios. Hence, simulation is performed for all obtain scenarios and following criteria are considered:

- Total cost (machine and worker related cost, configuration or reconfiguration cost)
- Social issues
- Total production waste
- Average queue length for machines
- Average percentage of machine idle time
- Average Time in Service (TIS) for parts

Three first criteria are also calculated in mathematical models and three last ones are new criteria for operational level of DCMS. Due to multicriteria consideration of problem and the different units and natures of these criteria, Data Envelopment Analysis (DEA) as multi-criteria method is applied to rank and choose the best scenario. Figure 5.1 shows a diagram of the proposed approach.

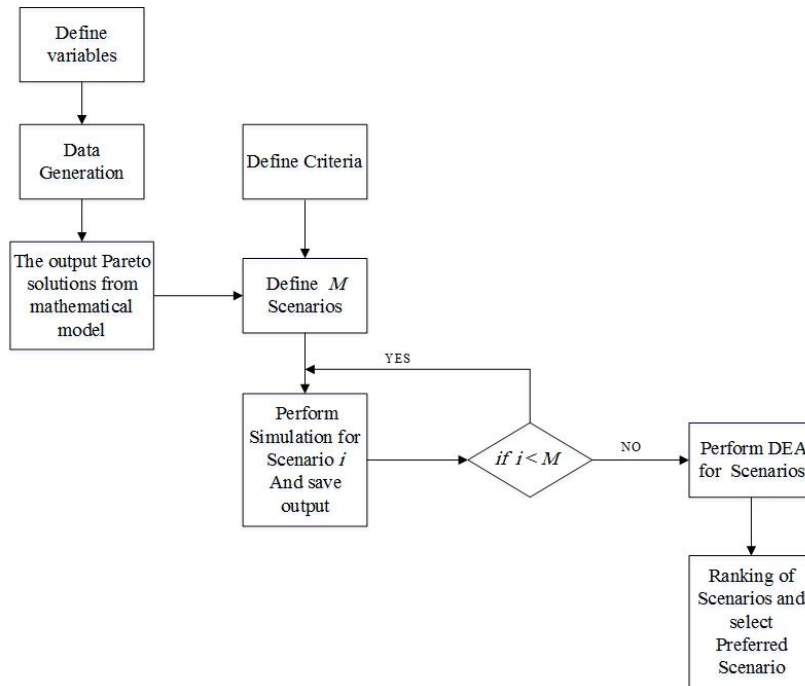


Figure 5.1 Diagram of the optimization-simulation approach

In the following, the DEA method is described.

### 5.2.3 Data Envelopment Analysis (DEA)

Data Envelopment Analysis (DEA) is presented as a non-parametric technique to evaluate the performance and efficiency of a set of Decision Making Units (DMUs) [146]. It is noteworthy that we apply DEA by considering each scenario to be one DMU. In this method, a surface is generated as frontier, which envelops the reminders and follows the peak performers. Two theoretical and empirical production frontier concepts can be applied in this method. The theoretical frontier defines the maximum possible production, which can be achieved by a DMU in any levels of inputs. Generally, it is difficult to identify and express mathematically the theoretical relationship between inputs (criteria with maximizing preference) and outputs (criteria with minimizing preference) of a system. Therefore, the empirical (relative) frontier is applied because it connects all the relatively best DMUs in the experimental populations. Figure 5.2 demonstrates the empirical and theoretical production frontiers for a two-dimensional surface.

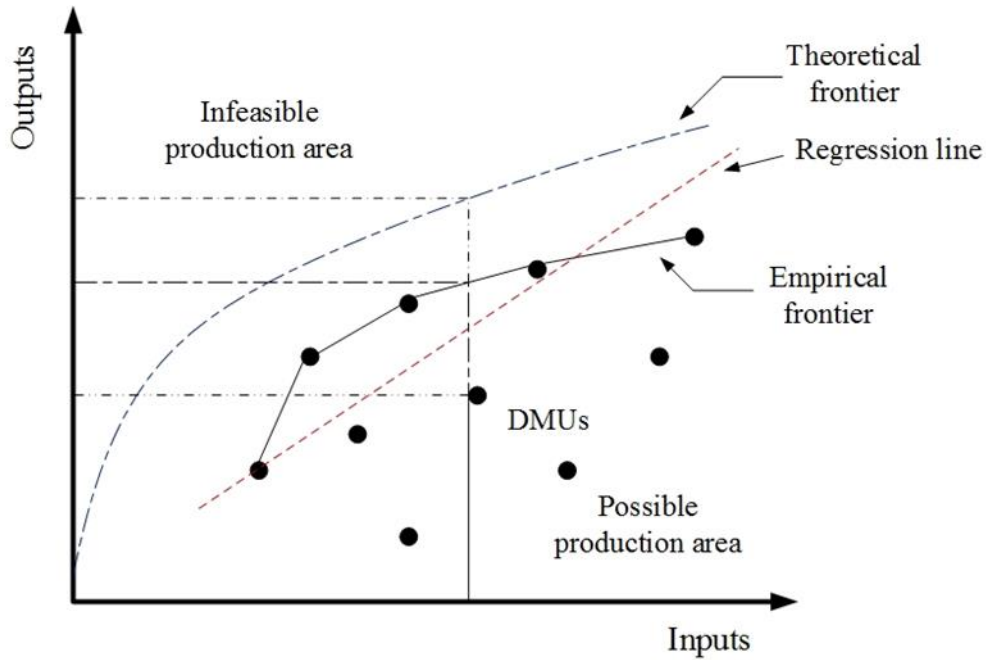


Figure 5.2 The empirical and theoretical frontiers [147]

Therefore, DEA identifies possible benchmarks by providing the experimental efficiencies of individual DMUs, towards which performance can be aimed. In other word, the objective of DEA is to obtain weights, which maximize the efficiency of the evaluated DMUs.

DEA method applies following fractional mathematical model to calculate efficiency ranking of each DMU relative to the others.

$$Max \sum_{r=1}^S \alpha_r y_{ro} \quad (5-1)$$

S.t.

$$\sum_{r=1}^S \alpha_r y_{rj} \leq \sum_{i=1}^m \beta_i x_{ij} \quad \forall j \quad (5-2)$$

$$\sum_{i=1}^m \beta_i x_{io} = 1 \quad (5-3)$$

$$\alpha_r, \beta_i \geq 0 \quad (5-4)$$

Where

- $j$  is the number of DMU,
- $i$  is the number of inputs (criteria with maximization preference),
- $r$  is the number of the outputs (criteria with minimization preference),

- $y_{rj}$  presents the amount of output  $r$  used by DMU  $j$ ,
- $x_{ij}$  defines the amount of input  $i$  used by DMU  $j$ ,
- $\alpha_r$  is the assigned weight by DEA to output  $r$
- $\beta_i$  is the assigned weight by DEA to input  $i$ .

Moreover,  $o$  presents each DMU. Equation 5.1 maximize the numerator of evaluated DMU by assigning of the highest possible productivity rating. Equation 5.4 is related to the Charnes-Cooper [146] transformation. Equation 5.3 ensure that the denominator of each DMU does not exceed 1.

### 5.3 Computational results

In order to evaluate the performance of the model and resolution approach, two test problems (Table 5.1) with different sizes are generated according to the generation pattern, which is presented in Table 5.2.  $P1$  is the problem with smaller dimension while  $P2$  has larger size. Therefor we tried to analyze the proposed approach against the caused complexity by size of the problem.

**Table 5.1** The size of test problem

Problem No	Number of								
	Machine skill level	Worker skill level	Cell	Part type	Machine type	Operation	Period	Shift	Worker type
$P1$	2	2	4	4	5	3	2	1	2
$P2$	3	3	5	6	8	5	4	2	2



**Table 5.2** Generation pattern of the parameter

Parameter	Generation pattern	Parameter	Generation pattern
$D_{ph}$	~ Uniform (50,100)	$\omega_m$	~ Uniform (0, 1) $\times \varphi_m$
$B_p^{inter}$	~ Uniform (10, 50)	$\bar{L}_k$	~ Uniform (65, 85)
$B_p^{inttra}$	$B_p^{inter} / 5$	$w_{j,m}$	~ Uniform (200, 300)
$\gamma_p^{inter}$	~ Uniform (100, 300)	$t_{j,p,m}^*$	~ Uniform (1, 1.45)
$\gamma_p^{inttra}$	~ Uniform (100, 300)	$H_{\alpha,h,r}$	~ Uniform (200, 400)
$\lambda_m$	~ Uniform (500, 800)	$C_{\alpha,\beta,h,r}$	~ Uniform (100, 200)
$\eta_{j,m}$	~ Uniform (100, 200)	$F_{\alpha,h,r}$	~ Uniform (300, 500)
$\delta_m$	$\lambda_m / 2$	$S_{\alpha,h,r}$	~ Uniform (500, 700)
$T_{m,h}$	~ Uniform (1, 5)	$NL_m$	~ Uniform (1, 4)
$UB$	4	$HZ_m$	~ Uniform (0, 1)
$LB$	2	$ALT$	~ Uniform (6, 8)
$\varphi_m$	~ Uniform (3000, 5000)	$t_s$	~ Uniform (4, 6)

\* Time in hours

The generated problems are solved, first by using the hybrid NSGA II-MOSA algorithm separately, and then each obtained optimal Pareto frontier are considered to develop simulation model. It is noteworthy that since the NSGA II-MOSA algorithm is very sensitive against input parameters, Taguchi design (explained in Chapter 3) is carried out to tune value of input parameters and increase the performance of algorithm. Figures 5.3 and 5.4 demonstrate obtained optimal Pareto frontier for problem P1 and P2 as output of phase 1. The NSGA II-MOSA algorithm is implemented in MATLAB 2012a and the simulation model is performed in FLEXSIM (<https://www.flexsim.com>) software on a computer with Intel Core i5, 2.27 GHz and 4 GB RAM.

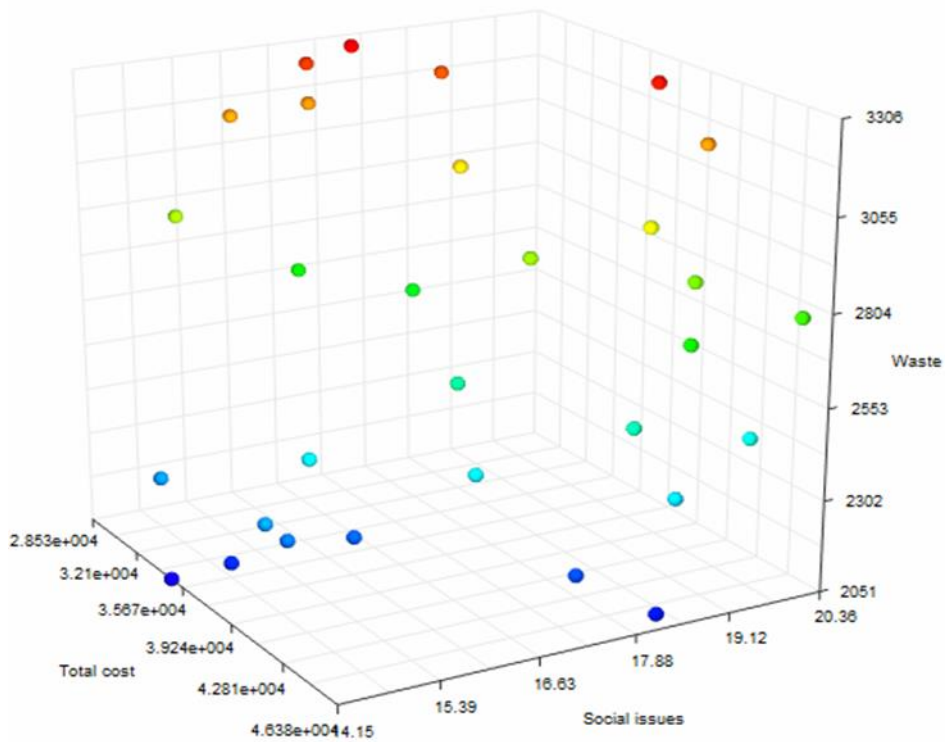


Figure 5.3 Optimal Pareto frontier for Problem P1

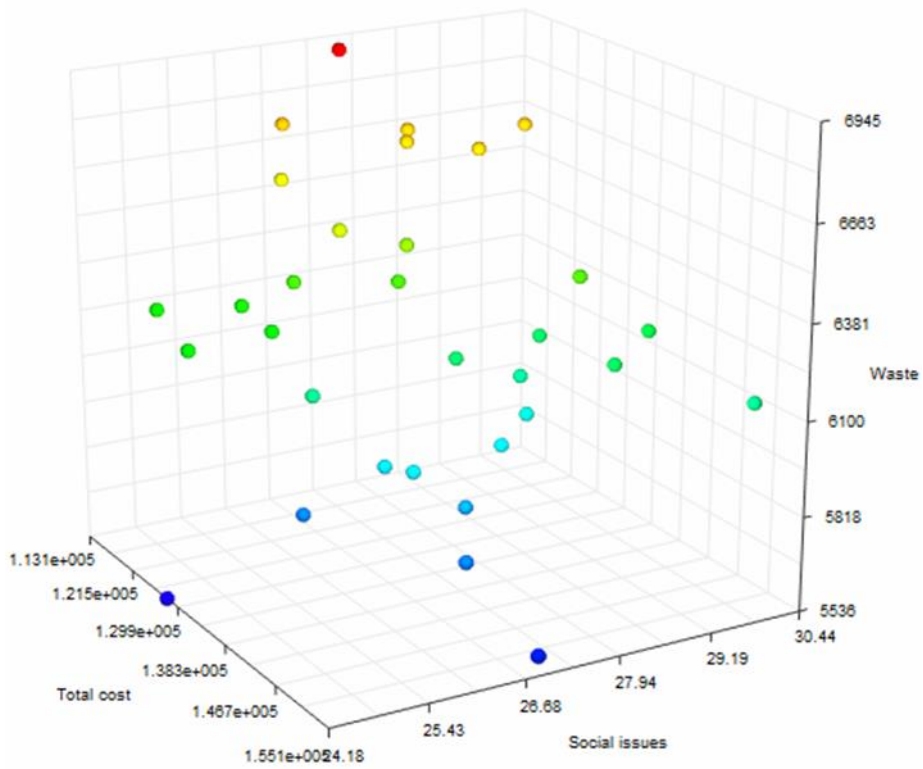


Figure 5.4 Optimal Pareto frontier for Problem P2

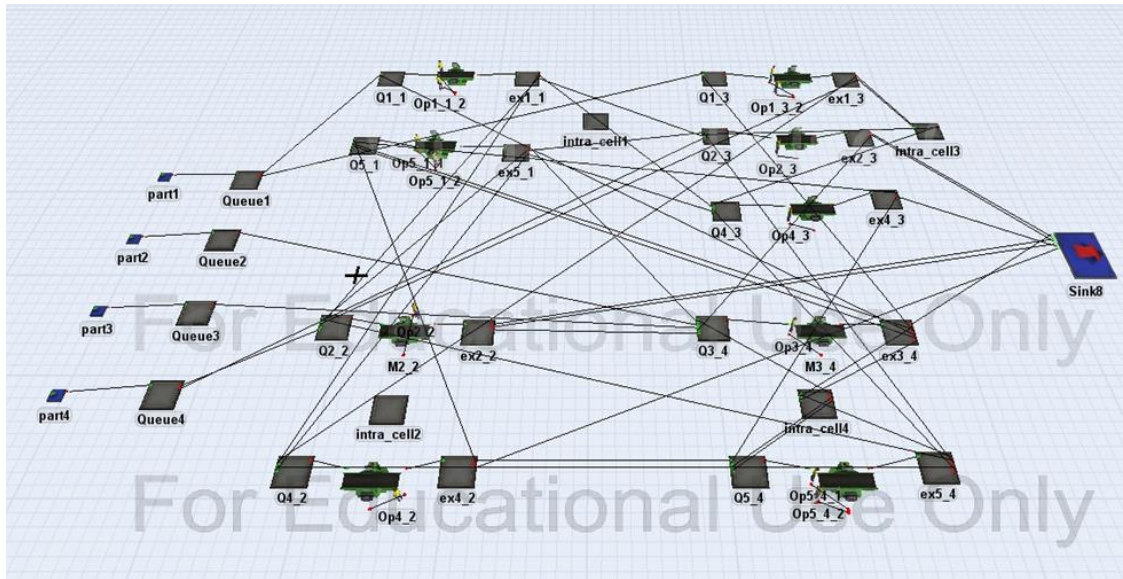


Figure 5.5 Simulation model of Problem P1

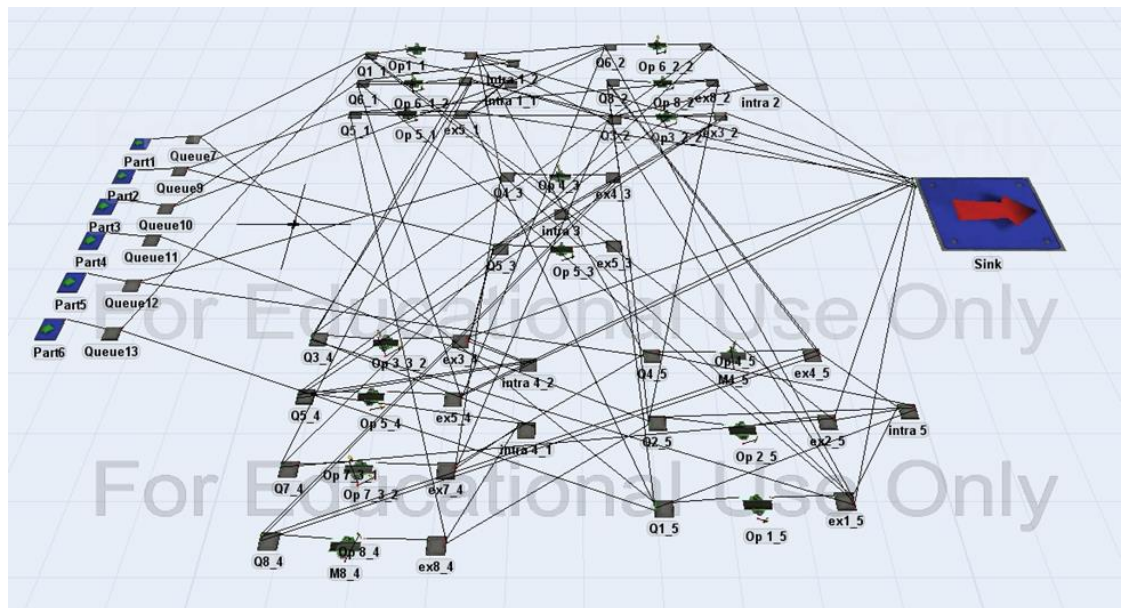


Figure 5.6 Simulation model of Problem P2

Each solution of the optimal Pareto frontier is fed to simulation as a single scenario (Figure 5.5 and 5.6) and the listed outputs and input are calculated. Table 5.3 demonstrates the output and input results of each solution for problem P2.

**Table 5.3** The simulation result of each scenario for P2

DMU	Input	Output 1	Output 2	Output 3	Output 4	Output 5
1	28.56	134398	5971	692	28.76	18186
2	27.43	126853	6338	629	29.01	16937
3	28.04	121083	6681	675	29.34	18063
4	27.40	117608	6945	732	30.19	18709
5	29.22	129140	6126	634	31.04	17056
6	25.89	129561	5728	724	31.47	18837
7	26.70	116130	6569	709	31.92	18248
8	27.98	129756	6114	712	32.09	18651
9	28.73	124784	6669	664	32.41	17907
10	28.70	131860	6053	641	32.62	17252
11	26.96	113105	6702	736	33.05	18671
12	29.67	121609	6685	684	33.64	18031
13	25.69	122034	6284	772	33.76	19652
14	29.34	139209	6140	727	34.18	18472
15	28.23	134182	5888	689	34.72	18154
16	26.07	129152	6075	751	34.97	19286
17	27.53	127049	6445	782	35.01	19703
18	24.18	127969	5536	749	35.13	19159
19	30.44	148112	6076	698	35.27	17085
20	24.85	118072	6265	749	35.62	19427
21	30.20	135373	6166	753	35.76	19329
22	26.69	126244	6512	789	36.29	19941
23	26.92	135261	5879	738	36.58	18864
24	28.30	118139	6684	775	36.62	19549
25	26.31	123097	6342	752	36.94	19402
26	24.64	126661	6242	756	37.31	19363
27	25.80	125808	6242	771	37.34	19792
28	27.40	137934	5782	745	37.89	19021
29	29.27	134617	6359	759	37.92	19247
30	26.88	143957	5718	768	38.26	19346
31	26.79	132160	5864	762	39.47	19709
32	26.84	155105	5595	773	40.72	20493

Note:

Input: Social issues

Output 1: Total cost

Output 2: Production waste

Output 3: Average queue length for machine

Output 4: Average percentage of machine idle time

Output 5: Average Time in Service (TIS) for part

**Table 5.4** The Results of DEA

DMU	Rank	Efficiency Score	DMU	Rank	Efficiency Score	DMU	Rank	Efficiency Score
1	7	0.970	12	8	0.963	23	17	0.927
2	3	0.980	13	21	0.912	24	25	0.882
3	4	0.978	14	14	0.932	25	26	0.880
4	13	0.933	15	5	0.974	26	27	0.868
5	1	1	16	20	0.916	27	31	0.711
6	12	0.940	17	24	0.883	28	16	0.929
7	9	0.962	18	18	0.925	29	22	0.889
8	11	0.946	19	10	0.957	30	23	0.885
9	6	0.971	20	28	0.846	31	30	0.746
10	2	0.995	21	19	0.919	32	32	0.673
11	15	0.929	22	29	0.824			

Table 5.4 shows the best scenario with higher efficiency score compared to the others. In other words, the first ranked scenario not only makes a trade-off between the main objective functions (Cost, Social issues, Production waste) but also it has good performance in terms of queue length of machines, machine idle time and TIS. Therefore, scenario number 5 obtained higher efficiency score comparing the other ones due to the better combination of input and outputs. Regarding to the above explanation scenario number 5 is selected as a compromise solution.

The proposed approach allows us to consider more practical issues, which are not taken into account by mathematical model. This would help the decision maker to identify solution with higher degree of reliability.

## 5.4 Conclusion

This study proposes an optimization-simulation approach to design and configure DCMS while considering environmental and social issues as well as economic aspects. The proposed approach allows decision makers and managers to achieve strategic and operational level decisions. In this way, simulation phase of the approach evaluates the performance of created scenarios according to the three new criteria, which are not considered in optimization phase. Therefore, all the Pareto solution are ranked and the best one is selected.

# 6

## Conclusion and directions of future research

## 6 Conclusion and directions of future research

In this thesis, the possibility of the integration of sustainable issues in the design and configuration of the Dynamic Cellular Manufacturing System (DCMS) are examined. Three mathematical models which are explained in Chapters two, three and four are developed. An attempt is made to develop various models according to the decision maker needs and requirements of real world in each chapter while the presented models are still open to integrate more issues.

The second chapter proposes a new bi-objective mathematical model in DCMS to make a tradeoff between cost as traditional objective and social issues. Job opportunities and occupational safety are the social issues that are integrated in the model while machine fixed and variable costs, machine procurement and relocation costs, intra-cell and inter-cell movement costs and wages are considered as related costs. This model can be applied to identify the family of product and machines for each period while social issues are integrated as well as economic criteria. In order to be closer to the reality, demand, machine related cost and time capacity of machines have been considered as uncertain parameter and then a robust counterpart is developed as robust optimization method to cope with the uncertainty. Afterwards, due to the NP-hardness of DCFP, a Non-dominated Sorting Genetic Algorithm (NSGA-II) as a meta-heuristic method is designed to investigate performance of the model. The computational results demonstrate the ability of the robust model to reach appropriate solutions at all levels of uncertainty, specifically when a feasible solution cannot be found with the deterministic model.

From applicability point of view, this model is suitable for the manufacturing firms, which face with high degree of variation in products such as high-tech industries. The presented model allows the managers to consider ergonomic and safety of workers in addition to cost of production and workers salary. In addition, this model enables managers to make robust decisions against the variation of the production parameters. The results of this study were presented and published in the international conference of APMS 2014 (*Advances in Production Management Systems*) [148] and Journal of Applied Mathematical Modeling [149].

In chapter 3, a bi-objective mathematical model addresses DCMS configuration problem while worker's assignment is considered. Since considering economic

criteria is no longer enough to configure the system, the study aims to investigate the trade-off between environmental, social and economic (sustainability) issues. The first objective function is related to economic criteria such as machine fixed and variable costs, inter/intra-cell movement costs, machine procurement, installation and relocation costs, and salaries, and hiring/firing and training costs. The production waste (e.g., energy, chemical material, raw material, CO<sub>2</sub> emissions, etc.) minimized by second objective function as environmental issues. It is noteworthy that, in this model all wastes are presented in an aggregated way. Therefore, the proposed model is able to integrate more environmental criteria in second objective function. Regarding the complexity of the model, social aspect has been presented as constraint by controlling maximum amount of Daily Noise Dosage (DND) for each worker. Due to NP-hardness of the problem, a new approach called NSGA II-MOSA is proposed which merges an efficient hybrid meta-heuristic based on the Non-dominated Sorting Genetic Algorithm (NSGA-II), with Multi-Objective Simulated Annealing (MOSA). The results show the supremacy of proposed hybrid method comparing two traditional MOSA and NSGA-II. In addition, an analysis is done based on optimal Pareto frontier to investigate the variation of the cell configuration and worker pattern against different objective priority. From applicability point of view, the second model can be employed for the industries, which produce the short-life cycle products. This model helps manufacturer to make decisions that are more comprehensive regards to exploitation of resources, which handles energy loss, waste of material, noise emission etc. The results of this study were presented in the international conference IEEM 2014 (*IEEE International Conference on Industrial Engineering and Engineering Management*) [150] which is received Honorable mentioned award. In addition, this study is published in the *Journal of Manufacturing System* [151].

Chapter 4 develops a new multi-objective optimization model for configuration of sustainable DCMS problem while all economic, environmental and social issues are considered as specific objectives. Therefore, the first objective function minimizes cost related to the configuration of DCMS, such as machine fixed and variable cost, inter/intra-cell movement cost, machine relocation and procurement cost, as well as hiring, training, salary and firing costs. The second objective maximizes social issues by maximizing of job opportunities and minimization of the potential machine hazards. Finally, third objective function minimizes the amount of production waste produced in the manufacturing process. Furthermore, a restriction is placed as social issue to control maximum of daily noise exposure level for each worker. To the best of our knowledge,



there is not any research considered simultaneously all sustainability issues as a specific objective in configuration of the DCMS problem.

To address the uncertainty and imprecision in the configuration of the system, some parameters as demand, machine related costs and machine time capacity are expressed in terms of fuzzy number which is close to the real life condition. A hybridized possibilistic fuzzy approach is applied to transform the fuzzy mathematical model to an equivalent crisp one. Then an efficient fuzzy approach is applied to find both balanced and unbalanced solution according to the decision maker priorities. The computational result and sensitivity analysis illustrate the strength of the proposed approach in the handling of uncertainty.

From applicability point of view, in addition to the matters enumerated in two previous models, the third model increases the capability of managers to pay more attention to the human resource aspect such as increasing of the job opportunity for the local workers, emphasize on worker training instead of firing etc. Moreover, the presented model not only consider the uncertainty in production parameters but also provides a compromise decision according to the managerial preferences. The results of this study were presented in the international conference of imss14-cie44 (*9<sup>th</sup> international symposium on Intelligent Manufacturing and Service Systems & 44<sup>th</sup> international conference on Computers and Industrial Engineering*) [152].

In chapter 5, an attempt has been made to investigate on a tentative approach to make applicable optimization method for the industries. The presented approach contains two phases: optimization and simulation. In the optimization phase of the algorithm, the proposed multi-objective model in Chapter 4, is firstly solved by the proposed hybrid NSGA II-MOSA method in Chapter 3 which allows to extract the optimal Pareto frontier and elected scenarios. Afterward, the simulation model is performed for the scenarios and a data envelopment analysis method is used to rank the scenarios according their performance.

From managerial and application viewpoint, this approach allows to extract the information, which is missing in the mathematical modeling and optimization method such as queue length, idle time and Time in Service. Therefore, the proposed approach can be more attractive for the practitioners due to the visibility of the system's functioning and the ease of analysis.

The models and resolution approaches proposed in this thesis for the configuration of dynamic cellular manufacturing system while it can be investigate in the other manufacturing system. The models are still open to incorporate other important features in DCMS such as routing of the handling equipment, pickup and drop off stations for each cells, lot splitting, machine adjacency requirements, etc. Another extension of current research can be the

consideration of other social, ergonomic and environmental issues, such as job severity, occupational diseases, worker days lost due to injury, etc.

Moreover, other compromise attributes such as the rate of flexibility and agility, can be concerned in DCMS problem to enhance the decision procedure of managers. Since the managers are more motivated to use mobile equipment and mobile robots in production process, it could be interesting to integrate them with DCMS problem. Furthermore, in order to be more realistic, various uncertain parameters, and stochastic and possibilistic approaches can be applied in future research.

## References

- [1] J. T. Black, *The design of the factory with a future*, 13th ed. New York, USA: McGraw-Hill, 1991.
- [2] R. G. Askin and C. R. Standridge, *Modeling and Analysis of Manufacturing Systems*. New York, USA: John Wiley & Sons, 1993.
- [3] C. Brecher, *Advances in Production Technology*. Cham: Springer International Publishing, 2015.
- [4] J. Balakrishnan and C. H. Cheng, "Multi-period planning and uncertainty issues in cellular manufacturing: A review and future directions," *Eur. J. Oper. Res.*, vol. 177, no. 1, pp. 281–309, Feb. 2007.
- [5] Report of the World Commission on Environment and Development, "Our Common Future," 1987.
- [6] J. McAuley, "Machine Grouping for Efficient Production," *Prod. Eng.*, pp. 53–57, 1972.
- [7] M. K. Lee, H. Luong, and K. Abhary, "A genetic algorithm based cell design considering alternative routing," *Comput. Integr. Manuf. Syst.*, vol. 10, no. 2, pp. 93–108, May 1997.
- [8] A. J. Vakharia and Y.-L. Chang, "Cell formation in group technology: A combinatorial search approach," *Int. J. Prod. Res.*, Nov. 1997.
- [9] C.-T. Su and C.-M. Hsu, "Multi-objective machine-part cell formation through parallel simulated annealing," *Int. J. Prod. Res.*, vol. 36, no. 8, pp. 2185–2207, Aug. 1998.
- [10] G. J. Nair and T. T. Narendran, "CASE: A clustering algorithm for cell formation with sequence data," *Int. J. Prod. Res.*, vol. 36, no. 1, pp. 157–180, Jan. 1998.
- [11] S. Sofianopoulou, "Manufacturing cells design with alternative process plans and/or replicate machines," *Int. J. Prod. Res.*, vol. 37, no. 3, pp. 707–720, Feb. 1999.
- [12] A. Baykasoglu, N. N. Z. Gindy, and R. C. Cobb, "Capability based formulation and solution of multiple objective cell formation problems using simulated annealing," *Integr. Manuf. Syst.*, vol. 12, no. 4, pp. 258–274, Jul. 2001.
- [13] K. L. Mak and X. X. Wang, "Production Scheduling and Cell Formation for Virtual Cellular Manufacturing Systems," *Int. J. Adv. Manuf. Technol.*, vol. 20, no. 2, pp. 144–152, Mar. 2002.
- [14] Y. Yin and K. Yasuda, "Manufacturing cells' design in consideration of various production factors," *Int. J. Prod. Res.*, vol. 40, no. 4, pp. 885–906, Nov. 2002.
- [15] K. Das, R. S. Lashkari, and S. Sengupta, "Reliability considerations in the design of cellular manufacturing systems," *Int. J. Qual. Reliab. Manag.*, vol. 23, no. 7, pp. 880–904, Aug. 2006.
- [16] J. Schaller, S. Selçuk Erengüç, and A. Vakharia, "A methodology for integrating cell formation and production planning in cellular manufacturing," *Ann. Oper. Res.*, vol. 77, no. 0, pp. 1–21, 1998.
- [17] R. Tavakkoli-Moghaddam, N. Javadian, A. Khorrami, and Y. Gholipour-Kanani, "Design of a scatter search method for a novel multi-criteria group scheduling problem in a cellular manufacturing system," *Expert Syst. Appl.*, vol. 37, no. 3, pp. 2661–2669, Mar. 2010.
- [18] I. Mahdavi, A. Aalaei, M. M. Paydar, and M. Solimanpur, "A new mathematical model for integrating all incidence matrices in multi-dimensional cellular manufacturing system," *J. Manuf. Syst.*, vol. 31, no. 2, pp. 214–223, Apr. 2012.

## References

- [19] M. Hamed, G. R. Esmaeilian, N. Ismail, and M. K. A. Ariffin, "Capability-based virtual cellular manufacturing systems formation in dual-resource constrained settings using Tabu Search," *Comput. Ind. Eng.*, vol. 62, no. 4, pp. 953–971, May 2012.
- [20] M. Chattopadhyay, P. K. Dan, and S. Mazumdar, "Comparison of visualization of optimal clustering using self-organizing map and growing hierarchical self-organizing map in cellular manufacturing system," *Appl. Soft Comput.*, vol. 22, pp. 528–543, Sep. 2014.
- [21] C. Dimopoulos and A. M. S. Zalzal, "Recent developments in evolutionary computation for manufacturing optimization: problems, solutions, and comparisons," *IEEE Trans. Evol. Comput.*, vol. 4, no. 2, pp. 93–113, Jul. 2000.
- [22] Y.-C. Ho and C. L. Moodie, "A hybrid approach for concurrent layout design of cells and their flow paths in a tree configuration," *Int. J. Prod. Res.*, vol. 38, no. 4, pp. 895–928, Mar. 2000.
- [23] L. Salum, "The cellular manufacturing layout problem," *Int. J. Prod. Res.*, vol. 38, no. 5, pp. 1053–1069, Mar. 2000.
- [24] M. S. Akturk and A. Turkcan, "Cellular manufacturing system design using a holonistic approach," *Int. J. Prod. Res.*, vol. 38, no. 10, pp. 2327–2347, Jul. 2000.
- [25] S.-D. Lee and C.-P. Chiang, "A cut-tree-based approach for clustering machine cells in the bidirectional linear flow layout," *Int. J. Prod. Res.*, vol. 39, no. 15, pp. 3491–3512, Jan. 2001.
- [26] C.-P. Chiang and S.-D. Lee, "A genetic-based algorithm with the optimal partition approach for the cell formation in bi-directional linear flow layout," *Int. J. Comput. Integr. Manuf.*, vol. 17, no. 4, pp. 364–375, Jun. 2004.
- [27] I. Chaieb and O. Korbaa, "Intra-cell machine layout associated with flexible production and transport systems," *Proc. Inst. Mech. Eng. Part B J. Eng. Manuf.*, vol. 217, no. 7, pp. 883–897, Jan. 2003.
- [28] F. Al-Mubarak, C. Canel, and B. M. Khumawala, "A simulation study of focused cellular manufacturing as an alternative batch-processing layout," *Int. J. Prod. Econ.*, vol. 83, no. 2, pp. 123–138, Feb. 2003.
- [29] M. Solimanpur, P. Vrat, and R. Shankar, "Ant colony optimization algorithm to the inter-cell layout problem in cellular manufacturing," *Eur. J. Oper. Res.*, vol. 157, no. 3, pp. 592–606, Sep. 2004.
- [30] C. O. Kim, J.-G. Baek, and J. Jun, "A machine cell formation algorithm for simultaneously minimising machine workload imbalances and inter-cell part movements," *Int. J. Adv. Manuf. Technol.*, vol. 26, no. 3, pp. 268–275, Mar. 2005.
- [31] F. T. S. Chan, K. W. Lau, P. L. Y. Chan, and K. L. Choy, "Two-stage approach for machine-part grouping and cell layout problems," *Robot. Comput. Integr. Manuf.*, vol. 22, no. 3, pp. 217–238, Jul. 2006.
- [32] E. Vila Gonçalves Filho and A. José Tiberti, "A group genetic algorithm for the machine cell formation problem," *Int. J. Prod. Econ.*, vol. 102, no. 1, pp. 1–21, Jul. 2006.
- [33] C. Hicks, "A Genetic Algorithm tool for optimising cellular or functional layouts in the capital goods industry," *Int. J. Prod. Econ.*, vol. 104, no. 2, pp. 598–614, Dec. 2006.
- [34] G. Ioannou, "Time-phased creation of hybrid manufacturing systems," *Int. J. Prod. Econ.*, vol. 102, no. 2, pp. 183–198, Aug. 2006.
- [35] X. Wu, C.-H. Chu, Y. Wang, and W. Yan, "A genetic algorithm for cellular manufacturing design and layout," *Eur. J. Oper. Res.*, vol. 181, no. 1, pp. 156–167, Aug. 2007.

## References

- [36] X. Wu, C.-H. Chu, Y. Wang, and D. Yue, "Genetic algorithms for integrating cell formation with machine layout and scheduling," *Comput. Ind. Eng.*, vol. 53, no. 2, pp. 277–289, Sep. 2007.
- [37] R. Tavakkoli-Moghaddam, N. Javadian, B. Javadi, and N. Safaei, "Design of a facility layout problem in cellular manufacturing systems with stochastic demands," *Appl. Math. Comput.*, vol. 184, no. 2, pp. 721–728, Jan. 2007.
- [38] I. Mahdavi and B. Mahadevan, "CLASS: An algorithm for cellular manufacturing system and layout design using sequence data," *Robot. Comput. Integr. Manuf.*, vol. 24, no. 3, pp. 488–497, Jun. 2008.
- [39] A. Ahi, M. B. Aryanezhad, B. Ashtiani, and A. Makui, "A novel approach to determine cell formation, intracellular machine layout and cell layout in the CMS problem based on TOPSIS method," *Comput. Oper. Res.*, vol. 36, no. 5, pp. 1478–1496, May 2009.
- [40] S. Ariaifar and N. Ismail, "An improved algorithm for layout design in cellular manufacturing systems," *J. Manuf. Syst.*, vol. 28, no. 4, pp. 132–139, Dec. 2009.
- [41] S. I. Satoglu and N. C. Suresh, "A goal-programming approach for design of hybrid cellular manufacturing systems in dual resource constrained environments," *Comput. Ind. Eng.*, vol. 56, no. 2, pp. 560–575, Mar. 2009.
- [42] M. M. Paydar, I. Mahdavi, I. Sharafuddin, and M. Solimanpur, "Applying simulated annealing for designing cellular manufacturing systems using MDmTSP," *Comput. Ind. Eng.*, vol. 59, no. 4, pp. 929–936, Nov. 2010.
- [43] V. R. Ghezavati and M. Saidi-Mehrabad, "An efficient hybrid self-learning method for stochastic cellular manufacturing problem: A queuing-based analysis," *Expert Syst. Appl.*, vol. 38, no. 3, pp. 1326–1335, Mar. 2011.
- [44] C.-C. Chang, T.-H. Wu, and C.-W. Wu, "An efficient approach to determine cell formation, cell layout and intracellular machine sequence in cellular manufacturing systems," *Comput. Ind. Eng.*, vol. 66, no. 2, pp. 438–450, Oct. 2013.
- [45] H. Nouri and T. S. Hong, "Development of bacteria foraging optimization algorithm for cell formation in cellular manufacturing system considering cell load variations," *J. Manuf. Syst.*, vol. 32, no. 1, pp. 20–31, Jan. 2013.
- [46] K. Izui, Y. Murakumo, I. Suemitsu, S. Nishiwaki, A. Noda, and T. Nagatani, "Multiobjective layout optimization of robotic cellular manufacturing systems," *Comput. Ind. Eng.*, vol. 64, no. 2, pp. 537–544, Feb. 2013.
- [47] A. Azab and B. Naderi, "A Variable Neighborhood Search Metaheuristic for Cellular Manufacturing with Multitask Machine Tools," *Procedia CIRP*, vol. 20, pp. 50–55, 2014.
- [48] G. Egilmez, B. Erenay, and G. A. Süer, "Stochastic skill-based manpower allocation in a cellular manufacturing system," *J. Manuf. Syst.*, vol. 33, no. 4, pp. 578–588, Oct. 2014.
- [49] M. Mohammadi and K. Forghani, "A novel approach for considering layout problem in cellular manufacturing systems with alternative processing routings and subcontracting approach," *Appl. Math. Model.*, vol. 38, no. 14, pp. 3624–3640, Jul. 2014.
- [50] C. R. Shiyas and V. Madhusudanan Pillai, "A mathematical programming model for manufacturing cell formation to develop multiple configurations," *J. Manuf. Syst.*, vol. 33, no. 1, pp. 149–158, Jan. 2014.
- [51] J. R. Brown, "A capacity constrained mathematical programming model for cellular manufacturing with exceptional elements," *J. Manuf. Syst.*, Oct. 2014.
- [52] M. Rheault, J. R. Drolet, and G. Abdunour, "Physically reconfigurable virtual cells: A dynamic model for a highly dynamic environment," *Comput. Ind. Eng.*, vol. 29, no. 1–4, pp. 221–225, Sep. 1995.

## References

- [53] M. Chen and D. Cao, "Coordinating production planning in cellular manufacturing environment using Tabu search," *Comput. Ind. Eng.*, vol. 46, no. 3, pp. 571–588, Jun. 2004.
- [54] D. Cao and M. Chen, "A robust cell formation approach for varying product demands," *Int. J. Prod. Res.*, vol. 43, no. 8, pp. 1587–1605, Apr. 2005.
- [55] R. Tavakkoli-Moghaddam, M. B. Aryanezhad, N. Safaei, and A. Azaron, "Solving a dynamic cell formation problem using metaheuristics," *Appl. Math. Comput.*, vol. 170, no. 2, pp. 761–780, Nov. 2005.
- [56] R. Tavakkoli-moghaddam, N. Safaei, and M. Babakhani, "Solving a Dynamic Cell Formation Problem with Machine Cost and Alternative Process Plan by Memetic Algorithms," in *Stochastic Algorithms: Foundations and Applications*, 2005, pp. 213–227.
- [57] F. M. Defersha and M. Chen, "A comprehensive mathematical model for the design of cellular manufacturing systems," *Int. J. Prod. Econ.*, vol. 103, no. 2, pp. 767–783, Oct. 2006.
- [58] F. M. Defersha and M. Chen, "Machine cell formation using a mathematical model and a genetic-algorithm-based heuristic," *Int. J. Prod. Res.*, vol. 44, no. 12, pp. 2421–2444, Jun. 2006.
- [59] M. Saidi-Mehrabad and N. Safaei, "A new model of dynamic cell formation by a neural approach," *Int. J. Adv. Manuf. Technol.*, vol. 33, no. 9–10, pp. 1001–1009, 2007.
- [60] R. Tavakkoli-Moghaddam, M. B. Aryanezhad, N. Safaei, M. Vasei, and A. Azaron, "A new approach for the cellular manufacturing problem in fuzzy dynamic conditions by a genetic algorithm," *J. Intell. Fuzzy Syst.*, vol. 18, no. 4, pp. 363–376, Jan. 2007.
- [61] N. Safaei, M. Saidi-Mehrabad, and M. Babakhani, "Designing cellular manufacturing systems under dynamic and uncertain conditions," *J. Intell. Manuf.*, vol. 18, no. 3, pp. 383–399, 2007.
- [62] N. Safaei, M. Saidi mehrabad, and R. Tavakkoli moghaddam, "A fuzzy programming approach for a cell formation problem with dynamic and uncertain conditions," *Fuzzy sets Syst.*, vol. 159, pp. 215–236, 2008.
- [63] N. Safaei, M. Saidi mehrabad, and M. S. Jabal Ameli, "A hybrid simulated annealing for solving an extended model of dynamic cellular manufacturing system," *Eur. J. Oper. Res.*, vol. 185, pp. 563–592, 2008.
- [64] F. M. Defersha and M. Chen, "A linear programming embedded genetic algorithm for an integrated cell formation and lot sizing considering product quality," *Eur. J. Oper. Res.*, vol. 187, no. 1, pp. 46–69, May 2008.
- [65] F. M. Defersha and M. Chen, "A parallel genetic algorithm for dynamic cell formation in cellular manufacturing systems," *Int. J. Prod. Res.*, vol. 46, no. 22, pp. 6389–6413, Oct. 2008.
- [66] R. Tavakkoli-Moghaddam, N. Safaei, and F. Sassani, "A new solution for a dynamic cell formation problem with alternative routing and machine costs using simulated annealing," *J. Oper. Res. Soc.*, vol. 59, no. 4, pp. 443–454, Jun. 2008.
- [67] S. Ahkioon, A. A. Bulgak, and T. Bektas, "Cellular manufacturing systems design with routing flexibility, machine procurement, production planning and dynamic system reconfiguration," *Int. J. Prod. Res.*, vol. 47, no. 6, pp. 1573–1600, Dec. 2008.
- [68] M. B. Aryanezhad, V. Deljoo, and S. M. J. Mirzapour Al-e-hashem, "Dynamic cell formation and the worker assignment problem: a new model," *Int. J. Adv. Manuf. Technol.*, vol. 41, no. 3–4, pp. 329–342, 2009.
- [69] N. Safaei and R. Tavakkoli-Moghaddam, "Integrated multi-period cell formation and subcontracting production planning in dynamic cellular manufacturing

## References

- systems," *Int. J. Prod. Econ.*, vol. 120, no. 2, pp. 301–314, Aug. 2009.
- [70] S. Ah kioon, A. A. Bulgak, and T. Bektas, "Integrated cellular manufacturing systems design with production planning and dynamic system reconfiguration," *Eur. J. Oper. Res.*, vol. 192, no. 2, pp. 414–428, Jan. 2009.
- [71] M. Aramoon Bajestani, M. Rabbani, A. R. Rahimi-Vahed, and G. Baharian Khoshkhou, "A multi-objective scatter search for a dynamic cell formation problem," *Comput. Oper. Res.*, vol. 36, no. 3, pp. 777–794, Mar. 2009.
- [72] X. Wang, J. Tang, and K. Yung, "Optimization of the multi-objective dynamic cell formation problem using a scatter search approach," *Int. J. Adv. Manuf. Technol.*, pp. 318–329, 2009.
- [73] V. Deljoo, S. M. J. Mirzapour Al-e-hashem, F. Deljoo, and M. B. Aryanezhad, "Using genetic algorithm to solve dynamic cell formation problem," *Appl. Math. Model.*, vol. 34, no. 4, pp. 1078–1092, Apr. 2010.
- [74] I. Mahdavi, A. Aalaei, M. M. Paydar, and M. Solimanpur, "Designing a mathematical model for dynamic cellular manufacturing systems considering production planning and worker assignment," *Comput. Math. with Appl.*, vol. 60, no. 4, pp. 1014–1025, Aug. 2010.
- [75] N. Javadian, A. Aghajani, J. Rezaeian, and M. Ghaneian Sebdani, "A multi-objective integrated cellular manufacturing systems design with dynamic system reconfiguration," *Int. J. Adv. Manuf. Technol.*, vol. 56, no. 1–4, pp. 307–317, 2011.
- [76] K. Rafiee, M. Rabbani, H. Rafiee, and A. Rahimi-Vahed, "A new approach towards integrated cell formation and inventory lot sizing in an unreliable cellular manufacturing system," *Appl. Math. Model.*, vol. 35, no. 4, pp. 1810–1819, Apr. 2011.
- [77] L. Saxena and P. Jain, "Dynamic cellular manufacturing systems design—a comprehensive model," *Int. J. Adv. Manuf. Technol.*, vol. 53, no. 1–4, pp. 11–34, 2011.
- [78] R. Kia, A. Baboli, N. Javadian, R. Tavakkoli-moghaddam, M. Kazemi, and J. Khorrami, "Solving a group layout design model of a dynamic cellular manufacturing system with alternative process routings, lot splitting and flexible reconfiguration by simulated annealing," *Comput. Oper. Res.*, vol. 39, no. 11, pp. 2642–2658, 2012.
- [79] H. Rafiee and R. Ghodsi, "A bi-objective mathematical model toward dynamic cell formation considering labor utilization," *Appl. Math. Model.*, vol. 37, no. 4, pp. 2308–2316, Feb. 2013.
- [80] M. Saidi-Mehrabad, M. M. Paydar, and A. Aalaei, "Production planning and worker training in dynamic manufacturing systems," *J. Manuf. Syst.*, vol. 32, no. 2, pp. 308–314, Apr. 2013.
- [81] R. Kia, H. Shirazi, N. Javadian, and R. Tavakkoli-Moghaddam, "A multi-objective model for designing a group layout of a dynamic cellular manufacturing system," *J. Ind. Eng. Int.*, vol. 9, no. 1, p. 8, 2013.
- [82] J. Fan and D. Feng, "Design of cellular manufacturing system with quasi-dynamic dual resource using multi-objective GA," *Int. J. Prod. Res.*, vol. 51, no. 14, pp. 4134–4154, Jul. 2013.
- [83] V. Majazi Dalfard, "New mathematical model for problem of dynamic cell formation based on number and average length of intra and intercellular movements," *Appl. Math. Model.*, vol. 37, no. 4, pp. 1884–1896, Feb. 2013.
- [84] H. Shirazi, R. Kia, N. Javadian, and R. Tavakkoli-Moghaddam, "An archived multi-objective simulated annealing for a dynamic cellular manufacturing system," *J. Ind. Eng. Int.*, vol. 10, no. 2, p. 58, May 2014.
- [85] R. Kia, F. Khaksar-Haghani, N. Javadian, and R. Tavakkoli-Moghaddam, "Solving a multi-floor layout design model of a dynamic cellular manufacturing

## References

- system by an efficient genetic algorithm," *J. Manuf. Syst.*, vol. 33, no. 1, pp. 218–232, Jan. 2014.
- [86] B. Javadi, F. Jolai, J. Slomp, M. Rabbani, and R. Tavakkoli-Moghaddam, "A hybrid electromagnetism-like algorithm for dynamic inter/intra-cell layout problem," *Int. J. Comput. Integr. Manuf.*, vol. 27, no. 6, pp. 501–518, Mar. 2014.
- [87] A. Aghajani, S. A. Didehbani, M. Zadahmad, M. H. Seyedrezaei, and O. Mohsenian, "A multi-objective mathematical model for cellular manufacturing systems design with probabilistic demand and machine reliability analysis," *Int. J. Adv. Manuf. Technol.*, vol. 75, no. 5–8, pp. 755–770, Aug. 2014.
- [88] B. Bootaki, I. Mahdavi, and M. M. Paydar, "New bi-objective robust design-based utilisation towards dynamic cell formation problem with fuzzy random demands," *Int. J. Comput. Integr. Manuf.*, pp. 1–16, Feb. 2014.
- [89] M. M. Paydar and M. Saidi-Mehrabad, "Revised multi-choice goal programming for integrated supply chain design and dynamic virtual cell formation with fuzzy parameters," *Int. J. Comput. Integr. Manuf.*, vol. 28, no. 3, pp. 251–265, Jan. 2014.
- [90] K. Deep and P. K. Singh, "Design of robust cellular manufacturing system for dynamic part population considering multiple processing routes using genetic algorithm," *J. Manuf. Syst.*, vol. 35, pp. 155–163, Apr. 2015.
- [91] T. Ertay and D. Ruan, "Data envelopment analysis based decision model for optimal operator allocation in CMS," *Eur. J. Oper. Res.*, vol. 164, no. 3, pp. 800–810, Aug. 2005.
- [92] M. Siemiatkowski and W. Przybylski, "Modelling and simulation analysis of process alternatives in the cellular manufacturing of axially symmetric parts," *Int. J. Adv. Manuf. Technol.*, vol. 32, no. 5–6, pp. 516–530, Mar. 2006.
- [93] L. N. Pitchuka, G. K. Adil, and U. Ananthakumar, "Effect of conversion of functional layout to a cellular layout on the queue time performance: some new insights," *Int. J. Adv. Manuf. Technol.*, vol. 31, no. 5–6, pp. 594–601, Jan. 2006.
- [94] F. Ranaiefar, R. Mohagheghzadeh, M. Chitsaz, M. F. Ardakani, and M. J. Shahbazi, "Material Flow Planning in Cellular Manufacturing Systems by Computer Simulation," in *2009 Third UKSim European Symposium on Computer Modeling and Simulation*, 2009, pp. 430–434.
- [95] A. Azadeh, M. Anvari, B. Ziaei, and K. Sadeghi, "An integrated fuzzy DEA–fuzzy C-means–simulation for optimization of operator allocation in cellular manufacturing systems," *Int. J. Adv. Manuf. Technol.*, vol. 46, no. 1–4, pp. 361–375, Jun. 2009.
- [96] A. Azadeh and M. Anvari, "Implementation of Multivariate Methods as Decision Making Models for Optimization of Operator Allocation by Computer Simulation in CMS," *J. Chinese Inst. Ind. Eng.*, vol. 26, no. 4, pp. 316–325, Jan. 2009.
- [97] A. R. Pitombeira Neto and E. V. Gonçalves Filho, "A simulation-based evolutionary multiobjective approach to manufacturing cell formation," *Comput. Ind. Eng.*, vol. 59, no. 1, pp. 64–74, Aug. 2010.
- [98] G. Egilmez, G. A. Süer, and J. Huang, "Stochastic cellular manufacturing system design subject to maximum acceptable risk level," *Comput. Ind. Eng.*, vol. 63, no. 4, pp. 842–854, Dec. 2012.
- [99] A. Baykasoglu and L. Gorkemli, "Agent-based dynamic part family formation for cellular manufacturing applications," *Int. J. Prod. Res.*, vol. 53, no. 3, pp. 774–792, Jun. 2014.
- [100] P. Renna and M. Ambrico, "Design and reconfiguration models for dynamic cellular manufacturing to handle market changes," *Int. J. Comput. Integr. Manuf.*, vol. 28, no. 2, pp. 170–186, Feb. 2014.



## References

- [101] C. R. Carter and M. M. Jennings, "Social responsibility and supply chain relationships," *Transp. Res. Part E Logist. Transp. Rev.*, vol. 38, no. 1, pp. 37–52, Jan. 2002.
- [102] J. M. Cruz and T. Wakolbinger, "Multiperiod effects of corporate social responsibility on supply chain networks, transaction costs, emissions, and risk," *Int. J. Prod. Econ.*, vol. 116, no. 1, pp. 61–74, Nov. 2008.
- [103] J. M. Cruz and Z. Liu, "Modeling and analysis of the multiperiod effects of social relationship on supply chain networks," *Eur. J. Oper. Res.*, vol. 214, no. 1, pp. 39–52, Oct. 2011.
- [104] A. Iacovides, K. . Fountoulakis, S. Kaprinis, and G. Kaprinis, "The relationship between job stress, burnout and clinical depression," *J. Affect. Disord.*, vol. 75, no. 3, pp. 209–221, Aug. 2003.
- [105] M. B. Aryanezhad, A. S. Kheirkhah, V. Deljoo, and S. M. J. Mirzapour Al-e-hashem, "Designing safe job rotation schedules based upon workers' skills," *Int. J. Adv. Manuf. Technol.*, vol. 41, no. 1–2, pp. 193–199, Mar. 2008.
- [106] SAI, "Social Accountability 8000 International Standards," *SAI, New York*, 2001.
- [107] ISO, "Final Draft International standard ISO/FDIS 26000," *Guid. Soc. Responsib.*, 2010.
- [108] GRI, "Sustainability Reporting Guidelines," *version 3.1. Available*, 2011.
- [109] National Institute of Occupational Safety and Health (NIOSH), "The National Occupational Research Agenda (NORA)," *Dep. Heal. Hum. Serv. Washington, DC*, pp. 96–115, 1996.
- [110] M. R. Garey and D. S. Johnson, *Computers and Intractability: A Guide to the Theory of NP-Completeness (Series of Books in the Mathematical Sciences)*. W. H. Freeman, 1979.
- [111] National Institute of Occupational Safety and Health (NIOSH), "Criteria for a recommended standard: occupational noise exposure," *Dep. Heal. Hum. Serv. Washington, DC*, pp. 98–126, 1998.
- [112] F. Dehghanian and S. Mansour, "Designing sustainable recovery network of end-of-life products using genetic algorithm," *Resour. Conserv. Recycl.*, vol. 53, no. 10, pp. 559–570, Aug. 2009.
- [113] A. Boggia and C. Cortina, "Measuring sustainable development using a multi-criteria model: A case study," *J. Environ. Manage.*, vol. 91, no. 11, pp. 2301–2306, Nov. 2010.
- [114] A. Ben-Tal and A. Nemirovski, "Robust Solutions of Uncertain Linear Programs," *Oper. Res. Lett.*, no. 1, pp. 1–16, 1999.
- [115] A. Ben-Tal, B. Golany, A. Nemirovski, and J.-P. Vial, "Retailer-Supplier Flexible Commitments Contracts: A Robust Optimization Approach," *Manuf. Serv. Oper. Manag.*, vol. 7, no. 3, pp. 248–271.
- [116] M. S. Pishvaei, M. Rabbani, and S. A. Torabi, "A robust optimization approach to closed-loop supply chain network design under uncertainty," *Appl. Math. Model.*, vol. 35, no. 2, pp. 637–649, Feb. 2011.
- [117] A. Ben-Tal, L. El-Ghaoui, and A. Nemirovski, *Robust Optimization*. New Jersey , USA: Princeton University Press, 2009.
- [118] O. Baron, J. Milner, and H. Naseraldin, "Facility Location: A Robust Optimization Approach," *Prod. Oper. Manag.*, vol. 20, no. 5, pp. 772–785, 2011.
- [119] K. Deb, A. Pratap, S. Agarwal, and T. Meyarivan, "A fast and elitist multiobjective genetic algorithm: NSGA-II," *Evolutionary Computation, IEEE Transactions on*, vol. 6, no. 2, pp. 182–197, 2002.
- [120] P. Chatsirirungruang, "Application of genetic algorithm and Taguchi method in

## References

- dynamic robust parameter design for unknown problems," *Int. J. Adv. Manuf. Technol.*, vol. 47, no. 9–12, pp. 993–1002, 2010.
- [121] J. P. Leigh and T. R. Miller, "Job-related diseases and occupations within a large workers' compensation data set," *Am. J. Ind. Med.*, vol. 33, no. 3, pp. 197–211, Mar. 1998.
- [122] W. E. Daniell, D. Fulton-Kehoe, T. Smith-Weller, and G. M. Franklin, "Occupational hearing loss in Washington state, 1984-1991: II. Morbidity and associated costs," *Am. J. Ind. Med.*, vol. 33, no. 6, pp. 529–36, Jun. 1998.
- [123] B. Niebel and A. Freivalds, *Niebel's Methods, Standards and Work Design*, 12th ed. McGraw-Hill, New York., 2009.
- [124] S. Nanthavanij, "Analytical Approach for Workplace Noise Assessment," *Thammasat Int. J. Sci. Technol.*, vol. 7, no. 3, pp. 8–16, 2002.
- [125] M. S. Sanders and E. J. McCormick, *Human factors in engineering and design*, vol. 1993. 1993.
- [126] W. Tharmmaphornphilas, "Developing worker rotation schedule based upon workers skills to minimize occupation injury," in *35th international conference on computers and industrial engineering, Istanbul, Turkey.*, 2002.
- [127] Occupational Safety and Health Administration (OSHA), "Guidelines for noise enforcement: appendix A," *US Dep. Labor, Washington, DCOccupational Saf. Heal. Adm.*, pp. 2–2.35A, 1983.
- [128] R. Ramanathan and L. S. Ganesh, "Group preference aggregation methods employed in AHP: An evaluation and an intrinsic process for deriving members' weightages," *Eur. J. Oper. Res.*, vol. 79, no. 2, pp. 249–265, Dec. 1994.
- [129] K. I. Smith, R. M. Everson, and J. E. Fieldsend, "Dominance measures for multi-objective simulated annealing," in *Proceedings of the 2004 Congress on Evolutionary Computation (IEEE Cat. No.04TH8753)*, vol. 1, pp. 23–30.
- [130] R. Tavakkoli-Moghaddam, M. Azarkish, and A. Sadeghnejad-Barkousaraie, "A new hybrid multi-objective Pareto archive PSO algorithm for a bi-objective job shop scheduling problem," *Expert Syst. Appl.*, vol. 38, no. 9, pp. 10812–10821, Sep. 2011.
- [131] M. Mohammadi, F. Jolai, and R. Tavakkoli-Moghaddam, "Solving a new stochastic multi-mode p-hub covering location problem considering risk by a novel multi-objective algorithm," *Appl. Math. Model.*, vol. 37, no. 24, pp. 10053–10073, Dec. 2013.
- [132] M. Jiménez, M. Arenas, A. Bilbao, and M. V. Rodríguez, "Linear programming with fuzzy parameters: An interactive method resolution," *Eur. J. Oper. Res.*, vol. 177, no. 3, pp. 1599–1609, Mar. 2007.
- [133] M. Arenas Parra, A. Bilbao Terol, B. Pérez Gladish, and M. V. Rodríguez Uría, "Solving a multiobjective possibilistic problem through compromise programming," *Eur. J. Oper. Res.*, vol. 164, no. 3, pp. 748–759, Aug. 2005.
- [134] S. A. Torabi and E. Hassini, "An interactive possibilistic programming approach for multiple objective supply chain master planning," *Fuzzy Sets Syst.*, vol. 159, no. 2, pp. 193–214, Jan. 2008.
- [135] M. Jiménez, "Ranking Fuzzy Numbers Through The Comparison of Its Expected Intervals," *Int. J. Unc. Fuzz. Knowl. Based Syst.*, vol. 4, no. 4, pp. 379–388, Nov. 1996.
- [136] Y.-J. Lai and C.-L. Hwang, "Possibilistic linear programming for managing interest rate risk," *Fuzzy Sets Syst.*, vol. 54, no. 2, pp. 135–146, Mar. 1993.
- [137] Y.-J. Lai and C.-L. Hwang, "A new approach to some possibilistic linear programming problems," *Fuzzy Sets Syst.*, vol. 49, no. 2, pp. 121–133, Jul. 1992.

## References

- [138] M. Inuiguchi and J. Ramík, "Possibilistic linear programming: a brief review of fuzzy mathematical programming and a comparison with stochastic programming in portfolio selection problem," *Fuzzy Sets Syst.*, vol. 111, no. 1, pp. 3–28, Apr. 2000.
- [139] S. Heilpern, "The expected value of a fuzzy number," *Fuzzy Sets Syst.*, vol. 47, no. 1, pp. 81–86, Apr. 1992.
- [140] R. R. Yager, "A procedure for ordering fuzzy subsets of the unit interval," *Inf. Sci. (Ny)*, vol. 24, no. 2, pp. 143–161, Jul. 1981.
- [141] D. Dubois and H. Prade, "The mean value of a fuzzy number," *Fuzzy Sets Syst.*, vol. 24, no. 3, pp. 279–300, Dec. 1987.
- [142] H.-J. Zimmermann, "Fuzzy programming and linear programming with several objective functions," *Fuzzy Sets Syst.*, vol. 1, no. 1, pp. 45–55, Jan. 1978.
- [143] H. Selim and I. Ozkarahan, "A supply chain distribution network design model: An interactive fuzzy goal programming-based solution approach," *Int. J. Adv. Manuf. Technol.*, vol. 36, no. 3–4, pp. 401–418, Dec. 2006.
- [144] B. Werners, "Aggregation Models in Mathematical Programming," in *Mathematical Models for Decision Support SE - 19*, vol. 48, G. Mitra, H. Greenberg, F. Lootsma, M. Rijkaert, and H. Zimmermann, Eds. Springer Berlin Heidelberg, 1988, pp. 295–305.
- [145] R. W. Saaty, "The analytic hierarchy process—what it is and how it is used," *Math. Model.*, vol. 9, no. 3–5, pp. 161–176, Jan. 1987.
- [146] A. Charnes, W. W. Cooper, and E. Rhodes, "Measuring the efficiency of decision making units," *Eur. J. Oper. Res.*, vol. 2, no. 6, pp. 429–444, Nov. 1978.
- [147] A. Azadeh, M. Sheikhalishahi, S. M. Khalili, and M. Firoozi, "An integrated fuzzy simulation–fuzzy data envelopment analysis approach for optimum maintenance planning," *Int. J. Comput. Integr. Manuf.*, vol. 27, no. 2, pp. 181–199, Jul. 2013.
- [148] F. Niakan, A. Baboli, T. Moyaux, and V. Botta-Genoulaz, *A Multi-objective Mathematical Model Considering Economic and Social Criteria in Dynamic Cell Formation*, vol. 439. Berlin, Heidelberg: Springer Berlin Heidelberg, 2014.
- [149] F. Niakan, A. Baboli, T. Moyaux, and V. Botta-Genoulaz, "A new multi-objective mathematical model for dynamic cell formation under demand and cost uncertainty considering social criteria," *Appl. Math. Model.*, 2015.
- [150] F. Niakan, A. Baboli, T. Moyaux, and V. Botta-Genoulaz, "A new bi-objective mathematical model for sustainable dynamic cellular manufacturing systems," in *2014 IEEE International Conference on Industrial Engineering and Engineering Management*, 2014, pp. 938–942.
- [151] F. Niakan, A. Baboli, T. Moyaux, and V. Botta-Genoulaz, "A bi-objective model in sustainable dynamic cell formation problem with skill-based worker assignment," *J. Manuf. Syst.*, vol. 38, pp. 46–62, 2016.
- [152] F. Niakan, A. Baboli, T. Moyaux, and V. Botta-Genoulaz, "A new multi-objective mathematical model for dynamic cell formation considering sustainability criteria," in *Joint Symposium on IMSS'14 and CIE44n IMSS'14 and CIE44*, 2014, pp. 464–478.

## Appendix A: Notations

### Sets

$c$	index for manufacturing cells ( $c = 1, 2, \dots, C$ )
$d$	index for number of days per period ( $d = 1, 2, \dots, D$ )
$h$	index for number of periods ( $h = 1, 2, \dots, H$ )
$j$	index for operation of parts ( $j = 1, 2, \dots, O_p$ )
$k, k'$	index for level of machine ( $1, 2, \dots, ML$ )
$l$	index for number of workers ( $l = 1, 2, \dots, NL$ )
$m$	index for machine types ( $m = 1, 2, \dots, M$ )
$p$	index for part types ( $p = 1, 2, \dots, P$ )
$r$	index for type of workers ( $r = 1, 2, \dots, R$ )
$s$	index for number of shifts per period ( $s = 1, 2, \dots, S$ )
$\alpha, \beta$	index for level of worker ( $1, 2, \dots, \psi$ )

### Parameters

$a_{j,p,m}$	1, if operation $j$ of part $p$ can be done on machine type $m$ ; 0 otherwise
$ALT$	available working time per worker in a working day
$B_p^{inter}$	batch size for inter-cell movement of part $p$
$B_p^{intra}$	batch size for intra-cell movement of part $p$
$BN$	an arbitrary big number
$C$	maximum number of cells
$C_{\alpha,\beta,h}$	training cost of each $\alpha$ -level worker for skill level $\beta$ in period $h$
$C_{\alpha,\beta,h,r}$	training cost of each $\alpha$ -level worker for skill level $\beta$ for worker type $r$ in period $h$
$D$	number of days per period
$D_{p,h}$	demand for part $p$ in period $h$
$F_{\alpha,h}$	firing cost of each $\alpha$ -level worker in period $h$
$F_{\alpha,h,r}$	firing cost of each $\alpha$ -level worker and type of $r$ in period $h$
$H$	number of periods
$h_{\alpha,h}$	cost of hiring a worker with skill level $\alpha$ in period $h$
$H_{\alpha,h,r}$	cost of hiring a worker with skill level $\alpha$ and type of $r$ in period $h$
$HZ_m$	average fraction of potential hazards of machine type $m$
$L_m$	amount of workers required for machine type $m$
$\bar{L}_k$	the combined noise level (dBA) measured at machine level $k$
$LB$	minimum cell size

$M$	number of machine types
$ML$	number of machine levels
$MTL_{m,k}$	1, if machine of type $m$ belongs to machine level $k$ , 0 otherwise
$NL$	number of workers
$NL_k$	number of workers needed for machine level $k$
$NL_m$	number of workers needed for machine type $m$
$O_p$	number of operation for part type $p$
$P$	number of parts
$R$	number of type of workers
$S$	number of shifts per period
$S_m$	average fraction of potential hazard of machine type $m$
$sa_{m,h}^L$	salary of worker who works machine type $m$ in period $h$
$S_{\alpha,h}$	salary of each $\alpha$ -level worker in period $h$
$S_{\alpha,h,r}$	salary of each $\alpha$ -level worker and type of $r$ in period $h$
$t_s$	Time duration for each shift $s$
$T_{m,h}$	time-capacity of machine type $m$ in period $h$
$t_{j,p,m}$	time required to process operation $j$ of part $p$ on machine type $m$
$UB$	maximum cell size
$UG_{\alpha,\beta}$	1, if training from skill level $\alpha$ to skill level $\beta$ is possible, 0 otherwise
$w_{j,m}$	total amount of waste of machine type $m$ to process each operation $j$
$WP_{\alpha,k}$	1, if working of a worker with skill level $\alpha$ on machine level $k$ is possible, 0 otherwise
$\alpha_{m,h}$	fixed cost of machine type $m$ in period $h$
$\beta_{m,h}$	variable cost of machine type $m$ in period $h$ per unit of time
$\gamma_p^{inter}$	inter-cell movement cost per batch
$\gamma_p^{intra}$	intra-cell movement cost per batch. It is assumed that $\forall p (\gamma_p^{intra} / B_p^{intra}) < (\gamma_p^{inter} / B_p^{inter})$
$\delta_m$	relocation cost of machine type $m$
$\delta_{m,h}$	relocation cost of machine type $m$ in period $h$
$\eta_{j,m}$	variable cost of machine type $m$ to process operation $j$
$\eta_{j,m,h}$	variable cost of machine type $m$ to process operation $j$ in period $h$
$\theta_{hd}$	normalized weighting factor of total number of potential machine hazard

## Appendix A

$\theta_{jo}$	normalized weighting factor of total number of job opportunities created
$\lambda_h$	maximum percentage of worker leveling variation in period $h$
$\lambda_m$	fixed cost of machine type $m$ per period
$\lambda_{m,h}$	fixed cost of machine type $m$ in period $h$
$\varphi_m$	cost of purchase machine type $m$
$\varphi_{m,h}$	cost of purchase machine type $m$ in period $h$
$\psi$	number of worker levels
$\omega_m$	marginal revenue from selling machine type $m$
$\omega_{m,h}$	marginal revenue from selling machine type $m$ in period $h$
<i>Variables</i>	
$EL_{\alpha,k,h}$	number of existing workers with skill level $\alpha$ who are assigned to machine level $k$ in period $h$
$EL_{\alpha,k,h,r}$	number of existing workers type $r$ with skill level $\alpha$ who are assigned to machine level $k$ in period $h$
$fi_h$	number of workers fired in period $h$
$FL_{\alpha,k,h}$	number of fired workers with skill level $\alpha$ who are assigned to machine level $k$ in period $h$
$FL_{\alpha,k,h,r}$	number of fired workers type $r$ with skill level $\alpha$ who are assigned to machine level $k$ in period $h$
$hi_h$	number of workers hired in period $h$
$HL_{\alpha,k,h}$	number of hired workers with skill level $\alpha$ who are assigned to machine level $k$ in period $h$
$HL_{\alpha,k,h,r}$	number of hired workers type $r$ with skill level $\alpha$ who are assigned to machine level $k$ in period $h$
$I_{m,h}^+$	number of machine type $m$ purchased at the beginning of period $h$
$I_{m,h}^-$	number of machine type $m$ sold at the beginning of period $h$
$K_{m,c,h}^+$	number of machine type $m$ added to cell $c$ at the beginning of period $h$
$K_{m,c,h}^-$	number of machine type $m$ removed from cell $c$ at the beginning of period $h$
$N_{m,c,h}$	number of machine type $m$ assign to cell $c$ at the beginning of period $h$
$TL_{\alpha,\beta,k,k',h}$	number of $\alpha$ -level workers who were working with machine level $k$ in period $h-1$ , and are upgraded by training to higher skill level $\beta$ and are assigned to machine level $k'$ in period $h$

## Appendix A

$TL_{\alpha,\beta,k,k',h,r}$	number of $\alpha$ -level workers type $r$ who were working with machine level $k$ in period $h-1$ , and are upgraded by training to higher skill level $\beta$ and are assigned to machine level $k'$ in period $h$
$x_{j,p,m,c,h}$	1, if operation $j$ of part $p$ is performed in cell $c$ in period $h$ by machine type $m$ ; 0 otherwise
$x'_{l,\alpha,k,h,s}$	1, if worker $l$ with skill level $\alpha$ is assigned to machine level $k$ in period $h$ and shift $s$ ; 0 otherwise
$x'_{l,\alpha,k,h,s,r}$	1, if worker $l$ with type $r$ skill level $\alpha$ is assigned to machine level $k$ in period $h$ and shift $s$ ; 0 otherwise
$y_{\alpha,k',h}$	an auxiliary binary variable
$y_{\alpha,k',h,r}$	an auxiliary binary variable

## Appendix B: Abbreviations

AHP	Analytic Hierarchy Process
BFO	Bacteria Foraging Optimization
CFP	Cell Formation Problem
CMS	Cellular Manufacturing System
CSR	Corporate Social Responsibility
DCFP	Dynamic Cell Formation Problem
DCMS	Dynamic Cellular Manufacturing System
DEA	Data Envelopment Analysis
DiM	Diversification Metric
DMU	Decision Making Unit
DND	Daily Noise Dosage
DOE	Design of Experiments
D2P	Distance to an ideal Point
EI	Expected Interval
EM-like	Electro Magnetism-like algorithm
EV	Expected Value
FCM	Focused Cellular Manufacturing
GA	Genetic Algorithm
GHG	Greenhouse Gas emission
GT	Group Technology
MA	Memetic Algorithm
MADM	Multiple Attribute Decision Making
MCDM	Multi Criteria Decision Making
MFA-SA	Mean Field Annealing-Simulated Annealing
MOILP	Multi Objective Integer Linear Programming
MOLP	Multi Objective Linear Programming
MOPMILP	Multi Objective Possibilistic Mixed-Integer Linear Programming
MOSA	Multi Objective Simulated Annealing
MOSS	Multi Objective Scatter Search
NSGA-II	Non-dominated Sorting Genetic Algorithm-II
NIOSH	National Institute of Occupational Safety and Health
OSHA	Occupational Safety and Health Administration
PCA	Principle Component Analysis
QAP	Quadratic Assignment Problem
QM	Quality Metric
SA	Simulated Annealing
SM	Spacing Metric
SDCWP	Simultaneous Dynamic Cell Formation and Worker assignment Problem



## Appendix B

TH	Torabi-Hassini Method
TIS	Time In Service
TS	Tabu Search
WCED	World Commission on Environment and Development
WIP	Work In Process

# Appendix C: List of Figures and Tables

## List of figures

<b>Figure 1.1</b> Material flow in job shop manufacturing system .....	2
<b>Figure 1.2</b> Material flow in flow shop manufacturing system .....	3
<b>Figure 1.3</b> Material flow in cellular manufacturing system (CMS).....	4
<b>Figure 1.4</b> A schematic view of Dynamic Cellular Manufacturing System (DCMS).....	5
<b>Figure 2.1</b> Distance of Pareto solutions from an ideal point .....	37
<b>Figure 2.2</b> Signal to noise ratio from Taguchi experiments .....	38
<b>Figure 2.3</b> Best results of Z1 for S2 .....	42
<b>Figure 2.4</b> Best results of Z2 for S2 .....	43
<b>Figure 2.5</b> Mean and standard deviation of first Objective function values (Z1) .....	43
<b>Figure 2.6</b> Mean and standard deviation of second Objective function values (Z2) .....	44
<b>Figure 3.1</b> The flow chart of Hybrid NSGA II-MOSA .....	59
<b>Figure 3.2</b> Chromosome structure .....	61
<b>Figure 3.3</b> Crossover operator.....	61
<b>Figure 3.4</b> Signal to noise ratio from Taguchi experiments .....	65
<b>Figure 3.5</b> Optimal Pareto solutions for problem 3.....	67
<b>Figure 3.6</b> Optimal Pareto solutions for problem 5.....	67
<b>Figure 3.7</b> Optimal Pareto solutions for problem 7.....	68
<b>Figure 3.8</b> Optimal Pareto solutions for problem 10 .....	68
<b>Figure 3.9</b> Cell configuration and worker pattern for solution A in problem 3 .....	69
<b>Figure 3.10</b> Cell configuration and worker pattern for solution B in problem 3 .....	69
<b>Figure 3.11</b> Cell configuration and worker pattern for solution C in problem 3 .....	70
<b>Figure 3.12</b> Comparison of Quality Metrics (QM) for three meta-heuristics.....	71
<b>Figure 3.13</b> Comparison of Spacing Metrics (SM) for three meta-heuristics .....	72
<b>Figure 3.14</b> Comparison of Diversification Metrics (DiM) for three meta-heuristics .....	72
<b>Figure 3.15</b> Computational time of two algorithms for ten test problems.....	73
<b>Figure 4.1</b> The impact of relative importance $\theta_1$ on total cost and social issues.....	94
<b>Figure 4.2</b> The impact of relative importance $\theta_1$ on total cost and waste .....	94
<b>Figure 4.3</b> The impact of process time of the part on total cost.....	95
<b>Figure 4.4</b> The impact of process time of the part on social issues... ..	95

<b>Figure 5.1</b> Diagram of the optimization-simulation approach .....	100
<b>Figure 5.2</b> The empirical and theoretical frontiers .....	101
<b>Figure 5.3</b> Optimal Pareto frontier for Problem P1 .....	104
<b>Figure 5.4</b> Optimal Pareto frontier for Problem P2 .....	104
<b>Figure 5.5</b> Simulation model of Problem P1 .....	105
<b>Figure 5.6</b> Simulation model of Problem P2 .....	105

## List of tables

<b>Table 1.1</b> Classification of literature about DCMS .....	16
<b>Table 2.1</b> Experiments of the Taguchi design .....	37
<b>Table 2.2</b> Obtained responses of Taguchi experiments .....	38
<b>Table 2.3</b> Pattern of sample generation .....	39
<b>Table 2.4</b> Different sizes of problems .....	39
<b>Table 2.5</b> Objective functions value with best Z1 in final Pareto results .....	40
<b>Table 2.6</b> Objective functions value with best Z2 in final Pareto results .....	41
<b>Table 2.7</b> Computational times (Second) .....	44
<b>Table 3.1</b> Design parameters and their levels .....	62
<b>Table 3.2</b> Experiments of the Taguchi design .....	63
<b>Table 3.3</b> Obtained responses of Taguchi experiments .....	64
<b>Table 3.4</b> Dimension of test problems .....	66
<b>Table 3.5</b> Pattern of data generation .....	66
<b>Table 3.6</b> Comparison Metrics .....	71
<b>Table 4.1</b> The Size of test problems .....	91
<b>Table 4.2</b> Generation pattern of the parameters .....	91
<b>Table 4.3</b> Results based on $\alpha$ -level variations .....	92
<b>Table 4.4</b> Sensitivity analysis on $\gamma$ -value .....	93
<b>Table 5.1</b> The size of test problem .....	102
<b>Table 5.2</b> Generation pattern of the parameter .....	103
<b>Table 5.3</b> The simulation result of each scenario DEA .....	106
<b>Table 5.4</b> The Results of DEA .....	107

# Appendix D: Résumé étendu en français

## 1 Introduction

Afin de rester compétitives et de répondre aux nouveaux challenges industriels, les entreprises doivent en permanence faire évoluer leurs produits et leurs méthodes de production. Elles doivent non seulement réduire leurs coûts, mais également répondre à des exigences de plus en plus fortes en termes de respect des contraintes sociales et environnementales. La conception d'un nouveau système de production et/ou une innovation technique apportée dans le processus de réalisation d'un produit (modification de sa composition ou dans les moyens mis en œuvre pour sa réalisation) doivent dès lors être analysés au regard du triptyque économique / social / environnemental sur lequel repose le Développement durable (*Sustainable development*).

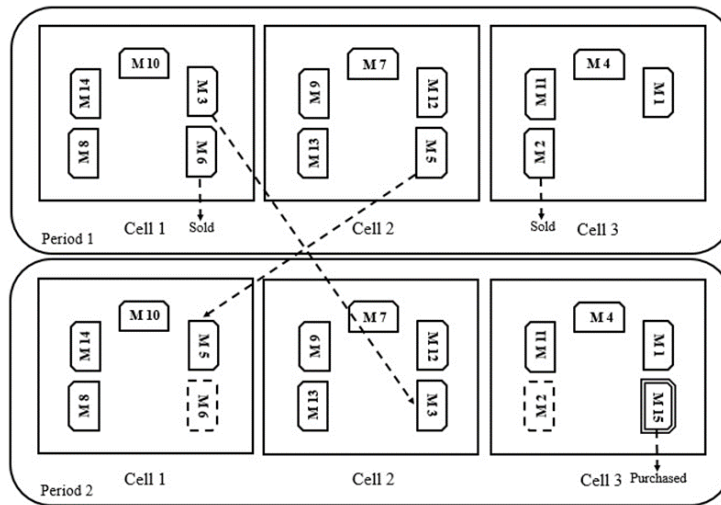
De nombreux travaux ont été menés sur l'implantation des systèmes de production en se limitant aux critères économiques, mais presque aucun n'aborde les dimensions environnementales et sociales. Par ailleurs, les critères du développement durable commencent à être pris en compte dans les problèmes d'organisation des chaînes logistiques, de planification, d'évaluation de performance, etc. mais moins dans les problématiques d'organisation interne des sites de production.

Les systèmes de fabrication cellulaires (*Cellular Manufacturing Systems – CMS*) font partie des systèmes de production connus pour être les plus efficaces lorsque la variété de la demande d'une famille de produits est moyenne. La configuration de ces systèmes de production est basée sur les technologies de groupe (*clustering*) afin d'obtenir des familles qui peuvent être fabriquées en cellules de production (regroupement des machines nécessaires dans une de ces cellules pour fabriquer une famille de produits). Les principaux avantages des CMS sont de :

- réduire les en-cours et les temps d'écoulement des produits,
- suivre la demande du marché au plus près et réduire les temps de réinstallation et de réglage,
- réduire les coûts d'outillage en les mutualisant sur la fabrication de mêmes familles de produits,
- optimiser l'utilisation de l'espace et du temps de déplacement des opérateurs,
- simplifier la planification de la production et du pilotage.

De nos jours, certains paramètres, tels que l'incertitude de la demande, la réduction de la durée du cycle de vie des produits et l'évolution des gammes de

produits, forcent à reconfigurer régulièrement les CMS afin de maintenir un haut niveau de performance.



**Figure 1** Schéma d'un système de fabrication cellulaire dynamique

De ce fait, les cellules formées pour être optimales dans une période peuvent ne plus l'être dans une autre. En outre, ce regroupement des familles de produits et cette reconfiguration des machines peuvent engendrer soit le déplacement de machines entre les cellules, soit le changement du nombre de cellules. Des études ont montré que cette reconfiguration coûte beaucoup aux entreprises manufacturières. Par exemple, Tompkins *et al.* (2003) estiment que 250 milliards de dollars sont dépensés chaque année aux Etats-Unis pour la reconfiguration des systèmes de production. Ce coût important pourrait être réduit de 10 à 30% par une configuration initiale plus efficace. De ce fait, la prise en compte des possibilités des reconfigurations éventuelles durant un horizon plus long qu'une seule période dès la première configuration permet certainement de réduire les coûts de reconfiguration (Figure 1). Ces raisons fournissent une motivation suffisante pour mener des recherches sur **la configuration des systèmes de fabrication cellulaires (CMS) ou des systèmes de fabrication cellulaires dynamiques (DCMS)**, tels que ceux utilisés par l'industrie d'assemblage par lots de production et les équipementiers automobiles.

## 2 Revue de la littérature

Tout d'abord, nous présentons une brève revue de la littérature sur les systèmes de fabrication cellulaires dynamiques (DCMS). En raison du grand nombre de recherches dans ce domaine, nous nous concentrons uniquement sur des études récentes.

Rheault *et al.* [52] ont été les premiers à introduire le concept d'environnement dynamique dans le problème de formation de cellules. Schaller *et al.* [16] ont intégré le problème de formation de cellules à la gestion de stocks. Ils ont proposé une procédure à heuristiques multiples et l'ont comparé à diverses méthodes d'évaluation de borne inférieure. Chen et Cao [53] ont proposé un modèle mathématique pour un système de production cellulaire multi-période afin de minimiser le coût total incluant ceux de manutention inter-cellule, d'inventaire et de mise en place des cellules. Ces auteurs ont également mis au point une méthode taboue pour obtenir une bonne solution et montrer l'efficacité de leur modèle.

Tavakkoli-Moghaddam *et al.* [55] ont présenté un modèle entier non linéaire de configuration de DCMS en tenant compte des capacités limitées des machines, de la réplification de machines et des mouvements intercellulaires qui se produisent par lots. Ils ont utilisé des coûts fixes et variables des équipements, les coûts des mouvements intercellulaires des pièces pour formuler leur fonction objectif. Ces auteurs ont résolu leur modèle par différentes méta-heuristiques traditionnelles, telles que les algorithmes génétiques, la recherche taboue et le recuit simulé, puis ils ont comparé les solutions obtenues par chaque méthode pour définir le meilleur algorithme. Tavakkoli-Moghaddam *et al.* [56] ont appliqué un nouvel algorithme mémétique pour résoudre leur modèle de configuration de DCMS. Defersha et Chen [57] ont formulé un nouveau modèle traitant à la fois de la configuration dynamique de cellules, des solutions alternatives, du fractionnement de lots et de l'équilibrage de la séquence des opérations et de la charge de travail. Ils ont également considéré la contiguïté des machines et la capacité de la taille de la cellule comme contraintes de leur modèle.

Safaei et al. [61],[62] ont présenté un modèle mathématique sous incertitude en supposant la demande et la disponibilité floues des machines. Ils ont résolu leur modèle de programmation en nombres entiers mixte par l'élaboration de programmes flous pour déterminer la configuration optimale des cellules avec satisfaction maximale de l'objectif flou et des contraintes. Defersha et Chen [64] ont intégré au problème de configuration de DCMS, la détermination de la taille de lots de production et ont formulé un modèle mathématique pour réduire à la fois les coûts de production et ceux liés à la qualité, tels que les coûts d'exploitation, d'installation et d'inventaire. Ils l'ont résolu par un algorithme génétique intégrant la programmation linéaire. Wang *et al.* [72] ont présenté un programme non-linéaire mixte pour modéliser la configuration d'un DCMS avec trois objectifs contradictoires (coût de relocalisation des machines, taux d'utilisation de la capacité des machines et nombre total de mouvements inter-cellules sur tout l'horizon de planification). Javadian *et al.* [75] ont présenté un problème multi-objectif de systèmes de fabrication cellulaires dans des

environnements dynamiques et déterministes pour minimiser la variation totale de la charge de la cellule et la somme de divers coûts simultanément (coûts des machines, de manutention inter-/intra-cellulaire, de backorders et de possession de stocks et de sous-traitance). Un algorithme génétique à tri non-dominé (NSGA-II pour Non-dominated Sorting Genetic Algorithm) a été développé pour obtenir la frontière de Pareto optimale. Rafiee *et al.* [76] ont intégré les problèmes de configuration de DCMS et de taille de lot d'inventaire en formulant un modèle mathématique complet. Le modèle proposé inclut plusieurs facteurs, tels que l'achat de machines, la reconfiguration des cellules, les maintenances préventive et corrective, la manutention intra-/inter-cellules, la sous-traitance, le coût des stocks et le coût de remplacement des pièces défectueuses. Saxena et Jain [77] ont développé un modèle de programmation non-linéaire en nombres entiers mixte pour fusionner les effets des défaillances des machines dans les DCMS en intégrant la modélisation de la fiabilité. Kia *et al.* [78] ont proposé un nouveau modèle de programmation non-linéaire en nombres entiers mixte en intégrant trois décisions lors de la conception d'un CMS (formation des cellules, aménagement des groupes et planification des groupes) et ils ont développé une méthode de recuit simulé efficace pour résoudre leur modèle. Rafiei et Ghodsi [79] ont présenté un problème bi-objectif de configuration de CMS dans lequel ils prennent en compte l'utilisation des travailleurs. Ils ont en outre suggéré une hybridation d'un algorithme d'optimisation par colonie de fourmis avec un algorithme génétique pour résoudre leurs modèles. Majazi-Dalfard [83] a développé un nouveau modèle de programmation non-linéaire en nombres entiers mixte et y a intégré les effets de la distance dans le flux de matière comme facteur important lors de la prise de décision.

Sur la base cette brève revue de la littérature et du tableau 1.1 (chapitre 1), nous observons que la plupart des critères étudiés dans des travaux de recherche sur les problèmes de configuration des CMS ou DCMS sont principalement économiques ; les dimensions social ou environnemental ne sont que très peu considérées. Une autre caractéristique de la littérature existante concerne le manque de prise en compte de paramètres incertains (comme les coûts, la demande...). De Plus et compte tenu de la complexité du problème, la plupart des travaux de recherche raisonnent sur une seule période.

Notre motivation est de développer de nouvelles méthodes qui peuvent capturer avec précision et de façon réaliste plusieurs caractéristiques importantes du problème de configuration de DCMS :

- Prise en compte de l'aspect dynamique de la configuration des cellules dans un contexte incertain (demande, capacité, coût, etc.) ;
- Intégration des critères sociaux et environnementaux en plus des critères économiques classiques.

Les questions de recherche qui se posent sont :

- Comment intégrer les critères durables dans la configuration des DCMS et comment faire un compromis entre les aspects économiques, sociaux et environnementaux ?
- Comment développer des approches de résolution pour faire face aux paramètres incertains du problème ?
- Comment développer des approches de résolution avec une meilleure performance dans le temps de calcul et la qualité de la solution ?
- Comment coupler optimisation et simulation pour analyser les solutions aux différents niveaux de décision stratégique, tactique, et opérationnels.

Nous présentons dans les trois sections suivantes trois problèmes de configuration de DCMS prenant en compte les caractéristiques ci-dessus et pour lesquels nous proposons des approches de résolutions originales.

### **3 Un modèle bi-objectif de configuration de cellules manufacturières sous incertitudes considérant des critères économiques et sociaux**

#### 3.1 Motivation et Contribution

La première contribution de la recherche présentée ici est un nouveau modèle mathématique multi-objectif pour la configuration de DCMS en tenant compte d'aspects sociaux. En d'autres termes, nous essayons de faire un compromis entre critères économiques et sociaux à chaque période lors de la conception d'un CMS.

La seconde contribution de ce travail est qu'il développe une contrepartie robuste équivalente (*robust counterpart*) du modèle proposé pour faire face à l'incertitude de la demande, à la disponibilité des machines et aux coûts de ces machines. Il peut sembler plus facile d'utiliser des paramètres déterministes durant la configuration d'un DCMS, mais dans le monde réel de nombreux paramètres doivent être considérés comme incertains. En outre, aucune solution satisfaisante ne peut être trouvée par l'approche déterministe. Ces considérations peuvent affecter légèrement la performance économique d'un système, mais elles permettent aussi d'approcher la réalité et surtout d'avoir une solution réalisable sous différents types et niveaux d'incertitude.



### 3.2 Description du problème

Cette étude vise à choisir des mesures sociales de telle manière qu'elles soient étroitement liées aux décisions de configuration des DCMS. En outre, elles peuvent être calculées et formulées simplement dans le modèle mathématique. À cette fin, deux mesures sociales sont sélectionnées qui sont tirées de la norme ISO 26000 et du cadre de travail GRI (que nous jugeons crédible) [108] : (1) le nombre de possibilités d'emplois créées et (2) le nombre de dangers potentiels des machines pour les opérateurs. La première mesure représente la variation des possibilités d'emplois créées en raison de l'embauche et du licenciement (ou réaffectation) du travailleur, résultant de l'achat et de la vente de machines et d'équipements. La deuxième mesure reflète le taux moyen des dangers potentiels de chaque machine pour les opérateurs, montrant le niveau de risque de maladies professionnelles provoquées par les machines et équipements de production. Cette dernière mesure est prise en compte par un paramètre appelé « taux moyen potentiel de dangerosité des machines ». Ce taux est un nombre continu entre 0 (le plus sûr) et 1 (le plus dangereux) et est défini par le décideur en utilisant une liste de contrôle de sécurité, les avis des travailleurs, les informations provenant du fabricant des machines, la vérification des préjudices et le nombre d'incidents de chaque machine. En raison des différentes unités de mesure, dans la fonction objectif, nous avons agrégé les deux critères sociaux étudiés par des méthodes de normalisation, puis de pondération. Cette agrégation représente non seulement l'importance de chaque critère, mais aussi diminue la complexité de calcul de l'évaluation de chaque solution avec les aspects sociaux. D'autres hypothèses, modélisées mathématiquement par des contraintes, sont présentées comme suit :

- Chaque pièce à une gamme opératoire et doit être traitée selon la séquence prédéfinie.
- La demande de chaque type de pièces dans chaque période est un paramètre aléatoire.
- La capacité de chaque machine pour le traitement des pièces est connue. Le temps de disponibilité de chaque machine est également un paramètre aléatoire.
- Le coût fixe de chaque machine est indépendant de la charge de travail affectée. Ce coût est considéré pour chaque machine si elle est utilisée dans l'horizon de planification et comprend les coûts totaux d'entretien et de services généraux. Ce coût est considéré comme un paramètre aléatoire.
- Le coût variable de chaque machine comprend le coût de fonctionnement et dépend de la charge de travail affectée à la machine. Ce paramètre est également supposé incertain.

- Le coût d'achat et le prix de vente de chaque machine à chaque période sont considérés comme une valeur incertaine et comprend les prix des machines et les frais de transport. Ce qui signifie que les coûts de déménagement entre lieux de stockage et d'installation ne sont pas considérés.
- Le coût de réinstallation (désinstallation, déplacement et installation) de chaque type de machines entre deux périodes est également un paramètre incertain.
- Chaque type de machines peut réaliser plusieurs opérations. Autrement dit, le traitement des opérations de chaque pièce peut être effectué sur différents types de machines avec, bien évidemment, des temps de traitement différents.
- Les limites de nombre minimal et maximal de machines dans chaque cellule sont connues et supposées fixes pour toutes les périodes.
- Les mouvements inter et intracellulaires de pièces sont effectués en lots de tailles différentes et les coûts liés à ces mouvements dépendent de la distance parcourue. Pour diminuer la complexité du problème, nous avons supposé que la distance entre deux cellules adjacentes (inter) est la même, et que, pour chaque cellule, la distance entre deux machines adjacentes (intra) est la même. En outre, l'espace affecté à chaque machine est supposé constant.

### 3.3 Formulation mathématique

La première fonction objectif minimise les coûts totaux et comprend huit éléments : (i) les coûts fixes des machines, (ii) les coûts variables des machines, (iii) les coûts des mouvements intercellulaires, (iv) les coûts des mouvements intracellulaires, (v) les salaires, (vi) le coût de relocalisation des machines (réinstallation dans une autre cellule), (vii) le coût d'acquisition des machines et (viii) les recettes provenant de la vente de machines.

La seconde fonction objectif maximise la valeur agrégée des critères sociaux durant l'horizon de planification, incluant la maximisation de création d'emplois et la minimisation du risque potentiel des machines.

Les contraintes, définissant les circonstances de notre problème, sont présentées comme suit :

1. Chaque opération d'une pièce est affectée seulement à une machine et à une cellule.
2. Une opération peut seulement être affectée aux machines qui peuvent la faire.
3. La disponibilité en temps de chaque machine doit être respectée.

4. Il faut détermine le nombre de machines disponibles (achat, vente et maintenu) dans chaque période de planification.
5. Il faut détermine le nombre d'opérateurs (recrutés, licenciés et maintenu) dans chaque période de planification.
6. Il faut s'assurer du respect de bornes supérieure et inférieure déterminées par le nombre maximum et minimum de machines dans chaque cellule.
7. La variation du nombre d'opérateurs dans chaque période doit rester dans un certain intervalle.

### 3.4 Méthode de résolution

Par linéarisation des termes non-linéaires de notre problème, nous transformons notre modèle mathématique sous sa forme linéaire. Afin d'augmenter la capacité du modèle proposé pour traiter les données incertaines, telles que les coûts de la machine, la demande pour les pièces et la capacité en temps machine, une approche d'optimisation robuste est présentée. Dans ce but, l'équivalent robuste du modèle mathématique linéarisé est développé en s'appuyant sur plusieurs lemmes.

Afin d'illustrer la performance de notre modèle robuste, un certain nombre de données et d'exemples sont générés et résolus en utilisant l'algorithme génétique à tri non-dominé NSGA-II, présenté comme l'un des algorithmes évolutionnaires les plus populaires pour les problèmes d'optimisation multi-objectif. Pour obtenir une meilleure solution, les paramètres critiques de l'algorithme proposé (NSGA-II) sont accordés par la méthode des plans d'expérience de Taguchi (DOE ou *Design Of Experiment*).

Dans notre étude, trois problèmes de base ont été examinés selon différents niveaux d'incertitude. Cela signifie que chacun des exemples de base a été utilisé pour générer les divers problèmes selon des paramètres incertains. Les résultats illustrent la supériorité du modèle robuste dans l'utilisation de paramètres incertains et aussi dans la robustesse des solutions pertinentes, en comparaison avec le modèle déterministe. En guise d'explication, contrairement au modèle déterministe, le modèle robuste pourrait permettre d'obtenir des solutions adaptées à tous les niveaux d'incertitude considérés et pour toutes les tailles de problème, alors que le modèle déterministe est probablement inutilisable lorsque le niveau d'incertitude augmente de manière importante. En outre, les résultats démontrent un écart type faible sur les fonctions objectif du modèle robuste en comparaison avec le déterministe.

## 4 Un modèle bi-objectif de configuration de cellules manufacturières dynamiques et d'affectation des opérateurs considérant des critères économiques, environnementaux et sociaux

### 4.1 Motivation et Contribution

Dans cette deuxième étude, nous considérons les trois dimensions du développement durable pour la conception et la configuration des DCMS. De ce fait, nous avons développé un nouveau modèle mathématique pour le problème de configuration et d'affectation simultanées des opérateurs de DCMS en faisant un compromis entre des objectifs économiques, sociaux et environnementaux.

En raison de la complexité des modèles de conception et de configuration du DCMS (problème *NP-Hard*), nous développons une nouvelle méta-heuristique hybride en nous appuyant sur deux méthodes bien connues, NSGA II et MOSA (Multi Objective Simulated Annealing). L'application de la méta-heuristique hybride proposée démontre l'efficacité et la performance de notre approche.

### 4.2 Description du problème

Dans le modèle proposé, la première fonction objectif minimise divers coûts, comme les coûts fixes et variables des machines, les coûts de déplacement inter et intracellulaires, les coûts d'acquisition de nouvelles machines, les coûts de réinstallation des machines et les coûts d'embauche, de formation, de licenciement et/ou de réaffectation des salariés à un autre service. La deuxième fonction objectif optimise l'aspect environnemental en réduisant d'une part le gaspillage de production total des machines au cours de la période de planification et d'autre part la dose de bruit quotidienne par opérateur (DND ou *Daily Noise Dosage*) pour chaque période selon les gammes standard spécifiées par la sécurité et les administrations sanitaires.

Les problèmes de bruit sont reconnus dans les établissements industriels. Les travailleurs sont en permanence exposés à des nuisances sonores dans les environnements de fabrication où un certain nombre de machines travaillent simultanément avec un niveau de bruit combiné plus ou moins important. Selon Leigh et Miller [121] dans leur étude sur les maladies liées à l'emploi, la perte de l'ouïe compte parmi les maladies professionnelles les plus fréquentes par rapport aux autres maladies professionnelles en touchant plus de 300 professions. Danial *et al.* [122] ont observé que les demandes d'indemnisation des travailleurs dans l'État de Washington concernant le règlement d'invalidité annuelle pour les problèmes connexes à l'ouïe coûtent près de 22,8 millions de

dollars. Du point de vue humain, l'exposition professionnelle au bruit provoque non seulement des troubles sociaux et psychologiques pour les travailleurs, mais aussi ces travailleurs souffrent de fatigue accrue au travail. Niebel et Freivalds [123] indiquent que l'exposition importante aux bandes intermittentes de bruit peut entraîner la diminution de la productivité et l'augmentation de la fatigue des employés en raison de la gêne et de la distraction. Ce gain de productivité n'est pas encore pris en compte dans notre modèle. En ce qui concerne la perte d'audition, l'Institut National de la Sécurité et la Santé au Travail (NIOSH) [109] a mentionné que la rotation horaire de l'emploi peut être utilisé comme moyen efficace pour contrôler et réduire l'exposition quotidienne au bruit. L'Administration de la Sécurité et de la Santé au Travail (OSHA) [127] ainsi que le NIOSH [111] ont fourni des valeurs limites d'exposition pour des niveaux d'exposition au bruit combiné quotidiennement qui représentent les conditions de niveaux sonores admissibles pour les travailleurs pouvant être exposés de manière continue.

Par ailleurs, le secteur industriel est considéré comme l'une des principales sources de pollution dans le monde et une grande partie de cette pollution est produite de diverses manières, telles que gaspillages de matériaux, pollution de l'eau, chaleur et émission de gaz à effet de serre (GHG ou *GreenHouse Gas emission*). Réchauffement climatique, pollution et destruction de la couche d'ozone forcent gestionnaires et fabricants à améliorer l'efficacité de leurs systèmes de production afin de les diminuer. Cette efficacité dépend des caractéristiques et de l'âge de l'équipement de fabrication. La sélection et la configuration ou reconfiguration de l'équipement sont donc l'un des problèmes de décision les plus importants dans la réduction de ces gaspillages de production. Il est donc nécessaire de tenir compte de critères environnementaux et sociaux en plus des questions économiques traditionnelles.

Selon l'explication ci-dessus et en se basant sur le rapport sur le Développement durable du GRI [108], nous avons considéré deux mesures sociale et environnementales dans le modèle mathématique proposé ; la dose quotidienne de bruit (DND) qui représente le niveau quotidien d'exposition au bruit pour chaque travailleur et le gaspillage d'énergie qui reflète la perte d'énergie moyenne pour chaque machine. Cette seconde mesure est prise en compte par le biais d'un paramètre calculé pour chaque opération sur chaque machine en fonction de l'étiquette d'énergie (qui présente l'efficacité énergétique) et la puissance (qui est représentée par le taux de consommation) fournies par le fournisseur de ces machines. D'autres hypothèses utilisées pour formuler le modèle mathématique sont :

- Chaque pièce à une gamme d'opérations et doit être traitée selon la séquence définie.

- La demande de chaque type de pièces dans chaque période est connue et est un nombre constant.
- La capacité de chaque machine pour le traitement des pièces est connue. La capacité en temps de chaque machine à chaque période est également un paramètre constant.
- L'affectation du travail se fait en fonction du niveau de compétence des travailleurs et du niveau d'efficacité de la machine. En d'autres termes, chaque type de machines est classé dans un niveau unique et chaque niveau de machine à besoin d'un niveau de compétence spéciale des opérateurs. Par exemple, un travailleur de niveau 2 peut être affecté à des machines de niveau 2 ou moins (un travailleur avec niveau de qualification 2 et 1 peut travailler sur le niveau 2 de la machine et un travailleur au niveau de compétence 1 peut seulement travailler avec le niveau 1 de la machine).
- La compétence des travailleurs de chaque niveau peut être améliorée au niveau supérieur par un processus de formation.
- Le coût fixe de chaque machine est indépendant de la charge de travail assigné. Ce coût est considéré pour chaque machine si elle est utilisée dans l'horizon de planification et comprend les coûts d'entretien et de services généraux totaux.
- Le coût variable de chaque machine comprend le coût de fonctionnement et dépend de la charge de travail affecté à chaque machine.
- Les coûts d'acquisition et de vente des machines à chaque période sont connus et restent constants. Ces coûts comprennent le prix des machines et les frais de transport, ce qui signifie que les frais de déménagement entre lieux de stockage et d'installation ne sont pas considérés.
- Le coût de réinstallation (désinstallation, déplacement et réinstallation) de chaque type de machines entre deux périodes est connu et constant.
- Chaque type de machines peut traiter plusieurs opérations. En d'autres termes, le traitement de chaque pièce peut être effectué sur différents types de machines avec des temps de traitement différents.
- Les limites supérieure et inférieure de la taille des cellules sont connues et constantes entre périodes.
- Les mouvements inter et intracellulaires de pièces sont effectués par des lots de différentes tailles et les coûts liés à ces mouvements dépendent de la distance parcourue. Pour diminuer la complexité du problème, nous supposons que la distance entre deux cellules adjacentes (inter) est la même et que, dans chaque cellule, la distance

entre deux machines adjacentes (intra) est la même. En outre, l'espace occupé par tous les types de machines est le même.

### 4.3 Formulation mathématique

La première fonction objectif minimise les coûts totaux et comprend les éléments suivants : (i) les coûts fixes des machines, (ii) les coûts variable des machines, (iii) les coûts des mouvements de pièces entre les cellules (intercellulaires), (iv) les coûts de mouvements de pièces à l'intérieur des cellules (intracellulaires), (v) les salaires, (vi) le coût de relocalisation des machines, (vii) le coût d'acquisition des machines, (viii) les recettes provenant de la vente des machines et (ix) les coûts d'embauche, de licenciement et de formation.

La deuxième fonction objectif considère la minimisation du gaspillage de production (comme les gaspillages d'énergie, les pertes de matières ou chimiques ou les émissions de gaz à effet de serre).

La troisième fonction objectif minimise le maximum de DND des travailleurs. Afin de simplifier la résolution de ce problème, cet objectif supplémentaire est transformé en contrainte au niveau maximum d'exposition quotidienne au bruit des travailleurs.

Les contraintes définissant les circonstances de notre problème sont répertoriées comme suit :

1. S'assurer que les pièces sont traitées conformément à la planification et aux processus nécessaires.
2. Contrôler que le processus de chaque pièce est attribué aux machines qui peuvent le faire.
3. S'assurer que la capacité en temps de chaque machine ne soit pas dépassée.
4. Garantir l'équilibre entre deux périodes consécutives en termes de nombre de machines respectivement attribuées à chaque cellule et de nombre de machines achetées ou vendues pour chaque type de machines.
5. Vérifier les tailles maximale et minimale des cellules selon leurs bornes supérieure et inférieure.
6. Contrôler que chaque travailleur dispose d'un niveau unique de compétence et lui affecter les opérations au niveau de compétence requis par la machine.
7. Garantir que le nombre de travailleurs disponibles est suffisant pour chaque niveau de la machine à chaque quart de travail.

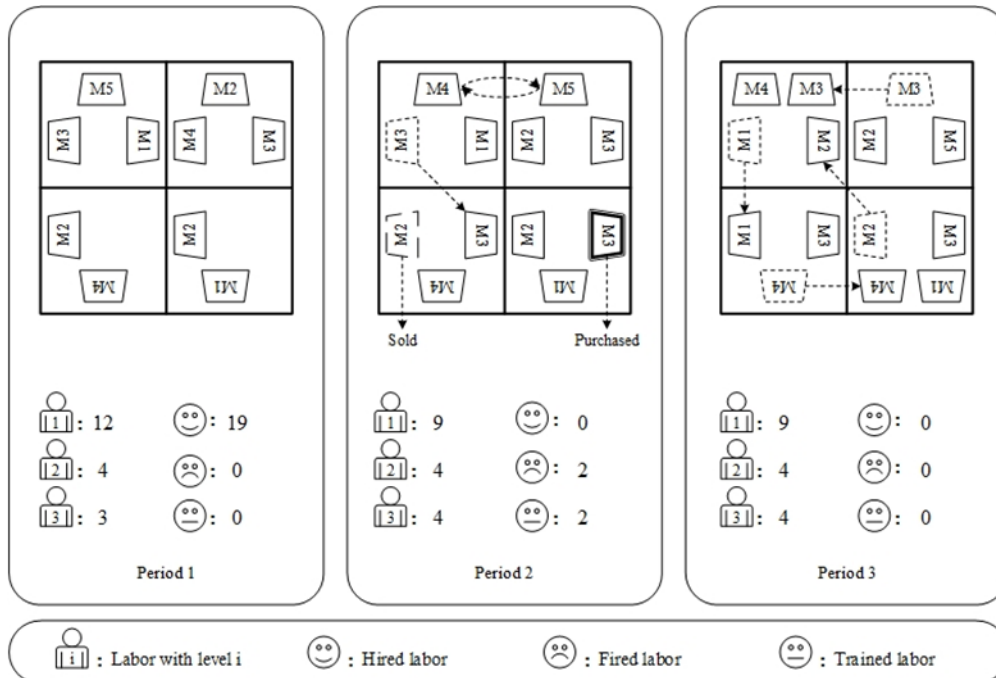
8. Appliquer les règles concernant les travailleurs dont le niveau de compétence est compatible avec le niveau de compétence requis par la machine.
9. Garantir l'équilibre du travail entre périodes et quarts de travail consécutifs.
10. Contrôler que le nombre de travailleurs disponibles est suffisant pour faire fonctionner des machines pour chaque cellule et chaque type de machines.
11. S'assurer que le nombre de licenciements de travailleurs nouvellement formés pour le niveau de compétence  $\alpha$  ne soit pas dépassé.

#### 4.4 Méthode de résolution

Nous proposons un modèle mathématique non linéaire que nous linéarisons. En raison de la complexité (*NP-hard*) du modèle proposé, nous développons une nouvelle méta-heuristique hybride en nous appuyant sur deux méthodes bien connues : NSGA-II et MOSA. Pour augmenter les performances de l'algorithme proposé (NSGA II-MOSA) et afin de trouver un meilleur résultat, la méthode des plans d'expérience de Taguchi est utilisée pour régler les paramètres de l'algorithme au niveau approprié.

La performance de cet algorithme est validée par la résolution de plusieurs problèmes de taille différente générés aléatoirement. Afin de démontrer l'efficacité de notre méthode, les frontières de Pareto obtenues par NSGA II-MOSA sont évaluées selon trois métriques (qualité, espacement et diversification) en comparaison avec les frontières de Pareto obtenues par les deux méthodes NSGA II et MOSA appliquées sans hybridation. Le résultat montre la supériorité de NSGA II-MOSA. La figure 2 montre la configuration d'une même cellule à trois périodes successives.





## 5 Un modèle multi-objectif de configuration de cellules manufacturières dynamiques durables

### 5.1 Motivation et Contribution

L'objectif principal de cette troisième étude est de développer un modèle multi-objectif faisant un compromis entre les aspects économique, social et environnemental modélisés comme trois objectifs distincts en intégrant les deux modèles précédents. En plus, de toutes les contributions dans des modèles précédents développés dans cette thèse, le type de travailleurs (nous considérons qu'il existe deux types d'opérateurs, locaux et non-locaux, ayant des coûts différents) est pris en compte dans le recrutement et la procédure d'embauche et de licenciement des travailleurs.

En outre, comme dans la vie réelle, certains paramètres, tels que la demande, les coûts liés à la machine et la capacité en temps machine, sont considérés comme incertains. En raison du manque de connaissances sur les paramètres incertains, des nombres flous de forme triangulaire représentent la distribution de possibilités. La procédure de résolution en deux approches possibilistes de phase est mise en œuvre. La première phase fait face à l'incertitude du modèle proposé, une méthode possibiliste hybride (Jiménez and Arenas Parra) [132], [133] est développé et transformé en un modèle crisper (déterministe)

équivalente. Ensuite, une approche floue interactive est appliquée pour résoudre et trouver une solution de compromis.

## 5.2 Description du problème

Dans ce modèle, la première fonction objectif minimise les coûts pertinents, tels que les coûts fixes et variables des machines, de déplacements entre et à l'intérieur des cellules (intracellulaires), les coûts d'approvisionnement et les coûts de réinstallation, d'embauche, de licenciement, de formation et des salaires. La deuxième fonction objectif maximise les critères sociaux à savoir l'augmentation des possibilités d'emplois et de diminution des risques potentiels sur l'horizon de planification. Enfin, le troisième objectif représente le critère environnemental modélisé comme la minimisation du total des déchets de production causés par les machines sur l'horizon de planification.

La nature complexe et les interdépendances entre les critères sociaux les rendent difficiles à modéliser et à mesurer. Cette étude sélectionne et extrait les questions sociales de l'ISO 26000 [107] et de GRI 2011 [108] qui sont étroitement liées aux DCMS et peuvent être suffisamment simplifiées pour être calculables dans un modèle mathématique. En conséquence, nous sélectionnons (i) le nombre de possibilités d'emplois créées, (ii) le nombre de dangers potentiels des machines et (iii) les pertes totales des machines (gaspillages de production) au cours de l'horizon de planification comme mesure environnementale. Le premier enjeu social est représenté par la variation des possibilités d'emplois créées en raison d'embauches et de licenciements et résultant en l'achat ou la vente de machines. Le deuxième enjeu mesure la moyenne des dangers potentiels de chaque machine, en termes de nombre de blessures, de maladies et de dommages que chaque machine provoque selon des critères ergonomiques. Cette valeur est un nombre continu entre 0 (le plus sûr) et 1 (le plus dangereux) et peut être choisi par les décideurs. Pour quantifier cet objectif, le décideur peut utiliser une liste de vérification de sécurité, parler aux travailleurs, étudier les informations du fabricant et vérifier les blessures et les rapports d'incidents de chaque machine. En raison de différences dans les unités de mesure des critères sociaux considérés dans notre deuxième objectif, une méthode de pondération normalisée a été appliquée afin de les agréger en un seul objectif [112], [113]. Enfin, comme troisième objectif, plusieurs gaspillages reflètent les pertes de la capacité de chaque machine pour traiter chaque opération. Cette mesure peut inclure plusieurs aspects, tels que les gaspillages d'énergie, chimiques et en matières premières, les émissions de gaz à effet de serre, etc.

D'autres hypothèses pour la modélisation mathématique sont :

- Chaque pièce à une gamme d'opérations et doit être traitée selon la séquence définie.
- La demande de chaque type de pièces à chaque période est un nombre flou.
- La capacité de chaque machine pour traiter chaque type de pièces est connue. La capacité en temps de chaque machine est également un nombre flou.
- Le coût fixe de chaque machine est indépendant de la charge de travail assigné. Ce coût est considéré pour chaque machine, même quand elle n'est pas utilisée dans l'horizon de planification, et comprend les coûts de maintenance et de services généraux totaux. Ce coût est supposé un nombre flou.
- Le coût variable de chaque machine comprend les coûts d'exploitation et dépend de la charge de travail associée à chaque machine. Ce paramètre du problème est un nombre flou dans chaque période.
- Le coût d'achat et le prix de vente de chaque machine dans chaque période sont considérés comme des nombres flous et comprennent les prix des machines et des frais de transport. Cela signifie que les frais de déménagement entre les lieux de stockage et d'installation ne sont pas considérés.
- Le coût de relocalisation (désinstallation, déplacement et installation) de chaque type de machines entre deux périodes est un paramètre constant.
- Chaque type de machines peut traiter plusieurs opérations. En d'autres termes, chaque traitement de pièces peut être effectué sur différents types de machines avec divers temps de traitement.
- Les limites supérieures et inférieures du nombre de cellules sont connues et fixes dans toutes les périodes.
- Les mouvements inter/intra de pièces sont réalisés en lots de différentes tailles et le coût de ces mouvements est fonction de la distance de déplacement. Afin de diminuer la complexité du problème, nous supposons que la distance entre deux cellules adjacentes (inter) est la même. De même, dans chaque cellule, la distance entre deux machines adjacentes (mouvements intra) est la même. En outre, l'espace alloué à chaque machine est le même. Il serait possible d'omettre cette hypothèse et d'examiner la distance réelle entre deux machines ou cellules (euclidiennes ou à distance discrète), mais la complexité du problème serait augmentée.
- L'affectation des travailleurs se fait en fonction du niveau de compétences des travailleurs et leur niveau requis en compétence par la machine. En d'autres termes, chaque type de machines est classé dans

un niveau unique de compétence et chaque niveau à besoin d'un niveau minimal de compétence des travailleurs. Par exemple, le travailleur affecté au niveau de compétences machine 2 doit être au moins de niveau de compétence 2 (un travailleur au niveau de qualification 2 peut travailler avec une machine aux niveaux de compétences 2 et 1 et un travailleur avec le niveau de compétence 1 ne peut que travailler avec une machine de niveau de compétence 1).

- Deux types de travailleurs locaux et non-locaux sont considérés qui ont des coûts différents.
- Le niveau de compétence d'un employé peut être amélioré par un processus de formation qui a un coût.

### 5.3 Formulation mathématique

La première fonction objectif minimise les coûts totaux et comprend les éléments suivants : (i) les coûts fixes des machines, (ii) les coûts variables des machines, (iii) les coûts des mouvements de pièces entre les cellules (intercellulaires), (iv) les coûts des mouvements de pièces à l'intérieur des cellules (intracellulaires), (v) les salaires, (vi) le coût de relocalisation des machines, (vii) le coût d'acquisition des machines, (viii) les recettes provenant de la vente des machines et (ix) les coûts d'embauche, de licenciement et de formation. La deuxième fonction objectif maximise la valeur agrégée des critères sociaux durant l'horizon de la planification, incluant la maximisation de création d'emplois et la minimisation du risque potentiel des machines. La troisième fonction objectif considère la minimisation du gaspillage de production comme les gaspillages d'énergie, chimiques et en matières premières, les émissions de gaz à effet de serre, etc.

Les contraintes de notre problème sont :

1. S'assurer que les pièces sont traitées conformément à la planification et les gammes opératoires nécessaires.
2. S'assurer que l'opération de chaque pièce est attribuée aux machines qui peuvent le faire.
3. Garantir que la capacité en temps de chaque machine ne soit pas dépassée.
4. Garantir l'équilibre entre deux périodes consécutives en termes de nombre de machines respectivement attribuées à chaque cellule et le nombre de machines achetées ou vendues pour chaque type de machines.
5. Déterminer les tailles maximale et minimale des cellules selon leurs bornes supérieure et inférieure.

6. Contrôler que chaque travailleur dispose d'un niveau unique de compétence et soit affecté aux opérations d'un niveau unique de compétence de la machine.
7. Garantir que le nombre de travailleurs disponibles sont suffisant pour chaque niveau de compétence de la machine à chaque quart de travail.
8. Appliquer des règles concernant les travailleurs dont les niveaux de compétences sont compatibles avec le niveau de compétence requis de la machine.
9. Garantir l'équilibre du travail entre les périodes et les quarts de travail consécutifs.
10. Contrôler que le nombre de travailleurs disponibles est suffisant pour faire fonctionner des machines pour chaque cellule et chaque type de machines.
11. Assurer que le nombre de licenciements de travailleurs nouvellement formés pour le niveau de compétence  $\alpha$  ne soit pas dépassé.

#### 5.4 Méthode de résolution

Le modèle mathématique non linéaire est transformé en modèle linéaire. Ensuite, afin de traiter les paramètres incertains, une approche floue possibiliste a été développée pour transformer le modèle mathématique flou en un modèle équivalent déterministe auxiliaire. Puis, une approche floue efficace a été appliquée pour trouver des solutions de compromis en fonction des priorités du décideur. L'analyse de sensibilité est également faite pour illustrer l'applicabilité de l'approche de résolution proposée dans le traitement des paramètres incertains.

## 6 Vers une approche d'optimisation-simulation pour la configuration de DCMS

Nous avons enfin investigué une approche en deux phases de simulation-optimisation pour trouver un ensemble de solutions et les classer en fonction de la méthode multicritère « *Data Envelopment Analysis* » (DEA). La figure 3 illustre les différentes étapes de cette approche.

Le modèle mathématique proposé dans le chapitre 4 dont nous venons de voir le résumé est appliquée pour la phase d'optimisation. Par conséquent, les questions économiques, sociales et environnementales sont les mêmes que celles expliquées à la section 4.3. Dans la suite, chaque phase de l'approche proposée est décrite.

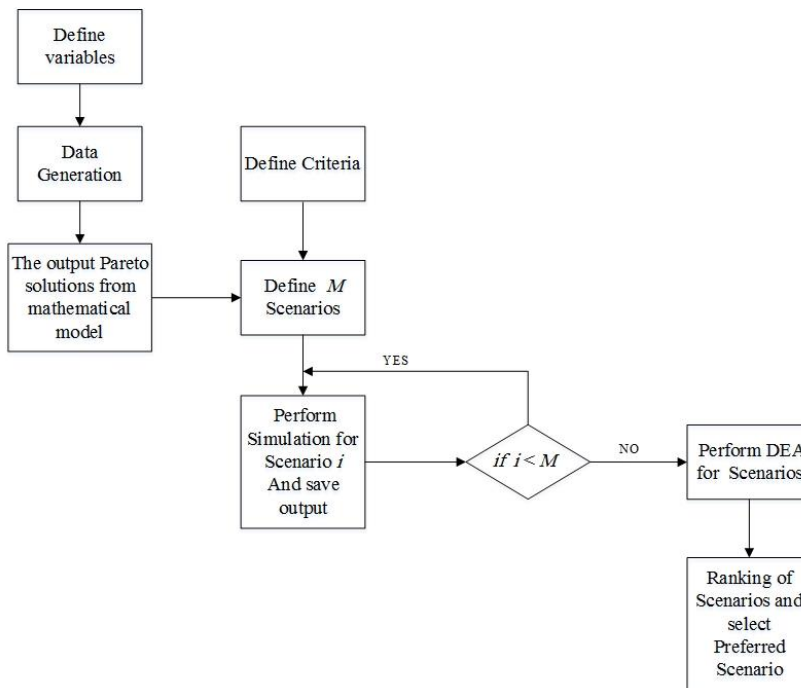


Figure 3 Schéma de l'approche d'optimisation-simulation

### 6.1 Phase 1 : Optimisation

Comme expliqué au chapitre 4, le problème présenté a été mentionnée comme un modèle d'optimisation NP-difficile. Afin de faire face à sa complexité, un modèle hybride d'un algorithme génétique à tri non-dominé et d'un algorithme de recuit simulé multi-objectif (NSGA II-MOSA) est appliqué, comme avant et qui va être détaillé dans le chapitre 3. La frontière de Pareto optimale en sortie de cette phase est utilisée comme entrée de la deuxième phase (simulation).

### 6.2 Phase 2 : Simulation

La simulation est une approche appropriée pour enquêter sur le comportement du système par rapport aux données d'entrée, l'analyse de scénarii et l'étude prédictive. Un modèle de simulation permet de mieux faire face aux phénomènes incertains existant dans le système et de rendre plus facile à analyser la performance du système par rapport à sa complexité. Ces caractéristiques font de la simulation l'un des outils les plus populaires dans la conception de systèmes de production et fournissent des informations tangibles sur le système pour les gestionnaires. La conception de systèmes de fabrication, en particulier les problèmes de formation des cellules manufacturières, ont un

grand nombre de variables et beaucoup d'hétérogénéité dans leur espace de recherche. Par conséquent, l'approche d'optimisation mathématique peut ne pas être suffisante pour analyser et mesurer la performance du système.

Dans cette phase, un modèle de simulation à événements discrets est proposé pour chaque ensemble de solutions de Pareto atteint dans la phase d'optimisation. En d'autres termes, chaque solution de la frontière de Pareto fait l'objet d'un scénario. En conséquence, la phase d'optimisation fonctionne comme fractionnement de scénarii pour réduire leur nombre. La simulation est effectuée pour tous les scénarii et plusieurs critères sont considérés, à savoir :

- *Coût total* : Coûts fixes et variables d'investissement et d'exploitation des machines, des mouvements inter et intracellulaires, d'approvisionnement et de réglage des machines, de salaire des opérateurs et d'embauche, de licenciements et de formation.
- *Enjeux sociaux* : Maximisation du nombre de possibilités d'emplois et minimisation des risques d'accidents du travail.
- *Total des gaspillages de production* : Gaspillages d'énergie, rejet de déchets chimiques, déchets de matières premières, etc.
- *Longueur moyenne de la file d'attente pour chaque machine.*
- *Pourcentage moyen du temps d'inactivité de chaque machine.*
- *Temps moyen de Service (TIS) des pièces.*

En raison de différentes unités et natures des critères, nous avons appliqué la méthode multicritère « Data Envelopment Analysis » (DEA) pour classer et choisir le meilleur scénario.

L'approche proposée nous permet de considérer des questions plus pratiques, qui ne sont pas prises en compte par le modèle mathématique (via les trois derniers critères). Cela peut aider le décideur à identifier la solution avec un degré plus élevé de fiabilité.

## 7 Conclusion et perspectives

Cette thèse étudie la possibilité d'intégrer des questions durables dans la conception et la configuration de systèmes de fabrication cellulaires dynamiques (DCMS). A cet effet, trois modèles mathématiques (*cf.* chapitres deux, trois et quatre) sont développés. Une tentative est faite pour développer différents modèles selon les besoins et les exigences de décideurs du monde réel dans chaque chapitre, tandis que les modèles présentés sont encore ouverts pour intégrer plus de critères et contraintes.

Du point de vue de l'applicabilité, le premier modèle est adapté aux entreprises manufacturières qui font face à un haut degré de variation dans les produits, tels que les industries de haute technologie. Le modèle présenté permet aux gestionnaires d'envisager l'ergonomie et la sécurité des travailleurs, en plus des

coûts de production et du salaire des travailleurs. En outre, ce modèle permet aux gestionnaires de prendre des décisions solides malgré l'imprévisibilité des paramètres de production. Les résultats de cette étude ont été présentés à la conférence internationale APMS 2014 (*Advances in Production Management Systems*) [148] et ont été acceptés pour publication dans *Journal of Applied Mathematical Modeling* [149].

Du point de vue de l'applicabilité, le second modèle peut être utilisé pour les industries qui produisent des produits à cycle de vie court. Ce modèle permet aux fabricants à prendre des décisions qui sont plus précises concernant l'exploitation des ressources, la gestion de l'énergie, les déchets de matériaux, l'émission de bruit, etc. Les résultats de cette étude ont été présentés à la conférence internationale IEEM 2014 (*IEEE International Conference on Industrial Engineering and Engineering Management*) [150] où il a reçu un prix de mention Honorable. En outre, cette contribution a été acceptée pour publication dans *Journal of Manufacturing Systems* [151].

Du point de vue de l'applicabilité, le troisième modèle augmente la capacité des gestionnaires à accorder plus d'attention à l'aspect des ressources humaines telles que l'augmentation de l'offre d'emplois pour les travailleurs locaux, favorisant de ce fait l'économie local et la réduction de gaz à effet de serre par la réduction de transport des travailleurs. De plus, l'accent est mis sur la formation des travailleurs au lieu de leur licenciement, favorisant ainsi la motivation de personnel. En outre, le modèle présenté considère non seulement l'incertitude dans les paramètres de production, mais fournit également une décision de compromis selon les préférences de décideurs. Les résultats de cette étude ont été présentés à la conférence internationale de IMSS14-CIE44 (*9<sup>th</sup> international symposium on Intelligent Manufacturing and Service Systems & 44<sup>th</sup> international conference on Computers and Industrial Engineering*) [152].

Enfin, une tentative de couplage optimisation-simulation est proposée pour extraire des informations qui sont absentes de la méthode de modélisation et d'optimisation mathématique (longueur de la file d'attente, le temps d'inactivité et de temps de service). L'approche proposée peut être plus attrayante pour les décideurs industriels en raison de la visibilité et de l'interface graphique qui affiche le fonctionnement du système et la facilité d'analyse.

Les travaux présentés dans cette thèse ont permis d'intégrer les concepts de développement durable dans les problèmes de configuration de DCMS, mais peuvent être appliqués à d'autres types de systèmes de fabrication. Par ailleurs,



les modèles présentés sont suffisamment ouverts pour incorporer d'autres spécificités et caractéristiques importantes des DCMS telles que le routage de l'équipement de manutention, de ramassage et de dépôt des produits dans des stocks tampons pour chaque cellule, beaucoup fractionnement, les exigences de contiguïté de la machine, etc. Une autre extension de la recherche actuelle peut être la prise en compte d'autres critères sociaux, telles que les problèmes ergonomiques, les maladies professionnelles, les jours de travail perdus pour cause de blessure, etc.

En outre, d'autres attributs tels que le taux de flexibilité et d'agilité, peuvent être concernés dans le problème configuration des DCMS pour améliorer la prise de décision des gestionnaires. La présence des équipements mobiles et/ou de robots mobiles, qui apparaissent progressivement dans les systèmes de production, pourrait également être considérée dans les problèmes de configuration de cellules manufacturières.