



HAL
open science

Study of the role of estrogen receptor variant, ERa36, in non genomic signaling and breast cancer

Soleilmane Omarjee

► **To cite this version:**

Soleilmane Omarjee. Study of the role of estrogen receptor variant, ERa36, in non genomic signaling and breast cancer. Cancer. Université de Lyon, 2016. English. NNT : 2016LYSE1041 . tel-01379002

HAL Id: tel-01379002

<https://theses.hal.science/tel-01379002>

Submitted on 11 Oct 2016

HAL is a multi-disciplinary open access archive for the deposit and dissemination of scientific research documents, whether they are published or not. The documents may come from teaching and research institutions in France or abroad, or from public or private research centers.

L'archive ouverte pluridisciplinaire **HAL**, est destinée au dépôt et à la diffusion de documents scientifiques de niveau recherche, publiés ou non, émanant des établissements d'enseignement et de recherche français ou étrangers, des laboratoires publics ou privés.

THESE DE L'UNIVERSITE DE LYON

Délivrée par
L'UNIVERSITE CLAUDE BERNARD LYON 1
ECOLE DOCTORALE EDBMIC
DIPLOME DE DOCTORAT

Soutenue publiquement le 7 avril 2016

OMARJEE Soleilmane

**ETUDE DU ROLE DU RECEPTEUR ER α -36
DANS LA SIGNALISATION NON GENOMIQUE
DES OESTROGENES**

Directrice de thèse: Muriel Le Romancer

JURY

M. Germain GILLET, Professeur Université, Lyon 1.

M. Jason CARROLL, Principal Investigator, Cancer Research UK.

M. Filippo ACCONCIA, Associate Professor, Università Degli Studi Roma Tre.

Mme. Cecile ROCHETTE-EGLY, Directrice de Recherche, INSERM.

Mme. Muriel LE ROMANCER, Directrice de Recherche, INSERM.

UNIVERSITE CLAUDE BERNARD - LYON 1

Président de l'Université

Vice-président du Conseil d'Administration

Vice-président du Conseil des Etudes et de la Vie Universitaire

Vice-président du Conseil Scientifique

Directeur Général des Services

M. François-Noël GILLY

M. le Professeur Hamda BEN HADID

M. le Professeur Philippe LALLE

M. le Professeur Germain GILLET

M. Alain HELLEU

COMPOSANTES SANTE

Faculté de Médecine Lyon Est – Claude Bernard

Directeur : M. le Professeur J. ETIENNE

Faculté de Médecine et de Maïeutique Lyon Sud – Charles Mérieux

Directeur : Mme la Professeure C. BURILLON

Faculté d'Odontologie

Directeur : M. le Professeur D. BOURGEOIS

Institut des Sciences Pharmaceutiques et Biologiques

Directeur : Mme la Professeure C. VINCIGUERRA

Institut des Sciences et Techniques de la Réadaptation

Directeur : M. le Professeur Y. MATILLON

Département de formation et Centre de Recherche en Biologie Humaine

Directeur : Mme. la Professeure A-M. SCHOTT

COMPOSANTES ET DEPARTEMENTS DE SCIENCES ET TECHNOLOGIE

Faculté des Sciences et Technologies

Directeur : M. F. DE MARCHI

Département Biologie

Directeur : M. le Professeur F. FLEURY

Département Chimie Biochimie

Directeur : Mme Caroline FELIX

Département GEP

Directeur : M. Hassan HAMMOURI

Département Informatique

Directeur : M. le Professeur S. AKKOUCHE

Département Mathématiques

Directeur : M. le Professeur Georges TOMANOV

Département Mécanique

Directeur : M. le Professeur H. BEN HADID

Département Physique

Directeur : M. Jean-Claude PLENET

UFR Sciences et Techniques des Activités Physiques et Sportives

Directeur : M. Y. VANPOULLE

Observatoire des Sciences de l'Univers de Lyon

Directeur : M. B. GUIDERDONI

Polytech Lyon

Directeur : M. P. FOURNIER

Ecole Supérieure de Chimie Physique Electronique

Directeur : M. G. PIGNAULT

Institut Universitaire de Technologie de Lyon 1

Directeur : M. le Professeur C. VITON

Ecole Supérieure du Professorat et de l'Education

Directeur : M. le Professeur A. MOUGNIOTTE

Institut de Science Financière et d'Assurances

Directeur : M. N. LEBOISNE

ACKNOWLEDGEMENTS

I wish to thank Dr. Acconcia and Dr. Rochette-Egly for their acceptance to be on my board of reviewers and to have taken the time to go through my manuscript. I wish to thank Pr. Gillet for his acceptance to preside my PhD jury. I would like to express my gratitude to Dr. Carroll for having made it to my thesis and to honor me as an examiner of my thesis work.

I wish to thank our director, Pr. Alain Puisieux for his welcome into the Cancer research Centre of Lyon and the exchanges we had the opportunity to have on the numerous council meetings.

I wish to thank Dr. Laura Corbo for her warm welcome into her team during my master's internship. Thank you for your encouragements and, needless to say, all your extraordinary scientific advice that appeared in milliseconds. These guided me all throughout my thesis and I wish to thank you for putting up with me every time I disturbed you in your office to ask for scientific advice.

To Dr. Muriel Le Romancer, I still remember how eager I was to come and join your team to work on ER α -36. The first thing that really impressed me was your truly dynamic nature, as well as your human and almost motherly way of directing your team. Thank you for your patience and I am so grateful for everything you brought me and the trust you put in me. Thanks for all the great times we have spent together and the times to come. And yes, the paper is finished and sent!!

I wish to acknowledge the help of Dr. Vanacker and Dr. Dutertre who accepted to be on my PhD follow up comitee and all the advice you gave me.

I have a very special thought for Dr. Isabelle Treilleux, our pathologist, for all her help during my thesis. Thanks for your involvement in every single ones of our project and your enthusiasm for our research. I also wish to thank former pathology technician Sophie Leon, and the current pathology girls, Amelie Colombe and Laetitia Odeyer

Thanks to all our collaborators for their precious help in the project, Elisabetta Marangoni, Natacha Rochel, Annick Dejaegere, Yasmine Chebaro.

I wish to thank Dr. Olivier Tredan for his participation in our work. I am very grateful to Dr Loay Kassem who carried out all our clinical analyses in a record time, as well as our collaborators at the statistics department, namely Emilie Lavergne and Sylvie Chabaud for their investment in our work.

I wish to thank Dr. Coralie Poulard for all the training she gave me during my M2 and her extremely useful advice. Thank you for everything you have taught me and for all your help with our projects even though you are no longer here. I wish you loads of success during you post-doc and we are definitely hoping to see you back real soon. In the same line, I wish to thank Dr. Juliette Rambaud, our former postdoc, for all her help, advice and for her immensely kind nature. We miss you both.

I have a special thought for Dr. Clement Chapat who helped me out on numerous occasions. Thanks for all your advice and we hope to see you back soon.

I wish to thank all team members of the new Le Romancer Team

Farida Nasri for all your solutions and buffers, as well as your constant good humor and your delicious pastries. Thanks for all the plasmids you prepared for me. I also wish to thank Cecile Languilaire, our lab technician, for all her technical help and hygiene and security advice.

I wish to thank Julien Jacquemetton alias 'Jack', our engineer, for all his precious help to finish the experiments for our project during the last rush hour. Thank you for all your microscopy skills and all your informatics advice.

I wish to thank my two previous trainees, Leon Guichard and Allison Voisin for their help on my project, as well as all our other team members. My thoughts go to Rana Ramouz, our lab technician/esthetician, we had loads of fun imitating your Iranian accent when you got here, thank you for always being present, I wish you all the best in your future career and loads of success in your personal life as well, you deserve it. I also wish to thank Ali Choucair, our PhD fellow from Lebanon with whom I shared a very special bond, thanks for all the invitations to taste some Lebanese specialities, and I wish him all the best with his wife and kid, and many other kids to come. I wish to thank Lucie Malbeteau for always being present to ease out our stress, don't worry the cells will grow and I'm confident you will do a great thesis. I wish to thank Hanine Lattouf, our other Lebanese student, for all the fun times we have had together, whether it be pinky and the brain out to do some vector digestion or some protein production, I wish you the best of luck with your LKB1 project and if there's one piece of advice I have to give you, it's definitely to lay down the timer and come grab a drink. Thanks to our new members, Henri Philippe, and Dr. Chang with his two fellows Samuele and Romain.

From the other side of the facilities, I would like to thank Caterina Donini, Evelyne Grisard and Aurelie Bellanger for all the good moments we spent together. My gratitude also goes towards Hubert Lincet and Pascale Cohen for their advice and suggestions on our various meetings.

I have a very special thought for my two friends and lab mates, Adrien Nougarede and Flora Clement. Adrien I wish to thank you for all the great times we have spent together, be it major scientific exchanges, our discrete collaborations or our personal exchanges. Thanks for always being present to advice me and right after submitting this manuscript we are definitely going back to hit the gym bench. Thank you for all the free guitar lessons and your general good humour. To Flora, who incidentally is currently chilling out on the beaches of Noumea, I wish to convey my heartfelt gratitude for all the good times we have spent together in this lab and for all the relaxation sessions when things were sour or when my boss is squeezing the experiments out of me. Thank your for always being here to listen and all the pastry lessons. I

hope all three of us will make the most out of the time we have left to spend together.

I wish to thank Dr. Veronique Maguer Satta and her team for her excellent advice and our fruitful collaborations. I have a thought for her team members with whom we have a good time; Boris, Stephanie, Anais, Elodie and Florence. I also wish to thank Dr. Ruth Rimokh for her useful advice and support, as well as her team, Stephane, Rudy, Mathieu, Ivan, Philippe, Jonathan and Margaux.

I have a special thought for my former M2 colleagues and friends, Baptiste, Loic, Thomas, Rodrigo. Thanks for all the great times we have spent together and the ones to come.

I wish to thank the English and Biology department of the Lyon 1 University with which I have been able to teach and learn so much from. I am thinking of Dr. Dominique Baas and Dr. Dominique Leguellec. Thank you for all the trust you invested in me and for giving me the passion to teach.

Many people in my personal life helped me make it to here,

I wish to thank my friend Julien and his family, Didier and Lucette, for all their help and kindness since my first years in France. I hope to see you guys very soon.

I wish to express my sincerest acknowledgements to my partner, Manon. Thank you for all your support, understanding and encouragements, the last months haven't been quite easy but we'll make that up as soon as this manuscript is away. Thank you for all you do for me. I also wish to thank her parents, Christophe for his advice and excellent culinary skills, and Scarlett for all the holidays and support.

I wish to express my heartfelt gratitude to my family, who were always here when I needed their support. I wish to thank my mum for all she has done and her continuous support daily skype calls lately just to make sure I'm alright. I also wish to express my gratitude to my auntie Zeera, without whom I definitely wouldn't have made it till here. Thank you for your ongoing support through all these years and I will see you soon in Cambridge. I also wish to thank my uncle Jim and his family from Birmingham for all the good times we spent together.

I have a very special thought for my brother Ommar, whose arrival here completely changed the way I felt about living here alone, thanks for all your help and all the cooking you've been doing lately. Last but not least, I cannot help but remember my father, whose absence is felt every passing day, and to whom I wish to dedicate this thesis.

Finally I wish to acknowledge the financial support of the Rhone Alpes Region and the Ligue Contre le Cancer for my PhD grants.

S.O

PUBLICATIONS & COMMUNICATIONS

Publications:

The molecular mechanisms underlying the ER α -36-mediated signaling in breast cancer. *Soleilmane Omarjee, Julien Jacquemetton, Coralie Poulard, Natacha Rochel, Annick Dejaegere, Yasmine Chebaro, Elisabetta Marangoni, Isabelle Treilleux, Laura Corbo, Muriel Le Romancer*

(Submitted to Nature Communications)

Analysis of HER2 genomic binding in breast cancer cells identifies a global role in direct gene regulation *Aisling M Redmond, Soleilmane Omarjee, Muriel Le Romancer, Jason S Carroll* (In Prep for Submission to Oncogene)

Identification and characterization of PRMT1 as a target for the treatment of breast cancer. (Authors include *Soleilmane Omarjee* and *Muriel Le Romancer*) (In Prep for Submission to Cancer Discovery)

Communications:

- September 2015 → **Poster** – EMBO Meeting: Nuclear Receptors From Molecules to Humans, Ajaccio.
- September 2015 → **Poster** - Cancer Research Centre of Lyon Scientific Day.
- July 2015 → **Poster** – ONCORIALS of the Lyon, Rhone Alpes and Auvergne Canceropole.
- April 2015 → **Poster** – Lyon, Rhone Alpes and Auvergne Canceropole Day.
- December 2014 → **Poster** – Lyon East Federative Research Structure Scientific Day.
- December 2014 → **Short Talk** – UCBL PhD Student Day.
- December 2014 → **Poster** – San Antonio Breast Cancer Symposium.
- September 2014 → **Short Talk** – Rhone Alpes Region Scientific Day
- May 2014 → **Short Talk** – Nuclear Receptor Meeting, Strasbourg.
- March 2014 → **Short Talk** – Cancer Research Centre of Lyon Scientific Day
- September 2013 → **Poster** – Lyon East Federative Research Structure Scientific Day.
- September 2013 → **Poster** – Rhone Alpes Region Scientific Day
- August 2013 → **Short Talk & Poster** – FEBS Advanced Lecture Course on Nuclear Receptor Signalling in Physiology and Disease, Greece.]

Table of Contents

List of Tables and Figures	Page 12
INTRODUCTION	Page 14
Chapter 1 – Breast Cancer	Page 15
1. Prevalence	Page 15
2. The Mammary Gland	Page 17
A. Anatomy of the mammary gland	Page 17
I. The Epithelial Compartment	Page 17
II. The Mesenchymal Compartment	Page 18
B. Development of the Mammary Gland	Page 18
3. Breast Cancer	Page 18
A. Histological Criteria	Page 19
B. Anatomic-pathological Criteria	Page 19
I. TNM Tumor Classification	Page 20
II. The Scarff, Bloom and Richardson Histoprognostic Grade	Page 22
C. Molecular Criteria	Page 23
I. Hormonal receptors	Page 24
a. Estrogen receptor	Page 24
b. Progesterone receptor	Page 24
II. HER2 receptors	Page 25
III. Ki67 antigen	Page 25
D. Transcriptome Analysis	Page 26
4. Origins of Breast Cancer	Page 27
A. Genetic Factors	Page 27
B. Environmental Factors and Lifestyle	Page 27
I. Ionizing Radiation	Page 27
II. Obesity, Breast Density and Size	Page 27
III. Physical Activity	Page 28
IV. Smoking and Alcohol	Page 28
C. Reproduction and Hormonal Changes	Page 28
D. Breast Cancer Stem Cells	Page 29
Chapter 2 – Estrogen Receptors	Page 30

1. Estrogens.....	Page 30
A. Synthesis and metabolism.....	Page 30
B. The Menstrual Cycle.....	Page 31
2. The Estrogen Receptor.....	Page 34
A. Structure of Estrogen Receptors.....	Page 34
I. Genomic Structure.....	Page 34
II. Protein Structure.....	Page 35
B. Isoforms of Estrogen Receptors.....	Page 36
C. Action of Estrogen Receptors.....	Page 37
I. Inactive, ligand unbounded ER α	Page 38
II. The Genomic Pathway of ER α	Page 39
a. The classical pathway.....	Page 39
b. The non-classical pathway.....	Page 41
c. The ligand-independent pathway.....	Page 41
d. Estrogen receptors on the genome.....	Page 42
D. ER α non-genomic pathway.....	Page 42
I. The nature of the receptor.....	Page 42
a. Conventional ER α	Page 42
b. GPR30.....	Page 43
c. ER α splice variants.....	Page 43
II. Protein Complexes.....	Page 43
a. The ER α /Src/PI3K complex.....	Page 43
b. P130 ^{Cas}	Page 44
c. MNAR.....	Page 44
III. Effects of the non-genomic pathway.....	Page 44
a. The MAPK Pathway.....	Page 44
b. The PI3K/Akt Pathway.....	Page 44
E. Post-Translational Modifications of ER α	Page 45
I. PTM Regulating the genomic pathway.....	Page 46
a. Phosphorylation.....	Page 46
b. Acetylation.....	Page 46
c. Ubiquitination.....	Page 46
d. Sumoylation.....	Page 46
e. Methylation.....	Page 46
II. PTM regulating the non-genomic pathway.....	Page 48
III. PTM deregulated in breast cancer.....	Page 48

a. Serine 118.....	Page 48
b. Serine 167.....	Page 48
c. Arginine 260.....	Page 49
d. Lysine 303.....	Page 49
e. Serine 305.....	Page 49
Chapter 3 – ERα-36	Page 50
1. Chromosomal Disposition and Generation.....	Page 50
2. Regulation of Expression.....	Page 51
A. Promoter Organization.....	Page 51
B. Transregulatory Elements.....	Page 52
I. ER α	Page 52
II. WT1.....	Page 52
III. EGFR.....	Page 52
IV. HER2.....	Page 52
V. Bone Morphogenetic Protein 2.....	Page 52
C. Action of Molecules.....	Page 52
3. Cellular Localization.....	Page 53
A. Potential Myristoylation of ER α -36.....	Page 54
B. Interaction with GP96.....	Page 54
4. Ligand Binding Properties.....	Page 54
5. Signaling Pathways of ER α -36.....	Page 55
A. The Src Pathway.....	Page 56
B. The PI3K/Akt Pathway.....	Page 56
C. The EGFR Pathway.....	Page 56
D. The PKC Pathway.....	Page 56
E. The ERK Pathway.....	Page 57
F. Involvement of Synuclein Gamma.....	Page 57
G. Cyclin D1.....	Page 57
H. C-MYC Induction.....	Page 57
I. JNK Pathway.....	Page 58
J. Biphasic Ligand Effects.....	Page 58
6. Physiological Consequences.....	Page 58
A. Proliferation.....	Page 58
B. Stemness.....	Page 58
C. Neuroprotective Effect.....	Page 59
D. Apoptosis.....	Page 59

E. Migration and Invasiveness.....	Page 59
F. Anti-inflammatory action.....	Page 59
7. Involvement in Cancer.....	Page 60
A. Breast Cancer.....	Page 60
B. Gastric Cancer.....	Page 60
C. Lung Adenocarcinoma.....	Page 61
D. Renal Cell Carcinoma.....	Page 61
E. Colorectal Cancer.....	Page 61
Chapter 4 – Breast Cancer Therapies and Resistance Mechanisms	Page 62
1. Breast Cancer Treatments.....	Page 62
A. Surgery.....	Page 62
B. Radiotherapy.....	Page 62
C. Chemotherapy.....	Page 62
D. Targeted Therapies.....	Page 63
I. Hormonotherapy.....	Page 63
a. Anti-Estrogens.....	Page 63
b. Anti-Aromatases.....	Page 63
II. mTOR Pathway Inhibitors.....	Page 64
III. Humanized Monoclonal Antibodies.....	Page 66
a. HER2.....	Page 66
b. VEGF.....	Page 67
2. Tumor Resistance to Treatment.....	Page 67
A. Hormonotherapy Resistance.....	Page 67
I. Growth Factor Signaling.....	Page 67
II. ER α	Page 68
a. Loss of Expression.....	Page 68
b. Mutations on ER α	Page 68
c. Co-Regulators.....	Page 69
III. Other isoforms.....	Page 69
a. ERB.....	Page 69
b. ER α -36.....	Page 69
IV. Pharmacokinetics.....	Page 69
B. Resistance to mTOR Inhibitors.....	Page 70
C. Trastuzumab Resistance.....	Page 70
Chapter 5 – The MAPK Signaling Pathway	Page 71
1. Generalities.....	Page 71

2. The ERK Pathway.....	Page 72
A. Molecular Actors of the Ras/MAPK pathway.....	Page 73
I. Tyrosine Kinase Receptors.....	Page 73
II. Ras and regulators.....	Page 73
a. The Ras Superfamily.....	Page 73
b. Structure and Function of Ras.....	Page 74
c. Ras activation.....	Page 74
III. The Raf MAPKKK.....	Page 75
IV. The Mek-1 and Mek-2 MAPKK.....	Page 76
V. The ERK-1 and ERK-2 MAPK.....	Page 76
a. Activation and Targets.....	Page 76
b. Distinct effects of ERK1 and ERK2.....	Page 77
B. Negative regulation of ERK.....	Page 77
3. Interactions in the MAPK Pathway.....	Page 78
A. D-Domains.....	Page 78
B. DEF Domains.....	Page 79
C. CD Domains.....	Page 79
4. Involvement in Breast Cancer.....	Page 79
A. Involvement in tamoxifen resistance.....	Page 79
B. Involvement in chemotherapy resistance.....	Page 80
 RESULTS	Page 81
1. ER α -36 and the non-genomic pathway.....	Page 82
2. ER α -36 expression in breast tumors.....	Page 92
 CONCLUSION AND PERSPECTIVES	Page 101
 REFERENCES.....	Page 105

List of Figures and Tables

Figure 1	<i>Incidence and mortality of breast cancer throughout Europe.....</i>	Page 15
Figure 2	<i>Estimated incidence and mortality related to breast cancer in France.....</i>	Page 16
Figure 3	<i>Anatomy of the mammary gland in sagittal section.....</i>	Page 17
Figure 4	<i>Schematic representation of a mammary gland cross section.....</i>	Page 17
Figure 5	<i>Adenocarcinomas.....</i>	Page 19
Figure 6	<i>Representation of tumor cells in a histology section.....</i>	Page 22
Figure 7	<i>Model of ER and PR cross-regulation for DNA binding.....</i>	Page 24
Figure 8	<i>Brief overview of the HER2 Signaling Pathway.....</i>	Page 25
Figure 9	<i>Normal and tumoral mammary differentiation and resulting metastasis.....</i>	Page 29
Figure 10	<i>Biosynthesis of the major steroid hormones.....</i>	Page 31
Figure 11	<i>The menstrual cycle.....</i>	Page 32
Figure 12	<i>Physiological effects of estrogens.....</i>	Page 33
Figure 13	<i>Genomic and protein arrangement of Estrogen Receptors.....</i>	Page 34
Figure 14	<i>Protein structures of some nuclear steroid receptors.....</i>	Page 35
Figure 15	<i>Structure of the DNA Binding domain of ER.....</i>	Page 35
Figure 16	<i>Isoforms of ER.....</i>	Page 37
Figure 17	<i>ER Signaling Pathways.....</i>	Page 38
Figure 18	<i>Post-Translational Modifications of ERα.....</i>	Page 45
Figure 19	<i>Chromosomal disposition of ERα-36.....</i>	Page 50
Figure 20	<i>Map of the 5' sequence flanking ERα-36 transcription start site.....</i>	Page 51
Figure 21	<i>Overview of the mTOR signaling pathway.....</i>	Page 65
Figure 22	<i>Classification of the MAPK signaling pathways.....</i>	Page 71
Figure 23	<i>Simplified overview of the ERK pathway.....</i>	Page 72
Figure 24	<i>The Ras-GTP/GDP cycle.....</i>	Page 74
Figure 25	<i>Simplified overview of the Proximity Ligation Assay Reaction.....</i>	Page 82
Figure 26	<i>Tamoxifen binding sites on ERα-36.....</i>	Page 84
Figure 27	<i>Tamoxifen mediated the formation of the ERα-36/Src and PI3K Complex..</i>	Page 85
Figure 28	<i>Tamoxifen induces ERK2/ERα-36 interaction and ERK phosphorylation...</i>	Page 85
Figure 29	<i>Growth of HBCc-12A cells under vehicle, estrogen or tamoxifen treatment</i>	Page 86
Figure 30	<i>ERα-36 interacts specifically with ERK2 and not with ERK1.....</i>	Page 87
Table 1	<i>Complete description of the TNM classification.....</i>	Page 20
Table 2	<i>Tumor Stages arising from the TNM classification.....</i>	Page 22
Table 3 & 4	<i>Grading scale for the SBR Classification.....</i>	Page 23
Table 5	<i>Modified residues of ERα and their functions.....</i>	Page 46
Table 6	<i>Clinico-Pathological Characteristics of the 160 patient cohort.....</i>	Page 94
Table 7	<i>Correlation between ERα-36 expression and clinico-pathological features</i>	Page 95
Table 8	<i>Death, relapse and metastatic events associated with ERα-36 expression</i>	Page 96

Preface

Breast cancer is a major cause of mortality in women. It is associated, in sporadic cases, with deregulation of signaling pathways within breast cells, which are essential for the maintenance of normal physiological functions. In this aspect, it becomes essential to define the role played by these actors. Breast cancer is mainly a hormone-dependent cancer, and the various actors involved in estrogen signaling can cause the deregulations observed in cancer cells.

Estrogen action mechanisms are quite complex. There exist a classical pathway where the hormone binds to its receptor and regulates gene transcription, and in parallel, a non-genomic pathway where estrogens induce more rapid effects in the cytoplasm, leading to the activation of signal transduction cascades.

ER α -36 is a new variant of the ER α , with a main cytoplasmic/membrane localization, which suggested its involvement in estrogen non-genomic pathway. Indeed ER α -36 has been shown to initiate non-genomic signaling under stimulation with estrogen, but also with clinical ER α antagonists such as tamoxifen or ICI 182,780. ER α -36 might therefore represent a new player in breast cancer and hormone therapy resistance.

My PhD project was, first, to dissect the molecular mechanisms associated with ER α -36 non genomic signaling, and then, to evaluate ER α -36 expression in cohorts of breast tumors to evaluate if its expression is correlated with clinical factors and whether it can constitute a new prognosis/predictive factor in breast cancer therapy.

My manuscript will present bibliographical data on 5 main axes, (i). Breast Cancer, (ii). The estrogen receptor, (iii). ER α -36, (iv). Breast cancer therapies and resistance mechanisms and finally, (v). The MAPK Signaling pathway. Results will then be presented and discussed. Finally I will give some conclusions and perspectives on my work.

INTRODUCTION

Chapter 1: Breast Cancer

1. Prevalence

Breast cancer is the most common breast pathology in women worldwide with about 1.7 million new cases diagnosed in 2012. It represents the second most common cancer overall. This means about 12% of all new cancer cases and 25% of all cancers in women (Figure 1).

In France, around 33% of all new cancer cases identify as breast cancers (Figure 2). It remains a major health problem. In 2012, there has been reported an estimate of 118 incidences breast cancers per 100,000 with a mortality rate of 23.7 per 100,000.

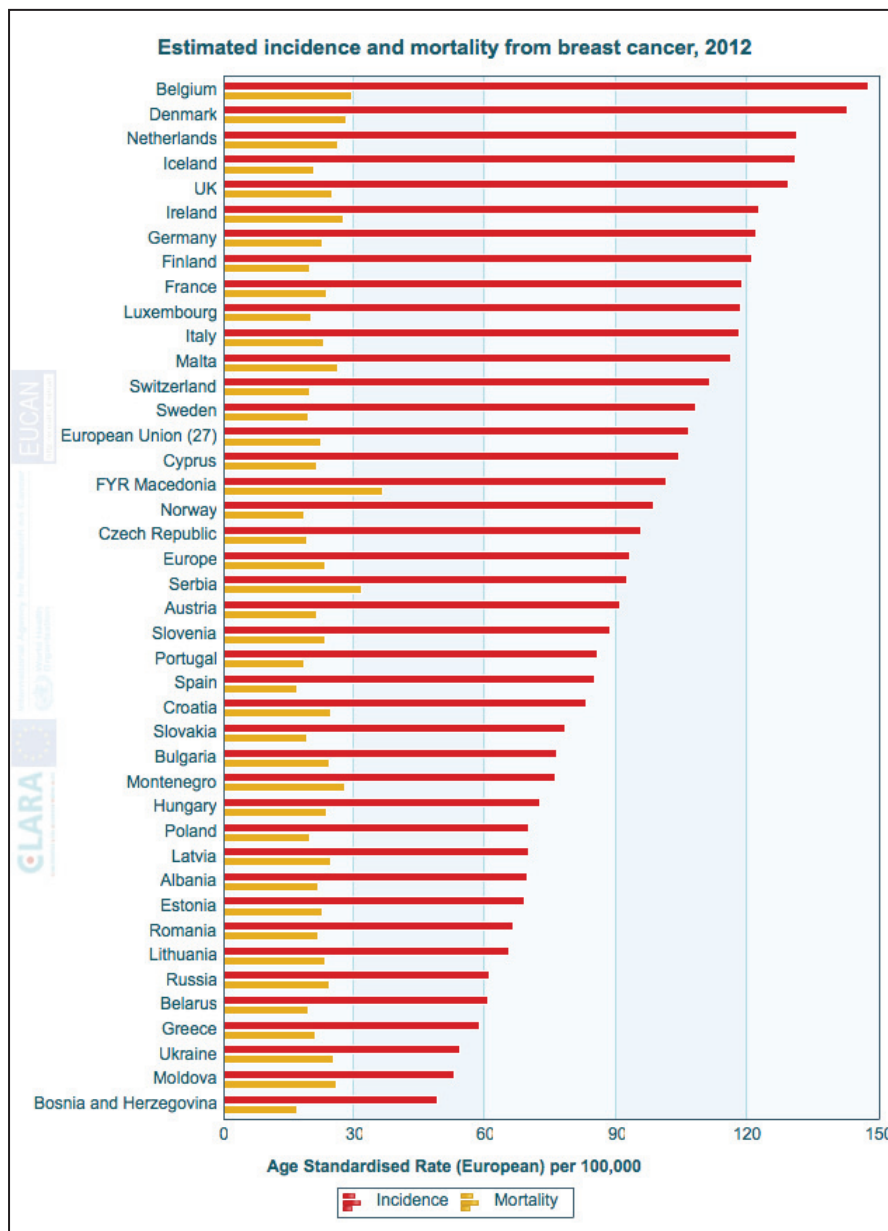

Figure 1: Incidence and mortality of breast cancer throughout Europe. (Source iarc.fr)

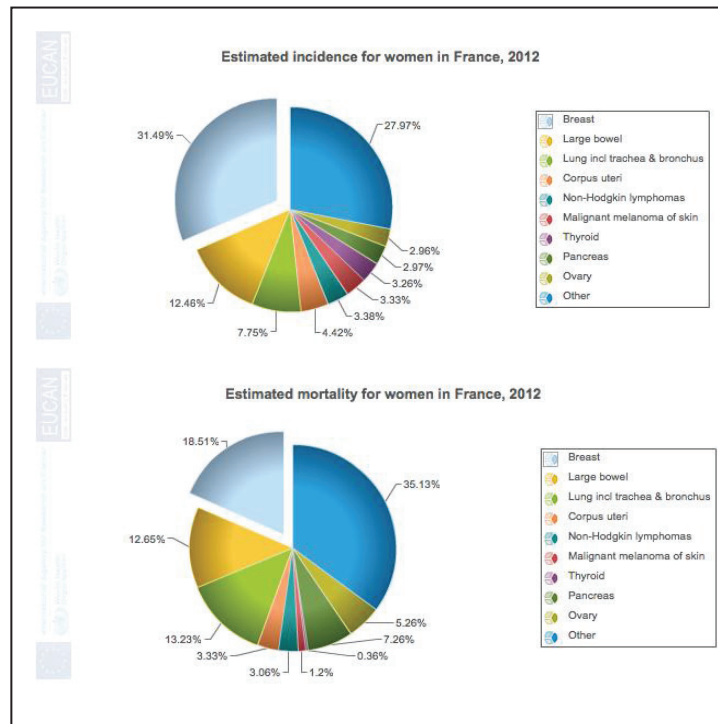

Figure 2: Estimated incidence and mortality related to breast cancer in France (Source iarc.fr)

Incidence of breast cancer in France has almost doubled between 1980 and 2005, while inversely breast cancer related mortality has undergone around a 13% decrease. This inverse tendency is mainly linked to major progresses being made in terms of early stage diagnosis and efficient treatments.

Detection of breast cancers is mainly carried out by mammography and is recommended every two years for women between 50 and 74 years of age. Magnetic Resonance Imaging (MRI) can also be used but on a much smaller scale due to costs and result interpretation. Estimates say that a tumor can be detected as early as two years before a woman feels any abnormal growth. Of a rarer occurrence (less than 15% of breast cancers), breast cancer can also appear in men and has mainly genetic origins.

2. The Mammary Gland

A. Anatomy of the mammary gland

The mammary gland is characterized by its main exocrine function for milk production for new-borns. It is made up of an epithelial and a mesenchymal (stromal) compartment (Figure 3).

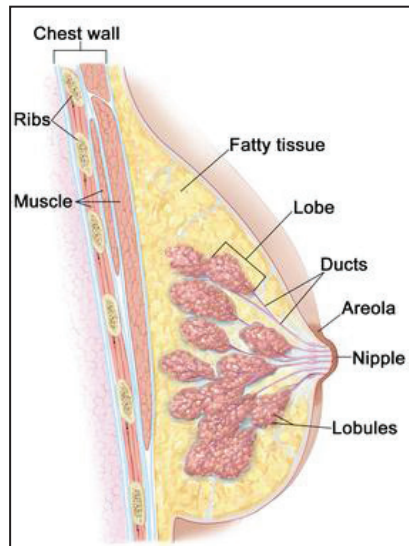

Figure 3: Anatomy of the mammary gland in sagittal section

I. The Epithelial Compartment

The epithelial compartment consists of a network of lobules arranged in acini joined together by galactophorous canals. The lobules have a main role in milk production during breastfeeding while the canals transport the milk to the nipple (Figure 3). Lobules and canals are made up of two distinct cell types, luminal cells and myoepithelial cells (Figure 4). Luminal cells, as their name suggests, border the lumen of canals and lobules. Myoepithelial cells surround the luminal cells and are in direct contact with the basal membrane. (Hennighausen et al, 2005)

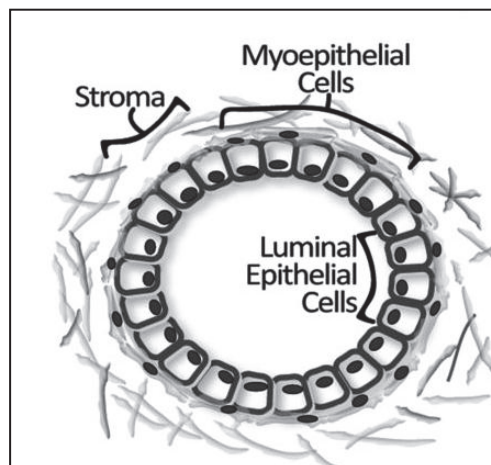

Figure 4: Schematic representation of a mammary gland cross section

Besides these cells, other cell types have been described such as stem and progenitor cells. These cells are mostly located in a basal position. The fate control of these bipotent cells towards either a luminal or a myoepithelial lineage depend on the microenvironment and transcription factors such as GATA-3 (Asselin-Labat et al., 2007).

II. The Mesenchymal Compartment

The breast stroma is composed of many cells types such as adipocytes, fibroblasts, nerve cells, as well as blood vessels and a lymphatic network draining in the axillary ganglions (Hennighausen and Robinson, 2005). This plays an important role in breast cancer where tumor cells can invade the lymphatic system and proliferate in ganglions representing the first step in metastasis. Also this represents a breast cancer prognostic factor (Weigelt et al., 2005).

B. Development of the mammary gland

Mammary gland development onsets during embryogenesis. This development is impeded and resumes in women on the onset of puberty with the development of lobules. Total breast development, however, occurs only by the time of the first birth giving.

The development of the mammary gland rests on numerous hormonal factors such as estrogen and progesterone. Estrogens mainly participate in mammary gland development at puberty by stimulating growth of galactophoric canals during the menstrual cycle. They also play a very important role during pregnancy. In the pregnant woman, estrogens and progesterone concentrations stimulate the proliferation of breast acini, which can triple their numbers.

Other factors such as EGF (Epidermal Growth Factor) and Prolactin can also influence breast development. In fact, in response to a decrease in estrogens and progesterone after birth, prolactin secreted by the pituitary gland induces the production of milk by breast acini. (McCave et al., 2010; Parmar and Cunha, 2004; Rudland et al., 1995)

3. Breast Cancer

Breast tumors account for a wide variety of cancers with distinct biological and morphological characteristics with varying types of progression and response to treatment (Rakha and Ellis, 2011). Breast cancer discovery arises from clinical symptoms such as pain and a detectable mass. Then follows a series of examinations (mammography, biopsy), which establishes the diagnostic. The histological examination allows the identification of an infiltrant breast cancer. Clinical treatment is proposed based on various prognostic and predictive factors and will help physicians decide whether to orient the treatment towards chemotherapy, radiotherapy or hormonotherapy. These prognostic factors are linked to the time of diagnosis, the histological grade of the tumor, to the pathology report and its molecular characteristics.

A. Histological Criteria

The most frequent cancers develop from the epithelial cells in the mammary gland and are known as adenocarcinomas. Histologically they can be either *in-situ* adenocarcinomas, which are generally associated with a good prognosis or infiltrant adenocarcinomas, which have a less favorable outcome. Infiltrant adenocarcinomas occur when tumor cells have passed

the basal membrane to invade the mesenchymal compartment thereby having a chance to infiltrate surrounding blood vessels and lymphatic canals. Adenocarcinomas represent about 95% of all breast cancers and can arise from either from mammary ducts, thereby being named ductal adenocarcinomas, or from mammary lobules, thereby being lobular adenocarcinomas (Figure 5).

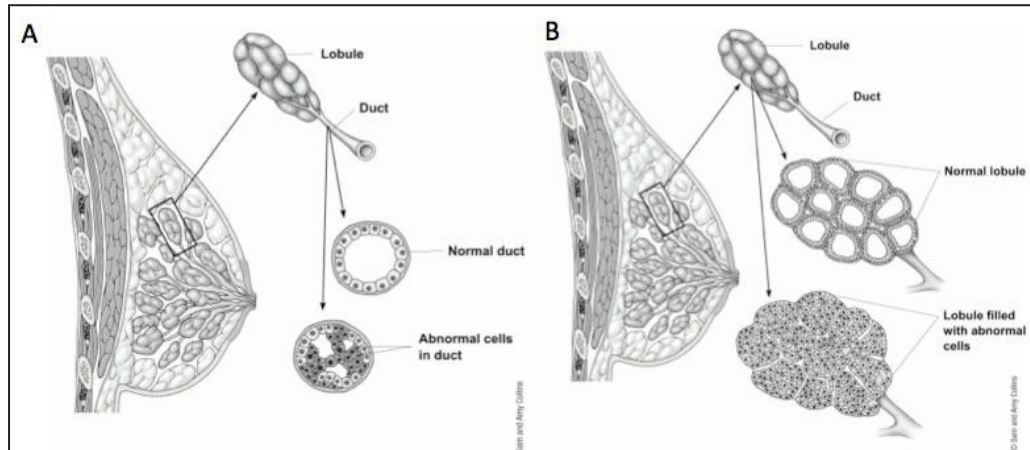

Figure 5: Adenocarcinomas. A: Ductal adenocarcinoma. B: Lobular adenocarcinoma. (Source American Cancer Society)

There are other types of breast cancer, on a rarer scale, with particular histological particularities notably, medullar carcinomas, tubular, papillary, Paget's nipple disease, each one with their own prognostic values.

B. Anatomopathological Criteria

Upon confirmation of the cancer diagnostic, therapy is applied in accordance with the disease stage and prognostic factors (Elston et al., 1999). Clinically, the disease stage is determined by tumor size, whether the tumor has infiltrative properties, ganglionnar involvement, and the presence of metastases. The tumor grade gives an insight into its agressivity and takes into account the differentiation of tumor cells and proliferation rate.

I. TNM Tumor Classification

The TNM classification has been proposed by the International Union Against Cancer and the American Joint Committee on Cancer. The TNM classification is based on Tumor size (T), the presence of lymph node involvement (N) and the presence of metastases (M) (Table 1). Tumors are therefore divided into 5 distinct stages (Table 2).

Primary tumor (T)	
TX	Primary tumor cannot be assessed
T0	No evidence of primary tumor
Tis	Carcinoma in situ
Tis (DCIS)	Ductal carcinoma in situ
Tis (LCIS)	Lobular carcinoma in situ
Tis (Paget)	Paget disease of the nipple NOT associated with invasive carcinoma and/or carcinoma in situ (DCIS and/or LCIS) in the underlying breast parenchyma.
T1	Tumor ≤ 20 mm in greatest dimension
T1mi	Tumor ≤ 1 mm in greatest dimension
T1a	Tumor > 1 mm but ≤ 5 mm in greatest dimension
T1b	Tumor > 5 mm but ≤ 10 mm in greatest dimension
T1c	Tumor > 10 mm but ≤ 20 mm in greatest dimension
T2	Tumor > 20 mm but ≤ 50 mm in greatest dimension
T3	Tumor > 50 mm in greatest dimension
T4	Tumor of any size with direct extension to the chest wall and/or to the skin (ulceration or skin nodules)
T4a	Extension to chest wall, not including only pectoralis muscle adherence/invasion
T4b	Ulceration and/or ipsilateral satellite nodules and/or edema (including peau d'orange) of the skin, which do not meet the criteria for inflammatory carcinoma
T4c	Both T4a and T4b
T4d	Inflammatory carcinoma
Regional lymph nodes (N)	
Clinical	
NX	Regional lymph nodes cannot be assessed (eg, previously removed)
N0	No regional lymph node metastasis
N1	Metastasis to movable ipsilateral level I, II axillary lymph node(s)
N2	Metastases in ipsilateral level I, II axillary lymph nodes that are clinically fixed or matted or in clinically detected* ipsilateral internal mammary nodes in the <i>absence</i> of clinically evident axillary lymph node metastasis
N2a	Metastases in ipsilateral level I, II axillary lymph nodes fixed to one another (matted) or to other structures
N2b	Metastases only in clinically detected* ipsilateral internal mammary nodes and in the <i>absence</i> of clinically evident level I, II axillary lymph node metastases
N3	Metastases in ipsilateral infraclavicular (level III axillary) lymph node(s), with or without level I, II axillary node involvement, or in clinically detected * ipsilateral internal mammary lymph node(s) and in the <i>presence</i> of clinically evident level I, II axillary lymph node metastasis; or metastasis in ipsilateral supraclavicular lymph node(s), with or without axillary or internal mammary lymph node involvement
N3a	Metastasis in ipsilateral infraclavicular lymph node(s)
N3b	Metastasis in ipsilateral internal mammary lymph node(s) and axillary lymph node(s)
N3c	Metastasis in ipsilateral supraclavicular lymph node(s)
Pathologic (pN)	
pNX	Regional lymph nodes cannot be assessed (for example, previously removed, or not removed for pathologic study)
pN0	No regional lymph node metastasis identified histologically. <i>Note:</i> Isolated tumor cell clusters (ITCs) are defined as small clusters of cells ≤ 0.2 mm, or single tumor cells, or a cluster of < 200 cells in a single histologic cross-section; ITCs may be detected by routine histology or by immunohistochemical (IHC) methods; nodes containing only ITCs are excluded from the total positive node count for purposes of N classification but should be included in the total number of nodes evaluated
pN0(i-)	No regional lymph node metastases histologically, negative IHC
pN0(i+)	Malignant cells in regional lymph node(s) ≤ 0.2 mm (detected by hematoxylin-eosin [H&E] stain or IHC, including ITC)
pN0(mol-)	No regional lymph node metastases histologically, negative molecular findings (reverse transcriptase polymerase chain reaction [RT-PCR])
pN0(mol+)	Positive molecular findings (RT-PCR) but no regional lymph node metastases detected by histology or IHC
pN1	Micrometastases; or metastases in 1-3 axillary lymph nodes and/or in internal mammary nodes, with metastases detected by sentinel lymph node biopsy but not clinically detected†
pN1mi	Micrometastases (> 0.2 mm and/or > 200 cells, but none > 2.0 mm)
pN1a	Metastases in 1-3 axillary lymph nodes (at least 1 metastasis > 2.0 mm)
pN1b	Metastases in internal mammary nodes, with micrometastases or macrometastases detected by sentinel lymph node biopsy but not clinically detected†
pN1c	Metastases in 1-3 axillary lymph nodes and in internal mammary lymph nodes, with micrometastases or

	macrometastases detected by sentinel lymph node biopsy but not clinically detected†
pN2	Metastases in 4-9 axillary lymph nodes or in clinically detected‡ internal mammary lymph nodes in the absence of axillary lymph node metastases
pN2a	Metastases in 4-9 axillary lymph nodes (at least 1 tumor deposit > 2.0 mm)
pN2b	Metastases in clinically detected‡ internal mammary lymph nodes in the absence of axillary lymph node metastases
pN3	Metastases in ≥ 10 axillary lymph nodes; or in infraclavicular (level III axillary) lymph nodes; or in clinically detected‡ ipsilateral internal mammary lymph nodes in the presence of ≥ 1 positive level I, II axillary lymph nodes; or in > 3 axillary lymph nodes and in internal mammary lymph nodes, with micrometastases or macrometastases detected by sentinel lymph node biopsy but not clinically detected‡; or in ipsilateral supraclavicular lymph nodes
pN3a	Metastases in ≥ 10 axillary lymph nodes (at least 1 tumor deposit > 2.0 mm); or metastases to the infraclavicular (level III axillary lymph) nodes
pN3b	Metastases in clinically detected‡ ipsilateral internal mammary lymph nodes in the presence of ≥ 1 positive axillary lymph nodes; or in > 3 axillary lymph nodes and in internal mammary lymph nodes, with micrometastases or macrometastases detected by sentinel lymph node biopsy but not clinically detected‡
pN3c	Metastases in ipsilateral supraclavicular lymph nodes
Distant metastasis (M)	
M0	No clinical or radiographic evidence of distant metastasis
cM0(i+)	No clinical or radiographic evidence of distant metastases, but deposits of molecularly or microscopically detected tumor cells in circulating blood, bone marrow, or other nonregional nodal tissue that are no larger than 0.2 mm in a patient without symptoms or signs of metastases
M1	Distant detectable metastases as determined by classic clinical and radiographic means and/or histologically proven > 0.2 mm

Table 1: Complete description of the TNM classification. Letter T symbolizes the initial tumor and is graded from T0 to T4. Letter N takes into account lymph node involvement with grading from N0 to N3. This can be split into two categories depending on how lymph node involvement is detected. cN stands for a clinical detection, while pN stands for a pathological exam detection. The letter M symbolizes the presence of metastases and is scored M0-M1. (Source Medscape)

Stage	T	N	M
0	Tis	N0	M0
IA	T1	N0	M0
IB	T0	N1mi	M0
	T1	N1mi	M0
IIA	T0	N1	M0
	T1	N1	M0
	T2	N0	M0
IIB	T2	N1	M0
	T3	N0	M0
IIIA	T0	N2	M0
	T1	N2	M0
	T2	N2	M0
	T3	N1	M0
	T3	N2	M0
IIIB	T4	N0	M0
	T4	N1	M0
	T4	N2	M0
IIIC	Any T	N3	M0
IV	Any T	Any N	M1

Table 2: Tumor Stages arising from the TNM classification. Different scores from T, N and M values allows to establish a stage I-IV (Source Medscape)

The higher the TNM grade, the worse is the prognosis for the patient. At stage IV, 5-year survival is dramatically reduced (less than 20%).

II. The Scarff, Bloom and Richardson histoprognostic grade (SBR)

The SBR classification evaluates aggressivity of infiltrating tumors (Tables 3&4). Tumors are generally considered to be of good prognosis when the cells show good differentiation i.e., morphology and characteristics similar to normal cells with epithelial phenotypes and little proliferation. Oppositely, less differentiated tumor cells have a bad prognosis (Figure 6). These have lost all epithelial characteristics and proliferate quite rapidly.

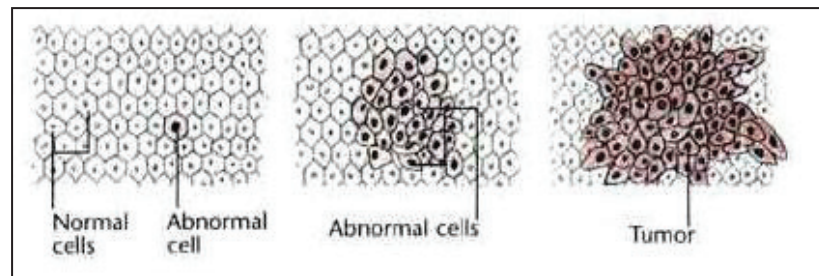

Figure 6: Representation of tumor cells in a histology section
(Source e-cancer.com)

Tubule Formation (% of Carcinoma Composed of Tubular Structures)	Score
> 75%	1
10-75%	2
less than 10%	3
Nuclear Pleomorphism (Change in Cells)	Score
Small, uniform cells	1
Moderate increase in size and variation	2
Marked variation	3
Mitosis Count (Cell Division)	Score
Up to 7	1
8 to 14	2
15 or more	3

Grade	Description	Score
Grade 1 (lowest)	Well-differentiated breast cells; cells generally appear normal and are not growing rapidly; cancer arranged in small tubules.	3,4,5
Grade 2	Moderately differentiated breast cells; have characteristics between Grade 1 and Grade 3 tumors.	6,7
Grade 3 (highest)	Poorly differentiated breast cells; Cells do not appear normal and tend to grow and spread more aggressively.	8,9

Tables 3 & 4: Grading scale for the SBR Classification. (Source Imaginis.com)

After microscopic analysis of the tumor, the pathologist evaluates the morphological characteristics and grades them from 1-3. The sum of the scores for the 3 above criteria allows the obtention of a global score ranging from I-III corresponding to the SBR Grade.

The tumor SBR grade thus obtained constitutes a prognostic marker. In fact, high SBR graded tumors are associated with a bad prognosis. It is also considered as a predictive marker for response to hormonotherapy and chemotherapy.

C. Molecular Criteria

Besides the numerous pathological characteristics listed above, there have been several molecular markers that have been developed to optimize patient treatment. Hence, clinical biomarkers with a clear prognostic/predictive value are used. These markers represent an important basis for therapeutic decision and takes into consideration the sensibility or resistance of the tumor towards treatment.

Therefore, clinicians analyze tumors for well-described molecular markers such as Estrogen Receptor α (ER α), Progesterone Receptor (PR), the genic amplification of the *HER2* gene and recently the proliferative antigen Ki-67. The presence or absence of these markers will determine the therapeutic strategy to be adopted.

I. Hormonal Receptors

a. Estrogen Receptor

The estrogen receptor α has been identified in 1966 (Toft and Gorski, 1966) which has then led to the use of anti-estrogenic molecules in the treatment of breast cancer. In normal mammary tissue, less than 10% of cells express the estrogen receptor ER α (Clarke et al 1997), but however, almost 70% of breast cancers are ER α -positive. These tumors depend on estrogen for growth, thus giving rise to the name of hormone-dependent breast cancers. It represents the most important biomarker in breast cancer as it is the major target of endocrine therapies and also represents a strong prognostic and predictive marker of hormonotherapy.

b. Progesterone Receptor

Progesterone receptor is a major biomarker in breast cancer since its expression strongly correlates with ER α . PR is considered as a functional marker of ER α since ER α induces PR expression. There are different PR isoforms namely PR-A and PR-B and some studies show that the PR-A/PR-B ratio can condition the response to endocrine therapy for ER+/PR+ patients(Hopp et al., 2004).

Recently a breakthrough study has revealed that PR does not actually have the attributed passive role of ER α activity report (Figure 7).

Instead, PR activity has been shown to change ER binding sites to DNA, directly modulating ER function (Baird and Carroll, 2016). When ER-positive, PR-positive tumors are compared with ER-positive, PR-negative tumors, the ER DNA binding sites are distinct, with different genes being switched on and off as a result (Mohammed et al., 2015).

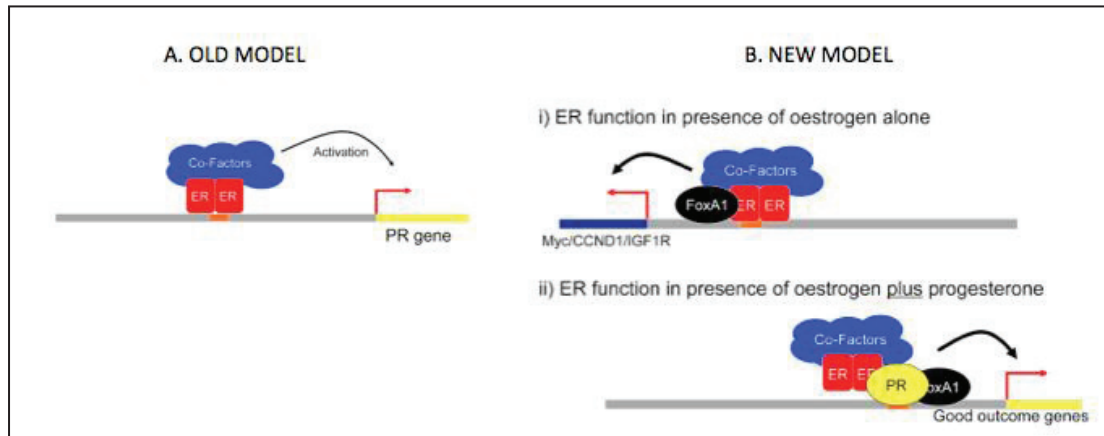

Figure 7: Model of ER α and PR cross-regulation for DNA binding A: Old model. B: New model(Baird and Carroll, 2016)

II. HER2 Receptors

Growth and differentiation of normal and breast cancer cells are partly regulated by human epidermal growth factors. HER is one of the receptors which can bind epidermal growth factors (EGF) and hence activate their transmembrane kinase activity to promote downstream cellular signaling leading to cell growth, migration or adhesion (Holbro et al., 2003). HER exists as many monomers (HER-1, 2, 3 and 4). HER2 principal function occurs as a result of its heterodimerization with HER-1, 2 or 3 (Figure 8) .

The first amplification of the *HER2* gene was described in 1987 in breast cancer. This results in a major overexpression of the corresponding protein. This genetic alteration is found in 15% of breast cancers and these correlate with a decrease disease free survival (Pegram and Slamon, 2000).

In breast tumors, HER2 status is monitored by Fluorescent In Situ Hybridization (FISH) on chromosome region 17q12 (Bertucci et al., 2004), or by IHC. An increase in HER2 protein results in a more active downstream signaling pathway. Nowadays, there are blocking agents that target the HER2 receptor and blocks its signaling in breast tumors.

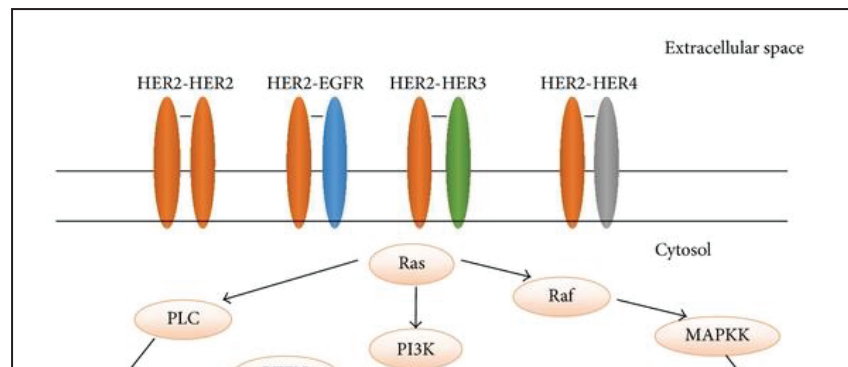

Figure 8: Brief overview of the HER2 Signaling Pathway.

Following ligand binding, the receptor heterodimerizes, undergoes autophosphorylation and activates downstream cellular kinases.

III. Ki67 antigen

Ki67 is a nuclear protein universally expressed in proliferating cells and absent from quiescent cells, making it a proliferation marker. Through there is not much known about Ki67, it is mainly expressed at a peak during mitosis (Lopez et al., 1991) Recent studies describe Ki67 as a prognostic marker where in ER α -positive, tumors, a low expression of Ki67 is more beneficial in terms of endocrine treatment (Delpech et al., 2012; Reyat et al., 2013). Cutbacks of this method is the lack of standardization in IHC reading and the positivity threshold is not clearly defined.

D. Transcriptome Analysis

Despite all the previous morphological and molecular characterizations, breast cancers remain quite different. This is mainly due to variations in the transcriptional program of these cells.

Using recent techniques such as high-throughput genomic and transcriptional analyzes, DNA chips, CGH arrays, the heterogeneity of breast cancer has been discovered.. These techniques have allowed to define different sub-types of breast cancer based on transcriptional programs with more and more precise genetic aberrations being identified (Perou et al., 2000; Sørli et al., 2001).

- The luminal A subtype expresses ER α and regroups low SBR grade tumors with a favorable evolution
- The luminal B subtype also expresses ER α , but regroups less differentiated tumors which proliferate more (SBR II or III). Some studies also propose a luminal C subtype which can be identified by its expression of the mesenchymal marker Vimentin
- The basal subtype which does not express hormone receptors (ER α , PR) and does not present HER2 amplification. These tumors are of high SBR grade and are of bad prognostic. They are often associated with triple

negative breast tumors. These tumors highly express cell cycle regulators and frequently present with P53 mutations. They can also be identified based on their expression of basal epithelial cell markers such as Cytokeratin 14 and Cytokeratin 5/6.

- The HER2+ subtype, which is characterized by an over-expression of HER2.
- The normal subtype is not widely known. These tumors do not express epithelial genes but rather express adipose tissue genes. Some speak of sample contamination by adipose tissue due to low tumor cellularity.

Basal and luminal cancers are quite different by the expression of approximately 5000 genes. The HER2+ and basal subtypes are the most well characterized (Gruver et al., 2011).

More recently, three more subtypes of tumors have been identified:

- The apocrine subtype which is characterized by the expression of the androgen receptor (AR). This subtype of tumors do not express the hormone receptors and is characterized by the expression of AR (Farmer et al., 2005).
- The claudin-low subtype, which forms part of basal tumors but is characterized by an expression of mesenchymal markers. These cells have been shown to have a high Epithelial to Mesenchymal transition (EMT) capacity which is a key process in tumor progression (Prat et al., 2010).
- The interferon-rich subtype forms part of basal tumors. It is characterized by a high expression of interferon regulated genes and lymphocyte infiltration (Teschendorff et al., 2007).

This molecular classification based on DNA chips is not robust enough to be used in clinical diagnostic for the moment and identification of novel prognostic markers is an ongoing thing.

4. Origins of breast cancer

Several epidemiological studies carried out worldwide have ascertained that several factors can influence breast cancer apparition, notably genetic susceptibility, environmental factors, lifestyle. These however are neither necessary nor sufficient to initiate the pathology. There is the notion of risk of breast cancer which means that the probability of developing the disease is higher than average. 5-10% of breast cancers have a genetic origin and 90% are sporadic. The latters are not hereditary and their origin is not well defined and multifactorial.

A. Genetic factors

Family history, in a general manner, is associated with an increase in the risk of breast cancer. Various mutations have been found to be associated with breast cancer. In cancers with genetic origins, the most commonly mutated genes are BRCA1 (BReast CAncer 1) and BRCA2 (BReast CAncer 2). The two corresponding proteins have a major role to play in DNA

damage repair. Having a mutation on either of those two genes greatly increases the risk of breast cancer. The breast cancer risk associated with these mutations is more than 87% in women and around 6% in men (Wolpert et al., 2000).

There are several other genetic predisposition factors to breast cancer and they affect in great majority genes involved in DNA repair: TP53, ATM, PTEN and others.

B. Environmental factors and lifestyle

I. Ionizing Radiation

Ionizing radiation is widely known to be detrimental to DNA and its constituents. The breast is a particularly sensitive organ to ionizing radiation and exposure of mammary tissue to an equivalent dose of 1Gy can triple the risk of breast cancer (Key et al., 2001).

II. Obesity, Breast Density and Size

Obesity doubles the risk of breast cancer in post-menopausal women. This is probably due to the fact that adipose tissue is a key storage and metabolism site for steroid hormones, thereby leading to an increase in circulating estrogens (Key et al., 2001).

Around 30% of breast cancers are associated with high breast density since the breast is very rich in glandular tissue. Furthermore studies have shown that typical mammography has a particular flaw in detecting tumoral anomalies in women with dense breast due to the fact that the mammography exam does not distinguish between normal breast tissue and tumor tissue thus delaying early detection and finding the disease at a much later stage of development (Rhodes et al., 2005).

III. Physical Activity

Some studies demonstrate that a moderate physical activity (30-60mins 4 times a week) can significantly decrease the risk of breast cancer by 35%, particularly in post-menopausal women (Glade, 1999). This could be linked to a decrease in estrogen production (Friedenreich, 2001).

IV. Smoking and Alcohol

Tobacco smoke has been proven to be a carrier of multiple cancer causing risk of breast cancer due to a decrease in circulating estrogens and tobacco's anti-estrogenic action. Other studies found an increased risk of breast cancer associated with smoking agents. Different conclusions have been drawn between smoking and cancer. Some studies have found that smoker women have a reduced. (Charafe-Jauffret et al. 2007)

Alcohol consumption has been found to be linked with breast cancer. In fact moderate alcohol has been found to increase the risk of breast cancer in women by 7% (Hamajima et al., 2002). This could be explained by the fact that alcohol increases the circulating amounts of hormones

and particularly an increase in IGF (Insulin-like Growth Factor) which increases breast cancer risk (Yu et al., 2003).

C. Reproduction and hormonal changes

Breast cancers are mainly hormone dependent cancers and are therefore influenced by hormonal imbalances in the body. Physiologically, breast cancer risk is increased with premature hormonal exposition (first menses before 12) and prolonged exposition in case of tardive menopause (Glade, 1999). The use of the contraceptive pill before the age of 20 could therefore also be a risk factor.

Women giving birth before the age of 30 find their risk factor decreased by 25% and this effect increases proportionally with the number of births given (Layde et al., 1989). The mechanisms for this protective effect are not well understood. Breast-feeding, on the same line seems to have a protective effect from breast cancer onset. Women who have breast-fed for at least 25 months have a 33% risk decrease in breast cancer compared to women who did not (Layde et al., 1989). Breastfeeding causes internal hormonal changes, particularly a decrease in estrogen and an increase in prolactin. This could reduce the cumulative exposition of women to estrogens and therefore repress the apparition and development of breast cancer.

D. Breast Cancer Stem Cells

An increasing number of arguments allow to hypothesize that breast cancer arises from mammary stem cells or their immediate descendants, progenitors. These cancer stem cells could undergo either symmetrical or asymmetric division, which engages a self-renewal or a differentiation process. The heterogeneity of breast tumors could be explained by the types of descendants given by the altered stem cell (Figure 9). For instance luminal breast tumors could arise from progenitors already engaged in that particular lineage in a more or less complete manner. The same statement could stand true for basal or myoepithelial differentiation.

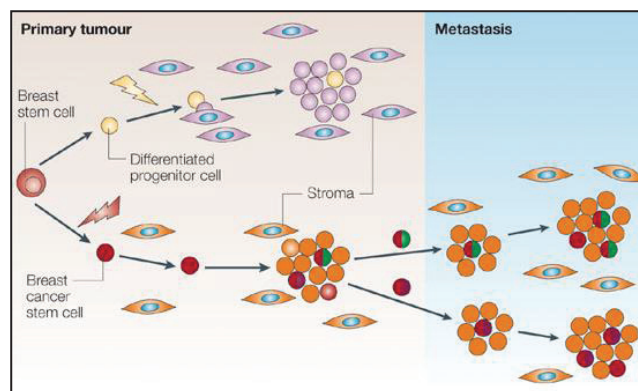

Figure 9: Normal and tumoral mammary differentiation and resulting metastasis (Weigelt et al., 2005)

Chapter 2: Estrogen Receptors

Estrogen receptors belong to the nuclear receptor superfamily binding steroid hormones. These receptors function mainly after their activation by the ligands estrogens.

1. Estrogens

Estrogens are synthesized in both sexes but are mainly produced in non menopausal women. They act on sexual traits and participate in controlling the menstrual cycle.

A. Synthesis and metabolism

Estrogens, like most steroid hormones, are derived from cholesterol, with a 4 cycle carbon skeleton. The main estrogens are Estradiol (E2) which is the principal form secreted by women and is obtained after testosterone processing, Estriol (E3) produced by the placenta during pregnancy and esterone (E1) produced after menopause by androgen processing.

In non pregnant women, estrogens are mainly synthesized by the ovaries, while during pregnancy, a large amount is synthesized by the placenta. Androgens are secreted by the ovaries in thecal cells then diffuse to the granulosa where they will be processed into estrogen by aromatization and demethylation (Figure 10).

After menopause, ovarian function ceases and estrogen synthesis is relayed by aromatization of androgens in various tissues such as adrenal glands, adipocytes, breast tissue, bones and the liver.

In men, estrogens are synthesized in the testicles and in the adrenal cortex. In the testicles, synthesis arises in leydig cells and resulting androgens are processed into estrogens in sertoli cells (Figure 10).

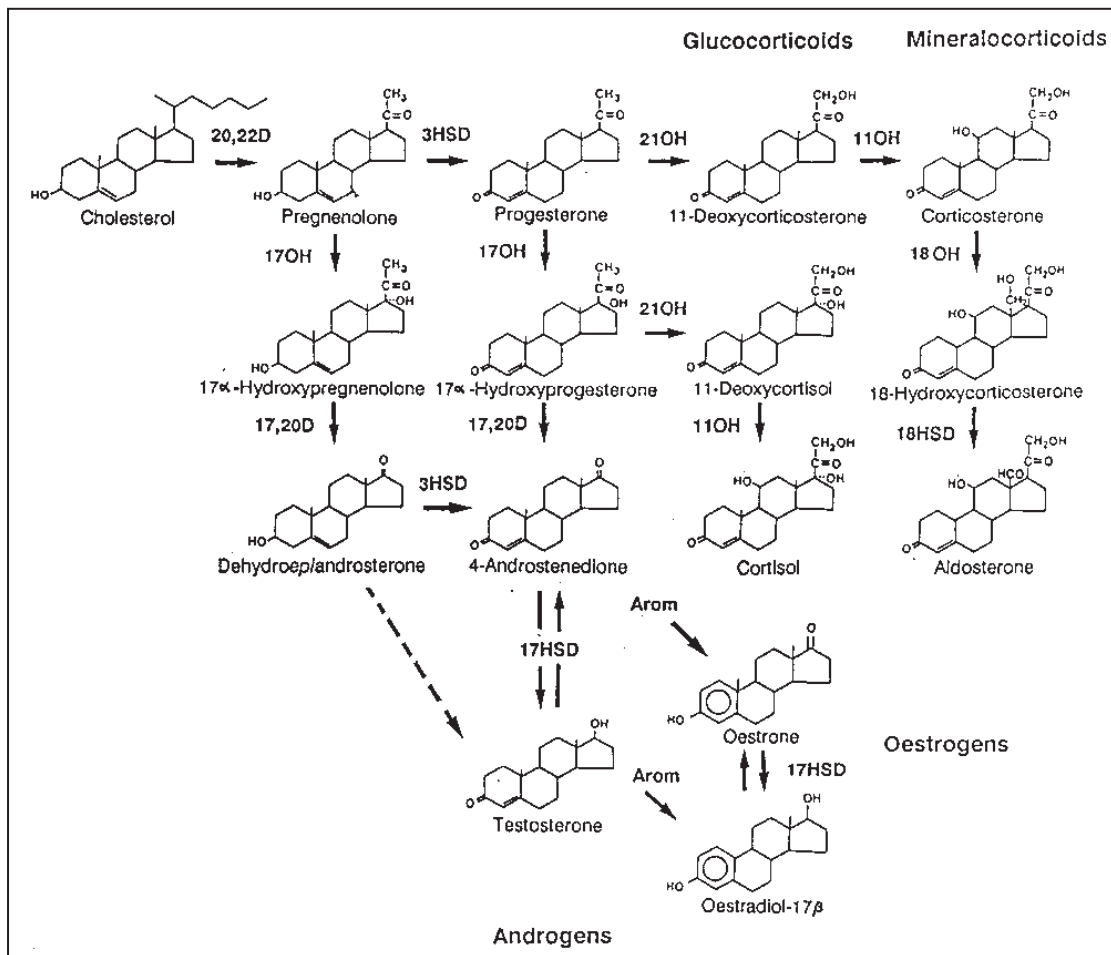

Figure 10: Biosynthesis of the major steroid hormones. Synthesis arises in gonads, leading to the formation of progesterone then androgens. Androgens are then aromatized into estrone and testosterone into estradiol (Source: gfmer.com)

Following synthesis, estrogens undergo endocrine secretion into the bloodstream where they are bound to carrier proteins such as albumin or Gonadal Steroid Binding Globulin.

B. The Menstrual Cycle

Estrogen production is under control of the hypothalamus-pituitary axis. Gonadotropin Releasing Hormone (GnRH) secreted by the hypothalamus acts on the anterior pituitary gland and promote secretion of Follicle Stimulating Hormone (FSH) and Luteinizing Hormone (LH)

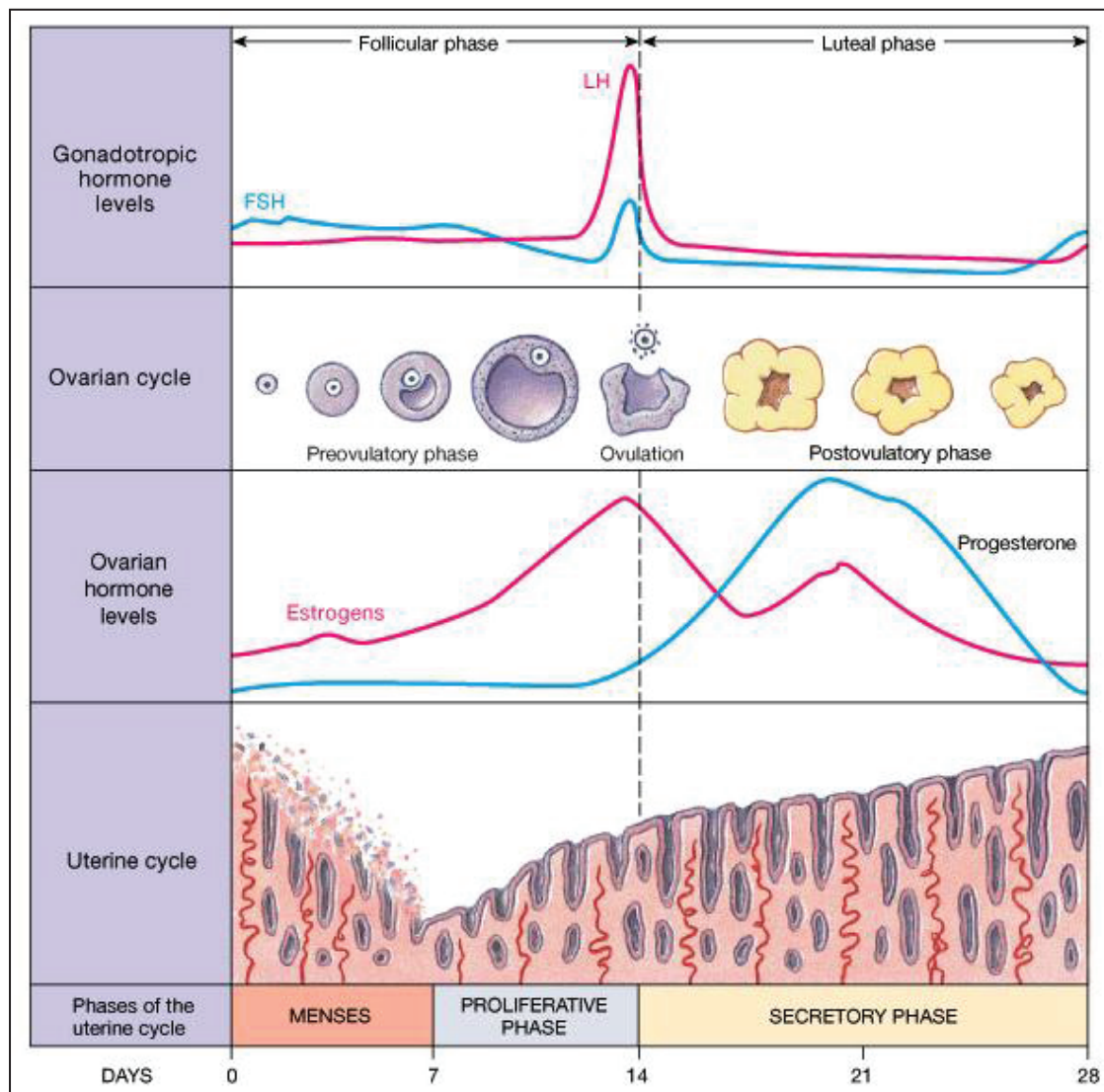

Figure 11: The menstrual cycle. The cycle is under strict hormonal control by pituitary hormones, estrogen and progesterone. The follicular phase begins on the day of menses and last 14 days and its end is marked by ovulation. Then begins the luteal phase.

During the first days of the cycle, FSH and LH secretion cause the maturation of ovarian follicles which in turn secrete estrogens which is responsible for the thickening of the uterine lining so as to be prepared for an eventual fertilization. During the follicular phase, estrogen concentrations increase and induce the secretion of LH by a positive feedback loop. This causes rupture of the ovarian follicle and ovulation takes place. The ruptured follicle, now known as corpus luteum, secretes progesterone. If the egg is not fertilized, the corpus luteum is evacuated, leading to a drastic progesterone decrease, which results in the shedding of the uterine lining. Another cycle can then take place (Figure 11).

In addition to their effects on the ovaries, estrogens have a number of additional functions in the body. Their effects have been mainly described on the cardiovascular system, skeletal functions, liver, central nervous system and growth regulation.

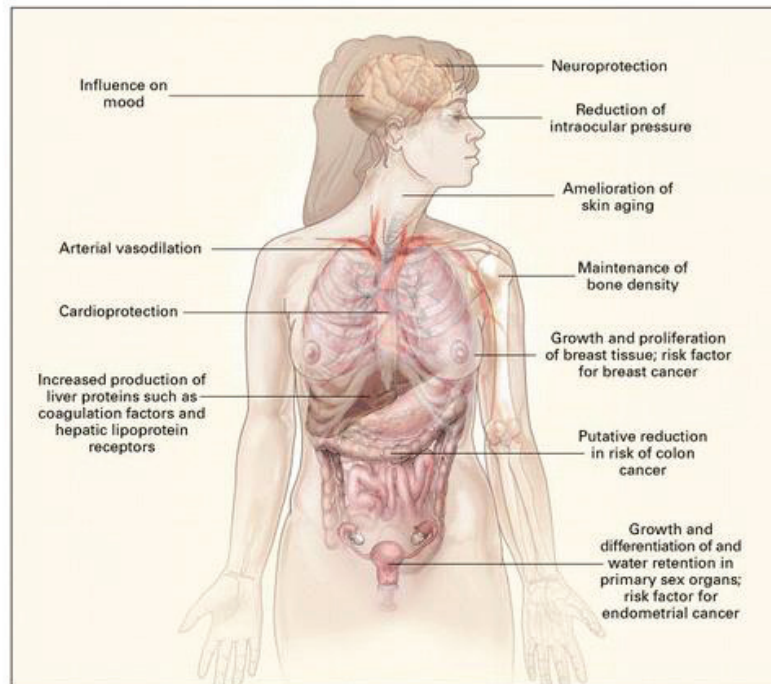

Figure 12: Physiological effects of estrogens (Gruber et al 2002)

In addition to their functions in reproduction, they have several roles in the development and the maintenance of the female reproductive organs and in the development of feminine traits (Carpenter and Korach, 2006). Furthermore they are deeply involved in the development of breast and endometrial cancer.

Estrogens play a natural role in the regulation of blood cholesterol levels by the liver by modulating lipoprotein receptors (Paganini-Hill et al., 1996). In the skeletal system, estrogens help maintain bone density which explains that post menopausal women are more susceptible to develop osteoporosis and are more prone to fractures. In vascular system, estrogens have an anti-apoptotic role in endothelial cell thereby maintaining endothelial integrity (Spyridopoulos et al., 1997). Estrogens have also been described as being a pro-angiogenic factor. In the nervous system, estrogens can play a role in synaptic remodeling and memory (Woolley et al., 1997). Furthermore, studies have shown that estrogens can mediate a neuroprotective effect against cell death.

2. The Estrogen Receptor

Estrogen receptor was first identified in 1962 and cloned in 1986 (Green et al.; Greene et al., 1986). 10 years later, another isoform Estrogen Receptor β (ER β) was identified (Kuiper et al., 1998), this giving the name ER α to the first one identified. These receptors are transcription factors, members of the steroid nuclear receptor superfamily. Our laboratory and this manuscript will concentrate mainly on ER α and its splice variant ER α -36.

A. Structure of Estrogen Receptors

I. Genomic Structure

The ER α gene, named *ESR1* is localized in chromosome 6q25.1 in humans (Menasce et al., 1993). Previously the *ESR1* gene was supposed to contain 8 coding exons, until in 2005, when a ninth exon was discovered downstream exon 8 (Wang et al., 2005). The coding exons 1-8 are highly conserved in between different species, except for exon 9, which is found only in humans and chimpanzees. The variable 5' extremity of the *ESR1* gene and the existence of multiple promoters in this region may account for the differential expression of ER α in different tissues and during development (Kos et al., 2001).

The ER β gene, named *ESR2* is localized on chromosome 14q23.2 and is composed of 8 coding exons (Enmark et al., 1997).

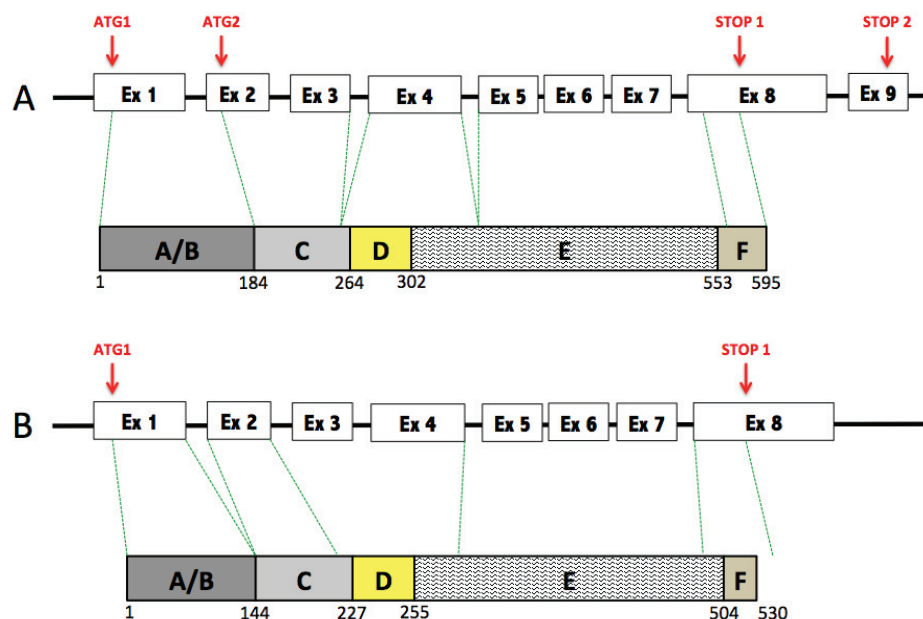

Figure 13: Genomic and protein arrangement of Estrogen Receptors (all intronic sequences between exons are not to scale) A: Structure of *ESR1* and corresponding ER α protein. B: Structure of *ESR2* and corresponding ER β protein. Numbers below the proteins represent amino acid numbers from the N-terminus.

II. Protein Structure

The nuclear receptor superfamily represents a great diversity of receptors and despite that, all these receptors have a relative homology in their organization and function. For most of these factors, the common fact is that they are capable of DNA binding in response to their ligands.

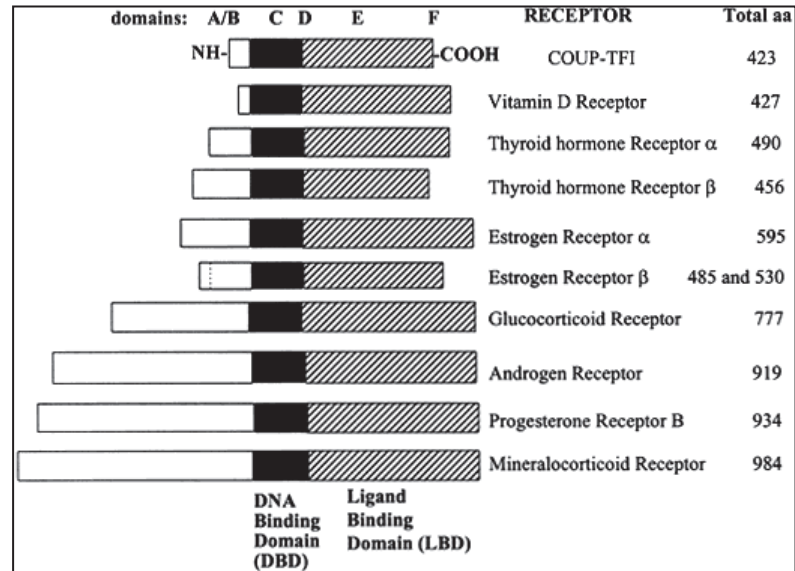

Figure 14: Protein structures of some nuclear steroid receptors (Wahli and Martinez, 1991)

In accordance to the structure of the nuclear receptor superfamily, ER α is composed of 6 functional domains named A – F (Kumar et al., 1987).

- The A/B domain is composed of the transcription transactivation domain AF1 (activation function 1), and is responsible for ligand independent transcription.
- The C domain, also called the DNA Binding Domain allows for the recognition of estrogen response elements (ERE) on DNA, generally located on the promoters of target genes. It is made up of two zinc-finger structure. A P-Box present in the first zinc finger structure is important for recognition of the ERE while a D-Box in the second zinc finger structure is responsible for receptor dimerization (Ponglikitmongkol et al., 1988).

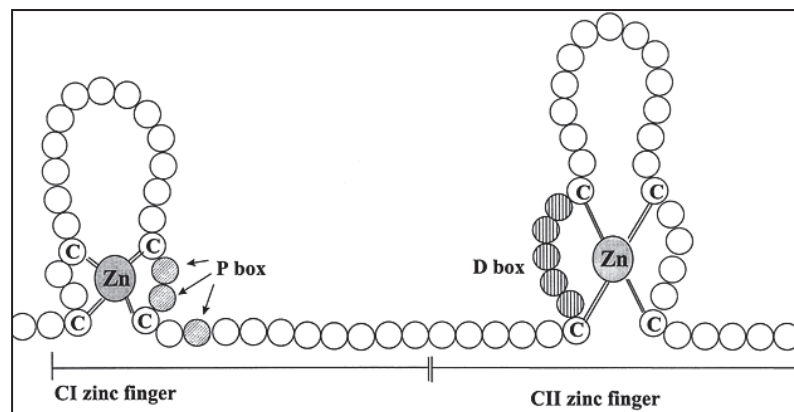

Figure 15: Structure of the DNA Binding domain of ER

- The D Domain serves as a Hinge between domains C and E and is responsible for providing flexibility to the DBD for adopting different conformations. This region also carries three Nuclear Localization Sequences, permitting nuclear import of the receptor
- The E domain carries the Ligand Binding Domain (LBD) and has a main function in the dimerization of ER. It also carries the AF2 (activator function 2) transcription transactivation domain, which is ligand dependent. After ligand binding, helix 12 of ER will close on the ligand binding pocket and this will lead to a stabilization of the dimeric form of the receptor, dissociation from co-repressors and the creation of new interaction sites for interactions with co-activators. Helix 12 also plays a crucial role in the conformation of the receptor when bound to different ligands and will be responsible for the agonist or antagonist actions of the receptor (Ruff et al., 2000).
- The F-Domain, located on the C-Terminal part of the protein is still not fully characterized. It could have a role in modulating ER α activity by modulating protein-protein interactions with co-activators such as SRC1 (Steroid Receptor Co-activator 1) (Koide et al., 2007).

At the functional level, ER α activity is associated with cell proliferation. Also, ER α KO mice present with infertility, uterine atrophy and impaired mammary development. Furthermore these mice are obese and there is no feedback loop on the hypothalamic-pituitary axis in regard to LH secretion (Emmen and Korach, 2003).

B. Isoforms of Estrogen Receptors

Besides the described ER α and ER β , many variants arising from either alternative splicing or alternative promoters have been characterized. The most described variants of ER α are ER α 46 and ER α 36, named thus due to their respective protein sizes (46kDa and 36 kDa respectively) (Figure 16A).

Isoform ER α 46 is transcribed from an alternative promoter in Exon 2 and was identified in 1996. It has been demonstrated to inhibit the transcriptional activity of ER α via the recruitment of co-repressors (Flouriot et al., 2000; Penot et al., 2005).

Isoform ER α -36 will be described in detail in the next chapter.

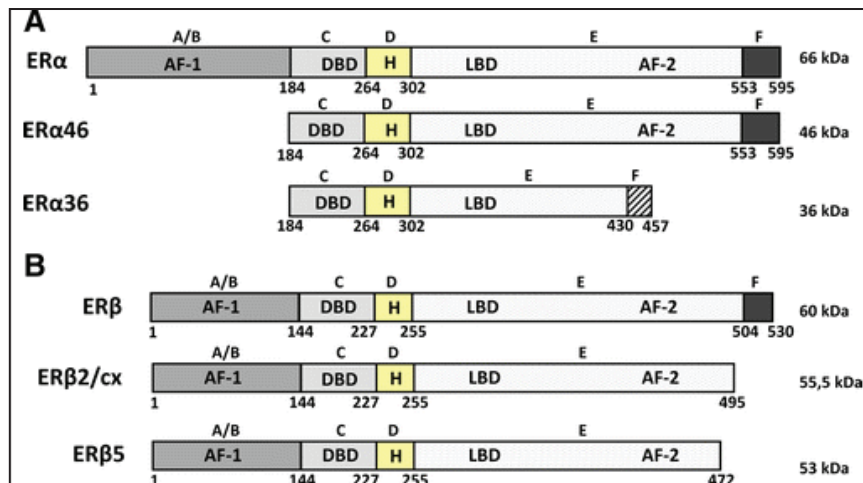

Figure 16: Isoforms of ER. A: ER α -36 and ER α 46 are variants of ER α . B: ER β 2/cx and ER β 5 are isoforms of ER β (Le Romancer et al., 2011).

Other splice variants have also been described for ER β (Figure 16B) in breast cancer (Davies et al., 2004). Their exact roles have not been described but they are suspected to be involved in resistance to hormonotherapy (Skirris et al., 2006).

C. Action of Estrogen Receptors

Estrogen receptor is the main mediator of estrogen action by regulating the expression of estrogen dependent genes involved in proliferation, development and differentiation of the mammary gland.

Briefly, after ligand binding, the receptor will dimerize and translocate into the nucleus to bind directly onto ERE or indirectly via binding to transcription factors, this is the classical genomic pathway (Figure 17A,B). Otherwise there is a ligand independent pathway, which relies on the phosphorylation of ER by Growth Factor Receptor activation, this is non non-classical genomic pathway (Figure 17C). Finally there is the non-genomic pathway, which involves a cytoplasmic fraction of ER α and the recruitment of cytoplasmic kinases to initiate a downstream signaling pathway (Figure 17D)

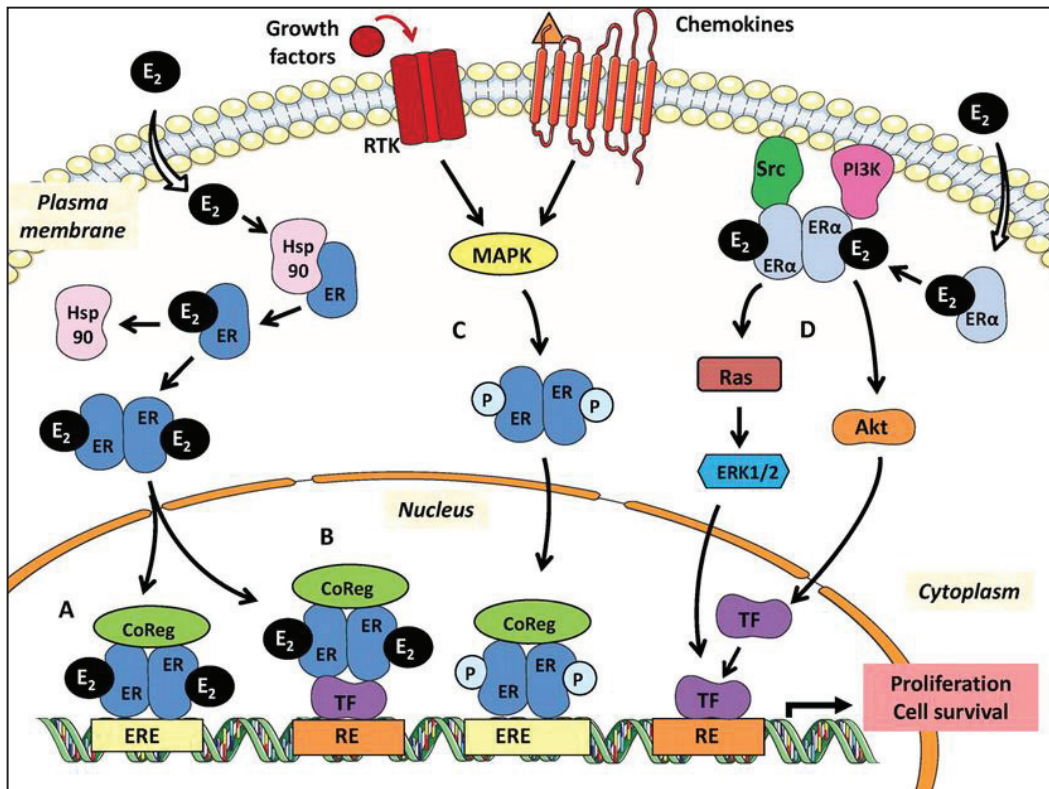

Figure 17: ER Signaling Pathways. ER designates either ER α or ER β . A,B: Classical Genomic Pathway, C: Non classical genomic pathway, D: Non-genomic signaling pathway (Le Romancer et al., 2011)

I. Inactive, ligand-unbounded ER α

Steroid receptors have been found to interact with Hsp90 (Heat shock protein) as well as other chaperones, which participate in maintaining the inactive state of these receptors (Sanchez et al., 1987). In eukaryotes, Hsp 90 plays a major role in the folding, localization and degradation of various proteins (Becker and Craig, 1994). Hsp90 is a dimer made up of three distinct domains, an ATP binding N-Terminal Domain, a central domain involved in protein recruitment and binding specificity and a C-terminal domain responsible for dimerization (Prodromou et al., 2000).

Besides Hsp90, many other chaperones have been described as steroid receptor couples such as Hsp40, Hsp70, which are also involved in maintaining the inactive state (Picard, 2006). Hsp90 will bind to the LBD of ER α and the C-terminal ends dimerize after ATP fixation which folds over ER α (Cintrón and Toft, 2006; Johnson et al., 1994).

Alongside these Hsp's, other proteins called immunophilins can form part of the complex to maintain ER α in its inactive state. Several of these immunophilins have been described such as FKBP52 (p59), FKBP51, Cyclophilin 40 (Ratajczak and Carrello, 1996; Renoir et al., 1990).

In the absence of ligand, this complex around Hsp90 sequesters the receptor but also allows ER α to acquire a structure having maximal affinity to its ligand.

Upon ligand binding, ATP hydrolysis allows the opening of the clamp around ER and ligand fixation.

II. The genomic pathway of ER α

a. The Classical Pathway

Hormone binding to the receptor brings a conformational change, which dissociates it from the complex of chaperone proteins. The receptor dimerizes and translocates in the nucleus (Sabbah et al., 1996). The receptor dimer can then bind to estrogen response elements (ERE), located in the promoter of target genes. The minimal conserved sequence between ERE is a 13bp palindromic sequence divided by 3 random nucleotides (n) 5'- GGTCAnnnTGACC-3' (Walker et al., 1984). However a limited number of ER α regulated genes possess this sequence and in most cases, the receptor dimer will bind on imperfect ERE or half-palindromic sequences (Ramsey and Klinge, 2001). Depending on the cell type, the type of ERE used and the ligand, the receptor can have either positive or negative trans-activation on target genes.

Transcriptional Activation

Once bound to an ERE, ER α can mediate gene transcription through its AF1 or AF2 transactivation domains and it can also recruit several co-activators. Three major co-activator complexes have been identified for ER α transcriptional activity and play a key role in transcription activation (Rosenfeld et al., 2006).

The p160/SRC family of co-activators

SRC-1, SRC-2 and SRC-3 are three members of this family and contain LxxLL motifs that allow binding to ER α hydrophobic pocket on the AF2 domain (Leers et al., 1998). Furthermore they contain two transcription activation domains AD-1 and AD-2. AD-1 is involved in the recruitment of CBP/p300 and AD-2 in the recruitment of PRMT1 and CARM1 which are involved in histone methylation and chromatin decompaction (Chen et al., 1999). SRC's N-terminal ends also have the capacity to recruit several co-activators including Fli-1 which is involved in recruiting the SWI/SNF complex.

CBP/p300 complex

CBP/p300 contains an ER α binding site via a consensus LxxLL motif and its role in ER α activation has been well documented.

The SWI/SNF complex

This complex is recruited to ER α target genes in the case of estrogenic signaling by BAF's (BRG1 associated factors), for instance BAF57 in the recruitment of ER α .

The Mediator Complex

This large co-activator complex is made up of more than 26 protein subunits and is also called the TRAP/SMCC/DRIP complex. It has a role in maintaining ER α dependent transcription after the CBP/p300 complex (Kim et al., 2006).

Other proteins have been described to act as ER genomic regulators. For instance, GREB1 has been identified as an ER co-factor that will serve to stabilize the binding of ER to other cofactors and mediate ER transcriptional activity.

In all, these complexes bring forward enzymatic activities that will allow histone modification and chromatin opening to facilitate transcription of target genes.

Transcriptional Repression

Apart from binding co-activators, the AF2 domain of ER α can also recruit various co-repressors. Two main proteins, RIP140 and SHP have co-repressor activities and act in a SRC antagonist manner.

RIP140

The RIP140 protein, identified as a co-repressor of ER α , includes 9 LxxLL repeats and can therefore be easily recruited onto steroid receptors (Cavaillès et al., 1995). RIP140 has the ability to recruit various transcriptional co-repressors such as HDACs I and II. RIP140 also has the capacity to recruit CtBP proteins, which act as negative transcriptional regulators. Other studies however have described RIP140 to act as a positive ER transcriptional regulator and to serve as a co-activator (Nautiyal et al., 2013).

SHP

SHP is a nuclear orphan receptor and can interact with ER α through a LxxLL motif. It can repress ER α activity by direct interaction with its AF2 domain (Johansson et al., 2000).

Upon binding to antagonists like Tamoxifen, a different conformation of the receptor is induced which leads to ERE binding but with the induction of binding to co-repressors like N-CoR, SMRT which participate in the recruitment of HDAC for chromatin compaction and transcriptional repression (Shang et al., 2000).

b. The Non-Classical Pathway

ER is also capable of inducing the transcription of genes devoid of ERE by indirect DNA binding through interactions with other transcription factors. ER can thus modulate the activity of transcription factors such as AP1, SP1 or NF- κ B.

AP-1

This is a transcription factor complex, which includes JUN, and FOS, which binds to AP-1 sites in gene promoters. Estrogen activated ER α can bind to the AP-1 complex through the p160 coactivator family (Webb et al., 1999).

Regulated genes through ER α and AP-1 interplay include c-fos, Cyclin D1 and IGF, all involved in cell proliferation and motility. In some cells types, this AP-1 interplay with ER α could account for the differential effects of anti-estrogens such as tamoxifen and fulvestrant (DeNardo et al., 2005).

SP-1

SP-1 was identified as forming part of an ER α /SP-1/DNA complex in the study of Cathepsin D, an estrogen-regulated gene. In this context, the SP-1/ER α complex has been found responsible for mediating transcription of c-myc, Cyclin D1 and Bcl-2 proteins, thus having a role in cell proliferation and apoptotic resistance (O'Lone et al., 2004).

NF- κ B

ER α has been reported to modulate NF- κ B transcriptional activity by acting as a transcriptional repressor. This pathway has been evidenced for in the maintenance of bone homeostasis to inhibit the NF- κ B induced IL-6 upregulation. ER α is thought to function by blocking NF- κ B's ability to bind DNA (Kalaitzidis and Gilmore, 2005).

c. The Ligand Independent Pathway

The activity of ER can be modulated, in the absence of ligand, by extracellular signals. EGF and IGF have been reported to activate ER by phosphorylation thus inducing the transcription of downstream target genes (Le Romancer et al., 2011). The AF-1 ligand independent transactivation domain of ER carries this out. The main described phosphorylation site on ER α is Serine 118 (Bunone et al., 1996). This phosphorylated ER had been found to bind DNA and locate on the promoters of several target genes.

d. ER on the genome

While most studies focus on the proximal ERE in the promoters of genes for ER binding, genome wide studies revealed that most ER binding sites are located at significant distances from TSS. Further investigation demonstrated that the Forkhead factor FoxA1 had a crucial role to play in ER chromatin binding in the sense that ERE which had a Fox A1 binding site in close proximity were much more likely to be bound by ER (Carroll et al., 2005) .

Furthermore, ER binding sites throughout the genome can be altered during drug resistance mechanisms. For instance, in an endocrine-resistance setting, ER has been shown to relocate with SRC-1 and the chromatin protein HMGB2 and bind a different subset of non-ER related regulatory elements (Redmond et al., 2015).

D. ER α non genomic pathway

Besides the fore-mentioned genomic effects, there are rapid effects mediated by estrogens which take place in the minutes following estrogen exposure, meaning they are way too fast to be mediated by transcriptional activation (Pietras and Szego, 1977).

I. The nature of the receptor

a. Conventional ER α

Several studies demonstrate the existence of a pool of ER α located at the plasma membrane (Chambliss and Shaul, 2002; Clarke, 2000; Pappas et al., 1995). It has also been reported in IHC studies (Norfleet et al., 1999). However these observations do not provide a mechanism for ER α location at the plasma membrane, keeping in mind that ER α does not process any membrane insertion signal or peptide, no hydrophobic domains nor any glycosylation. The protein shuttles between the cytoplasm and the nucleus through nuclear localization and export sequences.

In 2004, the palmitoylation of ER α on Cysteine 447 was described and was shown to contribute to ER α cytoplasmic localization. A mutation of this cysteine residue prevented cytoplasmic ER α localization and abrogated the rapid estrogen induced MAPK activation (Acconcia et al., 2004). Palmitoylation of ER α allows its interaction with Caveolin-1 at the plasma membrane in lipid rafts (Acconcia et al., 2005).

Furthermore, protein association seems to be necessary for ER α localization near the plasma membrane. The adaptor protein Shc which plays a role in IGF-1R signaling and upon auto-phosphorylation of IGF-1R, Shc is recruited and allows the recruitment of ER α (Ravichandran, 2001). These describe Shc and IGF1R as key regulators for ER α membrane localization (Song et al., 2004).

Serine 522 found in the E-Domain of ER α seems to play a role in its membrane localization. Mutants of this serine fail to locate to the membrane and fail to colocalize with Caveolin-1 (Razandi et al., 2003).

b. GPR30

The G-Protein coupled receptor 30 is a 7TM membrane receptor (Carmeci et al., 1997) which has been shown to mediate estrogen response in ER α negative cells (Filardo et al., 2000). GPR30 has been shown to mediate estrogen dependent MAPK activation, which leads to the accumulation of downstream c-fos. GPR30 signaling can also activate the PI3K/Akt pathway in a G-Protein independent manner suggesting its potential role as an estrogen receptor (Revankar et al., 2005). The signaling of GPR30 can induce rapid post-translational modifications of several transcription factors such as CREB with downstream accumulation of FOS and JUN and their respective target genes (Prossnitz and Maggiolini, 2009). The role of GPR30 in physiology is a bit less clear since mice devoid of GPR30 do not present major problems with mammary gland development or reproduction .

c. ER α splice variants

ER α splice variants could also be involved in the cytoplasmic localization. ER α 46 can be palmitoylated and inhibition of this palmitoylation impairs its membrane localization in endothelial cells (Li et al., 2003).

The ER α -36 isoform will be discussed in the next chapter.

II. Protein Complexes

ER α has no intrinsic kinase activity and cannot on its own transduce extracellular signals. Its association with different kinases is therefore necessary to initiate rapid membrane signaling. Ligand bound ER α dimers can bind to many different proteins for this purpose, mainly the tyrosine kinase Src and the regulatory sub-unit of the PI3K, p85.

a. The ER α /Src/PI3K Complex

The Src and PI3K proteins form part of the core of the non genomic signaling complex (Castoria et al., 2001). This association has been observed firstly in endothelial cells in the induction of eNOS and the activation of the Akt pathway (Simoncini et al., 2000). Then it was observed that estrogen induced the rapid and transient formation of a ER α /Src/PI3K complex (Castoria et al., 2001). Estrogens thus induce the activation of PI3K increasing the intracellular PIP3 concentration. In parallel, estrogens mediate Src kinase activity and the activation of the Src pathway (Castoria et al., 2001).

Phosphorylation of ER α on tyrosine 537 is essential for its fixation with the SH2 domain of Src (Migliaccio et al., 2000). Pharmacological

abrogation of this interaction with a peptide abrogated the ER α /Src interaction and the downstream signaling including the arrest of Cyclin D1 expression (Varricchio et al., 2007).

The interaction domains between ER α and P85 are not clearly elucidated.

There seems to be an interplay between the Src and PI3K activities mediated through ER α . In fact, inhibition of Src kinase activity abrogated the estrogen induced PI3K activation, and the formation of the core ER α /Src and PI3K complex (Cabodi et al., 2004). Inversely, the use of a PI3K inhibitor abrogates Src activity (Castoria et al., 2001).

b. P130^{Cas}

This adaptor protein, Crk-associated substrate, is a major Src substrate. It is involved in cytoskeleton remodeling during cell migration and transformation. It has been shown to be transiently associated with ER α upon estrogen stimulation and this association depends on Src kinase activity (Cabodi et al., 2004).

c. MNAR

MNAR (Modulator of Nongenomic Activation of ER) is an adaptor protein making up the Src/ER α /PI3K complex. It functions as a scaffold which favors the ER α /Src interaction and it is thought to be crucial in the recruitment of p85 to the complex (Greger et al., 2007).

III. Effects of the non genomic pathway

ER α non-genomic signaling has mainly been linked to two major pathways.

a. The MAPK pathway

Estrogen stimulation induces the ER α /Src interaction, which rapidly leads to Src activation. Src's tyrosine kinase properties will activate downstream RAS. This will in turn lead to the activation of MEK which will specifically lead to the activation of ERK1/2. Phosphorylated ERK1/2 will migrate to the nucleus where they activate the transcription of proliferative genes such as cyclin D1 (Zassadowski et al., 2012). The activation of the MAPK pathway has been described in numerous cells types such as nervous cells, endothelial cells and mammary cells (Hammes and Levin, 2007).

b. The PI3K/Akt pathway

Estrogen rapidly leads to the interaction between ER α and the regulatory subunit of the PI3K, p85. This will lead to the activation of the catalytic subunit p100 and leads to an increase in intracellular PIP3. The kinase Akt is then relocalized to the plasma membrane where it is activated and can lead to downstream substrate activation (Castoria et al., 2001).

The PI3K/Akt pathway is linked to an increase in cell proliferation by favoring S-phase entry of cells as well as the induction of Cyclin D1 (Castoria et al., 2001).

Akt can also phosphorylate the pro-apoptotic protein BAD which leads to its sequestration. BAD phosphorylation also leads to the release of anti-apoptotic proteins like Bcl-2 and Bcl-XL. Through this mechanism, estrogens protect against apoptotic cell death (Fernando and Wimalasena, 2004).

Non-genomic and genomic ER α pathways tend to converge rather than being two separate pathways. There is increasing evidence on the convergence between the two pathways, however there are some distinct estrogen effects that can be attributed to either one of these pathways. For instance, membrane induced expression of ER α cannot revert the ER α KO phenotype in mice (Abnormal reproductive system, mammary gland atrophy). Estrogen actions in the liver have been attributed to the non-genomic pathway.

E. Post-translational modifications of ER α

The discovery of post-translational modifications of proteins has brought forward a huge leap in understanding protein function diversity. In this perspective, the decrypting of ER α post-translational modifications (Figure 18) is crucial to understand the global estrogen signaling, be it the genomic or the non-genomic signaling (Table 5).

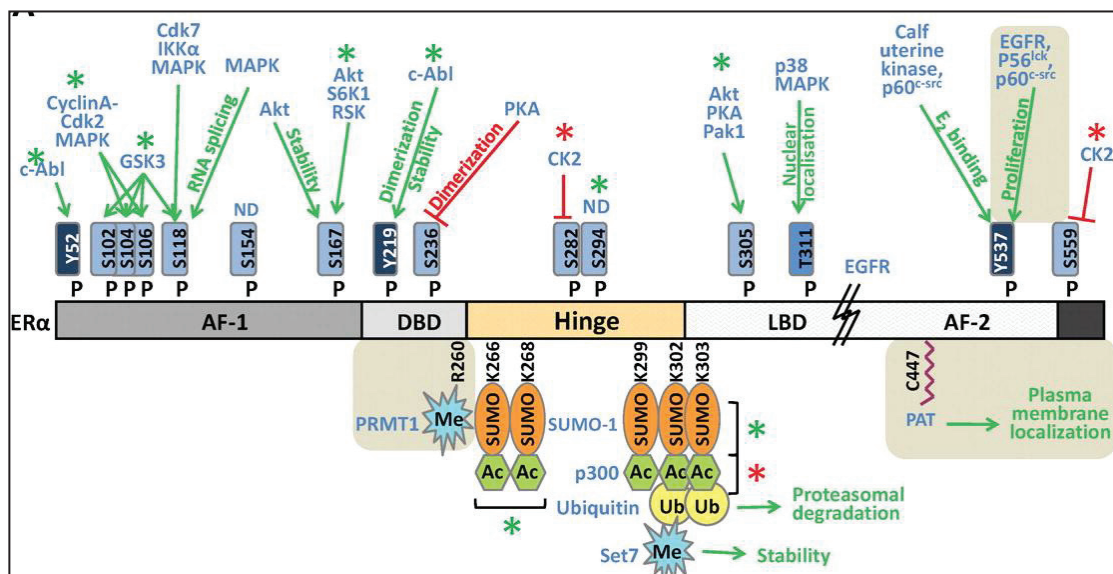

Figure 18: Post-Translational Modifications of ER α . Me: Methylation, P: Phosphorylation, Ub: Ubiquitination, SUMO: Sumoylation. Modification functions are represented in red for inhibitory and in green for activator (Le Romancer et al., 2011).

I. PTM regulating the genomic pathway

a. Phosphorylation.

ER α is subject to numerous phosphorylation along all its length and these are mainly involved in the activation of transcriptional activity. The serine 118 for instance can be phosphorylated by MAPK, thereby regulating ER α genomic pathway in an estrogen-independent manner (Bunone et al., 1996). Phosphorylation's on serines 104, 106, 167 and 305 are also involved in transcriptional activation (Le Romancer et al., 2011).

Other properties of ER α are also affected by phosphorylation such as phosphorylation on serine 236 which inhibits receptor dimerization (Sheeler et al., 2003). Phosphorylation of threonine 311 by p38 inhibits ER α nuclear import (He et al., 2010). Furthermore, phosphorylation of tyrosine 537 by the Src family of kinases regulates estradiol fixation on the receptor .

b. Acetylation

Histone acetyltransferase p300 has been shown to acetylate ER α . When acetylated on lysines 302 and 303, ER α transcriptional activity is repressed (Popov et al., 2007). Estrogen dependent acetylation of lysines 266 and 268 by p300 however stimulate the binding of ER α to DNA and boosts its transcriptional activity (Kim et al., 2006).

c. Ubiquitination

The proteasome pathway is involved in ER α turnover. The two lysines concerned with ubiquitination are lysines 302 and 303, which can also be acetylated (Berry et al., 2008). This turnover is essential to allow cells to respond quickly to changing hormonal concentrations.

d. Sumoylation

Our team showed that ER α can be sumoylated in its hinge domain by the E3 ligases PIAS1 and PIAS 3. This PTM affects lysines 266, 268, 299, 302 and 303 and allows a boost of ER α transcriptional activity (Sentis et al., 2005). Sumoylation of ER α is a dynamic and reversible process which can be a way to regulate the dynamics of ER α transcriptional complexes.

e. Methylation

ER α is methylated by the SET7 methyltransferase on lysine 302 located in the hinge domain. It is necessary for the recruitment of ER α to promoter regions and leads to transcriptional activation. This process is thought to be very rapid and transient and followed by a rapid deactivation by an unidentified demethylase (Subramanian et al., 2008).

Amino acid	Modification	Activator	Enzyme involved	Function
Y52	Phosphorylation	Ligand independent	c-Abl	Activates stability, transcription
S102	Phosphorylation	Constitutive, E ₂	GSK3	Activates transcription
S104/106	Phosphorylation	Constitutive, E ₂	GSK3	Activates transcription
		Constitutive, E ₂ , Tam	Cyclin A-Cdk2	Activates transcription
		E ₂ , Tam, ICI, PMA	MAPK	Activates transcription
		E ₂	MAPK	Dimerization
S118	Phosphorylation	E ₂ , Tam, ICI	ND	Activates transcription
		EGF, IGF-I	MAPK	Activates transcription
		E ₂	Cdk7	Activates transcription
		ND	MAPK	Activates RNA splicing
		E ₂	GSK3	Activates transcription
		E ₂	IKK α	Activates transcription
		Prolactin	ND	Activates transcription
		ROS	MAPK	Down-regulation
		E ₂	MAPK	Dimerization
S154	Phosphorylation	Constitutive, E ₂ , EGF	ND	ND
S167	Phosphorylation	Constitutive	Akt	Activates transcription
		ROS	Akt	Down-regulation
		EGF	p90 RSK	Activates transcription
		Insulin, PMA	S6K1	Activates transcription
		ND	Akt	Activates stability
S236	Phosphorylation	Constitutive	PKA	Inhibits dimerization
Y219	Phosphorylation	ND	c-Abl	Activates: dimerization, DNA binding, stability, and transcription
R260	Methylation	E ₂	PRMT1	Nongenomic signalling
K266	Acetylation	E ₂	p300	Activates transcription
	Sumoylation	E ₂ , Tam	SUMO-1	Activates transcription, DNA binding,
K268	Acetylation	E ₂	p300	Activates transcription
	Sumoylation	E ₂ , Tam	SUMO-1	Activates transcription, DNA binding
S282	Phosphorylation	E ₂	CK2	Inhibits transcription
S294	Phosphorylation	E ₂	ND	Activates transcription
K268	Acetylation	E ₂	p300	Activates transcription
	Sumoylation	E ₂ , Tam	SUMO-1	Activates transcription, DNA binding
S282	Phosphorylation	E ₂	CK2	Inhibits transcription
S294	Phosphorylation	E ₂	ND	Activates transcription
K299	Acetylation	Constitutive	p300	Inhibits transcription
	Sumoylation	E ₂ , Tam	SUMO-1	Activates transcription, DNA binding
K302	Acetylation	Constitutive	p300	Inhibits transcription
	Sumoylation	E ₂ , Tam	SUMO-1	Activates transcription, DNA binding
	Ubiquitination	Constitutive, E ₂ , ICI	Ubiquitin	Proteasomal degradation
	Methylation	Constitutive	SET7	Activates stability
K303	Acetylation	Constitutive	p300	Inhibits transcription
	Sumoylation	E ₂ , Tam	SUMO-1	Activates transcription, DNA binding
	Ubiquitination	Constitutive, E ₂ , ICI	ubiquitin	Proteasomal degradation
S305	Phosphorylation	ND	PAK1	Activates transcription
		ND	PKA	Activates transcription
		ND	Akt	Resistance to AI
T311	Phosphorylation	E ₂	p38-MAPK	Nuclear localization
C447	Palmitoylation	Constitutive	PAT	Plasma membrane localization
Y537	Phosphorylation	E ₂	Calf uterine kinase	E ₂ binding
		Constitutive	Src	Dimerization, DNA binding
		Constitutive	Src	E ₂ binding
		EGF	EGFR	Proliferation
S559	Phosphorylation	Constitutive	CK2	Inhibits transcription

Table 5: Modified residues of ER α and their functions. ND: Not determined, ROS: Reactive Oxygen Species, CK2: Casein Kinase 2, PMA: Phorbol Myristate Acetate (Le Romancer et al., 2011)

II. PTM regulating the non-genomic pathway

Our team clearly demonstrated that arginine methylation is a crucial step in the activation of the non-genomic pathway by estrogens. Following estrogen exposure, ER α is methylated on Arginine 260 by the Protein MethylTransferase 1 (PRMT1) (Le Romancer et al., 2008). This methylated form of ER α is exclusively cytoplasmic and is an essential prerequisite for the formation of the ER α /Src and PI3K complex. The methylation of ER α is rapid and transient and our team has identified the arginine demethylase JMJD6 to be involved in the negative regulation of the methylation process (Poulard et al., 2014, 2015).

Two other modifications are involved in the regulation of the non-genomic pathway. Palmitoylation of ER α on cysteine 447 which allows its anchorage to the plasma membrane and ER α phosphorylation of Tyrosine 537 which favors the interaction between Src and ER α through Src's SH2 domain (Migliaccio et al., 2000).

In the proposed model of ER α non genomic pathways, steroid deprivation induces palmitoylation of an ER α pool which localizes to the plasma membrane through association with Caveolin-1. Estrogen binding to the receptor induces a conformational change which leads to the disruption of the Caveolin-1/ER α complex. ER α dimerizes and can be methylated by PRMT1 and phosphorylated on tyrosine 537 by Src. This induces the recruitment of the Src/PI3K complex to induce downstream Akt signaling and downstream signaling cascades and physiological responses (Le Romancer et al.).

III. PTM deregulated in breast cancer

Owing to the different and dynamic roles brought about by protein modifications, their implication in breast cancer cannot be neglected. The use of histone deacetylase inhibitors in certain cancers has shown some promising results, but these approaches need, for obvious reasons, to be more targeted (Mottet and Castronovo, 2010). A few post translational modifications of ER α have been found in breast cancer with respect to their expression levels.

a. Serine 118

High Serine 118 phosphorylation on ER α has been found in low grade tumors with a good prognosis (Murphy et al., 2004). Furthermore, it has been concluded that this modification is associated with a better response to endocrine therapies such as tamoxifen and anti-aromatases (Generali et al., 2009).

b. Serine 167

In ER α positive tumors, phosphorylation of serine 167 is associated with good prognosis and an increase in global survival and disease free survival (Jiang et al., 2007).

c. Arginine 260

Our team demonstrated, using a specific antibody recognizing methylated R260 in IHC, that cytoplasmic methylated ER α expression is increased in 50% of mammary tumors (Le Romancer et al., 2008). Our team later demonstrated that tumors expressing high levels of methylated ER α had a higher expression of the ER α /Src and ER α /PI3K complexes. This also correlated with an increase in phosphorylated Akt in these tumors. We found that patients with tumors expressing high levels of these complexes had a poorer outcome in terms of disease free survival (Poulard et al., 2012).

d. Lysine 303

A study revealed that 505 of breast tumors have a somatic A908G mutation conducting to the lysine being replaced by an arginine. This modification is associated with a poor prognosis and induces a hypersensitivity of cells to estrogen (Herynk et al., 2007). This suggests that this lysine has a very important role to play in ER α regulation and it is subject to many PTM such as acetylation, ubiquitination and simulation.

e. Serine 305

Phosphorylation of ER α on serine 305 seems to play a role in tamoxifen resistance. It is a target site for PKA and induces a conformational change allowing the fixation of ER α with SRC-1 despite the presence of tamoxifen and therefore leads to an agonist action of tamoxifen on the receptor (Zwart et al., 2007).

These new data suggest that ER α PTM can be considered as new predictive and prognostic markers in breast cancer. In this objective the decrypting of all modified sites and mechanisms hold a huge potential in developing targeted therapies in breast tumorigenesis.

Chapter 3: ER α -36

Several reports indicated that three predominant bands of 36, 46 and 66kDa had been identified in western blots probed with hER α antibodies targeting the ligand-binding domain. In 2005, Z.Y Wang identified a full-length clone from a normal endometrium cDNA library (Genbank BX640939) encoding a 310aa ORF. This cDNA sequence matched 100% the DNA sequences of exons 2-6 of hER α genomic sequence (Wang et al., 2005).

1. Chromosomal disposition and generation

The human *ESR1* gene has been discussed in chapter 2. ER α -36 transcription is initiated from a previously unidentified promoter in the first intron of the *ESR1* gene. Transcription starts with a novel small exon located in the first intron of ER α , named exon 1'. This non-coding exon 1' is spliced directly onto exon 2 of *ESR1* and continues from exon 2 to exon 6.

While studying the 3' end of ER α -36 cDNA, Z.Y Wang found that the C-Terminal 27 amino acids and the 4293bp 3' untranslated region matched a continuous region 64,241bp downstream of the *ESR1* gene. This previously undescribed exon in has thus been designated Exon 9, to reflect the additional exon beyond the previously described 8 *ESR1* exons (Wang et al., 2005).

The hER α -36 protein is initiated from a favorable Kozak sequence located in the *ESR1* exon 2, which is the same used to generate ER α 46. The resulting hER α -36 protein differs from ER α by lacking both AF1 and AF2 transcription transactivation domains. ER α -36 retains the DNA binding, dimerization and partial ligand binding domains. Alternative splicing onto exon 9 confers it with a unique 27aa C-Terminal Domain that replace the last 138 amino acids encoded by exons 7 and 8 of the *ESR1* gene (Figure 19).

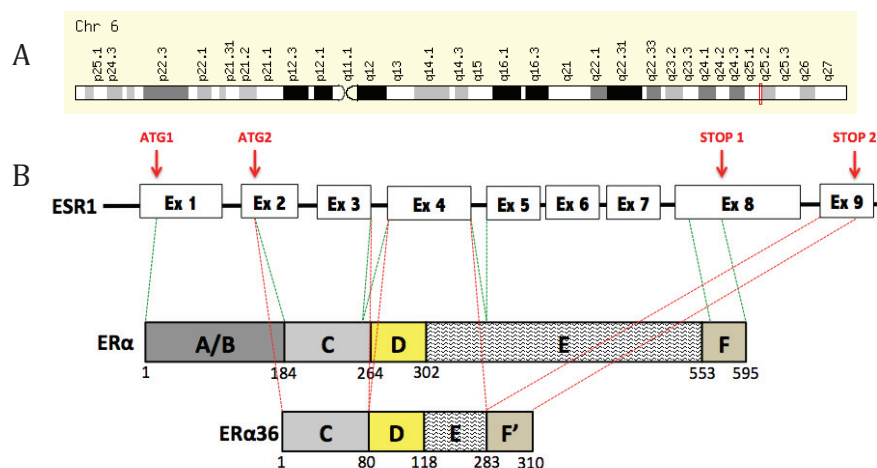

Figure 19: Chromosomal disposition of ER α -36. A: Chromosomal location of the *ESR1* locus (red). B: Genomic disposition of the different exons of the *ESR1* gene. AUG in exon 1 is used to initiate ER α while the AUG in Exon 2 is used to initiate both ER α 46 and ER α -36. The lower panel shows a representation of the resulting ER α -36 protein compared to ER α .

2. Regulation of expression

Like all other genomic elements, the ER α -36 gene is subject to regulation by its promoter and several other transcription factors and co-factors.

A. Promoter Organization

The molecular region corresponding to the promoter of ER α -36 has been identified and cloned in 2009. Sequence analysis revealed that the 5' flanking region contains a high G/C content, a non-canonical TATA box, but lacks the CCAAT box. A number of SP1 and AP1 sites were also identified in the 5' flanking region of ER α -36. The promoter region of ER α -36 also contains putative binding sites for the following transcription factors: AhR (Aryl Hydrocarbon Receptor), Erg-1 (ETS-related gene 1), NF- κ B (Nuclear Factor Kappa B), WT1 (Wilms' tumor suppressor), PU.1, GATA-1, Elk-1 and GR (Glucocorticoid Receptor) (Figure 20). The region is devoid of a consensus palindromic ERE site but however contains an imperfect half site located at -369 to -365, relative to the transcription initiation site.

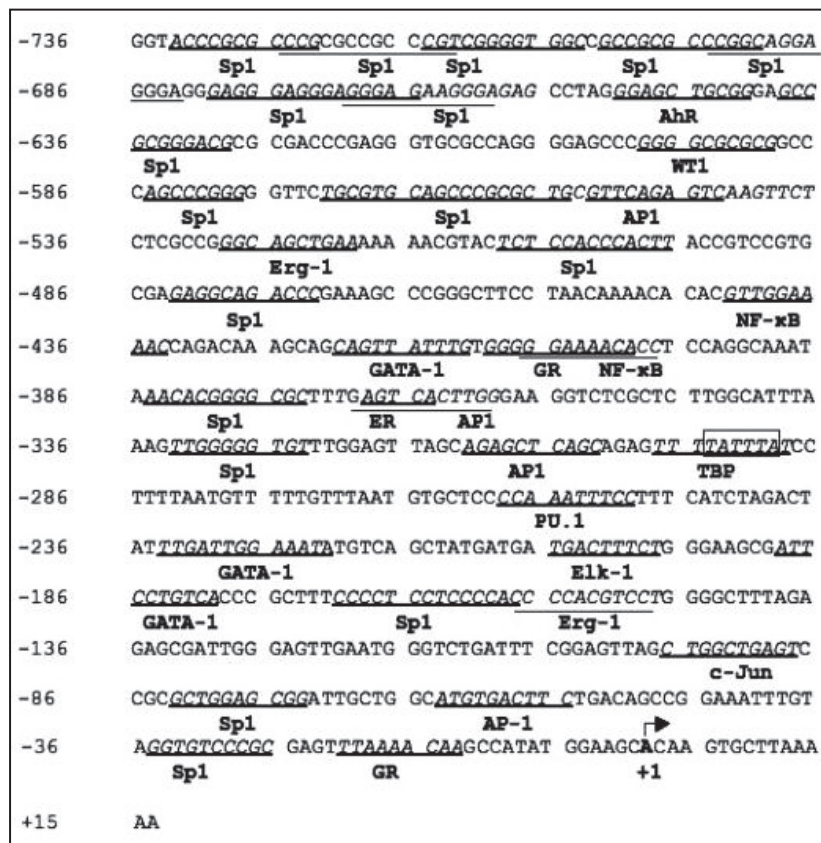

Figure 20: Map of the 5' sequence flanking ER α -36 transcription start site. +1 designates ER α -36 TSS.

B. Transregulatory Elements

I. ER α

Using the promoter region of ER α -36 in ER α negative HEK293 cells, it was shown that ER α can negatively regulate the transcription of ER α -36. This has been shown to be mediated through the imperfect ERE found in this region (Kang et al., 2011a).

II. WT1

Through silencing and luciferase approaches, a study has identified the Wilms' tumor suppressor to be a negative regulator of ER α -36 transcription. WT1 exists as four different isoforms and all four had the ability to negatively impact ER α -36 transcription. ER α -36 promoter analysis revealed the existence of two putative WT1 binding sites in this region, one located upstream and the other located downstream of the TATA box. Interestingly, WT1 has been shown to upregulate ER α transcription, consistent with the idea that it functions to oppositely regulate the promoter activities of ER α and ER α -36 (Kang et al., 2011a)

III. EGFR

EGFR signaling has been shown to positively regulate ER α -36 expression (Rao et al., 2011). Through luciferase assays and using specific EGFR inhibitors, it was concluded that EGFR signaling had a three-fold increase effect on ER α -36 promoter activity. Further assays using truncated promoters of ER α -36 showed that EGFR acted via an AP1 binding site in the ER α -36 promoter region (Yin et al., 2014).

IV. HER2

Using similar luciferase approaches in combination with the HER2 inhibitor Lapatinib, a study has shown that HER2 signaling can positively regulate ER α -36 promoter activity through the action of an AP1 binding site located upstream of the ER α -36 transcription initiation site (Kang et al., 2011b; Rao et al., 2011; Yin et al., 2014).

V. BMP2

Bone Morphogenetic Protein 2 has been described to upregulate ER α -36 expression in ER α -positive MCF7 and ER α -negative MDA-MB-231 cells through activation of the Smad pathway and this study supposed direct interactions between members of the Gab Family and ER's (Wang et al., 2012a).

C. Action of molecules

Besides the involvement of signaling pathways and transcription factors, some molecules have been reported to have an effect on ER α -36.

I. Tamoxifen

Through a positive regulatory loop involving EGFR, chronic exposition of MCF7 cells to tamoxifen has been reported to increase intracellular levels of ER α -36. This goes together with the fact that MCF7 cells rendered resistant to tamoxifen express higher levels of ER α -36 (Zhang et al., 2011a).

II. Brousoflavonol B

Brousoflavonol B (5, 7, 3', 4'-tetrahydroxy-3-methoxy-6,8-diprenylflavone) is a flavonoid purified from the bark of the paper mulberry tree. It has been shown to process a strong inhibitory effect on the proliferation of MCF7 and SKBR3 cells. Furthermore, Brousoflavonol B has successfully inhibited the growth of breast cancer stem cells and induced the differentiation of breast cancer stem-like cells (Guo et al., 2013a). A study revealed that the effects of this molecule had to do with its ability to strongly downregulate ER α -36 expression. Alongside downregulating ER α -36, Brousoflavonol B can also lead to the downregulation of HER2. It is supposed that this molecule acts on ER α -36 through the abolition of the positive feedback loop between ER α -36 and HER2 (Guo et al., 2013b; Yin et al., 2014).

III. Icaritin

Icaritin is a flavonoid isolated from the Chinese herb *Herba Epimedii*. It has been shown, like other flavonoids, to exert estrogen antagonist-like action. A brief report suggested that Icaritin might act as a SERM for ER α -36, thereby downregulating its expression levels. A phase I clinical trial is currently evaluating the use of Icaritin as an ER α -36 modulator in advanced breast cancer patients (Source: ClinicalTrials.gov).

3. Cellular Localization

ER α has been described to localize mainly in the nucleus when detected by IHC. This is mainly due to the presence of three NLS in its hinge domain. However, cell fractionation experiments revealed that unlike ER α , ER α -36 mainly localizes outside the nucleus. In fact, 50% of ER α -36 localizes at the plasma membrane, 40% in the cytoplasm and 10% of ER α -36 localizes in the nucleus. This result has been confirmed by IF and IHC using antibodies directed specifically at ER α -36 in numerous other studies (Rao et al., 2011; Weidle et al.). Further data show that the membrane fraction of ER α -36 colocalized perfectly with lipid rafts and Caveolin-1. The mechanism by which ER α -36 localizes to the plasma membrane is not clear. It has no N-Terminal Signal Peptide and retains the three NLS present in ER α .

A. Potential Myristoylation of ER α -36

Three potential myristoylation sites have been identified in ER α -36, which are conserved in ER α , residues 25-30 (GVWSCE), 76-81 (GMMKGG) and 171-176 (ELLTNL). This finding raised the possibility of myristoyl residues participating in the localization of ER α -36 to the plasma membrane (Wang et al., 2005).

Of note, these three putative myristoylation sites are localized proximal to the N-Terminus of the protein, a localization that favors myristoylation. These sites are located far away in ER α but when it comes to ER α -36 and ER α 46, they are well positioned to confer these two proteins the ability to locate to the plasma membrane (Wang et al., 2005).

B. Interaction with GP96

GP96 is an endoplasmic reticulum resident member of the cytosolic Heat Shock Protein 90 (HSP90) family. Interestingly, GP96 has been shown to translocate to the plasma membrane in certain tumor cells. It has been shown that ER α -36 can bind to GP96 at the plasma membrane. Invalidation of GP96 leads to a delocalization of ER α -36 from the plasma membrane and a loss in its stability through proteasomal degradation (Hou et al., 2015).

4. Ligand Binding Properties

Alternative splicing of *ESR1* exon 6 directly onto exon 9 in ER α -36 depletes it of exons 7 and 8. These exons in the structure of ER α are responsible for the formation of part of the ligand binding pocket and the AF2 domain and consequently, the classical C-Terminal Domain of ER α . When the structure of ER α -36 is analyzed, it does not possess a complete ligand-binding domain. Indeed, of the 12 helices required to form the ligand binding pocket in ER α (helices 1-12), it has been observed that ER α -36 lacks helices 9-12. This modification leads to a more open ligand-binding pocket, which is believed to confer ER α -36 the ability of binding a broader spectrum of ligands other than classical ER α ligands.

Various studies have depicted the role of E2 binding to ER α -36 to activate extra nuclear estrogen signaling. Most of these studies have been carried out in ER α positive MCF7, T47D and H3396 cell lines. In fact, overexpression or silencing of ER α -36 in these cell lines consequently affected the non genomic signaling mediated by E2 (Deng et al., 2014a; Wang et al., 2014; Zhang et al., 2012c). Other studies have revealed that E2 can also mediate non-genomic signaling through ER α -36. (Shi et al., 2010).

Tamoxifen is a widely used Selective Estrogen Receptor Modulator (SERM) to treat ER α positive breast cancers. It functions by occupying the LBD, thereby preventing fixation of estrogen and hence abolishes estrogen action. However, tamoxifen has been shown to have agonist actions on ER α in non-breast tissues, in the bone, liver or uterine cells for instance (Lin et al., 2010).

Studies have demonstrated that tamoxifen acts as an agonist through ER α -36 to activate estrogen non genomic signaling in breast cells (Shi et al., 2010).

Fulvestrant (ICI 182, 780) forms part of a family of molecules known as Selective Estrogen Receptor Downregulators (SERD). In contrast to SERM, they function by binding to ER α , which in turn leads to an accelerated degradation of the receptor by the proteasome pathway. SERD have effectively been used to treat ER α positive metastatic breast cancer.

In 2006, Z.Y Wang demonstrated that Fulvestrant could have an agonist action through ER α -36 to mediate rapid activation of the estrogen non-genomic signaling in breast cells. This controversial data can be explained by the fact that Helix12 of the LBD of ER α is important for fulvestrant-mediated degradation of the receptor, which is absent from the structure of ER α -36. Besides, the open conformation of the LBD in ER α -36 could explain the differential action between ER α and ER α -36.

Using the endometrial ER α and AR negative Hec1A cell line, Shi et al demonstrate that testosterone can bind to ER α -36 to mediate non-genomic signaling in a similar manner as estrogen. The authors suggest that this might be an explanation for the elevated risk of endometrial cancer in women with higher plasma levels of testosterone (Lin et al., 2009) .

The orphan G-Protein coupled receptor GPR30 has been a matter of great controversy in the estrogen receptor field for decades. Indeed there have been reports of GPR30 mediating rapid estrogen signaling via activation of the MAPK/AKT pathways(Filardo et al., 2000). Thus GPR30 has long been considered as a novel type of extranuclear ER (Filardo et al., 2007). Studies have used G1, a selective GPR30 agonist, to demonstrate that it can specifically bind to ER α -36 to mediate non-genomic signaling. Furthermore the authors demonstrate that GPR30 mediates its actions via upregulation of ER α -36 but G1 still functioned as a normal ER α -36 ligand in cells knocked down for GPR30 expression (Kang et al., 2010).

Z.Y Wang used ER α -36 overexpressing HEK293 cells to demonstrate that taken altogether, Estrone (E1), Estriol (E3) and Estetrol (E4), could activate the non-genomic pathway through ER α -36 (Liu et al., 2015; Su et al., 2014) .

Taken altogether, these observations help to conclude on the broader and more diverse ligand bonding spectrum of ER α -36 to mediate downstream cellular signaling pathways.

5. Signaling Pathways of ER α -36

The main cytoplasmic and membrane localization of ER α -36 led to believe that it could be involved in rapid extranuclear non-genomic signaling. Indeed, since its identification in 2005, ER α -36 has been shown to be involved in various rapid cytoplasmic non-genomic events.

A. The Src pathway

The Src pathway has been the first to be studied when it comes to ER α -36 signaling. Besides ER α -36's ability to physically associate with Src in an estrogen dependent manner (Gu et al., 2014), ER α -36 has been reported on several accounts to induce Src phosphorylation on Tyrosine 416, indicating its activation (Wang et al., 2013; Zhang et al., 2011a). Furthermore, other ER α -36 ligands, such as Tamoxifen and Fulvestrant (ICI182,780) have been reported to induce Src Y416 phosphorylation. In line with these findings, ER α -36 activity has been shown to reduce Src phosphorylation on Tyrosine 527 which represents an inactivation of Src. Src activation through ER α -36 has been demonstrated in both ER α positive MCF7 cells, and also ER α negative MDA-MB-231 and SKBR3 cells (Zhang et al., 2012b).

B. The PI3K/Akt pathway

In response to E2 or tamoxifen stimulation, ER α -36 has been reported to activate the PI3K/Akt pathway in endometrial cells. In fact, ligand treatment induces a rapid and transient increase in the phosphorylation of AKT. Furthermore, pretreatment of cells with a PI3K inhibitor (LY294002) abrogated ligand induced Akt activation confirming the involvement of PI3K in ER α -36 mediated PI3K signaling (Deng et al., 2014b; Fu et al., 2014; Lin et al., 2009).

C. The EGFR Pathway

ER α -36 has been described to interact with the EGFR pathway by inducing the phosphorylation of EGFR on Tyr 845 after estrogen or tamoxifen treatment. ER α -36 acts on EGFR by activating Src, which in turn leads to the phosphorylation and activation of EGFR. Furthermore, there appears to be a positive feedback loop between EGFR and ER α -36. Indeed, when ER α -36 is silenced, there is a significant decrease in EGFR protein without any change in EGFR mRNA levels. This has led to the conclusion that ER α -36 stabilizes EGFR through prevention of its degradation (Zhang et al., 2011a). In addition to the above, activated EGFR has been shown to upregulate ER α -36 promoter activity, thereby increasing ER α -36 transcription (Su et al., 2014).

D. The PKC Pathway

ER α -36 has been shown to activate Protein Kinase C (PKC) upon treatment with E2 and more particularly BSA-conjugated E2 demonstrating that the membrane fraction of ER α -36 is involved in this activation (Chaudhri et al., 2012; Tong et al., 2010). These results have been reproduced in MCF7, HCC38 breast cell lines but also in Ishikawa endometrial cells. Use of a PKC inhibitor in both cases completely abrogated ER α -36 mediated rapid ERK 1/2 phosphorylation. Data also suggested that the estrogen induced activation of PKC through ER α -36 will stabilize k-Raps through the inhibition of its proteasomal degradation (Koo et al., 2015).

E. The ERK Pathway

The MAPK pathway has been the most extensively studied in ER α -36 signaling. It has first been described in endometrial Ishakawa cells. Both estrogen and tamoxifen have been shown to activate the phosphorylation of ERK in a rapid and transient manner (Rao et al., 2011). Further studies confirmed these data in ER α -36 transfected MCF7 cells and in ER α negative MDA-MB-231 and MDA-MB-436 cells (Rao et al., 2011; Shi et al., 2010).

In terms of ligands, E2-BSA has been shown to induce ERK phosphorylation through ER α -36, and this activation was blocked when cells were pretreated with an ER α -36 specific antibody. Furthermore, ICI 128,780 has also been described to induce ERK phosphorylation through ER α -36 (Rao et al., 2011).

Further studies demonstrated that upon ERK activation by ER α -36, ERK could regulate the promoter activity of the transcription factor Elk-1. In line with these observations, use of a MEK Inhibitor U1026 abrogated ligand induced ER α -36 dependent ERK phosphorylation.

F. Involvement of Synuclein Gamma

Synuclein gamma has been identified as a breast cancer specific gene, which participates in the HSP90-based multi chaperone complex for steroid receptors. It has been shown that Synuclein gamma significantly enhanced ERK1/2 activation by ER α -36 in MCF7 cells. It functions by acting as a chaperone for ER α -36 through direct physical interaction. It binds to ER α -36 in the presence of E2 and potentiates its non genomic signaling activity (Shi et al., 2010).

G. Cyclin D1

The main described genomic downstream effect of ER α -36 signaling to be described is an increase in CyclinD1 transcription (Tong et al., 2010) which is involved in cell proliferation. Several reports show that estrogen and anti-estrogens (Tamoxifen, ICI182,780) activation of ER α -36 will result in increased cellular levels of CyclinD1 mainly through the activation of Src and EGFR (Wang et al., 2014; Zhang et al., 2012b).

It is of interest to note that the Cyclin D1 promoter contains consensus gamma interferon activation sites (GAS) for the activation of transcription through STAT5. In an attempt to evaluate whether estrogen/anti-estrogen mediated Cyclin D1 transcription involved STAT5, X.T Zhang demonstrated that following ER α -36 ligand treatment and through the activities of Src and EGFR, CyclinD1 transcription requires STAT5 binding to its promoter (Zhang et al., 2012c).

H. C-Myc Induction

In parallel to cyclin D1 induction, there has been a report of ER α -36 for its ability to induce transcription of the oncogene C-Myc. This induction is

dependent on the ER α -36 mediated ERK activation. MDA-MB-436 cells knocked for ER α -36 lost E2 dependent c-Myc activation (Guo et al., 2013b; Lin et al., 2010).

I. Jun Pathway

ER α -36 has been reported to have a positive regulatory effect on the Jun pathway. Indeed a knockdown of ER α -36 consequently reduced the Jun pathway and sensitized cells to paclitaxel treatment (Gu et al., 2014; Zhang et al., 2012a).

J. Biphasic Ligand Effects

ER α -36 signaling has been shown to be dependent ligand concentration. In fact ER α -36 has been shown to activate Src in a ligand concentration dependent manner. When used at relatively low concentrations (1nM), ER α -36 mediated Src activation by Y416 phosphorylation (Wang et al., 2014; Zhang et al., 2012c). On the other hand, when used at relatively higher concentrations, various ER α -36 ligands including E2, Tamoxifen and ICI 182,780, did not induce Src Y416 phosphorylation, but rather led to Src phosphorylation on Y526, which leads to its deactivation (Zhang et al., 2012b). This has also been shown to impact on ER α -36 mediated Cyclin D1 transcription, which comforts with the finding that ER α -36 can effect its signaling in a biphasic manner.

6. Physiological Consequences

In response to the vast array of signaling pathways described for ER α -36, there have been reports of the physiological responses of these pathways in cell lines and in vivo.

A. Proliferation

ER α -36 has been shown to be involved in the proliferation of MCF7 cells under E2 or Tamoxifen treatment. Furthermore, it participates in a ligand dependent manner to promote anchorage independent growth of MCF7 and T47D cells. More recently, ER α negative HCC38 cells have shown an increased cell proliferation and DNA synthesis through ER α -36 (Chaudhri et al., 2012).

B. Stemness

Aldehyde Dehydrogenase enzyme expression is a well-characterized hallmark of cancer stem cells. Interestingly, there has been report of a relatively high expression of ER α -36, suggesting that ER α -36 expression is associated with stem cell like properties (Deng et al., 2014a).

Further reports indicate that a knockdown of ER α -36 leads to reduced CD44⁺/CD24⁻ cells in breast cell tumorspheres. Accordingly, E2, tamoxifen and ICI182,780 treatment of spheres dramatically increases the CD44⁺/CD24⁻ cell population in spheres (Deng et al., 2014a). ER α -36 has

thus been described as one of the components, which participates in the maintenance of breast cancer stem cells in ER α positive tumors.

In line with these observations, another study confirmed that ER α -36 expression positively enriched the ALDH⁺ subpopulation in ER α negative SKBR3 cells, suggesting that ER α -36 could also have a role in the maintenance and proliferation of ALDH⁺ breast cancer cells (Kang et al., 2011b).

C. Neuroprotective effect

Estrogen receptor ER α has been described to have neuroprotective effects. A recent study carried out in SH-SY5Y and IMR-32 human neuroblastoma cell lines have demonstrates that E2 and the GPR30 agonist G1 confer a protective effect against H₂O₂ stress through ER α -36 (Han et al., 2015; Zou et al., 2015). Knockdown of ER α -36 in these cells resulted in a loss of the protective effect mediated by either ligand. The neuroprotective effects mediated by ER α -36 seem to be effected through the simultaneous activation of the MAPK and the AKT pathways.

D. Apoptosis

ER α -36 has been reported to have an anti apoptotic effect in HCC38 cells. Indeed, E2 and E2-BSA treated cells had a significantly higher resistance to taxol induced apoptosis. HCC38 cells knocked down for the expression of ER α -36 completely lost the ER α -36 mediated anti-apoptotic property (Chaudhri et al., 2014).

E. Migration & Invasiveness

ER α -36 has been identified as a positive regulator of migration and invasiveness through scratch assays performed in ER α negative HCC38 cells. Use of a blocking antibody abrogated this E2 dependent effect proving that the membrane signaling meaning from ER α 36 is responsible for the migratory phenotype. Furthermore ER α -36 has been found to upregulate EMT factors like Snail, while it's activity down regulated epithelial markers like E-Cadherin (Zhang et al., 2012a). These findings suggest that ER α -36 has a crucial role to play in invasive and metastatic tumor phenotypes (Chaudhri et al., 2012)

F. Anti-inflammatory action

A study carried out on Peripheral Mononuclear Cells from healthy patients showed that ER α -36 was the only ER to be expressed in these cells. Furthermore, when these cells are primed for inflammation by LPS treatment, parallel treatment with E2 dramatically decreased the secretion of pro-inflammatory cytokines IL6 and TNF α . ER α -36, under E2 activation was found to inhibit transcription of these pro-inflammatory cytokines by direct binding to the p65 subunit of the well known transcription factor NF κ B (Ohshiro et al., 2012). Further studies show that these cells still maintain the expression of ER α -36 after their differentiation to macrophages suggestion

that ER α -36 might have an inflammatory role in normal human tissues (Pelekanou et al., 2016)

7. Involvement in Cancer

A. Breast Cancer

Numerous studies have analyzed the expression of ER α -36 in breast tumor samples (Wang and Yin, 2015).

Most of the studies point towards a negative role of ER α -36 since its expression has been associated with poorer DFS. Furthermore, ER α -36 expression constitutes an independent marker of tamoxifen resistance. Indeed, women with high ER α -36 expression had much less benefit from tamoxifen treatment than women who expressed low levels of ER α -36.(Shi et al., 2009). Otherwise, ER α -36 expression has been found to be positively correlated to HER2 expression (Gu et al., 2014) which makes sense, knowing that there exists a positive feedback loop between both actors.

Further analyses revealed that ER α -36 was more likely to be expressed in a particular subtype of tumors. Indeed its expression was found mostly in apocrine and adenoid cystic carcinomas of the breast (Vranic et al., 2011). The two types of breast tumors are characteristically negative for ER α expression.

Using quantification of ER α -36 mRNA on 74 breast cancer samples and their normal matched tissues, one study reported that ER α -36 was down regulated in breast tumors when compared to normal tissues. Furthermore, the authors correlated low ER α -36 expression with local progression, lymph node metastasis and advanced cancer stage (Zheng et al., 2010).

B. Gastric Cancer

ER α has been found to be a marker of poor prognosis among patients with gastric cancer. There have been two independent clinical studies regarding the expression of ER α -36 in gastric cancer.

A first study on 45 patients who underwent curative resection of gastric cancer showed that ER α -36 mRNA was significantly higher in normal gastric tissues than in the matched cancerous tissues. Among these patients, tumors expressing high levels of ER α -36 mRNA had less lymph node metastasis and tumors of smaller sizes. Other studies provided similar results(Wang et al., 2012b).

A second study of ER α -36 expression by IHC and western blotting in a cohort of 117 gastric adenocarcinomas showed that ER α -36 expression positively correlated with age, male gender and serosal invasion. IHC also confirmed the membrane expression of ER α -36. Furthermore western

blotting revealed that ER α -36 expression positively correlated with expression of CyclinD1(Deng et al., 2010) .

C. Lung Adenocarcinoma

ER α -36 expression has been evaluated by IHC on a cohort of 126 tumor resections. The study revealed a high tendency of ER α -36 to associate with adenocarcinoma rather than squamous cell carcinoma. In 92% of cases, high ER α -36 expression was associated with lymph node metastasis (Zhang et al., 2014). In adenocarcinoma patients, high ER α -36 expression was associated with poorer prognosis in terms of Disease Free Survival (DFS) and Overall Survival (OS). No such difference has been observed in patients with squamous cell carcinoma. Multivariate analysis show that ER α -36 is an independent prognostic marker for DFS (Zhang et al., 2014).

D. Renal Cell Carcinoma

ER α -36 expression has been studied by IHC in 125 cases of renal cancer. Pericarcinous and benign renal tumors showed a faint staining for ER α -36. Its expression seemed to be limited to the cytoplasm and plasma membrane of cancer cells. ER α -36 expression positively correlated with tumor size, clinical stage and necrosis. More necrosis was observed when ER α -36 had a membranous expression. Patients with high ER α -36 staining had a poor clinical outcome in terms of DFS and OS. Furthermore patients with membrane ER α -36 expression had a worse prognosis. Multivariate analysis on this cohort showed that ER α -36 is an independent predictor of shorter DFS and ER α -36 membrane expression is a significant predictor of shorter DFS and OS (Wang et al., 2015).

E. Colorectal Cancer

35 malignant colorectal tumors and their normal matched tissues were analyzed for ER α -36 expression by RT-PCR. The authors found that ER α -36 expression was correlated to that of ER α 46 and that is was down regulated in 71% of colorectal cancers while compared to the normal tissues. ER α -36 expression was inversely correlated to lymph node metastasis (Jiang et al., 2008).

Chapter 4: Breast Cancer Therapy and Resistance Mechanisms

Various approaches are used to treat breast cancer which is a complex and diverse disease. The major approach to treating breast cancer remains surgical removal of tumor tissue coupled or not with radiotherapy. Besides these, there are systemic treatments such as chemotherapy or targeted treatments like hormonotherapy and other molecular targeted approaches. These treatments significantly impact on breast cancer remission and survival.

1. Breast Cancer Treatments

A. Surgery

Breast cancer surgery is a local treatment to control the tumor. When the latter is too voluminous, a neo-adjuvant therapy is administered to shrink tumor volume before surgery. Two types of breast surgeries are currently practiced: tumorectomy whereby only the tumor and some surrounding breast tissue, and mastectomy where the whole breast tissue is removed. In both cases, sentinel lymph node is analyzed to evaluate if cancer cells have migrated through the lymphatic system. Following breast surgery, a systemic treatment can be proposed to decrease the risk of tumor reappearance or metastasis.

B. Radiotherapy

Radiotherapy generally follows breast cancer surgery. It helps in preventing local relapse. Radiotherapy can also be applied to axillary lymph nodes if they are present with tumor cells. In some cases, curietherapy can also be given to the patient where radioactive sources are implanted in the tumor core or around the tumor to target it directly.

C. Chemotherapy

Most commonly administered through intravenous way, chemotherapy is a way of destroying proliferating cells. They can be used alone or more frequently in combinations. However these treatments are not specifically targeted to tumor cells. **Paclitaxel** which forms part of the taxane family of molecules inhibit microtubule depolymerization thereby leading to a mitotic catastrophe. **Cyclophosphamide** which is an alkylating agent. In functions by alkylating DNA thus inhibiting replication. **Doxorubicin**, of the family of anthracyclins, which intercross with DNA and are Topoisemerase I inhibitors. They also function through inhibition of DNA replication. **Fluoro-uracil**, an anti-metabolite which gets incorporated into RNA molecules and leads to transcription failure and cell death. **Methotrexate** which inhibits dihydrofolate reductase, thereby inhibiting folic acid synthesis and blocks mitotic cells in the S-phase.

D. Targeted Therapies

I. Hormonotherapy

a. Anti-Estrogens

These can be classified into two main categories:

- Selective Estrogen Receptor Modulators (SERM) which include tamoxifen and its analogs (raloxifen, toremifen and arzoxifen). These can act as antagonists or agonists depending on the tissular context.
- Selective Estrogen Receptor Downregulators (SERD) or pure anti-estrogens which are devoid of any agonist activity and induce ER α degradation

About 80% of breast tumors express ER α and are defined as being hormone-dependant. Despite their early discovery in 1963, anti-estrogens have not been used to clinically treat breast cancer until the 1970 (Lerner and Jordan, 1990), where tamoxifen was discovered. It became the standard treatment for targeted hormone-therapy (Lerner and Jordan, 1990). It reduced breast cancer relapse by 50% and reduces breast cancer related death by almost 35% annually.

Tamoxifen binds to ER α and induces a conformational change in the receptor structure which renders it only partially active, and thereby reduces its ability to induce gene expression (Jordan, 1994). Furthermore, tamoxifen bound ER α will recruit co-repressor complexes and histone deacetylases, which leads to transcriptional arrest.

However tamoxifen, while exhibiting antagonist estrogen effects in breast tissue, has been reported to have an agonist effect in the endometrium, increasing the risk of cervical cancer.

Pure anti-estrogens have been discovered in 1987 and the molecule ICI 182,780 is the most active one of them (Wakeling et al., 1991). It binds to ER α and prevents its nuclear import and directs it to the endoplasmic reticulum where ER α is ubiquitinated and undergoes proteosomal degradation (Wakeling, 1991). This molecule, also called Fulvestrant or Faslodex has been used to treat metastatic hormone-dependent breast cancer where the use of tamoxifen has failed.

b. Anti-Aromatases

More recently, other endocrine therapies have been used, targeting the physiological synthesis of estrogens. Estrogen production relies mainly on the aromatization of endogenous androgens. Anti-aromatases such as Anastrozole or Letrozole target the enzyme responsible for this aromatization and reduce estrogen production in peripheral and adipose tissue (Simpson and Dowsett, 2002). These

molecules have been used successfully in post-menopausal women and have a high anti-proliferative activity. Anti-aromatases are also used in anti-estrogen resistant breast tumors. Side effects include skeletal disorders such as osteoporosis .

II. mTOR Pathway inhibitors

The mammalian target of rapamycin (mTOR) signaling pathway integrates both intracellular and extracellular signals and serves as a central regulator of cell metabolism, growth, proliferation and survival. Numerous cellular stimuli can lead to mTOR pathway activation such as tyrosine kinase receptors which constitute the canonical activation pathway but also other stimuli such as genotoxic stress, inflammation and hypoxia (Laplante and Sabatini, 2009).

The mTOR protein is a 289-kDa serine-threonine kinase that belongs to the phospho-inositide 3-kinase (PI3K)-related kinase family. mTOR nucleates at least two distinct multi-protein complexes, mTOR complex 1 (mTORC1) and mTOR complex 2 (mTORC2) (Zoncu et al., 2011).

mTORC1 is sensitive to rapamycin and is responsible for the majority of rapamycin-induced processes. It consists of mTOR, raptor, proline-rich Akt substrate 40 kDa, and LST8. It appears that all of these components are needed for mTORC1 activity. mTORC1 is regulated by numerous signaling pathways, including the PI3K/Akt pathway, which is activated by growth factors and known to be dysregulated in many cancers, resulting in the activation of Akt. This regulates mTORC1 by (1) phosphorylating the tuberous sclerosis complex 2, preventing it from forming a heterodimer with tuberous sclerosis complex 1, and (2) phosphorylating PRAS40, causing it to disassociate from mTOR. Both of these phosphorylations prevent the activity of the negative regulators of mTORC1 and increase downstream signaling by mTORC1. mTORC1 activation results in the downstream phosphorylation of two main effectors: eukaryotic translation initiation factor 4E-binding protein 1 (4EBP1) and ribosomal protein S6 kinase 1 (S6K1). Phosphorylation of 4EBP1 prevents it from binding to and inactivating eukaryotic translation initiation factor 4E (eIF4E). eIF4E is then capable of increasing cell proliferation, survival, and angiogenesis through increased messenger RNA (mRNA) translation of cyclin D1, Bcl-2, and vascular endothelial growth factor. S6K1 is also phosphorylated by mTORC1, resulting in the phosphorylation of several proteins, including ribosomal protein S6 and insulin receptor substrate-1. Phosphorylation of S6 ribosomal protein allows for the translation of mRNAs encoding for proteins and elongation factors, while phosphorylation of IRS-1 prevents insulin-induced signaling to Akt *via* the PI3K pathway, providing negative feedback to mTOR activation (Laplante and Sabatini, 2009).

The second mTOR complex, mTORC2, contains mTOR, LST8, and several unique proteins, including rictor (rapamycin-insensitive companion of mTOR). Rapamycin and its analogues do not bind directly to mTORC2, and mTORC2 functioning is not impaired with short-term rapamycin treatment. Although less is known about this complex than mTORC1, two major functions have been attributed to mTORC2: regulation and organization of the actin cytoskeleton and Akt regulation through phosphorylation of its carboxyl terminal. Phosphorylation of Akt by mTORC2, along with phosphorylation through the PI3K pathway, is required for full Akt activation (Zoncu et al., 2011).

The different interactions in this signaling pathway give rise to a complex network in the regulation of cell growth. Deregulation of this pathway has been linked to breast cancer progression and is also linked to resistance to endocrine therapies.

Three generations of inhibitors have been developed to target the mTOR pathway (Figure 21).

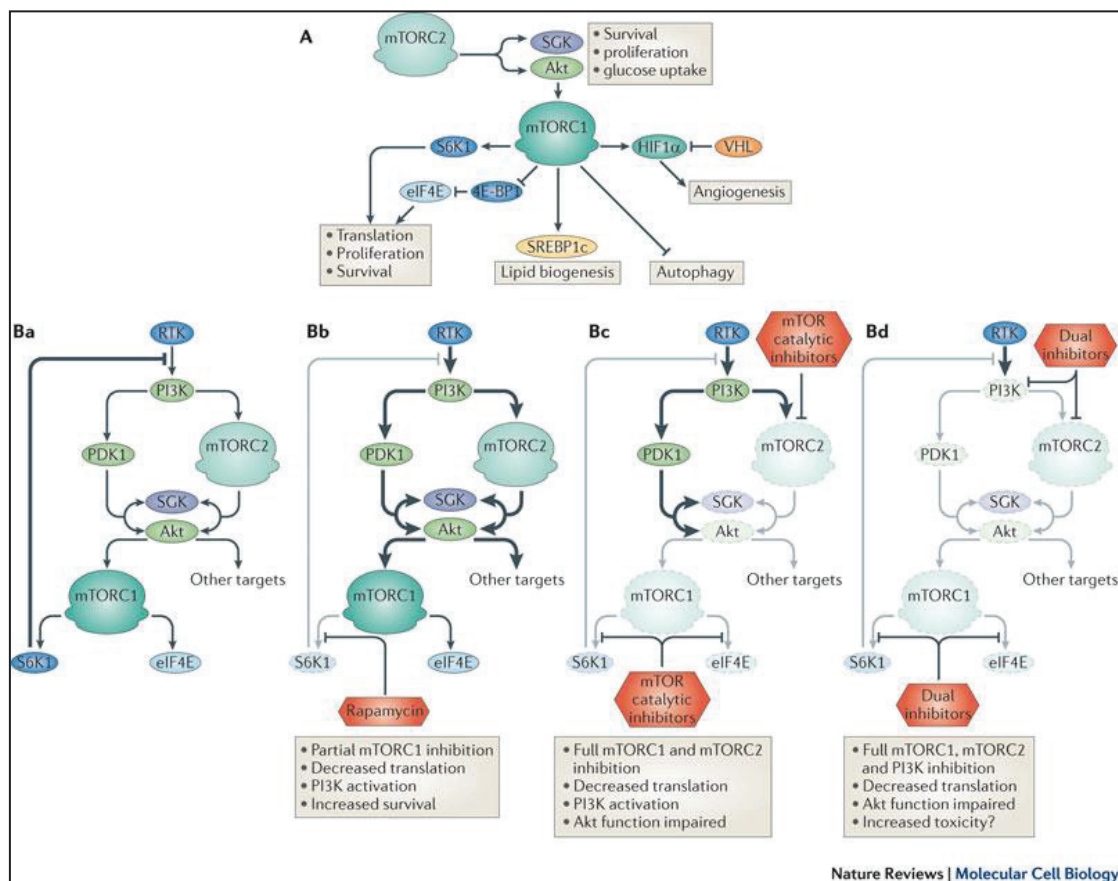

Figure 21: Overview of the mTOR signaling pathway. **A:** Physiological consequences of mTOR pathway activation with key protein actors. **Ba:** Interplay between the mTORC1 and 2 and main downstream effectors S6K1 and eIF4E. **Bb:** Mode of action of rapamycin and other rapalogues (first generation mTOR inhibitors). **Bc:** Mode of action of second generation inhibitors which suppress mTOR catalytic activity. **Bd:** Third generation mTOR inhibitors which suppress both mTOR activity and PI3K/Akt pathway (Zoncu et al., 2011).

The first generation of inhibitors of the mTOR pathway has focused on the use of rapamycin, along with three rapamycin analogues: temsirolimus, everolimus, and deforolimus. In vitro, Rapamycin and its analogues bind to their intracellular receptor, FKBP12, and this complex binds to mTORC1 at the FKBP12-rapamycin binding domain (FRB domain) that is adjacent to the kinase domain. This leads to a decrease in phosphorylation of the mTORC1 effectors 4EBP1 and S6K1 and a decrease in cell growth. Failure to inhibit mTORC2 is related to the fact that the FRB domain in this complex of mTOR is not accessible to the rapamycin-FKBP12 complex (Zoncu et al., 2011).

The second generation of inhibitors corresponds to Small-molecule inhibitors of mTOR kinase, which inhibit the kinase-dependent function of both mTORC1 and mTORC2. These agents have demonstrated the ability to block mTORC1 and mTORC2 effectors namely, S6K1 and Akt, respectively. Agents currently being evaluated include OSI-027 and XL765 compounds (Zoncu et al., 2011).

The third generation of inhibitors, commonly named dual-inhibitors, have the property of inhibiting both the mTORC1/2 complexes, as well as PI3K, thus preventing any feedback from the PI3K pathway. Such an inhibitor under development is the BEZ235 actually in Phase I and II trials and has demonstrated anticancer properties in a variety of cell lines.

III. Humanized monoclonal antibodies

a. HER2

After demonstration of HER2 amplification and overexpression in some breast cancers, a monoclonal antibody has been generated for the treatment of breast tumors. This antibody, trastuzumab or Herceptin, targets the extracellular domain of HER2 (Baselga et al., 1998). In fact, the antibody binding to the extracellular part of the receptor will inhibit receptor dimerization (Arnould et al., 2006), leads to its internalization and degradation, and will attract immune cells on the tumor site leading to ADCC. Herceptin has also been shown to inhibit the MAPK and PI3K/Akt pathways leading to cell cycle arrest. Other molecules targeting the ATP binding sites in the intracellular domains of HER2 have been developed, such as Lapatinib, which has proven to be efficient at targeting both HER2 and EGFR signaling (Rusnak et al., 2001).

b. VEGF

Vascular Endothelial Growth Factor (VEGF) is the main actor of angiogenesis in physiology and during tumoral neoangiogenesis which is essential for tumor progression and metastasis (Presta et al., 1997). Bevacizumab (commercially known as Avastin) is a monoclonal antibody targeted to bind VEGF and prevent the fixation of the latter to its receptor, thereby inhibiting its action. Clinically,

treatment with bevacizumab alone does not provide efficient results, but its efficiency increases when used in combination with chemotherapy. Patients with metastatic breast cancer benefited from this combination in terms of survival (Gerber and Ferrara, 2005).

2. Tumor resistance to treatment

Irrespective of the therapy, resistance of breast cancers to treatment occur and most of the mechanisms are poorly understood. Following are some mechanistic insights on the resistance to treatment of some breast cancers.

A. Hormonotherapy resistance

Endocrine therapies block the proliferative effects mediated by estrogens. The most common described resistance to endocrine therapy is with the case of tamoxifen, which is never administered for more than 5 years to patients. Furthermore, not all ER α positive breast tumors respond to tamoxifen, and this forms part of what is called 'de-novo' resistance. Regarding the tumors responding to tamoxifen at the start of therapy, some of them acquire a resistance to treatment, this is called 'acquired resistance'.

I. Growth Factor Signaling

The overexpression of HER2 and growth factors has been well characterized with respect to resistance to endocrine therapies. In cells overexpressing HER2, tamoxifen has been shown to have agonist effects on ER α . Independantly of estrogens, tamoxifen can lead to the activation of the HER2/EGFR signaling leading to MAPK/Akt activation. These kinases are able to phosphorylate ER α and leads to expression of estrogen dependant genes (Shou et al., 2004). In fact, the ER α /Tamoxifen complex recruits co-activators such as SRC-3. The proliferative effects mediated by the EGFR/ER α /Tamoxifen loop is significantly repressed by EGFR inhibitors (Shou et al., 2004).

The involvement of IGF-1R signaling in tamoxifen resistance has also been shown. In fact an increase of IGF-1R activity has been reported in tamoxifen resistant cells and acts upstream of the estrogen-mediated EGFR activation (Zhang et al., 2011b).

Recent studies from our lab have shown that the PI3K/Akt pathway is constitutively activated in anastrozole- or letrozole- resistant cells. This constitutive activation has also been demonstrated in anti-aromatase resistant breast tumors. These studies suggest that patients with anti-aromatase resistance could be treated in combination with inhibitors of the Akt/mTOR pathway (Vilquin et al., 2013).

II. ER α

a. Loss of expression

ER α positive tumor cells depend on its expression for proliferation and invasiveness. One of the leading mechanisms in resistance to endocrine therapies is the loss of expression of ER α , meaning that tumors cells have bypassed the ER α pathway dependence to other pathways. For 17% of patients, a loss in ER α expression could be responsible for tamoxifen resistance (Kuukasjärvi et al., 1996).

Chromatin modifications with histone deacetylation and DNA methylation could be an explanation for the loss of ER α in breast cancer cells. Some studies demonstrate that DNA methyltransferase deacetylase 1 can physically interact with HDAC and that co-treatment with DNMT1 inhibitors coupled with HDAC inhibitors could re-induce ER α expression in ER α negative cells (Mottet and Castronovo, 2010).

Growth factor signaling could also be involved in the decreased levels of ER α . Of note, EGFR, HER2 and IGF1R expression are more elevated in ER α negative tumors than in positive ones. This suggests that growth factor signaling can contribute to transcriptional repression of ER α and lead to treatment resistance .

The involvement of CUE domain containing protein 2 (CUEDC2) which contains an ubiquitin binding motif can modulate ER α stability through the proteasome pathway. There exists a very strong inverse correlation between CUEDC2 and ER α expression, which is also correlated with tamoxifen resistance, probably due to a loss in ER α expression by degradation through the proteasome pathway.

b. Mutations on ER α

Mutations on ER α can be linked to hormone resistance, however these events are relatively rare and cannot account on their own endocrine therapy resistance mechanisms. Lysine 303 mutation into arginine has been found in invasive tumors and has been linked to estrogen hypersensitivity, tamoxifen resistance and anti-aromatase resistance (Fuqua et al., 2000). Estrogen hypersensitivity occurs due to an increase in co-activator binding in the presence of low estrogen levels. This lysine 303 is a post-translational modification hotspot on ER α (Le Romancer et al., 2011) and prevention of PTM could lead to this ER α hypersensitivity.

c. Co-regulators

SRC-3 is a ER α coregulator overexpressed in 50% of breast tumors. High SRC-3 expression is associated with a DFS decrease in tamoxifen treated patients (Shou et al., 2004). This could be due to interplay between SRC-3 and HER2. Furthermore, in anti-

aromatase resistant cells, the ER α /SRC-3 complex is constitutively recruited onto ER α target gene promoters to promote their expression. This suggests that an increase in co-activator function can contribute to the agonist effect of endocrine therapies and hence, resistance.

III. Other isoforms

a. ER β

Discrete studies have suggested a role for ER β in hormone therapy resistance. It is suggested that tamoxifen binding to ER β can activate AP-1 regulated genes (Paech et al., 1997). Another study demonstrated that ER β mRNA was increased in patients presenting with tamoxifen resistance (Speirs et al., 1999). More study is however needed to elucidate the role of ER β in endocrine therapy resistance.

b. ER α -36

Estrogen receptor ER α -36 has been extensively shown to mediate non-genomic signaling (Chapter 3) and its role in breast cancer resistance to endocrine therapies has been evaluated. Tamoxifen and fulvestrant have both been shown to activate the MAPK and Akt pathway through ER α -36, leading to an anti-estrogen mediated cell growth and proliferation. In ER α -36 positive cells, these treatments would be likely to act as agonists of ER α -36 (Zhang et al., 2012b). A study on a large cohort of breast tumors showed that ER α positive patients were less likely to benefit from tamoxifen therapy if they expressed ER α -36 (Shi et al., 2009).

IV. Pharmacokinetics

Tamoxifen is metabolized by the liver into its metabolically active form 4-hydroxytamoxifen by cytochrome p450. About 8% of Caucasian women bear a p450 deficient allele which prevent tamoxifen metabolism into its active counterpart (Johnson et al., 2004). This might explain why these women do not react as well to tamoxifen and this has to do with primary or 'de-novo' resistance.

As discussed above, endocrine resistance is a multifactorial mechanism. However growth factor signaling seems to play a major role in breast cancer resistance to endocrine therapies.

B. Resistance to mTOR inhibitors

Rapalogues are drugs targeting specifically mTor1. There have been various accounts of resistance mechanisms regarding first generation mTOR inhibitors. Rapalogues inhibit only the phosphorylation of S6K1 without having any effect on 4E-BP1, therefore only partially inhibit protein synthesis (Lee et al., 2015). This could be part of the mechanism by which cells acquire resistance to rapalogues.

Furthermore there are many feedback mechanisms in the mTOR pathway and with these feedback loops blocked; a resistance mechanism is set up. Rapalogues block the protein degradation of IRS1 involved in IGF1R signaling. This can lead to an activation of PI3K which will then activate mTorc1. mTorc1 has been shown to inhibit mTorc2 through S6K mediated Rictor phosphorylation. Rapalogues, by blocking mTorc1 can induce Akt activation through mTorc2. mTorc1 inhibition induces the activation of the MAPK pathway through S6K/PI3K. Indeed there has been an association between apologue use and MAPK pathway activation in metastatic tumors (Lee et al., 2015).

C. Trastuzumab resistance

Trastuzumab mainly targets HER2 extracellular domain. However, since its use, many resistance mechanisms have been identified, which can be either primary or secondary.

There is a tumor sub-population expressing a mutated version of HER2 called p95-HER2. It is truncated in its extracellular N-Terminal domain and therefore cannot bind trastuzumab. Furthermore, this truncated form of HER2 is constitutively active and has been found in 30% of tumors overexpressing HER2 (Scaltriti et al., 2007) . A study had demonstrated that patients expressing p95-HER2 are less likely to benefit from trastuzumab treatment than patients who express the normal receptor.

Overexpression of tyrosine kinase receptors have a big role to play in trastuzumab resistance. For instance, it has been demonstrated that the c-Met tyrosine kinase receptor can physically interact with HER2 and modulate its signaling. Furthermore c-Met depletion renders HER2 expressing cells more sensitive to trastuzumab. IGF-1R overexpression renders normally sensitive SKBR3 cells resistant to trastuzumab (Nahta et al., 2005). This is thought to be due to a crosstalk whereby IGF-1R will phosphorylate HER2 and lead to downstream PI3K activation. Furthermore high expression of IGF-1R in breast tumors is associated with a weaker response to trastuzumab.

There are a few intracellular alterations that have been linked to trastuzumab resistance. For instance, it has been shown that relapsing HER2 expressing tumors have a loss of PTEN expression. Trastuzumab response is also significantly decreased in patients having low PTEN expression (Berns et al., 2007). Other cellular alterations such as on the catalytic subunit of PI3K have been shown to be linked to trastuzumab resistance (Kataoka et al., 2010). There has been a link between trastuzumab resistance and Src activation in breast cancer cells.

Chapter 5: The MAPK Signaling Pathway

1. Generalities

The Mitogen Activated Protein Kinase (MAPK) signaling pathways are responsible for the transduction of numerous extracellular signals from the plasma membrane to the nucleus in order to establish an appropriate cellular response. It is involved in the regulation of gene expression and controls several other cytoplasmic activities. The MAPK pathways are well conserved throughout evolution in all eukaryotes and the most characterized pathways can be clustered into three main pathways; the Extracellular signal regulated Kinase (ERK) pathway, the c-Jun N-Terminal Kinase (JNK) pathway and the p38/MAPK pathway (Figure 22) (Schaeffer and Weber, 1999). Each of these pathways responds to various external stimuli and exert different biological functions like proliferation, differentiation, cell cycle regulation or apoptosis. To add to the complexity of the MAPK signaling pathway, these 3 above-named pathways can have common effectors such as the Elk-1 transcription factor, which can be a substrate for either ERK or JNK (Houlston et al., 2001). In between these pathways, numerous interconnections exist that can lead to their activation by direct and canonical stimuli such as growth factor signaling, or indirectly by G-Protein coupled receptors and hormone receptors such as ER α and PR. The ERK/MAPK pathway will be the main focus of this chapter and can be activated by growth factor signaling and whose activation has also been reported possible by both ER α and ER α -36. This pathway is mainly involved in cell proliferation, differentiation, cell survival or apoptosis as well as cell cycle regulation (Malumbres and Barbacid, 2003).

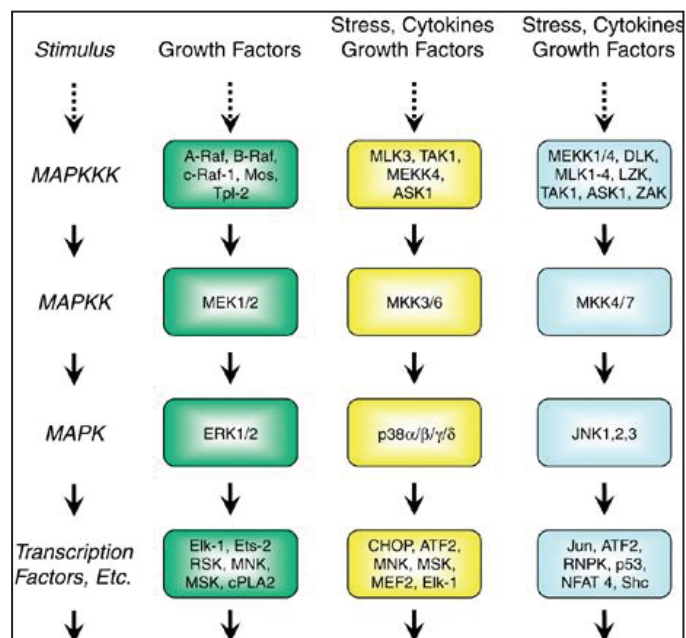

Figure 22: Classification of the MAPK signaling pathways. Signaling pathways can be classified into three main families, ERK, JNK and p38-MAPK. (Adapted from Roberts et al, 2007)

The MAPK signaling pathways share common mechanisms and a conserved structure composed of modules of three kinases. These three kinases are

activated through a phosphorylation cascade, in order to relay extracellular signals. The first kinase to be activated is a MAPKKK (MAP3K), activated by a small G-Protein which has been activated itself by cell surface receptors or intracellular receptors. The MAPKKK will activate a MAPKK (MAP2K) through phosphorylation, which will itself activate and phosphorylate a MAPK. The small G-Protein serves as an intermediate to phosphorylate MAPK modules. When the small G-Protein is activated, it physically interacts with the MAPKKK by recruiting it to the plasma membrane and activating it through phosphorylation. Once the MAPKKK has been activated the initiation of the complex signaling pathway can take place. MAPKK are very specific of their substrates and will activate only a handful of MAPK. The MAPK for their part have numerous substrates localized in the cytoplasm and in the nucleus.

2. The ERK Pathway

The ERK pathway has been the first signaling pathway to be fully characterized from plasma membrane to the nucleus. The involved MAPKKK is the Raf protein. Downstream Raf lies the MAPKK MEK1/2 which further activates ERK1/2. The ERK cascade is initiated by the small G-Protein Ras, which is activated following tyrosine kinase receptor activation at the plasma membrane. Following its activation, Ras will recruit Raf to the plasma membrane where it will be phosphorylated and activated. At the plasma membrane Raf will recruit the dual MAPKK Kinases MEK-1 and MEK-2 and these will lead to the downstream activation of ERK 1 and 2 (Chong et al., 2003). Phosphorylated ERK can in turn activate cytoplasmic proteins or translocate to the nucleus to regulate target genes by activation of transcription factors (Figure 23).

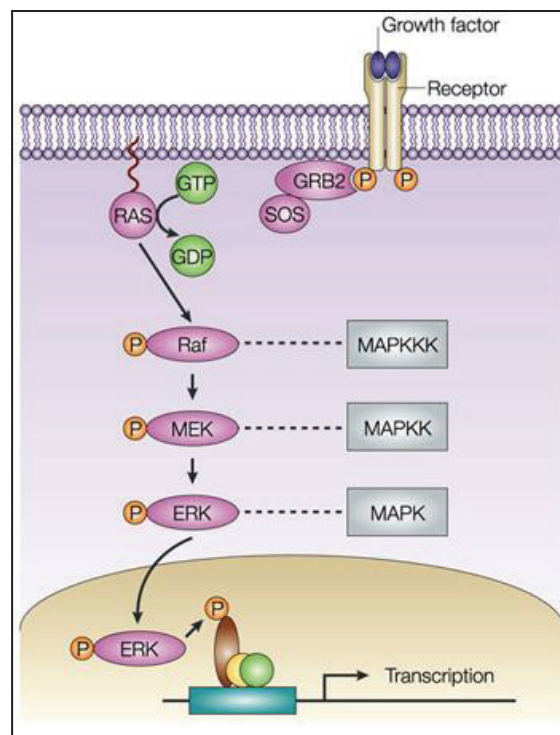

Figure 23: Simplified overview of the ERK pathway

(Adapted from diff.org)

A. Molecular actors of the Ras/MAPK Pathway

I. Tyrosine kinase receptors

Tyrosine kinase receptors are a superfamily of proteins with an intrinsic tyrosine kinase ability, i.e. transferring a phosphate group to a tyrosine of a substrate protein. They have a common transmembrane domain and differ by their extracellular part. TKR's are activated by ligand induced receptor dimerization which induces a conformational change in the receptor resulting in an autophosphorylation on tyrosine residues in their kinase activation loop. These phosphorylated residues serve as anchoring domains for adaptor proteins such as Grb2 and Crk *via* their SH2 or PTB domains. These adaptor proteins recruit downstream signaling proteins such as Guanine Exchange Factors (Sos) which leads to the activation of the small G-Protein Ras. A well documented example of TKR is EGFR and its homologues which are involved in cell division, adhesion and proliferation (Hubbard and Miller, 2007).

II. Ras and molecular actors

a. The Ras superfamily

The Ras superfamily are a cluster of small G Proteins possessing a GTPase activity. They are very well conserved throughout evolution. The Ras superfamily can be divided into 6 distinct sub-groups associated with distinct functions (Wennerberg et al., 2005).

The Ras (Rat Sarcoma) group is the most characterized and comprises 36 members. They are involved in various signaling pathways regulating gene expression, cell proliferation, as well as cellular differentiation and cell death. Most of the members of the Ras group are oncogenes where mutations have been identified in various cancer types (Wennerberg and Der, 2004).

The Rho group (Ras Homologous) is made up of 10 members including RhoA, Rac1 and Cdc42. These proteins are mainly involved in the regulation of the actin cytoskeleton, cell cycle progression and cell motility and polarity. They are also involved in exocytosis and endocytosis processes (Etienne-Manneville, 2006).

The Miro group has been described as a group of the Ras superfamily which are mainly located at the outer mitochondrial membrane and are involved in maintaining mitochondrial integrity (Zerial and McBride, 2001).

The Rab group which is involved in intracellular vesicular transport and protein trafficking between organelles involved in endocytosis or secretion.

The Ran group (Ras-like Nuclear) which is involved in nucleo-cytoplasmic RNA and protein transport. It is also involved in the regulation of DNA replication and spindle fiber assembly (Weis, 2003).

The Arf group (ADP-Ribosylation factor) is involved in regulating vesicular transport (Memon, 2004).

b. Structure and Function of Ras

Members of the Ras group are monomeric small G proteins with an intrinsic GTPase activity which oscillate between an inactive GDP bound form and an active GTP bound form. They are made up of a G-domain in their N-terminal part and a hypervariable domain in their C-Terminal region (Colicelli, 2004). The G-Domain carries the catalytic GTPase activity and also regulates binding to effectors and activators. The hypervariable domain is involved in protein trafficking and membrane anchoring of the Ras proteins *via* post-translational modifications on a CAAX site in their C-Terminal region. Membrane anchoring occurs upon farnesylation of the cysteine which will result in the creation of a hydrophobic region allowing membrane association (Mor and Philips, 2006). Ras proteins have been found at the plasma membrane but also on endoplasmic reticulum, mitochondrial and golgi membranes.

c. Ras Activation

Ras proteins are involved in various transmembrane receptor signaling such as TKR's, cytokine receptors, integrins or calcium channels. The switch from the inactive to the active form of Ras mainly depend on activators like Guanine Exchange Factors (GEF) which will switch GDP to GTP on Ras, or inhibitors such as GTPase Activating Proteins (GAP) which returns Ras to its GDP bound state.

Following TKR stimulation by their ligands and receptor dimerization and auto-phosphorylation, the phosphotyrosine sites will serve as anchoring sites for adaptor proteins such as Grb2 or Shc through SH2 or phosphotyrosine binding domains. Grb2, upon phosphorylation by the tyrosine kinase receptors will expose its two SH3 domains and associate with the proline rich C-Terminal domain of the protein Sos (son of Sevenless), which incidentally is a Ras GEF. Sos will then activate Ras by swapping GDP to GTP. GTP bound Ras is then able to recruit various effectors through their RBD's (Ras Binding Domains). Such effectors include the Raf kinase, and PI3K. The signaling is terminated through GTP hydrolysis with Ras's intrinsic GTPase activity and trough assistance from combined GAP's (Figure 24) (Sondermann et al., 2004).

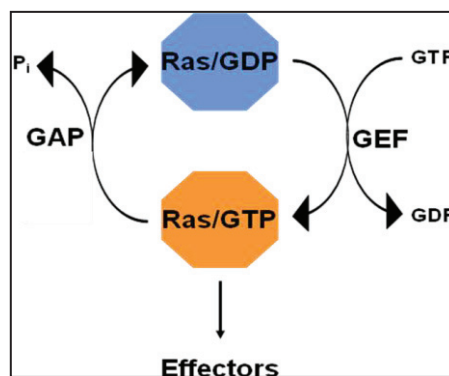

Figure 24: The RasGTP/GDP cycle

During the active period of Ras, it will interact with various effectors and initiate the canonical Ras/Raf/MEK/ERK pathway (Marshall, 1995).

III. The Raf MAPKKK

The Raf (Rapidly Accelerated Fibrosarcoma) of serine/threonine kinases are highly conserved in their structure and contain three CR1, CR2 and CR3 conserved regions corresponding to functional domains. The N-Terminal CR1 region carries a Ras Binding Domain and a Cystein Rich Domain. These two domains within the CR1 region are essential for Ras binding and are involved in Raf activation. The CR2 region is rich in serine and threonine residues, including the Raf activation site as well as inhibitory phosphorylation sites. The CR3 region carries the catalytic serine/threonine kinase domain (Wellbrock et al., 2004). There are different variants of Raf, some with tissue specific expression.

The Raf kinases represent the entry point of the ERK/MAPK pathway since its activation leads directly to the activation of the enzymatic cascade of ERK activation. The regulation of Raf kinases is very complex and still not completely understood.

The activation of Raf takes place near the plasma membrane in the presence of Ras. It rests on several factors such as relocalization to the plasma membrane, phosphorylation of activating sites and dephosphorylation of deactivating sites, adaptor and scaffold proteins. In its inactive form, Raf is phosphorylated on serines 259 and 261, which represent binding sites for the 14-3-3 protein. 14-3-3 will maintain Raf in its inactive state by masking Raf's CR2 and CR3 regions as discussed above (Dhillon and Kolch, 2002).

The first step in Raf activation is mediated by its binding to active Ras which displaces 14-3-3 from Raf. In fact Raf's RBD domain has a very high affinity for Ras-GTP (Kubicek et al., 2002). Upon binding to Ras and following 14-3-3's displacement, the serine phosphatase PP2A will dephosphorylate Raf on the inhibitory serines 259 and 261. Raf can only be activated if these two serines are dephosphorylated (Kubicek et al., 2002). The interaction between Ras and Raf therefore exposes Raf's catalytic site which primes the latter for anchoring Mek1/2.

To reach complete activation, Raf needs to be phosphorylated on specific residues within the CR3 region. Several mitogens, integrins and Ras itself participate in phosphorylating Raf mainly on Serine 338 which will lead to its complete activation. Phosphorylation on other residues such as tyrosine 341, threonine 491 and serine 494. These phosphorylations are effected by PAK kinases such as PAK 1 and 3 and some studies report this occurs in a PI3K dependant manner (Chiloeches et al., 2001).

Raf's deactivation occurs through a detachment from Ras-GDP and also through phosphorylation on Serine 43 with decreases its affinity for Ras.

ERK1 and 2 have been shown to exert a negative feedback loop on Raf by mediating the Serine 43 phosphorylation.

IV. The MEK-1 and MEK-2 MAPKK

There are two isoforms of MEK encoded by two distinct genes, MEK-1 (45kDa) and MEK-2 (47 kDa). These two proteins present with 80% homology and differ in their N- and C-Terminal regions (Zheng and Guan, 1994). In addition of their catalytic domains, MEK proteins have an ERK interacting domain in their C-Terminal region. Their proline rich N-Terminal region confers them with the ability to bind Raf (Zheng and Guan, 1994). The two MAPKK seem to present with different regulatory mechanisms since MEK-1 needs to undergo phosphorylation on some sites for activation and those sites are absent from MEK-2.

To undergo activation, MEKs have to be phosphorylated on two serine residues, S218 and S222 on MEK-1 and S22 and S226 on MEK-2. The phosphorylation is carried out by Raf (Catling et al., 1995). Other proteins can directly activate MEK such as the MEKK1-3 (MEK Kinase 1, 2 and 3), PKC α and ζ , PI3K and others. Different isoforms of Raf will preferentially activate MEK-1 or 2 in cells. MEK-1 and -2 have the property of being dual kinases, meaning that they can phosphorylate on Serine/Threonine, as well as on Tyrosine residues. MEK-1 and MEK-2 will therefore phosphorylate ERK1 on Threonine 183 and Tyrosine 185 and ERK2 on Threonine 202 and Tyrosine 204 (Catling et al., 1995; Payne et al., 1991).

V. The ERK-1 and ERK-2 MAPK

a. Activation and Targets

The ERK1 and ERK2 kinases are the last actors in the MAPK cascade and the two proteins present with 90% homology (Cobb et al., 1991). They differ mainly in their N-terminal region. They exert their functions on cytoplasmic as well as nuclear targets. As stated above, ERK activation results from a double phosphorylation by MEK on a TEY motif (Payne et al., 1991). Once active, the subcellular localization of these proteins can vary according to cell type, tissue or stimulus. In quiescent cells for instance, active ERK1 and 2 are mainly cytoplasmic. In other cases, upon stimulation active ERK1 and 2 will rapidly translocate to the nucleus. Through these processes, active ERK1 and 2 will activate their nuclear or cytoplasmic target substrates (Marchetti et al., 2005).

More than 160 substrates have been identified for active ERK1/2. These include transcription factors, cytoplasmic proteins, membrane proteins which will be phosphorylated on either a serine or a threonine residue (Pouyssegur et al., 2002). ERK substrates contain a consensus phosphorylation site PXS/TP or the minimal sequence S/TP where X is generally a leucine (Yoon and Seger, 2006). Phosphorylation of these substrates can impact on their stability, DNA binding capacity and transcription inhibition or activation.

Cytoplasmic targets of ERK include phospholipase A2, P90RSK, MSK1/2 and the phosphatase MKP3 as well as cytoskeletal proteins such as Tau, MAP2 or Paxillin, which plays a major role in cell adhesion.

Nuclear targets of ERK are mainly transcription factors such as Elk-1, c-Jun, c-Fos, c-Myc but also the MPKP1/2 phosphatases (Marchetti et al., 2005; Pouysségur et al., 2002). Recently, paxillin was identified to be a key mediator of MAPK action in the nucleus. This occurs via a Paxillin/ERK/Elk-1 complex which has been shown to be essential for the up-regulation of c-Fos and CyclinD1 (Sen et al., 2012).

b. Distinct effects of ERK1 and ERK2

For a long time, and mainly due to the high degree of homology between the two proteins, no distinction was made between the substrates of the 2 kinases. However more and more studies are starting to depict different roles for ERK1 and ERK2.

The first studies suggesting different roles for ERK1 and 2 appeared in 2008 when microarray based gene expression profiling studies on zebrafish embryos demonstrated that ERK1 and 2 regulated distinct gene sets (Krens et al., 2008). Later it was shown that ERK2 and not ERK1 was responsible for Ras induced EMT in oncogenic processes (Shin et al., 2010). More studies depicted a distinct role for ERK2 and not ERK 1 in processes such as HGF-induced cell motility (Radtko et al., 2013). Recently, a study found that only ERK2 alone was responsible for inflammatory pain and not ERK1 (O'Brien et al., 2015).

B. Negative Regulation of ERK

ERK pathway inactivation rests on the action of phosphatases. Three major phosphatase families participate in the inhibition of ERK kinases. The serine threonine phosphatase PP2A maintains ERK in an inactive state in the cytoplasm, the family of Phospho Tyrosine Phosphatase such as PTP-SL, HePTP and STEP, and finally the dual specificity phosphatases which are able to dephosphorylate on both tyrosine and threonine residues (Marchetti et al., 2005). The MKPs or DUSP dual phosphatases are the most characterized and they exert their function by removing the phosphate groups on threonines and tyrosines in the TXY activation motifs of MAPK. MKP's share a common structure composed on a non-catalytic N-Terminal Domain and a catalytic C-Terminal part. The non-catalytic domain is less conserved than the catalytic one and contains two CH2 (Cdc25 homology 2) domains as well as a positively charged amino acid sequence essential for binding with MAPK (Farooq and Zhou, 2004). The MKP family can be divided into 3 sub-groups, based on sequence homology and subcellular localization (Theodosiou and Ashworth, 2002).

- Class I MKPs (DUSP1/MKP1, DUSP2/PAC1, DUSP4/MKP2, and DUSP5) have a main nuclear localization and exert their phosphatase roles on ERK as well as JNK and P38.
- Class II MKPs (DUSP6/MKP3, DUSP7/MKP-X, DUSP9/MKP4) have a main cytoplasmic localization and dephosphorylate ERK1 and 2.
- Class III MKPs (DUSP8, DUSP10/MKP5) have a main cytoplasmic localization and act mainly on p38 and JNK.

Alongside regulating MAPK, these phosphatases are themselves subjected to regulation at different levels. At the transcriptional level, MKPs are induced as a early genes as targets of MAPK signaling to provide a negative feedback mechanism to avoid constitutive activation of the MAPK pathway (Bermudez et al., 2010). They can also be regulated through modulation of their mRNA stability. For instance HuR and NF90 are known to bind and stabilize DUSP mRNA (Kuwano et al., 2008). Another level of control is provided by the modulation of protein stability. For instance phosphorylation of DUSP6/MKP3 on serines 159,174 and 197 by either ERK or CK2a leads to its proteasomal degradation. Another means of regulations involves modulation of the catalytic activity of MKPs. Some MKP's like DUSP 1, 2, 6 and 9 need a conformational change to be active and this is provided by the binding of these MKP to their respective substrate (Bermudez et al., 2010).

3. Interactions in the MAPK pathways

Above, we discussed the specificity of MAPK to their substrate of their regulators. This specificity is given by a number of domains, which serve as specific recognition sites for the target proteins. Below is a list of some of these described domains.

A. D-Domains

MAPK signaling and specificity is achieved in part through a specialized docking motif present in the components of the MAPK cascade. The D-Domain or D-site consists of a core of basic residues followed by a hydrophobic patch (Lys/Arg-Lys/Arg-X₂-6-φ-X-φ), where φ is a hydrophobic residue such as Leu, Iso or Val, D-domains can be recognized by more than one group of MAPK but they have been demonstrated to increase signaling specificity and efficiency. D-domains are generally located upstream or downstream the phosphor-acceptor site and are present in many MAPK regulatory proteins and substrates. D-Domain mediated interactions are very stable and are often required for pre-existing complexes between MAPK and their substrates. Such motifs have been identified in several MAPK binding proteins such as MK5 and RSK.

B. DEF Domains

The second major MAPK docking sites are called DEF Domains (Docking site for ERK, FXFP), also called the F site of the DEF site. They have been identified in a number of ERK1/2 substrates. DEF domains are characterized

by a Phe-X-Phe-Pro sequence, where one of the Phe residues can also be a Tyr. This domain is generally located 6-20 amino acids, C-terminal to the phosphoacceptor site. DEF domains are required for efficient binding of ERK1/2 and have been showed to be required for ERK1/2 mediated substrate phosphorylation.

C. CD Domains

CD or Common Docking Domains have been identified independently outside the catalytic region of ERK, p38 and JNK. These domains are involved in D-Domain interactions. The CD Domain contains acidic and hydrophobic residues, which are necessary for establishing electrostatic and hydrophobic interaction with the positively charged and hydrophobic residues of D-Domains. The CD domain is prolonged by a specific 2 amino-acid patch, which is neutral in ERK1/2 (TT motif) and acidic in p38 (ED motif), and this results in the formation of a groove for their interacting partners.

4. Involvement in breast cancer

A. Involvement in endocrine therapy resistance

Several studies have pointed out the involvement of the MAPK pathway in tamoxifen resistance. In fact, an increased activity of ERK has been shown to be associated with endocrine resistance and decreased survival in breast cancer patients (Kurebayashi, 2005). One mechanism for this is the phosphorylation of Serine 118 in ER α which leads to the activation of ligand independent functions of the receptor (Le Romancer et al., 2011). Another possible mechanism of tamoxifen resistance involving the MAPK pathway is the overexpression of HER2. Indeed studies have shown that HER2 overexpression result in an increase in the MAPK pathway in breast cancer cell lines and HER2 inhibitors can partially restore sensitivity to anti-estrogens (Kurokawa et al., 2000).

Another suggested mechanism involves the induction of cell cycle arrest following the activation of the MAPK pathway. In this situation, strong, sustained ERK activity leads to senescence or differentiation. Increased MKP activity arising from HER2 overexpression, may reduce this strong signal. The result is weak or transient ERK activity, which favors cell proliferation (Boutros et al., 2008).

Increased p38 activity has also been observed in resistant tumors. It is possible that activated p38 may promote resistance to tamoxifen because of its ability to phosphorylate the ER and enhance its nuclear functions (Riggins et al., 2007).

B. Involvement in chemotherapy resistance

Triple-negative breast cancers do not express ER, PR, or HER2, and hence, do not respond to targeted therapy (Stockmans et al., 2008). Research has shown that MAPK expression may be an underlying mechanism contributing to the generation of chemoresistance in triple-negative breast cancer. Epidermal growth factor receptor, which is a receptor tyrosine kinase upstream from MAPK, has been shown to be overexpressed in up to 66% of triple-negative breast cancers (Reis-Filho and Tutt, 2008). Increased growth factor activity could lead to

increased MAPK activity, which can contribute to an increase in cell growth. In addition, microarray data derived from primary tumor samples identified a cluster of genes associated with triple-negative breast cancer. Among these are genes that activate ERK, PI3K, AKT, p38, and NF- κ B (Kang et al., 2008). Since triple-negative cancers do not respond to current targeted therapies aimed at the estrogen receptor and HER2, developing targeted agents aimed at the pathways that are activated in triple-negative breast cancer remains an important goal in cancer research.

RESULTS

Estrogens play a major role in breast cancer. While the main studied pathway of ER α activation remained the genomic pathway, our team and other demonstrated the relevance of the non-genomic pathway in breast tumors.

Upon my arrival as a PhD student, Muriel Le Romancer's team was extensively studying the role of ER α non-genomic pathway in breast tumorigenesis. In fact our team demonstrated that the methylation of ER α on Arginine 260 was an essential pre-requisite for estrogen non-genomic signaling and for the recruitment of the non-genomic actors Src and PI3K. Furthermore, our team demonstrated that estrogen non-genomic signaling was deregulated in aggressive breast cancer.

Upon my arrival in the team, we decided to study ER α -36 since it was reported this novel cytoplasmic splice variant was able to rapidly initiate MAPK signaling induced by estrogen but also by anti-estrogens.

Despite these reports on ER α -36, the mechanisms by which it mediated non-genomic signaling were not very clear. The first objective of my project was to unveil the molecular mechanisms in ER α -36 could mediate non-genomic signaling.

The second objective of my project was to study the expression of ER α -36 in breast tumors to evaluate whether its expression could constitute a prognostic/predictive marker in breast tumors. Through the pathology department of the Leon Berard cancer Hospital, our team has access to two cohorts of human breast tumors.

1. ER α -36 and the non-genomic pathway

INTRODUCTION TO ARTICLE 1

Estrogens play a major role in physiology as well as in the development of breast cancer. Besides its classical genomic action, the estrogen receptor ER α mediates rapid extranuclear signaling at the plasma membrane. Our team has thoroughly investigated the estrogen non-genomic pathway. In 2005, reports of a new ER α splice variant arose, namely ER α -36, and very quickly, it had been observed that this new variant had a main cytoplasmic and membrane localization. Furthermore ER α -36 mediated estrogen non-genomic signaling through the rapid and transient phosphorylation of MAPK. However, the mechanism by which ER α -36 mediated non-genomic signaling was not properly understood.

We decided to use several approaches to elucidate the non-genomic signaling mediated by ER α -36. We coupled *in-vitro* GST Pulldown assays and *in-cellulo* 'proximity ligation assays' to monitor and study the kinetics and proteins partners involved in ER α -36 non-genomic signaling.

The 'Proximity Ligation Assay' technology from OLINK Bioscience, commercialized by Sigma Aldrich Ltd, allows to monitor *in-situ* protein-protein interactions. A pair of antibodies recognize and bind to two potentially interacting targets. These antibodies are conjugated to a matched pair (labeled +/-) of short single-stranded oligonucleotides. If the two respective targets interact, and hence remain in very close proximity, the oligonucleotide probes will hybridize and ligate with two additional "connector oligos" to form a continuous circular DNA structure. DNA polymerase enzymes will amplify these circular molecules through simple, reliable rolling-circle amplification. The result is a highly amplified circular DNA molecule that can be detected via standard fluorescent methods, and that acts as a qualitative marker of interaction between the two proteins (Figure 25).

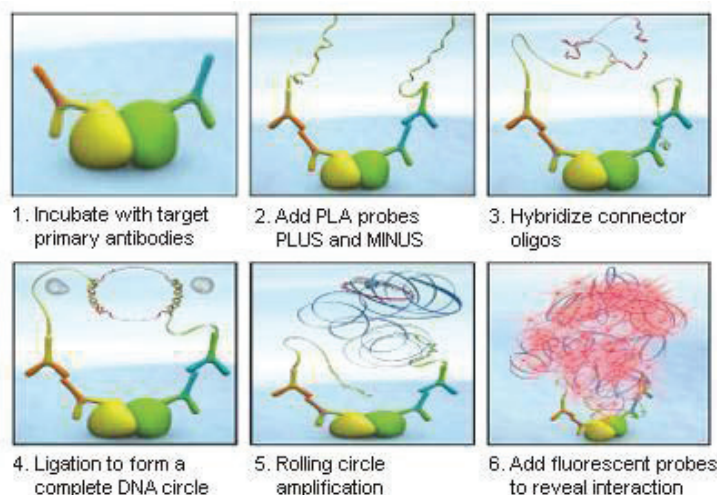

Figure 25: Simplified overview of the Proximity Ligation Assay Reaction

This work allowed us to identify key molecular actors involved in ER α -36 signaling and has allowed us to propose a model for the estrogen mediated cellular effects through ER α -36.

Article 1:
The molecular mechanisms underlying the ER α -36-mediated signaling in breast cancer

(Submitted to Nature Communications)

The molecular mechanisms underlying the ER α -36-mediated signaling in breast cancer

Soleilmane Omarjee^{1,2,3}, Julien Jacquemetton,^{1,2,3} Coralie Poulard^{1,2,3,4}, Natacha Rochel^{5,6,7,8}, Annick Dejaegere^{5,6,7,8}, Yasmine Chebaro^{5,6,7,8}, Isabelle Treilleux^{1,2,3,9}, Elisabetta Marangoni¹⁰, Laura Corbo^{1,2,3} and Muriel Le Romancer^{1,2,3}

1 Université Lyon 1, F-69000 Lyon, France

2 INSERM U1052, Centre de Recherche en Cancérologie de Lyon, F-69000 Lyon, France

3 CNRS UMR5286, Centre de Recherche en Cancérologie de Lyon, F-69000 Lyon, France

4 Department of Biochemistry and Molecular Biology, Norris Comprehensive Cancer Center, University of Southern California, Los Angeles, CA 90089, USA.

5 Institut de Génétique et de Biologie Moléculaire et Cellulaire, Illkirch, France

6 CNRS UMR7104, Illkirch, France

7 INSERM U964, Illkirch, France

8 Université de Strasbourg, Illkirch, France

9 Centre Léon Bérard, Pathology Department, F-69000 Lyon, France

10 Institut Curie, Translational Research Department, 75005 Paris, France

Address for all correspondence: Muriel Le Romancer, CRCL, INSERM 1052, CNRS 5286, Centre Léon Bérard, 28 rue Laennec, 69373 Lyon Cedex 08, France. Tel: 00 33 4 78 78 28 22. E-mail: muriel.leromancer@lyon.unicancer.fr

Keywords: Estrogen receptor α 36, Estrogen signaling, ERK, Breast cancer.

Abbreviated title: ER α -36 signaling in breast cancer

SUMMARY

Alterations in estrogen-mediated cellular signaling have largely been involved in the pathogenesis of breast cancer. Here, we investigate the signaling regulation of one splice variant of the estrogen receptor, namely ER α -36, associated with a poor prognosis in breast cancers. Coupling *in vitro* and *in vivo* approaches we determine the precise sequential molecular events of a new estrogen signaling network in an ER α -negative cell line and in an original patient derived xenograft. After estrogen treatment, ER α -36 rapidly associates with Src at the plasma membrane, initiating downstream cascade, including MEK1/ERK activation and paxillin phosphorylation on S126, which in turn triggers higher expression of cyclin D1. Of note, the direct binding of ER α -36 to ERK2 prevents its dephosphorylation from MKP3 and enhances the downstream signaling. These findings improve our understanding of the estrogen signaling regulation and open new avenues for personalized therapeutic approaches targeting Src or MEK inhibition in ER α -36-positive patients.

INTRODUCTION

Estrogen signaling is essential in the initiation and development of human breast cancers. The biological actions of estrogen are mediated through ER α and ER β which function in the nucleus as ligand-dependent transcription factors. Both receptors share the common nuclear hormone receptors structure composed of functional domains (Nilsson et al., 2001) including (i) the variable N-terminal A/B domain containing the transactivation domain AF-1, (ii) the C or DNA-binding domain (DBD), (iii) the hinge domain (D) and (iv) the E/F domains containing the ligand-binding domain (LBD) and the transactivation domain AF-2 (Kong et al., 2003).

The molecular mechanisms underlying estrogen signaling has been extensively studied for ERs. In addition to the well-documented effects on transcription (genomic signaling), estrogen can activate signal transduction cascades outside of the nucleus (i.e., non-genomic signaling) (Levin, 2009; Levin, 2015). In this process, ER α interacts directly with various proteins kinases to form protein complexes triggering the activation of downstream molecules such as Akt (Castoria et al., 2001; Song et al., 2005) One such complex is the ER α /Src/PI3K complex and our team demonstrated that methylation of the receptor on the arginine residue R260, located in the DBD, is a prerequisite for its estrogen-induced formation (Le Romancer M. et al., 2008). Recently, we showed that the ER α /Src/PI3K complex is activated in aggressive breast tumors and could constitute a new potential target for therapy (Poulard et al., 2012). Approximately 80% of breast cancers express ER α and endocrine therapies have led to significant improvements in patient survival. In contrast to ER α -positive breast cancers, triple-negative breast cancers, which are negative for ER α , for the progesterone receptor (PR) and for the human epidermal growth factor receptor 2 (HER2), are highly aggressive and treatment options are, so far, restricted to cytotoxic agents (Foulkes et al., 2010).

Owing to the alternative mRNA splicing of the *ESR1* gene, several isoforms are known to exist in cells. At least three ER α variants have been reported (Le Romancer M. et al., 2011) including ER α -36 (Wang et al., 2005). The transcription of ER α -36 is initiated by a previously unidentified promoter

located in the first intron of the *ESR1* gene. Compared to ER α , ER α -36 retains DNA-binding, dimerization, and partial LBD, but lacks both AF-1 and AF-2 domains. Furthermore, the last 138 amino-acids, encoded by the final exon 7 and 8 are replaced by an extra unique 27 amino-acid sequence at C-terminus domain (CTD). ER α -36 is mainly located at the level of the plasma membrane and within the cytoplasm, mediating non-genomic estrogen signaling by the activation of the ERK pathway (for review, (Rao et al., 2011). Indeed, ER α -36 was shown to activate ERK1/2 through the protein kinase C delta signaling pathway, leading to elevated expression of cyclin D1/cdk4, which modulates the cell cycle progression (Tong et al., 2010). Moreover, ER α -36-mediated MAPK/ERK signaling pathway contributes to the potential invasion and metastasis of cancer cells (Chaudhri et al., 2012). Interestingly, ER α -36 has been reported to be expressed in ER α -negative breast cancer cell lines and ER α -negative tumor samples (Gu et al., 2014; Lee et al., 2008; Shi et al., 2009; Wang et al., 2006). Intriguingly, ER α -36 can stimulate ERK activation in cells treated with the anti-estrogen tamoxifen (Wang et al., 2006; Zhang et al., 2012b), and is also involved in the development of tamoxifen resistance in ER α -positive breast cancer cell lines (Yin et al., 2014; Zhang et al., 2011). Indeed, a retrospective study of 896 cases of breast cancers revealed that ER α -positive patients, expressing high levels of ER α -36 are less likely to benefit to tamoxifen treatment (Shi et al., 2009). In ER α -negative breast cancer cell lines, ER α -36 induces paclitaxel resistance through c-jun N-terminal kinases, a component of the ERK family (Zhang et al., 2012a).

However, the exact mechanisms underlying ER α -36-mediated ERK activation were not explored. The aim of the present study was to unravel these molecular mechanisms, and we identified a new estrogen signaling network in ER α -negative cell lines, involving ER α -36/Src/ERK and PXN (paxillin), which regulates cell proliferation *via* cyclin D1 expression. This signaling was also shown to occur in patient-derived xenograft (PDX) models of breast cancer treated with estrogen, comforting our findings as to the importance of the activation of this signaling pathway in breast cancers.

RESULTS

ER α -36 contains a nuclear export signal and retains estrogen ligands binding sites

Although ER α -36 contains a nuclear localization signal, it is not expressed in the nucleus, and the protein has primarily been reported in the cytoplasm and at the plasma membrane (see Rao et al, 2011). Since ER α -36 differs from ER α by its unique C-terminal 27 amino-acid sequence, this sequence was submitted to the NetNES 1.1 prediction server which is a web interface designed to predict the presence of putative nuclear export signal (NES) sequences. A putative leucine-rich NES was identified in the CTD of ER α -36 (Figure S1A), which was very homologous to known NES sequences (Figure S1B). To confirm that this NES sequence was responsible for the absence of ER α -36 from the nucleus, we either deleted the 27 amino-acids (ER α -36 Δ C) or replaced two conserved hydrophobic residues, namely valine (V288) and Leucine (L295) by alanine (A) (ER α -36V288A/L295A) (Figure 1A). The different constructs were transfected into MCF-7 cells and analyzed by fluorescence microscopy. As expected, the wild type ER α -36 was localized in the cytoplasm and at the level of the plasma membrane (Figure 1B, *panels d-f*), whereas, the Δ C and the V288A/L295A NES mutants were mainly present in the nucleus (*panels g-l*). Hence, our results have uncovered the presence of a functional NES, inducing the exportation of ER α -36 from the nucleus.

Since ER α -36 lacks a part of the LBD, we verified, *in silico* and *in cellulo*, whether this isoform was able to transduce estrogen binding-dependent signal. For this purpose, we built homology models of ER α -36 with E₂ based on the available crystal structures of ER α LBD complexes. The initial model indicated that two residues, namely glutamic acid (E180) and arginine (R221) (corresponding to E353/R394 in ER α), could anchor the ligand in an open pocket in ER α -36 (Figure 1C). The remaining accessibility of a ligand pocket is in agreement with previous studies indicating high affinity binding of E₂ to ER α -36 (Kang et al., 2010). However, it must be noted that the modifications and truncation of the C-terminal helices in ER α -36 with respect to ER α will most likely alter the conformation of the LBD, an effect that was not modelled (Figure 1C), and more

detailed studies would be necessary to obtain a high resolution structure of ER α -36 LBD in complex with E₂. We next generated point mutations on these residues, replacing them with an A residue, and conducted *in cellulo* assays by transfecting HeLa cells with wild type (WT) or mutated ER α -36. We found that overexpression of the WT protein triggered activation of ERK upon E₂ treatment while the E180A and R221A mutants lost this capacity (Figure 1D).

E₂ triggers the interaction of ER α -36 with Src and PI3K kinases

In order to conduct experiments on cells endogenously expressing ER α -36, we produced an antibody specifically recognizing ER α -36, using a peptide containing the 27 amino-acids of the CTD of the protein. The antibody was validated by Western blot analyses using (i) GST-ER α -36, (Figure S2A), (ii) ER α -36 transfected into HeLa cells (Figure S2B), and (iii) in CAMA-1 cells, where ER α -36 was knocked down by a siRNA approach (Figure S2C). Next, we used the antibody to evaluate the level of ER α -36 expression in a panel of human breast cancer cell lines as well as in different PDX models of breast cancers (Marangoni et al., 2007). We initially confirmed, as noted previously (Gu et al., 2014; Lee et al., 2008; Shi et al., 2009; Wang et al., 2006), that ER α -36 is expressed both in ER α -positive and in ER α -negative breast tumors (Figures S2D and S2E). One triple negative PDX, namely HBCx-12A, clearly expressed higher level of ER α -36, both in Western blots and in immunohistochemically stained tissues (Figures S2E and S2F). Furthermore, a cell line (named HBCc-12A), conserving a strong expression of the protein (Figure S2G), was previously established from this PDX; both PDX and cell line were thus selected for future experiments to distinguish ER α -36-specific signaling, independently of ER α . Since ER α -36 was previously shown to trigger ERK and Akt activation (Lin et al., 2010; Wang et al., 2006), we studied these pathways in the HBCc-12A cells, and found that E₂ triggers a rapid and transient phosphorylation of ERK1/2 (Figure S2H), through no change in the phosphorylation of Akt was observed. Furthermore, the addition of E₂ led to an increase in cell proliferation *in vitro* (Figure S2I) and *in vivo*, since estradiol supplementation also stimulated the growth of the HBCx-12A PDX (Figure S2J).

To identify potential ER α -36 partners, we first targeted known ER α partners participating in non-genomic signaling, such as Src and the PI3K kinases (Cabodi et al., 2004; Castoria et al., 2001; Le Romancer M. et al., 2008). We initially demonstrated a direct interaction between ER α -36 and both Src and PI3K, by conducting GST pull-down experiments (Figures S3A and S3B). We next performed PLAs according to the method described by Soderberg et al. This assay enables a clear detection of protein-protein interactions *in situ*, with each red dot representing an interaction (Soderberg et al., 2006). Upon estrogen treatment, we found an increase in the number of ER α -36/Src and ER α -36/PI3K interactions in the cytoplasm of HBCc-12A cells (Figure 2A, *panels a-f*). These interactions were only detected when using a combination of both antibodies (Figures 2A, *panels g-I* and 2B). Interestingly, the number of red dots increased after 5 min of estrogen treatment, and then decreased after 15 min (Figures 2A and 2B). Since methylation of ER α on R260 was previously shown to trigger its association with Src and PI3K (Le Romancer M. et al., 2008), we attempted to detect methylation of ER α -36, but were unsuccessful (data not shown). Furthermore, since Src and PI3K kinase activities are required for their interaction with ER α (Poulard et al., 2012), we investigated whether they are also required to interact with ER α -36. We observed that treatment of HBCc-12A cells with the Src inhibitor PP1 abolished ER α -36/Src interactions but had no effect on the ER α -36/PI3K interaction. In contrast, the PI3K inhibitor LY294002 inhibited only ER α -36/PI3K interaction (Figures S3C and S3D).

ER α -36 binds specifically to P-ERK2

To identify ER α -36-specific partners, we performed a bioinformatics search of the CTD to find known protein motifs using the Scansite software. We uncovered a putative D domain (docking domain) for ERK2 and verified the alignment of this D domain with known MAPK interactors (Figure 2C). These D domains are characteristic of proteins involved in ERK signaling as they are present in ERK's substrates, phosphatases or adaptor proteins (Tanoue et al., 2000). We then verified by GST pull-down experiment whether ER α -36 interacts with ERK2. The data obtained (Figure 2D)

show that ER α -36 interacts specifically with ERK2, and that the deletion of the CTD of ER α -36 containing the putative D domain completely abolishes this interaction. These results were confirmed by immunoprecipitation in HeLa cells transfected with ER α -36 (Figure S4). Next, we studied endogenous ER α -36/ERK2 interactions in HBCc-12A cells by PLA. E₂ triggers a rapid interaction between both proteins with a peak at 5 min, and a decrease after 15 min (Figures 2E and 2F). Finally, *in vitro* phosphorylation assays revealed that ER α -36 is not a substrate for ERK2 (data not shown). To decipher the functional interplay between ER α -36 and ERK2 in HBCc-12A cells, we first checked whether ER α -36 interacts with phosphorylated ERK2 (P-ERK2). The use of the MEK inhibitor U1026 abolished the interactions between ER α -36 and ERK2 following E₂ treatment (Figures 2G and 2H), and concomitantly inhibited ERK phosphorylation (Figure 2I). These results suggest that ER α -36 interacts specifically with P-ERK2.

ER α -36 protects ERK dephosphorylation by the dual phosphatase MKP3

Next, we examined which amino-acid residues of ER α -36 were involved in its interaction with ERK2. An analysis of the 3D structure of ERK2-peptide complexes (Supplemental Table 3 for the list of the complexes) consistently pointed to R and L residues as playing an essential role in stabilizing the complexes (Table S1). Comparison of these data with the ER α -36 CTD sequence pointed to leucine (L297) residue as implicated in this interaction, and indicated that the CTD of ER α -36 could adopt a conformation similar to that seen in existing complexes (Figure 3A for a 3D *in silico* model representing a putative interaction between the CTD of ER α -36 and ERK2 and Table S1). The point mutation of this residue with an alanine residue resulted in an impairment in the binding of the ER α -36 L297A mutant to ERK2 (Figure 3B). Furthermore, we disrupted ER α -36/ERK interaction by transfecting HBCc-12A cells with a Flag-CTD of WT ER α 36 or of ER α -36 mutated on L297A. We found that the Flag-CTD strongly impaired the E₂-induced ER α -36/ERK2 interaction (Figure 3C, *panels d-f* and 3D) compared to the empty vector (Figure 3C, *panels a-c*). Interestingly, the Flag-CTD peptide also completely impaired ERK phosphorylation (Figure 3E). These effects

were not observed in cells transfected with the CTD mutant, which is unable to bind to ERK (Figures 3C, *panels g-I* and 3E). Control immunofluorescence (IF) experiments show that Flag-CTD peptides were equally expressed (Figure 3F). These findings show that L297 residue of ER α -36 is essential for the interaction between this receptor and ERK2.

Next, we overexpressed ER α -36 in HBCc-12A cells and found a sustained ERK phosphorylation (beyond 15 min) upon E₂ activation (Figure 4A). Concomitantly, a sustained ER α -36/ERK2 interaction was also observed by PLA in these cells (Figures 4B and 4C, *panels e-h*), compared to cells transfected with an empty vector (Figure 4C, *panels a-d*). We hypothesized that ER α -36 could regulate ERK phosphorylation by modulating its dephosphorylation. Since the dual phosphatase MKP3 has previously been implicated in ERK dephosphorylation (Roskoski, Jr., 2012), we knocked down MKP3 with 2 different siRNAs in HBCc-12A cells. This silencing approach resulted in sustained ERK phosphorylation upon E₂ treatment showing that MKP3 depletion is sufficient to inhibit ERK dephosphorylation (Figure 4D). This event occurred concomitantly with a sustained ER α -36/ERK2 interaction (Figures 4E and 4F). We then hypothesized that the binding of ERK2 to ER α -36 could impede its binding to MKP3 and therefore prevent ERK2 dephosphorylation. In order to verify this hypothesis, we studied the interaction between ERK2 and MKP3 by PLA in HBCc-12A cells transfected with the different Flag-CTD constructs as described above. Interestingly, we found that upon E₂ treatment, ER α -36 binds to ERK2 after 5 min while MKP3 binds to ERK2 after 15 min. However, when we disrupted ER α -36/ERK2 interaction with the ER α -36 Flag-CTD, MKP3 bound to ERK2 within 5 min of treatment (Figures 5A and 5B). Interestingly, the Flag-CTD L297A mutant, which does not impair the binding of ERK2 to ER α -36, displayed results similar to those obtained when transfecting with the empty vector. Finally, when we overexpressed ER α -36 in HBCc-12A cells (as in Figure 4A), we observed that the ERK2/MKP3 interaction occurred later than in the control cells (Figures 5C and 5D). Overall, these findings confirm our initial hypothesis, that ER α -36 prevents and delays the ERK2/MKP3 interaction, thus leading to a sustained ERK2 phosphorylation.

The activation and regulation of the E₂/ER α -36 pathway downstream of P-ERK

To investigate the signaling pathway induced by ER α -36, downstream of ERK, we initially demonstrated by IF that P-ERK remains exclusively localized in the cytoplasm of the cells (Figure 6A). From the literature, we identified a potential candidate, namely the adaptor paxillin (PXN), which is a cytoplasmic substrate for ERK, and which undergoes phosphorylation on its serine (S126) residue (Cai et al., 2006). We found that upon E₂ treatment of HBCc-12A cells, PXN phosphorylation increased in a rapid and transient manner following the same time course as ERK activation (Figure 6B). Since PXN has been described at the plasma membrane, as well as in the nucleus (Cai et al., 2006; Sen et al., 2012), we looked for the subcellular localization of P-PXN upon E₂ treatment. IF experiments showed that E₂ induced a rapid phosphorylation of PXN exclusively within the nucleus of HBCc-12A cells (Figure 6C). It was previously reported that P-S126-PXN can participate in the transcriptional regulation of cyclin D1 (Sen et al., 2012). We studied the expression of cyclin D1 following E₂ treatment and observed an increase in the level of Cyclin D1 expression after 12hr (Figure 6D). Interestingly, when the pathway was blocked with the MEK inhibitor or when the ER α -36/ERK2 interaction was disrupted, E₂ failed to induce PXN phosphorylation and cyclin D1 expression (Figure 6E and 6F). Furthermore, the longer time course of these experiments revealed a second activation wave of ERK after 1hr of induction, corroborating similar observations described previously in MDA-MB-231 cells (Zhang et al., 2011).

Having deciphered this new pathway in the HBCc-12A cell line, we investigated whether the pathway occurred in the corresponding PDX (HBCx-12A) grown in the presence of E₂. As described above, E₂ supplementation stimulated tumor growth *in vivo* (Figure S2J). The analysis of these xenografts tumors at the end of the 51-day experimental time course, showed an increase in ER α -36 interaction with Src (Figures 6G and 6H) and higher levels of P-ERK (Figure 6I), and, P-PXN expression (Figure 6J). In addition, this novel ER α -36-mediated signaling pathway was investigated in the ER α -negative HBL100 cell line, expressing ER α -36 (Figure S2D). This cell line responded

similarly to the HBCc-12A cell line, since incubation of E₂ also triggered ER α -36/ERK2 interaction, ERK activation, PXN phosphorylation, as well as cell proliferation (Figures S5A-S5D).

In order to establish the sequential events of the pathway, we investigated whether Src and PI3K activities occur upstream of the ERK pathway. To do so, we treated the HBCc-12A cells with PP1 and LY294002 and found that PP1 treatment completely abolished E₂-induced ERK and PXN phosphorylation (Figure 7A). ER α -36/ERK2 interaction (Figures 7B and 7C, compare *panels d-f* to control experiments *panels a-c*), as well as cyclin D1 expression (Figure 7D). LY294002 had no effect on these activities (Figures 7A; 7B, *panels g-i*; 7C and 7D). Finally, the kinetic of the various events of this signaling pathway was determined by treating the HBCc-12A cells with E₂ for a very short period of time. We found that (i) ER α -36 associates with Src within 3 min of E₂ treatment then dissociates after 5 min (Figures 7F and S6), (ii) ER α -36 binds to ERK2 with a peak occurring after 5 min of treatment, concomitantly with ERK and PXN phosphorylation (Figures 7E), (iii) after 11 min, MKP3 starts binding to ERK2 and the interaction lasts at 15 min after E₂ treatment (Figures 7F and S6).

DISCUSSION

In this study, we unveil the precise molecular events underlying ER α -36-mediated signaling pathway in triple negative breast cancers. These findings introduce a new paradigm in which ER α -36 activates ERK signaling at two levels, (i) firstly at the plasma membrane by binding to Src and, thereby, activating MEK-induced ERK phosphorylation and (ii) second in the cytoplasm by directly binding to P-ERK, and thus sustaining the ERK-mediated signals by preventing its dephosphorylation by the phosphatase MKP3.

In contrast to ER α , ER α -36 isoform has mainly been reported outside the nucleus (Wang et al., 2006). We uncovered a functional NES in ER α -36 CTD (Figures 1A; 1B; S1A and S1B), suggesting that ER α -36 normally enters the nucleus *via* its nuclear localization signal, and is then efficiently exported into the cytoplasm through its NES. These findings are similar to those observed for the PRMT1 isoform v2, which contains a similar NES responsible for its cytoplasmic localization, in contrast to other PRMT1 isoforms localized exclusively in the nucleus (Goulet et al., 2007).

The aim of the present investigation was to focus on triple negative breast cancers, since they are very aggressive, and no current targeted therapies. Using our antibody, we screened for a triple negative cell line endogenously expressing high levels of the protein, namely the HBCc-12A cell line, derived from the HBCx-12A PDX (Figure S2G). Next, while screening for cytoplasmic partners of ER α -36, we observed specific binding of the receptor with Src and with PI3K, which were also described to mediate ER α non-genomic signaling in breast cancer, by forming a trimeric complex (Cabodi et al., 2004; Castoria et al., 2001; Le Romancer M. et al., 2008; Poulard et al., 2012). However, the mechanisms underlying the formation of the complex seem to be different in the case of ER α -36. Indeed, the ER α /Src interaction was dependent on ER α methylation at the level of its R260 residue (corresponding to R184 in ER α -36) (Le Romancer M. et al., 2008) as well as on its phosphorylation at the level of the Y537 residue, a docking site for the SH2 domain of Src (Varricchio et al., 2007). Here, we were unable to detect any ER α -36 methylation on R184, and, in addition Y537 is not present in the ER α -36 sequence. We can speculate, seeing that the Src kinase

activity is required for its binding to ER α -36 (Figures 2A and 2B), that a yet unidentified tyrosine residue could be involved in their interaction. Moreover, the binding of ER α -36 with Src depends only on Src activity, as well as only PI3K activity is required for ER α -36/PI3K interaction. However, further investigations are required to ascertain which residues are involved in this interaction.

The functional activation of ERK by ER α -36 was shown by various research groups (Tong et al., 2010; Wang et al., 2006; Wang and Yin, 2015). In the present study, we mechanistically demonstrate that two routes tightly regulate ERK2 activation by acting both on its phosphorylation (i) and dephosphorylation (ii). We describe for the first time a direct binding of ER α -36 with ERK2 *via* a newly identified D domain located in the CTD of ER α -36. The D domain is a conserved docking motif in MAPKs used in the recognition of their activators, substrates and regulators, such as in MAKK kinases and phosphatases (Tanoue et al., 2000). The D-site contains both hydrophobic and positively charged basic residues with the following canonical sequence: (R/K)₂₋₃X₂₋₆- ϕ _A-X- ϕ _B, conserved in ER α -36 as the CTD contains **KKRILNL** (Figure 2C). A combined *in silico* 3D model and *in vitro* approach, enabled us to identify the crucial role of L297 in the binding interaction between ER α -36 and ERK2, which was confirmed as the mutation of L to A disrupted completely the interaction with ERK2 (Figure 3B). Deactivation of ERK1/2 is carried out by several serine threonine or tyrosine phosphatases. Among them MKP3 is a dual phosphatase with the capacity to dephosphorylate both threonine and tyrosine residues (Muda et al., 1996; Muda et al., 1998). Knowing that ER α -36 specifically binds to the phosphorylated form of ERK, we hypothesized that ER α -36 could regulate ERK dephosphorylation. Interestingly, ER α -36 was capable of preventing MKP3 binding to ERK presumably through steric competition, maintaining ERK activation. This was confirmed by the disruption of ER α -36/ERK2 interaction, allowing a more rapid binding of MPK3, and resulting in the constant dephosphorylation of ERK. Inversely, overexpression of ER α -36 delayed the binding of MKP3 to ERK. Such a regulation of P-ERK has already been described for the adaptor molecule MyD88 and the Rab2A GTPase. Indeed, MyD88 and Rab2A GTPase have been

shown to prevent ERK inactivation by MKP3, leading to cell transformation (Coste et al., 2010) and to promoting breast cancer stem cells respectively (Luo et al., 2015).

Although many ERK's substrates are localized in the nucleus and participate in the regulation of transcription, others are found in the cytosol and cellular organelles (Yoon and Seger, 2006). We found that P-ERK remained in the cytoplasm of HBCc-12A cells (Figure 6A), which directed our investigation to one of its cytoplasmic substrates. Recently, the hepatocyte growth factor (HGF) was shown to induce the phosphorylation of PXN, an important mediator downstream of ERK2 in HGF-induced motility, on its S126 residue (Radtke et al., 2013). PXN is a 68-kDa focal adhesion-associated protein that functions as a scaffolding protein assembling signaling molecules into complex downstream of integrin and growth factors. PXN regulates a variety of physiological functions, including matrix organization, cell motility, metastases and proliferation. PXN is comprised of multiple structural domains and several phosphorylation targets that act as docking sites for various signaling proteins (Brown and Turner, 2004; Schaller, 2001). Initially, ERK was identified as a priming kinase for the GSK3-mediated PXN phosphorylation on residue S126 (Cai et al., 2006). Furthermore, PXN was shown to function as an upstream mediator of ERK activation and a downstream regulator of ERK signaling *via* different phosphorylation. Epidermal growth factor and Dihydrotestosterone (a ligand to Androgen receptor) induces Src-mediated phosphorylation of PXN on residue Y118 to activate ERK phosphorylation but triggers also ERK-mediated phosphorylation of PXN on residue S126 (Sen et al., 2010). Since we found that P-PXN translocates to the nucleus following E₂ treatment (Figure 6C), and that ER α -36 triggers cyclin D1 transcription (Zhang et al., 2011), we speculate that PXN activates cyclin D1, thus triggering cell proliferation (Figure 6D). Of note, we proved that this ER α -36/Src/ERK2/PXN pathway is also activated in patient-derived breast tumors by showing that a treatment of the HBCx-12A PDX with E₂ induces tumor growth and an increase in ER α -36/Src interaction, P-ERK and P-PXN (Figure 6). Unfortunately, we were unable to detect ER α -36/ERK2 interaction in formalin-fixed tissues possibly due to the fact that ERK2 antibodies may not work in the PLAs conducted in formalin-fixed tissues.

Overall our work identified 2 complexes formed with ER α -36, namely: ER α -36/Src and ER α -36/ERK2 and we wanted to establish whether the ER α -36/Src interaction occurred upstream of ERK signaling. The use of kinase inhibitors clearly showed that Src activity not only triggers ER α -36/Src interaction but also ERK phosphorylation (Figure 7A). Several experiments were conducted to unveil the kinetics of this pathway, and based on these results we obtained; we propose the following preliminary model of regulation of the E₂/ER α -36 signaling pathway (Figure 7G). When E₂ enters within the cells, it causes ER α -36 interaction with Src, inducing MEK activation, which in turn phosphorylates ERK. Activated ERK phosphorylates its substrate PXN on residue S126, triggering its translocation to the nucleus where it acts as a coactivator to induce cyclin D1 transcription, and leading to an increase in cell proliferation. Interestingly, ER α -36 reinforces the signal induced by the P-ERK phosphorylation by preventing the rapid dephosphorylation of by MKP3. Given that the PI3K activity doesn't affect this pathway, we hypothesize that ER α -36/PI3K interaction may regulate other pathways.

The identification of this new signaling pathway could have significant implications in breast cancer treatment. Indeed, a retrospective study of 896 cases of breast cancer patients revealed that 40% cases of ER α -positive breast cancers expressed ER α -36, and those patients benefited less from tamoxifen therapy (Shi et al., 2009). Moreover, this study revealed that 40% of ER α -negative breast cancers, while lacking ER α expression, expressed ER α -36. Its prognosis value in this breast cancer subtype is less clear, since contradictories results have been published (for a review see: (Gu et al., 2014).

Future studies could, based on our approach, determine whether this novel pathway is conserved between ER α -positive and -negative subtypes; investigating whether it could impede the beneficial effect of tamoxifen or whether it is also active, *in vivo*, in triple negative breast cancers, respectively. For these ER α -36-positive tumors, combining Src or MEK inhibitors with hormonotherapy may improve the response to conventional treatment.

EXPERIMENTAL PROCEDURES

Antibodies

A polyclonal antibody against ER α -36 specifically generated for this study by Covalab (Lyon, France), and commercially-available antibodies are listed in the Supplemental Experimental Procedures.

Cell Culture

MCF-7 and HeLa cells were obtained from ATCC. The HBCc-12A cell line was established from the HBCx-12A xenograft, a PDX model of primary triple-negative breast cancer (Marangoni et al., 2007). Additional information can be found in the Supplemental Experimental Procedures.

Plasmids and mutagenesis

The pCDNA3-ER α -36 plasmid was a gift from Dr Wang (Wang et al., 2005). The mutations were obtained using the Quickchange XL Site-Directed Mutagenesis Kit according to the manufacturer's instructions (Agilent Technologies, USA). Additional information can be found in the Supplemental Experimental Procedures.

Proximity ligation assay (PLA)

This technology developed by Olink Bioscience (Sweden) enables the visualization of protein/protein interactions *in situ* and was firstly published in 2006 (Soderberg et al., 2006). Additional information can be found in the Supplemental Experimental Procedures.

Molecular modeling

Homology models of ER α -36 ligand binding domain (118-310) were obtained using the structure prediction server ROBETTA (<http://robeta.bakerlab.org/>). The amino-acid sequence of ER α -36 was retrieved from NCBI (GenBank: BX640939.1). 3D Models were compared to the crystal structures of

ER α -E₂ (PDB ID: 1A52). Analysis of the complexes between ERK2 and D motif peptides was performed as described in the Supplemental Experimental Procedures. Figures were realized with the PyMOL molecular graphics software.

CONFLICT OF INTEREST

The authors declare no conflict of interest

AUTHOR CONTRIBUTION

SO, JJ and CP performed most of the experiments. NR, YC and AD, the modelling; EM the mice experiments, IT the IHC experiments. LC participated in the writing of the article. MLR conducted the project and the article.

ACKNOWLEDGEMENTS

We thank C. Languilaire, A. Colombe, L Odeyer and F. Assayag for technical support, Y. Mikaelian (CRCL, Lyon) for the Histone-GFP vector. We thank G. Castoria for the PI3K plasmid, and Dr Wang for the pCDNA3-ER α -36 plasmid. A big thank for Brigitte Manship for the proofreading of the manuscript.

This study was supported by the Ligue Nationale Contre le Cancer (comité de Saône-et-Loire), the “Fondation Arc Cancer”. SO was supported by “the region Rhône-Alpes” and from “the Ligue Contre le Cancer”. CP was supported by the French Ministry of Research, by the “Fondation Arc Cancer” and the NIH. JJ was supported by the “Fondation Arc Cancer”.

NR, YC and AD acknowledge support from grant ANR-10-LABX-0030-INRT, a French State fund managed by the ANR (ANR-10-IDEX-0002-02).

No potential conflicts of interest were disclosed.

LEGENDS TO FIGURES

Figure 1: ER α -36 molecular properties.

(A) Schematic representation of ER α -36 mutants. ER α -36 Δ C has been generated by deleting the CTD. The mutant ER α -36V288A/L297A was obtained by mutating essential hydrophobic residues of the NES.

(B) MCF-7 cells were transfected with pSG5Flag vector (panels a–c), pSG5Flag-ER α -36 (panels d–f), pSG5Flag-ER α -36 Δ C (panels g–i), or pSG5FlagER α -36 V288A/L295A (panels j–l) for 36 hr, then fixed and stained with DAPI and anti-Flag antibody.

(C) (Left) Modelled structure of the LBD of ER α -36 showing E₂ docked in the ligand binding pocket. The proteins homology model is not refined and lacks the C-terminal part of ER α (H10 to H12). The specific sequence of ER α -36 is colored in blue and the ligand in red. The docked E₂ is forming electrostatic interactions with residues E180 and R221. (Right) The experimental crystal structure of ER α LBD (PDB ID 1A52, (Tanenbaum et al., 1998)) in complex with E₂ is shown for comparison. The C-Terminal part which differs from ER α -36 is highlighted in red and the position of the helices 9, 10 and 12 are indicated.

(D) HeLa cells were transfected with the pSG5Flag vector, with the pSG5Flag-ER α -36 plasmid, or the point mutated pSG5Flag-ER α -36-E180/A and pSG5Flag-ER α -36-E180/A-R221/A constructs, before being treated with E₂. A Western blot analysis was performed to detect P-ERK, ERK and ER α -36 expression.

Figure 2: ER α ligands trigger ER α -36 interaction with Src, PI3K and P-ERK2

(A) HBCc-12A cells were treated with E₂ for the indicated times. After fixation, *in situ* PLA for ER α -36/Src (panels a–c) and ER α -36/PI3K dimers (panels d–f) were performed with ER α -36-, Src-, and PI3K-specific antibodies. The detected dimers are represented by red dots. The nuclei were

counterstained with DAPI (blue) (Obj: X63). Control PLA experiments were performed using single antibodies (panels g-i).

B) Quantification of the Figure 2A was performed by counting the number of signals per cell as reported in the Supplemental Experimental Procedures. The experiment was performed three times, and this graph is representative of one of the experiment. The P-value was determined by the Student's t-test.

C) Sequence alignment of known D domains in selected MAPK substrates aligned with the putative docking site. Basic residues are highlighted in boldface type, and the hydrophobic motif ϕ A-X- ϕ B is underlined (modified from (Martin et al., 2008)).

(D) Direct interaction between ER α -36 and ERK2 was analyzed by GST-pull-down experiments. ³⁵S-labeled *in vitro* translated ER α -36 or ER α -36 Δ C was incubated with GST or GST-ERK2-glutathione-Sepharose beads. The eluted proteins and 1/50 of input radiolabeled proteins were analyzed by SDS-PAGE and visualized by autoradiography. The right panel shows the corresponding gel stained with Coomassie.

(E) HBCc-12A cells were treated for the indicated times with E₂. After fixation, *in situ* PLA for ER α -36/ERK2 interaction was performed. The nuclei were counterstained with DAPI (x63 magnification).

(F) The quantification of cells highlighted in Figure 2E was performed as described in Figure 2B.

(G) HBCc-12A cells were treated or not with the MEK inhibitor, U1026 (10 μ M) for 15 min prior to E₂ treatment. *In situ* PLA for ER α -36/ERK2 interaction was performed. The nuclei were counterstained with DAPI (x63 magnification).

(H) The quantification of cells highlighted in Figure 2G was performed as described in Figure 2B.

(I) Cell extracts from the experiment depicted in Figure 2G were analyzed by Western blot for P-ERK and ERK expression.

Figure 3: Disruption of ER α -36/ERK2 interaction abolishes E₂-induced ERK activation

(A) Modelled structure of ERK2 complex with the CTD of ER α -36. The structure of ERK2 is displayed as ribbons, and based the PDB ID 2FYS. The modelled CTD of ER α -36 is represented in red.

(B) GST pull down experiment was performed by incubating the GST-ERK2 fusion protein in the presence of *in vitro* translated ³⁵S-labeled ER α -36 or ER α -36-L297A mutant (*). 1/50 of input radiolabeled proteins were analyzed by SDS-PAGE and visualized by autoradiography. The corresponding Coomassie-stained gel is shown in the right panel.

(C) HBCc-12A cells were transfected with pSG5-Flag vector, pSG5-Flag-ER α -36-CTD or pSG5-Flag- ER α -36-CTD-L297A for 36 hr. The cells were treated with E₂ and fixed in methanol. ER α -36/ERK2 interactions were analyzed by PLA. The nuclei were counterstained with DAPI (blue) (x63 magnification).

(D) Quantification of the cells detected in Figure 3C was performed as described in Figure 2B. The experiment was performed in triplicate, and this graph is representative of one of the experiments. The P-value was determined by the Student's test. *** P<0.001.

(E) P-ERK and ERK, in cells from Figure 3C, were analyzed by Western blot.

(F) The cells from the experiment in Figure 3C were fixed and stained with DAPI and anti-Flag antibody.

Figure 4: Crosstalk between ER α -36 and MKP3 to regulate ERK phosphorylation

(A) The pSG5-Flag or pSG5-Flag-ER α -36 vectors were transfected into HBCc-12A cells for 36 hr prior to their treatment with E₂. The cell extracts were analyzed for the expression of P-ERK, ERK and ER α -36.

(B) Following the PLA conducted in Figure 4C, ER α -36/ERK2 interactions were quantified as described in Figure 2C. The experiment was performed in triplicate, and this graph is

representative of one of the experiments. The P-value was determined by the Student's test. *** P<0.001.

(C) Cells from the experiment conducted in Figure 4A were used to perform *in situ* PLA to detect, ER α -36/ERK2 interactions. (x63 magnification).

(D) Lysates of MCF-7 cells transfected with control siRNA duplexes or with specific MKP3 siRNA duplexes were analyzed for P-ERK, ERK and MKP3 expression.

(E) Quantification of the interactions detected in Figure 4F was done as described in Figure 4B.

(F) Cells from the experiment in Figure 4D were used to perform an *in situ* PLA, as described in Figure 4C, in order to detect ER α -36/ERK2 interactions following MKP3 silencing.

Figure 5: ER α -36 impedes MKP3 interaction with ERK2

(A) HBCc-12A cells were transfected with pSG5-Flag vector, pSG5-Flag-ER α -36-CTD or pSG5-Flag- ER α -36-CTD-L297A prior to E₂ treatment. A PLA was then conducted to analyze ERK2/MKP3 interactions. (x63 magnification).

(B) Quantification of the interactions detected in Figure 5A was performed as described in Figure 2B. The experiment was performed in triplicate, and this graph is representative of one of the experiments. The P-value was determined by the Student's test. *** P<0.001.

(C) The pSG5-Flag and pSG5-Flag-ER α -36 vectors were transfected into HBCc-12A cells for 36hr prior E₂ treatment. We then analyzed ERK2/MKP3 interactions by PLA as described in Figure 5A.

(D) Quantification of the interactions revealed experiment in Figure 5C was performed as described in Figure 5B.

Figure 6: The study of estrogen signaling pathway downstream of ERK

(A) HBCc-12A cells were treated with E₂. The cells were then fixed and immunostained with the anti-PERK antibody by immunofluorescence (IF).(x63 magnification).

(B) HBCc-12A cells were treated with E₂. The cell extracts were subsequently analyzed by Western blot for the expression of P-ERK, ERK, P-PXN and PXN.

(C) HBCc-12A cells were treated with E₂. The cells were then fixed and immunostained to study the localization of P-PXN by IF as described in Figure 6A.

(D) HBCc-12A cells were treated with E₂. The cell extracts were analyzed by Western blot for the expression of Cyclin D1 and tubulin.

(E) HBCc-12A cells were treated or not with the MEK inhibitor, U1026 (10μM) for 15 min prior to their treatment with E₂ for 5 min. Expression of cyclin D1 and tubulin were assessed by Western blot.

(F) HBCc-12A cells were transfected with pSG5-Flag vector, pSG5-Flag-ERα-36-CTD or pSG5-Flag-ERα-36-CTD-L297A for 36 hr. The cell extracts were analyzed by Western blot for P-ERK, ERK, P-PXN, PXN and cyclin D1 expression.

(G) HBCx-12A PDX was grown with and without the supplementation of E₂ in the drinking water of mice (See Figure S2I). Mice were sacrificed at the end of the experiment (day 51) and tumours were embedded in paraffin. A bright field PLA was performed to study ERα-36/Src interactions in each group. The brown dots represent protein-protein interactions (x40 magnification).

(H) The interactions detected in Figure 6G were quantified as reported in the Supplemental Experimental Procedures. The experiment was performed in triplicate, and this graph is representative of one of the experiments. The P-value was determined by the Student's test. *** P<0.001.

(I) From the paraffin-embedded tumors obtained from Figure 6G, P-ERK was assessed by IHC staining.

(J) From the paraffin-embedded tumors obtained from Figure 6G, P-PXN was assessed by IHC staining.

Figure 7: Src activity regulates E₂-induced ERK signaling

(A) HBCc-12A cells were treated or not with PP1 (5 μ M) or LY294002 (20 μ M) 15 min before E₂ treatment. Cell lysates were analyzed by Western blot for the expression of P-ERK, ERK, P-PXN and PXN.

(B) Cells from the experiment conducted in Figure 7A were used to perform *in situ* PLA to detect ER α -36/ERK2 interactions. (x63 magnification).

(C) Quantification of the interactions detected in Figure 7B was performed as described in Figure 2B. The experiment was performed in triplicate, and this graph is representative of one of the experiments. The P-value was determined by the Student's test. *** P<0.001.

(D) HBCc-12A cells were treated or not with PP1 (5 μ M) or LY294002 (20 μ M), as described in Figure 7A, were lysed and the expression of Cyclin D1 and tubulin were analysed by Western blot.

(E) HBCc-12A cells were treated with E₂. Cell lysates were analyzed by Western blot for the expression of P-ERK, ERK, P-PXN and PXN

(F) From the experiment performed in Figure 7E, ER α -36/Src, ER α -36/ERK2 and ERK2/MKP3 interactions were studied by PLA (pictures are shown in Figure S6) and the quantification was performed as already described.

(G) Model of the E₂/ER α -36 signaling pathway. Upon E₂ stimulation, ER α -36 binds to Src, activating MEK that phosphorylates ERK, which phosphorylates PXN on residue S126. P-PXN translocates to the nucleus to activate the transcription of cyclin D1, thus regulating cell proliferation. ER α -36 binds directly to P-ERK2 and prevents the dephosphorylation of ERK2 by MKP3, thereby sustaining the downstream signalling pathway.

REFERENCES

1. Brown, M.C., and Turner, C.E. (2004). Paxillin: adapting to change. *Physiol Rev.* 84, 1315-1339.
2. Cabodi, S., Moro, L., Baj, G., Smeriglio, M., Di, S.P., Gippone, S., Surico, N., Silengo, L., Turco, E., Tarone, G., and Defilippi, P. (2004). p130Cas interacts with estrogen receptor alpha and modulates non-genomic estrogen signaling in breast cancer cells. *J. Cell Sci.* 117, 1603-1611.
3. Cai, X., Li, M., Vrana, J., and Schaller, M.D. (2006). Glycogen synthase kinase 3- and extracellular signal-regulated kinase-dependent phosphorylation of paxillin regulates cytoskeletal rearrangement. *Mol. Cell Biol.* 26, 2857-2868.
4. Castoria, G., Migliaccio, A., Bilancio, A., Di, D.M., de, F.A., Lombardi, M., Fiorentino, R., Varricchio, L., Barone, M.V., and Auricchio, F. (2001). PI3-kinase in concert with Src promotes the S-phase entry of oestradiol-stimulated MCF-7 cells. *EMBO J.* 20, 6050-6059.
5. Chaudhri, R.A., Olivares-Navarrete, R., Cuenca, N., Hadadi, A., Boyan, B.D., and Schwartz, Z. (2012). Membrane estrogen signaling enhances tumorigenesis and metastatic potential of breast cancer cells via estrogen receptor-alpha36 (ERalpha36). *J. Biol. Chem.* 287, 7169-7181.
6. Coste, I., Le, C.K., Kfoury, A., Hmitou, I., Druillennec, S., Hainaut, P., Eychene, A., Lebecque, S., and Renno, T. (2010). Dual function of MyD88 in RAS signaling and inflammation, leading to mouse and human cell transformation. *J. Clin. Invest* 120, 3663-3667.
7. Foulkes, W.D., Smith, I.E., and Reis-Filho, J.S. (2010). Triple-negative breast cancer. *N. Engl. J. Med.* 363, 1938-1948.
8. Goulet, I., Gauvin, G., Boisvenue, S., and Cote, J. (2007). Alternative splicing yields protein arginine methyltransferase 1 isoforms with distinct activity, substrate specificity, and subcellular localization. *J. Biol. Chem.* 282, 33009-33021.
9. Gu, Y., Chen, T., Lopez, E., Wu, W., Wang, X., Cao, J., and Teng, L. (2014). The therapeutic target of estrogen receptor-alpha36 in estrogen-dependent tumors. *J. Transl. Med.* 12, 16.
10. Kang, L., Zhang, X., Xie, Y., Tu, Y., Wang, D., Liu, Z., and Wang, Z.Y. (2010). Involvement of estrogen receptor variant ER-alpha36, not GPR30, in nongenomic estrogen signaling. *Mol. Endocrinol.* 24, 709-721.
11. Kong, E.H., Pike, A.C., and Hubbard, R.E. (2003). Structure and mechanism of the oestrogen receptor. *Biochem. Soc. Trans.* 31, 56-59.
12. Le Romancer M., Poulard, C., Cohen, P., Sentis, S., Renoir, J.M., and Corbo, L. (2011). Cracking the estrogen receptor's posttranslational code in breast tumors. *Endocr. Rev.* 32, 597-622.

13. Le Romancer M., Treilleux, I., Leconte, N., Robin-Lespinasse, Y., Sentis, S., Bouchekioua-Bouzaghrou, K., Goddard, S., Gobert-Gosse, S., and Corbo, L. (2008). Regulation of estrogen rapid signaling through arginine methylation by PRMT1. *Mol. Cell* 31, 212-221.
14. Lee, L.M., Cao, J., Deng, H., Chen, P., Gatalica, Z., and Wang, Z.Y. (2008). ER-alpha36, a novel variant of ER-alpha, is expressed in ER-positive and -negative human breast carcinomas. *Anticancer Res.* 28, 479-483.
15. Levin, E.R. (2009). Membrane oestrogen receptor alpha signalling to cell functions. *J. Physiol* 587, 5019-5023.
16. Levin, E.R. (2015). Extranuclear steroid receptors are essential for steroid hormone actions. *Annu. Rev. Med.* 66, 271-280.
17. Lin, S.L., Yan, L.Y., Zhang, X.T., Yuan, J., Li, M., Qiao, J., Wang, Z.Y., and Sun, Q.Y. (2010). ER-alpha36, a variant of ER-alpha, promotes tamoxifen agonist action in endometrial cancer cells via the MAPK/ERK and PI3K/Akt pathways. *PLoS. One.* 5, e9013.
18. Luo, M.L., Gong, C., Chen, C.H., Hu, H., Huang, P., Zheng, M., Yao, Y., Wei, S., Wulf, G., Lieberman, J., Zhou, X.Z., Song, E., and Lu, K.P. (2015). The Rab2A GTPase promotes breast cancer stem cells and tumorigenesis via Erk signaling activation. *Cell Rep.* 11, 111-124.
19. Marangoni, E., Vincent-Salomon, A., Auger, N., Degeorges, A., Assayag, F., de, C.P., de, P.L., Guyader, C., De, P.G., Judde, J.G., Rebucci, M., Tran-Perennou, C., Sastre-Garau, X., Sigal-Zafrani, B., Delattre, O., Dieras, V., and Poupon, M.F. (2007). A new model of patient tumor-derived breast cancer xenografts for preclinical assays. *Clin. Cancer Res.* 13, 3989-3998.
20. Martin, M.C., Allan, L.A., Mancini, E.J., and Clarke, P.R. (2008). The docking interaction of caspase-9 with ERK2 provides a mechanism for the selective inhibitory phosphorylation of caspase-9 at threonine 125. *J. Biol. Chem.* 283, 3854-3865.
21. Muda, M., Boschert, U., Dickinson, R., Martinou, J.C., Martinou, I., Camps, M., Schlegel, W., and Arkinstall, S. (1996). MKP-3, a novel cytosolic protein-tyrosine phosphatase that exemplifies a new class of mitogen-activated protein kinase phosphatase. *J. Biol. Chem.* 271, 4319-4326.
22. Muda, M., Theodosiou, A., Gillieron, C., Smith, A., Chabert, C., Camps, M., Boschert, U., Rodrigues, N., Davies, K., Ashworth, A., and Arkinstall, S. (1998). The mitogen-activated protein kinase phosphatase-3 N-terminal noncatalytic region is responsible for tight substrate binding and enzymatic specificity. *J. Biol. Chem.* 273, 9323-9329.
23. Nilsson, S., Makela, S., Treuter, E., Tujague, M., Thomsen, J., Andersson, G., Enmark, E., Pettersson, K., Warner, M., and Gustafsson, J.A. (2001). Mechanisms of estrogen action. *Physiol Rev.* 81, 1535-1565.
24. Poulard, C., Treilleux, I., Lavergne, E., Bouchekioua-Bouzaghrou, K., Goddard-Leon, S., Chabaud, S., Tredan, O., Corbo, L., and Le, R.M. (2012). Activation of rapid oestrogen signalling in aggressive human breast cancers. *EMBO Mol. Med.* 4, 1200-1213.

25. Radtke, S., Milanovic, M., Rosse, C., De, R.M., Lachmann, S., Hibbert, A., Kermorgant, S., and Parker, P.J. (2013). ERK2 but not ERK1 mediates HGF-induced motility in non-small cell lung carcinoma cell lines. *J. Cell Sci.* 126, 2381-2391.
26. Rao, J., Jiang, X., Wang, Y., and Chen, B. (2011). Advances in the understanding of the structure and function of ER-alpha36, a novel variant of human estrogen receptor-alpha. *J. Steroid Biochem. Mol. Biol.* 127, 231-237.
27. Roskoski, R., Jr. (2012). ERK1/2 MAP kinases: structure, function, and regulation. *Pharmacol. Res.* 66, 105-143.
28. Schaller, M.D. (2001). Paxillin: a focal adhesion-associated adaptor protein. *Oncogene* 20, 6459-6472.
29. Sen, A., De, C., I, Defranco, D.B., Deng, F.M., Melamed, J., Kapur, P., Raj, G.V., Rossi, R., and Hammes, S.R. (2012). Paxillin mediates extranuclear and intranuclear signaling in prostate cancer proliferation. *J. Clin. Invest* 122, 2469-2481.
30. Sen, A., O'Malley, K., Wang, Z., Raj, G.V., Defranco, D.B., and Hammes, S.R. (2010). Paxillin regulates androgen- and epidermal growth factor-induced MAPK signaling and cell proliferation in prostate cancer cells. *J. Biol. Chem.* 285, 28787-28795.
31. Shi, L., Dong, B., Li, Z., Lu, Y., Ouyang, T., Li, J., Wang, T., Fan, Z., Fan, T., Lin, B., Wang, Z., and Xie, Y. (2009). Expression of ER- α 36, a novel variant of estrogen receptor α , and resistance to tamoxifen treatment in breast cancer. *J. Clin. Oncol.* 27, 3423-3429.
32. Soderberg, O., Gullberg, M., Jarvius, M., Ridderstrale, K., Leuchowius, K.J., Jarvius, J., Wester, K., Hydbring, P., Bahram, F., Larsson, L.G., and Landegren, U. (2006). Direct observation of individual endogenous protein complexes in situ by proximity ligation. *Nat. Methods* 3, 995-1000.
33. Song, R.X., Zhang, Z., and Santen, R.J. (2005). Estrogen rapid action via protein complex formation involving ER α and Src. *Trends Endocrinol. Metab* 16, 347-353.
34. Tanenbaum, D.M., Wang, Y., Williams, S.P., and Sigler, P.B. (1998). Crystallographic comparison of the estrogen and progesterone receptor's ligand binding domains. *Proc. Natl. Acad. Sci. U. S. A* 95, 5998-6003.
35. Tanoue, T., Adachi, M., Moriguchi, T., and Nishida, E. (2000). A conserved docking motif in MAP kinases common to substrates, activators and regulators. *Nat. Cell Biol.* 2, 110-116.
36. Tong, J.S., Zhang, Q.H., Wang, Z.B., Li, S., Yang, C.R., Fu, X.Q., Hou, Y., Wang, Z.Y., Sheng, J., and Sun, Q.Y. (2010). ER-alpha36, a novel variant of ER-alpha, mediates estrogen-stimulated proliferation of endometrial carcinoma cells via the PKCdelta/ERK pathway. *PLoS. One.* 5, e15408.
37. Varricchio, L., Migliaccio, A., Castoria, G., Yamaguchi, H., de, F.A., Di, D.M., Giovannelli, P., Farrar, W., Appella, E., and Auricchio, F. (2007). Inhibition of estradiol receptor/Src association and cell growth by an estradiol receptor alpha tyrosine-phosphorylated peptide. *Mol. Cancer Res.* 5, 1213-1221.

38. Wang, Z., Zhang, X., Shen, P., Loggie, B.W., Chang, Y., and Deuel, T.F. (2005). Identification, cloning, and expression of human estrogen receptor-alpha36, a novel variant of human estrogen receptor-alpha66. *Biochem. Biophys. Res. Commun.* 336, 1023-1027.
39. Wang, Z., Zhang, X., Shen, P., Loggie, B.W., Chang, Y., and Deuel, T.F. (2006). A variant of estrogen receptor- α , hER- α 36: transduction of estrogen- and antiestrogen-dependent membrane-initiated mitogenic signaling. *Proc. Natl. Acad. Sci. U. S. A* 103, 9063-9068.
40. Wang, Z.Y., and Yin, L. (2015). Estrogen receptor alpha-36 (ER-alpha36): A new player in human breast cancer. *Mol. Cell Endocrinol.*
41. Yin, L., Zhang, X.T., Bian, X.W., Guo, Y.M., and Wang, Z.Y. (2014). Disruption of the ER-alpha36-EGFR/HER2 positive regulatory loops restores tamoxifen sensitivity in tamoxifen resistance breast cancer cells. *PLoS. One.* 9, e107369.
42. Yoon, S., and Seger, R. (2006). The extracellular signal-regulated kinase: multiple substrates regulate diverse cellular functions. *Growth Factors* 24, 21-44.
43. Zhang, J., Li, G., Li, Z., Yu, X., Zheng, Y., Jin, K., Wang, H., Gong, Y., Sun, X., Teng, X., Cao, J., and Teng, L. (2012a). Estrogen-independent effects of ER-alpha36 in ER-negative breast cancer. *Steroids* 77, 666-673.
44. Zhang, X., Ding, L., Kang, L., and Wang, Z.Y. (2012b). Estrogen receptor-alpha 36 mediates mitogenic antiestrogen signaling in ER-negative breast cancer cells. *PLoS. One.* 7, e30174.
45. Zhang, X.T., Kang, L.G., Ding, L., Vranic, S., Gatalica, Z., and Wang, Z.Y. (2011). A positive feedback loop of ER-alpha36/EGFR promotes malignant growth of ER-negative breast cancer cells. *Oncogene* 30, 770-780.

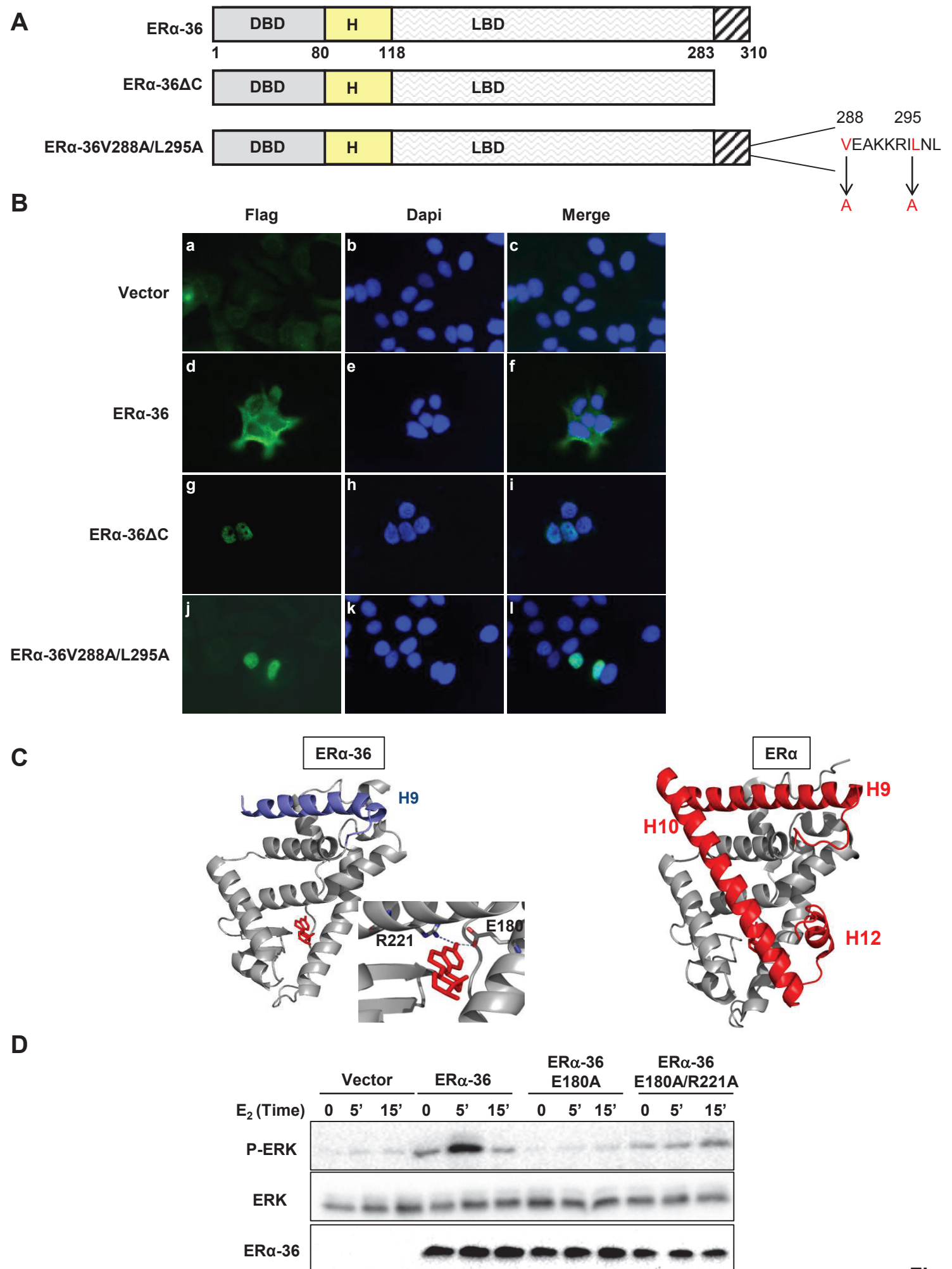

Figure 1

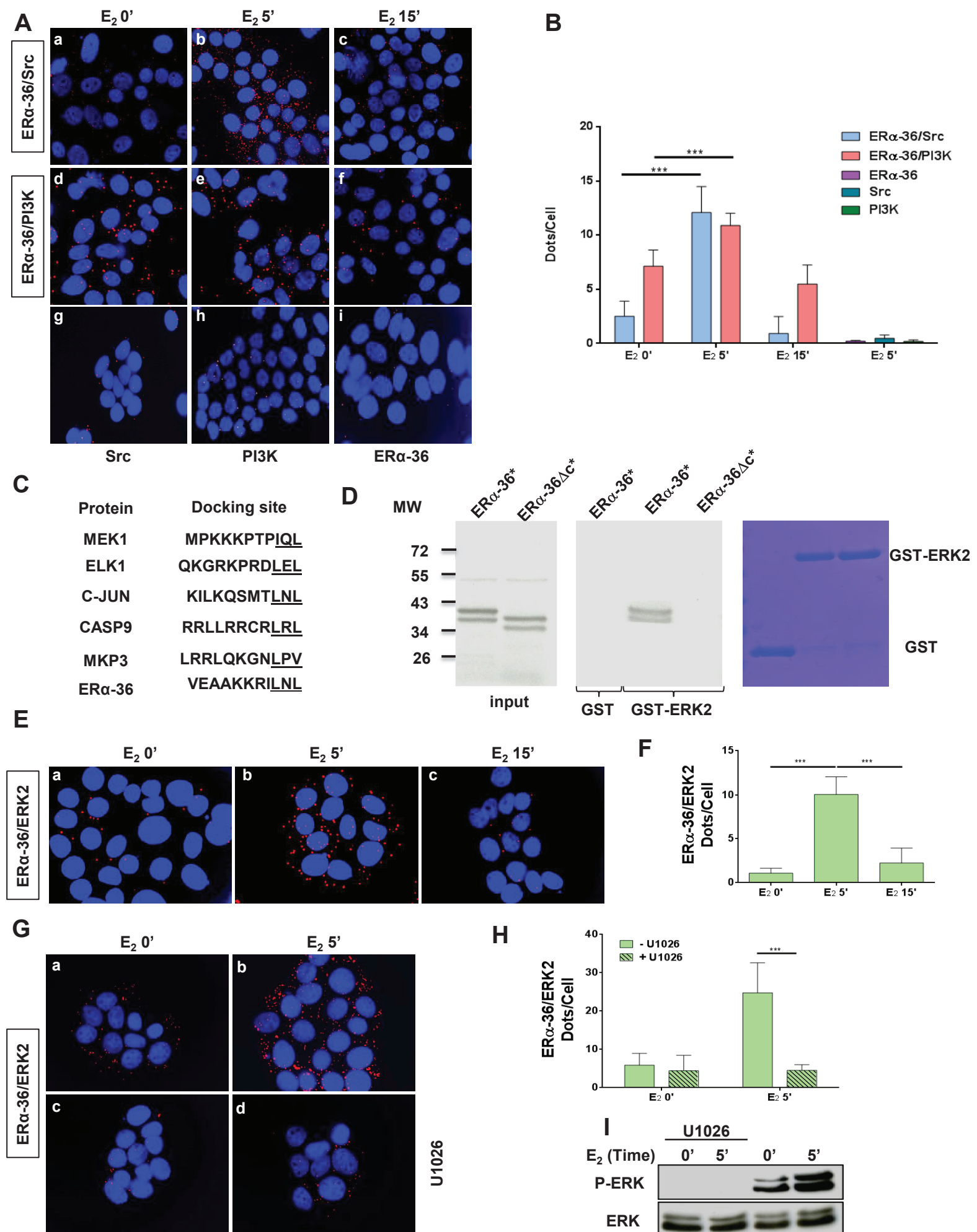
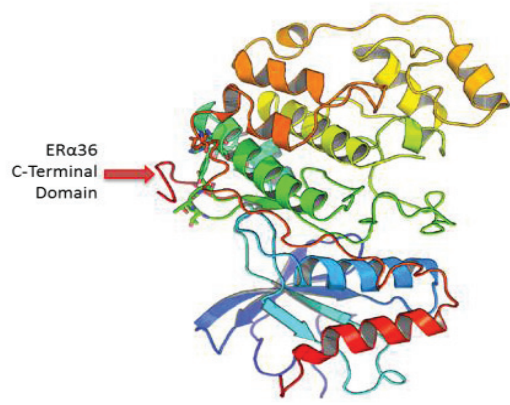
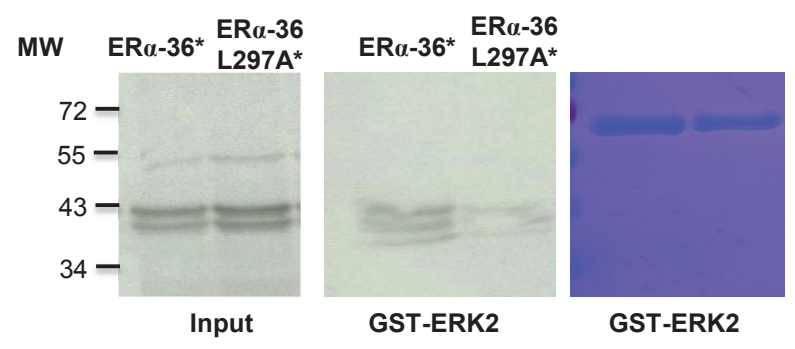
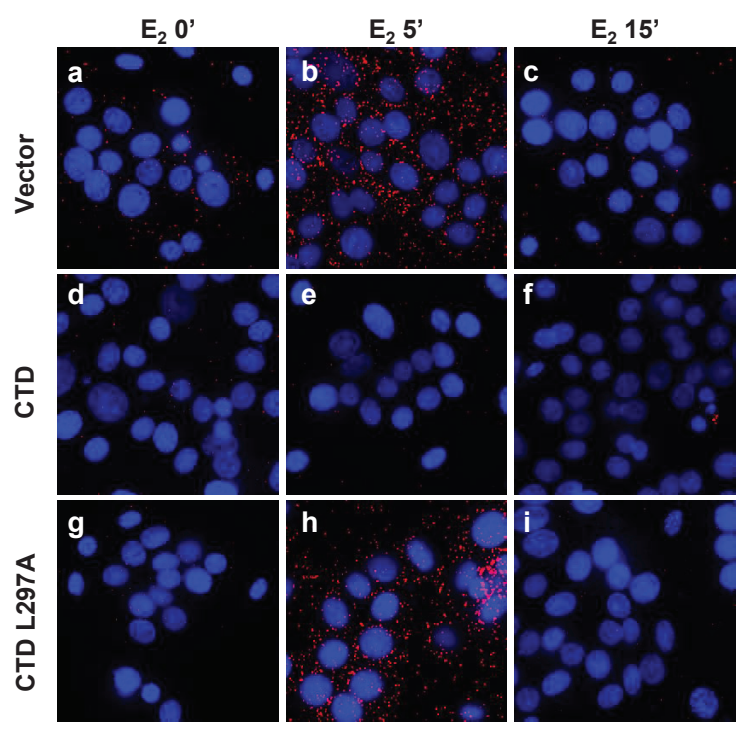
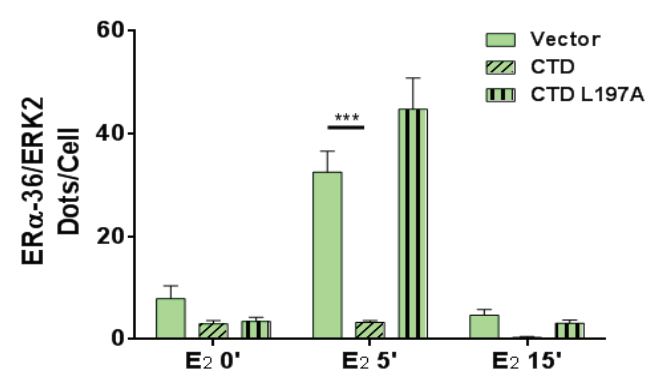
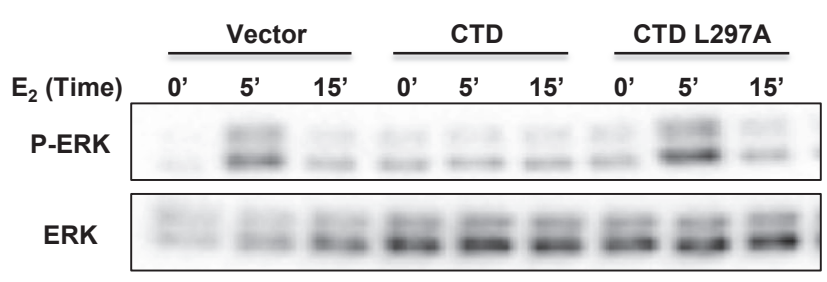
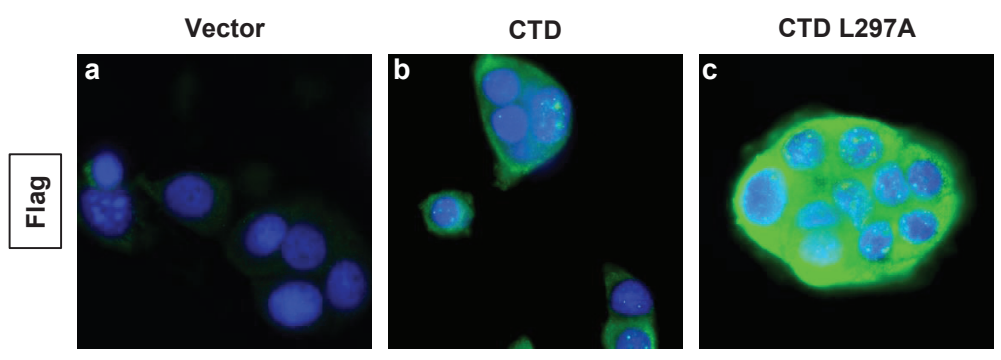

Figure 2

A**B****C****D****E****F****Figure 3**

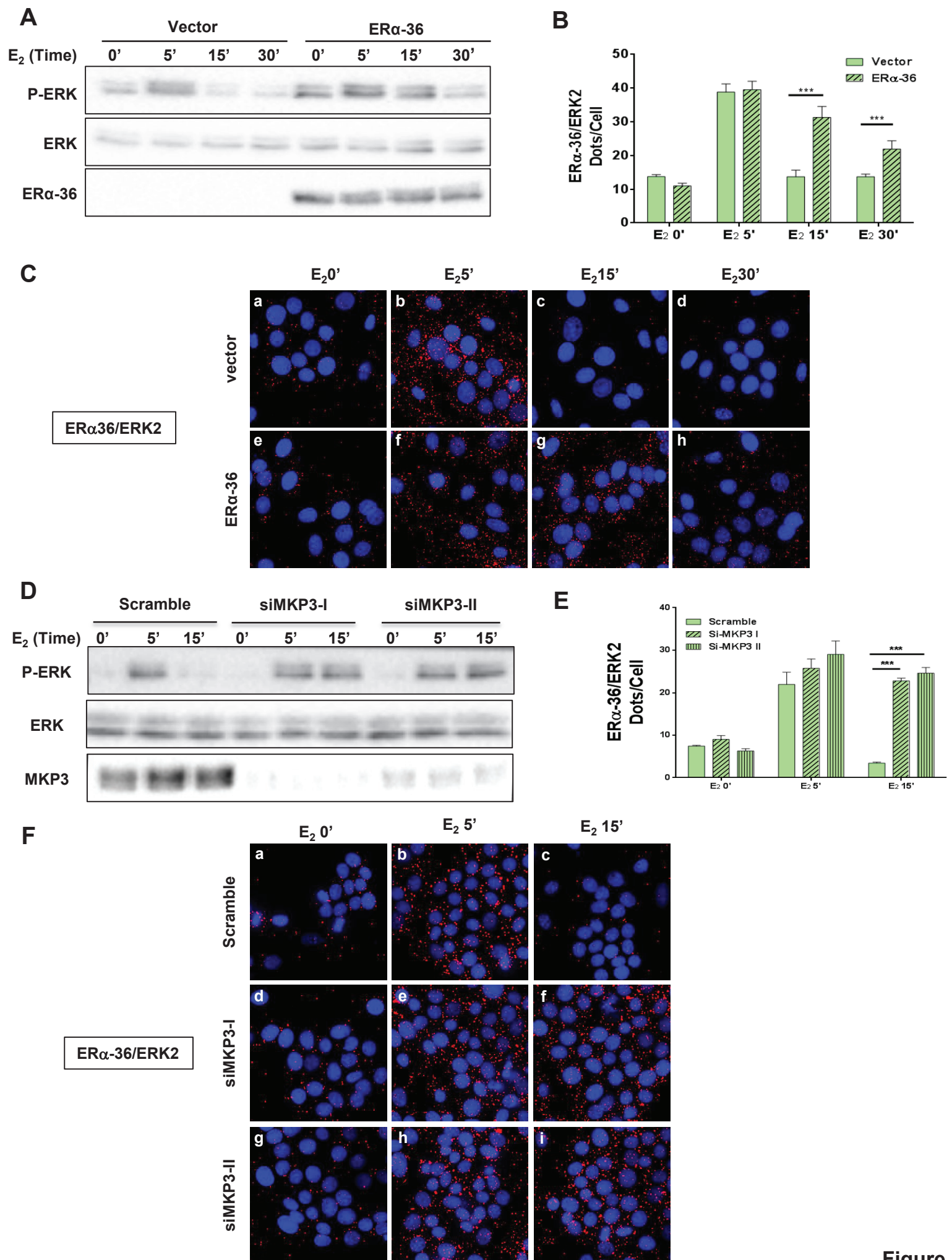
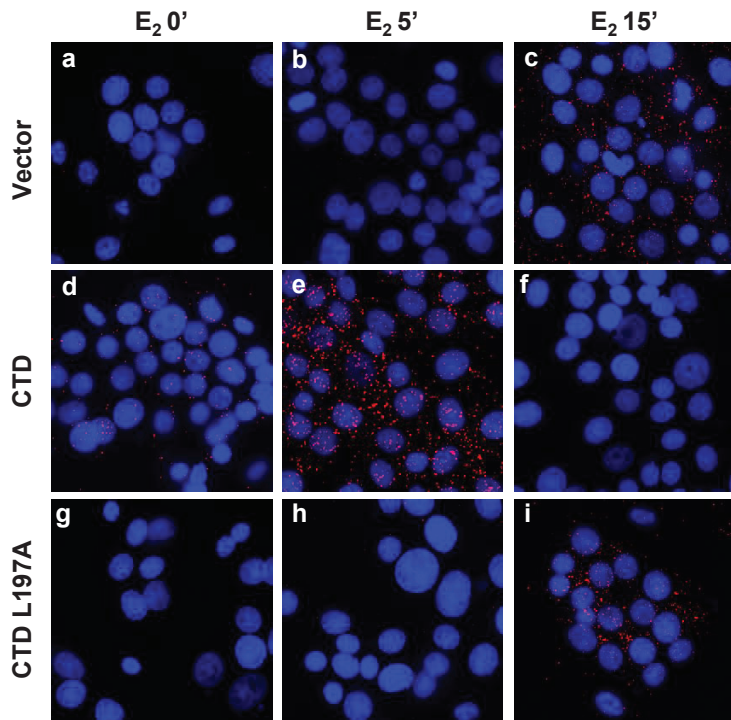
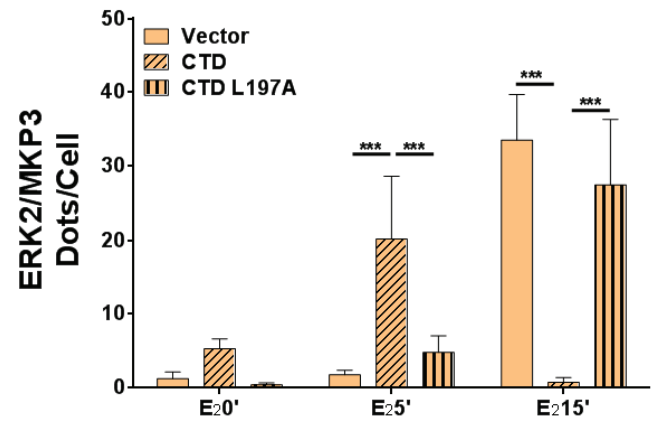
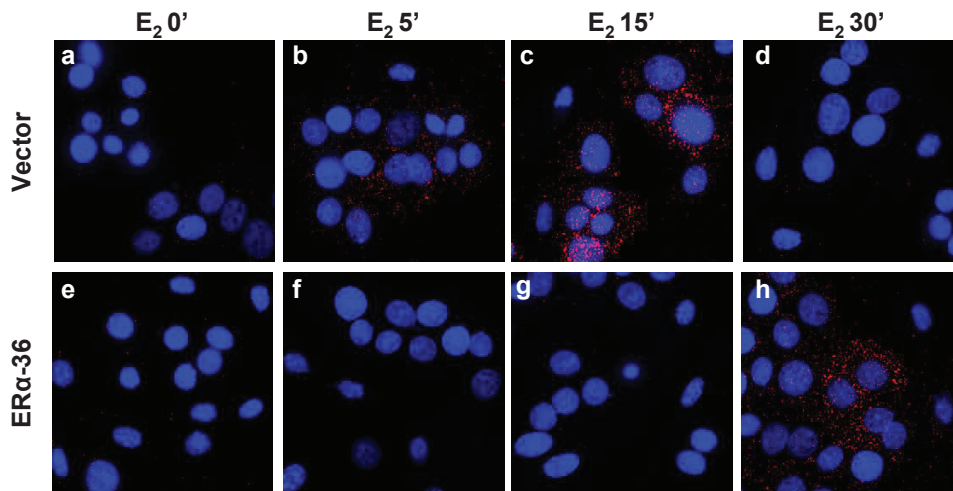
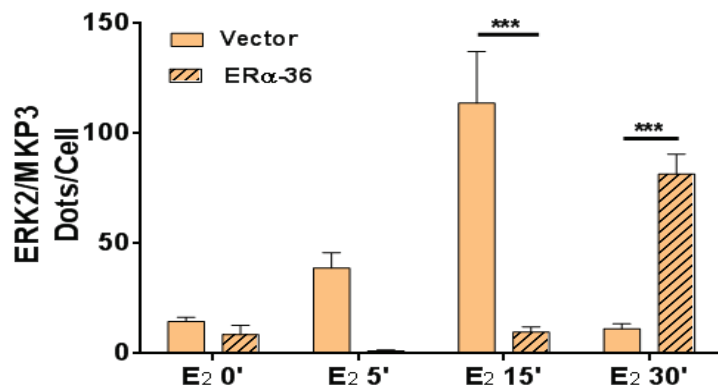

Figure 4

A**ERK2/MKP3****B****C****ERK2/MKP3****D****Figure 5**

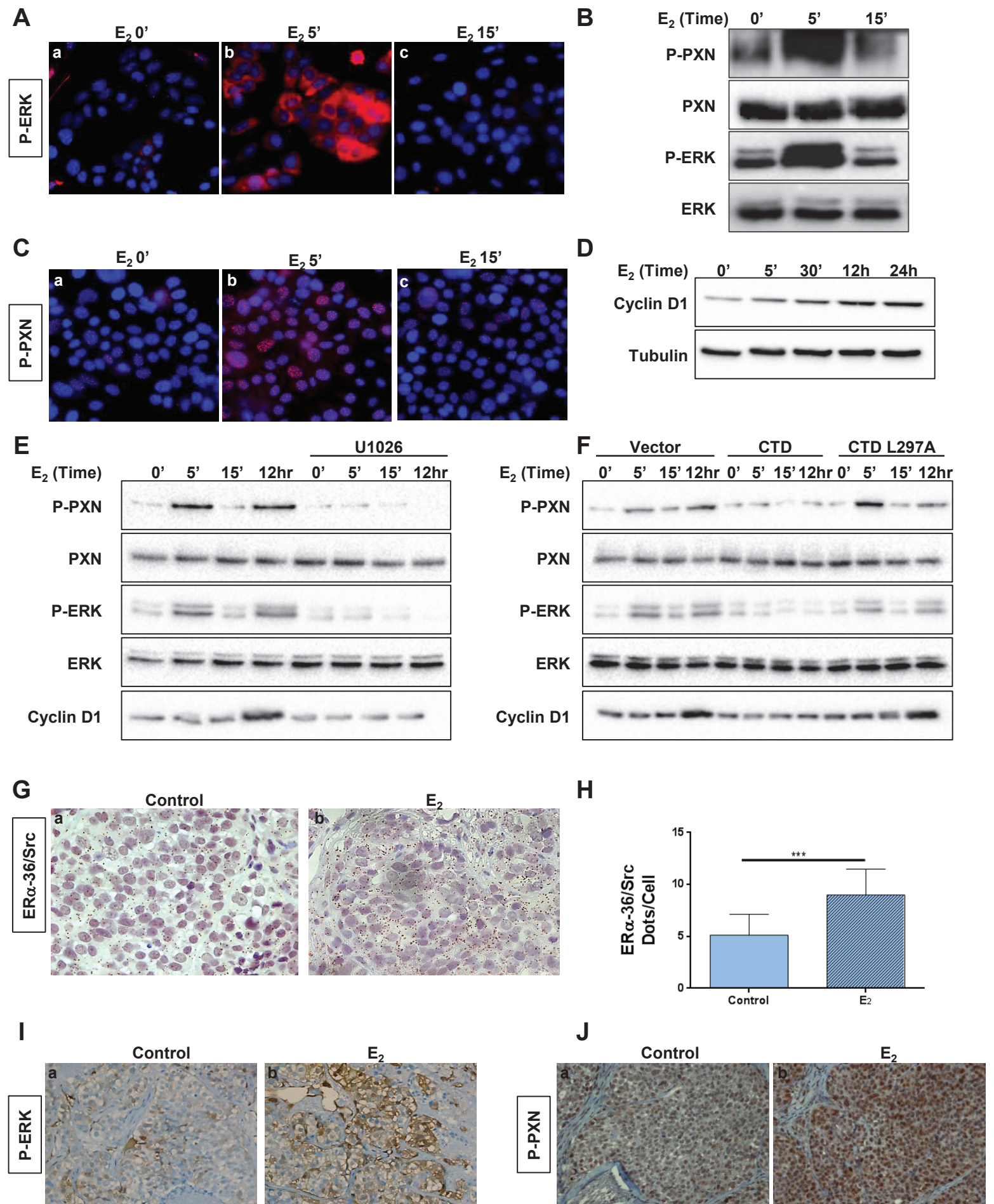
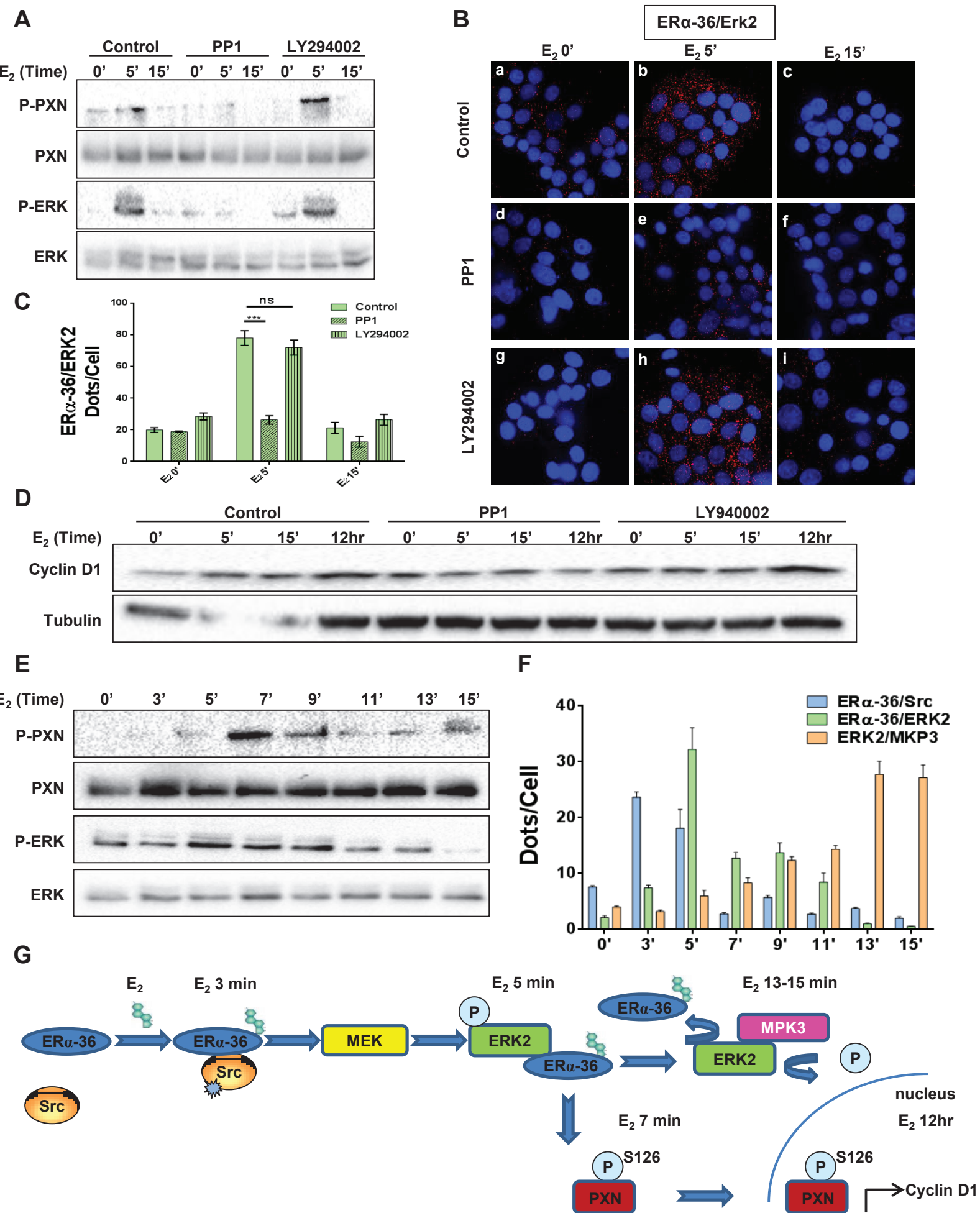

Figure 6



Supplemental Information

The molecular mechanisms underlying the ER α -36-mediated signaling in breast cancer

Soleilmane Omarjee^{1,2,3}, Julien Jacquemetton,^{1,2,3} Coralie Poulard^{1,2,3,4}, Natacha Rochel^{5,6,7,8}, Annick Dejaegere^{5,6,7,8}, Yasmine Chebaro^{5,6,7,8}, Isabelle Treilleux^{1,2,3,9}, Elisabetta Marangoni¹⁰, Laura Corbo^{1,2,3} and Muriel Le Romancer^{1,2,3}

A

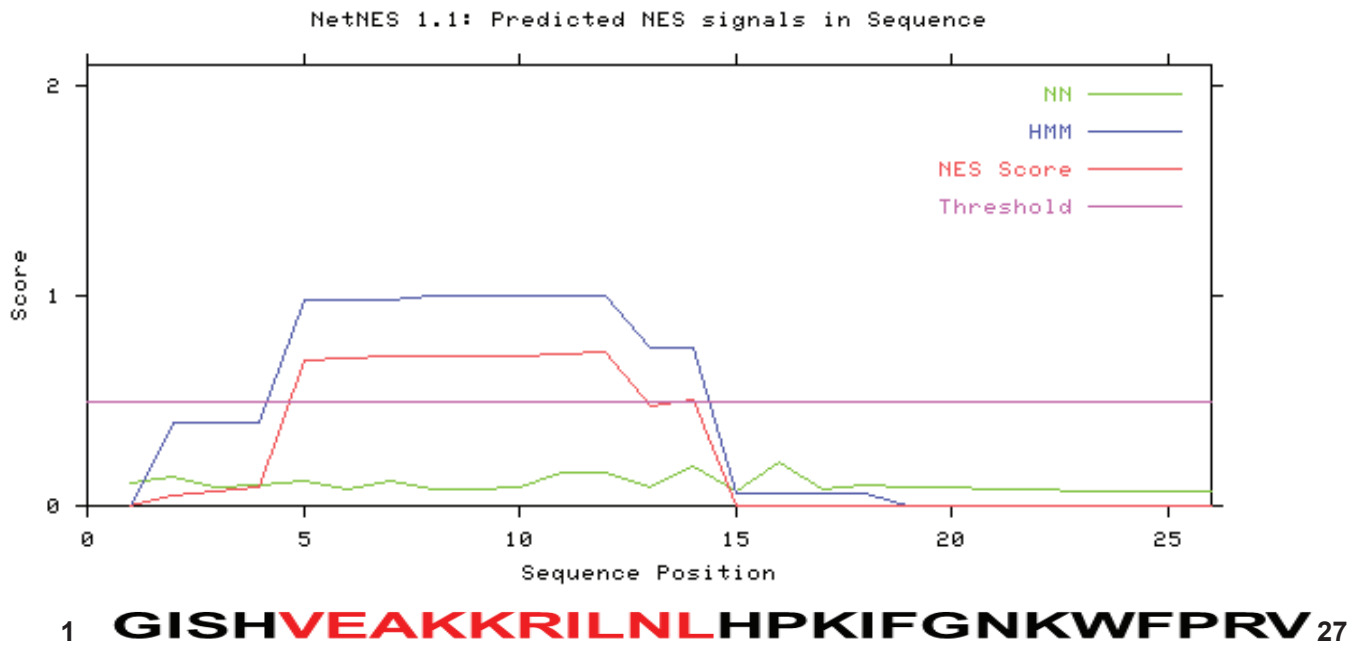

B

<u>Protein</u>	<u>NES sequence</u>
PKI	LALKLAGLDI
MAPKK	LQKKLEEELEL
NMD3	LAEMLEDLHI
TFIIIA	L-PVLENLTL
ER α -36	VEAKKRILNL
NES consensus	ϕ X ₂₋₃ ϕ X ₂₋₃ ϕ X ϕ

Figure S1, Related to Figure 1. *Identification of a nuclear export signal in ER α -36 sequence*

(A) The NetNES algorithm predicts a putative leucine-rich NES encoded by exon 9 in ER α -36. Scores obtained from the neural network (NN) and hidden Markov model (HMM) calculations are plotted in green and blue, respectively. The combined score obtained from the NetNES algorithm is plotted in orange, and the cut-off threshold is shown as a pink line. Only the portion of the sequence with scores above this threshold is shown.

(B) The putative ER α -36 NES sequence shows a high level of conservation with other known CRM1-dependent NES, following their alignment (modified from Goulet et al., 2007). The conserved hydrophobic residues are shown in red.

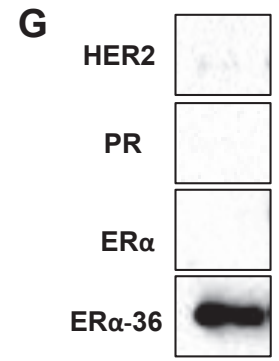
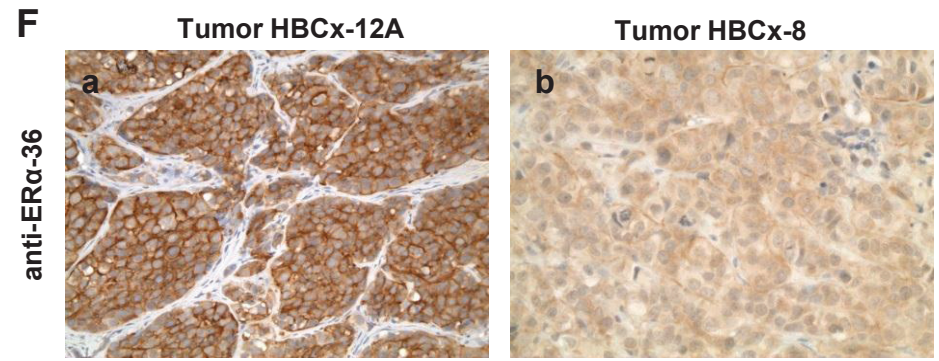
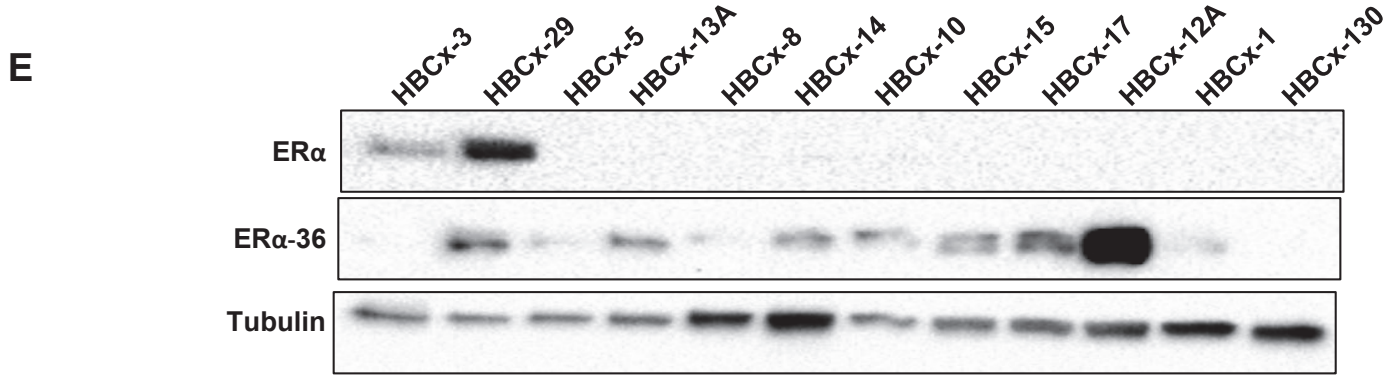
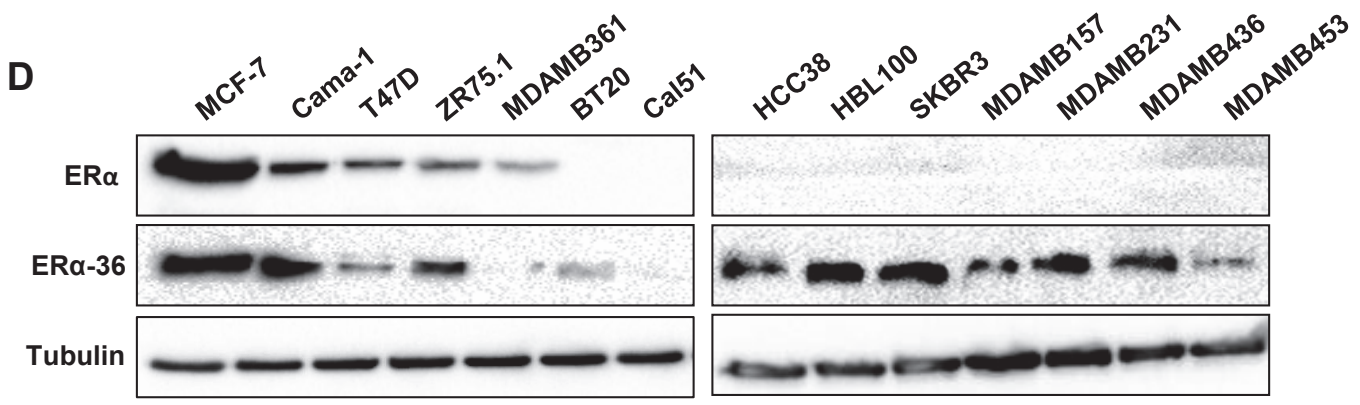
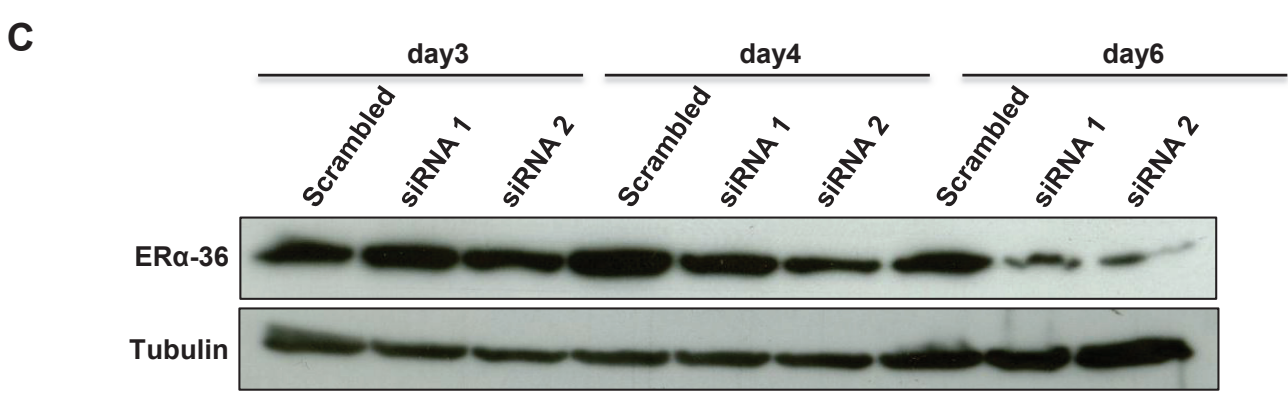
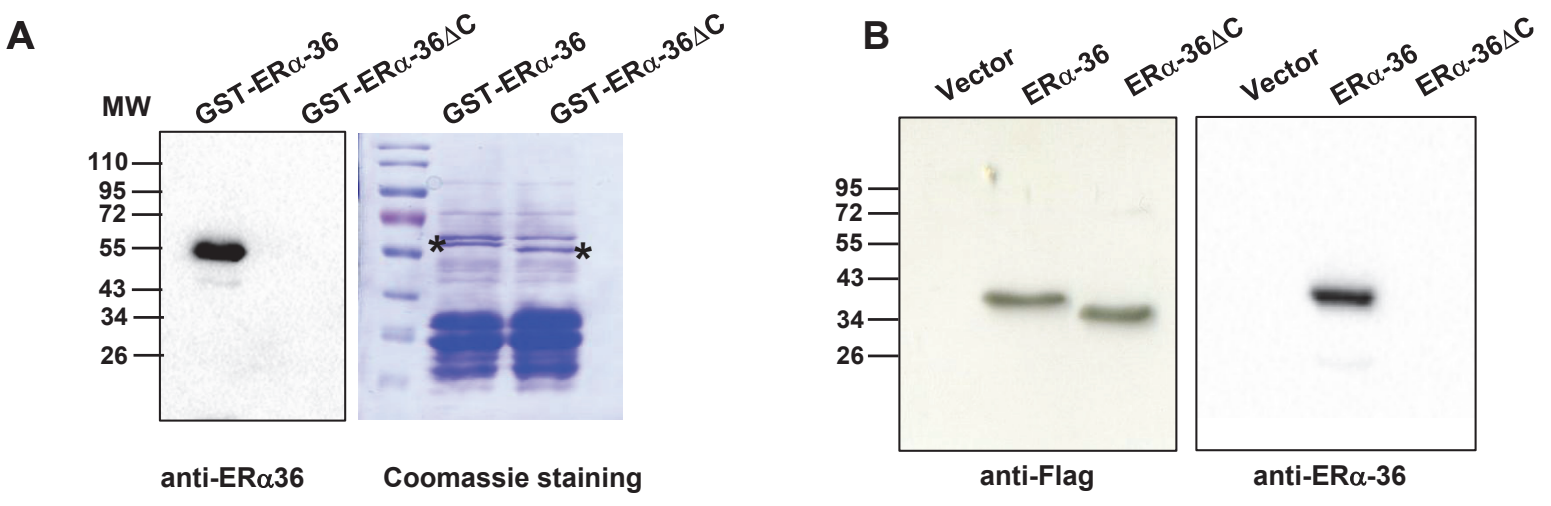
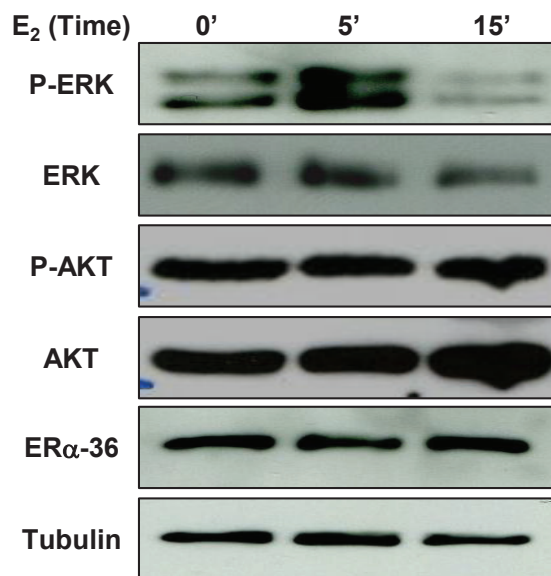
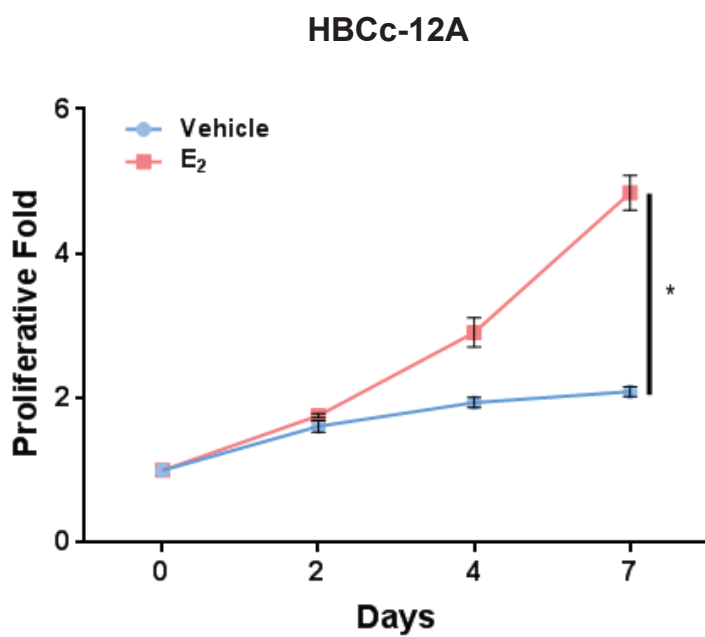

Figure S2

H



I



J

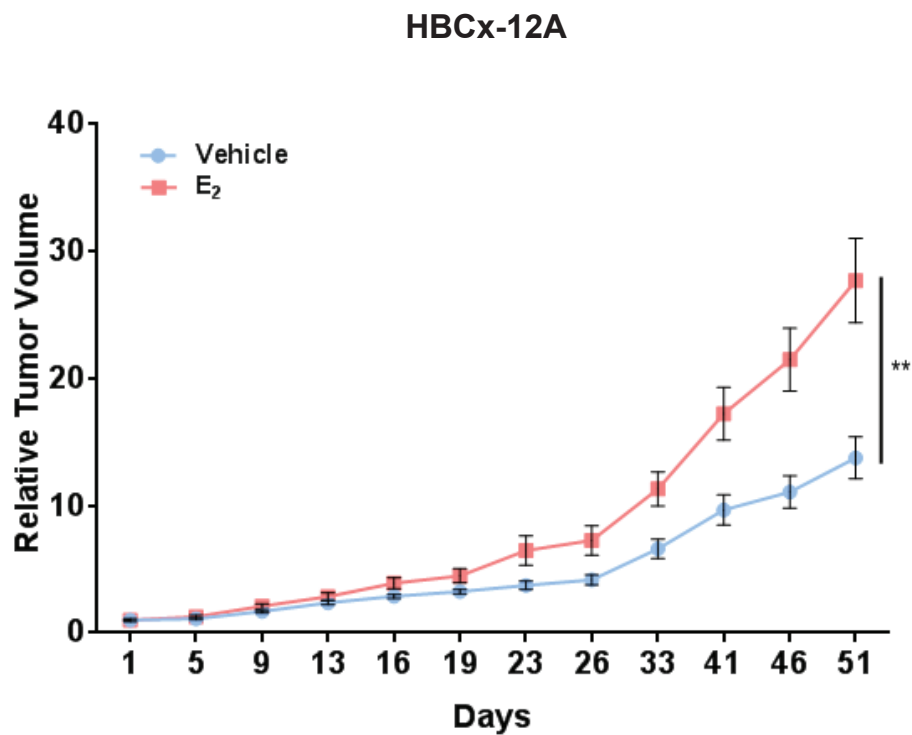

Figure S2

Figure S2, Related to Figure 2. Characterization of the in-house anti-ER α -36 antibody and of the HBCx-12A tumor

- (A) GST-ER α -36 and GST-ER α -36 Δ C were analyzed by SDS-PAGE followed by Western blot with our in-house anti-ER α -36 antibody (left panel), with the corresponding Coomassie-stained gel (right panel). * indicates the full length fusion proteins.
- (B) HeLa cells transfected with the empty vector, pSG5Flag-ER α -36 or pSG5Flag-ER α -36 Δ C were analyzed by Western blot using the anti-Flag (left panel) or the anti-ER α -36 antibodies (right panel).
- (C) Cama-1 cells were transfected with control siRNA duplexes or with 2 specific ER α -36 siRNA duplexes. On day 3, cells were re-transfected with the corresponding siRNAs. Cells were then lysed on the indicated dates and the lysates were tested for ER α -36 expression. Tubulin was used as a loading control.
- (D) ER α -36 expression was evaluated in a wide range of human breast cell lines by Western blot using the anti-ER α -36 antibody. ER α and tubulin expression were also assessed using the corresponding antibodies.
- (E) ER α -36 expression was evaluated in human patient derived xenografts (PDXs) as indicated in Figure S2D.
- (F) ER α -36 expression was analyzed by immunohistochemical (IHC) staining on formalin-fixed human tumors from 2 PDXs: namely the HBCx-12A, expressing high level of ER α -36 and the HBCx-8, which do not express ER α -36. (x40 magnification).
- (G) HBCc-12A cell lysate was assessed for ER α -36, ER α , PR and HER2 expression.
- (H) HBCc-12A cells were treated for the indicated times with E $_2$ (10^{-8} M). The cell lysates were analyzed by Western blot for ERK and Akt activation by measuring their phosphorylated state using specific antibodies. The abundance in ERK and Akt proteins were measured using specific antibodies.
- (I) HBCc-12A cells growth rate was monitored by the Incucyte real-time imaging system, under control conditions (vehicle) or after treatment with E $_2$ (10^{-8} M). The P-value was determined by the Student's test. *P<0.05.
- (J) Tumor growth of HBCx-12A PDX was analyzed with or without estrogen for 51 days. For each group the relative tumor volume was measured. Each treatment group included 10 mice. Statistical significances of TGI were calculated using an unpaired Student's test. **P<0.01

A**B****C****D****Figure S3**

Figure S3, Related to Figure 2. Study of ER α -36/Src and ER α -36/PI3K interaction.

(A) GST pull down Assay was performed by incubating *in vitro*-translated ³⁵S-labeled Src (*) with GST, GST-ER α -36 and GST-ER α -36 Δ C. The corresponding Coomassie-stained gel is shown in the lower panel. * indicates the full length fusion proteins.

(B) GST and GST-P85 of PI3K fusion proteins were incubated with *in vitro*-translated ³⁵S-labeled ER α -36 (*). The corresponding Coomassie-stained gel is shown in right panel. * indicates the full length fusion protein.

(C) HBCc-12A cells were treated in the presence or in the absence of the Src inhibitor PP1 (5 μ M) or the PI3K inhibitor LY294002 (20 μ M) for prior to the addition of E₂. After fixation, *in situ* PLA was performed with ER α -36-, Src-, and PI3K-specific antibodies. The detected dimers are represented by red dots. The nuclei were counterstained with DAPI (blue) (x63 magnification).

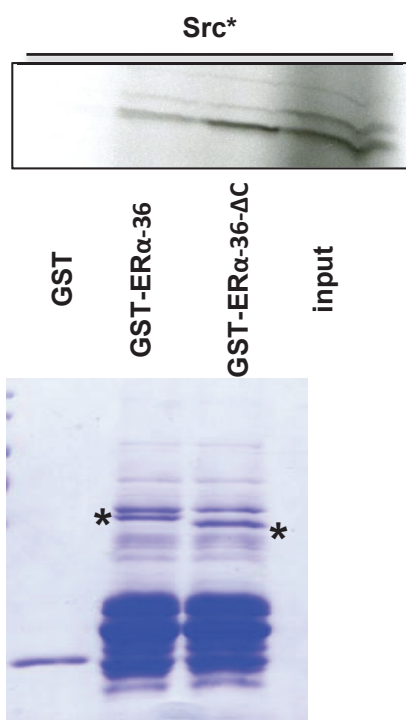
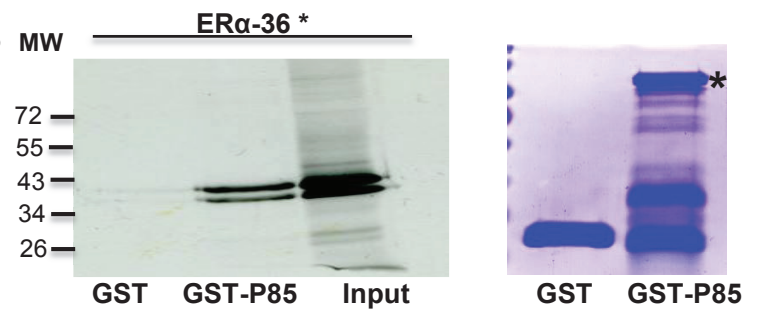
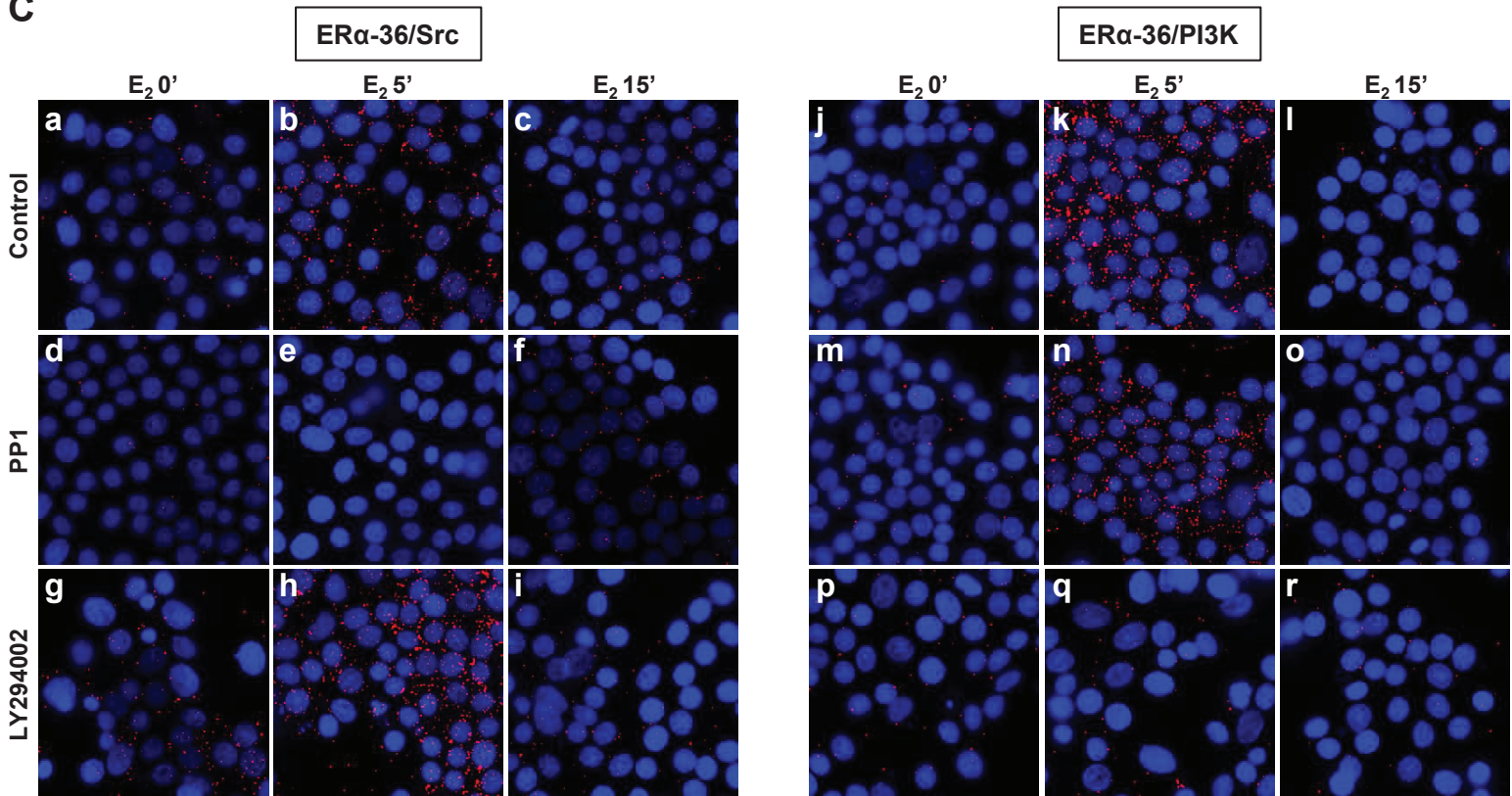
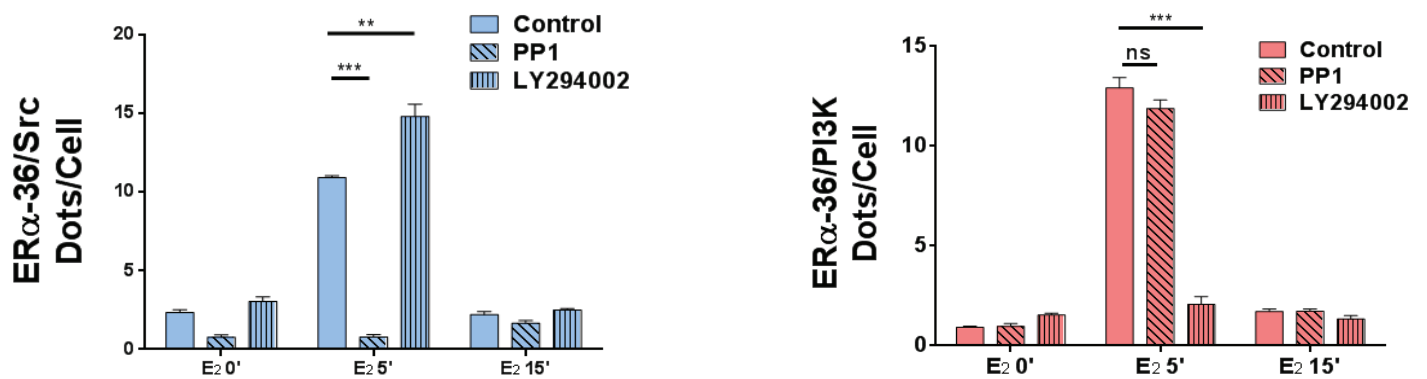
(D) Quantification of the number of signals per cell in Figure S3C was performed using computer-assisted analyses as reported in the Supplemental Experimental Procedures. The experiment was performed in triplicate, and this graph is representative of one of the experiments. The P-value was determined using the Student's test. ** P<0.01; *** P<0.001. NS: non significant.

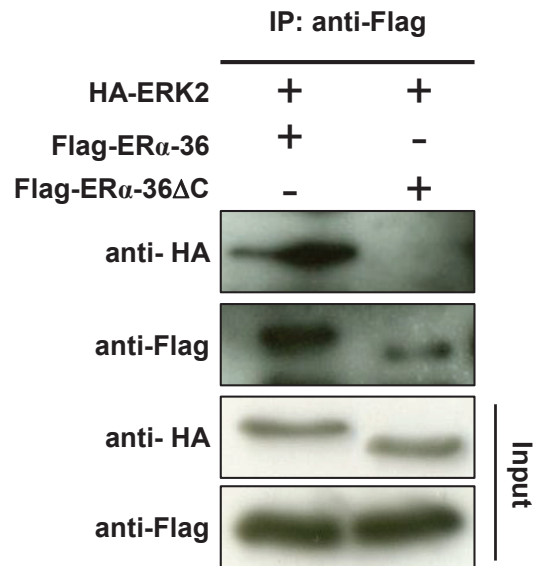

Figure S4

Figure S4, Related to Figure 2. *ERα-36/ERK2* interaction in *HeLa* cells.

(A) pSG5Flag-ERα-36, pSG5Flag-ERα-36ΔC and pCDNA3HA-ERK2 were overexpressed in HeLa cells. Cell lysates were immunoprecipitated with the anti-Flag antibody and the presence of ERα-36 and ERK2 were revealed by Western blot using the anti-Flag and anti-HA antibodies, respectively. The lower panel shows the expression of the different proteins in the input.

A**B****C****D**

Figure S5, Related to Figure 6. *ERα-36 signaling in HBL100 cells*

(A) The growth rate of HBL100 cells was monitored using the Incucyte real-time imaging system in the absence or in the presence of E₂ (10⁻⁸M). The experiment was performed in triplicate, and this graph is representative of one of the experiments.

(B) Steroid-depleted HBL100 cells were treated with E₂ (10⁻⁸M) for the indicated times. Cell lysates were analyzed by Western blot for expression of P-ERK and P-PXN. ERK and PXN expression was also assessed.

(C) From the same experiment as depicted in Figure S5B, *in situ* PLA was performed to detect ERα-36/ERK2 interactions. The detected dimers are represented by red dots. The nuclei were counterstained with DAPI (blue) (x63 magnification).

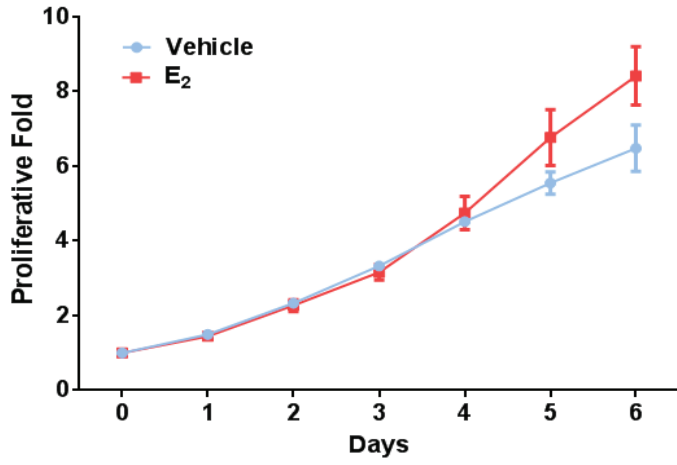
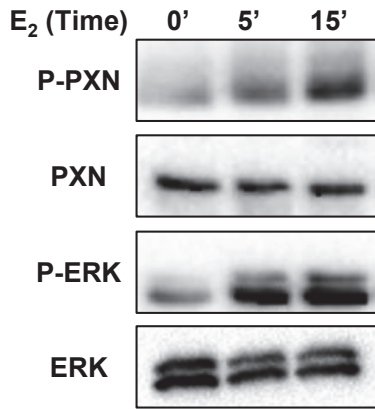
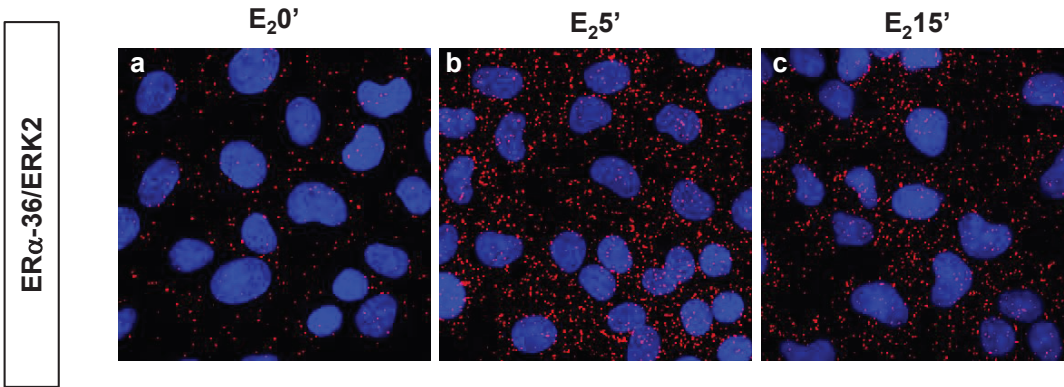
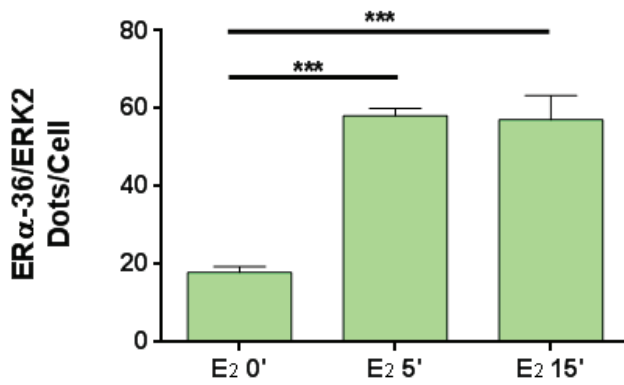
(D) The quantification of the interactions detected in the PLA in Figure S5C was performed by counting the number of signals per cell using computer-assisted analyses, as reported in the Supplemental Experimental Procedures. The experiment was performed in triplicate, and this graph is representative of one of the experiments. The P-value was determined using the Student's test. *** P<0.001.

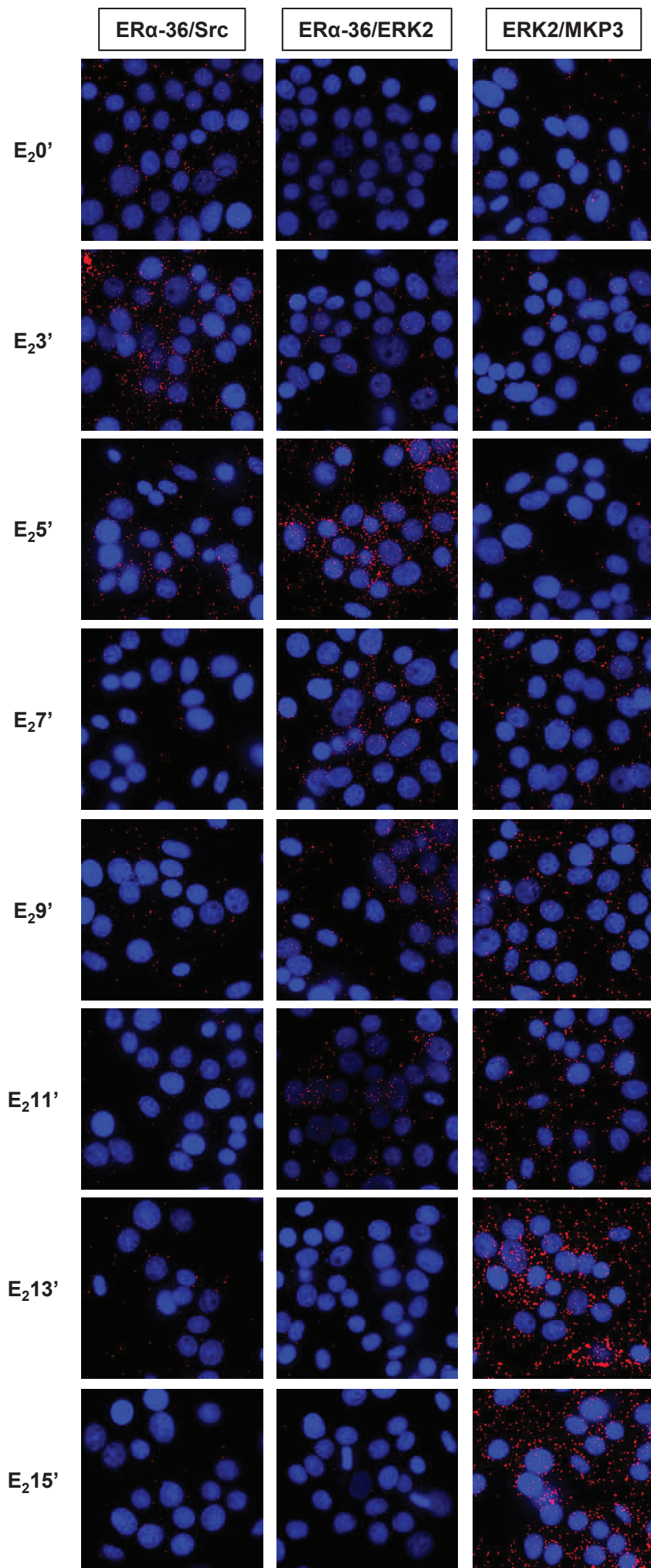

Figure S6

Figure S6, Related to Figure 7. *Precise time course of the E₂/ER α -36-mediated signaling pathway.*

HBCC-12A cells were treated with E₂ (10⁻⁸ M) for the indicated times. Then, ER α -36/Src, ER α -36/ERK2 and ERK2/MKP3 interactions were studied by PLA using the different couples of antibodies, as previously described. The detected dimers are represented by red dots. The nuclei were counterstained with DAPI (blue) (x63 magnification).

Table S1 Related to Figure 3: Residues in the D motif peptides which contribute for 4 kcal/mol and more to the binding free energy. For each structure listed in Table S3, we identified the residues of the bound peptide that contribute (in absolute value) for 4 kcal/mol or more to the binding free energy. For each complex, the number of the amino-acids, as given in Table S2, and the energetic contribution (in kcal/mol) are indicated. The known peptide binders differ in sequence, and do generally not conform exactly to the consensus (R/K)₂₋₃X₂₋₆-Φ_A-X-Φ_B D motif. However, basic and hydrophobic residues consistently emerge in all structures as making important stabilizing interactions, with the important hydrophobic interactions situated in either N-terminal or C-terminal (or sometimes on both side) of the important basic arginine (R). From this energetic analysis, and consideration of the structure of peptide bound ERK2, we identified L297 in ERα-36 (in the sequence: K₂₉₃KRIL₂₉₇NL₂₉₉) as a likely candidate for making essential interactions..

2GPH		4FMQ	
L ₁₇	-5.9	L ₄₃₆	-4
R ₂₁	-6.3	L ₄₃₉	-4.9
L ₂₇	-5.4	L ₄₄₄	-5.8
L ₂₉	-6.2	R ₄₄₈	-7.3
3TEI		2Y9Q	
L ₇₁₄	-6.7	M ₄₃₄	-4.7
I ₇₁₇	-5.2	L ₄₃₆	-6.8
L ₇₂₂	-5.4	P ₄₃₉	-4.9
R ₇₂₆	-4.4	L ₄₄₄	-5.6
		R ₄₄₈	-6.9
3O71		4H3P	
R ₁₁₄₈	-5.5	L ₇₁₄	-7.3
P ₁₁₄₉	-5	I ₇₁₇	-5.3
L ₁₁₅₂	-6.4	L ₇₂₂	-5.8
I ₁₁₅₄	-4.2	R ₇₂₅	-4
4H3Q		2FY5	
R ₅	-4.4	R ₆₅	-4.9
L ₉	-4	L ₇₁	-7.1
L ₁₂	-5.8	R ₇₄	-5.6
I ₁₄	-4.9		

Supplemental Experimental Procedures

Cell Culture

We used a panel of human tumoral mammary cells, a gift from Jessie Auclair (CLB, Lyon). (Cama-1, T47D, ZR75.1, MDAMB361, BT20, Cal51, HCC38, HBL100, SKBR3, MDAMB157, MDAMB231, MDAMB436, MDAMB453 cells).

We also used frozen tumors from human breast patient's derived xenograft (PDX) from Dr Marangoni of Curie Institute, Paris. These PDX have already been characterized: HBCx-14, HBCx-10, HBCx-15, HBCx-17, HBCx-3, HBCx-8, HBCx-13A, HBCx-5, HBCx-12A, HBCx-29, HBCx-1, HBCx-1 (Marangoni et al, 2007).

The HBCx-12A was established by engrafting a triple negative tumor, and its molecular characterization has been previously published (Marangoni et al., 2007). The HBCc-12A cell line was established from the HBCx-12A PDX. This cell line was grown at 37°C in DMEM Glutamax medium supplemented with 10% Fetal Bovine Serum, 1% Penicillin Streptomycine, 1% Hepes Buffer, 1% Sodium Pyruvate and 10 µg/ml Insulin (Novorapid).

Prior to performing treatment with estrogen ligands, cells were grown for 48 hr in phenol red-free medium supplemented with 10% charcoal-stripped serum (Biowest), in order to remove steroid hormones (steroid-depletion). The cells were then treated for different times with E₂ (Sigma) 10⁻⁸ M. When stated, cells were treated with the Src inhibitor PP1, the PI3K inhibitor LY294002, or with the MEK inhibitor U1026 (Calbiochem).

Plasmids

ERα-36 cDNA was cloned into the pSG5Flag and the pGEX-4T1 plasmids. The ERα36 CTD was cloned into a pSG5-Flag vector (pSG5Flag-ERα-36-CTD). The pSG5Flag-ERα-36 was used for mutagenesis to generate the following mutants: V288A/L295A, E180A, E180A/R221A, and L297A. The pCDNA3 ERK2-HA and pCDNA3-Src plasmids were purchased from Addgene. ERK2 cDNA was subsequently cloned into a pGEX-4T1 vector for recombinant protein production. pGEX-4T1-P85 (PI3K) plasmids are gifts from Dr G. Castoria.

Antibodies

Antibody	Company	Species	Dilution for WB	Dilution for PLA	Dilution for IF	Dilution for IHC
Flag (<i>E1B11</i>)	Euromedex	Mouse	1:1000		1 :250	
Tubulin (<i>T6074</i>)	Sigma	Mouse	1:10000			
Src, B12 (<i>sc-8056</i>)	Santa Cruz	Mouse		1:200		
ERα-36	In-house (Covalab, Lyon)	Rabbit	1:1000	1:100		1:50
PI3K (<i>ab86714</i>)	Abcam	Mouse		1:300		
p42/44 MAPK (<i>4376</i>)	CST	Rabbit	1:1000			
p-P42/44Thr 202/Tyr204 MAPK (<i>4370</i>)	CST	Rabbit	1:1000		1 :100	1 :400
ERK2 D2 (<i>1647</i>)	Santa Cruz	Mouse	1:1000	1:100		
MKP3 (<i>ab76310</i>)	Abcam	Rabbit	1:1000	1:100		
PXN (<i>5574</i>)	Santa Cruz	Rabbit	1:1000			
P-PXN Ser ¹²⁶ (<i>44-1022G</i>)	Invitrogen	Rabbit	1:1000		1 :100	1 :300
Cyclin D1 (<i>ab16663</i>)	Abcam	Rabbit	1:200			
AKT (<i>9272S</i>)	CST	Rabbit	1 :1000			
P-AKT Ser ⁴⁷³ (<i>9271L</i>)	CST	Rabbit	1 :1000			
HA (<i>H6908</i>)	Sigma	Rabbit	1:1000			
HER2 (<i>ab16901</i>)	Abcam	Mouse	1:500			
PR (<i>C1A2</i>)	CST	Rabbit	1:1000			
ERα (<i>60C</i>)	Millipore	Rabbit	1 :1000			

Table S2: List of the antibodies used in the current work

Modelling data: Analysis of ERK2/peptide structures and identification of important amino acids.

We analyzed 8 crystal structures of ERK2 bound to peptide that contain D motifs (see list in Table S1). Hydrogen atoms were added using the HBUILD facility (Brunger and Karplus, 1988) in the CHARMM program (Brooks et al., 2009). The structures were energy minimized and free energy decomposition (Lafont et al., 2007) of the minimized structure was used to estimate the contribution of each amino acid to the binding free energy. Free energy decomposition allows a semi-quantitative estimate of the contribution of amino acids to the stability of a complex, and is well suited to identify amino acids essential for complex formation (Lafont et al., 2007). Amino acids detailed in Table S1 are in bold red.

PDBid	Peptide sequence	Reference
2GPH	R ₁₆ LQERRGSNVALMLDC ₃₁	(Zhou et al., 2006)
4FMQ	L ₄₃₆ SSLAASSLAKRRQ ₄₅₀	(Garai et al., 2012)
3TEI	P ₇₁₂ QLKPIESSILAQR VR ₇₂₈	(Garai et al., 2012)
2Y9Q	M ₄₃₄ KLSPPSKSRLARRR AL ₄₅₀	(Garai et al., 2012)
3O7I	R ₁₁₄₈ PPDLW IH ₁₁₅₅	(Ma et al., 2010)
2FYS	R ₆₄ RLQKGNLP VR ₇₄	(Liu et al., 2006)
4H3P	P ₇₁₂ QLKPIEASILAARR V ₇₂₇	(Gogl et al., 2013)

Table S3: Structures used for the interaction between ERK2 and D motif peptides. Amino acids detailed in Table S1 are in bold red.

Patient-derived xenografts (PDXs)

The HBCx-12A PDX was established from a primary triple-negative breast cancer (ER α -, PR-, HER2-) with the patient's informed consent, as described previously (Marangoni et al., 2007). The PDXs were engrafted in 10-week old female Swiss nude mice, purchased from Charles River (L'Arbresle, France) and maintained under specific pathogen-free conditions. Their care and housing were done in accordance with institutional guidelines approved by the French Ethical Committee, (Marangoni et al., 2007). The ER+, HER2+ and triple-negative status were confirmed in the PDX models by immunohistochemistry (IHC) (Marangoni et al., 2007; Reyal et al., 2012). For *in vivo* studies, 10 mice received estradiol (E₂, Sigma-Aldrich, Saint-Quentin-Fallavier, France) diluted in their drinking water (8 μ g/ml). A two-tailed student t-test was used for the statistical analysis of tumor growth in treated E₂ versus control mice.

Glutathione transferase (GST) pull-down assay

ER α -36 and ER α -36 Δ C expression plasmids were transcribed and translated *in vitro* using T7-coupled reticulocyte lysate in the presence of [³⁵S] methionine. Labeled proteins were incubated with 10 μ g of purified recombinant GST-fusion proteins in 200 μ l of binding Buffer (Tris 20 mM pH7.4, NaCl 0.1 M, EDTA 1 mM, Glycerol 10%, Igepal 0,25%) with 1 mM DTT and 1% milk for 2 hr at room temperature. After washing, bound proteins were resolved on SDS-polyacrylamide gel electrophoresis (PAGE), and visualized by autoradiography.

Transfections

The siRNA sequences targeting ER α -36 correspond either ER α -36 to the 3'UTR (GGUCAAGAUAUCAAGAUAAdTdT) (Nucleotides 1631 – 1643) or to the ER α -36 and ER α conserved sequence (GAAUGUGCCUGGCUAGAGAdTdT) (Nucleotides 852 – 870).

SiRNA directed against MKP3 (DUSP6) were purchased from Qiagen GeneSolution (Cat No. GS1848). 50 nM of specific siRNAs or the scrambled siRNA (Eurogentec) were transfected into HBCc-12A cells (1 x 10⁶) using lipofectamine 2000 reagent (Invitrogen) according to the manufacturer's guidelines. The proteins were analyzed 72 hr after transfection.

Plasmids transfection was performed using the Xtreme gene agent following the manufacturer's instructions (Roche). Proteins were analyzed 48 hr after transfection.

HBCc-12A cells were infected with Histone H2B fused to GFP (gift from Dr Y. Mikaelia, CRCL, Lyon, France).

Proliferation assay

Cells were plated in quadruplicate in 96-well plates at a density of 2000 cells per well. After 6h, the ligands were added into the medium, and subsequently every two days. Growth curves were constructed by imaging plates using the Incucyte Zoom (Essen BioScience, Ann Arbor, USA). The growth curves were built from confluence measurements for HBL100 cells, and from counting fluorescent nuclei for HBCc-12A cells, acquired during round-the-clock kinetic imaging. Each experiment was performed in quadruplicate.

Immunoprecipitation and Western blot

To study the effect of ER α ligands on ER α -36 signaling, the cells were treated for different periods of time with E₂. After treatment, cells were lysed using RIPA buffer (50 mM Tris HCl, pH 8, 150 mM NaCl, 1 mM EDTA, 1% NP-40, 0.25% deoxycholate) supplemented with protease inhibitor tablets (Roche Molecular Biochemicals) and phosphatase inhibitors (1 mM NaF, 1 mM Na₃VO₄, 1 mM β -glycerophosphate). Protein extracts were incubated with primary antibodies overnight at 4°C with in a shaking incubator. Protein A-Agarose beads were added and the solution was incubated 1 hr at 4°C. The immunoprecipitates were separated on SDS-PAGE. The proteins were visualized by enhanced chemiluminescence (ECL) (Roche Molecular Biochemicals).

Immunofluorescence

HBCc-12A cells (9×10^4) were grown on coverslips in 12-well plates. Cells were fixed in methanol for 2 min, washed twice in PBS and incubated with primary antibodies for 1 hr at 37°C. After PBS washes, the cells were incubated for 30 min at 37°C with the secondary antibody Alexa Fluor 468 from Molecular Probes (1:3000) in Dako diluent, then washed in PBS and mounted on glass slides in mounting solution (Dako), and visualized using a fluorescent microscope.

Immunohistochemical (IHC) staining

Paraffin embedded tumour tissues fixed in formalin were used for analysis. After deparaffinization and rehydration, tissue sections were boiled in 10 mM citrate buffer pH 6 at 97°C for 40 min. The slides were then incubated in 5% hydrogen peroxide in sterile water to block the activity of endogenous peroxidases. The slides were then incubated at room temperature for 1 hr with the primary antibodies. The slides were subsequently incubated with a biotinylated secondary antibody bound to a streptavidin peroxidase conjugate (Envision Flex kit Ref: K800021-2, Dako). Bound antibodies were revealed by adding the substrate 3, 3'-diamino benzidine. Sections were counterstained with haematoxylin.

Proximity ligation assay (PLA)

PLAs performed on fixed cells were revealed by adding fluorescent probes, while PLAs performed on fixed tissues were revealed by adding peroxidase-labeled probes.

Fluorescence detection

Cells were grown on coverslips in 12-well plates, and then fixed in methanol for 2 min, before being washed twice in PBS. The cells were initially saturated using the blocking solution, then different couples of primary antibodies (rabbit and mouse in our case) were added and incubated 1 hr at 37°C. After washes, the PLA minus and plus probes (containing the secondary antibodies conjugated with complementary oligonucleotides) were added and incubated 1 hr at 37°C. Following the ligation of the oligonucleotides, nucleotides and a polymerase were added to the solution to initiate, a rolling-circle amplification (RCA) reaction, using the ligated circle as a template for 100 min at 37°C. The amplification solution contained fluorescent-labeled oligonucleotides, which hybridized to the RCA product. Following hybridization, the samples were mounted with Duolink II Mounting Medium containing 4',6-diamidino-2-phenylindole (DAPI), and then visualized under fluorescent microscopy.

Bright-field detection

Fixed tumor tissues were initially incubated in a hydrogen peroxide solution, for 5 min at room temperature, to avoid peroxidase quenching. The following steps were to those described above. For the detection, the probes were labeled with horseradish peroxidase after two washes in high purity water. A nuclear staining solution was added onto the slides and incubated 2 min at room temperature. After washing the slides 10 min under running tap water, the samples were dehydrated in ethanol and in xylene. Samples were mounted in non-aqueous mounting medium and then analyzed using a bright-field microscope.

Image acquisition and analysis

The hybridized fluorescent slides were viewed under a Nikon Eclipse Ni microscope. Images were acquired under identical conditions at x63 magnification. Image acquisition was performed by imaging DAPI staining at a fixed Z Position while a Z stack of +/- 5µm at 1 µm intervals was carried out. The final image was stacked to a single plane before further quantification. On each sample, at least one hundred cells were counted. Analyses and quantifications of these samples were performed using Image J software (free access). PLA dots were quantified on 8-bit images using the 'Analyse Particles' command, while cell numbers were numerated using the cell counter plugin. IHC images were acquired using a Leica DMRB microscope at x40 magnification and PLA dots were quantified as described above.

References

1. Brooks, B.R., Brooks, C.L., III, Mackerell, A.D., Jr., Nilsson, L., Petrella, R.J., Roux, B., Won, Y., Archontis, G., Bartels, C., Boresch, S., Caflisch, A., Caves, L., Cui, Q., Dinner, A.R., Feig, M., Fischer, S., Gao, J., Hodoscek, M., Im, W., Kuczera, K., Lazaridis, T., Ma, J., Ovchinnikov, V., Paci, E., Pastor, R.W., Post, C.B., Pu, J.Z., Schaefer, M., Tidor, B., Venable, R.M., Woodcock, H.L., Wu, X., Yang, W., York, D.M., and Karplus, M. (2009). CHARMM: the biomolecular simulation program. *J. Comput. Chem.* 30, 1545-1614.
2. Brunger, A.T., and Karplus, M. (1988). Polar hydrogen positions in proteins: empirical energy placement and neutron diffraction comparison. *Proteins* 4, 148-156.
3. Garai, A., Zeke, A., Gogl, G., Toro, I., Fordos, F., Blankenburg, H., Barkai, T., Varga, J., Alexa, A., Emig, D., Albrecht, M., and Remenyi, A. (2012). Specificity of linear motifs that bind to a common mitogen-activated protein kinase docking groove. *Sci. Signal.* 5, ra74.
4. Gogl, G., Toro, I., and Remenyi, A. (2013). Protein-peptide complex crystallization: a case study on the ERK2 mitogen-activated protein kinase. *Acta Crystallogr. D. Biol. Crystallogr.* 69, 486-489.
5. Lafont, V., Schaefer, M., Stote, R.H., Altschuh, D., and Dejaegere, A. (2007). Protein-protein recognition and interaction hot spots in an antigen-antibody complex: free energy decomposition identifies "efficient amino acids". *Proteins* 67, 418-434.
6. Liu, S., Sun, J.P., Zhou, B., and Zhang, Z.Y. (2006). Structural basis of docking interactions between ERK2 and MAP kinase phosphatase 3. *Proc. Natl. Acad. Sci. U. S. A* 103, 5326-5331.
7. Ma, W., Shang, Y., Wei, Z., Wen, W., Wang, W., and Zhang, M. (2010). Phosphorylation of DCC by ERK2 is facilitated by direct docking of the receptor P1 domain to the kinase. *Structure.* 18, 1502-1511.
8. Marangoni, E., Vincent-Salomon, A., Auger, N., Degeorges, A., Assayag, F., de, C.P., de, P.L., Guyader, C., De, P.G., Judde, J.G., Rebucci, M., Tran-Perennou, C., Sastre-Garau, X., Sigal-Zafrani, B., Delattre, O., Dieras, V., and Poupon, M.F. (2007). A new model of patient tumor-derived breast cancer xenografts for preclinical assays. *Clin. Cancer Res.* 13, 3989-3998.
9. Zhou, T., Sun, L., Humphreys, J., and Goldsmith, E.J. (2006). Docking interactions induce exposure of activation loop in the MAP kinase ERK2. *Structure.* 14, 1011-1019.

COMPLEMENTARY RESULTS TO ARTICLE 1

1. Tamoxifen mediates ER α -36 non-genomic signaling.

ER α -36 has been reported to mediate not only estrogen, but also anti-estrogen mitogenic signaling. For this purpose we wished to investigate whether the clinically used anti-estrogen (tamoxifen) could mediate similar signaling mechanisms as described in Article 1.

a. ER α -36 conserves tamoxifen binding properties

Bioinformatic analysis of ER α -36 structure revealed that, similarly to estrogen, it had two amino acids, E180 and R221, which constituted its affinity binding sites (Figure 26A). Upon mutagenesis of these two amino acids into alanines, we observed a loss of the ER α -36 mediated MAPK activation in HeLa cells transfected with either WT ER α -36 or the two mutant constructs (Figure 26B).

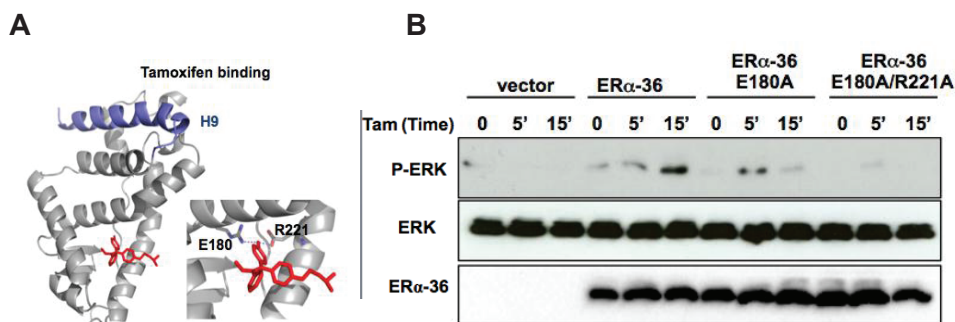

Figure 26: Tamoxifen binding sites on ER α -36. **A:** Modelization of the tamoxifen binding sites in ER α -36 ligand binding pocket. **B:** HeLa cells transfected with either WT of the indicated mutant versions of ER α -36 were treated with tamoxifen for the indicated times and western blot was carried out to detect P-ERK, ERK and ER α -36.

These results indicate that tamoxifen is a ligand for ER α -36 for MAPK pathway activation.

b. Tamoxifen treatment mediates ER α -36 binding with Src and PI3K

We wanted to investigate whether tamoxifen could mediate ER α -36 association with Src and PI3K in a similar action mechanism of estrogen. For this purpose, HBCc-12A cells were treated with tamoxifen and ER α -36/Src and ER α -36/PI3K interactions were analyzed by PLA (Figure 27).

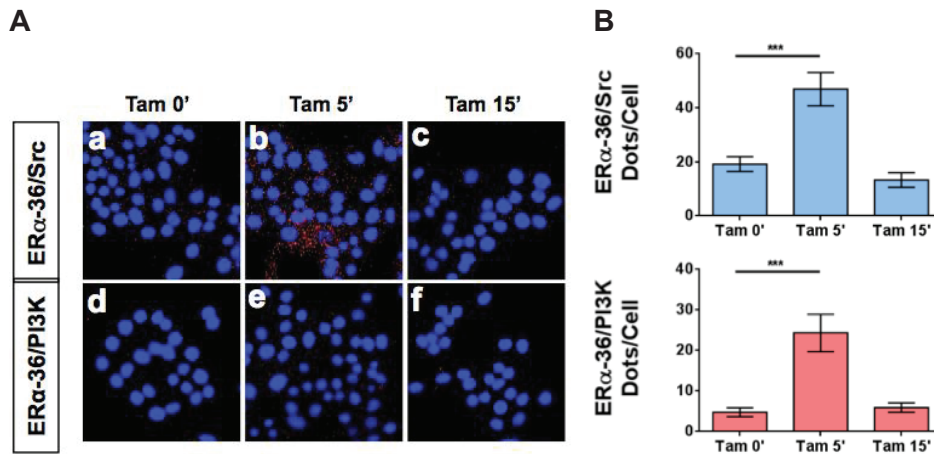

Figure 27: Tamoxifen mediates the formation of the ER α -36/Src and PI3K complex. **A:** PLA images of HBCc-12A cells treated with tamoxifen for the indicated times and the mentioned interactions have been analyzed. **B:** Quantification of the number of interaction dots/cell for both couples.

Our data revealed that, similarly to estrogens, tamoxifen mediated the formation of the ER α -36/Src and ER α -36/PI3K complexes in cells.

c. Tamoxifen induces ERK phosphorylation and the formation of the ER α -36/ERK2 complex

Similarly to what was observed in Article 1 for estrogen, tamoxifen mediated subsequent phosphorylation of ERK but not AKT in HBCc-12A cells. We also analyzed ER α -36/ERK2 interaction and found that tamoxifen treatment significantly increases it (Figure 28).

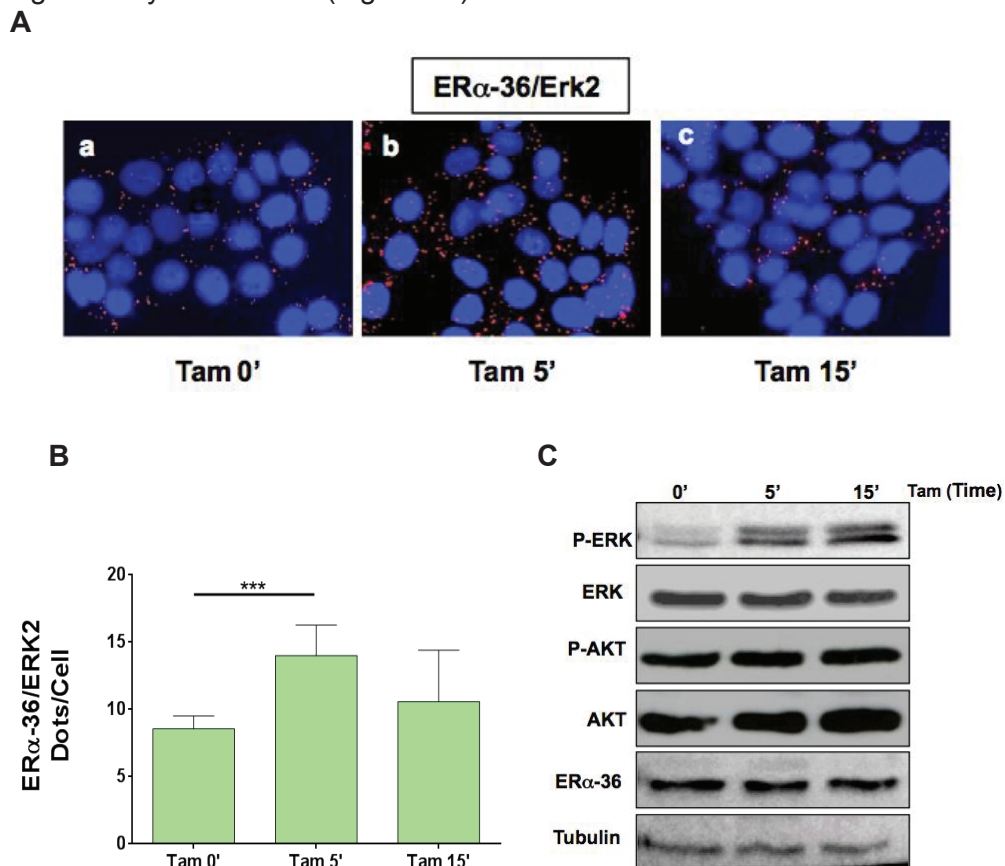

Figure 28: Tamoxifen induces ER α -36 interaction and ERK phosphorylation. **A:** PLA images of HBC12c cells treated with tamoxifen for the indicated times and analyzed for ER α -36/ERK2 interaction. **B:** Quantification of the data collected from PLA in **A**, **C:** Western blot analysis on protein extracts from the same experiment as in **A** and analyzed for the indicated proteins.

Furthermore we analyzed downstream ER α -36 signaling on these cells and found that tamoxifen mediated MAPK activation, without inducing any change in AKT phosphorylation (Figure 28C). Even if the whole pathway till the induction of Cyclin D1 has not been analyzed, these data seem to show that tamoxifen mediates ER α -36 non-genomic signaling in an estrogen-like manner as described in Article 1.

d. Tamoxifen regulates growth of triple negative HBCc-12A cells

According to what we have described in Article 1, we wanted to investigate whether tamoxifen could impact on the growth of HBCc-12A triple-negative cells. Cells were treated with tamoxifen or estrogen over 7 days and analyzed for proliferation (Figure 29) as described for estrogen in Article 1.

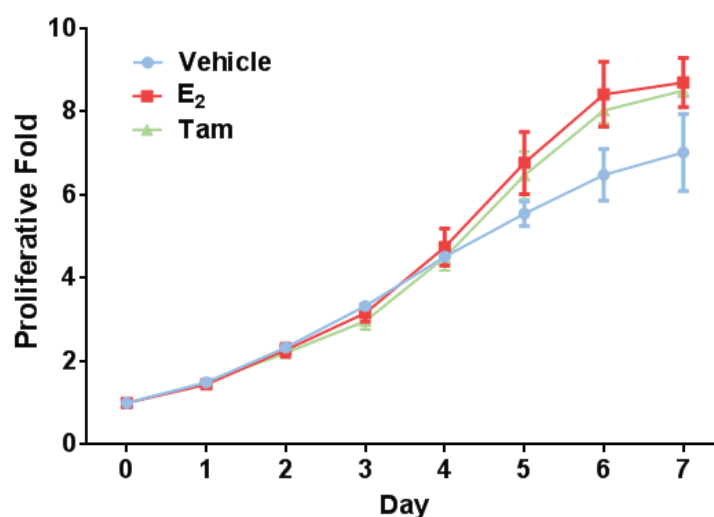

Figure 29: Growth of HBCc-12A cells under vehicle, estrogen (E2) or tamoxifen treatment (Tam).

Similarly to what has been observed with estrogen, tamoxifen also mediated cell proliferation. This is in accordance with what has been previously described for ER α -36 in MDA-MB-231 cells (Wang and Yin, 2015).

2. ER α -36 interacts specifically with ERK2 and not ERK1.

Following the bioinformatics detection of the specific ERK2 D-Domain in ER α -36 C-Terminal domain, we wanted to experimentally verify that ER α -36 binding was specific to ERK2. For this purpose, we used an *in-vitro* GST Pulldown approach (Figure 30A) followed by the study of ER α -36 and ERK1 interaction in HBCc-12A cells using an antibody specifically directed against ERK1 (Figure 30B). Cells were treated with tamoxifen and analyzed for both ER α -36/ERK2 and ER α -36/ERK1 interactions.

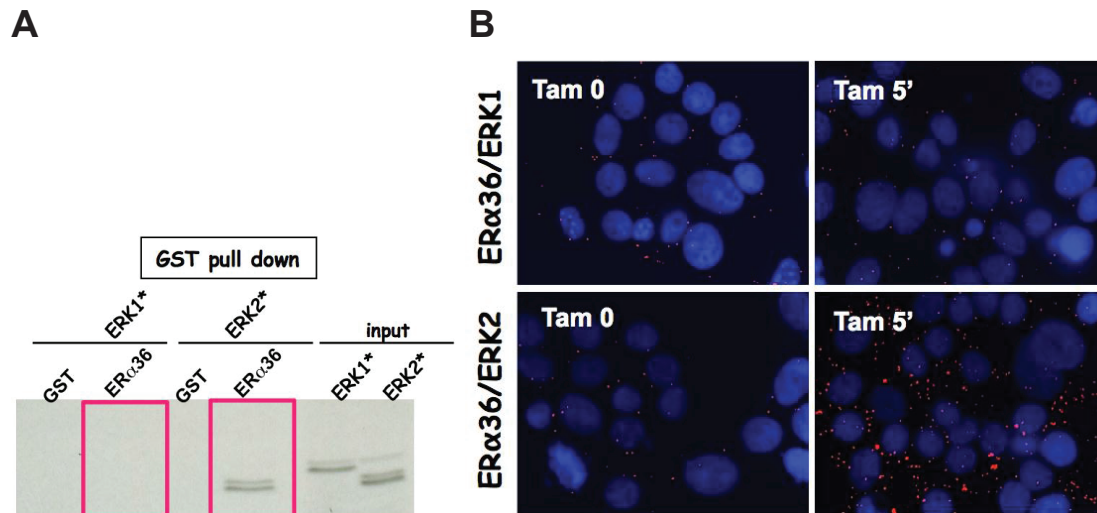

Figure 30: ER α -36 interacts specifically with ERK2 and not with ERK1. **A:** GST-Pulldown using recombinant GST or GST-ER α -36 and radioactive in-vitro translated ERK1 or ERK2. **B:** PLA images of HBCc-12A cells treated with tamoxifen for the indicated times and analyzed for ER α -36/ERK1 and ER α -36/ERK2 interaction.

Our data gathered using both approaches definitely demonstrate that ER α -36 binds specifically to ERK2 and not with ERK1. While 5min tamoxifen treatment dramatically increases ER α -36/ERK2 interaction, there is no change in ER α -36/ERK1 binding in HBCc-12A cells.

DISCUSSION TO ARTICLE 1

Since its discovery in 2005, enough evidence has been gathered to certify that ER α -36 is a functional estrogen receptor with distinct ligand binding properties and a main involvement in estrogen non-genomic signaling through initiation of signaling cascades at the level of the plasma membrane. One of the objectives of our team at the beginning of the project was to generate an animal model KO for the expression of ER α -36 to analyze its role in physiology and breast tumorigenesis. However we were confronted with a major obstacle. In fact, screening for ER α -36 revealed that its expression was limited to humans and higher mammals like chimpanzees (*pan troglodytes*). These findings were confirmed by an external group of bioinformaticians specialized in mice KO (Genoway, Lyon). Indeed, the unique 27 amino-acid C-Terminal domain of ER α -36 was not found in any genomic sequences except *Homo sapiens* and *Pan troglodytes*. The most controversial observations arose when three separate research groups used an anti-ER α -36 antibody designed to recognize the C-Terminal domain of ER α -36 (Wang et al., 2006) in IHC analyses on mice and rat tissues and promoting the discovery of a role for ER α -36 in mice meiotic oocytes (Xu et al., 2009) or rat hippocampal neurons (Liu et al., 2013).

Upon the start of our project on ER α -36, we wished to understand the specific cytoplasmic and membrane localization of ER α -36. First studies on ER α -36 suggested that putative palmitoylation sites in the protein were revealed and could be functional due to the alternative splicing of the first introns (Wang et al., 2005). These putative sites would then be localized in the N-Terminal part of the protein which could account for their functionality. While palmitoylation sites can actually have an effect on cytoplasmic localization (Marino et al., 2006), we proposed that the previously unidentified C-terminal domain could be responsible for the export of ER α -36. Indeed we found a functional nuclear export sequence in the C-terminal region of the protein. It is worthy to note that despite having a nuclear export sequence, ER α -36 retains three nuclear localization signals in its hinge domain (common to ER α). This suggests that the protein can be imported into the nucleus but our observations suggest that the latter is actively exported to the cytoplasm. The three putative palmitoylation sites identified could be responsible for the membrane anchoring of ER α -36 for non-genomic signaling, but this has not been clearly demonstrated.

The alternative splicing of the C-terminal domain of ER α -36 results in a protein lacking the AF-2 transcription transactivation domain and part of the ligand binding domain. One could argue whether missing α -helices in the LBD could still trigger a response to ligand. By collaborating with bioinformaticians from IGBMC (Strasbourg), we modeled ER α -36 structure and found that it had altered ligand binding properties, where estrogen would no longer bind in the ligand binding pocket but kept two amino acids, responsible for ligand anchorage, in the modified ligand binding pocket through electrostatic interactions. The bioinformaticians predicted that ER α -36, as a result, could have less affinity for estrogen, but we found no such change in affinity in terms of response to the hormone in practical. Furthermore alternative splicing in ER α -36 conferred it with a more open ligand binding pocket that enables it to bind not only estrogens, but a series of other molecules discussed

in the introduction (Chapter 3: ER α -36) which can have agonist effects on the receptor. Furthermore the lack of helix 12 in the ligand binding domains makes the receptor resistant to fulvestrant mediated proteasomal degradation, and many studies have depicted the importance of Helix 12 of the ER α ligand binding domain as an essential actor in fulvestrant-mediated degradation.

Our team was interested in understanding the non-genomic signaling pathway mediated by ER α -36, and at the beginning of the project, we turned to the known non-genomic actors of ER α , Src and PI3K. Surprisingly, we found through several approaches that ER α -36 has the ability to bind both Src and p85 of PI3K *in vitro*, and these interactions are modulated in cells following estrogen treatment. This result was quite surprising since, in the estrogen non-genomic pathway, P-Y537 has been shown to be essential for Src binding (Varricchio et al., 2007). Due to alternative splicing of the C-terminal domain, this tyrosine is absent from ER α -36 sequence. At first, we thought the binding could be mediated by the unique C-Terminal domain of ER α -36 but our experiments demonstrated that Src could bind to ER α -36 irrespective of its presence. We are currently investigating potential binding sites of Src with ER α -36 and we have identified a tyrosine, which, according to the bioinformaticians, could be a substrate and docking site for Src. We hypothesize that the new conformation of ER α -36 allows Src binding through unmasking of previously inaccessible phosphorylation sites in ER α . The binding of PI3K regulatory sub-unit p85 to ER α -36 was not characterized and remains to be done. Our team previously identified the methylation of arginine 260 on ER α to be an essential pre-requisite for the initiation of the non-genomic pathway. Despite having this arginine conserved in its sequence, we found no evidence of ER α -36 methylation. This suggests that methylation is not a crucial step in ER α -36-mediated non-genomic signaling and not necessary for conformational recruitment of molecular actors.

Our team investigated the expression of ER α -36 in breast cancer cell lines and breast tumor xenografts and we found it could be expressed in both ER α positive and ER α negative cells, confirming what has been observed in previous studies (Lee et al. 2010). Arguments also point toward the use of mice bearing patient derived xenografts for the study of breast tumors in terms of physiology and micro-environment, but solid transcriptomic studies have demonstrated that patient derived xenografts conserve the characteristics of the parental tumors, making them a model of choice to study breast cancer pathology (Marangoni et al., 2007).

Several studies reported Akt phosphorylation as being evidence for estrogen induced ER α non-genomic pathway. Our team previous showed that Akt is activated during the ER α mediated non genomic-pathway (Le Romancer et al., 2008). Other studies have demonstrated that Akt activation resulted from ER α -36 non-genomic pathway as well (Fu et al., 2014). In our study, we could not demonstrate any Akt phosphorylation mediated by ER α -36 through estrogen treatment. We suppose that Akt phosphorylation mediated by ER α -36 could be a separate event resulting from the formation of different molecular complexes that would be dependent on cell type and tissular context. To strengthen these observations, we found no clinical correlation between ER α -36 expression and Akt phosphorylation. Furthermore we

found that only Src activity was required for the mediation of downstream ERK signaling through ER α -36. We think this divergence in ER α and ER α -36 non-genomic pathways could imply that the role of PI3K in the complex is different for ER α -36. We hypothesize that ER α -36 and PI3K can form a different complex independently of Src with different regulatory elements that definitely need further investigation. Although these data clearly show that common actors are involved in both the ER α and ER α -36 non-genomic pathways, the regulation mechanisms involved are different.

For the first time, we describe a steroid receptor with a D-domain, conferring it the ability to directly bind to MAPK proteins. Although ER α can be phosphorylated by ERK, we found no D-Domain on the latter. This mechanism seems to be exclusive on ER α -36 and we are currently working on the docking site on the ERK2 protein. We are currently focusing on ERK2's CD-Domain, which has been confirmed by the bioinformaticians as the potential docking site for ER α -36. Furthermore, it is interesting to note that ER α -36 and the dual phosphatase MKP3 share the same docking site on ERK2, which makes sense according to our observations. We also found that ER α -36 can only bind to the phosphorylated form of ERK2 which allows us to suppose that a phosphorylation mediated conformational change of ERK2 is required for ER α -36 interaction.

We used a peptidic approach mimicking the C-Terminal domain of ER α -36 to break up its interaction with ERK2. Our peptide functioned successfully as the previously described peptide used to break up Src/ER α interaction (Varricchio et al., 2007). We found that we lost downstream activation of the ER α -36 pathway upon peptide use, which suggests that the whole ER α -36 protein is required to mediate its protective effect on ERK2, probably through steric hindrance of the binding of MKP3.

Our whole characterization of the ER α -36/ERK pathway has been done in triple negative HBCc-12A cells. We also wished to see if this pathway could exist in other cell lines and in ER α positive cell lines to determine whether ER α expression could impact on ER α -36 non-genomic signaling. We began enquiring this aspect and we found that the pathway is conserved in other ER α negative cells namely HBL100 cells as well as in ER α positive cells like MCF-7 (data not shown), suggesting that ER α expression has no influence in the non-genomic pathway mediated by ER α -36. This pathway may be extended to several types of breast cancers.

Using several approaches, we have shown that ER α -36 will bind specifically to ERK2 and not to ERK1. A poorly understood aspect of our work in the binding process of ER α -36 with ERK2, is that we find similar effects on downstream ERK1 and ERK2 signaling. Indeed the use of our inhibitory CTD peptide abrogates not only ERK2 but ERK1 phosphorylation as well. We suppose that in this context, ERK1 phosphorylation is dependent on ERK2 state of activation. Furthermore we found using *in-vitro* GST pulldown experiments that the C-Terminal domain of ER α -36 could bind to ERK2 as well as ERK1. In cells, this may translate as the C-terminal domain having an involvement in ERK1 dephosphorylation but more experiments are necessary to understand this process.

Our studies revealed the involvement of paxillin in the downstream ER α -36 signaling. Paxillin had been demonstrated to be a very important actor in the regulation of cell adhesion and migration in association with FAK at the plasma membrane (Sen et al., 2012). However, recent studies uncovered a nuclear role for paxillin as part of transcription factor complexes (Sen et al., 2012). In line with these observations, we also found a strong accumulation of phosphorylated paxillin in the nucleus and we hypothesize it is involved in the ER α -36 mediated Cyclin D1 transcription. We also found strong nuclear accumulation of active paxillin in nuclei of PDX IHC sections in ER α -36 positive PDX, comforting our results.

2. ER α -36 expression in breast tumors

INTRODUCTION TO CLINICAL STUDY

Growing evidence showed that ER α -36 expression is linked to hormone therapy resistance in patients expressing both ER α and ER α -36. Our team found that none of the commercially available antibodies directed against ER α could recognize ER α -36. For these reasons we produced a rabbit polyclonal antibody targeting the unique C-Terminal Domain of ER α -36. We used this antibody to assess ER α -36 expression in a cohort of 175 breast tumors from the Centre Leon Berard. In this study, we present the correlation between ER α -36 expression and clinic-pathological characteristics as well as its association to other well defined bio-markers.

METHODS

Patients

We screened 200 consecutive female patients with operable breast cancers who underwent radical surgery and received adjuvant/neoadjuvant therapy in Centre Leon Berard between January 1999 and December 2001. Paraffin blocks of tumor tissue were available for 182 patients. Among these, we failed to assess ER α -36 in 22 tumor specimens as a result of insufficient tumor or tissue loss during TMA preparation. Therefore, specimens from 160 patients with operable primary breast cancer were analyzed in this study.

Patients underwent either modified radical mastectomy, or breast-conserving surgery. Axillary lymph node invasion was assessed by sentinel node and/or level I and II axillary dissection and the number of lymph nodes harboring metastasis was determined based on histologic examination. Tumor size was defined as the maximum tumor diameter measured on the tumor specimens at the time of surgery. ER α and PR were detected by immunohistochemistry and tumors were considered positive if they have nuclear staining in 10% or more of the tumor cells. HER2 expression was determined using immunohistochemistry and tumors were considered positive if they have 3+ staining by immunohistochemistry or 2+ staining with HER2 amplification detected by FISH.

The data exported from the patients' files for analysis included: age, histologic subtype, maximum tumor size, number of LNs involved, SBR grade, date of diagnosis, date of relapse, and date of death or last clinic visit. Tumor samples and clinical data were obtained under Institutional Review Board approval.

Cutoff Definition

Biomarker expression was evaluated by 2 observers who assessed both the percentage and the intensity of the membranous staining for ER α -36 in the infiltrative carcinomatous cells only (Faint cytoplasmic staining which was found in almost all the malignant cells was not considered). For scoring purposes, the highest intensity of staining in malignant cells was classified into 3 levels (0: no staining, 1: weak staining, 2: moderate to strong staining) and the percentage of the stained cells was also classified into 3 levels (0: no stained cells, 1: staining in less than one half of the

malignant cells, 2: staining in one half or more of the malignant cells). Then both intensity and the percentage scores were added to conclude a single score (from 0 to 4) in a manner similar to the Allred score of ER and PR staining. For the purpose of correlation and survival analysis, tumours were considered to have low expression for ER α -36 if they had a score of 0-2 and were considered to have high expression if more than 2.

Immunohistochemistry

The breast tumour samples were inserted as triplicates using a 600 μ m needle in 4 Tissue Micro Array (TMA) blocks. The blocks containing invasive carcinoma were sectioned at a thickness of 4 μ m. After deparaffinization and rehydration, endogenous peroxidases were blocked by incubating the slides in 5% hydrogen peroxide in sterile water. For heat induced antigen retrieval, tissue sections were boiled in 10 mM Citrate Buffer pH6 (Dako, Trappes, France) using a water bath at 98°C for 50 minutes.

The slides were then incubated at room temperature for 60 minutes with the home made antibody against ER α -36 (rabbit polyclonal antibody) (Covalab, Lyon).

These antibodies were diluted using an antibody diluent solution (Chemmate, Dako, Trappes, France) at 1/50. After rinsing in Phosphate Buffer Saline, the slides were incubated with a biotinylated secondary antibody bound to a streptavidin peroxidase conjugate (LSAB+ Kit, Dako, Trappes, France). Bound antibody was revealed by adding the substrate 3, 3-diamino-benzidine. Sections were counterstained with hematoxylin.

Statistical analysis

The correlation between ER α -36 expression and clinico-pathologic characteristics was determined using Pearson's chi square test (or Fisher's exact test) for categorical variables and Student's T test for numerical variables. Distant metastasis free survival (DMFS) was defined as the time from the date of histological diagnosis of breast cancer to the date of distant metastasis or death. Disease free survival (DFS) was defined as the time from the date of histological diagnosis of breast cancer to the date of any cancer recurrence (local, distant or contralateral) or death. Overall survival (OS) was defined as the time from the date of histological diagnosis of breast cancer to the date of death. The database was locked at 12 years of follow up and patients who were event-free at the last follow up visit (or at 12 years) were censored.

Survival curves, median DMFS, DFS and OS (if reached) in addition to 8 year DMFS, DFS and OS (with 95% CIs) were derived from Kaplan-Meier estimates and the curves were compared using log-rank test (3). Hazard ratios and 95% CIs were calculated using Cox regression model (4). Cox multivariate analysis was performed to determine whether a factor is an independent predictor of DMFS, DFS or OS after adjusting for other significant factors at the univariate level. All statistical tests were two-sided, and the p value was considered statistically significant if less than 5%. The statistical analyses were performed using SPSS 17.0 statistics package (SPSS Inc, Chicago, IL).

RESULTS

Clinico-Pathological Characteristics

For the 160 assessable patients the median follow up interval was 10 years (range: 0.2 to 12y). Median age at diagnosis was 56.9 years (range: 30.4 to 87.4 years). 57.5% of the patients had tumors more than 20mm and 52.5% of had axillary LN metastasis. 18.8% of the patients had SBR grade I tumors, 56.3% grade II tumors and 25.0% grade III tumors. 63.1% of the patients received adjuvant chemotherapy while 83.1% received adjuvant hormonal therapy. Table 6 shows the clinico-pathological characteristics of the tested patient cohort (160 patients).

Characteristic		Number	Percent
Age group	<i>≤ 50 years</i>	51	31.9%
	<i>>50 years</i>	109	68.1%
Menopausal status	<i>Pre</i>	57	35.6%
	<i>Post</i>	103	74.4%
Tumor size	<i>≤2cm</i>	68	42.5%
	<i>>2cm</i>	92	57.5%
Axillary LN metastasis	<i>No</i>	76	47.5%
	<i>Yes</i>	84	52.5%
SBR grade	<i>I</i>	26	16.3%
	<i>II</i>	71	44.4%
	<i>III</i>	63	39.4%
ERα status	<i>Negative</i>	14	8.8%
	<i>Positive</i>	145	90.6%
	<i>Missing</i>	1	
PR status	<i>Negative</i>	40	25.3%
	<i>Positive</i>	118	74.7%
	<i>Missing</i>	2	
HER2 status	<i>Negative</i>	129	84.9%
	<i>Overexpressed</i>	23	15.1%
	<i>Missing</i>	8	
Breast cancer subtype	<i>Luminal</i>	142	91.6%
	<i>Basal</i>	10	6.5%
	<i>HER2 driven</i>	3	1.9%
	<i>Missing</i>	5	
Adjuvant Hormonal treatment	<i>No</i>	27	16.9%
	<i>Yes</i>	133	83.1%
Adjuvant (or neoadj) chemotherapy	<i>No</i>	59	36.9%
	<i>Yes</i>	101	63.1%
ERα-36	<i>Low</i>	95	59.4%
	<i>High</i>	65	40.6%

Table 6: Clinico-Pathological Characteristics of the 160 patient cohort.

Pattern of ER α -36 Expression

Representative images of microscopic pictures showing tumor cells with high and low expression of ER α -36 are shown in figure 1. ER α -36 was high in 65 (40.6%) cases (Figure 26 A), while 95 (59.4%) cases showed low expression (Figure 26 B). We observed no correlation between high expression of ER α -36 with any of the traditional prognostic markers as age, menopausal status, tumor size, ER α status, PR status or axillary lymph node metastasis. There was a tendency towards correlation between ER α -36 and high SBR grade (G3) but that was not statistically significant. The correlation between ER α -36 and different clinico-pathological parameters is shown in table 7

Variable		ER α -36 low No. (%) 95 (59.4%)		ER α -36 high No. (%) 65 (40.6%)		P*
Age (Yr)	Mean (\pm SD)	57.9	(\pm 11)	61.3	(\pm 11)	0.20 [†]
Breast side	-Right	42	(44.2%)	30	(46.2%)	0.81
	-Left	53	(55.8%)	35	(53.8%)	
Age groups	- \leq 50y	32	(33.7%)	19	(29.2%)	0.55
	- >50y	63	(66.3%)	46	(70.8%)	
T. size	- \leq 2cm	41	(43.2%)	27	(41.5%)	0.84
	- >2cm	54	(56.8%)	38	(58.5%)	
LN met	-Negative	45	(47.4%)	31	(47.7%)	0.97
	-Positive	50	(52.6%)	34	(52.3%)	
SBR grade	-Gr 1	13	(13.7%)	13	(20.0%)	0.04
	-Gr 2	50	(52.6%)	21	(32.3%)	
	-Gr 3	32	(33.7%)	31	(47.7%)	
SBR grade grouped	-Gr 1 & 2	63	(66.3%)	34	(52.3%)	0.08
	-Gr 3	32	(33.7%)	31	(47.7%)	
ER α -66 status	-Negative	9	(9.6%)	5	(7.7%)	0.68
	-Positive	85	(90.4%)	60	(92.3%)	
PR status	-Negative	23	(24.5%)	17	(26.6%)	0.77
	-Positive	71	(75.5%)	47	(73.4%)	
HER2 status	-Negative	78	(85.7%)	51	(83.6%)	0.72
	-Positive	13	(14.3%)	10	(16.4%)	
(Neo)/Adjuvant Hormonal ttt	-Tam.	64	(85.3%)	43	(75.4%)	0.33
	-Tam.+AI	4	(5.3%)	4	(7.0%)	
	-AI	7	(9.3%)	10	(17.5%)	
(Neo)/ Adjuvant chemotherapy	-Anthra. only	43	(79.6%)	29	(80.5%)	0.30
	-Anthra &	11	(20.4%)	7	(19.5%)	
	Taxane					

Table 7: Correlation between ER α -36 expression and clinico-pathological features. *Correlations tested by Pearson's Chi square test (2sided), [†] Difference between means by Student's T test.

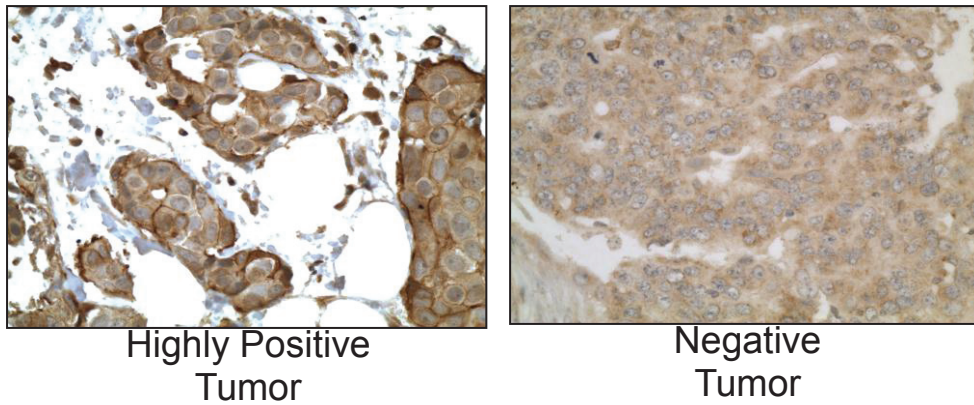

Figure 26: Representative microscopy images of ERα-36 IHC on breast tumors.
 A: Example of a high ERα-36 expression. B: ERα-36 negative tumor.

ERα-36 predicts poorer outcome in breast cancer

High expression of ERα-36 was a marker of poor prognosis. Patients with high ERα-36 expressing tumors had more distant metastasis than those with low expression (38.5% versus 23.2%, p=0.037). There was also a tendency towards more deaths in the ERα-36 high patients (36.9% versus 23.2, p=0.059). Death and relapse events in correlation with ERα-36 expression are shown in table 8.

By Kaplan Meier estimates, DMFS in patients with high ERα-36 expression was shorter than those with low expression with an 8y DMFS rate of 59.0% (95%CI: 43.9-74.1%) in patients with high expression versus 76.6% (95% CI: 65.3-89.9%) in the ERα-36 low expression group (p=0.007). DFS was similarly shorter with 8year DFS rate of 54.7% (95% CI: 37.8-71.6%) versus 70.9% (95%CI: 59.4-82.4%) respectively (p=0.029). OS was worse in cases with high ERα-36 expression with 8year OS of 68.6% (95%CI: 54.1-83.1%) versus 79.6% (95%CI: 69.8-89.4%) respectively (p=0.040). Figure 27 shows the Kaplan Meier's curves for DMFS, DFS and OS for patients with high versus low expression of ERα-36.

Events		ERα-36 low No. (%) 95 (59.4%)	ERα-36 high No. (%) 65 (40.6%)	P*
Death	<i>Alive</i>	73 (76.8%)	41 (63.1%)	0.059
	<i>Dead</i>	22 (23.2%)	24 (36.9%)	
Any Recurrence	<i>-No</i>	65 (68.4%)	35 (53.8%)	0.061
	<i>-Yes</i>	30 (31.6%)	30 (46.2%)	
Distant metastasis	<i>-No</i>	73 (76.8%)	40 (61.5%)	0.037
	<i>-Yes</i>	22 (23.2%)	25 (38.5%)	

Table 8: Death, relapse and metastatic events associated with ERα-36 expression

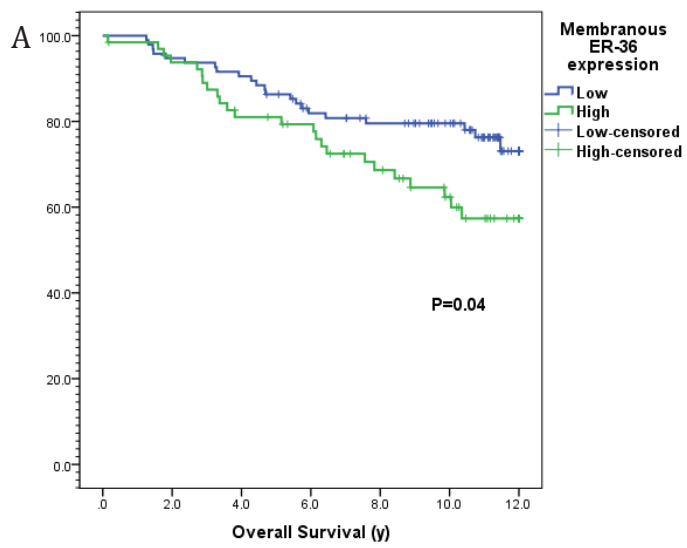
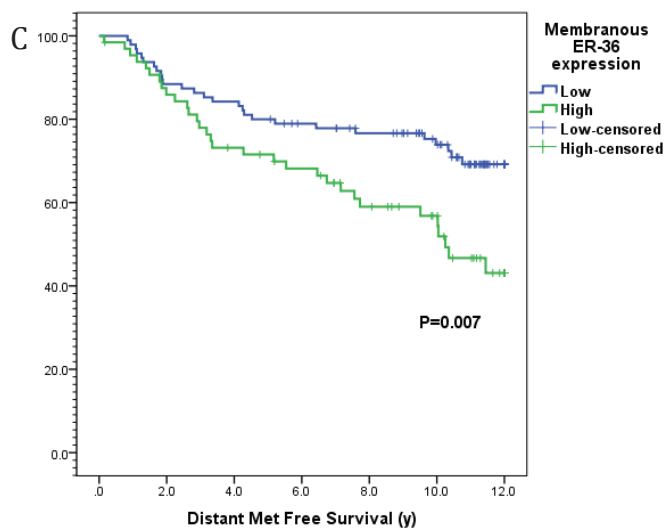
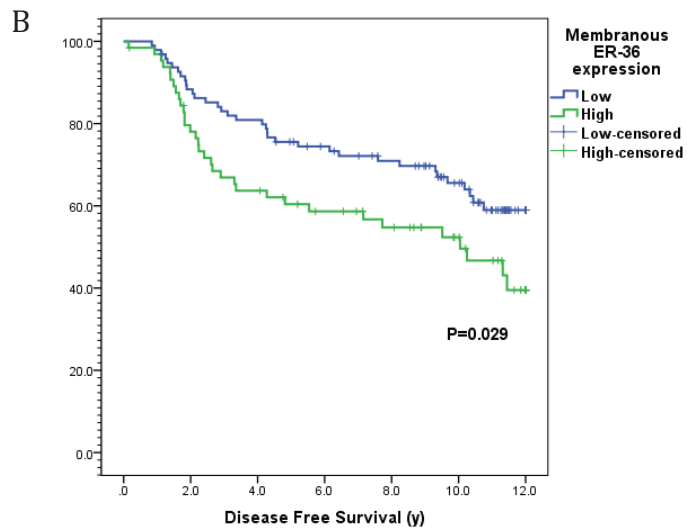

Figure 27: Kaplan Meier's curves for patients with high (green) versus low (blue) expression of ER α -36. A: Overall Survival, B: Disease Free Survival, C: Distant Metastasis Free Survival.



Cox Proportional Hazards Model

In the cox proportional hazard model high ER α -36 expression doubled the risk of developing distant metastasis (HR=2.02, 95%CI: 1.2-3.4, p=0.008). ER α -36 expression also increased the risk of any cancer recurrence (HR=1.69, 95%CI: 1.1-2.7, p=0.031) and the risk of death from any cause (HR=1.82, 95%CI: 1.02-3.2, p=0.043).

Regarding the effect of the classical prognostic factors, DMFS was also shorter with tumors larger than 2 cm (HR=2.17, 95%CI: 1.2-3.8, p=0.007), axillary LN metastasis (HR=2.04, 95%CI: 1.2-3.5, p=0.009) and high SBR grade (HR=2.64, 95%CI: 1.6-4.4, p=0.0002).

Multivariate Analysis

In the multivariate analysis, when adjusted to tumor size, LN metastasis and SBR grade, high ER α -36 expression was still an independent predictor for DMFS (HR=1.93, 95%CI: 1.1-3.3, p=0.016) with a tendency towards poorer OS (HR=1.65; 95%CI: 0.9-3.0, p=0.09).

In addition to ER α -36, large tumor size (HR=1.84; 95%CI: 1.04-3.28, p=0.04) and high SBR grade (HR=2.04; 95%CI: 1.2-3.5, p=0.008) were also independent predictors of poor DMFS.

CONCLUSION

In all our study reveals that ER α -36 has a main membrane localization in breast tumors. Its expression is not linked to the classical clinic-pathological characteristics such as age, or tumor size. There is a potential correlation between membrane ER α -36 expression and SBR grade. We did not find any correlation between anti-estrogen treatment and ER α -36 expression, nor ER, PR and HER2 expression. ER α -36 membrane expression is associated with more deaths, tumor recurrence and distance metastasis according to the cox proportional hazards model. Furthermore when adjusted to other parameters in a multivariate analysis, ER α -36 expression was shown to be an independent predictor of distant metastasis free survival and has a tendency to indicate poorer overall survival. Our study reveals that immunohistochemically detected membranous ER α -36 is a marker of poor prognosis in breast tumors.

DISCUSSION TO ARTICLE 2

To evaluate a role for ER α -36 in breast carcinomas, we analyzed its expression in a cohort of 160 breast tumors. As previous groups have reported we confirmed that ER α -36 is expressed in both ER α positive and negative tumors (Wang and Yin, 2015).

ER α -36 staining in the tumors present with a characteristic membrane expression as confirmed by the pathologist and a diffuse cytoplasmic marking was observed in most of the tumors suggesting a ubiquitous role for cytoplasmic ER α -36 in breast cancer biology. Our findings revealed that its expression was associated with poorer prognosis in terms of disease free survival and distant metastasis free survival. However, we did not find any association between ER α -36 expression and HER2 which has been previously reported (Shi et al., 2009). We believe this might be due to the relatively low number of HER2-positive tumors in our study (23).

Several studies have been done on ER α -36 expression in breast tumors, and till date, controversial association has been made for ER α -36 in triple negative breast tumors, which still remain the most aggressive tumor type these days, probably due to the use of different antibodies and low tumor numbers (Pelekanou et al., 2012). The data available on ER α -36 in breast tumors suggest that it might not be involved with the onset, but rather with the progression of breast tumors (Chaudhri et al., 2012).

Studies have shown that tamoxifen can induce ER α -36 expression and that patients with ER α -36 are less likely to benefit from tamoxifen treatment (Shi et al., 2009) suggesting a step forward in tumor resistance to hormone therapy. In our study, we did not find any kind of association between tamoxifen treatment and ER α -36 expression. Multivariate analysis did not reveal any correlation between tamoxifen treatment and survival data in our cohort. This is probably due to the fact that most of these patients were treated with tamoxifen, and we do not have a group of patients who underwent solely tamoxifen treatment, therefore biasing the results. Furthermore, chemotherapeutic drugs of the family of Topoisomerase-1 inhibitors have been shown to deeply affect alternative splicing events and could be responsible for the appearance of ER α -36 in breast cancers (Dutertre et al., 2010).

At the time being, only ER α expression is taken into account at the moment of diagnosis but our study comforts what has been previously data showing that ER α -36 expression constitutes a marker of poor outcome and poor prognosis in breast cancer. Other studies demonstrate that patients with high ER α -36 expression are less likely to benefit from tamoxifen treatment. We think that given the data on ER α -36, there should be a modulation of clinical practices in order to take into account the expression of this variant. In this line anti-aromatase therapy, currently used in postmenopausal women with metastatic breast cancer, could have an effect in tumors expressing high levels of ER α -36. Studies have revealed that some ER α negative breast tumors respond positively to anti-aromatase therapy and this could be due in part to the deprivation of estrogen to ER α -36 expressing cancer cells. In parallel, there is an actual phase 1 clinical trial using the flavonoid Icaritin on patients

with high ER α -36 expression in China (Chapter 3). This substance has been shown to downregulate ER α -36 expression and results of this study are not yet available.

CONCLUSIONS & PERSPECTIVES

In summary, our identified mechanism of ER α -36 signaling seems to rest on a previously undescribed mechanism in steroid receptor signaling where ER α -36 will act on a first level through Src/MAPK activation and then act on a second level by regulating the dephosphorylation of ERK by inhibiting MKP3 binding, revealing a new paradigm in ER α -36 non genomic signaling.

Our results demonstrate that ER α -36 can mediate the non-genomic pathway in an estrogen and tamoxifen dependent manner. We found that its cytoplasmic localization was mainly due to the presence of a functional nuclear export sequence in its C-Terminal domain thereby allowing it to translocate to the cytoplasm.

Similarly to ER α non-genomic signaling, we found the involvement of protein complexes including Src and PI3K. Our study mainly describes the involvement of the Src pathway in the activation of ER α -36 non-genomic signaling. In this aspect we wish to elucidate the binding sites of ER α -36 to Src. As previously discussed, the only interacting tyrosine described for Src in ER α is absent from the structure of ER α -36, and the interaction is also independent of ER α -36 unique C-Terminal domain. Our bioinformatics collaborators helped us identify a new potential phosphorylation site for Src on ER α -36 and this is currently under investigation.

Regarding PI3K, we found that it can form a rapid and transient complex with ER α -36 under both estrogen and tamoxifen treatment. However we have not been able to demonstrate its involvement in the downstream signaling pathway in terms of ERK2 binding and CyclinD1 induction. We are planning to understand which signaling pathways are regulated by this interaction through the use of phospho-antibody arrays regrouping various signaling pathways, coupled with the PI3K inhibitor LY294002.

Following activation of the MAPK pathway by ER α -36 our team discovered that the latter will act on a second level by directly binding to ERK2, thereby protecting it from dephosphorylation by MKP3. However many molecular mechanisms in this protection are still unclear. We have found that despite the specific interaction between ER α -36 and ERK2, both ERK1 and ERK2 undergo dephosphorylation upon abrogation of the ER α -36/ERK2 interaction. This data needs to be further studied using siRNA directed specifically at ERK1 or 2 and verifying if the use of our inhibitory peptide could also direct MKP3 to dephosphorylate ERK1 through an indirect mechanism. Collaborating bio-informaticians are currently helping us to identify other potential sites that could explain the specific interaction between ERK2 and ER α -36, as well as the understanding of molecular dynamics between ERK1/ERK2 and MKP3.

Our team has identified estrogen induced paxillin phosphorylation on Serine 126 as a molecular signature event of ER α -36 non-genomic pathway in HBCc-12A cells. This target has been identified through a screen for ERK substrates, but we have no idea whether it has a main involvement in Cyclin D1 regulation. First of all we wish to verify these results by making use of siRNAs to downregulate paxillin and observe whether we still have similar effects on cyclin D1 induction. Furthermore we have

performed a phospho-Antibody array chip focused on the MAPK pathway in order to identify new actors in the ER α -36 non-genomic signaling.

Our findings revealed that ER α -36 its expression was associated with poorer prognosis in terms of disease free survival and distant metastasis free survival. We are currently investigating ER α -36 expression in la larger cohort of 450 tumors and in another 150 breast tumors (Thierry Dubois, Curie Institute) in order to verify our previous findings and to assess the association between ER α -36 and to check whether its expression is associated with patient outcome in TNBC patients. We also wish to analyze the role of ER α -36 in tumors treated with tamoxifen or anti-aromatase to find if there are correlations in between these conditions and ER α -36 expression in terms of patient prognosis. Our ongoing work includes analysis of Src/ER α -36 interactions in breast cancer TMA, and we are currently awaiting statistical analyses on these experiments. Our data has helped us uncover new mechanistic insights into ER α -36 signaling and had also promoted the identification of new targets in breast cancer. We could imagine for instance that patients expressing high levels of ER α -36 could benefic from anti-aromatase therapy or current MEK inhibitors that are used in patients with metastatic melanoma.

Altogether our work has shed some light on the mechanistic of ER α -36 signaling, with the identification of novel signaling partners, which could be effectively targeted in breast cancer therapies.

Following my thesis defense, I will be staying as a post-doc in the lab for a couple of months and we wish to initiate the following projects in order to help us better understand the involvement of ER α -36 in breast tumorigenesis:

For the time being, our collaborating bioinformaticains have been working on predicted models of ER α -36, since there is no crystal structure of ER α -36 currently available. To go further we wish to initiate crystallization of the ER α -36 variant which will help us better understand its ligand binding properties and provide high resolution mapping for the study of ER α -36 docking with other proteins such as ERK2 and ERK1. This might help us find subtle differences explaining the binding of ER α -36 to one form and not the other despite the high degree of homology between these two proteins.

In the imparted time, I also wish to study the role of tamoxifen in the whole pathway mediated by ER α -36. Indeed preliminary results suggest that tamoxifen could be involved in the same pathway as mediated by estrogen and I wish to carry out an in depth investigation on the whole pathway till the study of cyclinD1 induction.

We have currently initiated a CRISPR-Cas9 approach to try and abrogate ER α -36 expression and I wish to develop this project to firstly establish ER α -36 KO HBCc-12A cells, which could be extended to other ER α -36 expressing cell lines. We wish to study the pathway in these cells and perform xenografts in mice mammary fat pads to investigate the role of ER α -36 in breast tumorigenesis.

A recent collaboration with S. Wittman (CLB) and Said El Elaoui (Covalab, Lyon) has revealed that a fraction of HBCc-12A cells express membranous ER α -36 detectable with our antibody in non-permeabilized cells through FACS analysis. I wish

to develop this project to investigate distinct properties of membrane ER α -36 expressing cells which would be more relevant to what is observed in breast tumors.

We also wish to perform a massive screening of all available anti-estrogens to see whether some of them could actually have an effect in downregulating ER α -36 or abrogating its signaling pathways. In parallel we also wish to investigate molecules having inhibitory properties on the ER α -36/ERK2 and ER α -36/Src interaction through the Centre for Drug Design and Discovery platform (Collab S.Giraud, CLB).

Altogether our project has led to understand the mechanistic insights of ER α -36 signaling and might open the way to novel therapeutic targets in breast cancer.

REFERENCES

Acconcia, F., Ascenzi, P., Fabozzi, G., Visca, P., and Marino, M. (2004). S-palmitoylation modulates human estrogen receptor- α functions. *Biochem. Biophys. Res. Commun.* *316*, 878–883.

Acconcia, F., Ascenzi, P., Bocedi, A., Spisni, E., Tomasi, V., Trentalance, A., Visca, P., and Marino, M. (2005). Palmitoylation-dependent estrogen receptor α membrane localization: regulation by 17 β -estradiol. *Mol. Biol. Cell* *16*, 231–237.

Arnould, L., Gelly, M., Penault-Llorca, F., Benoit, L., Bonnetain, F., Migeon, C., Cabaret, V., Fermeaux, V., Bertheau, P., Garnier, J., et al. (2006). Trastuzumab-based treatment of HER2-positive breast cancer: an antibody-dependent cellular cytotoxicity mechanism? *Br. J. Cancer* *94*, 259–267.

Asselin-Labat, M.-L., Sutherland, K.D., Barker, H., Thomas, R., Shackleton, M., Forrest, N.C., Hartley, L., Robb, L., Grosveld, F.G., van der Wees, J., et al. (2007). Gata-3 is an essential regulator of mammary-gland morphogenesis and luminal-cell differentiation. *Nat. Cell Biol.* *9*, 201–209.

Baird, R.D., and Carroll, J.S. (2016). Understanding Oestrogen Receptor Function in Breast Cancer and its Interaction with the Progesterone Receptor. *New Preclinical Findings and their Clinical Implications. Clin. Oncol. (R. Coll. Radiol.)* *28*, 1–3.

Baselga, J., Norton, L., Albanell, J., Kim, Y.M., and Mendelsohn, J. (1998). Recombinant humanized anti-HER2 antibody (Herceptin) enhances the antitumor activity of paclitaxel and doxorubicin against HER2/neu overexpressing human breast cancer xenografts. *Cancer Res.* *58*, 2825–2831.

Becker, J., and Craig, E.A. (1994). Heat-shock proteins as molecular chaperones. *Eur. J. Biochem.* *219*, 11–23.

Bermudez, O., Pagès, G., and Gimond, C. (2010). The dual-specificity MAP kinase phosphatases: critical roles in development and cancer. *Am. J. Physiol. Cell Physiol.* *299*, C189–C202.

Berns, K., Horlings, H.M., Hennessy, B.T., Madiredjo, M., Hijmans, E.M., Beelen, K., Linn, S.C., Gonzalez-Angulo, A.M., Stemke-Hale, K., Hauptmann, M., et al. (2007). A Functional Genetic Approach Identifies the PI3K Pathway as a Major Determinant of Trastuzumab Resistance in Breast Cancer. *Cancer Cell* *12*, 395–402.

Berry, N.B., Fan, M., and Nephew, K.P. (2008). Estrogen receptor- α hinge-region lysines 302 and 303 regulate receptor degradation by the proteasome. *Mol. Endocrinol.* *22*, 1535–1551.

Bertucci, F., Finetti, P., Rougemont, J., Charafe-Jauffret, E., Nasser, V., Loriod, B., Camerlo, J., Tagett, R., Tarpin, C., Houvenaeghel, G., et al. (2004). Gene expression

profiling for molecular characterization of inflammatory breast cancer and prediction of response to chemotherapy. *Cancer Res.* 64, 8558–8565.

Boutros, T., Chevet, E., and Metrakos, P. (2008). Mitogen-activated protein (MAP) kinase/MAP kinase phosphatase regulation: roles in cell growth, death, and cancer. *Pharmacol. Rev.* 60, 261–310.

Bunone, G., Briand, P.A., Miksicek, R.J., and Picard, D. (1996). Activation of the unliganded estrogen receptor by EGF involves the MAP kinase pathway and direct phosphorylation. *EMBO J.* 15, 2174–2183.

Cabodi, S., Moro, L., Baj, G., Smeriglio, M., Di Stefano, P., Gippone, S., Surico, N., Silengo, L., Turco, E., Tarone, G., et al. (2004). p130Cas interacts with estrogen receptor alpha and modulates non-genomic estrogen signaling in breast cancer cells. *J. Cell Sci.* 117, 1603–1611.

Carmeci, C., Thompson, D.A., Ring, H.Z., Francke, U., and Weigel, R.J. (1997). Identification of a gene (GPR30) with homology to the G-protein-coupled receptor superfamily associated with estrogen receptor expression in breast cancer. *Genomics* 45, 607–617.

Carpenter, K.D., and Korach, K.S. (2006). Potential biological functions emerging from the different estrogen receptors. *Ann. N. Y. Acad. Sci.* 1092, 361–373.

Carroll, J.S., Liu, X.S., Brodsky, A.S., Li, W., Meyer, C.A., Szary, A.J., Eeckhoutte, J., Shao, W., Hestermann, E. V., Geistlinger, T.R., et al. (2005). Chromosome-wide mapping of estrogen receptor binding reveals long-range regulation requiring the forkhead protein FoxA1. *Cell* 122, 33–43.

Castoria, G., Migliaccio, A., Bilancio, A., Di Domenico, M., de Falco, A., Lombardi, M., Fiorentino, R., Varricchio, L., Barone, M. V., and Auricchio, F. (2001). PI3-kinase in concert with Src promotes the S-phase entry of oestradiol-stimulated MCF-7 cells. *EMBO J.* 20, 6050–6059.

Catling, A.D., Schaeffer, H.J., Reuter, C.W., Reddy, G.R., and Weber, M.J. (1995). A proline-rich sequence unique to MEK1 and MEK2 is required for raf binding and regulates MEK function. *Mol. Cell. Biol.* 15, 5214–5225.

Cavaillès, V., Dauvois, S., L’Horset, F., Lopez, G., Hoare, S., Kushner, P.J., and Parker, M.G. (1995). Nuclear factor RIP140 modulates transcriptional activation by the estrogen receptor. *EMBO J.* 14, 3741–3751.

Chambliss, K.L., and Shaul, P.W. (2002). Rapid activation of endothelial NO synthase by estrogen: evidence for a steroid receptor fast-action complex (SRFC) in caveolae. *Steroids* 67, 413–419.

Charafe-Jauffret, E., Chaffanet, M., Bertucci, F., Ginestier, C., Jacquemier, J., deLapeyrière, O., and Birnbaum, D. [Towards an integrated cellular and molecular: definition of breast cancers]. *Médecine Sci. M/S* 23, 626–632.

Chaudhri, R.A., Olivares-Navarrete, R., Cuenca, N., Hadadi, A., Boyan, B.D., and Schwartz, Z. (2012). Membrane estrogen signaling enhances tumorigenesis and metastatic potential of breast cancer cells via estrogen receptor- α 36 (ER α 36). *J. Biol. Chem.* *287*, 7169–7181.

Chaudhri, R.A., Schwartz, N., Elbaradie, K., Schwartz, Z., and Boyan, B.D. (2014). Role of ER α 36 in membrane-associated signaling by estrogen. *Steroids* *81*, 74–80.

Chen, D., Ma, H., Hong, H., Koh, S.S., Huang, S.M., Schurter, B.T., Aswad, D.W., and Stallcup, M.R. (1999). Regulation of transcription by a protein methyltransferase. *Science* *284*, 2174–2177.

Chiloeches, A., Mason, C.S., and Marais, R. (2001). S338 phosphorylation of Raf-1 is independent of phosphatidylinositol 3-kinase and Pak3. *Mol. Cell. Biol.* *21*, 2423–2434.

Chong, H., Vikis, H.G., and Guan, K.-L. (2003). Mechanisms of regulating the Raf kinase family. *Cell. Signal.* *15*, 463–469.

Cintron, N.S., and Toft, D. (2006). Defining the requirements for Hsp40 and Hsp70 in the Hsp90 chaperone pathway. *J. Biol. Chem.* *281*, 26235–26244.

Clarke, R. Issues in experimental design and endpoint analysis in the study of experimental cytotoxic agents in vivo in breast cancer and other models. *Breast Cancer Res. Treat.* *46*, 255–278.

Clarke, R. (2000). Introduction and overview: sex steroids in the mammary gland. *J. Mammary Gland Biol. Neoplasia* *5*, 245–250.

Cobb, M.H., Boulton, T.G., and Robbins, D.J. (1991). Extracellular signal-regulated kinases: ERKs in progress. *Cell Regul.* *2*, 965–978.

Colicelli, J. (2004). Human RAS superfamily proteins and related GTPases. *Sci. STKE* *2004*, RE13.

Davies, M.P.A., O'Neill, P.A., Innes, H., Sibson, D.R., Prime, W., Holcombe, C., and Foster, C.S. (2004). Correlation of mRNA for oestrogen receptor beta splice variants ERbeta1, ERbeta2/ERbetacx and ERbeta5 with outcome in endocrine-treated breast cancer. *J. Mol. Endocrinol.* *33*, 773–782.

Delpech, Y., Wu, Y., Hess, K.R., Hsu, L., Ayers, M., Natowicz, R., Coutant, C., Rouzier, R., Barranger, E., Hortobagyi, G.N., et al. (2012). Ki67 expression in the primary tumor predicts for clinical benefit and time to progression on first-line endocrine therapy in estrogen receptor-positive metastatic breast cancer. *Breast Cancer Res. Treat.* *135*, 619–627.

- DeNardo, D.G., Kim, H.-T., Hilsenbeck, S., Cuba, V., Tsimelzon, A., and Brown, P.H. (2005). Global gene expression analysis of estrogen receptor transcription factor cross talk in breast cancer: identification of estrogen-induced/activator protein-1-dependent genes. *Mol. Endocrinol.* *19*, 362–378.
- Deng, H., Huang, X., Fan, J., Wang, L., Xia, Q., Yang, X., Wang, Z., and Liu, L. (2010). A variant of estrogen receptor- α , ER- α 36 is expressed in human gastric cancer and is highly correlated with lymph node metastasis. *Oncol. Rep.* *24*, 171–176.
- Deng, H., Zhang, X.-T., Wang, M.-L., Zheng, H.-Y., Liu, L.-J., and Wang, Z.-Y. (2014a). ER- α 36-mediated rapid estrogen signaling positively regulates ER-positive breast cancer stem/progenitor cells. *PLoS One* *9*, e88034.
- Deng, H., Yin, L., Zhang, X.-T., Liu, L.-J., Wang, M.-L., and Wang, Z.-Y. (2014b). ER- α variant ER- α 36 mediates antiestrogen resistance in ER-positive breast cancer stem/progenitor cells. *J. Steroid Biochem. Mol. Biol.* *144 Pt B*, 417–426.
- Dhillon, A.S., and Kolch, W. (2002). Untying the regulation of the Raf-1 kinase. *Arch. Biochem. Biophys.* *404*, 3–9.
- Dutertre, M., Lacroix-Triki, M., Driouch, K., de la Grange, P., Gratadou, L., Beck, S., Millevoi, S., Tazi, J., Lidereau, R., Vagner, S., et al. (2010). Exon-based clustering of murine breast tumor transcriptomes reveals alternative exons whose expression is associated with metastasis. *Cancer Res.* *70*, 896–905.
- Elston, C.W., Ellis, I.O., and Pinder, S.E. (1999). Pathological prognostic factors in breast cancer. *Crit. Rev. Oncol. Hematol.* *31*, 209–223.
- Emmen, J.M.A., and Korach, K.S. (2003). Estrogen receptor knockout mice: phenotypes in the female reproductive tract. *Gynecol. Endocrinol.* *17*, 169–176.
- Enmark, E., Pelto-Huikko, M., Grandien, K., Lagercrantz, S., Lagercrantz, J., Fried, G., Nordenskjöld, M., and Gustafsson, J.A. (1997). Human estrogen receptor beta-gene structure, chromosomal localization, and expression pattern. *J. Clin. Endocrinol. Metab.* *82*, 4258–4265.
- Etienne-Manneville, S. (2006). In vitro assay of primary astrocyte migration as a tool to study Rho GTPase function in cell polarization. *Methods Enzymol.* *406*, 565–578.
- Farmer, P., Bonnefoi, H., Becette, V., Tubiana-Hulin, M., Fumoleau, P., Larsimont, D., Macgrogan, G., Bergh, J., Cameron, D., Goldstein, D., et al. (2005). Identification of molecular apocrine breast tumours by microarray analysis. *Oncogene* *24*, 4660–4671.
- Farooq, A., and Zhou, M.-M. (2004). Structure and regulation of MAPK phosphatases. *Cell. Signal.* *16*, 769–779.

Fernando, R.I., and Wimalasena, J. (2004). Estradiol abrogates apoptosis in breast cancer cells through inactivation of BAD: Ras-dependent nongenomic pathways requiring signaling through ERK and Akt. *Mol. Biol. Cell* 15, 3266–3284.

Filardo, E., Quinn, J., Pang, Y., Graeber, C., Shaw, S., Dong, J., and Thomas, P. (2007). Activation of the Novel Estrogen Receptor G Protein-Coupled Receptor 30 (GPR30) at the Plasma Membrane. *Endocrinology* 148, 3236–3245.

Filardo, E.J., Quinn, J.A., Bland, K.I., and Frackelton, A.R. (2000). Estrogen-induced activation of Erk-1 and Erk-2 requires the G protein-coupled receptor homolog, GPR30, and occurs via trans-activation of the epidermal growth factor receptor through release of HB-EGF. *Mol. Endocrinol.* 14, 1649–1660.

Flouriot, G., Brand, H., Denger, S., Metivier, R., Kos, M., Reid, G., Sonntag-Buck, V., and Gannon, F. (2000). Identification of a new isoform of the human estrogen receptor-alpha (hER-alpha) that is encoded by distinct transcripts and that is able to repress hER-alpha activation function 1. *EMBO J.* 19, 4688–4700.

Friedenreich, C.M. (2001). Physical activity and cancer: lessons learned from nutritional epidemiology. *Nutr. Rev.* 59, 349–357.

Fu, Z., Zhen, H., Zou, F., Wang, X., Chen, Y., and Liu, L. (2014). Involvement of the Akt signaling pathway in ER- α 36/GRP94-mediated signaling in gastric cancer. *Oncol. Lett.* 8, 2077–2080.

Fuqua, S.A., Wiltschke, C., Zhang, Q.X., Borg, A., Castles, C.G., Friedrichs, W.E., Hopp, T., Hilsenbeck, S., Mohsin, S., O'Connell, P., et al. (2000). A hypersensitive estrogen receptor-alpha mutation in premalignant breast lesions. *Cancer Res.* 60, 4026–4029.

Generali, D., Buffa, F.M., Berruti, A., Brizzi, M.P., Campo, L., Bonardi, S., Bersiga, A., Allevi, G., Milani, M., Aguggini, S., et al. (2009). Phosphorylated ERalpha, HIF-1alpha, and MAPK signaling as predictors of primary endocrine treatment response and resistance in patients with breast cancer. *J. Clin. Oncol.* 27, 227–234.

Gerber, H.-P., and Ferrara, N. (2005). Pharmacology and pharmacodynamics of bevacizumab as monotherapy or in combination with cytotoxic therapy in preclinical studies. *Cancer Res.* 65, 671–680.

Glade, M.J. (1999). Food, nutrition, and the prevention of cancer: a global perspective. American Institute for Cancer Research/World Cancer Research Fund, American Institute for Cancer Research, 1997. *Nutrition* 15, 523–526.

Green, S., Walter, P., Kumar, V., Krust, A., Bornert, J.M., Argos, P., and Chambon, P. Human oestrogen receptor cDNA: sequence, expression and homology to v-erb-A. *Nature* 320, 134–139.

Greene, G.L., Gilna, P., Waterfield, M., Baker, A., Hort, Y., and Shine, J. (1986). Sequence and expression of human estrogen receptor complementary DNA. *Science* 231, 1150–1154.

Greger, J.G., Fursov, N., Cooch, N., McLarney, S., Freedman, L.P., Edwards, D.P., and Cheskis, B.J. (2007). Phosphorylation of MNAR promotes estrogen activation of phosphatidylinositol 3-kinase. *Mol. Cell. Biol.* 27, 1904–1913.

Gruver, A.M., Portier, B.P., and Tubbs, R.R. (2011). Molecular pathology of breast cancer: the journey from traditional practice toward embracing the complexity of a molecular classification. *Arch. Pathol. Lab. Med.* 135, 544–557.

Gu, Y., Chen, T., López, E., Wu, W., Wang, X., Cao, J., and Teng, L. (2014). The therapeutic target of estrogen receptor- α 36 in estrogen-dependent tumors. *J. Transl. Med.* 12, 16.

Guo, M., Wang, M., Zhang, X., Deng, H., and Wang, Z.-Y. (2013a). Brousoflavonol B restricts growth of ER-negative breast cancer stem-like cells. *Anticancer Res.* 33, 1873–1879.

Guo, M., Wang, M., Deng, H., Zhang, X., and Wang, Z.-Y. (2013b). A novel anticancer agent Brousoflavonol B downregulates estrogen receptor (ER)- α 36 expression and inhibits growth of ER-negative breast cancer MDA-MB-231 cells. *Eur. J. Pharmacol.* 714, 56–64.

Hamajima, N., Hirose, K., Tajima, K., Rohan, T., Calle, E.E., Heath, C.W., Coates, R.J., Liff, J.M., Talamini, R., Chantarakul, N., et al. (2002). Alcohol, tobacco and breast cancer--collaborative reanalysis of individual data from 53 epidemiological studies, including 58,515 women with breast cancer and 95,067 women without the disease. *Br. J. Cancer* 87, 1234–1245.

Hammes, S.R., and Levin, E.R. (2007). Extranuclear steroid receptors: nature and actions. *Endocr. Rev.* 28, 726–741.

Han, S., Zhao, B., Pan, X., Song, Z., Liu, J., Gong, Y., and Wang, M. (2015). Estrogen receptor variant ER- α 36 is involved in estrogen neuroprotection against oxidative toxicity. *Neuroscience* 310, 224–241.

He, X., Zheng, Z., Song, T., Wei, C., Ma, H., Ma, Q., Zhang, Y., Xu, Y., Shi, W., Ye, Q., et al. (2010). c-Abl regulates estrogen receptor alpha transcription activity through its stabilization by phosphorylation. *Oncogene* 29, 2238–2251.

Hennighausen, L., and Robinson, G.W. (2005). Information networks in the mammary gland. *Nat. Rev. Mol. Cell Biol.* 6, 715–725.

Herynk, M.H., Parra, I., Cui, Y., Beyer, A., Wu, M.-F., Hilsenbeck, S.G., and Fuqua, S.A.W. (2007). Association between the estrogen receptor alpha A908G mutation and outcomes in invasive breast cancer. *Clin. Cancer Res.* 13, 3235–3243.

Holbro, T., Civenni, G., and Hynes, N.E. (2003). The ErbB receptors and their role in cancer progression. *Exp. Cell Res.* *284*, 99–110.

Hopp, T.A., Weiss, H.L., Hilsenbeck, S.G., Cui, Y., Allred, D.C., Horwitz, K.B., and Fuqua, S.A.W. (2004). Breast cancer patients with progesterone receptor PR-A-rich tumors have poorer disease-free survival rates. *Clin. Cancer Res.* *10*, 2751–2760.

Hou, J., Deng, M., Li, X., Liu, W., Chu, X., Wang, J., Chen, F., and Meng, S. (2015). Chaperone gp96 mediates ER- α 36 cell membrane expression. *Oncotarget* *6*, 31857–31867.

Houliston, R.A., Pearson, J.D., and Wheeler-Jones, C.P. (2001). Agonist-specific cross talk between ERKs and p38(mapk) regulates PGI(2) synthesis in endothelium. *Am. J. Physiol. Cell Physiol.* *281*, C1266–C1276.

Hubbard, S.R., and Miller, W.T. (2007). Receptor tyrosine kinases: mechanisms of activation and signaling. *Curr. Opin. Cell Biol.* *19*, 117–123.

Jiang, H., Teng, R., Wang, Q., Zhang, X., Wang, H., Wang, Z., Cao, J., and Teng, L. (2008). Transcriptional analysis of estrogen receptor alpha variant mRNAs in colorectal cancers and their matched normal colorectal tissues. *J. Steroid Biochem. Mol. Biol.* *112*, 20–24.

Jiang, J., Sarwar, N., Peston, D., Kulinskaya, E., Shousha, S., Coombes, R.C., and Ali, S. (2007). Phosphorylation of estrogen receptor-alpha at Ser167 is indicative of longer disease-free and overall survival in breast cancer patients. *Clin. Cancer Res.* *13*, 5769–5776.

Johansson, L., Båvner, A., Thomsen, J.S., Färnegårdh, M., Gustafsson, J.A., and Treuter, E. (2000). The orphan nuclear receptor SHP utilizes conserved LXXLL-related motifs for interactions with ligand-activated estrogen receptors. *Mol. Cell. Biol.* *20*, 1124–1133.

Johnson, J.L., Beito, T.G., Krco, C.J., and Toft, D.O. (1994). Characterization of a novel 23-kilodalton protein of unactive progesterone receptor complexes. *Mol. Cell. Biol.* *14*, 1956–1963.

Johnson, M.D., Zuo, H., Lee, K.-H., Trebley, J.P., Rae, J.M., Weatherman, R. V, Desta, Z., Flockhart, D.A., and Skaar, T.C. (2004). Pharmacological characterization of 4-hydroxy-N-desmethyl tamoxifen, a novel active metabolite of tamoxifen. *Breast Cancer Res. Treat.* *85*, 151–159.

Jordan, V.C. (1994). Molecular mechanisms of antiestrogen action in breast cancer. *Breast Cancer Res. Treat.* *31*, 41–52.

Kalaitzidis, D., and Gilmore, T.D. (2005). Transcription factor cross-talk: the estrogen receptor and NF- κ B. *Trends Endocrinol. Metab.* *16*, 46–52.

Kang, L., Zhang, X., Xie, Y., Tu, Y., Wang, D., Liu, Z., and Wang, Z.-Y. (2010). Involvement of estrogen receptor variant ER- α 36, not GPR30, in nongenomic estrogen signaling. *Mol. Endocrinol.* *24*, 709–721.

Kang, L., Wang, L., and Wang, Z.-Y. (2011a). Opposite regulation of estrogen receptor- α and its variant ER- α 36 by the Wilms' tumor suppressor WT1. *Oncol. Lett.* *2*, 337–341.

Kang, L., Guo, Y., Zhang, X., Meng, J., and Wang, Z.-Y. (2011b). A positive cross-regulation of HER2 and ER- α 36 controls ALDH1 positive breast cancer cells. *J. Steroid Biochem. Mol. Biol.* *127*, 262–268.

Kang, S.P., Martel, M., and Harris, L.N. (2008). Triple negative breast cancer: current understanding of biology and treatment options. *Curr. Opin. Obstet. Gynecol.* *20*, 40–46.

Kataoka, Y., Mukohara, T., Shimada, H., Saijo, N., Hirai, M., and Minami, H. (2010). Association between gain-of-function mutations in PIK3CA and resistance to HER2-targeted agents in HER2-amplified breast cancer cell lines. *Ann. Oncol.* *21*, 255–262.

Key, T.J., Verkasalo, P.K., and Banks, E. (2001). Epidemiology of breast cancer. *Lancet Oncol.* *2*, 133–140.

Kim, M.Y., Woo, E.M., Chong, Y.T.E., Homenko, D.R., and Kraus, W.L. (2006). Acetylation of estrogen receptor alpha by p300 at lysines 266 and 268 enhances the deoxyribonucleic acid binding and transactivation activities of the receptor. *Mol. Endocrinol.* *20*, 1479–1493.

Koide, A., Zhao, C., Naganuma, M., Abrams, J., Deighton-Collins, S., Skafar, D.F., and Koide, S. (2007). Identification of regions within the F domain of the human estrogen receptor alpha that are important for modulating transactivation and protein-protein interactions. *Mol. Endocrinol.* *21*, 829–842.

Koo, K.-H., Jeong, W.-J., Cho, Y.-H., Park, J.-C., Min, D.S., and Choi, K.-Y. (2015). K-Ras stabilization by estrogen via PKC δ is involved in endometrial tumorigenesis. *Oncotarget* *6*, 21328–21340.

Kos, M., Reid, G., Denger, S., and Gannon, F. (2001). Minireview: genomic organization of the human ERalpha gene promoter region. *Mol. Endocrinol.* *15*, 2057–2063.

Krens, S.F.G., Corredor-Adámez, M., He, S., Snaar-Jagalska, B.E., and Spalink, H.P. (2008). ERK1 and ERK2 MAPK are key regulators of distinct gene sets in zebrafish embryogenesis. *BMC Genomics* *9*, 196.

Kubicek, M., Pacher, M., Abraham, D., Podar, K., Eulitz, M., and Baccarini, M. (2002). Dephosphorylation of Ser-259 regulates Raf-1 membrane association. *J. Biol. Chem.* *277*, 7913–7919.

Kuiper, G.G., Shughrue, P.J., Merchenthaler, I., and Gustafsson, J.A. (1998). The estrogen receptor beta subtype: a novel mediator of estrogen action in neuroendocrine systems. *Front. Neuroendocrinol.* *19*, 253–286.

Kumar, V., Green, S., Stack, G., Berry, M., Jin, J.R., and Chambon, P. (1987). Functional domains of the human estrogen receptor. *Cell* *51*, 941–951.

Kurebayashi, J. (2005). Resistance to endocrine therapy in breast cancer. *Cancer Chemother. Pharmacol.* *56 Suppl 1*, 39–46.

Kurokawa, H., Lenferink, A.E., Simpson, J.F., Pisacane, P.I., Sliwkowski, M.X., Forbes, J.T., and Arteaga, C.L. (2000). Inhibition of HER2/neu (erbB-2) and mitogen-activated protein kinases enhances tamoxifen action against HER2-overexpressing, tamoxifen-resistant breast cancer cells. *Cancer Res.* *60*, 5887–5894.

Kuukasjärvi, T., Kononen, J., Helin, H., Holli, K., and Isola, J. (1996). Loss of estrogen receptor in recurrent breast cancer is associated with poor response to endocrine therapy. *J. Clin. Oncol.* *14*, 2584–2589.

Kuwano, Y., Kim, H.H., Abdelmohsen, K., Pullmann, R., Martindale, J.L., Yang, X., and Gorospe, M. (2008). MKP-1 mRNA stabilization and translational control by RNA-binding proteins HuR and NF90. *Mol. Cell. Biol.* *28*, 4562–4575.

Laplante, M., and Sabatini, D.M. (2009). mTOR signaling at a glance. *J. Cell Sci.* *122*, 3589–3594.

Layde, P.M., Webster, L.A., Baughman, A.L., Wingo, P.A., Rubin, G.L., and Ory, H.W. (1989). The independent associations of parity, age at first full term pregnancy, and duration of breastfeeding with the risk of breast cancer. Cancer and Steroid Hormone Study Group. *J. Clin. Epidemiol.* *42*, 963–973.

Lee, J.J., Loh, K., and Yap, Y.-S. (2015). PI3K/Akt/mTOR inhibitors in breast cancer. *Cancer Biol. Med.* *12*, 342–354.

Lee, L.M.J., Cao, J., Deng, H., Chen, P., Gatalica, Z., and Wang, Z.-Y. ER-alpha36, a novel variant of ER-alpha, is expressed in ER-positive and -negative human breast carcinomas. *Anticancer Res.* *28*, 479–483.

Leers, J., Treuter, E., and Gustafsson, J.A. (1998). Mechanistic principles in NR box-dependent interaction between nuclear hormone receptors and the coactivator TIF2. *Mol. Cell. Biol.* *18*, 6001–6013.

Lerner, L.J., and Jordan, V.C. (1990). Development of antiestrogens and their use in breast cancer: eighth Cain memorial award lecture. *Cancer Res.* *50*, 4177–4189.

Li, L., Haynes, M.P., and Bender, J.R. (2003). Plasma membrane localization and function of the estrogen receptor alpha variant (ER46) in human endothelial cells. *Proc. Natl. Acad. Sci. U. S. A.* *100*, 4807–4812.

Lin, S.-L., Yan, L.-Y., Liang, X.-W., Wang, Z.-B., Wang, Z.-Y., Qiao, J., Schatten, H., and Sun, Q.-Y. (2009). A novel variant of ER-alpha, ER-alpha36 mediates testosterone-stimulated ERK and Akt activation in endometrial cancer Hec1A cells. *Reprod. Biol. Endocrinol.* *7*, 102.

Lin, S.-L., Yan, L.-Y., Zhang, X.-T., Yuan, J., Li, M., Qiao, J., Wang, Z.-Y., and Sun, Q.-Y. (2010). ER-alpha36, a variant of ER-alpha, promotes tamoxifen agonist action in endometrial cancer cells via the MAPK/ERK and PI3K/Akt pathways. *PLoS One* *5*, e9013.

Liu, J., Xu, Z., Ma, X., Huang, B., and Pan, X. (2015). Role of ER- α 36 in breast cancer by typical xenoestrogens. *Tumour Biol.* *36*, 7355–7364.

Liu, Y., Fang, C., Zou, P., Ma, Y.-N., Han, D.-N., Ji, Z.-H., Liang, X.-F., Guan, X., Huang, L., Feng, T., et al. (2013). [Diverse expression of ER- α 36, a novel variant of ER- α , in hippocampus and cortex of neonatal and adult rats]. *Sheng Li Xue Bao* *65*, 263–268.

Lopez, F., Belloc, F., Lacombe, F., Dumain, P., Reiffers, J., Bernard, P., and Boisseau, M.R. (1991). Modalities of synthesis of Ki67 antigen during the stimulation of lymphocytes. *Cytometry* *12*, 42–49.

Malumbres, M., and Barbacid, M. (2003). RAS oncogenes: the first 30 years. *Nat. Rev. Cancer* *3*, 459–465.

Marangoni, E., Vincent-Salomon, A., Auger, N., Degeorges, A., Assayag, F., de Cremoux, P., de Plater, L., Guyader, C., De Pinieux, G., Judde, J.-G., et al. (2007). A new model of patient tumor-derived breast cancer xenografts for preclinical assays. *Clin. Cancer Res.* *13*, 3989–3998.

Marchetti, S., Gimond, C., Chambard, J.-C., Touboul, T., Roux, D., Pouysségur, J., and Pagès, G. (2005). Extracellular signal-regulated kinases phosphorylate mitogen-activated protein kinase phosphatase 3/DUSP6 at serines 159 and 197, two sites critical for its proteasomal degradation. *Mol. Cell. Biol.* *25*, 854–864.

Marino, M., Ascenzi, P., and Acconcia, F. (2006). S-palmitoylation modulates estrogen receptor alpha localization and functions. *Steroids* *71*, 298–303.

Marshall, M. (1995). Interactions between Ras and Raf: key regulatory proteins in cellular transformation. *Mol. Reprod. Dev.* *42*, 493–499.

McCave, E.J., Cass, C.A.P., Burg, K.J.L., and Booth, B.W. (2010). The normal microenvironment directs mammary gland development. *J. Mammary Gland Biol. Neoplasia* *15*, 291–299.

Memon, A.R. (2004). The role of ADP-ribosylation factor and SAR1 in vesicular trafficking in plants. *Biochim. Biophys. Acta* *1664*, 9–30.

Menasce, L.P., White, G.R., Harrison, C.J., and Boyle, J.M. (1993). Localization of the estrogen receptor locus (ESR) to chromosome 6q25.1 by FISH and a simple post-FISH banding technique. *Genomics* 17, 263–265.

Migliaccio, A., Castoria, G., Di Domenico, M., de Falco, A., Bilancio, A., Lombardi, M., Barone, M. V, Ametrano, D., Zannini, M.S., Abbondanza, C., et al. (2000). Steroid-induced androgen receptor-oestradiol receptor beta-Src complex triggers prostate cancer cell proliferation. *EMBO J.* 19, 5406–5417.

Mohammed, H., Russell, I.A., Stark, R., Rueda, O.M., Hickey, T.E., Tarulli, G.A., Serandour, A.A.A., Birrell, S.N., Bruna, A., Saadi, A., et al. (2015). Progesterone receptor modulates ER α action in breast cancer. *Nature* 523, 313–317.

Mor, A., and Philips, M.R. (2006). Compartmentalized Ras/MAPK signaling. *Annu. Rev. Immunol.* 24, 771–800.

Mottet, D., and Castronovo, V. (2010). Histone deacetylases: anti-angiogenic targets in cancer therapy. *Curr. Cancer Drug Targets* 10, 898–913.

Murphy, L.C., Niu, Y., Snell, L., and Watson, P. (2004). Phospho-serine-118 estrogen receptor-alpha expression is associated with better disease outcome in women treated with tamoxifen. *Clin. Cancer Res.* 10, 5902–5906.

Nahta, R., Yuan, L.X.H., Zhang, B., Kobayashi, R., and Esteva, F.J. (2005). Insulin-like growth factor-I receptor/human epidermal growth factor receptor 2 heterodimerization contributes to trastuzumab resistance of breast cancer cells. *Cancer Res.* 65, 11118–11128.

Nautiyal, J., Steel, J.H., Mane, M.R., Oduwole, O., Poliandri, A., Alexi, X., Wood, N., Poutanen, M., Zwart, W., Stingl, J., et al. (2013). The transcriptional co-factor RIP140 regulates mammary gland development by promoting the generation of key mitogenic signals. *Development* 140, 1079–1089.

Norfleet, A.M., Thomas, M.L., Gametchu, B., and Watson, C.S. (1999). Estrogen receptor-alpha detected on the plasma membrane of aldehyde-fixed GH3/B6/F10 rat pituitary tumor cells by enzyme-linked immunocytochemistry. *Endocrinology* 140, 3805–3814.

O'Brien, D.E., Alter, B.J., Satomoto, M., Morgan, C.D., Davidson, S., Vogt, S.K., Norman, M.E., Gereau, G.B., Demaro, J.A., Landreth, G.E., et al. (2015). ERK2 Alone Drives Inflammatory Pain But Cooperates with ERK1 in Sensory Neuron Survival. *J. Neurosci.* 35, 9491–9507.

O'Lone, R., Frith, M.C., Karlsson, E.K., and Hansen, U. (2004). Genomic targets of nuclear estrogen receptors. *Mol. Endocrinol.* 18, 1859–1875.

Ohshiro, K., Schwartz, A.M., Levine, P.H., and Kumar, R. (2012). Alternate Estrogen Receptors Promote Invasion of Inflammatory Breast Cancer Cells via Non-Genomic Signaling. *PLoS One* 7, e30725.

Paech, K., Webb, P., Kuiper, G.G., Nilsson, S., Gustafsson, J., Kushner, P.J., and Scanlan, T.S. (1997). Differential ligand activation of estrogen receptors ER α and ER β at AP1 sites. *Science* 277, 1508–1510.

Paganini-Hill, A., Dworsky, R., and Krauss, R.M. (1996). Hormone replacement therapy, hormone levels, and lipoprotein cholesterol concentrations in elderly women. *Am. J. Obstet. Gynecol.* 174, 897–902.

Pappas, T.C., Gametchu, B., and Watson, C.S. (1995). Membrane estrogen receptor-enriched GH(3)/B6 cells have an enhanced non-genomic response to estrogen. *Endocrine* 3, 743–749.

Parmar, H., and Cunha, G.R. (2004). Epithelial-stromal interactions in the mouse and human mammary gland in vivo. *Endocr. Relat. Cancer* 11, 437–458.

Payne, D.M., Rossomando, A.J., Martino, P., Erickson, A.K., Her, J.H., Shabanowitz, J., Hunt, D.F., Weber, M.J., and Sturgill, T.W. (1991). Identification of the regulatory phosphorylation sites in pp42/mitogen-activated protein kinase (MAP kinase). *EMBO J.* 10, 885–892.

Pegram, M., and Slamon, D. (2000). Biological rationale for HER2/neu (c-erbB2) as a target for monoclonal antibody therapy. *Semin. Oncol.* 27, 13–19.

Pelekanou, V., Notas, G., Kampa, M., Tsenteliero, E., Radojicic, J., Leclercq, G., Castanas, E., and Stathopoulos, E.N. (2012). ER α 36, a new variant of the ER α is expressed in triple negative breast carcinomas and has a specific transcriptomic signature in breast cancer cell lines. *Steroids* 77, 928–934.

Pelekanou, V., Kampa, M., Kiagiadaki, F., Deli, A., Theodoropoulos, P., Agrogiannis, G., Patsouris, E., Tsapis, A., Castanas, E., and Notas, G. (2016). Estrogen anti-inflammatory activity on human monocytes is mediated through cross-talk between estrogen receptor ER α 36 and GPR30/GPER1. *J. Leukoc. Biol.* 99, 333–347.

Penot, G., Le Péron, C., Mérot, Y., Grimaud-Fanouillère, E., Ferrière, F., Boujrad, N., Kah, O., Saligaut, C., Ducouret, B., Métivier, R., et al. (2005). The human estrogen receptor-alpha isoform hER α 46 antagonizes the proliferative influence of hER α 66 in MCF7 breast cancer cells. *Endocrinology* 146, 5474–5484.

Perou, C.M., Sørlie, T., Eisen, M.B., van de Rijn, M., Jeffrey, S.S., Rees, C.A., Pollack, J.R., Ross, D.T., Johnsen, H., Akslen, L.A., et al. (2000). Molecular portraits of human breast tumours. *Nature* 406, 747–752.

Picard, D. (2006). Intracellular dynamics of the Hsp90 co-chaperone p23 is dictated by Hsp90. *Exp. Cell Res.* 312, 198–204.

Pietras, R.J., and Szego, C.M. (1977). Specific binding sites for oestrogen at the outer surfaces of isolated endometrial cells. *Nature* 265, 69–72.

- Ponglikitmongkol, M., Green, S., and Chambon, P. (1988). Genomic organization of the human oestrogen receptor gene. *EMBO J.* *7*, 3385–3388.
- Popov, V.M., Wang, C., Shirley, L.A., Rosenberg, A., Li, S., Nevalainen, M., Fu, M., and Pestell, R.G. (2007). The functional significance of nuclear receptor acetylation. *Steroids* *72*, 221–230.
- Poulard, C., Treilleux, I., Lavergne, E., Bouchekioua-Bouzaghrou, K., Goddard-Léon, S., Chabaud, S., Trédan, O., Corbo, L., and Le Romancer, M. (2012). Activation of rapid oestrogen signalling in aggressive human breast cancers. *EMBO Mol. Med.* *4*, 1200–1213.
- Poulard, C., Rambaud, J., Hussein, N., Corbo, L., and Le Romancer, M. (2014). JMJD6 regulates ER α methylation on arginine. *PLoS One* *9*, e87982.
- Poulard, C., Rambaud, J., Lavergne, E., Jacquemetton, J., Renoir, J.-M., Trédan, O., Chabaud, S., Treilleux, I., Corbo, L., and Le Romancer, M. (2015). Role of JMJD6 in Breast Tumourigenesis. *PLoS One* *10*, e0126181.
- Pouysségur, J., Volmat, V., and Lenormand, P. (2002). Fidelity and spatio-temporal control in MAP kinase (ERKs) signalling. *Biochem. Pharmacol.* *64*, 755–763.
- Prat, A., Parker, J.S., Karginova, O., Fan, C., Livasy, C., Herschkowitz, J.I., He, X., and Perou, C.M. (2010). Phenotypic and molecular characterization of the claudin-low intrinsic subtype of breast cancer. *Breast Cancer Res.* *12*, R68.
- Presta, L.G., Chen, H., O'Connor, S.J., Chisholm, V., Meng, Y.G., Krummen, L., Winkler, M., and Ferrara, N. (1997). Humanization of an anti-vascular endothelial growth factor monoclonal antibody for the therapy of solid tumors and other disorders. *Cancer Res.* *57*, 4593–4599.
- Prodromou, C., Panaretou, B., Chohan, S., Siligardi, G., O'Brien, R., Ladbury, J.E., Roe, S.M., Piper, P.W., and Pearl, L.H. (2000). The ATPase cycle of Hsp90 drives a molecular “clamp” via transient dimerization of the N-terminal domains. *EMBO J.* *19*, 4383–4392.
- Prossnitz, E.R., and Maggiolini, M. (2009). Mechanisms of estrogen signaling and gene expression via GPR30. *Mol. Cell. Endocrinol.* *308*, 32–38.
- Radtke, S., Milanovic, M., Rossé, C., De Rycker, M., Lachmann, S., Hibbert, A., Kermorgant, S., and Parker, P.J. (2013). ERK2 but not ERK1 mediates HGF-induced motility in non-small cell lung carcinoma cell lines. *J. Cell Sci.* *126*, 2381–2391.
- Rakha, E.A., and Ellis, I.O. (2011). Modern classification of breast cancer: should we stick with morphology or convert to molecular profile characteristics. *Adv. Anat. Pathol.* *18*, 255–267.

Ramsey, T.L., and Klinge, C.M. (2001). Estrogen response element binding induces alterations in estrogen receptor- α conformation as revealed by susceptibility to partial proteolysis. *J. Mol. Endocrinol.* *27*, 275–292.

Rao, J., Jiang, X., Wang, Y., and Chen, B. (2011). Advances in the understanding of the structure and function of ER- α 36, a novel variant of human estrogen receptor- α . *J. Steroid Biochem. Mol. Biol.* *127*, 231–237.

Ratajczak, T., and Carrello, A. (1996). Cyclophilin 40 (CyP-40), mapping of its hsp90 binding domain and evidence that FKBP52 competes with CyP-40 for hsp90 binding. *J. Biol. Chem.* *271*, 2961–2965.

Ravichandran, K.S. (2001). Signaling via Shc family adapter proteins. *Oncogene* *20*, 6322–6330.

Razandi, M., Alton, G., Pedram, A., Ghonshani, S., Webb, P., and Levin, E.R. (2003). Identification of a structural determinant necessary for the localization and function of estrogen receptor α at the plasma membrane. *Mol. Cell. Biol.* *23*, 1633–1646.

Redmond, A.M., Byrne, C., Bane, F.T., Brown, G.D., Tibbitts, P., O'Brien, K., Hill, A.D.K., Carroll, J.S., and Young, L.S. (2015). Genomic interaction between ER and HMGB2 identifies DDX18 as a novel driver of endocrine resistance in breast cancer cells. *Oncogene* *34*, 3871–3880.

Reis-Filho, J.S., and Tutt, A.N.J. (2008). Triple negative tumours: a critical review. *Histopathology* *52*, 108–118.

Renoir, J.M., Radanyi, C., Faber, L.E., and Baulieu, E.E. (1990). The non-DNA-binding heterooligomeric form of mammalian steroid hormone receptors contains a hsp90-bound 59-kilodalton protein. *J. Biol. Chem.* *265*, 10740–10745.

Revankar, C.M., Cimino, D.F., Sklar, L.A., Arterburn, J.B., and Prossnitz, E.R. (2005). A transmembrane intracellular estrogen receptor mediates rapid cell signaling. *Science* *307*, 1625–1630.

Reyal, F., Hajage, D., Savignoni, A., Feron, J.-G., Bollet, M.A., Kirova, Y., Fourquet, A., Pierga, J.-Y., Cottu, P., Dieras, V., et al. (2013). Long-term prognostic performance of Ki67 rate in early stage, pT1-pT2, pN0, invasive breast carcinoma. *PLoS One* *8*, e55901.

Rhodes, D.J., O'Connor, M.K., Phillips, S.W., Smith, R.L., and Collins, D.A. (2005). Molecular breast imaging: a new technique using technetium Tc 99m scintimammography to detect small tumors of the breast. *Mayo Clin. Proc.* *80*, 24–30.

Riggins, R.B., Schrecengost, R.S., Guerrero, M.S., and Bouton, A.H. (2007). Pathways to tamoxifen resistance. *Cancer Lett.* *256*, 1–24.

Le Romancer, M., Treilleux, I., Bouchekioua-Bouzaghoul, K., Sentis, S., and Corbo, L. Methylation, a key step for nongenomic estrogen signaling in breast tumors. *Steroids* 75, 560–564.

Le Romancer, M., Treilleux, I., Leconte, N., Robin-Lespinasse, Y., Sentis, S., Bouchekioua-Bouzaghoul, K., Goddard, S., Gobert-Gosse, S., and Corbo, L. (2008). Regulation of estrogen rapid signaling through arginine methylation by PRMT1. *Mol. Cell* 31, 212–221.

Le Romancer, M., Poulard, C., Cohen, P., Sentis, S., Renoir, J.-M., and Corbo, L. (2011). Cracking the Estrogen Receptor's Posttranslational Code in Breast Tumors. *Endocr. Rev.* 32, 597–622.

Rosenfeld, M.G., Lunyak, V. V, and Glass, C.K. (2006). Sensors and signals: a coactivator/corepressor/epigenetic code for integrating signal-dependent programs of transcriptional response. *Genes Dev.* 20, 1405–1428.

Rudland, P.S., Fernig, D.G., and Smith, J.A. (1995). Growth factors and their receptors in neoplastic mammary glands. *Biomed. Pharmacother. = Biomédecine Pharmacothérapie* 49, 389–399.

Ruff, M., Gangloff, M., Wurtz, J.M., and Moras, D. (2000). Estrogen receptor transcription and transactivation: Structure-function relationship in DNA- and ligand-binding domains of estrogen receptors. *Breast Cancer Res.* 2, 353–359.

Rusnak, D.W., Lackey, K., Affleck, K., Wood, E.R., Alligood, K.J., Rhodes, N., Keith, B.R., Murray, D.M., Knight, W.B., Mullin, R.J., et al. (2001). The effects of the novel, reversible epidermal growth factor receptor/ErbB-2 tyrosine kinase inhibitor, GW2016, on the growth of human normal and tumor-derived cell lines in vitro and in vivo. *Mol. Cancer Ther.* 1, 85–94.

Sabbah, M., Radanyi, C., Redeuilh, G., and Baulieu, E.E. (1996). The 90 kDa heat-shock protein (hsp90) modulates the binding of the oestrogen receptor to its cognate DNA. *Biochem. J.* 314 (Pt 1, 205–213.

Sanchez, E.R., Meshinchi, S., Tienrungroj, W., Schlesinger, M.J., Toft, D.O., and Pratt, W.B. (1987). Relationship of the 90-kDa murine heat shock protein to the untransformed and transformed states of the L cell glucocorticoid receptor. *J. Biol. Chem.* 262, 6986–6991.

Scaltriti, M., Rojo, F., Ocaña, A., Anido, J., Guzman, M., Cortes, J., Di Cosimo, S., Matias-Guiu, X., Ramon y Cajal, S., Arribas, J., et al. (2007). Expression of p95HER2, a truncated form of the HER2 receptor, and response to anti-HER2 therapies in breast cancer. *J. Natl. Cancer Inst.* 99, 628–638.

Schaeffer, H.J., and Weber, M.J. (1999). Mitogen-activated protein kinases: specific messages from ubiquitous messengers. *Mol. Cell. Biol.* 19, 2435–2444.

Sen, A., De Castro, I., Defranco, D.B., Deng, F.-M., Melamed, J., Kapur, P., Raj, G. V., Rossi, R., and Hammes, S.R. (2012). Paxillin mediates extranuclear and intranuclear signaling in prostate cancer proliferation. *J. Clin. Invest.* *122*, 2469–2481.

Sentis, S., Le Romancer, M., Bianchin, C., Rostan, M.-C., and Corbo, L. (2005). Sumoylation of the estrogen receptor alpha hinge region regulates its transcriptional activity. *Mol. Endocrinol.* *19*, 2671–2684.

Shang, Y., Hu, X., DiRenzo, J., Lazar, M.A., and Brown, M. (2000). Cofactor dynamics and sufficiency in estrogen receptor-regulated transcription. *Cell* *103*, 843–852.

Sheeler, C.Q., Singleton, D.W., and Khan, S.A. (2003). Mutation of serines 104, 106, and 118 inhibits dimerization of the human estrogen receptor in yeast. *Endocr. Res.* *29*, 237–255.

Shi, L., Dong, B., Li, Z., Lu, Y., Ouyang, T., Li, J., Wang, T., Fan, Z., Fan, T., Lin, B., et al. (2009). Expression of ER- α 36, a novel variant of estrogen receptor α , and resistance to tamoxifen treatment in breast cancer. *J. Clin. Oncol.* *27*, 3423–3429.

Shi, Y.E., Chen, Y., Dackour, R., Potters, L., Wang, S., Ding, Q., Wang, Z., and Liu, Y.E. (2010). Synuclein gamma stimulates membrane-initiated estrogen signaling by chaperoning estrogen receptor (ER)- α 36, a variant of ER- α . *Am. J. Pathol.* *177*, 964–973.

Shin, S., Dimitri, C.A., Yoon, S.-O., Dowdle, W., and Blenis, J. (2010). ERK2 but not ERK1 induces epithelial-to-mesenchymal transformation via DEF motif-dependent signaling events. *Mol. Cell* *38*, 114–127.

Shou, J., Massarweh, S., Osborne, C.K., Wakeling, A.E., Ali, S., Weiss, H., and Schiff, R. (2004). Mechanisms of tamoxifen resistance: increased estrogen receptor-HER2/neu cross-talk in ER/HER2-positive breast cancer. *J. Natl. Cancer Inst.* *96*, 926–935.

Simoncini, T., Hafezi-Moghadam, A., Brazil, D.P., Ley, K., Chin, W.W., and Liao, J.K. (2000). Interaction of oestrogen receptor with the regulatory subunit of phosphatidylinositol-3-OH kinase. *Nature* *407*, 538–541.

Simpson, E.R., and Dowsett, M. (2002). Aromatase and its inhibitors: significance for breast cancer therapy. *Recent Prog. Horm. Res.* *57*, 317–338.

Skiris, G.P., Leygue, E., Curtis-Snell, L., Watson, P.H., and Murphy, L.C. (2006). Expression of oestrogen receptor-beta in oestrogen receptor-alpha negative human breast tumours. *Br. J. Cancer* *95*, 616–626.

Sondermann, H., Soisson, S.M., Boykevich, S., Yang, S.-S., Bar-Sagi, D., and Kuriyan, J. (2004). Structural analysis of autoinhibition in the Ras activator Son of sevenless. *Cell* 119, 393–405.

Song, R.X., Barnes, C.J., Zhang, Z., Bao, Y., Kumar, R., and Santen, R.J. (2004). The role of Shc and insulin-like growth factor 1 receptor in mediating the translocation of estrogen receptor alpha to the plasma membrane. *Proc. Natl. Acad. Sci. U. S. A.* 101, 2076–2081.

Sørli, T., Perou, C.M., Tibshirani, R., Aas, T., Geisler, S., Johnsen, H., Hastie, T., Eisen, M.B., van de Rijn, M., Jeffrey, S.S., et al. (2001). Gene expression patterns of breast carcinomas distinguish tumor subclasses with clinical implications. *Proc. Natl. Acad. Sci. U. S. A.* 98, 10869–10874.

Speirs, V., Malone, C., Walton, D.S., Kerin, M.J., and Atkin, S.L. (1999). Increased expression of estrogen receptor beta mRNA in tamoxifen-resistant breast cancer patients. *Cancer Res.* 59, 5421–5424.

Spyridopoulos, I., Sullivan, A.B., Kearney, M., Isner, J.M., and Losordo, D.W. (1997). Estrogen-receptor-mediated inhibition of human endothelial cell apoptosis. Estradiol as a survival factor. *Circulation* 95, 1505–1514.

Stockmans, G., Deraedt, K., Wildiers, H., Moerman, P., and Paridaens, R. (2008). Triple-negative breast cancer. *Curr. Opin. Oncol.* 20, 614–620.

Su, X., Xu, X., Li, G., Lin, B., Cao, J., and Teng, L. (2014). ER- α 36: a novel biomarker and potential therapeutic target in breast cancer. *Onco. Targets. Ther.* 7, 1525–1533.

Subramanian, K., Jia, D., Kapoor-Vazirani, P., Powell, D.R., Collins, R.E., Sharma, D., Peng, J., Cheng, X., and Vertino, P.M. (2008). Regulation of estrogen receptor alpha by the SET7 lysine methyltransferase. *Mol. Cell* 30, 336–347.

Teschendorff, A.E., Miremadi, A., Pinder, S.E., Ellis, I.O., and Caldas, C. (2007). An immune response gene expression module identifies a good prognosis subtype in estrogen receptor negative breast cancer. *Genome Biol.* 8, R157.

Theodosiou, A., and Ashworth, A. (2002). MAP kinase phosphatases. *Genome Biol.* 3, REVIEWS3009.

Toft, D., and Gorski, J. (1966). A receptor molecule for estrogens: isolation from the rat uterus and preliminary characterization. *Proc. Natl. Acad. Sci. U. S. A.* 55, 1574–1581.

Tong, J.-S., Zhang, Q.-H., Wang, Z.-B., Li, S., Yang, C.-R., Fu, X.-Q., Hou, Y., Wang, Z.-Y., Sheng, J., and Sun, Q.-Y. (2010). ER- α 36, a novel variant of ER- α , mediates estrogen-stimulated proliferation of endometrial carcinoma cells via the PKC δ /ERK pathway. *PLoS One* 5, e15408.

Varricchio, L., Migliaccio, A., Castoria, G., Yamaguchi, H., de Falco, A., Di Domenico, M., Giovannelli, P., Farrar, W., Appella, E., and Auricchio, F. (2007). Inhibition of estradiol receptor/Src association and cell growth by an estradiol receptor alpha tyrosine-phosphorylated peptide. *Mol. Cancer Res.* 5, 1213–1221.

Vilquin, P., Villedieu, M., Grisard, E., Ben Larbi, S., Ghayad, S.E., Heudel, P.-E., Bachelot, T., Corbo, L., Treilleux, I., Vendrell, J.A., et al. (2013). Molecular characterization of anastrozole resistance in breast cancer: pivotal role of the Akt/mTOR pathway in the emergence of de novo or acquired resistance and importance of combining the allosteric Akt inhibitor MK-2206 with an aromatase inhibitor. *Int. J. Cancer* 133, 1589–1602.

Vranic, S., Gatalica, Z., Deng, H., Frkovic-Grazio, S., Lee, L.M.J., Gurjeva, O., and Wang, Z.-Y. (2011). ER- α 36, a novel isoform of ER- α 66, is commonly over-expressed in apocrine and adenoid cystic carcinomas of the breast. *J. Clin. Pathol.* 64, 54–57.

Wahli, W., and Martinez, E. (1991). Superfamily of steroid nuclear receptors: positive and negative regulators of gene expression. *FASEB J.* 5, 2243–2249.

Wakeling, A.E. (1991). Regulatory mechanisms in breast cancer. Steroidal pure antiestrogens. *Cancer Treat. Res.* 53, 239–257.

Wakeling, A.E., Dukes, M., and Bowler, J. (1991). A potent specific pure antiestrogen with clinical potential. *Cancer Res.* 51, 3867–3873.

Walker, P., Germond, J.E., Brown-Luedi, M., Givel, F., and Wahli, W. (1984). Sequence homologies in the region preceding the transcription initiation site of the liver estrogen-responsive vitellogenin and apo-VLDLII genes. *Nucleic Acids Res.* 12, 8611–8626.

Wang, Z.-Y., and Yin, L. (2015). Estrogen receptor alpha-36 (ER- α 36): A new player in human breast cancer. *Mol. Cell. Endocrinol.* 418 Pt 3, 193–206.

Wang, D., Huang, P., Zhu, B., Sun, L., Huang, Q., and Wang, J. (2012a). Induction of estrogen receptor α -36 expression by bone morphogenetic protein 2 in breast cancer cell lines. *Mol. Med. Rep.* 6, 591–596.

Wang, J., Li, J., Fang, R., Xie, S., Wang, L., and Xu, C. (2012b). Expression of ER α 36 in gastric cancer samples and their matched normal tissues. *Oncol. Lett.* 3, 172–175.

Wang, Q., Zhang, W., Yang, J., Liu, Y.-L., Yan, Z.-X., Guo, Z.-J., Li, Y.-J., and Bian, X.-W. (2015). High ER α 36 Expression Level and Membrane Location Predict Poor Prognosis in Renal Cell Carcinoma. *Medicine (Baltimore)*. 94, e1048.

Wang, X., Deng, H., Zou, F., Fu, Z., Chen, Y., Wang, Z., and Liu, L. (2013). ER- α 36-mediated gastric cancer cell proliferation via the c-Src pathway. *Oncol. Lett.* 6, 329–335.

Wang, X., Huang, X., Fu, Z., Zou, F., Li, Y., Wang, Z., and Liu, L. (2014). Biphasic ER- α 36-mediated estrogen signaling regulates growth of gastric cancer cells. *Int. J. Oncol.* *45*, 2325–2330.

Wang, Z., Zhang, X., Shen, P., Loggie, B.W., Chang, Y., and Deuel, T.F. (2005). Identification, cloning, and expression of human estrogen receptor-alpha36, a novel variant of human estrogen receptor-alpha66. *Biochem. Biophys. Res. Commun.* *336*, 1023–1027.

Wang, Z., Zhang, X., Shen, P., Loggie, B.W., Chang, Y., and Deuel, T.F. (2006). A variant of estrogen receptor- α , hER- α 36: transduction of estrogen- and antiestrogen-dependent membrane-initiated mitogenic signaling. *Proc. Natl. Acad. Sci. U. S. A.* *103*, 9063–9068.

Webb, P., Nguyen, P., Valentine, C., Lopez, G.N., Kwok, G.R., McInerney, E., Katzenellenbogen, B.S., Enmark, E., Gustafsson, J.A., Nilsson, S., et al. (1999). The estrogen receptor enhances AP-1 activity by two distinct mechanisms with different requirements for receptor transactivation functions. *Mol. Endocrinol.* *13*, 1672–1685.

Weidle, U.H., Maisel, D., Klostermann, S., Schiller, C., and Weiss, E.H. Intracellular proteins displayed on the surface of tumor cells as targets for therapeutic intervention with antibody-related agents. *Cancer Genomics Proteomics* *8*, 49–63.

Weigelt, B., Peterse, J.L., and van 't Veer, L.J. (2005). Breast cancer metastasis: markers and models. *Nat. Rev. Cancer* *5*, 591–602.

Weis, K. (2003). Regulating access to the genome: nucleocytoplasmic transport throughout the cell cycle. *Cell* *112*, 441–451.

Wellbrock, C., Karasarides, M., and Marais, R. (2004). The RAF proteins take centre stage. *Nat. Rev. Mol. Cell Biol.* *5*, 875–885.

Wennerberg, K., and Der, C.J. (2004). Rho-family GTPases: it's not only Rac and Rho (and I like it). *J. Cell Sci.* *117*, 1301–1312.

Wennerberg, K., Rossman, K.L., and Der, C.J. (2005). The Ras superfamily at a glance. *J. Cell Sci.* *118*, 843–846.

Wolpert, N., Warner, E., Seminsky, M.F., Futreal, A., and Narod, S.A. (2000). Prevalence of BRCA1 and BRCA2 mutations in male breast cancer patients in Canada. *Clin. Breast Cancer* *1*, 57–63; discussion 64–65.

Woolley, C.S., Weiland, N.G., McEwen, B.S., and Schwartzkroin, P.A. (1997). Estradiol increases the sensitivity of hippocampal CA1 pyramidal cells to NMDA receptor-mediated synaptic input: correlation with dendritic spine density. *J. Neurosci.* *17*, 1848–1859.

- Xu, B.-Z., Lin, S.-L., Li, M., Zhu, J.-Q., Li, S., Ouyang, Y.-C., Chen, D.-Y., and Sun, Q.-Y. (2009). Changes in estrogen receptor-alpha variant (ER-alpha36) expression during mouse ovary development and oocyte meiotic maturation. *Histochem. Cell Biol.* *131*, 347–354.
- Yin, L., Zhang, X.-T., Bian, X.-W., Guo, Y.-M., and Wang, Z.-Y. (2014). Disruption of the ER- α 36-EGFR/HER2 positive regulatory loops restores tamoxifen sensitivity in tamoxifen resistance breast cancer cells. *PLoS One* *9*, e107369.
- Yoon, S., and Seger, R. (2006). The extracellular signal-regulated kinase: multiple substrates regulate diverse cellular functions. *Growth Factors* *24*, 21–44.
- Yu, H., Shu, X.-O., Li, B.D.L., Dai, Q., Gao, Y.-T., Jin, F., and Zheng, W. (2003). Joint effect of insulin-like growth factors and sex steroids on breast cancer risk. *Cancer Epidemiol. Biomarkers Prev.* *12*, 1067–1073.
- Zassadowski, F., Rochette-Egly, C., Chomienne, C., and Cassinat, B. (2012). Regulation of the transcriptional activity of nuclear receptors by the MEK/ERK1/2 pathway. *Cell. Signal.* *24*, 2369–2377.
- Zerial, M., and McBride, H. (2001). Rab proteins as membrane organizers. *Nat. Rev. Mol. Cell Biol.* *2*, 107–117.
- Zhang, J., Li, G., Li, Z., Yu, X., Zheng, Y., Jin, K., Wang, H., Gong, Y., Sun, X., Teng, X., et al. (2012a). Estrogen-independent effects of ER- α 36 in ER-negative breast cancer. *Steroids* *77*, 666–673.
- Zhang, S., Qiu, C., Wang, L., Liu, Q., and Du, J. (2014). The elevated level of ER α 36 is correlated with nodal metastasis and poor prognosis in lung adenocarcinoma. *Steroids* *87*, 39–45.
- Zhang, X., Ding, L., Kang, L., and Wang, Z.-Y. (2012b). Estrogen receptor-alpha 36 mediates mitogenic antiestrogen signaling in ER-negative breast cancer cells. *PLoS One* *7*, e30174.
- Zhang, X.-T., Ding, L., Kang, L.-G., and Wang, Z.-Y. (2012c). Involvement of ER- α 36, Src, EGFR and STAT5 in the biphasic estrogen signaling of ER-negative breast cancer cells. *Oncol. Rep.* *27*, 2057–2065.
- Zhang, X.T., Kang, L.G., Ding, L., Vranic, S., Gatalica, Z., and Wang, Z.-Y. (2011a). A positive feedback loop of ER- α 36/EGFR promotes malignant growth of ER-negative breast cancer cells. *Oncogene* *30*, 770–780.
- Zhang, Y., Moerkens, M., Ramaiahgari, S., de Bont, H., Price, L., Meerman, J., and van de Water, B. (2011b). Elevated insulin-like growth factor 1 receptor signaling induces antiestrogen resistance through the MAPK/ERK and PI3K/Akt signaling routes. *Breast Cancer Res.* *13*, R52.

Zheng, C.F., and Guan, K.L. (1994). Cytoplasmic localization of the mitogen-activated protein kinase activator MEK. *J. Biol. Chem.* *269*, 19947–19952.

Zheng, Y., Zhang, J., Xu, Z., Sheng, J., Zhang, X., Wang, H., Teng, X., Liu, X., Cao, J., and Teng, L. (2010). Quantitative profiles of the mRNAs of ER-alpha and its novel variant ER-alpha36 in breast cancers and matched normal tissues. *J. Zhejiang Univ. Sci. B* *11*, 144–150.

Zoncu, R., Efeyan, A., and Sabatini, D.M. (2011). mTOR: from growth signal integration to cancer, diabetes and ageing. *Nat. Rev. Mol. Cell Biol.* *12*, 21–35.

Zou, W., Fang, C., Ji, X., Liang, X., Liu, Y., Han, C., Huang, L., Zhang, Q., Li, H., Zhang, Y., et al. (2015). Estrogen Receptor (ER)- α 36 Is Involved in Estrogen- and Tamoxifen-Induced Neuroprotective Effects in Ischemic Stroke Models. *PLoS One* *10*, e0140660.

Zwart, W., Griekspoor, A., Berno, V., Lakeman, K., Jalink, K., Mancini, M., Neefjes, J., and Michalides, R. (2007). PKA-induced resistance to tamoxifen is associated with an altered orientation of ERalpha towards co-activator SRC-1. *EMBO J.* *26*, 3534–3544.