



HAL
open science

Desalination of saline waste water containing organic solute by electro dialysis

Le Han

► **To cite this version:**

Le Han. Desalination of saline waste water containing organic solute by electro dialysis. Environmental Engineering. Université Paul Sabatier - Toulouse III, 2015. English. NNT : 2015TOU30245 . tel-01391437

HAL Id: tel-01391437

<https://theses.hal.science/tel-01391437>

Submitted on 3 Nov 2016

HAL is a multi-disciplinary open access archive for the deposit and dissemination of scientific research documents, whether they are published or not. The documents may come from teaching and research institutions in France or abroad, or from public or private research centers.

L'archive ouverte pluridisciplinaire **HAL**, est destinée au dépôt et à la diffusion de documents scientifiques de niveau recherche, publiés ou non, émanant des établissements d'enseignement et de recherche français ou étrangers, des laboratoires publics ou privés.



THÈSE

En vue de l'obtention du

DOCTORAT DE L'UNIVERSITÉ DE TOULOUSE

Délivré par :

Université Toulouse 3 Paul Sabatier (UT3 Paul Sabatier)

Présentée et soutenue par :

Le HAN

le lundi 14 décembre 2015

Titre :

Desalination of saline waste water containing organic solute by electro dialysis

École doctorale et discipline ou spécialité :

ED MEGEP : Génie des procédés et de l'Environnement

Unité de recherche :

Laboratoire de Génie Chimique UMR 5503, CNRS, Université de Toulouse

Directeur/trice(s) de Thèse :

Hélène ROUX-de BALMANN, Directrice de Recherches, LGC, CNRS, Toulouse
Sylvain GALIER, Maître de Conférences, LGC, Université de Toulouse, Toulouse

Jury :

Stéphan BROSILLON, Professeur, Université de Montpellier 2, France (Rapporteur)
Bart VAN DER BRUGGEN, Professeur, Katholietke Universiteit Leuven, Belgique (Rapporteur)
Matthieu JACOB, Ingénieur Recherche Total, France (Examineur)
Natalia PISMENSKAYA, Professeur, Kuban State University, Russia (Examineur)
Tongwen XU, Professeur, University of Science and Technology of China, China
(Examineur)

Remerciements

Cette thèse s'est déroulée au Laboratoire de Génie Chimique de Toulouse, au sein du département Génie des Interfaces et des Milieux Divisés. Je remercie donc tout d'abord les deux équipes de direction successives pour m'y avoir accueilli.

Ce travail a été encadré par Hélène ROUX-de BALMANN et Sylvain GALIER au sein de l'équipe Procédés Electromembranaires et Nanofiltration. Je tiens à les remercier, tous deux, car l'aboutissement de ce travail n'aurait pas été possible sans l'investissement dont ils ont fait preuve tout au long de cette thèse. Leur disponibilité, leur énergie et leur soutien m'ont permis de surmonter les obstacles. Tout ce qu'ils m'ont apporté tant sur le point professionnel que personnel est mémorable dans ma vie.

Que Stephan BROSILLON et Bart VAN DER BRUGGEN soient remerciés pour avoir accepté de rapporter mon travail, et particulièrement Stephan qui en a aussi accepté la présidence. Je remercie également Matthieu JACOB, Natalia PISMENSKAYA et Tongwen XU pour avoir siégé au jury de soutenance.

J'adresse un grand merci à mes co-bureaux, Ioannis GERGIANAKIS, Lucia BENAVENTE et Johanne TEYCHENE pour les moments que nous avons passé ensemble avec le même but, partageant les joies et les difficultés d'une thèse. Merci également à Arthur (tous les deux), Zena, Izabella, Yandi, Emelyne, Alessio, Joseph avec qui j'ai passé ces trois années dans ce labo international avec plaisir ! Une pensée particulière à mes amis chinois: Dancheng CHEN, Yingying GU, Xinqiang YOU, Jin WANG, Ran ZHAO, Yang LIU, Tian ZHAO, Tiantian XIONG, Gang WANG, Guanghua JIN, Jin HUANG, Xue LIU... pour les joies pendant nos vies et études en France.

Enfin, je voudrais remercier toute ma famille, spécialement mes parents et ma sœur. Plus particulièrement, un grand merci à ma copine Mei et courage à elle pour sa thèse !

Table of content

Chapter I	7
Introduction	7
I.1 Reverse Osmosis Concentrate	10
I.1.1 Reverse Osmosis Concentrate characteristics.....	10
I.1.2 Reverse Osmosis Concentrate treatment	14
I.2 Electrodialysis for Saline Water Desalination	16
I.2.1 Principle and applications of electrodialysis.....	16
I.2.2 Bottleneck of electrodialysis as ROC treatment	17
I.3 Aim and outline of thesis	20
Chapter II	25
Materials and Methods	25
II.1 Experimental materials and procedures.....	27
II.1.1 Chemicals	27
II.1.2 Membrane and Electrodialysis set-up.....	30
II.1.3 Experimental procedures	33
II.1.4 Analytical methods	35
II.2 Mass transfer mechanisms.....	38
II.2.1 Salt transfer.....	38
II.2.2 Water transfer	39
II.2.3 Organic solute transfer.....	40
Chapter III	43
Salt and water transfer through ion-exchange membranes: electro-osmosis and ion hydration number	43
III.1 Theory	45
III.1.1 Salt and water mass transfer.....	45
III.1.2 Hydration number calculation.....	46

III.2 Salt and ion hydrations	49
III.2.1 Hydration number of salts	49
III.2.2 Hydration number of ions	53
III.3 Discussion	58
III.4 Conclusions	61
Chapter IV	63
Transfer mechanism of organic solute through ion-exchange membranes: influence of salt composition	63
IV.1 Saline water containing neutral organic solute	65
IV.1.1 Salt and water transfer	65
IV.1.2 Neutral organic solute transfer	71
IV.2 Saline water containing charged organic solute	98
IV.2.1 Inorganic salt and water transfer	98
IV.2.2 Charged organic solute transfer	103
IV.3 Conclusions	113
Chapter V	117
Desalination performance of electrodialysis for saline water treatment.....	117
V.1 Desalination of synthetic saline water containing organic solute	119
V.1.1 Desalination performance of synthetic saline water containing single organic solute	119
V.1.2 Desalination performance of synthetic saline water containing mixed organic solutes	129
V.2 Desalination of oil process water	133
V.3 Conclusions	141
Conclusions and perspectives	143
References	151
Nomenclature.....	163

Chapter I

Introduction

One pressing challenge today to human being development is the water availability, due to simultaneous increases in water use and reduction in remaining fresh water resources by pollution and over exploitation. Recovery of clean water from saline water, i.e. seawater, and the treatment or recycle of any available water are worldwide issues. The available water resource may concern not only seawater that is by far the most abundant water resource (97% of total water resource), but also the newly produced saline water during human activity.

On one hand, seawater desalination by Reverse Osmosis (RO) membrane technology has been widely used for production of portable water in Arabian Gulf, Mediterranean Sea and the Red Sea or the coast waters of California, China and Australia [1]. As the market share of RO in worldwide desalination field is rapidly increasing [2-3], the reverse osmosis concentrate (ROC), a kind of RO by-product discharge also named retentate or brine with elevated salinity, is thus more and more produced, endangering the environment.

On the other hand, many other industries are generating large quantities of saline or hyper saline effluent. In food-processing industry, brine solution or dry salt is necessary for nutrition and for food conservation, for meat canning, pickled vegetables, dairy productions and fish processing. In leather industry, the tanning process has many steps requiring salt addition. In the petroleum industry the refine process effluents contain a broad range of salinity, up to three times the salinity of seawater or beyond, resulting from the decantation used for the separation of the oil-water emulsion [4].

Moreover, it is important to note that many saline waters contain organic matter (OM), such as natural organic matter contained in sea water, nutrition materials in food-processing, various hydrocarbons in petroleum fields [4]. This OM content can be either a hazardous pollutant to treat (e.g. pharmaceutically active compounds, hormones, pesticides etc.) or a valuable resource to recycle (e.g. organic acids, sugar, protein etc.). Thus, compositions of the saline water might be diverse and complex, with inorganic salts and/or organic matter in different quantity, making it difficult to standardize such water from case to case.

Considering the tightening regulations and further economic value, such saline waters treatment has to be improved. However, disposal like deep injection to the underground or direct discharge is used, endangering the water environment [5], and attention is not enough paid to the valorization of either salt or OM content yet [6]. Regarding this issue, the following section will focus on one selected type of saline water to discuss.

I.1 Reverse Osmosis Concentrate

Because RO is more and more used in many fields, ROC will be chosen in this thesis as an example to illustrate the current issue of saline water. First, water characteristics are summarized; then treatments regarding such water are briefly reviewed.

I.1.1 Reverse Osmosis Concentrate characteristics

Usually, water recovery in RO may vary from 35 % to 85% in the three categories of its application: seawater / inland water desalination for the production of potable water, municipal waste water treatment as tertiary process [6]. In all cases, the ROC is supposed to contain elevated salinity and organic matter, with quality subject to many parameters like feed characteristics, water recovery degree, but also influenced by the pretreatment and cleaning procedures.

Concerning the concentration and volume of the saline water, values can be very high especially in case of seawater desalination. The high salinity of the feed seawater reduces water recovery i.e. below 60% for various seawater RO (SWRO) systems, which is very low compared to those in case of brackish or wastewater treatments (75-90%). Indeed, the volume of seawater reverse osmosis concentrate (SWROC) is about half of the feed water, while the Total Dissolved Salinity (TDS) in SWROC is approximately doubled, i.e. 50000-80000 mg.L⁻¹.

Then, the composition of ROC varies from case to case. Concerning the salt and OM contents, brine characteristics are described in Table I-1. It reports the ROC from seawater (a) and inland water desalination (b), as well as from municipal wastewater treatment plants (c).

(a) Sea water desalination								
Ref Streams	[7]		[8]		[9]		[10]	[11]
	Feed	ROC	Feed	ROC	Feed	ROC	ROC	ROC
TDS (mg.L ⁻¹)	35300	70460	38000	50200	38951	63840	49241	47500
Conductivity (μ S.cm ⁻¹)	-	-	-	-	46200	75300	-	70700
Na ⁺ (mg.L ⁻¹)	10900	21921	11600	15500	11781	19346	16571	-
Mg ²⁺ (mg.L ⁻¹)	1420	2479	1427	2020	1021	1909	2039	-
Ca ²⁺ (mg.L ⁻¹)	440	790	455	625	962	1583	650	-
Cl ⁻ (mg.L ⁻¹)	20250	38886	20987	28800	21312	43362	29981	-
SO ₄ ²⁻ (mg.L ⁻¹)	2150	5315	2915	3060	3162	5548	-	-
TOC (mg.L ⁻¹)	-	-	-	-	-	-	-	3.0
COD (mg.L ⁻¹)	-	-	-	-	-	-	-	-
Concentration factor*	-	2	-	1.3	-	1.6	-	-
pH	-	-	-	-	-	-	-	7.9

(b) Inland water desalination								
Ref Streams	[12]		[13]		[14]		[15]	
	Feed	ROC	Feed	ROC	Feed	ROC	Feed	ROC
TDS (mg.L ⁻¹)	2879	9232	9000	28000	-	-	6883	22942
Conductivity (μ S.cm ⁻¹)	3900	13500	12500	33000	-	-	9990	33300
Na ⁺ (mg.L ⁻¹)	661	2084	1950	5120	991	5130	1616	5387
Mg ²⁺ (mg.L ⁻¹)	96	245	-	770	-	386	243	810
Ca ²⁺ (mg.L ⁻¹)	189	540	720	2080	1032	819	432	1440
Cl ⁻ (mg.L ⁻¹)	1172	4068	3550	14170	2832	8960	2812	9372
SO ₄ ²⁻ (mg.L ⁻¹)	462	2160	2250	5920	1553	1920	1110	3700
TOC (mg.L ⁻¹)	-	-	-	-	-	-	-	-
COD (mg.L ⁻¹)	-	-	-	-	-	-	-	-
Concentration factor*	-	3.2	-	3.1	-	-	-	3.3
pH	8.22	4	7.2	7.2	8	7	6.51	6.3

Ref Streams	(c) Municipal wastewater treatment								
	[16] ROC	[17] ROC	[18] ROC	[19] ROC	[20] ROC	[21] ROC	[22] ROC	[23] ROC	[24] ROC
TDS (mg.L ⁻¹)	1685	1685	-	-	-	1218	1276	5560	2950
Conductivity (μ S.cm ⁻¹)	2820	2820	4110	3250	4450	1972	1990	10000	3600
Na ⁺ (mg.L ⁻¹)	529	529	-	-	435	240.9	226.9	-	580
Mg ²⁺ (mg.L ⁻¹)									
Ca ²⁺ (mg.L ⁻¹)	68	68	-	-	306	110.1	63.8	-	96
Cl ⁻ (mg.L ⁻¹)	780	256	1.4	479	220.1	267.1	333.2	-	684
SO ₄ ²⁻ (mg.L ⁻¹)	233	217	240	443	1584	218.4	159.1	-	468
TOC (mg.L ⁻¹)	>21	18	>57.2	-	>19.2	18.4	24.5	-	25
COD (mg.L ⁻¹)	65	60		-	-	64.6	-	138	-
Concentration factor*	-	-	-	-	-	-	-	-	-
pH	-	-	-	-	-	-	-	-	-

Table I-1 Characteristics of the ROC from seawater (a), inland water desalination (b) and municipal wastewater treatment plant (c)

Concentration factor*: calculated as ratio of TDS in ROC over that in Feed

Table I-1 reports varying characteristics of the ROC from different resources. Concerning the salinity, it is highest for ROC from seawater, followed by that of inland water, and finally that of municipal wastewater. Then, RO concentration factors in seawater and inland water desalination are similar, i.e. 2-3. One can say the difference on the salinity is mainly due to that of the feed water (ca. 35000 mg.L⁻¹ for seawater and ca. 10000 mg.L⁻¹ for inland water). Then, much lower salinity of municipal wastewater ROC is expected, considering much less salt in the feed water.

Besides, concerning the main salt compositions, Table I-1 shows the main five ions contained in ROC (same as in feed water) as Na⁺, Mg²⁺, Ca²⁺, Cl⁻, SO₄²⁻. The main ions in the case of seawater are Na⁺, Mg²⁺, Cl⁻, SO₄²⁻, while the Mg²⁺ is replaced by the Ca²⁺ in the two other cases. ROC has similar ionic composition ratio with that in feed water, in agreement with the concentration factor, indicating RO plays mainly a concentration role, i.e. total salt removal from feed water.

Concerning the organic matter, Table I-1 shows that very few data are available for the seawater or inland water desalination plants, while for ROC from municipal wastewater treatment plant, the TOC can be ca. 20 mg.L⁻¹.

The isolation and characterization of dissolved organic matter (DOM) are still representing a real challenge today, especially in marine waters. The advanced analytical techniques can hardly be used to characterize marine DOM because of the difficulty in collecting significant amounts (ca. 20-100 mg [25]) of this highly dilute material and because DOM is usually in high saline solution [26]. It is reported that the mass ratio of salt to organic content in seawater is as high as 16000:1 [11]. Therefore, for analysis of marine organic matter, a desalting step of seawater by electrodialysis before the concentration step by RO was proposed [26], and the OM was further characterized by 3D fluorescence spectroscopy.

Table I-2 reports some information concerning the characterized OM present in seawater.

OM characterized	% of total Dissolved Organic Carbon (DOC)	Ref
Amino acid	12	[27]
Carbohydrates (as saccharide)		[28]
Carbohydrates+amino acids	24 (12+12)	[29]

Table I-2 Characteristics of the characterized OM in seawater

It shows that only a small fraction of the total organic content is identified. Carbohydrates account for the largest identified fraction of DOC in the ocean, ranging from 3%-30% of the total. Others characterized organic constituents such as amino acids, uranic acids, aldehydes and ketones together can make up ca. 12% of DOC. Then, carbohydrate is reported to be mainly saccharide throughout the ocean, regardless of location and depth. And the saccharide shows aldose distribution rich in galactose and deoxy sugar. Recently, it was found that total dissolved carbohydrates and total hydrolysable amino acids comprised 24% of the bulk DOC in seawater. To be specific, dissolved combined amino acids (10.4%) and monosaccharides (7.2%) were major fractions of DOC, followed by polysaccharides (4.7%) and dissolved free amino acids (1.6%).

Then, one can briefly conclude that only a part of the organics (ca. 1/5) in seawater has been characterized, which consists of carbohydrates (in form of saccharide) and amino acids.

I.1.2 Reverse Osmosis Concentrate treatment

The different technologies available for the treatment of ROC have been well summarized [4,30]. Evaluations of these technologies are reported in Table I-3.

These technologies can be classified within two categories, physico-chemical ones, and biological ones. Regarding the solution composition, biological and advanced oxidation actually targets the OM, and other processes are for salt removal, where membrane technology is considered to be the most promising one, shown in Table I-3.

Concerning OM disposal, it is reported that the presence of large amount of salt makes it very difficult and even impossible [4]. Specifically, salt may inhibit biomass activity in biological oxidation processes [31], decrease the reaction efficiency of advanced oxidation processes [32], or even produce new toxic compounds [33].

The separation of salt and organic matter in brine is thus proposed, since the separated OM can be more easily treated, recycled or even fractionated as well as the salts depending on the brine composition.

Concerning the following integrated process, the separation of salt and organic solutes helps to reduce many adverse effects like scaling and / or fouling on membrane based processes, which gives new options of membrane integration in versatile emerging processes. For instance, saline solution with less or without OM can be exploited for the production of energy by Pressure Retarded Osmosis (PRO) or Reverse Electrodialysis (RED) [34] [35], or to produce crystal salt like NaCl by membrane distillation-crystallization [8] or to produce base (e.g. NaOH) or acid (e.g. HCl) in case of NaCl brine by Bipolar Membrane Electrodialysis (EDBM) [36]. Potential use of OM with few salt is also possible as feed for bacterial in Microbial Electrolysis Cells (MEC) [37] and Microbial Fuel Cells (MFC) for energy production [6].

Current treatments applied to ROC		Pros	Cons	
Physico-chemical	Thermal techniques	Natural evaporation (solar)	Low cost	High land requirement, low productivity, geography limitation
		Wind aided intensified evaporation	Alternative energy	Geography limitation
		Multi-stage flash	Industrial feasibility	Energy cost
	Membrane techniques	Membrane distillation	Low temperature and pressure	Low flux, not commercially available
		RO, NF	High efficiency, economical	Pumping energy, fouling
		ED	Industrial feasibility	Electrical energy
		Forward osmosis	No hydraulic pressure, high rejection, low fouling	Scale-up feasibility to be proved
	Others	Advanced oxidation	Organic matter removal (especially refractory)	Chemical dosage, low efficiency
		Ion-exchange resin	Inorganics removal, regenerable	Fouling, costly regenerant
		Coagulation-flocculation	Colloidal removal	Poor efficiency for salt
Biological	Activated sludge based technologies	Biomass oxidation	Economical, biodegradable organic matter removal	Efficiency inhibited by salt

Table I-3 Evaluations of pros-cons of treatment technologies applied to ROC

Therefore, the treatment policy is to first separate OM and salt, then to apply further technologies to remove or recover the contents. As the integrated processes offer flexibility

and efficiency to brine disposal, separation/desalination as first step would be significant for following integration.

I.2 Electrodialysis for Saline Water Desalination

In this part, electrodialysis is first briefly introduced, and then some key factors concerning desalination performance are discussed.

I.2.1 Principle and applications of electrodialysis

As above mentioned, membrane based separation technology can play a primary role in desalination. There are many successful applications addressing the desalination issue by reverse osmosis and electrodialysis [38]. But once OM / salt separation or further purification is concerned, membrane processes with selectivity like electrodialysis and / or nanofiltration (NF) are required. ED is reported to be less prone to fouling [39]. Moreover, unlike NF, where the high osmotic pressure from solution of high salinity, e.g. ROC can limit the application of the pressure driven process, ED is not susceptible because it is electrical driven. Thus, ED can be a better choice for desalination of ROC.

Electrodialysis has been utilized for over 50 years for desalination, production of high quality industrial process water or the treatment of certain industrial effluents. Even though other ion-exchange membrane based processes like bipolar electrodialysis, capacitive deionization and reverse electrodialysis have recently gained interest, the conventional electrodialysis is still dominant [40]. Many new applications like treatment of the saline solution containing sugar, protein, chemical acid and different kinds of hazardous matter were promising in food, beverage, drug and chemical process industries as well as in biotechnology and wastewater treatment [41-44].

Indeed, on the contrary to RO, ED is a selective process that makes it an efficient option to deal with complex fluids containing salt and organic solutes. It is reported that ED removed a high percentage of salt (more than 70%) from a solution of aromatic amino acid with a loss below 15% [45]. For treatment of ROC from WWTP (Waste Water Treatment Plant), ED removes the salt and facilitates the following oxidation process [44]. ED successfully reduced the salt concentration below to micro-organism growth limit and enabled the following upstream biological process for the improvement of the salted liquid waste

treatment [46]. The fractionation of salts and organic solutes (e.g. Acetate, Aspartate, Glycine, Methylammonium ion) was found to be feasible. There is a study showing that the TOC loss is about 15% when the demineralization rate reached ca. 90% [47].

I.2.2 Bottleneck of electrodialysis as ROC treatment

Although ED is a mature process for many applications, several fundamental questions concerning the transfer of solutes through IEM still remain as bottleneck, limiting its further applications where even higher selectivity is required. It occurs not only in normal desalination referred as separation of salt/water, but also in extended desalination of saline water containing OM referred as separation of OM/salt, as well as additional selectivity.

Firstly, salt-water transfer is widely reported. In ED, the salt/ion migration under current is always associated with a transfer of water, referred as electro-osmosis, resulting from the shell of water carried by the transferring ions [39]. This electro-osmotic flux can restrict the process performances and it must be taken into account [48-51]. Indeed, this water transfer limits the brine concentration that can be reached in the concentrate compartment, which is unfavorable in case of coarse salt production from the final brine [52]. Likewise, in the production of organic acid from fermentation, it was reported that the maximum achievable concentration of organic acids is directly limited by such electro-osmotic flux [53].

Since the electro-osmosis is due to transfer of an amount of water molecules accompanying the ions migration, it is linked to the hydration of the ions transferring through the membranes during the ED process [48,53-54]. Moreover, it can also be insightful for future membrane materials fabrication, regarding structure/property relations in polymers related to water and salt transport properties [55-56]. As a result, the fundamental study of salt-water transfer deserves further investigation.

Secondly, regarding desalination of a saline water containing OM, the objective is to remove salt as much as possible, and to minimize the transfer of OM. In fact, OM transfer is crucial not only in ED process, but also in many versatile applications of IEM such as microbial electrolysis cell and microbial fuel cell, where OM transfer is either unwanted [57] or selective transport of certain organics is desired [58].

Thus, a thorough understanding of transport phenomena of organic solutes through IEM is necessary, and can benefit to a wide variety of applications. However, previous studies mainly focus on OM transfer in case of pressure-driven membrane like NF/RO [59-60]. The

main mechanism of solute rejection is physical sieving, while other such as electrostatic exclusion and hydrophobic-hydrophobic interactions between membrane and solute are also considered important. On the contrary, few works were devoted to the study of the mechanism governing the transfer of organic solutes through IEM [61-64]. Literature on the subject focuses mainly on sorption of organics and/or a limited set of mainly negatively charged organic compounds. Furthermore, few results on membrane performance regarding the organic solute transfer are available [53].

Thirdly, attention should be given to the influence of salt on OM transfer through membrane, especially in the case of brines where the concentration of salt is high. Indeed, it was shown that salt affects the OM transfer. For instance, a higher transfer of acetic acid was reported in presence of Na_2SO_4 compared to that with NaCl [46]. Thus, the process performance can be significantly influenced by the salt composition, (i.e. nature and concentration). Again, most of the results were reported about NF and few in ED in the last 15 years [63-72].

Wang et al. [65] first reported in NF that the transfer of glucose increases with NaCl concentration. Then, Bouchoux et al. [72] reported the influence of the salt nature. More precisely, a relationship between hydration of the ions and glucose transfer was established, i.e. increasingly hydrated ions were found to give increasing glucose transfer. These findings are further confirmed by following studies, showing that in any case, increasing ion concentration and increasing ion hydration lead to a higher solute transfer in NF.

The explanation for the influence of salt has also been developed. It can be summarized as combination of two types of modifications induced by salt. On one hand, it is reported that the membrane structural properties vary according to the counter-ion hydration, which can be considered as a membrane swelling effect [65,66,69]. On the other hand, neutral solute properties are reported to vary, referred as solute dehydration effect, more precisely, a decrease in presence of more hydrated ion [67,70].

Previous work in our group investigated these two contributions on solute transfer, using a specific procedure to distinguish each contribution.

Boy et al. [70] pointed out that the diffusion flux of sugars (xylose, glucose and sucrose) through a NF membrane, in presence of various salts (NaCl , Na_2SO_4 , CaCl_2 , MgCl_2), is mainly fixed according to the modification of the solute properties, more precisely its hydration, the influence of the membrane modification remaining negligible. This study also confirmed that more hydrated salts or higher concentrations induce a higher increase of the

solute transfer (Table I-4).

Salt	$j_s (\times 10^{-7} \text{ mol.m}^{-2}.\text{s}^{-1})$		
	Xylose	Glucose	Sucrose
Na₂SO₄	15.3	12.1	6.3
NaCl	7.5	4.6	0.7
CaCl₂	11.6	12.1	22.8
MgCl₂	13.2	14.4	18.3

Table I-4: Sugar diffusion flux through NF membrane in different organic solute / salt systems

[Sugar] = 1 mol.L⁻¹ and [salt] = 1eq. L⁻¹ (Boy et al. [70])

The specific procedure developed to dissociate the contribution of each phenomenon has been also used by Savignac et al. [63] to investigate the transfer of sugars through ion-exchange membranes. The transfer of various saccharides (xylose, glucose and sucrose) in different salt solutions (NaCl, NH₄Cl, CaCl₂ and MgCl₂) was studied in a diffusion regime.

It was thus demonstrated that the influence of the salt composition on the sugar transfer is mainly due to the following modifications of the membrane properties, which are fixed by the membrane soaking. A quantitative correlation has been established between the solute transfer and the hydration number of the membrane counter-ion. Indeed, the transfer of sugar through an ion-exchange membrane was found to decrease when the membrane is equilibrated with a more hydrated counter-ion, like calcium with respect to sodium in the case of CMX membrane (Table I-5).

Salt	$j_s (\times 10^{-6} \text{ mol.m}^{-2}.\text{s}^{-1})$		
	Xylose	Glucose	Sucrose
NH₄Cl	23.3	16.7	2.6
NaCl	13.3	8.9	1.5
CaCl₂	10.0	6.1	0.9
MgCl₂	6.0	3.9	0.6

Table I-5 Sugar diffusion flux through CMX membrane soaked in different salts in different organic solute / salt systems

[Sugar] = 1 mol.L⁻¹ and [salt] = 1eq.L⁻¹ (Galier et al. [63])

Physical modification of anion/cation exchange membranes induced by the ionic composition of the surrounding solution was already reported in the literature. In fact, this membrane modification arises from a swelling mechanism at a microscopic scale, particularly studied in the case of ion-exchange resins [73-74] and Nafion membrane [75]. Specifically, the swelling of the membrane according to ion hydration can be associated to a modification in its free fraction volume, a property that can be correlated with the membrane performance at a macroscopic scale [63,73-74].

However, the contribution of the free volume to solute transfer is not well demonstrated, and the role of other factors like the solute solubility inside the membrane polymer is unclear. Recently, our group also investigated multiple interactions between the polymer, water and solutes at a molecular scale. A computational investigation using Quantum Mechanics was carried out, using glucose as a model of neutral OM and same type of CMX as used in the present work [76]. The computed OM-polymer fragment interaction, related to the solubility of the glucose inside the membrane, was found to be almost independent from the membrane counter-ion. On the contrary, significant variations of the chain-chain interaction, i.e. the interaction energies per trapped water molecule or hydrogen bonding wire connecting the polymer fragments, were observed according to the counter-ion. The computational result can well correlate the experimental sugar fluxes in different solutions: increasing chain-chain interaction inside the membrane was found to give decreasing sugar flux. Thus, it was concluded that the polymer chain-chain interaction which are very sensitive to the counter-ion, govern the solute transfer.

However, as aforementioned, most studies regarding the influence of salt remains in NF regime, whereas studies relating to ion-exchange membrane are rare. Moreover, since few reports are on the mechanism governing the OM transfer in ED [62], such salt effect on OM transfer is further unclear. Moreover, these studies focus on sugar (e.g. glucose) as model organic solute, while in practice more complex fluids are concerned. Then ED performance regarding the treatment of such solutions needs systematic investigation, knowing the influence of salt on solute transfer and the following process performances [64].

I.3 Aim and outline of thesis

In this context, the objective of the project is to investigate the demineralization of saline water containing organic matter by electrodialysis. Indeed, it was concluded from previous review that ED can be an interesting technology for the desalination of such complex

fluids. Depending on the kind of saline water considered, different options or integration following ED can be possible. But in any case, the objective is to achieve a selective desalination, i.e. the removal of salt (ions) while keeping the transfer of organic matter as low as possible. This is schematically illustrated in Figure I-1.

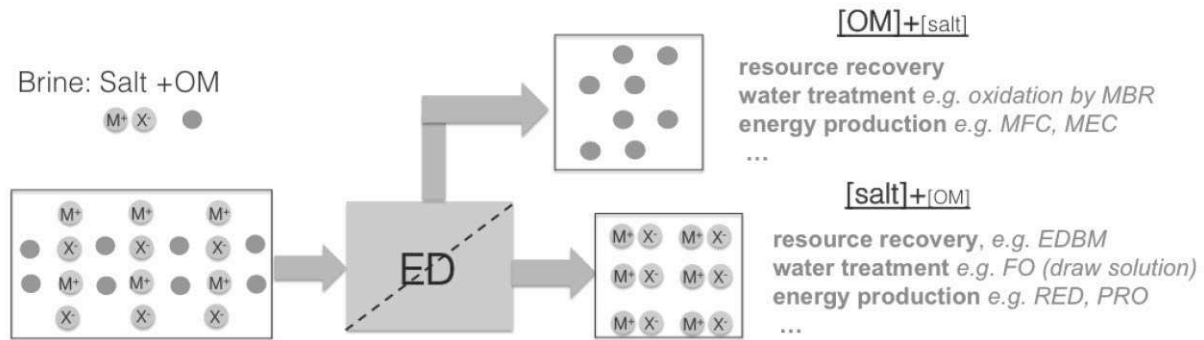

Figure I-1 Schematic diagram of saline water treatment by electro dialysis with further integration

Concerning the desalinated solution containing the organic matter, different situations can be considered given the organic content is valuable or unfavorable like pollutant. For instance, in food processing industries, ED can be used to recover organic solutes like sugars and organic acids frequently obtained together with a given amount of salt in solution. In that case, the main requirement is the purity as well as the recovery rate of the organic solutes, which are valuable products. On the contrary, when the organic content of the saline solution is detrimental to the environmental, like phenol or pharmaceutical residues, the main requirement for the ED treatment is the compatibility of the desalted brine with respect to the further treatment used to remove the pollution. Process based on oxidation regarding water treatment is thus possible. Biodegradable organic source can be fed to the biomass or biomass integrated membrane technology like MBR, while bio-refractory organics can be disposed by advanced oxidations. Particularly, a membrane process can extend the objective of water treatment to an additional energy production. By using electrogenic microorganism to oxidize OM in anode, which release electrons and protons, it is possible to establish a circuit to produce hydrogen in cathode by a Microbial Electrolysis Cell (MEC) [37], or electricity in cathode by a Microbial Fuel Cell (MFC) [6]. More efficient water treatment can be achieved in a Microbial Desalination Cell (MDC) [77], i.e. a process based on development of MFC, with the biomass exploited energy from OM to support desalination process. These membrane

based technologies integrating microorganism oxidation are crucial issues, and the ED treated effluents containing organic substance can be helpful.

On the other hand, the extracted salt solution is also important to be considered. Again, depending on its composition, i.e. purity of salt and concentration, different way of reuse can be possible, after further concentration or not. For instance, coarse salt i.e. NaCl is often recovered from brines, and it can be important raw materials for further production of chemicals like NaOH by EDBM [78]. Also, the concentrated saline solution can be useful for some emerging membrane processes. It is reported that brine serves as draw solution in Forward Osmosis (FO) for wastewater reclamation [11]. Concerning energy production, osmotic process as Pressure Retarded Osmosis (PRO), or process based on chemical gradient like Reverse Electrodialysis (RED) attract great interest. These technologies aim to exploit the salinity gradient energy or blue energy, where seawater (ca. salt concentration 50 g.L^{-1}) is widely used. ED effluent can be hyper brine like concentrated SWROC [79], with well controlled organic concentration. Indeed, membrane fouling due to organics can limit the energy production efficiency of these processes. In RED, biofouling can be serious for the ion-exchange membrane if directly using natural water, which increases the membrane resistance and decrease ion permeability [80-81]. Also, in FO / PRO, organics of high concentration in draw solution side (concentrated salinity) may foul the membrane and decline the water transfer [11,82-83]. Then the possibility to produce from an effluent a saline solution without or with a very low content of organic matter using ED can stimulate the development of salinity gradient power production.

Thus, desalination of saline water containing organic solutes by electrodialysis is an environmental-friendly and promising option for such complex fluids treatment.

Then, in the present work the performances of ED regarding the desalination of saline waters of different compositions is investigated.

The manuscript is outlined as follows.

The materials and methods used to carry out the work will be presented in Chapter II.

Then, in chapter III, the study will focus on the salt and water transfer during ED. The relationship of salt migration under current and water transfer will be investigated under different conditions, like saline water compositions and current. The ion compositions are Na^+ , Mg^{2+} , Cl^- , SO_4^{2-} , main species in brine, e.g. SWROC. The ion selectivity will also be discussed as well as the hydration of the ions.

In chapter IV, the transfer of organic solutes through IEM without current and in normal ED conditions, i.e. with current will be investigated. OM transfer in former regime refers as solute diffusion, while in latter there is also an additional solute transfer. The solute transfer mechanisms will be studied, using synthetic solutions of different salt and organic matter compositions. Salt compositions are same to that in previous chapter. Model organic solutes are glucose, phenol, acetic acid and acetate, representative carbohydrates either in nature or industrial effluents.

These results will be further used in chapter V to determine the performances of ED for the desalination of saline waters containing organic matter. This will be first discussed with synthetic waters of different compositions. The key factors influencing the desalination performance will be studied. Finally, the case study of the desalination of industrial waste water will be considered to check the methodology.

Chapter VI will end it up with general conclusions and recommendations for further investigations.

Chapter II

Materials and Methods

II.1 Experimental materials and procedures

II.1.1 Chemicals

Saline solutions with and without organic solute were selected to investigate the salt, water and organic solute transfer. Four different inorganic salts containing ions of various hydrations were used (Table II-1).

Inorganic salt	Molecular weight (g.mol ⁻¹)
NaCl	58.44
Na ₂ SO ₄	142.04
MgCl ₂ ·6H ₂ O	203.31
MgSO ₄ ·7H ₂ O	147.02

Table II- 1 Characteristics (Molecular weight, Mw) of the salt

The corresponding ion hydration scale is given as follows [84]:

$$\text{Anions: } n_h^{Cl^-} < n_h^{SO_4^{2-}} \quad \text{cations: } n_h^{Na^+} < n_h^{Mg^{2+}}$$

The investigation of the salt and water transfer (chapter III) has been carried out with solutions of different compositions, i.e. single salt and mixed ones (2 or 3 salts) as shown in Table II-2.

Salt	Single salts (eq.L ⁻¹)				Mixed salts (eq.L ⁻¹)					
	S1	S2	S3	S4	S5	S6	S7	S8	S9	S10
NaCl	1				0.5	0.5			0.33	0.63
Na ₂ SO ₄		1			0.5		0.5		0.33	0.08
MgCl ₂			1			0.5		0.5	0.33	0.16
MgSO ₄				1			0.5	0.5		

Table II- 2 Composition and concentration of the salt solutions (Chapter III)

Ten solutions of different compositions were prepared according to Table II-2, namely S1-S10. The total salt concentration in this study was fixed at 1 eq.L⁻¹ except for S10 (0.87eqL⁻¹). Single salt solutions (solution S1-S4) were used for the determination of the salt-water

transfer (i.e. salt hydration number). Mixed salt solutions (solution S5-S9) were used to study the ion-water transfer relationship, i.e. to calculate the individual ion hydration numbers. Finally, S10 was an artificial seawater reverse osmosis concentrate (SROC), prepared according to the standard method (ASTM D 1141-86) for artificial sea water preparation.

The OM transfer in saline water (Chapter IV and V) has been investigated with three different salts (NaCl - Na₂SO₄ - MgCl₂). In each synthetic solution, the salt concentration in saline solution was fixed at 0.8 eq.L⁻¹.

The organic solutes of various molecular weight used in the experiments are listed in Table II-3.

Name	Chemical Formula		Molecular weight (g.mol ⁻¹)	pKa	pH	log P
Glucose	C ₆ H ₁₂ O ₆		180.16	12.28	6.0±0.5	-2.93
Phenol	C ₆ H ₅ OH		94.11	9.99	5.4±0.3	1.48
Acetic acid	CH ₃ COOH		60.05	4.76	3.0±0.2	-0.32
Acetate	CH ₃ COO ⁻		59.04	4.76	6.7±0.3	

Table II- 3 Relevant characteristics of the organic solutes

These organic compounds were typically representative solutes found in industrial effluent or natural water body. As shown in Table II-3, one obvious difference of these organic is their molecular weight (M_w), with an order of sequence:

$$M_w(\text{glucose}) > M_w(\text{phenol}) > M_w(\text{acetic acid}) \approx M_w(\text{acetate})$$

These OMs have different pKa value, indicating the prepared solution containing the OM may have different pH value. Indeed, all the solutions without OM were neutral in this work, while it was not the case for solution containing OM, regardless the presence of salt. The pH of the various solutions of glucose, phenol and acetate was neutral, without any adjustment. As for acetic acid the observed pH value was 3.0±0.2, indicating that merely 5% of acetic acid molecules were dissociated considering its pKa. Thus, one can state that these

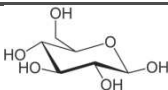
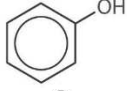
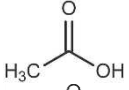
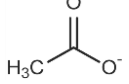
OMs except acetate were neutral solute, nearly non-dissociable in our conditions. In addition, the hydrophobicity was presented as $\log P$, known as partition coefficient between octanol and water. The order of sequence of the hydrophobicity for the 3 neutral OM is:

$$\log P_{glucose} < \log P_{acetic\ acid} < \log P_{phenol}$$

One can state that glucose is the most hydrophilic OM in this study (lowest value of $\log P$), followed by acetic acid, while phenol is very hydrophobic (highest, positive value of $\log P$). This is mainly due to the functional group as hydroxyl and carboxyl and benzene, seen in Table II-3. Glucose has 5 hydroxyl groups while acetic acid as only 1 carboxyl group, which determines their hydrophilicity. Phenol has only 1 hydroxyl group and a strongly hydrophobic benzene group. This information can be important for understanding noncovalent interactions (e.g. electrostatic interactions, van der Waals forces, hydrogen bonding) among molecules, especially in complex fluids containing multi-compositions or membrane polymeric network [85].

Concerning the charged OM, acetate, one can assume that it should be more hydrophilic than the considered neutral OMs due to its charge nature.

The concentration of OM was fixed at 0.1 mol.L⁻¹. Finally, the synthetic saline solutions used containing single or mixed OM were listed in Tables II-4 and II-5.

Soaking solution	Solutions for OM / Salt system		Solutions for OM / Water system	
	OM	Salt	OM	Water
[Salt]=0.8 eq.L ⁻¹	[OM] = 0.1 mol.L ⁻¹	[Salt]=0.8 eq.L ⁻¹	[OM] = 0.1 mol.L ⁻¹	
NaCl	glucose or phenol	NaCl	glucose or phenol	RO water
Na₂SO₄	or acetic acid	Na ₂ SO ₄	or acetic acid	RO water
MgCl₂	or acetate	MgCl ₂	or acetate	RO water

Table II- 4 Composition and concentration of the solutions containing single OM (Chapter IV); synthetic solution: OM / Salt system (OM / S) and OM / Water system (OM / W)

Soaking solution	Solutions for OMs / Salt system		Solutions for OMs / Water system	
	Mixture of OM [OM] = 0.1 mol.L ⁻¹ for each solute	Water [Salt] = 0.8 eq.L ⁻¹	Mixture of OM [OM] = 0.1 mol.L ⁻¹ for each solute	Water [Salt] = 0.8 eq.L ⁻¹
NaCl	glucose + acetic acid	NaCl	glucose + acetic acid	RO water
Na ₂ SO ₄	or glucose + acetate	Na ₂ SO ₄	or glucose + acetate	RO water

Table II- 5 Composition and concentration of the solutions containing mixed OM (Chapter V); synthetic solution: OMs / Salt system (OMs / S) and OM / Water system (OMs / W)

In this case, the OM solutes were mixture of glucose and acetic acid (acidic condition, pH \approx 3) as well as mixture of glucose and acetate (neutral condition, pH \approx 7).

An industrial solution, i.e. oil process water (OPW) from Total, France, pretreated by microfiltration, is desalinated by electrodialysis (Chapter V). The characteristics of the industrial solution are reported in Table II-6.

Conductivity (ms.cm)	34
pH	8.2
Na⁺ (eq.L⁻¹)	0.34
Cl⁻ (eq.L⁻¹)	0.30
SO₄²⁻ (eq.L⁻¹)	Not determined
TOC (ppm)	35.4

Table II-6 Characteristics of industrial solution (T= 25°C)

The inorganic fraction is mainly composed by sodium and chloride (sulfate concentration detection is interfered by the absorbed carbonate). The organic fraction is unclear.

II.1.2 Membrane and Electrodialysis set-up

The ED experiments were performed with EUR 2B-10 stack (Eurodia, France). The ED stack comprised 10 cells of AEM / CEM as Neosepta AMX/CMX, Tokuyama Corp,

Japan. For each type of membrane, the effective membrane surface is 0.02m^2 for each cell, i.e. total effective membrane surface of 0.2 m^2 . The principal properties of these membranes AMX and CMX were listed in Table II-7.

Membrane property	AMX	CMX
Ion-exchange capacity (meq.g⁻¹)	1.4-1.7	1.5-1.8
Specific		
Resistance*($\Omega\cdot\text{cm}^{-1}$)	2.0-3.5	2.0-3.5
Permselectivity (%)	0.98	0.98
Water content (%)	25-30**	25-30***
pH	0-12	0-12
Function group	ammonium quaternary	sulfonic acid
Thickness(mm)	0.16-0.18	0.17-0.19
Reticulant	divinyl benzene	divinyl benzene

Table II- 7 Principal properties of ion-exchange membranes; *determined at $25\text{ }^\circ\text{C}$ in $0.5\text{ mol}\cdot\text{L}^{-1}$ NaCl solution; **membrane soaking in Cl^- solution [86]; ***membrane soaking in Na^+ solution [87]

The ion-exchange capacity is a crucial parameter which affects almost all other membrane properties. It is a measure of the number of fixed charges per unit weight of the dry polymer. The electrical resistance of the membrane is one of the parameters which determine the energy requirements of electro dialysis process. Determined by the capacity and the mobility of the ion within the matrix, the electrical resistance can be expressed as specific resistance ($\Omega\cdot\text{cm}^{-1}$) or membrane area resistance ($\Omega\cdot\text{cm}^{-2}$). The permselectivity of a membrane is determined by the ratio of the flux of specific components to the total mass flux through the membrane under a given driving force. The membrane used here has no selectivity to separate ions with different charge.

A schematic diagram for an ED set-up is shown in Figure II-1.

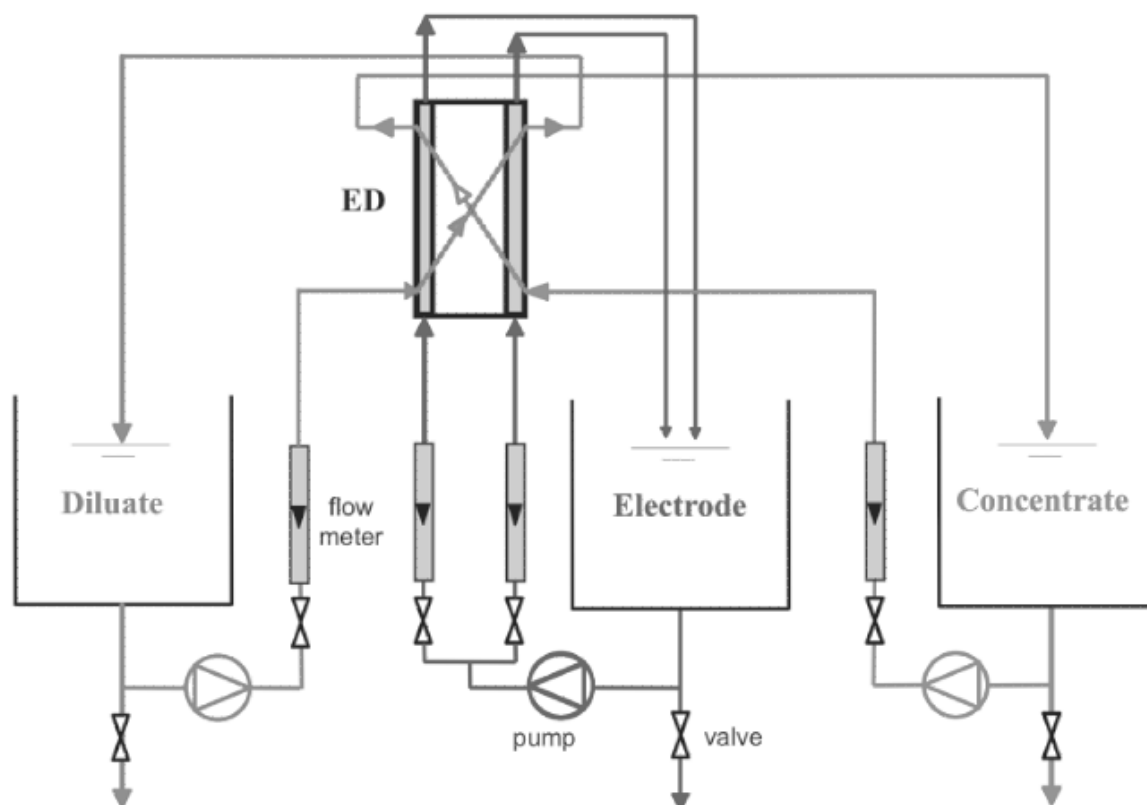

Figure II-1 Schematic diagram of the electro dialysis set-up

The ED experiments were operated in batch mode (complete recycling of diluate, concentrate and electrode rinse solution). The set-up consists of three separated circuits, for diluate, concentrate and electrode rinse solution, with three 4 L vessels.

Three centrifugal pumps were used to circulate these solutions, and flow meters were used to set the flow rates. The feed flow rates were set at constant values of $180 \text{ L}\cdot\text{h}^{-1}$ for both diluate and concentrate compartments, and $360 \text{ L}\cdot\text{h}^{-1}$ for the electrode rinsing solution. All the experiments were carried out at constant temperature $25\pm 1 \text{ }^\circ\text{C}$ using a circulating thermostatic bath.

The electrode rinse solution compartment was fed with 3 L of Na_2SO_4 solution at a concentration of $10 \text{ g}\cdot\text{L}^{-1}$.

Both diluate and concentrate compartments were initially fed with 2 L of salt solution at a given composition for the investigation of the salt and water transfer (see Table II-2).

For the study of the mass transfer of OM, the diluate was initially fed with 2 L of salt solution containing the organic solute at a given composition (Tables II-4 and II-5), while the

concentrate one was fed with 2 L of a solution at the same ionic composition without OM or RO water (Chapter IV and V).

II.1.3 Experimental procedures

For each salt, the membranes were first soaked in 4 L of the salt solution for 4 hours at a flow rate of $180 \text{ L}\cdot\text{h}^{-1}$ and then the solution was kept at least 10 hours without circulation. This soaking solution was exactly the same electrolytic solution as that used in ED. Since the quantity of ions in these solutions was about 40 times higher than the total ion-exchange capacity of AMX and CMX membranes in the ED stack, one can consider that this procedure ensures a complete exchange of the membrane counter ion, thus a fully equilibrated IEM. It is important to note that the system pH condition was acidic in case of acetic acid, different from those of other solutes; but the IEMs were considered to be still in counter-ion form after each soaking, rather than in form of H^+ , due to a much higher salt concentration (i.e. concentration ratio $C_{\text{counter-ion}}/C_{\text{H}^+}$ approximates to about 1000 in case of acetic acid), which dominated the exchange equilibrium.

Then, experiments were carried out without current ($I = 0$), diffusion regime, and under normal ED conditions ($I \neq 0$).

Diffusion experiments were carried out with such conditioned membranes using OM / water (OM / W) as Case 1, OM / salt solutions (OM / S) as Case 2 as shown in Figure II-2.

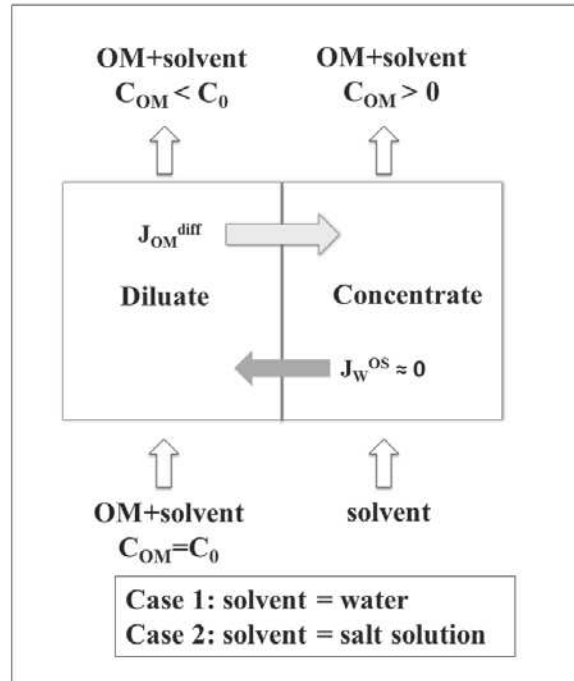

Figure II-2 Protocol of diffusion regime: systems of OM / water and OM / salt

As aforementioned, the initial OM concentration (C_{OM}) was kept as 0.1 mol.L^{-1} .

Due to the concentration difference, the diffusion flux of OM was found to transfer across the membrane from the diluate to the concentrate, indicating a decrease of the total OM quantity in the diluate compartment and an increase of the OM concentration in the concentrate compartment. The water flux in reversed direction under the osmotic pressure was expected, but it was found to be weak owing to the low concentration of OM i.e. low osmotic pressure.

The influence of the membrane soaking, i.e. the impact of the salt on the membrane properties, was estimated from the OM flux measured with OM / water systems (Case 1). Then the overall effect of the salt was characterized by the OM flux determined in OM / salt solution (Case 2) [63].

In normal ED regime, experiments were carried out at various constant currents (2, 3, 4, 6A), i.e. in the range $0\text{-}300 \text{ A.m}^{-2}$. The experiment duration was determined according to the conductivity of the diluate. They were stopped as soon as the conductivity reached 5 mS.cm^{-1} in order to have current lower than limiting current for any set of experiments. Consequently, different experiment duration resulted according to the operating conditions.

The solvent and solute (ions and OM) fluxes were deduced from the variation of the volume and solute mass transferred through the membranes versus time.

Protocol of ED regime was illustrated as below, taking saline solution containing OM as example.

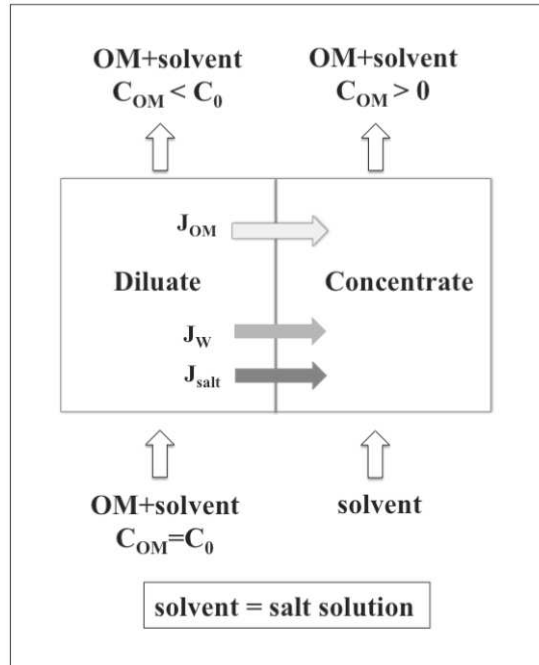

Figure II-3 Protocol of normal ED regime, e.g. system of OM / salt

II.1.4 Analytical methods

In the ED experiments, solution conductivities, pH and temperature in the two compartments were measured in real-time, as well as the electrical current and voltage. The solutes (ions and OM) concentration and the volume were determined in the two compartments as a function of time.

The salt concentration in single salt case was determined from conductivity measurements, using a conductivity meter (HI933100, Hanna Instruments). For mixed salt solutions the concentrations of ions species were determined by ion chromatography (IEC, Dionex, France). The characteristics of the ion chromatography system are listed in Table II-8.

Dionex ICS 3000	
Ion type	Anion, cation
Column	IonPac™ AS11, IonPac™ CS12
Temperature	30°C
Mobile phase	NaOH: 5 mM (95%) + 100 mM (5%); CH ₄ O ₃ SO ₃ : 20 mM (100%)
Flow rate	1 mL.min ⁻¹
Pump	GP40
Auto sample	AS50
Injection volume	25uL
Suppresser	ASRS_4mm (137mA) CSRS_4mm (59mA)
Conductivity detector	CD20

Table II- 8 Characteristics of the ion chromatography analysis

Samples were diluted to a maximum of 1000 folds by ultra-pure water before analysis by ion chromatography.

The concentrations of glucose, acetic acid and acetate were measured by high-performance liquid chromatography (HPLC), Jasco, France. The details of the HPLC conditions are depicted in Table II-9.

HPLC, Jasco	
Column	Shodex SH1011
Temperature	50°C
Mobil phase	H ₂ SO ₄ (10 mM)
Flow rate	1 mL.min ⁻¹
Pump	PU2089plus
Auto sample	AS2055plus
Injection volume	20 uL
refractive index detector	RI-2031plus

Table II- 9 Characteristics of the high-performance liquid chromatography analysis

Samples from diluate compartment were diluted to a maximum of 200 folds and samples from the concentrate compartment to a maximum of 20 folds by ultra-pure water.

The concentration of phenol was measured by an ultraviolet (UV) spectroscopy at 270 nm, as shown below.

UV spectrophotometer, Uvi light XTD5 (SECOMAM)	
Wavelength range	190-900 nm
Bandwidth	2 nm
Detector	Silicon diode
Light sources	Deuterium and Tungsten-Halogen lamps
Accuracy	+/- 1 nm
Fixed wavelength for phenol	270 nm

Table II- 10 Characteristics of the UV spectrophotometer

Samples for the concentrate were diluted of 20 folds and of 100 folds for the diluate.

The transfer of organic solute in the industrial solution (OPW) was measured by concentration of the total organic carbon (TOC), Shimadzu 5050A. The details of the TOC analyzer were depicted in Table II-11 (TC is total carbon, IC is inorganic carbon, TOC is difference of TC and IC, NPOC is non-purgable organic carbon).

TOC, Shimadzu	
Analyte	TC, IC, TOC (TC-IC), NPOC
TC method	Catalytically aided combustion oxidation
IC method	Pre-acidification
NPOC method	Non-dispersive infrared gas analysis
Acidification	H ₃ PO ₄ (25% v/v)
Flow rate	150 mL.min ⁻¹ (carrier gas)
Detection range	50 ppb – 4000 ppm

Table II- 11 Characteristics of the TOC analysis

The concentration of organic solute in oil process solution is measured without dilution, in NPOC method.

The mass balance for solvent and solute were checked, knowing the variation of the volume and concentration in the two compartments.

The difference of volume variation vs time in two compartments was compared according to the following equation.

$$E_V = \left[\sum_n \frac{|V_{tot}(t) - V_{tot}(t=0)|}{\left(\frac{V_{tot}(t) + V_{tot}(t=0)}{2}\right)} \right] \cdot \frac{1}{N} \cdot 100 \quad (\text{II- 1})$$

where N is the number of experimental samples, $V_{tot}(t)$ and $V_{tot}(t = 0)$ were the values of total volume in the two compartments in real time and that at the initial beginning of experiment.

Likewise, the difference of solute (salt / OM) transfer variation vs time in two compartments can be checked.

The maximum deviation was less than 2% for solvent, 5% for salt and 10% for OM solute. The mass balance of OM shows neither leakage nor adsorption was observed.

In the same way, the theoretically calculated quantity transferred (m_{theo}) and the experimentally obtained values (m_{exp}) can also be compared using the following equation:

$$\text{C. V.} = \left[\sum_n \frac{|m_{exp}(t) - m_{theo}(t)|}{\left(\frac{m_{exp}(t) + m_{theo}(t)}{2}\right)} \right] \cdot \frac{1}{N} \cdot 100 \quad (\text{II- 2})$$

This equation has been used for water flux when ionic hydration number is used to calculate the theoretical water flux.

The hydration number calculation was achieved by fitting method, using an open access software Rstudio (RStudio Inc, Version 3.0), based on a nonlinear regression method.

II.2 Mass transfer mechanisms

There are different contributions for the mass transfer of solute and solvent in ED. This part was to illustrate the transfer phenomena through ion-exchange membrane, concerning transfer of salt, water and solute, respectively.

II.2.1 Salt transfer

In ED process, the salt flux, j_s ($\text{eq} \cdot \text{m}^{-2} \cdot \text{s}^{-1}$), is the sum of two contributions. The first one is a flux coupled with the chemical potential gradient, i.e. a diffusion flux, j^{diff} , due to the difference of solute's concentration across the membrane and with the direction towards the compartment of decreasing concentration. The other one is the flux coupled with the electrical current, i.e. the migration flux, j^{mig} , due to the electrical potential gradient [39]. Then the salt transfer is expressed by the following equation:

$$j_s = j^{diff} + j^{mig} \quad (II-3)$$

According to previous experimental results, the diffusion contribution can be neglected compared to that of migration in most of the ED conditions [43,53].

The contribution of the migration to the salt transport can be expressed using the salt transference number, t_s , which is the fraction of the total current that is carried by the salts.

$$j^{mig} = \frac{t_s \times I}{F \times S_m} \quad (II-4)$$

where I is the electric current applied (A), S_m is the total surface of one type of membrane, 0.2 (m²), F is the Faraday constant. Eq.(II-4) shows salt migration is proportional to the current, scaled by the salt transference number, divided by the Faraday constant and the membrane area. Furthermore, a modified flux equation can be obtained by phenomenological approach as Eq.(II-5):

$$j_s \approx j^{mig} = \alpha I \quad (II-5)$$

the salt flux due to migration being proportional to the electric current, I , and α (eq·m⁻²·s⁻¹·A⁻¹) as the current coefficient.

In ED, the effective membrane area concerning the salt and ion transfer is S_m , the total surface area of one type of membrane.

II.2.2 Water transfer

The water transfer in ED is the result of two contributions, osmosis (j^{os}) and electro-osmosis (j^{eo}), as expressed in the following equation:

$$j_w = j^{os} + j^{eo} \quad (II-6)$$

where the osmotic flux is due to the chemical potential gradient across the membrane, while the electro-osmotic flux is due to the water transfer coupling the ion migration through the membrane [1].

Usually in ED, when an electric current is applied, the water flux caused by osmosis can be neglected compared to that of electro-osmosis [43,48,52-53]. And owing to its link to the salt, this flux j^{eo} is also proportional to the current. Introducing an electro-osmotic coefficient, β (m³·m⁻²·s⁻¹·A⁻¹), the expression of the water transfer can be written as in Eq.(II-7):

$$j_w \approx j^{eo} = \beta I \quad (II-7)$$

In ED, the effective membrane area concerning the water transfer is $2S_m$, the total surface area of two type of membrane.

II.2.3 Organic solute transfer

This section deals with the organic solute (OM) transfer included neutral organic solute as well as charged one.

Neutral solute, can be transferred in ED process due to diffusion caused by the concentration gradient. But from the theoretical point of view, a convective contribution can be expected for conditions that the solvent flow is significant. Then, the neutral organic solute flux, j_{OM} , can be expressed as the sum of the diffusion flux, j^{diff} , and the convective flux, j^{conv} according to the Eq. (II-8):

$$j_{OM} = j^{diff} + j^{conv} \quad (II-8)$$

The diffusion flux due to concentration gradient can be further expressed as:

$$j^{diff} = P_{OM}\Delta C_{OM} \quad (II-9)$$

where ΔC_{OM} is concentration gradient across the membrane ($\Delta C_{OM} = C_{OM,D}^0 - C_{OM,C}^0$). In this study ΔC_{OM} is assumed to be equal to $C_{OM,D}^0$ since the amount of neutral organic solute transferred is negligible compared to the initial amount in the diluate compartment, which will be discussed later. P_{OM} ($m.s^{-1}$) is solute permeability.

The diffusion may be the mainly reported contribution [88], but convective contribution can also be expected when the solution flow is significant [43]. Indeed, since in ED there is significant electro-osmotic flux under current, such water transfer is supposed to entrain / drag some organic solute towards the membrane. Such electro-osmotic enhancement of OM solute transport has been reported in fuel cell [89-90] and biological membrane [91] but very few on ED as separation process [92].

The convective flux of a solute through a permeable membrane separating two well-mixed compartments can be expressed from the equation, derived from irreversible thermodynamics, proposed by Kedem et Katchalsky [93]:

$$j^{conv} = \bar{C}_{OM}(1 - \sigma)j_W \quad (II-10)$$

where \bar{C}_{OM} is the mean solute concentration on either side of the membrane, and it is assumed to be equal to the initial concentration in the diluate compartment, $C_{OM,D}^0$ as aforementioned.

σ is the reflection coefficient, which varies from 0 for a freely permeable molecule to 1 for a non-permeating solute.

Therefore, the neutral OM flux can be expressed as follows, combining Eqs.(II-7 to II-10):

$$j_{OM} = j^{diff} + \bar{C}_{OM}(1 - \sigma)j_W = j^{diff} + \bar{C}_{OM}(1 - \sigma)\beta I \quad (\text{II-11})$$

where the aforementioned water transfer under current refers to the electro-osmotic flux, which is proportional to current. Thus, one can consider that the convection flux is proportional to the current in ED process. From the experimental approach, the equation can be simplified as Eq.(II-12):

$$j_{OM} = j^{diff} + \gamma I \quad (\text{II-12})$$

In this expression, the convective coefficient γ ($\text{mol}\cdot\text{m}^{-2}\cdot\text{s}^{-1}\cdot\text{A}^{-1}$) relates to the OM flux density due to convection flux, which is observed as proportional to current.

In ED, the effective membrane area concerning the organic solute transfer is $2S_m$, the total surface area of two type of membrane.

From Eqs. (II-7) and (II-12), one can determine the reflection coefficient of organic solute, σ_{OM} , as shown in the Eq.(II-13):

$$\sigma_{OM} = 1 - \frac{\gamma}{\beta \times C_{OM,D}^0} \quad (\text{II-13})$$

In the case of charged OM, the transfer can be expressed as the sum of the diffusion contribution (without current) and the migration one (under current):

$$j_{OM'} = j^{diff} + j_{OM'}^{mig} \quad (\text{II-14})$$

where OM' indicates the charged OM.

As for inorganic ions, the migration flux of a charged OM can be expressed using its transference number according to Eq.(II-15):

$$j_{OM'}^{mig} = \frac{t_{OM'} \times I}{F \times S_m} \quad (\text{II-15})$$

where $t_{OM'}$ is the organic salt transference number, F is the Faraday constant and S_m is the total surface of one type of membrane, i.e. $0.2 \text{ (m}^2\text{)}$. It is assumed that organic anion, i.e. acetate migrate through anion-exchange membrane under current like inorganic anion, i.e. chloride or sulfate, and in the mixture of acetate and inorganic anion, the sum of their transference number through anion-exchange membrane is one:

$$t_S + t_{OM'} = 1 \quad (\text{II-16})$$

showing the sum of the two transference numbers equals to one, under ideal condition (e.g. membrane has perfect counter-ion selectivity).

According to Eq.(II-15), one can find the migration is proportional to the current, and then is further simplified using the transfer coefficient γ' , in analogy with the case of neutral OM. Thus, the transfer of charged OM is written as

$$j_{OM'} = j^{diff} + \gamma'I \quad (\text{II-17})$$

Chapter III

Salt and water transfer through ion-exchange membranes: electro-osmosis and ion hydration number

In this chapter, salt and water transfer during desalination of synthetic saline solution without organic solute is studied. Particularly, water transfer due to electro-osmosis, i.e. the water carried by the migrating species is related to their hydration. Then, this chapter focuses on the hydration number of solutes transferring through ion-exchange membranes.

In the first part, a theory to calculate the hydration numbers of ions transferring through ion-exchange membranes during electrodialysis is proposed based on mass transfer phenomena.

In the second part, salt and water transfer is experimentally determined, concerning single salt and mixed salt cases. From mass transfer in single salt case, salt hydration is obtained. Knowing salt hydration numbers, then the hydration numbers of 4 transferring ions (Na^+ , Mg^{2+} , Cl^- , SO_4^{2-}) are calculated simultaneously, from mass transfer in mixed salt cases.

In the third part, the calculated ion hydration numbers are further discussed, in comparison with values reported in literature.

This Chapter has been published as: Le Han, Sylvain Galier, H Roux-de Balmann, Ion hydration number and electro-osmosis during electrodialysis of mixed salt solution, *Desalination* 373(2015)38-46.

III.1 Theory

III.1.1 Salt and water mass transfer

As aforementioned in section of Mass Transfer Mechanism (Chapter II), salt transfer is dominated by migration, which is proportional to current, expressed as Eq.(II-5):

$$j_s \approx j^{mig} = \alpha I \quad (\text{II-5})$$

where α ($\text{eq.m}^{-2}.\text{s}^{-1}.\text{A}^{-1}$) is the current coefficient.

Water flux is dominated by electro-osmosis, which is proportional to current, expressed as Eq.(II-7):

$$j_w \approx j^{eo} = \beta I \quad (\text{II-7})$$

where β is an electro-osmotic coefficient ($\text{m}^3.\text{m}^{-2}.\text{s}^{-1}.\text{A}^{-1}$).

However, it should be noted that in theory, the experimentally observed volumetric flux, j_V ($\text{m}^3.\text{m}^{-2}.\text{s}^{-1}$), includes the volume contribution of both water transferred (i.e. water flux, j_w), and the ions, as shown in Eq.(III-1):

$$j_V = j_w + \sum_i j_V^i \quad (\text{III-1})$$

The total ionic volume contribution $\sum_i j_V^i$ can be calculated according to Eq.(III-2):

$$\sum_i j_V^i = \sum_i \frac{j_i}{z_i} \times V_m^i \quad (\text{III-2})$$

with j_i (eq.m⁻².s⁻¹) the ionic flux, V_m^i the molar volume of the ion (m³.mol⁻¹) and z_i the valence of the ion (eq.mol⁻¹), $\frac{j_i}{z_i}$ (mol.m⁻².s⁻¹) is ionic flux in mole.

In most ED conditions, like those in this study, the ionic volume contribution is negligible compared to that of water (less than 7% of the total volume flux). Therefore, the volume flux can be considered as a water flux, as represented in Eq. (III-3):

$$j_V \approx j_w \quad (\text{III-3})$$

III.1.2 Hydration number calculation

For any salt like $C_{\vartheta_C}A_{\vartheta_A}$ (ϑ_C and ϑ_A being the stoichiometric coefficients for cation and anion, respectively), a salt flux (mol.m⁻².s⁻¹) can be written as:

$$\frac{j_C/z_C}{\vartheta_C} = \frac{j_A/z_A}{\vartheta_A} = \frac{j_i/z_i}{\vartheta_i} \quad (\text{III-4})$$

which is the number of mole of salt like $C_{\vartheta_C}A_{\vartheta_A}$ transferred per unit membrane area per second.

As discussed above, the water transfer (electro-osmotic flux) is linked to the salt transfer in ED. Then, one can calculate the salt hydration number (n_h^S), defined as the number of mole of water per mole of salt, knowing the simultaneous transfer of salt and the associated water, according to Eq. (III-5):

$$n_h^S = \frac{j_w/V_m^W}{j_i/(z_i\vartheta_i)} \quad (\text{III-5})$$

where V_m^W is the molar volume of water (m³.mol⁻¹).

Combining with Eq. (II-5) and Eq. (II-7), this equation can be expressed as below:

$$n_h^S = \frac{\beta/V_m^W}{\alpha/(z_i\vartheta_i)} \quad (\text{III-6})$$

Therefore, the hydration number for each single salt can be calculated from the experimental measurements of the salt and water flux. Indeed, this salt hydration number can be assumed as the total amount of water accompanying the cation and anion migration through the membranes.

Then, for any salt like $C_{\vartheta_C}A_{\vartheta_A}$, the following relation can be drawn:

$$n_h^{S(C\vartheta_C A\vartheta_A)} = \vartheta_C n_h^C + \vartheta_A n_h^A \quad (\text{III-7})$$

where n_h^C and n_h^A are the hydration numbers for cation and anion, respectively. But in order to solve Eq. (III-7) to get the individual hydration numbers of cation and anion, an additional equation is necessary.

In general, one can calculate the hydration number of a transferring ion, n_h^i , as:

$$n_h^i = \frac{m_w^i}{m_i} \quad (\text{III-8})$$

where m_i (mol) and m_w^i (mol) are the number of moles of ion and water transferred through the membrane.

Assuming that the ion hydration number remains constant over time, this equation can be further expressed as:

$$n_h^i = \frac{m_w^i(t)}{m_i(t)} \quad (\text{III-9})$$

where the values $m_i(t)$, $m_w^i(t)$ are the transferred quantities (in mole) for ion and water respectively, from the initial beginning of ED until the time t .

However, as previously explained, it is not possible to get the individual values of the water transfer corresponding to each ion, $m_w^i(t)$, versus time, but only the total amount of water transferred, $m_w(t)$, deduced from the variation of the volume, which can be expressed by Eq. (III-10):

$$m_w(t) = \sum_i m_w^i(t) \quad (\text{III-10})$$

Thus, combining Eqs. (III-9) and (III-10), one can obtain Eq. (III-11):

$$m_w(t) = \sum_i n_h^i \times m_i(t) \quad (\text{III-11})$$

The ion hydration numbers are obtained by fitting the value of the water transfer as obtained by Eq.(III-11) knowing the experimental values of the ion transfer m_i for each ion with that obtained experimentally. The least square method is used for that fitting. The ionic hydration numbers are assumed to be constant, regardless of the ion concentration and composition in mixtures. This assumption will be further checked.

This theoretical water transfer can be written as a matrix considering the 4 ions (Na^+ , Mg^{2+} , Cl^- , SO_4^{2-}) used in this study, as seen in Eq. (III-12):

$$(m_w) = (m_{Na} \quad m_{Mg} \quad m_{Cl} \quad m_{SO_4}) \times \begin{pmatrix} n_h^{Na} \\ n_h^{Mg} \\ n_h^{Cl} \\ n_h^{SO_4} \end{pmatrix} \quad (\text{III-12})$$

The experimental results corresponding to the different salt compositions offer a database for ion and water transfer at each time t during the ED, and thus the 4 ion hydration numbers can be solved simultaneously.

In addition, to solve the matrix and ensure the calculated result reasonable, a constraint, i.e. upper and lower limits, of hydration numbers for the 4 ions is required.

In this study, we are dealing with hydration number during ion's migration through ion-exchange membranes. Then, on one hand, the lower limit corresponds to the case where the ion sheds its waters of hydration, upon sorbing into the polymer, in favor of possible interactions with the polymer matrix [55]. Thus, a value of zero, corresponding to an unhydrated ion, may be regarded as the lower limit. On the other hand, the upper limit can be considered to be that obtained for the salt hydration number as determined from single salt solutions, since the individual value of an ion, n_h^i , cannot exceed the value of the salt hydration number n_h^S based on Eq. (III-7).

Therefore, the constraint for ionic hydration number is seen in Table III-1.

n_h^i	Na ⁺	Mg ²⁺	Cl ⁻	SO ₄ ²⁻
Lower limit	0	0	0	0
Upper limit	$\max(n_h^{NaCl}, n_h^{Na_2SO_4})$	$\max(n_h^{MgCl_2}, n_h^{MgSO_4})$	$\max(n_h^{NaCl}, n_h^{MgCl_2})$	$\max(n_h^{Na_2SO_4}, n_h^{MgSO_4})$

Table III-1 Ionic hydration number constraint for calculation

As shown in Table III-1, the constraint of hydration number is with the lower limit as 0, and the upper limit as the higher value of two salt hydration numbers n_h^S involving the same ion (e.g. $n_h^{Na} \leq \max(n_h^{NaCl}, n_h^{Na_2SO_4})$), which needs further estimation. This constraint is the input parameter to the experimental database for hydration number calculation.

To sum up, the assumptions used for the calculation of the ion hydration numbers in this study are listed in Table III-2.

Negligible ionic volume	Cumulative volume/hydration	Constant n_h^i
$j_V \approx j_w$	$m_w = \sum_i m_w^i(t)$	$n_h^i = \text{constant}$
	$n_h^{S(C\vartheta_C A\vartheta_A)} = \vartheta_C n_h^C + \vartheta_A n_h^A$	$0 \leq n_h^i \leq n_h^S$

Table III-2 Calculation assumptions

Hydration number is assumed as cumulative. Ionic hydration number is considered to be not affected by using different current intensities and salt composition as well as concentration.

Four different salts were selected and used in the ED experiments, making salt solutions of single salt and mixed ones (2 or 3 salts) as reported in Table II-4.

III.2 Salt and ion hydrations

III.2.1 Hydration number of salts

An example of the variations of the salt and water quantities transferred versus time in the case of single salt is shown in Figure III-1 for different current intensities.

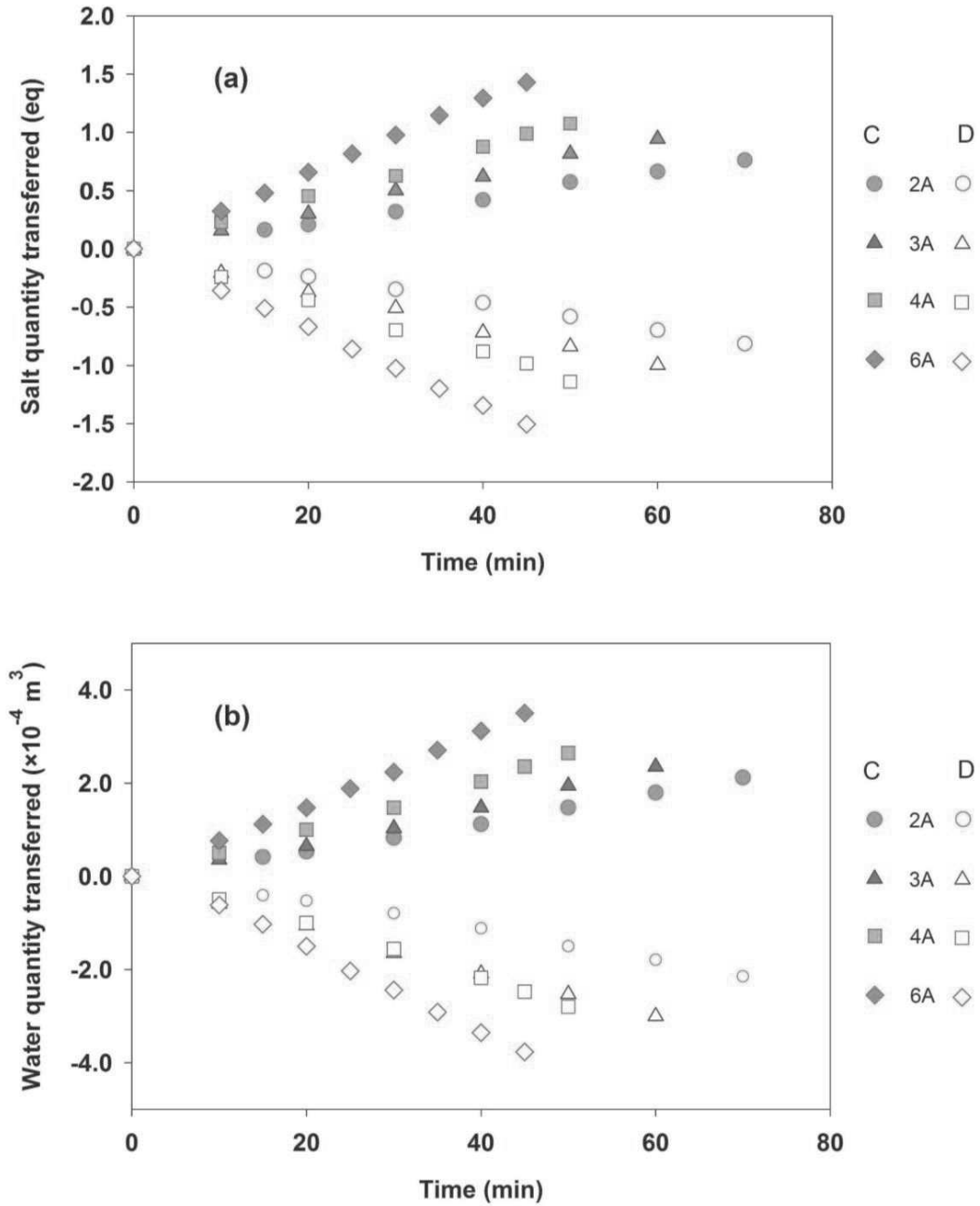

Figure III-1 Variation of the salt transfer (a) and water transfer (b) versus time
 Solution S1, $[\text{NaCl}] = 1 \text{ eq.L}^{-1}$; C for Concentrate, D for Diluate

Figure III-1 shows a simultaneous increase of both salt (a) and water (b) quantities transferred versus time from the diluate to the concentrate compartment. According to the mass balance, a decrease trend of salt and water quantities in the diluate compartment was found.

One can also observe in Figure III-1 that the transfer increases with the current intensity (2-6A). For each current, there is a linear variation of the salt and water transfer over time, which is in agreement with previous results [43,52-53,64]. Then the corresponding slopes provide the salt and water flux densities, the values of which are plotted on Figure III-2 versus the current, with S1 as example.

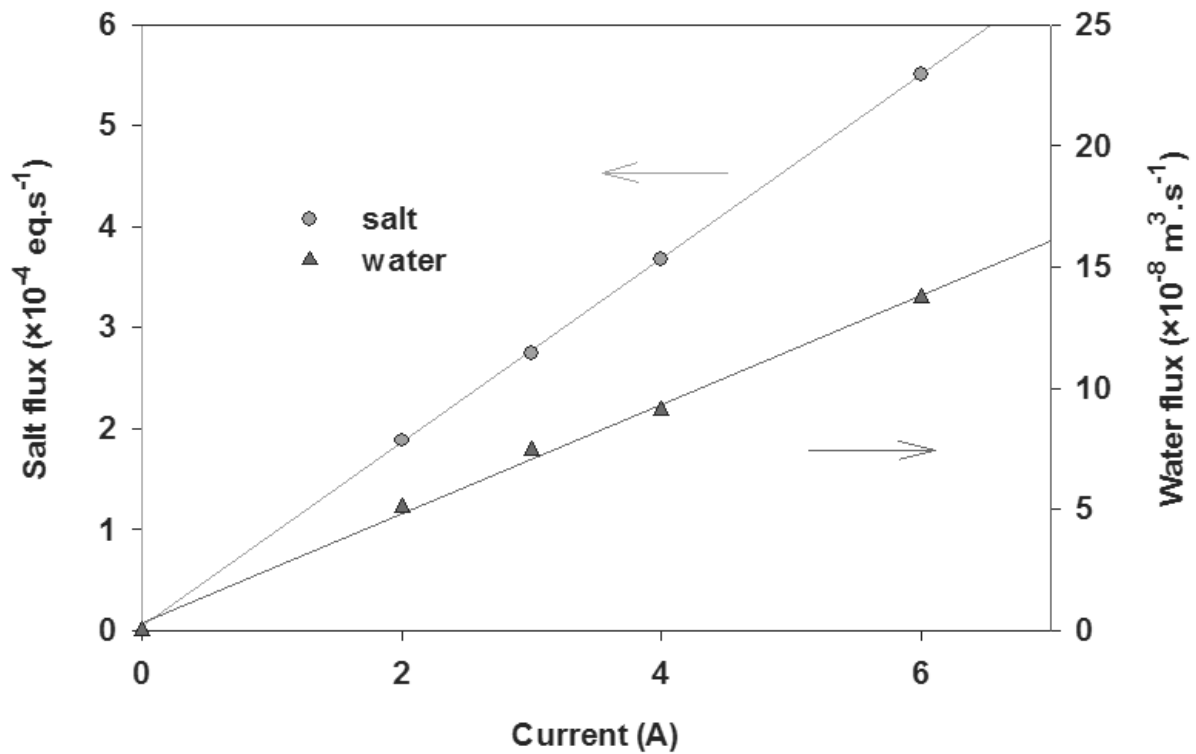

Figure III-2 Flux of salt and water versus current
Solution S1, $[\text{NaCl}] = 1 \text{ eq.L}^{-1}$

Figure III-2 demonstrates that the flux for both salt and water are proportional to the current. This confirms that under current, migration determines the salt transfer and electro-osmosis defines the water transfer, i.e. that the contribution of diffusion to the salt flux as well as that of osmosis to the water flux are negligible [43].

Then, according to Eqs. (II-5) and (II-7), the aforementioned coefficients α and β can be estimated from the linear variation of the salt and water transfer versus current, based on the corresponding slope. The salt hydration number can also be calculated based on these two coefficients according to Eq. (III-5). The results obtained for the different salts are reported in Table III-3.

Salt	NaCl	Na ₂ SO ₄	MgCl ₂	MgSO ₄
α ($\times 10^{-4}$ mol.m ⁻² .s ⁻¹ .A ⁻¹)	4.60	2.38	2.46	2.93
β ($\times 10^{-7}$ m ³ .m ⁻² .s ⁻¹ .A ⁻¹)	1.16	1.12	1.36	1.37
n_h^s (mol water / mol salt)	14.0	26.1	30.8	26.0

Table III-3 Transfer coefficient of salt (α), water (β) and salt hydration number (n_h^s)

The following trend for the salt hydration numbers of the 4 salts is obtained:

$$n_h^{NaCl} < n_h^{Na_2SO_4} \approx n_h^{MgSO_4} < n_h^{MgCl_2}.$$

These results can be compared with the ones obtained from experimental studies previously reported in the literature. For instance, the hydration number of NaCl is found to be 14 in this study. This is close the values of 11, 11.4 and 13 reported in comparable conditions [49,94-95]. However, much lower values like a hydration number as low as 5 were also reported but in different conditions [51,96]. This will be discussed later into more details. Concerning Na₂SO₄, the value of 26.1 obtained in this work is very close to 26, which is the value previously reported [94]. No value was reported for MgCl₂. However, Mg²⁺ is known to be more hydrated than Ca²⁺ [97] and a value of 29 was reported for the hydration number of CaCl₂ [95]. Then the value of 31 obtained in the present work seems to be in agreement with the one that can be expected. Finally, one can conclude that the values obtained in the present work are in good agreement with the ones previously reported in comparable conditions.

Knowing the salt hydration number(n_h^s), the upper limit of the ion hydration number can be fixed, as previously explained (see Table III-1). Then the range of values is reported in Table III-4.

n_h^i	Na ⁺	Mg ²⁺	Cl ⁻	SO ₄ ²⁻
Constraint	0 -27	0 -31	0 -31	0 -27

Table III-4 Input ion hydration number constraint

III.2.2 Hydration number of ions

The transfer of water and ions versus time obtained under different currents in mixed salts (containing at least 3 different ions) is shown in Figure III-3, with solution S5 (NaCl-Na₂SO₄ case, 3 ions included) as example.

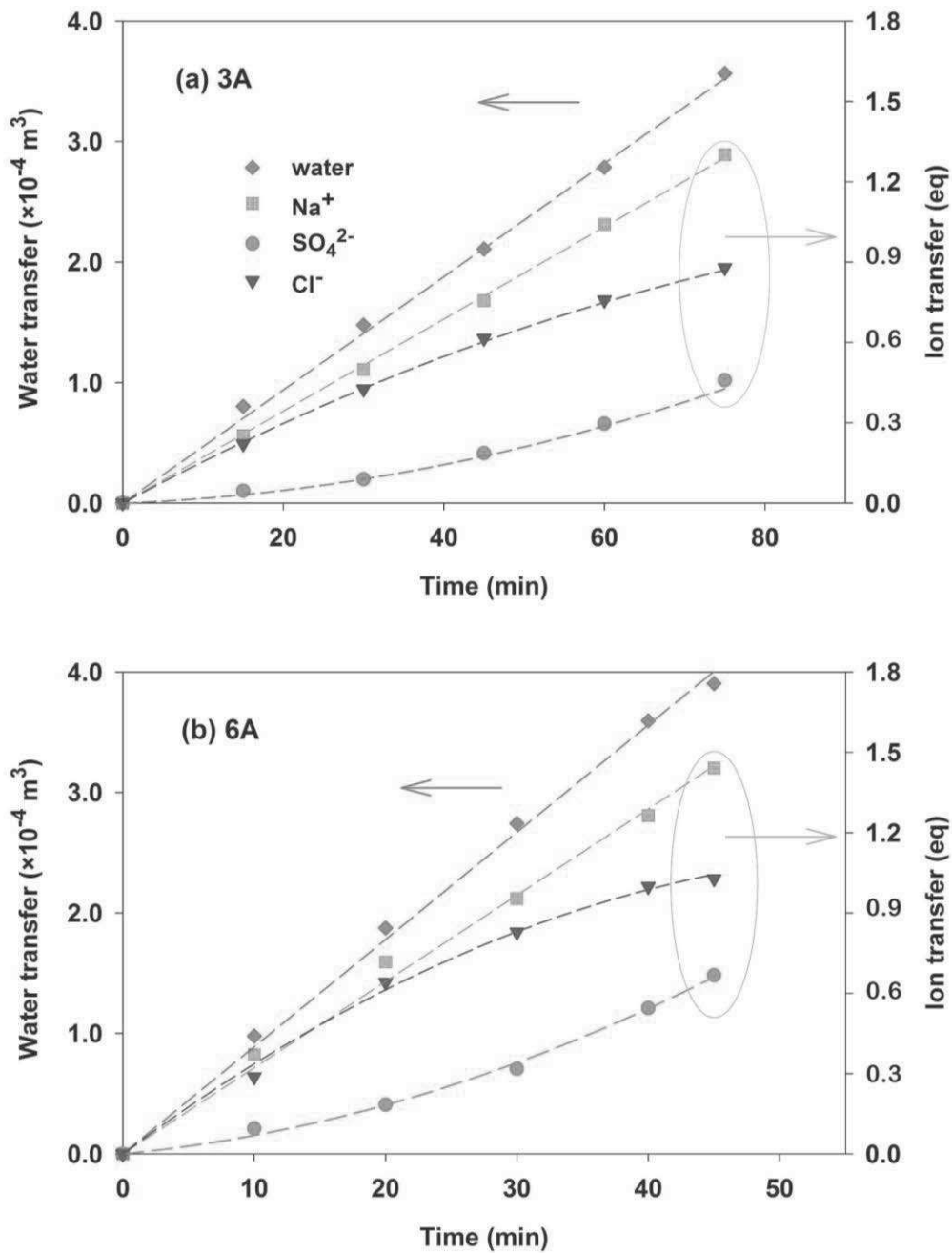

Figure III-3 Variation of the water and ion transfer versus time Solution S5, [NaCl] = [Na₂SO₄] = 0.5 eq.L⁻¹; I = 3A (a) and 6A (b)

For any current, one can observe a linear increase of the water transferred versus time, as observed in the case of single salt. The transfer of Na^+ varies also in a linear manner versus time. On the contrary, the transfer of the individual anions, Cl^- and SO_4^{2-} does not follow a linear trend. A selectivity between the anions is thus emphasized, as already reported with the same membranes [98]. Finally, in this study, only the anion selectivity was observed (solution S5,S8,S9,S10) while there was no such phenomenon for cations (Na^+ and Mg^{2+}).

In fact, for the calculation of the ion hydration number, mass transfer data under 4 different currents in all these experiments are mixed as an overall database. One can arrange all these data as function of the electrical charge (i.e. the product of current with time, as quantity of coulomb given to ED stack) [50]. Figure III-4 illustrates these transfer variations versus the electrical charge.

Figure III-4 (a) shows that the mass transfer data obtained under different currents are located on a single curve when plotted as function of the electrical charge, for Na^+ , Cl^- and SO_4^{2-} . Likewise, in Figure III-4 (b), one can observe that the water transfer is directly related to the electrical charge.

Moreover, it should be noted that although NaCl and Na_2SO_4 have variable composition ratio versus the electrical charge, because of the anion selectivity, and their hydration numbers are different (Table III-3), no visible influence is observed on the water transfer once considering the electrical charge. Indeed, salt hydration numbers in Table III-3 indicate that for an electrical driving charge of 1 equivalent, the number of moles for water transferred with NaCl is 14 while it is 13 (26/2) for Na_2SO_4 .

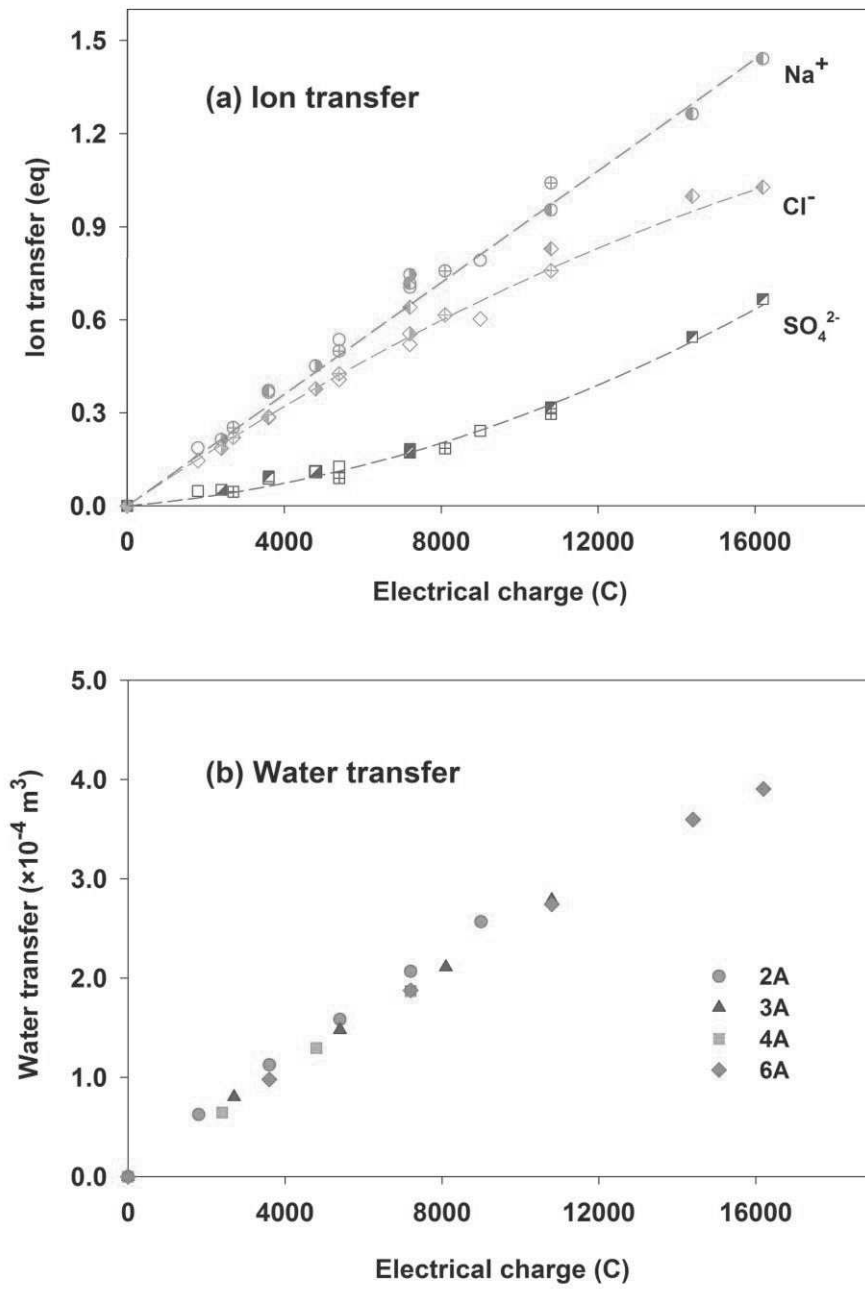

Figure III-4 Variation of the ion transfer (a) and water transfer (b) versus electrical charge Solution S5, $[\text{NaCl}] = [\text{Na}_2\text{SO}_4] = 0.5 \text{ eq.L}^{-1}$; symbol in (a): 2A (blank), 3A (cross), 4A (right solid), 6A (left solid)

Finally, following the method previously explained, it is possible to get the values of the ion hydration numbers knowing the values of the water and ion transfer determined experimentally.

The fitted values obtained for the 4 ions investigated are reported in Table III-5.

Na^+	Mg^{2+}	Cl^-	SO_4^{2-}
6	15-16	8	13-14

Table III-5 Calculated values of the ion hydration number n_h^i

The validation of the result is checked by comparing the calculated water transfer obtained according to Eq.(III-11) considering the hydration numbers reported in Table III-5 with the experimental one. For any condition (S1-S9), the difference does not exceed 7%.

To further check the robustness of the method and the values of the hydration numbers, another solution, S10, with a different ionic composition is used. On one hand, the experimental values of the ion and water transfer are plotted in Figure III-5(a) versus the electrical charge. On the other hand, the water transfer, m_w^{theo} , is calculated using the ion transfer and the values of the hydration numbers previously determined. The obtained values are reported in Figure III-5 (b). One can observe that there is a good agreement between these calculated values and the experimental ones (relative difference ca. 3%).

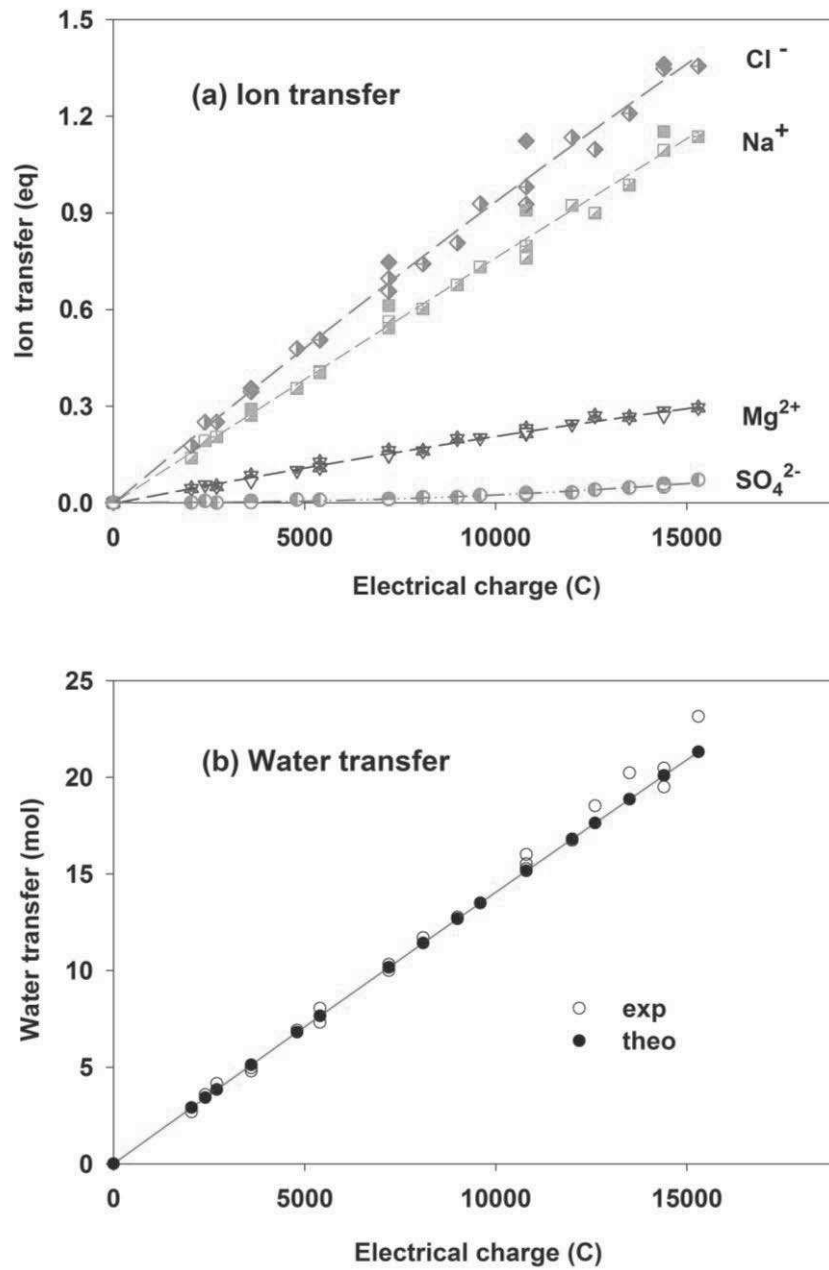

Figure III-5 Variation of the ion transfer (a) and the theoretical and experimental water transfer(b) versus electrical charge

Solution S10, $[\text{NaCl}] = 0.63 \text{ eq.L}^{-1}$, $[\text{Na}_2\text{SO}_4] = 0.08 \text{ eq.L}^{-1}$, $[\text{Na}_2\text{SO}_4] = 0.16 \text{ eq.L}^{-1}$; symbol in (a) indicating under different current as 2A (blank), 3A (cross), 4A (right solid), 6A (left solid)

It means that in the conditions of this study for a salt concentration up to 1 eq.L^{-1} , the hydration numbers of the individual ions do not change with the ionic composition or with the current intensity.

III.3 Discussion

It is further interesting to compare the ion hydration numbers obtained in this study with those reported in the literature. However, it is important to keep in mind that the literature values concern the hydration number of the ions in solution, while those obtained in this study are related to the ions transferring through the membranes. One can expect the hydration of the transferring ions to be lower than that in the solution.

Figure III-6 provides the values reported in the literature for the hydration number for each ion investigated in this work. More precisely, the plot shows the frequency distribution of the different values reported in the literature, concerning the 1st hydration shell, i.e. that in which the water molecules interact directly and strongly with the ion. The values of the hydration numbers obtained in this work are also indicated on the graph for comparison.

Figure III-6 shows a broad distribution of the reported values for each ion, 3 to 9 for Na⁺, 4 to 12 for Mg²⁺, 2 to 10 for Cl⁻ and 3 to 15 for SO₄²⁻. As already mentioned, this broad distribution comes from the different methods (experimental and computational ones based on various assumptions on the ion structure and water dynamic) used to get the hydration number [84,97]. Nevertheless, for any ion, the distribution shows a maximum, corresponding to the most frequently reported value. Then the hydration number for Na⁺ is about 6-7, a value similar to that for Mg²⁺ (6-7). For the anions, the hydration number of Cl⁻ is 6-9, while it is around 8 for SO₄²⁻.

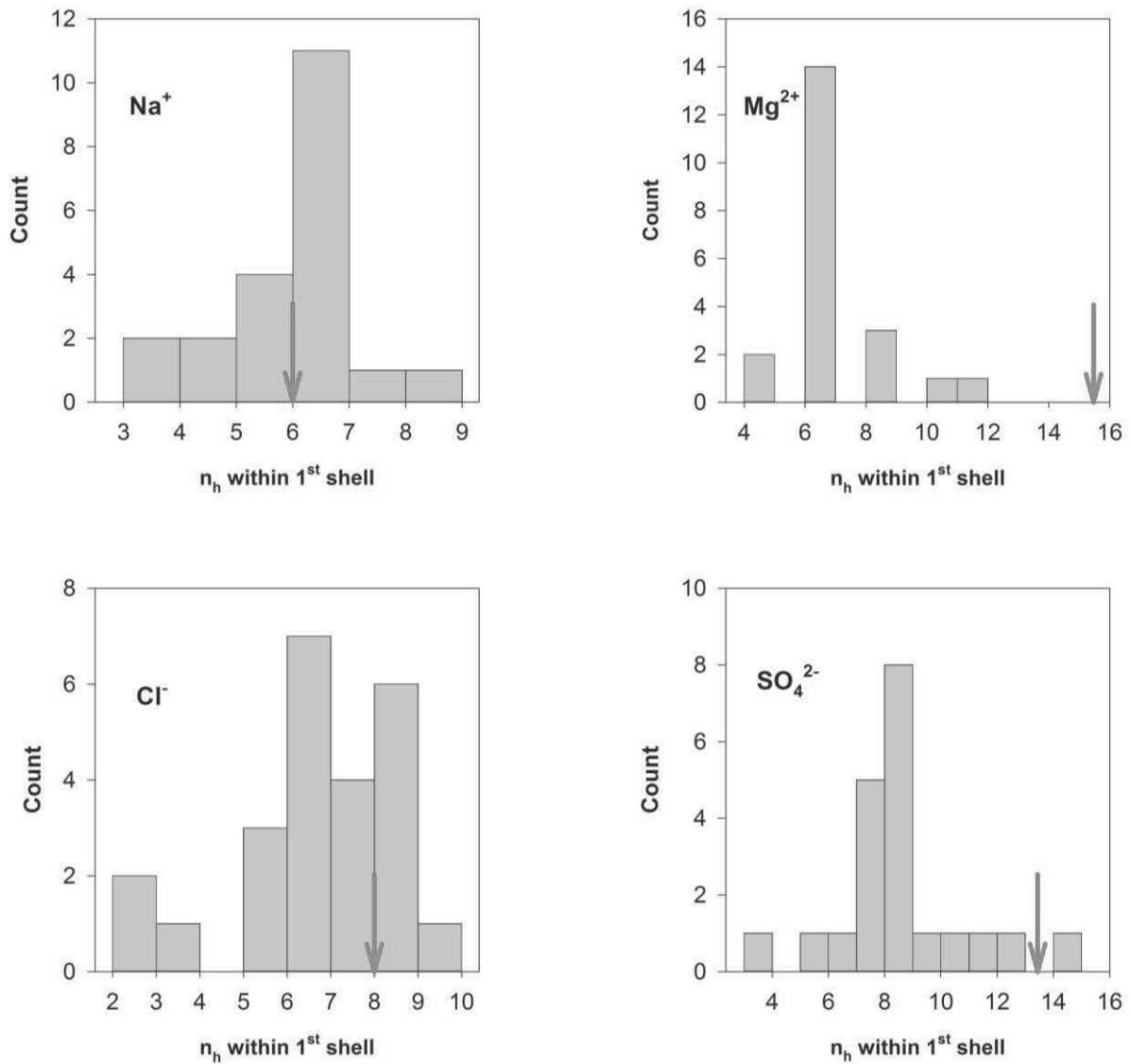

Figure III-6 Frequency distribution histogram of ion hydration number within 1st shell from literature [84,97]

Each value based on different methodology but same salt as in this study; arrows indicating the values obtained in this study

The values obtained in this work can be further compared to the ones reported. For monovalent ions (Na^+ , Cl^-), one can observe that the hydration number of the transferring ion obtained in this work is not only within the reported 1st shell distribution but also quite close to the most frequent value of the considered ion. On the contrary, the values obtained for divalent ions are higher than the most frequently reported values. In the case of SO_4^{2-} it is

close to the highest value reported in the literature for the 1st hydration shell, about 15. For Mg²⁺ it is still higher, around 16 while the highest reported value is around 12.

Other ionic characteristics, like ion charge density and hydration free energy for instance, are also interesting to characterize the ion hydration. For instance, the hydration energy represents the strength of the bound between the ion and its surrounding water. Then it can probably be linked to the variation of the hydration number of the ion while transferring through the membrane [99-100]. The values are reported in Table III-6 for the 4 ions considered in this study.

Parameter	Na ⁺	Mg ²⁺	Cl ⁻	SO ₄ ²⁻	Ref
Molar mass (g·mol ⁻¹)	23	24	35.5	96	
Valence (eq·mol ⁻¹)	1	2	-1	-2	
Hydration free energy (kJ·mol ⁻¹)	-375	-1838	-347	-1090	[97]
Hydration number (mol water/ mol ion)	6	15-16	8	13-14	this study

Table III-6 Calculated ion hydration number in this study and some other ionic characteristics

One can state that the hydration free energy of divalent ions, and thus the bonding strength of water and ion, is stronger compared to that of monovalent ones (3-5 times for anion and cation). In particular, the fact that Mg²⁺ has the highest value may also agree with its highest hydration energy among the considered ions.

Meanwhile, the fact that these transferring hydration numbers of monovalent ions approximate the values corresponding to the 1st hydration shell has to be pointed out. It means that in the conditions investigated, the water contained in the 1st hydration shell is transferred together with the ion through the membranes. But it also suggests that while transferring through the membranes, the ions are dehydrated, losing the water contained in their 2nd hydration shell. It is accepted that the 2nd shell's water molecules are weakly bonded and can more easily be reoriented and/or detached when ion is in motion, even in aqueous solution, compared with the 1st shell [97,101]. The very few data available regarding the 2nd hydration shell of ions can also be attributed to its weak strength and a consequently not well-defined hydration structure [84].

Concerning divalent ions, it is shown that the hydration number of the transferring ions is higher than the most frequent value corresponding to the 1st hydration shell. Especially for Mg²⁺ the hydration number of the transferring ion is about 15-16, while the only reported

value of hydration number of the 2nd hydration shell is about 12 [84], that of the first hydration shell ranging from 4 to 12 with the most frequent value about 6-7. Then, the results show that the Mg^{2+} transferring through the membrane carries more water than that comprised in its 1st hydration shell, i.e. also part of the water in its 2nd hydration shell.

These results show that the membranes used in this study have no significant influence on the hydration of the transferring ions, at least on their first hydration shell. It means that the water-ion interactions are dominant with respect to membrane-ion interactions. In fact, there is hypothesis that transfer through membrane depends on the comparison of ‘transport energy’ and the hydration energy that bonds the hydrated shell to the ion [30]. In ED, the ion migrates towards the membrane with current as driving force; the polymer matrix of the ion-exchange membrane may interact with the ion and serve as barrier to the ion transfer. Thus, one can imagine that with stronger membrane-ion interaction, stronger dehydration of the ions may happen. As a result, lower hydration numbers can be expected [51,96,101-102]. Indeed, lower salt hydration number of NaCl (4.5 [51] and 3.5 [96]) have been sometimes reported, compared with that (equal to 14) obtained in this study. Further comparison shows that the membranes used in these previous studies were selective IEM membranes for which lower electro-osmotic flux was observed [49]. As a result, the hydration number of the migrating ions, directly linked to the electro-osmotic flux as indicated in the present work, was lower.

Overall, attention should be paid to hydration of ions that fixes electro-osmosis and thus the performances of electrodialysis. Present work shows that mass transfer prediction in ED is possible knowing hydration number of ions, as shown in Figure III-5, which can be significant for process control, considering different kinds of applications like purification of fermentation broth or desalination/ concentration of brines [53].

III.4 Conclusions

The aim of this work was to investigate the transfer of salt and water during electrodialysis. The objective was to determine the water transfer due to electro-osmosis and the hydration number of ions transferring through ion-exchange membranes, since it is a key parameter with respect to the process performance.

A methodology was proposed to calculate these ion hydration numbers. It was based on the experimental measurements of ion and water transfer under different conditions, like salt composition and concentration and current. Salt hydration was first obtained, and then the individual hydration numbers of 4 transferring ions (Na^+ , Mg^{2+} , Cl^- , SO_4^{2-}) were

calculated simultaneously. It was shown that, in the conditions investigated, these hydration numbers are constant, independent from the salt composition and current. The hydration number for monovalent ions was found to be lower than that of divalent one, for cation and anion respectively. This is in agreement with the values of the hydration free energy, characterizing the strength of bond between the ion and its surrounding water. Further comparison with the reported values concerning the hydration of the same ions in solution demonstrated that for monovalent ions the hydration numbers are close to those reported for the 1st hydration shell while much higher values are obtained for divalent ions.

Chapter IV

Transfer mechanism of organic solute through ion-exchange membranes: influence of salt composition

Chapter IV: Transfer mechanism of organic solute through ion-exchange membranes:
influence of salt composition

This chapter investigates the transfer of organic solutes through ion-exchange membrane (IEM). Indeed, the mechanism controlling organic matter (OM) transfer through IEM was not systematically investigated yet, particularly in the presence of large quantity of salt such as in brine.

The transfer of neutral and charged organic solutes with different salt composition is investigated. The experimental procedure splits the total solute flux in two contributions, as diffusive transfer (without current applied) and an additional one (with current applied, i.e. in normal ED conditions). Moreover, the influence of the nature of the salt (particularly the ion hydration) on the transfer of organic solutes is reported.

Firstly, the salt and water transfer observed in presence of different OMs are investigated, and compared with those obtained without OM. Secondly, the transfer of neutral organic solutes is studied. Normally, it is controlled by solute-membrane interaction, and mainly by steric effects (size exclusion). The transfer of three different neutral organic solutes of varying characteristics like size, hydrophobicity (i.e. acetic acid, phenol, and glucose) is investigated with and without current. Thirdly, the transfer of a charged organic solute (acetate) is studied using the same kind of approach. The results are compared with those of the corresponding neutral solute (acetic acid). The solute-membrane interaction for acetate is more complex.

IV.1 Saline water containing neutral organic solute

In this part, salt and water transfer are firstly investigated. Then, transfer of neutral OM through IEM is investigated in two cases (without current and with current). In each case, the salt effect on the OM transfer is pointed out according to the counter-ion hydration level and the corresponding membranes (i.e. AEM and CEM).

IV.1.1 Salt and water transfer

In analogy with previous chapter, i.e. when no OM is contained in the saline solution, salt and water transfer is studied in this chapter for desalination of saline water containing organic solute. Then, the results with and without neutral OM are put in parallel for discussion.

Firstly, variations of the quantities of salt and water transferred versus time for different current intensities are shown in Figure IV-1.

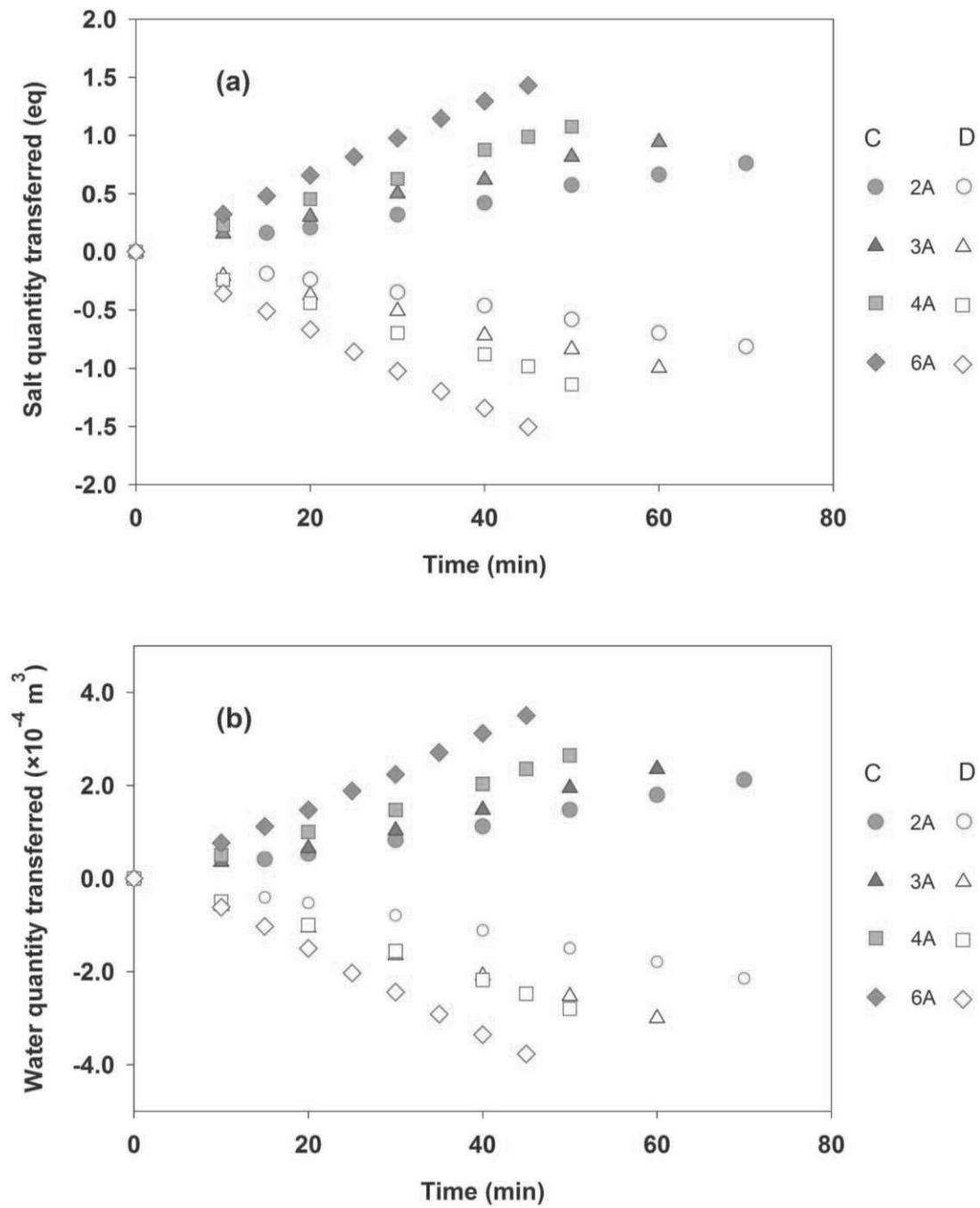

Figure IV-1 Variation of salt (a) and water (b) quantities transferred versus time:
influence of the current
Glucose / NaCl system, $[OM] = 0.1 \text{ mol.L}^{-1}$ and $[S] = 0.8 \text{ eq.L}^{-1}$; C for Concentrate, D for diluate

As expected, the quantity of salt (a) and water (b) transferred versus time are positive in the concentrate compartment while negative in the diluate compartment. It indicates that the direction of salt and water transfer is from diluate towards concentrate under current, seen in Figure IV-1. The mass balance is respected, with the difference below 5% for salt and 2% for water, calculated according to Eq.(II-1).

One can further observe that the quantities of salt and water transferred increase with the current intensity applied. Under each current, the salt and water transfer vary linearly versus time, which is in agreement with previous results [43,52-53,64]. Then, the salt and water fluxes are deduced from the corresponding slopes, and further plotted on Figure IV-2 versus current.

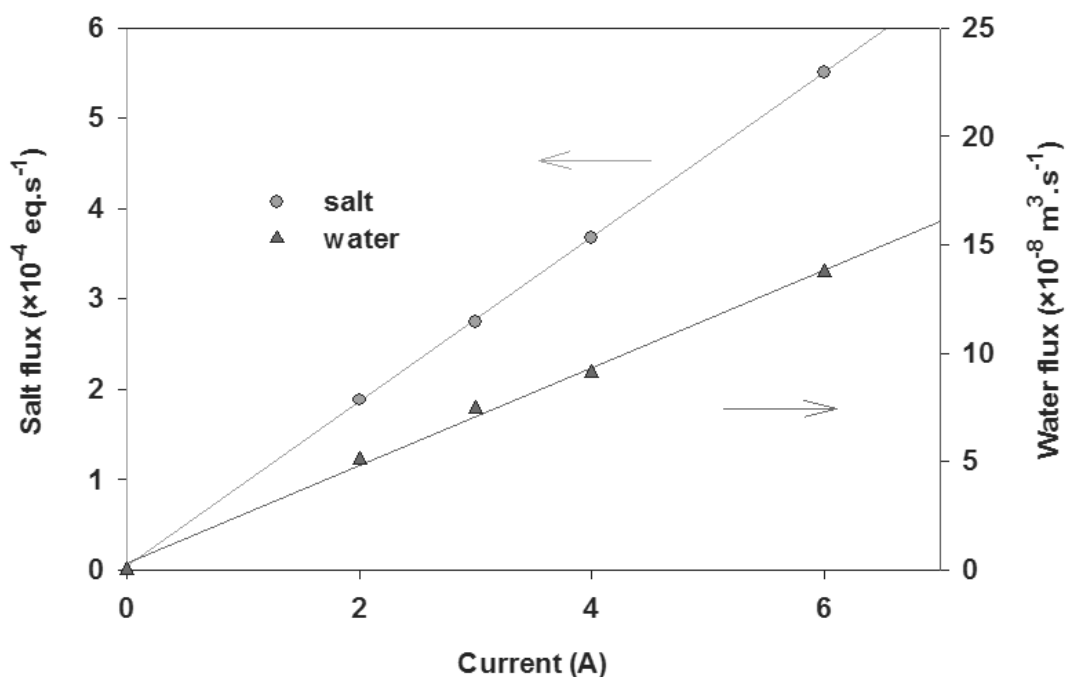

Figure IV-2 Variation of salt and water flux versus current
Glucose / NaCl system, $[\text{OM}] = 0.1 \text{ mol.L}^{-1}$ and $[\text{S}] = 0.8 \text{ eq.L}^{-1}$

Figure IV-2 shows that the variations of both salt and water flux are proportional to the current ($R^2 > 99\%$). This observation confirms that under current, electrical migration dominates the salt transfer as indicated by Eq.(II-5), and electro-osmosis dominates water transfer as indicated by Eq.(II-7). Then, the contribution of diffusion to the salt flux and that

of osmosis to the water flux are negligible [43]. These findings are observed for any condition investigated.

Then, deduced from the linear variation of the salt and water transfer versus current, the corresponding coefficients α and β can be obtained, according to Eq.(II-5) and (II-7). Values of current coefficients α for all the solutions investigated are reported in Table IV-1 and illustrated in Figure IV-3.

α $\times 10^{-4} \text{ eq.m}^{-2}.\text{s}^{-1}.\text{A}^{-1}$	acetic acid	phenol	glucose	no OM
MgCl₂	4.7	4.5	5.1	4.9
NaCl	5.1	4.5	5.0	4.6
Na₂SO₄	4.8	4.4	4.9	4.8

Table IV-1 Current coefficient (α , $\text{eq.m}^{-2}.\text{s}^{-1}.\text{A}^{-1}$) in different OM / S systems
[OM] = 0.1 mol.L⁻¹ and [S] = 0.8 eq.L⁻¹; calculated according to Eq.(II-5)

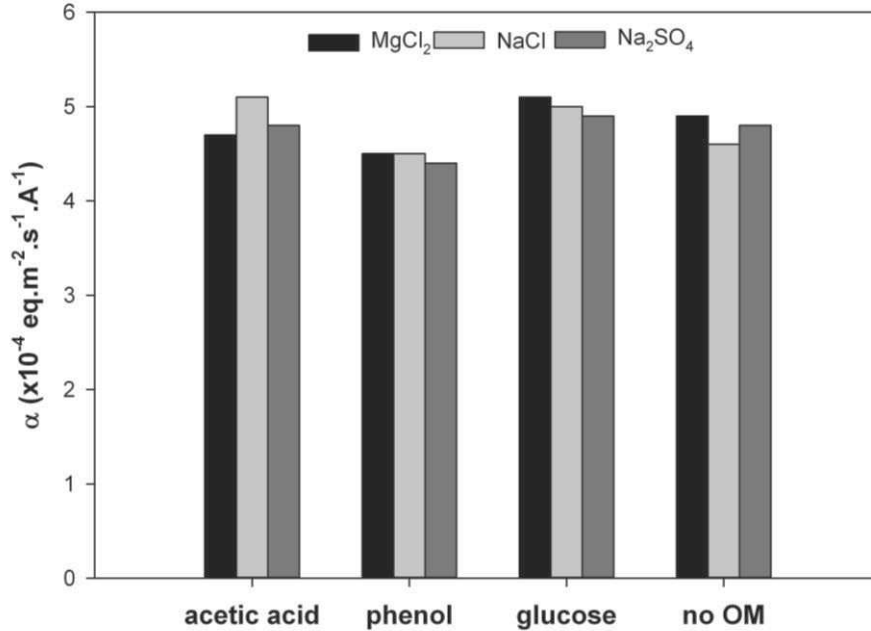

Figure IV-3 Histogram of current coefficient (α , $\text{eq.m}^{-2}.\text{s}^{-1}.\text{A}^{-1}$) in different OM / S systems
[OM] = 0.1 mol.L⁻¹ and [S] = 0.8 eq.L⁻¹; calculated according to Eq.(II-5)

One can find that for a given solute, the current coefficient α has very small variation according to the salt. This was already observed in case with no organic solute. This result is mainly due to the constant current applied, which fixes the total quantity of salt transferred .

Concerning the different solutes, values obtained with acetic acid and glucose are very close, and also close to those obtained without OM. For any salt composition, slightly lower values are obtained with phenol, compared to the two other solutes.

Then, the obtained electro-osmotic coefficients, characterising the water transfer, in different systems are reported in Table IV-2, and illustrated in Figure IV-4 .

β $\times 10^{-8} \text{ m}^3 \cdot \text{m}^{-2} \cdot \text{s}^{-1} \cdot \text{A}^{-1}$	acetic acid	phenol	glucose	no OM
MgCl ₂	7.0	6.1	6.6	6.8
NaCl	6.3	5.5	5.9	5.8
Na ₂ SO ₄	5.9	5.1	5.6	5.6

Table IV-2 Electro-osmotic coefficient (β , $\text{m}^3 \cdot \text{m}^{-2} \cdot \text{s}^{-1} \cdot \text{A}^{-1}$) in different systems
[OM] = 0.1 mol.L⁻¹ and [S] = 0.8 eq.L⁻¹; calculated according to Eq.(II-7)

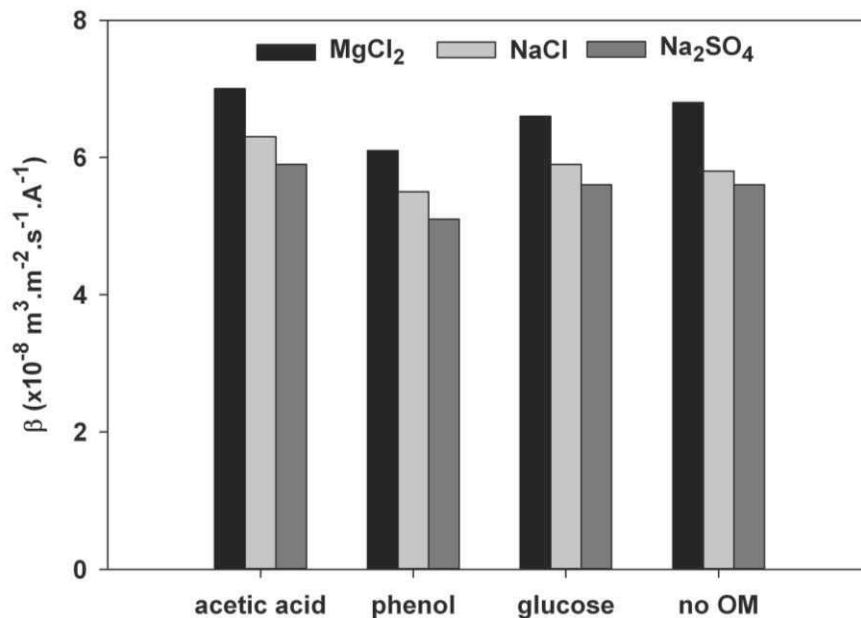

Figure IV-4 Histogram of electro-osmotic coefficient (β , $\text{m}^3 \cdot \text{m}^{-2} \cdot \text{s}^{-1} \cdot \text{A}^{-1}$) in different
OM / S systems

[OM]=0.1 mol.L⁻¹ and [S]=0.8 eq.L⁻¹; calculated according to Eq.(II-7)

For a given solute, one can observe that β varies according to the salt composition (variation ca. 30%). Moreover, for any solute, the same order of magnitude of β is observed according to the salt as:

$$\beta_{MgCl_2} > \beta_{NaCl} > \beta_{Na_2SO_4}$$

Concerning different OMs, Table IV-2 shows that the values with acetic acid and glucose are close, and approximating those obtained in case without OM (difference below 8%). Again, the values obtained with phenol are systematically slightly lower (difference below 12%).

As demonstrated in Chapter III, the coefficient β characterizes the water transfer due to electro-osmosis, i.e. the water accompanying the salt migration. Then, the ratio between water and salt transfer, calculated as β / α , characterizes the salt hydration, as explained in Chapter III. The values of this ratio obtained for the different systems are reported in Table IV-3.

β / α $\times 10^{-4} \text{ m}^3 \cdot \text{eq}^{-1}$	acetic acid	phenol	glucose	no OM
MgCl₂	1.5	1.3	1.3	1.4
NaCl	1.2	1.2	1.2	1.3
Na₂SO₄	1.2	1.2	1.2	1.2

Table IV-3 Ratio of water and salt transfer (β / α , $\text{m}^3 \cdot \text{eq}^{-1}$) in different OM / S systems
[OM]=0.1 mol.L⁻¹ and [S]=0.8 eq.L⁻¹

It shows that for a given salt, very close values of β / α are obtained for the different solutes. Even if the respective value α and β with phenol is slightly lower, as aforementioned, the ratio is found close to results for the two other solutes. Moreover, the results indicate that the salt hydration is constant with and without the neutral OM and for any organic solute.

Thus, these findings of salt and water transfer in presence of OM coincide with the results obtained without OM. It suggests that the presence of organic solute (of different nature, i.e. size, hydrophibility, solution pH) doesn't affect significantly the salt and water transfer in the conditions investigated here.

IV.1.2 Neutral organic solute transfer

As discussed previously in the theoretical part, the transfer of organic solutes is studied in two conditions: without current ($I=0$) and with current ($I\neq 0$). In fact, the transfer of neutral organic solutes through IEM without current corresponds to the diffusion. Then, in normal ED conditions ($I\neq 0$), a total flux consisting of diffusion and additional flux is observed (see chapter II). Thus, dedicated experimental procedures are proposed to determine the diffusion flux, the additional and total flux. The solute-membrane interactions controlling the transfer of organic solutes as well as the impact of the salt are also discussed.

In this part, the transfer of organic solutes without current is firstly investigated; then the following study is on OM transfer with current [64].

IV.1.2.1 Transfer of neutral organic solute without current

In the diffusion regime, experiments are carried out using water and salt solution as two different solvents, respectively [63]. Transfer of organic solutes in water system (W) is affected only by interaction between the solute and the membrane, which is well pre-soaked by the counter-ion. Thus, OM / W system is to highlight the membrane soaking effect due to different counter-ion on the diffusion of the solute.

Then in salt system (S), the transfer of organic solutes results from both effects due to the membrane (i.e. membrane soaking) and the additional salt in aqueous solution. Thus, OM / S system is to study the overall impact of the salt on the transfer.

Firstly, the observed variation of organic solute diffusion transfer is shown in Figure IV-5, using example of glucose / NaCl system (OM / S system).

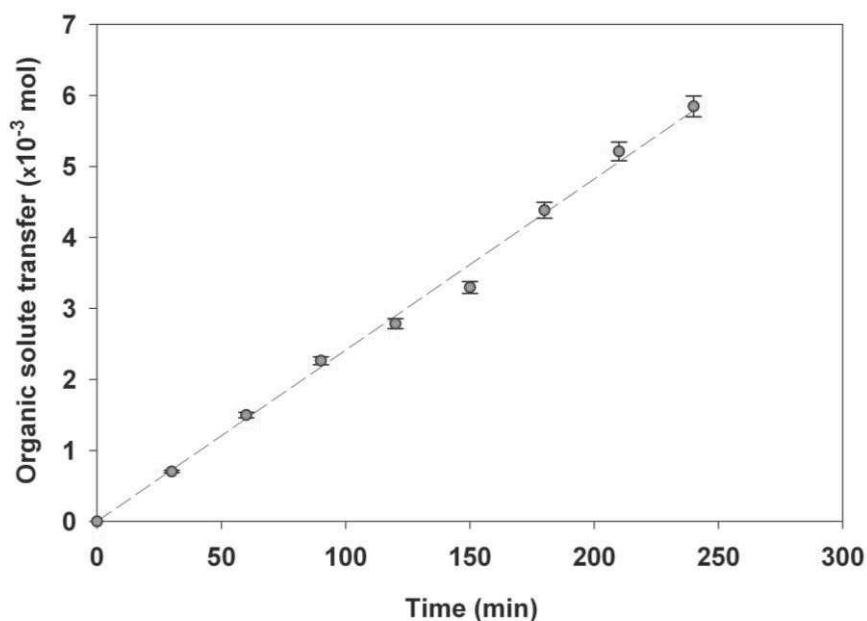

Figure IV-5 Variation of organic solute quantity transferred versus time
Glucose / NaCl system, $[OM] = 0.1 \text{ mol.L}^{-1}$ and $[S] = 0.8 \text{ eq.L}^{-1}$

Figure IV-5 shows a linear increase of OM quantity transferred in the concentrate compartment versus time, with decreasing OM quantity in the diluate compartment (results not shown). It agrees with the aforementioned transport phenomena that a diffusion flux is due to the concentration gradient of solute across the membrane. Since the solute concentration gradient in this study is approximately constant (variation less than 10%), thus the variation of OM transfer is proportional to experiment time ($R^2 > 98\%$). The same finding is observed for any solution investigated in this work.

In this manner, the OM diffusion flux through IEM in different systems is obtained. Then, the diffusion results are reported, in the section of the OM / W and the OM / S. As aforementioned, the two systems concerning solute diffusion are carried out for two different objectives. Thus, the following discussion is first on the OM / W system, then on the OM / S system.

Transfer of neutral organic solute in OM / Water system

As aforementioned, the OM / W system is to investigate the effect of solute-membrane interactions on one hand, and the counter-ion effect on membrane soaking on the other hand on the transfer of the organic solute.

j_{OM}^{diff}	OM / W		
	acetic acid	phenol	glucose
$\times 10^{-6} \text{ mol.m}^{-2}.\text{s}^{-1}$			
NaCl	7.5	7.3	1.1
MgCl ₂	7.2	---	1.0
Na ₂ SO ₄	6.9	4.5	0.9

Table IV-4 OM diffusion flux density in different OM / W systems
[OM] = 0.1 mol.L⁻¹

Table IV-4 compares the diffusion flux of three neutral solutes in pure water (i.e. OM / W system), given the membrane soaked according to different salt.

For a given salt, the same sequence of the solute diffusion flux can be drawn as:

$$j_{acetic\ acid}^{diff} > j_{phenol}^{diff} > j_{glucose}^{diff}$$

Indeed, the results show the diffusion flux densities vary ca. 7 folds among different solutes e.g. from glucose ca. $1.0 \times 10^{-6} \text{ mol.m}^{-2}.\text{s}^{-1}$ to acetic acid ca. $7.5 \times 10^{-6} \text{ mol.m}^{-2}.\text{s}^{-1}$.

Then, for any organic solute, one can find a same sequence according to the salt as:

$$j_{OM}^{diff}(NaCl) > j_{OM}^{diff}(MgCl_2) > j_{OM}^{diff}(Na_2SO_4)$$

The values reported in Table IV-4 are further plotted for discussion in Figure IV-6.

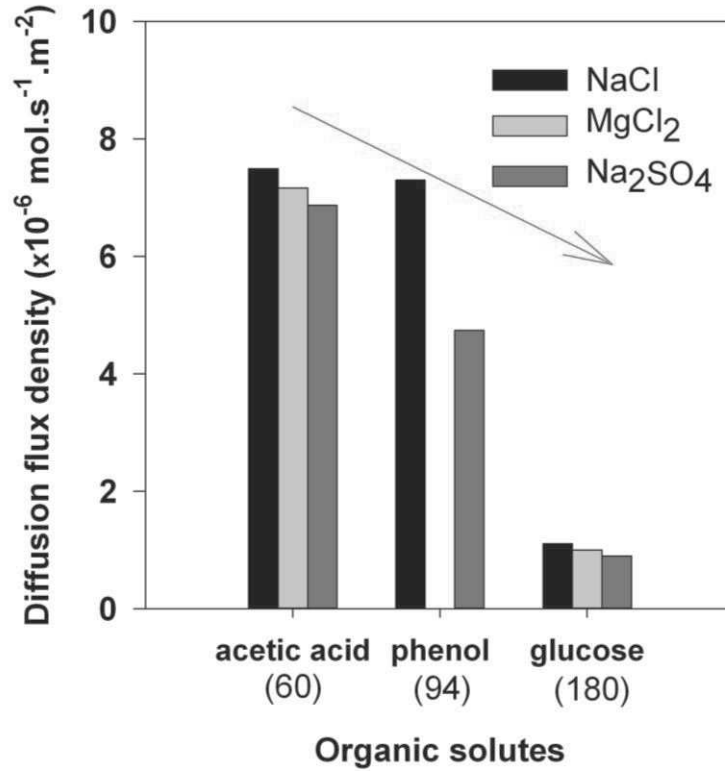

Figure IV-6 Variation of OM diffusion flux density in different OM / W systems
[OM] = 0.1 mol.L⁻¹; solute molecular weight (Mw) shown in bracket (unit: g.mol⁻¹)

Figure IV-6 shows a decreasing trend of solute diffusion flux for increasing solute Mw. One can conclude that the finding on the three neutral OMs is in accordance with steric effects, indicating that steric effects is the dominant solute-membrane interaction in this study.

Furthermore, the mechanism of solute diffusion through a polymeric membrane was reported to follow a “scale law”. It means that the correlation between the solute diffusion coefficient and its Mw can be expressed as:

$$D \propto \frac{1}{M_w^\delta} \quad (\text{IV-1})$$

where D is the solute diffusion coefficient through the membrane, Mw is the solute molecular weight as previous mentioned. δ is a coefficient linked to the diffusion mechanism, with value reported as 2-3, indicating solute reptation in swollen membrane [103].

One can consider that the apparent diffusion coefficient (D) is proportional to the observed flux (j_{OM}^{diff}), given a fixed solute concentration in this work. Thus, the above expression can be further written as:

$$j_{OM}^{diff} \propto \frac{1}{M_w^\delta} \quad (IV-2)$$

Then, logarithm is used for both diffusion flux and solute M_w , which gives

$$\ln(j_{OM}^{diff}) \propto \delta \ln(M_w) \quad (IV-3)$$

Eq. (IV-3) means that the logarithm of the diffusion flux is expected to vary linearly with the logarithm of solute M_w , with δ as the slope of the straight. Then, the results obtained in OM / W system are plotted in Figure IV-7. Data from previous work obtained with xylose, glucose and sucrose are also plotted for comparison.

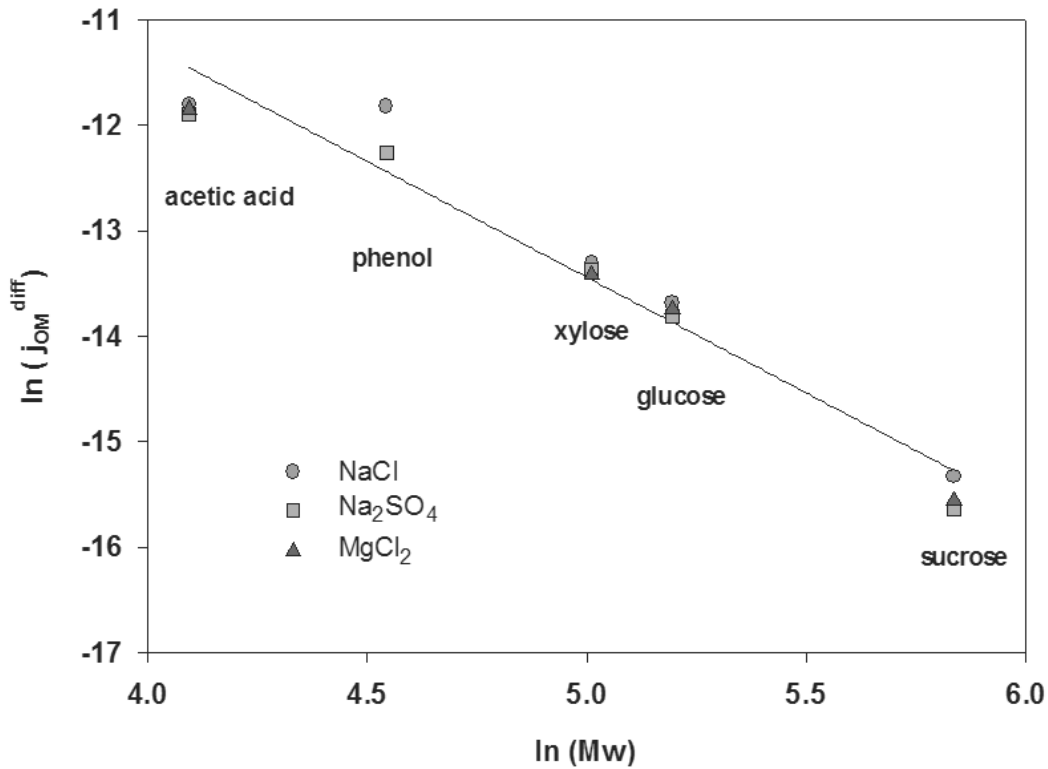

Figure IV-7 $\ln(j_{OM}^{diff})$ versus $\ln(M_w)$ in different OM / W systems: influence of solute size $[OM] = 0.1 \text{ mol.L}^{-1}$; data of xylose, sucrose are from ref [104] ; straight line obtained from average results for each solute

For any soaking salt, a value of δ ranging between 2-3 for each corresponding straight line is obtained (i.e. 2.1 for $MgCl_2$, 2.2 for Na_2SO_4 , 2.2 for $NaCl$), which agrees with the reptation theory [62]. Because of such similar values, all the results can be represented by a

single straight, as plotted on Figure IV-7. These results indicate that in the conditions investigated, the steric effects governs the diffusion transfer of neutral solutes.

On the other hand, the salt influence on the diffusion of organic solutes is noticeable in this study, seen in Table IV-4. The results are further illustrated, showing normalized value, i.e. the ratio of the flux obtained with one salt over that obtained with NaCl, in Figure IV-8:

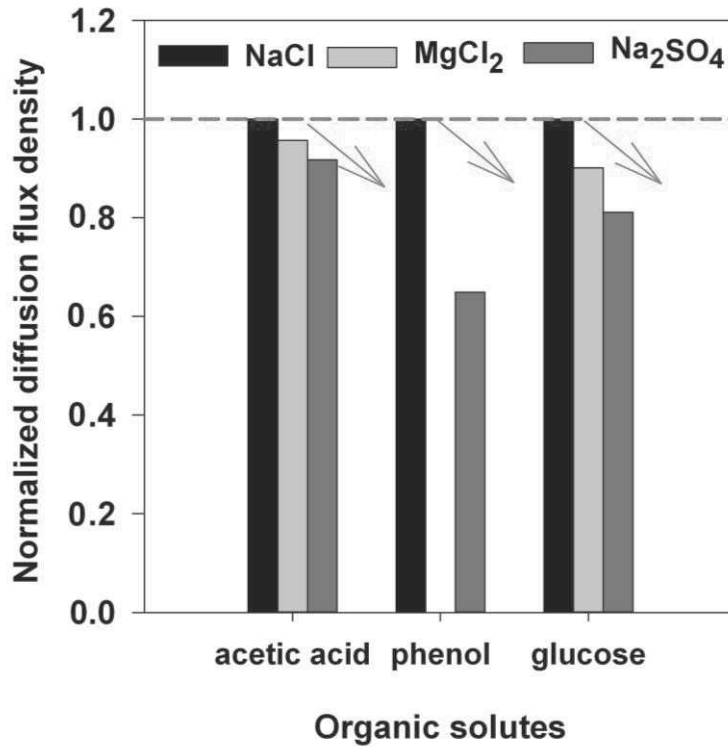

Figure IV-8 Normalized diffusion flux versus salt in different OM / W systems
[OM]=0.1 mol.L⁻¹

Considering the salt effect, Figure IV-8 shows the same sequence of normalized diffusion flux for the three OMs as:

$$j_{OM}^{diff}(NaCl) > j_{OM}^{diff}(MgCl_2) > j_{OM}^{diff}(Na_2SO_4).$$

It is noteworthy that the observed OM flux in this study is the sum of flux through two different membranes (AEM and CEM), having different soaking conditions owing to different counter-ions. It is then difficult to compare two salts having no common ion, i.e. MgCl₂ and Na₂SO₄ for instance. Thus, considering the salt effect or more precisely the counter-ion effect, the previous flux sequence with different salt is further split, for cation and anion respectively:

$$\text{Cation: } j_{OM}^{diff}(\text{NaCl}) > j_{OM}^{diff}(\text{MgCl}_2)$$

$$\text{Anion: } j_{OM}^{diff}(\text{NaCl}) > j_{OM}^{diff}(\text{Na}_2\text{SO}_4)$$

For example, the difference of the flux obtained with NaCl and MgCl₂ can be mainly ascribed to the different transfer through the CEM, considering an identical transfer through the AEM. Knowing the CEM counter-ion's hydration level as $\text{Na}^+ < \text{Mg}^{2+}$, one can state that Mg²⁺, as more hydrated counter-ion, results in lower diffusion flux compared to Na⁺ through CEM. Accordingly, for AEM, more hydrated counter-ion, i.e. SO₄²⁻, leads to lower flux, compared with Cl⁻. These results show that the sequence of diffusion flux through specific IEM is reversed to counter-ions' hydration level. More hydrated counter-ion results in lower flux.

These results agree with the finding from quantitative correlation between ion hydration and transfer of saccharide through AEM and CEM obtained in previous work carried out in our group [63,104]. Given the membrane equilibrated by the more hydrated counter-ion, lower transfer for both the water and sugar was found ($\text{Mg}^{2+} < \text{Ca}^{2+} < \text{Na}^+ < \text{NH}_4^+$ and $\text{SO}_4^{2-} < \text{Cl}^-$). It was further reported that these transfer variations at macroscopic scale indicate membrane modification, i.e. changes in the membrane structural properties at microscopic scale such as the free volume.

In fact, this membrane modification arises from the swelling mechanism at a microscopic scale, particularly studied in case of ion-exchange resins [73-74] and Nafion membrane [75]. Ion exchanger usually expands or swells in presence of solvent, due to the combination of different phenomena such as the solvation of fixed and mobile ions, the osmotic pressure difference between the solution inside and outside the ion exchanger and the electrostatic repulsion between the fixed ionic groups [73]. Specifically, it is reported that more hydrated counter-ion leads to a decrease of the free-water content or the free volume of the membrane [63,73-74]. Then, according to these experimental results, one can link the ion hydration and solute / solvent transfer: a more hydrated counter-ion is expected to reduce the free volume in the membrane material, and thus to decrease the transfer. However, the contribution of the free volume to solute transfer is not well documented, and the role of other factors like the solute solubility inside the membrane polymer is unclear.

Then, a recent computational investigation further explains the membrane modification at the molecular level, using glucose as a model of neutral organic solute and

same type of CMX as reported in the present work [105]. The computed glucose-polymer fragment interactions, related to the glucose solubility inside the membrane, were found to be almost independent from the membrane counter-ion. On the contrary, significant variations of the chain-chain interaction, i.e. the interaction energies per trapped water molecule or hydrogen bonding wire connecting the polymer fragments, were observed according to the counter-ion. The computational result can well correlate the experimental sugar fluxes in different solutions: increasing chain-chain interaction inside the membrane was found to give decreasing sugar flux. Thus, it is concluded that the polymer chain-chain interactions which are very sensitive to the counter-ion, govern the solute transfer.

This confirms that the present variation of organic solute transfer is due to the salt induced membrane modification. Therefore, in OM / W system, for a given membrane soaking, diffusion of organic solute is mainly fixed by steric effects. Moreover, the diffusion flux is influenced by the salt composition through membrane soaking, i.e. modification of the membrane structural properties at the microscopic scale.

Transfer of neutral organic solute in OM / Salt system

The study in OM / S system is to investigate the further influence of the presence of salt in aqueous solution on the diffusion of organic solutes, additionally to that mentioned in OM / W system (influence of salt on membrane).

The diffusion results in OM / S system are reported in Table IV-5, in comparison with OM / W systems.

j_{OM}^{diff} $\times 10^{-6} \text{ mol.m}^{-2}.\text{s}^{-1}$	OM / S			OM / W		
	acetic acid	phenol	glucose	acetic acid	phenol	glucose
NaCl	8.1	7.5	1.2	7.5	7.3	1.1
MgCl ₂	7.4	6.8	1.1	7.2	---	1.0
Na ₂ SO ₄	7.0	4.5	1.0	6.9	4.5	0.9

Table IV-5 Organic solute diffusion flux density in different OM / W and OM / S systems
[OM] = 0.1 mol.L⁻¹ and [S] = 0.8 eq.L⁻¹

Table IV-5 compares the diffusion flux of three neutral solutes in a saline solution (i.e. OM / S) and in pure water (i.e. OM / W), with different salts. The similar finding observed in OM / S compared to OM / W systems are firstly pointed out.

Concerning different OMs, for a given salt, the same sequence of the solute diffusion flux can be drawn as

$$j_{acetic\ acid}^{diff} > j_{phenol}^{diff} > j_{glucose}^{diff}$$

Indeed, the results show that the diffusion flux densities vary ca. 8 folds among different solutes in OM / S systems, e.g. from glucose ca. $1.0 \times 10^{-6} \text{ mol.m}^{-2}.\text{s}^{-1}$ to acetic acid ca. $8.0 \times 10^{-6} \text{ mol.m}^{-2}.\text{s}^{-1}$.

Then, concerning different salts, one can state a same sequence of salt effect on each OM as

$$j_{OM}^{diff}(NaCl) > j_{OM}^{diff}(MgCl_2) > j_{OM}^{diff}(Na_2SO_4).$$

Finally, comparing the two systems, i.e. OM / S and OM / W, one can find that even if the values observed in these two systems are not very different (variation below 10%), those in OM / S system are systematically higher than those in OM / W system

Then, in same manner with the study in OM / W system, the results in Table IV-5 in different OM / S systems are illustrated.

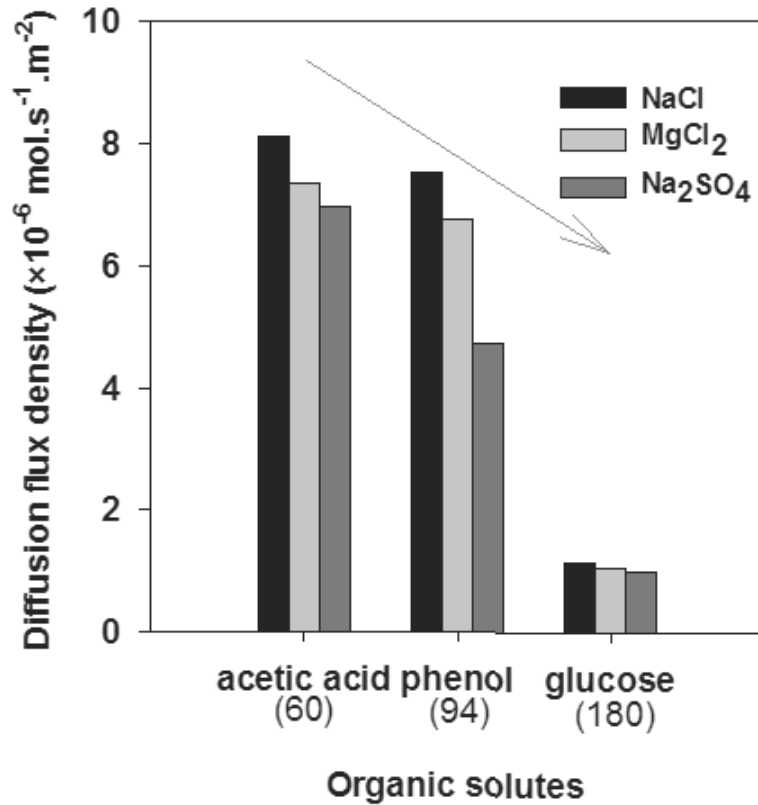

Figure IV-9 Variation of OM diffusion flux density in different OM / S systems:
influence of solute size
[OM] = 0.1 mol.L⁻¹ and [S] = 0.8 eq.L⁻¹; solute molecular weight (Mw) shown in bracket
(unit: g.mol⁻¹)

Figure IV-9 shows a decreasing trend of the solute diffusion flux with increasing solute Mw. One can consider that the steric effect fixes the diffusion in OM / S systems. Indeed, in same manner as with OM / W systems, a linear relationship of $\ln(j_{OM}^{diff})$ versus $\ln(Mw)$ is found in different OM / S systems, with the value of the slope ranging 2-3 (results not shown). It confirms the role of the steric effects in diffusion of neutral solute, with or without salt.

Then, concerning the influence of salt, normalized diffusion flux are plotted for different systems, using the solute diffusion flux with NaCl as reference.

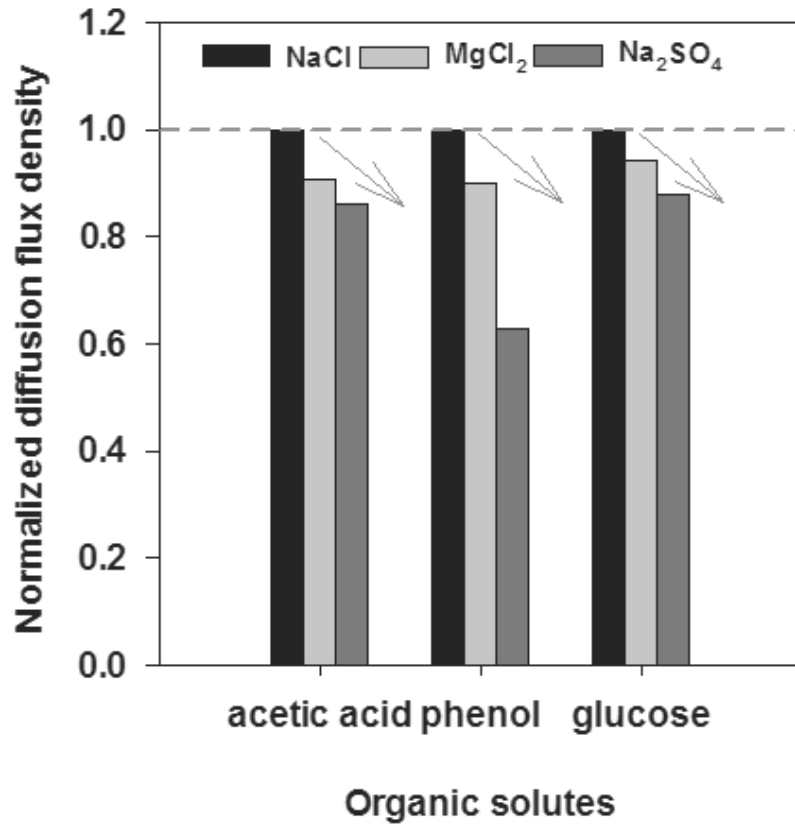

Figure IV-10 Normalized diffusion flux density versus salt in different OM / S systems:
influence of the salt compositions
[OM]=0.1 mol.L⁻¹ and [S]=0.8 eq.L⁻¹

Then, for any organic solute, an identical sequence of solute diffusion flux according to the salt nature is obtained as

$$j_{OM}^{diff}(NaCl) > j_{OM}^{diff}(MgCl_2) > j_{OM}^{diff}(Na_2SO_4)$$

These findings are in agreement with the results obtained in OM / W system. It suggests the diffusion flux is further modified by the different salt composition.

In fact, concerning the influence of salt, the present results for three solutes in OM / S system are in agreement with previous finding in saccharide / salt system [63,104]. Specifically, the same counter-ion effect on diffusion flux sequence is observed ($Na^+ > Mg^{2+}$ and $Cl^- > SO_4^{2-}$). In addition, regarding the salt nature, similar finding with other neutral solutes which coincides with the present results were also reported, i.e. diffusion coefficient of neutral boron for various cations on CEM, having sequence as $K^+ > Na^+ > Ca^{2+} > Mg^{2+}$ [92,106] and that of arsenite ($K^+ > Na^+ > Ca^{2+}$) [106]. Thus, one can state that more hydrated

counter-ion induces lower solute diffusion flux in OM / S system. This will be further discussed later.

Another result shown in Table IV-5 is that values with presence of salt (i.e. OM / S) are systematically higher compared to those obtained with water (i.e. OM / W). As aforementioned, steric effects is the dominant interaction governing the neutral solute diffusion through the membrane. Then, variation of solute transfer can be ascribed to the variation of size for solute and/or membrane. As the membrane soaking is the same in both OM / W and OM / S systems, same membrane properties (i.e. membrane swelling) can be assumed. Thus, the results (the observed diffusion variation in two systems) suggest the variation of solute properties, i.e. modification in OM / S system compared to that in OM / W system.

Indeed, as previously discussed, study on OM / W and OM / S systems have different objectives, i.e. the former for membrane impact, and the latter for the overall (membrane and additional impact). Then, the modification of solute properties can be ascribed to the additional salt effect in aqueous solution. Furthermore, it can be stated that the additional salt in OM / S leads to the decrease of solute size, thus higher transfer compared with OM / W system.

The present finding is in agreement with previous ones obtained during electro dialysis [46,63] as well as nanofiltration experiments [65-70], showing that the transfer of a neutral solute is increased by the addition of salt. Moreover, the solute dehydration by the salt is reported in the work of Boy et al [11]. In that investigation concerning sugar / water and sugar / salt systems, the sugar hydration state was characterized using the physicochemical parameter, i.e. the apparent molar volume. It was then observed that sugars are less hydrated in presence of more hydrated ions and with increasing amount of salts. It was thus concluded that the increase of sugar transfer observed in nanofiltration in OM / S system is due to the resultant solute dehydration.

Therefore, the present results agree with the solute dehydration assumption.

However, it is noteworthy that the transfer increase (variation between OM / W and OM / S systems) due to solute dehydration is small, indicating this dehydration effect is not so important. It is in accordance with the result on sugar diffusion through same IEM, showing that solute transfer is fixed mainly by membrane soaking rather than solute dehydration [104]. The same sequence of salt effect on diffusion is hereby observed in both OM / S and OM / W, coinciding with the main contribution of membrane soaking.

Therefore, in the present work, diffusion results of three OMs in different solutions not only highlight the steric effects, but also confirm the influence of salt: the higher counter-ion hydration, the lower the diffusion flux, through CEM and AEM, respectively. The influence of salt is found on membrane (to modify the structure properties due to swelling), and on solute in solution (to modify the solute hydration level due to dehydration). Nevertheless, the solute transfer modification with different salt is mainly due to the membrane swelling, while the OM dehydration is not important. Finally, all these modifications apply to different solutes.

Previous work was conducted mainly with saccharide as neutral OM. In the present study, experiments are carried out with neutral solutes of different properties, which is of interest regarding different complex fluids. Specifically, one would expect different behavior with phenol, which is a hydrophobic solute. However, not only phenol diffusion respects the steric effects (i.e. compared to acetic acid and glucose), but also the influence of salt on neutral solute transfer is found applicable to phenol, like the hydrophilic solutes. More hydrated counter-ion leads to lower phenol diffusion, and increase concentration of salt lead to higher phenol transfer. In addition, in case of acetic acid, where the system is under acidic condition, the findings agree with those under neutral pH condition (for phenol and glucose).

IV.1.2.2 Transfer of neutral organic solute with current

In this part, ED experiments, i.e. desalination of various solutions containing organic solutes and salts, are conducted under four different applied currents. As aforementioned in the case of diffusion OM / S, the overall impacts of membrane swelling and solute dehydration are expected to be concerned for the transfer of organic solutes with current.

Firstly, the variations of the organic solute quantity transferred versus time for the different applied current are plotted in Figure IV-11, using glucose / NaCl system as an example:

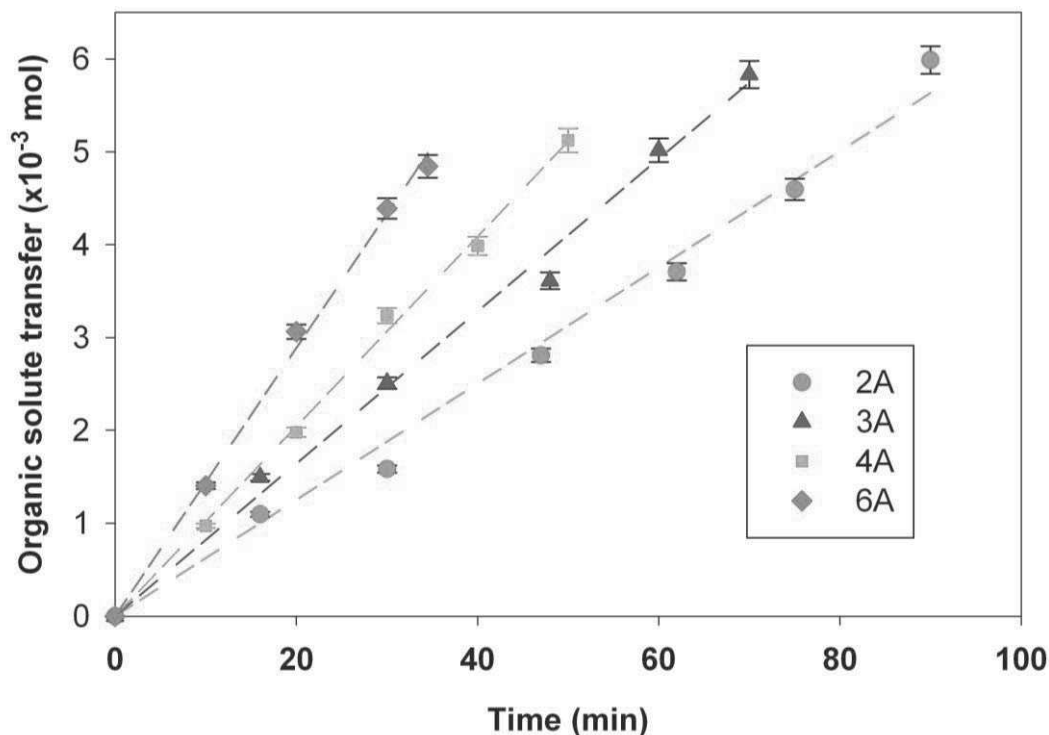

Figure IV-11 Variation of the organic solute quantity transferred versus time:
influence of the current

Glucose / NaCl system, $[OM] = 0.1 \text{ mol.L}^{-1}$ and $[S] = 0.8 \text{ eq.L}^{-1}$

A linear increase of the quantity transferred versus time can be found under each current. A decrease of the total quantity in the diluate compartment is accordingly observed (results not shown). The results respect the mass balance (maximum deviation of total mass of organic solute in the system below 10%). Also, Figure IV-11 shows that a higher current intensity leads to a higher transfer through the membrane. The same phenomena are observed for all the conditions investigated.

Then, the organic solute flux density under each current can be determined from the corresponding slope of the linear variation for all the systems ($R^2 > 98\%$). These values are plotted versus current including diffusion ($I=0$) in Figure IV-12, showing the variation of different OMs flux densities with NaCl as an example.

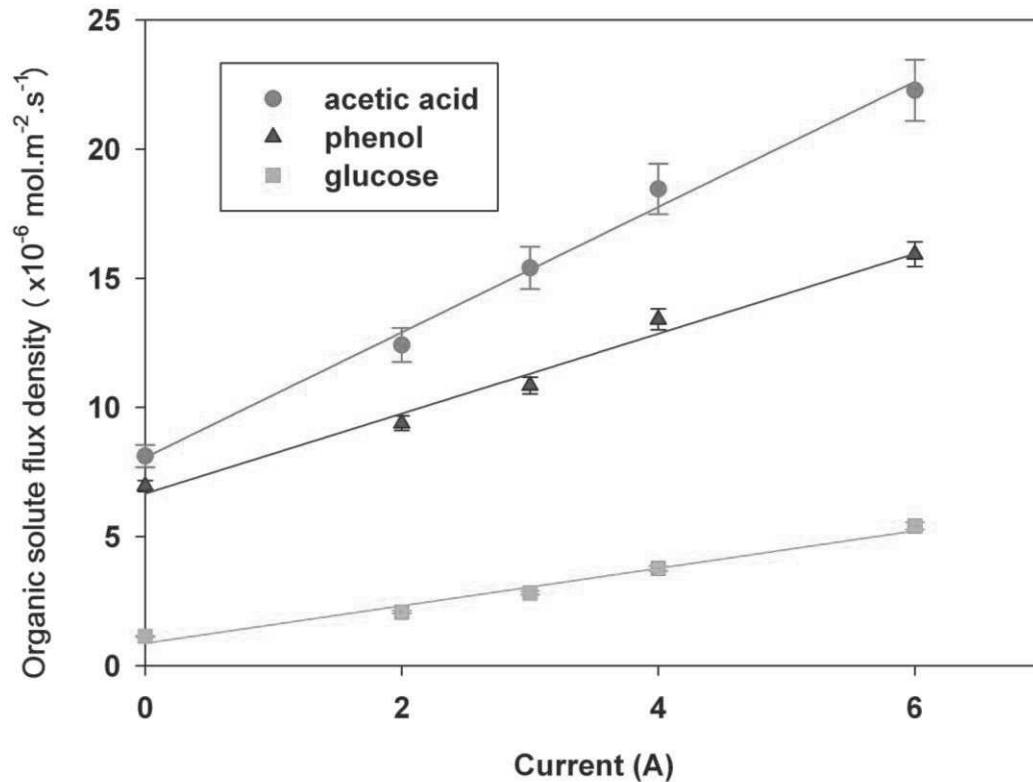

Figure IV-12 Variation of organic solutes flux density versus current in different OM / NaCl systems
[OM] = 0.1 mol.L⁻¹ and [S] = 0.8 eq.L⁻¹

For each current, the following sequence is observed:

$$j_{OM}^{glucose} < j_{OM}^{phenol} < j_{OM}^{acetic\ acid}$$

The observed sequence of solute transfer in OM / NaCl system is also found in systems with different salts. These results suggest that the transfer of neutral organic solutes through IEM is governed by steric effects, both without current and with current.

As previously explained, the dedicated experimental approach enables to distinguish the total transfer under current as diffusion and additional transfer. Then, the flux density versus current is further illustrated, using the glucose / NaCl system as example in Figure IV-13.

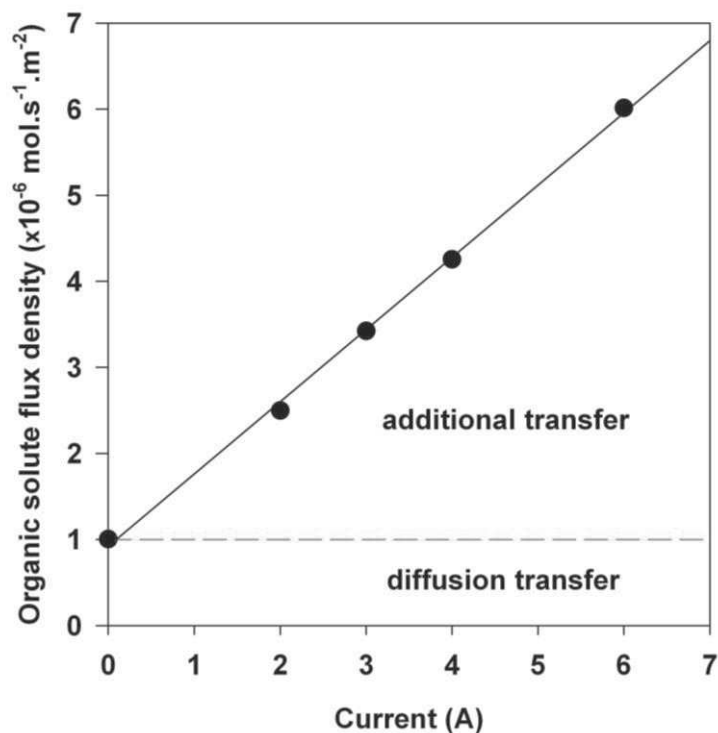

Figure IV-13 Variation of organic solute flux density versus current
Glucose / NaCl system, $[\text{OM}] = 0.1 \text{ mol.L}^{-1}$ and $[\text{S}] = 0.8 \text{ eq.L}^{-1}$

Figure IV-13 shows a linear increase of the flux density versus the current starting from the value for diffusion ($I=0$). This shows that the additional transfer is proportional to the current. Similar variations are observed for all the OM / S systems investigated in this work, i.e. proportionality of flux with the current ($R^2 > 98\%$).

Such results are in agreement with Eq. (II-11), considering the two contributions to the solute transfer, i.e. diffusion and convection due to the electro-osmosis flux $j_{OM} = j^{diff} + \gamma I$. Moreover, the slope of the variation of the flux density versus current in Figure IV-13 provides the convective coefficient γ ($\text{mol.m}^{-2} \cdot \text{s}^{-1} \cdot \text{A}^{-1}$). The γ values obtained for the different systems investigated are reported in Table IV-6, and plotted in Figure IV-14.

γ $\times 10^{-7} \text{mol.m}^{-2}.\text{s}^{-1}.\text{A}^{-1}$	acetic acid	phenol	glucose
NaCl	24.3	15.5	7.3
MgCl ₂	25.1	17.9	7.6
Na ₂ SO ₄	30.3	8.8	8.4

Table IV-6 Convective coefficients γ for different organic solutes
[OM]=0.1 mol.L⁻¹ and [S]=0.8 eq.L⁻¹; calculated according to Eq.(II-11)

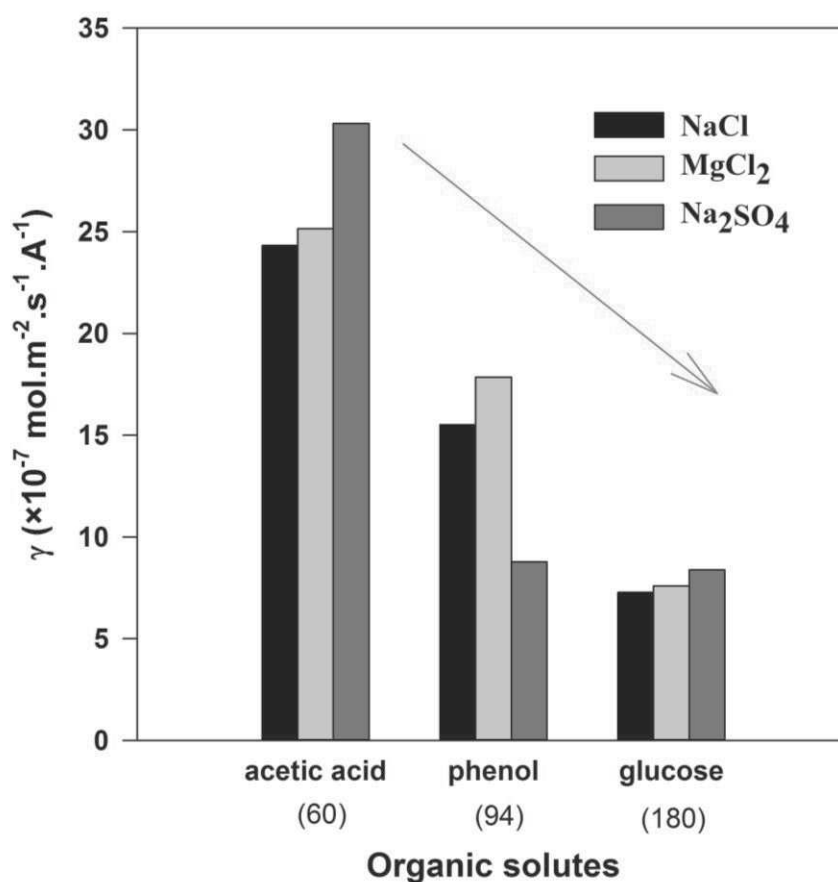

Figure IV-14 Variation of convective coefficients γ for different organic solutes:
influence of the solute size

[OM] = 0.1 mol.L⁻¹ and [S] = 0.8 eq.L⁻¹ ; solute molecular weight (Mw) shown in bracket
(g.mol⁻¹)

A clear difference of γ value with varying solutes is found in Figure IV-14. For a given salt, there is always the order of sequence as:

$$\gamma_{\text{acetic acid}} > \gamma_{\text{phenol}} > \gamma_{\text{glucose}}$$

indicating that a smaller solute has a higher convection flux. It shows that convection flux is mainly fixed by steric effects. Then, considering results for diffusion (Table IV-5) and total flux (Figure IV-12), one can state that steric effects governs the solute transfer through IEM.

Then, for a given solute, concerning the influence of the salt on the convection term, the results in Figure IV-15 show the following sequence

$$\gamma_{\text{NaCl}} < \gamma_{\text{MgCl}_2} < \gamma_{\text{Na}_2\text{SO}_4}$$

for both glucose and acetic acid.

Concerning phenol, the sequence is $\gamma_{\text{NaCl}} < \gamma_{\text{MgCl}_2}$ like it is for the other two solutes. But the γ value of phenol with Na_2SO_4 is surprisingly low. In fact, the observed value is about half those for phenol with other salts, and it is almost as low as the value for glucose transfer with Na_2SO_4 , despite the much lower size of phenol compared to glucose. Indeed, comparing with glucose, it indicates additional mechanism rather than steric effects may play a role on phenol convective transfer through Na_2SO_4 soaked IEM. This exception of phenol convection with Na_2SO_4 will be discussed later.

Then, the following discussion begins with the results for other OM / S systems.

Firstly, it is interesting to plot logarithm of convection flux versus logarithm of solute M_w , in the same manner as reported for diffusion case to check the influence of the size effect on the convection flux. Then, logarithm of γ value is used, which characterizes the convection flux (γI) and plotted in Figure IV-15.

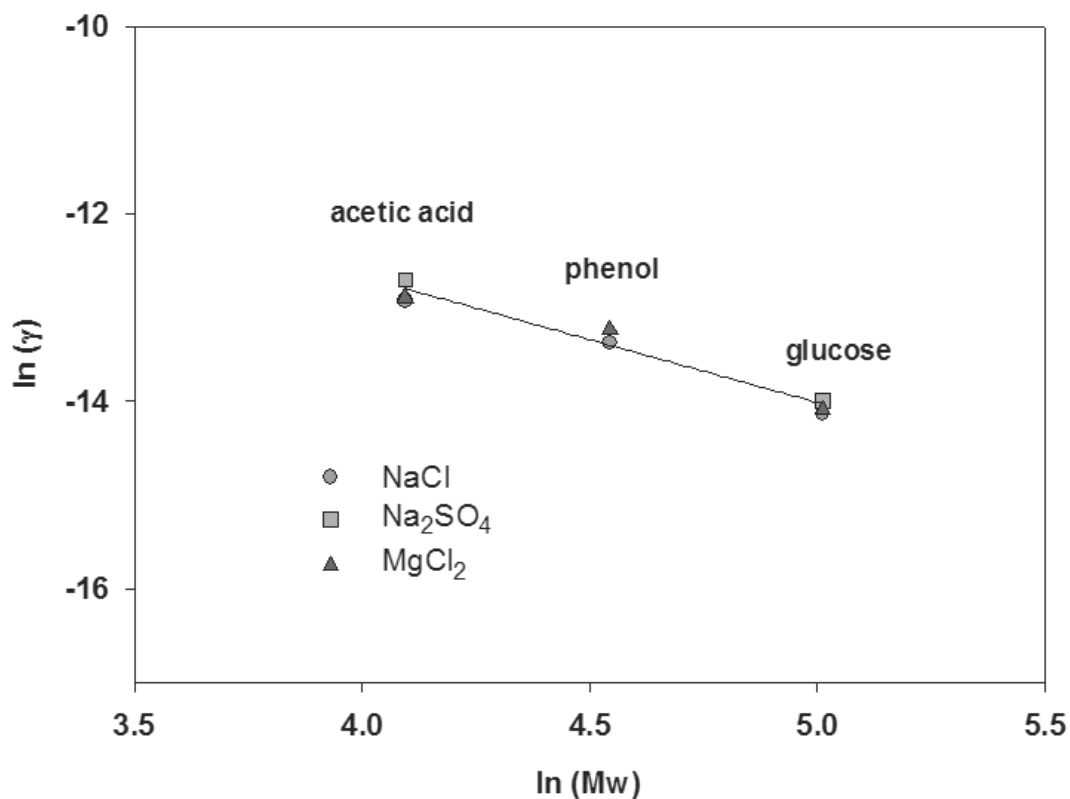

Figure IV-15 $\ln(\gamma)$ versus $\ln(Mw)$ in different OM / S systems: influence of solute size
[OM] = 0.1 mol.L⁻¹ and [S] = 0.8 eq.L⁻¹

One can observe a linear relationship between the convection of various solutes and their Mw in any solution. The slope ranges between 1 and 2. It is thus smaller than that obtained in the diffusion case (δ equal to 2-3). Such a lower value for the convection implies that the influence of the membrane materials is probably not as important as in the diffusion.

The results in Table IV-5 are further illustrated in Figure IV-16, clearly showing the salt effect on the OM convection for different solutes (normalized values are used, i.e. ratio of γ obtained with one salt over γ with NaCl).

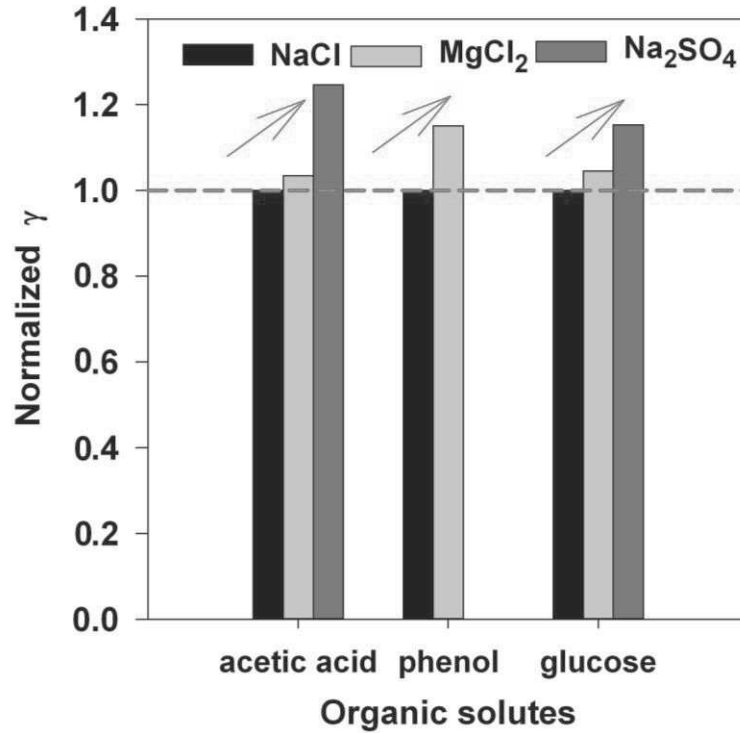

Figure IV-16 Normalized γ values versus salt for different organic solute:
influence of salt compositions
[OM] = 0.1 mol.L⁻¹ and [S] = 0.8 eq.L⁻¹

From Figure IV-16, one can observe the following sequence regarding the convection of a given organic solute

$$j_{OM}^{conv}(NaCl) < j_{OM}^{conv}(MgCl_2) < j_{OM}^{conv}(Na_2SO_4).$$

Then, splitting common cation or anion to consider the counter-ion effect, this sequence can be written as below.

$$\text{Cation: } j_{OM}^{conv}(NaCl) < j_{OM}^{conv}(MgCl_2)$$

$$\text{Anion: } j_{OM}^{conv}(NaCl) < j_{OM}^{conv}(Na_2SO_4)$$

Dealing with the cation effect, Na⁺ induces a lower convection than Mg²⁺, for a given anion (Cl⁻). Meanwhile, for the anion effect, Cl⁻ induces a lower convection than SO₄²⁻, for a given cation (Na⁺). Then, one can observe that the sequence of the counter-ion effect on the convection contribution is the opposite of that previously pointed out for the diffusion (IV.1.2.1), for cation and anion respectively.

These results are in agreement with previous ones obtained with the same type of IEM and glucose convective transfer (Na⁺ < Ca²⁺, Cl⁻ < SO₄²⁻), also showing an opposite trend compared to the diffusion transfer [64]. The similar finding of the counter-ion effect on the

solute convection was also reported ($Cl^- < NO_3^- < SO_4^{2-}$) for the transfer of boric acid as neutral solute through various AEM [92]. All these results including the current work, suggest that a more hydrated ion leads to a higher convection flux.

Then, the observed salt effect on solute convection flux can be further illustrated by using the reflection coefficient σ calculated according to Eq.(II-12), i.e. $\sigma_{OM} = 1 - \frac{\gamma}{\beta \times C_{OM,D}^0}$. As aforementioned, the value σ equal to 1 means the solute is totally retained by the membrane, while the value equal to 0 means the solute is not retained at all by the membrane. Table IV-7 reports the values of the reflection coefficient σ obtained for different OM / S systems.

σ	acetic acid	phenol	glucose
MgCl₂	0.64	0.71	0.89
NaCl	0.61	0.72	0.88
Na₂SO₄	0.48	(0.83)	0.85

Table IV-7 Reflection coefficient σ for different organic solutes:
influence of the salt compositions
[OM]=0.1 mol.L⁻¹ and [S]=0.8 eq.L⁻¹

First, considering the different solutes, one can find an identical sequence for the different salts as:

$$\sigma_{\text{acetic acid}} < \sigma_{\text{phenol}} < \sigma_{\text{glucose}}$$

These results are consistent with the solute molecular weight since higher molecular is expected to give higher σ values meaning lower transfer. They also agree with those previously reported with the same membranes for the transfer of phenol in phenol / NaCl system (σ value ca. 0.7) and for the transfer of glucose in different salt systems (σ value ca. 0.9) [43,64].

Moreover, concerning the influence of the salt for a given organic solute, one can draw the sequence as

$$\sigma_{\text{MgCl}_2} \approx \sigma_{\text{NaCl}} > \sigma_{\text{Na}_2\text{SO}_4}$$

This shows that for each solute, the difference between SO_4^{2-} and Cl^- is higher than that between Na^+ and Mg^{2+} , suggesting a stronger anion effect. Specifically, the result as

$\sigma_{\text{SO}_4^{2-}} < \sigma_{\text{Cl}^-}$ is found for glucose and acetic acid. It implies solute with Na_2SO_4 is less retained than with NaCl or MgCl_2 .

As aforementioned, in OM / S systems, both membrane modification (swelling) and solute dehydration are concerned regarding the influence of the salt composition. Then, one can conclude that the variation of the reflection coefficient is more in accordance with the dehydration effect. As more hydrated ion dehydrates more the neutral solute, decreasing the solute size consequently, a higher convection transfer is expected, which gives decreasing values of the reflection coefficient.

As shown in diffusion case of the present work, the transfer increase in OM / S systems compared to that in OM / W systems is due to solute dehydration [70,107]. In fact, solute dehydration phenomenon has already been reported with salt like 1 eq.L^{-1} [108-112], but only in the case of hydrophilic solutes and mainly sugars or PEG. Then, the results of the present study show that dehydration due to the salt takes place not only with hydrophilic solutes but also with more hydrophobic ones like phenol (i.e. $\gamma_{\text{NaCl}} < \gamma_{\text{MgCl}_2}$).

Previous work in our group focused on dehydration phenomenon of hydrophilic solutes in presence of the salt. Bouchoux et al. [67] first proposed the possible variation of glucose size due to ion hydration to explain the variation of the retention observed in NF. Then, Boy et al. [70] determined the variation of solute apparent molar volume (AMV), a macroscopic parameter which characterizes the hydration state of the solutes in saccharide / salt systems. The results showed that all the saccharides (xylose, glucose and sucrose) dehydrated for various salt compositions, which explained the increase of the saccharide transfer in presence of salt. It was also reported that dehydration comes from interaction of ions and hydrophilic sites of the saccharide i.e. $-\text{OH}$, $-\text{O}-$.

Then, in the present work, all the neutral solutes considered have polarized functional groups ($-\text{OH}$, $-\text{O}-$, $-\text{COOH}$), through which they can be influenced by the large amount of strongly charged ions, thus resulting in decreasing hydration in presence of salts [70]. Indeed, phenol has only one $-\text{OH}$ as hydrophilic site, which is much less compared to glucose (five $-\text{OH}$ and one $-\text{O}-$), and acetic acid (one $-\text{COOH}$). Nevertheless, it is found that phenol can be dehydrated in presence of various salt compositions. Then, the results suggest that both hydrophilic and hydrophobic solutes are subject to the salt induced dehydration.

Moreover, solute dehydration is highlighted in this study in both diffusion and convection. Specifically, solute dehydration governs the OM convection, while it is not very

important in the diffusion case, which is more governed by the membrane swelling, i.e. the modification of the structural properties of the membrane.

Then, concerning the salt effect on the transfer of organic solutes, diffusion and convection contributions are further compared for each one of them, as illustrated in Figure IV-17.

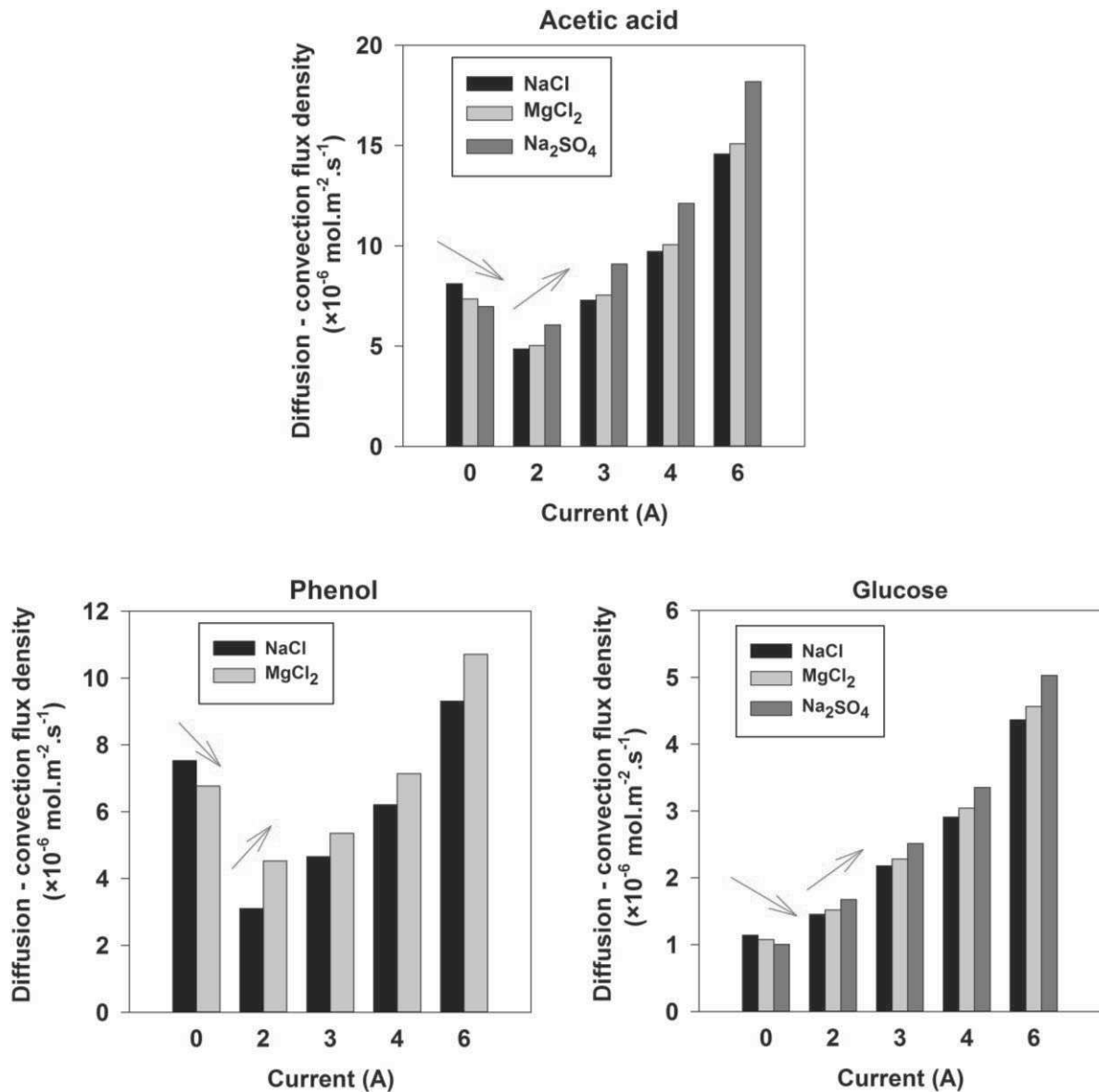

Figure IV-17 Comparison of diffusion ($I=0$) and convection ($I\neq 0$) transfer of organic solutes versus current: influence of the salt compositions
[OM] = 0.1 mol.L⁻¹ and [S] = 0.8 eq.L⁻¹

As already mentioned, reversed trends of salt effect on diffusion and convection are found for each solute. For diffusion, more hydrated ion induces lower transfer, while higher transfer for convection. It is worthwhile to note that, in OM / S systems for both diffusion and convection, ion hydration can modify both the membrane and solute properties, while contributions of these modifications can be different in the two cases. The diffusion is governed by the membrane structural modifications, thus the tendency is due to materials free volume variation arising from chain-chain interaction. More hydrated ion, stronger chain-chain interaction, or less free volume, explain lower diffusion transfer. The convection is governed by solute modification in solution, thus the tendency is due to solute dehydration. More hydrated ion, more dehydration of the solute, which explains the higher convection transfer.

For a given solute, diffusion and convection flux densities (j_{OM}^{diff} and j_{OM}^{conv}) can be in the same order of magnitude, suggesting both contributions are important. Then, since the convection flux is current dependent, i.e. a higher current leads to a higher convection, its contribution can become dominant for the highest values of the current [90].

Both contributions of diffusion and convection are further compared, using results at two different currents as comparison, in Figure IV-18.

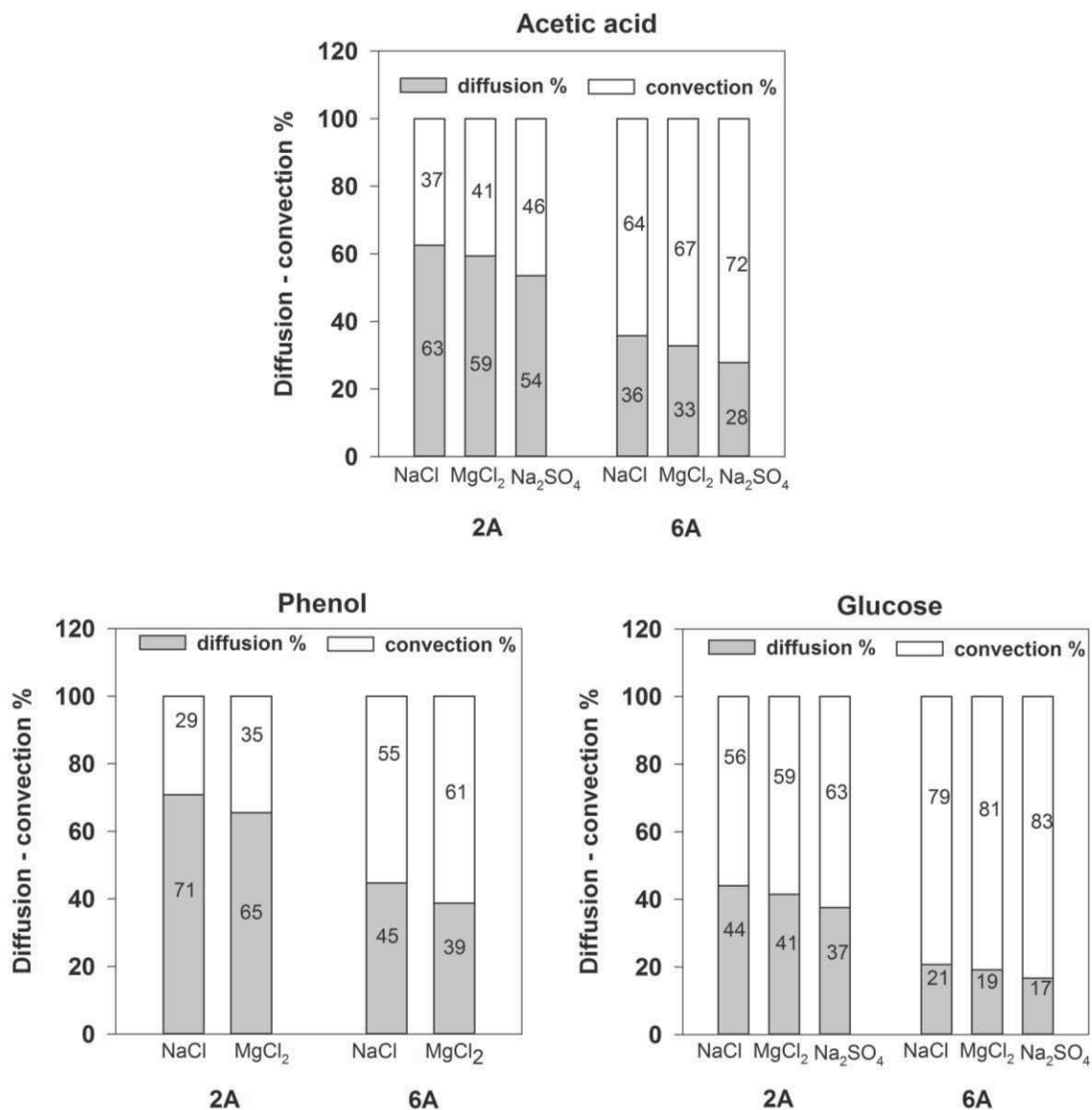

Figure IV-18 Diffusion and convection contribution to organic solute transfer in different OM / S systems
[OM]=0.1 mol.L⁻¹ and [S]=0.8 eq.L⁻¹; I = 2A (left) and 6A (right)

Again one can state that the contribution of convection increases with the current. At higher current, it is dominant with respect to diffusion especially for the larger solute like glucose (ca. 80%). At lower current, diffusion can be the main contribution to the solute transfer, especially for the solute of low Mw (i.e. diffusion contribution > 50%) because of the steric effects. Then, for solute of higher Mw like glucose, diffusion is much lower and thus the contribution of convection is stronger.

Therefore, one can summarize the main results of this study as follows. Neutral OM transfer in ED consists of diffusion due to concentration gradient and convection due to electro-osmosis, and both are important. In any case, the solute transfer is governed by steric effects (i.e. relationship between solute size and membrane free volume). Then, in saline solutions, salt has an influence on the transfer of the organic solutes. The triple interaction in salt-OM-membrane system is thus illustrated in Figure IV-19.

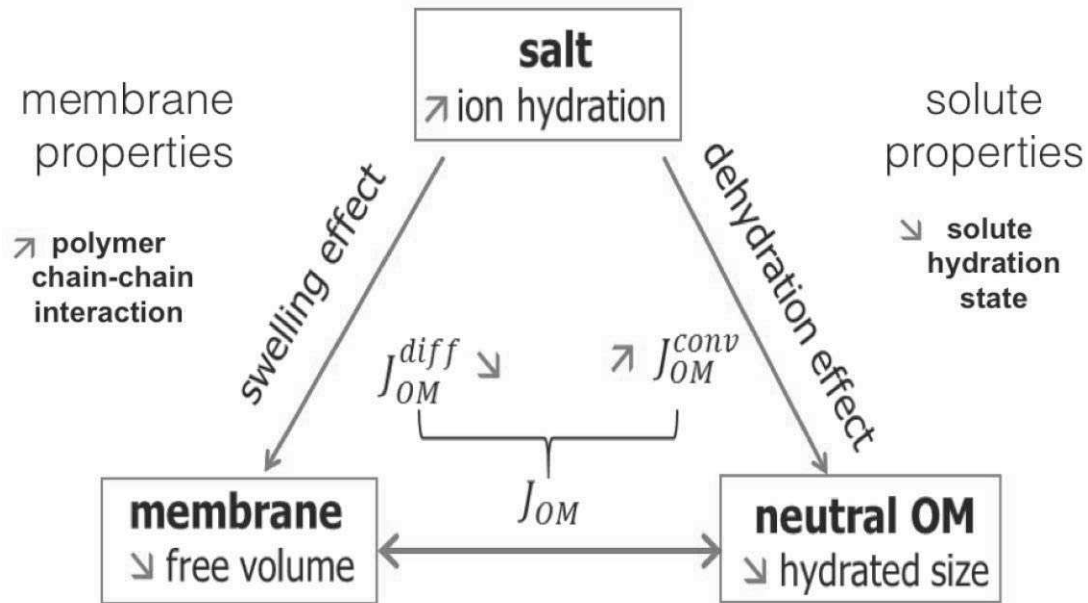

Figure IV-19 Influence of salt (ion hydration) on the transfer of neutral organic solutes in ED

Salt can modify both the membrane and solute properties. On one hand, concerning the membrane, more hydrated counter-ion results in stronger polymer chain-chain interaction, which governs the diffusion. Stronger chain-chain interaction further results in a decreasing fragment-fragment distance in the membrane materials, and then a lower diffusion of the organic solutes. This kind of membrane swelling effect according to ion hydration controls the solute diffusion. On the other hand, concerning the solute, more hydrated ion result in decreasing solute hydration, which governs the convection. Solute dehydrates some water molecules bound to its hydration shell, causing a decreasing dynamic hydrated size, and then higher transfer of convection is expected. Finally, dealing with the influence of the salt opposite trend is expected for diffusion and convection.

Moreover, a stronger salt effect is observed with Na_2SO_4 compared with other salts for both diffusion and convection, in Figure IV-18. Since each observed flux consists of contribution from AMX and CMX, this result is probably due to the anion effect on AMX.

It was also previously mentioned that the convection flux of phenol in phenol / Na_2SO_4 system is surprisingly lower than those in phenol / Cl^- salt systems (see in Figure IV-14). Indeed, Table IV-7 shows that the calculated value of σ_{phenol} with Na_2SO_4 is ca. 0.8, higher than those obtained for NaCl or MgCl_2 (ca. 0.7). Following the solute dehydration, σ_{phenol} with Na_2SO_4 should be lower, as observed for glucose and acetic acid. Thus, such result concerning the influence of anions (i.e. Cl^- and SO_4^{2-}) on the transfer of phenol does not follow the trend expected from the solute dehydration.

In fact, different behavior of phenol can be also observed regarding its diffusive transfer compared with other two solutes, i.e. flux with SO_4^{2-} is discrepant (lower) from that with Cl^- soaked membrane in Figure IV-9. Thus, all these results in diffusion and convection imply a special behavior of phenol with SO_4^{2-} . Since diffusion transfer observed for phenol / water and phenol / Na_2SO_4 are similar in Table IV-5, one can conclude that such special behavior probably takes place in the membrane, i.e. AEM, rather than in aqueous solution. It suggests that the SO_4^{2-} soaked AEM lowers the phenol transfer, in both diffusion and convection. This finding may relate to specific interaction.

As aforementioned, it was reported that solute dehydration arises from the interaction of ion and hydrophilic or polar sites of solute, and such work focused on mainly hydrophilic solutes. Until now, ion-hydrophobic solute / group interaction is comparatively less published than that for ion-hydrophilic [108-109,113], and there are still some questions remaining unanswered with regard to various interaction type (e.g. σ or π type) and strength [114-119]. Moreover, regarding membrane fields there is quite few report on hydrophobic solute dehydration [107], i.e. none for anions. Thus, interaction between salt and hydrophobic organic solute deserves future study.

Nevertheless, the influence of salt on membrane and solute in ED system is highlighted. Attention can also be given to other membrane processes like UF [107], NF [70], for which the influence of the salt composition on the transfer of organic solutes was reported as well.

IV.2 Saline water containing charged organic solute

In this part, the transfer of a charged organic solute (acetate) is investigated using the same experimental methodology and conditions as reported in the case of neutral ones, i.e. inorganic salt concentration of 0.8 eq.L^{-1} and organic solute concentration of 0.1 mol.L^{-1} .

Inorganic salt and water transfer are firstly studied. Then the acetate transfer in the case without current applied, and that with current applied are considered. Data for the corresponding neutral solute, i.e. acetic acid, are further used for comparison.

IV.2.1 Inorganic salt and water transfer

This part focuses on the transfer of inorganic ionic species (of different cations or anions) and the water. As aforementioned in Chapter III, water transfer is due to the electro osmosis accompanying the migration of salts. Then, in such mixture of organic and inorganic salts, the observed water transfer is due to the contributions of the two types of salts.

First, the observed transfer of charged species and water is shown in Figure IV-20, using acetate / S systems under 2A for example.

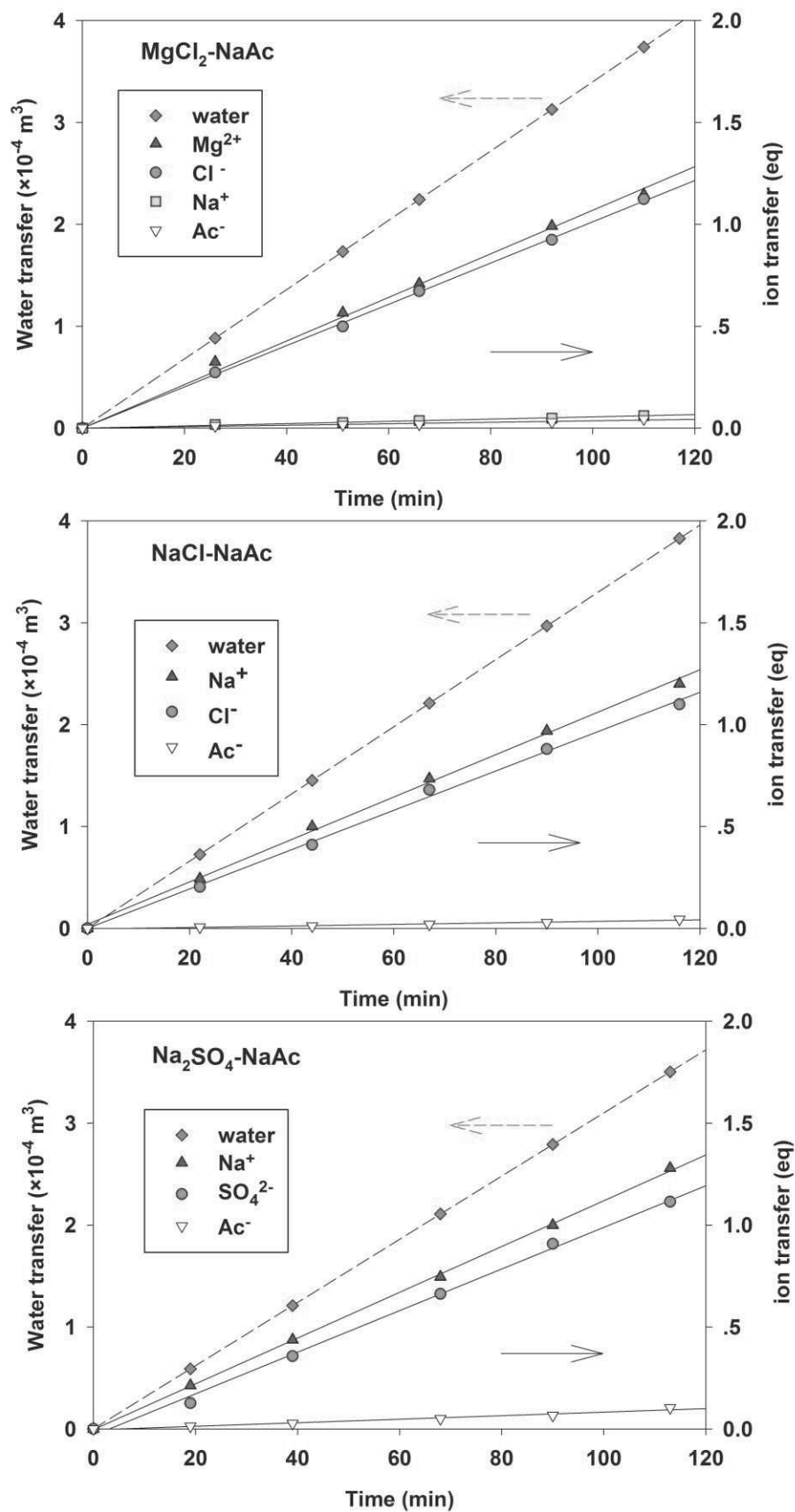

Figure IV-20 Variation of the inorganic ions and water transfer versus time:
influence of salt compositions
[OM]=0.1 mol.L⁻¹ and [S]=0.8 eq.L⁻¹; I = 2 A

Figure IV-20 shows that a linear increase of ion (cation and anion) and water transfer is found for the different systems investigated. Accordingly, the quantities of ions and water in diluted compartment are decreased (results not shown), respecting the mass balance.

According to the previous results concerning salt and water transfer in ED, one can say that the observed transfer of ion and water under current is mainly due to migration and electro-osmosis, respectively.

Then, concerning the ionic migration, one can compare the transfer of both cation and anion. For example, in NaAc-MgCl₂ system, same migration for Mg²⁺ and Cl⁻ is observed, as well as the close value for Na⁺ and acetate. The results show that the electroneutrality is respected (i.e. difference between cation and anion transfer below 13%). Moreover, the observed quantity of inorganic ion (e.g. Cl⁻) transferred is higher than that of acetate, which agrees with the initial concentration difference, i.e. the inorganic anion has much higher concentration than the organic. These findings are observed for all the compositions investigated.

Concerning the water transfer, a linear variation is obtained versus time despite the fact that it is the result of the hydration of different ions. Indeed, because of the much lower concentration of the organic ions compared to inorganic ones, one can consider that the water transfer is mainly due to the contribution of the inorganic salt. It is thus linear because each inorganic salt has fixed hydration, as shown in Chapter III.

Same observations are found for all systems and currents applied. Then, salt and water flux are obtained from slope of the transfer variation versus time under each current ($R^2 > 98\%$). The values are plotted in Figure IV-21, showing the inorganic salt and water flux versus current, with acetate / NaCl system as example.

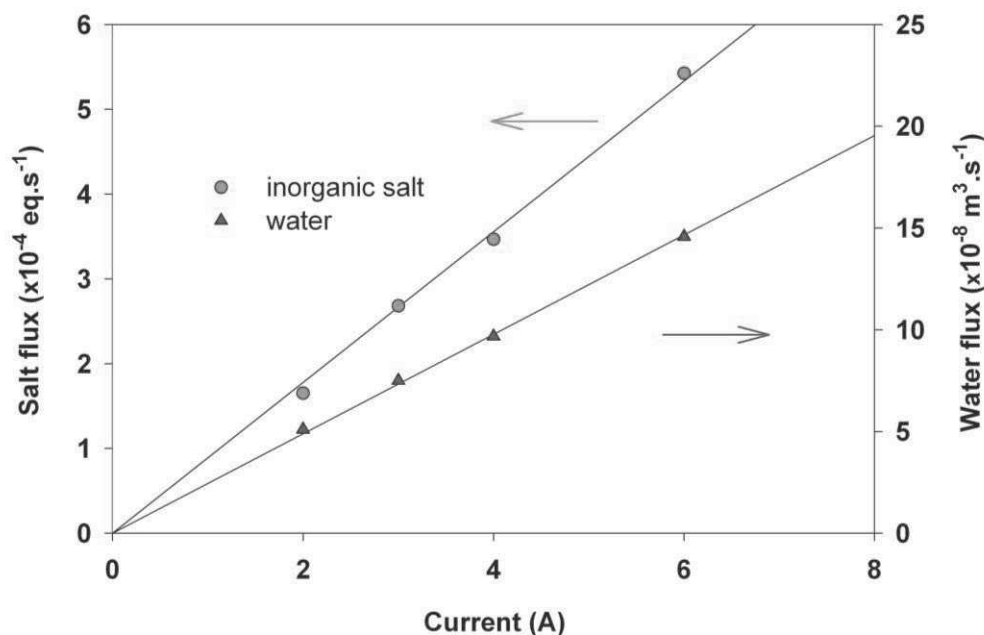

Figure IV-21 Variation of inorganic salt and water flux versus current
Acetate / NaCl system; [acetate]=0.1 mol.L⁻¹ and [S]=0.8 eq.L⁻¹

Figure IV-21 shows that both inorganic salt and water fluxes are proportional to the current, in agreement with the transport phenomena discussed before. One can state that these fluxes are due to salt migration and water electro-osmosis, respectively. Transfer for acetate (sodium acetate) is discussed later.

Then, the current coefficient and water electro-osmotic coefficient with acetate are determined as the corresponding slope of the straight. First, the current coefficients obtained in different systems are reported in Table IV-8, in parallel with previous data obtained for acetic acid or in the absence of organic solute.

α $\times 10^{-4} \text{ eq.m}^{-2} \cdot \text{s}^{-1} \cdot \text{A}^{-1}$	acetate		acetic acid	no OM
	Inorganic	Total*	Inorganic	Inorganic
MgCl ₂	4.6	4.7	4.7	4.9
NaCl	4.4	4.9	5.1	4.6
Na ₂ SO ₄	4.0	4.7	4.8	4.8

Table IV-8 Current coefficient (α , eq.m⁻².s⁻¹.A⁻¹) in different OM / S systems
[S] = 0.8 eq.L⁻¹ and [OM] = 0.1 mol. L⁻¹; Total*: total α integrates both inorganic and acetate transfer; calculated according to Eq.(II-5);

With acetate, the current coefficient for inorganic salt and the total one (considering also the acetate transfer) are reported. Indeed, acetate migration is observed as shown in Figure IV-20.

As expected, in presence of acetate, the value for inorganic ion is lower than the total one for any salt composition, which is expressed as:

$$\alpha_{inorganic}^{acetate} < \alpha_{total}^{acetate}$$

For a given salt, the total value with acetate is close to those obtained with the other two cases, expressed as

$$\alpha_{total}^{acetate} \approx \alpha_{inorganic}^{acetic\ acid} \approx \alpha_{inorganic}^{no\ OM}$$

(difference below 10%). The previous finding shows close values of current coefficient with / without OM (neutral) with each salt, as $\alpha_{inorganic}^{acetic\ acid} \approx \alpha_{inorganic}^{no\ OM}$. Then, one can say that the total current coefficient is constant with / without charged OM for a given salt.

Concerning the results obtained with acetate and different salts, the value corresponding inorganic salts varies and the observed sequence concerning the salt is $MgCl_2 \approx NaCl > Na_2SO_4$. It means that the transfer of SO_4^{2-} in Na_2SO_4 systems is lower (α approximates to $4.0 \times 10^{-4} \text{ eq.m}^{-2}.\text{s}^{-1}.\text{A}^{-1}$) than that of Cl^- in $NaCl$ and $MgCl_2$ systems (ca. $4.5 \times 10^{-4} \text{ eq.m}^{-2}.\text{s}^{-1}.\text{A}^{-1}$). Simultaneously, it means that the transfer of acetate is different with different anions, which is further discussed in the following section concerning acetate transfer.

Then, Table IV-9 reports the water transfer coefficients observed in different OM / S systems.

β $\times 10^{-8} \text{ m}^3.\text{m}^{-2}.\text{s}^{-1}.\text{A}^{-1}$	acetate	acetic acid	no OM
MgCl₂	6.6	7.0	6.8
NaCl	6.1	6.3	5.8
Na₂SO₄	6.0	5.9	5.6

Table IV-9 Electro-osmotic coefficient (β , $\text{m}^3.\text{m}^{-2}.\text{s}^{-1}.\text{A}^{-1}$) in different OM / S systems
[OM]=0.1 mol.L⁻¹ and [S]=0.8 eq.L⁻¹; calculated according to Eq.(II-7)

With respect to the water transfer, the sequence of electro-osmotic coefficient with acetate is:

$$\beta_{MgCl_2} > \beta_{NaCl} > \beta_{Na_2SO_4}$$

This sequence is identical to that observed in the case of neutral OM, i.e. acetic acid. These values with acetate are close to those in other cases (difference below 7%).

As aforementioned, water transfer is due to the total contribution of the different ions hydration, and with acetate it consists of both inorganic ions and acetate. Nevertheless, the results show that no significant variation of water transfer is observed with acetate compared with others.

These results show that, for a given salt composition, the total salt and water transfer are the same with acetate, acetic acid or without organic solute. For the former, it is due to the constant current applied; while for the latter, it is due to the negligible effect of electro-osmosis due to acetate, owing to its too low concentration compared with inorganic salts.

IV.2.2 Charged organic solute transfer

In this part, the transfer of a charged organic solute, i.e. acetate, through the IEM is investigated firstly without current, i.e. in diffusion regime, with two different solvents (water and salt solution). Then, transfer in normal ED regime under various currents is studied. The results obtained with acetate, are compared with those obtained with acetic acid. Their Mw are similar, 60 g.mol⁻¹ for acetic acid and 59 g.mol⁻¹ for acetate, respectively.

IV.2.2.1 Transfer of charged organic solute without current

As aforementioned, experiments without current are carried out first with water and then with salt. The water case (W) is to study the membrane soaking effect on the diffusion of the organic solute, while in salt case (S), the transfer results from both the membrane (i.e. membrane soaking) effect and the additional salt effect in aqueous solution.

Then, the observed acetate transfer in diffusion is shown in Figure IV-22, using acetate / NaCl system as example.

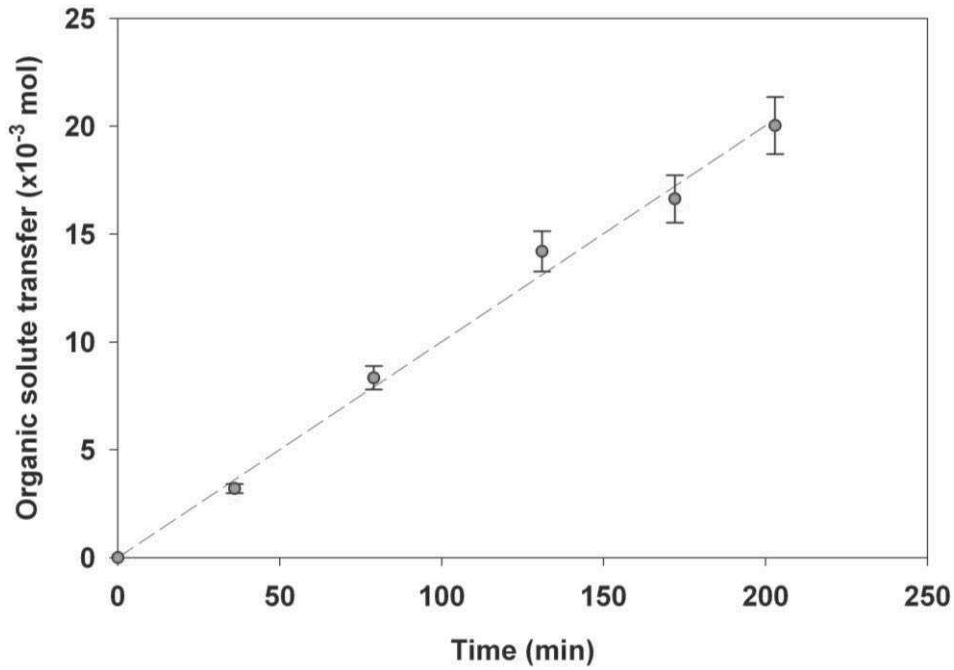

Figure IV-22 Variation of acetate quantity transferred by diffusion versus time
Acetate / NaCl system; [acetate] = 0.1 mol.L⁻¹ and [S] = 0.8 eq.L⁻¹

Figure IV-22 shows a linear increase of the quantity transferred in the concentrate compartment with time, and a decreased quantity is observed in the diluate compartment (results not shown). It agrees with the transport phenomena that solute diffusion is due to the concentration gradient, which is approximately constant (variation less than 10%). The same finding is observed for each composition used in this work.

Then, the diffusion flux is determined as the slope of the straight, and values in different systems are reported in Table IV-10, including data for neutral OM (acetic acid) for comparison.

$j_{OM}^{diff} \times 10^{-6} \text{ mol.m}^{-2}.\text{s}^{-1}$	acetate / W	acetate / S	acetic acid / W	acetic acid / S
NaCl	1.4	4.2	7,5	8.1
MgCl ₂	1.4	5.7	7,2	7.4
Na ₂ SO ₄	1.6	5.4	6,9	7.0

Table IV-10 Diffusion flux densities of acetate and acetic acid in different
OM / W and OM / S systems

[OM] = 0.1 mol.L⁻¹ and [S] = 0.8 eq.L⁻¹

Table IV-10 systematically compares solute diffusion in OM / W and OM / S cases, for different salts and OM (acetate and acetic acid).

Firstly, concerning the charged organic solute, i.e. acetate, the diffusion in acetate / W case is much lower than that in acetate / S case by a factor of 3-4. Regarding the effect of the salt nature, one can find in acetate / W case that the diffusion flux of acetate does not vary significantly according to the salts. On the contrary, in acetate / S case, different diffusion flux are observed for acetate according to the inorganic salt composition. One can draw such sequence:

$$j_{acetate}^{diff}(NaCl) < j_{acetate}^{diff}(MgCl_2) \approx j_{acetate}^{diff}(Na_2SO_4)$$

On the contrary, concerning the neutral solute, i.e. acetic acid, diffusion in OM / W system is just slightly lower than that in OM / S. But same sequence can be drawn in the two systems, regarding the salt effect:

$$j_{acetic\ acid}^{diff}(NaCl) > j_{acetic\ acid}^{diff}(MgCl_2) > j_{acetic\ acid}^{diff}(Na_2SO_4)$$

Finally, comparing the two solutes, Table IV-10 shows that the diffusion of acetate is very different from that of acetic acid in any case. In fact, acetate diffusion is always lower, by a factor of ca. 2 for OM / S system and a factor of ca. 5 for OM / W system, respectively.

The results are further discussed based on solute-membrane interaction (e.g. steric effects and electrostatic effect) which can affect the transfer through the polymeric membrane [55,59]. In the present work, for neutral solute the main interaction comes from steric effects [63,70], while for the charged solute both the steric and electrostatic effects may be concerned [120]. Thus, even if acetate and acetic acid have similar Mw, their transfer behavior can be different due to different solute-membrane interaction.

As aforementioned, diffusion in OM / W system is to study this solute-membrane interaction. Then, lower acetate diffusion is found, compared to that of acetic acid, which was found to be mainly governed by the steric effects. Taking acetic acid as reference, one can expect for acetate a much higher steric effects on one hand owing to bigger hydrated size of acetate, considering its charge nature (i.e. more water molecules are electro-stricted by the charged acetate than neutral acetic acid). On the other hand, electrostatic interaction due to the charge can play a role. Accordingly, the acetate transfer with water is expected to be much lower than that of acetic acid and this is what is experimentally observed.

Regarding OM / S system, both solutes show an increased transfer compared to that in OM / W system. But for acetic acid, the increase is minor while for acetate, it is remarkable

(from initial value ca. $2 \times 10^{-6} \text{ mol.m}^{-2}.\text{s}^{-1}$ observed in acetate / W system to finally ca. $6 \times 10^{-6} \text{ mol.m}^{-2}.\text{s}^{-1}$ observed in acetate / S system). The increase with large quantity of salt shows acetate's transfer approaches to that for the neutral solute (value ca. $7 \times 10^{-6} \text{ mol.m}^{-2}.\text{s}^{-1}$).

As previously reported, the marginal increase of neutral OM diffusion is due to weak solute dehydration effect by the additional salt [63]. Thus, one can say salt's presence in aqueous solution has little influence on acetic acid diffusion, which is governed by steric effects.

On the other hand, results suggest that acetate is more sensitive to the addition of salt, and one can thus expect it is due to influence on acetate-membrane interaction. Indeed, regarding steric effects, the acetate effective size can be decreased owing to the solute dehydration, as reported on acetic acid. Regarding the electrostatic interaction, acetate-IEM electrostatic force can be screened with a large amount of salt.

Then, concerning the different salts, the observed salt effect on OM diffusion differs in any case, between acetate / W and acetate / S, and between acetate and acetic acid. First, in OM / W system, the membrane soaking effect, i.e. different extent of membrane swelling arising from the different counter-ion hydration is already reported [63]. This explains the sequence observed in acetic acid / W system but not the result in acetate / W system, where comparable diffusion indicates negligible soaking effect. For the two OMs, considering that membrane has same swelling for a given salt, this different behavior can be due to the different OM charge nature or different solute-membrane interaction. Thus, this result suggests electrostatic interaction is more concerned in acetate diffusion rather than steric effects.

Regarding the additional salt effect, same sequence is found for neutral solute (for both acetic acid / S and acetic acid / W systems). However, the sequence for acetate / W is different with that for acetate / S. Salt effect is observed in acetate / S as $\text{NaCl} < \text{MgCl}_2 \approx \text{Na}_2\text{SO}_4$, compared to a negligible salt effect observed in acetate / W system.

As reported, the result obtained for acetic acid (same sequence for acetic acid / S and acetic acid / W systems) is because the additional salt effect in solution is too weak to modify its transfer, which is mainly governed by membrane soaking. While for acetate, one can state that the presence of salt in solution significantly modifies the acetate-membrane interaction. One possible reason can be the higher ionic strength with the latter two salts, i.e. MgCl_2 and Na_2SO_4 (1.2 mol. L^{-1}) compared to that with NaCl (0.8 mol.L^{-1}). Indeed, higher ionic strength can decrease the acetate-membrane interactions, and thus facilitate the diffusion of acetate.

One another possible explanation is related to the hydration of acetate which is also expect to change with the ionic strength. Higher ionic strength gives lower hydration and then possibly higher transfer of acetate.

Therefore, the electrostatic effect on the transfer of charged organic solute is highlighted in this study, concerning not only the level of diffusion flux in different solvents but also the salt effect, compared with neutral organic solute.

IV.2.2.2 Transfer of charged organic solute with current

As discussed previously, transfer of both neutral and charged OM with current includes a diffusive contribution and additional one. This additional flux corresponds to convection for neutral OM, and migration for charged OM.

The quantity of acetate transferred is plotted versus time in Figure IV-23 under different currents, using acetate / NaCl system as example.

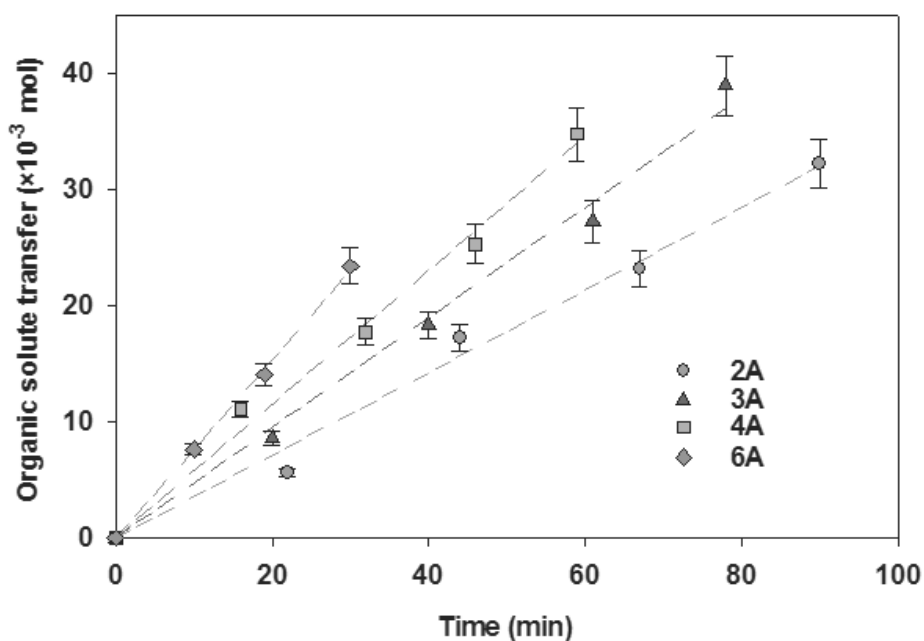

Figure IV-23 Variation of acetate quantity transferred versus time: influence of the current
Acetate / NaCl system, [acetate] = 0.1 mol.L⁻¹ and [S] = 0.8 eq.L⁻¹

This shows that acetate transfer increases linearly versus time under each current ($R^2 > 96\%$), and that a higher current leads to a higher transfer. The same results are found for all

the systems. The acetate flux density under each current can be further determined from the corresponding slope of the linear variation.

Then, the values for the different systems investigated are plotted, together with those obtained with acetic acid, including the values concerning diffusion.

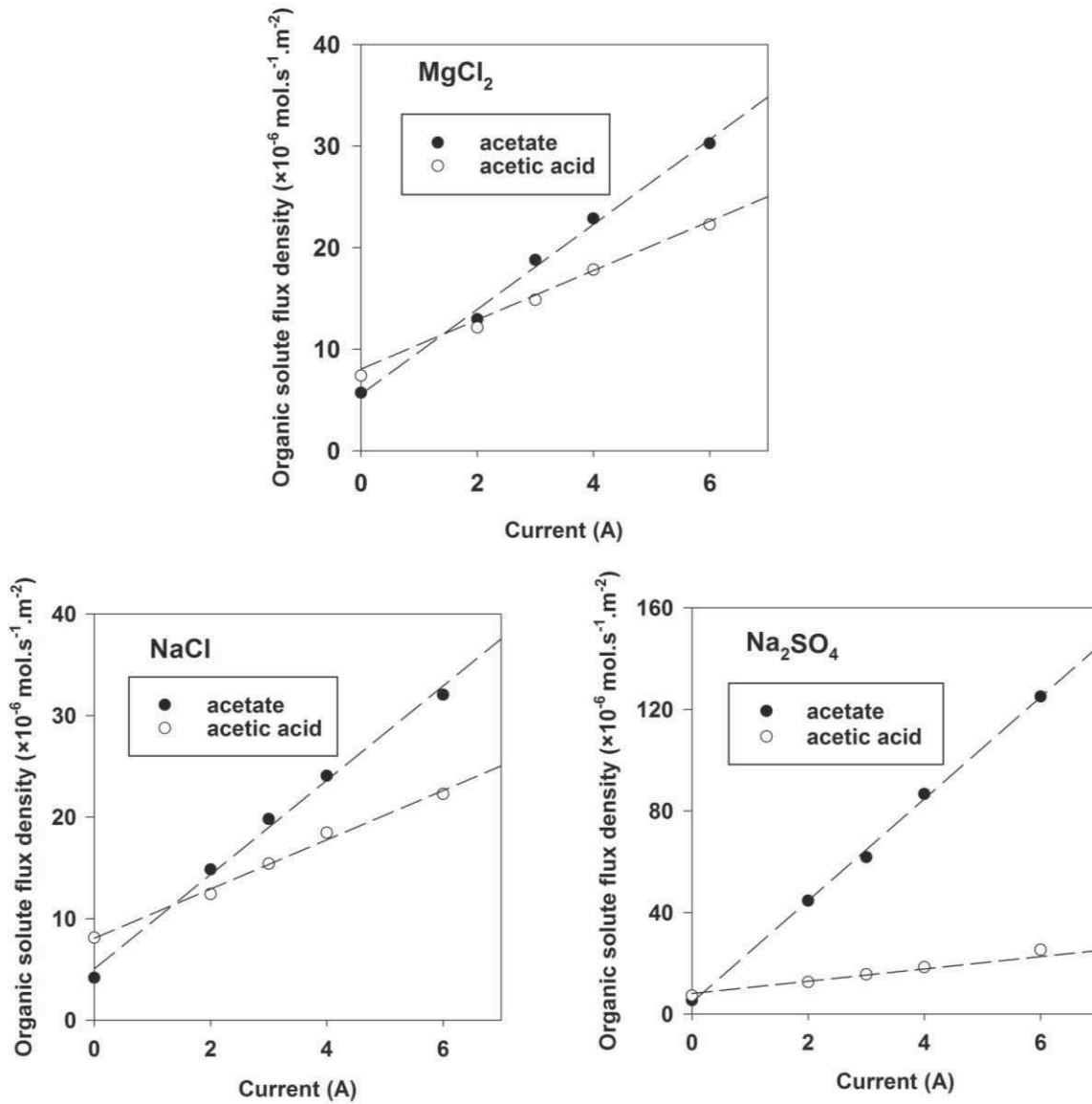

Figure IV-24 Variation of OM flux densities of acetate and acetic acid versus current
[OM] = 0.1 mol.L⁻¹ and [S] = 0.8 eq.L⁻¹

Figure IV-24 shows that the flux density of the organic solutes increases linearly with the current. This finding agrees with the OM transfer theory, indicated by Eq.(II-11) as $j_{acetic\ acid} = j^{diff} + \gamma I$ and (II-16) as $j_{acetate} = j^{diff} + \gamma' I$.

Except for the lowest current where diffusion is dominant, a higher transfer for acetate is always found compared to acetic acid. This means that under current the migration of acetate is more important than the convection of acetic acid. Concerning the influence of the salt on the solute transfer, remarkable difference between acetate and acetic acid is observed with Na₂SO₄, the difference being less pronounced with the two other salts.

Then, the additional transfer coefficient is determined, as the slope of the line from Figure 24. The coefficient γ is for neutral OM convection, and γ' is used for acetate migration, indicated in Eq.(II-11) and (II-16). The observed values for γ' and γ in different systems are reported in Table 11.

Additional transfer coefficient	acetate	acetic acid
$\times 10^{-7} \text{ mol.m}^{-2}.\text{s}^{-1}.\text{A}^{-1}$	γ'	γ
NaCl	46	24
MgCl₂	42	25
Na₂SO₄	200	30

Table IV-11 Additional transfer coefficient in different OM / S systems
[OM]=0.1 mol.L⁻¹ and [S]=0.8 eq.L⁻¹

For a given salt, Table IV-11 shows that the value of the additional coefficient is always higher for acetate (γ') than for acetic acid (γ) by a factor comprised between 2-7. Then, concerning the salt nature, similar values are found for acetate with NaCl and MgCl₂. These values are lower than those obtained with Na₂SO₄ by a factor of 5. An identical trend was observed with acetic acid, ($\text{Cl}^- < \text{SO}_4^{2-}$), but with a much lower difference. Thus, one can conclude that the anion effect, i.e. Cl⁻ and SO₄²⁻ in the present study, is important with respect to the transfer of both neutral and charged organic solutes, with a more pronounced influence on acetate compared to acetic acid.

Even if similar trends are obtained, the reason for the observed anion effect may be different for the two solutes. Indeed, for acetic acid, it is mainly due to a stronger solute dehydration with SO₄²⁻ compared to Cl⁻, which facilitates the solute transfer. On the other hand for acetate, there is an additional effect coming from the migration of both acetate and inorganic anions, i.e. Cl⁻ and SO₄²⁻.

Indeed, for a given current, the total number of charges is fixed, as it was demonstrated by the constant values of α . In the case of acetate, the total charge is distributed between acetate and inorganic anions. The transport number of each ion through the membrane can be calculated knowing the migration flux, i.e. $j^{mig} = \frac{t_S \times I}{F \times S_m}$, according to Eq.(II-4) and (II-14) for inorganic anion and acetate respectively. The values are reported in Table IV-12. On the other hand, assuming that the ions have identical motilities through the membrane, one can calculate a theoretical value of the transport number, t^* , which is only fixed according to the proportion of each ion. In our conditions, since the concentration of acetate and inorganic salts are 0.1 and 0.8 eq.L⁻¹ respectively, the values of t^* are 0.11 and 0.89 for acetate and inorganic anions respectively. These values are also reported in Table IV-12 for comparison.

Anion transport number (t)	acetate	inorganic anion
Acetate - NaCl	0.02	0.98
Acetate - Na₂SO₄	0.08	0.92
t*	0.11	0.89

Table IV-12 Anion transport number (t) in different systems
[acetate] = 0.1 mol.L⁻¹ and [S] = 0.8 eq.L⁻¹ ; t* calculated value

The results reported in Table IV-12 show that in any case, the transport number of acetate is lower than the value of inorganic anion. It means that in the conditions investigated, the inorganic ions are preferentially transferred compared to acetate. Such result can be put in parallel with those reported in Chapter III, where selectivity between Cl⁻ and SO₄²⁻ was found on AEM showing a preferential transfer of Cl⁻ compared to SO₄²⁻.

The acetate transport number with Na₂SO₄ (0.08) is close to the theoretical one (0.11), showing only a slight selectivity. On the contrary, that with NaCl (0.02) is 4 times lower than that with Na₂SO₄ and 5 times lower than the theoretical value, showing a strong selectivity between chloride and acetate.

As it was done in the case of neutral organic solutes, diffusion and migration flux of acetate are compared, using data for different systems under different currents, in Figure IV-25.

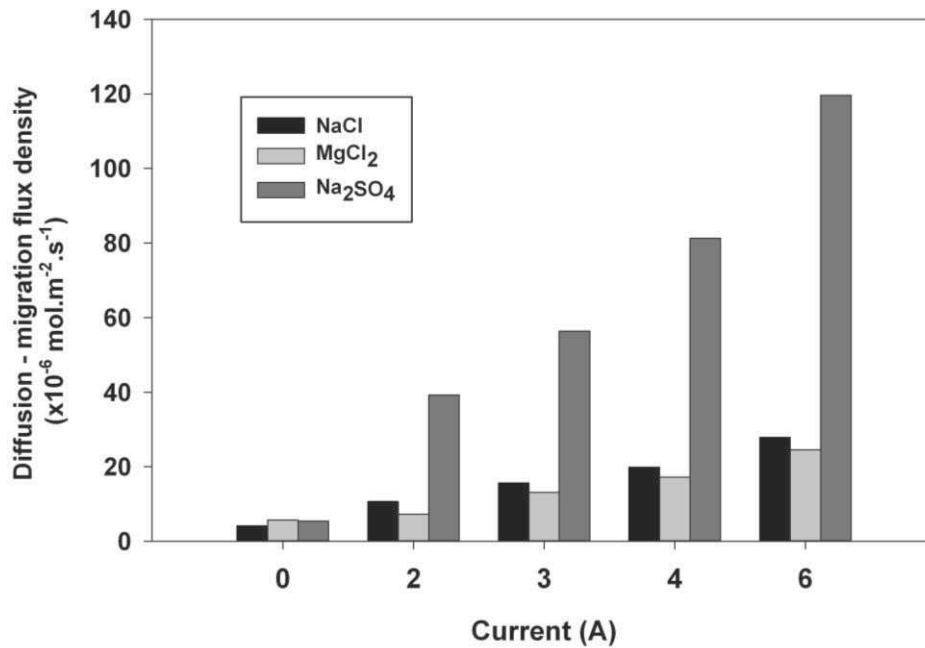

Figure IV-25 Comparison of diffusion flux ($I=0$) and migration flux ($I \neq 0$):
influence of the salt compositions
Different acetate / S systems, $[\text{acetate}] = 0.1 \text{ mol.L}^{-1}$ and $[S] = 0.8 \text{ eq.L}^{-1}$

One can observe that for any condition the diffusion flux (current equal to 0) is always lower than the migration flux.

Then, concerning the influence of salt, one can find sequence of migration as

$$j_{\text{acetate}}^{\text{mig}}(\text{NaCl}) \approx j_{\text{acetate}}^{\text{mig}}(\text{MgCl}_2) \ll j_{\text{acetate}}^{\text{mig}}(\text{Na}_2\text{SO}_4).$$

suggesting more pronounced migration with Na_2SO_4 , as expected.

Furthermore, the contributions of diffusion and migration for acetate are compared in different conditions, in parallel with those observed for acetic acid (i.e. diffusion and convection), in Figure IV-26.

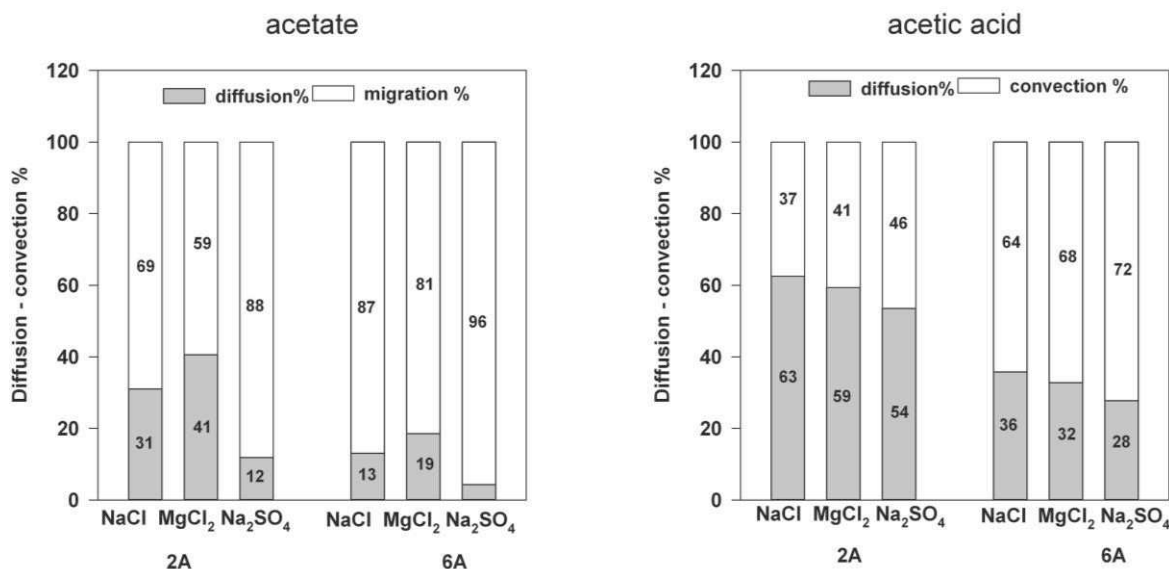

Figure IV-26 Diffusion and additional transfer contribution of acetic acid and acetate versus salt

Different OM / S systems, [OM] = 0.1 mol.L⁻¹ and [S] = 0.8 eq.L⁻¹; I = 2 A and 6 A

Firstly, one can find contribution of diffusion between these two solutes is different. For acetic acid, diffusion and convection are in same order of magnitude; while for acetate migration is always predominant compared to diffusion. Indeed, under 6A migration contribution reached maxi ca. 90%, with diffusion negligible.

Secondly, regarding the diffusion contribution, different sequence is observed for the two solutes concerning the influence of salt as:

Acetate: MgCl₂ > NaCl > Na₂SO₄

Acetic acid: NaCl > MgCl₂ > Na₂SO₄.

The common observation for both solutes is Cl⁻ > SO₄²⁻.

For acetic acid, where both diffusion and convection are important, the results agree with the membrane soaking sequence due to the counter-ion in diffusion, as aforementioned.

For acetate, migration is more remarkable, which explains the sequence due to salt. Migration with Na₂SO₄ is so important that diffusion contribution with Na₂SO₄ is the lowest. Then, between NaCl and MgCl₂, contribution of migration with NaCl is higher as indicated in Figure IV-24, thus its diffusion contribution is lower than that with MgCl₂.

To summarize, transfer of charged organic solute is studied in same manner as neutral one, regarding diffusion and migration. Unlike neutral solute, acetate migration as current carrier is more pronounced than diffusion. The influence of salt is also highlighted. In

diffusion, the increase of salt concentration increases acetate diffusion significantly; while in migration, higher transfer with sulfate is observed compared to that with chloride due to membrane selectivity.

IV.3 Conclusions

The aim of this chapter was to investigate the mechanism of the organic solute transfer through ion-exchange membrane and the further influence of salt on solute transfer. Varying salts of different hydration and solutes of different size, hydrophobicity, and charge were used.

Firstly, the salt and water transfer were studied.

As expected, it was found that the salt transfer (α) is mainly fixed according to the current and does not show significant variations according to the salts and organic solute present in the solution. Meanwhile, the water transfer (β) was found to vary according to the salt composition and the following sequence was obtained

$$\beta_{MgCl_2} > \beta_{NaCl} > \beta_{Na_2SO_4}.$$

Both salt and water transfer were found not influenced by the presence of different neutral organic solutes. On the contrary, when a charged organic solute (i.e. acetate) is present, it was found to compete with the inorganic salt as current carrier. This resulted in lower inorganic salt transfer, the total salt transfer including acetate remaining constant and identical to that obtained without organic solute. Water transfer is found to be mainly fixed by the inorganic salt (same sequence with case of no OM), not influenced by acetate, because of the much lower concentration of acetate compared to inorganic ions.

Secondly, the mechanism and influence of salt on the transfer of organic solutes were studied, through specific procedure to dissociate the diffusion and additional transfer.

For neutral organic solutes, the transfer consisted of two contributions, diffusion and convection. For any solute and both diffusion and convection flux, the following sequence was pointed out:

$$\text{acetic acid} > \text{phenol} > \text{glucose}$$

It was then concluded that the transfer of neutral organic solutes was mainly fixed by the steric effects. Then, concerning the salt effect, the trend for the diffusion flux was found as

$$\text{Cation: } Na^+ > Mg^{2+} \text{ and Anion: } Cl^- > SO_4^{2-},$$

showing a reversed trend compared to that of the counter-ion hydration. It is mainly due to membrane swelling effect: more hydrated counter-ion leads to stronger polymer chain-chain interaction, and thus lower diffusion is expected.

On the contrary, the convection flux was found to vary as:

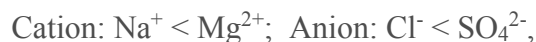

same to the sequence of counter-ion hydration. It is mainly due to solute dehydration effect: more hydrated ion give more solute dehydration, causing decrease of solute hydrated size, and thus higher convection is expected.

Indeed, salt simultaneously modify the membrane and solute properties, and the solute transfer is influenced by the salt under combination of these two effects: more hydrated the salt (counter-ion), more modification on the transfer. Moreover, both diffusion and convection were important.

These findings were applicable to neutral solute of different size and hydrophilicity, in different pH conditions. Exception on phenol with SO_4^{2-} was found, indicating further interaction. Future study is necessary to better understand the specific solute-membrane interaction i.e. phenol - anion-exchange membrane equilibrated by SO_4^{2-} .

For charged organic solute, the transfer consisted of diffusion and migration under current. Due to the charge, not only steric effects but also electrostatic effect can be concerned for its transfer mechanism. In diffusion regime, acetate transfer with water was found to be lower than that with salt by a factor of 3-4. Indeed, compared with acetic acid, the presence of salt significantly influences the solute-membrane interaction. The influence of salt on acetate diffusion was observed in acetate / S as



while a negligible influence of salt was observed in acetate / W system.

In normal ED regime, i.e. with a current applied, the migration of acetate was found to be much more important than the convection of acetic acid. In addition to that, because of the partition between inorganic and organic anion to carry the current, acetate migration was found to vary according to the anion. The calculation of the transport number of acetate and comparison with the theoretical value has shown selectivity between acetate and inorganic ions, this selectivity being higher with Cl^- compared to SO_4^{2-} . Then, the contribution of diffusion and migration was evaluated. Unlike convection for neutral organic solutes, migration is always much more important than diffusion, especially with SO_4^{2-} .

This chapter thus pointed out the mechanism governing the transfer of organic solutes, and the further influence of the salt. In the next chapter, the influence of these mechanisms on the performance of ED as a desalination process will be discussed.

Chapter V

Desalination performance of electrodialysis for saline water treatment

The aim of this chapter is to investigate the performance of electrodialysis for the desalination of saline waste water containing organic solutes.

On one hand, desalination performances to treat synthetic brines are discussed. Firstly, desalination of synthetic solutions containing single organic solute is investigated. A phenomenological model using four parameters, characterizing the salt, water and organic solute transfer (diffusion and additional transfer), is proposed. From this model, the salt and organic concentrations in the diluate and concentrate can be calculated. A case study is further considered to illustrate the influence of the current and water composition on the process performances. Secondly, the desalination of synthetic brines containing mixed organic solutes is studied using the same approach, to check the validity of the proposed model.

On the other hand, the desalination of an industrial saline waste water, that is an oil process water (OPW) provided by TOTAL company, is studied in order to evaluate the applicability of the model and the desalination performances of ED to treat such more complex waste waters.

V.1 Desalination of synthetic saline water containing organic solute

The first section deals with the desalination of synthetic brines containing single organic solute. The main experimental results are already described in Chapter IV. Then, according to the mass transfer study, a phenomenological model is proposed to predict the process performances. The second section is focused on the desalination of synthetic brine containing mixed organic solutes. The previously proposed phenomenological model is then applied for the mixture case.

V.1.1 Desalination performance of synthetic saline water containing single organic solute

As previously explained in Chapter I, the objective of the desalination considered in this work can be represented in Figure V-1, with the main expected characteristics of the feed water (saline waste water or brine to be treated) and those of the two treated streams obtained after electrodialysis.

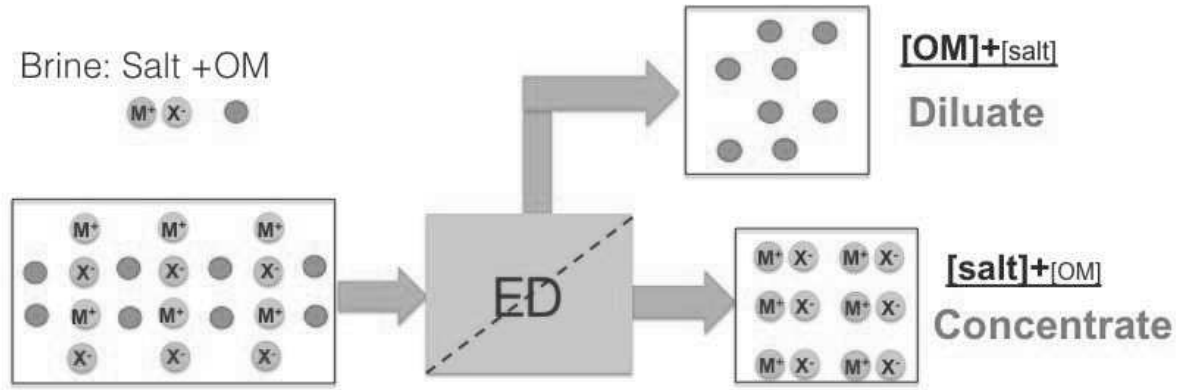

Figure V-1 Schematic drawing of solution characteristics before and after ED process

As shown in Figure V-1, ED can remove salts from the brine. Then, a diluate is obtained in which the salt content is decreased compared to that in the feed, and a concentrate containing the extracted salts. The key factor is then the transfer of organic solutes, which has to be kept as low as possible to keep the organic content in the diluate and not polluting the extracted salts in the concentrate. Indeed, as aforementioned, both salt and organic solute, as well as water transfer are involved in the desalination process. Then, the ED performances are discussed based on mass balance analysis.

In Chapter IV, the transfer of salt and water, as well as that of the organic solutes with and without current were investigated for different systems. For each system investigated, it was shown that the fluxes can be characterized by the corresponding parameters, as indicated in the following equations:

$$j_s \approx j^{mig} = \alpha I \quad (\text{II-5})$$

The salt flux density, i.e. j_s ($\text{eq.m}^{-2}.\text{s}^{-1}$), is due to migration, and characterized by α ($\text{eq.m}^{-2}.\text{s}^{-1}.\text{A}^{-1}$) as the current coefficient.

$$j_w \approx j^{eo} = \beta I \quad (\text{II-7})$$

The water flux density, i.e. j_w ($\text{m}^3.\text{m}^{-2}.\text{s}^{-1}$), is due to electro-osmosis, and characterized by β ($\text{m}^3.\text{m}^{-2}.\text{s}^{-1}.\text{A}^{-1}$) as the electro-osmotic coefficient.

$$j_{OM} = j^{diff} + j^{additional} = P_{OM}C_{OM,D}^0 + \gamma I \quad (\text{II-8 to II-17})$$

The organic solute flux density is due to diffusion, characterized by P_{OM} ($\text{m}.\text{s}^{-1}$), and an additional transfer due to convection for neutral OM, i.e. coefficient γ ($\text{mol.m}^{-2}.\text{s}^{-1}.\text{A}^{-1}$). For charged OM, the additional transfer is migration, which is characterized by γ' ($\text{mol.m}^{-2}.\text{s}^{-1}.\text{A}^{-1}$).

Then, the salt concentration (eq.m^{-3}) and organic solute concentration (mol.m^{-3}) in the two compartments are expressed according to the following equations:

in the concentrate compartment:

$$C_s^C = \frac{C_{s,C}^0 V_C^0 + \alpha I S_m t}{V_C^0 + 2\beta I S_m t} \quad (\text{V-1})$$

$$C_{OM}^C = \frac{(P_{OM} C_{OM,D}^0 + \gamma I) 2 S_m t}{V_C^0 + 2\beta I S_m t} \quad (\text{V-2})$$

then according to the mass balance, in the diluate compartment:

$$C_s^D = \frac{C_{s,D}^0 V_D^0 - \alpha I S_m t}{V_D^0 - 2\beta I S_m t} \quad (\text{V-3})$$

$$C_{OM}^D = \frac{C_{OM}^0 V_D^0 - (P_{OM} C_{OM,D}^0 + \gamma I) 2 S_m t}{V_D^0 - 2\beta I S_m t} \quad (\text{V-4})$$

In fact, knowing these parameters, it is possible to predict variation of salt and OM concentration, i.e. desalination performance. As previously explained, the 4 parameters (α , β , P_{OM} and γ) can be experimentally obtained. Specifically, the coefficients α and β are the proportionalities of salt and water flux density to current, respectively; the solute permeability (P_{OM}) is determined from diffusion flux, the additional transfer coefficient (γ) is the proportionality of OM flux density to current.

In Eqs. (V-1 to V-4), other parameters are from solution characteristics like initial concentration (C_s^0, C_{OM}^0) and volume (V_C^0, V_D^0), and from the ED apparatus like membrane effective surface (S_m) or operation condition such as current (I) and time (t).

Since the mass transfer mechanisms were concerned, the model was previously developed using the concentration of organic solute (C_{OM}) expressed in mole per cubic meter. For further results, since the processes performances are concerned, the organic solute concentration will be preferably expressed in ppm, which is a more common unit, according to Eq. (V-5):

$$C_{OM} (\text{ppm})^* = C_{OM} (\text{mol.m}^{-3}) * M_w (\text{g.mol}^{-1}) \quad (\text{V-5})$$

One can also further convert the concentration of organic solute to TOC (ppm of C), multiplying C_{OM} (mol.m^{-3}) in Eq.(V-5) by the carbon content ratio of the solute. In the

following sections, organic concentration expressed in ppm of solute is used for synthetic solution, and in ppm of TOC in last section concerning the oil process water.

The variations of salt and organic solute concentrations in the two compartments are plotted versus time, using data experimentally obtained and calculated using the fitted parameters according to the above equations. Figure V-2 is an example for the acetic acid / NaCl system under 2 A.

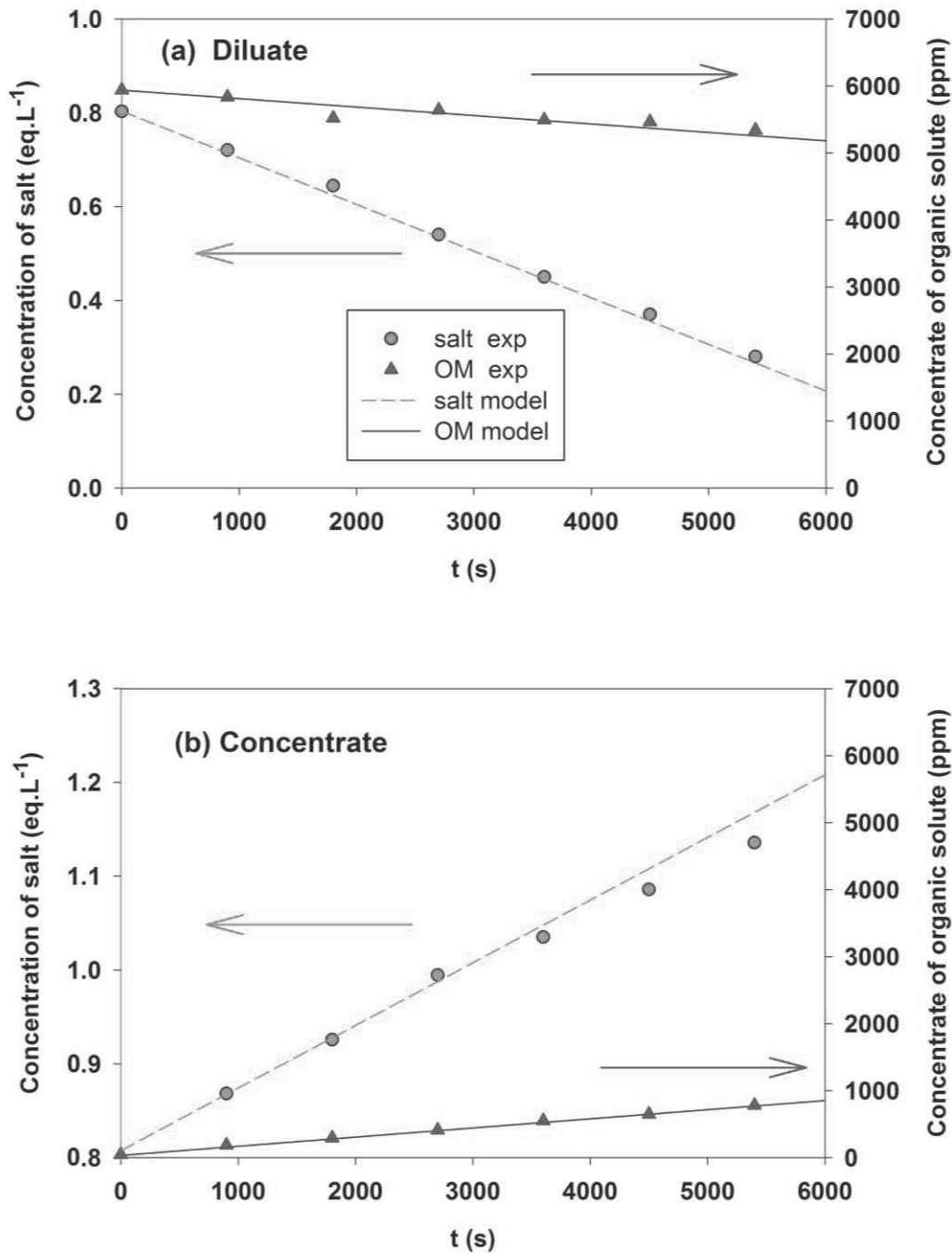

Figure V-2 Variation of salt and OM concentration versus time in (a) Diluate and (b) Concentrate

Acetic acid / NaCl system, [acetic acid] = 6000 ppm and [S] = 0.8 eq.L⁻¹; I = 2A experimental results (symbols) and modelled results (curves)

One can observe that the calculated variations fit well with the experimental data for both the salt and organic solute in two compartments versus time. As expected, the transfer of

salt and thus the variation of salt concentration is much higher than that of OM. These results show again the feasibility of ED to extract the salt from the brine.

Moreover, the observed good agreement of calculated results with the experimental data highlights the validity of the phenomenological model. It suggests application for scale-up cases, once the transfer parameters are known from lab-scale equipment. Then, the ED desalination performance can be predicted, and further improvement or optimization can be done regarding varying objectives.

As discussed in Chapter I, there are many different objectives for brine treatment (Figure I-1). Concerning the organic content of the feed water, the objective can be the recovery or the decomposition depending on it is a valuable fraction or a pollutant. On the other hand, it is also interesting to have further utilization for the extracted salt in the concentrate, such as recovery / raw materials production, or salinity gradient energy exploitation. Nevertheless, it is important to note that desalination in the diluate and OM transfer in the concentrate are simultaneous process. Then, attention should be given to process control, regarding the solution impurity in two compartments, which may limit further integration.

Different situations are already presented in Chapter I, a case study, i.e. the desalination of a waste water to be treated by further biological oxidation, is illustrated as the following.

It is reported that too much salt inhibits the bacterial activity, thus limiting or even prevent the organic matter biodegradation [31-32]. However, once the salt concentration is reduced down to a critical concentration, the biomass can have a good activity and biodegradation can take place. Therefore, ED can serve as a pretreatment, i.e. desalination, for further biological oxidation. The objective is to desalinate the brine until the critical concentration of salt. It was reported that critical concentration of sodium chloride is about 0.3 eq.L^{-1} , ca. 18 g.L^{-1} [94]. This value will thus be considered as the one to be achieved after desalination, i.e. as a controlling factor, in the case study considered in the following part. The performances of ED will be further discussed considering the salt concentration in the diluate and the organic solute concentration in the concentrate.

The variation of the solute concentrations, i.e. salt in the diluate and OM in the concentrate versus time is shown in Figure V-3, using acetic acid / NaCl as synthetic brine, under two different currents, 2A and 6A, as example.

To reach the final salt critical NaCl concentration in the diluate of 0.3 eq.L^{-1} , it is necessary to extract a given amount of salt, i.e. to transfer a fixed number of charge, that is represented by the product of the current and time ($I.t$).

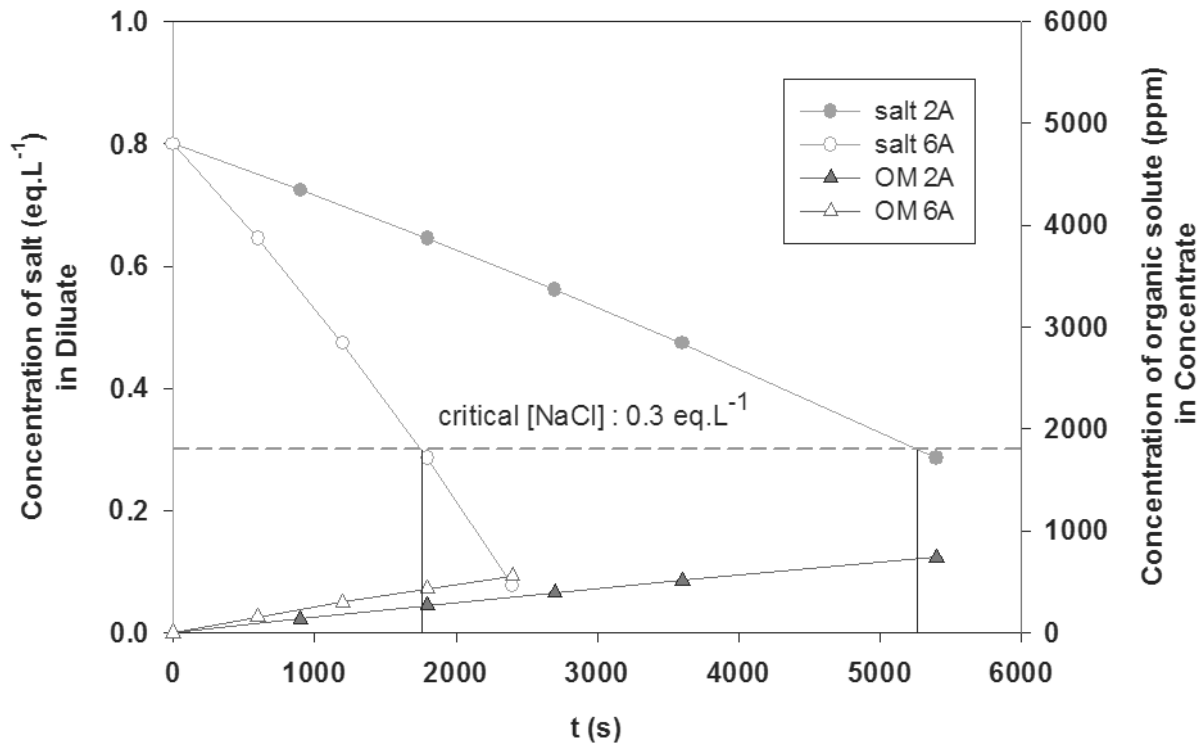

Figure V-3 Variation of salt concentration in the diluate and OM concentration in the concentrate versus time: influence of the current
Acetic acid / NaCl system, [acetic acid]= 6000 ppm and [S]= 0.8 eq.L^{-1} ; $I = 2\text{A}$ and 6A

Then, obviously, less time is required to reach the objective with the higher current. Meanwhile, one can observe that the quantity of organic solute transferred in the concentrate is different, higher current leading to lower OM concentration.

The influence of current on the OM transfer is further reported in Table V-1, considering the fixed final salt concentration in the diluate, i.e. 0.3 eq.L^{-1} . The concentrations of organic solute in the concentrate compartment are calculated according to Eq.(V-2). The total value C_{OM}^{total} consisting of contribution of diffusion and convection is firstly calculated, then OM concentration due to only diffusion (C_{OM}^{diff} , assuming $\gamma = 0$), and the one due to only convection (C_{OM}^{conv} , assuming $P_{OM} = 0$), are also reported.

I (A)	Time (s)	Electrical charge (C)	C_{OM}^{total} (ppm)	C_{OM}^{diff} ($\gamma = 0$) (ppm)	C_{OM}^{conv} ($P_{OM} = 0$) (ppm)
2	5265	10530	720	450	270
6	1755	10530	420	150	270

Table V-1 Influence of the current on the desalination performance
Acetic acid / NaCl system, [acetic acid] = 6000 ppm and [S] = 0.8 eq.L⁻¹

As explained, the electrical charge (i.e. product of current and time) is constant because the initial and final salt concentrations are fixed. Concerning the concentration of the organic solute in the concentrate, the results show that the total concentrations C_{OM}^{total} are different. Higher current gives lower organic concentration in the concentrate, the value under 6A being about 60% of that under 2A. Looking further to the two contributions, one can state that, as expected, the value of C_{OM}^{diff} is proportional to the experiment duration, because the solute diffusion is time dependent. Concerning the convection contribution, constant values for C_{OM}^{conv} are observed, because the convection is fixed by electrical charge (It). Then, due to the contribution of convection, less difference between of the OM concentrations (C_{OM}^{total}) under the two currents is found, compared to that expected according to the only contribution of diffusion C_{OM}^{diff} . This shows that convection for OM transfer is important to be considered regarding the ED process.

As previously reported, OM transfer through IEM is systematically investigated using different OM - salt compositions. Then, the influence of the brine composition is discussed, regarding the desalination performance.

First, the variation of the OM concentration in the concentrate versus the salt concentration in the diluate is shown in Figure V-4, using OM / NaCl under 2A as an example. It is important to note that the X axis, i.e. remaining salt concentration in the diluate, represents the desalination process with time, and Y axis, i.e. organic solute concentration in the concentrate, represents the simultaneous OM transfer with time.

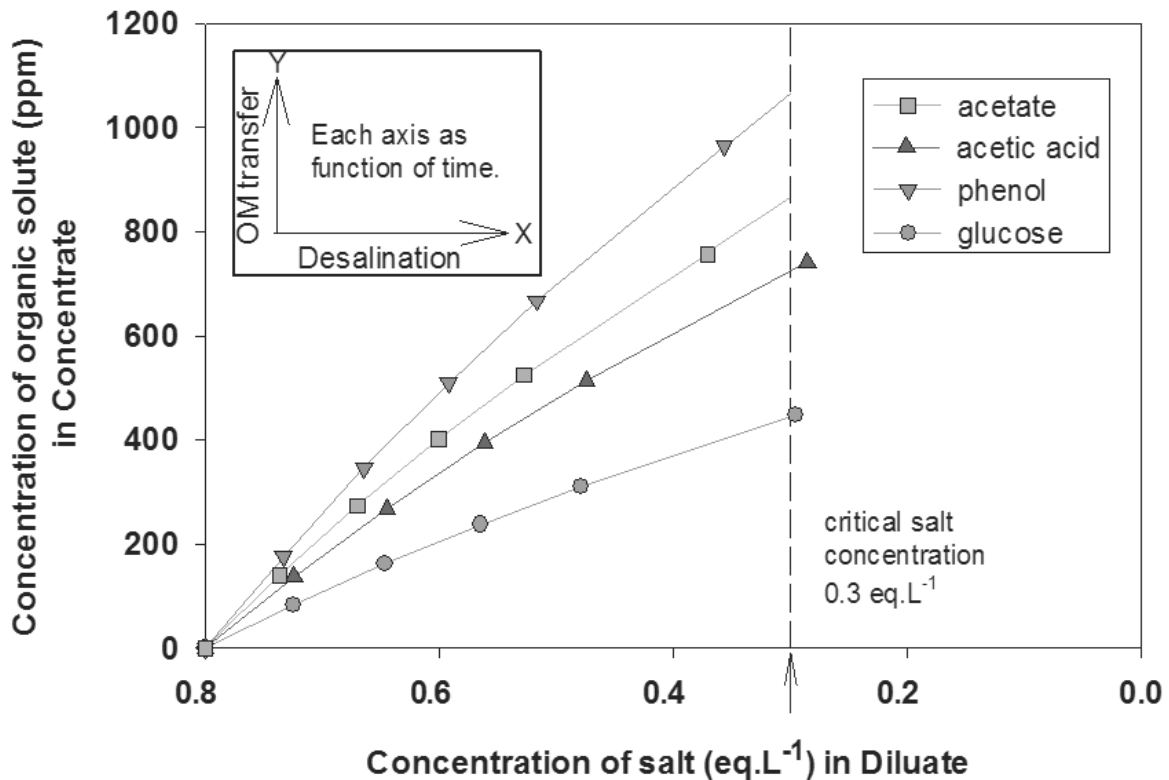

Figure V-4 Variation of OM concentration in the concentrate versus salt concentration in the diluate: influence of the solute

OM / NaCl systems, $[OM] = 0.1 \text{ mol.L}^{-1}$ (glucose 18016 ppm, phenol 9400 ppm, acetic acid 6000 ppm, acetate 5900 ppm) and $[S] = 0.8 \text{ eq. L}^{-1}$; $I = 2A$

As expected, with decreasing salt concentration in the diluate, the concentration of organic solute increases in the concentrate. This increase depends on the solute, and the following sequence is observed for OM concentration in ppm:

$$\text{phenol} > \text{acetate} > \text{acetic acid} > \text{glucose}$$

The present result in term of solute transfer in ppm, shows that phenol has highest transfer, followed by acetate, and glucose has lowest transfer. In fact, in unit of mole of solute, it was observed that the sequence for organic solute transfer is acetate > acetic acid > phenol > glucose (Chapter IV). The displacement of phenol in the present sequence is mainly due to its higher Mw (94 g.mol^{-1}) compared to that of acetate (59 g.mol^{-1}). For instance, one can consider that solution containing phenol can be more difficult to treat compared to other solute, because of higher phenol transfer through the membrane.

The influence of salt on OM transfer has been also studied in Chapter IV. The influence of salt on ED desalination performance is shown in Figure V-5, in the case of acetic acid and acetate, with two salts, NaCl and Na₂SO₄.

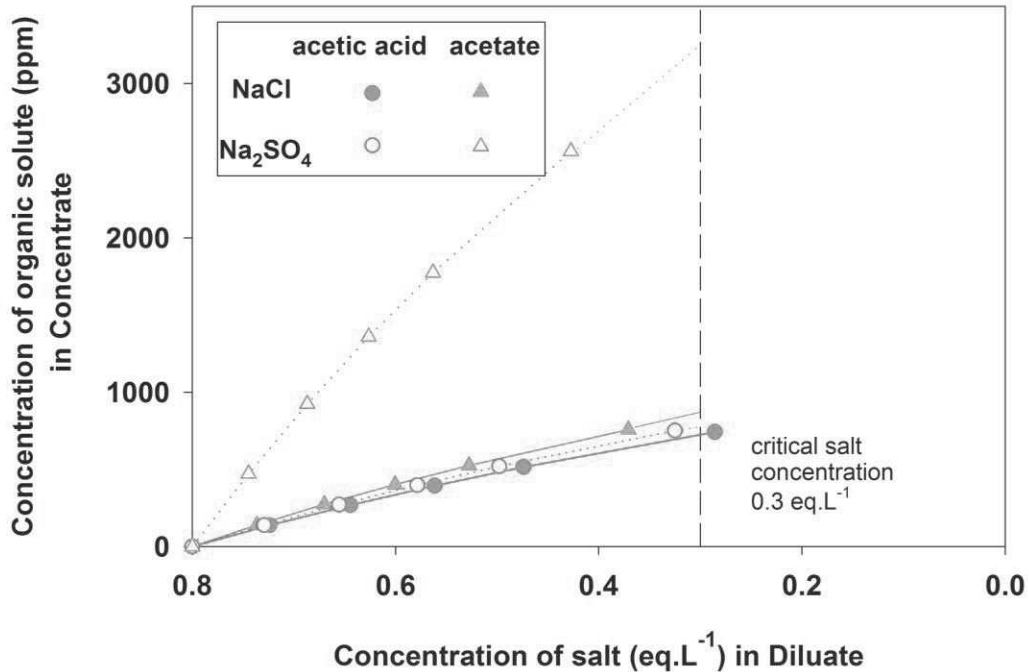

Figure V-5 Variation of OM concentration in the concentrate versus salt concentration in the diluate: influence of the salt compositions
OM / NaCl - Na₂SO₄ systems, [OM] = 0.1 mol.L⁻¹ (acetic acid 6000 ppm, acetate 5900 ppm)
and [S] = 0.8 eq.L⁻¹; I = 2A

For each solute, neutral or charged one, the OM transfer with SO₄²⁻ is always higher than that with Cl⁻, for a fixed salt concentration in the diluate. As previously mentioned in Chapter IV, this anion-induced difference on the OM transfer is more important with acetate than with acetic acid.

The influence of the salt composition is also observed with other solutes. Considering a controlling factor of desalination, i.e. the final salt concentration in the diluate as 0.3 eq.L⁻¹, the corresponding concentrations of the organic solute in the concentrate compartment are reported in Table V-2, for the different compositions (organic solute and salt) investigated.

C_{OM}^{total} (ppm)	glucose	phenol	acetic acid	acetate
NaCl	448	1060	723	849
Na ₂ SO ₄	473	673	775	3193

Table V-2 Influence of the salt composition and solute on the desalination performance OM / NaCl - Na₂SO₄ systems, [OM] = 0.1 mol.L⁻¹ (glucose 18016 ppm, phenol 9400 ppm, acetic acid 6000 ppm, acetate 5900 ppm) and [S] = 0.8 eq.L⁻¹; I = 2A

The influence of salt, more precisely, anions SO₄²⁻ and Cl⁻, on organic transfer is observed, regarding different organic solutes. Higher transfer with SO₄²⁻ compared to Cl⁻ is found for glucose, acetic acid and acetate. Among the three solutes, transfer of acetate / SO₄²⁻ is higher than acetate / Cl⁻ by a factor of 3-4, whereas less pronounced influence of anions is found for the two neutral solutes. On the contrary, the result for phenol is that SO₄²⁻ leads to a lower transfer by a factor of ca 1.5, compared to that for phenol / Cl⁻. These findings agree with those reported and already discussed in Chapter IV.

On the other hand, it suggests in which way a modification of the solution composition can improve the desalination performances. For instance, Table V-2 shows a highest transfer of organic solute with acetate / SO₄²⁻ system compared to the other ones. Then, two approaches can be considered to improve the process, i.e. to decrease the acetate transfer during the desalination. One is to neutralize acetate into its neutral form acetic acid, by decreasing the pH of the water, since it is a weak acid salt. Indeed, our results show that the transfer of organic solute can be drastically reduced from a final value about 3200 ppm for acetate down to about 800 ppm with acetic acid under the same conditions. Another way is to make use of membrane selectivity with respect to the ions, e.g. changing the salt composition or choosing a membrane with stronger selectivity. Indeed, the present results show that the acetate transfer can be also largely reduced if the co-ion is changed from SO₄²⁻ to Cl⁻. Similar approach (changing salt compositions) can also be applied on saline solution containing phenol since it was observed that the transfer of phenol is much lower in presence of SO₄²⁻ compared to Cl⁻ (Table V-2).

V.1.2 Desalination performance of synthetic saline water containing mixed organic solutes

In the same manner as in the case of single organic solute, the performance of ED for the desalination of brines containing mixed OMs is investigated. The solution composition

and concentration has already been reported in Table II-5 (Chapter II). It is important to note that the salt concentration is the same as in single OM case, while total OM concentration is doubled (each organic solute concentration being kept constant at 0.1 mol.L^{-1}), compared to single OM case (0.1 mol.L^{-1}).

The mass transfer of salt, water and organic solutes are studied using the same methodology, and the 4 transfer parameters are determined. These parameters are reported in Table V-3. They will be used later to predict the desalination performance. In the case of glucose-acetate solution, the reported current coefficients (α) are the values corresponding to the inorganic salt only (NaCl or Na_2SO_4), i.e. without taking the contribution of acetate into consideration.

Mixture of organic solutes / salt	Mixture 1 : Glucose - acetic acid				Mixture 2 : Glucose - acetate			
	NaCl		Na_2SO_4		NaCl		Na_2SO_4	
α ($\times 10^{-4} \text{ eq.m}^{-2}.\text{s}^{-1}.\text{A}^{-1}$)	4.4		4.5		4.0		4.1	
β ($\times 10^{-8} \text{ m}^3.\text{m}^{-2}.\text{s}^{-1}.\text{A}^{-1}$)	5.8		5.9		5.8		5.9	
Organic solutes	Glu	HAc	Glu	HAc	Glu	Ac^-	Glu	Ac^-
j_{OM}^{diff} ($\times 10^{-6} \text{ mol.m}^{-2}.\text{s}^{-1}$)	1.6	9.8	1.4	8.3	1.2	4.8	1.3	7.6
γ ($\times 10^{-7} \text{ mol.m}^{-2}.\text{s}^{-1}.\text{A}^{-1}$)	7.6	21.1	8.3	34.2	8.8	58.9	8.8	203

Table V-3 Parameters characterizing salt, water and OM transfer for mixtures α are values for inorganic salt only; $[\text{OM}] = 0.1 \text{ mol.L}^{-1}$ for each solute and $[\text{S}] = 0.8 \text{ eq.L}^{-1}$; Glu: glucose, HAc: acetic acid, Ac^- : acetate

Table V-3 reports the transfer parameters with comparable values to those determined from the results obtained with single organic solutes in previous chapter (results not shown). These results are in agreement with the aforementioned transfer mechanism and the influence of solution compositions, concerning the salt and solute. It is important to mention that knowing these parameters, one can check the robustness of the proposed model.

Then, the variations of the concentration of organic solutes and salt in the two compartments are illustrated in Figure V-6, where experimental points are reported together with the fitted curves calculated using the 4 parameters model.

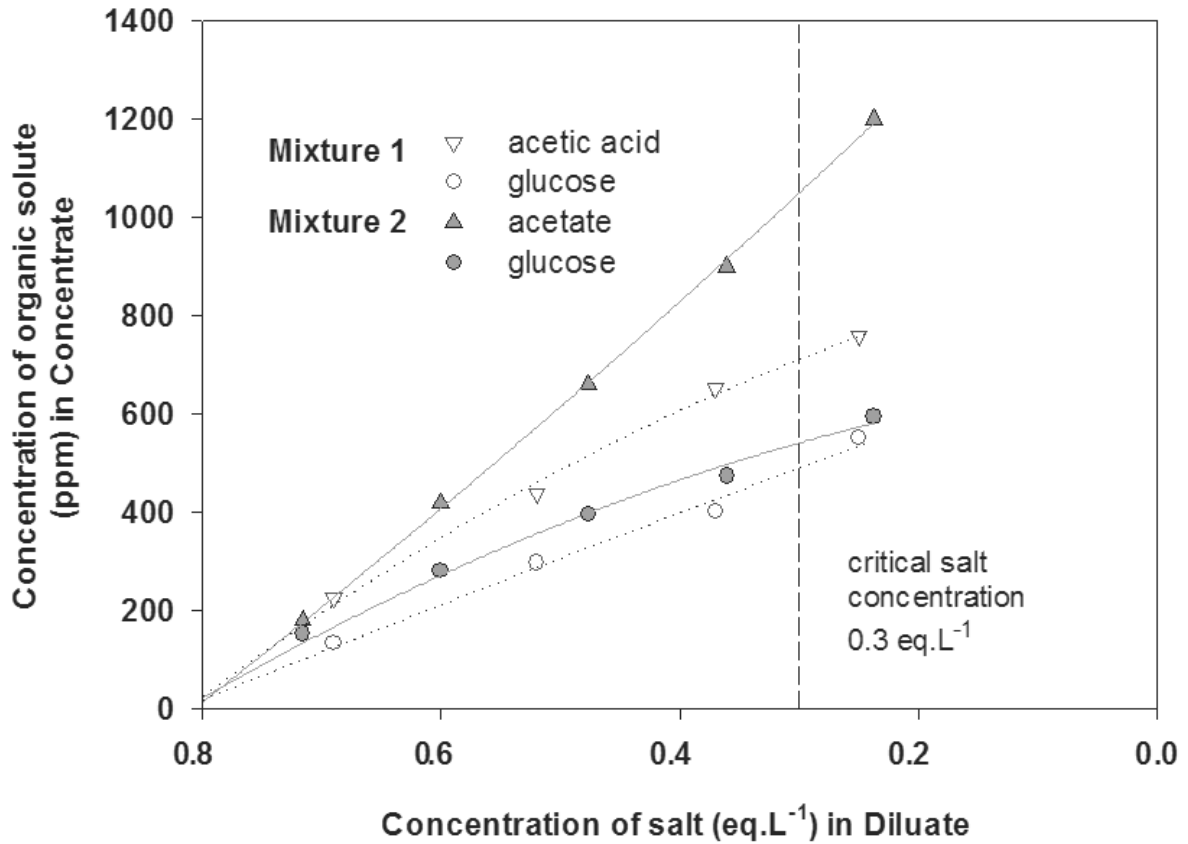

Figure V-6 Variation of OM concentration in the concentrate versus salt concentration in the diluate: influence of the solute

OMs / NaCl systems, in each mixture, $[OM] = 0.1 \text{ mol.L}^{-1}$ for each solute and $[S] = 0.8 \text{ eq.L}^{-1}$; experiments results in mixture 1: acetic acid + glucose (open symbol), mixture 2: acetate + glucose (solid symbol) and modelled results (curves); $I = 3A$

Figure V-6 shows that the calculated results fit well with the experimental ones, illustrating the robustness of the model. Concerning the concentration of organic solutes in the concentrate for fixed salt concentration in the diluate, the order of sequence is:

$$\text{acetate} > \text{acetic acid} > \text{glucose}$$

As expected, the transfer of acetate is the highest, mainly due to the important contribution of migration. The concentration of glucose in each mixture is always lower, compared to the co-existing solute; and variations of glucose concentration are comparable in the two cases. It may imply that the co-existing solute has no significant influence on the transfer of glucose. Same results are observed in systems of organic solute mixture / Na_2SO_4 .

In the same manner with the single solute case, one can check the influence of the solution compositions on the ED performance, regarding the complex systems. Considering a fixed salt concentration in the diluate, i.e. 0.3 eq.L^{-1} , the organic solute concentrations in each mixture are reported in Table V-4 according to the model. It concerns concentration of organic solute, mixed with different salt compositions, for each single solute and total value in different mixtures.

Organic solute Concentration in the concentrate (ppm)	Mixture 1 : Glucose - acetic acid			Mixture 2 : Glucose - acetate		
	Glucose	Acetic acid	Total	Glucose	Acetate	Total
NaCl	498	691	1189	544	1062	1606
Na ₂ SO ₄	503	784	1287	555	3101	3656

Table V-4 Concentration of organic solute in different mixture:

influence of solution composition on process performance

Mixture of organic solutes / NaCl - Na₂SO₄ systems, [OM] = 0.1 mol.L^{-1} for each solute (glucose 18016 ppm, phenol 9400 ppm, acetic acid 6000 ppm, acetate 5900 ppm) and [S] = 0.8 eq.L^{-1} ; I = 3A

Table V-4 shows that sulfate leads to a higher transfer of each organic solute in each mixture, as well as the total value. As reported in Figure V-6, in any condition, the concentration of glucose is lower compared to that of the co-existing solute. Then, for a given salt, comparable result of glucose in each mixture is found (difference below 10%). Finally, the total organic solute concentration in the concentrate is lower for mixture 1 compared to mixture 2, which is mainly due to the higher transfer of acetate, compared to acetic acid.

Indeed, in mixture of glucose and acetate, neutral OM can be easily yielded in the diluate, while charged one has propensity of higher transfer. Aiming to minimizing the final acetate transfer, one possible solution is to turn acetate to acetic acid with pH adjustment, as aforementioned. This solution is confirmed here (comparison of mixture 1 and 2 in Table V-4). Also, the influence of salt composition on acetate transfer is highlighted. These results are in agreement with those in single solute case.

V.2 Desalination of oil process water

In this part, the desalination of oil process water (OPW) containing both salt and organic matter is investigated by ED. It is an industrial effluent (Total, France), which was already pretreated by microfiltration. The characteristics of the OPW are reported in Table V-5.

Composition	OPW characteristics
Conductivity (mS.cm ⁻¹)	34
pH	8.2
Na ⁺ (eq.L ⁻¹)	0.34
Cl ⁻ (eq.L ⁻¹)	0.30
SO ₄ ²⁻ (eq.L ⁻¹)	Not determined
TOC (ppm)	35.4

Table V-5 Characteristics of OPW (T= 25 °C)

It shows that the inorganic fraction is mainly composed by sodium and chloride, with salinity about 0.34 eq.L⁻¹, comparable to that of seawater (about 0.5 eq.L⁻¹ NaCl). Concerning the organic content, the concentration in TOC is ca. 35 ppm, which is comparable to that for ROC from municipal wastewater treatment plant, i.e. ca. 20 ppm (Chapter I). It is important to mention that some trace compositions are also possible in the solution, like salt impurities or surfactant.

Experiments are carried out with 0A, 2A and 4A, respectively. To perform the experiment without current, i.e. to determine the contribution of the diffusion to the transfer of the organic matter, OPW is initially put in the diluate compartment while a synthetic saline solution containing NaCl at 0.34 eq.L⁻¹ (same salt composition than the OPW) is fed in the concentrate compartment. For desalination experiments, under current, the concentrate compartment is initially fed with tap water. During any experiment, the solution conductivity and pH is measured at 25 °C. It is found that the pH remains constant, while the conductivity varies linearly versus time showing the desalination process. Ion chromatography is also used to follow the salt concentration and a linear variation versus time is found in the two compartments, dominantly in form of sodium and chloride. Then one can conclude that in that case, following the conductivity would have been sufficient to follow the desalination process.

Organic concentration is measured versus time in the two compartments by TOC measurement.

Desalination results are illustrated in Figure V-7, showing the variation of the salt and organic solute concentration versus time in both compartments for the two different currents, 2A and 4A. The fitted curves based on the 4 parameters model are plotted together with the experimental points.

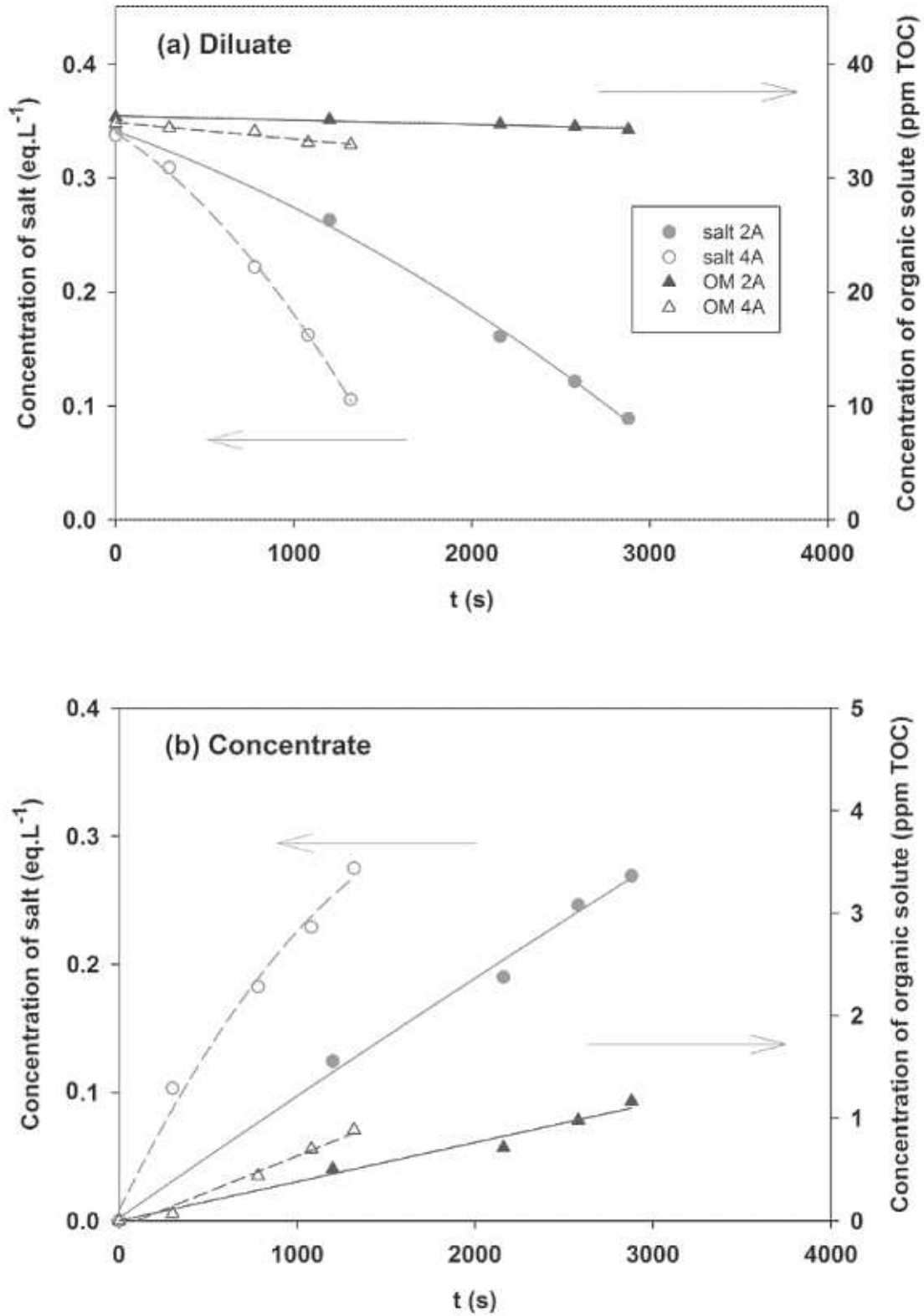

Figure V- 7 Variation of salt and OM concentration versus time for OPW in
 (a) Diluate and (b) Concentrate
 Experimental results (symbols) and modelled results (curves)

Figure V-7 shows that both salt and organic solute concentrations decrease in the diluate compartment, while increasing in the concentrate compartment according to the mass balance. Then, the predicting curves fit well the experimental results in each condition. The influence of current is also observed, as a higher current leads to shorter experiment duration for a fixed solute variation. This is in agreement with previous results for synthetic solutions.

As expected, the changes in the concentration of the salt is always more pronounced than that of the organic solutes (Figure V-7). For example, in the diluate, when the salt concentration decreases rapidly from initial value ca. 0.35 eq.L⁻¹ to ca. 0.1 eq.L⁻¹ (by ca. 70%), the organic solute concentration only decreases from ca. 35 ppm to ca. 32 ppm. One can state that the salts are largely removed, with the desalinated solution containing mainly organic solutes, which is good for further disposal. On the other hand, the concentrate solution contains mainly the extracted salt while few organics (below 2 ppm). Since the concentrate is initially the tap water, NaCl solution with high purity is finally obtained, which can be easily used. One can conclude that ED process is very feasible for desalination of OPW.

As aforementioned, the transfer parameters for oil process water are determined in the same manner as with synthetic solutions, according to the proposed phenomenological model. It consists of the coefficients for salt (α) and water (β) transfer, as well as those for organic solute transfer, i.e. solute permeability (P_{OM}) and additional transfer coefficient (γ). Specifically, the transfer of organic solute can be expressed using the following equation shown in Chapter II:

$$j_{OM} = j^{diff} + j^{additional} = P_{OM}C_{OM,D}^0 + \gamma I \quad (\text{II-8 to II-17})$$

It can be further rewritten with these coefficients independent to the solute concentration gradient, shown as Eq.(V-7):

$$j_{OM} = P_{OM}C_{OM,D}^0 + \gamma^* C_{OM,D}^0 I \quad (\text{V-7})$$

considering that

$$\gamma^* = \frac{\gamma}{C_{OM,D}^0} \quad (\text{V-8})$$

Then, Eq. (V-7) can be used to predict the organic solute transfer, e.g. for oil process water, using coefficient γ^* (m.s⁻¹.A⁻¹) and permeability P_{OM} (m.s⁻¹), given the concentration gradient in term of TOC, as $C_{OM,D}^0$ (mg C.m⁻³).

These transfer parameters determined for oil process water are reported in Table V-6, in parallel with those obtained with synthetic brines, i.e. various organic solute / NaCl systems. Since the oil process water consists of mainly NaCl and few OM (with unknown composition

and concentration except information from TOC), results for synthetic brine can be a reference. All these solutions contain NaCl as salinity, carbohydrate compound as OM, regarding the nature of charge (neutral and charged), Mw and hydrophilicity.

Parameters	Oil process water	glucose	phenol	acetic acid	acetate
α ($\times 10^{-4}$ eq.m ⁻² .s ⁻¹ .A ⁻¹)	4.5	5.0	4.5	5.3	4.4
β ($\times 10^{-8}$ m ³ .m ⁻² .s ⁻¹ . A ⁻¹)	5.3	5.9	5.5	6.3	6.1
P_{OM} ($\times 10^{-8}$ m.s ⁻¹)	2.4	1.1	7.5	8.1	4.2
γ^* ($\times 10^{-8}$ m.s ⁻¹ . A ⁻¹)	1.7	0.73	1.6	2.4	4.6

Table V-6 Parameters characterizing salt, water and OM (TOC) transfer Oil process water and synthetic solutions; [OM] = 35 ppm TOC, [NaCl] = 0.34 eq.L⁻¹; I = 0A, 2A, 4A

Table V-6 shows that concerning these solutions, salt and water transfer coefficients are in same order of magnitude, while OM diffusion and additional transfer coefficients are very different. The OM in oil process solution shows higher permeability than glucose but lower than other solutes, in diffusion system. Under current, the additional transfer coefficient γ^* is comparable to that for phenol, while higher than that for glucose by a factor of ca. 2.

The organic solute flux under each current is then illustrated in Figure V-8, according to Eq. (V-7), knowing the transfer parameters.

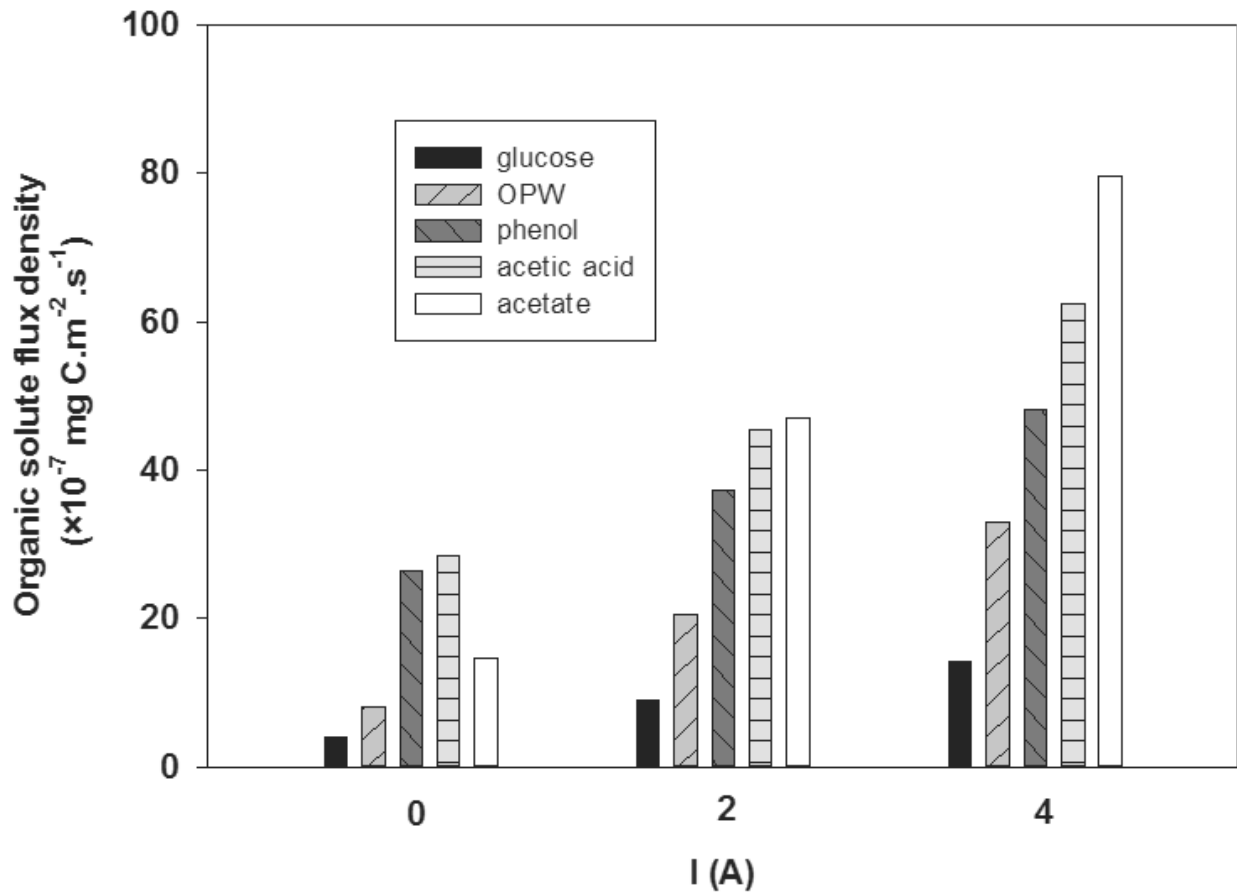

Figure V- 8 Variation of organic solute flux versus current

Oil process water and synthetic solutions; $[OM] = 35 \text{ ppm in TOC}$, $[NaCl] = 0.34 \text{ eq.L}^{-1}$

As expected, organic solute flux increases with the current. Without current, i.e. $I=0A$, the diffusion flux for oil process solution is almost twice that of glucose, one half that of acetate as charged solute, and it is slightly lower than those of phenol and acetic acid as two smaller neutral solutes compared to glucose. With current, i.e. normal ED condition, the flux of organic matter with the oil process water is about twice that of glucose, still lower than those observed with the two other solutes.

The results shown in Figure V-8 and Table V-3 imply an important contribution of solute diffusion for smaller solute like phenol and acetic acid, while the diffusion for charged solute, i.e. acetate, is much less pronounced. One can find another situation for glucose and the organic in oil process water: for each solute, the contribution of additional transfer is slightly higher than that for diffusion (Table V-6).

Then, the influence of the current on the salt desalination in the diluate and organic solute transfer in the concentrate is illustrated, in Figure V-9.

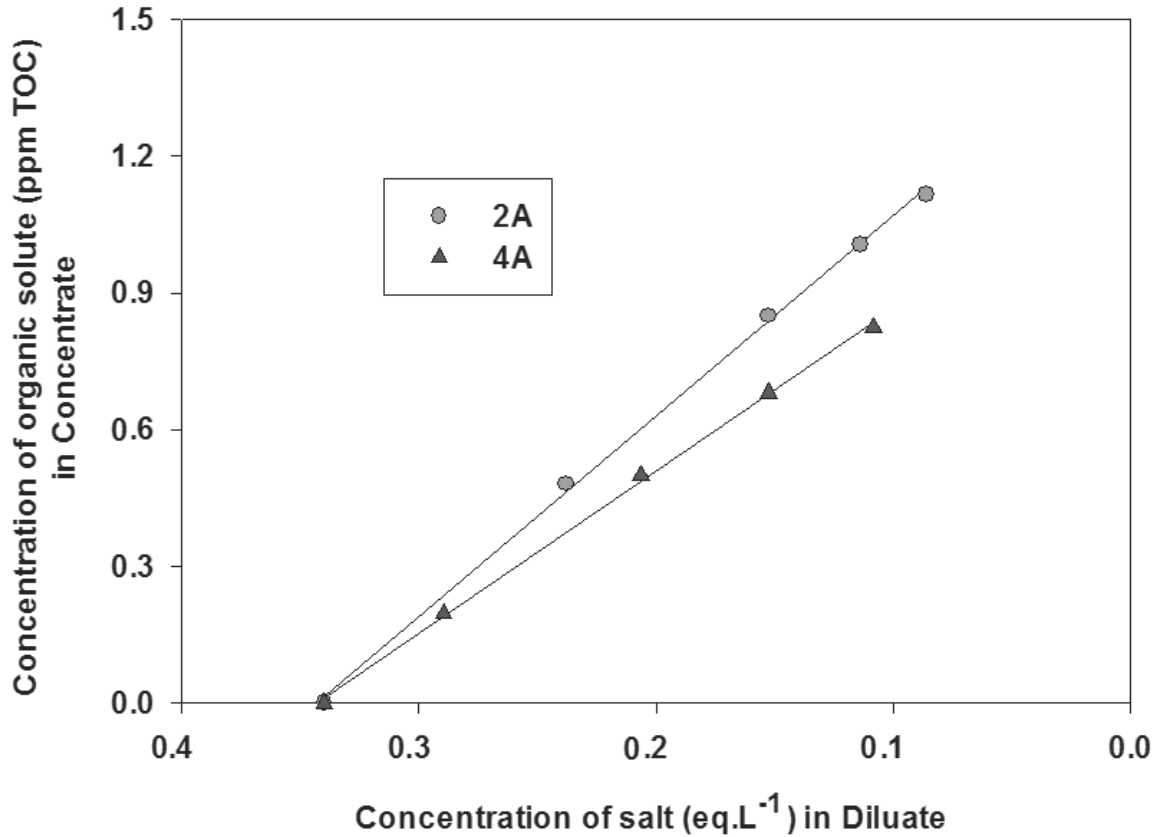

Figure V- 9 Variation of OM concentration in the concentrate versus salt concentration in the diluate for oil process solution: influence of the current
 $[OM] = 35 \text{ ppm TOC}$, $[NaCl] = 0.34 \text{ eq.L}^{-1}$

This shows that for a fixed salt concentration in the diluate, lower current leads to higher organic solute concentration in the concentrate. This is in agreement with previous results for synthetic solution (Figure V-3). One can consider that the different concentrations for organic solute arise from the contribution of diffusion under two currents, which is time dependent (Table V-1). Thus, the present results suggest higher current to minimize organic transfer, optimizing the oil process performance by ED.

Then, comparison of the desalination performance for oil process solution with those for synthetic solutions can be done, according to the phenomenological model. Using the transfer parameters in Table V-6, one can predict the performance for synthetic solutions containing organic solute / NaCl, given an initial concentration gradient ca. 35 ppm in TOC,

identical to that for the oil process water. The results are illustrated in Figure V-10, using again the variation of the organic solute concentration in the concentrate versus the salt concentration in the diluate under 2A.

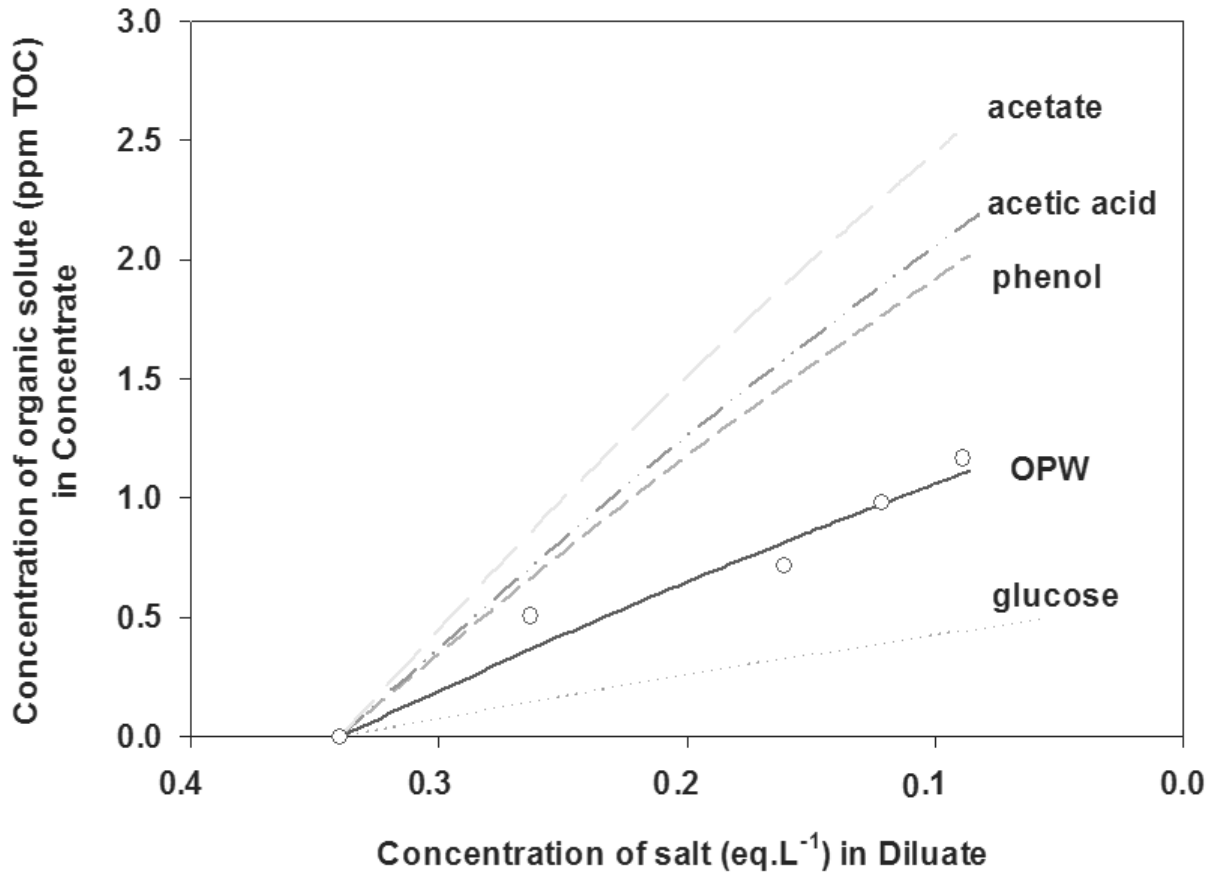

Figure V- 10 Variation of OM concentration in the concentrate versus salt concentration in the diluate: influence of the solute

Oil process water and synthetic solutions; $[OM] = 35 \text{ ppm TOC}$, $[NaCl] = 0.34 \text{ eq.L}^{-1}$; modelled results (curves) and experimental results (symbols, oil process water)

Figure V-10 shows that for fixed salt concentration in the diluate, organic solute transfer for oil process water is higher than glucose but lower than other solutes. The sequence of the predicting curves agrees with results in normal ED condition, shown Figure V-8. For oil process water, a good fit of experimental results is observed.

Therefore, the present results highlight the robustness of the proposed phenomenological model. One can apply it to simulate the desalination performance under

different conditions e.g. not only for synthetic solutions, but also for complex solutions like oil process wastewater.

It is important to note that the oil process water may contain impurities or additional compounds such as surfactant, with unclear ionic properties or hydrophilicity. As reported in Chapter IV, the influence of salt (of different nature and concentration) as well as solute properties can affect the solute transfer through the membrane. In practical work, variations of the solute transfer due to different membrane swelling conditions or solute hydration states is still possible. It is advisable to pay attention to the solution conditions, especially solute and salt type, in order to have better desalination process.

The present work shows a very low concentration of organic solute in the concentrate after ED desalination for the OPW (Figure V-10). Indeed, ED efficiently removes the salt of the OPW, meanwhile keeps the organic solute from transfer through the membrane. It suggests that ED can be a very promising process for petroleum wastewater desalination.

V.3 Conclusions

The aim of this chapter was to evaluate the desalination performance of electro dialysis for saline solution containing organic solute. This was carried out using an experimental approach with brines of different compositions, i.e. synthetic ones containing single or mixed organic solutes, and an oil process water.

First, a phenomenological model consisting of 4 parameters was proposed, based on transfer of salt (α), water (β) and organic solute, i.e. diffusion (P_{OM}) and the additional one under current (γ), concerning desalination of synthetic solution containing single organic solute. With this model, the variation of the salt and organic solute concentration can be calculated in each compartment. Then, performance of electro dialysis was evaluated, considering the influence of current and compositions through a case study. A higher current leads to a lower organic solute transfer, given a fixed salt quantity removed (i.e. electrical charge). This is mainly explained by contribution of solute diffusion, which is time dependent. Convection contribution is fixed by electrical charge, which is also important to be considered in ED process. Then, solution compositions regarding the organic solute type and salt hydration was also discussed, concerning the desalination process.

The model robustness was checked using synthetic solution containing mixture of different organic solutes. In the same manner as with the single organic solute case, the

experiments were conducted and the transfer parameters characterizing salt, water, and organic solute diffusion and additional transfer were determined. Comparable results with those obtained in single solute case were observed. The desalination performance can be well predicted by the proposed model for the complex solution.

Some possible strategies to improve the process performance are proposed, like applying higher current to reduce the transfer of organic solute, changing solution pH condition (acetate and acetic acid) and salt composition (chloride and sulfate for phenol, acetate).

Second, desalination of oil process water was studied. The phenomenological model was validated, using the 4 parameters experimentally obtained for the oil process water. The results confirmed that the proposed model can be used to predict desalination process with different initial compositions e.g. solute concentration, under different experimental condition. Furthermore, the present results suggest that ED can be a very promising process for desalination of oil process water, with efficient salt removal and very low organic solute transfer. Further applications of ED for petroleum effluent desalination would be interesting.

Conclusions and perspectives

Saline water or brine accounts for important portion of water resource, regarding portable water production and many other essential human activities. It is continuously being produced such as sea water reverse osmosis concentrate, which has large amount of volume and high salinity. Moreover, saline water mixing with organic solute is problematic to the environment. Either the organic solute is a hazardous pollutant to treat or valuable resource to recycle, the presence of large quantity of salt makes the treatment very difficult and even impossible. Membrane processes, particular nanofiltration and electrodialysis, can be used to improve the treatment of such brine since the salts and organic matter can be separated. Indeed, such separation can be environmental-friendly, giving many different options for integration process regarding the salt and organic solute. Electrodialysis can be a better option compared to nanofiltration, specially to treat waters with high salinity.

However, some bottlenecks regarding mass transfer through ion-exchange membranes may limit the application of ED for the desalination of such complex fluids. The water transfer due to electro-osmosis due to the salt migration may be a limit, while the understanding of this salt - water transfer in complex solutions needs more investigation. Concerning organic solutes, the mechanisms controlling the solute transfer also needs further study, regarding solute size, charge nature, hydrophilicity and so on. Moreover, the influence of the salt composition on the transfer of organic solutes was reported, which further make it difficult to predict and thus to improve the desalination process performance.

Then, the thesis objective was to investigate desalination of saline water containing organic solute by electrodialysis. Synthetic saline waters containing various salt compositions with /without different organic solutes were first considered in order to study the mass transfer mechanisms. Then, the desalination of a real industrial saline solution, i.e. oil process water, was carried out.

In the first part, desalination of synthetic saline waters without OM was studied, using single or mixed salt containing Na^+ , Mg^{2+} , Cl^- , SO_4^{2-} . This work aimed to investigate salt - water transfer through ion-exchange membrane.

A methodology was proposed to calculate the hydration numbers of ions transferring through the membrane. It is based on experimental measurements of ion and water transfer under different conditions, like salt compositions and current. The computed ion hydration numbers were found to be constant, independent from the salt composition and current. The hydration number for monovalent ions was found to be lower than that of divalent ones,

which was in agreement with the values of the hydration free energy. Further comparison with the reported values concerning the hydration of the same ions in solution showed that for monovalent ions the hydration numbers were close to those reported for the 1st hydration shell while much higher values were obtained for divalent ions.

In the second part, desalination of synthetic saline waters with organic solute was studied, using the same salt compositions as in the first part, mixed with organic solute (i.e. acetic acid, phenol, glucose, acetate) of different size, charge, hydrophilicity. The objective was to investigate the mechanism of organic solute transfer and further influence of salt.

In any condition, it was found that the salt transfer is mainly fixed according to the current, and the water transfer fixed according to the salt. Both salt and water transfer were not influenced by the neutral solute. The charged solute (acetate) competes with inorganic salt as current carrier, the total salt transfer including acetate remaining constant and identical to that without solute.

Then, transfer of organic solute during the desalination was found to consist of two contributions, one due to diffusion and the other due to additional transfer, proportional to the current. For neutral solute this additional transfer is convection due to electro-osmosis, while it is due to the migration for charged solute.

For neutral organic solutes, for a given salt composition, the following sequence was pointed out for both diffusion and convection contributions:

acetic acid > phenol > glucose

It was then concluded that the transfer of neutral organic solutes is mainly fixed by the steric effects. Then, concerning the salt effect, the trend for the diffusion flux was found as:

Cation: $\text{Na}^+ > \text{Mg}^{2+}$ and Anion: $\text{Cl}^- > \text{SO}_4^{2-}$,

showing a reversed trend compared to that of the counter-ion hydration. It is mainly due to membrane swelling effect: more hydrated counter-ion leads to stronger polymer chain-chain interaction, and thus lower diffusion is expected.

On the contrary, the convection flux was found to vary as:

Cation: $\text{Na}^+ < \text{Mg}^{2+}$; Anion: $\text{Cl}^- < \text{SO}_4^{2-}$,

same to the sequence of counter-ion hydration. It is mainly due to solute dehydration effect: more hydrated ion give more solute dehydration, causing decrease of solute hydrated size, and thus higher convection is expected.

Indeed, salt simultaneously modify the membrane and solute properties, and the solute transfer is influenced by the salt under combination of these two effects: more hydrated salt (counter-ion) modifies more the solute transfer. Moreover, both diffusion and convection were important.

These findings were applicable to neutral solute of different size and hydrophilicity, in different pH conditions. Exception on phenol with SO_4^{2-} was found, indicating further interaction. Future study is necessary to better understand the specific solute-membrane interaction i.e. phenol - anion-exchange membrane equilibrated by SO_4^{2-} .

For charged organic solute, the transfer consisted of diffusion and migration under current. Due to the charge, not only steric effects but also electrostatic effect can be involved. In diffusion regime, acetate transfer with water was found to be lower than that with salt by a factor of 3-4. Indeed, compared with acetic acid, the presence of salt significantly influences the solute-membrane interaction. The influence of the salt on the acetate diffusion was observed as

$$\text{NaCl} < \text{MgCl}_2 \approx \text{Na}_2\text{SO}_4$$

while a negligible influence of the salt was observed in acetate / W system.

In normal ED regime, i.e. with a current applied, the migration of acetate was found to be much more important than the convection of acetic acid. In addition to that, because of the partition between inorganic and organic anion to carry the current, acetate migration was found to vary according to the anion. The calculation of the transport number of acetate and comparison with the theoretical value has shown selectivity between acetate and inorganic ions, this selectivity being higher with Cl^- compared to SO_4^{2-} . Then, the contribution of diffusion and migration was evaluated. Unlike convection for neutral organic solutes, migration is always much more important than diffusion, especially with SO_4^{2-} .

At last, the desalination performance of electrodialysis for saline solution containing organic solute was evaluated, concerning synthetic solutions containing single or mixed organic solutes, and an industrial effluent, i.e. oil process water (OPW).

Concerning synthetic solutions, a phenomenological model consisting of 4 parameters was firstly proposed, based on the transfer of salt (α), water (β) and organic solute, i.e. diffusion (P_{OM}) and the additional transfer under current (γ), considering the desalination of synthetic solutions containing single organic solutes. With this model, variations of salt and organic solute concentrations in two compartments can be calculated. Performance of

electrodialysis was thus evaluated, considering the influence of current and solution compositions through a case study.

Then, the model robustness was checked using synthetic solutions containing mixtures of different organic solutes. Comparable results for transfer parameters with those obtained in single solute case were observed. It shows that the desalination performance can be well predicted by the proposed model for the complex solution.

Concerning oil process water, the desalination performance of electrodialysis was evaluated. The phenomenological model was validated for the industrial effluent, confirming that it can be used to predict desalination process for complex fluid, with different initial compositions e.g. solute concentration, under different experimental conditions. The present results also suggested that ED can be a very promising process for desalination of oil process water.

In addition, some perspectives following the thesis can be interesting.

Since ion hydration number can be calculated in ED process, it is possible to predict water flow through ion-exchange membrane, knowing the corresponding ion transfer. It was already validated for the brines with different ionic compositions, containing organic solute or not. Thus, it is probably very useful for process performance control and for up-scaled desalination systems dealing with various fluids.

Concerning transfer of organic solute, attention should be given to the triple interaction in salt-organic solute-membrane system, not only for ED. Meanwhile, transfer of organic solute through ion-exchange membrane still deserves further investigations. Specifically, result of phenol transfer through anion-exchange membrane equilibrated with sulfate suggests additional solute-membrane interaction. It might be referred as interaction between hydrophobic solute and charged membrane, which is scarcely reported.

Then, further study with charged solute can be also explored. In this work, acetate was the only charged solute, where influence of salt on its diffusion and migration were highlighted (salt nature and concentration). In diffusion, increase of the salt concentration in aqueous solution may either influence solute hydrated size and / or solute-membrane interaction due to electrostatic effect. Theoretical understanding for the exact mechanism controlling the mass transfer is necessary. In migration, acetate transfer was significantly

influenced regarding other co-ions. The role of membrane (selectivity) can be further studied. The work on charged solute may complement the knowledge regarding the triple interaction of salt-organic solute-membrane.

Future work on the topic of mass transfer through membrane in saline solution case is suggested to comprise macroscopic and microscopic studies.

On one hand, experimentally, transfer of solute through different polymers is worth investigating (only standard membrane for the present work). Different membrane polymer properties (e.g. different cross-linking) may affect not only the salt transfer due to specific selectivity, as well as the observed ion hydration number, but also the organic solute. Moreover, different ion-exchange membrane configurations (e.g. AEM or CEM only) are worth trying to distinguish the contribution of cation and anion, as well as their specific interaction with membrane / organic solute. These experimental studies give quantitative information on mass transfer and salt influence in macroscale. On the other hand, at the microscale, computational approaches (e.g. quantum mechanics) may help to better explain the experimental observation. Nanoscale investigation on solute / membrane interaction and others like those for salt / solute, salt / membrane should be carried out. The influence of hydration on membrane process can be also further developed. The finding may also insight the development of membrane materials, concerning a better performance.

In fact, the present work also suggests many opportunities to better desalination / fractionation performance for complex fluids, as well as the valorization of produced streams. Concerning a pretreatment for ED desalination, changing the solution properties like pH (acetate and acetic acid) and salt composition (chloride and sulfate for phenol, acetate) can be useful approach. Concerning a followed integration for ED desalination, the produced streams can be valorized for the salt and organic solute, by different means as reported in Chapter I.

An industrial application concerning desalination of oil process water by electrodialysis is promising. Following a further lab-scale study, e.g. concerning a better characterized solution of petroleum fluid (salt, organic solute, surfactant and so on), ED process can be put into practice in such field with good optimized performance.

References

- [1] S. Lattemann, T. Höpner, Environmental impact and impact assessment of seawater desalination, *Desalination* 220 (2008) 1–15.
- [2] P. Chelme-Ayala, D.W. Smith, M.G. El-Din, Membrane concentrate management options: a comprehensive critical review, *Can. J. Civ. Eng.* 36 (2009) 1107–1119.
- [3] L.F. Greenlee, D.F. Lawler, B.D. Freeman, B. Marrot, P. Moulin, Reverse osmosis desalination: water sources, technology, and today's challenges., *Water Res.* 43 (2009) 2317–48.
- [4] O.Lefebvre, R. Moletta, Treatment of organic pollution in industrial saline wastewater: a literature review, *Water Res.* 40 (2006) 3671–82.
- [5] N. Voutchkov, Overview of seawater concentrate disposal alternatives, *Desalination* 273 (2011) 205–219.
- [6] B.E.Logan, M.Elimelech, Membrane-based processes for sustainable power generation using water, *Nature* 488 (2012) 313–319.
- [7] R. Ibáñez, A. Pérez-González, P. Gómez, A. M. Urtiaga, I. Ortiz, Acid and base recovery from softened reverse osmosis (RO) brines. Experimental assessment using model concentrates, *Desalination* 309 (2013) 165–170.
- [8] X. Ji, E. Curcio, S. Al Obaidani, G. Di Profio, E. Fontananova, E. Drioli, Membrane distillation-crystallization of seawater reverse osmosis brines, *Sep. Purif. Technol.* 71 (2010) 76–82.
- [9] R. Zimmerman, Dhekelia desalination Plant, 1996.
- [10] I.M.El-Azizi, A.Mohamed Omran, Design criteria of 10,000 m³/d SWRO desalination plant of Tajura, Libya, *Desalination* 153 (2002) 273–279.
- [11] C. Boo, M. Elimelech, S. Hong, Fouling control in a forward osmosis process integrating seawater desalination and wastewater reclamation, *J. Membr. Sci.* 444 (2013) 148–156.
- [12] F. Macedonio, L. Katzir, N. Geisma, S. Simone, E. Drioli, J. Gilron, Wind-Aided Intensified evaporation (WAIV) and Membrane Crystallizer (MCR) integrated brackish water desalination process: Advantages and drawbacks, *Desalination* 273 (2011) 127–135.
- [13] F. Hajbi, H. Hammi, A. M'nif, Reuse of RO Desalination Plant Reject Brine, *J. Phase Equilibria Diffus.* 31 (2010) 341–347.
- [14] C.R. Martinetti, A.E. Childress, T.Y. Cath, High recovery of concentrated RO brines using forward osmosis and membrane distillation, *J. Membr. Sci.* 331 (2009) 31–39.
- [15] W. Arras, N. Ghaffour, A. Hamou, Performance evaluation of BWRO desalination plant - A case study, *Desalination* 235 (2009) 170–178.

- [16] K. Liu, F. a Roddick, L. Fan, Impact of salinity and pH on the UVC/H₂O₂ treatment of reverse osmosis concentrate produced from municipal wastewater reclamation, *Water Res.* 46 (2012) 3229–39.
- [17] T. Zhou, T.T. Lim, S.S. Chin, A. G. Fane, Treatment of organics in reverse osmosis concentrate from a municipal wastewater reclamation plant: Feasibility test of advanced oxidation processes with/without pretreatment, *Chem. Eng. J.* 166 (2011) 932–939.
- [18] J. Radjenovic, A. Bagastyo, R. A. Rozendal, Y. Mu, J. Keller, K. Rabaey, Electrochemical oxidation of trace organic contaminants in reverse osmosis concentrate using RuO₂/IrO₂-coated titanium anodes, *Water Res.* 45 (2011) 1579–1586.
- [19] G. Pérez, A. R. Fernández-Alba, A. M. Urriaga, I. Ortiz, Electro-oxidation of reverse osmosis concentrates generated in tertiary water treatment, *Water Res.* 44 (2010) 2763–2772.
- [20] B.P.Chaplin,G.Schrader, J.Farrell,Electrochemical destruction of N-nitrosodimethylamine in reverse osmosis concentrates using Boron-doped diamond film electrodes, *Environ. Sci. Technol.* 44 (2010) 4264–4269.
- [21] L.Y. Lee, H.Y. Ng, S.L. Ong, J.Y. Hu, G. Tao, K. Kekre, Ozone-biological activated carbon as a pretreatment process for reverse osmosis brine treatment and recovery from water reclamation plant, *Water Res.* 43 (2009) 3948–55.
- [22] L.Y. Lee, H.Y. Ng, S.L. Ong, G. Tao, K. Kekre, B. Viswanath, et al., Integrated pretreatment with capacitive deionization for reverse osmosis reject recovery from water reclamation plant., *Water Res.* 43 (2009) 4769–77.
- [23] P. Westerhoff, H. Moon, D. Minakata, J. Crittenden, Oxidation of organics in retentates from reverse osmosis wastewater reuse facilities, *Water Res.* 43 (2009) 3992–3998.
- [24] M. Badruzzaman, J. Oppenheimer, S. Adham, M. Kumar, Innovative beneficial reuse of reverse osmosis concentrate using bipolar membrane electrodialysis and electrochlorination processes, *Journal Membr. Sci.* (2009) 392–399.
- [25] K. Mopper, A. Stubbins, J.D. Ritchie, H.M. Bialk, P.G. Hatcher, Advanced instrumental approaches for characterization of marine dissolved organic matter: Extraction techniques, mass spectrometry, and nuclear magnetic resonance spectroscopy, *Chem. Rev.* 107 (2007) 419–442.
- [26] A. Huguet, H. Roux-de Balman, E. Parlanti, Fluorescence spectroscopy applied to the optimisation of a desalting step by electrodialysis for the characterisation of marine organic matter, *J. Membr. Sci.* (2009) 186-196
- [27] J.D. Pakulski, R. Benner, An improved method for the hydrolysis and MBTH analysis of dissolved and particulate carbohydrates in seawater, *Mar. Chem.* 40 (1992) 143–160.

- [28] M. McCarthy, J. Hedges, R. Benner, Major biochemical composition of dissolved high molecular weight organic matter in seawater, *Mar. Chem.* 55 (1996) 281–297.
- [29] C.Y. Liu, X.M. Yang, G.P. Yang, L.M. Zhou, P.F. Li, Composition and characterization of colloidal organic matter in the coastal surface waters of Qingdao, China, *Mar. Chem.* 121 (2010) 123–131.
- [30] A. Pérez-González, A. Urtiaga, R. Ibáñez, I. Ortiz, State of the art and review on the treatment technologies of water reverse osmosis concentrates, *Water Res.* 46 (2012) 267–83.
- [31] F. Ludzack, D. Noran, Tolerance of high salinities by conventional wastewater treatment processes, *J. Water Pollut. Control Fed.* 37 (1965) 1404–1416.
- [32] R. Maciel, G.L. Sant’Anna, M. Dezotti, Phenol removal from high salinity effluents using Fenton’s reagent and photo-Fenton reactions, *Chemosphere.* 57 (2004) 711–9.
- [33] E.B. Azevedo, F.R.D.A. Neto, M. Dezotti, Lumped kinetics and acute toxicity of intermediates in the ozonation of phenol in saline media, *J. Hazard. Mater.* 128 (2006) 182–91.
- [34] J.W. Post, J. Veerman, H.V.M. Hamelers, G.J.W. Euverink, S.J. Metz, K. Nymeijer, Salinity-gradient power: Evaluation of pressure-retarded osmosis and reverse electro dialysis, *J. Membr. Sci.* 288 (2007) 218–230.
- [35] Y. Xu, X. Peng, C.Y. Tang, Q.S. Fu, S. Nie, Effect of draw solution concentration and operating conditions on forward osmosis and pressure retarded osmosis performance in a spiral wound module, *J. Membr. Sci.* 348 (2010) 298–309.
- [36] K. Ghyselbrecht, A. Silva, B. Van der Bruggen, K. Boussu, B. Meesschaert, L. Pinoy, Desalination feasibility study of an industrial NaCl stream by bipolar membrane electro dialysis, *J. Environ. Manage.* 140 (2014) 69–75.
- [37] B.E. Logan, D. Call, S. Cheng, H.V.M. Hamelers, Critical Review Microbial Electrolysis Cells for High Yield Hydrogen Gas Production from Organic Matter, *Environ. Sci. Technol.* 42 (2008) 8630–8640.
- [38] V. Shaposhnik, K. Kesore, An early history of electro dialysis with permselective membranes, *J. Membr. Sci.* 136 (1997) 35–39.
- [39] H. Strathmann, *Ion-Exchange Membrane Separation Processes*, Elsevier Science, Stuttgart, 2004.
- [40] H. Strathmann, Electro dialysis, a mature technology with a multitude of new applications, *Desalination* 264 (2010) 268–288.
- [41] C. Huang, T. Xu, Y. Zhang, Y. Xue, G. Chen, Application of electro dialysis to the production of organic acids: State-of-the-art and recent developments, *J. Membr. Sci.* 288 (2007) 1–12.
- [42] C. Abels, F. Carstensen, M. Wessling, Membrane processes in biorefinery applications, *J. Membr. Sci.* 444 (2013) 285–317.

- [43] F.J. Borges, H. Roux-de Balmann, R. Guardani, Investigation of the mass transfer processes during the desalination of water containing phenol and sodium chloride by electrodialysis, *J. Membr. Sci.* 325 (2008) 130–138.
- [44] Y. Zhang, K. Ghyselbrecht, B. Meesschaert, L. Pinoy, B. Van der Bruggen, Electrodialysis on RO concentrate to improve water recovery in wastewater reclamation, *J. Membr. Sci.* 378 (2011) 101–110.
- [45] J. Gonza, F. Carmona, A. Aldaz, V. Montiel, V. Garcõ, Recovery by means of electrodialysis of an aromatic amino acid from a solution with a high concentration of sulphates and phosphates, *J. Membr. Sci.* 140 (1998) 243–250.
- [46] E. Singlande, H. Roux-de Balmann, X. Lefevbre, M. Sperandio, Improvement of the treatment of salted liquid waste by integrated electrodialysis upstream biological treatment, *Desalination*. 199 (2006) 64–66.
- [47] Y. Zhang, B. Van der Bruggen, L. Pinoy, B. Meesschaert, Separation of nutrient ions and organic compounds from salts in RO concentrates by standard and monovalent selective ion-exchange membranes used in electrodialysis, *J. Membr. Sci.* 332 (2009) 104–112.
- [48] A.H. Galama, M. Saakes, H. Bruning, H.H.M. Rijnaarts, J.W.Post, Seawater pre-desalination with electrodialysis, *Desalination* 342 (2013) 61–69.
- [49] W. Walker, Y. Kim, D. Lawler, Treatment of model inland brackish groundwater reverse osmosis concentrate with electrodialysis–Part II: Sensitivity to voltage application and membranes, *Desalination* 345 (2014) 128–135.
- [50] M. Fidaleo, M. Moresi, Electrodialytic desalting of model concentrated NaCl brines as such or enriched with a non-electrolyte osmotic component, *J. Membr. Sci.* 367 (2011) 220–232.
- [51] T. Rottiers, K. Ghyselbrecht, B. Meesschaert, B. Van der Bruggen, L. Pinoy, Influence of the type of anion membrane on solvent flux and back diffusion in electrodialysis of concentrated NaCl solutions, *Chem. Eng. Sci.* 113 (2014) 95–100.
- [52] C. Jiang, Y. Wang, Z. Zhang, T. Xu, Electrodialysis of concentrated brine from RO plant to produce coarse salt and freshwater, *J. Membr. Sci.* 450 (2014) 323–330.
- [53] M. Bailly, H. Roux-de Balmann, P. Aimar, F. Lutin, M. Cheryan, Production processes of fermented organic acids targeted around membrane operations: design of the concentration step by conventional electrodialysis, *J. Membr. Sci.* (2001) 129–142.
- [54] N.P. Berezina, N.A. Kononenko, O.A. Dyomina, N.P. Gnusin, Characterization of ion-exchange membrane materials: properties vs structure, *Adv. Colloid Interface Sci.* 139 (2008) 3–28.
- [55] G.M.Geise, D.R. Paul, B.D. Freeman, Fundamental water and salt transport properties of polymeric materials, *Prog. Polym. Sci.* 39 (2014) 1–42.
- [56] C. Jiang, Q. Wang, Y. Li, Y. Wang, T. Xu, Water electro-transport with hydrated cations in electrodialysis, *Desalination* 365 (2015) 204–212.

- [57] Y.Kim, B.E.Logan, Microbial desalination cells for energy production and desalination, *Desalination* 308 (2013) 122–130.
- [58] S.J. Andersen, T. Hennebel, S. Gildemyn, M. Coma, J. Desloover, J. Berton, Electrolytic Membrane Extraction Enables Production of Fine Chemicals from Biorefinery Sidestreams, *Environ. Sci. Technol.* 48 (2014) 7135–7142.
- [59] C. Bellona, J.E. Drewes, P. Xu, G. Amy, Factors affecting the rejection of organic solutes during NF/RO treatment—a literature review, *Water Res.* 38 (2004) 2795–809.
- [60] A.W. Mohammad, Y.H. Teow, W.L. Ang, Y.T. Chung, D.L. Oatley-Radcliffe, N. Hilal, Nanofiltration membranes review: Recent advances and future prospects, *Desalination* 356 (2014) 226–254.
- [61] L.J.Banasiak, Removal of inorganic and trace organic contaminants by electrodialysis, The University of Edinburgh, UK, 2009.
- [62] M. Vanoppen, A.F.A.M. Bakelants, D. Gaublomme, K.V.K.M. Schoutteten, J. Vanden Bussche, L. Vanhaecke, Properties Governing the Transport of Trace Organic Contaminants through Ion-Exchange Membranes, *Environ. Sci. Technol.* 49 (2015) 489–497.
- [63] S. Galier, J. Savignac, H. Roux-de Balmann, Influence of the ionic composition on the diffusion mass transfer of saccharides through cation-exchange membrane, *Sep. Purif. Technol.* 109 (2013) 1–8.
- [64] S. Galier, H. Roux-de Balmann, Demineralization of Glucose Solutions by Electrodialysis: Influence of the Ionic Composition on the Mass Transfer and Process Performances, *Can. J. Chem. Eng.* 93 (2015) 378–385.
- [65] X.L. Wang, C. Zhang, P. Ouyang, The possibility of separating saccharides from a NaCl solution by using nanofiltration in diafiltration mode, *J. Membr. Sci.* 204 (2002) 271–281.
- [66] G. Bargeman, J.M. Vollenbroek, J. Straatsma, C.G.P.H. Schroën, R.M. Boom, Nanofiltration of multi-component feeds. Interactions between neutral and charged components and their effect on retention, *J. Membr. Sci.* 247 (2005) 11–20.
- [67] A. Bouchoux, H. Roux-de-Balmann, F. Lutin, Nanofiltration of glucose and sodium lactate solutions Variations of retention between single- and mixed-solute solutions, *J. Membr. Sci.* 258 (2005) 123–132.
- [68] C. Umpuch, S. Galier, S. Kanchanatawee, H. Roux-de Balmann, Nanofiltration as a purification step in production process of organic acids, *Process Biochem.* 45 (2010) 1763–1768.
- [69] A. Escoda, P. Fievet, S. Lakard, A. Szymczyk, S. Déon, Influence of salts on the rejection of polyethyleneglycol by an NF organic membrane: Pore swelling and salting-out effects, *J. Membr. Sci.* 347 (2010) 174–182.

- [70] V. Boy, H. Roux-de Balmann, S. Galier, Relationship between volumetric properties and mass transfer through NF membrane for saccharide/electrolyte systems, *J. Membr. Sci.* 390-391 (2012) 254–262.
- [71] G. Bargeman, J.B. Westerink, O. Guerra Miguez, M. Wessling, The effect of NaCl and glucose concentration on retentions for nanofiltration membranes processing concentrated solutions, *Sep. Purif. Technol.* 134 (2014) 46–57.
- [72] A. Bouchoux, H. Roux-de Balmann, F. Lutin, Investigation of nanofiltration as a purification step for lactic acid production processes based on conventional and bipolar electrodialysis operations, *Sep. Purif. Technol.* 52 (2006) 266–273.
- [73] F.G. Helfferich, *Ion Exchange*, McGraw-Hill, New York, USA, 1962.
- [74] G.M. Geise, C.L. Willis, C.M. Doherty, A.J. Hill, T.J. Bastow, J. Ford, Characterization of aluminum-neutralized sulfonated styrenic pentablock copolymer films, *Ind. Eng. Chem. Res.* 52 (2013) 1056–1068.
- [75] G. Gebel, Structural evolution of water swollen perfluorosulfonated ionomers from dry membrane to solution, *Polymer* 41 (2000) 5829–5838.
- [76] A. Fuoco, S. Galier, H. Roux-de Balmann, G. De Luca, Correlation between macroscopic sugar transfer and nanoscale interactions in cation exchange membranes, *J. Membr. Sci.* 493 (2015) 311–320.
- [77] H.M. Saeed, G. a Hussein, S. Yousef, J. Saif, S. Al-asheh, A.A. Fara, Microbial desalination cell technology : A review and a case study, *Desalination* 359 (2015) 1–13.
- [78] Y. Tanaka, Ion-exchange membrane electrodialysis program and its application to multi-stage continuous saline water desalination, *Desalination* 301 (2012) 10–25.
- [79] M. Reig, S. Casas, C. Aladjem, C. Valderrama, O. Gibert, F. Valero, Concentration of NaCl from seawater reverse osmosis brines for the chlor-alkali industry by electrodialysis, *Desalination* 342 (2014) 107–117.
- [80] J.W. Post, *Blue Energy: electricity production from salinity gradients by reverse electrodialysis*, Ph.D. Dissertation, Wageningen University, 2009.
- [81] D.A. Vermaas, D. Kunteng, M. Saakes, K. Nijmeijer, Fouling in reverse electrodialysis under natural conditions, *Water Res.* 47 (2013) 1289–1298.
- [82] N.Y. Yip, M. Elimelech, Influence of natural organic matter fouling and osmotic backwash on pressure retarded osmosis energy production from natural salinity gradients, *Environ. Sci. Technol.* 47 (2013) 12607–12616.
- [83] Q. She, Y. kong W. Wong, S. Zhao, C.Y. Tang, Organic fouling in pressure retarded osmosis: Experiments, mechanisms and implications, *J. Membr. Sci.* 428 (2013) 181–189.
- [84] H. Ohtaki, T. Radnai, Structure and dynamics of hydrated ions, *Chem. Rev.* 93 (1993) 1157–1204.

- [85] J.M. Lehn, *Supramolecular Chemistry - Scope and Perspectives Molecules, Supermolecules, and Molecular Devices*, *Angew. Chemie Int. Ed. English*. 27 (1988) 89–112.
- [86] A. Elattar, A. Elmidaoui, N. Pismenskaia, C. Gavach, G. Pourcelly, Comparison of transport properties of monovalent anions through anion-exchange membranes, *J. Membr. Sci.* 143 (1998) 249–261.
- [87] J.H. Choi, H.J. Lee, S.H. Moon, Effects of Electrolytes on the Transport Phenomena in a Cation-Exchange Membrane, *J. Colloid Interface Sci.* 238 (2001) 188–195.
- [88] Y. Gong, L.M. Dai, X.L. Wang, L.X. Yu, Effects of transport properties of ion-exchange membranes on desalination of 1,3-propanediol fermentation broth by electro dialysis, *Desalination* 191 (2006) 193–199.
- [89] T.F. Fuller, J. Newman, Experimental determination of the transport number of water in nafion 117 membrane, *J. Electrochem. Soc.* 139 (1992) 1332–1337.
- [90] B.D. Bath, H.S. White, E.R. Scott, Electrically facilitated molecular transport. Analysis of the relative contributions of diffusion, migration, and electroosmosis to solute transport in an ion-exchange membrane, *Anal. Chem.* 72 (2000) 433–442.
- [91] L.Q. Gu, S. Cheley, H. Bayley, Electroosmotic enhancement of the binding of a neutral molecule to a transmembrane pore, *PNAS*. 100 (2003) 15498–15503.
- [92] P. Dydo, The mechanism of boric acid transport during an electro dialytic desalination process, *J. Membr. Sci.* 407-408 (2012) 202–210.
- [93] O. Kedem, A. Katchalsky, Thermodynamic analysis of the permeability of biological membranes to non-electrolytes, *Biochim. Biophys. Acta* 27 (1958) 229–246.
- [94] E. Singlande, *Integrated Process Coupling Electro dialysis and Upstream Biological Treatment: Influence of the Ionic Composition and Application to the Treatment of Salted Liquid Wastes*, Ph.D. Dissertation, Université Paul Sabatier, 2006.
- [95] A.J. Rutgers, Y. Hendrikx, Ionic hydration, *Trans. Faraday Soc.* 58 (1962) 2184–2191.
- [96] H.Y. Lu, C.S. Lin, S.C. Lee, M.H. Ku, J.P. Hsu, S. Tseng, et al., In situ measuring osmosis effect of Selemion CMV/ASV module during ED process of concentrated brine from DSW, *Desalination* 279 (2011) 278–284.
- [97] Y. Marcus, *Ion properties*, Marcel Decker, INC, New York, 1997.
- [98] A.H. Galama, G. Daubaras, O.S. Burheim, H.H.M. Rijnaarts, J.W. Post, Seawater electro dialysis with preferential removal of divalent ions, *J. Membr. Sci.* 452 (2013) 219–228.
- [99] J. Havel, E. Högfeltdt, Evaluation of water sorption equilibrium data on Dowex ion exchanger using WSLET-MINUIT program, *Scr. Fac. Sci. Masaryk Univ.* 25 (1995) 73–84.

- [100] B. Tansel, Significance of thermodynamic and physical characteristics on permeation of ions during membrane separation: Hydrated radius, hydration free energy and viscous effects, *Sep. Purif. Technol.* 86 (2012) 119–126.
- [101] R. Rautenbach, R. Albrecht, *Membrane processes*, Wiley, 1989.
- [102] L.A. Richards, A.I. Schäfer, B.S. Richards, B. Corry, The importance of dehydration in determining ion transport in narrow pores, *Small* 8 (2012) 1701–1709.
- [103] T. Lodge, Reconciliation of the Molecular Weight Dependence of Diffusion and Viscosity in Entangled Polymers, *Phys. Rev. Lett.* 83 (1999) 3218–3221.
- [104] J. Savignac, Impact of interaction membrane/electrolyte on the diffusion of sugar, Ph.D Dissertation, Université Paul Sabatier, 2011.
- [105] A. Fuoco, Computational and experimental studies on membrane-solute interactions in desalination systems using ionic-exchange membrane, Ph.D Dissertation, Université Toulouse III - Paul Sabatier, 2015.
- [106] E. Goli, T. Hiemstra, W.H. Van Riemsdijk, R. Rahnemaie, M.J. Malakouti, Diffusion of neutral and ionic species in charged membranes: Boric acid, arsenite, and water, *Anal. Chem.* 82 (2010) 8438–8445.
- [107] F. Zhao, C. Tang, X. Liu, F. Shi, X. Song, Transportation characteristics of bisphenol A on ultra filtration membrane with low molecule weight cut-off, *Desalination* 362 (2015) 18–25.
- [108] H. Zhao, Viscosity B-coefficients and standard partial molar volumes of amino acids, and their roles in interpreting the protein (enzyme) stabilization, *Biophys. Chem.* 122 (2006) 157–183.
- [109] T.S. Banipal, D. Kaur, P.K. Banipal, Apparent Molar Volumes and Viscosities of Some Amino Acids in Aqueous Sodium Acetate Solutions at 298.15 K, *J. Chem. Eng. Data.* (2004) 1236–1246.
- [110] K. Zhuo, J. Wang, Y. Yue, H. Wang, Volumetric properties for the monosaccharide (D-xylose, D-arabinose, D-glucose, D-galactose)-NaCl-water systems at 298.15 K, *Carbohydr. Res.* 328 (2000) 383–91.
- [111] S.K. Bansal, A Study of Volumetric Properties and Volumetric Interaction Parameters of the CsCl-saccharides (D-glucose, D-fructose) – water Solutions at 298.15 K, *Science* 8 (2014) 23–24.
- [112] C. De Visser, G. Perron, J.E. Desnoyers, Volumes and heat capacities of ternary aqueous systems at 25.degree.C. Mixtures of urea, tert-butyl alcohol, dimethylformamide, and water, *J. Am. Chem. Soc.* 99 (1977) 5894–5900.
- [113] V.N. Afanas'ev, Solvation of electrolytes and nonelectrolytes in aqueous solutions, *J. Phys. Chem. B.* 115 (2011) 6541–6563.

- [114] C. Garau, A. Frontera, D. Quiñonero, P. Ballester, A. Costa, P.M. Deyà, Cation- π versus anion- π interactions: Energetic, charge transfer, and aromatic aspects, *J. Phys. Chem. A.* 108 (2004) 9423–9427.
- [115] D. Quiñonero, C. Garau, A. Frontera, P. Ballester, A. Costa, P.M. Deyà, Structure and binding energy of anion- π and cation- π complexes: A comparison of MP2, RI-MP2, DFT, and DF-DFT methods, *J. Phys. Chem. A.* 109 (2005) 4632–4637.
- [116] A. Frontera, D. Quiñonero, P.M. Deyà, Cation- π and anion- π interactions, *Wiley Interdiscip. Rev. Comput. Mol. Sci.* 1 (2011) 440–459.
- [117] B.L. Schottel, H.T. Chifotides, K.R. Dunbar, Anion- π interactions, *Chem. Soc. Rev.* 37 (2008) 68–83.
- [118] A.S. Reddy, G.N. Sastry, Cation [$M=H^+,Li^+,Na^+,K^+,Ca^{2+},Mg^{2+},NH_4^+$, and NMe_4^+] Interactions with the Aromatic Motifs of Naturally Occurring Amino Acids: A Theoretical Study, *J. Phys. Chem. A.* 109 (2005) 8893–8903.
- [119] T.D. Vaden, J.M. Lisy, Characterization of hydrated Na^+ (phenol) and K^+ (phenol) complexes using infrared spectroscopy, *J. Chem. Phys.* 120 (2004) 721–730.
- [120] Y. Zhang, P. Luc, B. Meesschaert, B. Van der Bruggen, Separation of small organic ions from salts by ion-exchange membrane in electrodialysis, *AIChE.* 57 (2011) 2070–2078.

Nomenclature

List of symbols

C	solute concentration ($\text{mol}\cdot\text{m}^{-3}$)
D	diffusion coefficient ($\text{m}^2\cdot\text{s}^{-1}$)
j_s	salt flux ($\text{mol}\cdot\text{m}^{-2}\cdot\text{s}^{-1}$)
j_i	ion flux ($\text{eq}\cdot\text{m}^{-2}\cdot\text{s}^{-1}$)
j_v	volumetric flux ($\text{m}^3\cdot\text{m}^{-2}\cdot\text{s}^{-1}$)
j_w	water flux ($\text{m}^3\cdot\text{m}^{-2}\cdot\text{s}^{-1}$)
m_i	number of mole of ion transferred (mol)
m_w	number of mole of water transferred (mol)
n_h^i	ion hydration number, (mol water/ mol ion)
n_h^s	salt hydration number, (mol water/ mol salt)
P	solute permeability
S_m	total surface area of one type of membrane (m^2)
t	transference number
V_m^i	ion molar volume ($\text{m}^3\cdot\text{mol}^{-1}$)
V_m^w	water molar volume ($1.8\times 10^{-5} \text{m}^3\cdot\text{mol}^{-1}$ at 25°C)
z	valence ($\text{eq}\cdot\text{mol}^{-1}$)
I	current intensity (A)

Greek symbols

α	current coefficient ($\text{eq}\cdot\text{m}^{-2}\cdot\text{s}^{-1}\cdot\text{A}^{-1}$)
β	electro-osmotic coefficient ($\text{m}^3\cdot\text{m}^{-2}\cdot\text{s}^{-1}\cdot\text{A}^{-1}$)
δ	diffusion mechanism coefficient
γ	convective coefficient ($\text{mol}\cdot\text{m}^{-2}\cdot\text{s}^{-1}\cdot\text{A}^{-1}$)
γ'	migration coefficient ($\text{mol}\cdot\text{m}^{-2}\cdot\text{s}^{-1}\cdot\text{A}^{-1}$)
ν	electrolyte stoichiometric coefficient
σ	reflection coefficient

Abbreviations

A	anion
AEM	anion-exchange membrane
C	cation
CEM	cation-exchange membrane
ED	Electrodialysis
EDBM	Electrodialysis with bipolar membrane
Mw	molecular weight
NF	nanofiltration
OM	organic matter/solute

Nomenclature

RO	reverse osmosis
S	salt
SWRO	seawater reverse osmosis
SWROC	seawater reverse osmosis concentrate
W	water

Superscripts & subscripts

<i>conv</i>	convection
<i>diff</i>	diffusion
<i>eo</i>	electro-osmosis
<i>exp</i>	experimental data
<i>h</i>	hydration
<i>i</i>	ion
<i>mig</i>	migration
<i>os</i>	osmosis
<i>s</i>	salt
<i>theo</i>	theoretical data
<i>w</i>	water

Desalination of saline waste water containing organic solute by electrodialysis

Electrodialysis can be used to treat saline water containing organic solute, separating organic solutes from salt. The understanding of salt, water and organic solute transfer through ion-exchange membranes and especially the influence of salt composition is a key factor regarding the process performances. The aim of the Thesis is to investigate the mass transfer and the relationship with the desalination performance. Firstly, hydration numbers of individual ion transferring through the membranes are computed based on experimental measurements of ion-water flux. They are independent from the salt compositions and current. Comparison with literatures values shows that the membranes have a weak influence on the ion hydration. Secondly, the transfer of different organic solutes is investigated with different salt compositions. Two contributions are pointed out, diffusion and additional one (convection for neutral solute, migration for charged one). For neutral solutes, diffusion and convection are comparable and both fixed by steric effect. Ion hydration leads to reversed trend for diffusion due to membrane swelling and convection due to solute dehydration. For charged solute, migration is more important than diffusion, both being influenced by the presence of salt. Then, desalination performance is discussed based on a phenomenological model, consisting of 4 parameters, related to ion, water and organic solute transfer respectively. The robustness of the model is demonstrated for different conditions.

This work shows that electrodialysis can be a very promising process for the desalination of saline water containing organic solutes.

Traitement d'effluents salins contenant de la matière organique par électrodialyse

L'électrodialyse peut être utilisée pour traiter des effluents salins contenant de la matière organique. La compréhension des mécanismes de transfert (eau, ions, espèces organiques) à travers les membranes échangeuses d'ions et particulièrement l'influence de la composition ionique est un point clé vis-à-vis des performances du procédé. L'objectif de cette thèse est l'étude du transfert et la relation avec les performances de dessalement. Les nombres d'hydratation des ions sont tout d'abord calculés à partir des mesures du transfert des ions et de l'eau. Ils sont indépendants du courant et de la composition saline. La comparaison avec des valeurs de la littérature montre que les membranes ont peu d'effet sur l'hydratation des ions. Le transfert d'espèces organiques est ensuite étudié pour différentes compositions salines. Outre la diffusion, une contribution additionnelle est mise en évidence (convection pour les espèces neutres, migration pour les espèces chargées). Pour les espèces neutres, diffusion et convection sont du même ordre de grandeur et fixées par l'effet stérique. Des tendances inverses sont obtenues concernant l'hydratation des ions, la diffusion étant limitée par les modifications des membranes, la convection étant limitée par l'hydratation des espèces organiques en solution. Pour les espèces chargées, la migration domine la diffusion, les deux contributions étant influencées par la présence de sel. Les performances de dessalement sont enfin discutées sur la base d'un modèle phénoménologique à 4 paramètres liés au transfert de l'eau, des ions et des espèces organiques. La robustesse du modèle est validée pour différentes conditions.

Ce travail montre que l'électrodialyse est une technologie très prometteuse pour le dessalement d'effluents contenant de la matière organique.