



**HAL**  
open science

# Integration des véhicules électriques dans les réseaux électriques : Modèles d'affaire et contraintes techniques pour constructeurs automobiles

Paul Codani

► **To cite this version:**

Paul Codani. Integration des véhicules électriques dans les réseaux électriques : Modèles d'affaire et contraintes techniques pour constructeurs automobiles. Autre. Université Paris Saclay (COMUE), 2016. Français. NNT : 2016SACLC073 . tel-01394385

**HAL Id: tel-01394385**

**<https://theses.hal.science/tel-01394385>**

Submitted on 9 Nov 2016

**HAL** is a multi-disciplinary open access archive for the deposit and dissemination of scientific research documents, whether they are published or not. The documents may come from teaching and research institutions in France or abroad, or from public or private research centers.

L'archive ouverte pluridisciplinaire **HAL**, est destinée au dépôt et à la diffusion de documents scientifiques de niveau recherche, publiés ou non, émanant des établissements d'enseignement et de recherche français ou étrangers, des laboratoires publics ou privés.

NNT : 2016SACL073

THÈSE DE DOCTORAT  
DE  
L'UNIVERSITÉ PARIS-SACLAY  
PRÉPARÉE A  
CENTRALESUPÉLEC

ÉCOLE DOCTORALE 575 EOBÉ  
Electrical, optical, bio-physics and engineering  
Spécialité de doctorat : Génie Électrique

Par

**M. Paul Codani**

GRID INTEGRATED VEHICLES: BUSINESS MODELS AND TECHNICAL  
CONSTRAINTS FOR CAR MANUFACTURERS

Thèse présentée et soutenue à Gif-Sur-Yvette, le 19 Octobre 2016

**Composition du Jury :**

M. C. Marchand	Professeur	Université Paris-Sud	Président
M. P. Frias	Professeur Associé	Universidad Pontificia Comillas	Rapporteur
M. G. Deconinck	Professeur	KU Leuven	Rapporteur
M. W. Kempton	Professeur	University of Delaware	Examineur
M. M. Petit	Enseignant Chercheur HDR	CentraleSupélec	Co-encadrant
M. Y. Perez	Enseignant Chercheur HDR	Université Paris-Sud	Co-encadrant
Mme I. Bouessay	Docteure, Spécialiste Stockage et Production Électrique	PSA Groupe	Invitée

---

---

*“The Stone Age came to an end, not because we had a lack of stones, and the oil age will come to an end not because we have a lack of oil.”*

Sheikh Yamani, former Saudi oil minister, 2000

---

## Acknowledgments

First, I would like to sincerely thank my two main PhD supervisors, Marc Petit and Yannick Perez, who proved to be amazing supervisors during these three years. They provided me with great ideas and support, and really taught me how research work should be conducted. They also granted me with a lot of autonomy, and I was proud to have their trust.

I would also like to thank all the people from the group PSA who guided me throughout this thesis. First and foremost, I address my deep thanks to Igor Demay, who provided advanced industrial support, and gave me the opportunity to join inter-company meetings which happened to be very helpful not only for my PhD but also for my personal achievement. Then, I would like to thank Isabelle Bouessay, who kindly accepted to become my new PhD supervisor a few months before I was finished... quite a challenge! I also have a thought for Sandrine Delenne, who trusted me from the beginning and provided me with regular advises, and Bernard Sahut for his valuable insights on the battery topic.

The best way to improve one's research work is to question it. In that sense, I would like to deeply thank professors Frias and Deconinck, who kindly accepted to review my manuscript. Their comments were very valuable and helped me improving this thesis.

I would like to address some particular thanks to Willett Kempton. Willett introduced me to this research topic during my master internship, at the University of Delaware, followed my work all along my PhD, and finally participated in my PhD jury. He is always very curious and eager to learn some new French expressions; in order to describe my feeling, the best French wording would be *la boucle est bouclée*.

I would like to thank all the people from the Chaire Armand Peugeot who supported me, and in particular Yurong Chen and Olivier Borne, with who I have been working closely especially towards the end of my PhD.

I have had many fruitful collaborations and discussions during my PhD: with my co-authors, Cherrelle Eid and Katarina Knezovic; with talented researchers from the Danish Technical University and the University of Delaware; and with industrial partners including but not limited to Francois Colet (Renault, then Vedecom) who spent a lot of time with me despite of his busy schedule.

Last but not least, I would like to thank my family who has always supported me, in particular during some difficult - sometimes lonely - moments. A special thank to Manon, who has become a V2G expert against her will because of me!

*Paul Codani has benefited from the support of the Chair "PSA Peugeot Citroen Automobile: Hybrid technologies and Economy of Electromobility", so-called Armand Peugeot Chair led by CentraleSuplec, and ESSEC Business School and sponsored by PEUGEOT CITROEN Automobile.*

---

## Executive Summary

In order to cope with the emerging climate change challenges, the electricity sector is undergoing profound mutations. More and more Renewable Energy Sources (RES) are introduced to reduce CO<sub>2</sub> emissions. However, such RES are unpredictable and intermittent by nature. In order to address this issue, the concept of *integrated grids* was developed. According to this approach, all units (including distributed energy resources) should be considered in the planning and in the operation of electric grids.

The automotive industry has to face similar challenges, and therefore car manufacturers offer plug-in hybrid (PHEV) and full electric (EV) vehicles in their product line to cap their overall CO<sub>2</sub> emissions. However, the increase in PHEV and EV penetration may trigger additional stress on the electrical grids, which already have to face an increase in RES penetration. Indeed such vehicles require high charging power and are likely to charge during peak periods. Several surveys show that PHEVs and EVs could severely overload electric grids, in particular at the local scale.

On the other hand, if their charging pattern is managed properly, EVs could be used as distributed storage units and turn into valuable assets for the electrical grids.

In this thesis, Grid Integrated Vehicles (GIVs) are studied from technical, regulatory, and economics perspectives. First, the general framework for a smart grid integration of EVs is reviewed: application areas and benchmark scenarios are described, the main actors are listed, and the most important challenges are analyzed.

Then, the emphasis is put on system wide services, and more particularly on frequency control mechanisms. The regulatory conditions enabling the participation of GIV fleets to this service are studied based on an intensive survey of existing transmission system operator rules. Several economics and technical simulations are performed for various market designs.

Then, local grid services are investigated. A representative eco-district is modeled, considering various consumption units and distributed generation. A local energy management system is proposed; it is responsible for controlling the charging / discharging patterns of the GIVs which are located in the district in order to mitigate the overloading conditions of the eco-district transformer. Economic consequences are derived from this technical analysis.

At last, some real life experiments are carried out within the Danish Nikola demonstration project. The experimental proof of concepts confirms the theoretical abilities of GIVs: they are very fast responding units (even considering the complete required IT framework) and are able to follow grid signals very accurately.

---

# Contents

<b>Acknowledgments</b>	<b>ii</b>
<b>Executive Summary</b>	<b>iii</b>
<b>Table of Contents</b>	<b>vii</b>
<b>List of Figures</b>	<b>xi</b>
<b>List of Tables</b>	<b>xiv</b>
<b>List of Acronyms</b>	<b>xv</b>
<b>1 Introduction</b>	<b>1</b>
1.1 Climate Change . . . . .	1
1.1.1 A New Paradigm . . . . .	1
1.1.2 Emissions by Economic Sectors . . . . .	4
1.1.3 Energy and Transportation Emissions Policies . . . . .	7
1.2 Major Changes in the Electricity Sector . . . . .	8
1.2.1 Main Characteristics of the Power Systems . . . . .	8
1.2.2 Evolutions Towards Integrated Grids . . . . .	12
1.3 Automotive Industry: Electrification Strategies . . . . .	14
1.3.1 Several Electrification Levels . . . . .	14
1.3.2 Charging Systems . . . . .	16
1.3.3 Plug-in Vehicles Penetration Rates . . . . .	16
1.4 Integration of Plug-in Vehicles in the Electrical Grids . . . . .	19
1.4.1 Are Plug-in Vehicles a Threat to Electrical Grids? . . . . .	19
1.4.2 Plug-in Vehicles as Storage Units Supporting the Grid . . . . .	20
1.5 Research Objectives . . . . .	21
1.6 Positioning with respect to the state-of-the-art . . . . .	22
<b>2 Grid Integration of Electric Vehicles: General Framework</b>	<b>25</b>
2.1 Distributed Energy Resources as Grid Service Providers . . . . .	26
2.1.1 Definition of a Flexibility Product . . . . .	26
2.1.2 DER Characteristics as Flexibility Providers . . . . .	26
2.1.3 System Operators as Purchasers of Flexibility Products . . . . .	30



2.2	Plug-in Vehicles as Efficient Distributed Energy Resources . . . . .	34
2.2.1	Application Areas . . . . .	35
2.2.2	Benchmark scenarios . . . . .	37
2.2.3	Stakeholders . . . . .	38
2.2.4	Best Adapted Grid Services . . . . .	39
2.3	Challenges . . . . .	40
2.3.1	Energy Losses . . . . .	41
2.3.2	Battery Degradation . . . . .	42
2.3.3	Additional Costs . . . . .	44
2.3.4	Regulatory Challenges . . . . .	45
2.4	Partial Conclusion . . . . .	45
<b>3</b>	<b>Grid Integrated Vehicle Fleets Providing System Wide Grid Services: Towards Viable Business Models</b>	<b>47</b>
3.1	Regulatory Analysis . . . . .	48
3.1.1	The Basics of Frequency Control . . . . .	48
3.1.2	TSO Rules Survey . . . . .	49
3.2	Bidirectional Grid Integrated Vehicles . . . . .	58
3.2.1	Fleet Modeling . . . . .	58
3.2.2	Frequency Data Set . . . . .	62
3.2.3	Aggregator Modeling . . . . .	62
3.2.4	Results and Discussion . . . . .	65
3.2.5	Partial Conclusion . . . . .	68
3.3	Unidirectional Grid Integrated Vehicles . . . . .	69
3.3.1	Symmetrical Market Design . . . . .	69
3.3.2	Asymmetrical Market Design . . . . .	71
3.3.3	Results . . . . .	73
3.4	Sensitivity Analysis . . . . .	75
3.4.1	Fleet Types . . . . .	75
3.4.2	Market Clearing Period . . . . .	77
3.5	Partial Conclusion . . . . .	79
3.5.1	From the Vehicle Owner Perspective . . . . .	79
3.5.2	From the System Operator Perspective . . . . .	79
<b>4</b>	<b>Grid Integrated Vehicle Fleets Providing Local Grid Services</b>	<b>81</b>
4.1	Introduction . . . . .	81
4.2	Eco-district Description . . . . .	82
4.2.1	Residential Consumption Modeling . . . . .	82
4.2.2	Commercial Building Modeling . . . . .	83
4.2.3	Electric Vehicle Fleet Modeling . . . . .	83
4.2.4	Photovoltaic Production Data . . . . .	85
4.3	Transformer & Energy Management System Characterizations . . . . .	86
4.3.1	Transformer Sizing . . . . .	86
4.3.2	Transformer Operating Conditions . . . . .	86
4.3.3	Energy Management System . . . . .	87
4.4	Mitigation of Overloading Occurrences . . . . .	91

## CONTENTS

---

4.4.1	Simulation Parameters . . . . .	91
4.4.2	Overloading Characterizations . . . . .	92
4.4.3	Impacts on the Fleets' Conditions . . . . .	94
4.5	Economic Aspects . . . . .	95
4.5.1	French Economic Framework . . . . .	96
4.5.2	Expected Yearly Savings for the Eco-district . . . . .	98
4.5.3	Reinforcement Costs Avoided . . . . .	99
4.6	Partial Conclusion . . . . .	99
<b>5</b>	<b>Experimentation</b>	<b>101</b>
5.1	An introduction to the Nikola Project . . . . .	101
5.2	Contributions to the Project . . . . .	102
5.2.1	Tests with a Unidirectional Vehicle . . . . .	103
5.2.2	Tests with a Bidirectional Vehicle . . . . .	106
5.3	Partial Conclusion . . . . .	110
<b>6</b>	<b>Conclusion</b>	<b>113</b>
6.1	Conclusion Towards Research Objectives . . . . .	113
6.2	Recommendations and Future Work . . . . .	116
	<b>Bibliography</b>	<b>118</b>
	<b>Publications</b>	<b>135</b>
<b>A</b>	<b>Secondary Control</b>	<b>137</b>
<b>B</b>	<b>Distributed Energy Resources characteristics</b>	<b>139</b>
B.1	Residential Loads . . . . .	139
B.2	Bidirectional Distributed Energy Resources . . . . .	140
B.3	Producing Distributed Energy Resources . . . . .	140
<b>C</b>	<b>Summary in French</b>	<b>143</b>
C.1	Chapitre 1 : Introduction . . . . .	143
C.2	Véhicules Électriques et Flexibilité . . . . .	145
C.3	Services Système . . . . .	146
C.4	Services Locaux . . . . .	147
C.5	Expérimentations . . . . .	148
C.6	Conclusion . . . . .	148



# List of Figures

1.1	Earth temperature evolutions relative to 1951-1989 average since 1880. Source: NASA . . . . .	2
1.2	CO <sub>2</sub> emissions since 1850 (Intergovernmental Panel on Climate Change, 2015) . . . . .	3
1.3	Breakdown of global GHG emissions by economic sectors (Victor et al., 2015) . . . . .	4
1.4	Life-cycle GHG Emissions Intensity of Electricity Generation Methods (World Nuclear Association, 2011) . . . . .	5
1.5	GHG emissions from the transportation sector (Sims et al., 2015)	6
1.6	Energy mixes of different regions. Figure created using data from (International Energy Agency, 2013a; Réseaux de Transport d'Electricité, 2016a; Ministère Fédéral de l'Economie et de la Technologie, 2015; Danish Energy Agency, 2012) . . . . .	10
1.7	Frequency map gradient in the USA. Picture taken on March 23 <sup>rd</sup> , 9:22AM Paris Time. The three main interconnected networks can be easily distinguished. Extracted from FNET (2016) website . . . . .	11
1.8	Electricity markets organization from long term to real time. . .	13
1.9	Sales and market shares of plug-in vehicles in various markets in 2015. Figure created using data from Automobile Propre (2016a), Avere (2016), & EV Volumes (2016) . . . . .	18
1.10	Current and estimated future battery prices and energy density (International Energy Agency, 2015) . . . . .	19
2.1	The attributes of an electric flexibility product at a given node .	27
2.2	Schematic diagram of the application domain <i>individual housing</i>	35
2.3	Schematic diagram of the application domain <i>company fleet</i> . . .	36
2.4	Schematic diagram of the application domain <i>collective dwellings</i>	37
2.5	Schematic diagram of the application domain <i>public charging</i> . .	37
2.6	A daily load curve and how corresponding PJM markets are suited for GIV fleets, from PJM Interconnection . . . . .	40
2.7	PEU efficiency as a function of output power and output voltage (Barbé, 2014) . . . . .	41

2.8	Battery degradation as a function of the Depth of Discharge (extracted from Peterson et al. (2010a)) . . . . .	43
3.1	Impacts of primary and secondary frequency controls when a frequency deviation occurs (for illustrative purposes only) . . . . .	49
3.2	Power-frequency curve of a traditional unit . . . . .	50
3.3	Maps of the six TSOs under study . . . . .	51
3.4	Power responses to frequency fluctuations for a fast ramping and a slow ramping unit (for illustrative purposes only) . . . . .	55
3.5	Typical daily SOC variations for a GIV, and the associated upper and lower SOC allowed . . . . .	60
3.6	Distribution function of the frequency recordings . . . . .	62
3.7	Dispatch algorithm operating scheme . . . . .	64
3.8	Illustration of the calculation method of the Preferred Operating Point (POP) . . . . .	66
3.9	Simulation results for a single bidirectional capable GIV over 5 working days, with $P_{home} = 3kW$ and $P_{work} = 0kW$ . . . . .	67
3.10	GIV fleet power response to frequency deviations . . . . .	72
3.11	GIV determination of available power for regulation . . . . .	73
3.12	Instantaneous power flow of the fleet for the different market designs . . . . .	74
3.13	Probability that the power bid $P_{bid}$ be superior to a certain value, for two different market designs . . . . .	75
3.14	Instantaneous GIV fleet power flow with market clearing periods of (a) 1h and (b) 4h . . . . .	78
3.15	Probability that the power bid $P_{bid}$ be superior to a certain value, for two different market clearing periods . . . . .	79
4.1	Eco-district Overview . . . . .	82
4.2	Typical daily load curves . . . . .	83
4.3	Example of a hourly-averaged PV production values for one particular day . . . . .	85
4.4	Operating conditions of the transformer (no EV & no PV) over one year of simulation . . . . .	87
4.5	Energy Management System power flow strategy in the district . . . . .	88
4.6	Energy Management System operating principle . . . . .	90
4.7	Variations of $P_{flow}$ and $P_{GIV}$ throughout more than six days of simulation . . . . .	91
4.8	Substation daily peak powers for the whole year and for the different scenarios . . . . .	92
4.9	Operating conditions of the transformer during overloading occurrences, with respect to the limitations provided in (Schneider Electric, 2009) . . . . .	93
4.10	Power $P_{GIV}$ provided by the GIV fleet for the EMS . . . . .	94
4.11	Cumulative energy discharged by the GIVs throughout the simulation . . . . .	95

## LIST OF FIGURES

---

5.1	The seven work packages of the Nikola project . . . . .	103
5.2	The unidirectional Citroën Berlingo Electric at DTU facilities . .	104
5.3	Citroën Berlingo Electric droop function . . . . .	104
5.4	Experimental setup for the Berlingo Electric test . . . . .	105
5.5	Computer requests and corresponding Berlingo Electric responses over 15 minutes of test . . . . .	105
5.6	Experimental results for the Berlingo Electric over the seven test- ing hours . . . . .	106
5.7	The bidirectional Peugeot iOn at DTU EV Lab facilities . . . . .	107
5.8	Experimental setup for the Peugeot iOn test . . . . .	108
5.9	Experimental results of the frequency control experiment with the iOn for four consecutive hours . . . . .	109
5.10	Experimental results of the iOn test over three minutes . . . . .	110
5.11	iOn SOC variations during four experimental hours . . . . .	110
5.12	Zoom in Fig. 3.9. Four hour time window. . . . .	111
A.1	Probability density function of "niveau de telereglage" data set .	138
A.2	SOC variations induced by following the "niveau de telereglage" signal for a GIV with a 3kW charging station . . . . .	138

LIST OF FIGURES

---

# List of Tables

- 1.1 Some examples of RES and EV deployment objectives in some countries / areas . . . . . 8
- 1.2 Rated ( $U_N$ ), minimum ( $U_{min}$ ) and maximum ( $U_{max}$ ) voltage levels in the French grid (Hennebel, 2013) . . . . . 12
- 1.3 The different types of plugs used to charge plug-in vehicles (from the charging station and vehicle sides) . . . . . 17
  
- 2.1 The different DER and their technical characteristics . . . . . 29
- 2.2 The various electricity markets and their main characteristics . . . 31
- 2.3 Assets cost, adapted from Green eMotion (2013), Siemens (2016) and Pieltain Fernandez et al. (2011) . . . . . 33
  
- 3.1 The Different Organizations for Module 1 . . . . . 53
- 3.2 The Different Organizations for Module 2 . . . . . 56
- 3.3 Evaluation of the representative TSOs . . . . . 57
- 3.4 Ideal TSO VS ENTSO-E guidelines . . . . . 57
- 3.5 Trip-related models and parameters . . . . . 59
- 3.6 The four scenarios for secondary EVSE penetration levels . . . . . 61
- 3.7 Breakdown of *primary* and *secondary* EVSEs by charging technology type. Data deduced from Prefet Vuibert (2015) . . . . . 61
- 3.8 Main characteristics of the frequency data set used, and comparison with RTE measurements . . . . . 63
- 3.9 Average earnings per vehicle and per year depending on the EVSE power level . . . . . 67
- 3.10 Average earnings per GIV and per year for each scenario. . . . . 68
- 3.11 Minimum and average values for  $P_{bid}$  for a fleet of 200,000 GIVs 68
- 3.12 Average earnings per vehicle and per year depending on the EVSE power level . . . . . 70
- 3.13 Minimum and average values for  $P_{bid}$  for a fleet of 200.000 GIVs 71
- 3.14 Minimum, maximum and quartile values for  $P_{bid}$  for two different market designs . . . . . 75
- 3.15 Mean values of the characteristics of the different fleets understudy 77
- 3.16 Average earnings per GIV and per year for each type of fleet . . . 77
- 3.17 Quartile values for  $P_{bid}$  for 1h and 4h market clearing time stamps 78



LIST OF TABLES

---

4.1	Description of the scenarios under study . . . . .	82
4.2	Electric Vehicle Supply Equipment (EVSE) power values for fleets A, B & C . . . . .	84
4.3	Mean ( $\mu$ ) and standard deviation ( $\sigma$ ) values of EV fleet trip char- acteristics . . . . .	84
4.4	Comparison of the dumb and controlled charging scenarios on the criteria defined in section 4.3.2 . . . . .	93
4.5	The five temporal classes of the cost structure (ERDF, 2014) . .	96
4.6	Optimal contracted powers with and without the implementation of the EMS . . . . .	98
4.7	Energy costs for both scenarios . . . . .	98

# List of Acronyms

<b>AC</b>	Alternating Current
<b>BMS</b>	Battery Management System
<b>CAN</b>	Controller Area Network
<b>CCS</b>	Combined Charging System
<b>CHP</b>	Combined Heat and Power
<b>COP</b>	Conference of Parties
<b>CSO</b>	Charging Station Operator
<b>DC</b>	Direct Current
<b>DER</b>	Distributed Energy Resource
<b>DoD</b>	Depth-of-Discharge
<b>DR</b>	Demand Response
<b>DSO</b>	Distribution System Operator
<b>EMS</b>	Energy Management System
<b>eMSP</b>	e-Mobility Service Provider
<b>EV</b>	Electric Vehicle
<b>EVSE</b>	Electric Vehicle Supply Equipment
<b>FCR</b>	Frequency Containment Reserves
<b>FNR</b>	Frequency-controlled Normal operation Reserves
<b>FRR</b>	Frequency Restoration Reserves
<b>GCP</b>	Grid Connection Point
<b>GHG</b>	Green House Gas
<b>GIV</b>	Grid Integrated Vehicle
<b>GNP</b>	Gross National Product
<b>HEV</b>	Hybrid Electric Vehicle
<b>HVDC</b>	High Voltage Direct Current
<b>IEC</b>	International Electrotechnical Commission
<b>INDC</b>	Intended Nationally Determined Contribution
<b>IPCC</b>	Intergovernmental Panel on Climate Change
<b>ISO</b>	International Standardization Organization
<b>MHEV</b>	Mild-Hybrid Electric Vehicle
<b>NPV</b>	Net Present Value
<b>OEM</b>	Original Equipment Manufacturer

---

LIST OF TABLES

<b>PEU</b>	Power Electronic Unit
<b>PHEV</b>	Plug-in Hybrid Electric Vehicle
<b>POP</b>	Preferred Operating Point
<b>PV</b>	Photovoltaic
<b>PWM</b>	Pulse Width Modulation
<b>RES</b>	Renewable Energy Source
<b>SOC</b>	State Of Charge
<b>SoH</b>	State Of Health
<b>TCO</b>	Total Cost of Ownership
<b>TSO</b>	Transmission System Operator
<b>V2G</b>	Vehicle-to-Grid
<b>ZEV</b>	Zero Emission Vehicle

# Chapter 1

## Introduction

### 1.1 The General Context: Climate Change and Emissions Reduction

”Nous voici donc presque au bout du chemin, et, sans doute, au début d’un autre.”<sup>1</sup> Laurent Fabius, president of the Conference of Parties (COP) 21 which took place in Paris in December 2015, opened his closing speech with the latter quotation. This conference was recognized as a success worldwide: 196 parties gathered together and succeeded in finding a legally binding agreement dedicated to improving the Earth’s environmental conditions. Each country committed to comply with an Intended Nationally Determined Contribution (INDC); the joint efforts of all parties are made to cap the average temperature increase below 1.5 ° Celsius.

#### 1.1.1 A New Paradigm

##### Evidences of Climate Change

This commitment from the – almost – entire international community was becoming a necessity to limit global warming. Earth has been continuously warming up since 1880, with the major temperature increases happening from 1970. In 2009, Peterson and Baringer (2009) showed that the 20 warmest years from 1880 occurred since 1981. According to the NASA, February 2016 was the warmest month ever with an average global temperature 1.35 ° C higher than the average observed over the period 1951-1989. Fig. 1.1 illustrates this phenomenon by displaying the Earth temperatures since 1880.

There are other evidences showing that climate change is happening today (NASA, 2016b): sea levels are rising more and more rapidly; oceans are warming up; the Greenland and Antarctic ice sheets, as well as the Arctic ice sea, are shrinking; glaciers from all mountain ranges are melting each year more severely;

---

<sup>1</sup>”Here we are almost at the end of the road, and, probably, at the beginning of another”

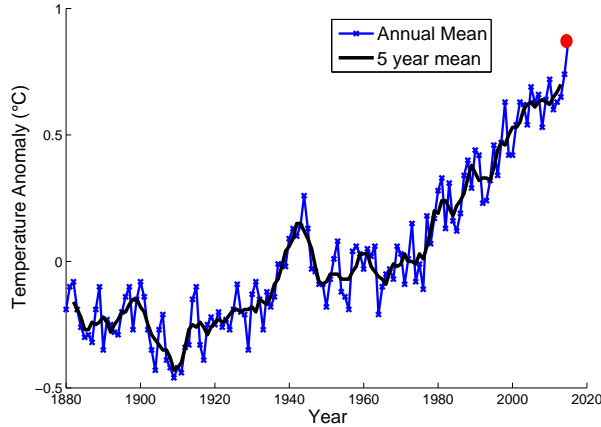

Figure 1.1: Earth temperature evolutions relative to 1951-1989 average since 1880. Source: NASA

extreme events including intense rainfall events, hurricanes, etc. are becoming more common; the acidification of the oceans rose by 30% since the Industrial Revolution. All these evidences are described in more details on the NASA website, which also provides references for each fact (NASA, 2016b).

### Causes of Climate Change

According to the Intergovernmental Panel on Climate Change (IPCC), which gathers thousands of scientists from all over the world studying climate change, human influence on all the aforementioned parameters is clear and demonstrated (Intergovernmental Panel on Climate Change, 2015). Greenhouse gas (GHG) emissions have drastically increased since the Industrial Revolution, reaching a historical peak during the period 2000-2010 (Intergovernmental Panel on Climate Change, 2015):

*Historical emissions have driven atmospheric concentrations of carbon dioxide, methane and nitrous oxide to levels that are unprecedented in at least the last 800,000 years, leading to an uptake of energy by the climate system.*

Fig. 1.2 shows the CO<sub>2</sub> emissions due to human activities since 1850. Driven largely by economic and population growth, more than half of the emissions happened after 1970.

### Effects of Climate Change

Climate change will have serious effects on people and ecosystems. The IPCC predicts that (Intergovernmental Panel on Climate Change, 2015):

## 1.1. CLIMATE CHANGE

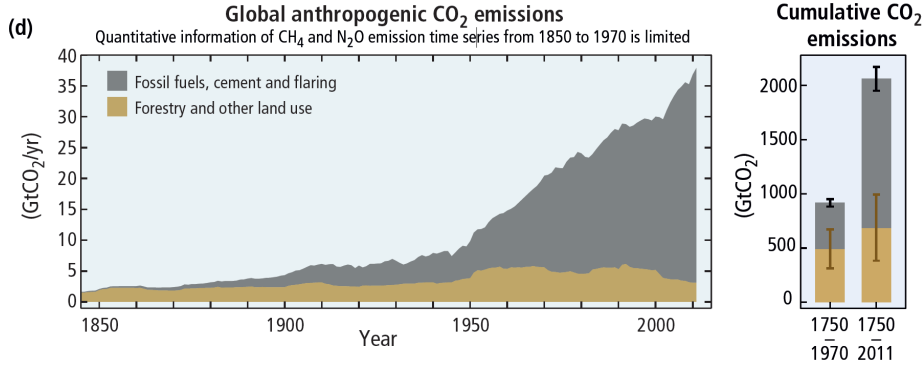

Figure 1.2: CO<sub>2</sub> emissions since 1850 (Intergovernmental Panel on Climate Change, 2015)

*Continued emission of greenhouse gases will cause further warming and long-lasting changes in all components of the climate system, increasing the likelihood of severe, pervasive and irreversible impacts for people and ecosystems.*

The expected undesirable future effects of climate change are (NASA, 2016a): surface temperatures and sea level will continue to rise; frost-free season will lengthen; extreme precipitation events will occur more often; extreme temperature events, in particular heat waves, will also become more common; hurricanes will be more frequent and stronger; and finally ice sheets and ice seas will continue to melt.

### Solutions to Mitigate Climate Change

GHG emissions are primary responsible for climate change. According to the Intergovernmental Panel on Climate Change (2015), "Substantial emissions reductions over the next few decades can reduce climate risks in the 21st century and beyond". Reducing emissions due to human activities is thus the main lever to combat climate change, and to move towards a more sustainable development. The IPCC has designed several GHG emissions scenarios that would lead to different temperature increases. In order to cap the temperature increase to 0 °C, annual GHG emissions should quickly decrease to less than 10 GtCO<sub>2</sub>-eq/yr by 2080 against more than 40 GtCO<sub>2</sub>-eq/yr today.

As a consequence, most of the countries which attended the COP21 committed themselves to cap their CO<sub>2</sub> emissions – or at least, to cap the increase rate of their CO<sub>2</sub> emissions – by means of their INDC. These contributions cover 87% of the global GHG emissions (France Diplomatie, 2016). The main ones are the followings:

**the European Union** is to reduce its GHG emissions by 40% by 2030 compared to 1990 levels (EU, 2015);

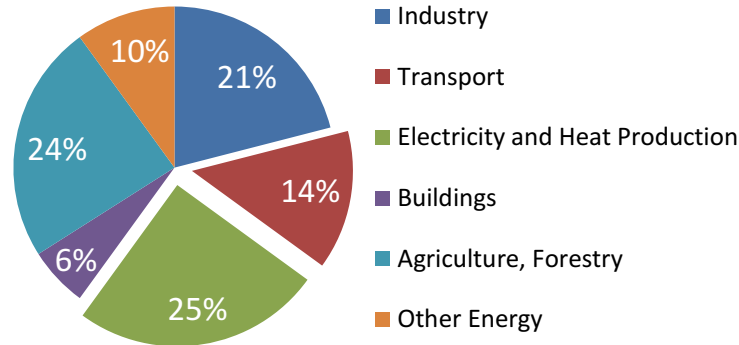

Figure 1.3: Breakdown of global GHG emissions by economic sectors (Victor et al., 2015)

**the United States** have committed to reduce their GHG emissions by 26%-28% by 2025 compared to 2005 level (USA, 2015);

**China** is expecting to reach its emission peak before 2030, and forecasts a carbon intensity reduction (in CO<sub>2</sub> by GNP unit) of 60% to 65% by 2030 compared to 2005 (China, 2015);

What are the main levers for these parties to reduce their GHG emissions?  
What are the main sectors responsible for CO<sub>2</sub> emissions?

### 1.1.2 Emissions by Economic Sectors

#### Breakdown of GHG Emissions by Economic Sectors

In order to reduce GHG emissions, it is particularly relevant to look into the emissions by economic sector; based on this information, it is then possible to identify the economic sectors that should be prioritarily targeted in terms of GHG emissions reductions. Fig. 1.3 represents the global breakdown of GHG emissions by sectors.

Electricity and Heat production is the most GHG emitting sector, with 25% of total GHG emissions. Then come the agriculture and the industry sectors. The transportation sector is below the previous ones in terms of emissions, but still accounts for 14% of the total GHG emissions. Together, the electricity and the transportation sectors are responsible for 40% of the total GHG emissions. As a consequence, these two sectors happen to be important levers for governments wishing to reduce their national GHG emissions.

## 1.1. CLIMATE CHANGE

---

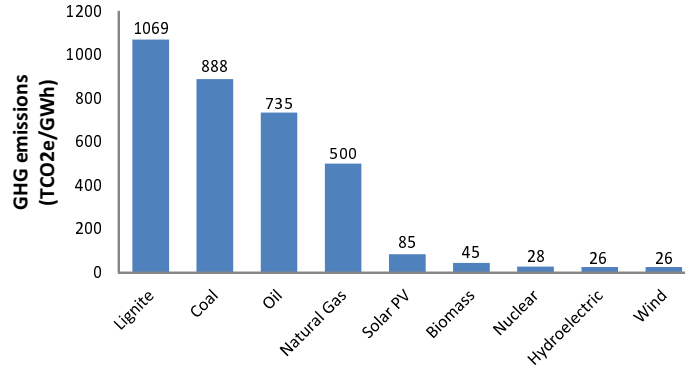

Figure 1.4: Life-cycle GHG Emissions Intensity of Electricity Generation Methods (World Nuclear Association, 2011)

### Emissions in the Energy Sector

As pictured on Fig. 1.3, energy (*electricity and heat production + other energy*) is responsible for around 35% of the total GHG emissions. According to Bruckner et al. (2015), electricity and heat production accounted for 72.6% of these emissions in 2010, making this pole the most emitting one by far for the energy sector. However, different electricity production sources have different GHG emissions intensity. The World Nuclear Association (2011) has conducted a literature review from which was derived an analysis of the life-cycle GHG emissions of various electricity generation sources, including the GHG emitted during the plant's construction, operation and decommissioning phases. Results are featured on Fig. 1.4.

Fossil fuels such as lignite, coal, oil and gas are by far the most GHG emitting sources. Electricity production sources using lignite as a primary fuel emit more than twelve times as much GHG as Solar PV and more than forty times as much GHG as wind mills over their lifetime. Natural gas is the less emitting source among the fossil fuel ones: GHG emissions of gas power plants are twice as low as those of lignite power plants.

Bruckner et al. (2015) provide some clues about how to reduce GHG emissions from the energy sector. Fuel switching, which consists in switching from one fossil fuel to a less emitting one (e.g. from coal to gas), is a first solution to mitigate GHG emissions during extraction, transport and conversion phases. However, a second, more efficient, manner to reduce GHG emissions is to replace traditional fossil fuel power plants with technologies without direct emissions. The latter include in particular solar PV and wind turbines<sup>2</sup>.

---

<sup>2</sup>They also include nuclear power, and all other wind-, solar- and water-based energies. However, PV panels and wind turbines will represent the core of the discussions in the rest of this thesis.



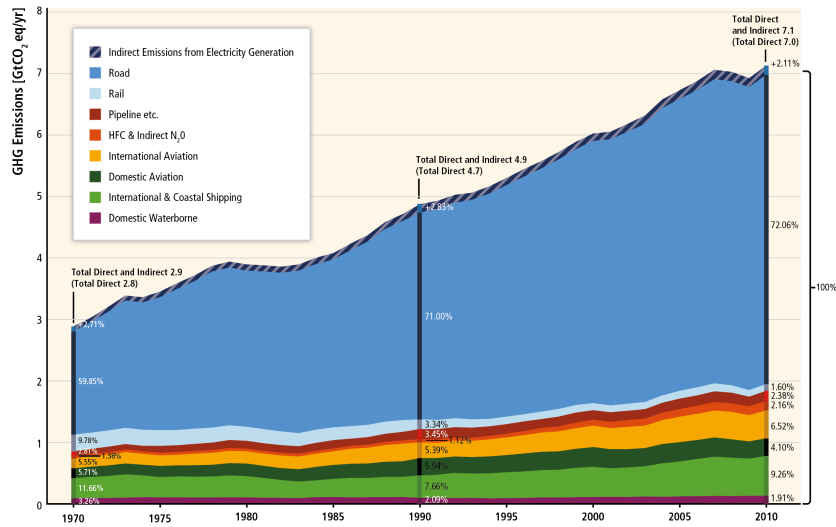

Figure 1.5: GHG emissions from the transportation sector (Sims et al., 2015)

### Emissions in the Transportation Sector

According to Fig. 1.3, the transportation sector is responsible for 14% of the global GHG emissions. However, there are many different types of transportation means, which use different fuels and are used for different purposes. The evolution of GHG emissions of these various transportation modes over the period 1970 - 2010 is graphed on Fig. 1.5.

From this figure, it is striking to see how important road emissions are compared to any other transportation mode; in 2010, they accounted for 72% of the transportation sector's total GHG emissions. Moreover, road's emissions have been drastically increasing over the past forty years, while emissions from other transportation modes only slightly increased over the same period.

The mitigation options include lowering the GHG emissions of traditional Internal Combustion Engine (ICE) light and heavy duty vehicles. Reducing vehicles' weights, rolling and air resistances, improving the engines' energy efficiency, are all manners to reduce GHG emissions. A more radical solution is to develop alternative propulsion systems that have no tailpipe emissions. Electric Vehicles (EVs), which use electric motors powered by electrochemical batteries, fit in this category. They represent a tremendous solution to reduce GHG emissions in the transportation sector (Sims et al., 2015). Similarly Plug-In Hybrid Electric Vehicles (PHEV), i.e. hybrid vehicles whose battery can be recharged from the grid and which have an important Zero Emission Vehicle (ZEV) range<sup>3</sup>, are promising solutions.

It is worth noting that the well-to-wheel emissions of electric vehicles will be highly dependent on the fuel used to produce the electricity stored in their

<sup>3</sup>Typically from 30 to 50km.

## 1.1. CLIMATE CHANGE

---

batteries (ADEME, 2013). In this respect, it would be very beneficial to power EVs with electricity produced by Renewable Energy Sources (RES).

### 1.1.3 Energy and Transportation Emissions Policies

The energy and the transportation sectors are responsible for 40% of the total GHG emissions. In order to reduce the emissions of these sectors, several policies are implemented throughout the world. They are part of the broader emission policies of all the countries willing to respect their Intended Nationally Determined Contributions (INDC, see section 1.1.1).

The European Union has set emissions objectives to all car manufacturers selling vehicles in Europe: the average<sup>4</sup> emissions of all new vehicles sold should not exceed 95gCO<sub>2</sub>/km by 2020 (European Commission, 2012). As an indication, PSA Groupe was the European leader in terms of CO<sub>2</sub> emissions at the end of 2014 with an average emission of 110gCO<sub>2</sub>/km per vehicle (CCFA, 2015a). In the energy sector, the European Union has set the objective of having renewable energy sources (RES) producing 27% of the total energy consumption by 2030 (European Commission, 2016). In the United States, the Environmental Protection Agency (EPA) has developed a National Program for GHG and fuel economy standards. This program has set the target of reaching average vehicles emissions of 89gCO<sub>2</sub>/km by 2025 (EPA, 2012). In China, the government objectives are to reduce vehicles' average emissions to 116gCO<sub>2</sub>/km by 2020 (CCFA, 2014).

It has been increasingly difficult for OEMs to cope with these objectives of reduction in CO<sub>2</sub> emissions, which are moreover coupled with emission targets for other pollutants (NO<sub>x</sub>, CO, etc.). The so-called "DieselGate" case, during which the Volkswagen Group admitted to having cheated during official emission tests, revealed this difficulty to the public.

As explained above, technological breakthroughs such as the integration of renewable energy sources (RES) in the energy mix and the large scale roll-out of electric vehicles could help countries and OEMs achieving their objectives. Thus, in order to reduce their GHG emissions, almost all countries or states have implemented targets for RES and EV penetration. Some examples of such targets are presented in Table 1.1. The introduction of these two recent technologies<sup>5</sup> poses challenges respectively to the energy and automotive industries. The challenges faced by both industries are respectively explained in sections 1.2 and 1.3.

---

<sup>4</sup>The average emissions of each car manufacturers are calculated according to the Corporate Average Fuel Economy (CAFE) methodology. Please refer to Wikipedia (2016) for more details.

<sup>5</sup>EV and RES technologies are not new technologies strictly speaking; rather, they are reaching penetration levels that were never reached before.

Table 1.1: Some examples of RES and EV deployment objectives in some countries / areas

<i>Area</i>	<i>EV deployment plans</i>	<i>RES objectives</i>	<i>Reference</i>
France	450,000 EVs on the roads by 2020 7 Million charging stations <sup>a</sup>	27% of elec. produced by RES by 2020 8GW of PV by 2020 25GW of wind power by 2020	(Ministère de l'Environnement, 2016; Etat Francais, 2015; RTE, 2014)
China	5 million vehicles propelled by alternative fuels by 2020	≈ 150GW of solar power by 2020 250GW of wind power by 2020	(NY Times, 2015; CCFA, 2016)
California	1.5 Million EVs by 2025	33% RES by 2020	(AVEM, 2013; Ministère de l'Écologie, 2013)

<sup>a</sup>According to the French energy transition law.

## 1.2 Major Changes in the Electricity Sector

Electrical networks emerged in the late 19<sup>th</sup> century. They were initially small local DC networks intended for public lighting only. Throughout the 20<sup>th</sup> century, electrical grids have expanded and interconnected significantly. Similar frequency and voltage values were selected to harmonize the different local networks' characteristics and make it possible to interconnect them.

Today, due to the objectives of reaching a certain level of RES penetration while still ensuring the security of supply, electrical grids are facing major challenges. In this section, the aim is to address these challenges and to explain how power systems' operations are impacted by these changes. First, in section 1.2.1, the basics of power systems are recalled. Then, section 1.2.2 deals with the main changes happening in the power systems' operations.

### 1.2.1 Main Characteristics of the Power Systems

#### Main Components of the Electrical Grids

The electric power networks are divided into two parts: the transmission grid and the distribution grid. The former links the centralized power plants to the largest consumers and to large substations that feed the distribution grids. The transmission grid has a meshed topology to maintain the continuity of service and to increase the system stability in case of line tripping. In continental Eu-

## 1.2. MAJOR CHANGES IN THE ELECTRICITY SECTOR

---

rope, its upper voltage levels are 400 kV and 225 kV, and all national 400-kV grids are interconnected to commercialize electricity among the countries and to increase reliability. In each country, the transmission grid is operated by one (France) or several (Germany) operators called Transmission System Operators (TSOs) if the operator owns the grid, or Independent System Operator (ISO) if the operator manages the grids without owning the assets (Rious et al., 2008)<sup>6</sup>. The substation transformers step down the voltage to feed the distribution grid at medium voltage level and then distribution transformers deliver the low voltage to small customers. The distribution grids were built with a radial topology to make them easier and cheaper to operate. They are operated by Distribution System Operators (DSOs). An important specificity of an electric network is the long lifespan of equipment (several decades) and their sunk costs. Thus, any evolution and investment must be carefully analyzed bearing in mind its impacts on the system security and operation costs.

Alternating Current (AC) is used to carry the power from large power plants to final customers. Direct Current (DC) is sometimes used in High-Voltage applications (HVDC), for instance to connect an island with a continental area – however, DC remains marginal compared to AC.

### Energy Mix

Several primary energies may be used to produce electricity: gas, oil, wind, solar, hydro, etc. An energy mix consists of the respective shares of the primary energies that are used to produce electricity in a particular network. It depends on local available resources, and strategic and technical choices to guarantee security of supply at all times. For example, France opted for nuclear power in the 1970s to ensure its energy independence, Norway has a 95% hydro mix owing to its resources, and Poland has a 90% coal generation mix.

From the power system perspective, power plants are divided into three main categories: base-load plants (nuclear, run-of-river hydro, and large coal units), semi-base load plants (coal and gas turbines), and peak load plants (pumped hydroelectric storage (PHS) and gas or oil combustion turbines). The first ones have the highest investment costs, but the lowest marginal costs. They are supposed to operate more than 8000 hours/year. Conversely, a peak load plant has an equilibrium point at 300 hours/year, low investment costs and high marginal costs. Peak load plants are able to ramp up and down much quicker than base-load plants. System Operators (SOs) need to diversify the nature of the power plants operating in their networks in order to cover all their needs.

Fig. 1.6 presents the energy mixes of several areas. Coal is still the main resource worldwide (40%) because it is the most affordable one. Nuclear represents only 12% of the world production, with large disparities among the countries, because nuclear plants have the highest investment costs and require a complex technological know-how. France has the highest nuclear share in its energy mix ( $\approx 80\%$ ). Denmark is the country with the highest share of wind,

---

<sup>6</sup>In the rest of the document, the term TSO will be arbitrarily used, although ISOs are also concerned by this wording.

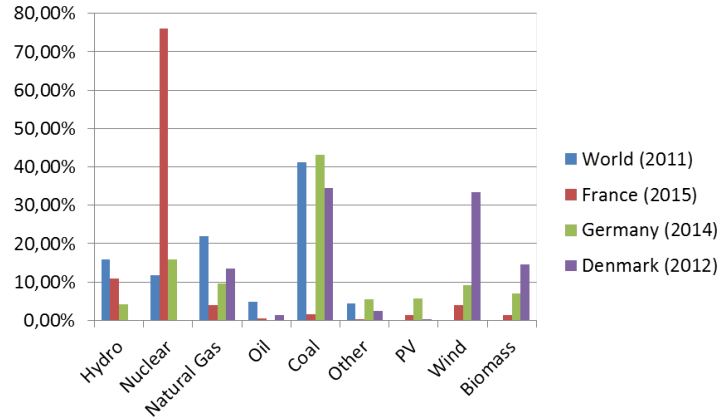

Figure 1.6: Energy mixes of different regions. Figure created using data from (International Energy Agency, 2013a; Réseaux de Transport d’Electricité, 2016a; Ministère Fédéral de l’Economie et de la Technologie, 2015; Danish Energy Agency, 2012)

which remains marginal globally (as PV production). Hydro power is the most important renewable energy source (RES) in the world.

Each generation technology has its own dynamic performances that characterize its flexibility: startup and shut-down durations, ramping limits (in MW/s), and minimum production output. The power plant flexibility is critical to securely operate the power system because generation must continuously balance demand. The optimal generation plan depends on the plants’ marginal costs, their flexibility and availability, and the load profile. It is the solution of a unit commitment problem (Guan et al., 1992).

### Frequency Control

Frequency is a common characteristic within an interconnected network; at any node of the grid, the frequency value is the same (conversely to voltage, whose value is different from one node to another). The frequency value fluctuates around its nominal value at each moment (50Hz in Europe and Asia, 60Hz in the USA and both in Japan). However, maintaining the frequency close to its rated value is important, because most of the materials have been optimized to operate at this frequency value, and devices with magnetic materials may come out of their linear range. The local TSO is responsible for controlling the frequency value. Fig. 1.7 shows the instantaneous values of the frequency in the three North-American interconnected areas.

The frequency is linked to the generators’ rotation speeds, and its variations reflect the real time balance between supply and demand. If electricity generation exceeds electricity consumption, the frequency will rise above its rated value and vice versa. Consequently, TSOs manage the frequency by implement-

## 1.2. MAJOR CHANGES IN THE ELECTRICITY SECTOR

---

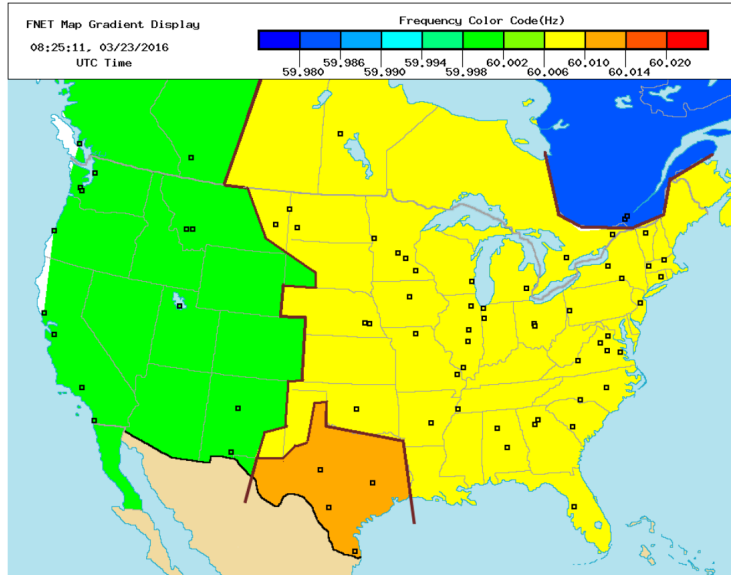

Figure 1.7: Frequency map gradient in the USA. Picture taken on March 23<sup>rd</sup>, 9:22AM Paris Time. The three main interconnected networks can be easily distinguished. Extracted from FNET (2016) website

ing several control levels that balance production and demand in real time (see section 3.1.1 (page 48) for a more complete description of these control levels). Historically, the control levels have been used to manage the mechanical power delivered by the production turbines in such a way that they would adapt to changes in demand. As demand continuously changes, some power plants must be flexible enough to supply reserve power very quickly.

Introducing variable and unpredictable RES into the grid may require TSOs to have more frequency reserve power (as well as other types of reserve, such as restoration reserves, hourly balancing reserves, etc.) (Ackermann et al., 2007). Finally, demand loads may also contribute to frequency control by controlling their consumption patterns.

### Voltage Control

Apart from frequency, the second key parameter is voltage. Voltage values change from one node to the other because the characteristics of the loads located at the end of the line have an impact on its value (Hennebel, 2009). DSOs and TSOs must keep the voltage levels within a range to ensure a good power quality to their customers and to secure the grid stability. Table 1.2 displays the rated, minimum and maximum allowed voltage values in the French grid.

In transmission systems, the generators mainly control the voltage under

Table 1.2: Rated ( $U_N$ ), minimum ( $U_{min}$ ) and maximum ( $U_{max}$ ) voltage levels in the French grid (Hennebel, 2013)

<i>Network</i>		$U_R$	$U_{min}$	$U_{max}$
Transmission	HTB 3	400kV	365kV	420kV
	HTB 2	225kV	200kV	245kV
Repartition	HTB 1	90kV	83kV	97kV
		63kV	58kV	68kV
Distribution	HTA	21 & 5 kV	-5%	+5%
Low voltage	LV	230V	-10%	+10%

the supervision of the TSOs. In radial distribution networks, load levels and line lengths have a strong impact on the voltage quality. Moreover, distributed generators (DG) (solar, wind, etc.) tend to increase the voltage at the node they are connected to (and consequently to neighboring nodes). In such networks, voltage regulation is mainly performed with the addition of capacitor banks (for reactive power control), or by means of on-load tap changing (OLTP) transformers (for active power control) (Short, 2014). According to European standard EN50160, the 10 minutes voltage deviation should not exceed  $\pm 10\%U_n$  on a weekly basis (Markiewicz and Klajn, 2004).

### Congestion Management

All power equipment (lines, cables, transformers, etc.) is sized for a given rated current. Any overload will increase losses and hence equipment temperature what can reduce their lifespan. Thus, TSOs and DSOs aim to prevent overloading. TSOs use different technical and economical solutions such as re-dispatching, zonal, or nodal market-oriented tools (Rious et al., 2008). In high voltage lines, overload protection relays may trip lines if an overloading duration exceeds a predefined threshold. At the distribution level, investments in equipment upgrades is used to prevent overloading from happening.

### 1.2.2 Evolutions Towards Integrated Grids

Electric grids were traditionally composed of large and central power plants producing huge amount of electricity for inflexible final consumers. However, with the rise of Distributed Energy Resources (DER) (including Distributed Generation (DG), distributed storage units, flexible loads such as heating, cooling, Electric Vehicles (EVs)...), the system is starting to change. Such DER have an impact on the grids (on the energy mix, on frequency and voltage control operations), which were not designed to accommodate a high penetration of these new units.

In order to maintain the same quality of service for consumers (reliability, quality, electricity prices, etc) DER integration should be considered in the planning and in the operation of the electric grids. This will require technological

## 1.2. MAJOR CHANGES IN THE ELECTRICITY SECTOR

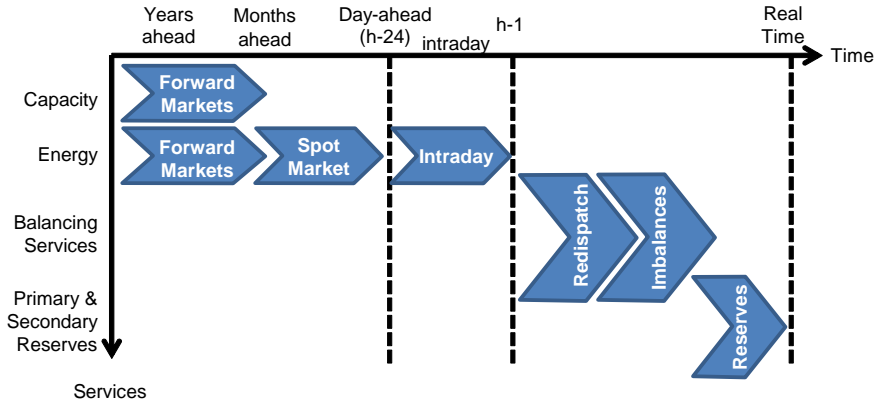

Figure 1.8: Electricity markets organization from long term to real time.

and policy adaptations. The Electric Power Research Institute (2014) has called such a grid an *Integrated Grid*.

### Economic Context: Gradual Liberalization of the Energy Sector

Electric grids used to be operated by utility companies which were very vertically integrated; they were at the same time electricity producers, TSOs, DSOs and retailers. Twenty years ago, the liberalization of the electricity sector has been decided in Europe to improve social welfare. Step by step, the incumbent utilities (CEGB in England and Wales, EDF in France, ENEL in Italy, etc.) have been split into several independent activities: producers, suppliers, and grid operators. This evolution has been observed almost all over the world. Electricity markets have been set up under the supervision of national regulators (Glachant et al., 2013). Currently, the interconnected grids are also merging their national electricity markets: in Europe, the EPEX SPOT market enables a common electricity day-ahead market between France, Germany, Austria, Luxembourg and Switzerland.

The electricity markets have been set up to respect the technical constraints of the electric grids; in particular, they were designed to guarantee a continuous balance between production and demand. As a consequence, several markets were created: some of them are responsible for securing large electricity transactions from years to day ahead, while others are used to ensure a balance in real time. A typical organization of such markets is illustrated on Fig. 1.8. Electricity producers, traders and suppliers play in the long-term markets; on the other side, TSOs, producers and flexible consumers are concerned with short-term markets. Mainly predictable generation is exchanged on wholesale markets; variable generators usually participate to mid-term markets (day ahead and intraday).



### Advanced Metering Infrastructure and Demand Response

Demand response is a term that refers to "the changes in electric usage by end-use customers from their normal consumption patterns in response to changes in the price of electricity over time, or to incentive payments designed to induce lower electricity use at times of high wholesale market prices or when system reliability is jeopardized" (Aghaei and Alizadeh, 2013). In the context of *Integrated Grids*, Distributed energy resources (DER) are potential providers of flexibility services, which is also referred to as Demand Response (DR).

The concept of demand response is a new approach in the electricity grids: it is completely different from the traditional grid operations in which power plants' production is strictly following inflexible demand patterns. In order to enable DER to provide demand response, smart metering together with alternative contracting and pricing methods are important requirements (Faruqui et al., 2010; Geelen et al., 2013). Furthermore, from a technical perspective, investments in distributed intelligence, distributed automation and in-building energy management could further facilitate the efficient operations of appliances connected at the distribution grid.

## 1.3 Automotive Industry: a Shift Towards Electrification?

According to Carlos Tavares, CEO of PSA Groupe, the automotive sector will undergo "more changes in the coming decade than in the previous century". Due to increasingly ambitious targets of CO<sub>2</sub> emissions, car manufacturers (or Original Equipment Manufacturer (OEM)) have to adapt their product line to this new challenge. There are several possible ways to reduce the CO<sub>2</sub> emissions of a vehicle: reducing its weight, improving its engine's efficiency, reducing the ground and air frictions when driving, improving the mechanical and thermal energy recovery, using low-consumption electric equipment, etc. Among these available solutions, electrifying part of or the entire drivetrain is probably the largest impact.

### 1.3.1 Several Electrification Levels

Conventional Vehicles (CV) use diesel or gasoline engines. An electric motor can be used to support or temporary or permanently take over the engine, leading to various electrification levels which are described hereafter (Ehsani et al., 2005; Sanden, 2013):

**Stop&Start systems** In this configuration, a small electric motor is used only to support the engine in start-up phases.

**Mild Hybrid Electric Vehicle (MHEV)** Full hybrid vehicles' drivetrains are completely different from conventional vehicles' ones. Manufacturing a full hybrid vehicle is therefore complex and requires significant investments.

### 1.3. ELECTRIFICATION STRATEGIES

---

A compromise consists in equipping conventional vehicles with an electric motor that will operate as an engine starter, as an electrical generator, and as a power assist to the engine in particular conditions. MHEV never operate in Zero Emission Vehicle (ZEV) mode, meaning that the vehicle is never propelled by means of the electric motor only (if it were, the ZEV range would be approximately a few hundred meters).

**Full Hybrid Electric Vehicle (HEV)** HEV use two power sources: an electric motor which is powered by an electrochemical battery and a diesel or gasoline engine<sup>7</sup>. Hybrid drivetrains supply the required power through an adapted power train. There are many different ways of combining the power flows from the two power sources, leading to various drive train configurations. The two main ones are Series HEV and Parallel HEV<sup>8</sup>. In the former configuration, the electric motor, the engine and the transmission are in series: the engine is dedicated to charging the battery pack or to powering directly the electric motor. In the latter configuration, the electric motor and the conventional engine power the transmission line in parallel through a torque coupler. In all configurations, energy optimization strategies are developed to determine the relative contribution of each power source depending on internal vehicle parameters. The battery capacity of such vehicles is around 1kWh, allowing a ZEV range of a few kilometers.

**Plug-in Hybrid Electric Vehicle (PHEV)** PHEV are HEV with significantly higher battery capacities (from 5 to 12 kWh). Consequently, they have a longer ZEV range, typically from 30 to 50 km. The energy strategy is the following: the vehicle is propelled by the electric motor and the battery only until the battery state-of-charge (SOC) reaches its lower limit (typically around 1kWh). Then, the PHEV is operated as an HEV. After such a driving cycle, the battery needs to be charged with an external power source; the PHEV has to plugged-in to the electric grid through an electric outlet.

**Full Electric Vehicle (EV)** An EV does not have any engine; it is only propelled using an electric motor and a battery pack. Battery sizes typically range from 16-24kWh (today) to 50kWh (in a near future), leading to driving ranges from 120km to 300km, respectively. The battery is charged by plugging the vehicle to an external electric power source.

The higher the electrification level, the less the CO<sub>2</sub> emissions: an EV is CO<sub>2</sub> free<sup>9</sup>, a PHEV typically emits 50gCO<sub>2</sub>/km<sup>10</sup>, while HEV's consumption is around 90gCO<sub>2</sub>/km.

---

<sup>7</sup>HEV may use other primary and secondary energy sources, such as hydrogen, compressed-air, etc. Here, the emphasis is put on electric hybrid vehicles only.

<sup>8</sup>Other configurations are possible, such as series-parallel hybrid.

<sup>9</sup>When driving only. The production of the electricity used by the vehicle may have generated CO<sub>2</sub> emissions; it depends on the energy mix, see 1.2.1.

<sup>10</sup>With the current NEDC tests.

In the rest of this thesis, the emphasis will be put on vehicles that need their battery to be charged by an external power source, namely PHEV and EV.

### 1.3.2 Charging Systems

PHEV and EV can be plugged-in to electrical outlets. Several charging modes have been defined in the standard IEC 62196. They enable different communication and power levels:

**Mode 1** charging enables a vehicle to plug-in in a typical E/F standard socket up to 16A (either with one-phase or three-phase connection). There is no minimum communication between the vehicle and the electric outlet.

**Mode 2** charging is very similar to mode 1, but enables advanced communication, in particular regarding earth presence detection, residual current and over-temperature protection. The charging cable requires an additional box to deal with these communication steps. The maximum current level drawn by the vehicle is 32A.

**Mode 3** requires a specific charging station (or so called wall box) to enable high-level communication and high power. The vehicle and the wall box communicate by means of pilot lines. In particular, as specified in the IEC 61851 standard, the EVSE may use the control pilot line to send a PWM signal indicating the maximum charging current allowed. If the vehicle and the charging station abide by the same standard, Power Line Carrier (PLC) or wireless communications are also available<sup>11</sup>.

**Mode 4** is dedicated to Direct Current (DC) charging, meaning that there is a direct connection between the battery bus and the EVSE which is responsible for performing the AC/DC conversion. This mode enables very fast charging (>50kW).

Several types of plug are associated to these charging modes. They are illustrated in Table 1.3.

### 1.3.3 Plug-in Vehicles Penetration Rates

#### Plug-in Vehicle Sales

Almost all car manufacturers have EVs in their product line. The Nissan Leaf is the world most sold EV, with more than 200,000 vehicles on the road today. In France, the Renault Zoe is the most sold EV with 60% market share in 2015 (Automobile Propre, 2016a). PHEVs have been commercialized more recently, and their sales are therefore lower than those of EVs. However, as an example, the Mitsubishi Outlander PHEV sales exceeded 50,000 at the end of 2015, i.e. two years after the first deliveries (AVEM, 2015).

---

<sup>11</sup>As scheduled in the ISO/IEC 15118 standard.

### 1.3. ELECTRIFICATION STRATEGIES

Table 1.3: The different types of plugs used to charge plug-in vehicles (from the charging station and vehicle sides)

<i>Plug type</i>	<i>Illustration</i>	<i>Description</i>
E/F Socket		Used in mode 1/2 for low-power charging
Type 1		Used in mode 3; vehicle inlet only
Type 2		Used in mode 3; European standard
Type 3		Used in mode 3
Combo charging system (CCS)		Used in mode 4; European standard
Chademo		Used in mode 4; Japanese standard

Fig. 1.9 displays the sales and market shares of plug-in vehicles (PHEV & EV) in various markets for 2015. In total, nearly 540,000 plug-in vehicles were sold worldwide in 2015, which is an increase of 70% compared to 2014 (EV Volumes, 2016). Europe and China (+233% compared to 2014) are boosting

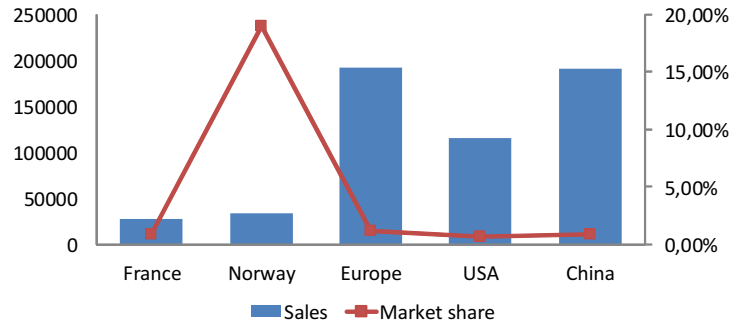

Figure 1.9: Sales and market shares of plug-in vehicles in various markets in 2015. Figure created using data from Automobile Propre (2016a), Avere (2016), & EV Volumes (2016)

worldwide sales. However, the relative market shares of plug-in vehicles remain marginal; apart from Norway (19% market share in 2015), the average market share is 1% in the leading markets.

EV and PHEV market shares are still rather low for three main reasons: (a) the limited EV driving ranges compared to their equivalent in conventional vehicles; (b) the lack of charging infrastructure; and (c) their relatively high price (Board on Energy and Environmental Systems; Division on Engineering and Physical Sciences; Transportation Research Board, 2013).

### Expected Future Sales

Significant decreases in battery prices are expected in the coming years, while their energy density is forecasted to increase in the mean time. Fig. 1.10 illustrates the forecasts of the International Energy Agency (IEA): battery prices drop from 600\$/kWh in 2011 to around 150\$/kWh in 2022. In the mean time, battery energy density increases approximately from 100Wh/L to 400Wh/L. According to the same report, the global charging station stock more than doubled for slow charging between 2012 and 2014.

Due to these improvements in EV and PHEV technologies, and to the gradual roll-out of charging stations, the number of plug-in sales is likely to increase drastically in the coming years. Among others, Toyota has set the target of selling no more conventional vehicles by 2050 (CCFA, 2015b). Similarly, Honda CEO announced that only one vehicle out of three coming from Honda plants will be a conventional vehicle by 2030 (Brezza, 2016). According to the Bloomberg New Energy Finance (2016), the EV revolution could turn out to be more dramatic than governments and oil companies have yet realized. The agency forecasts that EV sales will hit 41 million worldwide by 2040, accounting for 35% of market share.

## 1.4. INTEGRATION OF PLUG-IN VEHICLES IN THE ELECTRICAL GRIDS

---

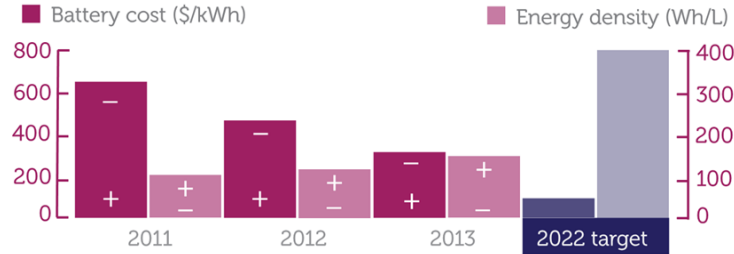

Figure 1.10: Current and estimated future battery prices and energy density (International Energy Agency, 2015)

## 1.4 Integration of Plug-in Vehicles in the Electrical Grids

EV and PHEV sales are expected to increase rapidly. However, these vehicles need to be charged from the electric grids – which are themselves undergoing severe mutations. Are electric grids able to cope with these new loads? What are the solutions to integrate softly EV and PHEV into the grids?

### 1.4.1 Are Plug-in Vehicles a Threat to Electrical Grids?

From the grid perspective, EV and PHEV are large loads in comparison with traditional household loads. As a consequence, their charging process can significantly increase the load in low-voltage grids (Green eMotion, 2013). Silva and Kieny (2011) demonstrate that EV charging patterns could also impact transmission grids and induce congestion on the high-voltage lines, although there are differences between the countries.

Several plug-in vehicles charging simultaneously can impact the electric grids at several levels. Let's focus on the French case, as an example.

The typical contracted power of an **individual housing** is 6kVA in France. Plug-in vehicles characteristically charge at 3kW or 7kW in mode 2 or mode 3. A single vehicle charging would account for 50% to 100% of the contracted power. Moreover, without controlling the charging patterns of EV, they tend to occur at peak periods (Green eMotion, 2013), thus happening at the worst moment for the home electrical grid.

The electrical situation of a **building** depends on its nature (tertiary, industrial, residential) and on its activities. Here, a tertiary building is considered. Its main electrical consumption patterns' characteristics and the features of its electric contract with the local system operator are available. This building hosts around 100 workers. Its average consumption is 25kVA, and its contracted power with the system operator is 30kVA. Under such conditions, 10 charging stations at 3kW (respectively 7kW) would require a contracted power twice as high as the current one.

Some surveys conducted by ERDF (French main DSO) show that around 25% of the 780,000 **local distribution stations** would need to have their transformers replaced if one million plug-in vehicles were on the road in France<sup>12</sup>. Such a distribution transformer costs between 5,000€ to 10,000€; the total upgrading costs would amount to one billion euros, that is to say 1,000€/vehicle<sup>13</sup>.

At the **system wide scale**, one million plug-in vehicles charging simultaneously at 3kW (respectively at 7kW) would trigger a peak power of 3GW (respectively 7GW), i.e. 2.5% (respectively 5.8%) of the total installed production power in France. Such peak power would cause an important increase of the daily 7PM peak power, up to 17.5% as the latter ranges approximately from 40GW to 100GW.

The approach discussed above could be extended to other countries, although results might differ slightly. It shows that the smaller the scale considered, the more important the impacts of EV charging. At the very local scale, a few vehicles charging at the same moment can impact the grid severely. At higher level scale, more EV would be required to raise issues on the grid.

### 1.4.2 Plug-in Vehicles as Storage Units Supporting the Grid

In France, a vehicle is used in average 5 hours per week and 80% of the cars drive less than 50km a day (Commissariat General au Developpement Durable, 2011). Considering an energy consumption of 200Wh/km, 50km represents a consumption of 10kWh a day, what should be considered relatively to the battery sizes: around 25kWh today and 50kWh tomorrow.

As a consequence, EVs have a good temporal flexibility in their charging process: for instance, it would only take 1h30 for an EV to charge its daily 10kWh energy needs with a 7kW charging station. These charging needs could be satisfied any time during the night (at the beginning, at the end, etc.) but also spread over the entire night time.

This calls for the implementation of smart charging strategies. Indeed, according to section 1.4.1, EV charging could induce additional stress on the electric grids, particularly during peak hours. However, it is possible to delay the charging process of an EV at the right moment, and even to control its charging rate depending on external factors. Going one step further, EVs could inject power back to the grid (using Vehicle-to-grid (V2G) concept) at special moments, and charge the required energy later.

More broadly speaking, EVs could be considered in the planning and in the operation of power systems, as suggested in the concept of *integrated grids* (see section 1.2.2). Such EV, with the required software and hardware components, are called Grid Integrated Vehicles (GIV). Their charging / discharging patterns

<sup>12</sup>The survey was conducted for the city of Lyon only, and the results are here expanded to then entire French territory.

<sup>13</sup>According to Derdevet (2015), the total costs for the DSO in France would amount to 5 Billion euros, taking into account the installation of charging stations and the upgrading costs of other electrical equipment.

can be controlled according to an energy strategy. EVs can be controlled individually, or as part of a larger fleet which is more reliable from a statistical point of view (Pearre et al., 2011). Under such approach, GIVs are akin to stationary storage units, unless their primary usage remains transportation.

Controlling the charging / discharging patterns of one or several EV can fulfill several objectives. First, it may help, from a **technical** perspective, introducing large number of EVs into the grid. Indeed, not all local or national grids would be able to cope with the expected EV roll-out with no control on the EV charging patterns. Second, from an **ecological** perspective, controlling the charging / discharging patterns of EVs may help introducing intermittent RES into the grid, by charging EVs when RES are producing. This would be beneficial for the energy industry which would lower its emissions, but also for EVs which would truly achieve a CO<sub>2</sub>-free mobility. The expected savings in CO<sub>2</sub> emissions by means of smart charging strategies could amount to 300 million euros in 2050 (Eurelectric, 2015). At last, smart charging / discharging strategies could lead to **economical savings**: for grid operators, which could reduce their grid investment needs and for EVs which could reduce their total cost of ownership (TCO).

## 1.5 Research Objectives

The main objective of this thesis is to study the technical constraints and business models that are associated to the development of smart charging / discharging strategies, from the perspective of an OEM. A multi-disciplinary approach is required for such a study. First, a **technical** approach is necessary to understand the power systems' operation, the characteristics of a (fleet of) plug-in vehicle(s), and the associated energy strategies. Then, an **economical** approach is required to develop solutions that are viable on the long run for all stakeholders of the value chain. At last, a **regulatory** analysis of each solution is mandatory to back up the legal feasibility of any solution.

The main research questions that are addressed in the PhD are the followings: what are the main use cases for smart charging / discharging strategies? For each of these use cases, what the associated challenges and benefits? For the most interesting use cases, what are the relevant business models? Finally, what are the impacts on the EV side, both from software and hardware perspectives?

In order to address these questions, the present thesis is structured according to the following outline:

**Chapter 2** explains how Distributed Energy Resources (DER) could be integrated in the electric grids, and how they could provide system operators with flexibility services. DER technical abilities and systems' needs for flexibility are described. Then, the emphasis is put on plug-in vehicles and on their challenges as particular DERs.

**Chapter 3** focuses on the provision of system wide services by a GIV fleet. More precisely, the possibilities for an EV fleet to provide frequency con-



trol are investigated, in the light of the three approaches discussed above (technical, economical and regulatory).

**Chapter 4** deals with the integration of a GIV fleet in a small micro-grid. As in the previous chapter, the technical feasibility, the economics, and the regulatory aspects are detailed.

**Chapter 5** reports on real-life experiments that were conducted with vehicles from PSA Groupe in order to prove the technical feasibility of GIV. Both a unidirectional and a bidirectional capable cars were tested, acting as if they were providing grid services.

**Chapter 6** is the conclusion. Several recommendations are made, in particular towards car manufacturing companies.

## 1.6 Positioning with respect to the state-of-the-art

In the scientific literature, there are several publications addressing the smart grid integration of GIVs from a technical perspective. Most of them focus on the GIV control strategies, both for smart charging strategies and for more complex bidirectional grid services.

Some papers address day-ahead and intraday electricity markets. For instance, Peterson et al. (2010b) cover an economic assessment of GIVs providing energy arbitrage with bi-directional power flow capability, taking into account battery degradation. Similarly, Hoke et al. (2011) present a method minimizing GIV charging costs considering variable electricity costs and a battery degradation model. Al-Awami and Sortomme (2012) aim at coordinating unidirectional V2G services in order to cope with the risks of trading energy in the day-ahead electricity markets. They eventually show that coordinating V2G services with energy trading has several merits: an increase of expected profits, a decrease in risk management and a reduction in emissions. Sioshansi and Denholm (2009) present a Unit Commitment (UC) model including PHEVs and show that, with an uncontrolled strategy, PHEV charging costs are more than twice as high as those gained with a controlled strategy. Wu et al. (2012) present a GIV aggregator which maximizes its energy-trading related profits. A cost-optimization algorithm is implemented to trade electricity in the day-ahead market and to negotiate bilateral contracts. Some adjustments are also made in the real-time market.

There is also an intensive literature dealing with the provision of frequency control products with GIV fleets. For example, Kamboj et al. (2011) detail the aggregator algorithm which is actually implemented in the V2G project of the University of Delaware. Vandael et al. (2013) draw a comparison between the algorithm described in the previous paper and a similar but centralized one, solving a complex optimization problem. The authors conclude that the enhanced performances of the centralized solution do not really outweigh its drawbacks.

## 1.6. POSITIONING WITH RESPECT TO THE STATE-OF-THE-ART

---

Similarly, Sortomme and El-Sharkawi (2012) propose an optimization problem in order to simultaneously optimize V2G bidding in energy, regulation UP and DOWN, and spinning reserves considering bi-directional power flow. Han et al. (2012) is one of the very few presenting an economic assessment of GIVs providing frequency regulation taking into account battery degradation, but a steady regulation price is considered, the battery wear model is rather simple, EV use for transportation is not taken into account, and the aggregator is not considered. Donadee and Ilic (2012) propose a stochastic dynamic programming method to optimize EV charging and frequency regulation decisions, under costs and regulation benefits uncertainties, presenting an interesting innovative approach. However, the new regulation signal from PJM is not considered, and thus results seem to be outdated. Liu et al. (2013) present a decentralized algorithm that controls GIVs participation to primary frequency control, considering charging demands. The individual strategy proposed is interesting, but it would hardly be implementable in real life because all GIVs constantly change their frequency droop without notifying the aggregator.

Garcia-Villalobos et al. (2014) provide a comprehensive review of smart charging approaches for more information.

On the other side, there are some papers dealing with the regulatory and economics analysis of Distributed Energy Resources (DER) integration in the electric grids. For instance, Picciariello et al. (2015) deal with the tariff issues, while Niesten and Alkemade (2016) address the value chain of new smart grids. However, these papers have usually top view approaches and do not focus on the operational details; similarly, they would not make any distinction between DER types.

In the end, the state-of-the-art is composed of: papers that evaluate the potential savings for EV fleets thanks to smart charging strategies in long-term energy markets; papers that deal with EV providing ancillary services, but only from the technical perspective; and papers that address the economics of DER grid integration.

With respect to these findings, the main contribution of the work presented in this thesis is to provide a comprehensive analysis of EV grid integration taking into account technical, regulatory and economics aspects at the same time and for various use cases. Such a multi-disciplinary approach seems to be missing in today's literature.



## Chapter 2

# Grid Integration of Electric Vehicles: General Framework

The previous chapter highlighted the fact that the electric and automotive industries are facing new challenges which may lead to paradigm shifts in both of them. Electric vehicles (EVs) are at the frontier of these crucial changes for both industries: on one hand, they are likely to lead to reductions in CO<sub>2</sub> emissions for the transportation sector; on the other hand, they are significant loads which, if not managed properly, could induce additional stress on the electrical grids.

In this previous chapter, the general context was explained. Before conducting detailed analysis for precise use cases, general information about the concept of EV grid integration needs to be provided both from a power system and a vehicle perspective. Thus, in this chapter, the aim is to show how EVs could be integrated in the electrical grids in such a way that they would not only reduce their impact on the power systems' stability but also improve the overall grid operating conditions by acting as distributed storage units. The underlying solutions require EVs to have communication means and controllable (or at least curtailable) charging rates, turning them into so-called Grid Integrated Vehicles (GIVs). Such GIVs face particular technical and regulatory challenges which are addressed in this chapter.

First, Distributed Energy Resources (DERs) are proved to be efficient flexibility providers for System Operators (SOs) in section 2.1. Then, the emphasis is put on GIVs: in section 2.2, the application domains and use cases for GIV frameworks are described. Section 2.3 deals with the technical and regulatory challenges that GIVs have to cope with. Finally, section 2.4 is the conclusion to this chapter.

## 2.1 Distributed Energy Resources as Grid Service Providers

On one side, as briefly explained in chapter 1, System Operators (SOs) seek to procure flexibility in order to ensure a continuous balance between generation and demand. On the other side, traditional power plants usually provide SOs with such flexibility (ancillary services and reserves).

In this section, the objective is to show that Distributed Energy Resources (DER) (e.g. Electric Vehicles (EVs), combined heat and power (CHP) units, electric water heaters and storage units) are also efficient providers of flexibility services. In order to do so, the following approach is adopted: electric flexibility products are defined and considered as any other commodity product. Buyers (SOs) and sellers (such as DERs) of flexibility products trade a product (electric flexibility products) that may have different characteristics, through various mechanisms.

First, the concept of flexibility product is defined in section 2.1.1. Then, DERs as flexibility providers are characterized by means of a literature survey in section 2.1.2. This survey suggests that different types of DERs are suitable to provide different types of flexibility products. In section 2.1.3, the System Operators' needs in terms of flexibility are tackled, as well as the procurement method TSOs use to procure the various flexibility products they need.

### 2.1.1 Definition of a Flexibility Product

From a technical perspective, an electric flexibility product can be defined as a power adjustment sustained at a given moment for a given duration from a specific location within the network. Thus, a flexibility product is characterized by five attributes: (a) its direction; (b) its electrical composition in power; its temporal characteristics defined by (c) its starting time and (d) its duration; and (e) its base for location. Fig. 2.1 illustrates these attributes at a given node of the network.

### 2.1.2 Characteristics of Distributed Energy Resources as Flexibility Providers

In this section, the DER types are differentiated on the characteristics of the flexibility products they are able to provide.

Some DERs may have a single direction (for instance typical household loads, such as water heaters, dishwashers and electric heaters), while others have bi-directional capabilities and could both act as consuming and producing units (e.g. EVs and storage units).

Furthermore, the electrical composition is of importance in order to state what flexibility products DER could serve, which calls for a differentiation between *power* and *energy* resources. The former have a rather low energy/power ratio. Those DERs can provide flexibility products with high power capacities,

## 2.1. DER AS GRID SERVICE PROVIDERS

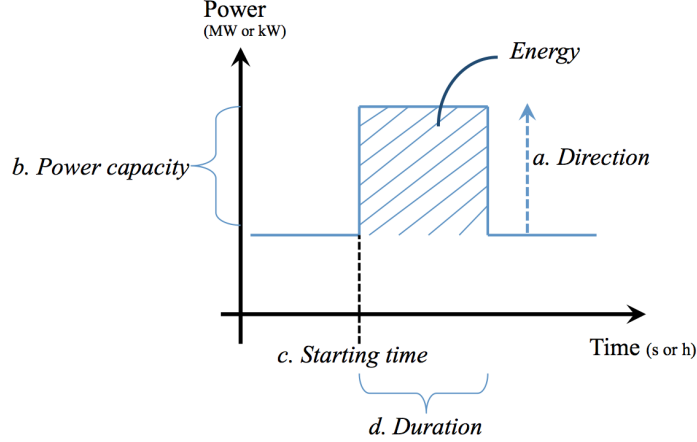

Figure 2.1: The attributes of an electric flexibility product at a given node

but over short durations. The latter have a high energy/power ratio and are more appropriate to maintain a change in power level for a longer period of time.

In order to compare the different DERs on this criterion, the maximum power temporal ratio  $t_r$  (expressed in time) is defined as the maximum duration a DER can sustain its maximum power variation with respect to its nominal power. For some DER types, this parameter can be computed by dividing the allowed energy range by the maximum power capacity (e.g. considering a stationary battery with a charging/discharging power equal to 10 kW and an energy capacity equal to 50 kWh,  $t_r = 5\text{h}$ ). For some other DER, it may be related to physical characteristics (for instance for a water heater with thermal inertia,  $t_r \approx 30\text{ min}$ ). The lower this value, the more the DER can be considered as a capacity type DER, and conversely the higher this value, the more the DER can be considered as an energy type DER. This variable is intended to provide insights on differences between DER categories, although there is not a singular value for all DER in such category, simply because this is technology specific<sup>1</sup>.

Moreover, the availability (in time) is a constraint that distinguishes the moment at which DER could provide services to the system. Some resources may only be available during specific periods of time – for instance EVs are most likely to be available from 8 PM to 6 AM. In order to compare the flexibility providing units on this criterion, the ratio  $\alpha_r$  is computed for each of the DER. It is defined as the average number of hours during which the unit is available divided by the total number of hours in a week. As for the previous criteria, the aim is to provide insights in expected values to compare different

<sup>1</sup>Obviously, individual power and energy ratings are also of paramount importance; they will characterize the contributions of each individual DER. However, because DER will be gathered into aggregations to provide grid services,  $t_r$  is more insightful to characterize DER abilities to provide capacity- or energy- related grid services.

DER categories, although in reality similar DERs may offer different availability times<sup>2</sup>.

Additionally, the activation time refers to the aspect that some resources may be able to adjust their power much quicker than other sources<sup>3</sup>. Generally, almost all electric appliances have a fast activation time, ranging from the order of a second to one minute, except for CHP units which have longer ramping times (Houwing et al., 2010).

The location of DER is of importance. For example, locational specific demand response could be of interest for local congestion management or distributed generation (DG) optimization. Controlling the voltage level at a precise node of the grid can only be done through power modulation of DERs located in neighboring nodes. Thus, whether the DER will be located at the transmission or at the distribution matters for grid services; similarly, its precise location on these grids is important.

Lastly, the ability to consume / produce reactive power could be valuable for voltage control. Basically, all DER that are connected to the grid through a power converter can provide reactive power.

Table 2.1 provides an overview of common DER and their characteristics. The table is divided into different types of DER; consumption, bi-directional and generation. More details about each DER type are provided in appendix B.

It is worth noting that Electric Vehicles have sound arguments as providers of flexibility products. They have a decent availability ratio, a good predictability, they are able to react within seconds and to provide reactive power. They perform better than most of the other DERs, except from stationary storage units which are fully dedicated to the provision of grid services (however, stationary batteries are very expensive today if purchased only to provide grid services, what makes them not cost-efficient for individuals or local site managers).

---

<sup>2</sup>Besides the average availability over one week, the specific period of time when the DER is available is also a crucial parameter. However, because this criterion is case dependent on the respective end user, it is not possible to provide general representative estimations for this parameter.

<sup>3</sup>Here, the activation time is an equivalent to the response time. However, for other units such as industrial processes it may include an additional mobilization time, which corresponds to the required period of time to re-organize the processes.

Table 2.1: The different DER and their technical characteristics

<i>DER</i>	<i>Power vs energy type</i>	<i>Availability ratio</i>	<i>Predictability</i>	<i>Technical response time</i>	<i>Grid</i>	<i>Reac. Power</i>	<i>Ref</i>	
<i>Electrical Consumption</i>	Lighting loads (W)	New LED : energy types; older lighting: power types	$\alpha_r \in [0.2, 0.5]$ during peak hours	Good	Second	DG <sup>a</sup>	No	Lee et al. (2011); Lu et al. (2008); Samarakoon et al. (2012)
	Dispatchable residential appliances	Power type $t_r \in [5s, 5min]$	$\alpha_r < 0.5$	Average	Second	DG <sup>a</sup>	No	Lu et al. (2008); Samarakoon et al. (2012)
	Electrical heating / Cooling	Power type $t_r \approx 15min$	$\alpha_r \in [0.2, 1]$	High	Second	DG <sup>a</sup>	No	Samarakoon et al. (2012); Tomiyama et al. (1998)
<i>Bidirectional</i>	Electrochemical Energy Storage (EES)	Power and Energy types $t_r \in [4s, 10h]$	$\alpha_r \approx 1$	Very High	Second to Minute	DG <sup>a</sup> or TG <sup>b</sup>	Yes	Yang et al. (2011); Divya and Østergaard (2009)
	Electric Vehicle	Power and Energy types $t_r \in [30min, 6h]$	$\alpha_r \in [0.5, 0.9]$	High	Second	DG <sup>a</sup>	Yes	Kempton et al. (2009); Pearre et al. (2011)
<i>Generation</i>	PV Unit	Curtaillable	$\alpha_r \in [0.25, 0.4]$	Good a few hours ahead	Second to Minute	DG <sup>a</sup>	Yes	International Energy Agency (2013b)
	Micro CHP Unit	Energy Type	$\alpha_r \approx 1$	Perfect	Rather Slow (5%/min)	DG <sup>a</sup>	No	Houwing et al. (2010)

<sup>a</sup>Distribution Grid; <sup>b</sup>Transmission Grid



### 2.1.3 System Operators as Purchasers of Flexibility Products

System Operators are responsible for monitoring electric grids and their main characteristics (frequency, voltage, power quality), and for ensuring a continuous balance between production and demand. In order to do so, they implement several mechanisms: while Transmission System Operators (TSOs) organize various capacity and energy markets, Distribution System Operators (DSOs) monitor their networks and control capacity banks or adjust tap transformers according to the local grid conditions. TSO and DSO mechanisms are successively addressed in the followings.

#### **Transmission System Operators: Flexibility Provision Through Electricity Markets**

Among other things, TSOs are responsible for: balancing production and demand at the system wide scale; controlling the frequency; avoiding congestion on the high-voltage (HV) lines; and controlling the voltage and power quality on the HV lines.

Balancing production and demand requires planning and scheduling from years ahead to real time operation. Since the liberalization of the electricity sector, this scheduling is achieved by means of electricity markets<sup>4</sup> operated either by the TSOs or by third party market operators such as EPEX Spot in Europe. Producers and traders use these markets to offer capacity and energy products; retailers and traders to procure such products.

In such markets, all participants may submit tenders provided that they abide by the market rules; TSOs then select the most competitive tenders based on the merit order principle. A tender (or bid) is typically an amount of energy (MWh) or of power (MW) and an associated price (in €/MWh or in €/MW). Selected units are then paid either according to the pay-as-clear method – all selected units are paid at the market clearing price – or to the pay-as-bid one – units are paid according to their bid price.

The various existing electricity markets are described in Table 2.2. They are sorted by ascending orders of characteristic times.

DERs could participate in these markets and thereby earn money from their participation to grid services. Short term services are best adapted to fast-ramping and *capacity type* DERs. Conversely, *energy type* DERs are suitable for medium- and long-term services.

---

<sup>4</sup>TSOs may also procure grid services through bilateral contracts. However, in this thesis, the emphasis is put on electricity markets as they are recommended by the ENTSO-E and are likely to take over bilateral contracts in the future.

Table 2.2: The various electricity markets and their main characteristics

<i>Time Frame</i>	<i>Technical Flexibility Need</i>	<i>System</i>	<i>Trading Mechanism</i>	<i>Capacity VS Energy trade</i>	<i>Notification before real time<sup>a</sup></i>	<i>Market Operator<sup>a</sup></i>
<i>Short Term</i>	Ancillary services		Frequency Containment Reserves (FCR) or Primary Reserves	Capacity	<30s (automatic)	RTE <sup>b</sup>
			Frequency Restoration Reserves (FRR), or Secondary Reserves	Capacity	<15min (automatic)	RTE <sup>b</sup>
↓	System Balancing		Balancing Mechanism or Spinning Reserves (including Restoration Reserves (RR))	Energy and / or Capacity	13min – 2h	RTE <sup>b</sup>
↓			Network constraints / Network capacity planning	Transmission congestion management	Energy	13min – 2h procured with balancing mechanism or separately
<i>Long term</i>	Bulk electricity trading		Intraday market	Energy	1 - 24h	EPEX Spot
			Day ahead market	Energy	24 - 48h	EPEX Spot
			Energy Forward Markets	Energy	Weeks to years ahead	EPEX Spot
	Generation Capacity planning		Capacity Market	Capacity	Year ahead	RTE <sup>b</sup>

<sup>a</sup>Based on French rules and organizations; <sup>b</sup>French TSO

**Recommendations for the Integration of DERs into TSO Reserves**

As detailed in section 3.1, some TSO rules were deeply analyzed by screening their manuals and by receiving feedback from demonstration projects. In order to enable the participation of DERs in their markets, TSO should:

1. properly redefine a legal framework and a formal status for distributed storage units. Indeed, TSO rules have no specific considerations regarding storage units, which therefore have to abide by both producer and consumer rules and requirements. Compliance tests, ongoing validation procedures, etc. should be defined specifically for storage units, bearing in mind their particular technical characteristics.
2. ease and encourage the building of coalitions of small distributed units. These aggregations should have a single entry point from the TSO perspective (even if non-material, i.e. even if there is not one single physical connection point with the TSO), which would enable them to dispatch the power flows among the distributed units as they wish, thus maximizing the aggregations' ability to bid in the electricity markets.
3. remunerate in a fair manner all ancillary services; there should not be any grid service left unremunerated, as this is the case with primary frequency control and inertia in some regions today.

**Distribution System Operators: No Existing Framework Yet**

DSOs are responsible for controlling the voltage and the congestion on low-voltage (LV) lines.

Voltage regulation is of paramount importance. Among others, under- and over-voltages can cause (Short, 2014): equipment dysfunctions or failure due to operation out of the rated ranges; tripping of sensitive loads; overloading of induction motors; higher no-load losses in transformers. Therefore, the cost of voltage regulation to society amounts to significant values. Voltage could be controlled by modulating active and reactive power of end-user flexible loads (Hennebel, 2009).

Transformers, underground and overhead lines are manufactured to operate at a given rated power or current (ampacity). Overloading will inevitably result in overheating temperatures, and thus in shortened life expectancies for the mentioned components. Reducing the transformer and cable lifetime can significantly increase the grid operating costs. Table 2.3 provides orders of magnitude of cost estimations for the main distribution grid components: underground cables, overhead lines and transformer substations. Active power consumed by flexible loads could be modulated as an effective way to mitigate congestion and overloading.

Historically, DSOs have operated grids with radial topologies, from HV/MV substations to the end-users. Electricity flow was unidirectional only, and consumption loads were largely inflexible. In this context, DSO activities were – and still are – mainly focused on long term grid planning and design rather

## 2.1. DER AS GRID SERVICE PROVIDERS

Table 2.3: Assets cost, adapted from Green eMotion (2013), Siemens (2016) and Pieltain Fernandez et al. (2011)

<i>Component</i>	<i>Estimated cost</i>	<i>Average power P</i>
Medium Voltage (MV) lines/cables	100-200 k€/km	n/a <sup>a</sup>
Low Voltage (LV) cables	70-100 k€/km	n/a <sup>a</sup>
LV lines	30-65 k€/km	n/a <sup>a</sup>
Ground Mounted MV/LV transformer	14-35 k€	10MVA < P < 100MVA
Pole Mounted MV/LV transformer	5 k€	P < 30MVA
HV/MV transformer	1700-5200 k€	P > 100MVA

<sup>a</sup>not applicable

than on real-time operation. Congestion is dealt with by upgrading the cables/transformers to equivalent components with higher rated power. Voltage regulation is mainly performed with the addition of capacitor banks, or by means of On-Load Tap Changing (OLTP) transformers (Short, 2014).

Moreover, DSOs remuneration scheme is most of the time based on a cost of service regulation, meaning that their remuneration is based on an estimation of their costs, tightly linked to their investment plans (Schuster et al., 2014); typically, regulators allocate funds to DSOs as a percentage of their investment needs. Thus, DSOs have a strong bias in promoting their investments to solve their grid-related issues. Considering the current funding methods, and even though quality of service indicators are sometimes included in the remuneration calculation, it is more attractive for the DSOs to conduct grid reinforcement work than to implement active demand management strategies.

On the other hand, with the liberalization of the electricity industry and the recent technological improvements (in particular the deployment of Advanced Metering Infrastructures (AMI)), all stakeholders' roles are evolving and active demand management could be more largely introduced in the electricity industry, which is in particular true for DSOs. Thus, in the future, DSO roles are likely to evolve from ex-post corrective activities to performing proactive grid management. Remuneration schemes need to be redesigned accordingly, and the building of appropriate human and technological competencies is required. Nevertheless, today frameworks do not allow for DERs to trade their flexibility with the DSOs for local grid services.

### **Recommendations Regarding the Implementation of a DSO Framework for Flexibility**

The DSO operating modes were analyzed by conducting a complete literature review (Knezovic et al., 2015). In order to enable and facilitate the provision of

local services by DERs, a complete DSO framework for providing flexibility is required:

1. DSO investment plans should be challenged by the regulator. If proactive management of DER flexibility is proved to be cost-efficient, then appropriate remuneration schemes should be designed in order to encourage DSOs to implement such solutions;
2. definitions of clear DSO roles and responsibilities are required; in particular, the new role of Distribution Constraints Market Operator should be specified (EvolvDSO project report, 2014).
3. smart meters should be widely rolled-out, as they appear to be the main facilitator for enabling DER flexibility<sup>5</sup>;
4. the minimum size (in kW or kWh) to participate in flexibility services should be as low as possible to enable all DER types to participate; Nordentoft (2013) even suggests bidless markets, where anyone can respond to the real-time price signals at any time.
5. clear priorities between TSOs' and DSOs' activation means of flexibility should be defined: local and system-wide needs are not necessarily aligned at each moment. This advocates for the creation of a flexibility platform – rather than using bilateral contracts – as such a platform is much more transparent and would provide DSOs with the possibility to temporary deactivate a service following a TSO request.

DERs could be valuable flexibility providers. In the rest of this chapter, the emphasis is put on Electric Vehicles providing flexibility products; such EVs are called Grid Integrated Vehicles (GIVs) as they become active components of the electric grids.

## 2.2 Plug-in Vehicles as Efficient Distributed Energy Resources

When focusing on GIVs more precisely, many different situations emerge, and defining the different use cases is necessary to understand the wide range of potential applications. The use cases differ in terms of: location of charging, number of GIVs, objective in controlling the charging/discharging patterns, GIV ownership, nature and number of stakeholders involved, communication means. . . Two main reasons account for this diversity of use cases: (a) the solutions developed are used to deal with local issues – which depend on the local energy mix, on the constraints and conditions of the local grid, on the local

---

<sup>5</sup>It is worth noting that smart meters usually do not have very precise time stamps, and thus would not be adapted for TSO fast services; however, they could be used for slower services, potentially DSO services.

## 2.2. GIV AS FLEXIBLE DER: GENERALITIES

---

regulation, etc. – and (b) the solutions developed are likely to evolve in the future as regulatory and technology improvements are achieved.

First, the different application areas and use cases are defined respectively in sections 2.2.1 and 2.2.2. The actors involved in these use cases are listed in section 2.2.3. In section 2.2.4 the most valuable TSO services for GIV fleets are identified (TSO services are investigated first because, as explained in section 2.1.3, there are today no available DSO services).

### 2.2.1 Four Main Application Areas

Four application domains are identified: individual housing, company fleets, collective dwellings and public charging. These four application domains were commonly acknowledged by the French stakeholders as representing most of the real-life situations (Caillat et al., 2016).

#### Individual Housing

This application area concerns a single privately-owned vehicle connected at the owner’s residential housing. The EV power connection is typically below 7.4kW in France<sup>6</sup>. Fig. 2.2 illustrates this application area.

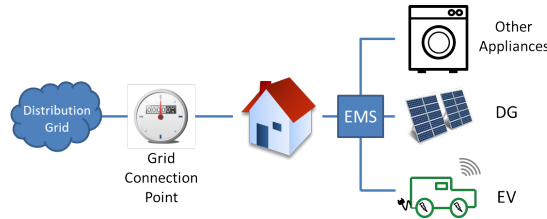

Figure 2.2: Schematic diagram of the application domain *individual housing*

In this context, the GIV communicates with an Energy Management System (EMS) whose objectives could be: minimizing the overall electricity costs of the households (which are twofold: capacity and energy based), maximizing the consumption from local Distributed Generation (DG) production, deferring the charging process to low-price hours. Moreover, the GIV can ensure house energy security since it can provide power in periods of serious grid outages. System Operators are not directly involved: energy exchanges are controlled behind the meter. The GIV owner benefits from these solutions.

Several distributed GIVs connected at residential houses could also participate in TSO markets. A central aggregator responsible for clustering the GIVs and presenting the fleet as a single entity would be required.

---

<sup>6</sup>The EV power connection could be more important in countries where houses have three-phase connections to the grid, such as in Germany or in Denmark.

### Company Fleets

This application domain depicts a company fleet, which is therefore owned and operated by the same entity<sup>7</sup>. GIVs are typically located in the same parking lot. Fig. 2.3 represents this application domain.

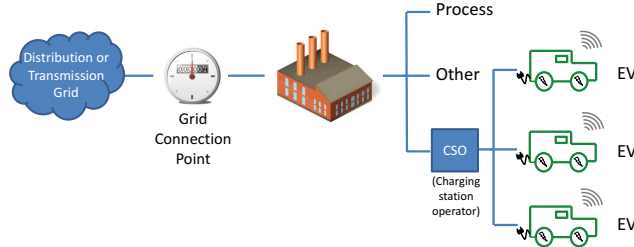

Figure 2.3: Schematic diagram of the application domain *company fleet*

The GIVs communicate with a local Energy Management System (EMS) which controls their charging and discharging rates. The latter can fulfill several objectives: ensuring that the rated power of the transformer of the site is never exceeded, minimizing the fleet's charging costs, maximizing consumption from local DG. System Operators are not directly involved: energy exchanges are controlled downstream of the meter. The company which owns the vehicles benefit from these solutions.

Other use cases are possible for this application domain, in particular if the number of GIVs is important: a company could control its fleet's charging / discharging patterns depending on the grid conditions, and thereby offer the flexibility provided by its fleet in the electricity markets. The company itself would be the aggregator and would earn the revenues from the fleet participation in the markets. The System Operators would benefit from an additional competitive flexibility providing unit. It is worth noting that a company could aggregate several GIV fleets that would be located at different sites.

### Collective Dwellings

This application domain is similar to the previous one, except that the GIV fleet is not only composed of vehicles belonging to a single company, but of a mix of company and privately-owned vehicles. Thus, a third-party entity is required to operate the GIV fleet. The vehicles may be spread over several parking lots. This application area is pictured on Fig. 2.4. It is worth noting that one connection diagram only is represented on this figure; others could also be implemented.

The GIV fleet provides the same services as in the previous application domain; it is more difficult to manage this diverse fleet though, and user behaviors

<sup>7</sup>This is particularly important because it makes it easier for scheduling and planning purposes.

## 2.2. GIV AS FLEXIBLE DER: GENERALITIES

---

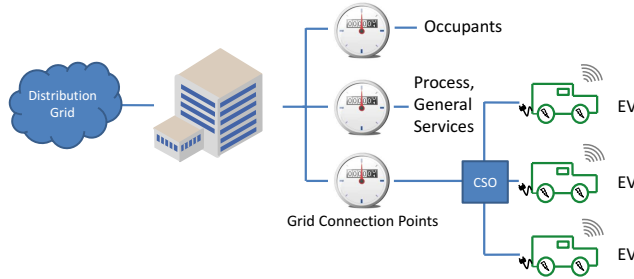

Figure 2.4: Schematic diagram of the application domain *collective dwellings*

are less predictable. The services benefit to the GIV owners (private or professionals), to the building energy manager, and potentially to the SOs.

### Public Charging

The last application domain deals with EVs charging on semi-public or public locations; the charging stations belong either to a company (in case of charging stations installed in the parking lot of a mall for instance) or to local authorities. See Fig. 2.5 for the schematic diagram of this application domain.

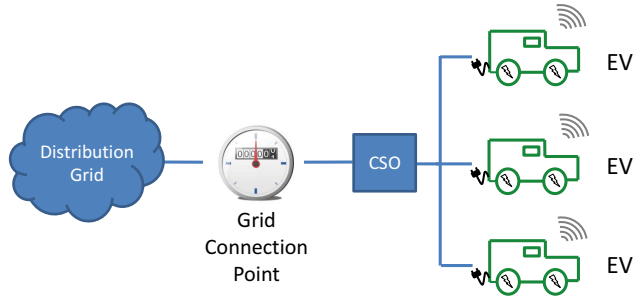

Figure 2.5: Schematic diagram of the application domain *public charging*

This application domain is more complicated as it involves many different stakeholders; furthermore, it is very difficult to know the identity and to predict the behaviors of the drivers who plug-in at these stations. Thus, it is almost impossible to contract with these users, and their charging patterns are not predictable. Typically, a Charging Station Operator (CSO) may control the charging rate of various vehicles charging simultaneously in order not to exceed the charging station power capacity.

### 2.2.2 Four Benchmark scenarios

The description of the application domains and of the technical solutions associated disclose four benchmark scenarios, which differ in terms of levels of



communication and smartness, power flow directions, and actors involved. The main stakeholders of the French industry agreed on these scenarios (Caillat et al., 2016):

1. **The plug & charge** solution which corresponds to the historical solution: as soon as the vehicles plug-in, they start charging at maximum power.
2. **The basic control** implies unidirectional power flows from the grid to the vehicles and limited communication means between the GIVs and their eco-system. A distinction between two control methods is made:
  - (a) **by means of price signals**: GIVs receive a mere price signal and shift their charging process based on this signal;
  - (b) **by means of direct load control** (usually managed by an EMS) to delay the charging process to another period of time.
3. **The control of the charging process at the housing or building level** implies advanced communication means between one (or several) GIV and a local EMS. The latter schedules load curves for the GIVs in order to fulfill the *local* objectives mentioned in the application domains *residential housing*, *company fleet* and *residential dwellings*. Two directions for energy flows are considered:
  - (a) **unidirectional**, GIVs are only able to charge, and
  - (b) **bidirectional**, GIVs are able to inject power into the grid.
4. **The control of the charging process at the system scale**, either at the distribution or at the transmission level. Highly-resilient and low-latency communications are necessary between GIVs, SOs, charging operators and aggregators. GIV fleets provide SOs with flexibility products, most likely through electricity markets. As previously, a distinction is made between:
  - (a) a **unidirectional** solution and
  - (b) a **bidirectional** one.

### 2.2.3 List of Stakeholders Involved

These use cases involve several stakeholders. It is worth noting that there is a wide diversity of stakeholders, which have not historically been used to working together: some actors are from the automotive industry, some others are from the energy sector and others are from the IT world. The main actors involved are:

**the GIV user**: depending on his needs for transportation, his constraints and priorities, he may be willing to have his vehicle involved in smart charging / discharging programs or not. Potentially, he communicates information about his future trips.

## 2.2. GIV AS FLEXIBLE DER: GENERALITIES

---

**the battery owner** which may be different from the GIV owner. Due to the concerns related to battery degradation (see section 2.3.2), he is necessarily involved in the business model definition.

**the charging station operator (CSO)** is responsible for installing, operating and doing the maintenance of the charging stations. He may operate smart charging / discharging strategies in some use cases and application domains.

**the e-mobility service provider (eMSP)** provides the EV user with mobility services (such as localization of available charging stations, roaming and billing...). Car OEMs may fulfill this role.

**the electricity provider** provides the electricity to the final user or to the CSO through a Grid Connection Point (GCP).

**the distribution system operator (DSO)** monitors, controls and operates the distribution grids. In particular, it is concerned with local congestion and voltage issues on the LV lines.

**the transmission system operator (TSO)** monitors, controls and operates the transmission grids. In order to ensure a continuous balance between production and demand, it organizes various electricity markets (see section 2.1.3).

**the energy management system (EMS)** which is mandated to optimize the energy flows of the site in question. If it is responsible for controlling a large fleet, spread over a wide area, the term **aggregator** shall be used.

**the OEMs** which have to manufacture products (cars, charging stations) that will be compatible with the solutions proposed (communication means, compliance with the standards, etc.).

The GIV user and the battery owner are always involved in all use cases. The eMSP is also probably involved in all use cases, as its role is not dependent on the implementation of smart charging / discharging solutions. The CSO is mainly concerned in the application areas *company fleets* and *collective dwellings*, where it can also play the role of the EMS. The latter is necessarily involved in all benchmark scenarios apart from (1.a). DSOs and TSOs are involved in benchmark scenarios (3.a) and (3.b).

### 2.2.4 System Wide Grid Services: Best Fits for Grid Integrated Vehicle Fleets

In scenarios (3.a) and (3.b), GIVs provide SOs with flexibility products. In section 2.1, the various TSO grid services that could be provided by DERs were defined and the lack of DSO services was accounted for. Table 2.2 presents many different TSO grid services. Here, the objective is to identify the ones

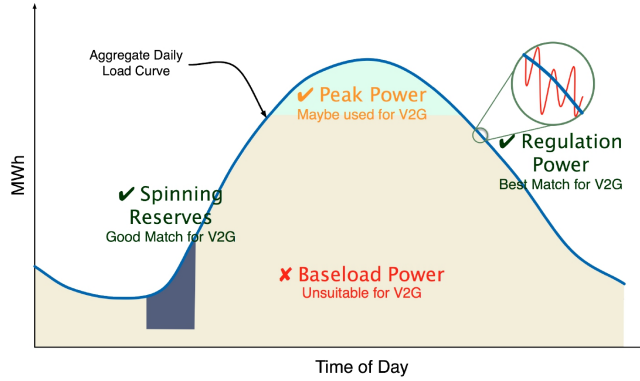

Figure 2.6: A daily load curve and how corresponding PJM markets are suited for GIV fleets, from PJM Interconnection

that would be best adapted for GIV fleets. In order to do so, the characteristics of such a fleet need to be analyzed first.

Typically, a GIV fleet has (see also section 2.1.2 and appendix B): a rather low amount of available energy in comparison with traditional power plants; a good availability and predictability; and a very fast response time.

The electricity markets that appear to be the most promising for GIV fleets are the ones: that require little amount of energy (i.e. the ones that are noted *capacity* type in Table 2.2); that require a high reactivity; for which the remuneration scheme is based on availability (€/MW) and not utilization (€/MWh).

Thus, according to Table 2.2, the most promising markets for GIV fleets are ancillary services (both primary and secondary frequency controls) and balancing mechanisms (including tertiary frequency control). As an example, Fig. 2.6 was made by a north-east American TSO, PJM, and it shows which of its own markets are best adapted to GIV fleets. The conclusion in the short run is that the regulation market (a market which is in between the primary and secondary frequency control markets) is the best fit for GIV fleets; on the opposite, the bulk electricity market is denoted as "unsuitable" for GIV fleets<sup>8</sup>.

## 2.3 Challenges

GIVs could be valuable providers of flexibility services, for a wide range of use cases. What are the requirements from a vehicle perspective? What are the regulatory challenges? Here, four points need to be highlighted: the energy losses (section 2.3.1), the battery degradation (section 2.3.2), the induced additional costs (section 2.3.3) and the regulatory issues (section 2.3.4).

<sup>8</sup>Here, the best services were defined from a technical perspective; then, there might be some regulatory considerations that could change the conclusions, for instance if some services are not available to GIV fleets.

## 2.3. CHALLENGES

---

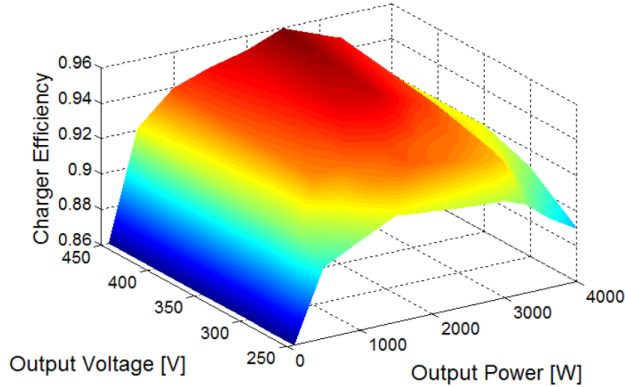

Figure 2.7: PEU efficiency as a function of output power and output voltage (Barbé, 2014)

### 2.3.1 Energy Losses

Basically, energy losses in the charging process could occur in two components: the electrochemical battery and the Power Electronic Unit (PEU), which performs the AC/DC conversion.

As only plug-in vehicles are considered, only Li-ion batteries should be addressed. Such batteries show very high efficiencies, which drop slightly at high currents (Barbé, 2014). Altering the charging / discharging patterns of a GIV should not result in significant battery losses.

On the other hand, substantial losses could occur in the PEU. A PEU is designed for operating at a rated power; typically, PEUs are sized considering charging power levels that will be used by common users. When operating far from their rated power, losses may reach significant values. Fig. 2.7 shows an experimental efficiency curve for a 3kW PEU; at low current, the efficiency drops to 86%, what would lead to a round-trip efficiency of 74%. If the PEU considered had been sized for a higher power, say 22kW, the losses at low power would have been even more significant.

Few academic articles report test data on EV charging efficiency. For instance, Musavi et al. (2011) provide insights on PEU losses, but only near design conditions. Smart charging / discharging strategies could require PEUs to operate at low or high charging currents, what could lead to high losses depending on the PEU rated power. Car OEMs are advised to wisely design their EVs' PEUs at the risk of having very substantial losses when implementing smart charging / discharging controls.

### 2.3.2 Battery Degradation

Most of (if not all) plug-in vehicles commercialized today have a Li-ion battery; however, several Li-ion technologies are used: NMC, LFP, NCA, LCO. . . Even though battery prices are expected to decrease in the coming years (see Fig. 1.10 (page 19)), they are still expensive components: a battery that has a capacity of 30kWh costs today around 10,000€.

Battery degradation is twofold: batteries have a calendar life and a cycle life. The former is due to the aging of the battery when it is idle; the latter is induced by the cycles experienced by the battery when it is used. Smart charging / discharging strategies could induce additional cycles to the battery. Battery aging is thus a crucial topic as it may have an impact on the business models and on users' willingness to participate in smart charging programs.

#### Main Factors Impacting Battery Degradation

Battery degradation is very complex: it depends on many factors which do not have the same weigh from one battery technology to the other. The two main phenomena responsible for battery wear are: the phase changes of the active material of the positive electrode and the formation of a passivation film on the surface of the negative electrode (Badey, 2012). Battery degradation can be assessed through several aging mechanisms, including internal resistance, internal impedance, static capacity, or stability of the solid electrolyte interface (Broussely et al., 2005). In the literature, chemical models have been proposed to account for the aforementioned phenomenons in order to predict battery degradation (Millner, 2010; Ning et al., 2006). However, these models are rather complicated and are hardly usable to evaluate battery wear induced by typical power cycles.

Here, the aim is to identify the key macro factors that impact battery degradation. Based on the literature, they are sorted below by order of importance (Bloom et al., 2001; Do, 2010):

**the depth of discharge (DoD):** the gaps of state of charge (SOC) variations have a significant impact on battery aging. The higher the DoD of the cycles performed, the more important the battery degradation as illustrated on Fig. 2.8.

**the temperature:** executing cycles at high temperatures has a negative impact on the battery State-of-Health (SoH)<sup>9</sup>.

**the charging rate:** high charging / discharging rates impact negatively the battery lifetime, in particular because they contribute to warming up the battery. Obviously, charging rate values should be considered relatively to the battery capacity: charging at 7kW may be quite important for a 7kWh battery, but pretty low for a 50kWh one.

---

<sup>9</sup>On the other side, low temperatures are good for the SoH, but lower the battery efficiency.

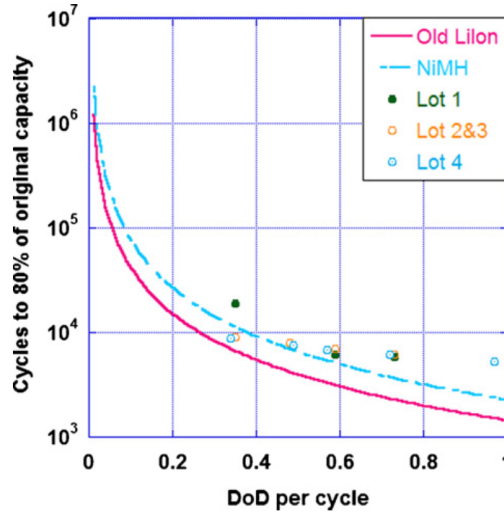

Figure 2.8: Battery degradation as a function of the Depth of Discharge (extracted from Peterson et al. (2010a))

**the operating State of Charge:** the SOC around which the cycles are carried out also impacts battery wear. Generally speaking, cycles should be performed close to 50% SOC; for instance, cycling from 5 to 15% SOC damages the battery more severely than from 45 to 55%.

#### Impacts of Smart Charging / Discharging Cycles on Battery Degradation

All in all, considering the abovementioned factors, the best cycles in terms of battery degradation would be those inducing small DoD variations around 50% SOC, at low charging rate and ambient temperature.

Consequently, unidirectional smart charging solutions should not increase the wear of the batteries. On the opposite, by reducing the charging rate compared to a charge-as-plugged strategy, they could even improve battery lifetimes.

Bidirectional solutions should be investigated more carefully; bidirectional cycles with large DoD, performed at high temperatures could significantly reduce the battery lifetime. On the other hand, small SOC variations carried out around 50% SOC are not likely to induce additional battery wear. A large number of scientific papers and projects dealing with battery degradation due to V2G activities were identified. However most – if not all – of them use oversimplified models which are not relevant considering the complex battery degradation effects mentioned above. Another difficulty lies in the fact that these factors do not have the same influence depending on the battery technology; PSA was involved in projects that led to such conclusions. As a consequence, it

is not really relevant to develop a model that would be intended for all battery technologies. Similarly, models are developed with respect to particular battery usages; for instance, PSA Groupe has developed advanced battery degradation models, but they were designed to evaluate battery wear due to driving cycles which are very different from V2G cycles; thus, these models appeared to be not satisfactory for the case of GIVs.

Other car manufacturers which have conducted bidirectional tests argue that the battery degradation will be restricted. According to Honda, the effects of V2G operation on battery wear will be *"negligible small"* (Shinzaki et al., 2015). Nissan claim that the additional capacity loss after 10 years of V2G will be below 5%.

### Battery Degradation and Vehicle-to-Grid in the Literature

Most of the papers dealing with battery degradation induced by vehicle-to-grid (V2G) cycles use simplistic models, which rely on manufacturers' data sheets that provide the number of cycles allowed under standard conditions (ambient temperature, predefined cycles, etc.). This number of cycles is either used directly (Hoke et al., 2011), or converted into a number of kWh (Peterson et al., 2010b; Han et al., 2014, 2012). Then, the battery lifetime is merely calculated as the initial number of cycles allowed minus the already processed cycles. Only Zhou et al. (2011) take into account the ambient temperature and the DoD; they show that battery degradation can make V2G solutions for peak-shaving unprofitable.

These theoretical papers are not completely satisfactory from an OEM perspective: they are certainly relevant to provide orders of magnitude, but are not able to account for individual and particular situations. Some users may use their EVs in extreme temperature conditions for example. Conducting battery degradation analysis under standard conditions does not allow to understand the full range of implications.

### 2.3.3 Additional Costs

The development of a complete framework for Grid Integrated Vehicles (GIVs) induces additional costs, which may impact the business models.

Considering unidirectional solutions (in which GIVs are only able to charge), the costs incurred by the various stakeholders are: the costs related to the development of a full information system fulfilling the requirements in terms of data exchanged, resiliency and latency; and the risk management costs for charging operators, Energy Management Systems and aggregators.

Bidirectional solutions require extra-hardware investments since the power electronic units must be able to perform the AC/DC conversion in both ways. There are two distinct situations. First, the PEU may be located in the charging station. A 10kW bidirectional charging station costs today around 5,000€, all costs included. Second, the bidirectional PEU may be located in the vehicle. It

## 2.4. PARTIAL CONCLUSION

---

is difficult to assess the extra costs of such an improved charger, but it should amount to a few hundreds euros.

### 2.3.4 Regulatory Challenges

Distributed Energy Resources (DERs) are new components to the electrical grids. As a consequence, the historical grid regulation has not been designed with these new units in mind. A distinction is made between the *behind-the-meter* solutions and the provision of grid services to System Operators (SOs). The former correspond to benchmark scenarios from (1.a) to (2.b); the latter to scenarios (3.a) and (3.b) (see section 2.2.2).

*Behind the meter* frameworks do not involve directly SOs. All the control is performed by and for stakeholders which are concerned with the grid located downstream of the Grid Connection Point. As a consequence, the charging control strategies are performed for a private network, and there is no regulatory framework to abide by. These scenarios are already possible today; there is no need to wait for changes in the regulation allowing GIVs to provide flexibility.

Regarding GIVs offering their flexibility to SOs, they have to comply with the SOs' rules and regulation. As explained in section 2.1.3, there is not yet any DSO framework adapted to contract flexibility services. As far as TSOs are concerned, a wide diversity of rules and market designs is observed (Rious et al., 2008; Codani et al., 2014). Consequently, it is quite challenging to implement scenarios (3.a) and (3.b) today as regulation is not adapted yet. Regulatory challenges are further developed in sections 2.1.3 and 3.1.

## 2.4 Partial Conclusion

Distributed Energy Resources (DERs) have the technical abilities to provide electric flexibility products. System Operators (SOs) are willing to procure such products in order to balance generation and demand, to control the stability indicators of their grids (voltage, frequency) and to ensure a good power quality. Yet, changes in TSO and DSO rules and market designs are required to align SOs' needs with DERs' incentives: while DSOs have today no existing framework to trade flexibility products with DERs, TSO markets have constraining and restrictive rules.

Grid Integrated Vehicles (GIVs) are electric vehicles that have communication means, potentially bidirectional capabilities, and whose charging (and discharging) patterns are controlled to provide flexibility products for various purposes. There are several application domains and use cases, which were described throughout this section. Generally speaking, GIVs could support local and system-wide grid operations; in return, they could lower their charging costs, earn money by participating in grid services or by reducing SOs' investment needs, ensure energy independence to their users, etc.

However, GIVs face technical and regulatory challenges. Smart charging / discharging patterns could make GIVs' power electronic units operate far from



their rated power; this could result in substantial energy losses. Moreover, such cycles could induce additional battery wear if not managed properly. The business model of these solutions will depend on the additional costs required to turn an EV into a GIV.

Another important issue for the development of smart charging / discharging solutions is customer acceptance. The energy needs for transportation have to be fulfilled in all situations; the way unscheduled trips are dealt with is of paramount importance. Charging operators and EV users need to have a relationship of trust, in particular with respect to data privacy. The solutions have to be user-friendly but still transparent.

In the following two chapters, simulation models are implemented in order to evaluate the possibilities for GIVs respectively in scenarios (3.a) & (3.b) (chapter 3) and (2.b) (chapter 4).

## Chapter 3

# Grid Integrated Vehicle Fleets Providing System Wide Grid Services: Towards Viable Business Models

As demonstrated in the previous chapter, Grid Integrated Vehicles (GIVs) can be valuable flexibility providers; among various use cases, GIVs could provide Transmission System Operators (TSOs) with grid services. The grid services that best fit GIV fleets were identified in section 2.2.4: they are ancillary services and balancing mechanisms. In this chapter, the emphasis is put on the grid service that turns out to be the most profitable one for GIV fleets, namely frequency control. First, in section 3.1, the existing frequency regulation market rules of six representative TSOs are reviewed and a ‘best option’ for frequency regulation market rules is presented<sup>1</sup>. In sections 3.2 and 3.3, the participation of a GIV fleet to primary frequency control is modeled, considering bidirectional and unidirectional-only capabilities for the vehicles, respectively. In particular, insights on the expected earnings for GIV fleets participating in frequency control mechanisms are provided. Section 3.4 is dedicated to sensitivity analysis. Finally, section 3.5 sums up the main results from this chapter.

Throughout this chapter, the viewpoint taken is the one of Electric Vehicle (EV) owners; thus, the expected earnings from the GIV fleet participation to

---

<sup>1</sup>The term ‘best option’ used here refers to the best combination of rules from a GIV fleet standpoint, i.e. maximizing the GIV fleet revenues. Similarly, the term ‘ideal TSO’ used later in this chapter refers to an ideal TSO from the GIV fleet viewpoint only. Obviously, TSOs have to deal with myriad of other parameters, and defining a real ideal TSO is out of the scope of this work.

grid services are fully directed to them. The aggregator is assumed to be a benevolent third party; obviously, in real life, the aggregator should earn part of these revenues, but addressing business models is beyond the scope of this chapter.

## 3.1 Regulatory Analysis

Rules and market designs differ from one TSO to the other (see section 2.3.4 (page 45)). In order to study the provision of primary frequency control by a GIV fleet, first the frequency control rules have to be analyzed and the ones that are most important to GIV fleets should be identified.

### 3.1.1 The Basics of Frequency Control

Frequency is a crucial characteristic for an AC network: it reflects the real time imbalances between generation and demand. Please refer to section 1.2.1 (page 10) for more generalities about frequency control. TSOs manage the frequency by implementing several control levels that balance production and demand in real time. Even if each TSO has its own rules and regulations, all of them basically implement three similar control levels to monitor and control the frequency.

#### Three Control Levels

The *primary control* (also called *Frequency Containment Reserves (FCR)*, sometimes referred to as *frequency reserves*) is an automatic control activated instantaneously. All the TSOs that are part of the same interconnected grid participate in this control when a frequency deviation occurs. The aim of this control is to stop the frequency deviation, but it does not restore the frequency to its pre-disturbance value. The units that are part of the primary reserve have to measure the frequency locally, and to respond accordingly. Power plants or other traditional units have been providing this service for years, mainly by implementing speed control loops on their motor shaft.

The *secondary control* (or *Frequency Restoration Reserves (FRR)*, or so-called *frequency regulation*) is an automatic control performed only by the local TSO where the frequency disturbance occurred. The latter implements an integral (I) control loop with a characteristic time of approximately 30 seconds, and sends a correction signal to all the units that are part of the secondary reserve. This control aims at restoring the frequency to its rated value.

The *tertiary control* is a manual control whose objective is to support primary and secondary controls. It has a response time of 15-30 minutes.

Fig. 3.1 shows the successive effects of the primary and secondary controls on the frequency value after a deviation. More information about the technical and economical aspects of frequency control mechanisms is provided by Rebours et al. (2007a,b).

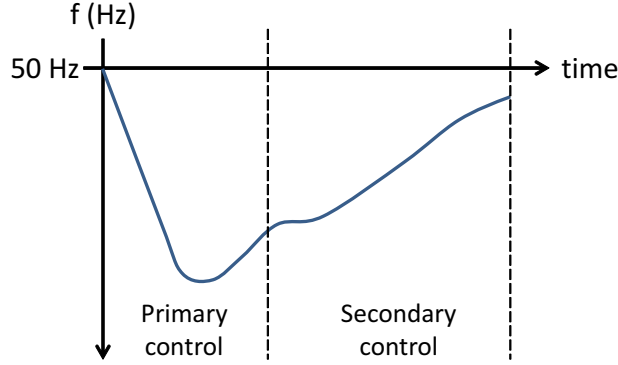

Figure 3.1: Impacts of primary and secondary frequency controls when a frequency deviation occurs (for illustrative purposes only)

### Primary Frequency Control: Technical Requirements

Units participating in the primary frequency control measure the frequency locally, and respond to all frequency deviations by modulating their active power output according to their frequency droop  $K$  according to equation (3.1):

$$|P_i - P_{i0}| = \min(P_r, |K_i \times (f - f_0)|) \quad (3.1)$$

with  $P_i$ ,  $P_{i0}$  and  $P_r$  respectively the total power output, operational power setpoint and primary power reserve of the unit  $i$ ,  $K_i$  the frequency droop,  $f$  the current frequency value and  $f_0$  the frequency rated value (50Hz). For any frequency deviation exceeding 200mHz in absolute value, the entire reserve  $P_r$  should be activated. Fig. 3.2 presents the power-frequency (P-f) curve of a traditional unit.

Other technical requirements are: units should be able to release half of their reserve in 15 seconds, and all of it in 30 seconds; frequency measurement accuracy should be better than 10mHz; a dead-band of 20mHz is allowed ( $\pm 10$ mHz around the rated value); the frequency measurement period must be between 0.1 and 1 second (Union for the Co-ordination of Transmission of Electricity, 2004).

Power variations that are used to increase the frequency will be called regulation *UP* products; they consist in an increase in production, or a decrease in consumption. On the opposite, *DOWN* tenders are used to decrease the frequency.

### 3.1.2 TSO Rules Survey

Although all TSOs implement the three same control levels, they all have their own rules and market designs for the organization of each control. In this

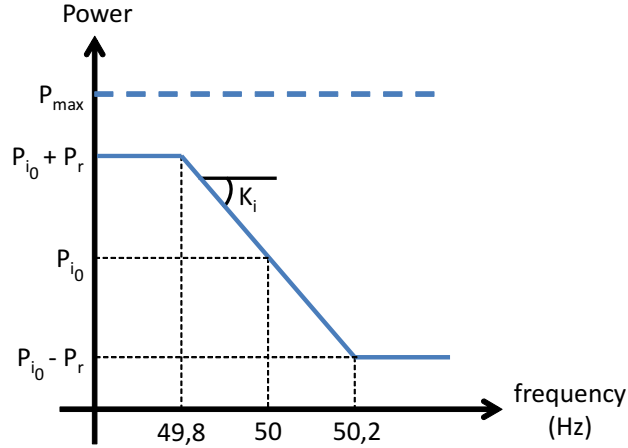

Figure 3.2: Power-frequency curve of a traditional unit

section, the aim is to identify the most important TSO rules for GIVs providing frequency reserves.

A comparison among six representative TSOs is made by screening their manuals on a list of rules and characteristics that are important for enabling the integration of GIV fleets into frequency reserves. The six TSOs in question, represented in Fig. 3.3, are: Energinet.dk (Denmark), RTE (France), ERCOT (Texas, USA), CAISO (California, USA), PJM (North-East, USA), and NGC (UK). The associated regulatory manuals are (Energinet.dk, 2012), (Réseaux de Transport d'Electricité, 2004, 2011b,a), (Electric Reliability Council of Texas, 2012, 2013d,c,b,a), (California Independent System Operator, 2013, 2011, 2009), (PJM Interconnection, 2013a,b,c, 2012), (National Grid, 2012a,b, 2013).

These six TSOs approach the wide diversity of TSOs<sup>2</sup>. PJM is one of the most advanced TSOs in terms of Distributed Energy Sources (DER) integration: there are several ongoing demonstration projects (including the *Grid On Wheels* project) and stationary storage units already participate in grid services. ERCOT is the only isolated TSO in the US – it is connected with its neighboring TSOs via DC lines. Thus, it faces particular stability issues. CAISO is particularly interesting as California is the state with the highest EV penetration in the USA; similarly, PV penetration is very important in this region. RTE is the largest TSO in Europe; however, it used to be very vertically integrated with EDF and ERDF, and France has a low penetration of renewables. On the other side, Energinet.dk is a very small TSO. Wind energy produced more than 40% of Danish electricity in 2016 (The Guardian, 2016). Moreover, Energinet.dk rules over two areas which are connected to different interconnected grids: while

<sup>2</sup>It is worth noting that all systems under study are large interconnected ones. Other smaller systems, such as islands, could also be studied.

### 3.1. REGULATORY ANALYSIS

---

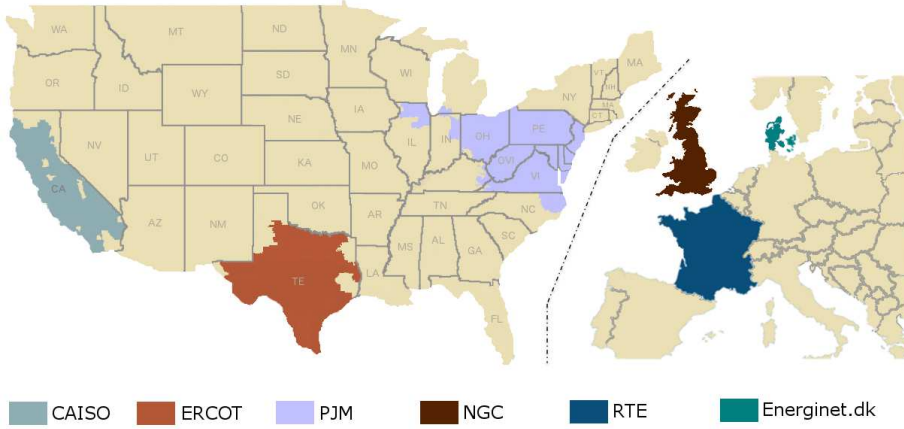

Figure 3.3: Maps of the six TSOs under study

western Denmark (DK1) is connected to continental Europe (French, Germany, etc.), eastern Denmark (DK2) is connected to the Nordpool (Sweden, Norway, Finland). Finally, NGC is an islanded TSO facing very particular constraints compared to other European TSOs.

Based on this analysis, and on feedback from the *Grid On Wheels* (GridOnWheels project, 2016) and Nikola (Nikola project, 2016) demonstration projects, a very large number of important TSO rules for GIV fleets were identified. Here, the emphasis is put on two key sets of rules that gather the essential ones for GIVs: the rules governing the aggregation of GIVs, and the rules defining the payment scheme of the services. The two modules are described in more detail in the two following subsections. It is worth noting that the rules may have changed since the analysis was conducted; however, the rationale remains valid and interesting to capture the diversity of TSO rules.

#### **Module 1: The Rules Towards the Aggregation of Grid Integrated Vehicles**

An aggregator<sup>3</sup> has a fundamental role in GIV architectures for TSO services: it is responsible for presenting a fleet of GIVs as a single entity to the TSO. Aggregators are required because: (a) TSOs deal with large entities (MW rather than kW size), (b) TSO data processing capabilities do not have the bandwidth for controlling millions of kW size units; they were designed for 100s of multi-MW sized units, and (c) TSOs expect their resources to be reliable, which is a problem for a single GIV. A GIV necessarily gives first priority to transportation, but from the power system perspective, one GIV may leave the power system at any moment. Aggregators can address these issues by controlling a large

<sup>3</sup>An aggregator is typically a third party entity, but different stakeholders could fulfill this role: System Operators, utility companies, car OEMs, etc.

number of GIVs (Kamboj et al., 2011; Kempton and Tomić, 2005) and offering a single, statistically-reliable entity to the TSO (Lam et al., 2014). Finally, aggregators should also be able to deal with a large amount of information and with uncertainty induced by many different vehicle types, driver plans, and irregularities in driver behaviors (Kempton and Letendre, 1997; Bessa and Matos, 2010), details well outside the business expertise or interest of TSOs.

Correspondingly, TSOs must allow such aggregation for GIV use. Here three rules are emphasized: the size of the minimum bid allowed in the market, the interoperability among DSOs, and the technical form of aggregation.

**Minimum size to be included in the market.** In all reserve markets, tender values cannot be less than a minimum power level; there is a range of minima from 100 kW (PJM, frequency regulation) to 10 MW (NGC). In terms of GIV coalitions, this minimum-bidding amount can be converted into a minimum number of vehicles in the fleet. A high value of minimum bidding amount would represent a challenge for the development of pilot and early commercial projects, because they may not have enough vehicles to meet the minimum.

For instance, considering charging stations of 3kW (domestic plugs), and that one GIV out of three is available for reserve markets (because of transportation, charging needs, etc. just as a rule of thumb), the minimum fleet size would be 100 vehicles for a minimum bid value of 100kW. On the other hand, given a minimum bidding size of 10MW, the number of GIVs in a coalition should be at least 10,000. These figures should be considered in relation to those of today's EV sales; by the end of 2015, only around 50,000 EVs were on the road in France (Avere, 2016). Thus, given a high minimum bidding size, it would be impossible to make a coalition of privately owned vehicles in France, never mind a company fleet<sup>4</sup>.

Even if a high penetration of GIVs is considered, say, in 10 years, a high minimum bidding value would narrow the diversity of potential GIV fleets: apart from anything else, company fleets of utility vehicles would not be allowed to participate in the frequency control market.

**Interoperability among DSOs.** The possibility to aggregate GIV across multiple DSO technical areas is also a major concern for aggregators. GIVs can potentially change their location, and they may be spread across several DSO zones<sup>5</sup>. This problem is all the more important that there are numerous DSOs working with one TSO: Knezovic et al. (2015) show that some TSOs work mainly with a single DSO (as in France, where ERDF is responsible for 97% of the distribution grid), but some others work with many DSOs (there are, for example, more than 850 DSOs in Germany). Not being able to aggregate across DSOs when there are so many of them would make aggregation almost

---

<sup>4</sup>Note that the geographical location of the GIVs bears little importance here as frequency is a common characteristic within an interconnected grid.

<sup>5</sup>Registering EVSE rather than GIV may settle the issue of locational shift, but EVSE would still be spread across various DSOs.

### 3.1. REGULATORY ANALYSIS

---

unfeasible. The most favorable option is therefore to allow such cross-DSO aggregation.

More broadly speaking, according to the Electric Power Research Institute (2014), an extended cooperation between the DSOs and the TSOs will be necessary to ensure a cost-efficient integration of Distributed Energy Resources (DERs) in the future, and this is in particularly true for GIVs.

Thus, the best option is to allow and organize interoperability among various DSOs as is done in RTE or Energinet.dk. From an aggregator’s point of view, a restrictive implementation of this rule could be very constraining. Indeed, the minimum fleet size is induced by the rationale described in the previous paragraph, and if this minimum has to be reached in a single DSO area, it may be impossible for aggregators to meet the minimum fleet size requirements.

**Telemetry versus financial aggregation.** Finally, a difference between operational and financial-only aggregations should be made. The best form of aggregation is the operational one; it makes it possible to combine bids and then for a central aggregator to directly control distributed power flows. In other words, the aggregator may disaggregate the TSO request among its units as it wishes. In a financial-only aggregation, aggregators are only allowed to merge financial bids, but the deaggregation of the TSO request is not at the sole discretion of the aggregator, it is bound by the individual offers of each unit.

Table 3.1 sums up the identified rules regarding aggregation and the different possible organizations for each rule.

Table 3.1: The Different Organizations for Module 1

<i>Rule</i>	<i>Organization</i>	
	<i>Best Option</i>	<i>Restrictive Option</i>
<b>R1:</b> Minimum size	100kW	10MW
<b>R2:</b> Interoperability among DSOs	Feasible	Not feasible
<b>R3:</b> Aggregation level	Telecontrol	Financial

#### Module 2: The Rules Defining the Payment Scheme of Grid Services

The provision of grid services by GIVs is a mean to lower their Total Cost of Ownership (TCO). As a consequence, the payment scheme of these grid services is of paramount importance. GIVs should be remunerated in a fair manner, and from a financial perspective, this remuneration should at least cover the induced costs<sup>6</sup>.

---

<sup>6</sup>These costs include battery degradation and hardware and software investments.



**Nature of the payment scheme (Regulated or Market Based).** TSOs have several means at their disposals to dispatch the power among the units that are participating in a grid service. The two main ways of doing so are proceeding through open markets or through regulated contracts (Raineri et al., 2006). In the former solution, participating units may bid in the market as they wish. A bid is typically consisting of a capacity and its price. Depending on its needs, the TSO will then accept all or part of the bids. This approach ensures transparency in the dispatch process. In the latter solution, the dispatch method differs from one unit to the other, as each unit has its own contract with the TSO. For instance, some TSO base the amount of capacity to be provided by a particular unit on its historical load share.

Auction markets are much more appropriate than regulated approaches for new innovative units such as GIV. Regulated approaches are very lengthy to change; however, quick regulatory adaptations are required to integrate new resources. Furthermore, considering a GIV fleet, some vehicles are likely to join and leave the coalition at any moment; as a consequence, a fixed bilateral contract might turn out to be very constraining for an aggregator.

**Incompleteness of the payment scheme.** As well as the nature of the payment scheme, the second element of the structure is its consistency regarding the services offered – or possibly offered – by GIVs. It is puzzling to identify ancillary services that are required but not remunerated specifically by some TSOs and DSOs. Some services are just mandatory with no explicit remuneration nor explicit reserve allocation method. Examples are PJM or CAISO not paying for primary frequency regulation<sup>7</sup>.

From the GIV fleet standpoint, the more incomplete the payment scheme is and the less it compensates the services provided by all the actors, the more GIVs are penalized in their contribution as GIV resources. A clear and complete payment scheme is needed as a condition in the Ideal TSO for GIV fleets.

From the TSO perspective, it could also be beneficial to complete the payment scheme of ancillary services. Indeed, as ancillary services providing units do not have any incentive to provide these unpaid services, they sometimes achieve poor performance in their provision. For instance, Ingleson et al. (2009) point out that the total frequency droop (also referred to as frequency characteristic) of Eastern Interconnection in the US has been dangerously decreasing for the past 10 years, jeopardizing grid security.

**Extra financial bonus for intense flexibility.** In the United States, the Federal Energy Regulatory Commission (FERC) has investigated the different frequency regulation compensation practices of TSOs (FERC, 2011). Its conclusion is that current compensation methods are unfair and discriminatory, specifically because fast ramping resources (resources that are able to change

---

<sup>7</sup>In this case, participating in primary frequency control is mandatory for all power plants, which have to bear the costs of providing this control mechanism.

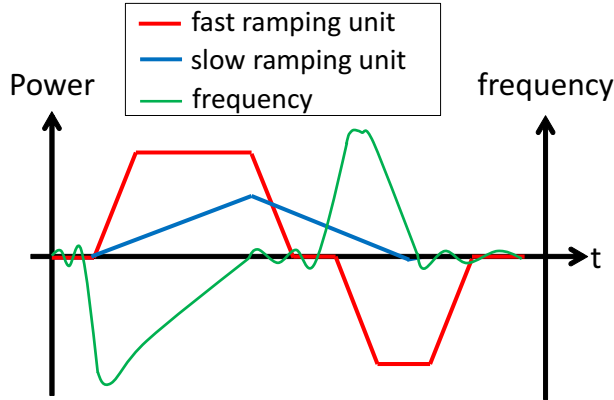

Figure 3.4: Power responses to frequency fluctuations for a fast ramping and a slow ramping unit (for illustrative purposes only)

their power output very quickly) are not remunerated enough with respect to the greater amount of frequency regulation provided.

To deal with this issue, the FERC makes two recommendations. First, remuneration should not only be based on availability (i.e. in \$/MW), but also on utilization (\$/MWh), and every MWh exchanged with the grid for the purpose of frequency control should be counted as a source of positive revenue for the resource in question, whether the MWh flowed from the grid to the resource or from the resource to the grid. That way, as fast-ramping resources respond faster, they exchange more MWh with the grid than slow-ramping units, so payment will be fairer. Fig. 3.4 reflects this rationale and shows that a fast-ramping unit is likely to exchange more MWh (in absolute values) with the grid than a slow ramping unit, even if they have bid the same capacity value in the market.

Second, regulation resources should receive a two-part payment: the first one is the capacity and utilization payment discussed in the previous paragraph. The second one is based on performance, taking into account the response accuracy. Further details about the performance calculation are provided in the more recent FERC order 784 (FERC, 2013): speed and accuracy should be taken into account in the payment of ancillary services.

GIVs are very fast-ramping resources. Therefore, TSOs that abide by FERC compensation recommendations, or similar compensation schemes reflecting the value of fast responses, are more attractive for GIV aggregators. The best solution is therefore to be able to benefit from this kind of compensation. However, the implementation of this financial bonus should be managed carefully. Indeed, the addition of an extra financial bonus to an existing payment scheme should be set at the efficient level. The risk induced by introducing a compensation is that it might create a distortion that could either overcompensate the initial problem, or not compensate enough and leave the issue unresolved.

An alternative way of proceeding would be to consider fast and slow ramping tenders as two different products. Thus, establishing a separate market earmarked for fast-ramping resources, with its own rules and regulations, might be another way to remunerate these services in a fair manner.

Finally, some electrical grids might not currently have the need for fast-ramping resources. The droop control method of conventional units has been operating for a long time and seems to be working quite well provided that financial incentives are adequate (see previous rule). Thus, the possibility of introducing more fast responses in this context has to be investigated thoroughly by the TSOs. Initially, such services may be mostly suited for extreme frequency containment plans after severe disturbances rather than for normal operations. Then, with the increasing penetration of intermittent renewable sources, which induce more production fluctuation and less system inertia, the need for fast-ramping units may increase (Sharma et al., 2011; O’Sullivan et al., 2014). This phenomenon is already observed in some island networks, which are isolated - and so very sensitive to frequency drops - and benefit from substantial wind and solar resources, as, for instance, in the Danish island of Bornholm (Yu Chen et al., 2008).

Table 3.2 sums up the rules dealing with the payment scheme, and the different possible organizations.

Table 3.2: The Different Organizations for Module 2

<i>Rule</i>	<i>Organization</i>	
	<i>Best Option</i>	<i>Restrictive Option</i>
<b>R4:</b> Nature of the payment	Market Based	Regulated
<b>R5:</b> Incompleteness of the payment	All AS should be paid	Incomplete payment scheme
<b>R6:</b> Extra financial bonus for flexibility	Set at the efficient level, or separate market created	Not Existing

### Partial Conclusion

Two sets of rules were identified, leading to different forms of organization. The six TSOs under study are compared on these rules in Table 3.3, which represents a picture of the rules as they were when their manuals were screened. Two main conclusions from this table can be inferred. First, there is no TSO implementing a perfect regulation favorable to the development of GIV. However, some of them are closer to the ideal one than others. Second, this frame can be used as a methodological tool, which can be applied to other TSOs in order to assess their friendliness towards GIV deployment, and guide reforms towards what should be done to go a step further.

### 3.1. REGULATORY ANALYSIS

Table 3.3: Evaluation of the representative TSOs

<i>TSO</i>	<i>R1</i>	<i>R2</i>	<i>R3</i>	<i>R4</i>	<i>R5</i>	<i>R6</i>
RTE	X	✓	✓	X	✓	X
PJM	✓	X	✓	✓	X	✓
ERCOT	✓	X	X	✓	X	X
Energinet.dk	~	✓	✓	✓	✓	X
CAISO	~	X	X	✓	X	✓
NGC	X	✓	✓	~	X	X

✓: good ~: so so X: bad

A best case, a worst case and some intermediate cases can now be defined. However, these rules are constantly evolving to face the new challenges from the electricity sector. A good way to anticipate these changes is to look into the ENTSO-E (the European Network of Transmission System Operators - Electricity) network codes that will come into force in the coming years and will lay the foundation for future TSO market designs. Thus, in Table 3.4, the ideal TSO for GIV fleets is compared with the recommendations from the ENTSO-E network codes (European Network of Transmission System Operators for Electricity, 2013, 2012, 2014a,b). Note that ENTSO-E recommendations are aligned with the European Commission strategic plans (European Commission, 2007).

Table 3.4: Ideal TSO VS ENTSO-E guidelines

<i>Rule</i>	<i>Ideal TSO</i>	<i>ENTSO-E Proposals</i>
Minimum size	100kW	Not addressed
Interoperability among DSOs	Possible	Not clearly defined, but TSOs and DSOs should make all endeavors and cooperate in order to ease the participation of Demand Side Response
Aggregation level	Telemetry	Status of <i>aggregator</i> defined. Telemetry aggregation considered for FCR up to 1.5MW
Nature of the payment	Market Based	Market Based
Incompleteness of the payment	All AS should be paid	All AS should be paid
Extra bonus for flexibility	Set at the efficient level / separate market created	Demand Side Response Very Fast Active Power Response should be implemented

From these findings, it seems that the ENTSO-E rules are paving the way in the right direction, and that they should ease and enable the participation of GIV fleets into frequency control mechanisms.

It is now possible to define a regulatory framework for the simulation model, and to compare it with the ideal, existing and expected future rules. In the following, the emphasis is put on the French primary control, considering regulatory adaptations. The French secondary control, less interesting for GIV fleets, is tackled in Appendix A.

## 3.2 Provision of Primary Frequency Control with Bidirectional Grid Integrated Vehicles

In this section, the aim is to evaluate the potential earnings of a fleet of GIVs participating in the primary frequency control in France. In order to do so, a simulation model is developed; it takes into account the GIV owners' usages, accounts for the behavior of the aggregator and evaluates the potential earnings of the fleet on this market.

As the French market design for this control is not optimal (with the current rules, GIV fleets would just not be allowed to participate), some of the market rules are adapted according to the findings from the previous section. Thus, it is assumed that primary control is organized through an hourly auction market; for each hour, participants can bid an offer in the market (an offer being a price (in €/kW) and a capacity amount (in kW)). Moreover, the market is assumed to be symmetrical; this means that UP (used to increase the frequency) and DOWN (used to decrease the frequency) tenders are procured jointly. As a consequence, all participating units have to provide the same amount of upward and downward reserves for each market clearing period.

### 3.2.1 Grid Integrated Vehicle Fleet Modeling

All the vehicles are assumed to be full-electric vehicles (EVs), and to have a 22 kWh battery, as 60% of the French EVs sold in 2015 (Avere, 2016). The constraint  $0.2 < SOC/SOC_{max} < 0.9$  is added in order not to reach extreme SOC values, which could damage the battery severely (such phenomenon is observed at the cell level (Bloom et al., 2001) and may then be extended at the battery level (Fernández et al., 2013)). Moreover, they are all assumed to have bidirectional capabilities, i.e. to be able to feed power into the grid.

#### Driver Needs for Transportation

GIVs are primarily used for transportation. Taking into account GIV trips in the model is required: they will have an impact on their availabilities for frequency control (because GIVs will not be plugged-in, or because they will need to charge for their next trip) and on the amount of energy remaining in GIV batteries. Then, the four relevant parameters for the model are: (a) the

### 3.2. BIDIRECTIONAL GIV

number of trips in a day; (b) each trip’s durations; (c) departure times; and (d) trip energy consumption.

The GIV trip characteristics are based on several references: internal PSA Peugeot Citroen data, ministerial surveys (Commissariat General au Developpement Durable, 2011) and demonstration project results (Cross-border Mobility for EVs, 2013). The GIV fleet model is stochastic and dynamic. GIV average distance trips ( $d$ ), departure times ( $t$ ), vehicle speed ( $v$ ), daily number of trips ( $N$ ) and seasonal energy consumption ( $c$ ) are provided in Table 3.5.  $d$  and  $t$  are distributed according to Gaussian distributions with mean  $\mu$  and standard deviations  $\sigma$ .  $v$  is derived from average speeds on highways, on roads, in provincial urban environments and in Paris, each average speed being balanced by the percentage of trips carried out on the roads in question<sup>8</sup>.

Table 3.5: Trip-related models and parameters

<i>Trip charac.</i>	<i>Model</i>	<i>Parameter values</i>
Daily trip numbers	Steady value	2
Trip distances	$d \sim \mathcal{N}(d_{data}; \sigma_d)$	$d_{data}$ : internal use ( $\approx 22km$ ) $\sigma_d$ : $5km$
Departure times	$t \sim \mathcal{N}(t_{mean}; \sigma_t)$	$t_{mean}$ : Best adapted to usual commuting trips $\sigma_t$ : 2 hours
Consumption	Steady values	$c_{summer} = 129Wh/km$ $c_{winter} = 184Wh/km$
Speed	Steady value	Internal use ( $\approx 40km/h$ )

We only consider commuting trips during weekdays, i.e. we assume that all drivers go to work in the morning and come back home at late afternoon. Obviously, this is not completely satisfactory. However, these trips can be considered as very representative since they account for most of the trips and kilometers driven in France (CGDD, 2010), which makes these results a good first basis for estimation.

The advantage of the modeling approach considered here is that each GIV is modeled independently. Thus, extreme driver behaviors are taken into account by using probabilistic distribution functions. Similarly, the availability of each individual GIV is used to build the overall fleet availability (*bottom-up* approach). Many papers model GIV fleets as large single batteries (Izadkhast

<sup>8</sup>Vehicle speeds are not distributed according to any probabilistic law because they are used to deduce trip durations from trip distances, which are themselves already distributed according to a Gaussian law.

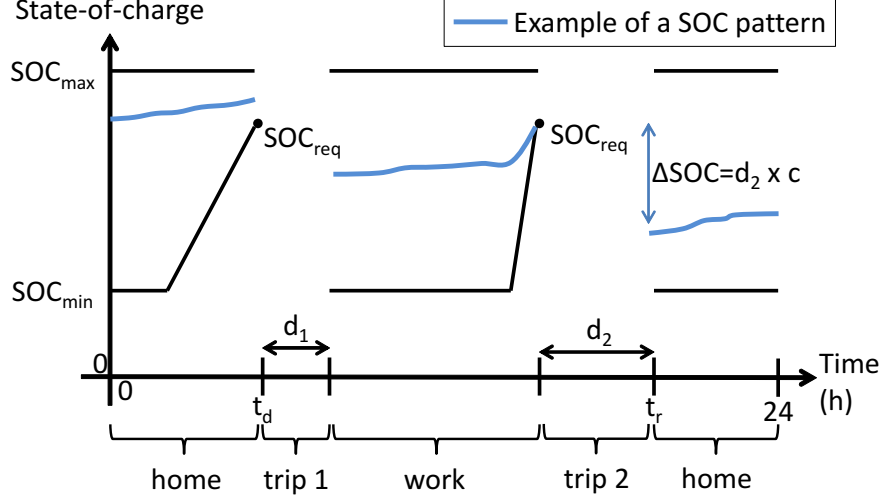

Figure 3.5: Typical daily SOC variations for a GIV, and the associated upper and lower SOC allowed

et al., 2015), what makes it easier for computation, but less accurate with respect to the individual situation of each GIV. For instance, using a single battery model, it would not be possible to identify a GIV not capable of performing its next trip because it lacks energy for transportation, which is not satisfactory even if only one single GIV is concerned.

These values have an impact on the GIV availabilities for grid services as they directly impact the minimum State-of-Charge ( $SOC_{min}$ ) allowed at each moment, which not only depends on the battery characteristics but also on the future needs for transportation and on the available charging station power level. A typical daily SOC pattern is pictured on Fig. 3.5 with the upper and lower SOC limitations (respectively  $SOC_{max}$  and  $SOC_{min}$ ) and the different parameters from Table 3.5.

GIV owners are supposed to communicate their next departure time and required energy ( $SOC_{req}$ ) for their next trip to the aggregator<sup>9</sup>. In order to account for the users' range anxiety, the assumption described in equation (3.2) is made:

$$\forall i \in 1..N_{EV}, \forall j \in 1..N_{trip_i}, SOC_{req_i} = c_{winter} \times \max_j d_{i,j} \quad (3.2)$$

with  $N_{EV}$  the number of GIVs,  $N_{trip_i}$  the number of trips for the  $i^{\text{th}}$  GIV,  $SOC_{req_i}$  the required SOC for the all trips of the  $i^{\text{th}}$  GIV,  $c_{winter}$  the energy consumption and  $d_{i,j}$  the distance of the  $j^{\text{th}}$  trip of the  $i^{\text{th}}$  GIV. This means

<sup>9</sup>In the longer term, aggregators could also manage to estimate these values based on historical data and learning processes.

### 3.2. BIDIRECTIONAL GIV

---

that drivers estimate each of their future trip needs as those of their longest trip of the simulation.

#### Charging Station Power Levels

The power level of the charging stations, or so-called Electric Vehicle Supply Equipment (EVSE), will have a significant impact on the expected fleet earnings since market remuneration is based on €/MW. As explained in the previous paragraph, it is assumed that GIV uses for transportation are limited to commuting trips. Therefore, GIVs can charge either at home, with their *primary EVSE*, or at work with their *secondary EVSE*. The penetration level of EVSEs at workplaces in a near future remaining uncertain, four possible scenarios are considered for this parameter. They are described in Table 3.6.

Table 3.6: The four scenarios for secondary EVSE penetration levels

<i>Scenarios</i>	<i>Ratio of GIVs having an EVSE at work</i>
Scenario 1	0%
Scenario 2	25%
Scenario 3	50%
Scenario 4	75%

There are four different charging power levels, which are related to conventional voltage and current values: *slow charging A* (3kW, 230V, 1-phase, 16A), *slow charging B* (7kW, 230V, 1-phase, 32A), *intermediate charging* (22kW, 400V, 3-phases, 32A), *fast charging* (43kW, 400V, 3-phase, 64A – or DC charging). Table 3.7 presents the charging level distribution for both primary and secondary EVSEs.

Table 3.7: Breakdown of *primary* and *secondary* EVSEs by charging technology type. Data deduced from Prefet Vuibert (2015)

<i>Charging level</i>	<i>Primary EVSE</i>	<i>Secondary EVSE</i>
Slow charging A (3kW)	95%	35%
Slow charging B (7kW)	5%	34%
Intermediate charging (22kW)	0%	29%
Fast charging (43kW)	0%	2%

This share was deduced from a French governmental survey (Prefet Vuibert, 2015). Due to the high cost of charging stations, all EVSEs at home are slow chargers. Charging levels of *secondary EVSEs* are more evenly distributed, apart from fast chargers whose penetration level remains marginal.



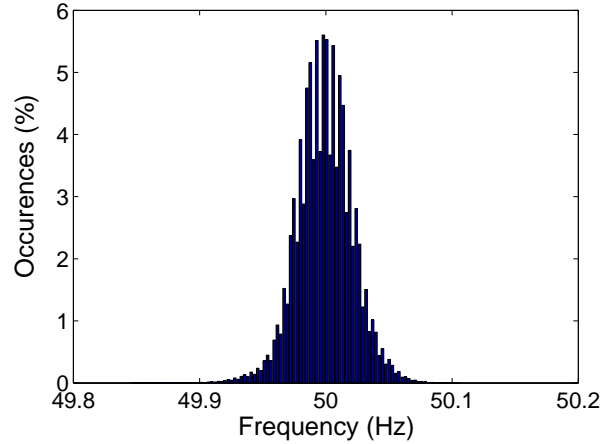

Figure 3.6: Distribution function of the frequency recordings

### 3.2.2 Frequency Data Set

The frequency data set was recorded at CentraleSupélec during the entire month of April 2014. These measurements abide by ENTSO-E requirements, i.e. they have a resolution better than 10mHz and the frequency measurement period is 1s. A summary of the frequency data set characteristics is provided in Table 3.8, and Fig. 3.6 displays the distribution function of the recordings. In order to check the consistency of the measurements, the data set characteristics were compared over the same period of time with those of the RTE data set available on the RTE website (Réseaux de Transport d'Electricité, 2016b) (which only has a 10-second time stamp, and this is why it was not usable).

The two data sets turn out to have very similar characteristics. In particular, the frequency is contained in the interval  $[49.95\text{Hz} ; 50.05\text{Hz}]$  97% of the time; within this interval, primary reserve units should provide less than 25% of their reserve power (see section 3.1.1).

### 3.2.3 Aggregator Modeling

A GIV aggregator plays the fundamental role of presenting the GIV fleet as a single entity to the TSO. One single GIV is very unpredictable from the grid perspective as it may leave for transportation at any moment. Furthermore, it has a very small power level on its own. An aggregator is able to deal with these issues by controlling large, statistically reliable GIV fleets.

In order to do so, aggregators basically implement two algorithms: a *scheduling* algorithm that will evaluate the potential offers that can be made in the market in the future based on the expected GIV fleet conditions, and a *dispatching* algorithm that dispatches the power among the GIVs in real time. The scheduling algorithm is out of the scope of this work, and only the real

### 3.2. BIDIRECTIONAL GIV

Table 3.8: Main characteristics of the frequency data set used, and comparison with RTE measurements

	<i>Criteria</i>	<i>Author data set</i>	<i>RTE data set</i>	<i>Difference (%)</i>
f	Mean (Hz)	50	50	-0,002
	Std (Hz)	0,02	0,02	0,4
	Min (Hz)	49,9	49,9	-0,01
	Max (Hz)	50,1	50,1	0
	P( 49,95 < f < 50,05)	0,97	0,97	-0,22
$\frac{df}{dt}$	Mean (Hz.s <sup>-1</sup> )	9.8E-4	n/a <sup>a</sup>	n/a <sup>a</sup>
	Std (Hz.s <sup>-1</sup> )	0.001	n/a <sup>a</sup>	n/a <sup>a</sup>
	Min (Hz.s <sup>-1</sup> )	0.09	n/a <sup>a</sup>	n/a <sup>a</sup>
	Max (Hz.s <sup>-1</sup> )	-0.09	n/a <sup>a</sup>	n/a <sup>a</sup>

<sup>a</sup>n/a: not applicable, as RTE data set has a 10 second time stamp

time behavior of the GIV fleet is considered here (dispatch algorithm). Thus, the results should be perceived as an upper limit of the amount of power that can be provided by the GIV fleet at each moment; it could then be used to wisely design scheduling algorithms.

#### Aggregator Dispatch Algorithm

The objective of this thesis is not to focus exclusively on the development of technical algorithms; rather, it is to use such algorithms to derive business model and regulatory analysis. As a consequence, the implemented dispatch algorithm mimics the one implemented in the University of Delaware GridOn-Wheels demonstration project detailed by Kamboj et al. (2011). In this project, a small GIV coalition participates in the PJM frequency regulation market, and competes in this market just as the other traditional units. Thus, the algorithm employed has been proved efficient in real life demonstrations.

The operating principle of the algorithm is as follows:

1. At each market clearing period, each GIV computes its individual contribution for the coming period  $P_{bid,i}$ , and communicates this value to the aggregator. The aggregator, by summing up all the individual GIV contributions, deduces the total fleet power available for frequency control  $P_{bid}$  until the next clearing period.
2. Then, within this period, the aggregator measures the frequency at each time stamp and, depending on the frequency value, computes the power for frequency control that should be provided to the TSO  $P_{reg}$  according

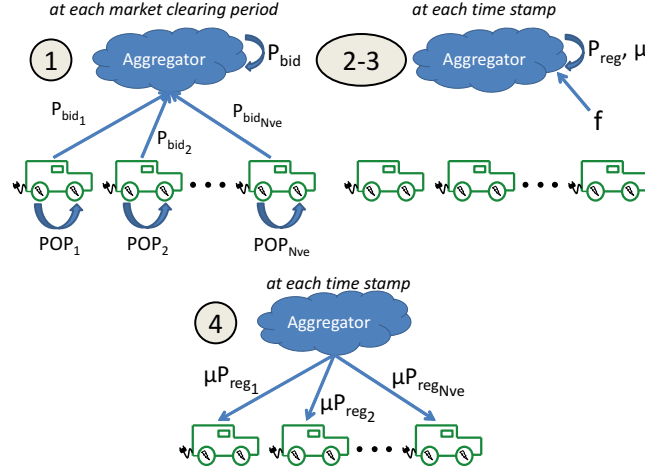

Figure 3.7: Dispatch algorithm operating scheme

to equation 3.3:

$$P_{reg} = \begin{cases} -\frac{f - f_0}{f_{max} - f_0} P_{bid}, & |f - f_0| < 0.2Hz \\ P_{bid}, & |f - f_0| \geq 0.2Hz \end{cases} \quad (3.3)$$

with  $f_0 = 50Hz$  and  $f_{max} = 50.2Hz$ . These equations reflect the required response of primary reserve units to frequency deviations (Union for the Co-ordination of Transmission of Electricity, 2004).

3. The aggregator deduces from  $P_{reg}$  a scaling factor  $\mu_F$  which is equal to the ratio between the power required for frequency control and the power available from GIVs:  $\mu_F = P_{reg}/P_{bid}$
4. The aggregator communicates to all the GIVs their power set point for frequency control  $\mu_F * P_{reg,i}$
5. Back to step 1 if a new market clearing period is about to start (every hour), otherwise back to step 2.

Fig. 3.7 summarizes the algorithm operating principle. This scheme is repeated for each new frequency measurement, that is to say for each second.

Here, the aggregator is assumed to measure the frequency (step 2). Thus, it is able to dispatch the power among the vehicles as it wishes (for instance, dispatch methods more complex than the one proposed here could be implemented); however, it also requires resilient and low-latency communication means. Each GIV could also measure the frequency independently. This would reduce the communication needs, but would require each GIV or EVSE to have a frequency

### 3.2. BIDIRECTIONAL GIV

---

meter. It is worth noting that this algorithm is a decentralized one; centralized algorithms have been proved slightly more efficient, but more computing time consuming (Vandael et al., 2013).

The calculation method of each individual GIV contribution (step 1) is based on the Preferred Operating Point (POP) of this vehicle, which is equivalent to the operating point of a traditional unit (such as a power plant); it represents the charging rate around which the GIV will provide frequency control. The way of computing the POP is also inspired by the University of Delaware solution (Kamboj et al., 2011). It takes into account the current GIV conditions, and future trip needs:

$$\left\{ \begin{array}{l} POP_i(t) = \frac{P_{h_i} + P_{b_i}}{2} \\ P_{h_i} = -\min(P_{max_i}, \frac{SOC_{max_i} - SOC_i}{\delta t}) \\ P_{b_i} = \min(P_{max_i}, \frac{SOC_i - SOC_{min_i}(t + \delta t)}{\delta t}) \\ P_{bid_i} = P_{max_i} - |POP_i(t)| \end{array} \right. \quad (3.4)$$

with, considering the GIV  $i$ ,  $SOC_i$  the State Of Charge of the battery,  $SOC_{min_i}(t)$  the energy required at time  $t$  to be able to achieve the next trip,  $SOC_{max_i}$  the upper SOC limit and  $P_{max_i}$  the power level of the EVSE.  $SOC_{min_i}$  is computed using the trip-related information that each GIV owner provides the aggregator with. Fig. 3.8 illustrates how equation set (3.4) operates, considering three SOC levels:

- I:** In situation I, the SOC is not close to the upper nor to the lower SOC limits.  $P_h$  and  $P_b$  have opposite values; the resulting POP is null.
- II:** In situation II, the SOC is closed to the upper limit. As a consequence,  $P_h$  is lower in absolute value than  $P_b$ . The POP value will make the GIV slightly discharge until the next market clearing period.
- III:** In situation III, the SOC is closed to the lower limit: the POP value will get the car charging before the next market clearing period.

Fig. 3.9 presents the simulation results over 5 working days for one GIV (negative power values stand for charging). The *primary* EVSE level is 3kW, and there is no *secondary* EVSE. This accounts for the fact that the SOC remains steady during working periods. When parked at home, the GIV participates in the primary frequency control. When the next trip is getting close, the POP increases (in absolute value) and there is less power available for regulation, so less power is used for regulation. Meanwhile, the battery charges thanks to the new POP value.

#### 3.2.4 Results and Discussion

##### Simulation Parameters

For each EVSE power level, 100 simulations are run following the Monte Carlo approach for 100 GIVs. The simulations are performed with a one second time

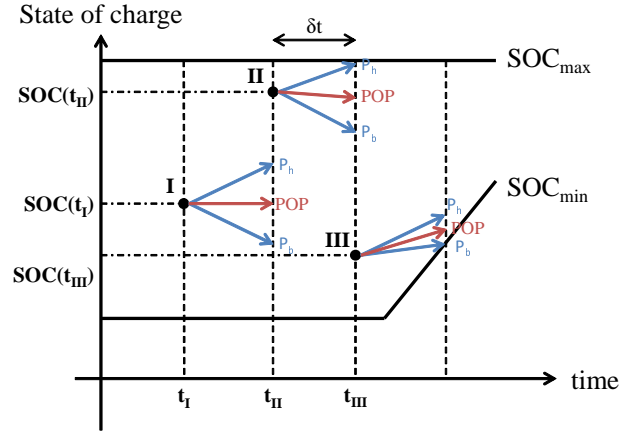

Figure 3.8: Illustration of the calculation method of the Preferred Operating Point (POP)

stamp over 5 week days. In order to compute the revenues, prices from the Energinet.dk primary control market are used. This Danish TSO is part of the same interconnected area as RTE, but primary frequency control is organized in an hourly auction market. Similarly to trip-related consumptions, a distinction is made between a *winter* and a *summer* season for prices: data from 2013 quarters 2 & 3 are used for summer prices, and data from 2012 quarter 4 and 2013 quarter 1 for winter prices. These clearing prices are available online (Energinet.dk, 2013). For each simulation, five continuous hourly market prices are selected randomly from the data set, as well as five continuous days of frequency values from the data set described in section 3.2.2.

## Results

**Remuneration per vehicle.** Average earnings per vehicle and per year are presented in Table 3.9, for the various EVSE power levels. As simulations were performed for five continuous working days, results in Table 3.9 do not take into account week-end remunerations, so the overall yearly GIV earnings may actually be higher. Results from *summer* and *winter* simulations are averaged. The results are very sensitive to the available power level. The expected remuneration reaches significant values for high power levels, up to 1,950€ per vehicle and per year.

These results, given the EVSE penetration level at work and the EVSE power level breakdown provided respectively in Table 3.6 and Table 3.7, lead to the findings summarized in Table 3.10. The aggregator is assumed to equally remunerate all the GIVs, that is, the overall fleet earnings are fairly divided among the vehicles irrespective of their charging station power.

The average market clearing price from the data set is 16.8€/MW. As a

### 3.2. BIDIRECTIONAL GIV

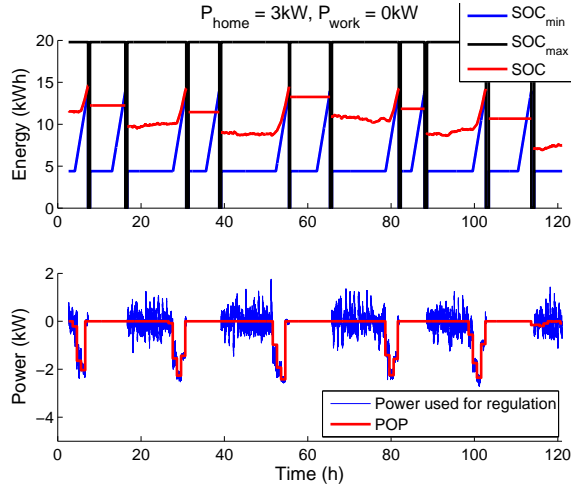

Figure 3.9: Simulation results for a single bidirectional capable GIV over 5 working days, with  $P_{home} = 3kW$  and  $P_{work} = 0kW$

Table 3.9: Average earnings per vehicle and per year depending on the EVSE power level

<i>EVSE power level (kW)</i>		<i>GIV revenues per year (€)</i>
<i>Primary</i>	<i>Secondary</i>	
3	0	138
3	3	239
3	7	389
3	22	1036
3	43	1 665
7	0	365
7	3	418
7	7	600
7	22	1 114
7	43	1 950

comparison, the regulated price of RTE is 19.8€/MW. Thus, similar levels of remuneration could be expected considering RTE prices (provided, of course, that RTE market design was made more suitable for GIV fleets).

**Considerations regarding the fleet size.** Let's consider the value of the power provided in the market, and scale the results for a fleet of  $N_{EV} = 200,000$

Table 3.10: Average earnings per GIV and per year for each scenario.

<i>Scenario</i>	<i>Average yearly GIV revenues (€)</i>
Scenario 1	149
Scenario 2	251
Scenario 3	353
Scenario 4	456

GIVs<sup>10</sup>. Results are displayed in Table 3.11.

Table 3.11: Minimum and average values for  $P_{bid}$  for a fleet of 200,000 GIVs

<i>Scenarios</i>	<i>P<sub>bid</sub></i>	
	<i>Min (MW)</i>	<i>Average (MW)</i>
Scenario 1	1.6	311
Scenario 2	6.5	501
Scenario 3	11.4	692
Scenario 4	16.2	882

These results should be put in perspective considering that the French primary reserve amounts approximately to 600MW (Commission de Regulation de l’Energie, 2016). The question of the ideal fleet size arises: in scenarios 3 and 4, the primary reserve would be in average saturated by the GIV fleet. Thus in these scenarios the GIV fleet size is too important, since in some cases the aggregator would have to cap its bid values. Under such conditions, adding an extra GIV in the fleet would result in a diminution of the earnings per GIV.

TSOs will likely not let all their reserve be provided by a single type of unit (for risk diversification purposes). Let’s consider that RTE would let one third of its primary reserve be provided by GIVs. Let’s assume that these GIVs are equipped with 10kW bidirectional charging stations, and that one out of three is available for providing primary control. Then, only around 60.000 GIVs are required to provide the entire share of the reserve dedicated to the vehicles.

### 3.2.5 Partial Conclusion

It was demonstrated that if market rules were properly designed and adapted for distributed storage units (and thereby for GIVs), bidirectional GIVs could

<sup>10</sup>The number of EVs on the road in France is expected to reach 450,000 by 2020 (RTE, 2014). The aim is to evaluate the power that could be provided by GIVs if half of existing EVs would participate in 2020.

earn a significant amount of money each year by providing primary frequency control; depending on the EVSE penetration at work, they could earn between 149€ to 456€ per year. These earnings could even increase by taking into account weekend earnings, by considering higher power levels for the charging stations, or if a bonus for extra-flexibility was implemented (see section 3.1.2). The results also show that the number of GIVs providing frequency control should not be too important, at the risk of saturating the reserve.

In the next section, GIVs with unidirectional capabilities only are considered, i.e. GIVs that are only able to charge and not to discharge.

## 3.3 Provision of Primary Frequency Control with Unidirectional Grid Integrated Vehicles

This section addresses the same topic (the provision of primary frequency control with Grid Integrated Vehicles (GIVs)) except that GIVs are assumed to have only unidirectional capabilities. In a first approach (section 3.3.1) the same market design as in the previous section is considered. Then, in section 3.3.2, because unidirectional GIV fleets perform poorly under such assumption, new simulations are conducted considering a different market design: the market is now considered to be an asymmetrical one, meaning that UP and DOWN products are procured through two different markets.

### 3.3.1 Symmetrical Market Design

#### Simulation Framework

The same simulations as in the previous section are conducted: the GIV fleet modeling (section 3.2.1), the simulation parameters and the data (sections 3.2.2 and 3.2.4), and the aggregator algorithms (section 3.2.3) are kept the same.

However, because they do not have the same capabilities as in the previous section, the way GIVs compute their POP and their available power for regulation  $P_{bid_i}$  is different. As only unidirectional capabilities are considered, GIVs need to charge permanently at a given point, namely the POP, in order to modulate their charging rate in both directions around this POP and to provide symmetrical reserve power. The POP is computed at each market clearing period as the charging power that would enable the GIV to reach its required energy for transportation for its next trip:

$$POP_i = \frac{SOC_{req_i} - SOC_i(t)}{\Delta t} \quad (3.5)$$

with  $SOC_{req_i}$  the required energy of the GIV  $i$  for its next trip,  $SOC_i(t)$  the current state of charge of the  $i^{\text{th}}$  GIV and  $\Delta t$  the time before next departure. The available individual power for regulation is then simply calculated according to equation (3.6):

$$P_{bid_i} = \min(POP_i, P_{EVSE_i} - POP_i) \quad (3.6)$$



with  $P_{bid_i}$  the individual available power for regulation of the  $i^{\text{th}}$  GIV and  $P_{EVSE_i}$  the EVSE power level.

At last, the way the aggregator dispatches the power among the GIVs is slightly changed (step 4 in section 3.2.3). Instead of computing a repartition factor  $\mu_F$  that requires the same amount of power from all the GIVs, the aggregator first requests charging power from the GIVs that have the lowest State-of-Charge (SOC) compared to their future energy needs for transportation. By doing so, the power provided for frequency control is optimized as some GIVs get fully charged later compared with an equal power repartition.

### Results

Under such assumptions, as in the previous section, the expected yearly remuneration per vehicle is computed, and the minimum and average power bid in the market  $P_{bid}$  by a fleet of 200.000 GIVs is also provided. Results are respectively provided in Table 3.12 and Table 3.13.

Table 3.12: Average earnings per vehicle and per year depending on the EVSE power level

<i>EVSE power level (kW)</i>		<i>GIV revenues per year (€)</i>
<i>Primary</i>	<i>Secondary</i>	
3	0	26
3	3	42
3	7	29
3	22	27
3	43	30
7	0	26
7	3	27
7	7	28
7	22	40
7	43	28

The expected earnings per GIV and per year are very low considering only unidirectional capabilities. Moreover, they are not dependent on the EVSE power levels. Indeed, because GIVs need to charge constantly to provide symmetrical power around their POP, they get fully charged rather quickly (and then cannot provide frequency control anymore). Thus, they cannot benefit from having charging stations with higher power levels since their available power for frequency control would be limited in the upward direction. Such low remuneration would not enable an aggregator to develop a viable business model.

As GIVs get fully charged quickly, the minimum available power for regu-

### 3.3. UNIDIRECTIONAL GRID INTEGRATED VEHICLES

Table 3.13: Minimum and average values for  $P_{bid}$  for a fleet of 200.000 GIVs

<i>Scenarios</i>	$P_{bid}$	
	<i>Min (MW)</i>	<i>Average (MW)</i>
Scenario 1	0	102
Scenario 2	0	109
Scenario 3	0	116
Scenario 4	0	123

lation always reaches 0 at some point. The average power is much lower than with bidirectional capabilities. These results would make it difficult for an aggregator to bid in a market without taking too substantial risks of being unable to provide the reserve power it has to.

Here, the GIV fleet performance level is pretty poor because of the market design which is symmetrical. Thus, it seems interesting to assess the same fleet performance considering asymmetrical markets.

#### 3.3.2 Asymmetrical Market Design

Asymmetrical markets are markets that are divided into two independent sub-markets (one dedicated to the trading of UP products, and the other to the trading of DOWN products). Such markets already exist in some countries (e.g. Denmark (Energinet.dk, 2012)) and they are likely to further develop in a near future as ENTSO-E recommends such market design in its network codes (European Network of Transmission System Operators for Electricity, 2014a). In this section, the emphasis is put on the provision of DOWN products only by a fleet of unidirectional GIVs.

The basics of the simulation model and parameters are the same as for the unidirectional strategy considering a symmetrical market. When not mentioned otherwise, everything is kept the same between the two simulation frameworks. In the rest of the section, before moving on to the results, the differences between the two simulation models are underlined.

#### Aggregator Dispatch Algorithm

Whether operating in a symmetrical or in an asymmetrical market, the operating principle of the dispatch algorithm, which is described in section 3.2.3 and summed up in Fig. 3.7, is the same. However, because the bid power  $P_{bid}$  is not symmetrical anymore, equation (3.3) is replaced with equation (3.7). Note that in these equations, negative power stands for charging and vice versa.

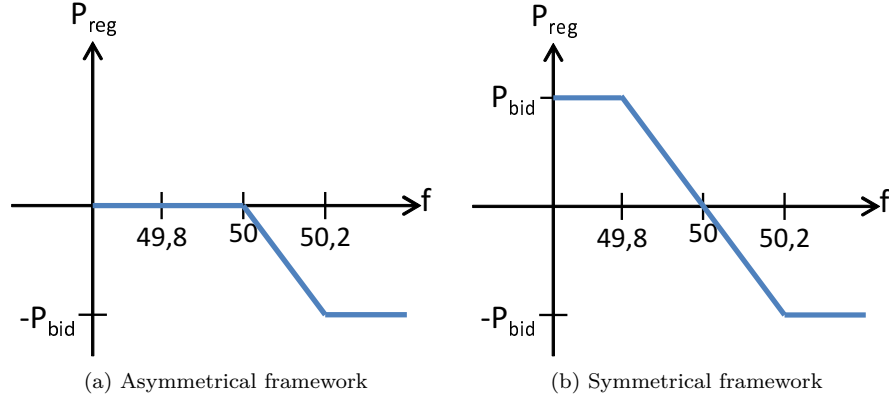

Figure 3.10: GIV fleet power response to frequency deviations

$$P_{reg} = \begin{cases} -P_{bid} * \min\left(\frac{f - 50}{0.2}, 1\right), & f > 50Hz \\ 0, & f < 50Hz \end{cases} \quad (3.7)$$

Equations (3.3) and (3.7) reflect the required response of primary reserve units to frequency deviations (Union for the Co-ordination of Transmission of Electricity, 2004). The two fleet responses are graphically represented in Fig. 3.10, where (3.10a) and (3.10b) respectively represent P-f curves under asymmetrical and symmetrical frameworks.

### Individual GIV Power for Regulation

In this section, the method enabling each individual GIV to assess its available power for frequency control  $P_{bid_i}$  at the beginning of each market clearing period is detailed. In an asymmetrical framework, there is no longer need for a permanent Preferred Operating Point (POP), the GIVs can stay idle when they do not need to charge for transportation, and just charge when necessary for frequency control purposes.

Fig. 3.11 shows the several use cases regarding the GIV decision processes in an asymmetrical market, for a period of time during which the GIV is plugged-in (related to Fig. 3.5). The thick black curves represent respectively the maximum and minimum state-of-charges ( $SOC_{min}(t)$  and  $SOC_{max}(t)$ ). For each market clearing period, a particular SOC condition for the considered vehicle is represented. In each situation, details are provided about the GIV availability for frequency control purposes. The amount of power that the aggregator can be provided with is also tackled.

**I** Situation I stands for the basic and most common situation: the GIV is not

### 3.3. UNIDIRECTIONAL GRID INTEGRATED VEHICLES

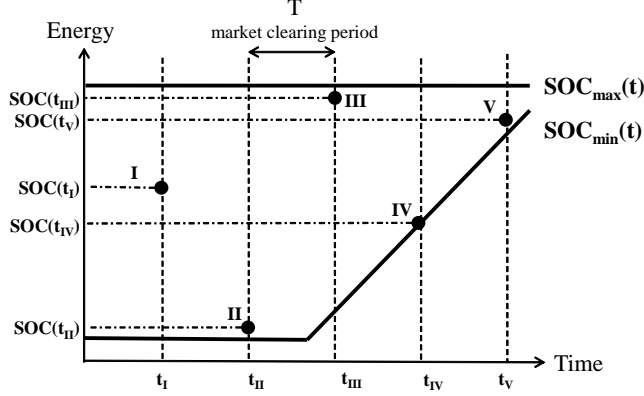

Figure 3.11: GIV determination of available power for regulation

about to reach its SOC limitations, thus it is available for frequency control and can offer its maximum power, i.e. its EVSE power level.

**II** In situation II, the GIV SOC is lower than the minimum SOC at next clearing time:  $SOC(t_{II}) < SOC_{min}(t_{III})$ . In this case, as the GIV may need to charge for transportation before the next clearing time, the aggregator does not rely on him and its available power is null. However, the GIV is still available for the aggregator which can always decide to charge him for frequency control purposes in case it would have difficulties in dispatching the entire requested power.

**III** In situation III, the EV is available for regulation, however the power that can be offered is restricted to the maximum charging power that would fully charge the GIV at the next clearing period:

$$P_{bid_i} = (SOC_{max}(t_{IV}) - SOC(t_{III})) / T.$$

**IV** In situation IV, the GIV is not available for frequency control as  $SOC(t_{IV}) \approx SOC_{min}(t_{IV})$ , it needs to charge for transportation.

**V** At last, in situation V, the GIV will leave before the next market clearing time: the strategy is then the same as in situation II.

All in all, these bidding strategies always ensure: (a) that all GIVs will fulfill all their needs for transportation; and (b) that the total fleet power that is bid in the frequency control market is always inferior to the actual available fleet power.

#### 3.3.3 Results

The same simulations as in the previous sections are performed for the asymmetrical and symmetrical frameworks. Here, all GIVs are considered to have an

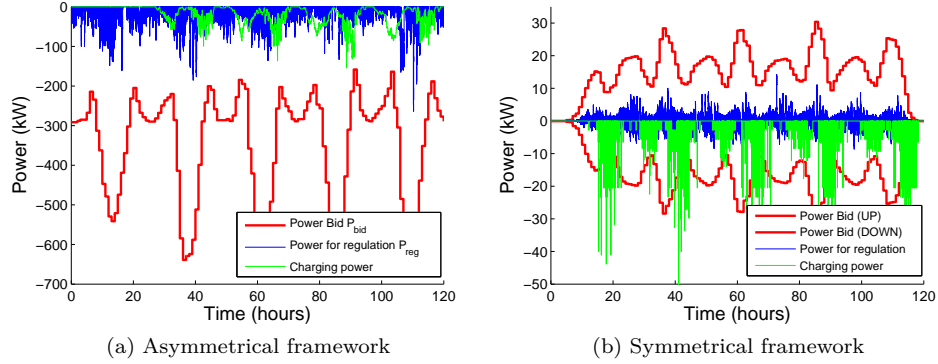

Figure 3.12: Instantaneous power flow of the fleet for the different market designs

EVSE at work to make the comparison between the two market designs easier. The aggregator and GIV strategies are implemented respectively according to sections 3.3.1 and 3.3.2.

Fig. 3.12 shows the instantaneous GIV fleet power flows for asymmetrical and symmetrical use cases in Fig. 3.12a and Fig. 3.12b, respectively. The red curve represents the power that has been bid in the market, i.e.  $P_{bid}$ . The power actually provided for regulation,  $P_{reg}$  in equations (3.3) and (3.7), is pictured in blue. When GIVs are not available for frequency control and that they need to charge for transportation, their charging power is drawn in green.

It is striking on these curves how the power bid under an asymmetrical framework is much more important than considering a symmetrical framework. In average, in the asymmetrical market design, the power bid is nine times as high as in a symmetrical situation. Table 3.14 displays, for both market designs, the minimum, maximum, first, second and third quartiles of the power bid in the market  $P_{bid}$ , while Fig. 3.13a and Fig. 3.13b provide the density function  $P(X) = probability(Power > X)$  for asymmetrical and symmetrical frameworks, respectively. These two graphics strengthen the results of Table 3.14: GIVs fleets with unidirectional capabilities perform way better under an asymmetrical market design than under a symmetrical market design. Considering a symmetrical market, the minimum power bid in the market is 0kW, while it reaches 125kW under an asymmetrical configuration. For the same fleet, 75% of the power provided in the market is superior to 243kW in an asymmetrical market, while this figure amounts to only 22kW under a symmetrical framework. There is a threshold on Fig. 3.13a around 40%-50% of probability: this is due to the fact that GIVs provide roughly half of their reserve from workplaces, and that EVSE power levels at work are considerably higher than at home (see Table 3.7).

### 3.4. SENSITIVITY ANALYSIS

Table 3.14: Minimum, maximum and quartile values for  $P_{bid}$  for two different market designs

<i>Market Design</i>	<i>Min (kW)</i>	<i>Max (kW)</i>	<i>1<sup>st</sup> quartile (kW)</i>	<i>2<sup>nd</sup> quartile (kW)</i>	<i>3<sup>rd</sup> quartile (kW)</i>
Asymmetrical Market	125	675	243	281	441
Symmetrical Market	0	61	22	31	37

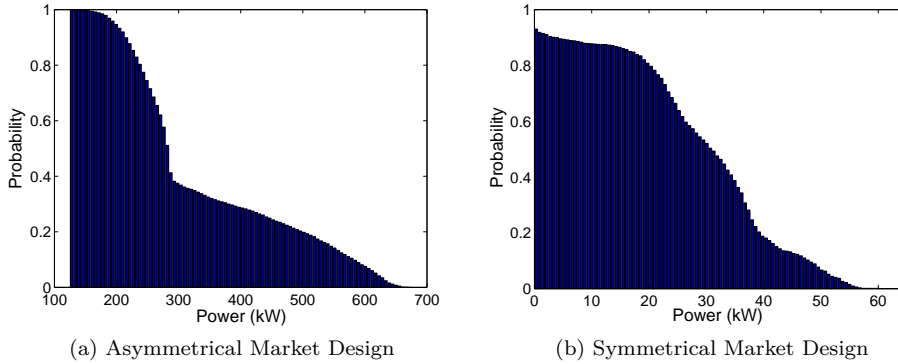

Figure 3.13: Probability that the power bid  $P_{bid}$  be superior to a certain value, for two different market designs

## 3.4 Sensitivity Analysis

The expected yearly revenues for a fleet participating in the primary frequency control market were estimated, for several market designs and GIV capabilities. In this section, sensitivity analysis for two important parameters are conducted: the GIV fleet parameters, in section 3.4.1, which are modeled through different fleet types, and the market clearing period in section 3.4.2.

### 3.4.1 Fleet Types

#### Description of the Fleets Understudied

The GIV owners' driving patterns, the EVSE power levels, the possibility to charge at workplaces are all factors that will impact the GIV fleet performance for grid services, as it will directly influence the GIV availabilities and available power for frequency control. Rather than conducting sensitivity analysis for

each of these parameters, fleet types that are representative of existing French fleets are defined, and they are compared on their performance for grid services. The fleets defined are the following:

**Private Vehicle Fleet:** this fleet is the same as in section 3.2.1 and is used as a benchmark. It is composed of privately owned vehicles. A penetration level of EVSE at workplaces of 25% is considered (scenario 2 in Table 3.6).

**Postal Mail Services Fleet:** the characteristics of this fleet are based on those of the French postal mail services fleet, which is the largest one in the world (Breezcar website, 2015). The GIVs typically leave in the morning for the morning delivery tour, and come back around noon. Then, they start their afternoon delivery tour around 2PM, and come back for the night around 5PM. They are able to charge during the lunch break. We assume that all GIVs have a 22kW EVSE.

**Paris Airport Fleet:** this fleet would be used by the Paris Airport staff. Vehicles are typically used during working days, for rather small distances but with very limited speed. They charge at night, with 3kW charging stations. Contrary to postal mail vehicles, they are not able to charge during the lunch break.

**Company Vehicle Fleet:** driving patterns of company fleet users are quite similar as those of Private Vehicle Fleet users: they use their EVs to commute to work. However, their driving distances is increased as their vehicles is paid by the company. An additional small working trip is added randomly during the day. Moreover, the EVSE at home is assumed to be also paid by the company, hence available for all GIV owners; half of EVSE are assumed to be 3kW charging plugs, and the other half are 7kW charging stations.

Here, all GIVs are assumed to have a 22kWh battery, and to have bidirectional capabilities. The approximate mean values of the characteristic parameters of each fleet are summed up in Table 3.15. The exact values of all parameters are based on internal PSA data, thus they cannot be disclosed. Then, based on these mean values, trip distances and departure times are distributed for each vehicle according to Gaussian distributions. The standard deviation values are assumed to be 20% of the mean value for trip distances, and are set to two hours for departure times.

### Earnings Per Fleet

Simulations are conducted for each type of fleet following the simulation procedure (number of GIVs, number of simulations, seasons...) detailed in section 3.2.4. Results are provided in Table 3.16; again, the aggregator is assumed to equally remunerate all the GIVs, that is, the overall fleet earnings are fairly divided among the vehicles no matter their charging station power.

### 3.4. SENSITIVITY ANALYSIS

Table 3.15: Mean values of the characteristics of the different fleets under study

<i>Fleet</i>	<i>Parameter</i>			
	<i>Average speed (km/h)</i>	<i>Trip distances (km)</i>	<i>Departure times</i>	<i>EVSE charac.</i>
Private Fleet	40	22	8h & 17h30	See Table 3.6 and Table 3.7, scenario 2
Postal Mail Fleet	10	AM: 50 PM: 30	8h & 14h	22kW available at all times
Airport Fleet	10	6	8h & 12h	3kW, charge overnight
Company fleet	40	commuting trips: 44 working trip: 15	8h & 17h30	100% EVSE at work 50% 3kW; 50% 7kW

Table 3.16: Average earnings per GIV and per year for each type of fleet

<i>Fleet</i>	<i>Earnings (€)</i>
Private Fleet	251
Postal Mail Fleet	2004
Airport Fleet	215
Company Fleet	501

The postal mail fleet achieves the best revenues due to high power EVSE and a large availability. Company fleet revenues are higher than those of the private fleet mainly because all GIV owners have an EVSE both at work and at home. Then, there are small differences between the private fleet and the airport fleet revenues.

#### 3.4.2 Market Clearing Period

In this section, the objective is to compare the impacts of having different market clearing periods on the ability of a GIV fleet to provide primary frequency control. In order to do so, the simulation model developed in section 3.3 is



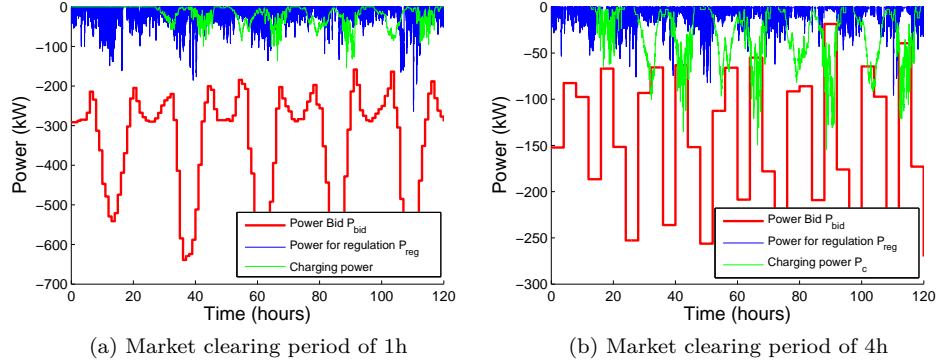

Figure 3.14: Instantaneous GIV fleet power flow with market clearing periods of (a) 1h and (b) 4h

used, i.e. the one presenting a fleet of unidirectional GIVs providing primary frequency control in an asymmetrical market, and the fleet performance on two market clearing values are compared: one hour and four hours.

As an example, Fig. 3.14 shows the results of one simulation test for the two market clearing periods. In Table 3.17, the minimum, maximum, first, second and third quartiles of  $P_{bid}$  are provided for both market designs, while in Fig. 3.15a and Fig. 3.15b provide the density function  $P(X)$  for 1h and 4h market clearing periods, respectively ( $P(X) = probability(Power > X)$ ).

Table 3.17: Quartile values for  $P_{bid}$  for 1h and 4h market clearing time stamps

market clearing period	Min (kW)	Max (kW)	1 <sup>st</sup> quartile (kW)	2 <sup>nd</sup> quartile (kW)	3 <sup>rd</sup> quartile (kW)
1 hour	125	675	243	281	441
4 hours	19	271	70	133	202

The impact of having a shorter market clearing period is significant: the median power bid is more than twice as high with a one-hour clearing period as with a four-hour one. With a one hour time stamp, 75% of the offers made in the market by the aggregator exceed 243kW, while they only exceed 70kW with a four-hour market clearing period. As in Fig. 3.13a, there is a threshold on Fig. 3.15a and Fig. 3.15b around 50% of probability, which is due to the difference of charging station power levels at home and at work.

### 3.5. PARTIAL CONCLUSION

---

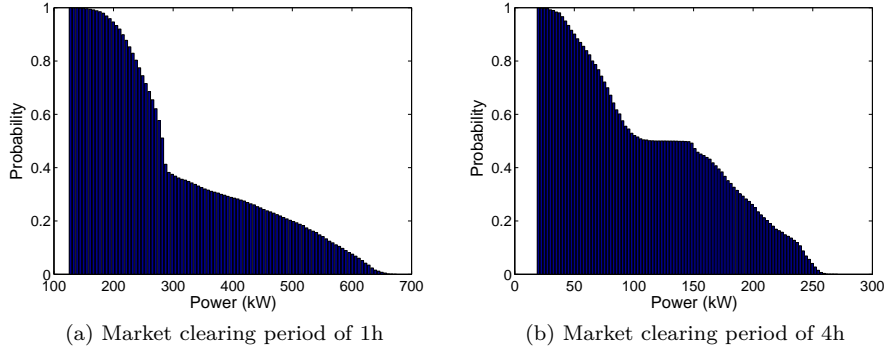

Figure 3.15: Probability that the power bid  $P_{bid}$  be superior to a certain value, for two different market clearing periods

## 3.5 Partial Conclusion

### 3.5.1 From the GIV Owner Perspective

It was demonstrated that GIV fleets could be very valuable primary frequency control reserve units. By providing this grid service, most likely through a third-party aggregator, GIV owners could lower substantially their Total Cost of Ownership (TCO), from 149 to 456€ per year with a bidirectional GIV depending on the EVSE penetration level at work. Bidirectional capabilities significantly increase the expected revenues from the participation in this market. Company fleets appear as promising early adopters for the following reasons:

- the company decides both on the driving patterns, which are easy to forecast, and on the charging management strategies, hence co-optimization is possible;
- the vehicles are not spread over a large area;
- companies are likely to have rather high power level EVSEs

### 3.5.2 From the System Operator Perspective

Each year, TSOs spend a significant amount of money to procure the primary reserve they need. For instance in France, with a regulated tariff of 16.96€/MWh (Réseaux de Transport d'Electricité, 2011a) and a primary reserve of around 600MW, procuring this reserve amounts to approximately 90 million euros each year to RTE (this amount is in the end paid by the end users through electricity tariffs). When the procurement method is an auction market, it is difficult to evaluate the costs for each reserve providing unit, because they do not necessarily bid at their marginal costs. However, in the case of a GIV fleet, it is certain that the cost of providing primary reserve will be very low – and with no doubt

lower than the cost of most of other competitors. Indeed, with unidirectional capabilities, the only additional hardware required would be a frequency meter. Apart from that, the remaining costs are: communications costs (quite low because using existing communication networks) and risk management costs. With respect to bidirectional capabilities, extra hardware costs consist in the bidirectional Power Electronic Unit (PEU).

Thus, if the share of the reserve provided by GIVs rises, reserve clearing prices will naturally go down; TSOs would spend less money procuring the primary reserve. As a consequence, TSOs should make all possible endeavors to have their frequency control markets opened to GIV fleets:

- the rules towards aggregation of GIV should be enhanced (see 3.1.2);
- the payment scheme of grid services should be properly addressed (see 3.1.2);
- UP and DOWN products should be procured through separate markets (see 3.3.2);
- the market clearing period should be kept as short as possible (see 3.4.2);

Obviously, TSOs would bear the costs of changing their rules; however, these costs should remain low in comparison with the savings achieved.

There are several challenges to get TSOs close to the ideal one defined in section 3.1.2. First, changing TSO rules is a lengthy process that should be carried out thoroughly. Indeed, TSO costs are reflected in electricity tariffs for end users, thus any change in the rules that could have an impact on electricity bills should be deeply analyzed and validated by the local regulation commission. Any change in market design should not result in other unexpected market disruptions. Then, the priority of TSOs is the security of supply, i.e. to serve all their customers at any time. Considering this fact, some TSOs might be reluctant to change towards rules which could improve the competitiveness or the sustainability, but whose impacts on the security of supply is considered uncertain.

TSO reserves are limited in terms of power (e.g. 600MW for French primary reserve), and TSOs are likely not willing to have a single technology providing all this amount of reserve (because they need to diversify their risks). As a consequence, the number of GIVs providing each grid service should be limited, otherwise earnings per vehicle will decrease. For instance, a fleet of 200.000 GIVs would already saturate the reserve under certain conditions (see Table 3.11).

## Chapter 4

# Grid Integrated Vehicle Fleets Providing Local Grid Services

### 4.1 Introduction

Besides providing Transmission System Operators (TSOs) with system services, Grid Integrated Vehicles (GIVs) could provide services at the local level. As explained in section 2.3.4 (page 45), there is currently no existing framework to contract services with Distribution System Operators (DSOs). In this chapter, the objective is to show how GIVs could be used to deal with local grid issues.

In section 2.1.3 (page 32), two main concerns for grid operators at the local scale were identified: voltage regulation and local congestion. Here, the emphasis is put on the latter issue. The overloading conditions of the power transformer of an eco-district<sup>1</sup> induced by the introduction of photovoltaic (PV) panels and Electric Vehicles (EVs) are characterized. Initially, such a district, pictured in Fig. 4.1, only has residential and commercial facilities. It is connected to the distribution grid through an oil-immersed power transformer. The time frame is one full year. As underlined by Igualada et al. (2014), very little research has already been conducted on the coupling of local grid energy management with Vehicle-to-grid (V2G) strategies.

First, when there is neither PV nor EV in the district, the transformer is sized in such a way that overloading are allowed as long as the thermal limitations of the transformer are not exceeded. Then, the impacts of introducing PV units and EVs in the district on the operating conditions of the transformer are assessed. At this point, EVs are considered as dumb loads, i.e. they abide

---

<sup>1</sup>In France, the term *eco-district* is used to describe any kind of district whose conception and operation integrate an environmentally-oriented concern. It is thus a rather broad concept, which can be applied to a myriad of use cases.

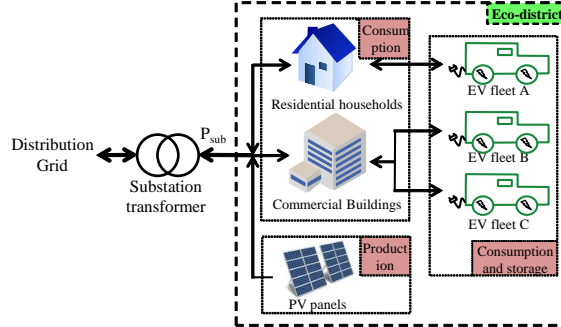

Figure 4.1: Eco-district Overview

by a "charge-as-plugged" strategy. Finally, the same analysis is conducted considering that EVs have bidirectional capabilities and that their charging and discharging patterns are controlled by an Energy Management System (EMS), whose aim is to mitigate the transformer overloading periods (thus, at this step, EVs turn into GIVs). These successive steps and scenarios are illustrated in Table 4.1.

Table 4.1: Description of the scenarios under study

<i>Scenario</i>	<i>Description</i>
Baseline scenario	Consumption of the residential houses and the tertiary building only
Dumb charging	Introduction of PV panels and EV fleets. No EMS
Controlled charging	Introduction of PV panels and EV fleets. GIVs charging / discharging patterns controlled by an EMS

The chapter is organized as follows. Section 4.2 provides a description of the system under study and all its components. In section 4.3, the transformer operating conditions are described in the *baseline* scenario and the EMS operating principle is explained. Section 4.4 provides the simulation results; the transformer overloading occurrences are characterized for the three scenarios from Table 4.1. Economic consequences are derived from these results in section 4.5. Finally, section 4.6 is the conclusion.

## 4.2 Eco-district Description

### 4.2.1 Residential Consumption Modeling

800 people are assumed to be living in the eco-district; they are spread over 200 residential houses. The residential consumption model is based on the study of

## 4.2. ECO-DISTRICT DESCRIPTION

---

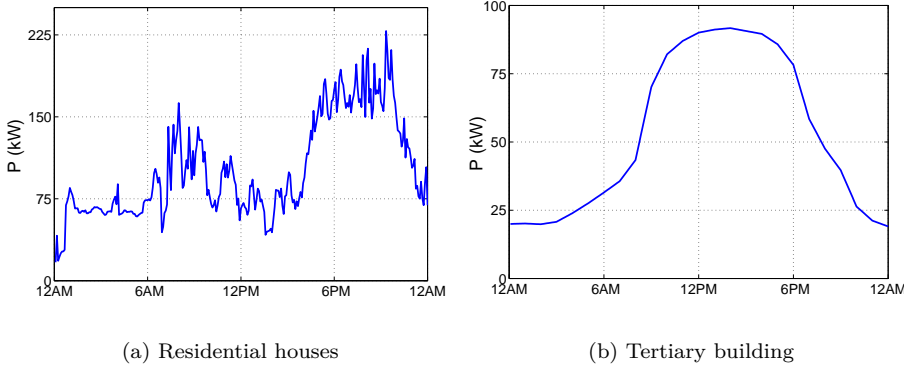

Figure 4.2: Typical daily load curves

Richardson et al. (2010), in which a stochastic model is proposed to simulate the inhabitants' behaviors. Indeed, electricity consumption in households is tightly linked to the occupants' activities. Thus, the model takes into account the use of electric appliances, lighting, heating and domestic water heaters at different times of the day. A typical daily load curve of the residential houses is provided in Fig. 4.2a.

### 4.2.2 Commercial Building Modeling

1000 people are assumed to be working in the tertiary building. The historical load data of a tertiary building which is allegedly located in the suburb of Paris are used. This building has a base load during the night time. In the early morning, the electric demand increases as cooling/warming systems (depending on the outdoor air temperature) come into action. This might trigger a short-lived load spike called morning start-up. Later, as working people arrive in the building and start their daily activities, the electricity consumption increases. The typical load curve varies on a daily and seasonal basis. At the end of the day, the power consumption reduces quite significantly, due to the fact that electric appliances are successively turned off. A typical daily load curve of the building is provided in Fig. 4.2b.

### 4.2.3 Electric Vehicle Fleet Modeling

All EVs are assumed to be full-electric vehicles. They have a 22kWh battery with a state of charge (SOC) constrained at any time in the range [20%, 90%] (see section 3.2.1). The EV fleet is divided into three different sub-fleets:

**EV fleet A:** people living in the eco-district. These EVs are typically plugged-in during the night at the district's residential houses, leave in the morning to go to work and come back at late afternoon;

**EV fleet B:** people working in the eco-district. These EVs typically arrive in the morning in the eco-district at the tertiary building site, and leave in late afternoon. They charge at work during the day;

**EV fleet C:** a company fleet, for instance belonging to the mail services. These EVs are typically used from early morning to noon for the first-round delivery tour, and from the early afternoon to the middle of the afternoon for the second-round delivery tour.

Fleets A and B have the same characteristics as the *Private Fleet* described in Table 3.5 and Table 3.15 respectively on pages 59 and 77. Fleet C has the same characteristics as the *Postal Mail Fleet* from Table 3.15. As a reminder, Electric Vehicle Supply Equipment (EVSE) power values are recalled in Table 4.2, and trip characteristics in Table 4.3. As in the previous chapter, a distinction between summer ( $c_s = 0.13\text{kWh/km}$ ) and winter ( $c_w = 0.18\text{kWh/km}$ ) consumptions is made.

Table 4.2: Electric Vehicle Supply Equipment (EVSE) power values for fleets A, B & C

<i>EVSE power level</i>	<i>Fleet A</i>	<i>Fleet B</i>	<i>Fleet C</i>
Slow (a) - 3kW	93%	35%	0%
Slow (b) - 7kW	7%	34%	0%
Intermediate charging - 22kW	0%	29%	100%
Fast charging - 43kW	0%	2%	0%

Table 4.3: Mean ( $\mu$ ) and standard deviation ( $\sigma$ ) values of EV fleet trip characteristics

<i>Parameters</i>	<i>Fleet A</i>		<i>Fleet B</i>		<i>Fleet C</i>	
	$\mu$	$\sigma$	$\mu$	$\sigma$	$\mu$	$\sigma$
Distance (km)	22	4.5	22	4.5	50 <sup>a</sup>	10 <sup>a</sup>
					30 <sup>b</sup>	10 <sup>b</sup>
Morning departure (h)	8	2	8	2	7	0.5
Afternoon departure (h)	18	2	18	2	14	0.5
Trips per day	2	n/a <sup>c</sup>	2	n/a <sup>c</sup>	2	n/a <sup>c</sup>
Speed (km/h)	40	n/a <sup>c</sup>	40	n/a <sup>c</sup>	10	n/a <sup>c</sup>

<sup>a</sup>Morning values, <sup>b</sup>Afternoon values, <sup>c</sup>Not Applicable

## 4.2. ECO-DISTRICT DESCRIPTION

---

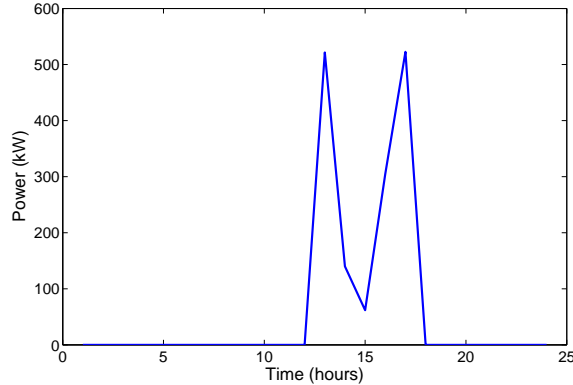

Figure 4.3: Example of a hourly-averaged PV production values for one particular day

Note that, as in the previous chapter, only some approximate trip characteristic values are provided, because the real values cannot be disclosed. Vehicle speeds are not distributed according to any probabilistic law because they are used to deduce trip durations from trip distances, which are themselves already distributed according to a Gaussian law

Several driver behaviors are considered. First, drivers of the fleet B are divided into two categories: (a) the drivers who have an "ordinary" behavior: they charge at home (outside of the district) during the night and are willing to participate in the EMS control strategy during the day in the district; and (b) the drivers who aim to charge as much as they can at work (because this energy is free) during the day. During the night, at home, they only charge the required energy for their morning trip, and they are not willing to participate in the EMS strategy during the day.

Then, range anxiety is also taken into account for all the drivers: as in the previous chapter, drivers are assumed to overestimate their future trip distances when they communicate this value to the EMS: they always provide their yearly maximum traveled distance (see equation (3.2) on page 60).

### 4.2.4 Photovoltaic Production Data

The photovoltaic production data was measured in the area of Paris, during one full year. The PV panels are located on the rooftop of the commercial building. Fig. 4.3 displays an example of the hourly-averaged PV production for one particular day. It is worth noting that PV production curves are very different from one day to the other, and that the curve presented in figure 4.3 is only an example for one day.



### 4.3 Transformer & Energy Management System Characterizations

First, the transformer sizing method is described. This method is implemented when the district only comprises of the residential houses and the tertiary building. Then, some criteria that will be used to characterize the transformer overloading events during the simulations are defined. Finally, the operating principle of the Energy Management System (EMS) is explained.

#### 4.3.1 Transformer Sizing

The rated power of the transformer depends on the transformer yearly load profile – at this step, induced only by the residential and tertiary loads. The net instantaneous power value,  $P_{sub}(t)$ , at the transformer substation is calculated according to (4.1):

$$P_{sub}(t) = - (P_{resi}(t) + P_{terti}(t)) \quad (4.1)$$

where  $P_{resi}(t)$  and  $P_{terti}(t)$  are respectively the consumption of the residential households and the tertiary building. Then, the yearly maximum substation power,  $P_{sub.max}$ , is computed according to equation (4.2):

$$P_{sub.max} = \max_t (-P_{sub}(t)) \quad (4.2)$$

A commercial transformer from a transformer manufacturer is selected (Schneider Electric, 2009). It has a rated apparent power  $S_{rated} = 315\text{kVA}$ . The active rated power is calculated with a low power factor (0.8) to be conservative:  $P_{rated} = 252\text{kW}$ .

Considering this rated power value, the overloading occurrences are compared with the thermal limitations indicated by the manufacturer (Schneider Electric, 2009). Results are provided in Fig. 4.4. It is worth noting that the Transformer is sized in such a way that not a single overloading occurrence exceeds the limitations.

#### 4.3.2 Characterization of the Transformer Operating Conditions

Here, the introduction of both the PV panels and the EV fleets, which charge according to a "charge-as-plugged" strategy, are considered. In other words, the EV charging patterns are not controlled by any third-party agent, and drivers plug-in as soon as possible (reflecting a normal and intuitive behavior).

Based on the fleet model described in section 4.2.3, the electric demand of the three EV fleets,  $P_{EV}(t)$ , is calculated. Its value is computed on a minute-basis. It differs significantly from one day to the other and from one season to the

<sup>2</sup>A commercial transformer was selected; in real life, other national standards might have to be taken into account for the transformer sizing.

### 4.3. TRANSFORMER & EMS CHARACTERIZATIONS

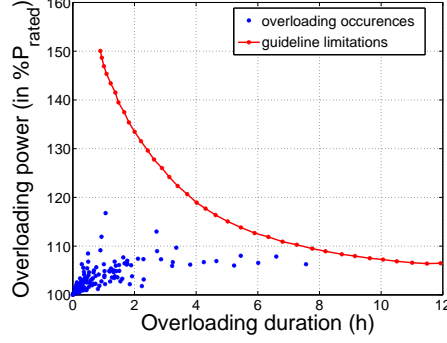

Figure 4.4: Operating conditions of the transformer (no EV & no PV) over one year of simulation

other. Then, the instantaneous net power value of the substation transformer is given by (4.3):

$$P_{sub}(t) = P_{PV}(t) - (P_{resi}(t) + P_{terti}(t) + P_{EV}(t)) \quad (4.3)$$

with  $P_{PV}$  the power produced by the PV panels. To characterize the overloading occurrences, the cumulative energy exchanged during the overloading occurrences  $E_{ex}$  is computed, as well as the cumulative durations of overloading periods  $d_{ov}$ , respectively according to equations (4.4) and (4.5) :

$$E_{ex} = \sum_{j=1}^{N_{ov}} \left( \int_{t_{a_j}}^{t_{b_j}} (|P_{sub}(t)| - P_{rated}) dt \right), t \in [t_{a_j}; t_{b_j}] \Rightarrow |P_{sub}(t)| > P_{rated} \quad (4.4)$$

$$d_{ov} = \sum_{j=1}^{N_{ov}} (t_{b_j} - t_{a_j}) \quad (4.5)$$

with  $[t_{a_j}, t_{b_j}]$  an overloading time interval and  $N_{ov}$  the number of overloading time intervals. The average daily substation overloading power of day  $i$   $P_{sub\_ave}^i$  is calculated as the energy exchanged during overloading intervals during day  $i$   $E_{ex}^i$  divided by the cumulative durations of overloading periods during day  $i$   $d_{ov}^i$ :  $P_{sub\_ave}^i = E_{ex}^i / d_{ov}^i$

#### 4.3.3 Energy Management System

##### Energy Management System Operating Principle

The Energy Management System (EMS) uses Grid Integrated Vehicles (GIVs) with bidirectional capabilities to mitigate the overloading periods of the transformer.

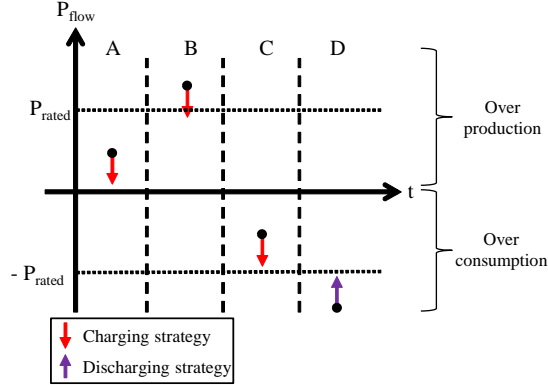

Figure 4.5: Energy Management System power flow strategy in the district

At each time stamp, the power flow  $P_{flow}(t)$  between the eco-district and the distribution grid (apart from the GIVs power flow used by the EMS) is calculated as follows:

$$P_{flow}(t) = P_{PV}(t) - (P_{resi}(t) + P_{terti}(t) + P_{EV}(t)) \quad (4.6)$$

where  $P_{EV}(t)$  denotes the consumption of EVs that are not available for the EMS – most of the time, because they need to charge for transportation needs, or because they are used by drivers from fleet B who do not allow their EV to take part in the EMS strategy (see 4.2.3). Then, based on the maximum available charging ( $P_{charg}$ ) and discharging ( $P_{disch}$ ) powers that GIVs can provide (see below), the EMS calculates the power  $P_{GIV}(t)$  that has to be actually supplied by the GIVs. It depends on the current balance between supply and demand in the district  $P_{flow}$ , as shown in Fig. 4.5.

The general rationale of the EMS is the following: as long as the transformer is not overloaded in consumption mode, the available GIVs are charged as much as possible; when the transformer is overloaded due to too much consumption from the district, the GIVs are discharged at the right amount to get back below the rated power. This approach is graphically illustrated on Fig. 4.5: in cases A, B and C, the EMS requests charging power from the available GIVs until  $P_{flow}$  reaches  $-P_{rated}$  (or until all GIV charging capabilities are used, i.e.  $P_{GIV} = P_{charg}$ ). When the transformer is overloaded in consumption mode (case D), the EMS requests discharging power until  $P_{flow}$  reaches  $-P_{rated}$  (or until all GIV discharging capabilities are used, i.e.  $P_{GIV} = P_{disch}$ ). Charging power is first requested from GIVs that have the lowest State-of-Charge (SOC) in comparison with their future needs for transportation. On the opposite, discharging power is first requested from GIVs that have the highest SOC.

The mathematical formulation of the calculation of  $P_{GIV}$  is provided in equation (4.7):

### 4.3. TRANSFORMER & EMS CHARACTERIZATIONS

---

$$P_{GIV}(t) = \begin{cases} \max(P_{charg}(t), -P_{flow}(t) - P_{rated}), & \text{cases A or B} \\ \max(P_{charg}(t), |P_{flow}(t)| - P_{rated}), & \text{case C} \\ \min(P_{disch}(t), |P_{flow}(t)| - P_{rated}), & \text{case D} \end{cases} \quad (4.7)$$

In these equations, positive power values stand for discharging power and negative power values stand for charging power. Finally, the net power flow at the substation level is given by (4.8):

$$P_{sub}(t) = P_{flow}(t) + P_{GIV}(t) \quad (4.8)$$

Fig. 4.6 sums up the entire EMS operating principle. It is worth noting that, with the current algorithm, the forecasted loads and PV production data are assumed to perfectly fit with the actual loads and PV production for the coming fifteen minutes. Further work could consist in adding uncertainty in the actual consumption and production levels compared to the EMS forecasts. However, the time resolution (15 minutes) is very short, and small differences would be expected.

#### Individual GIV Contributions

In order to respect the needs for future transportation, each EV decides for the next time stamp whether it participates in the EMS control strategy or not. GIVs provide the EMS with their available charging / discharging powers over the next period according to equation (4.9):

$$\begin{aligned} P_{charg_j}(t) &= -\min\left(P_{EVSE_j}, \frac{SOC_{max_j} - SOC_j(t)}{\Delta t}\right) \\ P_{disch_j}(t) &= \min\left(P_{EVSE_j}, \frac{SOC_j(t) - SOC_{req_j}}{\Delta t}\right) \end{aligned} \quad (4.9)$$

where  $P_{charg_j}(t)$  and  $P_{disch_j}(t)$  are respectively the available charging and discharging powers of the GIV  $j$  for the next time interval,  $P_{EVSE_j}$  is the EVSE power;  $SOC_j(t)$ ,  $SOC_{max_j}$  and  $SOC_{req_j}$  denote respectively the current, maximum and minimum required state of charge for the  $j^{\text{th}}$  GIV.  $\Delta t$  is the time stamp.

Finally, the EMS sums up all the individual GIV contributions:

$$\begin{aligned} P_{charg}(t) &= \sum_j P_{charg_j}(t) \\ P_{disch}(t) &= \sum_j P_{disch_j}(t) \end{aligned} \quad (4.10)$$

As an example, Fig. 4.7 illustrates the EMS impacts on the charging / discharging patterns of the GIV fleet. On this graph,  $P_{flow} < 0$  denotes that the district consumes more power than it produces with the PV panels and vice

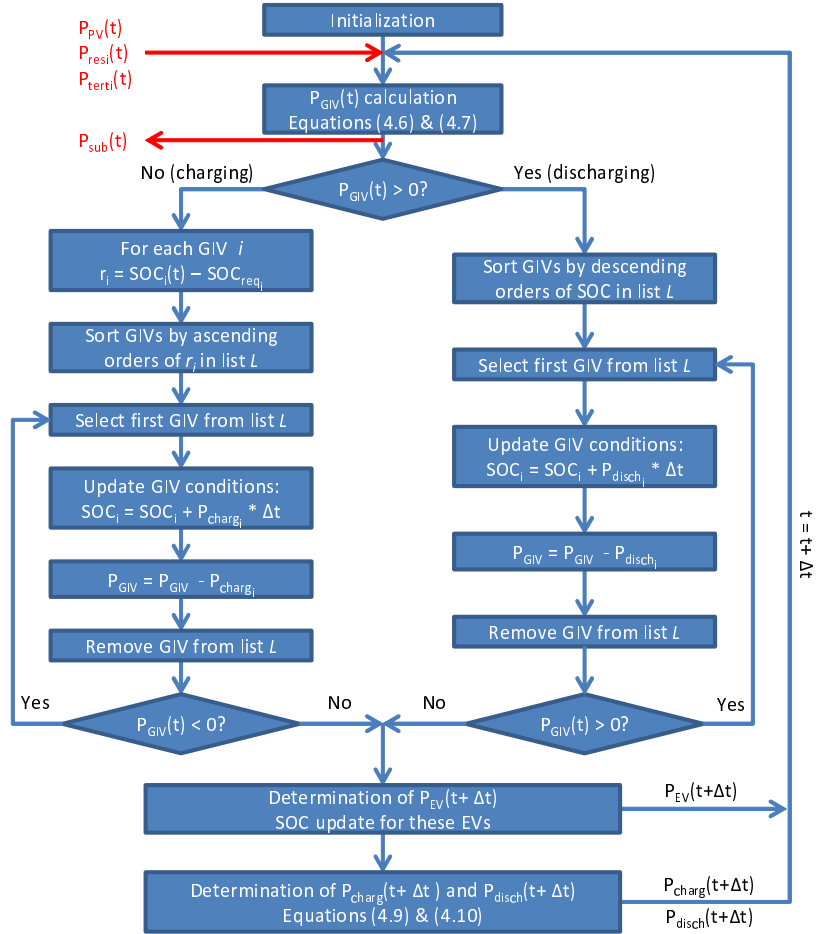

Figure 4.6: Energy Management System operating principle

versa;  $P_{GIV} > 0$  means that the GIVs are discharging and vice versa. As expected, when the district power exceeds the rated power in consumption mode ( $P_{flow} < -252\text{kW}$ ) GIVs discharge in order to mitigate the transformer overloading. The next section's objective is to characterize and quantify more precisely the impacts of the EMS implementation.

#### 4.4. MITIGATION OF OVERLOADING OCCURRENCES

---

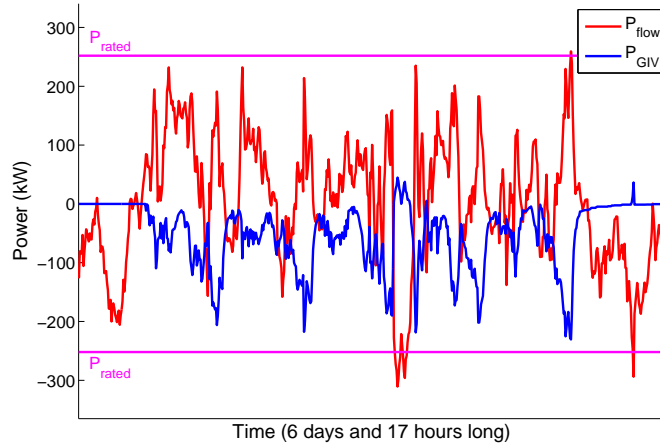

Figure 4.7: Variations of  $P_{flow}$  and  $P_{GIV}$  throughout more than six days of simulation

### 4.4 Technical Aspects: Using the Energy Management System to Mitigate Transformer Overloading

According to Fig. 4.4, considering the rated power chosen, the transformer undergoes some overloads. In this section, after having described the simulation parameters (section 4.4.1), the impacts of introducing PV panels and EV fleets on the transformer's overloads are evaluated, without and with the EMS (section 4.4.2). Finally, in section 4.4.3, the GIV individual contributions are more carefully analyzed in order to provide insights on the induced battery degradation, and on the adequacy with the use for transportation.

#### 4.4.1 Simulation Parameters

Twenty percent of the people living in the district and ten percent of the people working in the district are assumed to have an Electric Vehicle (EV) (fleets A and B). Additionally, the surface area of the PV panels is supposed to be 3000m<sup>2</sup> (which corresponds to the rooftop surface of the tertiary building considered) and there are 10 electric vehicles in the company fleet (the fleet C). Simulations are run over one full year with a 15-minute time stamp.

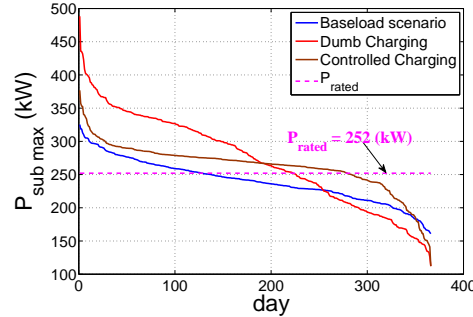

Figure 4.8: Substation daily peak powers for the whole year and for the different scenarios

#### 4.4.2 Transformer Operating Conditions with the Introduction of PV and EVs

The PV panels and the EV fleets are introduced in the eco-district. In a first step, all EVs follow a "charge-as-plugged" strategy. Then, the EMS strategy described in section 4.3.3 is applied. In both scenarios, the transformer overloading occurrences are characterized according to the criteria provided in section 4.3.2.

Fig. 4.8 pictures the substation daily peak power (in absolute value) for each day of the simulation, arranged by descending orders. The results are featured for: the baseline scenario (no EV, no PV), the dumb charging scenario (EV fleets and PV introduced, no EMS) and the controlled charging scenario (EV fleets and PV introduced, EMS strategy implemented). The EMS allows a reduction in substation yearly peak power by 23%. The daily peak power is reduced for the 200 days with the highest peak power values, and slightly increased for the other days: the EMS levels the curve in the controlled charging scenario. In other words, the EMS postpones part of the GIV fleets' power demand to periods when the overloading conditions are not critical or when the transformer is not overloaded. It is worth noting that the red curve is below the blue one for the last days: for some days of high PV production, the local production offsets the EV fleet demand, and even part of the other loads.

Finally, the transformer overloading occurrences' characteristics are compared between the *dumb charging* and *controlled charging* scenarios. Results are provided in Fig. 4.9<sup>3</sup>.

Due to the introduction of PV panels and uncontrolled EV fleets in the eco-district, there are more than 30 overloading occurrences that exceed the transformer thermal limitations (Fig. 4.9a). On the other hand, with the implementation of the EMS, all overloading occurrences are within the acceptable limits (Fig. 4.9b); the overloading characteristics are confined to the interval

<sup>3</sup>The overloading limitation guidelines used in this figure are provided by a transformer commercial manufacturer. Other approaches could be considered, in particular according to the IEC60076-7 standard.

#### 4.4. MITIGATION OF OVERLOADING OCCURRENCES

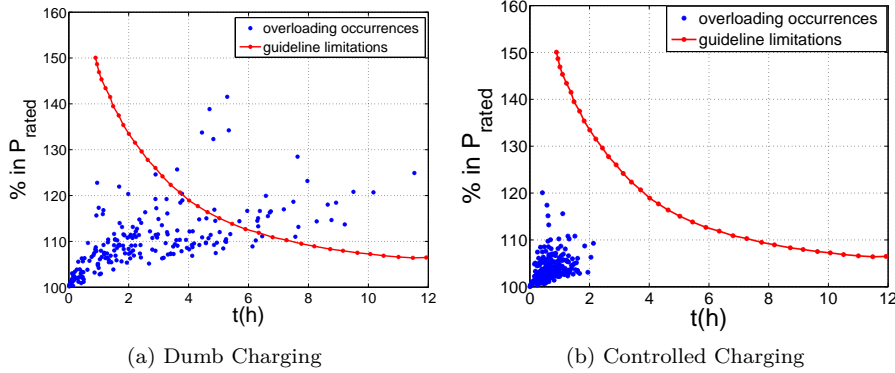

Figure 4.9: Operating conditions of the transformer during overloading occurrences, with respect to the limitations provided in (Schneider Electric, 2009)

[110%; 2h]<sup>4</sup>. These results are corroborated with those provided in Table 4.4, which compares the *dumb charging* and *controlled charging* scenarios on the substation yearly peak power ( $P_{sub-max}$ ), cumulative energy exchanged during the overloading occurrences ( $E_{ex}$ , equation (4.4)), cumulative overloading durations ( $d_o$ , equation (4.5)) and average overloading power ( $P_{sub-ave}$ ).

Table 4.4: Comparison of the dumb and controlled charging scenarios on the criteria defined in section 4.3.2

<i>Scenario</i>	$P_{sub-max}$ (kW)	$E_{ex}$ (MWh)	$d_{ov}$ (h)	$P_{sub-ave}$ (kW)
Dumb charging	488	21.2	613	35
EMS strategy	376	2.0	186	11
Improvement ratio (%)	23	90	70	71

The results provided in Table 4.4 are very promising: the energy exchanged during overloading periods is reduced by 90% with the EMS. Similarly, the cumulative overloading duration is reduced by 70%, and the average overloading power by 71%. The overloads that have a long duration but a relatively low overloading power are drastically reduced; some short peak overloads are more difficultly controlled, as they require a substantial amount of available power at a very precise period of time. This explains why the average energy exchanged is much more reduced than the peak power.

<sup>4</sup>Following discussions with the French DSO ERDF, it turned out that they set this interval as the acceptable overloading interval for their own transformers.



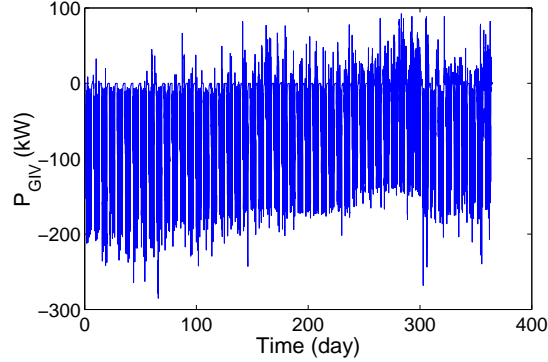

Figure 4.10: Power  $P_{GIV}$  provided by the GIV fleet for the EMS

### 4.4.3 Impacts on the Grid Integrated Vehicle Fleets' Conditions

The GIVs contribute significantly to the eco-district balance and to the reduction in transformer overloading conditions. Moreover, the EMS strategy always ensures that all GIVs have enough State-of-Charge (SOC) for their next trip.

Still, watching over the power solicitations of the GIVs induced by the EMS is important since it will provide insights into, among others, potential impacts on battery wear. Having too many discharge patterns could degrade the battery and reduce its lifetime, in particular if the Depth-of-Discharge of the cycles are important (see section 2.3.2 (page 42)).

Fig. 4.10 shows the power requested by the EMS from the participating GIVs  $P_{GIV}$  for the whole simulation year. Negative values stand for charging, and positive values stand for discharging.

First, it is worth noting that the EMS calls for charging power most of the time. Indeed, discharging power requests only represent 4% of the EMS requests. Moreover, discharging power requests are lower in absolute values than the charging power requests: in average, discharging power requests amount to 22kW while the average charging power request amounts to 46kW. The maximum discharging power requested is 92kW, while the maximum charging power requested (in absolute value) is 285kW.

These figures should be considered in relation to the GIV fleets' available power. Indeed, there are 270 EVs in the district. Even if only one EV out of four is available as a GIV (because others are being driven, need to charge for transportation, etc), it still makes 67 available GIVs. Thus, each available GIV should only discharge at less than 1.4kW to provide the full yearly discharge peak power.

Fig. 4.11 provides the cumulative energy discharged by the GIVs throughout the simulation (the energy charged is not pictured on this graph). The total amount of energy discharged from the GIVs, over the whole simulation year,

## 4.5. ECONOMIC ASPECTS

---

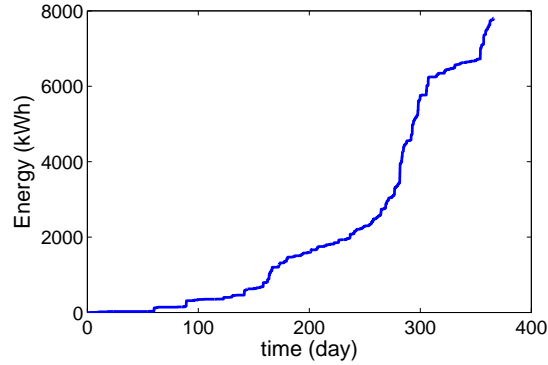

Figure 4.11: Cumulative energy discharged by the GIVs throughout the simulation

amounts to 7,800kWh. This comes down to 30kWh per GIV and per year (which is almost an equivalent to a full battery capacity). The energy discharged is therefore relatively low compared to the vehicles' capacities over one year.

All in all, these results show that the discharging power requests from the EMS have relatively low power and energy values in comparison with the GIVs' capabilities. In the end, these requests should not impact the battery life in a significant manner.

Generally speaking, the EMS proves to be very efficient in mitigating the transformer's overloads, and hereby in limiting the transformer overheating. Besides this technical approach, the EMS could also help reducing the electricity costs, and deferring grid reinforcement investments. Savings for both the district energy manager and the DSO could be achieved. This approach is tackled in the following section.

## 4.5 Cost Savings Achieved by Implementing the Energy Management System

Customers are under contract with their local Distribution System Operator (DSO); among others, this contract specifies the *contracted power* of the customer, i.e. the maximum acceptable power consumption<sup>5</sup> of the customer. If the latter exceeds this value, he/she will face financial penalties. It is worth noting that the contracted power value is not identical to the actual material power limitations (i.e. their *rated* powers).

In this section, the objective is to evaluate the financial savings that can be achieved by implementing the EMS as described in the previous section. First, the economic framework of the contract binding the eco-district manager and the

---

<sup>5</sup>The contracted power also applies to the production power if the customer operates as a generator.

DSO is defined (section 4.5.1). The contract's characteristics are based on the French rules. Then, the potential savings that can be achieved when the EMS is implemented are evaluated (section 4.5.2). The results from the previous section are used, and the eco-district contract's characteristics are optimized in order to minimize the yearly energy costs. Finally, an estimation of the reinvestment costs that could be avoided for the DSO due to the mitigation of the transformer overloading is provided (section 4.5.3).

### 4.5.1 French Economic Framework

The French economic framework is considered in order to determine the electricity costs of the eco-district. This framework is described in the so-called *tariff for use of public electricity networks*. This tariff is set by the French regulator (CRE) and available online (ERDF, 2014). Considering the value of the transformer rated power ( $P_{rated} = 252kW$ ), the district is connected at the medium voltage level (so-called HTA level in France). The cost structure is composed of: an energy component  $C_E$  which is related to the electricity consumption/production (kWh); a capacity component  $C_P$  which is related to the contracted power (kW); other components (such as metering and customer management costs) that are not related to the energy and power flows between the district and the grid.

The latter components are not taken into account since they will not be impacted by the energy management strategy. The two first components depend on when the energy exchanges occur. The eco-district is assumed to have a contract with a pricing structure divided into five different temporal classes; they are summarized in Table 4.5. In this Table, the power and energy coefficients that will be used later in the calculation of the power and energy components are also provided.

Table 4.5: The five temporal classes of the cost structure (ERDF, 2014)

<i>Class number</i>	<i>Corresponding period of time</i>	<i>Power coeff <math>k_i</math></i>	<i>Energy coeff <math>d_i</math> (c€/kWh)</i>
1	critical peak	100%	2.98
2	on-peak winter	92%	2.56
3	off-peak winter	55%	1.53
4	on-peak summer	40%	1.30
5	off-peak summer	12%	0.87

The power and energy coefficients are higher for the critical periods, i.e. for peak time periods and for winter. For each temporal class  $i$ , a specific contracted power value  $P_{c_i}$  has to be determined. These contracted powers should abide by the constraint expressed in equation (4.11), which ensures that the power contracted for the critical temporal classes is inferior to the power contracted

## 4.5. ECONOMIC ASPECTS

---

for the less critical temporal classes.

$$\forall i \in \{1; 4\}, P_{c_i} \leq P_{c_{i+1}} \quad (4.11)$$

Equation (4.11) and Table 4.5 show that savings can be achieved by shifting energy and power consumptions from critical periods to less critical ones.

### Capacity Component Calculation

The capacity component  $C_P$  is itself divided into two sub-components: the yearly capacity subscription cost  $C_{sub}$ , and the monthly overloading cost  $C_{over}$ . Both components are computed according to equation (4.12):

$$\begin{aligned} C_P &= C_{sub} + C_{over} \\ C_{sub} &= a_2 \left( k_1 \times P_{c_1} + \sum_{i=2}^5 k_i \times (P_{c_i} - P_{c_{i-1}}) \right) \\ C_{over} &= 0.15 \cdot k_i \cdot a_2 \times \sqrt{\sum (P_{sub} - P_{c_i})^2}, i \in \{1; 5\} \text{ and } |P_{sub}| \geq |P_{c_i}| \end{aligned} \quad (4.12)$$

with  $a_2 = 9.24$  (€/kW/year),  $P_{c_{1 \rightarrow 5}}$  and  $k_{1 \rightarrow 5}$  respectively the contracted powers and power coefficients for the five temporal classes, and  $P_{sub}$  the substation power.

$C_{sub}$  is calculated once for the whole year; it depends only on the five contracted power values. The smaller these five values, the smaller the yearly capacity subscription cost.

$C_{over}$  is calculated for each month, and depends mostly on the overloading power values with respect to the contracted power. It is worth noting that overloading occurrences during critical periods will induce more financial penalties than during less critical periods because of the weight induces by the power coefficients.

### Energy Component Calculation

The energy component  $C_E$  is computed according to equation (4.13):

$$C_E = \sum_{i=1}^5 d_i \times E_i \quad (4.13)$$

with  $d_{1 \rightarrow 5}$  the energy coefficients (see Table 4.5) and  $E_i$  the net energy exchanged during temporal class  $i$ . According to this equation, energy exchanges during non-critical periods cost less than during critical periods. Grid parity is supposed to be achieved, i.e. energy is sold at the same price as it is bought. As a matter of fact, grid parity is expected in France before 2020 (Photovoltaïque.info, 2015).

### Capacity Costs Optimization

In order to minimize the yearly electricity costs, an optimization problem is developed. Its objective function is the total capacity costs  $C_P$ :

$$\min_{P_{c_1 \rightarrow 5}} C_P \tag{4.14}$$

The problem is subject to the constraint expressed in equation (4.11). The power and energy flows between the district and the grid are given as parameters; they are issued from the previous section’s results (see section 4.4.2). The emphasis is put on the capacity costs because the EMS reduces the overloading power values which have a direct impact on the capacity costs.

### 4.5.2 Expected Yearly Savings for the Eco-district

The *dumb* (EV fleets and PV introduced in the district, but no EMS) and *controlled* (PV introduced, EV fleets controlled by the EMS) charging scenarios are compared. The results from the optimization problem described in section 4.5.1 are provided in Table 4.6.

Table 4.6: Optimal contracted powers with and without the implementation of the EMS

<i>Scenario</i>	$P_{c_1}$ (kW)	$P_{c_2}$ (kW)	$P_{c_3}$ (kW)	$P_{c_4}$ (kW)	$P_{c_5}$ (kW)
Dumb charging	406	406	406	406	406
Controlled Charging	288	288	310	310	310

In the dumb charging scenario, the transformer peak powers occur during the critical peak tariff period. As a consequence, and because of constraint (4.11), all the contracted power values are set by the contracted power of the critical peak period ( $P_{c_1}$ ). On the other hand, the EMS makes it possible to have contracted powers for high-tariff temporal classes lower than for low-tariff temporal classes. Moreover, the values of the contracted powers are significantly reduced. These results have an impact on the yearly electricity costs of the eco-district as shown in Table 4.7.

Table 4.7: Energy costs for both scenarios

<i>Scenario</i>	<i>Capacity costs</i> $C_P$ (k€)	<i>Energy costs</i> $C_E$ (k€)	<i>Total Electricity costs</i> (k€)
Dumb charging	4.01	15.5	19.51
Controlled charging	3.04	13.5	16.14
Improvement ratio (%)	24	13	17

## 4.6. PARTIAL CONCLUSION

---

The contracted power values are much lower with the EMS, so the capacity costs are reduced by 24% (around 1,000€). Overall, the savings in electricity costs are reduced by 17% (more than 3,000€). Breaking down these revenues by GIV, the savings amount to approximately 15€/GIV/year.

### 4.5.3 Reinforcement Costs Avoided

By mitigating the transformer overloading conditions, the EMS improves the transformer's lifetime since it reduces its overheating periods. DSO investment costs in a new transformer are either deferred, or merely not necessary any more. This represents potential savings for the DSO.

The savings achieved by postponing investments are defined in the literature as the difference between the initial investment and the net present value at the time when the investment is postponed (Delille et al., 2009; Eyer et al., 2004).

Let  $C_t$  be the cost of a new transformer for the eco-district. The Net Present Value (NPV) of this transformer after  $t$  years is:

$$NPV(t) = \frac{C_t}{(1+i)^t} \quad (4.15)$$

with  $i$  the discount rate.

Then, the savings achieved by deferring the investments to year  $t$  are:

$$Savings = C_t - \frac{C_t}{(1+i)^t} \quad (4.16)$$

According to Table 2.3 (page 33), a ground mounted MV/LV transformer costs up to 35,000€. Let's assume  $i=10\%$ , which is a standard value for discount rates in power systems (Eyer et al., 2004). The lifetime of a transformer depends on many parameters (Roselind, 2013). It is out of the scope of this thesis to account precisely for these parameters, thus a rule-of-thumb approach is used. A transformer lifetime is approximately 30 years. The results provided in Fig. 4.9 and Table 4.4 show very significant reductions in overloading power and energy values. Let's assume that these achievements improve the transformer lifetime by 15 years. Then, the savings for the DSO amount to 26,621€<sup>6</sup>.

These results highlight the fact that DSOs would have a vested interest in switching from their traditional *fit and forget* approach to an *active demand management* approach (see section 2.1.3 (page 32)).

## 4.6 Partial Conclusion

In this chapter, the yearly energy consumption of an eco-district composed of residential houses and of a tertiary building was modeled. Under such hypothesis, the district transformer was supposed to undergo some overloads.

---

<sup>6</sup>According to Table 2.3, these savings could be more important if investments in lines and cables reinforcement were taken into account.

Then, PV panels and three EV fleets were introduced in the district. The overloading occurrences of the transformer were monitored, and some very important overloading events were observed.

Finally, an Energy Management System (EMS) controlling the charging / discharging patterns of Grid Integrated Vehicles (GIVs) was implemented. The EMS drastically reduces the average power, energy exchanged and durations of the overloading events.

As a consequence, the transformer lifetime would be increased with the EMS. DSOs could defer reinforcement investments and save money by implementing such an EMS. Similarly, a district energy manager could reduce its total electricity costs by 17% over one year with the EMS.

GIVs could be valuable flexibility providers for local grid issues. In this chapter, the emphasis was put on local congestion. Voltage control could also be provided by GIVs. However, there is currently a lack of adapted framework to make it economically viable for GIV fleets. DSOs should make all endeavors possible to develop regulatory and economic frameworks for Distributed Energy Resources.

The results from this chapter call for more decentralization from the energy management system perspective<sup>7</sup>. Decentralized management approaches could open up possibilities for locational pricing, local balancing and optimization at community level. Besides the fact that decentralized management would yield benefits for more cost-causality based incentives, it is discussed by Goulden et al. (2014) that moving away from centralized system towards decentralized system furthermore encourages a new approach on consumption, moving from "passive energy consumer" towards an "active energy citizen". Therefore the use of current markets for DER management might be a transition phase possibly towards a decentralized techno-economic management approach of the electricity systems (Eid et al., 2016).

---

<sup>7</sup>See also the work of Beaudé (2015) on this topic.

## Chapter 5

# Field Demonstration Confirms the Theoretical Capabilities of Grid Integrated Vehicles

In chapters 3 and 4, simulations were conducted and demonstrated how EVs could be valuable flexibility providers while still meeting with the mobility needs of the users. In chapter 2, the technical challenges associated with these solutions were mentioned. In the present chapter, the results of real-life experiments that were conducted with two PSA Groupe vehicles are displayed: one Citroën Berlingo Electric with unidirectional capabilities only, and one Peugeot iOn with bidirectional capabilities. In particular, the objective is to show that the theoretical abilities of Grid Integrated Vehicles (GIVs) described in section 2.1.2 (page 26) are achieved in real-life conditions.

In order to test these GIVs in the most representative situation, both vehicles are incorporated into the Nikola project (Nikola project, 2016), a Danish demonstration project which aims to test the provision of grid services by GIVs.

In section 5.1 the Nikola project is briefly introduced. Then, the test procedures and their results for both the unidirectional and the bidirectional vehicles are described in sections 5.2.1 and 5.2.2, respectively. Section 5.3 provides a conclusion on the EV real-life abilities to provide grids services.

### 5.1 An introduction to the Nikola Project

The Nikola project is a Danish demonstration project focusing on the interaction between EVs and the electrical grid. It is a 2 million euro budget project funded by ForskEL (Danish public support). It lasted for three and a half years, from February 2013 to May 2016. There are four partners collaborating in this



project:

**The Danish Technical University (DTU)**  which is responsible for managing the project and coordinating all the project activities, and for evaluating the distribution grid services and the user added services.

**Nuvve**  which is a San Diego based startup company, responsible in the Nikola project for evaluating the system-wide services, for developing the user added services together with DTU, and for enabling technologies and standards.

**Eurisco**  is a Danish independent software development company in charge of the standards development and of the field tests in the Nikola project.

**Seas-nve**  is a Danish electricity provider. Its task is to assist in field tests and demonstrations.

The Nikola project consists of 7 work packages (WP) which are summed up on Fig. 5.1. **WP1** aims at assessing the possibility for GIVs to provide system-wide services, such as those tackled in chapter 3. Technical, economics and regulatory issues are addressed. The final objective of this task is to rank and prioritize the system-wide services in order to identify the ones that should be implemented first. **WP2** consists of the same analysis for distribution grid services, such as those studied in chapter 4. Again, the objective of this WP is to identify the most relevant local services based on a multidisciplinary approach. **WP3** focuses on the end-users and on the additional charging services that they could be provided with. In particular, customer involvement in the smart grids is addressed. A web user interface was developed to show how users could be involved in the smart grid management of their EVs, using a *gamification* process. **WP4** is to develop the required technologies for Electric Vehicles and their interaction with the grids. At last, real-life demonstration and field tests are in the scope of **WP6**; the tests described hereafter involving two PSA Groupe vehicles are part of this WP.

## 5.2 Contributions to the Project

Two PSA Groupe series vehicles were used in the Nikola project to participate in the field demonstrations: a unidirectional Citroën Berlingo Electric and a bidirectional Peugeot iOn. In the rest of the chapter, the tests that were conducted with both vehicles are described. All these tests were carried out within the EV lab of DTU, and performed by Nikola project members. The author's personal contribution lies mainly in the design of the test procedures, what was done in such a way that the tests were very close to the simulation model hypothesis.

In the literature, some papers implement tests with bidirectional power flows, such as the work done by Ota et al. (2015). However, none of these tests

## 5.2. CONTRIBUTIONS TO THE PROJECT

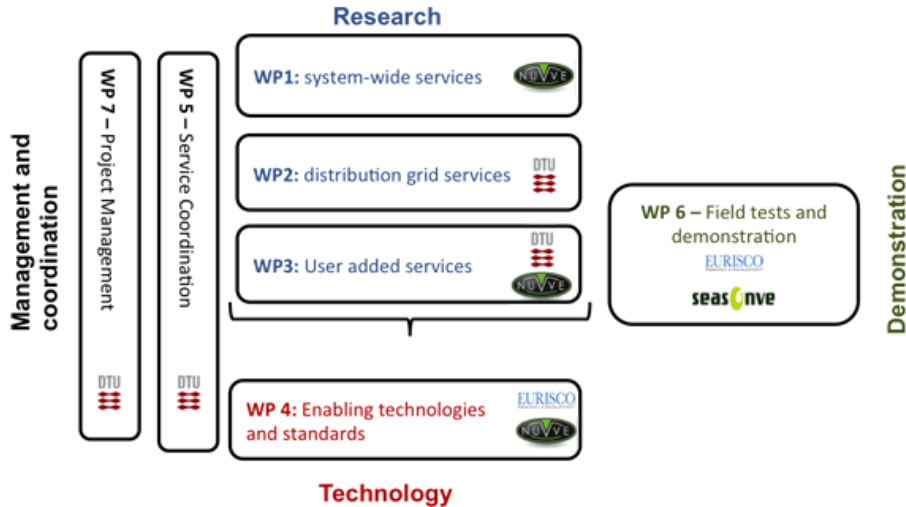

Figure 5.1: The seven work packages of the Nikola project

involve series EVs nor series EVSEs; rather, they are lab experiments using prototypes. On the other side, some research work, such as the one conducted by Mouli et al. (2016), present experimentation with series vehicles. However, only unidirectional capabilities are tested.

The main contribution of the present work, with respect to the state of practice, is to conduct tests with series vehicles, considering bidirectional capabilities and a complete IT framework.

### 5.2.1 The Tests Conducted with the Citroën Berlingo Electric Confirm Unidirectional Grid Integrated Vehicles' abilities

#### The Berlingo Electric Characteristics

The unidirectional car is a light duty vehicle Citroën Berlingo Electric. It is pictured on Fig. 5.2 at the DTU EV Lab facilities. This vehicle has a 22.5kWh battery, and is able to charge in modes 2 and 3<sup>1</sup> by means of its AC plug, up to 3.7kW with a 16A outlet. The complete description of the Berlingo Electric characteristics is available online (Automobile Propre, 2016b). The charging process of the Berlingo Electric follows the IEC 61851 standard; therefore, it is possible to control the Berlingo charging rate by means of the PWM signal of the control pilot according to IEC 61851-1 Annex D. It is then possible to control the charging current from 6A up to 16A (that it is to say from 1.4kW to 3.7kW).

<sup>1</sup>See section 1.3.2 (page 16) for the description of the charging modes.



Figure 5.2: The unidirectional Citroën Berlingo Electric at DTU facilities

### Test Procedure & Experimental Setup

The tests involving the Citroën Berlingo were led by Andreas Thingvad from DTU. The vehicle participates in the Frequency-controlled Normal operation Reserves (FNR) mechanism for seven consecutive hours. This control is implemented by Energinet.dk in Eastern Denmark (DK2, interconnected with the Nordic area). The participating units are required to respond linearly to frequency deviations, and to provide their full reserve power if the frequency deviation exceeds  $\pm 100\text{mHz}$ .

The FNR reserve power is to be provided symmetrically (see chapter 3 section 3.3). As a consequence, the Berlingo Electric has to provide upwards and downwards power reserves around a charging power setpoint (or preferred operating point (POP)). The POP value is set to 11A, so that the charging current can be modulated symmetrically by  $\pm 5\text{A}$  from 6 to 16A. The vehicle power-frequency droop is pictured on Fig. 5.3

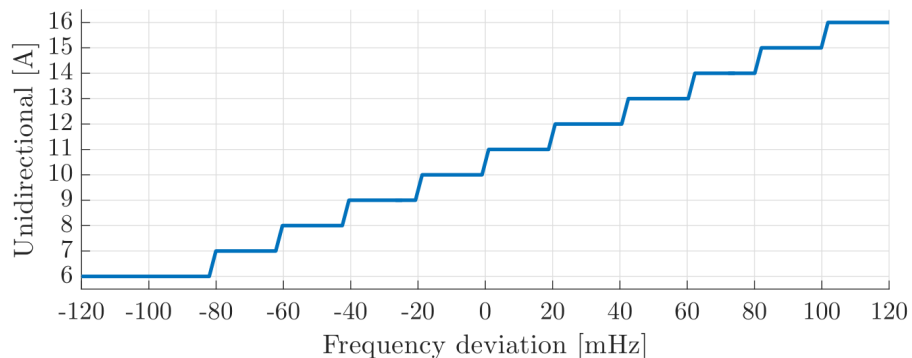

Figure 5.3: Citroën Berlingo Electric droop function

## 5.2. CONTRIBUTIONS TO THE PROJECT

The experimental setup is the following. A computer has a recording of seven consecutive hours of frequency data (recorded at DTU). These frequency values are converted into required vehicle current values by the computer based on Fig. 5.3. Then, at each second, the computer sends a corresponding PWM value to the EVSE, which then applies this PWM value on its control pilot line and thereby limits the Berlingo Electric charging current. The experimental setup is simply illustrated on Fig. 5.4. It is worth noting that this test is very representative of the simulation use case studied in chapter 3 section 3.3.1.

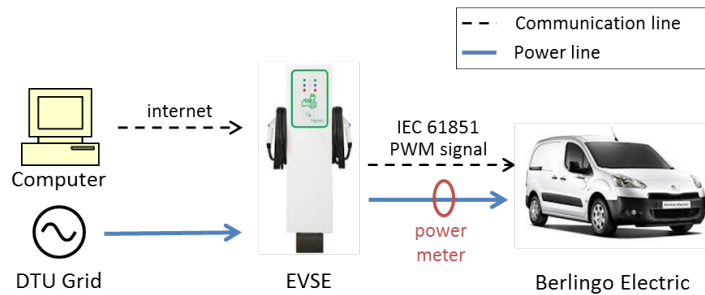

Figure 5.4: Experimental setup for the Berlingo Electric test

## Results

The responses of the Berlingo Electric to the computer requests are plotted on Fig. 5.5.

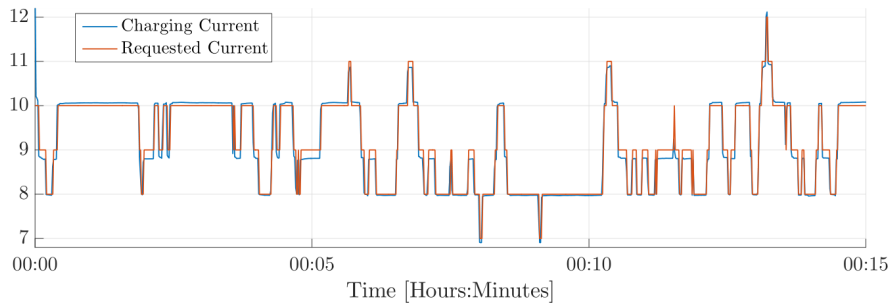

Figure 5.5: Computer requests and corresponding Berlingo Electric responses over 15 minutes of test

The Berlingo Electric is able to follow very accurately the computer request. The response time is extremely short, largely inferior to one second, which is satisfactory with respect to the FNR market requirements. The main limitation observed is that the vehicle charging current reaches (only) 15.3A when the

request is 16A, what is probably due to vehicle internal limitations<sup>2</sup>. The results over the seven hours of tests are presented on Fig. 5.6. The vehicle starts with a 60% SOC based on the publicly displayed information, i.e. the battery capacity is 13.5kWh and there are 9kWh of remaining energy room.

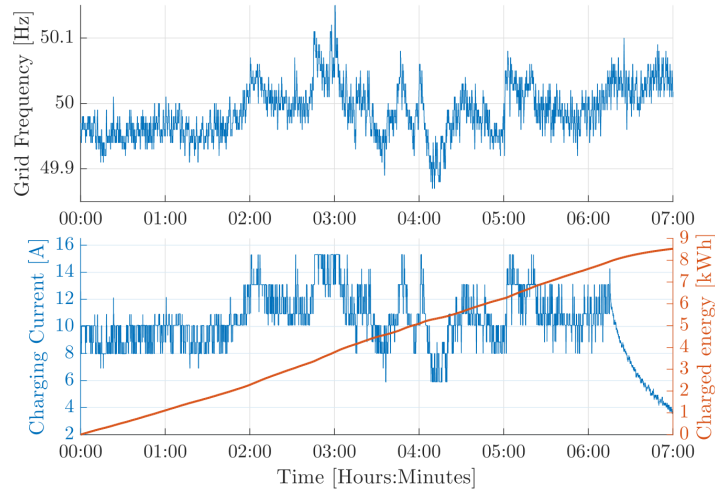

Figure 5.6: Experimental results for the Berlingo Electric over the seven testing hours

It is worth noting that the Berlingo Electric strictly follows the frequency variations until the battery charging mode switches from Constant Current (CC) to Constant Voltage (CV). The last 45 minutes are under the supervision of the Battery Management System (BMS), and the current limit imposed by the BMS is lower than the power requested by the computer.

## 5.2.2 The Tests Conducted with the Peugeot iOn Confirm Bidirectional Grid Integrated Vehicles' abilities

### The Peugeot iOn Characteristics

The vehicle used to conduct bidirectional tests is a Peugeot iOn. Such a vehicle has a 16kWh battery. It is able to charge at 3.7kW using AC charging in mode 2 or mode 3. It is also capable of doing fast charging thanks to its Chademo plug, up to 50kW. A picture of this vehicle is shown in figure 5.7.

The Chademo protocol enables bidirectional power exchanges, provided that both the vehicle and the charging station abide by the same Chademo discharge software version. The vehicle is equipped with such a discharge software, which was designed initially by Mitsubishi Motors. This protocol requires the vehicle

<sup>2</sup>The IEC 61851-1 Annex D part was initially designed for safety purposes only, and not for smart charging purposes.

## 5.2. CONTRIBUTIONS TO THE PROJECT

---



Figure 5.7: The bidirectional Peugeot iOn at DTU EV Lab facilities

and the charging station to exchange some precise data, such as the State-of-Charge (SOC) of the vehicle, the present AC current and voltage, etc. Communications between the EV and the EVSE are based on the CAN protocol.

### **Provision of Grid Services: Test Procedure & Experimental Setup**

The Peugeot iOn is plugged-in to a V2G bidirectional charging station manufactured by Endesa. This EVSE is equipped with a micro controller from Nuvve enabling a communication with the University of Delaware (UD) aggregation software (located on a server in Denmark). Thus, by means of internet communications, the EVSE is able to receive communication messages from the aggregator.

As a consequence, the Peugeot iOn is involved in the FNR DK2 market by means of direct control from the UD aggregator. The frequency value is measured every second locally in Denmark by means of a Multi-Transducer MTR-3 frequency meter (DEIF Company, 2016), which has a 10mHz resolution and a  $\pm 10\text{mHz}$  accuracy. The frequency value is then sent to the UD aggregator through the internet. In return, based on the frequency value and on the present iOn's conditions, the aggregator sends a power request to the iOn. The aggregator operating principle has been partly tackled in chapter 3 section 3.2.3. Bach Andersen et al. (2012) provide a more detailed description of the UD project. The experimental setup is summarized on Fig. 5.8.

By means of the bidirectional charging station, the charging power of the iOn can be modulated from  $-10\text{kW}$  to  $+10\text{kW}$ . The power requested by the aggregator is based on the FNR DK2 market rules, i.e. the vehicle is to respond linearly to frequency deviations from  $-100\text{mHz}$  to  $+100\text{mHz}$ . The aggregator also computes the preferred operating point (POP) of the vehicle according to the calculation process explained in chapter 3, section 3.2.3. In this precise experiment, the POP is kept null (the objective is simply to evaluate the capabilities of the iOn to follow the aggregators' requests) and the power variations are restricted to  $-8.5\text{kW}$  to  $+8.5\text{kW}$ .

It is worth noting that this test is very representative of the simulation use

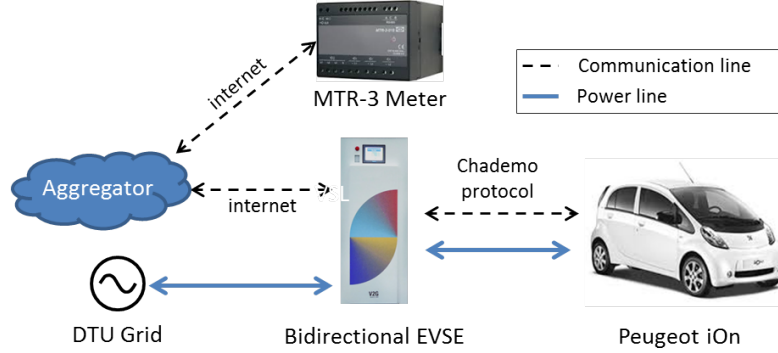

Figure 5.8: Experimental setup for the Peugeot iOn test

case studied in chapter 3 section 3.2.

## Results

The iOn is involved in the FNR mechanism for four consecutive hours, from 10:00 to 14:00 on May 26<sup>th</sup>, 2016. Fig. 5.9 provides the experimental results over the entire experiment duration. The UP and DOWN capacities are set to 8.5kW by the aggregator (with respect to the 10kW EVSE capabilities). Thus, the power request is always within -8.5kW and 8.5kW, while it happens that the response slightly exceeds these limitations. The regulation signal (request) varies significantly from one minute to the other, and extreme values are often reached. As may be seen on Fig. 5.9, the vehicle was able to follow the regulation signal very closely during the four consecutive hours.

Fig. 5.10 zooms in and displays the results for a shorter time scale (3 minutes). This figure shows that the average response time of the vehicle is approximately 5 seconds: the two data cursors show a six second response time for this particular point.

In order to ensure that the overall delay is five seconds, the correlation function of the two signals (request and response) is computed for several possible delays according to equation (5.1).

$$Corr(\tau) = \int_t (request(t) \cdot response(t - \tau) dt) \quad (5.1)$$

with  $Corr(\tau)$  the correlation between the request and the response with a delay of  $\tau$  seconds for the response. The delay maximizing the correlation between the two signals is  $\tau_{best} = 5s$ , which confirms the first graphical analysis.

It is worth noting that the vehicle's response increases and decreases stepwise. The Chademo protocol enables to specify very precisely the power requested (digital communications), thus it is not responsible for making these steps. The steps could come from any component in the command and traction chain: the EVSE computer, the EVSE power electronic unit, etc.

## 5.2. CONTRIBUTIONS TO THE PROJECT

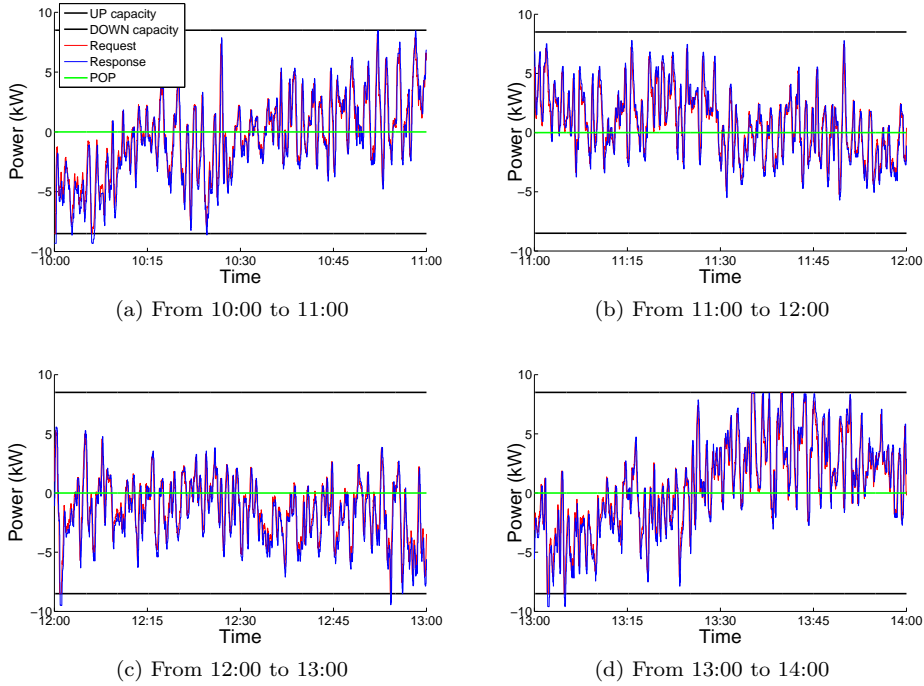

Figure 5.9: Experimental results of the frequency control experiment with the iOn for four consecutive hours

The variations of the iOn SOC are presented on Fig. 5.11 for the four experimental hours. They happen to be relatively null in average: after a severe decrease around 11:00, the SOC reaches back its original value around 13:30. However, it is worth noting that the SOC variations may be quite important. This is in particular due to the fact that frequency deviations are larger in eastern Denmark (interconnected with Sweden, Norway and Finland), where the tests were conducted, than in Continental Europe. Indeed, the Continental Europe area has more system inertia as it gathers more TSO areas.

In order to compare the SOC variations between the Continental Europe area and the Nordic region, the iOn SOC deviations are compared with the ones resulting from the simulations conducted in chapter 3. More precisely, a zoom in is performed on Fig. 3.9 (page 67) in order to have the same time window as in Fig. 5.11, i.e. for four hours. Results are displayed in Fig. 5.12

Although the charging power is not the same in simulation (3kW) and in the experiment (8.5kW), one can see that the SOC variations are much less significant when the GIV is operating in Continental Europe.



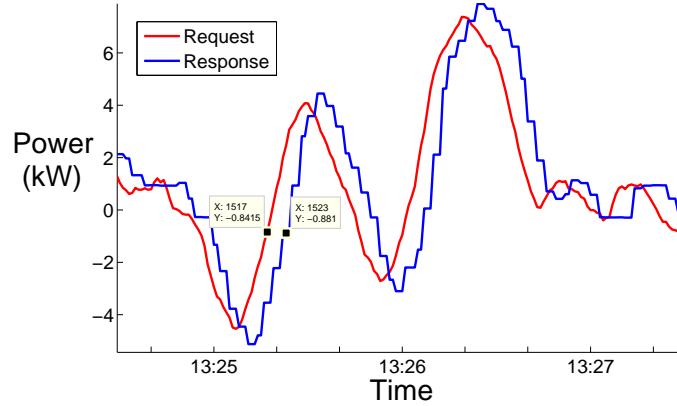

Figure 5.10: Experimental results of the iOn test over three minutes

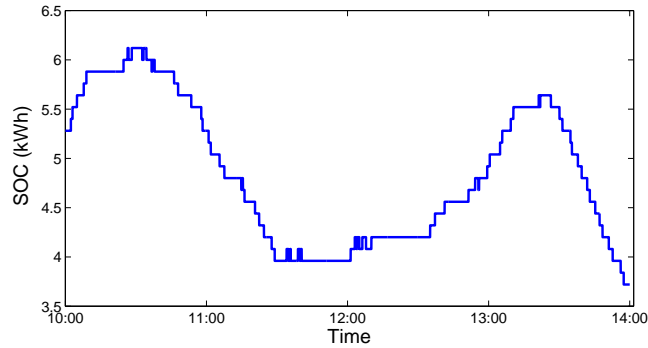

Figure 5.11: iOn SOC variations during four experimental hours

### 5.3 Partial Conclusion

In this chapter, the experimental results of two experiments that were conducted with two different PSA Groupe vehicles were presented. Both experiments were part of broader experiments conducted by the Nikola project.

The first experiment was carried out with a unidirectional Citroën Berlingo Electric, which took part in the Frequency-controlled Normal operation Reserve (FNR) for seven consecutive hours. The charging rate of the Berlingo Electric was modulated by means of the PWM control pilot signal. The results are very promising and show that the Berlingo Electric is able to follow a power request very accurately, with a negligible response time.

A bidirectional Peugeot iOn was used in the second experiment, together with a DC bidirectional charging station manufactured by Endesa. The charging station charger is controlled by the aggregation software implemented by the

### 5.3. PARTIAL CONCLUSION

---

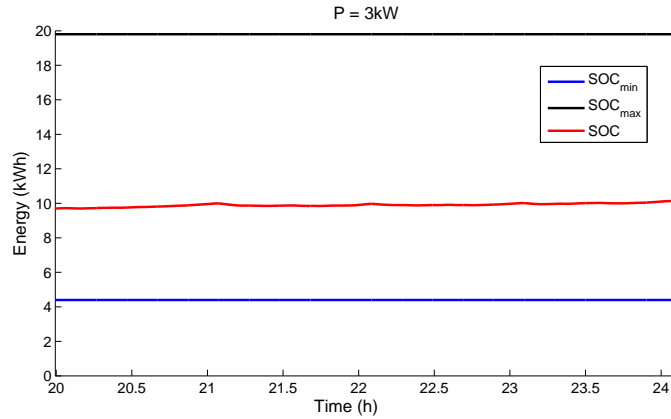

Figure 5.12: Zoom in Fig. 3.9. Four hour time window.

University of Delaware in such a way that the iOn participates in the FNR control mechanism. As in the previous experiment, the iOn performs very well and is able to follow the regulation signal command for the entire test duration (four hours). The overall response time, including communication delays between the frequency meter and the aggregator, and then between the aggregator and the charging station, is five seconds.

These results prove that both unidirectional and bidirectional Grid Integrated Vehicles (GIVs) have the technical characteristics that were used in the theoretical parts of this thesis in chapters 3 and 4: they have a very good accuracy and a very short response time.



## Chapter 6

# Conclusion and Recommendations

### 6.1 Conclusion Towards Research Objectives

Throughout this thesis, an in-depth analysis of the smart grid integration of Electric Vehicles (EVs) was conducted. First, Distributed Energy Resources (DERs) and their capabilities to provide flexibility services, i.e. to sustain a variation in power for a given duration, at a precise moment, were characterized. The mechanisms through which System Operators (SOs), both at the distribution (DSOs) and at the transmission (TSOs) levels, could procure and benefit from such flexibility products were also analyzed. TSOs already have two main means to procure flexibility products: bilateral contracts and auction markets. As a consequence, some DERs are already providing TSOs with flexibility products in some regions; however, the overall amount of flexibility products provided by DERs remains marginal, in particular because TSO rules are not really adapted to DERs. The European Union Energy Efficiency Directive, which is reflected in the ENTSO-E network codes, should make the rules evolve in the right direction in a near future. Meanwhile, there is a clear lack of existing means for DSOs to procure flexibility from DERs; due to historical and operational reasons, and due to the way they are financed, not a single DSO has yet created adapted flexibility procurement method. Nevertheless some DSOs, such as ENEL, are starting to show a great interest for DERs, and the required mechanisms are likely to emerge in the coming years.

Among all DERs, EVs have a great potential as flexibility providing units. Equipped with the necessary communication means, and potentially with bidirectional power electronic units (PEUs) enabling them to inject power back to the grid (providing so-called Vehicle-to-Grid (V2G) power), EVs are called Grid Integrated Vehicles (GIVs). GIVs are able to ramp up and down very quickly, they have a good availability and predictability (especially when they are gathered in an aggregation), and they are able to provide a fair amount of power.

Considering these technical characteristics, they appear to be more adapted to flexibility services that require quick power activations rather than long energy exchanges.

Several application areas where GIVs could provide flexibility services were identified: at home in individual housing, at work within company fleets, in residential dwellings and in public places. Company fleets are owned and operated by a single entity, and they have very regular trips, what makes them potential early adopters of smart charging/discharging solutions. On the other side, it will be more difficult – although not impossible – to implement sophisticated smart charging/discharging solutions at public places. Four benchmark scenarios that differ in terms of level of grid integration for the vehicles were also singled out. Each scenario provides the GIV owner with a wide range of newly available services; among others, GIV owners could maximize their self-consumption, or reduce the Total Cost of Ownership (TCO) of their vehicles. Caillat et al. (2016) calculate that the return on investment of these scenarios range from 5 months to a few years, which sounds very promising. These benchmark scenarios involve various stakeholders, which were listed and depicted. It is worth noting that some of these actors come from different industrial sectors, and are thus not used to working on common projects.

There are several challenges to the implementation of smart charging / discharging strategies. First, there are technical challenges. Energy losses should be monitored very closely because PEUs might operate far from their rated power value. Battery degradation should be assessed precisely for each service; however, first estimations show that battery wear could remain a marginal effect if handled properly. Additional costs due to communication means and hardware components have to be mastered: a bidirectional DC charging station costs today around 5,000€, while a bidirectional on-board charger would cost only a few hundreds euros. Then, there are regulatory challenges. GIVs are new entities for the SOs, thus the latter have to adapt their rules and regulation. Finally, there are economic challenges: although economic models were addressed in this thesis, there is an obvious lack of viable and efficient business models. The value created needs to be shared among the different actors involved. Each stakeholder's incentive should be determined in such a way that they all break even.

Two main simulation models were developed. The first one aimed at evaluating the potential revenues for a fleet of GIVs providing the local TSO with frequency control products. This model is based on an intensive survey of the frequency control rules, as well as on a detailed analysis of French typical trips for different fleet types. According to the results, with an ideal combination of TSO rules, bidirectional GIVs could earn from 150€/year to 500€/year depending on the Electric Vehicle Supply Equipment (EVSE) penetration level at workplaces. These remunerations could be actually more important as the model does not account for week-end remunerations, and as the EVSE power levels are likely to increase in the future. These simulations also point out the fact that frequency control markets could be saturated quite quickly by GIV fleets. Unidirectional vehicles require a particular market design to be able to

## 6.1. CONCLUSION TOWARDS RESEARCH OBJECTIVES

---

provide a fair amount of frequency control power: UP and DOWN products should be procured through two separate asymmetrical markets. Under such market design, a unidirectional GIV fleet is able to provide ten times as much power as under a symmetrical market design. Similarly, the smaller the market clearing period, the better the participation of a GIV fleet: the average participation of a GIV fleet with a one-hour clearing period is twice as important as with a four-hour clearing period. At last, the simulation results confirm that company fleets are particularly adapted to the provision of grid services.

The second simulation model assesses the possibility for a GIV fleet to participate in the general electric balance of an eco-district. The eco-district understudied comprises residential and commercial facilities, as well as local generation. The bidirectional GIV fleet charging patterns are controlled by a local Energy Management System (EMS) which objective is to mitigate the transformer overloading occurrences. The implementation of the EMS enables to reduce the energy exchanged during overloading periods by 90%, and the average overloading power by 71%. If such strategy is implemented with respect to the rated power of the transformer, the lifetime of the transformer is likely to increase (because of reductions in overheating periods), leading to savings for the transformer owner. Such savings were roughly evaluated for the eco-district transformer. Meanwhile, savings can be achieved for the eco-district operator by reducing the contracted power thanks to the EMS. With the French economic framework, results indicate that a reduction of 17% in electricity bill is achievable. Such results were obtained without significant solicitations for the GIV batteries: for instance, discharging power requests only represented 4% of the EMS requests.

At last, the operational and actual feasibility of the theoretical solutions proposed in this thesis were experimentally proved, using various technological solutions. Two PSA Groupe vehicles were included in the Nikola project, where GIVs are used to provide advanced grid services. The charging patterns of a unidirectional Citroën Berlingo Electric, controlled by means of the PWM control pilot signal (IEC 61581), were modulated in order to balance the frequency fluctuations according to the Frequency-controlled Normal operation Reserve (FNR) rules. The vehicle's response time was a few hundreds milliseconds, and it was able to provide FNR accurately for seven consecutive hours. In addition a bidirectional Peugeot iOn, using the Chademo protocol and a 10kW bidirectional charging station, also participated in the FNR control mechanism. Its charging / discharging patterns were controlled by the University of Delaware aggregator (located on a server in Denmark). For four consecutive hours, this vehicle participated in the frequency control mechanisms, and responded to the request with a response time of approximately five seconds.

In summary, the main contributions of this thesis to the state of the art are the following. First, an evaluation of the potential earnings of an EV fleet participating to frequency containment reserves was conducted, both for unidirectional and bidirectional vehicles. Then, the impacts of the regulatory framework on these potential earnings were evaluated: key sets of rules for EV fleets were identified and the impacts of changing some of the rules were quantified.

Moreover, some representative French characteristics were used for the EV fleet, based on multiple reliable sources. Finally, experimentation were carried out in order to validate the simulation model hypothesis with series electric vehicles including one with bidirectional capabilities.

Generally speaking, the findings of this thesis show that electric vehicles should be largely integrated in the power systems' operation. Such solutions would be beneficial to the all the stakeholders: EV owners, system operators, OEMs, charging station operators, etc. Indeed, EV owners could expect significant savings / earnings by having their EV involved in smart charging / discharging strategies. System operators would benefit from new flexibility sources; however, they have to make their rules and market designs evolve in order to capture the full potential of these new sources. OEMs and charging station operators could provide additional charging services to their customers. Thus, all these stakeholders should make all endeavors possible to develop smart charging / discharging solutions.

## 6.2 Recommendations and Future Work

This thesis provides a theoretical analysis of some grid services that could be provided by GIV fleets, as well as the experimental validation of the GIVs technical characteristics. Economic models were proved efficient, and technical characteristics were validated. However, some other aspects need to be further developed to complete the analysis of GIV possibilities.

First, real user involvement should be investigated. Both theoretical – customer surveys – and experimental – demonstration projects – approaches could be considered to evaluate the EV owner willingness to have its EV integrated in the smart grids. Several grid integration levels should be considered, with different impacts on the mobility usage and on the expected revenues for the user. Similarly, numerous types of users should be considered: commuters, car-sharing users, company fleet users, etc.

Then marketing aspects and business models should be studied in more details. What will be the roles of the different stakeholders? How should the revenues be shared among them? How to get the EV owner involved in the solution? What kind of incentive should be promoted? All these questions have yet not found any definitive answer.

Increased battery degradation due to the provision of grid services is still a concern for most of the stakeholders. Although preliminary analysis from various OEMs suggest that the induced battery wear should be limited, further experimental measurements should be conducted. Results could be made publicly available so as to reassure stakeholders and in particular battery owners.

There is today no existing mechanism enabling the remuneration of flexibility offers at the Distribution System Operator (DSO) level. Voltage control and congestion management are services that could be provided by Distributed Energy Resources (DER) and in particular GIVs, but corresponding remuneration mechanisms need to be created. Similarly, rules of existing Transmission

## 6.2. RECOMMENDATIONS AND FUTURE WORK

---

System Operator (TSO) markets should evolve towards more favorable rules for DERs. Thus, further research is required to help developing and promoting such new rules and regulation.

The preliminary work conducted in this thesis leads to three main recommendations for PSA Groupe<sup>1</sup>.

**Recommendation 1:** PSA Groupe should make all possible endeavors to have its future plug-in vehicles compatible with smart grid solutions. From a vehicle standpoint, this implies having the software solutions enabling high level communication between the vehicle and external third party actors. Hardware components are also required, such as bidirectional on-board chargers.

**Recommendation 2:** The associated business models and marketing aspects needs to be developed. In particular, customer involvement should be carefully studied. The OEM position in the value chain, among the other stakeholders, has to be clarified.

**Recommendation 3:** The impacts of having frequent charging / discharging cycles on the vehicle components should be carefully investigated. Obviously, battery wear is a major concern. However, other components such as battery contactors may age more rapidly because of such cycles.

An efficient solution to start addressing most of these issues would be to engage in medium scale pre-commercial demonstration projects involving several vehicles (from 10 to 30 GIVs could be a first estimation) and real users. Feedbacks from such projects would help understanding customer expectations and learning about business models and marketing aspects. Technological solutions could also be evaluated, and aging tests could be conducted during such an experiment.

At the same time, System Operators should implement favorable rules for GIV fleets. Transmission System Operators (TSOs) should adapt their market rules according to the findings from chapter 3: market designs should ease the aggregation of GIVs into coalitions; the payment scheme of system services should be enhanced; UP and DOWN products should be procured separately (asymmetrical markets); and the market clearing period should be reduced to short durations (e.g. one hour). Distribution System Operators (DSOs) should encourage the provision of flexibility products for congestion management and voltage control. Energy regulators should ask DSOs to conduct analysis in order to compare the traditional fit and forget approach with the more recent pro-active approach. If results show that a pro-active approach results in cost reductions for the DSOs, then suitable means to procure local flexibility products should be implemented.

---

<sup>1</sup>These recommendations could be extended to other OEMs; however, the state of progress of the other OEMs on this topic is unknown to the author, and therefore recommendations apply first and foremost for the group PSA.





# Bibliography

- Ackermann, T., Abbad, J., Dudurych, I., Erlich, I., Holttinen, H., Kristoffersen, J., and Sorensen, P. (2007). European Balancing Act. *IEEE Power and Energy Magazine*, 5(6):90–103.
- ADEME (2013). Élaboration selon les Principes des ACV des Bilans Energetiques, des Emissions de Gaz à Effets de Serre et des autres Impacts Environnementaux Induits par l'Ensemble des Filières de Véhicules Électriques et de Véhicules Thermiques, VP de segment B et VUL. Technical report, ADEME.
- Aghaei, J. and Alizadeh, M.-I. (2013). Demand response in smart electricity grids equipped with renewable energy sources: A review. *Renewable and Sustainable Energy Reviews*, 18:64–72.
- Al-Awami, A. T. and Sortomme, E. (2012). Coordinating Vehicle-to-Grid Services With Energy Trading. *IEEE Transactions on Smart Grid*, 3(1):453–462.
- Arteconi, A., Hewitt, N. J., and Polonara, F. (2013). Domestic demand-side management (DSM): Role of heat pumps and thermal energy storage (TES) systems. *Applied Thermal Engineering*, 51:155–165.
- Automobile Propre (2016a). Chiffres de vente & immatriculations de voitures électriques en france. <http://www.automobile-propre.com/dossiers/voitures-electriques/chiffres-vente-immatriculations-france/>, Last Accessed March 26<sup>th</sup>, 2016.
- Automobile Propre (2016b). Citroen berlingo electric. <http://www.automobile-propre.com/voitures/citroen-berlingo-electrique/>, Last Accessed April 30<sup>th</sup> 2016.
- AVEM (2013). Californie - un objectif de 1.5 millions de véhicules électriques d'ici 2025. <http://www.avem.fr/actualite-californie-un-objectif-de-1-5-millions-de-vehicules-electriques-d-ici-2025-3903.html>, Last Accessed March 17<sup>th</sup>, 2016.
- AVEM (2015). Mitsubishi outlander phev : en 2 ans, plus de 50 000 ventes en europe. Online. <http://www.avem.fr/actualite-mitsubishi-outlander-phev-en-2-ans-plus-de-50-000-ventes-en-europe-5894.html>, Last accessed March 26<sup>th</sup>, 2016.

- Avere (2016). Plus de 22 000 véhicules électriques immatriculés en France en 2015 ! [http://www.aver-france.org/Site/Article/?article\\_id=6424&from\\_espace\\_adherent=0](http://www.aver-france.org/Site/Article/?article_id=6424&from_espace_adherent=0), Last Accessed April 4<sup>th</sup>, 2016.
- Bach Andersen, P., Garcia-Valle, R., and Kempton, W. (2012). A comparison of electric vehicle integration projects. In *2012 3rd IEEE PES Innovative Smart Grid Technologies Europe (ISGT Europe)*, number 081216 in 1, pages 1–7. IEEE.
- Badey, Q. (2012). *Étude des mécanismes et modélisation du vieillissement des batteries lithium-ion dans le cadre d'un usage automobile*. PhD thesis, Université Paris-Sud.
- Barbé, D. (2014). Optimal current setpoint policy for energy losses minimization during battery charging process. In *European Electric Vehicle Congress (EEVC)*, pages 1–11.
- Beaude, O. (2015). *Modélisation et Optimisation de l'Interaction entre Véhicules Électriques et Réseaux d'Électricité : Apport de la Théorie des Jeux*. PhD thesis, University Paris-Saclay, CentraleSupélec, Gif-Sur-Yvette, France.
- Bessa, R. and Matos, M. (2010). The role of an aggregator agent for EV in the electricity market. In *7th Mediterranean Conference and Exhibition on Power Generation, Transmission, Distribution and Energy Conversion (MedPower 2010)*, pages 126–126. IET.
- Bloom, I., Cole, B., Sohn, J., Jones, S., Polzin, E., Battaglia, V., Henriksen, G., Motloch, C., Richardson, R., Unkelhaeuser, T., Ingersoll, D., and Case, H. (2001). An accelerated calendar and cycle life study of Li-ion cells. *Journal of Power Sources*, 101(2):238–247.
- Bloomberg New Energy Finance (2016). The electric vehicle revolution. <http://about.bnef.com/press-releases/electric-vehicles-to-be-35-of-global-new-car-sales-by-2040/>, Last Accessed July 1<sup>st</sup>, 2016.
- Board on Energy and Environmental Systems; Division on Engineering and Physical Sciences; Transportation Research Board (2013). *Overcoming Barriers to Electric-Vehicle Deployment*. National Academies Press, Washington, D.C.
- Breezcar website (2015). La poste : plus importante flotte de véhicules électriques au monde. <http://www.breezcar.com/actualites/article/groupe-la-poste-plus-grande-flotte-voitures-electriques-0715>, Last Accessed July 1<sup>st</sup>, 2016.
- Breezcar (2016). Véhicules "propres" : Honda majoritairement électrique en 2030. <http://www.breezcar.com/actualites/article/honda-voiture-hybride-electrique-et-hydrogene-2030>, Last Accessed March 26<sup>th</sup>, 2016.

## BIBLIOGRAPHY

---

- Broussely, M., Biensan, P., Bonhomme, F., Blanchard, P., Herreyre, S., Nechev, K., and Staniewicz, R. (2005). Main aging mechanisms in Li ion batteries. *Journal of Power Sources*, 146(1-2):90–96.
- Bruckner, T., Bashmakov, I. A., Mulugetta, Y., Chum, H., Navarro, A. d. l. V., Edmonds, J., Faaij, A., B. Fungtammasan, Garg, A., Hertwich, E., Honnery, D., Infield, D., Kainuma, M., Khennas, S., Kim, S., Nimir, H. B., Riahi, K., Strachan, N., Wisser, R., and Zhang, X. (2015). 2014: Energy Systems. In Edenhofer, O., Pichs-Madruga, R., Sokona, Y., E. Farahani, Kadner, S., Seyboth, K., Adler, A., I. Baum, Brunner, S., Eickemeier, P., Kriemann, B., Savolainen, J., Schlömer, S., von Stechow, C., Zwickel, T., and Minx, J., editors, *Climate Change 2014: Mitigation of Climate Change. Contribution of Working Group III to the Fifth Assessment Report of the Intergovernmental Panel on Climate Change*, chapter 7, pages 511 – 598. Cambridge University Press, Cambridge. <https://www.ipcc.ch/report/ar5/wg3/>.
- Caillat, O., Chevreau, M., Codani, P., Colet, F., Demay, I., Dobrowolski, B., Dumouchel, D., Dupuy, P., Mazzoni, S., Neau, E., and Ricaud, C. (2016). Feuille de route pour une intégration des véhicules rechargeables dans les réseaux électriques. Position Paper. Position Paper for the French Association for Standardization (AFNOR).
- California Independent System Operator (2009). Proposal for participation of non-generator resources in California ISO ancillary services markets. <http://www.caiso.com/246f/246fb968171e0.pdf>.
- California Independent System Operator (2011). Non-Generator Resources - Regulation Energy Management - Frequently Asked Questions. <https://www.caiso.com/Documents/FrequentlyAskedQuestions-NonGeneratorResourceRegulationEnergyManagementMarketSimulation.pdf>.
- California Independent System Operator (2013). Tariff Clarifications to Implement Pay for Performance Regulation. <http://www.caiso.com/Documents/TariffClarifications-ImplementPay-PerformanceRegulation.pdf>, Last Accessed July 1<sup>st</sup>, 2016.
- CCFA (2014). Les nouvelles normes d'émissions de CO<sub>2</sub> en Chine : un défi pour l'industrie automobile. Online. <http://www.ccfa.fr/Les-nouvelles-normes-d-emissions>, Last accessed March 17<sup>th</sup>, 2016.
- CCFA (2015a). PSA Peugeot Citroën leader en Europe dans la réduction des émissions de CO<sub>2</sub>. Online. <http://www.ccfa.fr/PSA-Peugeot-Citroen-leader-en-144632>, Last Accessed March 17<sup>th</sup>, 2016.
- CCFA (2015b). Toyota veut la fin des voitures tout carburant fossile d'ici à 2050. <http://www.ccfa.fr/Toyota-veut-la-fin-des-voitures>, Last Accessed March 26<sup>th</sup>, 2016.

- CCFA (2016). Comment la Chine veut promouvoir les véhicules électriques. Online. <http://www.ccfa.fr/Comment-la-Chine-veut-promouvoir-155774>, Last accessed March 17<sup>th</sup>, 2016.
- CGDD (2010). La mobilité des Français, panorama issu de l'enquête nationale transports et déplacements 2008. <http://www.developpement-durable.gouv.fr/IMG/pdf/Rev3.pdf>, Last Accessed July <sup>st</sup>, 2016.
- China (2015). Chinese INDC. Online. <http://www4.unfccc.int/submissions/INDC/Published%20Documents/China/1/China's%20INDC%20-%20on%2030%20June%202015.pdf>.
- Codani, P., Petit, M., and Perez, Y. (2014). Diversity of transmission system operators for Grid Integrated Vehicles. In *11th International Conference on the European Energy Market (EEM14)*, pages 1–5. IEEE.
- Commissariat General au Developpement Durable (2011). Les vehicules electriques en perspectives. <http://www.developpement-durable.gouv.fr/IMG/pdf/ED41.pdf>, Last Accessed July <sup>st</sup>, 2016.
- Commission de Regulation de l'Energie (2016). Services système et mécanisme d'ajustement. <http://www.cre.fr/reseaux/reseaux-publics-d-electricite/services-systeme-et-mecanisme-d-ajustement>, Last Accessed July 1<sup>st</sup>, 2016.
- Cross-border Mobility for EVs (2013). Online publications. <http://crome.forschung.kit.edu/francais/57.php>.
- Danish Energy Agency (2012). Energy statistics 2012. <http://www.ens.dk/sites/ens.dk/files/info/tal-kort/statistik-noegletal/aarlig-energistatistik/tables2012.xls>.
- DEIF Company (2016). Multi-Transducer - MTR-3. <http://www.deif.com/products-documentation/products/diesel/mtr3>, Last Accessed June 9<sup>th</sup>, 2016.
- Delille, G., Francois, B., and Malarange, G. (2009). Construction d'une offre de services du stockage pour les reseaux de distribution dans un contexte reglementaire deregule. *European Journal of Electrical Engineering*, 12(5-6):733–762.
- Derdevet, M. (2015). *Energie, l'Europe en Reseaux*. La documentation francaise.
- Divya, K. C. and Østergaard, J. (2009). Battery energy storage technology for power systems-An overview. *Electric Power Systems Research*, 79:511–520.
- Do, D. V. (2010). *Diagnostic de batteries Lithium ion dans des applications embarquées*. PhD thesis, Universite Technologique de Compiègne.

## BIBLIOGRAPHY

---

- Donadee, J. and Ilic, M. (2012). Stochastic co-optimization of charging and frequency regulation by electric vehicles. *North American Power Symposium (NAPS)*.
- Ehsani, M., Gao, Y., Gay, S. E., and Emadi, A. (2005). *Modern Electric, Hybrid Electric, and Fuel Cell Vehicles: Fundamentals, Theory and Design*. CRC Press.
- Eid, C., Codani, P., Perez, Y., Reneses, J., and Hakvoort, R. (2016). Managing Distributed Energy Resources in a Smart Grid Environment : A review for incentives, aggregation and market design. *Renewable and Sustainable Energy Reviews*.
- Electric Power Research Institute (2014). The Integrated Grid. <http://www.epri.com/Our-Work/Pages/Integrated-Grid.aspx>.
- Electric Reliability Council of Texas (2012). Nodal Protocols Section 8: Performance Monitoring. <http://www.ercot.com/mktrules/nprotocols/current>.
- Electric Reliability Council of Texas (2013a). Nodal Protocols Section 16: Registration and Qualification of Market Participants. <http://www.ercot.com/mktrules/nprotocols/current>.
- Electric Reliability Council of Texas (2013b). Nodal Protocols Section 3: Management Activities for the ERCOT System. <http://www.ercot.com/mktrules/nprotocols/current>.
- Electric Reliability Council of Texas (2013c). Nodal Protocols Section 4: Day-Ahead Operations. <http://www.ercot.com/mktrules/nprotocols/current>.
- Electric Reliability Council of Texas (2013d). Nodal Protocols Section 6: Adjustment Period and Real-Time Operations. <http://www.ercot.com/mktrules/nprotocols/current>.
- Energinet.dk (2012). Ancillary services to be delivered in Denmark Tender conditions. <http://energinet.dk/EN/El/Systemydelse-for-el/Sider/default.aspx>.
- Energinet.dk (2013). Energinet.dk market clearing prices. <http://energinet.dk/EN/El/Engrosmarked/Udtraek-af-markedsdata/Sider/default.aspx>.
- EPA (2012). Epa and nhtsa set standards to reduce greenhouse gases and improve fuel economy for model years 2017-2025 cars and light trucks. <https://www3.epa.gov/otaq/climate/documents/420f12051.pdf>.
- ERDF (2014). Tarif d'Utilisation du Reseau Public de Distribution d'Electricite (TURPE). [http://www.erdf.fr/sites/default/files/documentation/TURPE\\_{ }4\\_{ }Plaqueette.pdf](http://www.erdf.fr/sites/default/files/documentation/TURPE_{ }4_{ }Plaqueette.pdf).

- Etat Francais (2015). Arrêté du 28 août 2015 modifiant l'arrêté du 15 décembre 2009 relatif a la programmation pluriannuelle des investissements de production d'électricité. Legifrance. <https://www.legifrance.gouv.fr/eli/arrrete/2015/8/28/DEVR1520025A/jo/texte>.
- EU (2015). Intended nationally determined contribution of the eu and its member states. Online. <http://www4.unfccc.int/submissions/INDC/Published%20Documents/Latvia/1/LV-03-06-EU%20INDC.pdf>.
- Eurelectric (2015). Smart Charging: steering the charge, driving the change. [http://www.eurelectric.org/media/169888/20032015\\_paper\\_on\\_smart\\_charging\\_of\\_electric\\_vehicles\\_finalpsf-2015-2301-0001-01-e.pdf](http://www.eurelectric.org/media/169888/20032015_paper_on_smart_charging_of_electric_vehicles_finalpsf-2015-2301-0001-01-e.pdf).
- European Commission (2007). Strategic Research Agenda for Europe's Electricity Networks of the future. Technical report, European Commission. [StrategicResearchAgendaforEurope'sElectricityNetworksofthefuture](#).
- European Commission (2012). Press release about the vehicles' co<sub>2</sub> emissions objectives. Online. [http://europa.eu/rapid/press-release\\_IP-12-771\\_fr.htm?locale=en](http://europa.eu/rapid/press-release_IP-12-771_fr.htm?locale=en), Last Accessed March 17<sup>th</sup>, 2016.
- European Commission (2016). 2030 energy strategy. Online. <http://ec.europa.eu/energy/en/topics/energy-strategy/2030-energy-strategy>, Last Accessed March 17<sup>th</sup>, 2016.
- European Network of Transmission System Operators for Electricity (2012). Network Code on Demand Connection. <https://www.entsoe.eu/major-projects/network-code-development/demand-connection/Pages/default.aspx>, Last Accessed July 1<sup>st</sup>, 2016.
- European Network of Transmission System Operators for Electricity (2013). Network Code on Operational Security. <https://www.entsoe.eu/major-projects/network-code-development/operational-security/Pages/default.aspx>, Last Accessed July 1<sup>st</sup>, 2016.
- European Network of Transmission System Operators for Electricity (2014a). Network Code on Electricity Balancing. <http://networkcodes.entsoe.eu/>, Last Accessed July 1<sup>st</sup>, 2016.
- European Network of Transmission System Operators for Electricity (2014b). Network Code on Load-Frequency Control and Reserves. <https://www.entsoe.eu/major-projects/network-code-development/load-frequency-control-reserves/Pages/default.aspx>, Last Accessed July 1<sup>st</sup>, 2016.
- EV Volumes (2016). The electric vehicle world sales database. Online. <http://www.ev-volumes.com/>, Last Accessed April 4<sup>th</sup>, 2016.

## BIBLIOGRAPHY

---

- EvolvDSO project report (2014). D1.3 - Preliminary assessment of the future roles of DSOs, future market architectures and regulatory frameworks for network integration of DRES. <http://www.evolvdsso.eu/getattachment/26ff93f4-46d1-4e13-9e15-215bb3159c10/D1-3-v1-0.aspx>.
- Eyer, J. and Corey, G. (2010). Energy Storage for the Electricity Grid : Benefits and Market Potential Assessment Guide. Technical Report February.
- Eyer, J., Iannucci, I., and Corey, G. (2004). *Energy Storage Benefits and Market Analysis Handbook*. Sandia National Laboratories.
- Faruqui, A., Harris, D., and Hledik, R. (2010). Unlocking the 53 billion savings from smart meters in the EU: How increasing the adoption of dynamic tariffs could make or break the EU's smart grid investment. *Energy Policy*, 38(10):6222–6231.
- FERC (2011). Order 755 - Frequency Regulation Compensation in the Organized Wholesale Power Markets. <https://www.ferc.gov/whats-new/comm-meet/2011/102011/E-28.pdf>.
- FERC (2013). Order 784 - Third Party Provision of Ancillary Services; Accounting and Financial Reporting for New Electric Storage Techno.
- Fernández, I., Calvillo, C., Sánchez-Miralles, A., and Boal, J. (2013). Capacity fade and aging models for electric batteries and optimal charging strategy for electric vehicles. *Energy*, 60:35–43.
- FNET (2016). Frequency map gradient. Online. <http://fnetpublic.utk.edu/gradientmap.html>, Last Accessed on March 23<sup>rd</sup>, 2016.
- France Diplomatie (2016). Cop21 – la carte des contributions nationales. Online. <http://www.diplomatie.gouv.fr/fr/politique-etrangere-de-la-france/climat/paris-2015-cop21/les-contributions-nationales-pour-la-cop-21/article/la-carte-mondiale-des-contributions-nationales>, Last Accessed March 15<sup>th</sup>, 2016.
- García-Villalobos, J., Zamora, I., San Martín, J., Asensio, F., and Aperribay, V. (2014). Plug-in electric vehicles in electric distribution networks: A review of smart charging approaches. *Renewable and Sustainable Energy Reviews*, 38:717–731.
- Geelen, D., Reinders, A., and Keyson, D. (2013). Empowering the end-user in smart grids: Recommendations for the design of products and services. *Energy Policy*, 61:151–161.
- Glachant, J.-M., Khalfallah, H., Perez, Y., Rious, V., and Saguan, M. (2013). Implementing Incentive Regulation with Imperfect Regulators. *Competition and Regulation of Network Industries*, (2013-14-3):264–289.



- Goulden, M., Bedwell, B., Rennick-Egglestone, S., Rodden, T., and Spence, A. (2014). Smart grids, smart users? The role of the user in demand side management. *Energy Research & Social Science*, 2:21–29.
- Green eMotion (2013). D4.3 - B2: Grid Impact studies of electric vehicles ; Reinforcement Costs in Low-voltage Grids. Technical report.
- GridOnWheels project (2016). Gridonwheels project webpage. <http://grid-on-wheels.com>, Last Accessed July 1<sup>st</sup>, 2016.
- Guan, X., Luh, P., Yan, H., and Amalfi, J. (1992). An optimization-based method for unit commitment. *International Journal of Electrical Power & Energy Systems*, 14(1):9–17.
- Han, S., Han, S., and Aki, H. (2014). A practical battery wear model for electric vehicle charging applications. *Applied Energy*, 113:1100–1108.
- Han, S., Han, S., and Sezaki, K. (2012). Economic assessment on V2G frequency regulation regarding the battery degradation. In *2012 IEEE PES Innovative Smart Grid Technologies, ISGT 2012*.
- Hennebel, M. (2009). *Valorisation des Services Systeme sur un Réseau de Transport d'Electricite en Environnement Concurrentiel*. PhD thesis, University Paris-Sud 11.
- Hennebel, M. (2013). Cours 2 - réglage de la tension. Master course. Master course from Supelec Graduate School.
- Hoke, A., Brissette, A., Maksimovic, D., Pratt, A., and Smith, K. (2011). Electric vehicle charge optimization including effects of lithium-ion battery degradation. In *2011 IEEE Vehicle Power and Propulsion Conference*, pages 1–8, Chicago (USA). Ieee.
- Houwing, M., Negenborn, R. R., and De Schutter, B. (2010). Demand Response With Micro-CHP Systems. In *Proceedings of the IEEE*, volume 99, pages 200–213.
- Igualada, L., Corchero, C., Cruz-Zambrano, M., and Heredia, F.-J. (2014). Optimal Energy Management for a Residential Microgrid Including a Vehicle-to-Grid System. *IEEE Transactions on Smart Grid*, 5(4):2163–2172.
- Ingleson, J. W., Member, S., Allen, E., Interconnection, D. E., and Beta, A. (2009). Tracking the Eastern Interconnection Frequency Governing Characteristic. *Power and Energy Society General Meeting 2010 IEEE*, pages 1–6.
- Intergovernmental Panel on Climate Change (2015). Climate change 2014: synthesis report. summary for policymakers. Technical report, Intergovernmental Panel on Climate Change. [https://www.ipcc.ch/pdf/assessment-report/ar5/syr/AR5\\_SYR\\_FINAL\\_SPM.pdf](https://www.ipcc.ch/pdf/assessment-report/ar5/syr/AR5_SYR_FINAL_SPM.pdf).

## BIBLIOGRAPHY

---

- International Energy Agency (2013a). Key World Energy Statistics. <http://www.iea.org/publications/freepublications/publication/>.
- International Energy Agency (2013b). Photovoltaic and Solar Forecasting: State of the Art.
- International Energy Agency (2015). Global EV Outlook 2015: Key Takeaways. [http://www.iea.org/evi/Global-EV-Outlook-2015-Update\\_2page.pdf](http://www.iea.org/evi/Global-EV-Outlook-2015-Update_2page.pdf).
- Izadkhast, S., Garcia-Gonzalez, P., and Frias, P. (2015). An Aggregate Model of Plug-In Electric Vehicles for Primary Frequency Control. *IEEE Transactions on Power Systems*, 30(3):1475–1482.
- Kamboj, S., Kempton, W., and Decker, K. S. (2011). Deploying Power Grid-Integrated Electric Vehicles as a Multi-Agent System. *10th Int. Conf. on Autonomous Agents and Multiagent Systems - Innovative Applications Track (AAMAS)*, 1(Aamas):2–6.
- Kempton, W. and Letendre, S. (1997). Electric Vehilces as a new power electric utilities source for electric utilities. *Transportation Research Part D: Transport and Environment*, 2(3):157–175.
- Kempton, W. and Tomić, J. (2005). Vehicle-to-grid power implementation: From stabilizing the grid to supporting large-scale renewable energy. *Journal of Power Sources*, 144(1):280–294.
- Kempton, W., Udo, V., Huber, K., Komara, K., Letendre, S., Baker, S., Brunner, D., and Pearre, N. (2009). A Test of Vehicle-to-Grid ( V2G ) for Energy Storage and Frequency Regulation in the PJM System. Technical report.
- Knezovic, K., Marinelli, M., Codani, P., and Perez, Y. (2015). Distribution grid services and flexibility provision by electric vehicles: A review of options. In *2015 50th International Universities Power Engineering Conference (UPEC)*, pages 1–6, Staffordshire (UK). IEEE.
- Lam, A. Y. S., Leung, K.-c., and Li, V. O. K. (2014). Capacity Estimation for Vehicle-to-Grid Frequency Regulation Services with Smart Charging Mechanism. *IEEE Transactions on Smart Grid*, PP(99):1–11.
- Lee, C. K., Li, S., and Hui, S. Y. (2011). A design methodology for smart LED lighting systems powered by weakly regulated renewable power grids. *IEEE Transactions on Smart Grid*, 2:548–554.
- Liu, H., Hu, Z., Song, Y., and Lin, J. (2013). Decentralized Vehicle-to-Grid Control for Primary Frequency Regulation Considering Charging Demands. *IEEE Transactions on Power Systems*, pages 1–10.
- Lu, N., Xie, Y., Huang, Z., Puyleart, F., and Yang, S. (2008). Load component database of household appliances and small office equipment. In *IEEE Power and Energy Society 2008 General Meeting: Conversion and Delivery of Electrical Energy in the 21st Century, PES*, pages 1–5.

- Markiewicz, H. and Klajn, A. (2004). Voltage disturbances standard EN50160. Technical report.
- Millner, A. (2010). Modeling Lithium Ion battery degradation in electric vehicles. *2010 IEEE Conference on Innovative Technologies for an Efficient and Reliable Electricity Supply*, pages 349–356.
- Ministère de l'Écologie (2013). L'impact des EnR : regards croisés sur la Suède et la Californie. Online. <http://www.developpement-durable.gouv.fr/IMG/pdf/025.pdf>.
- Ministère de l'Environnement (2016). Politique de développement des énergies renouvelables en France. Online. <http://www.developpement-durable.gouv.fr/Politique-de-developpement-des,13554.html>, Last Accessed March 16<sup>th</sup>, 2016.
- Ministère Fédéral de l'Economie et de la Technologie (2015). Zahlen und fakten energiedaten. <http://www.bmwi.de/BMWi/Redaktion/Binaer/energie-daten-gesamt,property=blob,bereich=bmwi2012,sprache=de,rwb=true.xls>.
- Mouli, G. R. C., Kaptein, J., Bauer, P., and Zeman, M. (2016). Implementation of dynamic charging and V2G using Chademo and CCS/Combo DC charging standard. In *2016 IEEE Transportation Electrification Conference and Expo (ITEC)*, pages 1–6. IEEE.
- Musavi, F., Edington, M., Eberle, W., and Dunford, W. G. (2011). Energy efficiency in plug-in hybrid electric vehicle chargers: Evaluation and comparison of front end AC-DC topologies. In *2011 IEEE Energy Conversion Congress and Exposition*, pages 273–280. IEEE.
- NASA (2016a). Global climate change: effects. Online. <http://climate.nasa.gov/effects/>, Last Accessed March 15<sup>th</sup>, 2015.
- NASA (2016b). Global climate change: evidence. Online. <http://climate.nasa.gov/evidence/>, Last accessed March 15<sup>th</sup>, 2016.
- National Grid (2012a). Balancing code 3: Frequency control process. <http://www2.nationalgrid.com/uk/industry-information/electricity-codes/grid-code/the-grid-code/>, Last Accessed April 4<sup>th</sup>, 2016.
- National Grid (2012b). CUSC - Section 4 Balancing Services. <http://www2.nationalgrid.com/uk/industry-information/electricity-codes/cusc/the-cusc/>, Last Accessed April 4<sup>th</sup>, 2016.
- National Grid (2013). Grid Code Chapter 06 - Connection conditions. <http://www2.nationalgrid.com/uk/industry-information/electricity-codes/grid-code/the-grid-code/>, Last Accessed April 4<sup>th</sup>, 2016.

## BIBLIOGRAPHY

---

- Nielsen, E. and Alkemade, F. (2016). How is value created and captured in smart grids? A review of the literature and an analysis of pilot projects. *Renewable and Sustainable Energy Reviews*, 53:629–638.
- Nikola project (2016). Nikola project webpage. <http://www.nikola.droppages.com/>, Last Accessed April 30<sup>th</sup>, 2016.
- Ning, G., White, R. E., and Popov, B. N. (2006). A generalized cycle life model of rechargeable Li-ion batteries. *Electrochimica Acta*, 51(10):2012–2022.
- Nordentoft, N. C. (2013). Development of a dsp-market on flexibility services. Project report, iPower Project.
- NY Times (2015). China raises its targets for renewable energy. <http://www.nytimes.com/interactive/projects/cp/climate/2015-paris-climate-talks/china-raises-its-targets-for-renewable-energy>, Last Accessed March 17<sup>th</sup>, 2016.
- O’Sullivan, J., Rogers, A., Flynn, D., Smith, P., Mullane, A., and O’Malley, M. (2014). Studying the Maximum Instantaneous Non-Synchronous Generation in an Island System Frequency Stability Challenges in Ireland. *IEEE Transactions on Power Systems*, 29(6):2943–2951.
- Ota, Y., Taniguchi, H., Baba, J., and Yokoyama, A. (2015). Implementation of autonomous distributed V2G to electric vehicle and DC charging system. *Electric Power Systems Research*, 120:177–183.
- Pearre, N. S., Kempton, W., Guensler, R. L., and Elango, V. V. (2011). Electric vehicles: How much range is required for a day’s driving? *Transportation Research Part C: Emerging Technologies*, 19(6):1171–1184.
- Peterson, S. B., Apt, J., and Whitacre, J. (2010a). Lithium-ion battery cell degradation resulting from realistic vehicle and vehicle-to-grid utilization. *Journal of Power Sources*, 195(8):2385–2392.
- Peterson, S. B., Whitacre, J., and Apt, J. (2010b). The economics of using plug-in hybrid electric vehicle battery packs for grid storage. *Journal of Power Sources*, 195(8):2377–2384.
- Peterson, T. C. and Baringer, M. O. (2009). State of the Climate in 2008. *Bulletin of the American Meteorological Society*, 90(8):S1–S196.
- Photovoltaïque.info (2015). Parité avec le réseau. Online. <http://www.photovoltaïque.info/Parite-avec-le-reseau,203.html>, Last Accessed July 1<sup>st</sup>, 2016.
- Picciariello, A., Reneses, J., Frias, P., and Söder, L. (2015). Distributed generation and distribution pricing : Why do we need new tariff design methodologies ? *Electric Power Systems Research*, 119:370–376.

- Pieltain Fernandez, L., Gomez San Roman, T., Cossent, R., Mateo Domingo, C., and Frias, P. (2011). Assessment of the Impact of Plug-in Electric Vehicles on Distribution Networks. *IEEE Transactions on Power Systems*, 26(1):206–213.
- PJM Interconnection (2012). Manual 12: Balancing Operations. <http://www.pjm.com/~media/documents/manuals/m12.ashx>.
- PJM Interconnection (2013a). Manual 1: Control Center and Data Exchange Requirements. <http://www.pjm.com/~media/documents/manuals/m01.ashx>.
- PJM Interconnection (2013b). Manual 10: Pre-Scheduling Operations. <https://www.pjm.com/~media/documents/manuals/m10.ashx>.
- PJM Interconnection (2013c). Manual 11 : Energy & Ancillary Services. <http://www.pjm.com/~media/documents/manuals/m11.ashx>.
- Prefet Vuibert (2015). Livre Vert sur les infrastructures de recharge ouvertes au public pour les véhicules décarbonés. Technical report, CGDD.
- Raineri, R., Rios, S., and Schiele, D. (2006). Technical and economic aspects of ancillary services markets in the electric power industry : an international comparison. *Energy Policy*, 34(1010750):1540–1555.
- Rebours, Y. G., Kirschen, D. S., and Trotignon, M. (2007a). A Survey of Frequency and Voltage Control Ancillary Services Part I : Technical Features. *IEEE Transactions on Power Systems*, 22(1):350–357.
- Rebours, Y. G., Kirschen, D. S., and Trotignon, M. (2007b). A Survey of Frequency and Voltage Control Ancillary Services Part II : Economic Features. *IEEE Transactions on Power Systems*, 22(1):358–366.
- Réseaux de Transport d’Electricité (2004). Mémento de la sûreté du système électrique. [https://eco2mix.rte-france.com/uploads/media/pdf\\_zip/publications-annuelles/memento\\_surete\\_2004\\_complet\\_\\_.pdf](https://eco2mix.rte-france.com/uploads/media/pdf_zip/publications-annuelles/memento_surete_2004_complet__.pdf).
- Réseaux de Transport d’Electricité (2011a). Documentation technique de référence Article 8.10: Modèle de contrat de participation aux services système.
- Réseaux de Transport d’Electricité (2011b). Documentation Technique de Référence Chapitre 4.1 - Contribution des utilisateurs aux performances du RPT. [http://clients.rte-france.com/htm/fr/mediatheque/telecharge/reftech/30-06-05\\_article\\_4-8\\_\\_v1.pdf](http://clients.rte-france.com/htm/fr/mediatheque/telecharge/reftech/30-06-05_article_4-8__v1.pdf).
- Réseaux de Transport d’Electricité (2016a). Bilan électrique 2015. [http://www.rte-france.com/sites/default/files/2015\\_bilan\\_electrique.pdf](http://www.rte-france.com/sites/default/files/2015_bilan_electrique.pdf).

## BIBLIOGRAPHY

---

- Réseaux de Transport d'Electricité (2016b). RTE Frequency Data Set. Webpage. [https://clients.rte-france.com/lang/fr/visiteurs/vie/vie\\_frequence.jsp](https://clients.rte-france.com/lang/fr/visiteurs/vie/vie_frequence.jsp), Last Accessed July 1<sup>th</sup>, 2016.
- Richardson, I., Thomson, M., Infield, D., and Clifford, C. (2010). Domestic electricity use: A high-resolution energy demand model. *Energy and Buildings*, 42(10):1878–1887.
- Rious, V., Glachant, J.-M., Perez, Y., and Dessante, P. (2008). The diversity of design of TSOs. *Energy Policy*, 36(9):3323–3332.
- Roselind, J. (2013). *Lifetime Modeling and Management of Transformers*. PhD thesis, KTH Royal Institute of Technology.
- RTE (2014). Bilan previsionnel de l'equilibre offre-demande d'electricite en France. [http://www.rte-france.com/sites/default/files/bilan\\_complet\\_2014.pdf](http://www.rte-france.com/sites/default/files/bilan_complet_2014.pdf).
- Samarakoon, K., Ekanayake, J., and Jenkins, N. (2012). Investigation of domestic load control to provide primary frequency response using smart meters. *IEEE Transactions on Smart Grid*, 3:282–292.
- Sanden, B. (2013). *Systems Perspectives on Electromobility*. Chalmers.
- Schneider Electric (2009). Guide de la distribution electrique basse tension et HTA. <http://www.e-catalogue.schneider-electric.fr/navdoc/catalog/GD/catalogue/pdf/chapitre/gdA.pdf>.
- Schuster, H., Kellermann, J., Bongers, T., Gomez Oñate, V., and Hermes, R. (2014). EvolvDSOD Project report 2.1 - Business Use Cases Definition and Requirereport.
- Sharma, S., Huang, S.-H., and Sarma, N. (2011). System Inertial Frequency Response estimation and impact of renewable resources in ERCOT interconnection. In *2011 IEEE Power and Energy Society General Meeting*, pages 1–6. IEEE.
- Shinzaki, S., Sadano, H., Maruyama, Y., and Kempton, W. (2015). Deployment of Vehicle-to-Grid Technology and Related Issues. SAE Paper. <http://papers.sae.org/2015-01-0306/>.
- Short, T. (2014). Voltage Regulation. In *Electric Power Distribution Handbook*, chapter 6. CRC Press.
- Siemens (2016). Transformers. In *Power Engineering Guide*. Siemens Energy Sector. <http://www.energy.siemens.com/MX/pool/hq/power-transmission/Transformers/downloads/peg-kapitel-5.pdf>.
- Silva, V. and Kieny, C. (2011). G4V WP6 Report: Impacts of EV on Power Systems and minimal control solutions to mitigate these impacts. Technical report.

- Sims, R., Schaeffer, R., Creutzig, F., Cruz-Núñez, X., D'Agosto, M., Dimitriu, D., Meza, M. J. F., Fulton, L., Kobayashi, S., Lah, O., McKinnon, A., Newman, P., Ouyang, M., Schauer, J. J., and D. Sperling, G. T. (2015). 2014: Transport. In Edenhofer, O., Pichs-Madruga, R., Sokona, Y., Farahani, E., Kadner, S., Seyboth, K., Adler, A., Baum, I., Brunne, S., Eickemeier, P., Kriemann, B., Savolaine, J., Schlömer, S., von Stechow, C., Zwickel, T., and Minx, J., editors, *Climate Change 2014: Mitigation of Climate Change. Contribution of Working Group III to the Fifth Assessment Report of the Intergovernmental Panel on Climate Change*, chapter 8. Cambridge University Press, Cambridge. <https://www.ipcc.ch/report/ar5/wg3/>.
- Sioshansi, R. and Denholm, P. (2009). The Value of Plug-In Hybrid Electric Vehicles as Grid Resources. *The Energy Journal*, pages 1–16.
- Sortomme, E. and El-Sharkawi, M. a. (2012). Optimal Combined Bidding of Vehicle-to-Grid Ancillary Services. *IEEE Transactions on Smart Grid*, 3(1):70–79.
- The Guardian (2016). Denmark broke world record for wind power in 2015. <https://www.theguardian.com/environment/2016/jan/18/denmark-broke-world-record-for-wind-power-in-2015>, Last Accessed July 1<sup>th</sup>, 2016.
- Tomiyaama, K., Daniel, J., and Ihara, S. (1998). Modeling air conditioner load for power system studies. *IEEE Transactions on Power Systems*, 13:414–421.
- Union for the Co-ordination of Transmission of Electricity (2004). Operation Handbook. Technical Report June, Union for the Co-ordination of Transmission of Electricity.
- USA (2015). USA INDC. <http://www4.unfccc.int/submissions/INDC/Published%20Documents/United%20States%20of%20America/1/U.S.%20Cover%20Note%20INDC%20and%20Accompanying%20Information.pdf>.
- Vandael, S., Holvoet, T., Deconinck, G., Kamboj, S., and Willett, K. (2013). A comparison of two V2G mechanisms for providing ancillary services at the University of Delaware. In *IEEE International Conference On Smart Grid Communications*, pages 211 – 216, Vancouver (Canada). IEEE.
- Victor, D. G., Zhou, D., Ahmed, E. H. M., Dadhich, P. K., Olivier, J. G. J., Rogner, H.-H., Sheikho, K., and Yamaguchi, M. (2015). 2014: Introductory Chapter. In Edenhofer, O., Pichs-Madruga, R., Sokona, Y., Farahani, E., Kadner, S., Seyboth, K., Adler, A., Baum, I., Brunner, S., Eickemeier, P., Kriemann, B., Savolainen, J., Schlömer, S., VonStechow, C., Zwickel, T., and Minx, J., editors, *Climate Change 2014: Mitigation of Climate Change. Contribution of Working Group III to the Fifth Assessment Report of the Intergovernmental Panel on Climate Change*, chapter 1, pages 109–150. Cambridge University Press, Cambridge. <https://www.ipcc.ch/report/ar5/wg3/>.

## BIBLIOGRAPHY

---

- Wikipedia (2016). Corporate Average Fuel Economy. Online. [https://en.wikipedia.org/wiki/Corporate\\_Average\\_Fuel\\_Economy](https://en.wikipedia.org/wiki/Corporate_Average_Fuel_Economy), Last Accessed March 17<sup>th</sup>, 2016.
- Wong, S. and Pelland, S. (2013). Demand response potential of water heaters to mitigate minimum generation conditions. In *2013 IEEE Power & Energy Society General Meeting*, pages 1–5.
- World Nuclear Association (2011). Comparison of lifecycle greenhouse gas emissions of various electricity generation sources. Technical report, World Nuclear Association. [http://www.world-nuclear.org/uploadedFiles/org/WNA/Publications/Working\\_Group\\_Reports/comparison\\_of\\_lifecycle.pdf](http://www.world-nuclear.org/uploadedFiles/org/WNA/Publications/Working_Group_Reports/comparison_of_lifecycle.pdf).
- Wu, D., Aliprantis, D., and Ying, L. (2012). Load scheduling and dispatch for aggregators of plug-in electric vehicles. *Smart Grid, IEEE Transactions on*, 3(1):368–376.
- Yang, Z., Zhang, J., Kintner-Meyer, M. C. W., Lu, X., Choi, D., Lemmon, J. P., and Liu, J. (2011). Electrochemical Energy Storage for Green Grid. *Chemical Reviews*, 111(5):3577–3613.
- Yu Chen, Zhao Xu, and Ostergaard, J. (2008). Frequency analysis for planned islanding operation in the Danish distribution system - Bornholm. In *2008 43rd International Universities Power Engineering Conference*, pages 1–5. IEEE.
- Zhou, C., Qian, K., Allan, M., and Zhou, W. (2011). Modeling of the Cost of EV Battery Wear Due to V2G Application in Power Systems. *IEEE Transactions on Energy Conversion*, 26(4):1041–1050.



BIBLIOGRAPHY

---

# Publications

## International Journals

**Codani, P.**, Perez, Y., Petit, M. (2016). Financial Shortfall for Electric Vehicles: economic impacts of Transmission System Operators market designs. *Energy*. *Accepted for publication*

Eid, C., **Codani, P.**, Perez, Y., Reneses, J., Hakvoort, R. (2016). Managing electric flexibility from Distributed Energy Resources: A review of incentives for market design. *Renewable and Sustainable Energy Reviews*. 64, 237–247. doi:10.1016/j.rser.2016.06.008

**Codani, P.**, Portz, P.L. Le, Claverie, P., Petit, M., Perez, Y. (2016). Coupling local renewable energy production with electric vehicle charging: a survey of the French case. *International Journal of Automotive Technology and Management*. 16, 55. doi:10.1504/IJATM.2016.076443

**Codani, P.**, Petit, M., Perez, Y. (2015). Participation of an electric vehicle fleet to primary frequency control in France. *International Journal of Electric and Hybrid Vehicles* 7, 233. doi:10.1504/IJEHV.2015.071639

## International Conferences

Dang, X., Petit, M., **Codani, P.** (2015). Energy optimization in an eco-district with electric vehicles smart charging. In: *2015 IEEE Eindhoven PowerTech*. *IEEE*, pp. 1–6. doi:10.1109/PTC.2015.7232574

Dang, X., Petit, M., **Codani, P.** (2015). Transformer operating conditions under introduction of PV and EVs in an eco-district, in: *2015 IEEE Power & Energy Society General Meeting*. *IEEE*, Denver, pp. 1–5. doi:10.1109/PESGM.2015.7286380

Eid, C., **Codani, P.**, Chen, Y., Perez, Y., Hakvoort, R. (2015). Aggregation of demand side flexibility in a smart grid: A review for European market design,

in: *2015 12th International Conference on the European Energy Market (EEM)*. *IEEE*, Lisboa, pp. 1–5. doi:10.1109/EEM.2015.7216712

Knezovic, K., Marinelli, M., **Codani, P.**, Perez, Y. (2015). Distribution grid services and flexibility provision by electric vehicles: A review of options, in: *2015 50th International Universities Power Engineering Conference (UPEC)*. *IEEE*, Staffordshire (UK), pp. 1–6. doi:10.1109/UPEC.2015.7339931

**Codani, P.**, Petit, M., Perez, Y (2014). Diversity of transmission system operators for Grid Integrated Vehicles, in: *11th International Conference on the European Energy Market (EEM14)*. *IEEE*, pp. 1–5. doi:10.1109/EEM.2014.6861209

## Book Chapters

**Codani, P.**, Perez, Y., Petit, M. (2015). Electric Vehicle as a mobile storage device, in: Yan, J. (Ed.), *Handbook of Clean Energy Systems*. Wiley.

## Position Paper

Caillat, O., Chevreau, M., **Codani, P.**, Colet, F., Demay, I., Dobrowolski, B., Dumouchel, D., Dupuy, P., Mazzoni, S., Neau, E., and Ricaud, C. (2016). Feuille de route pour une intégration des véhicules rechargeables dans les réseaux électriques. *Position Paper for the French Association for Standardization (AFNOR)*.

## Appendix A

# Secondary Frequency Control Provision with Electric Vehicles

In chapter 3, we have shown that Grid Integrated Vehicles (GIVs) could be very valuable providers of primary frequency control in France, if some regulatory adaptations were made by the Transmission System Operator (TSO). In this section, we target the secondary frequency control. This control differs from the primary one in the sense that providing units do not react to their own frequency measurements but rather to a signal sent by the TSO. In France, this signal is called "niveau de telereglage". Its value is comprised between -1 and 1, and the reserve unit receiving this signal has to change its power output between  $-P_{reserve}$  and  $P_{reserve}$  where  $P_{reserve}$  is the power that was contracted between this unit and RTE for secondary frequency control. Obviously, most of the required regulatory changes that would be required for the primary control would also be needed for the secondary control.

In this section, we use some "niveau de telereglage" data which was recorded over the whole year 2010. Fig. A.1 provides the probability density function of this data set. It can be observed that this distribution looks like a Gaussian one with a very significant standard deviation and with a large number of extreme values close to  $\{-1; 1\}$ . Moreover, the consecutive values of this signal are correlated by nature; thus, several extreme values with the same sign might follow each other in a row for quite a long period of time.

As a consequence, a GIV trying to follow up with this signal is very likely to have its battery fully charged or discharged very often. The consequences would be: (a) possible inconvenience to the end user; and (b) limited possible participation in this control due to large periods of unavailability. Fig. A.2 shows the SOC of a GIV participating in the secondary frequency control with a 3kW charging station (here, the GIV is assumed to be idle during the entire simulation).

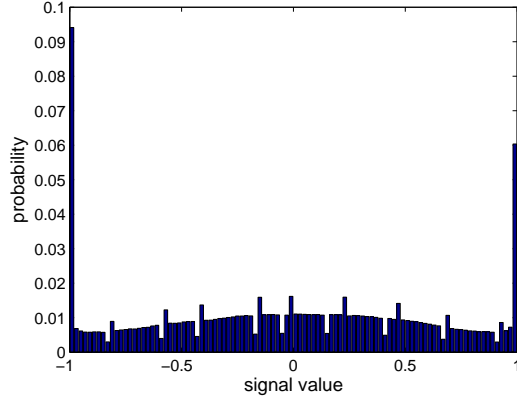

Figure A.1: Probability density function of "niveau de telereglage" data set

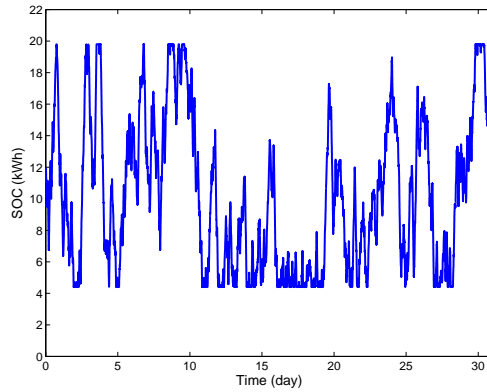

Figure A.2: SOC variations induced by following the "niveau de telereglage" signal for a GIV with a 3kW charging station

As expected, the impacts of following the secondary frequency control signal on the SOC are significant. The battery can stay almost empty for several days in a row. Thus, participating in the secondary frequency control does not appear to be a promising solution for GIVs in France. Note that this conclusion does not extend to other locations: for instance in PJM area, this signal is voluntary balanced on a 15-minute basis, i.e. the average solicitation must be null over a 15 minute time stamp.

## Appendix B

# Distributed Energy Resources characteristics

In this appendix, we account for the values provided in Table 2.1.

### B.1 Consuming Distributed Energy Resources: Residential Loads

New generation LED lighting could adapt their power consumption to required grid power variations (Lee et al., 2011). Future LED systems could undergo power variations up to 35% while humans would only perceive a variation of 15% in light intensity. This method would be particularly interesting for public lighting. On the contrary, older lighting systems do not have the same abilities (Lee et al., 2011; Lu et al., 2008; Samarakoon et al., 2012), since changing their power consumption would have a serious impact on their luminous capability. LED lighting systems can maintain this power variation for a significant period of time and therefore can be considered as energy type flexibility resources. Their predictability is relatively good, while their availability highly depends on the usage considered. Typical lighting would be turned on from a few hours a day during peak hours to 12 hours a day, thus we find  $0.2 < \alpha_r < 0.5$ . It is noticeable that this criterion is highly seasonal dependent.

Residential appliances, such as water heaters, washing machines, electrical heaters and air conditioners have rather low max power temporal ratios  $t_r$ . The latter can range from a few seconds (e.g. for cookers) to about a dozen of minutes (electric space heaters) (Samarakoon et al., 2012), thus providing a maximum temporal ratio of  $5s < t_r < 5min$ . Their availability depends a lot on the appliance considered: whereas electric space heaters have a good availability ( $0.4 < \alpha_r < 1$ ), washing machines have a very limited one ( $\alpha_r < 0.1$ ). Similar rationale applies for their predictability (Tomiyama et al., 1998; Wong and Pelland, 2013). Heat pumps coupled with thermal energy storage stand out

in this category; their max power temporal ratio can reach up to 3h without any inconvenience for end-users (Arteconi et al., 2013), making those units suited for longer grid services such as peak shaving.

## B.2 Bidirectional Distributed Energy Resources: Electrochemical Storage and Electric Vehicles

Storage units are potentially beneficial for electric energy time-shift, power supply capacity and transmission congestion relief (Eyer and Corey, 2010). Electrochemical Energy Storage (EES) units have a perfect availability and predictability ( $\alpha_r \approx 1$ ). Whether they should be considered as energy type or power type resources depend on their power density and energy density characteristics, both parameters being much related to the type of battery technology, e.g., Li-ion, Ni-MH and Ni-Cd (Yang et al., 2011). Thus, it is possible to find EES units for all kind of applications, from very-fast high-power responding units (such as supercapacitors,  $t_r = 4s$ ) to energy type chemical batteries (such as Li-ion batteries,  $t_r \approx 10h$ ) (Yang et al., 2011).

Most Electric Vehicles that are on the roads today have a battery capacity around 20 kWh. Their maximum power temporal ratio depends on the power of the charging station they are plugged in. Typical charging station powers range from 3kW to 50kW, leading to approximately  $30min < t_r < 6h$ . Because EVs are primarily used for transportation, capacity type services that would not empty the battery should be encouraged. Privately owned EVs are mainly available during nighttime and weekends ( $\alpha_r \approx 0.5$ ), but the availability could rise up to  $\alpha_r > 0.9$  if charging points are installed at working places. Company fleets have slightly different usage patterns and could also be available in the afternoon ( $\alpha_r \approx 0.8$ ). EVs' predictability patterns are easily foreseeable (Pearre et al., 2011), especially considering a fleet of EVs and not a single vehicle.

## B.3 Producing Distributed Energy Resources: Micro Combined Heat and Power and Photovoltaic Units

Micro-CHP units are small heat and electricity generating entities. They have a large availability and predictability since they are dedicated to heat and electricity production  $\alpha_r \approx 1$ . It is more difficult to define a maximum power temporal ratio for micro-CHP units because they could produce electricity at maximum power continuously, as far as they are being supplied in primary energy source (mainly gas). Rather, their availability to maintain a change in their electricity production will be based on economic considerations. The control strategies of micro-CHP units are likely to take into account energy costs (Houwing et al.,

### B.3. PRODUCING DISTRIBUTED ENERGY RESOURCES

---

2010) in their economic balance. Therefore, micro-CHP units would fit in the energy type category.

PV units are different from the others, in the sense that their production output cannot be controlled – however, with the introduction of smart inverters, PV production can be curtailable and, considering aggregation across multiple sites, PV aggregations could even provide downward and upward reserves. The units produce electricity between six and ten hours a day depending on their location. Generally production forecasts can be achieved a few hours ahead (International Energy Agency, 2013b) for single units. However, the predictability improves for aggregations of many solar units rather than individual units (similar to EV fleets as discussed above).





# Appendix C

## Summary in French

### C.1 Chapitre 1 : Introduction

La réalité du changement climatique est aujourd’hui un constat partagé par l’ensemble de la planète. Rares sont ceux qui osent encore contester la légitimité de cette théorie scientifique, comme l’a montré la COP21 de Paris (Décembre 2015), au cours de laquelle 196 pays se sont engagés à tout mettre en œuvre pour limiter le réchauffement planétaire à 1.5 ° Celsius. Selon le Groupe d’experts intergouvernemental sur l’évolution du climat (GIEC), les émissions de gaz à effet de serre liées à l’activité humaine, et en particulier de CO<sub>2</sub>, sont les principales responsables de ce changement climatique.

En conséquence l’ensemble des filières industrielles, orientées par des politiques publiques, mais aussi et de plus en plus par des intérêts économiques, se réorganisent pour faire face aux nouveaux défis environnementaux et limiter leurs émissions de CO<sub>2</sub>. Les secteurs industriels automobile et électrique sont respectivement responsables de 14% et 25% des émissions mondiales de gaz à effet de serre. De ce fait, ils sont tous les deux sujets à de profondes mutations pour s’adapter aux nouvelles contraintes environnementales : alors que les normes d’émission de CO<sub>2</sub> par véhicule sont de plus en plus contraignantes, les États se sont aussi engagés à décarboner leurs mixs énergétiques.

La gestion et l’organisation historiques des réseaux électriques se trouvent bouleversées par ces changements. L’utilisation massive d’énergies renouvelables qui n’émettent pas de CO<sub>2</sub> pose des problèmes opérationnels : ces nouvelles sources sont souvent raccordées au réseau de distribution (on parle de *Distributed Generation*, par opposition aux centrales de production classiques raccordées au niveau du réseau de transport) et elles sont intermittentes et moins prévisibles par nature. Une solution envisagée pour surmonter ces difficultés est de rajouter de l’intelligence au niveau du réseau de distribution, et de contrôler les unités de consommation (“charges”) pour qu’elles consomment de l’énergie au moment opportun. Cela constitue un véritable changement de paradigme dans l’opération des réseaux électriques, qui plus est dans un contexte

de libéralisation de ce secteur.

De la même manière, afin de réduire leurs émissions de CO<sub>2</sub> par véhicule, l'offre des constructeurs automobiles en véhicules à énergies alternatives s'est largement étoffée ces dernières années. Les ventes de véhicules tout électrique (VE) et plug-in hybride rechargeable (PHVE) ont notamment augmenté de manière significative depuis quelques années. Ces véhicules ont tout ou partie de leurs déplacements assurés par un moteur électrique, lui-même alimenté par une batterie électrochimique (souvent de technologie Li-Ion). Ces batteries doivent être rechargées depuis le réseau électrique, à des puissances pouvant aller de quelques kilowatts à une centaine de kilowatts.

En conséquence, les VE pourraient représenter une charge conséquente supplémentaire pour les réseaux électriques, qui doivent déjà faire face à une augmentation de la pénétration d'énergies renouvelables. De nombreuses études montrent qu'une recharge simultanée de plusieurs VE pourrait mettre en danger les réseaux électriques, en particulier à l'échelle locale (du bâtiment, du quartier...) mais également à l'échelle nationale.

Néanmoins, la plupart des VE disposent d'une flexibilité importante dans l'établissement de leur plan de charge : un VE a rarement besoin de se recharger à pleine puissance dès son raccordement au réseau pour assurer les futurs besoins de mobilité de son utilisateur. Il est donc possible de décaler le début de la charge d'un VE à un moment ultérieur, et/ou de moduler sa puissance de charge afin de ne pas surcharger le réseau électrique local. L'étape suivante consiste ensuite à considérer la possibilité de décharger le véhicule temporairement dans le réseau électrique ; ainsi, un VE peut se comporter, lorsqu'il est raccordé au réseau, comme une unité de stockage distribuée, qui peut se charger et se décharger en fonction de contraintes et d'objectifs économiques, réglementaires et techniques. Typiquement, les phases de charge / décharge d'un VE seraient contrôlées par un opérateur tiers (un gestionnaire énergétique local, ou bien un agrégateur pour une échelle plus grande).

Les intérêts du développement de cette solution sont multiples. Ils sont tout d'abord techniques : si les processus de charge des VE ne sont pas contrôlés, ils risquent de mettre en péril le bon fonctionnement des réseaux électriques. Ils sont ensuite économiques : il est possible, en contrôlant les puissances de charge / décharge des VE, de reporter voire d'annuler des besoins en investissement dans les réseaux électriques ; l'utilisateur peut aussi réduire le coût total de possession de son véhicule si celui-ci se charge au moindre coût. Enfin, les enjeux sont aussi écologiques : il est envisageable de réussir à synchroniser les périodes de charge des VE avec celles de mix énergétique faiblement carboné, tendant alors vers une mobilité décarbonnée du puit à la roue.

L'objectif de la thèse est d'étudier les stratégies possibles d'intégration intelligente des véhicules électriques dans les réseaux électriques. Les aspects techniques, économiques et réglementaires sont abordés.

## C.2 Chapitre 2 : les Véhicules Électriques Comme Sources d'Énergie Distribuées Flexibles

Le chapitre 2 définit le cadre général de cette étude. Tout d'abord, la définition d'un produit de flexibilité électrique est proposée comme une variation d'une puissance donnée, pendant une certaine durée et à un instant donné. En plus des véhicules électriques, de nombreuses autres sources d'énergie distribuées pourraient apporter de la flexibilité aux réseaux électriques en modifiant leur consommation / production : systèmes de chauffage, batteries stationnaires, charges résidentielles (type machines à laver), etc. Ces différentes sources sont comparées sur leur capacité à fournir de la flexibilité aux réseaux, en s'appuyant sur la définition de ce terme proposée précédemment. Ensuite, les marchés électriques à travers lesquels cette flexibilité pourrait être valorisée sont étudiés. Les marchés existants mis en place par les gestionnaires de réseaux de transport (GRT) sont caractérisés en détail. L'utilisation de cette flexibilité pour les réseaux de distribution est également considérée ; néanmoins, il n'existe aujourd'hui aucun mécanisme réglementaire permettant de valoriser de la flexibilité pour ces réseaux locaux. Les principales raisons de ce manque de mécanisme sont explorées.

L'accent est ensuite porté sur les véhicules électriques. Différents domaines d'application des processus de charge / décharge intelligente sont décrits : en maison individuelle, en flotte d'entreprise, en résidentiel collectif et en espace public. Ils nécessitent une organisation différente, et l'usage des véhicules d'un domaine d'application à l'autre est sensiblement différent ; en conséquence, les services réseaux envisageables sont différents d'un domaine à l'autre. Plusieurs scénarios de référence sont proposés à la lumière de cette approche. De la même manière, une liste des acteurs impliqués dans le développement de ces solutions est proposée. Ce travail préliminaire (qualification des caractéristiques des VE, description des services réseaux, étude des scénarios de référence, des acteurs et des domaines d'application, etc.) nous permet d'arriver à la conclusion suivante : les services réseaux qui correspondent le mieux à des flottes de VE, d'un point de vue aussi bien technique qu'économique et réglementaire, sont les services de réglage de fréquence des réseaux électriques.

Enfin, les principaux défis à l'implémentation de ces solutions sont analysés. Il y a tout d'abord les pertes énergétiques qui pourraient survenir dans la chaîne de puissance d'un véhicule potentiellement bidirectionnel. En particulier, les pertes dans l'électronique de puissance à basses puissances pourraient être importantes. Ensuite, les aspects liés à la dégradation de la batterie sont abordés. Les cycles additionnels liés à l'utilisation de la batterie pour les besoins du réseau pourraient réduire sa durée de vie ; cependant, les premières conclusions laissent penser que cette dégradation devrait rester limitée. Enfin, les coûts additionnels à supporter par le véhicule et les défis réglementaires sont brièvement explicités.

### C.3 Chapitre 3 : Fourniture de Services Systèmes

Selon les conclusions du chapitre 2, le chapitre 3 se focalise sur le service système qui semble le plus prometteur pour des flottes de VE : celui du réglage de fréquence. Dans un premier temps, le cadre réglementaire de ce service est analysé. Les règles de six gestionnaires de réseaux de transport (GRT) sont étudiées en détail. Ces dernières sont regroupées en deux modules principaux : les règles qui concernent l'agrégation de véhicules et les règles qui définissent les modalités de paiement de ce service système. Cette étude est par ailleurs conduite avec le retour des équipes de recherche des projets Nikola et GridOnWheels, deux projets de démonstration de participation d'une flotte de VE au réglage de fréquence. Les six GRT sont finalement comparés sur la base de ces deux modules de règles.

Ensuite, un modèle de simulation est développé. Il nous permet de simuler la participation d'une flotte de VE au réglage primaire de fréquence, à travers un agrégateur dont le rôle est de faire les offres sur le marché (en anticipation) et de contrôler les taux de charge / décharge des VE. La flotte est modélisée de manière dynamique et stochastique : chaque VE a ses propres trajets, et ceux-ci diffèrent d'un jour sur l'autre. Une base de données construite à partir de plusieurs sources est utilisée pour paramétrer les usages des VE pour le transport : données internes PSA Groupe, retours de projets, études académiques et mini-stérielles, etc. Plusieurs scénarios de pénétration d'infrastructure de recharge sur les lieux de travail sont considérés. L'agrégateur proposé met en oeuvre un algorithme décentralisé qui s'inspire de celui développé par l'Université du Delaware (projet GridOnWheels).

Ce modèle est utilisé pour simuler plusieurs situations. Dans un premier temps, nous considérons que les véhicules ont des capacités bidirectionnelles, c'est-à-dire qu'ils sont capables de réinjecter de l'énergie sur le réseau, et qu'ils sont possédés par des particuliers et utilisés pour faire des déplacements domicile-travail. Notre étude préliminaire des règles réseau nous permet de définir le cadre réglementaire. Nous considérons un marché du réglage de fréquence à enchères, symétrique (i.e. la même capacité à la hausse et à la baisse doit être offerte à chaque instant), avec un pas de temps d'une heure. Les prix de marché sont basés sur ceux du GRT Danois Energinet.dk. Les résultats des simulations nous permettent de conclure sur les rémunérations que les véhicules pourraient tirer de leur participation au réglage de fréquence. Cette rémunération dépend largement de la puissance de recharge disponible pour le véhicule en question. Les résultats donnent également des éléments sur les sollicitations des véhicules (en terme de puissance, énergie) induites par leur participation à ce service.

Ensuite, nous considérons que les VE ne peuvent opérer qu'en mode unidirectionnel (charge uniquement). Une nouvelle stratégie de participation au réglage de fréquence, adaptée aux nouvelles capacités des véhicules, est proposée. Avec le même cadre réglementaire, la rémunération des VE unidirectionnels est beaucoup moins importante que celle des véhicules bidirectionnels. En conséquence, un nouveau cadre réglementaire est étudié : le marché est considéré asymétrique, c'est-à-dire que les offres à la hausse et à la baisse sont émises sur deux marchés

séparés. Ce nouveau cadre réglementaire permet à la flotte de VE unidirectionnels de maximiser ses offres sur le marché.

Enfin, des analyses de sensibilité sont proposées. Plusieurs autres types de flotte sont étudiés, et des périodes de marché d'une heure et quatre heures sont comparées.

## C.4 Chapitre 4 : Fourniture de Services Locaux

Dans le chapitre 4, nous étudions la possibilité d'utiliser la flexibilité d'une flotte de VE en support d'un réseau local d'électricité, plus précisément à l'échelle d'un éco-quartier. Un modèle de simulation est proposé. L'éco-quartier est composé de maisons résidentielles, dont les niveaux de consommation horaires sont basés sur des études académiques approfondies. Un bâtiment tertiaire est également intégré dans ce quartier ; des données de consommation historiques d'un bâtiment tertiaire sont utilisées pour modéliser son comportement. Trois flottes de VE sont considérées : une flotte pour les habitants de l'écoquartier ; une flotte pour les gens qui viennent travailler dans le quartier ; et enfin une flotte d'entreprise. Enfin, des panneaux solaires sont modélisés à partir de données de production historiques.

Dans un premier temps, les VE et les panneaux solaires ne sont pas introduits dans le quartier. Seules les unités de consommation tertiaire et résidentielles sont considérées. Un an de consommation est simulé, et utilisé pour dimensionner le transformateur de l'éco-quartier. Ce dimensionnement autorise certaines surcharges selon une courbe d'échauffement maximal admissible fournie par un constructeur de transformateurs industriels.

Ensuite, les panneaux solaires et les flottes de VE sont introduits dans l'éco-quartier. Les profils de charge des VE ne sont pas contrôlés ; dès qu'un VE se raccorde au réseau après un trajet, il se charge à pleine puissance. Dans ces conditions, les surcharges du transformateur sont caractérisées. Les limitations thermiques sont largement dépassées sous ces nouvelles conditions. Les charges des véhicules électriques conduisent à d'importantes surcharges du transformateur.

Un gestionnaire énergétique local, qui contrôle les régimes de charge / décharge des VE est ensuite proposé. Un algorithme de gestion de la flotte est développé. Les VE se chargent en respectant les limites du transformateur, et se déchargent si le transformateur est surchargé. Les nouvelles conditions opérationnelles sont caractérisées. Les durées de surcharge du transformateur, ainsi que les énergies et puissances moyennes pendant les périodes de surcharge sont réduites drastiquement grâce à la gestion de la charge des flottes.

Enfin des opportunités économiques liées à la mise en place du gestionnaire énergétique sont présentées. Tout d'abord, la puissance souscrite auprès du gestionnaire de réseau peut être optimisée grâce au gestionnaire énergétique. Cela permet de réaliser des économies sur la facture énergétique de l'éco-quartier. Ensuite, diminuer les surcharges du transformateur peut permettre de limiter sa dégradation, et donc de reporter, voire d'éviter, des investissements pour

renforcer le transformateur.

## C.5 Chapitre 5: Expérimentations

Le chapitre 5 présente des résultats d'expérimentations conduites avec des véhicules du groupe PSA. Les expériences sont réalisées au sein du projet Nikola, un projet de démonstration Danois. Deux véhicules sont utilisés : une Citroën Berlingo Electric et une Peugeot iOn. Les expériences menées avec ces véhicules permettent de vérifier les hypothèses utilisées dans les simulations numériques.

La Berlingo Electric peut se charger en mode 3 jusqu'à 3,7kW. Sa puissance de charge est contrôlable selon la norme IEC 61851-1 et en fonction de la valeur de la modulation à largeur d'impulsion (MLI) appliquée sur la Control Pilot Line. Ainsi, il est possible de moduler la puissance de 1,4 à 3,7kW. Ces caractéristiques sont utilisées pour faire participer le véhicule au réglage de fréquence primaire en unidirectionnel. Le véhicule présente un temps de réponse extrêmement court (de l'ordre de la seconde) et une très bonne précision en puissance. Le contrôle s'effectue en local par un ordinateur qui possède sept heures d'enregistrement de fréquence.

La Peugeot iOn a les capacités d'utiliser sa prise de recharge rapide en mode bidirectionnel selon le protocole Chademo. Une borne de charge rapide bidirectionnelle  $\pm 10\text{kW}$  est utilisée en complément, permettant à la iOn de se charger et de se décharger dans ces limites de puissance. La Peugeot iOn est utilisée pour participer au réglage de fréquence primaire en mode bidirectionnel, pendant quatre heures consécutives. La mesure de fréquence du réseau est réalisée en temps réel, et la iOn est contrôlée par un agrégateur situé sur un serveur basé au Danemark. Le temps de réponse de la chaîne complète s'avère satisfaisant vis-à-vis des exigences réseau ( $\approx 5\text{s}$ ) avec une très bonne précision en puissance.

## C.6 Chapitre 6 : Conclusion

Le chapitre 6 rappelle les principales conclusions de la thèse et propose des pistes de travail pour le groupe PSA.

## C.6. CONCLUSION

---



**Title:** Grid Integrated Vehicles: Business Models and Technical Constraints for Car Manufacturers

**Keywords:** Smart Grids; Electric Vehicles; Grid Integration; Smart Charging

**Abstract:** Electric vehicles (EVs) penetration has been rapidly increasing during the last few years. If not managed properly, the charging process of EVs could jeopardize electric grid operations. On the other hand, Grid Integrated Vehicles (GIVs), i.e. vehicles whose charging and discharging patterns are smartly controlled, could turn into valuable assets for the electrical grids as distributed storage units.

In this thesis, GIVs are studied from a technical, regulatory, and economic perspectives. First, the general framework for a smart grid integration of EVs is reviewed: application areas and benchmark scenarios are described, the main actors are listed, and the most important challenges are analyzed.

Then, the emphasis is put on system wide services, and more particularly on frequency control mechanisms. The regulatory conditions enabling the participation of GIV fleets to this service are studied based on an intensive survey of existing transmission system operator rules. Several economic and technical simulations are performed for various market designs.

Then, local grid services are investigated. A representative eco-district is modeled, considering various consumption units and distributed generation. A local energy management system is proposed; it is responsible for controlling the charging / discharging patterns of the GIVs which are located in the district in order to mitigate the overloading conditions of the eco-district transformer. Economic consequences are derived from this technical analysis.

At last, some experimental results are presented. They show the behavior of two GIVs, including one with bidirectional capabilities. The experimental proof of concepts confirms the theoretical abilities of GIVs: they are very fast responding units (even considering the complete required IT architecture) and are able to follow grid signals very accurately.

**Title:** Intégration des Véhicules Électriques dans les Réseaux Électriques : Modèles d’Affaire et Contraintes Techniques pour Constructeurs Automobiles

**Mots-clés:** Smart Grids ; Véhicules Électriques ; Intégration Réseaux ; Charge Intelligente

**Résumé:** Les ventes de Véhicules Électriques (VE) ont fortement augmenté ces dernières années. Si les processus de charge de ces VE ne sont pas gérés de manière intelligente, ils risquent de surcharger les réseaux électriques. Inversement, les VE pourraient représenter une opportunité pour ces réseaux en tant qu’unités de stockage distribuées.

Cette thèse se propose d’étudier l’intégration intelligente des véhicules rechargeables dans les réseaux électriques d’un point de vue technique, réglementaire et économique. Dans un premier temps, le cadre général nécessaire au développement de ces solutions est passé en revue : les domaines d’application et scénarios de référence sont décrits, les acteurs principaux listés, et les défis majeurs analysés.

Ensuite, l’accent est mis sur les services système, et plus particulièrement sur le réglage de fréquence. Les conditions réglementaires permettant la participation d’une flotte de véhicules électriques à ce service sont étudiées à partir d’une revue des règles de gestionnaires de réseau de transport existants. De nombreuses simulations techniques et économiques sont réalisées, pour différentes règles de marché.

Les services réseau locaux sont ensuite considérés. Un éco-quartier est modélisé : il comprend différentes unités de consommation et des sources de production distribuées. Un gestionnaire énergétique local est proposé : son rôle est de contrôler les taux de charge / décharge des véhicules électriques de l’éco-quartier dans l’objectif de limiter les surcharges subies par le transformateur électrique de l’éco-quartier. Des conséquences économiques sont tirées des résultats techniques.

Enfin, des résultats expérimentaux sont présentés. Le comportement de deux VE est analysé, dont un dispose de capacités bidirectionnelles. Les preuves de concept expérimentales confirment les capacités théoriques des véhicules électriques : il s’agit d’unités à temps de réponse très court (même en considérant l’architecture IT complète) et ils sont capables de réagir à des signaux réseau très précisément.