



HAL
open science

Migration and specification of CGE-derived GABAergic cortical interneurons during mouse development

Audrey Touzot

► **To cite this version:**

Audrey Touzot. Migration and specification of CGE-derived GABAergic cortical interneurons during mouse development. Agricultural sciences. Université Nice Sophia Antipolis, 2014. English. NNT : 2014NICE4089 . tel-01406276

HAL Id: tel-01406276

<https://theses.hal.science/tel-01406276>

Submitted on 30 Jun 2017

HAL is a multi-disciplinary open access archive for the deposit and dissemination of scientific research documents, whether they are published or not. The documents may come from teaching and research institutions in France or abroad, or from public or private research centers.

L'archive ouverte pluridisciplinaire **HAL**, est destinée au dépôt et à la diffusion de documents scientifiques de niveau recherche, publiés ou non, émanant des établissements d'enseignement et de recherche français ou étrangers, des laboratoires publics ou privés.



Ecole doctorale des Sciences de la Vie et de la Santé

THÈSE de Doctorat

**pour obtenir le titre de
Docteur en Biologie**

Spécialité: Interactions moléculaires et cellulaires

**“Migration et spécification des interneurones
GABAergiques corticaux issus de la CGE au cours du
développement chez la souris”**

**“Migration and specification of CGE-derived GABAergic
cortical interneurons during mouse development”**

Audrey TOUZOT

Institut Biologie Valrose

INSERM1091 CNRS7277 UNS

28 avenue Valrose 06108 Nice

Présidente: Dr. BARDONI Barbara

Rapporteurs: Prof. PRICE David

Dr. VITALIS Tania

Directrice de thèse: Dr. STUDER Michèle

À ma mère,

Acknowledgments

“All truths are easy to understand once they are discovered, the point is to discover them.”

- Galileo Galilei –

First and foremost, I would like to thank my advisor Michèle Studer for providing me with the opportunity to complete my Ph.D. thesis in her laboratory and encouraging me over the past years. It has been an honor to be her Ph.D. student. She has been actively interested in my work and has always been available to advise me. I am very grateful for your patience and I would like to thank you for encouraging my research and for allowing me to grow as a research scientist.

I would like to thank all the members of the Studer’s lab for sharing their knowledge and skills with me; in particular Christian and Maria Anna that are my primary resources for getting my science questions answered. A big thank you to those of you who were here when I started and now have moved on (Nadia, Lisa, Jessica, Salsa, Mariel), those who have been here throughout most of my Ph.D. (Kawssar, Elia, Joséphine) and all of you have joined the last few years (Eya, Michele). Thank you for your continued friendship, support, hugs, whatsApp chats, laughs and for all the conversations, philosophical debates and inspirational conversations over coffee and cake. I’ll never forget the many wonderful lunches and fun activities we’ve done all together. Thank you all for making the lab such an enjoyable and pleasant place to work.

I’m thankful for my years spent with my friends Yoann, Adrien, Marc, Jessica, Aude D, Lucile, Aude V, Antoine, Amélie, Nolwen, Julien for everything we shared, every chance we had to grow. I’ll take the best of you and lead by your example where ever I go.

I especially thank my dad Denis, my siblings Laura and Michael. My hard-working parent has sacrificed his life for my sister, my brother and myself and provided unconditional love and care. I love him so much, and I would not have made it this far without him. My sister has been my best friend all my life and I love her dearly and thank her for all her advice and support. My brother has been my little boy and I thank him to be so strong and courageous. I know I always have my family to count on when times are rough. I also thank Audrey and her daughter Lou that are more than my cousins but my sister and my niece. I love you.

All these persons let me understand over the last years that I should look at everything as a lesson and shouldn’t want to walk around angry. And there are things we don’t want to happen, but have to accept; things we don’t want to know, but have to learn, and people we can’t live without, but have to let go. Thank you.

Abstract

In the cerebral cortex, normal neuronal activity relies on the balance between excitation, provided by pyramidal glutamatergic neurons, and inhibition, executed by GABAergic cortical interneurons. Abnormal development of interneurons can alter cortical activity leading to various neurodevelopmental diseases, such as epilepsy, autism or other intellectual disabilities. Understanding the molecular mechanisms that control interneuron development and diversity has therefore received considerable attention by neuroscientists and clinicians. In rodents, cortical interneurons are highly heterogeneous and originate from the medial (MGE) and caudal ganglionic eminence (CGE) according to precise temporal schedules, express a defined combination of factors, and reach their final laminar position through tangential and radial cell migration. Although great progress have been made over the last decade in elucidating the diversity and fate-specification of MGE-derived interneuron subtypes, the molecular mechanisms controlling the migration and development of CGE-derived interneurons, which comprise around 30% of all cortical interneurons, are still very vague. In this study, I directly address this question, first by investigating the migratory paths of cortical interneurons using a reporter line (5HTGFP) specific to the CGE, and second by challenging the functional role of two transcription factors, COUP-TFI and COUP-TFII, highly expressed in the embryonic CGE during development. My data unraveled two major previously non-characterized migratory streams from the subpallium to the pallium; a dorsal stream (CLMS) in which CGE-derived cells migrate to the lateral GE (LGE), and a ventral one (CMMS) in which CGE-derived cells migrate to the MGE before reaching the pallium. Together with the already well-described caudal stream (CMS), I analyzed their mode of migration at different ages and identify a series of genes expressed in the migrating GFP+ cells. While Sp8 is mainly expressed in the CLMS, Prox1, COUP-TFI, COUP-TFII and Nrp2 are expressed in the CMMS. Beside COUP-TFII, I found that also COUP-TFI and Nrp1 are expressed in the CMS. By inactivating COUP-TFI and/or COUP-TFII in developing interneurons, these streams are perturbed and expression of these factors affected. As a consequence, adult mutant mice have an altered distribution of interneuron subpopulations, particularly the ones derived from the CGE. Taken together, my study identified and characterized two novel CGE-derived interneuron migratory routes to the cortex and showed that COUP-TF transcription factors directly contribute in modulating these paths by regulating the expression of distinct factors in the migrating cells.

Résumé

Dans le cortex cérébral, l'activité neuronale repose sur la maintenance d'une délicate balance entre l'excitation, assurée par les neurones pyramidaux glutamatergiques, et l'inhibition, réalisée par les interneurons corticaux GABAergique. L'altération du développement des interneurons peut modifier l'activité corticale et ainsi conduire à plusieurs troubles mentaux, tels que l'épilepsie et l'autisme. Les mécanismes qui contrôlent le développement et la diversité des interneurons sont donc une question de haute priorité non seulement pour les chercheurs en neurosciences, mais aussi pour les cliniciens. Chez les rongeurs, les interneurons corticaux sont issus de l'éminence ganglionnaire médiale et caudale (CGE et MGE respectivement) selon une séquence temporelle précise et expriment une combinaison de facteurs définis. Ils atteignent leur position laminaire définitive grâce à la migration cellulaire tangentielle et radiale. Bien que d'énormes progrès ont été faits pour élucider la diversité et la spécification des sous-types d'interneurons provenant de la MGE, les mécanismes moléculaires contrôlant la migration et la spécification des interneurons issus de la CGE, qui représentent environ 30% des interneurons corticaux, sont toujours incertains. Dans cette étude, je traite de cette question en examinant premièrement les voies de migration des interneurons grâce à une lignée de souris rapportrice des interneurons issus de la CGE (5HTGFP), et dans un second temps en comprenant le rôle fonctionnel de deux facteurs de transcription, COUP-TFI et COUP-TFII, qui sont hautement exprimés dans la CGE au cours du développement cortical. Mes données ont montré deux voies de migration précédemment non caractérisées qui vont du télencéphale ventrale à la plaque corticale ; une voie dorsale (CLMS) où les interneurons issus de la CGE migrent vers l'éminence ganglionnaire latérale (LGE) et une voie ventrale (CMMS) où les interneurons migrent vers la MGE avant de rejoindre le cortex. J'ai analysé le mode de migration de ces interneurons dans ces deux voies de migration ainsi que dans la voie de migration caudale (CMS) et j'ai identifié certains gènes exprimés dans les cellules utilisant ces voies de migration tels que Sp8 qui est principalement exprimé dans le CLMS, et Prox1, COUP-TFI, COUP-TFII et Nrp2 qui sont exprimés dans le CMMS. Dans le CMS, en plus de COUP-TFII, j'ai trouvé que COUP-TFI et Nrp1 s'y expriment également. En inactivant conditionnellement COUP-TFI et/ou COUP-TFII dans les interneurons, les voies de migration sont altérées ainsi que l'expression des différents facteurs identifiés. Comme probable conséquence les souris mutantes adultes montrent une distribution altérées des sous-populations d'interneurons en particulier de celles issues de la CGE. De façon globale mon étude a donc permis d'identifier et de caractériser deux nouvelles voies de migration vers le cortex pour les interneurons provenant de la CGE et a montré que les facteurs de transcriptions COUP-TFs contribuent directement à la modulation de ces voies en régulant l'expression de facteurs dans les cellules en migration.

Table of Contents

<i>Acknowledgments</i>	v
<i>Abstract</i>	vii
<i>Résumé</i>	viii
<i>Abbreviations</i>	xi
<i>Figures Index</i>	xii
Chapter I Introduction	1
1. The cerebral cortex: a delicate balance between excitation and inhibition	3
1.1. The excitatory projection neurons	4
1.2. The inhibitory cortical GABAergic interneurons	6
1.2.1. Parvalbumin-expressing interneurons	6
1.2.2. Somatostatin-expressing interneurons	7
1.2.3. Serotonin receptor 3a-expressing interneurons	7
2. Cortical interneuron neurogenesis: a tight spatio-temporal control	11
2.1. The anatomical origin of cortical interneurons	11
1.1. The time of generation of cortical interneurons	14
2. Molecular mechanisms of interneuron development	19
2.1. Transcription factors required in MGE- and LGE-derived interneuron specification	19
2.2. Molecular control of CGE-derived interneurons	22
2.2.1. <i>Gsx, Mash1, Dlx and Prox1</i>	23
2.2.2. <i>COUP-TFs</i>	24
3. Interneuron migration: a long journey	31
3.1. The major dorsal routes taken by migrating interneurons	31
3.1.1. <i>Tangential migration of cortical interneurons</i>	31
3.1.2. <i>Radial migration of cortical interneurons</i>	33
3.2. Guidance factors involved in interneuron migration	35
3.2.1. <i>Secreted molecules</i>	35
3.2.2. <i>Transcription factors</i>	38
4. Aim of the study	39
Materials and Methods	41
Chapter II Identification of two novel tangential paths of CGE-derived interneurons	45
1. CGE-derived interneurons migrate caudally but also rostrally along distinct dorsal and ventral routes	47
2. Semaphorins and Neuropilins might be involved in guiding CGE-derived migratory pathways	50
2.1. Neuropilin 1 (Nrp1) is expressed in caudally-migrating 5HTGFP+ interneurons (CMS) and might respond to local sources of <i>Sema3A</i>	50
2.2. Neuropilin 2 (Nrp2) is expressed in the CMMS and CMLS of 5HTGFP+ migrating interneurons and might respond to local sources of <i>Sema3F</i>	52

3. Expression of transcription factors in migrating CGE-derived interneurons	54
3.1. The MGE-marker Nkx2.1 is expressed in a subset of 5HTGFP+ cells in the MGE/POA region .	54
3.2. The transcription factor Sp8 labels two independent 5HTGFP+ sources of interneurons	56
3.3. The homeodomain gene Prox1 is expressed in a subset of CMMS 5HTGFP+ interneurons	58
3.4. COUP-TF genes are differentially expressed in 5HTGFP+ CGE-derived interneurons	58
4. Conclusion	64
<i>Chapter III Role of COUP-TFI and COUP-TFII in CGE-derived interneuron migration and specification.....</i>	67
1. Loss of COUP-TFI affects CGE proliferation and proper balance of CGE-derived interneuron migration during development	69
2. COUP-TFI controls the ratio between MGE- and CGE-derived interneurons in adult mice	77
3. Loss of COUP-TFII affects mainly CMS and CMMS migration	79
4. Opposed role of COUP-TFII in controlling the balance between MGE- and CGE-derived interneurons in adult mice	83
5. Partial additive effects on interneuron migration in COUP-TF compound mutants	85
<i>Chapter IV Discussion and Perspectives.....</i>	91
Discussion	93
Perspectives.....	101
<i>Supplementary</i>	103
<i>Loss of COUP-TFI Alters the Balance between Caudal Ganglionic Eminence- and Medial Ganglionic Eminence-Derived Cortical Interneurons and Results in Resistance to Epilepsy</i>	
<i>References</i>	106

Abbreviations

5HT3aR	5-hydroxytryptamine (serotonin) receptor 3a
AEP	Entopeduncular
BrdU	Bromodeoxyuridine
CGE	Caudal ganglionic eminence
CKO	Conditional knock out
CMS	Caudal migratory stream
COUP-TFI	Chicken ovalbumin upstream promoter transcription factor I
COUP-TFII	Chicken ovalbumin upstream promoter transcription factor II
CP	Cortical plate
CR	Calretinin
Ctrl	Control
DAPI	4',6-diamidino-2-phenylindole
DNA	Deoxyribonucleic acid
E0.5	Embryonic day 0.5
EDTA	Ethylenediaminetetraacetic acid
GABA	γ -aminobutyric acid
GE	Ganglionic eminences
GFP	Green fluorescent protein
ISH	<i>In situ</i> hybridization
IZ	Intermediate zone
LGE	Lateral ganglionic eminence
LHX6	LIM homeodomain transcription factor 6
MGE	Medial ganglionic eminence
MZ	Marginal zone
NKX2.1	NK2 homeobox 1
NPY	Neuropeptide Y
NRP1	Neuropilin-1
NRP2	Neuropilin-2
P21	Postnatal day 21
PBS	Phosphate Buffered Saline
PFA	Paraformaldehyde
POA	Preoptic area
PROX1	Prospero homeobox protein 1
PV	Parvalbumin
RNA	Ribonucleic acid
SDS	Sodium dodecyl sulfate
Shh	Sonic hedgehog
SOX6	Sry-related HMG-box-containing transcription factor 6
SP	Subplate
SP8	Specificity protein 8
SSC	Sodium Chloride-Sodium Citrate
SST	Somatostatin
SVZ	Subventricular zone
VIP	Vasoactive intestinal peptide
VZ	Ventricular zone

Figures Index

Figure 1 : Origin of cortical interneuron subpopulations.....	10
Figure 2: Schematic representation of the developing murine brain at E13.5..	12
Figure 3: Temporal origin of cortical interneurons.....	15
Figure 4: Specification of GABAergic cortical interneurons.	18
Figure 5: Cortical interneuron migration in the developing telencephalon.	30
Figure 6: 5HTGFP expression pattern during development..	46
Figure 7: Migrating pathways of CGE-derived interneurons.	49
Figure 8: Cell tracking along the CLMS and the CMMS..	49
Figure 9: Guidance of 5HTGFP cells through the CMS by Nrp1/Sema3A.....	51
Figure 10: Guidance of 5HTGFP cells through the CMMS by Nrp2/Sema3F.....	53
Figure 11: Some 5HTGFP+ cells express Nkx2.1 in the MGE/POA.....	55
Figure 12: Sp8 labels specific subpopulations of interneurons.....	57
Figure 13: A subpopulation of CGE-derived interneurons express Prox1 in the CMMS..	59
Figure 14: COUP-TFI is expressed highly in the CMS and in a subpopulation of CMMS migrating cells.	61
Figure 15: COUP-TFII-expressing cells migrate through the CMMS and is present in cells exiting CGE to migrate caudally.	62
Figure 16: High co-expression of COUP-TFI and COUP-TFII.....	63
Figure 17: Transcription factors are expressed in different migratory paths.	65
Figure 18: Altered migration in absence of COUP-TFI function.	68
Figure 19: Increased proliferation in absence of COUP-TFI.....	70
Figure 20: Downregulation of Prox1 in the CMMS in absence of COUP-TFI.	72
Figure 21: COUP-TFII subpopulation might compensate the decrease of Prox1 subpopulation in CMMS of <i>TFICKO</i> brain.	74
Figure 22: Some CGE-derived interneurons are redirected through the CLMS in absence of COUP-TFI.....	75
Figure 23: Nrp2 guides the CGE-derived interneurons along the CMMS whereas Nrp1 is required in the caudal cortex.	76
Figure 24: Altered balance between PV- and VIP- and CR-expressing cortical interneurons in the absence of COUP-TFI function.....	78
Figure 25: Altered migration in absence of COUP-TFII function.....	80
Figure 26: Regulation of COUP-TFI by COUP-TFII.	80
Figure 27: Downregulation of Prox1 in the CMMS in absence of COUP-TFII.	82
Figure 28: Some CGE-derived interneurons are redirected through the CLMS in absence of COUP-TFII.....	82
Figure 29: Altered balance between PV- and VIP- and CR-expressing cortical interneurons in the absence of COUP-TFII function..	84
Figure 30: Additive effects of COUP-TFI and COUP-TFII on the migration.....	86
Figure 31: Increased number of Sp8+/5HTGFP+ in the CLMS at earlier stage.....	88
Figure 32: Upregulation of Prox1 in the CMMS at E15.5 in absence of COUP-TFI and COUP-TFII.....	89
Figure 33: Putative new migratory streams for CGE-derived cortical interneurons.	96
Figure 34: Putative regulatory model between the transcription factors in the CGE at E15.5	100

Chapter I
Introduction

1. The cerebral cortex: a delicate balance between excitation and inhibition

The mammalian neocortex is a highly evolved organ and an extremely complex biological entity that is responsible for the higher brain functions of the central nervous system. Located in the roof of the dorsal telencephalon (pallium), the neocortex is the largest and most pivotal structure of the mammalian telencephalon and is organized into unique areas that serve distinct functions such as sensory perception, learning, memory, and motor outputs. The size of the primary cortical areas vary across species, and also within a specie (Leingärtner et al., 2007).

Arealization of the neocortex is controlled by a regulatory hierarchy beginning with morphogens secreted from patterning centres positioned at the perimeter of the dorsal telencephalon. These morphogens act in part in cortical progenitors to establish the differential expression of transcription factors that specify their area identity, which is inherited by their neuronal progeny, providing the genetic framework for area patterning (O'Leary and Sahara, 2008). The different areas are typically arranged in six layers (lamina), which differ in neuronal composition, density, and connectivity (Parnavelas, 2002). In the nervous system, the diversification of neuronal cell types is a common strategy to ensure functional complexity and flexibility of the neural networks. These circuits are functionally organized into radial units that span the cortical layers and consist of two major classes of neurons: glutamatergic excitatory cells (pyramidal and spiny stellate neurons) and GABA (γ -aminobutyric acid)-ergic inhibitory interneurons (Hensch, 2005).

Proper development and functioning of the neocortex critically depends on the coordinated production and migration of excitatory and inhibitory neurons. Pyramidal neurons, which make up approximately 75% of all neurons in the cortex, are the projection cells that send axons to other areas of the cortex and to distant parts of the brain. They utilize the excitatory amino acid glutamate as a neurotransmitter. Non-pyramidal cells are interneurons and their connections are all made locally. There are many varieties of interneurons based on differences in size and shape of their dendrites and patterns of axonal branching. They all contain the inhibitory neurotransmitter GABA and also one or more neuropeptides and/or calcium-binding proteins (Parnavelas, 2002).

For proper functioning, a delicate balance between excitatory and inhibitory inputs must be carefully maintained during assembly of cortical circuits. Disrupting this balance may very well contribute to the emergence of neuropsychiatric disorders, such as epilepsy, autism spectrum disorders, and intellectual disabilities. Recent studies in animal models demonstrate that the molecular basis of inhibitory circuit disruption is often linked to specific abnormalities in the development and function of interneurons (Marín, 2012) and that perturbations of regional and laminar identity may be important factors in neurodevelopmental diseases (Bedogni et al., 2010).

1.1. The excitatory projection neurons

Glutamatergic excitatory neurons are characterized by a typical pyramidal morphology. They comprise the majority of cells in the neocortex and extend their axons to distant intracortical, subcortical and subcerebral targets generating the output both within the cortex and to distant brain regions (Molyneaux et al., 2007).

During early development, there is a dramatic expansion of the neuroepithelium in the dorsolateral wall of the rostral neural tube that will give rise to neocortical projection neurons. The layer immediately adjacent to the ventricle is termed the ventricular zone (VZ). As neurogenesis proceeds, an additional proliferative layer known as the subventricular zone (SVZ) forms above the VZ at embryonic day (E) 13.5 in the mouse (Anderson et al., 2002; Gorski et al., 2002). Progenitors residing in the VZ and SVZ produce projection neurons of the different neocortical layers in a tightly controlled temporal order from E11.5 to E17.5 (Caviness and Takahashi, 1995; Rakic, 1974). There are at least three basic types of neurogenic progenitors within the developing neocortex: neuroepithelial cells, radial glia cells, outer radial glial cells and intermediate progenitors (Gotz and Huttner, 2005). The pseudostratified neuroepithelial cells undergo symmetric cell divisions to expand the pool of multipotent progenitors as well as a smaller percentage of asymmetric cell divisions to generate the earliest born neurons (Gotz and Huttner, 2005; Chenn and McConnell, 1995; Smart, 1973). These neurons form a layered structure termed the preplate, which is later split into the more superficial marginal zone and the deeply located subplate. The cortical plate (CP), which will give rise to the multilayered neocortex, begins to develop in between these two layers (Bayer and Altman, 1991). Then, neuroepithelial cells transform into radial glial

cells (Malatesta et al., 2003; Hartfuss et al., 2001). Radial glial cells possess long processes that span the entire neocortical wall and maintain contact both at the ventricular and pial surfaces throughout their mitotic division cycles. Radial glial cells undergo interkinetic nuclear migration, whereby the nucleus moves within the cytoplasm of elongated neuroepithelial progenitor cells in synchronization with the cell cycle phase (Gotz and Huttner, 2005; Noctor et al., 2004). The nucleus ascends to the upper region of the VZ during S phase, and later descends to the apical part of the VZ. The outer radial glial cells in mice were shown to be the progeny of ventricular radial glial cells (Shitamukai et al., 2011; Wang et al., 2011), and to undergo similar mitotic movements (Wang et al., 2011). In human timelapse imaging and fate analysis show that outer radial glial cells divide asymmetrically to self-renew, and give rise to an extended lineage of transit amplifying cells (Hansen et al., 2010). Unlike radial glial cells, outer radial glial cells are located far from the ventricle, with no apical contact to the luminal surface, but they possess a long basal fiber that often extends to the pial surface. Intermediate progenitor cells (also known as basal progenitors) reside within the VZ and often divide at ventricular surface at early stages of neurogenesis (Franco and Müller, 2013; Noctor et al., 2004). However, as neurogenesis proceeds, the intermediate progenitor cells migrate to the SVZ. Retroviral labelling and time-lapse imaging in embryonic rodent cortical slice cultures as well as staining for neuron markers was used to demonstrate that intermediate progenitor cells most often undergo one round of symmetric division to produce two neurons (Attardo et al., 2008; Haubensak et al., 2004; Kriegstein and Noctor, 2004; Noctor et al., 2004). The “two-step pattern” of neurogenesis, involving radial glial cells and intermediate progenitor cells, appears to be the predominant principle for cortical neurogenesis in rodents (Haubensak et al., 2004; Kriegstein and Noctor, 2004).

Upon induction of the telencephalon by gradients of extracellular signalling molecules, such as sonic hedgehog, fibroblast growth factors and bone morphogenetic proteins (Rallu M. et al., 2002), a number of genes that direct neocortical neurogenesis are expressed across the dorsolateral wall of the telencephalon. These include LIM homeobox 2 (Lhx2), forkhead box G1 (Foxg1), empty spiracles homologue 2 (Emx2) and paired box 6 (Pax6), each of which has crucial roles in specifying the progenitors that give rise to the projection neurons of the neocortex. Together, these four genes establish the neocortical progenitor domain by repressing dorsal midline (Lhx2 and Foxg1) (Vyas et al., 2003; Bulchand et al., 2001; Monuki et al., 2001) and ventral (Emx2 and Pax6) fates (Muzio et al., 2002).

1.2. The inhibitory cortical GABAergic interneurons

GABAergic interneurons are local circuit cells responsible for inhibitory transmission in the neocortex. While they only comprise approximately 20 % of all neocortical cells, interneurons are key regulators of cortical activity in all organisms, both invertebrates and vertebrates. They generate and maintain network oscillations, which provide the temporal structures that orchestrate the activities of neural assemblies (Isaacson and Scanziani, 2011). However interneurons that use GABA (γ -aminobutyric acid) as their neurotransmitter have far more functions than just the “inhibition” of other neurons. GABA transmission that typically acts through postsynaptic GABA_A ionotropic receptors, regulates as well synaptic integration, probability and timing of action potential, and plasticity in principal neurons (Huang et al., 2007). This variety of inhibitions is made possible by a myriad of GABAergic interneuron subtypes characterized by their neurochemical, morphological and physiological properties, the three main criteria recommended by The Petilla Interneuron Nomenclature Group (PING) (DeFelipe et al., 2013; Ascoli et al., 2008; Markram et al., 2004). Molecular features include transcription factors, neuropeptides, calcium-binding proteins, and receptors that these interneurons express, among many others. Morphologically speaking, cortical interneurons are classified in function of their soma, dendrites, axons, and the connections they make. Physiological characteristics include firing pattern, action potential measurements, passive or subthreshold parameters, and postsynaptic responses, just to name a few (Ascoli et al., 2008). Each of these properties influences the role of each interneuron within the cortical circuitry.

1.2.1. Parvalbumin-expressing interneurons

Current data suggest that around 40% of neocortical GABAergic interneurons express the calcium-binding protein parvalbumin (PV) in the somatosensory cortex (Lee et al., 2010; Xu et al., 2010; Fogarty et al., 2007). The majority of PV-expressing interneurons are basket cells, which can be further subdivided by size of their cell body (e.g., large basket cell, small basket cell, and nest basket cell), and chandelier cells (Helmstaedter et al., 2009; Uematsu et al., 2008; Markram et al., 2004). Physiologically, PV-expressing cells exhibit fast-spiking (FS) electrophysiological profiles, characterized by a high-frequency train of action potentials (APs) with little adaptation (Xu and Callaway, 2009; Gibson et al., 1999; Cauli et al., 1997; Kawaguchi, 1997; Kawaguchi et al., 1987). Additionally, these interneurons possess the lowest input resistance and the fastest membrane time constant of all interneurons (Ascoli et

al., 2008; Goldberg et al., 2008; Markram et al., 2004; Gibson et al., 1999; Cauli et al., 1997; Kawaguchi and Kubota, 1997; Connors and Gutnick, 1990). Far more is understood about basket cells, which are interneurons that make synapses at the soma and proximal dendrite of target neurons, and usually have multipolar morphology (Ascoli et al., 2008; Kawaguchi and Kubota, 1997). Fast-spiking basket neurons are the dominant inhibitory system in the neocortex, where they mediate the fast inhibition of target neurons, among many other functions (Cruikshank et al., 2007; Gabernet et al., 2005; Lawrence and McBain, 2003; Pinto et al., 2003; Miller et al., 2001; Pouille and Scanziani, 2001; Pinto et al., 2000) and play a key role in controlling the delicate balance between excitatory and inhibitory inputs in the cerebral cortex (Haider and McCormick, 2009; Hasenstaub et al., 2005). Less is known about the second subgroup of PV-expressing interneurons, the chandelier cells. Unlike basket neurons, chandelier cells target the axon initial segment of pyramidal neurons (Ascoli et al., 2008; Kawaguchi and Kubota, 1997).

1.2.2. Somatostatin-expressing interneurons

Interneurons expressing the neuropeptide somatostatin (SST) account for around 30% of the neocortical interneurons and represent the second-largest interneuron group in the mouse neocortex. SST-expressing interneurons have little overlap with PV-expressing interneurons (Lee et al., 2010; Xu et al., 2010; Fogarty et al., 2007). Representative cell types that belong to SST-expressing neurons include Martinotti cells in the neocortex, which possess ascending axons that arborize layer I and establish synapses onto the dendritic tufts of pyramidal neurons (Wang et al., 2004; Kawaguchi and Kubota, 1997). Martinotti cells are found throughout cortical layers II-VI, but are most abundant in layer V (Uematsu et al., 2008; Wang et al., 2004; Kawaguchi and Kubota, 1997). These GABAergic interneurons typically exhibit a regular adapting firing pattern, but also may initially fire bursts of two or more spikes on slow depolarizing humps when depolarized from hyperpolarized potentials (Xu et al., 2013; McGarry et al., 2010; Ma et al., 2006). In contrast to PV-positive interneurons, excitatory inputs onto Martinotti cells are strongly facilitating (Fanselow et al., 2008; Kapfer et al., 2007; Silberberg and Markram, 2007; Beierlein et al., 2003; Reyes et al., 1998).

1.2.3. Serotonin receptor 3a-expressing interneurons

The remaining 30% of neocortical interneurons largely express the 5-hydroxytryptamine (serotonin) receptor 3a (5-HT_{3a}R) and are divided into two subclasses, vasoactive intestinal

peptide (VIP)-expressing cells and non-VIP-expressing cells. VIP is expressed in about 40% of the 5HT3aR population in the somatosensory cortex and does not overlap with SST and PV neurons (Rudy et al., 2011; Lee et al., 2010). VIP interneurons generally make synapses onto dendrites (Lee et al., 2010; Miyoshi et al., 2010; Cauli et al., 2000), and some have been observed to target other interneurons (Dávid et al., 2007; Acsády et al., 1996). Compared to all cortical interneurons, VIP interneurons possess a very high input resistance and are among the most excitable cells in the cortex (Lee et al., 2010; Miyoshi et al., 2010; Cauli et al., 2000). A significant number of VIP interneurons coexpress calretinin (CR) and display bitufted/bipolar morphology (Lee et al., 2010; Miyoshi et al., 2010; Caputi et al., 2009; Cauli et al., 2000). By physiological characterizations, these neurons are usually referred to as irregular-spiking cells (Miyoshi et al., 2010; Férézou et al., 2002; Cauli et al., 2000; Porter et al., 1998; Cauli et al., 1997). Irregular-spiking interneurons possess a vertically oriented, descending axon that extends to deeper cortical layers, and have an irregular firing pattern that is characterized by action potentials occurring irregularly during depolarization near threshold (Lee et al., 2010; Miyoshi et al., 2010; Galarreta et al., 2004; Férézou et al., 2002; Cauli et al., 2000; Porter et al., 1998; Cauli et al., 1997). The second major subtype of VIP neurons displays bitufted/multipolar morphology but does not express CR (Lee et al., 2010). These neurons are referred to as fast-adapting cells, which show rapidly adapting firing traits (Lee et al., 2010; Miyoshi et al., 2010).

In the 60% of non-VIP 5HT3aR neurons nearly 80% express the interneuronal marker Reelin. Neurogliaform cells are a type of cortical interneuron that belongs to this category. These cells have multiple dendrites radiating from a round soma and express neuropeptide Y (NPY) (Oláh et al., 2007; Kawaguchi and Kubota, 1997). They are unique relative to other GABAergic cortical interneurons because they are capable of forming synaptic connections with each other as well as with other interneuronal types (as opposed to other interneurons that can only make synapses onto homologous neurons), thus solidifying their important role in regulating neural circuitry (Price et al., 2005; Simon et al., 2005; Zsiros and Maccaferri, 2005). Furthermore, neurogliaform cells function by activating slow GABA_A and GABA_B receptors in order to provoke long lasting inhibitory postsynaptic potentials onto pyramidal neurons and other interneurons (Ma et al., 2013; Armstrong et al., 2012; Rudy et al., 2011; Lee et al., 2010; Oláh et al., 2007; Tamás et al., 2003).

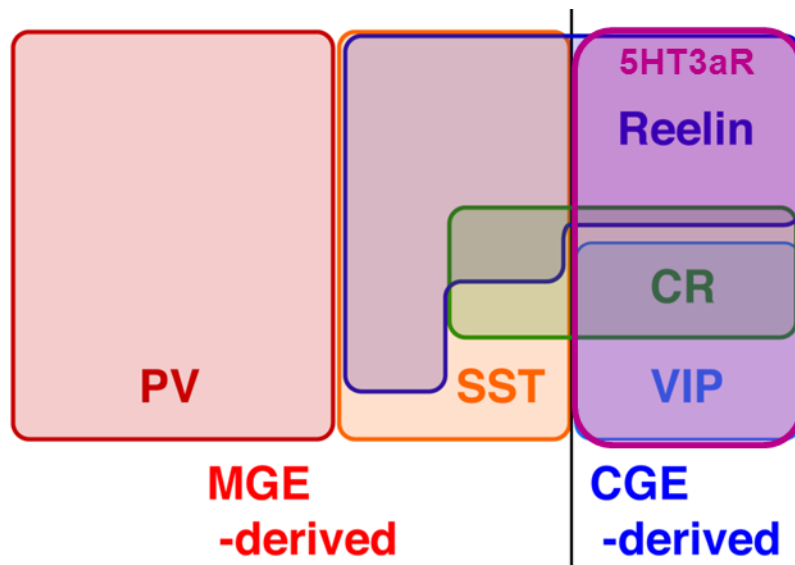

Figure 1: Origin of cortical interneuron subpopulations. Schematic showing the molecular expression profiles of GABAergic interneurons in the P21 somatosensory mouse barrel cortex. PV-, SST-, and 5HT3aR-immunopositive populations constitute mutually exclusive interneuron subtypes. PV- and SST-expressing populations are exclusively derived from the Lhx6-expressing MGE lineage (Fogarty et al., 2007). All CGE-derived interneurons express 5HT3aR. The MGE gives rise to a population of interneurons that coexpress Reelin and SST, while those Reelin expressing interneurons lacking SST-expression are CGE-derived. CR is coexpressed with all markers with the exception of PV. In addition, there appears to be a small population that is solely CR-positive within the CGE-lineage (adapted from Myioshi et al., 2010).

2. Cortical interneuron neurogenesis: a tight spatio-temporal control

The diversity of cortical interneurons appears to rely on differential developmental ontogeny that is becoming another criterion of their classification which helps in understanding their functional specificity. Previous genetic and transplantation studies have demonstrated that the distinct interneuron subtypes are produced in spatially and temporally distinct regions in the subpallium (Miyoshi et al., 2010; Wonders et al., 2008; Xu et al., 2008; Flames et al., 2007; Fogarty et al., 2007; Miyoshi et al., 2007; Butt et al., 2005; Xu et al., 2004).

2.1. The anatomical origin of cortical interneurons

In rodents, unlike in humans or primates (Letinic et al., 2002), telencephalic interneurons mainly derive from the ventral telencephalon (subpallium) (Corbin et al., 2001; Marín and Rubenstein, 2001). Similarly to the production of glutamatergic neurons in the dorsal telencephalon, neocortical interneuron neurogenesis occurs proximal to the ventricle of the developing neuroepithelium, with the majority of neocortical interneurons produced between E11 and E17. During embryonic development, the ventral telencephalon consists of the ganglionic eminences (GE) and preoptic area (POA)/ anterior entopeduncular (AEP) domains. The GE can be further subdivided into three anatomically distinct regions namely the medial (MGE), lateral (LGE), and caudal (CGE) ganglionic eminences (**Fig. 1**). The names of these different areas are based on their rostral-caudal location in the telencephalon. As embryonic development continues, the GEs grow and ultimately the morphological boundaries between these regions recede and are no longer present in the post-natal brain.

In vitro studies of cortical interneuron migration (Lavdas et al., 1999; Wichterle et al., 1999) and fate-mapping experiments (Xu et al., 2003) have shown that the ganglionic eminences (LGE, MGE, and CGE) are the principal sources of cortical interneurons (Xu et al., 2003; Nery et al., 2002). Within the subpallium, the MGE appears to be the primary source (around 70%) of cortical interneurons (Jiménez et al., 2002; Anderson et al., 2001; Wichterle et al., 2001; Marín et al., 2000). Transplantation experiments of MGE precursors have revealed that the majority of MGE-derived interneurons express either PV or SST (Xu et al., 2004; Valcanis and Tan, 2003; Wichterle et al., 2001; Wichterle et al., 1999) (**Fig. 2**). The MGE and POA express the homeobox transcription factor Nkx2.1, but the dorsal-most MGE additionally expresses Nkx6.2 and Gli1 and is partially Nkx2.1 negative

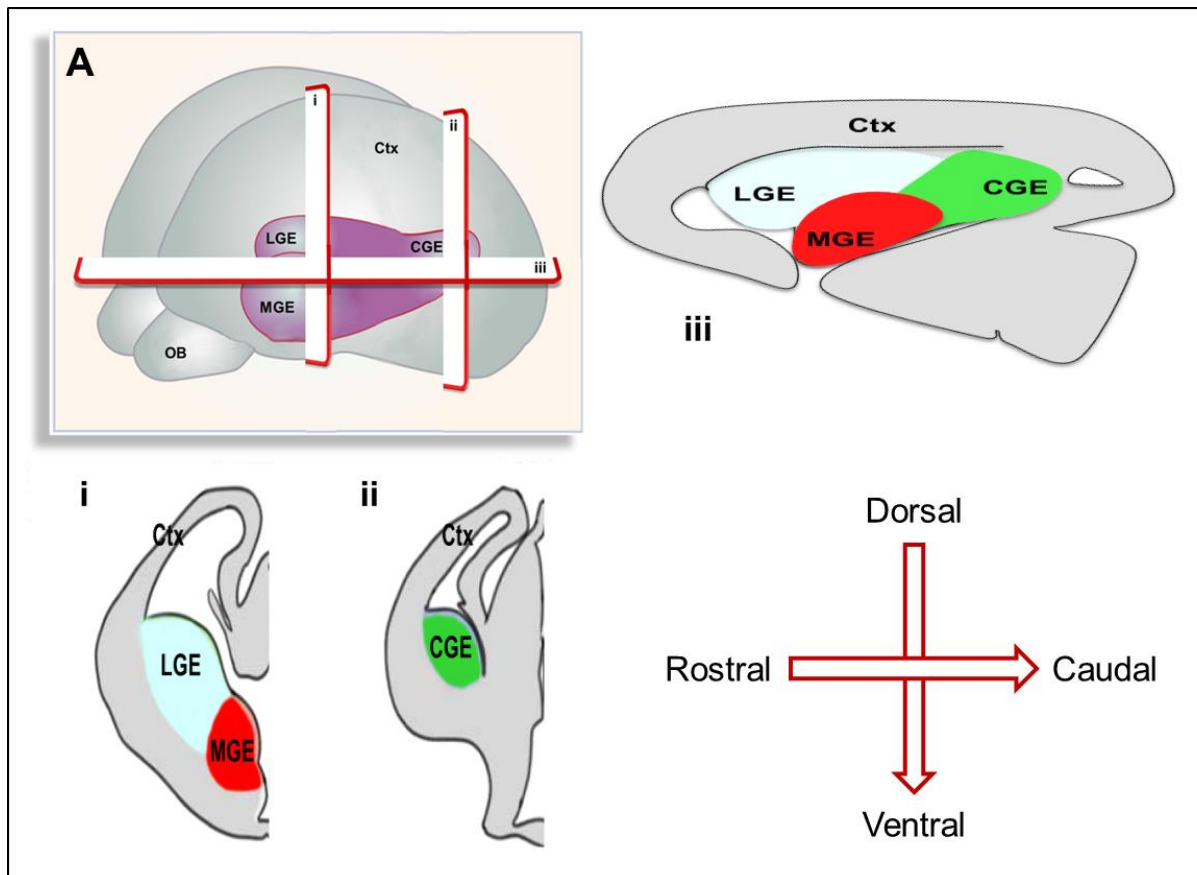

Figure 2: Schematic representation of the developing murine brain at E13.5. (A) Three dimensional view of a developing brain indicating the ventral anatomical regions that give rise to interneurons. Both the MGE (red) and CGE (green) produce cortical interneurons. Whether the LGE (blue) produces cortical interneurons is still a matter of debate. (i-ii) Coronal views of the brain at two locations along the rostro-caudal axis. (iii) Horizontal view of the brain axis at one location in the middle of the dorso-ventral axis. CGE, caudal ganglionic eminence; LGE, lateral ganglionic eminence; MGE, medial ganglionic eminence; OB, olfactory bulb; Ctx, cortex. (adapted from Batista-Brito and Fishell, 2009).

(Sousa et al., 2009; Wonders et al., 2008; Fogarty et al., 2007; Rallu Murielle et al., 2002). *In vitro* transplantation studies of dorsal (d) and ventral (v) MGE-derived cells revealed that, while both regions produce a mixed population of interneurons, there is a strong bias for the production of SST⁺ and PV⁺ cells in the dMGE and vMGE, respectively (Wonders et al., 2008; Flames et al., 2007). In particular, some evidence suggest that the Nkx6.2-expressing progenitors in the dMGE preferentially generate SST-positive cells, whereas progenitors expressing both Nkx2.1 and Nkx6.2 are the sole contributors of the double SST/CR-positive Martinotti cells in the cortex (Sousa et al., 2009; Flames et al., 2007; Fogarty et al., 2007).

The next major source of inhibitory neurons is the CGE, which is responsible for producing about 30% of all cortical interneurons (Miyoshi et al., 2010; Nery et al., 2002; Anderson et al., 2001) (**Fig. 2**). The CGE generates diverse subtypes of interneurons that preferentially populate the superficial layers of the neocortex. Nery *et al* were the first to show, via *in utero* transplantation analyses, that a certain percentage of interneurons destined for the cortex indeed originates in the CGE (Nery et al., 2002). Other studies have utilized both *in vitro* and *in vivo* experiments to confirm this initial discovery, and have further added that CGE-derived interneurons are bipolar or double-bouquet in morphology. These interneurons express VIP and/or CR (not SST) (Butt et al., 2005; Pleasure et al., 2000). Recently, Miyoshi and colleagues used a genetic fate mapping approach to corroborate the finding that the CGE is indeed a source of cortical interneurons (Miyoshi et al., 2010). Findings from several studies indicate that 5HT3aR-expressing cortical interneurons are actually largely CGE-derived, as demonstrated by EGFP visualization in the *5HT3aR-BACEGFP* mouse, a transgenic mouse generated by the GENESAT consortium (Vucurovic et al., 2010; Chameau et al., 2009; Inta et al., 2008). Lee *et al* compared cortices derived from the *Nkx2.1-BACcre* crossed to the *Cre*-dependent red *R26RtdRFP* reporter with the *5HT3aR-BACEGFP* mouse to exclude the MGE as a possible source of this population of interneurons (Lee et al., 2010). No overlap of cells labelled in red and cells labelled in green was observed, and since the *Nkx2.1-BACcre* line labels MGE-derived cortical interneurons, the MGE was thus be discounted as a source of 5HT3aR-positive interneurons (Lee et al., 2010). In addition, the *Mash1-BACCreER; R26RtdRFP* mouse line, which is CGE-specific, displayed significant and near complete overlap with 5HT3aR-expressing cells, confirming the CGE as the major source of 5HT3aR-positive cortical interneurons (Lee et al., 2010).

While it is largely agreed that the MGE and CGE serve as primary sources of cortical interneurons in the developing rodent nervous system, the possibility of the LGE as a third

source has been heavily debated. Results from several studies have suggested that the LGE could as well be a contributor of cortical interneurons (Anderson et al., 2001; Wichterle et al., 2001; Wichterle et al., 1999). Effectively, Sussel and colleagues reported that Nkx2.1 mutants, in which the MGE fails to form, show a 50% reduction in cortical interneuron numbers relative to wild-type (Sussel et al., 1999). If the MGE were the origin of the majority of cortical interneurons, then a 50% reduction implies other regions of interneuron production beside the CGE that contribute only to 30%. More convincing evidence come from E15.5 Nkx2.1 mutant embryos in which the LGE-like region seem to heavily contribute to cells migration into the developing cortex (Nery et al., 2003; Anderson et al., 2001). BrdU labeling of neural progenitors also supports the notion of a cellular migratory route from the LGE to the cortex during embryogenesis, although only a portion of the BrdU-labeled cells were also GABA-positive (Anderson et al., 2001). Additionally, Jimenez and colleagues discovered that when the MGE is removed in explants taken from rat embryos, cellular migration from the LGE to the cortex continued to be observed, suggesting that the migrating cells are not MGE cells merely passing through the LGE (Jiménez et al., 2002).

Previous reports have also indicated the contribution of several other regions, such as the POA and AEP, to the pool of cortical interneurons. Indeed, a recent study by Gelman *et al* proposed the POA as an additional source of cortical GABAergic interneurons (Gelman et al., 2011). The POA is a region of the hypothalamus, and results from this study indicate that this area contributes approximately to 10% of all GABAergic interneurons of the murine cerebral cortex. On the contrary, the AEP which is located between the MGE and the hypothalamus would contribute to the generation of cortical and hippocampal oligodendrocytes (He et al., 2001).

1.1. The time of generation of cortical interneurons

Similarly to excitatory neurons, cortical interneurons are specified in an “inside-out” manner and this laminar distribution is produced in a temporal sequence (Miyoshi et al., 2007; Anderson et al., 2002; Cavanagh and Parnavelas, 1989). Furthermore, MGE and CGE derived cells are generated with different temporal profiles (**Fig. 3**). While MGE-derived interneurons

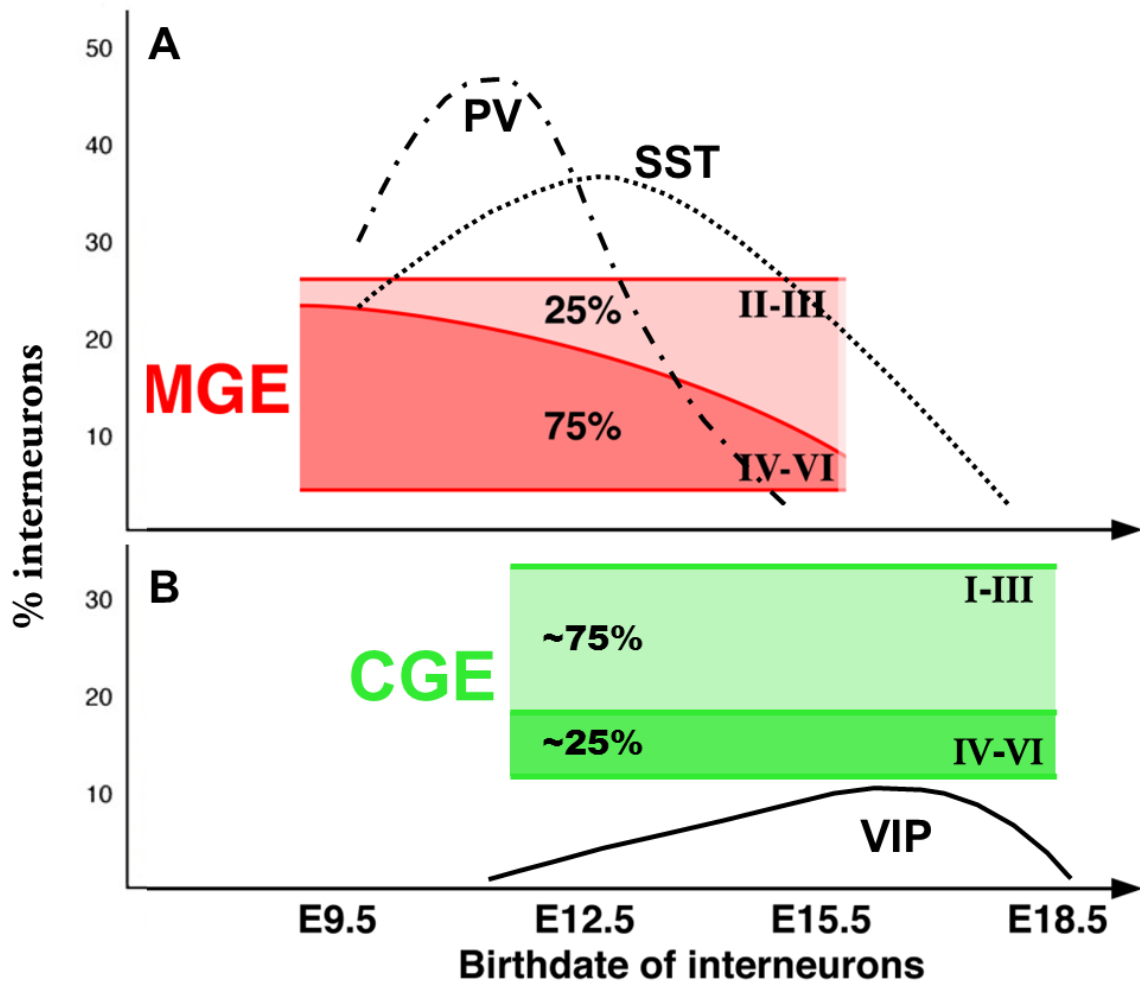

Figure 3: Temporal origin of cortical interneurons. (A) A schematic drawing showing the contribution of MGE-derived interneurons with different cortical layers based on birthdate and diagram of temporal origin of two subtypes, the parvalbumin (PV-dash-dot line) and the somatostatin (SST-dot line). MGE-derived interneurons exhibit inside-out layering. (B) A schematic drawing showing the contribution of CGE-derived interneurons with different cortical layers based on birthdate and diagram of temporal origin of one subtype, the vasoactive intestinal peptide (VIP-continuous line). Interneurons derived from the CGE preferentially occupy superficial layers. (adapted from Miyoshi and Fishell, 2011 and Batista-Brito and Fishell, 2009).

are mostly born between E11 and E17.5 (with a peak at E13.5) (**Fig. 3A**), the majority of CGE-derived interneurons are produced at later developmental time points (E12.5–E18.5, with a peak at E16.5) (**Fig. 3B**), and generate distinct interneuron subtypes, suggesting that the time of origin plays an important role in interneuron specification (Taniguchi et al., 2013; Miyoshi et al., 2010; Miyoshi et al., 2007; Butt et al., 2005; Nery et al., 2002) (**Fig. 3**). Heterochronic transplants of progenitors indicated that the fate of transplanted cells is determined by the age of the donor and not by the age of the recipient (Butt et al., 2005). Moreover, both *in vitro* culture assays and fate mapping experiments of cohorts have revealed that the competence of MGE progenitors to produce different interneuron subtypes changes over the course of neurogenesis (Miyoshi et al., 2007; Xu et al., 2004). Specifically, a high proportion of SST+ cells are born at early developmental stages, but are almost absent in E15.5, while PV+ cells are generated at a consistent rate throughout MGE-derived interneuron production. Moreover, each cohort exhibits unique physiological properties characteristic of its birthdate. A particularly interesting example of this temporal diversity phenomenon is represented by the Chandelier cells. These neurons typically, though not always, express PV+, are fast-spiking and located both superficially and in deeper regions of the cortex. Recent studies have elegantly demonstrated that these cells are predominantly produced in the vMGE at later stages, around E15.5–E17.5, of interneuron production (Taniguchi et al., 2013; Inan et al., 2012). Contrary to the MGE, genetic fate-mapping analyses have shown that interneuron subtypes generated within the CGE appear to not significantly change over time. CGE-derived cells typically populate the superficial layers of the neocortex, but there is no correlation between their temporal origin and their specific layer destination (Miyoshi et al., 2010).

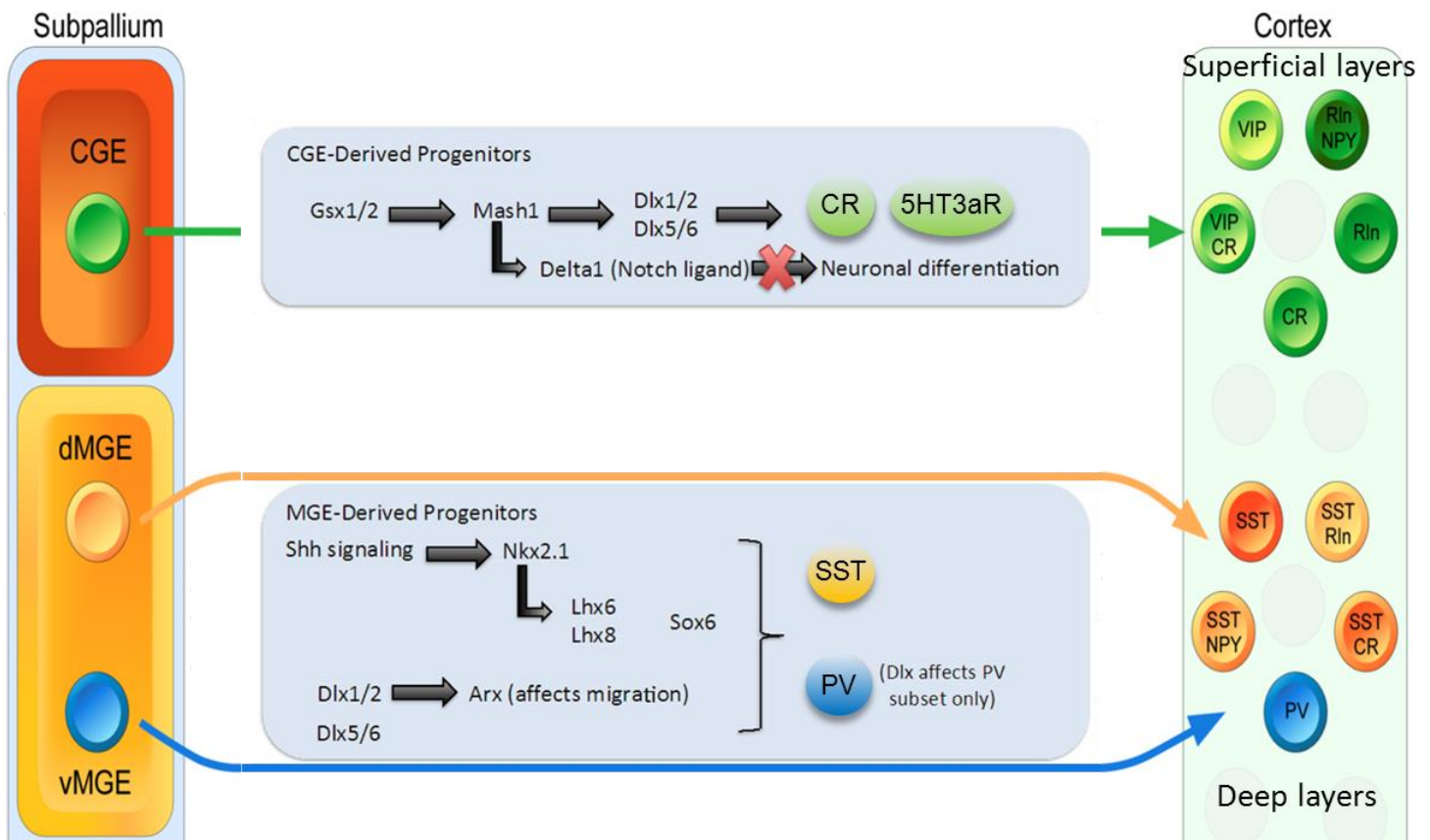

Figure 4: Specification of GABAergic cortical interneurons. With regard to the specification of MGE-derived interneuronal progenitors, several transcription factors play a role. Shh signaling activates Nkx2.1, which is the key transcription factor in specifying PV- and SST-positive interneurons from this region. Lhx6 and Lhx8 are transcription factors that lie downstream of Nkx2.1; they also aid in the specification of PV and SST interneurons. Sox6 lies downstream of both Nkx2.1 and Lhx6/8. The Dlx homeobox family of genes play a key role in specification of CGE-derived cortical interneurons, although they also function to maintain the PV-expressing subset of MGE-derived interneurons (Dlx5 in particular). Gsx1 and Gsx2 are both required for the specification of cortical interneurons that originate in the CGE. Mash1 is a downstream transcription factor whose absence results in reduced cortical interneuron numbers; it is required for proper function of the Notch ligand Delta1, which, in the Notch signaling pathway, serves to repress neuronal differentiation. The Dlx genes lie further downstream and play a crucial role in CGE-derived interneuron specification. (adapted from Kelsom and Lu, 2013 and Gelman et al., 2012)

2. Molecular mechanisms of interneuron development

The first step toward the generation of GABAergic interneurons is the subdivision of the neuroepithelium into pallium (the dorsal telencephalon that generates cortical pyramidal neurons) and subpallium (the ventral telencephalon that generates cortical interneurons). Upon patterning of the neuroepithelium along the dorsal-ventral axis through the actions of morphogens, such as Shh (Butt et al., 2008; Fjose et al., 1993) and bone morphogenetic proteins (Tang et al., 2014; Matharu and Sweeney, 1992), different sets of transcription factors begin to be expressed by progenitor cells in distinct progenitor domains (**Fig. 4**). In the telencephalon, similarly to the spinal cord, a specific combination of transcription factors seems to specify the identity of each class of interneurons (**Fig. 4**) and to be sufficient to target one interneuron type to a specific prosencephalic area and more precisely to distinct cortical lamina (Tsai and Tsai, 1997b;a). Most transcription factors are turned off in part or entirely at postnatal stages (such as Nkx2.1 or Lhx6) when interneurons are mature and express neurochemical markers used for their classification (Leng et al., 1996). So far, only few factors have been identified as being continuously expressed, from the embryonic to adult ages, by a distinct subtype of interneurons,

2.1. Transcription factors required in MGE- and LGE-derived interneuron specification

Several studies report on the identification and characterization of a transcriptional network playing key roles in regulating proper development and specification of MGE-derived GABAergic cortical interneurons. While transcription factors, such as the *Dlx* homeobox genes, *Lhx6* and *Sox6* are crucial toward specification of the PV- and SST-positive subsets of interneurons derived from the MGE, the transcription factor that seems to play a major role in MGE interneuron specification is Nkx2.1 (Cai et al., 2013; Vucurovic et al., 2010; Xiaoren et al., 1995; Ldias and Karathanasis, 1991b; Tsai et al., 1987; Wang et al., 1987), whose expression is localized and confined within the MGE (Xu et al., 2008; Xianming and Janet, 2001) (**Fig. 4**).

Nkx2.1 plays a pivotal role in the establishment of MGE progenitors as well as the specification of MGE-derived interneuron subtypes located throughout the cortical lamina (Xiaoren et al., 1995; Tsai and O'Malley, 1994). In addition, maintenance of Nkx2.1

expression is regulated by Sonic hedgehog (Shh) signalling (Butt et al., 2008). More specifically, the levels of Shh signalling to the MGE interneuronal progenitors seem to be determinant for the specification of the interneuron sub-type, either PV or SST: Xu *et al* have shown that high levels of Shh signalling preferentially give rise to SST-expressing interneurons, which in turn results in reduced production of PV-expressing interneurons (Kanatani et al., 2008). A loss-of-function study revealed that in *Nkx2.1 null* mutant mice, the MGE is mis-specified to the fate of the LGE and as a consequence, more than half of the cortical interneurons, including SST-, NPY-, and calbindin-expressing neurons, are lost (Pereira et al., 2000). A subsequent study utilizing a conditional *Nkx2.1* allele demonstrated that removal of *Nkx2.1* gene function after establishment of the MGE identity alters the fate of MGE-derived progenitors to CGE ones, so that VIP/CR-expressing neurons are generated instead of MGE-derived PV- and SST-expressing neurons (Xiaoren et al., 1995). These results indicate that *Nkx2.1* functions as a molecular switch that favours the fate of MGE progenitors rather than that of LGE and CGE.

A second transcription factor whose role is crucial to MGE-derived interneuronal specification, and whose expression is also confined to the MGE, is *Lhx6* (Vucurovic et al., 2010; Xiaoren et al., 1995; Ldias and Karathanasis, 1991b) (**Fig. 4**). *Lhx6* is a LIM homeodomain transcription factor and a direct downstream target of *Nkx2.1* (Tran et al., 1992). It is expressed in intermediate progenitors in the SVZ of the MGE (Pereira et al., 2000; Qiu et al., 1994b; Tran et al., 1992) and continues to be expressed in developing and mature postmitotic cortical interneurons. In the mature cortex, the expression of *Lhx6* is confined to PV- and SST-expressing neurons (Vucurovic et al., 2010; Xianming and Janet, 2001; Ldias and Karathanasis, 1991b). Manipulation of *Lhx6* expression levels either through genetic engineering has confirmed its importance in determining the fate of both PV- and SST-positive interneurons. In the absence of *Lhx6*, *null* mutant mice have two major phenotypes: cell migration and cell type specification defects. First, *Lhx6*-deficient neurons show a delay in reaching the cortex and are unable to properly integrate into their respective cortical layers (Vucurovic et al., 2010; Ldias and Karathanasis, 1991b). Consistent with these findings, expression of several receptor molecules such as CXCR4, CXCR7, and ErbB4, which are involved in interneuron migration and positioning, is reduced (Vucurovic et al., 2010). This observation suggests that factors downstream of *Lhx6* could contribute to the process of cortical integration. Second, MGE-derived neural progenitors are still able to migrate to the pallium in *Lhx6 null* mice, but most of these interneurons fail to express either PV or SST;

rather, they seem to express NPY, which turned out to be increased in the cortices of these mice (Vucurovic et al., 2010; Xiaoren et al., 1995; Ldias and Karathanasis, 1991b).

Transcription factors, other than *Nkx2.1* and *Lhx6*, are important for the specification of MGE-derived, PV and SST interneurons and one such factor is *Sox6* (**Fig. 4**). *Sox6* is a Sry-related HMG-box-containing transcription factor that is expressed by immature and mature MGE-derived GABAergic cortical interneurons. It has been shown that *Sox6* controls interneuron subtype differentiation by controlling the temporal segregation of transcriptional programs between progenitors and post-mitotic neurons (Tsai et al., 1987; Wang et al., 1987). Genetic removal of *Sox6* in mice results in a dramatic reduction in the number of PV- and SST-expressing interneurons (93% and 70% respectively) and an alteration in their laminar position (Tsai et al., 1987; Wang et al., 1987). However, although interneurons fail to express PV, they are morphologically like basket cells and continue to exhibit fast-spiking, albeit immature, electrophysiological features (Tsai et al., 1987). Interestingly, *Lhx6* function is required for the maintenance of *Sox6* expression in neurons that are actively migrating toward the cortex, but not in MGE-derived interneuronal progenitors (Renaud et al., 1995; Tsai et al., 1987). These data suggest that *Sox6* is necessary for proper positioning and maturation, but not specification of MGE-derived interneurons.

Another transcription factor that works in conjunction with *Lhx6* is *Lhx8*, which is regulated by *Nkx2.1* and is co-expressed with *Lhx6* in MGE-derived neuronal progenitors (Tang et al., 2012; Pereira et al., 2000) (**Fig. 4**). While *Lhx8*-positive cells are not specified to become GABAergic cortical interneurons, genetic analysis of mice lacking both *Lhx6* and *Lhx8* provided some unexpected insights toward the *Lhx8* role in cortical interneuron specification. *Lhx6/8* double mutants exhibited a significantly reduced number of MGE-derived interneuron and defective migratory paths. However, this phenotype is not observed in mice mutant for only *Lhx8* (Renaud et al., 1995). Genetic and molecular biological analyses have also revealed that the expression of *Shh* in the MZ is controlled by redundant activities of *Lhx6* and *Lhx8*, which can bind to the *Shh* enhancer and regulate its expression (Renaud et al., 1995).

Differently from the previous genes, the *Dlx* family of homeobox genes, specifically *Dlx1*, *2*, *5*, and *6*, play a role in the specification of all interneuronal progenitors (**Fig. 4**). They are expressed in most subpallial neural progenitor cells (Ldias and Karathanasis, 1991a; Wang et al., 1989) and continue to be expressed in most of their postmitotic progenies in embryonic, postnatal, and mature cortices (Cooney et al., 1993). Cortical interneurons show similar

tangential migration defects in *Dlx1/2* and *Dlx5/6* double mutants (Cai et al., 2013; Avram et al., 1999; Thummel, 1995). However, recent studies have shown that different members of the *Dlx* genes have unique gene expression dynamics and specific functions throughout development and maturation. For instance, Wang *et al* utilized transplantation experiments to demonstrate that loss of *Dlx5* or both *Dlx5* and *Dlx6* in mice leads to a significant reduction of PV-expressing interneurons, alteration in dendritic morphology, and epilepsy (Cai et al., 2013). In the adult cortex, *Dlx1* is preferentially expressed in SST- and CR-positive neurons (Cooney et al., 1993). Consistent with its expression pattern, *Dlx1* knockout mice exhibit specific and progressive loss of SST- and CR-expressing cortical interneurons, mainly due to apoptotic cell death and immature dendritic arborization in these classes of interneurons (Cooney et al., 1993).

Unlike the MGE, the contribution of cortical interneurons by the LGE remains controversial but some evidences suggest that the LGE produces a small population of Sp8-expressing cortical interneurons (Tricoire et al., 2010; Li et al., 2003; Tsai and O'Malley, 1994). Sp8 is a member of the Sp1 zinc finger transcription factor family. It is widely expressed in the mouse embryonic telencephalon (Bell et al., 2003; Treichel et al., 2003). Its expression in pallial progenitors regulates patterning of the cerebral cortex (Sahara et al., 2007; Zembrzycki et al., 2007), and its subpallial expression regulates differentiation of olfactory bulb (OB) interneurons (Waclaw et al., 2006). Sp8 is strongly expressed in the dorsal LGE (dLGE), a domain that prenatally generates OB interneurons, and unlike other transcription factors such as *Emx1*, *Gsh2*, *Nkx2.1*, *Dlx2*, and *Mash1*, Sp8 appears to be continuously expressed in the majority of mature OB interneurons (Wei et al., 2011; Liu et al., 2009; Waclaw et al., 2006). Moreover, Sp8 is required for the production of OB calretinin-expressing (CR+) and PV+ interneurons (Li et al., 2011; Waclaw et al., 2006).

2.2. Molecular control of CGE-derived interneurons

As mentioned above, approximately 30% of GABAergic cortical interneurons originate from the CGE. While it was previously thought that the CGE was merely an extension of the LGE (Yozu et al., 2005; Qiu et al., 1994b; Ldias and Karathanasis, 1991a; Wang et al., 1989), recent work considers the CGE an independent source of cortical interneurons, separated from the LGE and MGE, and with a proper transcriptional network (Lin et al., 2011; van der Wees

et al., 1996; Ldias and Karathanasis, 1991a). However, the factors and molecular mechanisms controlling the fate determination of the CGE remain largely elusive.

2.2.1. *Gsx, Mash1, Dlx and Prox1*

Among the transcription factors expressed in LGE and CGE, the homeobox transcription factors *Gsx1* and *Gsx2* are both required for the specification of interneuronal progenitors in these regions (**Fig. 4**). Xu *et al* have shown through conditional loss and gain of *Gsx2* function that *Gsx2* is required in the generation of CR-expressing bipolar cortical interneurons (Kanatani et al., 2008). Investigation of genes downstream of *Gsx1* and *Gsx2* resulted in the discovery of *Mash1* (also called *Ascl1*), a basic-helix-loop-helix transcription factor also involved in interneuron specification (**Fig. 4**). *Mash1* mutants show a significant neuronal loss early in development, as well as reduced cortical interneuron numbers (Pastorcic et al., 1986). *Mash1* has a cell-autonomous function in the development of a subset of early telencephalic progenitors and a non-cell autonomous function in mediating lateral inhibition through positively regulating Notch signalling (Miyoshi et al., 2010; Mlodzik et al., 1990; Pastorcic et al., 1986). Thus, loss of *Mash1* results in the premature differentiation of cells within the SVZ expressing the *Dlx* genes (Miyoshi et al., 2010; Pastorcic et al., 1986). The *Dlx* genes are, as in the MGE, key players in the specification of CGE-derived interneurons and lie downstream of both *Gsx2* and *Mash1* (Alfano et al., 2014; Reinchisi et al., 2011; Tripodi et al., 2004; Chan et al., 1992). Onset of expression of the *Dlx* genes follows a *Dlx2*, *Dlx1*, *Dlx5*, and *Dlx6* temporal progression (Kastner et al., 1995; Wang et al., 1990). *Gsx2*- and *Mash1*-positive neural progenitor cells simultaneously express *Dlx1/2* (Miyoshi et al., 2010; Thummel, 1995; Wang et al., 1989) and loss of *Dlx1/2* function results in the failure of *Dlx5/6* expression (Miyoshi et al., 2010; Thummel, 1995; Wang et al., 1989). Importantly, *Dlx1/2* double mutants exhibit incorrect specification of the LGE/CGE, with inappropriate expression of ventral cortical markers (Ldias and Karathanasis, 1991a; Wang et al., 1989). A detailed analysis of the transcriptional network in *Dlx1/2* double mutants has resulted in the identification of almost 100 transcription factors that may play a role, both dependently and independently of the *Dlx* genes, in MGE, LGE and CGE-derived cortical interneuron specification (Ldias and Karathanasis, 1991a; Wang et al., 1989).

A recent study showed that *Prox1*, a homeobox encoding gene, is expressed in a subset of CGE/LGE- and POA-derived interneurons during embryonic development and maintained in

the mature cortex (Miyajima et al., 1988). Indeed, during early development Prox1 expression is observed in the SVZ of all three ganglionic eminences as well as the POA, which suggests that the gene may be actively down-regulated in MGE interneurons migrating to the cortex. In the striatum however, expression of Prox1 in interneurons is independent of origin and can be detected in nearly all subtypes (Miyajima et al., 1988). The function of Prox1 in cortical interneurons is unknown. However, in the dentate gyrus of the embryonic and adult hippocampus, Prox1 is activated downstream of Wnt signals and is required for maintenance of intermediate precursors (Karalay et al., 2011; Lavado et al., 2010). In these cells Prox1 also acts as a postmitotic cell fate determinant specifying granule cell identity over CA3 pyramidal cell fate (Iwano et al., 2012) and later on it is required for maturation and survival of immature granule cells (Lavado et al., 2010). In the lymphatic system Prox1 expression is maintained in lymphatic endothelial cells (LEC) and is required throughout life for maintenance of cell identity (Johnson et al., 2008).

2.2.2. COUP-TFs

The orphan nuclear receptors, COUP-TFI and COUP-TFII are the only transcription factors identified so far that become either gradually restricted to the CGE (Ritchie et al., 1990) or widely expressed within CGE (Kanatani et al., 2008; Tripodi et al., 2004). COUP-TFs stands for Chicken Ovalbumin Upstream Promoter Transcriptional Factors, since they were shown to be transcriptional regulators binding specifically to the promoter region of the chicken ovalbumin gene and regulating its expression in chicken oviducts (Wang et al., 1989; Tsai et al., 1987; Wang et al., 1987; Pastorcic et al., 1986). More generally, COUP-TFs are nuclear receptors belonging to the steroid/thyroid hormone receptor superfamily (Tsai and Tsai, 1997a). Members of this family are internalized to the nucleus both in a ligand-dependent or independent manner and act as strong transcriptional regulators by binding to the DNA of their target genes. COUP-TFs are defined as orphan receptors, since ligands regulating their activity have not been identified so far. They are required in many vital processes, such as organogenesis, angiogenesis, and metabolic homeostasis, as well as in a variety of developmental programs. These developmental processes involve COUP-TFs in different cellular functions, such as cell fate determination, cell differentiation, cell survival, and cell migration (reviewed in (Alfano et al., 2014; Lin et al., 2011; Park et al., 2003)).

In vertebrates, there are two major homologues of COUP-TFs, COUP-TFI (also known as EAR-3, NR2F1) (Wang et al., 1989; Miyajima et al., 1988) and COUP-TFII (also known as ARP-1, NR2F2) (Tsai and Tsai, 1997a; Ladias and Karathanasis, 1991a; Ritchie et al., 1990; Wang et al., 1990). Little is known about EAR2, the other COUP-TF member in vertebrates (Miyajima et al., 1988), which is expressed in the brain and can form heterodimers with COUP-TFII (Avram et al., 1999). In humans, hCOUP-TFI and hCOUP-TFII genes are located on chromosome 5 and chromosome 15, respectively. Human COUP-TFI was the first COUP transcription factor purified and characterized from HeLa cell nuclear extracts (Wang et al., 1989). The second human family member, hCOUP-TFII, was identified based on its high sequence homology to hCOUP-TFI (Wang et al., 1991). Since their identification, COUP-TF homologs and orthologs have been obtained from numerous species by homology screening leading to the identification of three members in *Xenopus* (the xCOUP-TFA, xCOUP-TFB and xCOUP-TFC) (Tsai and Tsai, 1997a; van der Wees et al., 1996; Matharu and Sweeney, 1992) and zebrafish (zCOUP-TFII (svp40), zCOUP-TFI (svp44) and zCOUP-TFIV (svp46) (Fjose et al., 1993). The fruit fly *Drosophila* and the sea urchin have only one member (the seven-up gene (svp) in *Drosophila* (Mlodzik et al., 1990) and the *spCOUP-TF* gene in the sea urchin (Chan et al., 1992). The sequences of COUP-TF genes are highly conserved from invertebrate to humans which normally indicates evolutionary conserved important functions (Alfano et al., 2014; Tsai and Tsai, 1997a).

Similar to other nuclear receptors, COUP-TFs possess a typical receptor domain structure consisting of a DNA binding domain (DBD) containing two zinc-finger motifs of 66 amino acids, a putative C terminal ligand binding domain (LBD) containing two regions, I and II, which have been shown to be important for the formation of a ligand-binding pocket (Renaud et al., 1995). COUP-TFs have also two activation functional domains, AF-1 and AF-2, necessary for co-factor recruitment (Tsai and Tsai, 1997a) and positioned in the N-terminal and in the LBD domains, respectively (Li et al., 2003). COUP-TFs form homodimers and bind to a wide range of direct GGTC repeat motifs with a variety of spacing and orientation (Cooney et al., 1992; Kliewer et al., 1992). They can also form heterodimers with retinoic acid receptor (RAR), thyroid hormone receptor (TR), and retinoid X receptor (RXR) (Leng et al., 1996; Cooney et al., 1993; Kliewer et al., 1992; Tran et al., 1992). COUP-TFI and COUP-TFII have 80 % homology within the DBD (Alfano et al., 2014). Furthermore, the DBDs of COUP-TFs in different species are almost identical, implying that they bind to similar *cis*-responding elements (Tsai and Tsai, 1997a; Tsai and O'Malley, 1994). Additionally, COUP-

TFI and COUP-TFII share 97 % sequence homology in the LBD, and most surprisingly, the putative LBDs are 99.6% identical among vertebrates and 90% between human and fly (Tsai and Tsai, 1997a). Such a high degree of sequence conservation strongly suggests that these domains are critical for their biological function. In contrast, the N-terminal domain of COUP-TFI and COUP-TFII are significantly divergent, having only 45% identity (Ladiaz and Karathanasis, 1991a; Wang et al., 1989) and suggesting that, while these two factors share similar activation mechanisms, they might differ remarkably in their molecular interactions (Zhou et al., 1999; Ladiaz and Karathanasis, 1991a; Wang et al., 1991; Wang et al., 1989). Based on this high sequence conservation between species, it has been proposed that COUP-TFs might play a vital role for cellular function. Indeed, it is known that *null* mutants of the *Drosophila* *svp* are lethal (Mlodzik et al., 1990) and that COUP-TFI and COUP-TFII loss-of-function mouse mutants lead to perinatal and embryonic lethality, respectively (Pereira et al., 1999; Qiu et al., 1997).

During development COUP-TFI and COUP-TFII are first detected at E8.5 in the mouse head mesenchyme. Up to E10.5, they share common expression patterns in the optic stalk, in the dorso-caudal region of the telencephalon and in the diencephalon (Qiu et al., 1994a). However, while COUP-TFI is expressed in a rostral low to caudal high gradient in the telencephalon from E9.5 onwards (Tripodi et al., 2004; Liu et al., 2000; Qiu et al., 1994a), COUP-TFII expression remains limited to its caudalmost regions in both dorsal and ventral telencephalon (Qiu et al., 1994a). In addition, slight differences in the pattern of COUP-TFI and II expression in the thalamus have also been described (Qiu et al., 1994a). Starting from E11.5, their expression profile becomes increasingly complementary in the cerebral cortex, in the ganglionic eminences, and in the thalamus (Tripodi et al., 2004; Qiu et al., 1994a). At E13.5, COUP-TFs are both expressed in the cerebral cortex (in the archicortex, neocortex, and paleocortex primordia), in the POA, in the LGE and CGE, in the dorsalmost region of MGE and in scattered cells of the ventral telencephalon (Tripodi et al., 2004). However, COUP-TFII is generally expressed in more restricted regions than COUP-TFI, and, most importantly, the characteristic rostromedial-low to caudolateral-high gradient of COUP-TFI expression is only partially mirrored by COUP-TFII, which remains primarily limited to the caudalmost region of the telencephalon (Tripodi et al., 2004; Qiu et al., 1994a).

Given the significant expression of COUP-TFs in the developing nervous system, both genes have been objects of intense functional studies over several years. Analysis of loss of function

mice has revealed central roles of COUP-TFI and COUP-TFII in specific aspect of brain formation. Here, I focus on what is known so far on their roles in interneuron genesis, migration, and specification. The first evidence of COUP-TFI and II expression in cortical interneurons and their possible function during tangential migration came from Tripodi *et al.* (Tripodi *et al.*, 2004). Ectopic expression of COUP-TFI and COUP-TFII in the ganglionic eminences resulted in an increased rate of migrating cells towards the cerebral cortex, indicating novel functions of COUP-TFs in regulating cell migration in the developing forebrain (Tripodi *et al.*, 2004). Although both genes are expressed at high levels in the CGE (in addition to the dorsal MGE for COUP-TFI and the interganglionic sulcus for COUP-TFII), they seem to be expressed in different cortical interneuron populations and to follow distinct migratory paths, dorsal and ventral for COUP-TFI (Tripodi *et al.*, 2004) and caudal for COUP-TFII (Miyoshi *et al.*, 2010; Vucurovic *et al.*, 2010). Fate mapping and transplantation analyses demonstrated that COUP-TFII is highly expressed in the caudal migratory stream (CMS) constituted mainly by CGE-derived cells directed towards the cortex, amygdala, and hippocampus (Tang *et al.*, 2012; Reinchisi *et al.*, 2011; Tricoire *et al.*, 2010; Kanatani *et al.*, 2008; Yozu *et al.*, 2005; Nadarajah *et al.*, 2003). The morphology adopted by these cells during caudal migration is similar to that of cells migrating radially to upper layers of the cortex, hence they might exploit similar mechanisms for their locomotion (Yozu *et al.*, 2005; Nadarajah *et al.*, 2003). These neurons begin their migration as early as E13.5, and probably require external signaling, since grafting CGE cells into the MGE impairs migration (Yozu *et al.*, 2005), and ectopic expression of COUP-TFII in the MGE with subsequent grafting into the CGE allows MGE cells to migrate caudally (Kanatani *et al.*, 2008). This is also consistent with the observation that a small population of cells in the dorsal MGE expressing COUP-TFII migrate caudally in the CGE, which strongly supports the role for COUP-TFII in promoting caudal migration of GE cells in a cell-autonomous way (Kanatani *et al.*, 2008).

Contrary to COUP-TFII, the function and mechanisms of COUP-TFI in directing interneuron migration is still not clear and requires further study. In contrast, COUP-TFI has been shown to play a crucial role in the specification of distinct cortical interneuron subpopulations (Lodato *et al.*, 2011). By abolishing COUP-TFI function in intermediate progenitors and early post-mitotic interneurons derived from the MGE and CGE, the total number of GABAergic interneurons reaching the cerebral cortex remained normal; however, the proportion of GE-derived specific interneuronal subtypes was altered. The VIP- and CR-expressing interneurons, originating from the CGE, were significantly decreased with a corresponding

increase in PV-expressing neurons derived from the MGE (Lodato et al., 2011). This phenotype correlated with an increased proliferation of intermediate progenitor cells, indicating that COUP-TFI might control cell fate specification by modulating cell-cycle progression during interneuron specification. Strikingly, in contrast with other genetic mouse models, which normally show a higher predisposition to epileptic seizures when interneuron subpopulations are unbalanced, COUP-TFI mutants are more resistant to pharmacologically induced seizures when compared to control mice, possibly due to an overproduction of PV-expressing interneurons (Lodato et al., 2011). How this excess of PV interneurons affects the local cortical circuits and neuronal activity is still unknown and might be worth analyzing in future studies.

Whether and how COUP-TFII acts during cortical interneuron specification is, to date, still unclear. At present, COUP-TFII is mainly used as a CGE marker and it has been shown to be abnormally upregulated in the MGE of E10.5 *Nkx2.1* mutants in accordance with an MGE to CGE fate switch (Butt et al., 2008), suggesting that COUP-TFII might play a role in early regionalization of the GE during interneuron development. Two recent studies described COUP-TFII expression in distinct GABAergic cortical interneuron subtypes; however, their conclusions were not always univocal. On the one hand, Tang et al. (Tang et al., 2012) used the lacZ reporter gene inserted in the *COUP-TFII flox* allele and observed co-localization of lacZ with CR- and VIP-positive cells (CGE-derived), but not with SST- and PV-expressing interneurons (MGE-derived cells). On the other hand, immunofluorescence with a monoclonal anti-COUP-TFII antibody labeled mainly SST- and Sox6-expressing cells in layer V and Sp8-expressing cells, originating from the dorsal LGE and CGE, in upper cortical layers. However, no CR-positive cells co-localized with COUP-TFII in this study (Cai et al., 2013). Surprisingly, conditional inactivation of COUP-TFII by using a *RxCre* mouse line, normally active in the ventral forebrain and developing retina (Swindell et al., 2006), did not alter the distribution and number of cortical interneurons (Tang et al., 2012), suggesting that either the *Cre* line was not appropriate for inactivating COUP-TFII in cortical interneurons or that COUP-TFI might compensate for the absence of COUP-TFII during interneuron specification and migration. Finally, COUP-TFII expression was analyzed in samples of fetal human brain, and a sparse expression of this gene was found in 9 gestational weeks (GW) human forebrains (Reinchisi et al., 2011). Similarly to rodents (Qiu et al., 1994a), hCOUP-TFII is expressed in the GE, and at 15 GW, at a higher rate in the CGE than in the LGE or

MGE (Reinchisi et al., 2011). In summary, all these data suggest a potential role for COUP-TFI and COUP-TFII in the migration and specification of CGE-derived cortical interneurons.

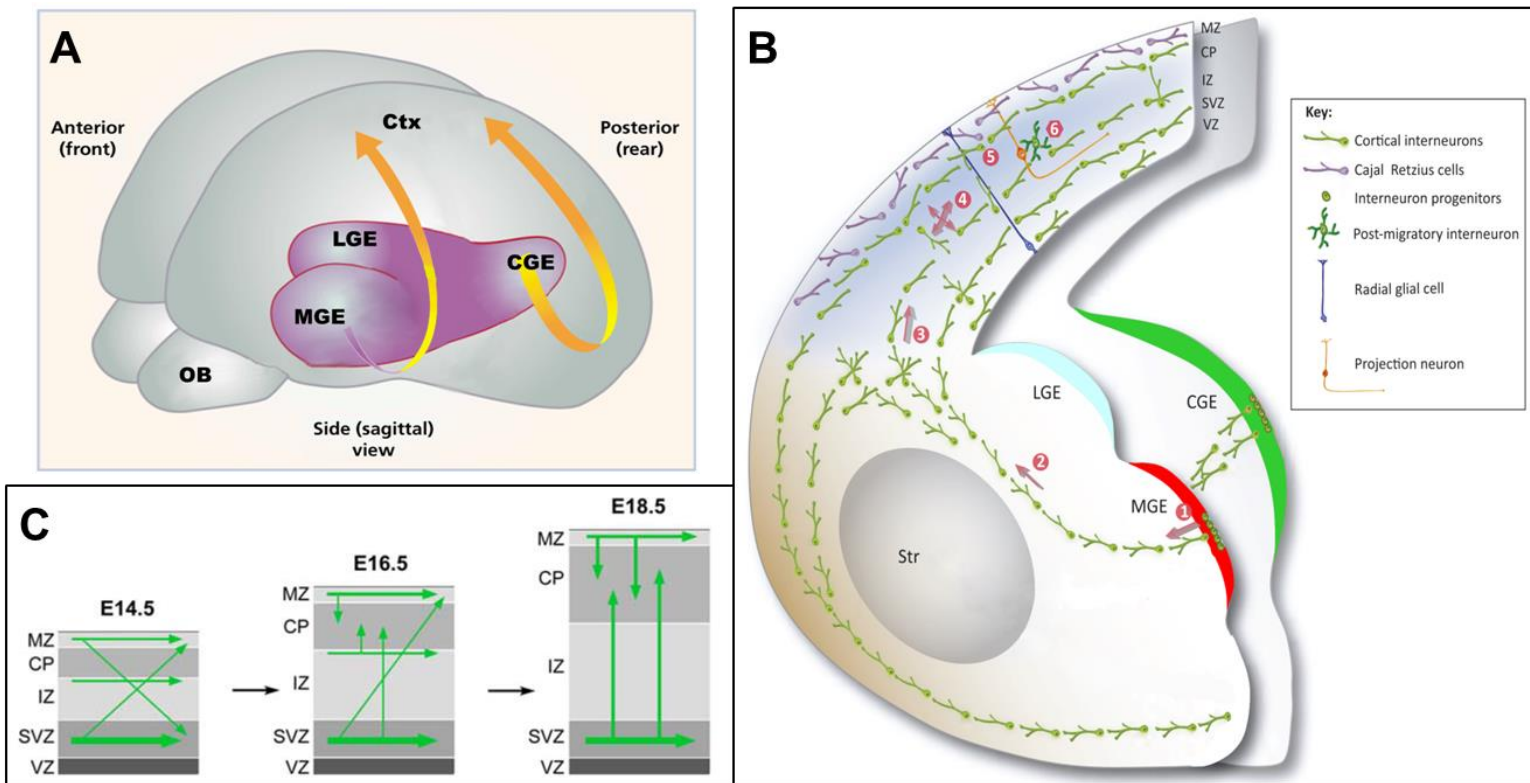

Figure 5: Cortical interneuron migration in the developing telencephalon. (A) Major routes of tangential migration with the route from MGE to the dorsal telencephalon and the caudal migratory stream (CMS) established between the CGE and the caudo-dorsal telencephalon. (B) Illustration of the major decision-making steps (1–6) involved in the migration of cortical interneurons derived from the subpallium. (1) Interneurons derived from the MGE (red) or the CGE (green) exit the proliferative zones and initiate their migration toward the developing neocortex. (2) Cortical interneurons traverse around the developing striatum, transit across the corticosubpallial boundary, and course tangentially into the cortex. (3) They transit the neocortex mainly through the marginal zone (MZ), subplate (SP), and intermediate zone (IZ)/subventricular zone (SVZ) migratory streams. Once in the neocortex, (4) tangentially migrating interneurons undergo multimodal local migration as they reach and (5) settle in specific areas and laminar locations within the emerging cortical plate (CP) before (6) forming functional synaptic contacts with appropriate projection neuron partners. Multiple decision-making steps are involved in this process. Arrows indicate net directionality of movement. (C) Schemas summarizing the main tangential migratory routes in the cortex used by Gad65Gfp interneurons and their radial paths at different developmental stages. Tangential migration of cortical interneurons is preferentially done by the SVZ before the radial migration from E14.5. Ctx, cortex; Str, striatum; VZ, ventricular zone; SVZ, subventricular zone; IZ, intermediate zone; CP, cortical plate; MZ, marginal zone. (adapted from Corbin et al., 2001; Guo and Anton, 2014 and Lopez-Bendito et al., 2008).

3. Interneuron migration: a long journey

Once generated and specified in their respective origins within the ventral telencephalon, GABAergic cortical interneurons migrate tangentially in multiple streams over long distances to reach their final destinations in the cortex and establish proper patterning of the cortical network. During this process, interneurons integrate their cell-intrinsic characteristics with cues from the local environment to facilitate decisions that are necessary for their appropriate patterns of migration.

3.1. The major dorsal routes taken by migrating interneurons

3.1.1. *Tangential migration of cortical interneurons*

Interneurons do not disperse throughout the cortex in an indiscriminate way, but rather use a very specific set of routes or migratory streams. Early postmitotic interneurons exit the VZ/SVZ and start migrating through distinct routes: the MGE-derived cells disperse dorso-medially and migrate toward all rostrocaudal cortical regions (**Fig. 5A**) (Tang et al., 2014), while the CGE-derived cells primarily migrate toward the caudal region of the cortex through the Caudal Migratory Stream (CMS) (**Fig. 5A**) (Rubin and Kessaris, 2013; Vucurovic et al., 2010; Swindell et al., 2006). Although the majority of LGE-derived cells contributes to the Rostral Migratory Stream (RMS) toward the olfactory bulb (Lois and Alvarez-Buylla, 1994; Luskin, 1993) it has been reported that a subpopulation of LGE cells might migrate dorsomedially toward the cortex (Tripodi et al., 2004). Tangential migration is, for the most part, complete by birth.

Most of the studies dealing with interneuron migration focus on the dorsal migratory routes when cells approach the cortex. Early tracing studies have demonstrated that different streams of interneurons arising from the GE are able to cross the Pallial-Subpallial Boundary (PSB) and course tangentially into the cortex. Analogous to their specification process, the migratory trajectories of interneurons display distinct spatial and temporal patterns (**Fig. 5B**). At E12.5 in the mouse, a time point that corresponds to early stages of neurogenesis (Tricoire et al., 2010; Kanatani et al., 2008; Liu et al., 2000), an early stream of interneurons from the MGE avoids the developing striatum and reaches the cortex, migrating at the level of the preplate (PP). Later during corticogenesis (E12.5–E14.5), a second and more prominent stream of

interneurons, mainly from the MGE, rapidly migrates into the neocortex, through the intermediate zone (IZ) (Liu et al., 2000). This latter stream is joined by interneurons from the LGE, although much less robustly and via a more restricted route through the cortical proliferative zone (**Fig. 5B**) (Tripodi et al., 2004; Liu et al., 2000). Finally, at a later time point of corticogenesis (E14-15), three migratory routes, called tangential migratory streams, are observed in the cortex. Interneurons enter the cortex largely through the lower IZ/subventricular zone (SVZ) but also through the marginal zone (MZ) and the subplate (SP) (**Fig. 5C**). Within the MZ stream, interneurons exhibit a particular migratory behaviour called “random walk”, leading to constant multidirectional changes (Kelsom and Lu, 2013). This behaviour of interneurons is believed to contribute to the tangential dispersion of interneurons to appropriate cortical areal positions.

Transplantation experiments have suggested that the mechanisms controlling the direction of migration of CGE and MGE cells from the subpallium to the developing cortex are intrinsically different (Vucurovic et al., 2010). The pathways of migration used by cortical interneurons suggest that, simultaneously with the MGE-derived streams, a wave of interneurons originating from the CGE migrate caudally toward the caudal-most end of the telencephalon (Vucurovic et al., 2010; Nery et al., 2002) and may enter the cortex through the SVZ and IZ. In fact, Yozu *et al.* labeled E13.5 CGE-derived cells by electroporation and showed that these cells migrate caudally mainly through the vicinity of the cortical SVZ and IZ, but also toward the MZ (Vucurovic et al., 2010). Consistent with these findings, cells derived from the LGE/CGE, labelled in *Nkx2.1-Cre^{Tg}/Dlx1-Venus^{fl}* transgenic embryos where the expression of the *Dlx1-Venus^{fl}* that is found to be maintained in the entire cortical GABAergic interneuron population (Cobos et al., 2006) is subtracted from MGE and POA-derived cells by the expression of the Cre under control of *Nkx2.1*, were first found in the neocortical SVZ at E13.5-14.5 and were later observed in the CP and MZ (Rubin and Kessaris, 2013). Furthermore, CGE cells labelled by administration of tamoxifen at E12.5 in *Mash1BAC-CreER /RCE:loxP*-transgenic mice first appeared in the IZ and were later observed in the CP and MZ (Tang et al., 2012). Most of these cells had become GABAergic interneurons at P21 (Cooney et al., 1992).

There is still a debate on whether LGE-derived cells migrate dorsally to the cortex. If any, the LGE contribution to cortical interneurons is far smaller than that of the MGE (Tang et al., 2014; Reinchisi et al., 2011; Tripodi et al., 2004). Nevertheless, evidences in support of some

LGE contribution exist. First, *Nkx2.1 null* mutants lacking normal MGE tissue show a robust migration from the LGE-like region to the cortex at E15.5 (Tripodi et al., 2004; Tsai and Tsai, 1997a), although this might be due to a partial change of fate of the LGE to MGE. In the same direction, injection of DiI into slices of the LGE where the VZ and the SVZ of the MGE had been removed shows as well robust migration from the LGE to the cortex, implying that the observed migration is not simply due to MGE cells migrating through the LGE (Pereira et al., 2000). Second, Anderson *et al.* investigated this possibility by labelling murine LGE cells with BrdU at E14.5-16.5 and E12.5, transplanting them into host slices at the same stage of development, and culturing them. The data showed that the BrdU-labelled LGE cells at E14.5-16.5 had migrated into the cortex through the proliferative zones but that the cells labelled at E12.5 had not. Some of the LGE cells that had been labelled with BrdU at E15.5 were found to be GABA-positive after they had reached the cortex (Tripodi et al., 2004). These findings suggested that only murine LGE-derived GABAergic interneurons born at E14.5 or later entered the cortex and migrated dorsomedially through the proliferative zones (Tang et al., 2014; Tripodi et al., 2004). However, MGE cells are still generated at this age and might have contributed to this stream as well.

3.1.2. Radial migration of cortical interneurons

After an interneuron has made its way to the cerebral cortex from the subpallium, its journey is not yet complete. An interneuron now needs to join with the locally derived excitatory neurons and form functional connections. Once in the cerebral cortex, interneurons generally enter the CP by turning to migrate radially to reach their final positions (**Fig. 5C**) (Alfano et al., 2014; Elena et al., 2014; Southwell et al., 2014; Vogt et al., 2014). To make the tangential-to-radial directional switch, interneurons rapidly extend new branches that are oriented orthogonally to their tangential migratory direction (Elena et al., 2014; Tochitani and Kondo, 2013; Pereira et al., 1999). Changes in the dynamics of interneuron branching appear to be critical for this transition. Recent evidences demonstrate that migrating interneurons and radial glia fibers interact via gap junctions expressing the connexin 43 subunit. The downregulation of connexin 43 expression in interneurons significantly decreased the percentage of radially oriented cells, with a concomitant increase in tangential cell orientation (Parent and Murphy, 2013). This interaction mediating the tangential to radial migratory switch indicates that some interneurons may utilize the radial glial scaffold as a means to migrate within the CP (Elena et al., 2014; Parent and Murphy, 2013).

Birthdating studies reveal that the timing of the generation of cortical interneurons matches the timing of the generation of cortical excitatory neurons (Guo and Anton, 2014; Willi-Monnerat et al., 2008; Glickstein et al., 2007). Thus, in general cortical interneurons are born in the classical “inside-out” manner in which MGE-derived interneurons that are born at earlier times preferentially populate deep layers while those from the CGE are found in larger numbers more superficially (Tang et al., 2012). This temporal matching is quite remarkable considering that excitatory and inhibitory neurons are generated in spatially distinct compartments. To reconcile this problem, there are several evidences indicating that interneurons receive their correct laminar positional information only after they have reached the cortex (Cai et al., 2013; Zhou et al., 1999; Qiu et al., 1997). Time lapse imaging has shown that about 70% of GABAergic interneurons following the IZ/SVZ stream perform “ventricle-directed migration” where they dive down to the ventricular zone of the cortex, make contact, and pause; they then migrate radially to the CP (Daniëlle et al., 2014). This occurs at all stages of corticogenesis by neurons positioned at different depths of the cortical anlage (Daniëlle et al., 2014). Thus, these neurons might receive some layer information from developing excitatory cells or from progenitors in the VZ that might potentially providing positional information for appropriate laminar- and areal-specific integration (Taniguchi, 2014). However, some lines of evidence suggest that excitatory projection neurons do play an instructive role in directing interneurons to their proper location. Cortical interneurons invade the CP only after their projection neuron partners have migrated, possibly reflecting a need for signals from appropriately located projection neurons (Nadarajah et al., 2003). In line with this notion, a recent study reported that in *Fezf2-null* mice, the exclusive absence of subcerebral projection neurons and their replacement by callosal projection neurons cause distinctly abnormal lamination of PV+ and SST+ interneurons and altered GABAergic inhibition. In addition, experimental generation of either corticofugal neurons or callosal neurons below the cortex is sufficient to recruit cortical interneurons to these ectopic locations (Cai et al., 2013). Together these results suggest a model in which cues provided by projection neurons guide cortical interneurons to their appropriate layers.

3.2. Guidance factors involved in interneuron migration

3.2.1. Secreted molecules

Interneuron motility and guidance is mediated by the coordination of several molecular cues that function to both selectively repel and attract cortical interneuron populations. The combination of these repulsive and attractive substrates creates a corridor for migrating interneurons along the SVZ of the subpallium, leading to the formation of defined migratory routes to the cortex.

Motogens are secreted factors that influence newly specified interneurons in their ability to migrate (Liu et al., 2000). One such example of a motogen is Hepatocyte Growth Factor (HGF), which was discovered to regulate the migratory abilities of subpallial-derived cortical interneurons. HGF is required for interneuron migration, and encourages interneurons to migrate away from their sites of origin (Ldias and Karathanasis, 1991a). *Mu-PAR null* embryos (mu-PAR is a required component of the HGF pathway) have significant deficits in interneuron migration from the GEs to the cortex (Lin et al., 2011; Ldias and Karathanasis, 1991a). In addition to HGF, genes of the neurotrophin family serve as motogens for migratory cortical interneurons. Various developmental studies have shown that the cortex express several neurotrophins (Ldias and Karathanasis, 1991b; Ritchie et al., 1990; Wang et al., 1990; Wang et al., 1989), and that the neurotrophin receptors TrkB and TrkC (tyrosine kinase receptors) are expressed by interneurons (van der Wees et al., 1996; Matharu and Sweeney, 1992). One member of the neurotrophins is known as Brain-Derived Neurotrophic Factor (BDNF) (Tsai and Tsai, 1997b). Loss of proper BDNF signalling results in the downregulation of cortical interneuron markers (Xianming and Janet, 2001; Fjose et al., 1993; Mlodzik et al., 1990) and affects the numbers of cells migrating away from the subpallium (Elena et al., 2014; Ldias and Karathanasis, 1991a). Lastly, the neurotrophin glial cell line-derived neurotrophic factor (GDNF), which is expressed in migrating cortical interneurons (Chan et al., 1992), acts as a motogen for GABAergic interneurons. A study demonstrated that members of the GDNF family bind to specific types of receptors known as GFR α 1-4 and that loss of GFR α 1 in mice results in abnormal interneuron migration from the MGE and in an inability to reach the cortex (Renaud et al., 1995). Another study using the *GFR α 1 null* mice proposed that GFR α 1 signalling may serve in guiding the migration of a population of PV-expressing interneurons to the cortex (Qiu et al., 1994b).

Whereas motogens affect the ability of interneurons to migrate, chemorepellants and chemoattractants serve to provide migratory cells with the information about precise directions to follow. Conceivably, chemorepellants serve as a type of guidance cue that will direct migrating interneurons away from a certain area. Wichterle and colleagues have shown through cell culture studies that in the telencephalon, the GEs exert a repulsive force on interneurons, allowing the assumption that chemorepellants are primarily expressed in the subpallium (1992). One such example of a chemorepellant is the family of ligands known as the semaphorins (Sema) (Zhou et al., 1999). The semaphorins are able to exert their repulsive forces on interneurons in the striatum because striatal interneurons express neuropilins (Nrp1 and Nrp2) and plexin coreceptors, both of which bind to the semaphorins (Zhou et al., 1999). A study demonstrated that two semaphorins in particular, Sema 3A and 3F, modulate the migratory ability of GABAergic interneurons toward the cortex (Tran et al., 1992). Additionally, Zimmer *et al* have shown that the chondroitin sulfate proteoglycan known as chondroitin-4-sulfate acts in concert with Sema 3A to repel cortical interneurons within the LGE, further defining the boundary of the migrating cells (Cooney et al., 1993). Slit1 is a second chemorepellant whose expression is found in the VZ and SVZ of the GEs. Slit1 is able to exert its chemorepulsive effects due to its receptor, Roundabout (Robo1), which is expressed on the migrating cortical interneurons (Leng et al., 1996; Xiaoren et al., 1995; Tsai et al., 1987; Pastorcic et al., 1986). Analysis of the complementary expression patterns of both Slit and Robo proteins and their corresponding functional assays strongly indicate that the Slit/Robo system is required in repelling interneurons from their sites of origin (Kastner et al., 1995; Thummel, 1995; Tsai and O'Malley, 1994; Wang et al., 1987). The last type of chemorepellant is Ephrin and its Ephrin receptor tyrosine kinases, which are repulsive cues for MGE-derived interneurons, as demonstrated both *in vitro* and *in vivo* (Cooney et al., 1992; Wang et al., 1991). Ephrin A5, in particular, is expressed in the VZ of the GE, whereas its receptor, EphA4, is expressed by calbindin-expressing MGE-derived interneurons (Cooney et al., 1992). Interestingly, *siRNA* knockdown of the EphA4 receptor resulted in the inability of Ephrin A3 to exert its repulsive effects on interneurons within the MGE (Wang et al., 1991).

While inhibitory signals exhibited by chemorepellants are undoubtedly essential in defining the tangential migratory route cortical interneurons must undertake, chemoattractive factors are just as important during the migration process. Whereas chemorepellants are mainly localized in the subpallium, chemoattractive molecules are present in the pallium. One such

chemoattractant is the chemokine CXCL12, which signals through its receptors CXCR4 and CXCR7. Interneurons derived from the MGE are found to express both of these receptors (Yozu et al., 2005). The expression pattern of CXCL12 varies throughout development: its expression remains high in the MZ and SVZ until E14.5, but during later stages of corticogenesis its expression is significantly reduced in the SVZ (expression in the MZ remains unchanged) (Zhou et al., 1999) until it is completely lost in neonatal interneurons. This loss coincides with the timing of radial invasion into the CP by interneurons, suggesting that these two processes are linked. Li *et al* have further described CXCL12 function: it exerts its attractant force on MGE-derived interneurons guiding them to the tangential migratory streams (Qiu et al., 1997). Constitutive deletion of CXCR4 results in interneuron accumulation in the ventral pallidum as well as disorganization of their migratory streams in the cortex. These defects ultimately result in abnormal interneuron lamination in post-natal brains (Nadarajah et al., 2003; Zhou et al., 1999).

The glycoprotein Neuregulin 1 (NRG1) also serves as a chemoattractant in the interneuronal migration process. NRG1 was discovered to be essential for interneurons to leave the MGE, traverse through the LGE and into the cortical wall (Qiu et al., 1994a). Flames *et al* more specifically demonstrated that NRG1 plays a major role in the guiding of interneuron precursors via the regulation of two different isoforms, soluble NRG1-Ig and membrane bound NRG1- CRD. These isoforms act as long and short-range attractants for tangential migration. NRG1-CRD is highly expressed in the GE creating a permissive effect for migrating interneurons through the SVZ of the LGE. NRG1-Ig is expressed in the cortical VZ/SVZ and is involved in attracting the subventricular stream of tangentially migrating interneurons (Qiu et al., 1994a). When interneurons are exposed to an exogenous source of NRG1, neurons extend new neurites in the direction of the source (Pereira et al., 1999), suggesting that endogenous NRG1 present during development might indeed be required in attracting migrating cells. Reduction or loss of NRG1 in the forebrain prevents GABAergic interneurons from leaving the MGE (Qiu et al., 1994a). Accordingly, the NRG receptor ErbB4 is expressed by migratory interneurons and particularly by PV+ interneurons (Qiu et al., 1994a). In conditional ErbB4 mutants a reduced number of cortical interneurons is observed (Qiu et al., 1994a). Thus, NRG1 seems to act through ErbB4 during interneuron migration. Interestingly, both NRG1 and ErbB4 have been linked to schizophrenia in humans (Tang et al., 2014; Rubin and Kessaris, 2013).

3.2.2. *Transcription factors*

While both motogenic and chemotactic factors have been recognized as important cues on interneuron migration to the cortex, several studies have attributed to transcription factors an equally important role during migration. One such transcription factor is the LIM homeodomain *Lhx6*. MGE-derived interneurons that are actively migrating to the cerebral cortex express *Lhx6* (Lodato et al., 2011; Wang et al., 1991). Moreover, *Lhx6* is also expressed in most PV- and SST-positive cortical interneurons in mice (Butt et al., 2008). By knocking down *Lhx6* using RNA interference, the migration of cortical interneurons, is affected, suggesting that *Lhx6* might somehow play a role in the migratory capability of interneurons (Miyoshi et al., 2010). Recent studies have also shown that *Lhx6* might operate by controlling the expression of receptors such as ErbB4, CXCR4 and CXCR7 (Miyajima et al., 1988). Furthermore, while *Nkx2.1* is known to be a key transcription factor for the specification of MGE-derived GABAergic interneurons (Avram et al., 1999; Pereira et al., 1999), it has also been shown to control migration of interneurons toward the cortex. Nobrega-Pereira and colleagues have shown that proper migration of MGE-derived interneurons to the cortex requires downregulation of *Nkx2.1* expression (Liu et al., 2000). Accordingly, ectopic expression of *Nkx2.1* in migrating MGE interneuron progenitors results in the inability of *Sema3A* and *Sema3F* to exert their repulsive effects because *Nrp2* is repressed by *Nkx2.1* and by consequence an accumulation of cells in the basal ganglia is observed (Liu et al., 2000). *Sip1* (*Zfhx1b*, *Zeb2*), a transcription factor which was previously known for its non-cell-autonomous role in controlling neurogenesis of excitatory projection neurons in the cerebral cortex (Seuntjens et al., 2009), is necessary to modulate *Nkx2.1* levels within migrating cortical interneurons and to control their migration to the cortex (McKinsey et al., 2013; van den Berghe et al., 2013). Using several *Cre* lines to conditionally delete *Sip1* in the ventral telencephalon, a striking reduction in the number of PV+ and SST+ interneurons that reach the cortex in these mutants was found. This is accompanied by the ectopic accumulation of interneurons in the striatum (McKinsey et al., 2013) and other regions of the ventral telencephalon (van den Berghe et al., 2013). COUP-TFII, another transcription factor, is preferentially expressed in the CGE and required in CGE-derived interneuron migration directed to caudal regions (Swindell et al., 2006). Notably, overexpression of COUP-TFII in MGE is sufficient to promote caudal interneuron migratory orientation after transplantation of the MGE into the CGE, thus providing an example of how a single, locally expressed transcription factor is capable of determining the migratory fate of interneurons in its local environment (Swindell et al., 2006). Finally, the *Dlx* family of

homeobox genes is also involved in controlling migration of interneurons to the cortex (Alfano et al., 2014; Qiu et al., 1997). More specifically, *Dlx1* and *Dlx2* can repress expression of the cytoskeletal molecules PAK3 and MAP2 in order to restrain neurite outgrowth (Alfano et al., 2014). PAK3 is a gene involved in regulating and maintaining cytoskeletal dynamics, and whose expression is low in migrating interneurons; *Dlx1/2* mutants show an increase in PAK3 expression, and an inability of interneurons to migrate to the cortex. Reducing PAK3 levels restores the ability of these interneurons to migrate tangentially to the cortex (Alfano et al., 2014). Additionally, results from another study have shown that *Dlx1* and *Dlx2* control *Nrp2* expression, one of the semaphoring receptors (Avram et al., 1999), suggesting the *Dlx* genes have multiple modes of action in regulating migration. Lastly, the homeobox transcription factor *Arx* is located downstream of the *Dlx* genes, and manipulation of *Dlx* function directly affects *Arx* expression: *Dlx1/2* double mutants show a down-regulation of *Arx* expression (Nadarajah et al., 2003). In the absence of *Arx*, MGE-derived interneuron progenitors are unable to migrate toward the cortex, resulting in reduced numbers of interneurons in the cortex (Ma Y. et al., 2012; Swindell et al., 2006).

4. Aim of the study

As described previously, the normal activity of the cerebral cortex relies on a delicate balance between excitation and inhibition. The inhibition is provided by GABAergic interneurons and their abnormal development can lead to neurodevelopmental diseases. GABAergic interneurons are born in the subpallium (MGE and CGE) and migrate to reach their targets in the pallium or the dorsal cortex. While a lot of attention has been directed to understand the factors involved in the migration and in the specification of MGE-derived interneurons; the molecular mechanisms underlying CGE-derived interneuron migration and specification still remain vague. In my study, I will take advantage of a CGE specific mouse reporter line to understand by which pathways migrate the CGE-derived interneurons to reach the cortex and then define the transcription factor involved in this process.

Materials and Methods

Mice

*COUP-TFII**flox*⁺ and *COUP-TFII**flox*⁺ mice were generated as previously reported (Armentano et al., 2007; Bardoux et al., 2005), and propagated by backcrossing to C57BL/6 in bred mice. Conditional *COUP-TFICKO* and *COUP-TFIICKO* mutant mice were obtained by mating homozygous *COUP-TFII**flox*/*flox* and heterozygous *COUP-TFII**flox*⁺ mice to the *Dlx5/6-Cre* transgenic line (Stenman et al., 2003), a kind gift from K. Campbell (Children's Hospital Research Foundation, Cincinnati, Ohio). Double conditional *COUP-TFI-TFIICKO* mice were generated by crossing the two mouse lines described above. Then, the single and double *COUP-TFs* conditional mutant mice were mated with the *5HT3aR-GFP* reporter line (Lee et al., 2010; Vucurovic et al., 2010). Homozygous *COUP-TFII**flox*/*flox* adult mice tend to die at birth ($p=1.38*10^{-12}$; n=179) due to the *flox* position in the 5' UTR of *COUP-TFII* gene. Throughout the study we used as controls either heterozygous (*COUP-TFII**flox*⁺ or *COUP-TFII**flox*⁺), homozygous (*COUP-TFII**flox*/*flox*) or *Dlx5/6-Cre-positive* (Cre⁺) mice, since they show no phenotypic abnormalities, as previously described (Armentano et al., 2007; Stenman et al., 2003). We found no phenotypic differences between male and female mutant mice. Genotyping was performed as previously described (Stenman et al., 2003; Armentano et al., 2007). Midday of the day of the vaginal plug was embryonic day 0.5 (E0.5). All experiments were conducted according to French ethical regulations and this project received the approval from our local ethics comity (NCE/2011).

Embryos fixation

Mice were perfused with 4% buffered paraformaldehyde (PFA) and brains (P21) were post-fixed in 4% PFA for 12 hours at 4°C. Decapitated head of embryos (E12.5 to E18.5) were fixed in 4% PFA for 12 hours at 4°C then brains were post-fixed in 4% PFA for 2 hours at 4°C. Following fixation, the brains were washed three times for 5min with 1X PBS.

Synthesis of RNA probes

The RNA probes used in this work are listed on Table 5. Template DNA (6-8µg) was linearized with a restriction enzyme (NEB) for 2h at the appropriate temperature and purified by illustra™ MicroSpin S-200 HR Columns (GE Healthcare 27-5120-01). Linearization was

confirmed by electrophoresis using a 1% agarose gel and the concentration of the linearized DNA determined using a NanoDrop ND-1000 spectrophotometer.

Transcription reactions containing 1µg of purified linearized DNA, Digoxigenin or Fluorescein labelling mix (Roche) and T7 or T3 RNA polymerases (Roche) in the correspondent transcription buffer were carried out at 37°C for 2h. Following DNaseI treatment, the reaction was stopped by the addition of 0.5M EDTA and precipitated overnight with 4M LiCl and 15 volumes of ice-cold 100% ethanol. The RNA pellet was air dried and resuspended in 40µL of water. Probes were stored at -20°C and used at a concentration of 300ng/mL in hybridization buffer.

***In situ* Hybridization on Floating Sections**

The Day1 of the *in situ* hybridization the sections were placed in a plate and they were washed in 1X PBS before cell lysis and protein solubilization by incubation in RIPA buffer (150mM NaCl, 1% NP-40, 0.5% Na deoxycholate 0.1% SDS, 1mM EDTA, 50mM Tris, pH to 8.0). Then, the sections were postfixed with 4% PFA and washed with 1X PBS. After washes, the sections were incubated with 100mM triethanolamine and 0.25% acetic anhydride and washed with 1X PBS. The sections were prehybridize in hybridization buffer (50% formamide, 5X SSC, 5X denhardtts, 500µg/mL herring sperm DNA, 250µg/mL yeast RNA).

At the end of ISH Day1, the sections were incubated overnight at 55°C with the indicated probes (300ng/mL). The following day, the sections were washed in post-hybridization solution (50% formamide, 2X SSC, 0.1% tween-20) and then in B1 buffer (100mM maleic acid, 150mM NaCl, 0.1% tween-20, pH to 7.5). The sections were incubated with blocking buffer (B1 buffer, 10% sheep serum). The alkaline phosphatase conjugated anti-digoxigenin or anti-fluorescein antibody was added previously diluted 1:2000 in the blocking buffer and the sections were incubated overnight at 4°C. The ISH Day3, the sections were washed in B1 buffer and incubated in B3 buffer (100mM Tris, 50mM MgCl₂, 100mM NaCl, 0.1% tween-20, pH to 9.5) before the addition of the BCIP/NBT Liquid Substrate System (Sigma), supplemented with 0.1% tween-20. Once staining had suitably developed, the reaction was stopped by washing the sections in PBST buffer (1X PBS, 0.1% tween-20).

Immunofluorescence

Brains were sectioned on a vibratome (Leica VT1000S) at 40 µm. Vibratome sections were processed free floating and immunofluorescence protocol was used. The first day, sections were washed 3 times for 10min with 1X PBS and incubated with blocking buffer (1X PBS,

10% serum, 0.1% X-100 triton) for 40min. The following primary antibodies were used diluted in blocking buffer (1X PBS, 3% serum, 0.1% X-100 triton): BrdU (mouse, 1:300, Sigma B8434); Calretinin (rabbit, 1:5000, Swant 7699/4); COUP-TFI (mouse, 1:100, Abcam ab41858); COUP-TFII(mouse, 1:100, Abcam ab41859); GABA (rabbit, 1:1000, Sigma A2052); GFP (rabbit, 1:1000, Molecular Probes A11122); GFP (chicken, 1:800, Abcam ab13970); Lhx6 (rabbit, 1:1000, kind gift from V. Pachnis); Neuropilin-1 (goat, 1:40, R&D Systems AF566); Neuropilin-2 (goat, 1:40, R&D Systems AF567); Nkx2.1 (rabbit, 1:300, Santa Cruz sc13040); NPY (rabbit, 1:500, Abcam ab43871); Parvalbumin (mouse, 1:1000, Millipore MAB1572); Prox1 (rabbit, 1:1000, AngioBio 11002); Reelin (mouse, 1:500, Millipore MAB5364); Somatostatin (rat, 1:50, Millipore MAB354); Sp8 (goat, 1:500, Santa Cruz sc104661) and VIP (rabbit, 1:500, ImmunoStar 20077).

The second day, sections were washed 3 times for 10min with 1X PBS and incubated with blocking buffer (1X PBS, 10% serum, 0.1% X-100 triton) for 40min. The following secondary antibodies were used diluted in blocking buffer (1X PBS, 3% serum, 0.1% X-100 triton): 1:300, Alexafluor 488 α -chicken; Alexafluor 488 α -rabbit; Alexafluor 488 α -mouse; Alexafluor 594 α -rabbit; Alexafluor 594 α -mouse; Alexafluor 594 α -goat; Alexafluor 594 α -rat; Alexafluor 647 α -rabbit; Alexafluor 647 α -mouse (Invitrogen).

BrdU birthdating

Timed pregnant females received a single intraperitoneal injection of bromodeoxyuridine (BrdU) (50 mg/kg) one hour before sacrifice and embryos were collected at E13.5 or E15.5. A set of three WT, *COUP-TFICKO*, *COUP-TFIICKO* and *TFI-TFIICKO* embryos were examined for BrdU-positive cell distribution in the MGE and CGE, as previously described (Tomassy et al., 2010). The percentage of BrdU-positive was calculated as the ratio of double BrdU/DAPI-positive cells divided by the total of DAPI-positive cells.

Organotypic slice cultures

Brains were embedded in 3% low melting agarose and cut using a vibratome (Leica VT1000S) at 300 μ m thickness. Slices were cultured for 3 days in Neurobasal Medium (GIBCO) plus N-2 and B27 supplements (GIBCO), as previously described (Tripodi et al., 2004).

Imaging

The sections were imaged using the Leica DM6000B microscope equipped with a colour camera or with the Leica SPE confocal microscope and images were acquired using the LAS AF software and processed in with Adobe Photoshop and ImageJ softwares.

Cell counting

For the quantification of interneuron subpopulations three coronal anatomically matched sections within the sensorimotor area in the rostral-caudal axis (Bregma:0.50, -0.34 and) were selected from littermate mice and processed by immunofluorescence to detect GABA, PV, SST, NPY, VIP, CR, Reelin and 5HTGFP. Digital boxes of fixed width were superimposed on each coronal section and they were divided into ten sampling areas (bins) with a dorso-ventral extent from the pial surface to the white matter (corpus callosum). Deep layer were assigned to bin 1 to 5 and upper layers were assigned to bin 6 to 10, based on anatomical features. Cell detection and counting was performed using Photoshop software.

Data analysis

All cell counting data and the graphs were constructed using Microsoft Excel software. For each animal a mean value was calculated from all the sections counted, and for each genotype a mean value was obtained by pooling the means of the three sampled animals. All error bars represent the standard error of the mean (s.e.m.). Statistical significance was determined using two-tailed Student's *t*-tests. * $p < 0.05$, ** $p < 0.01$.

Chapter II

Identification of two novel tangential paths of CGE-derived interneurons

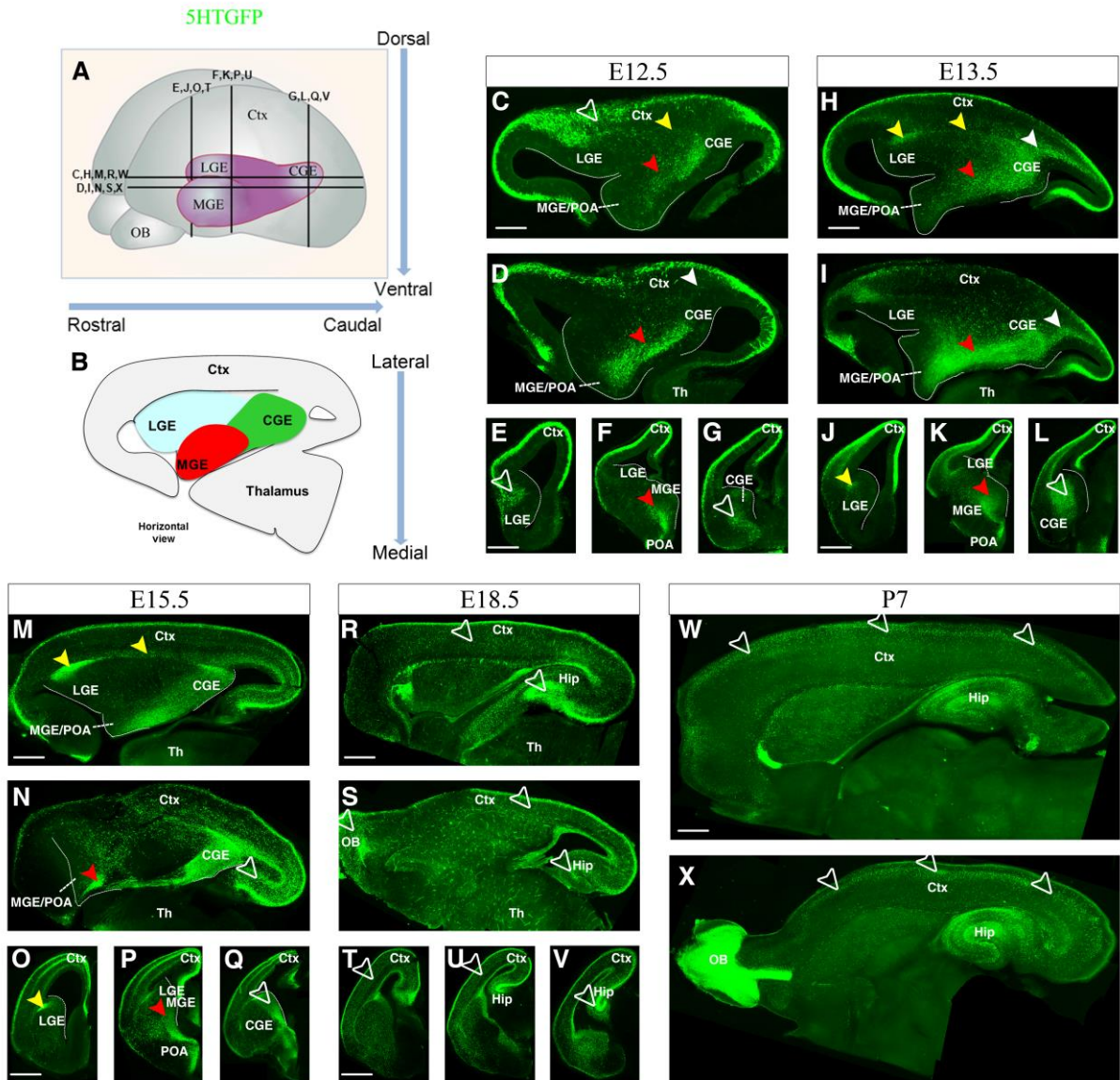

Figure 6: 5HTGFP expression pattern during development. (A) Schematic of mouse brain indicating the position of horizontal and coronal panels. (B) Horizontal section of E13.5 brain indicating the caudal, medial and lateral ganglionic eminences (CGE, MGE and LGE respectively) along the rostral to caudal axis and from lateral to medial. (C-X) Dorsal to ventral sequential horizontal sections and rostral to caudal sequential coronal sections of wild-type embryos stained with GFP. Red arrowheads indicate regionalized expression of the GFP between the CGE and the MGE. Yellow arrowheads show the GFP expression between the CGE and the LGE and white arrowheads point for the caudal migratory stream (CMS). Empty arrowheads indicate the presence of GFP in the dLGE (C, E) at E12.5, in the CGE (G, L,Q) from E12.5 to E15.5, in the hippocampal region (N, R-S, V) at E15.5 and E18.5, in the all the cortex (R-U) at E18.5, and in upper layers at P7 (W-X). Abbreviations: LGE, lateral ganglionic eminence; MGE/POA, medial ganglionic eminence/preoptic area; CGE, caudal ganglionic eminence; Ctx, cortex; Th, thalamus; OB, olfactory bulb; Hip, hippocampus.

1. CGE-derived interneurons migrate caudally but also rostrally along distinct dorsal and ventral routes

With the aim to study the specification and migration of caudally derived interneurons, I started to investigate the migratory pathways followed by CGE-derived interneurons during development. To this purpose, I used as an experimental tool the 5HT3aR-GFP (called 5HTGFP) mouse line that has been shown to specifically label interneurons born in the CGE in adult mice (Rudy et al., 2011; Lee et al., 2010; Vucurovic et al., 2010; Inta et al., 2008). Although previous data reported the contribution of 5HTGFP+ to several cortical and subcortical structures (Vucurovic et al., 2010; Inta et al., 2008), little is known on how CGE-derived interneurons reach their respective targets. In this part, I aimed to identify the migratory routes of these cells from the CGE to the developing cortex.

To have an overview of all three GE structures in one section, E12.5 to P7 5HTGFP+ brains were cut in a horizontal plane, as depicted in the diagram of **Figure 6A-B**, and representative dorsal to ventral sections were carefully analysed. Already at E12.5, GFP+ cells were observed not only in the CGE, but also in the MGE/POA and LGE (**Fig. 6C-D**). At this level, GFP+ cells seem to migrate dorsally from the CGE to the LGE (yellow arrowhead in **Fig. 6C**), and ventrally from the CGE to the MGE/POA area (red arrowhead in **Fig. 6C-D**). The ventral path is very well represented in a slightly more ventral horizontal section (red arrowhead in **Fig. 6D**). E12.5 coronal sections confirmed the presence of GFP+ in the LGE (**Fig. 6E**), MGE (**Fig. 6F**) and CGE, as expected (**Fig. 6G**). Surprisingly, a large amount of 5HTGFP+ cells can be already observed in the cortex and in the LGE at this stage (empty arrowheads in **Fig. 6A, 6E** respectively). It is unlikely that these cells derive from the CGE through the lateral path, since this path seems to have just started at this stage and only few cells are observed between the CGE and LGE (yellow arrowhead in **Fig. 6C**). In addition, it is known that the majority of CGE-derived interneurons are produced at later developmental time points (E13.5 to E18.5) (Vucurovic et al., 2010). Thus, I hypothesize that GFP+ cells in the LGE are locally produced and might contribute to the olfactory bulb interneurons (Inta et al., 2008) and/or to the cortex, as previously suggested by the work of Anderson *et al.* in 2001. On this type of plane, I can also see few cells exiting caudally (white arrowhead **Fig. 6D**) via the caudal migratory stream (CMS) to reach the cortex, as described previously (Kanatani et al., 2008). At E13.5, the amount of 5HTGFP+ cells increases in the CGE (**Fig. 6L**) and GFP+ cells in the pathway between the CGE and the MGE seem to be more abundant

when compared to E12.5-old embryos (red arrowhead in **Fig. 6I**). Similarly, the CMS is more visible (white arrowheads in **Fig. 6H-I**) and the dorsal pathway between the CGE and the LGE appears to be clearly established (yellow arrowhead in **Fig. 6H**). Finally, expression of GFP in the LGE is confined to its dorso-lateral part (yellow arrowheads **Fig. 6H, 6J**). The increase in GFP+ cells at E13.5 correlates well with the birthdating of these cells, which start colonizing cortical structures, particularly the hippocampus (Vucurovic et al., 2010).

At later stages of mouse brain development, I noticed that the number of GFP+ cells in the CGE start to decrease (**Fig. 6Q**) in agreement with birthdating analysis on this line (Vucurovic et al., 2010). At E15.5, a large pool of GFP+ cells can be detected in the dorsal LGE (dLGE) (yellow arrowheads in **Fig. 6M, 6O**) and 5HTGFP+ cells are still present in the MGE/POA (red arrowheads in **Fig. 6N, 6P**). Caudally, the CMS pathway has well advanced and starts colonizing the presumptive hippocampus (empty arrowhead in **Fig. 6N**) (Alfano et al., 2014; Elena et al., 2014; Southwell et al., 2014; Vogt et al., 2014). At E18.5, when the tangential migration of interneurons is at its end, GFP+ cells have colonized the olfactory bulb, the hippocampus and the cortex (**Fig. 6R-V**). At P7, the majority of GFP+ cells was found in the olfactory bulb and in the hippocampus. In the cortex, GFP+ cells were detected mainly in superficial layers (empty arrowheads in **Fig. 6W-X**), as it was previously described for CGE- and 5HTGFP-derived interneurons (Taniguchi et al., 2013; Lee et al., 2010; Miyoshi et al., 2010; Vucurovic et al., 2010; Inta et al., 2008; Miyoshi et al., 2007; Butt et al., 2005; Nery et al., 2002).

My observations on horizontal brain sections from E12.5 to P7 have highlighted two previously uncharacterized migratory pathways within the subpallium of the 5HTGFP mouse lines. While the CMS was previously described (Kanatani et al., 2008; Yozu et al., 2005), I found that GFP+/CGE-derived interneurons also follow a pathway between the CGE and the MGE that will be called throughout this thesis caudo-medial migratory stream or CMMS, and a third one from the CGE to the LGE, which I label it as the caudo-lateral migratory stream or CLMS (**Fig. 7A-B**). Chronologically, the CMMS from the CGE to the MGE/POA region, is the first one to be established, followed by the CMS, which will be largely colonize the hippocampal plate, and the CLMS, from the CGE to the LGE.

Although the 5HTGFP mouse line is well accepted to label CGE-derived interneurons (Lee et al., 2010), I used an independent approach to directly confirm the CGE origin of these two

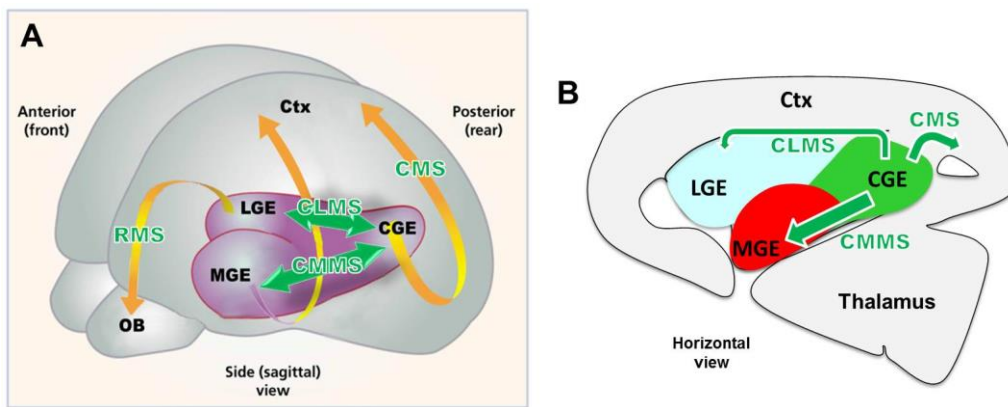

Figure 7: Migrating pathways of CGE-derived interneurons. (A) Schematic indicating the major routes of tangential migration already known (yellow-orange arrow): from MGE to the dorsal telencephalon, the caudal migratory stream (CMS) established between the CGE and the caudo-dorsal telencephalon and the rostral migratory stream (RMS) between the LGE and the olfactory bulb. Green arrows indicate the new migratory routes identified from the CGE to the LGE (CLMS) and to the MGE (CLMS). (B) Schematic showing the localization of the three CGE-derived interneurons migratory routes on horizontal sections.

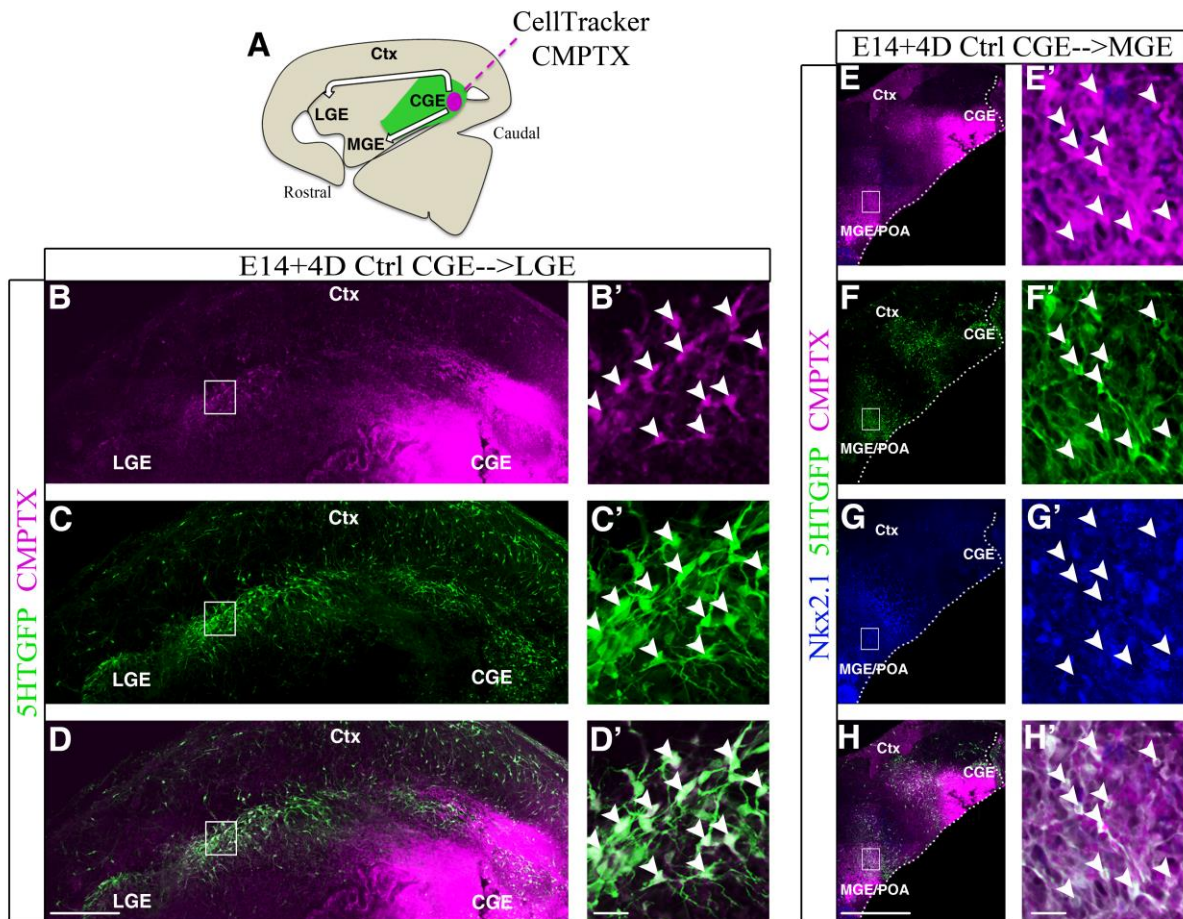

Figure 8: Cell tracking along the CLMS and the CMMS. (A) Schematic of experimental approach illustrating the position in the CGE of the resin ball soaked with CMPTX. (B-H') E14+4 days organotypic sections showing colocalization between the cell tracker and the 5HTGFP at the level of the LGE (B-D'), and in the MGE (E-H') identified by the expression of Nkx2.1 (G-G'). Abbreviations: LGE, lateral ganglionic eminence; MGE/POA, medial ganglionic eminence/preoptic area; CGE, caudal ganglionic eminence; Ctx, cortex.

new pathways, the CMMS and CLMS ones. I performed a cell tracking experiment by inserting a resin ball soaked with CMPTX, a non-fluorescent cell-permeant molecule, into the CGE of E14 5HTGFP organotypic sections (**Fig. 8A**). Upon internalization by the cells, CMPTX is converted by glutathione-S-transferase to a fluorescent compound. Presence of the fluorescence indicates that the cells that have taken up the liquid and not of the residual dye. After 4 days of culture, I can observe double-positive cells for GFP and CMPTX migrating from the CGE to the LGE (**Fig. 8B-D'**) and to the MGE/POA (**Fig. 8E-H'**) which is marked by the expression of Nkx2.1 (**Fig. 8G-G'**). This experiment confirms that GFP+/CGE-derived interneurons migrate caudo-rostrally through the CLMS and CMMS pathways.

2. Semaphorins and Neuropilins might be involved in guiding CGE-derived migratory pathways

Interneuron motility and guidance is mediated by the coordination of several molecular cues, such as chemorepellants and chemoattractants, which help migratory cells to follow distinct directions. It was previously shown that the semaphorin ligands, and particularly Sema3A and Sema3F, act as chemorepellent cues in the striatum to guide the ventral to dorsal migratory path of MGE interneurons (Marín et al., 2001). To respond to semaphorins, migrating interneurons express neuropilins (Nrp1 and Nrp2) (Marín et al., 2001; Zhou et al., 1999).

2.1. Neuropilin 1 (Nrp1) is expressed in caudally-migrating 5HTGFP+ interneurons (CMS) and might respond to local sources of Sema3A

To understand whether semaphorins and neuropilins could also be involved in the CGE-derived migratory paths, I assessed expression of semaphorins by in situ hybridization and expression of Neuropilin receptors in 5HTGFP+ interneurons. My in situ expressions on horizontal sections at E12.5 show expression of Sema3A in the caudoputamen region (white arrowhead in **Fig. 9A**), as previously reported (Marín et al., 2001). In addition, Sema3A is also highly expressed in the ventricular zone (VZ) along the CGE, MGE/POA and LGE (**Fig. 9A'-A''**). At the same age, Nrp1 is expressed mainly in post-mitotic cells of the caudal cortex (**Fig. 9B, B''**). By looking at 5HTGFP expression (**Fig. 9C, C''**) in the same area, I could identify by confocal microscopy a subpopulation of CGE-derived interneurons expressing Nrp1 only in the caudal part of the cortex and not in the CGE (arrowhead in **Fig. 9B, D**). At E15.5, Nrp1 is still expressed caudally in the IZ and SVZ of

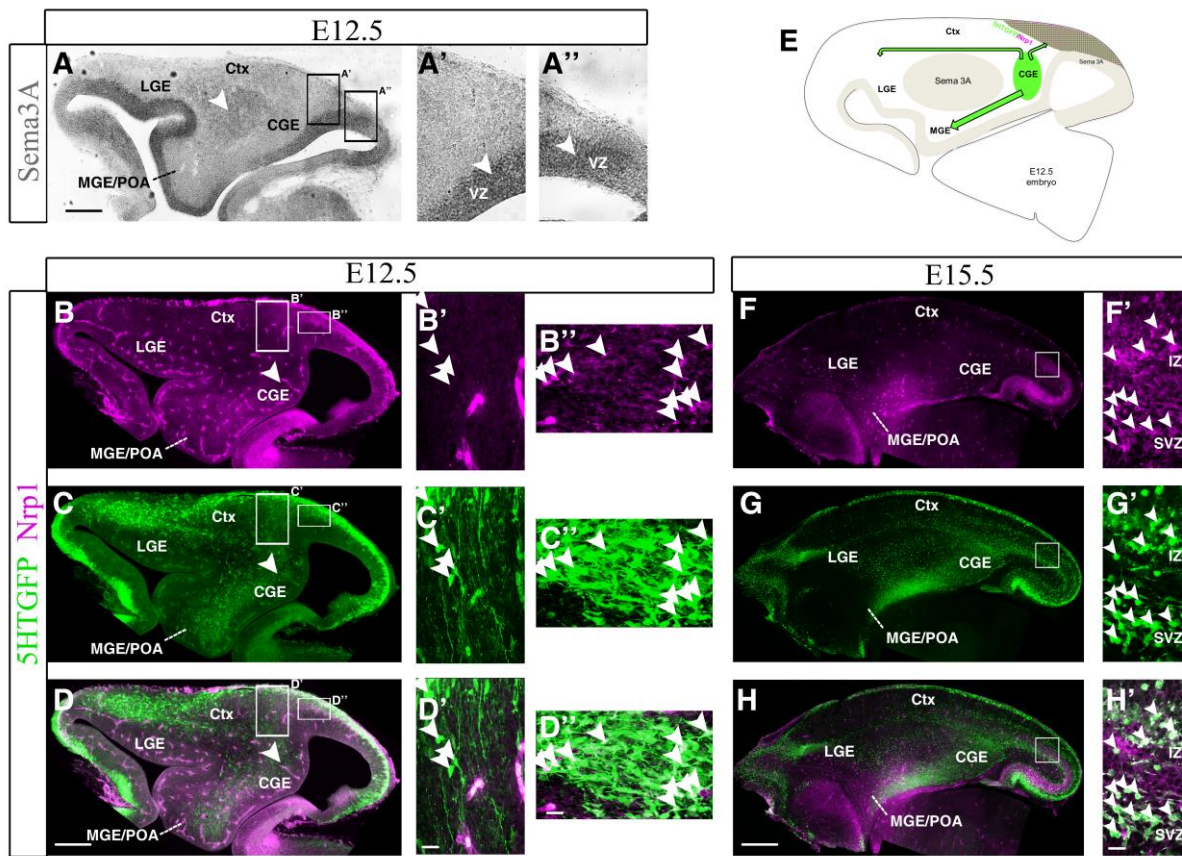

Figure 9: Guidance of 5HTGFP cells through the CMS by Nrp1/Sema3A. (A-A'') *In situ* hybridization of *Sema3A* on E12.5 horizontal sections. White arrows show the expression of *Sema3A* in the caudoputamen region in (A) and in the VZ on the high magnifications (A'-A''). (B-H') Horizontal sections of E12.5 and E15.5 wild type brains immunostained with anti-Nrp1 (B, F), anti-Gfp (C, G), and merge sections (D, H). High magnification views of a representative detail from (B-H) indicate no co-expression of 5HTGFP/Nrp1 in the CMS at E12.5 (B'-D') whereas double-positive cells are present in the cortex at E12.5 (B''-D'') and E15.5 (F'-H'). (E) Schematic representation of Nrp1/Sema3A/5HTGFP merged expression at E12.5. 5HTGFP+ cells do not express Nrp1 when they exit from the CGE to the caudal cortex through the CMS. Once in the cortex CGE-derived interneurons express Nrp1 and are guiding by the repulsive cue of Sema3A along the VZ. Abbreviations: LGE, lateral ganglionic eminence; MGE/POA, medial ganglionic eminence/preoptic area; CGE, caudal ganglionic eminence; Ctx, cortex.

the cortex and co-localizes with a large population of 5HTGFP⁺ interneurons (**Fig. 9F-H'**). These expression patterns suggest that 5HTGFP⁺ interneurons expressing Nrp1 might be repelled by Sema3A secreted in the caudal VZ. Since double expressing GFP/Nrp1 neurons are localized in the cortex, they presumably have already used the migratory CMS path to enter the cortex (**Fig. 9E**). In addition, no co-localization between Nrp1 and 5HTGFP could be detected in the area where the cells exit from the CGE at E12.5 (**Fig. 9B', D'**). Thus, Nrp1 and Sema3A might be involved in the tangential migration of CGE-derived interneurons once they have reached the cortex to find their final location and not in guiding CGE neurons towards the CMS. Therefore, I hypothesize that it is the source of Sema3A in the caudal VZ and not that in the caudoputamen that is used by CGE neurons during their migratory path to reach their caudal targets.

2.2. Neuropilin 2 (Nrp2) is expressed in the CMMS and CMLS of 5HTGFP⁺ migrating interneurons and might respond to local sources of Sema3F

Expression of Sema3F is also confined to the caudoputamen and ventricular zones of the GEs at E12.5, as indicated by horizontal sections (**Fig. 10A-A''**). However, differently from Sema3A, Sema3F is expressed at high levels in the caudoputamen (while Sema3a is expressed at low levels) and in the VZ of the CGE. Interestingly, this Sema3F *free corridor* is occupied by migrating CGE to MGE/POA 5HTGFP⁺ cells (**Fig. 10C**), suggesting that two close sources of chemorepellents might guide CMMS migrating interneurons. To understand whether Nrp2, the most used Sema3F receptor (Tamamaki et al., 2003) is expressed in migrating CMMS GFP⁺ cells, horizontal E12.5 and E13.5 5HTGFP sections were immunostained with an antibody against Nrp2 that is normally localized at the membrane (**Fig. 10B-H'**). Interestingly, I found that Nrp2 is expressed in the majority of CMMS⁺ (**Fig. 10B''**) and that its expression is down regulated as soon as cells enter the MGE/POA region at E12.5 (arrows in **Fig. 10B'**). At E13.5 the expression pattern of Nrp2 follows a similar rule: the 5HTGFP⁺ cells migrating along the CMMS express Nrp2 (**Fig. 10H''**) before entering in the MGE/POA (**Fig. 10H'**). This suggests that another source of chemorepellents and/or chemoattractants might take the relay in allowing CGE-derived cells to cross the MGE. In addition, I could also identify GFP⁺ cells expressing Nrp2 along the CLMS (arrowheads in **Fig. 10B-D**), indicating that the Sema3F source of the caudoputamen might be also involved in directing GFP⁺ cells along the CLMS. Taken together, my data suggest that Sema3F and

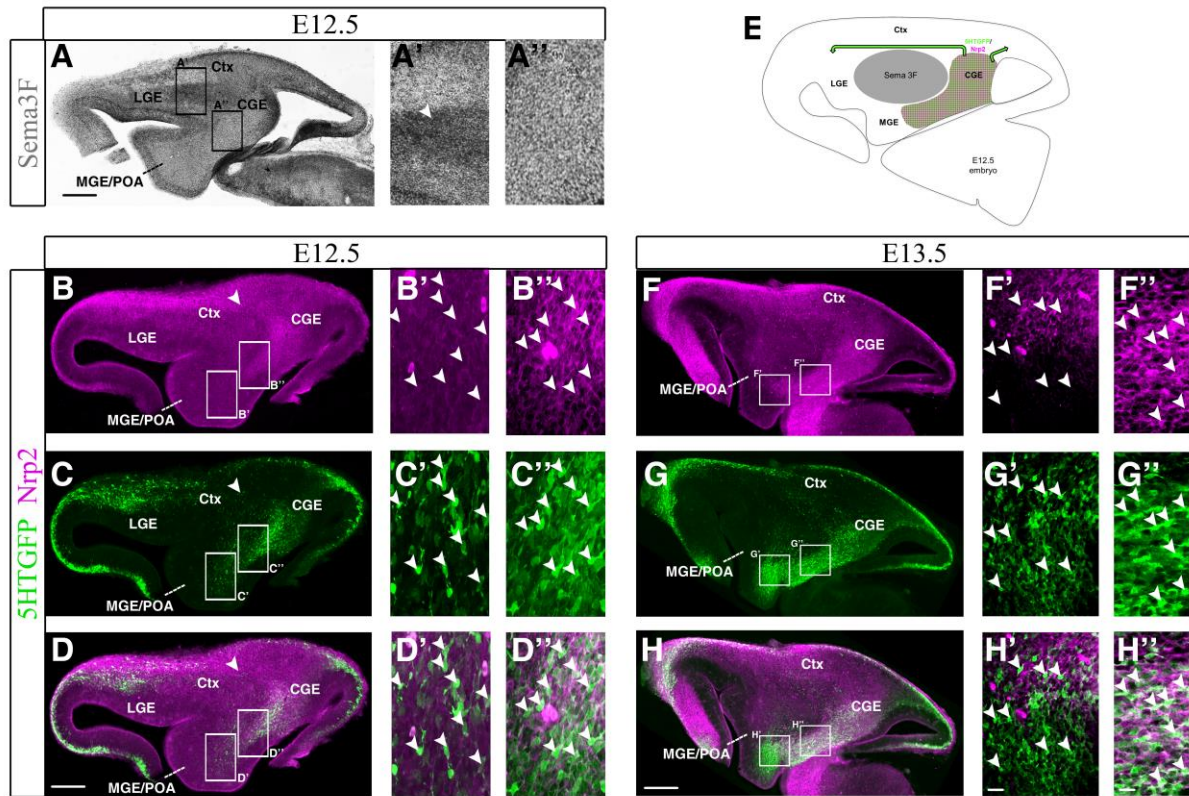

Figure 10: Guidance of 5HTGFP cells through the CMMS by Nrp2/Sema3F. (A-A'') *In situ* hybridization of *Sema3F* on E12.5 horizontal sections. White arrow on the high magnification (A') shows the expression of *Sema3F* in the caudoputamen region and no expression in the corridor between the CGE and the MGE (A''). (B-H') Horizontal sections of E12.5 and E13.5 wild type brains immunostained with anti-Nrp2 (B, F), anti-Gfp (C, G), and merge sections (D, H). High magnification views of a representative detail from (B-H) indicate a co-expression of 5HTGFP and Nrp2 in the CMMS migrating cells (B''-H'') before entering in the MGE/POA (B'-H'). White arrowheads in (B-D) indicate Nrp2 expression along the CLMS. (E) Schematic representation of Nrp2/Sema3F/5HTGFP merged expression at E12.5. 5HTGFP+ cells express Nrp2 when they exit from the CGE and migrate through the CMMS in the free corridor where Sema3F is not present. Abbreviations: LGE, lateral ganglionic eminence; MGE/POA, medial ganglionic eminence/preoptic area; CGE, caudal ganglionic eminence; Ctx, cortex.

Nrp2 are involved in guiding CGE-derived interneurons along the CMMS and CLMS paths during migration of CGE-derived interneurons (**Fig. 10E**).

This first analysis on Semaphorin and Neuropilin receptor expression suggest that this system might be required not only for the migration of MGE interneurons to the cortex, as previously reported (Marin et al., 2001), but also for CGE interneuron migration. In addition, my data suggest that Nrp2 expressed in migrating neurons respond to Sema3F and possibly also to Sema3A during the guidance of CGE-derived interneurons along the CMMS and CLMS paths, whereas Nrp1 seems to be involved in guiding CMS interneurons once they have reached the cortex by responding to sources located in the caudal cortex. These expression data prompt us now to directly test this hypothesis *in vitro* and/or in organotypic cultures, as summarized in the *Perspective* section.

3. Expression of transcription factors in migrating CGE-derived interneurons

To understand whether the different populations of CGE-derived interneurons that migrate through the CLMS, the CMMS and the CMS express transcription factors that have been shown to be involved in interneuron specification during mouse brain development (reviewed in (Kelsom and Lu, 2013)), I immunostained E13.5 and E15.5 5HTGFP horizontal sections with Nkx2.1, Sp8, Prox1, COUP-TFI and COUP-TFII antibodies.

3.1. The MGE-marker Nkx2.1 is expressed in a subset of 5HTGFP+ cells in the MGE/POA region

Previous studies on the 5HTGFP line have demonstrated that the 5HTGFP mouse line does not contribute to the MGE-derived PV subpopulation, whereas a small percentage of SST-expressing cells co-localize with 5HTGFP+ cells (Lee et al., 2010; Vucurovic et al., 2010). However, my data on the characterization of the different CGE-derived paths show that 5HTGFP+ cells could migrate through the MGE/POA region before reaching the cortex (**Fig. 6**). To understand whether these cells express MGE-specific genes, I immunostained E13.5 and E15.5 5HTGFP+ horizontal and coronal sections with an antibody against Nkx2.1. As expected from previous studies (Price et al., 1992; Lazzaro et al., 1991), Nkx2.1 is highly expressed at both stages in the MGE/POA and in the presumptive globus pallidus (GP) located caudal to the MGE (**Fig. 11A-B, G-H**). Double immunofluorescence indicates a

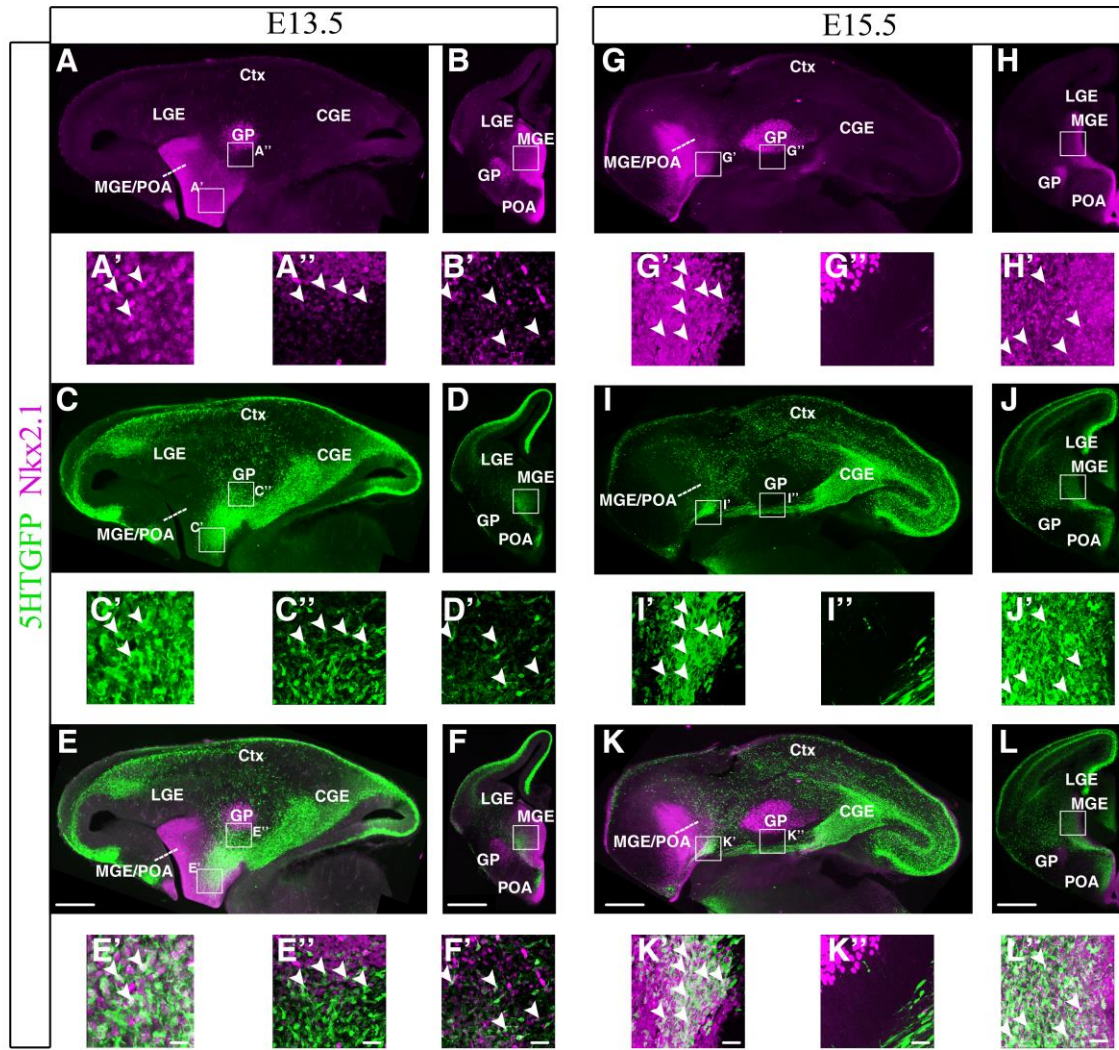

Figure 11: Some 5HTGFP+ cells express Nkx2.1 in the MGE/POA. Horizontal and coronal sections of E13.5 and E15.5 wild type brains immunostained with anti-Nkx2.1 (A-B, G-H), anti-Gfp (C-D, I-J), and merge sections (E-F, K-L). High magnification views of a representative detail from (A-L) indicate a co-expression of 5HTGFP and Nkx2.1 in the MGE/POA (A'-F', G'-L'). 5HTGFP+ cells migrating along the CMMS do not pass through the Nkx2.1 positive globus pallidus (A''-E'', G''-K''). Abbreviations: LGE, lateral ganglionic eminence; MGE/POA, medial ganglionic eminence/preoptic area; CGE, caudal ganglionic eminence; Ctx, cortex; GP, globus pallidus.

partial overlap between Nkx2.1 and GFP staining in the MGE/POA region (**Fig. 11E-F, K-L**). Confocal images confirm that some cells are double positive for GFP and Nkx2.1, particularly in the POA region (**Fig. 11E'**). Few double-positive cells are also located in the cohort of GFP⁺ cells migrating along the MGE (**Fig. 11F', L'**) and in the ventralmost part of the MGE/POA of E15.5 old embryos (**Fig. 11K'**). These double-positive cells might generate a fraction of NPY⁺, Reelin⁺ and SST⁺ interneurons, as previously shown by fate map analysis of Nkx2.1- and POA-derived interneurons (Gelman et al., 2011; Lee et al., 2010; Vucurovic et al., 2010; Gelman and Martini, 2009).

3.2. The transcription factor Sp8 labels two independent 5HTGFP⁺ sources of interneurons

As previously described, the transcription factor *Sp8* starts to be expressed at E13.5 during development mainly in the dLGE and dCGE and in 20% of cortical interneurons (Ma T. et al., 2012). In addition, dLGE/dCGE-derived *Sp8*-expressing interneurons are born at later embryonic stages than MGE-derived Nkx2.1-expressing ones, with peak production occurring at E15.5. My horizontal and coronal E13.5 brain sections confirmed *Sp8* expression in the dLGE and dCGE (**Fig. 12A-C'**) and show that all *Sp8*-positive cells are 5HTGFP⁺ in these two structures (**Fig. 12H-H', I-I'**). Since the CLMS path connect dCGE to dLGE, I hypothesized that *Sp8* might be expressed in GFP⁺ CLMS migrating cells. At E13.5, the majority of double GFP/*Sp8*⁺ cells were located in the dCGE (**Fig. 12G''')**) and dLGE (**Fig. 12G'**), and only a few were localized in the CLMS (**Fig. 12G, G''**), in line with the fact that the CLMS is poorly represented at this stage (**Fig. 6H**). No *Sp8* positive cells were detected in the other migratory paths (CMMS or CMS). This further indicates that expression of *Sp8* in the GFP⁺ dLGE might not originate from the dCGE at this stage, but more likely from a local source in the dLGE (see also (Ma T. et al., 2012)). At E15.5 a higher number of double GFP/*Sp8*⁺ cells was observed in the dCGE (**Fig. 12P''')**) and in the dLGE (**Fig. 12P'**). In addition, the CLMS was more pronounced at this stage and the majority of GFP⁺ migrating cells expressed *Sp8* (**Fig. 12P''**). These data suggest two independent sources of double GFP/*Sp8*⁺ cells: one local source in the dLGE that might give rise to olfactory bulb interneurons and another one in the dCGE that migrating through the CLMS to the dLGE and cortex will give rise to cortical interneurons. Grafting experiments transplanting either the GFP-positive dLGE or dCGE into GFP-negative embryos might support this model.

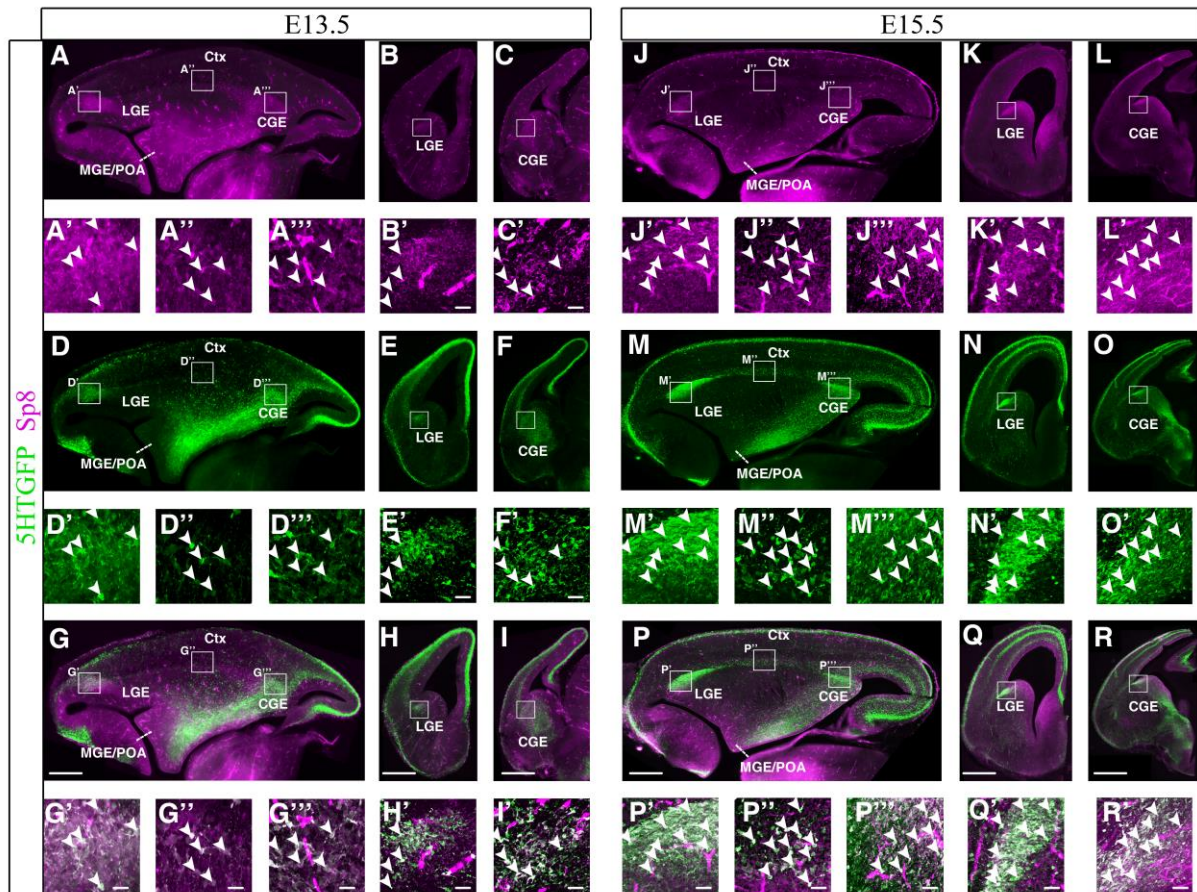

Figure 12: Sp8 labels specific subpopulations of interneurons. Horizontal and coronal sections of E13.5 and E15.5 wild type brains immunostained with anti-Sp8 (A-C, J-L), anti-Gfp (D-F, M-O), and merge sections (G-I, P-R). High magnification views of a representative detail from (A-R) indicate double Sp8+/5THGFP+ cells in the dLGE (G'-H', P'-Q'), in the CLMS (G'', P'') and in the dCGE (G''', I', P''', R'). 5HTGFP+ cells migrating from the CGE to the LGE and 5HTGFP+ cells of the dLGE express specifically Sp8. Abbreviations: LGE, lateral ganglionic eminence; MGE/POA, medial ganglionic eminence/preoptic area; CGE, caudal ganglionic eminence; Ctx, cortex.

3.3. The homeodomain gene *Prox1* is expressed in a subset of CMMS 5HTGFP+ interneurons

A recent study has shown that the homeobox-encoding gene *Prox1* is expressed in the SVZ of the MGE, in the dLGE, and in the CGE at E13.5 (Rubin and Kessaris, 2013). My immunolabelling on E13.5 horizontal and coronal sections confirm high *Prox1* expression in the CGE and low expression in the MGE/POA and dLGE (**Fig. 13A-C'**). In E13.5 5HTGFP+ sections, double-labeled cells were mainly detected in the CMMS from the CGE to the MGE/POA, although many cells were single positive for GFP or for *Prox1* at this stage (**Fig. 13G-G''**). Some double-positive cells were also observed in the MGE/POA and CGE of E13.5 coronal sections (**Fig. 13H-I'**), whereas no co-localization was found in the dLGE (data not shown). At E15.5 during the peak of CGE interneuron generation, a larger amount of GFP+ cells is migrating along the CMMS (**Fig. 13M-O'**) and accordingly a higher number of double-labelled GFP+/Prox1+ could be observed in this stream and in the MGE/POA region (**Fig. 13P-R'**). 5HTGFP cells expressing *Prox1* were not found in the CLMS or the CMS either at E13.5 or at E15.5.

My expression analysis shows that *Prox1* is expressed in 5HTGFP+ cells migrating along the CMMS to reach the MGE/POA and eventually the cortex. However, only a subpopulation of the cells following this stream is positive for *Prox1* indicating that other factors might be expressed in CGE-derived interneurons migrating from the CGE to the MGE.

3.4. COUP-TF genes are differentially expressed in 5HTGFP+ CGE-derived interneurons

The first transcription factors described to be specifically involved in the specification and migration of CGE-derived interneurons are the two orphan nuclear receptor COUP-TFI and COUP-TFII (Alfano et al., 2014; Cauli et al., 2014). We previously showed that the expression of COUP-TFI becomes regionalized in the subpallium with a low rostral to high caudal expression gradient at E13.5 (Lodato et al., 2011) and together with COUP-TFII is required for the caudal migration of cortical interneurons (Kanatani et al., 2008; Tripodi et al., 2004). In addition, COUP-TFII is known to be expressed in the CMS and to promote CMS migration when overexpressed in the MGE and transplanted to a CGE location

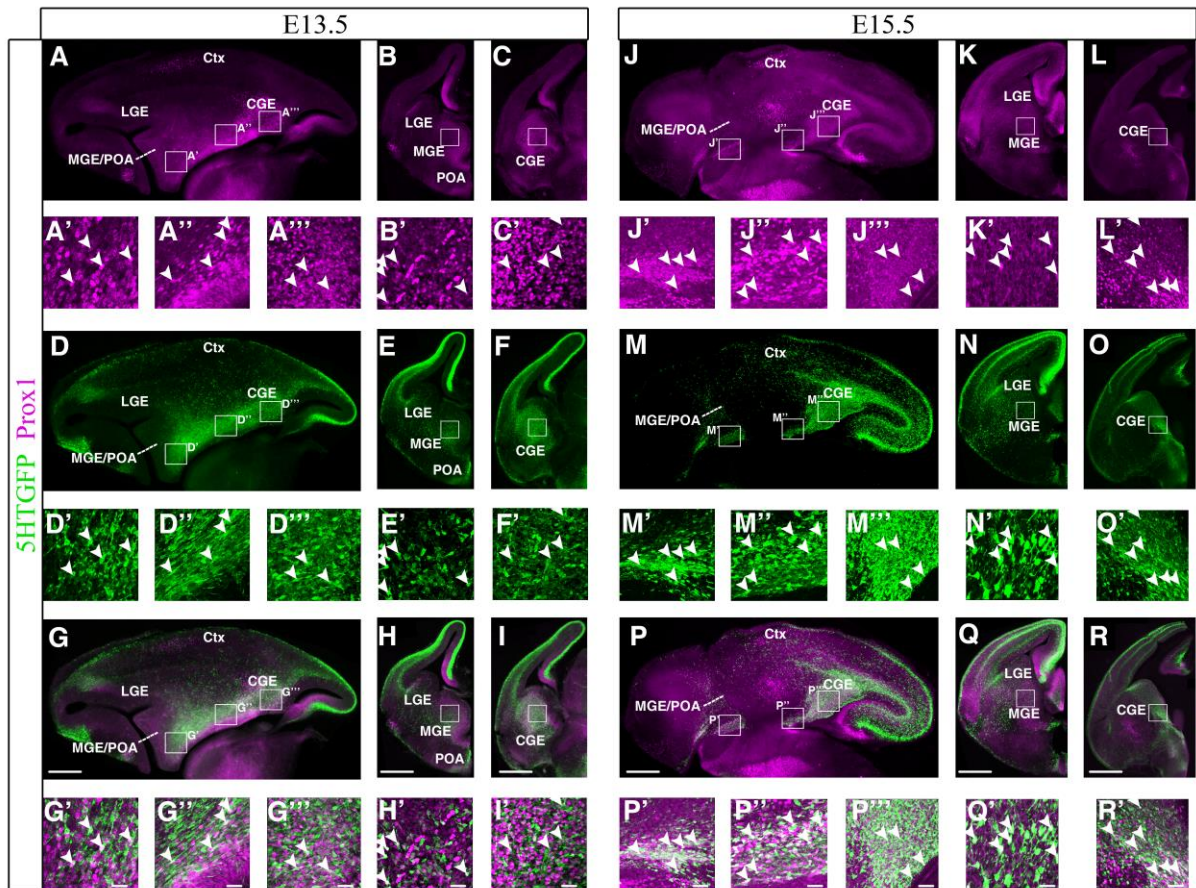

Figure 13: A subpopulation of CGE-derived interneurons express Prox1 in the CMMS. Horizontal and coronal sections of E13.5 and E15.5 wild type brains immunostained with anti-Prox1 (A-C, J-L), anti-Gfp (D-F, M-O), and merge sections (G-I, P-R). High magnification views of a representative detail from (A-R) indicate a co-localization between 5HTGFP+ and Prox1+ cells in the MGE/POA (G'-H', P'-Q'), in the CMMS (G'', P'') and in the CGE (G''', I', P''', R'). Abbreviations: LGE, lateral ganglionic eminence; MGE/POA, medial ganglionic eminence/preoptic area; CGE, caudal ganglionic eminence; Ctx, cortex.

(Kanatani et al., 2008). Thus, COUP-TFI and COUP-TFII might cooperate with each other in driving CGE-derived cortical interneuron migration during development.

Horizontal and coronal sections confirm high expression of COUP-TFI in the CGE and very low expression in the VZ of dMGE at E13.5 (**Fig. 14A-C'**, (Lodato et al., 2011)). Coronal sections at the level of the CGE show several cells expressing both COUP-TFI and 5HTGFP at E13.5 (**Fig. 14C-C', F-F', I-I'**) and at E15.5 (**Fig. 14L-L', O-O', R-R'**). Confocal images on E13.5 and E15.5 horizontal sections indicate that COUP-TFI never colocalizes with 5HTGFP-expressing cells migrating along the CLMS path (**Fig. 14A', D', G', J', M', P'**). On the contrary, several GFP⁺ cells following the CMS are positive for COUP-TFI (**Fig. 14A'', D'', G'', J'', M'', P''**) and stay positive all along their migration to the caudal cortex. Differently, only a subpopulation of GFP⁺ cells moving along the CMMS express COUP-TFI (**Fig. 14A'', D'', G'', J'', M'', P''**) and only before reaching the MGE (**Fig. 14B-B', E-E', H-H', K-K', N-N', Q-Q'**). Thus, COUP-TFI is highly expressed in the CMS migratory path and just in a subpopulation of GFP⁺/CMMS cells.

As previously reported, COUP-TFII has a restricted expression in the CGE at E13.5 (**Fig. 15A-C'**; (Kanatani et al., 2008; Tripodi et al., 2004)). As expected, a large majority of COUP-TFII-expressing cells colocalize with 5HTGFP⁺ cells in the CGE (**Fig. 15I-I', R-R'**) and in the CMS (**Fig. 15G'', P''**) at E13.5 and E15.5 (Vucurovic et al., 2010). However and differently from COUP-TFI, COUP-TFII is highly expressed in GFP⁺ cells only when they exit the CGE (**Fig. 15G'', P''**) and it is downregulated when the cells migrate caudally through the cortex (**Fig. 15G'', P''**). Along the CMMS, COUP-TFII, similarly to COUP-TFI, is expressed in a subpopulation of cells migrating from the CGE to the MGE and is downregulated as soon as CMMS cells enter the MGE/POA region at E13.5 (**Fig. 15A', D', G'**) and at E15.5 (**Fig. 15J', M', P'**). Double COUP-TFI/COUP-TFII immunofluorescence confirm a high number of double-positive cells in the CMS and CMMS (**Fig. 16A-C''**). High magnification views show that in the CMS almost all COUP-TFI⁺ cells are COUP-TFII⁺ (**Fig. 16A', B', C'**) while in the CMMS some cells are single positive for COUP-TFI (empty arrowhead in **Fig. 16A'', B'', C''**) or COUP-TFII (red arrowhead in **Fig. 16A'', B'', C''**).

These data show first, that both COUP-TFI and COUP-TFII are expressed in the CMS but at slightly different locations. While both COUP-TFI and COUP-TFII are highly expressed in cells exiting the CGE and migrating caudally, only COUP-TFI is maintained in caudally-

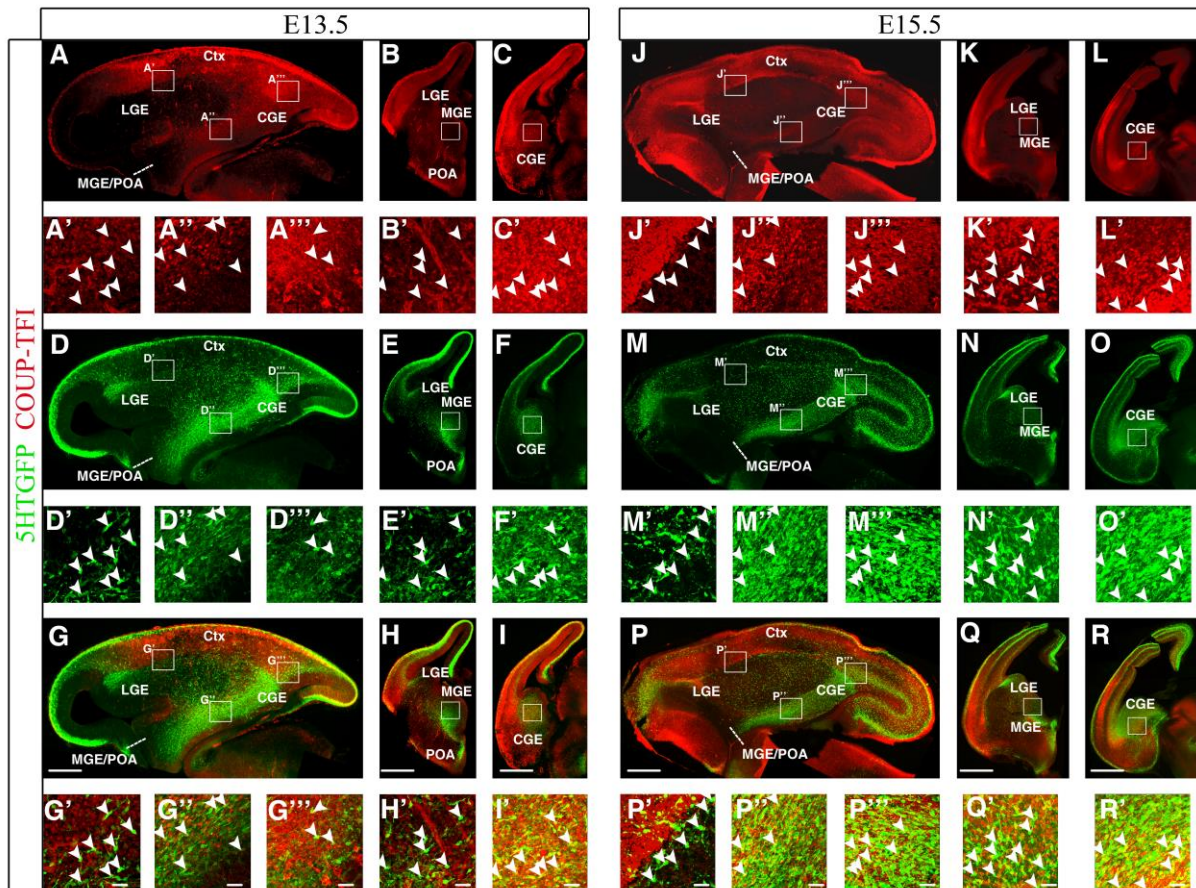

Figure 14: COUP-TFI is expressed highly in the CMS and in a subpopulation of CMMS migrating cells. Horizontal and coronal sections of E13.5 and E15.5 wild type brains immunostained with anti-COUP-TFI (A-C, J-L), anti-Gfp (D-F, M-O), and merge sections (G-I, P-R). High magnification views of a representative detail from (A-R) show no expression of COUP-TFI in 5HTGFP+ cells migrating through the CLMS (G', P') whereas a subpopulation of the CMMS express COUP-TFI (G'', P'') before entering in the MGE/POA (H', Q'). A proportion of 5HTGFP+/COUP-TFI+ cells of the CGE (I', R') migrate as well through the CMS (G''', P''') to reach the caudal cortex. Abbreviations: LGE, lateral ganglionic eminence; MGE/POA, medial ganglionic eminence/preoptic area; CGE, caudal ganglionic eminence; Ctx, cortex.

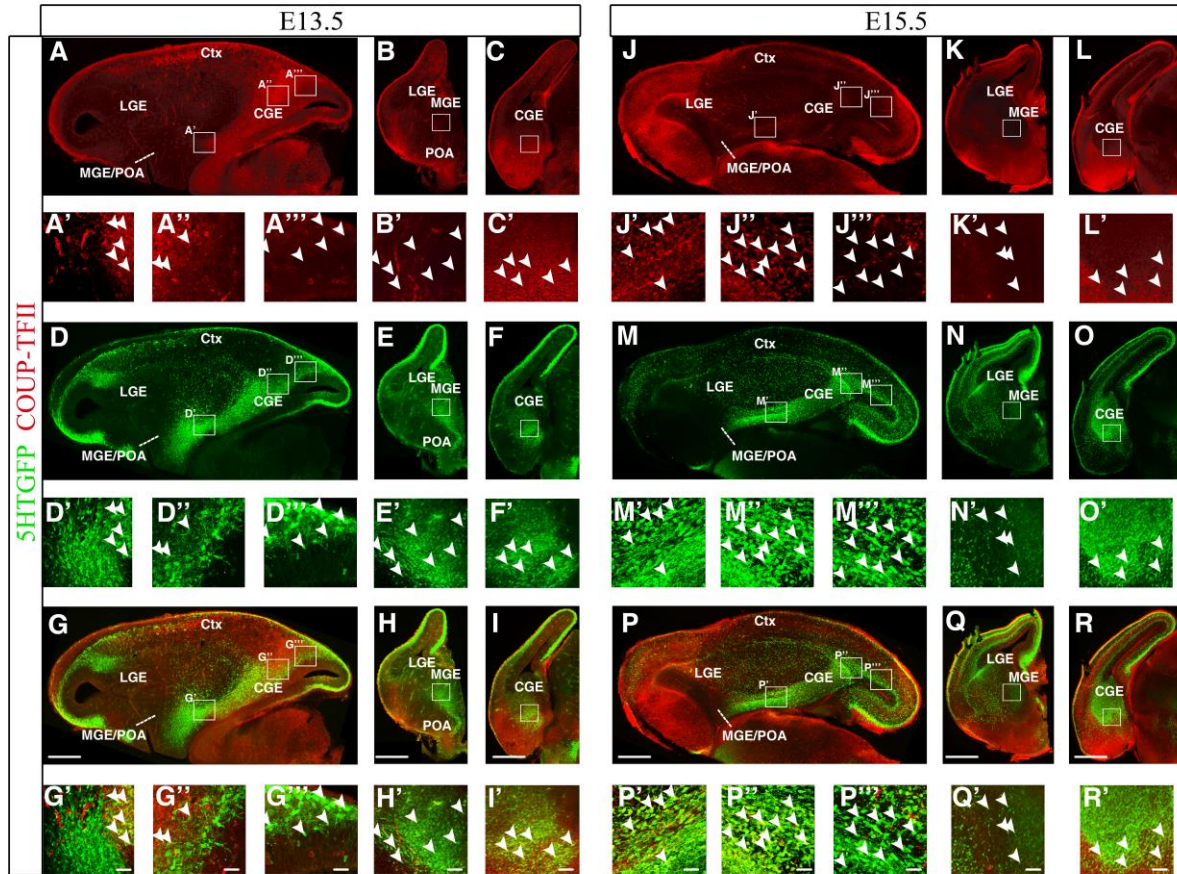

Figure 15: COUP-TFII-expressing cells migrate through the CMMS and is present in cells exiting CGE to migrate caudally. Horizontal and coronal sections of E13.5 and E15.5 wild type brains immunostained with anti-COUP-TFII (A-C, J-L), anti-Gfp (D-F, M-O), and merge sections (G-I, P-R). High magnification views of a representative detail from (A-R) show that double 5HTGFP+/COUP-TFII+ cells migrate from the CGE (I', R') through the CMMS before downregulation of COUP-TFII in the MGE/POA (G'-H', P'-Q'). Similarly, 5HTGFP+ cells express COUP-TFII when they exit from CGE to reach the caudal cortex (G'', P'') but then, double positive cells are absent in the cortex (G''', P'''). Abbreviations: LGE, lateral ganglionic eminence; MGE/POA, medial ganglionic eminence/preoptic area; CGE, caudal ganglionic eminence; Ctx, cortex.

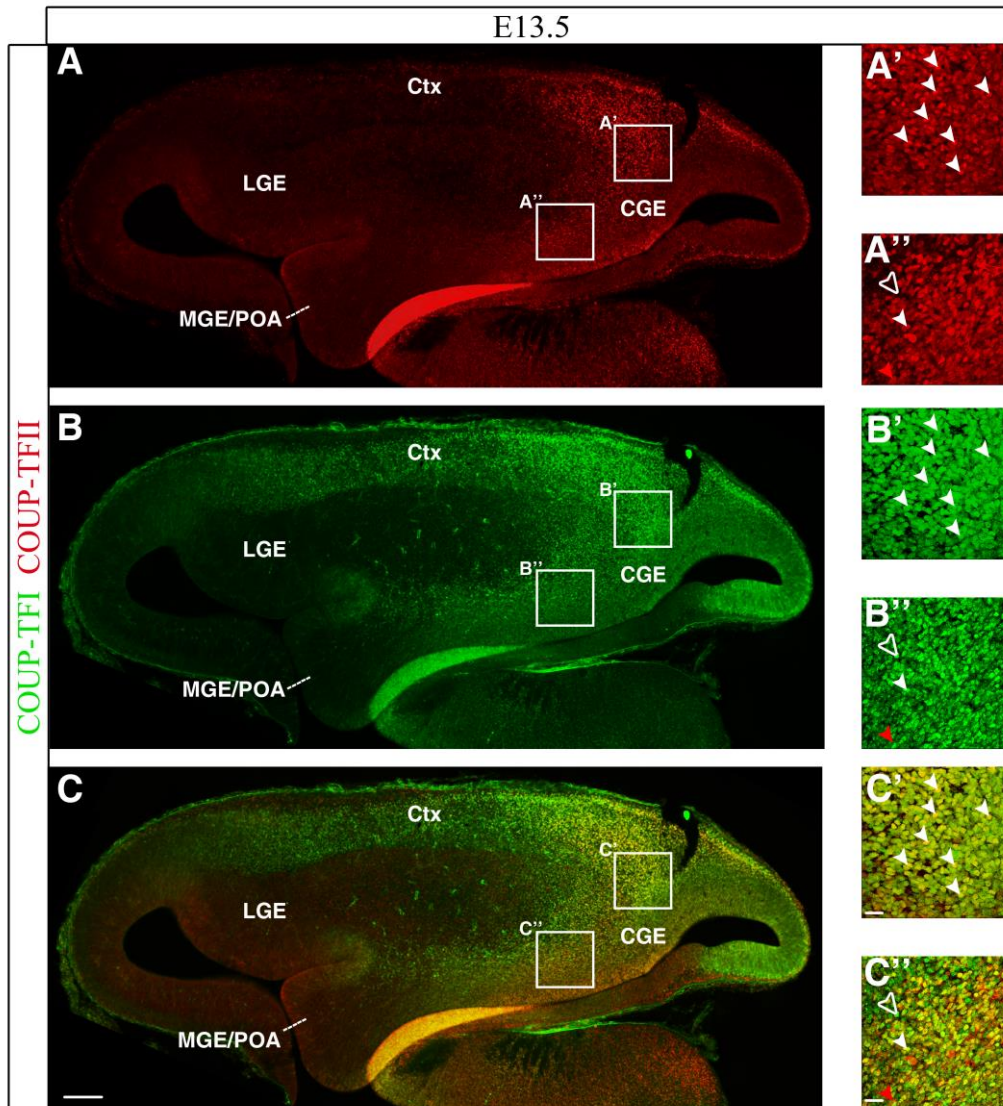

Figure 16: High co-expression of COUP-TFI and COUP-TFII. Horizontal of E13.5 wild type brains immunostained with anti-COUP-TFII (A), anti-COUP-TFI (B), and merge section (C). High magnification view of cells at the level of the CMS (A'-C') indicates that almost all the cells are double positive COUP-TFI/COUP-TFII. At the level of CMMS a majority of cells co-express COUP-TFI and COUP-TFII (white arrowhead in A''-C'') but empty and red arrowheads mark single expressing cells for COUP-TFI and COUP-TFII respectively (A''-C''). Abbreviations: LGE, lateral ganglionic eminence; MGE/POA, medial ganglionic eminence/preoptic area; CGE, caudal ganglionic eminence; Ctx, cortex.

migrating 5HTGFP+ interneurons. This suggests that both COUP-TFI and COUP-TFII might be required in promoting CMS migration, as previously demonstrated for COUP-TFII (Kanatani et al., 2008), and that only COUP-TFI might be involved in specifying and/or guiding migrating interneurons in the caudal cortex. Second, COUP-TFI and COUP-TFII co-localize in some but not all cells along the CMMS. This indicates that they might have common but also divergent functions during CMMS migration.

4. Conclusion

Taken together these results allow me to propose a new picture of what happens during CGE-derived interneuron tangential migration. First, cells directly reach the caudal cortex through the caudal migratory stream (CMS). This stream seems to be under the control of both COUP-TFs, particularly at the CGE level where cells have to decide which direction to take. While COUP-TFII is required in promoting caudal cell migration, maintenance of COUP-TFI expression in the caudal cortex might help interneurons in reaching their final caudal targets, such as the hippocampus and amygdala (Tang et al., 2012). The caudal path seems also to be under the control of the chemorepellent Sema 3A and its receptor Nrp1 in which Sema 3A repels CGE-derived cells expressing Nrp1. Second, my data identified two novel streams of migration that, to my knowledge, have never been described before: the caudo-lateral migratory stream (CLMS) and the caudo-medial migratory stream (CMMS). Transcription factors, known to play a role during interneuron development, are expressed in distinct paths (**Fig. 17**). While the majority of CGE-derived interneurons migrating through the CLMS to the LGE express Sp8, cells using the CMMS express a combination of transcription factors. I found that Prox1, COUP-TFI and COUP-TFII are expressed in these caudo-medial migrating populations until they reach the MGE/POA. COUP-TFI and COUP-TFII are then downregulated in this region, whereas Prox1 expression is maintained. Migration of the cells from the CGE to the MGE seems to be under the control of Sema3F expressed in the caudoputamen and its receptor Nrp2.

In the next chapter, I will describe the roles of COUP-TFI and COUP-TFII in these three different migratory streams during development and in the specification of interneuron subpopulations during adulthood.

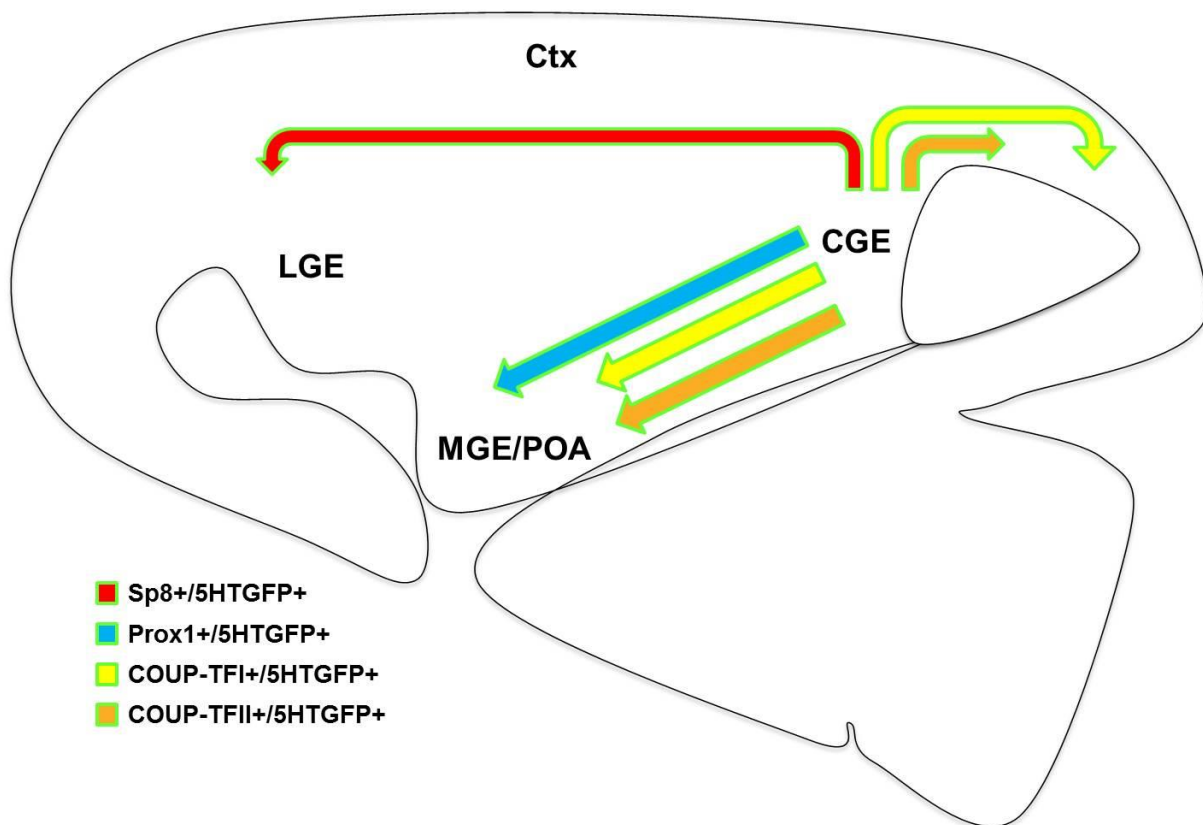

Figure 17: Transcription factors are expressed in different migratory paths. Schematic of horizontal hemisection indicating the expression pattern of the different transcription factors involved in the different streams of migration. Sp8 is expressed in the stream established between the CGE and the LGE (CLMS, red arrow); Prox1 (blue arrow) is present all along the CMMS (between CGE and MGE/POA); COUP-TFI (orange arrow) and COUP-TFII (yellow arrow) are expressed in the CMMS until the MGE/POA and in the CMS; whereas COUP-TFI is present in all the cortex, only cells existing the CGE express COUP-TFII. Note that the size of the arrows does not reflect the contribution of the markers to the paths. Abbreviations: LGE, lateral ganglionic eminence; MGE/POA, medial ganglionic eminence/preoptic area; CGE, caudal ganglionic eminence; Ctx, cortex.

Chapter III

Role of COUP-TFI and COUP-TFII in CGE-derived interneuron migration and specification

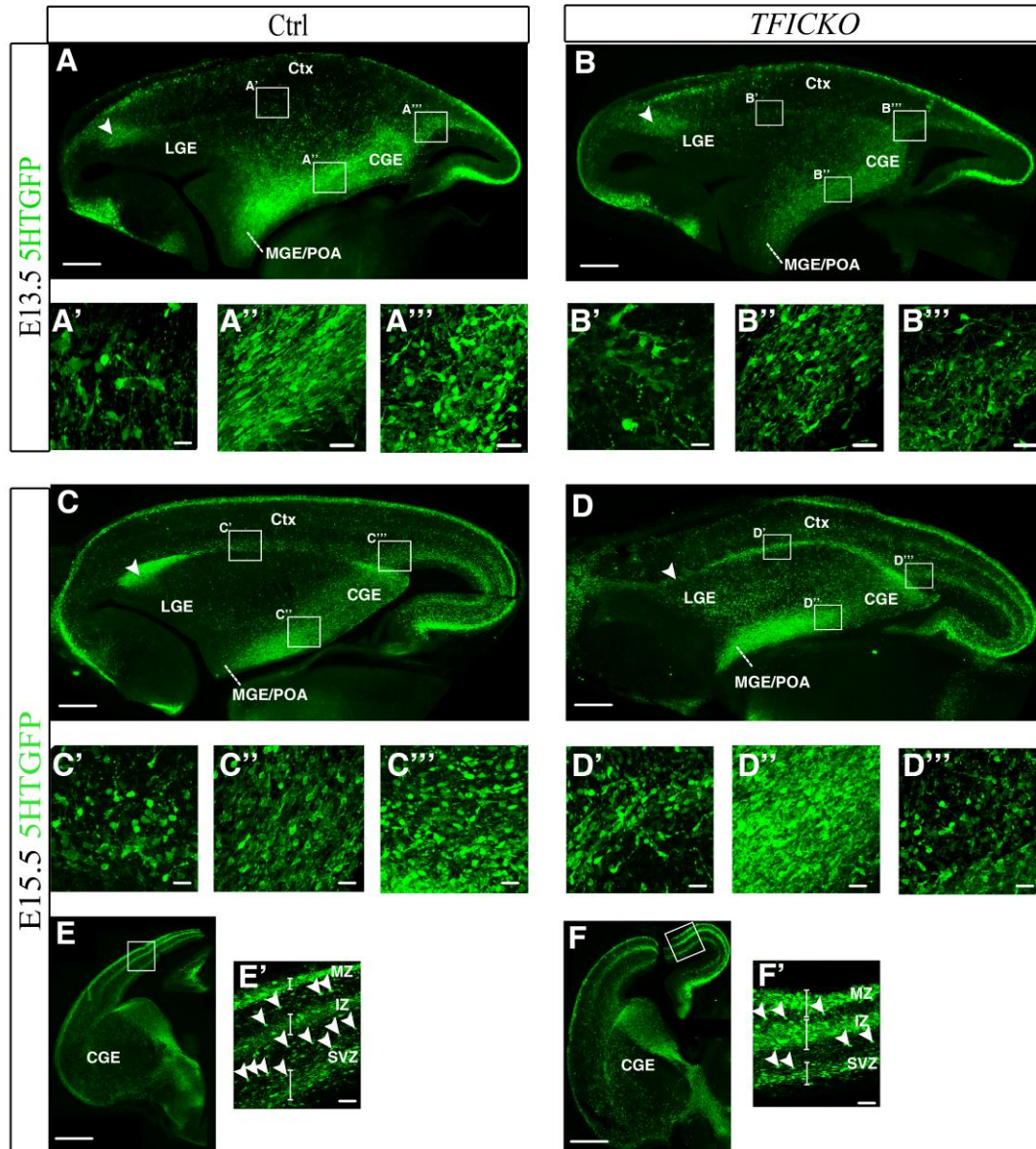

Figure 18: Altered migration in absence of COUP-TFI function. (A-D) Horizontal sections of E13.5 and E15.5 control and *TFICKO* brains immunostained with anti-GFP. High magnification views of a representative detail in the migratory paths show less 5HTGFP+ cells in the CMMS (A''-B'') and in the CMS (A'''-B''') at E13.5. More 5HTGFP+ cells are observed in the CLMS (C'-D') and the CMMS (C''-D'') at E15.5. The CMS is reduced at E15.5 (C'''-D'''). White arrowheads in (A-D) point the dLGE which is reduced at E15.5. (E-F) Coronal section of E15.5 control and *TFICKO* brains showing the cortical tangential migration. High magnifications highlight an increased number of 5HTGFP+ cells in the MZ and in the IZ. Less cells are present between the paths. Abbreviations: LGE, lateral ganglionic eminence; MGE/POA, medial ganglionic eminence/preoptic area; CGE, caudal ganglionic eminence; Ctx, cortex.

1. Loss of COUP-TFI affects CGE proliferation and proper balance of CGE-derived interneuron migration during development

To investigate the function of COUP-TFI in CGE-derived interneurons migration, I first analysed the three CGE-derived migratory paths identified in the 5HTGFP transgenic line and described above, in a conditional COUP-TFI mutant background (*TFICKO*). In this line, COUP-TFI was inactivated in all Dlx5/6+ cortical interneurons (Lodato et al., 2011). Horizontal sections at E13.5 show a decrease of GFP+ cells migrating caudally along the CMS and medially along the CMMS (**Fig. 18A''-A'''**, **B''-B'''**). On the contrary, CLMS migrating cells seem to be unaltered in *TFICKO* brains at this stage (**Fig. 18A'-B'**). As previously mentioned, COUP-TFI and COUP-TFII are expressed in almost all CMS- and in some CMMS-migrating cells at E13.5. In the absence of COUP-TFI, a subpopulation of CMMS and CMS/GFP+ cells could be missing and/or mis-specified. Surprisingly, I found an increase of GFP+ cells in the CMMS and the MGE/POA region (**Fig. 18C''**, **D''**), as well as in the CLMS (**Fig. 18C'**, **18D'**), whereas the stream of caudally-migrating cells is diminished (**Fig. 18C'''**, **D'''**) in E15.5 *TFICKO* brains. However, while cells migrating from the CGE to the LGE are increased, cells in the dLGE are drastically decreased in the absence of COUP-TFI (arrowhead in **Fig. 18C-D**). This might indicate a delay in migration from the CGE to the LGE.

We previously showed that at E13.5 the ratio of proliferative cells increases in the MGE and CGE (Lodato et al.). Indeed, acute BrdU injections in E13.5 control and *TFICKO* brains indicate increased proliferation in the MGE and CGE (**Fig. 19A-C**) and increased expression of the G1-active cell cycle marker *Cyclin D2*, known to promote SVZ divisions in the telencephalon (Glickstein et al., 2007), in SVZ progenitors of E13.5 *TFICKO* embryos (Lodato et al., 2011). Thus, this increase of proliferation could explain the reduced number of GFP+ migrating interneurons I have observed in the CMMS and CMS of mutant embryos at E13.5 since cells are still dividing instead of exiting the cell cycle and start migration. As a consequence, an abnormally higher number of CGE cells might have exited the cell cycle later and contributed to the increased CLMS and CMMS streams at E15.5 (**Fig. 18C'**, **D'** and **Fig. 18C''**, **D''** respectively). The slight reduction in the CMS stream at E15.5 might be instead due to a specific COUP-TFI role within this stream, as previously suggested by the double GFP/COUP-TFI expression in the CMS (**Fig. 14P'''**).

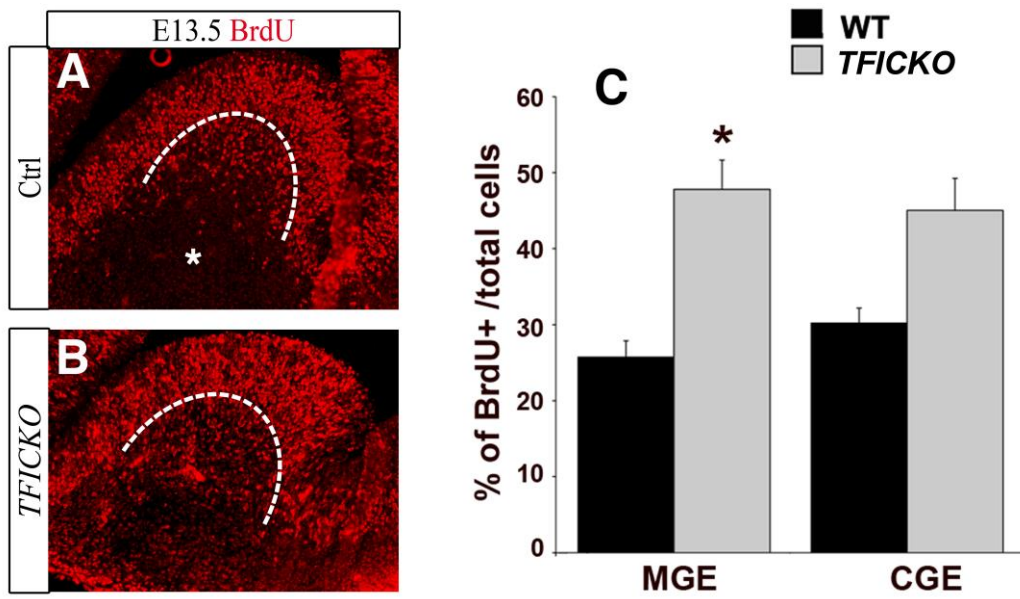

Figure 19: Increased proliferation in absence of COUP-TFI. (A-B) BrdU immunofluorescence on coronal sections indicate increased proliferation in the CGE of E13.5 *TFICKO* embryos. Asterisk in (A) denotes an absence of BrdU+ cells. (C) Graphical representation demonstrates an increase of BrdU-positive cells in the MGE and in the CGE.

Finally, to investigate the cortical tangential migration after interneurons have entered the cortex through the subventricular (SVZ), lower intermediate (IZ) and marginal zones (MZ) (**Fig. 18E-E'**), I used coronal sections of control and *TFICKO* E15.5 brains. In *TFICKO* brains, I observed an increased number of GFP+ cells particularly in the IZ and MZ streams, whereas the SVZ seems not to be altered (**Fig. 18F-F'**). At this stage interneurons normally start to migrate radially from the MZ and IZ to the forming cortical plate (arrowheads in **Fig. 18E'**). In the mutant brains, I found instead a reduced number of cells between the streams (arrowheads in **Fig. 18F'**), suggesting that tangentially migrating GFP+ interneurons are delayed and/or affected in their radially migratory mode and thus tend to accumulate in the streams.

Next, I used the battery of genes expressed in the different migratory streams (**Fig. 17**) to understand whether their expression have been altered within the three main streams of CGE-derived GFP+ migrating cells. For each marker I deliberately chose horizontal sections that represent the best expression pattern of the genes within their migratory streams. Because of the density of GFP+ cells along the different streams and in the CGE, it is very difficult to quantify the number of double-positive cells. This analysis has thus remained qualitative and not quantitative in my thesis report.

First, I focused on the *Prox1*-expressing population that is specifically expressed in the CMMS. At E13.5, *Prox1* expression is slightly increased in the CGE (empty arrowheads in **Fig. 20A, C-D, F**) and decreased in the CMMS (red arrowheads in **Fig. 20A, D** and **Fig. 20G'', J''**) in accordance with the higher proliferation rate observed in the CGE cells, as described before. At E15.5, *Prox1* is downregulated in the CGE (empty arrowheads in **Fig. 20M, O-P, R**) and the CMMS stream (**Fig. 20S'', V''**) but highly expressed in the MGE/POA region (red arrowheads in **Fig. 20M, P**), suggesting that the CGE produces less *Prox1*-positive cells in the absence of COUP-TFI. The high number of *Prox1*+ cells in the MGE/POA region might be due to the accumulation of GFP+ cells, which express this gene (**Fig. 20S', V'**).

The second transcription factor expressed in the CMMS is COUP-TFII. Similarly to *Prox1*, I found a slight increase in COUP-TFII expression in the CGE (empty arrowheads in **Fig. 21A-B** and **Fig. 21C'', D''**) and a concomitant slight decrease in the CMMS in E13.5 *TFICKO*

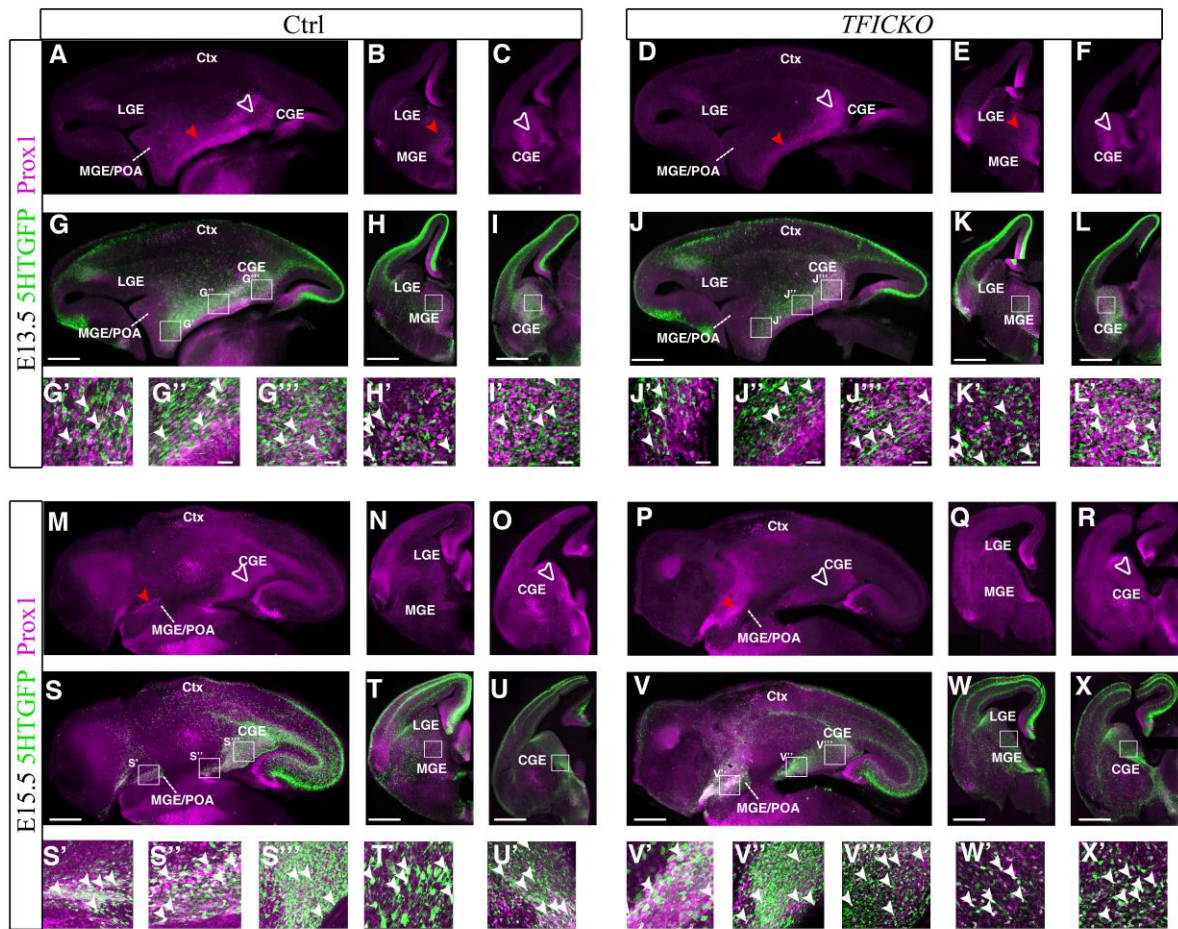

Figure 20: Downregulation of Prox1 in the CMMS in absence of COUP-TFI. (A-X) Horizontal and coronal sections of E13.5 and E15.5 control and *TFICKO* brain immunostained with anti-Prox1 (A-F, M-R), anti-GFP and merge sections (G-L, S-X). Red arrowheads in (A,D) and high magnification views of a representative detail in the CMMS (G'', J'', S'', V'') show a decrease of Prox1 at E13.5 and E15.5. (Empty arrowheads in A, C-D, F and G''', I', J''', L') Slight increase of Prox1 in the CGE at E13.5 but decrease at E15.5 (S''', U', V''', X'). (Red arrowheads in M, P and S'', V') Increased expression of Prox1 in the MGE/POA at 15.5. Abbreviations: LGE, lateral ganglionic eminence; MGE/POA, medial ganglionic eminence/preoptic area; CGE, caudal ganglionic eminence; Ctx, cortex.

brains (red arrowheads in **Fig. 21A-B**). In accordance with an increase of GFP⁺ cells from the CGE to the MGE, I found a slight upregulation of COUP-TFII along the CMMS stream at E15.5 (red arrowheads in **Fig. 21E-F**) This is different from Prox1, which is instead downregulated in the CMMS at E15.5, suggesting that COUP-TFI might regulate the balance between Prox1- and COUP-TFII-expressing subpopulations migrating toward the MGE. In the CMS, the expression of COUP-TFII seems to not change at E15.5 (white arrowheads in **Fig. 21E-F** and **Fig. 21G'', H''**) and no double 5HTGFP⁺/COUP-TFII⁺ cells were found in the cortex at E13.5 (**Fig. 21C'', D''**) and E15.5 (**Fig. 21G'', H''**). Quantitative analysis, which I plan to perform in the future (see also *Perspectives*) will help me in better define how the ratio of double-expressing cells has changed in all streams of *TFICKO* brains at both ages.

Finally, I previously showed that the CLMS seems to increase in *TFICKO* at E15.5 (**Fig. 18D**) but not at E13.5 (**Fig. 18B**). This is confirmed in brains immunostained with Sp8, a marker of CLMS migrating cells. At E13.5, Sp8 expression is slightly increased in the CGE in accordance with the high proliferation rate (empty arrowheads in **Fig. 22A, C-D, F**). However, no obvious differences could be observed in the Sp8-positive CLMS stream at this age (yellow arrowheads in **Fig. 22A, D** and **Fig. 22E'', H''**). As expected, at E15.5 when cells exit the cell cycle and start migrating, a higher proportion of double Sp8/GFP-positive cells are detected in the CLMS of *TFICKO* embryos (**Fig. 22Q''-T''**). As previously mentioned, this could be due to an over proliferation of the CGE, but I cannot exclude that COUP-TFI regulates Sp8 expression, as previously reported in the cortex (Borello et al., 2014).

Finally, regarding the molecules implicated in the guidance of the CGE-derived interneurons to the MGE and cortex, I observed that while Nrp2 expression is decreased in the CMMS at E13.5 (**Fig. 23A-D**), Nrp1 expression is increased in the caudal cortex at E15.5 of *TFICKO* brains (**Fig. 23E-H**). Higher cortical Nrp1 expression might explain why tangentially migrating cortical GFP-expressing neurons accumulate in the streams instead of radially migrating to the cortical plate, as previously described in **Figure 18**.

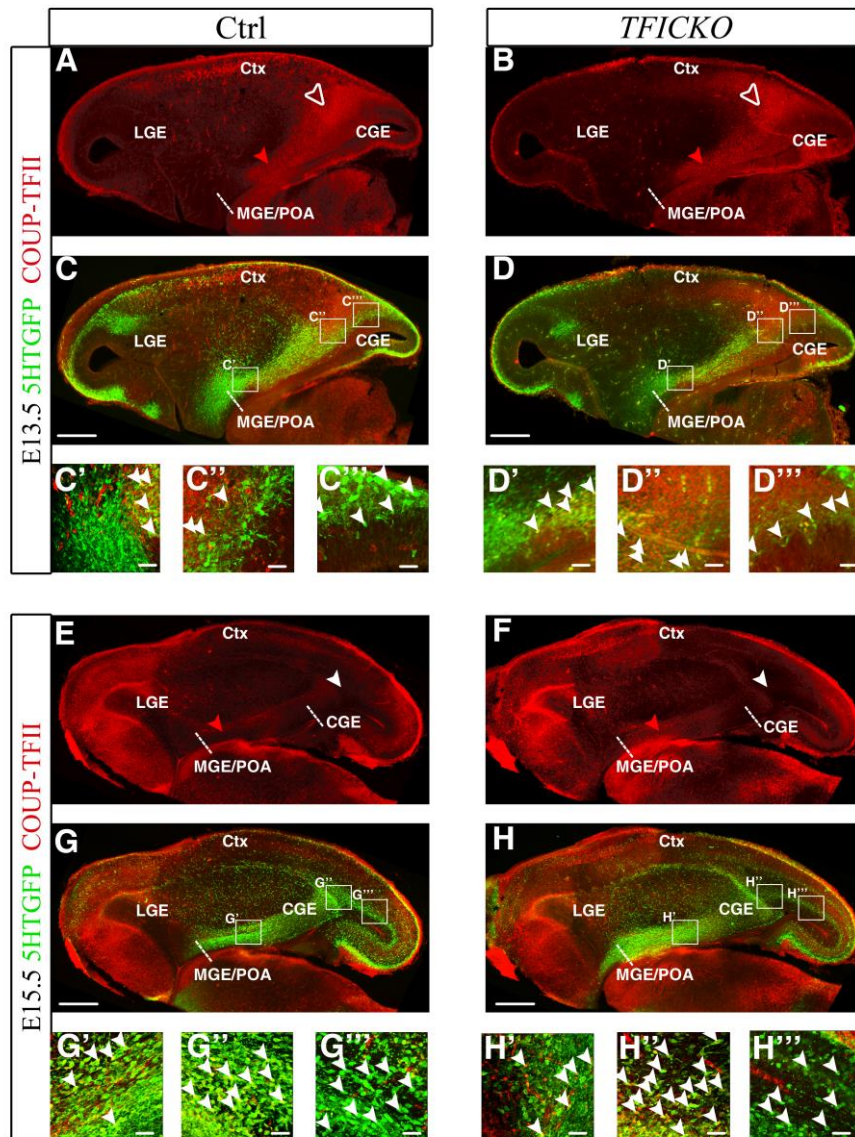

Figure 21: COUP-TFII subpopulation might compensate the decrease of Prox1 subpopulation in CMMS of *TFICKO* brain. (A-H) Horizontal sections of E13.5 and E15.5 control and *TFICKO* brain immunostained with anti-COUP-TFII (A-B, E-F), anti-GFP and merge sections (C-D, G-H). (Empty arrowheads in A-B) Slight increase of COUP-TFII in the CGE associated with a slight decrease in the CMMS (red arrowheads in A-B) in *TFICKO* at E13.5. (Red arrowheads in E-F) COUP-TFII expression increase in the CMMS of *TFICKO* brains at E15.5 unlike Prox1 at the same age. White arrowheads in (E-F) and high magnification views of a representative detail in the CMS (G''-H'') show a constant COUP-TFII subpopulation in the CMS despite the decrease of 5HTGFP+ cells in mutant brain at E15.5. (C'''-D''', G'''-H''') No double 5HTGFP+/COUP-TFII+ cells are observed in the caudal cortex at E13.5 and E15.5. Abbreviations: LGE, lateral ganglionic eminence; MGE/POA, medial ganglionic eminence/preoptic area; CGE, caudal ganglionic eminence; Ctx, cortex.

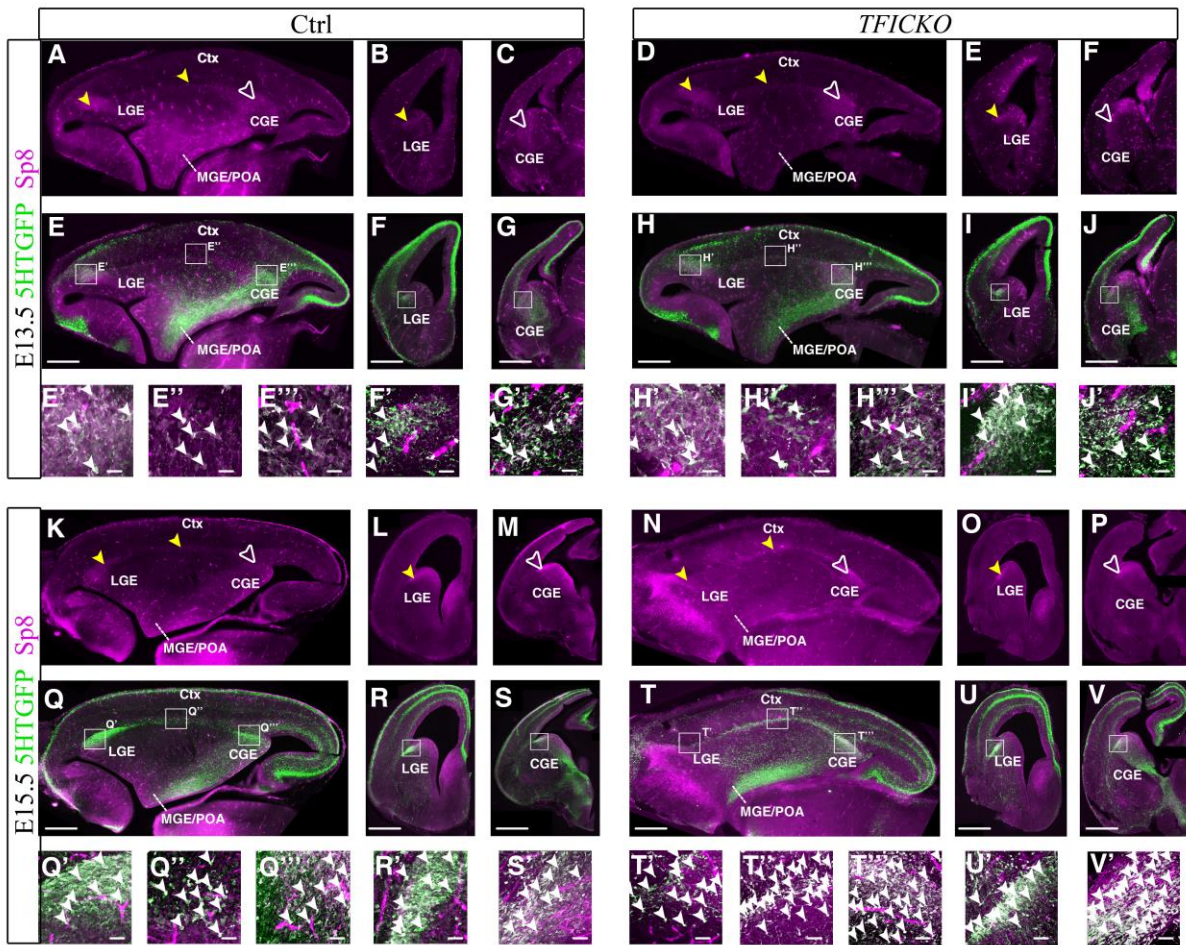

Figure 22: Some CGE-derived interneurons are redirected through the CLMS in absence of COUP-TFI. (A-V) Horizontal and coronal sections of E13.5 and E15.5 control and *TFICKO* brain immunostained with anti-Sp8 (A-F; K-P), anti-GFP and merge sections (E-J, Q-V). Empty arrowheads in (A, C, D, F) show a slight increase of Sp8 expression but no variation in the CLMS (E'', H'') at E13.5 in the COUP-TFI mutant brain and (Q'', S'', T'', V'') confirm the increased expression at E15.5 in the CGE. (Q'', T'') High magnification views of a representative detail in the CLMS show an augmentation of Sp8+/GFP+ cells at E15.5. Abbreviations: LGE, lateral ganglionic eminence; MGE/POA, medial ganglionic eminence/preoptic area; CGE, caudal ganglionic eminence; Ctx, cortex.

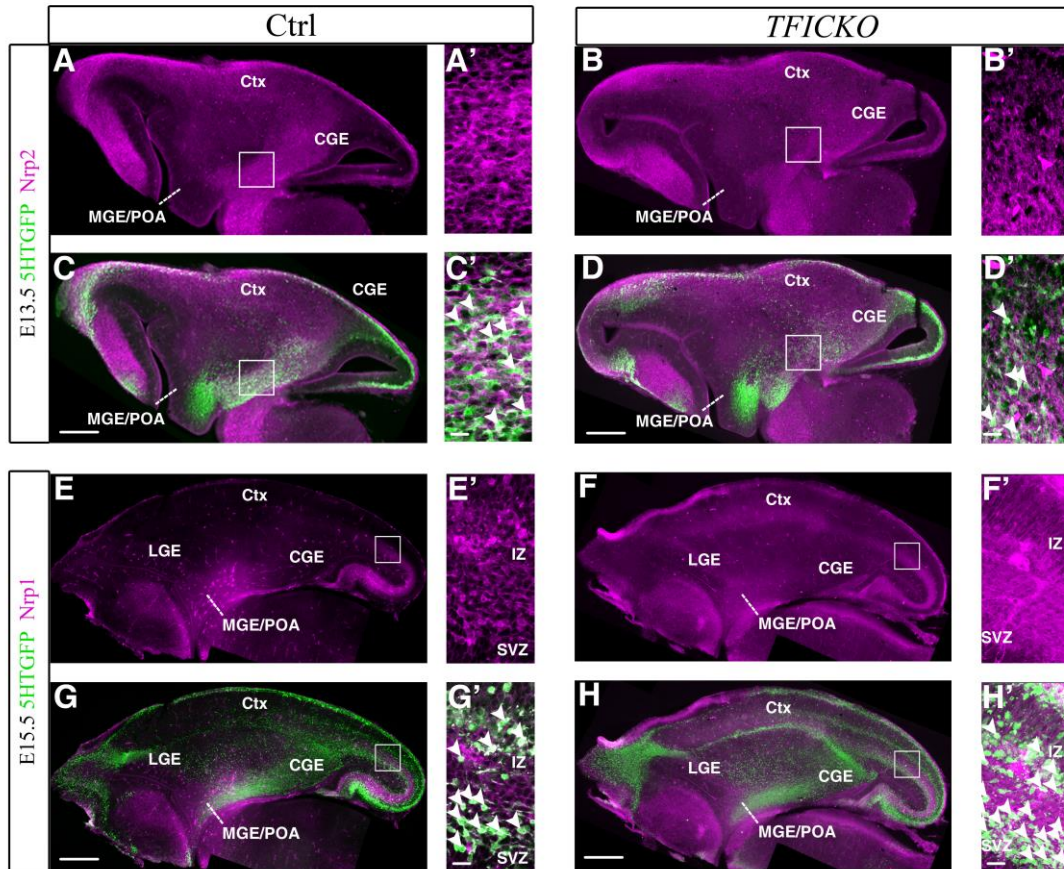

Figure 23: Nrp2 guides the CGE-derived interneurons along the CMMS whereas Nrp1 is required in the caudal cortex. (A-D) Horizontal sections of E13.5 control and *TFICKO* brain immunostained with anti-Nrp2 (A-B), anti-GFP and merge sections (C-D). (A'-B') High magnification views of a representative detail in the CMMS indicate a decrease of Nrp2 expression in the pathway at E13.5. (E-H) Horizontal sections of E15.5 control and *TFICKO* brain immunostained with anti-Nrp1 (E-F), anti-GFP and merge sections (G-H). (E'-F') High magnification views of a representative detail in the caudal cortex indicate an increase of Nrp1 expression in the tangential migratory streams and between them at E15.5.

2. COUP-TFI controls the ratio between MGE- and CGE-derived interneurons in adult mice

Next, we investigated whether loss of function of COUP-TFI in SVZ progenitors of the basal telencephalon would affect the total number and laminar distribution of cortical GABAergic interneurons and interneuron subtypes at P21 in *TFICKO* brains compared with control brains. By counting GABA-positive cells in the somatosensory cortex of P21 *TFICKO* brains, we found no difference in the overall number of cortical interneurons between the mutant and the control cortices (**Fig. 24G**) ($p=0.79$; $n=3$). Then, we evaluated the total number and the radial distribution of distinct cortical interneuron subtypes by performing immunostaining and *in situ* hybridization using subtype-defining molecular markers for distinct GABAergic interneuron subpopulations (Ascoli et al., 2008) in P21 Ctrl and *TFICKO* cortices (**Fig. 24A-F**). As previously reported, PV+ and SST+ interneurons are two MGE early-born subclasses predominantly located in deep layers, whereas VIP+ cells are primarily CGE late-born interneurons located in superficial layers (Miyoshi et al., 2010; Miyoshi et al., 2007; Wonders and Anderson, 2006; Butt et al., 2005; Kawaguchi, 1997). By contrast, CR+ and NPY+ interneurons derive from both the MGE and the CGE and are distributed along the whole radial extent of the cortex (Caputi et al., 2009; Fogarty et al., 2007; Xu et al., 2004). Interestingly, we found that loss of COUP-TFI function affects the specification of PV+ interneurons and the VIP+ and CR+ subpopulations in opposite ways. Whereas the number of PV+ interneurons was increased significantly by 33% (**Fig. 24J**) ($p=0.0004$; $n=3$), the total number of bipolar CR+ and VIP+ interneurons was decreased significantly by 21% (**Fig. 24J**) ($p=0.007$; $n=3$) and by 26% (**Fig. 24J**) ($p=0.03$; $n=3$), respectively. Conversely, there was no significant change in the total number of SST+ (**Fig. 24J**) ($p=0.09$; $n=3$) and NPY+ (**Fig. 24J**) ($p=0.19$; $n=3$) subpopulations, although the number of NPY+ interneurons increased by 25% in deep layers of *TFICKO* cortices (**Fig. 24I**) ($p=0.0028$; $n=3$). Differences in layer distribution were also detected in the MGE-derived PV+ population, which was strikingly increased by 50% in deep layers (**Fig. 24I**) ($p=0.0001$; $n=3$), but not affected in superficial layers (**Fig. 24H**) ($p=0.98$) of *TFICKO* mice. Regarding the CGE-derived subpopulations, the number of VIP-expressing cells was reduced significantly in all layers (36% reduction in deep layers, $p=0.02$; and 22% in superficial layers, $p=0.04$; $n=3$) (**Fig. 24H-I**), whereas the number of CR-expressing cells was decreased by 27% in superficial layers (**Fig. 24H**)

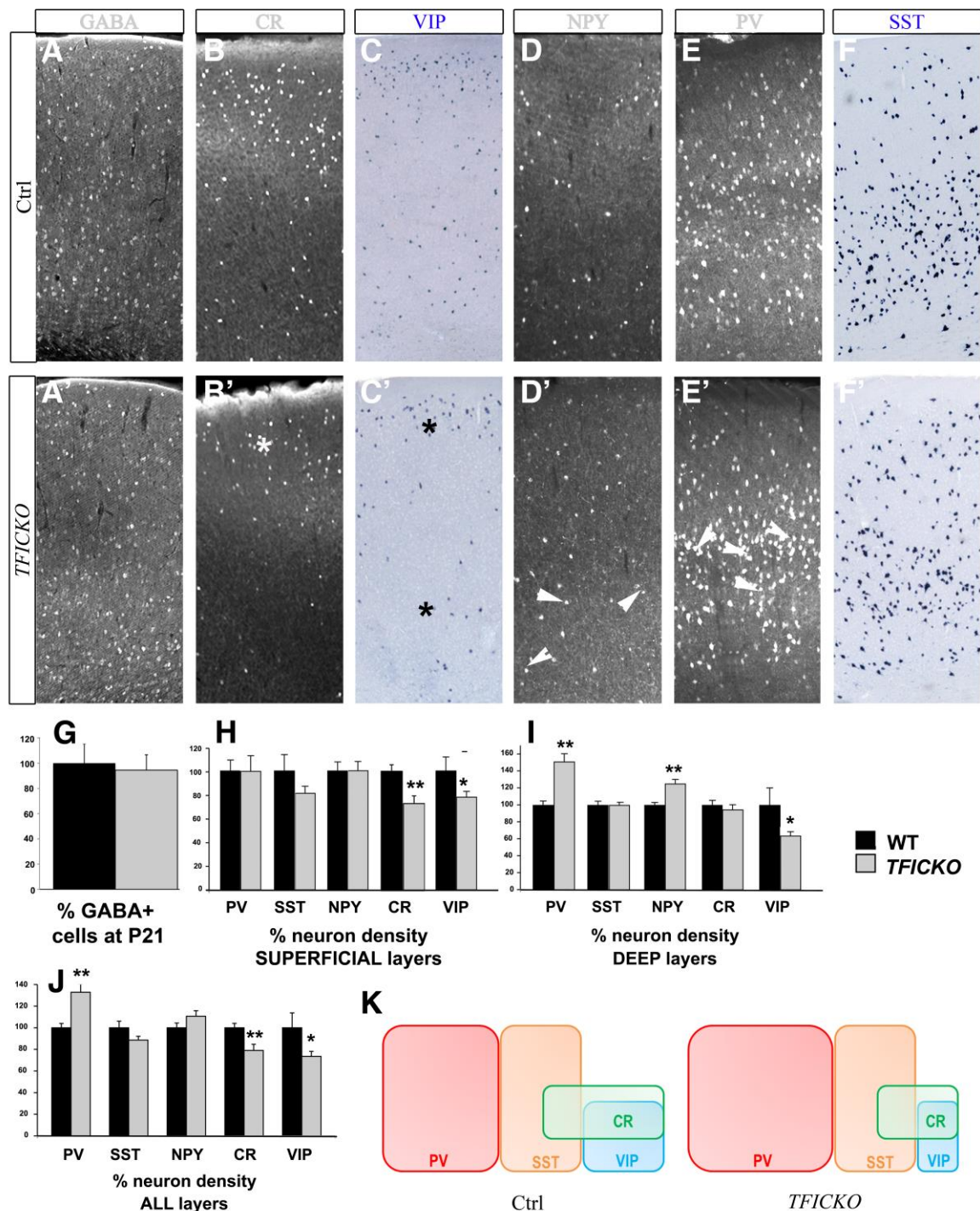

Figure 24: Altered balance between PV- and VIP- and CR-expressing cortical interneurons in the absence of COUP-TFI function. (A-F') Representative coronal sections of young adult control and *TFICKO* cortices within the sensorimotor cortex of control (A-F) and *TFICKO* (A'-F') immunostained with anti-GABA (A-A') and with different cortical interneuron subtypes, as indicated (B-F'). (C, C', F, F') *In situ* hybridization of *SST* and *VIP* on adjacent sections. (G) No significant difference in the total amount of GABA+ cells was detected between control and mutant cortices. Arrowheads in (D') and (E') point to an increased number of NPY- and PV-expressing cells, respectively, in deep layers. Asterisk in (B') denotes a reduction of CR-expressing cells in superficial layers, whereas asterisks in (C') indicate a reduction of VIP-expressing cells in both superficial and deep layers. (H-J) Graphical representation of the percentage of density of the different cortical interneuron subpopulations in the *TFICKO* relative to control, as indicated (Lodato et al., 2011). (K) Schematic showing the proportion of the different cortical interneuron subpopulation classified according to their molecular expression profiles. In the normal mouse neocortex, parvalbumin (PV)-positive interneurons and somatostanine (SST) positive cells mainly derive from the medial ganglionic eminence (MGE). Instead, vasoactive intestinal peptide (VIP)-expressing interneurons originate from the caudal ganglionic eminence (CGE). Interneurons expressing the neurotransmitter peptide NPY, calretinin (CR) are known to derive from both the MGE and the CGE.

($p=0.0034$; $n=3$), but not altered in deep layers (**Fig. 24I**) ($p=0.57$; $n=3$) (Lodato et al., 2011). Together, these results indicate that loss of COUP-TFI function alters the balance between MGE-derived and CGE-derived interneuron subpopulations during development, without however affecting the overall cortical interneuron number (**Fig. 24K**).

3. Loss of COUP-TFII affects mainly CMS and CMMS migration

Next, I analysed conditional mutant mice for COUP-TFII (*TFIICKO*) to understand whether and how COUP-TFII affects CGE-derived interneuron migration. Similarly to *TFICKO* mice, COUP-TFII was inactivated in all cortical interneurons by using the *Dlx5/6-Cre-recombinase* line (Lodato et al., 2011). The 5HTGFP line was used as readout of the migratory patterns of CGE-derived interneurons in the absence of COUP-TFII.

To this purpose, I analysed horizontal and coronal sections of control and *TFIICKO* brains at E15.5 since this is the peak time of CGE interneuron generation (Taniguchi et al., 2013; Miyoshi et al., 2010; Miyoshi et al., 2007; Butt et al., 2005; Nery et al., 2002). Similarly to *TFICKO*, absence of COUP-TFII seems to affect all three CGE-derived migratory paths (**Fig. 25A-B''**). Horizontal sections of E15.5 *TFIICKO* brains show an increase of GFP+ cells migrating from the CGE to the LGE (**Fig. 25A', B'**). However, since less GFP+ neurons are observed in the dLGE at this stage (empty arrowheads in **Fig. 25A-B**), I hypothesize that CLMS neurons are delayed in reaching the dLGE. Surprisingly, the CMS is absent in E15.5 *TFIICKO* brains (**Fig. 25A''', B'''**), confirming the important role of COUP-TFII in promoting the caudal migration of CGE interneurons (Kanatani et al., 2008). In addition, I also observed a migratory defect of CMMS/GFP+ cells once entering the MGE/POA region (red arrowhead in **Fig. 25B**). A subpopulation of these GFP+ cells seems to be misdirected to the hypothalamic region. Finally, the distribution of GFP+ cells within the cortical migratory streams on coronal sections of *TFIICKO* cortices is affected. I can observe an increased number of cells particularly in the IZ/SVZ and an abnormal distribution of cells between the streams (**Fig. 25C-D'**). This might suggest altered tangential and radial migration of CGE-derived interneurons in the cortex in the absence of COUP-TFII.

Analysis of transcription factor expression indicates that COUP-TFI expression is reduced in the CMMS of E15.5 *TFIICKO* embryos (red arrowhead in **Fig. 26A-B** and **Fig. 26C'-D'**), suggesting that COUP-TFII might regulate COUP-TFI expression in this stream. Moreover

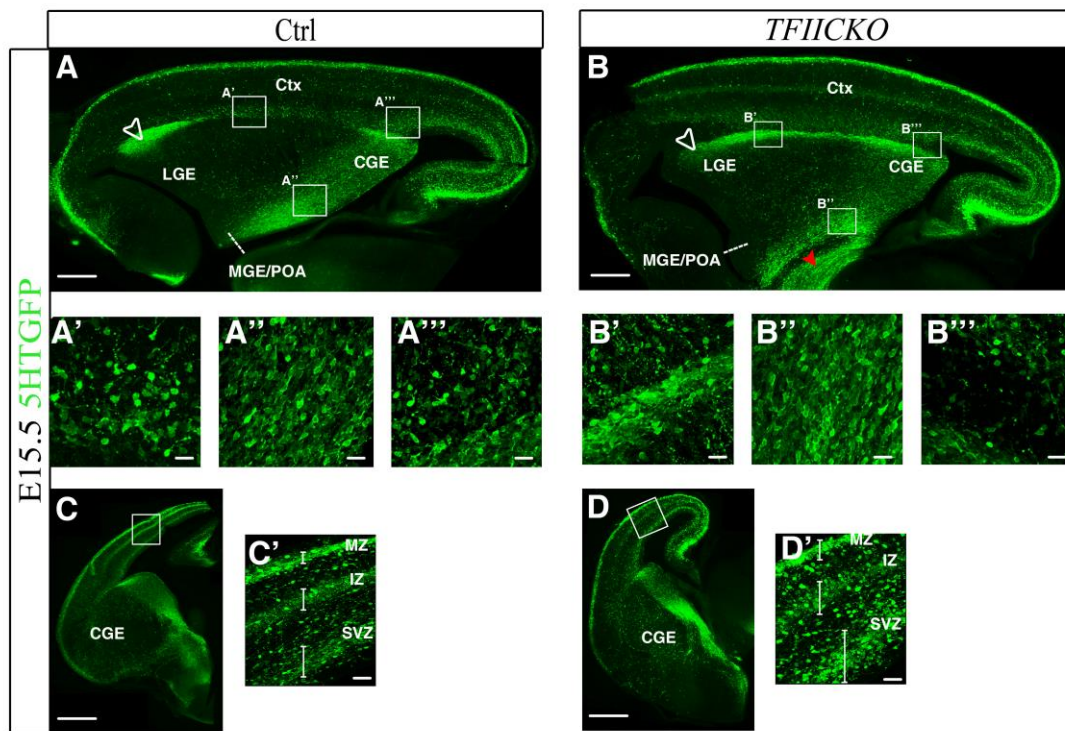

Figure 25: Altered migration in absence of COUP-TFII function. (A-B) Horizontal sections of E15.5 control and *TFIICKO* brains immunostained with anti-GFP. (A'-B') High magnification views of a representative detail in the migratory path show an increase of cells in the CLMS but a decrease in the dLGE (empty arrowhead in A-B). (A''-B'') The CMMS appears to remain constant but a proportion of 5HTGFP+ seems to be misdirected in the hypothalamic region (red arrowhead in B). (A'''-B''') The CMS is absent in the *TFIICKO* brains. (C-D') Coronal section of E15.5 control and *TFIICKO* brains showing the cortical tangential migration. High magnifications highlight an increased number of 5HTGFP+ cells in the IZ/SVZ and an abnormal distribution of cells between the streams. Abbreviations: LGE, lateral ganglionic eminence; MGE/POA, medial ganglionic eminence/preoptic area; CGE, caudal ganglionic eminence; Ctx, cortex

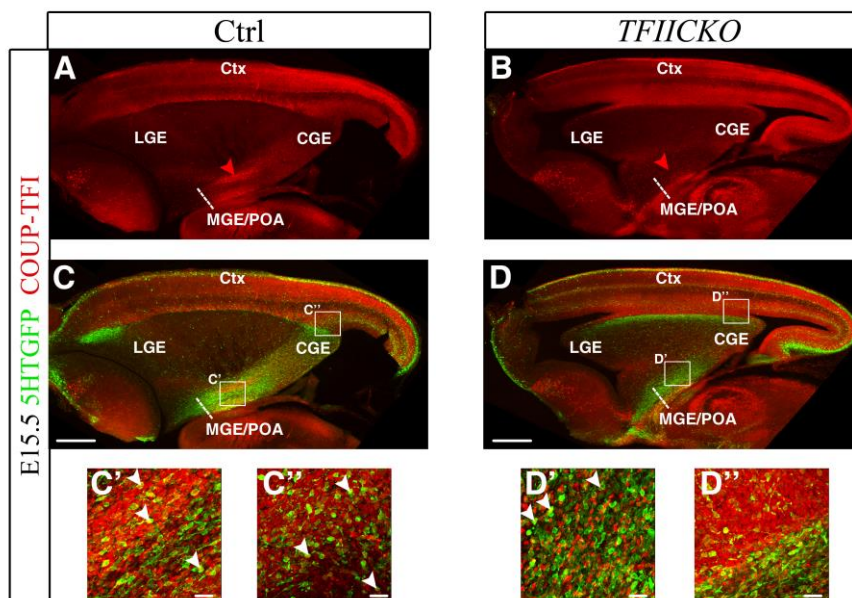

Figure 26: Regulation of COUP-TFI by COUP-TFII. (A-D) Horizontal sections of E15.5 control and *TFIICKO* brains immunostained with anti-COUP-TFI (A-B), anti-GFP and merge sections (C-D). (C'-D') The expression of COUP-TFI is reduced in absence of COUP-TFII in the CMMS at E15.5. (C''-D'') No 5HTGFP+ cells migrate through the CMS in *TFIICKO*. COUP-TFI expression is observed only in the cortex of COUP-TFII mutant brain.

and similarly to *TFIICKO* brains, *Prox1* is downregulated in the CMMS next to the CGE (**Fig. 27G'', J''**), but upregulated in the MGE/POA region where GFP+ cells seem to accumulate in *TFIICKO* brains (red arrowheads in **Fig. 27A, D, G', J'**).

As previously mentioned, more GFP+ cells are found in the CLMS of *TFIICKO* brains and as a consequence an increased number of Sp8+/5HTGFP+ cells in the stream between the CGE and the LGE (yellow arrowheads in **Fig. 28A, D** and **Fig. 28G'', J''**). Finally, although fewer GFP+ cells can be observed in the dLGE of *TFIICKO* horizontal sections (yellow arrowheads in **Fig. 28A-B, D-E** and **Fig. 28G', J'**), coronal sections indicate that expression of Sp8 and GFP+ cells are ventrally expanded in the dLGE (**Fig. 28H-H', K-K'**). These data highlight the important role of COUP-TFII in the migration of CGE-derived interneurons along the CMS. In its absence, CGE cells might take the CLMS instead of the CMS. In addition, COUP-TFII seems to play an important role in guiding CMMS cells to the MGE, since in its absence some of these cells take a more medial path and tend to enter the hypothalamus. This strongly suggests that COUP-TFII might control cues and/or factors important for guiding CGE-derived cells to their final target.

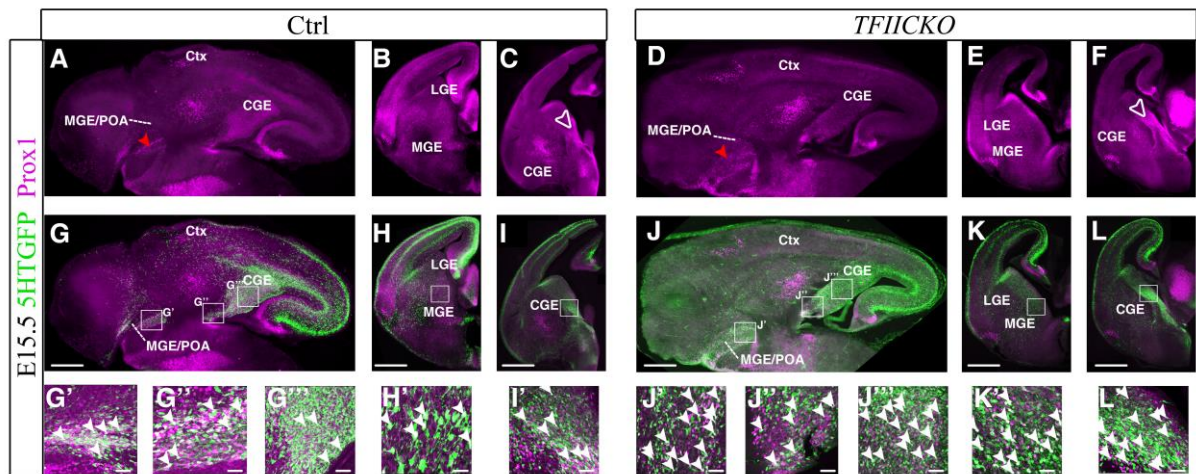

Figure 27: Downregulation of Prox1 in the CMMS in absence of COUP-TFII. (A-L) Horizontal and coronal sections of E15.5 control and *TFIICKO* brain immunostained with anti-Prox1 (A-F), anti-GFP and merge sections (G-L). High magnification views of a representative detail in the CMMS (G'', J'') show a decrease of Prox1 expression at E15.5 in *TFIICKO* brain but an accumulation of Prox1+/5HTGFP+ cells are observed in the MGE/POA of mutant brains at E15.5 (G'-H', J'-K'). Abbreviations: LGE, lateral ganglionic eminence; MGE/POA, medial ganglionic eminence/preoptic area; CGE, caudal ganglionic eminence; Ctx, cortex.

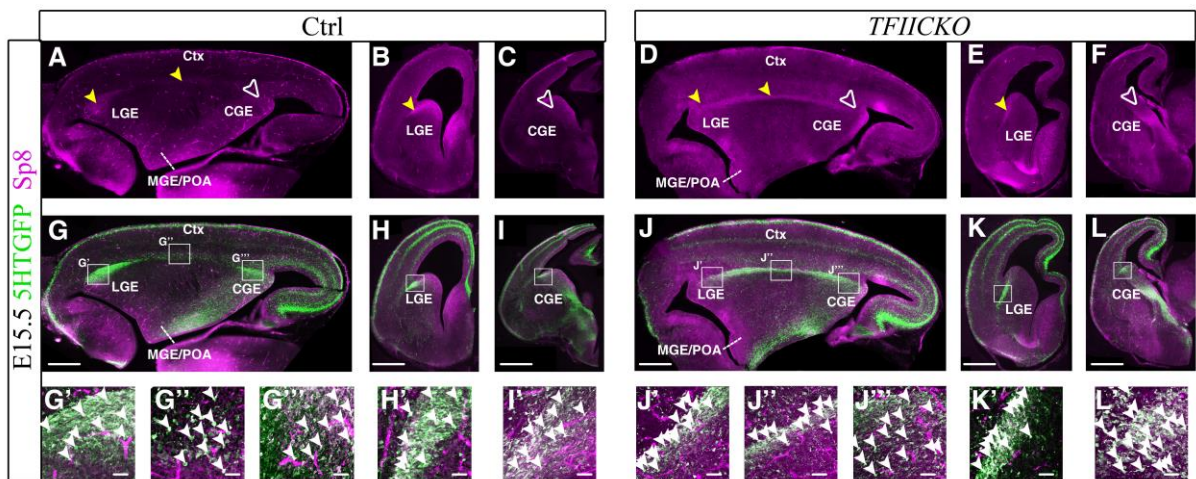

Figure 28: Some CGE-derived interneurons are redirected through the CLMS in absence of COUP-TFII. (A-L) Horizontal and coronal sections of E15.5 control and *TFIICKO* brain immunostained with anti-Sp8 (A-F), anti-GFP and merge sections (G-L). (G'-J') Fewer GFP+/Sp8+ cells are present in the dLGE on *TFIICKO* horizontal section but the dLGE is expended ventrally (H-H', K-K'). (G'', J'') As the number of GFP+ cells increases in the CLMS of *TFIICKO* brain at E15.5, the number of double GFP+/Sp8+ cells augments. Abbreviations: LGE, lateral ganglionic eminence; MGE/POA, medial ganglionic eminence/preoptic area; CGE, caudal ganglionic eminence; Ctx, cortex.

4. Opposed role of COUP-TFII in controlling the balance between MGE- and CGE-derived interneurons in adult mice

Next, I investigated the laminar distribution and the ratio of the different interneuron subpopulations in *TFIICKO* adult brains compared to controls. Due to the problem of obtaining *COUP-TFII**flox/flox* adult mice (see Materials & Methods), I could only evaluate a tendency of variation between the adult *TFIICKO* mutant (n=1) and controls (n=3). As in the *TFIICKO* mice, I found no difference in the total number of GABA-positive cells in the somatosensory area of the cortex (**Fig. 29G**). However, by analyzing the different markers of interneuron subpopulations (**Fig. 29A-F'**), I found that loss of COUP-TFII function affects the number of PV+ and CR+ interneurons and the VIP+ subpopulation in opposite ways (**Fig. 29H**). While the PV+ and CR+ interneurons are decreased by 20% and by 27% respectively, the number of VIP+ interneurons is increased by 29% (**Fig. 29H**). Conversely, there was no change in the total number of SST+ and Reelin+ (**Fig. 29H**). Then, I investigated the double expressing subpopulations. In the MGE, SST+ interneurons can be subdivided into different subpopulations: the SST+/Reelin+ and the SST+/CR+ interneurons. The comparison between control and *TFIICKO* adult brains shows that the ratio of SST+/Reelin+ increased (+50%), whereas the ratio of SST+/CR+ decreased (-43%) (**Fig. 29I**). These data are consistent with the fact that there is no difference in the total number of SST+ cells and can explain the decrease of the total number of CR+ interneurons. Indeed, no variation of the double VIP+/CR+ cells was observed (**Fig. 29I**) while the VIP+/CR- population increased (+30%) (**Fig. 29H**), suggesting that the missing CR+ cells in *TFIICKO* were most probably MGE-derived and only the single VIP+ population deriving from the CGE increased.

Taken together, these data show that COUP-TFII plays an important role in the migration and specification of CGE-derived interneurons. Altered migration might have an effect in the laminar distribution of the different subpopulations (an issue that I have not analysed yet), whereas altered specification affects the ratio of the different subpopulations (**Fig. 29J**).

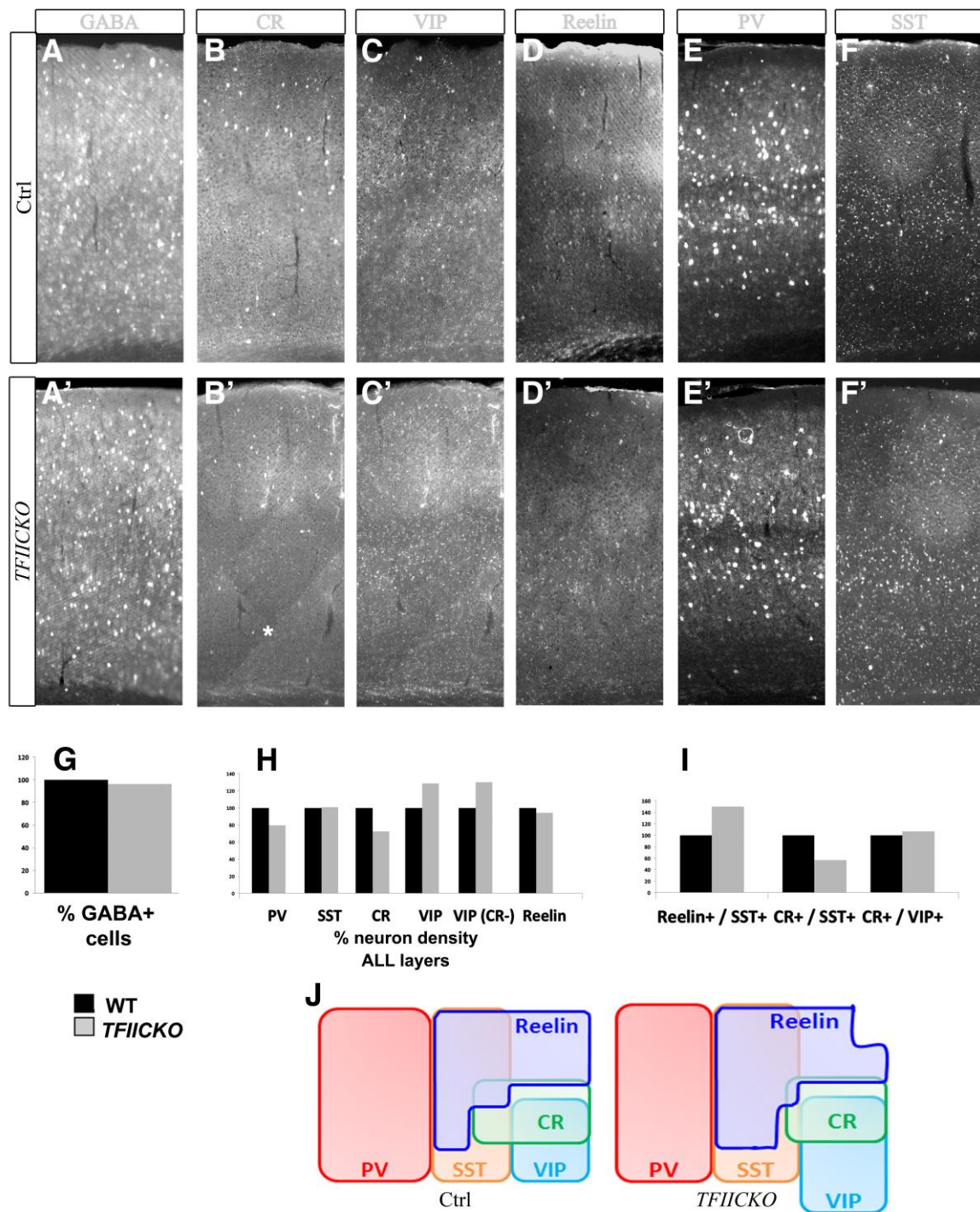

Figure 29: Altered balance between PV- and VIP- and CR-expressing cortical interneurons in the absence of COUP-TFII function. (A-F') Representative coronal sections of adult control and *TFIICKO* cortices within the sensorimotor cortex of control (A-F) and *TFIICKO* (A'-F') immunostained with anti-GABA (A-A') and with different cortical interneuron subtypes, as indicated (B-F'). (G) No significant difference in the total amount of GABA+ cells was detected between control and mutant cortices. Asterisk in (B') denotes a reduction of CR-expressing cells in deep layers. (H-I) Graphical representation of the percentage of density of the different cortical interneuron subpopulations in the *TFIICKO* relative to control, as indicated. (K) Schematic showing the proportion of the different cortical interneuronal subpopulation classified according to their molecular expression profiles. In the normal mouse neocortex, parvalbumin (PV)-positive interneurons and somatostanine (SST) positive cells mainly derive from the medial ganglionic eminence (MGE). Instead, vasoactive intestinal peptide (VIP)-expressing interneurons originate from the caudal ganglionic eminence (CGE). Interneurons expressing the Reelin, calretinin (CR) are known to derive from both the MGE and the CGE.

5. Partial additive effects on interneuron migration in COUP-TF compound mutants

Since a high number of cells in the CGE express both COUP-TFI and COUP-TFII, I crossed single conditional mice and obtained double mutant conditional knock-outs, called *TFI-TFII**CKO*. Again, thanks to the presence of the 5HTGFP in the double mutant background, I could analyse the different CGE-derived GFP⁺ trajectories at E13.5 and E15.5, and expression of Prox1 and Sp8 within these streams. Already at E13.5, a higher number of cells in the CLMS (**Fig. 30A'-B'**) and a reduced density of GFP⁺ cells in the CMMS (**Fig. 30A''-B''**) are detected in *TFI-TFII**CKO* horizontal sections. At E15.5, more GFP⁺ cells still migrate along the CLMS than in controls (**Fig. 30C'-D'**), however the stream seems to be less abundant than in single mutants and the size of the dLGE is reduced in *TFI-TFII**CKO* brains (empty arrowheads in **Fig. 30C-D**). Importantly, these brains show a disorganized pattern of GFP⁺ cells between the CMMS and the CMLS at E13.5 (arrowhead in **Fig. 30B**). At E15.5, this abnormal migration can still be observed in double mutant brains, but at a minor rate (arrowhead in **Fig. 30D**), when compared to brains at E13.5, and thickness of the CMMS is reduced in E15.5 double mutants (**Fig. 30C, C'', D, D''**). In addition, the number of GFP⁺ positive cells located in the CGE seems to be increased in double *TFI-TFII**CKO* brains at E13.5 and E15.5 (red arrowheads in **Fig. 30B, D**), suggesting a defect in proliferation, as described for *TFII**CKOs*. However, this effect is more severe than in single COUP-TFI mutant brains (**Fig. 18**) and might suggest that both COUP-TFs cooperate in regulating CGE proliferation.

Surprisingly, although the CMS is almost normal at E13.5 (**Fig. 30A'''-B'''**), it increases at E15.5 (**Fig. 30C'''-D'''**) differently from what observed in single mutants in which the CMS is reduced, suggesting that other mechanisms might compensate for the lack of both COUP-TFs. Finally, the density of tangentially migrating interneurons in the caudal cortex of E15.5 double mutant brains is augmented in all streams (SVZ, IZ and MZ, **Fig. 30F'**) suggesting an additive effect of COUP-TFI and COUP-TFII loss in cortical tangential migration (see also **Fig. 18 and 25**).

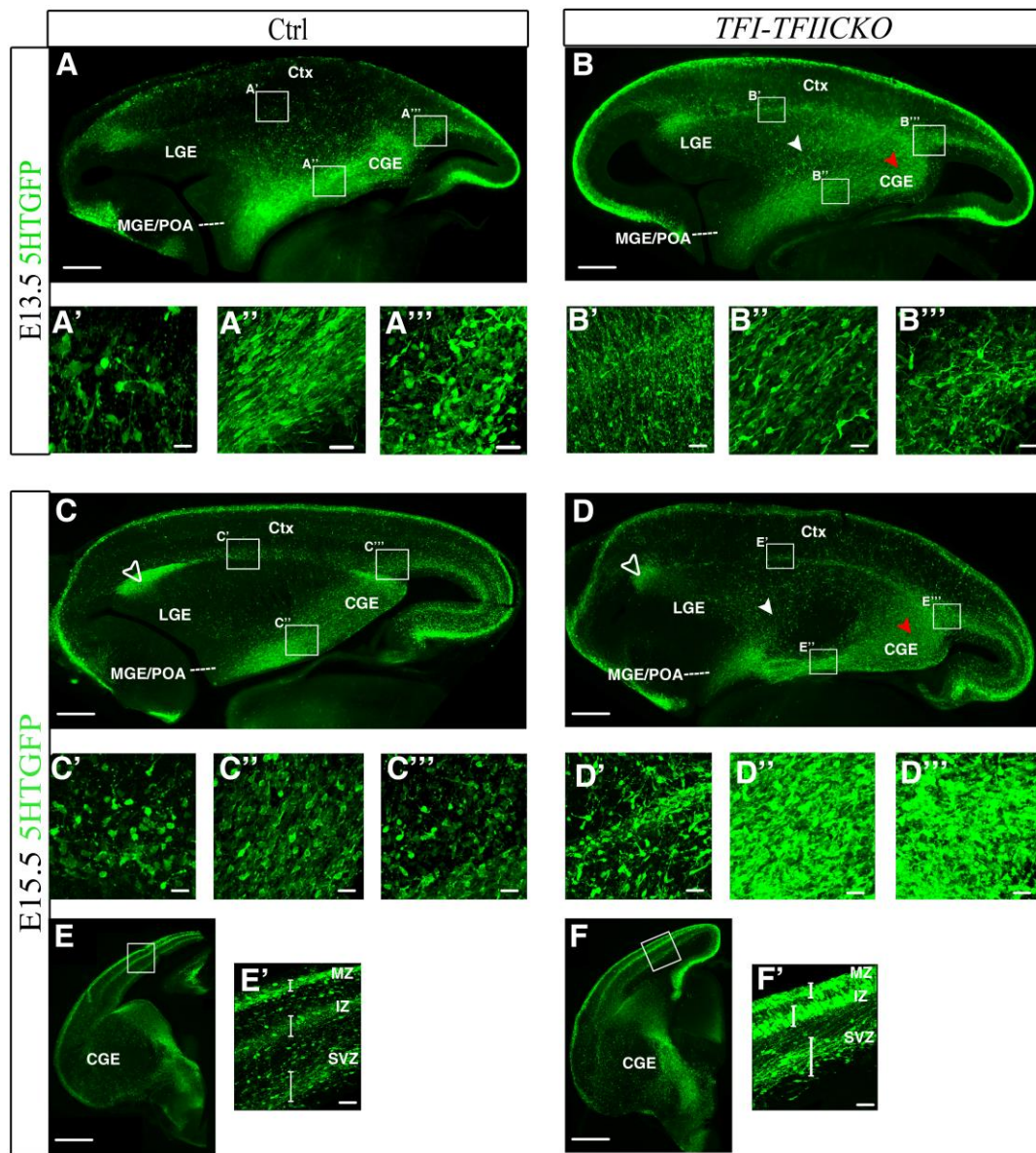

Figure 30: Additive effects of COUP-TFI and COUP-TFII on the migration. (A-D) Horizontal sections of E13.5 and E15.5 control and *TFI-TFII*CKO brains immunostained with anti-GFP. (Red arrowheads in B,D) Increased number of cells in the CGE of double mutant at E13.5 and E15.5 suggestion a defect in proliferation. (A'-D') High magnification views of a representative detail in the CLMS indicate an increased number of cells at E13.5 and E15.5. (empty arrowheads in C-D) Reduction of the dLGE at E15.5. (A''-D'') The CMMS is reduced at E13.5 and its thickness is narrowed at E15.5 showing a higher density of cells. (A''', D''') At E13.5 the CMS seems to be normal whereas it is increased at E15.5. This observation was not expected since COUP-TFII seems to have an important role in this migratory pathway. (E-F') High magnifications highlight an increased number of 5HTGFP+ cells in all the tangential streams in accordance with the additive effect of COUP-TFI and COUP-TFII loss. Abbreviations: LGE, lateral ganglionic eminence; MGE/POA, medial ganglionic eminence/preoptic area; CGE, caudal ganglionic eminence; Ctx, cortex

The expression pattern analysis shows that the transcription factor Sp8, expressed in all GFP+ CLMS cells, is increased at E13.5 (yellow arrowheads in **Fig. 31A, D** and **Fig. 31G'', J''**) and E15.5 (yellow arrowheads in **Fig. 31M, P** and **Fig. 31S'', V''**) in *TFI-TFII*CKO in accordance with the higher number of migrating GFP+ cells in this path. As expected, double positive GFP+/Sp8+ cells are also increased in the dCGE at E13.5 (**Fig. 31G''', I', J''', L'**) and E15.5 (**Fig. 31S''', U', V''', X'**) in accordance with the possible increase in proliferation of the CGE.

The expression of Prox1 is decreased in the CGE (empty arrowheads in **Fig. 32A, C, D, F**) and CMMS (red arrowheads in **Fig. 32A, D** and **Fig. 32G'', J''**) of E13.5 *TFI-TFII*CKO brains. Surprisingly, at E15.5 Prox1 is increased in the CGE (empty arrowheads in **Fig. 32M, P**), the CMMS (**Fig. 32S'', V''**) and in the MGE/POA (red arrowheads in **Fig. 32M, P** and **Fig. 32S', V'**). This is different from what observed in single COUP-TF mutants (**Fig. 20** and **27**). These differences between single and double mutants might suggest that the Prox1 subpopulation partially compensates for the absence of COUP-TFI and COUP-TFII in this stream.

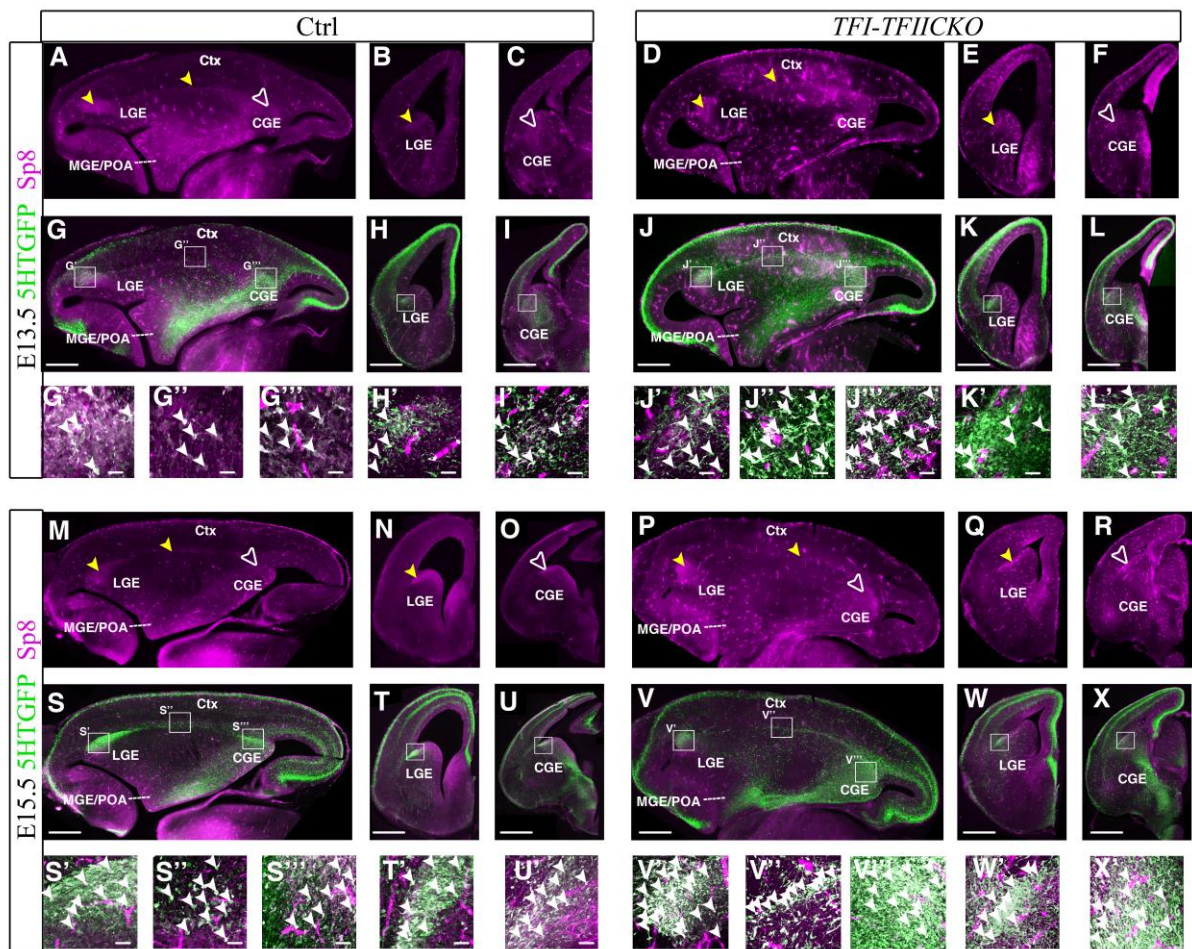

Figure 31: Increased number of Sp8+/5HTGFP+ in the CLMS at earlier stage. (A-X) Horizontal and coronal sections of E13.5 and E15.5 control and *TFI-TFI1CKO* brain immunostained with anti-Sp8 (A-F; M-R), anti-GFP and merge sections (G-L, S-X). (G', J', S', V') High magnification views of a representative detail in the CLMS show an augmentation of double positive cells at E13.5 and E15.5. (G'', I', J'', L' and S'', U', V'', X') indicate an increase of these cells in the CGE at E13.5 and E15.5 respectively. Abbreviations: LGE, lateral ganglionic eminence; MGE/POA, medial ganglionic eminence/preoptic area; CGE, caudal ganglionic eminence; Ctx, cortex.

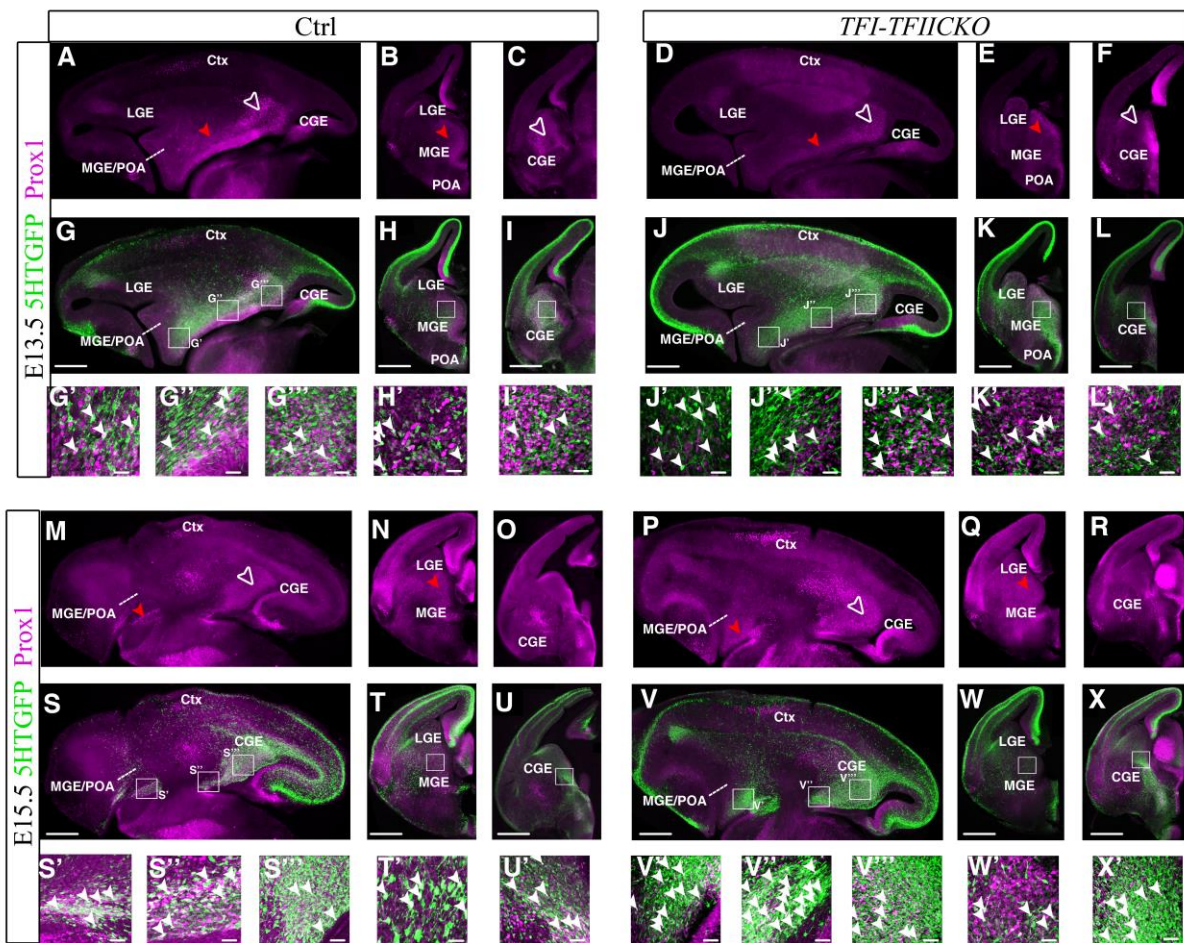

Figure 32: Upregulation of Prox1 in the CMMS at E15.5 in absence of COUP-TFI and COUP-TFII. (A-X) Horizontal and coronal sections of E13.5 and E15.5 control and *TFI-TFI1CKO* brain immunostained with anti-Prox1 (A-F, M-R), anti-GFP and merge sections (G-L, S-X). Red arrowheads in (A,D) and high magnification views of a representative detail in the CMMS (G'', J'') show a decrease of Prox1 at E13.5. (Empty arrowheads in A, C-D, F) Decrease of Prox1 in the CGE at E13.5 confirmed by high magnification in (G''', I'', J''', L'). At E15.5, unexpected increase of Prox1 expression in the CGE (empty arrowheads in (M, P), the CMMS (S'', V'')). (S', V') The MGE/POA show an augmentation of double positive. Abbreviations: LGE, lateral ganglionic eminence; MGE/POA, medial ganglionic eminence/preoptic area; CGE, caudal ganglionic eminence; Ctx, cortex.

Chapter IV

Discussion and Perspectives

Discussion

CGE-derived interneurons migrate rostrally within the subpallium before reaching the dorsal cortex

In the ventral telencephalon, transcription factors, expressed in progenitors and then maintained in postmitotic neurons, have been shown to play fundamental roles in the specification, migration and maturation of specific interneuron subpopulations (Batista-Brito et al., 2009, Corbin et al., 2011). Several studies have shown that the intrinsic specification and migratory fate of interneurons are determined by the combinatorial expression of several key transcription factors that are expressed within the progenitor domains of the subpallium (Willi-Monnerat et al., 2008). These transcription factors not only define subpallial patterning and interneuron differentiation, but also provide migratory route instructions for newborn interneurons (Kelsom et al., 2013). The transcription factor Nkx2.1 is a typical example on how a unique factor can control fate determination and migration (Nóbrega-Pereira et al., 2008).

While a lot of attention has been directed to understanding the molecular mechanisms involved in the specification of the different cortical interneuron subtypes, less is known on how interneurons, which are born in the subpallium, reach their targets in the pallium or dorsal cortex. Early tracing studies have demonstrated that different streams of interneurons arising from the GE are able to transit across the corticosubpallial boundary and course tangentially into the cortex. Later experiments have shown that MGE-derived cortical interneurons avoid the ventral POA and lateral striatum as they migrate toward the dorsal cortex and that chemorepulsive cues play an essential role in establishing this pattern. The repellent activity mediated by class 3 semaphorins (Sema3A and Sema3F) expressed in the developing caudoputamen/striatum has been shown to be largely responsible for the sorting between MGE-derived cortical interneurons and striatal interneurons. Moreover, the expression of Neuropilin (Nrp) 1 and 2 receptors by MGE-derived interneurons destined for the cortex ensures that cortical interneurons are competent to respond to the repulsive actions of Sema3A and Sema3F and thus enables them migrating around the developing striatum and entering the dorsal cortex (Marín et al., 2001). Importantly, Nkx2.1 has been shown to directly repress Nrp levels and thus downregulation of Nkx2.1 expression in MGE-derived

interneurons renders them sensitive to the Sema3A/ Sema3F repellent cue and facilitates their choice of specific migratory routes (Marín, Yaron, Bagri, Tessier-Lavigne and Rubenstein, 2001, Guo et al., 2014). Sema3 expression is not only confined to the rostral striatal region but encompasses the whole caudoputamen along the rostrocaudal axis and might thus act on other types of interneurons. For example, whether Sema3/Nrp signalling is also involved in repelling CGE-derived interneurons along their route towards the dorsal cortex is not known.

Although great progress has been made over the last decade in understanding the diversity and migratory properties of MGE-derived interneuron subtypes, the molecular mechanisms controlling the birth, diversification and migration of CGE-derived interneurons remain largely unexplored. Until recently, the CGE was not considered a distinct anatomical and molecular entity, mainly because of the absence of a morphologically definite sulcus demarcating the CGE from the MGE and LGE, and to the lack of CGE-restricted molecular markers (Flames et al., 2007). However, a series of experimental evidence including in vivo transplantation studies, in vitro migratory assays, and fate-mapping analyses have established the CGE as a separate molecular territory and confirmed that CGE-derived cortical interneurons contribute to a subset of interneuron subtypes with distinct morphological and electrophysiological interneurons (Nery et al., 2002, Willi-Monnerat, Migliavacca, Surdez, Delorenzi, Luthi-Carter and Terskikh, 2008, Miyoshi et al., 2010). At present, only COUP-TFI and COUP-TFII, preferentially expressed in the CGE have been recognized to play an important role in CGE-derived specification and migration, respectively. While COUP-TFI represses PV+ and promotes CR+ and VIP+ interneuron specification (Lodato et al., 2011), COUP-TFII is required for CGE-derived interneuron migration in the caudal direction (Kanatani et al., 2008). Thus, to date, the only route of migration described for CGE-derived interneurons is the caudal migratory stream (CMS) in which CGE-derived cells migrate toward the hippocampus and amygdala (Kanatani, Yozu, Tabata and Nakajima, 2008, Yozu et al., 2005). However, CGE-derived as well as COUP-TFII+ interneurons are dispersed along the whole cortex, as shown in mice and humans (Reinchisi et al., 2011, Fuentealba et al., 2010), but the way they reach their cortical targets is still not known.

In this study, I have taken advantage of the 5HTGFP mouse line, in which the GFP gene is under the control of the 5HT3aR promoter, and which labels all CGE-derived interneurons (Rudy et al., 2011, Lee et al., 2010, Vucurovic et al., 2010). By using horizontal sections

along the dorso-ventral axis and coronal sections along the rostro-caudal axis at E13.5 and E15.5, I was able to show that CGE-derived interneurons undertake two additional pathways that, differently from the CMS, take a caudal to rostral direction. GFP+ cells migrate ventrally from the CGE to the MGE/POA region, a new migratory path that I denominated the caudo-medial migratory stream (CMMS), and from the CGE to the LGE, the caudo-lateral migratory stream (CLMS). These two novel caudo-rostral migratory routes were never described before, even if the group of Nakajima observed some COUP-TFII-negative/calbindin-positive cells migrating antero-laterally from the CGE on E13.5 horizontal brain sections (Kanatani, Yozu, Tabata and Nakajima, 2008, Yozu, Tabata and Nakajima, 2005); they however described only the big cohort of COUP-TFII+/calbindin+ population moving caudally along the CMS. With the help of a cell tracker molecule, which is incorporated in the migrating cells at the level of the CGE, I was able to confirm the existence of these two migratory routes (**Fig. 8**). In the future, I plan to homotopically graft the GFP+/CGE region into a non-GFP+ embryo and follow birthdate and molecular profile of the migrating cells.

Complex genetic interactions during CGE-derived interneuron migration

The final goal of these subpial routes is most probably reaching distinct regions of the dorsal cortex or pallium so that CGE-derived GABAergic interneurons can properly interact with glutamatergic projection neurons at a precise time and place. Beside the CMS route, to date it was not known whether CGE-derived cells were reaching the cortex through other paths. Some studies reported that Sp8+ cells migrate to the cortex from the dLGE and contribute to the Reelin+, VIP+, NPY+ and bipolar CR+ interneuron subpopulations (Ma et al., 2012, Cai et al., 2013). Since Sp8 is also expressed in the dCGE (my study and (Ma, Zhang, Cai, You, Rubenstein and Yang, 2012)) and in the CLMS (**Fig. 12**), it is very plausible that the Sp8+ cells use this path to reach the cortex passing through the dLGE. My data on 5HTGFP+ horizontal sections confirmed that already at E13.5 the GFP+ cells along the CLMS were positive for Sp8. At E15.5 this group of cells increased dramatically and almost all cells maintained Sp8 expression (**Fig. 12**). However, a relatively high number of GFP+ cells could already be detected in the dLGE at E12.5, a stage corresponding to the beginning of 5HTGFP+/CGE generation (from E11.5 to E16.5 (Vucurovic, Gallopin, Ferezou, Rancillac, Chameau, van Hooft, Geoffroy, Monyer, Rossier and Vitalis, 2010)). Thus, it is possible that the GFP+/dLGE cells are locally produced and migrate primordially to the

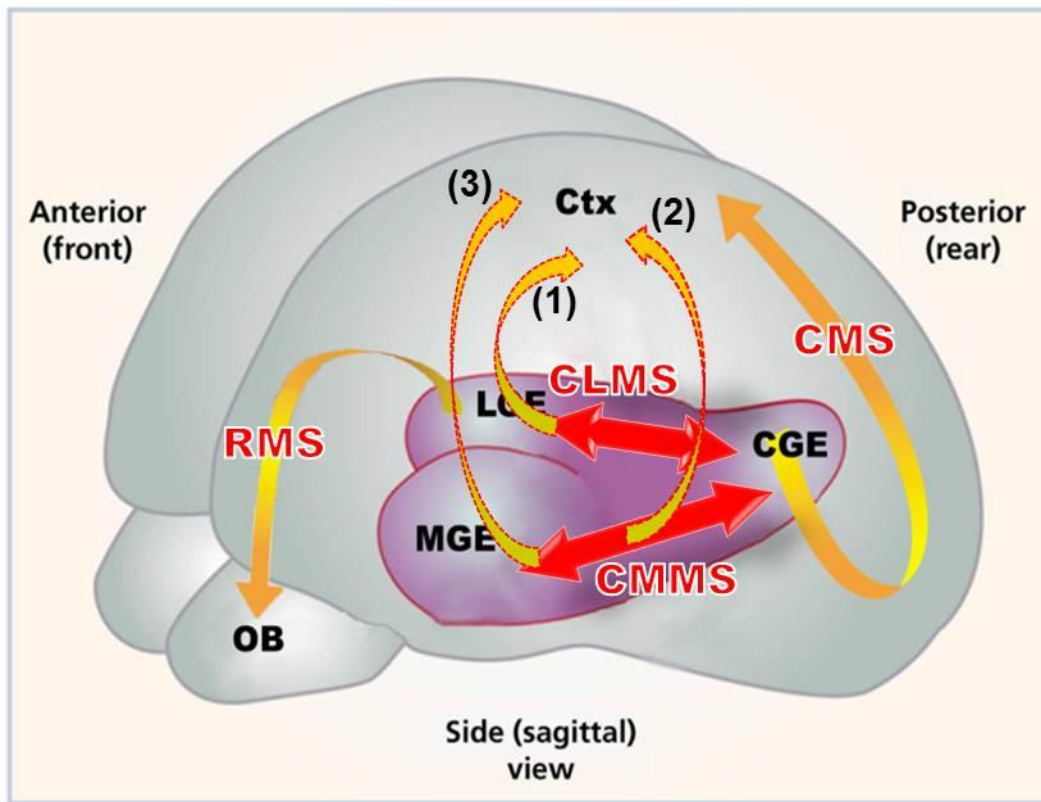

Figure 33: Putative new migratory streams for CGE-derived cortical interneurons. Schematic of already characterized migratory paths, the RMS from LGE to olfactory bulb and the CMS from CGE to caudal cortex, and putative new pathways for migrating CGE-derived interneurons to reach the cortex. (1) Migration through the CLMS and the dLGE. (2) Migration through the CMMS. (3) Migration through the CMMS, the MGE and the LGE.

olfactory bulb, as previously reported (Inta et al., 2008). This is also supported by the presence of double PH3+/Sp8+ cells in the dLGE indicating that Sp8+ cells are locally generated (Cai, Zhang, Wang, Zhang, Ma, Zhou, Tian, Rubenstein and Yang, 2013). The same paper show double Sp8+/COUP-TFII+ in the dLGE only at E16.5 and in the cortex at birth but no double co-localization of COUP-TFII/PH3 in the dLGE and very few COUP-TFII/Sp8+ cells in the olfactory bulb. My immunofluorescences were not able to identify any COUP-TFII+ cells in the dLGE, possibly because my analysis was done on E13.5 and E15.5 brains. Analysis at later stages will help me in assessing whether COUP-TFII is expressed in the CLMS and in the dLGE. Overall, I propose that the Sp8+ cortical interneurons derive mainly from the dCGE migrating rostrally towards the dLGE and then dorsally to the cortex (see model in **Fig. 33**). I can however not completely excluding that some Sp8+/dLGE-locally generated cells do also contribute to cortical interneurons. Studies on mice devoided of Sp8 have shown a severe reduction in the number of CR+, PV+, SST+ interneurons in the olfactory bulb (Li et al., 2011, Jiang et al., 2013); however, nothing is known on the generation and distribution of cortical interneurons in Sp8 mutant mice, despite the fact that Sp8 is expressed in 20% of all cortical interneurons and particularly in the CGE-derived ones, such as Reelin+, CR+ and VIP+ (Ma, Zhang, Cai, You, Rubenstein and Yang, 2012).

The 5HTGFP line also labels a compact cohort of cells migrating from the CGE to the MGE/POA (the CMMS). This is a very prominent stream, which is already established at E12.5. Although CMMS/GFP+ cells seem to enter the MGE/POA, as demonstrated by my horizontal sections on the 5HTGFP line (**Fig. 6**) and on the cell tracker experiment (**Fig. 8**), it is not clear whether these cells migrate dorsally to the cortex through the MGE and LGE, or just stop at the MGE/POA level. Even if it has been previously demonstrated that 5HTGFP+ cells do not originate from the MGE (Lee, Hjerling-Leffler, Zaghera, Fishell and Rudy, 2010), I nevertheless found few double Nkx2.1/GFP+ cells in the MGE/POA (**Fig. 11**) These cells could originate from the POA consistent with the observations that Nkx2.1 is expressed in the POA and that the POA generates a wide variety of cortical interneurons starting from E12.5 (Gelman et al., 2011, Gelman et al., 2009). Thus, it is plausible that the 5HTGFP+ expression found in the MGE/POA region and along the dorsal route to the cortex, just originate from an independent source located in the POA; however, I cannot exclude that these cells also originate directly from the CGE and migrate through the MGE/POA before reaching the cortex.

My horizontal sections at E13.5 and E15.5 also show scattered GFP+ cells between the CMMS and CLMS that tend to avoid the caudoputamen/globus pallidus region (**Fig. 6**). These cells could reach the dorsal cortex and contribute to the different tangential GFP+ cortical streams. In support of this, I found expression of Nrp2 in the CMMS cells, which might respond to the chemorepellent cues, such as Sema3A and/or Sema3F, secreted from the caudoputamen/globus pallidus region (**Fig. 10**). I also found that these cells express Prox1, COUP-TFI and COUP-TFII (**Fig. 13-15**). However, at present I do not know whether these transcription factors discriminate distinct or overlapping subgroups within the CMMS population. Interestingly, while Prox1 is expressed all along the stream to the MGE/POA, COUP-TFI and COUP-TFII expression stop just before the MGE, similarly to Nrp2 (**Fig. 10, 14-15**). Since neuropilins are target genes of COUP-TFs (Tang et al., 2012), it is plausible to hypothesize that COUP-TFs might regulate Nrp2 expression levels during migration of CMMS cells to the dorsal cortex. Accordingly, Nrp2 is downregulated in the CMMS of E13.5 TFICKO brains (**Fig. 23**) and a larger cohort of GFP+ cells migrates to the dorsal cortex in the absence of COUP-TFI at E15.5 (**Fig. 18**). In addition, brains devoid of both COUP-TFs have an even bigger increase of GFP+ cells migrating to the dorsal cortex together with increased GFP+ cells in all cortical streams (**Fig. 30**). Although I still do not know whether Nrp2 is also downregulated in TFIICKO, a previous report has shown direct binding of COUP-TFII on the Nrp2 locus and downregulation of Nrp2 in COUP-TFII mutants (Tang, Rubenstein, Tsai and Tsai, 2012), thus suggesting that both COUP-TFs might indeed regulate Nrp2 during cortical development.

In addition to Nrp2, previous studies showed that Prox1 is activated by COUP-TFII in embryonic veins by directly binding a conserved DNA domain in the regulatory region of Prox1 (Srinivasan et al., 2010). Accordingly, Prox1 is downregulated in the CMMS of COUP-TFII and COUP-TFI mutant brains (**Fig. 20, 27**). Since Prox1 is expressed in CGE-derived interneuron subpopulations, such as CR, NPY, Reelin and VIP, mis-regulation of its expression in the CMMS of single COUP-TF mutant might contribute to the altered ratio of interneuron subpopulations observed in mutant adult brains (**Fig. 24, 29**). However, Prox1 is increased in double COUP-TF mutants at E15.5, but not at E13.5, suggesting that upregulation of Prox1 might either compensate for the absence of both COUP-TF genes or due to other types of regulation independent of COUP-TFI or II.

Regarding the CMS, I confirmed expression of COUP-TFII in cells exiting the dCGE (**Fig. 15**). However, I also found that COUP-TFI is expressed in the same cells (**Fig. 14**) and maintained in the caudal cortex. This indicates a possible cooperation of both COUP-TFs in guiding CMS to their target. Indeed, expression of *Nrp1*, a possible COUP-TFI/II target gene (Tang, Rubenstein, Tsai and Tsai, 2012), is also expressed in the caudal cortex and thus CMS cells might be repelled by Sema3A secreted from the VZ of the caudal cortex (**Fig. 9**).

Finally, my data also suggest that COUP-TFs regulate CGE proliferation, which might have a secondary effect on migration. It is known that differently from the cortex, the SVZ of the GE is a highly proliferative zone (Taverna et al., 2014). Both COUP-TFs are expressed in the VZ, SVZ and mantle zone of the subpallium (Tripodi et al., 2004) and since in my studies I used conditional mutant mice in which COUP-TF functions are abolished in the SVZ of the GE (i.e. using the *Dlx5/6-Cre*, see (Lodato, Tomassy, De Leonibus, Uzategui, Andolfi, Armentano, Touzot, Gaztelu, Arlotta, Menendez de la Prida and Studer, 2011)), it is plausible that COUP-TFI and/or COUP-TFII regulate CGE proliferation. In support of this, my data show that, the SVZ is increased in the absence of COUP-TFI at E13.5 and that after inactivation of both genes, the CGE seems to produce an even higher number of GFP+ cells compared to single COUP-TF mutants (**Fig. 30**). This suggests an additive role of COUP-TFs in restricting the pool of CGE progenitors in the SVZ. Detailed birthdating and proliferation analysis will help me in confirming this hypothesis.

Together my data highlight new migratory pathways for CGE-derived interneurons (see model **Fig. 33**) and propose some of the molecules that might be involved in the decision-making steps of CGE interneuron migration. The analysis of the single and double COUP-TF mutants have helped me to propose some potential links between the different transcription factors expressed in the CGE and within the different paths. I suggest a regulatory model in which COUP-TFI and COUP-TFII repress *Sp8* in the CLMS and promote *Prox1* expression in the CMMS at E15.5. COUP-TFII controls expression of COUP-TFI, and both genes modulate cell migration by regulating expression levels of neuropilins, which respond to distinct Sema3F and Sema3A sources. Finally, COUP-TFI, and in part COUP-TFII, is involved in modulating the rate of CGE proliferation (see model **Fig. 34**). Future studies will be essential to characterize the precise identity of 5HTGFP cells in the different migratory

paths, to molecularly quantify the different subpopulations and to understand the mechanisms allowing these sub-migrations.

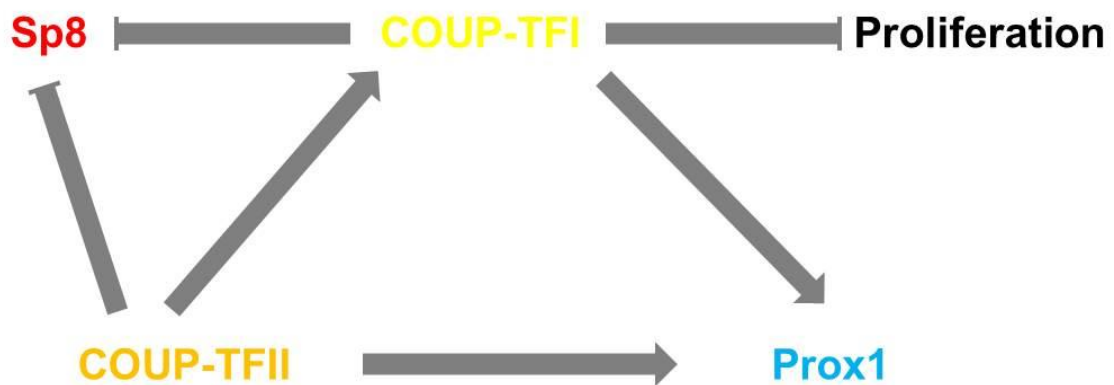

Figure 34: Putative regulatory model between the transcription factors in the CGE at E15.5. COUP-TFI and COUP-TFII could repress Sp8 in the CLMS and promote Prox1 in the CMMS. COUP-TFII could regulate COUP-TFI and COUP-TFI seems to control the CGE proliferation. With this model COUP-TFII could affect indirectly the CGE proliferation.

Perspectives

These data partially contribute in understanding how CGE-derived interneurons reach their targets and highlight the nature of some of the molecular players involved in the migration and specification of CGE-derived cortical interneurons. However, I am fully aware that my data are preliminary and need further experiments to confirm the models I have proposed in Figs. 33 and 34.

In particular, I propose the following experiments:

1. To confirm the different migratory streams deriving from the CGE and find out whether other sources of 5HTGFP+ interneurons might contribute to the CMS, CLMS and/or CMMS, I would perform CGE, dLGE and MGE/POA grafts from the 5HT3aR-GFP mouse line into a non-GFP background in organotypic brain slices. In addition, I would like to follow the GFP+ migrating cells and their mode of migration over time with time-lapse video microscopy on E11.5 to E15.5 brain slices.
2. Because of the high density of 5HTGFP+ cells in the CGE and in the different migratory streams, my analysis has remained mainly qualitative and not quantitative. However, I need to establish the percentage of double-positive cells in the different migratory streams if I want to better understand the expression of the different markers in the GFP+ cells. In addition, I also need to statistically analyse the differences between control and mutant brains in order to have a good understanding of the roles of both COUP-TFs in specifying CGE-derived interneuron sub-populations. To overcome these difficulties, I would use flow cytometry (our facility has the LSRFortessa cell analyzer (BD Biosciences)), which would sort out GFP+ cells from the different streams and allow me quantifying their expression with different markers. I would use E15.5 thick horizontal sections and dissect the different stream under a fluorescent microscope. Cells need to be dissociated and then fixed before adding the antibodies specific to the different markers. In this way, I should be able to quantify the percentage of 5HTGFP+ expressing one or more markers by normalizing the double- or triple-positive cells to the total number of cells. In parallel, I would also perform triple immunofluorescence to visualise the expression pattern of

the 5HTGFP with COUP-TFI/COUP-TFII, COUP-TFI/Prox1 and COUP-TFII/Prox1 that are specifically express in the CMMS.

3. To discover a mechanism involved in guiding the different CGE-derived paths, as proposed in my thesis, I would need to set up explants of GFP+ cells with different secreted molecules. To directly demonstrate that Sema3A/Nrp1 and Sema3F/Nrp2 are involved in the guidance of the 5HTGFP+ cells through the CMS and the CMMS, respectively, I will need to co-culture CGE and cortical explants with semaphorin-expressing COS cell aggregates in a collagen matrix. Downregulation of neuropilins by electroporating different *shRNA* against Nrp1 and Nrp2 would also allow me to test *in vitro* whether neuropilins are the specific receptors of Sema3A and/or Sema3F in GFP+/CGE-derived interneurons. For an ultimate *in vivo* confirmation I would need to cross Nrp1 and/or Nrp2 with 5HTGFP line and follow their CGE migratory paths.
4. To understand whether and how COUP-TFII is required in cell proliferation in the CGE, I need to perform acute BrdU injections in E13.5 *TFIICKO* and double mutants and/or use cell-cycle specific markers such as PH3, PCNA and cyclinD2 on horizontal E11.5 to E15.5 old brains.
5. To study the exact chronology of the different migratory paths and whether individual paths contribute to specific CGE-derived subpopulations, I would need to combine long-term birthdating from E11.5 to E15.5 with interneuron specific markers, such as CR, VIP and Reelin.

Finally, I need to finish the analysis of the distribution of interneuron subpopulations on COUP-TFII adult mice and eventually of double COUP-TF mutant mice.

Supplementary

Loss of COUP-TFI Alters the Balance between Caudal Ganglionic Eminence- and Medial Ganglionic Eminence-Derived Cortical Interneurons and Results in Resistance to Epilepsy

Simona Lodato,^{1,2,3*} Giulio Srubek Tomassy,^{1,3*} Elvira De Leonibus,^{1*} Yoryani G. Uzcategui,^{4,5} Gennaro Andolfi,¹ Maria Armentano,¹ Audrey Touzot,^{6,7} Jose M. Gaztelu,⁵ Paola Arlotta,³ Liset Menendez de la Prida,⁴ and Michèle Studer^{1,2,6,7}

¹Telethon Institute of Genetics and Medicine, Developmental Disorders Program, and ²European School of Molecular Medicine, 80131 Naples, Italy,

³Department of Stem Cell and Regenerative Biology and Harvard Stem Cell Institute, Harvard University, Cambridge, Massachusetts 02138, ⁴Instituto Cajal–Consejo Superior de Investigaciones Científicas, 28002 Madrid, Spain, ⁵Hospital Ramón y Cajal, 28034 Madrid, Spain, and ⁶Inserm, Unit 636, and ⁷University of Nice Sophia-Antipolis, F-06108 Nice, France

In rodents, cortical interneurons originate from the medial ganglionic eminence (MGE) and caudal ganglionic eminence (CGE) according to precise temporal schedules. The mechanisms controlling the specification of CGE-derived interneurons and their role in cortical circuitry are still unknown. Here, we show that COUP-TFI expression becomes restricted to the dorsal MGE and CGE at embryonic day 13.5 in the basal telencephalon. Conditional loss of function of COUP-TFI in subventricular precursors and postmitotic cells leads to a decrease of late-born, CGE-derived, VIP (vasoactive intestinal peptide)- and CR (calretinin)-expressing bipolar cortical neurons, compensated by the concurrent increase of early-born MGE-derived, PV (parvalbumin)-expressing interneurons. Strikingly, COUP-TFI mutants are more resistant to pharmacologically induced seizures, a phenotype that is dependent on GABAergic signaling. Together, our data indicate that COUP-TFI controls the delicate balance between MGE- and CGE-derived cortical interneurons by regulating intermediate progenitor divisions and ultimately affecting the activity of the cortical inhibitory circuitry.

Introduction

In rodents, interneurons are born in basal telencephalic structures, such as the medial ganglionic eminence (MGE), the caudal ganglionic eminence (CGE), and the preoptic area from which they migrate to populate the cortex (Corbin et al., 2001; Marin and Rubenstein, 2001, 2003). Various transplantation and fate-mapping experiments have shown that such a wide diversity is intimately dependent on their birth date and location. Early-born interneurons originate from the MGE and produce mainly the

parvalbumin (PV)- and somatostatin (SST)-expressing subtypes, which contribute primarily to deep cortical layers; late-born interneurons derive predominantly from the CGE, generate calretinin (CR)- and vasoactive intestinal peptide (VIP)-expressing interneurons, and preferentially occupy superficial cortical layers (Nery et al., 2002; Xu et al., 2004; Butt et al., 2005, 2008; Cobos et al., 2006; Fogarty et al., 2007; Miyoshi et al., 2007, 2010).

Understanding the spatial and temporal mechanisms of GABAergic cortical interneuron determination is attracting much interest in the last few years. Transcription factors expressed either broadly within the two eminences or predominantly in one eminence play a fundamental role in the specification and maturation of these cells (Batista-Brito and Fishell, 2009). Whereas loss of *Dlx1/Dlx2* function results in a massive decrease of neocortical GABAergic interneurons at birth (Anderson et al., 1997), mice lacking only the *Dlx1* gene show reduction of CR- and SST-expressing interneurons without affecting the PV-expressing population (Cobos et al., 2005). These mice have cortical dysrhythmia and generalized seizures. Early removal of the transcription factor *Nkx2.1*, restricted to the MGE domain, results in a molecular and cellular switch of MGE-derived cortical interneurons (PV- and SST-positive subpopulations) to CGE-derived neurons (VIP- and CR-expressing cells), leading ultimately to seizure activities (Butt et al., 2008). Down-

Received Dec. 17, 2010; accepted Jan. 17, 2011.

This work was supported by the Italian Telethon Foundation (M.S.), the Spanish Fundación Alicia Koplowitz (L.M.d.I.P.), the Harvard Stem Cell Institute (P.A.), and European Community FP6 STREP Contract 005139 (INTERDEVO) (M.S., L.M.d.I.P.). S.L. is the recipient of a predoctoral fellowship of the European School of Molecular Medicine (Naples, Italy). We are grateful to G. Fishell, O. Marin, M. Ross, and M. Nieto for helpful comments on this manuscript. We thank F. Guillemot for cyclin D1 and cyclin D2 plasmids; V. Pachnis for the VIP plasmid and the *Lhx6* antibody; J. L. R. Rubenstein for the *Nkx2.1*, *Gad67*, and somatostatin plasmids; R. Rusconi for designing the cell counting algorithm developed in Matlab; M. Mancuso, F. Russo, A. I. Merlino for technical assistance; and M. Giordano for animal husbandry. L.M.d.I.P. and M.S. jointly coordinated and designed this work.

*S.L., G.S.T., and E.D.L. contributed equally to this work.

Correspondence should be addressed to Michèle Studer at the above address. E-mail: michele.studer@unice.fr.

E. De Leonibus's present address: Consiglio Nazionale delle Ricerche Institute of Genetics and Biophysics "Adriano Buzzati Traverso," 80131 Naples, Italy.

M. Armentano's present address: Department of Veterinary Morphophysiology, University of Turin, 10095 Grugliasco, Turin, Italy.

DOI:10.1523/JNEUROSCI.6580-10.2011

Copyright © 2011 the authors 0270-6474/11/314650-13\$15.00/0

stream of Nkx2.1, the transcription factor Lhx6 is involved in the specification and migration of PV- and SST-expressing interneurons (Liodis et al., 2007), whereas Sox6, acting downstream to Lhx6 (Batista-Brito et al., 2009), is required for the correct balance of PV-, SST-, and neurotransmitter peptide Y (NPY)-expressing subpopulations (Azim et al., 2009; Batista-Brito et al., 2009). Loss of function of Sox6 results in a dramatic reduction of PV- and SST-expressing interneurons, whereas NPY+ interneurons outnumber the normal level without affecting the CGE-derived CR- and VIP-expressing subpopulations. Interestingly, similarly to Dlx1 and Nkx2.1 mutant mice, Sox6 mutants suffer from generalized epileptic seizures (Batista-Brito et al., 2009).

Although many reports have characterized genetic determinants of MGE-derived cortical interneurons, little is known about the regional and cell type specification of CGE-derived interneurons, which comprise ~30% of all cortical interneurons with an unexpected higher diversity than previously anticipated (Miyoshi et al., 2010). The orphan nuclear receptor COUP-TFII shows restricted expression in the CGE (Kanatani et al., 2008; Willi-Monnerat et al., 2008) and, together with COUP-TFI, is required for the caudal migration of cortical interneurons (Tripodì et al., 2004; Kanatani et al., 2008). Moreover, in Nkx2.1 conditional mutant mice, in which a high number of CR- and VIP-expressing cortical interneurons are generated, COUP-TFII is ectopically expressed in the MGE (Butt et al., 2008). Together, these reports strongly suggest that COUP-TF members might be directly involved in the migration and specification of CGE-derived cortical interneurons.

Here, we show that COUP-TFI expression becomes gradually restricted to the caudal basal telencephalon. Conditional inactivation of COUP-TFI using a pan-interneuronal *Cre* mouse line leads to increased PV-expressing interneurons and decreased VIP- and CR-expressing bipolar neurons, without affecting the total number of cortical GABAergic cells. Interestingly, COUP-TFI conditional embryos show increased cellular proliferation predominantly in the MGE as well as enhanced expression of the cell cycle gene *cyclinD2*, known to establish the proper density of PV-expressing interneurons (Glickstein et al., 2007b). Strikingly, we found no discernible electroencephalographic (EEG) abnormalities, but, instead, *COUP-TFI* conditional mice are more resistant to pharmacologically induced seizures, a GABA-dependent property. Together, our data indicate an intrinsic property of COUP-TFI in regulating the balance between MGE- and CGE-derived cortical interneurons, thus contributing to the proper formation of the cortical local inhibitory circuitry.

Materials and Methods

Mice. *COUP-TFI*^{lox/+} mice were generated as previously reported (Armentano et al., 2007) and propagated by backcrossing to C57BL/6 inbred mice. Homozygous *COUP-TFI*^{lox/lox} mice were obtained by intercrossing heterozygous *COUP-TFI*^{lox/+} mice and mated to the *Dlx5/6-Cre-IRES-GFP* transgenic line (Stenman et al., 2003), a kind gift from K. Campbell (Children's Hospital Research Foundation, Cincinnati, OH), to generate conditional *COUP-TFI* *CKO-Dlx5/6* embryos and mice (*COUP-TFI*^{lox/lox} homozygous-*Dlx5/6* *Cre* heterozygous). Throughout the study, we used as controls [referred also as wild type (WT)] either heterozygous (*COUP-TFI*^{lox/+}), homozygous (*COUP-TFI*^{lox/lox}), or *Dlx5/6-Cre*-positive (*Cre*+) mice, since they show no phenotypic abnormalities, as previously described (Stenman et al., 2003; Armentano et al., 2007). We found no phenotypic differences between male and female mutant mice. Genotyping was performed as previously described (Stenman et al., 2003; Armentano et al., 2007). Midday of the day of the vaginal plug was embryonic day 0.5 (E0.5). All experiments were conducted

following guidelines of the Institutional Animal Care and Use Committee, Cardarelli Hospital (Naples, Italy).

Immunocytochemistry and in situ hybridization. Mice were perfused with 4% buffered paraformaldehyde (PFA), and decapitated heads (E12.5–E14.5) or brains [postnatal day 21 (P21)] were postfixed in 4% PFA for 12 h at 4°C. Brains were either sectioned on a vibratome at 50 μm or cryosectioned in OCT medium (Tissue-Tek) at 20 μm. Vibratome sections were processed free floating, and standard nonradioactive *in situ* hybridization and immunofluorescence protocols were used. *In situ* hybridization and combined immunohistochemistry were performed as previously described (Tripodì et al., 2004). The following primary antibodies were used: COUP-TFI (rabbit; 1:500) (Tripodì et al., 2004), bromodeoxyuridine (BrdU) (mouse; 1:300; Sigma-Aldrich), Ki67 (rat; 1:250; Dako), GABA (rabbit; 1:1000; Sigma-Aldrich), NPY (rabbit; 1:3000; Diasorin), calretinin (rabbit; 1:5000; Swant), parvalbumin (mouse; 1:1000; Millipore), Lhx6 (rabbit; 1:500; kind gift from V. Pachnis), and green fluorescent protein (GFP) (rabbit; 1:1000; Millipore). The following secondary antibodies were used: 1:400, Alexa Fluor 488 α-rabbit; Alexa Fluor 594 α-rabbit; Alexa Fluor 594 α-mouse (Invitrogen); 1:200, biotinylated goat anti-rabbit (Vector Laboratories). Nonradioactive *in situ* hybridization on 16- to 20-μm-thick cryostat sections were performed as previously described (Armentano et al., 2007). Antisense RNA probes were labeled using a DIG-RNA labeling kit (Roche). The following probes were used: *COUP-TFI*, *Gad67*, *SST*, *VIP*, *CyclinD2*, and *Nkx2.1*.

BrdU birthdating. Timed-pregnant females received a single intraperitoneal injection of BrdU (50 mg/kg) 1 h before being killed, and embryos were collected at E13.5. WT and *COUP-TFI* *CKO-Dlx5/6* embryos were examined for BrdU-positive cell distribution in the MGE and CGE, as previously described (Tomassy et al., 2010). Sections from rostral to intermediate levels (see Fig. 1B,C), where the MGE is still distinct, and from caudal to caudalmost levels where the CGE (see Fig. 1D) is clearly defined, were photographed at 10× magnification on a Leica DM5000B equipped with Leica IM image management software (Leica Microsystems), and then imported into Adobe Photoshop for counting. The percentage of BrdU-positive cells was calculated as the ratio of double BrdU/4',6'-diamidino-2-phenylindole (DAPI)-positive cells divided by the total number of DAPI-positive cells.

Electroencephalographic recordings. Freely moving mice aged between 7 and 13 weeks were tested for spontaneous EEG activity. Animals were anesthetized with ketamine (100 mg/kg) and xylazine (10 mg/kg, i.p.) and placed in a stereotaxic apparatus. Cortical EEG recordings were obtained from 100-μm-wide tungsten wires implanted over the parietal cortex at 0.2–0.4 mm depth from the cortical surface using bone cement. Two screws were used as a reference and ground at the occipital region. In a group of animals, two separate wires were bilaterally implanted in the dorsal hippocampus to obtain simultaneous cortical and hippocampal EEG activity. After recovering from surgery, EEG was recorded from individual mice over several days, for a maximum of 2 h per day, by using a Grass EEG Neurodata system. Total recording time per mouse ranged from 18 to 36 h over the course of 12–20 d. Animals were simultaneously videotaped for identifying different behavioral states. EEG recordings during awake states were bandpass FIR filtered between 1 and 200 Hz and sampled at 500 Hz. After completing EEG recordings, brains were fixed in 4% PFA for electrode placement verification.

EEG data were analyzed with Spike 2 and routines developed in Matlab. The spectral power was calculated using the fast Fourier transform with Hamming window and 1024 points for artifact-free recording windows of 10 min duration. To study the frequency content independently of amplitude changes, each EEG spectrum was normalized by the total power in the 1–100 Hz band. The mean power spectrum for each group is represented together with the 95% confidence intervals. To look at spectral differences between types of oscillations, four different frequency bands were defined: 1–4 Hz (delta), 4–10 Hz (theta), 10–40 Hz (beta), and 40–100 Hz (gamma). The power spectrum value for each band was calculated by integrating the normalized power spectrum in the corresponding frequency interval. For statistical comparisons, we first tested data for normal distribution using the Kolmogorov–Smirnov test. Power spectral values in a logarithmic scale were normally distributed

except for the 40–100 Hz gamma band. Thus, to quantify statistical differences, spectra from the two experimental groups were compared using a nonparametric test for multiple comparisons (Mann–Whitney *U* test). To compare the spectral distribution at the delta, theta, and beta bands, a two-way ANOVA was used with the factors group and gender. Differences in the gamma band were compared using the Kruskal–Wallis nonparametric test for the group and for the gender independently.

Pharmacological seizure induction. For pilocarpine-induced seizures, mice were intraperitoneally injected with lithium chloride (423 mg/kg) between 18 and 20 h before 100 mg/kg pilocarpine hydrochloride. Pentylentetrazole (PTZ) (Sigma-Aldrich) was administered subcutaneously at a dose of 90 mg/kg. We chose a suprathreshold dose of PTZ to induce clonic seizures independently on the gender and with uniform latency within groups (Löscher et al., 1991). In a group of PTZ experiments, we pretreated mice with the GABA_B receptor antagonist (3-aminopropyl)(diethoxymethyl)phosphinic acid hydrate (GCP 35348) (Sigma-Aldrich) at a dose of 136 mg/kg. Mice injected with PTZ and not pretreated with GCP 35348 were divided in two groups, one-half not injected and one-half injected with vehicle. Animals were observed for 45 min after the PTZ injection. Three different stages of seizure activity were scored: stage 1, body and tail rigidity; stage 2, characterized by whole-body clonus; and stage 3, characterized by generalized tonic-clonic hindlimb extensions.

Cell counting. For the quantification of interneuron subpopulations in COUP-TFI *CKO-Dlx5/6* and wild-type cortices, three coronal anatomically matched sections within the sensorimotor area in the rostrocaudal axis (bregma, from 0.50 to –0.34 mm) were selected from littermate mice and processed by immunocytochemistry to detect GABA, PV, NPY, and CR, and *in situ* hybridization to detect SST and VIP transcript ($n = 3$ COUP-TFI *CKO-Dlx5/6*; $n = 3$ wild type, 6 hemispheres per area, for each mouse at P21). Digital boxes of fixed width were superimposed on each coronal section and they were divided into 10 sampling areas (bins) with a dorsoventral extent from the pial surface to the white matter (corpus callosum). Deep layer were assigned to bin 1–5 and superficial layers were assigned to bin 6–10, based on anatomical features. Cell detection and counting were performed using a customized imaging processing software. Bipolar cells were identified manually. The automated algorithm has been developed in Matlab (version 7.6; The MathWorks) by an investigator blinded to the study design and consisted in a series of processing steps. In the first one, original fluorescent or bright-field images, taken at 4× magnification, are corrected for uneven illumination and background noise. Image segmentation is then obtained through edge detection, in which minimum and maximum levels of the intensity gradient are established a priori for each staining analyzed and kept constant throughout the counting analysis. Then, morphological characteristics were added to the filtering process. The eccentricity parameter—where 1 indicates a linear shape and 0 indicates a circular shape—was used to identify cell bodies, by using a threshold values established a priori. In combination with the eccentricity parameter, thresholds for the cell size were established a priori based on the normal distribution of cell area for each staining analyzed. In addition, the area parameter was used to discriminate single cells within clusters. For the quantification of the percentage of interneuron subtypes that express COUP-TFI in P8 and P21 wild-type cortices, three coronal sections spanning within the somatosensory area in the rostrocaudal axis (bregma, –0.34 mm) were selected from littermate mice ($n = 3$, 6 hemispheres per area, for each wild-type mouse at P8 and P21). Digital boxes of fixed width were superimposed on each coronal section and cell counting was performed on images taken at 10× magnification by an investigator blinded to the study design. Counting criteria were established a priori.

Data analysis. All cell counting data and the graphs were constructed using Microsoft Excel software. For each animal, a mean value was calculated from all the sections counted, and for each genotype, a mean value was obtained by pooling the means of the three sampled animals. EEG data were analyzed using the Mann–Whitney *U* test for comparison of the power spectra between groups and an ANOVA or a Kruskal–Wallis test for comparison of the four different frequency bands between group and gender (see above, Electroencephalographic recordings). All behavioral pharmacological data were analyzed using either one-way ANOVA (genotype, two levels: WT and CKO) or two-way ANOVA [genotype

(two levels: WT and CKO) and pretreatment (two levels: vehicle and CGP 35348)]. *Post hoc* analysis was performed using Duncan's *post hoc* test. All error bars represent the SEM. Statistical significance was determined using two-tailed Student's *t* tests ($*p < 0.05$; $**p < 0.01$).

Results

COUP-TFI is preferentially expressed in the dorsal MGE, in the CGE, and in a subpopulation of mature cortical interneurons

To investigate the function of COUP-TFI in the development of cortical GABAergic interneurons, we first characterized its expression profile in the developing ganglionic eminences. From E10.5 to E12.5, COUP-TFI is expressed in the subpallium, and in the lateral ganglionic eminence (LGE) and MGE, respectively (Armentano et al., 2007; Faedo et al., 2008) (Fig. 1A). However, at E13.5, COUP-TFI expression becomes highly regionalized with a low rostral to high caudal expression gradient (Fig. 1B–D). Whereas COUP-TFI expression is restricted to the corticostriatal boundary and dorsal MGE (dMGE) at rostromedial levels (Fig. 1B), its expression increases at intermediate levels and includes also the preoptic area (Fig. 1C) (Flames et al., 2007). Expression becomes highest in the caudalmost basal telencephalon, particularly in the ventricular zone (VZ) and subventricular zone (SVZ) of the ventral CGE (vCGE), whereas in the LGE and dorsal CGE (dCGE) expression of COUP-TFI is lower (Fig. 1D). Thus, we found that, at E13.5, COUP-TFI becomes restricted in a rostrocaudal and dorsoventral expression gradient in the basal telencephalon, being strongest in the VZ and SVZ of the ventrocaudal ganglionic eminence, the vCGE.

COUP-TFI is also expressed in immature interneurons migrating tangentially from the basal telencephalon to the developing neocortex, as previously described (Tripodi et al., 2004), and in mature cortical interneuron subtypes at postnatal stages (this study) (Fig. 1E–J''). Double labeling for COUP-TFI protein and the glutamate decarboxylase *GAD67* transcript shows a high proportion of postnatal GABAergic interneurons positive for COUP-TFI in the somatosensory cortex ($83.1 \pm 2.2\%$; $n = 3$; P8) (Fig. 1E, E'). To further address whether specific subtypes of cortical interneurons express COUP-TFI, we performed double labeling for COUP-TFI and different molecular markers of mature cortical interneurons including the peptide hormone SST, NPY, and VIP at P8 ($n = 3$) (Fig. 1F–H'), as well as the calcium-binding proteins CR and PV at P21 ($n = 3$) (Fig. 1I, I'') within the somatosensory cortex. At P8, COUP-TFI was found in $55.8 \pm 1.1\%$ of SST-expressing, in $70.0 \pm 2.1\%$ of NPY-expressing, and in $78.1 \pm 5.4\%$ of VIP-expressing interneurons (Fig. 1F–H'). At P21, we found only a $4.0 \pm 0.3\%$ overlapping between COUP-TFI and PV, and $51.6 \pm 5.3\%$ colabeling between COUP-TFI and CR (Fig. 1I, I''). However, detailed morphological analysis indicates that COUP-TFI is highly expressed ($89.2 \pm 5.9\%$) in a subpopulation of CR+ cells that shows a characteristic vertically oriented bipolar morphology (Fig. 1I'–I''). Together, these data indicate that, at postnatal stages, COUP-TFI is expressed in most mature cortical interneuron subtypes, with a preference to CGE-derived interneurons, such as bipolar VIP+ and CR+ cells, and to a subpopulation of NPY+ cells (Karagiannis et al., 2009), whereas it is generally excluded from the MGE-derived PV-expressing cells.

Specific inactivation of COUP-TFI in SVZ intermediate progenitors of the basal telencephalon

To investigate the role of COUP-TFI in interneuron diversity and in the maturation and specification of different cortical interneuron subtypes, we used a conditional genetic approach in which the COUP-TFI *lox/lox* (COUP-TFI^{lox}) line (Armentano et al.,

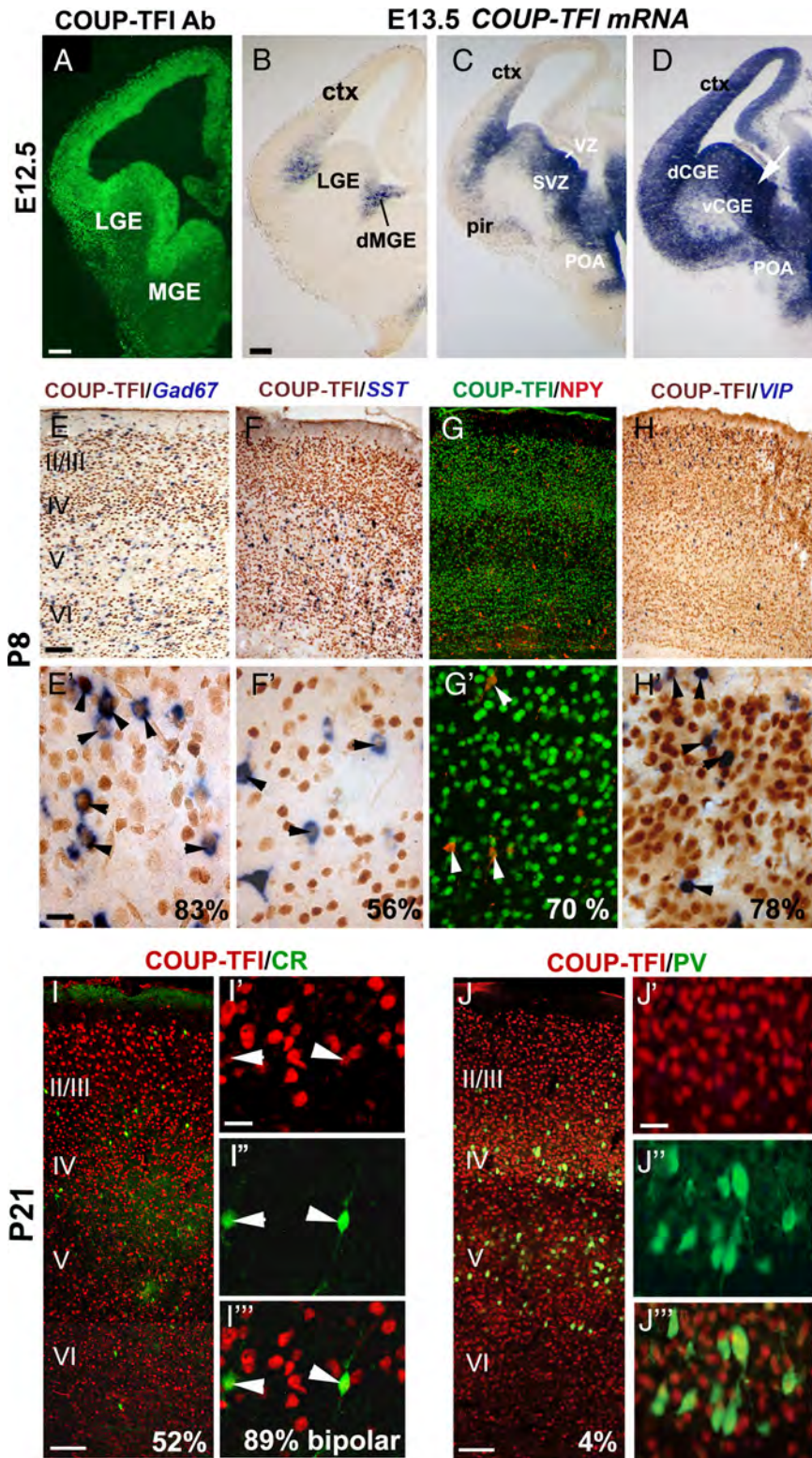

Figure 1. COUP-TFI becomes gradually restricted to the dorsal MGE and CGE and is highly expressed in CGE-derived cortical interneurons. **A**, Coronal section of E12.5 wild-type embryo at intermediate levels showing localization of COUP-TFI protein in the telencephalon. Note high expression in the LGE and dorsal half of the MGE. **B–D**, Rostral to caudal sequential coronal sections of E13.5 wild-type embryos hybridized with *COUP-TFI* riboprobe indicate a low rostral to high caudal expression gradient, with regionalized expression in the dMGE (**B**, **C**) and preoptic area (POA) (**C**, **D**). Expression is confined to the VZ and SVZ. The arrow in **D** indicates highest COUP-TFI expression levels in vCGE. **E–H**, Double immunostaining for COUP-TFI protein and *in situ* hybridization for *Gad67*, *SST*, and *VIP* (**E**, **F**, **H**) and double immunofluorescence for COUP-TFI and NPY in P8 somatosensory cortices (**G**). The roman numerals denote cortical layers. **E'–H'**, High-magnification views of a representative detail from **E–H** indicate double-positive cells (arrowheads) and the different percentage of *Gad67*+ (83%), *SST*+ (56%), *NPY*+ (70%), and *VIP*+ (78%) interneurons expressing COUP-TFI. **I–J''**, Double immunofluorescence for COUP-TFI and CR (**I**), and COUP-TFI and PV in P21 somatosensory cortices (**J**). High-

2007) was mated to the *Dlx5/6-Cre-IRES-GFP* transgenic line (Stenman et al., 2003), which drives the CRE-mediated activity exclusively within the basal telencephalic SVZ and mantle zone (MZ) (Fig. 2A). Mice homozygous for *COUP-TFI^{fllox}* and heterozygous for *Dlx5/6-Cre-IRES-GFP* are viable and fertile, and will be named *COUP-TFI CKO-Dlx5/6* throughout this study.

We first assessed whether and at what age COUP-TFI was specifically inactivated in *Dlx5/6*-positive cells by taking advantage of the endogenous GFP fluorescence of the *Dlx5/6-Cre-IRES-GFP* transgenic line (Stenman et al., 2003). In the basal telencephalon of *COUP-TFI CKO-Dlx5/6* heterozygotes, only SVZ progenitors are double positive for GFP and COUP-TFI (Fig. 2E,H), whereas VZ progenitors express COUP-TFI (in red) but not GFP (in green) (Fig. 2C,F,D,G). No, or very few, COUP-TFI/GFP double-positive cells are detected in the SVZ or mantle zone of *COUP-TFI CKO-Dlx5/6* homozygous embryos at E12.5 and E13.5 (Fig. 2E',H') (data not shown), indicating that, already at E12.5, before COUP-TFI becomes regionalized to dMGE and CGE, COUP-TFI function is specifically abolished in the SVZ (*Dlx5/6*-positive domain), but not in progenitors located in the VZ (*Dlx5/6*-negative domain). Accordingly, at E15.5, COUP-TFI fails to be expressed in postmitotic neurons of the basal telencephalon (Fig. 2I–J'), with the exception of the ventrally migrating stream originating from the *Dlx5/6*-negative interganglionic region, which coexpress COUP-TFI and COUP-TFII (Tripodi et al., 2004). Thus, we generated a conditional COUP-TFI mutant line, in which COUP-TFI is specifically inactivated in SVZ progenitors and postmitotic interneurons, but not in VZ progenitors.

Conditional loss of COUP-TFI function alters the balance of interneuron subtypes without affecting the total number of GABAergic cortical interneurons

Next, we investigated whether loss of function of COUP-TFI in SVZ progenitors of the basal telencephalon would affect the total number and laminar distribution of cortical interneurons at P21 in

magnification views indicate highest colocalization of COUP-TFI with bipolar CR-positive cells (**I'–I'''**, arrowheads), and lowest colocalization of COUP-TFI with PV-positive cells (**J'–J'''**). Abbreviations: ctx, Cortex; dMGE, dorsal medial ganglionic eminence; LGE, lateral ganglionic eminence; pir, piriform cortex. Scale bars: **A–D**, 200 μm; **E–J**, 100 μm; **E'–J''**, 50 μm.

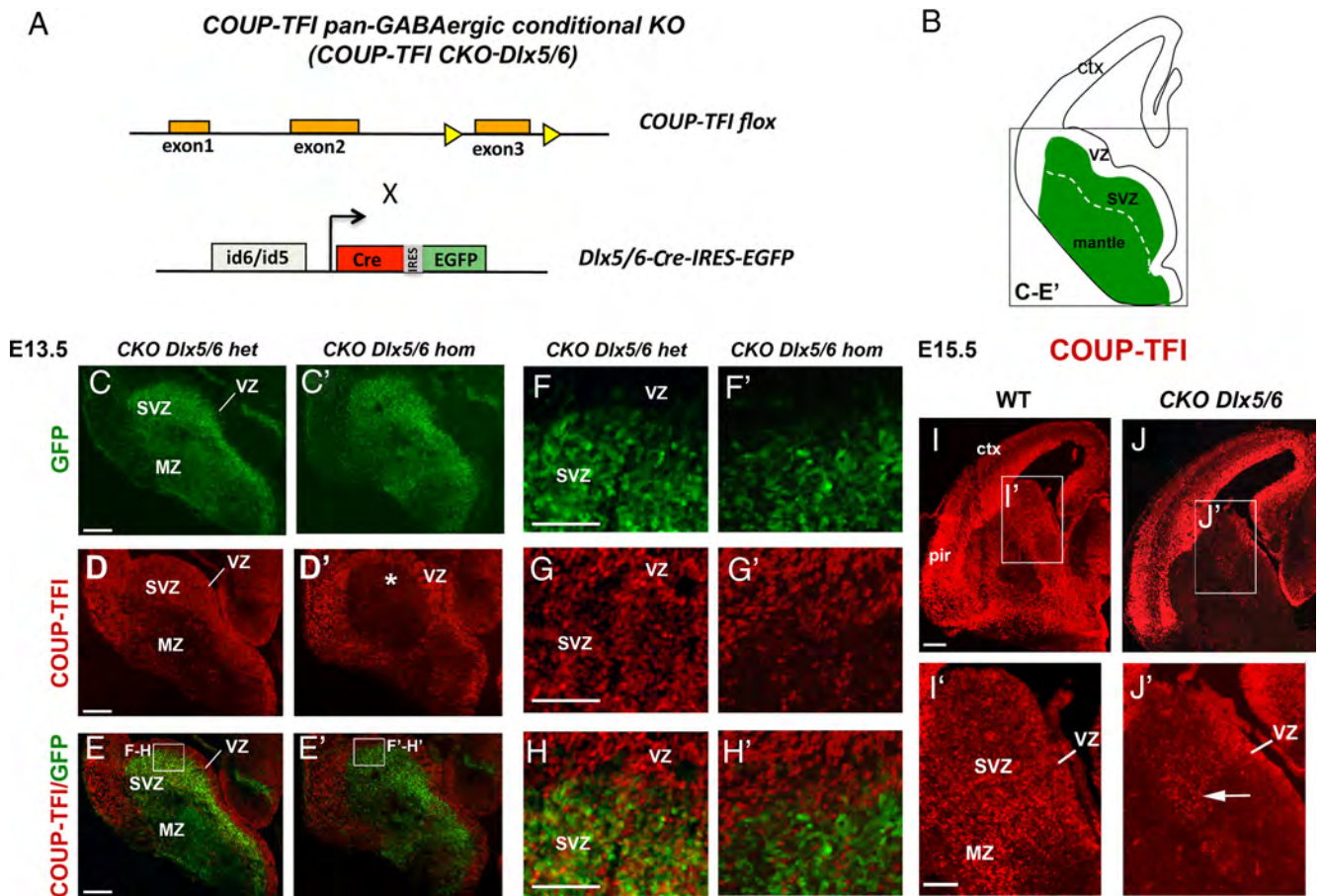

Figure 2. Conditional loss of COUP-TFI in cortical interneurons affects SVZ progenitors in the basal telencephalon. **A**, Schematic of the genetic strategy for examining COUP-TFI conditional loss of function by using the *Dlx5/6-Cre-IRES-EGFP* mouse active in the SVZ progenitors and postmitotic interneurons of the basal telencephalon (Stenman et al., 2003). **B**, Schematic of a E13.5 coronal hemisection indicating the position of C–E'. Green indicates the expression of the EGFP on Cre-mediated recombination. C–E', Coronal sections of E13.5 *COUP-TFI* *CKO-Dlx5/6* (*CKO-Dlx5/6*) heterozygotes and homozygotes immunostained with anti-GFP (C, C', F, F'), anti-COUP-TFI (D, D', G, G'), and merge sections (E, E', H, H'). Note that GFP is expressed in the SVZ and MZ, but absent in the VZ, whereas COUP-TFI is expressed in the VZ, SVZ, and MZ of the basal telencephalon. F–H', High-magnification views of a region in the basal telencephalon indicated in E and E'. E', H', In *COUP-TFI* *CKO-Dlx5/6* homozygotes, no double-labeled cells are detected, confirming loss of COUP-TFI function in SVZ and MZ (*Dlx5/6*-positive domains), but not in progenitors located in VZ (*Dlx5/6*-negative domain). I–J', Immunostaining of anti-COUP-TFI in E15.5 WT and *CKO-Dlx5/6* embryos confirms specific inactivation of COUP-TFI in the SVZ and MZ of the basal telencephalon. I', J', High-magnification views of a region in the basal telencephalon indicated in I and J. Note that expression of COUP-TFI in the VZ and in the ventrally migrating stream is not affected in *COUP-TFI* conditional mutants (J', arrow). Scale bars: C–E', I, J, 200 μ m; F–H', 50 μ m; I', J', 100 μ m.

COUP-TFI *CKO-Dlx5/6* adult brains compared with control brains. Interestingly, we found no difference in the overall number of cortical interneurons between *COUP-TFI* mutant and WT sensorimotor cortices (Fig. 3A, A', G) ($p = 0.79$; $n = 3$), and no difference in the radial distribution of GABA-positive cells along the cortical wall of the *COUP-TFI* *CKO-Dlx5/6* compared with WT (Fig. 3H). We next evaluated the total number and the radial distribution of distinct cortical interneuron subtypes by performing immunostaining and *in situ* hybridization using subtype-defining molecular markers for distinct GABAergic interneuron subpopulations (Ascoli et al., 2008) in P21 WT and *COUP-TFI* *CKO-Dlx5/6* cortices (Fig. 3B–F'). As previously reported, PV+ and SST+ interneurons are two MGE early-born subclasses predominantly located in deep layers, whereas VIP+ cells are primarily CGE late-born interneurons located in superficial layers (Kawaguchi and Kubota, 1997; Butt et al., 2005; Wonders and Anderson, 2006; Miyoshi et al., 2007, 2010). By contrast, CR+ and NPY+ interneurons derive from both the MGE and the CGE, and the preoptic area, and are distributed along the radial extent of the cortex, although bipolar CR+ cells are predominantly located in superficial layers (Xu et al., 2004; Fogarty et al., 2007; Caputi et al., 2009).

Interestingly, we found that loss of COUP-TFI function affects the specification of PV+ interneurons and the VIP+ and CR+ bipolar subpopulations in opposite ways (Fig. 3I). Whereas the number of PV+ interneurons was increased significantly by 33% (Fig. 3B, B', I) ($p = 0.0004$; $n = 3$), the total number of bipolar CR+ and VIP+ interneurons was decreased significantly by 21% (Fig. 3E, E', I) ($p = 0.007$; $n = 3$) and by 26% (Fig. 4F, F', I) ($p = 0.03$; $n = 3$), respectively. Conversely, there was no significant change in the total number of SST+ (Fig. 3C, C', I) ($p = 0.09$; $n = 3$) and NPY+ (Fig. 3D, D', I) ($p = 0.19$; $n = 3$) subpopulations, although the number of NPY+ interneurons increased by 25% in deep layers of *COUP-TFI* *CKO-Dlx5/6* cortices (Fig. 3J) ($p = 0.0028$; $n = 3$). Differences in layer distribution were also detected in the MGE-derived PV+ population, which was strikingly increased by >50% in deep layers (Fig. 3J) ($p < 0.0001$; $n = 3$), but not affected in superficial layers (Fig. 3K) ($p = 0.98$) of *COUP-TFI* *CKO-Dlx5/6* mice. Regarding the CGE-derived subpopulations, the number of VIP-expressing cells was reduced significantly in all layers (36% reduction in deep layers, $p = 0.02$; and 22% in superficial layers, $p = 0.04$; $n = 3$) (Fig. 3F, F', I), whereas the number of CR-expressing cells was decreased by 27% in superficial layers (Fig. 3K) ($p = 0.0034$;

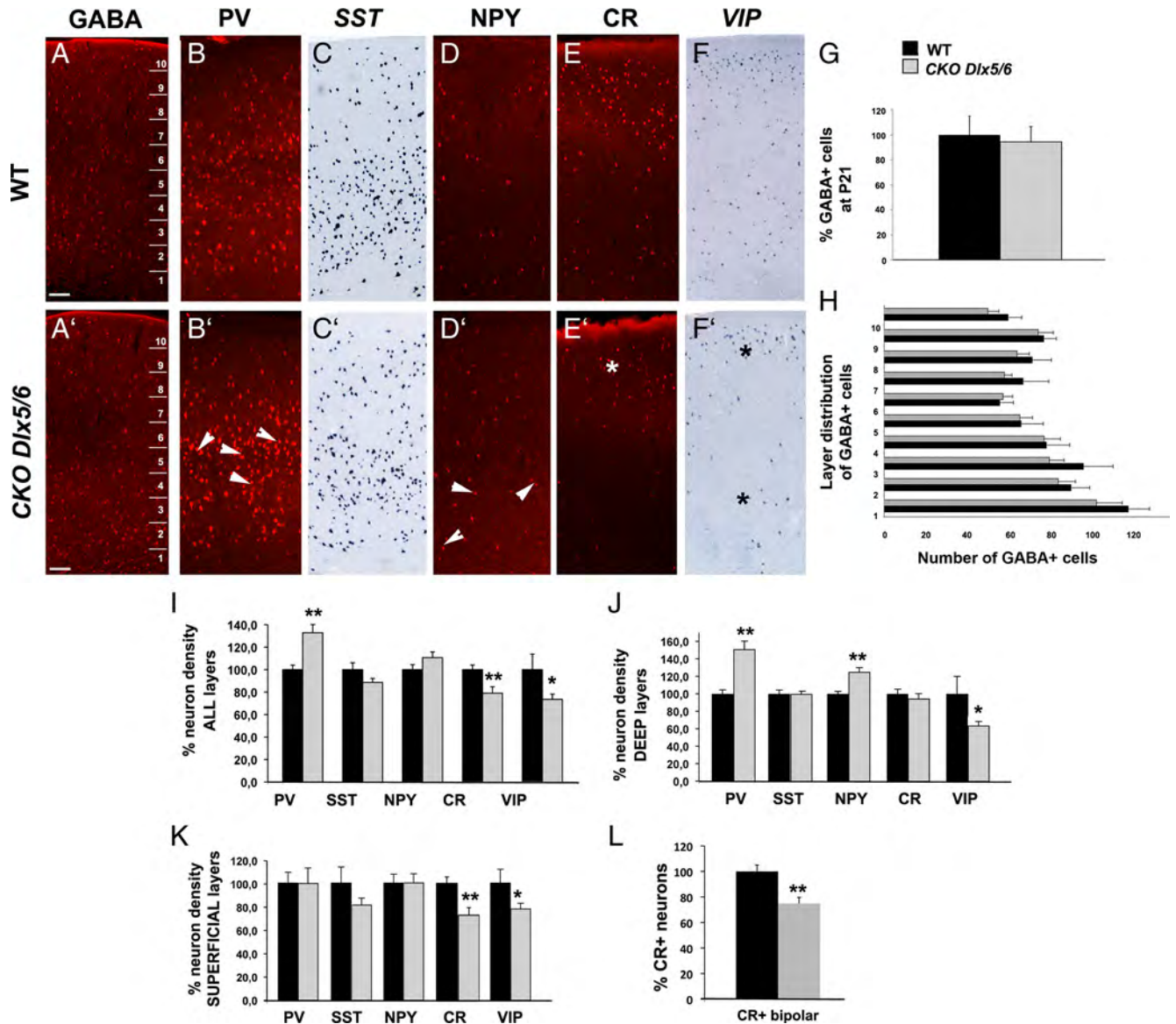

Figure 3. Altered balance between PV- and bipolar VIP- and CR-expressing cortical interneurons in the absence of COUP-TFI function. Representative coronal sections of P21 WT (*A–F*) and *CKO-Dlx5/6* (*COUP-TFI CKO-Dlx5/6*) (*A'–F'*) immunostained with anti-GABA (*A–A'*) and with different cortical interneuron subtypes, as indicated (*B–F'*). *C, C', F, F'*, *In situ* hybridization of *SST* and *VIP* on adjacent sections. *G, H*, The number and distribution of GABA+ cells were quantified by subdividing the cortex into 10 bins along the ventricular (bin 1) to pial (bin 10) axis of equivalent areas of the sensorimotor cortex from WT and *CKO-Dlx5/6* animals. No significant difference in the total amount of GABA+ cells (*G*) and in the distribution of cells in each bin (*H*) was detected between WT and mutant cortices. The arrowheads in *B'* and *D'* point to an increased number of PV- and NPY-expressing cells, respectively, in deep layers. The asterisk in *E'* denotes a reduction of CR-expressing cells in superficial layers, whereas asterisks in *F'* indicate a reduction of VIP-expressing cells in both superficial and deep layers. *I–L*, Graphical representation of the percentage of density of the different cortical interneuron subpopulations in the *COUP-TFI CKO* relative to WT, as indicated. *I*, Along the whole radial extent of the cortex, the number of the PV+ subpopulation increased significantly by 33% (WT, 165.3 ± 6.7 ; CKO, 219 ± 12.4 ; $p < 0.01$; $n = 3$), whereas the total number of bipolar VIP+ and CR+ interneurons decreased significantly by 26% (VIP, WT, 208.2 ± 28.6 ; CKO, 153.1 ± 9.8 ; $p = 0.03$; $n = 3$) and by 21% (CR; WT, 130.9 ± 5.4 ; CKO, 103.5 ± 7.1 ; $p = 0.01$; $n = 3$), respectively. *J*, In deep layers, the PV+ (WT, 85.9 ± 4.5 ; CKO, 130.1 ± 8.4 ; $p < 0.001$; $n = 3$) and NPY+ (WT, 42.8 ± 1.4 ; CKO, 53.71 ± 2.3 ; $p = 0.003$; $n = 3$) cohorts increased significantly, whereas the VIP+ subpopulation decreased significantly (WT, 64.1 ± 13.3 ; CKO, 40.8 ± 3.3 ; $p = 0.02$; $n = 3$) in *CKO-Dlx5/6* mutants. *K*, In superficial layers, the CR+ (WT, 94.7 ± 5.1 ; CKO, 69.2 ± 5.8 ; $p = 0.003$; $n = 3$) and VIP+ (WT, 144.1 ± 16.8 ; CKO, 112.3 ± 6.9 ; $p = 0.04$; $n = 3$) subpopulations are decreased significantly in *CKO-Dlx5/6* mice. *L*, Graphical representation of the percentage of bipolar-shaped CR+ interneurons indicates a statistically significant decrease of 25% in *CKO-Dlx5/6* cortices (WT, 21.8 ± 1.2 ; CKO, 16.3 ± 1.4 ; $p = 0.008$; $n = 3$). Scale bars: *A–F'*, 100 μm . Error bars indicate SEM.

$n = 3$), but not altered in deep layers (Fig. 3*J*) ($p = 0.57$; $n = 3$). Detailed morphological characterization of the CR+ subpopulation demonstrated a 25% decrease (Fig. 3*L*) ($p = 0.007$; $n = 3$) of bipolar-shaped cells, strongly indicating that the CR+ cohort altered in *COUP-TFI CKO-Dlx5/6* mice was mainly composed of bipolar CR+ cells (Caputi et al., 2009). Together, these results indicate that loss of COUP-TFI function alters the balance between PV+ (MGE-derived) and bipolar VIP+, CR+ (CGE-derived) interneuron subpopulations, without affecting the overall cortical interneuron number.

COUP-TFI does not act on cell identity but regulates cell cycle divisions of SVZ precursors in the basal telencephalon

An increase of MGE-derived PV+ interneurons at the expense of CGE-derived CR+ and VIP+ interneurons might suggest either a molecular switch between MGE and CGE identity or an imbalance in the rate of proliferation/differentiation between MGE- and CGE-derived cortical interneurons. To discern between these two hypotheses, we first investigated whether developmental regulators of MGE interneuron cell fate were abnormally expressed in *COUP-TFI CKO-Dlx5/6* embryos. We looked at the expression of *Nkx2.1*,

known to determine the identity of progenitor cells in the MGE (Sussel et al., 1999; Butt et al., 2008; Nóbrega-Pereira et al., 2008), and its downstream target *Lhx6* (Du et al., 2008), which starts to be expressed as soon as MGE-derived progenitors leave the VZ (Liodis et al., 2007). No obvious changes in the expression pattern of *Nkx2.1* and *Lhx6* at rostromedial and caudal levels were observed in E13.5 *COUP-TFI* *CKO-Dlx5/6* embryos (Fig. 4*A–D'*), indicating that loss of COUP-TFI in the SVZ does not induce a molecular fate change between CGE- and MGE-derived interneurons.

To further assess whether inactivation of COUP-TFI would have an effect on cell cycle divisions, similarly to what observed in the neocortex (Faedo et al., 2008; Tomassy et al., 2010), we performed acute injection of BrdU in pregnant females and compared the percentage of BrdU-positive cells in the MGE and CGE of WT and E13.5 *COUP-TFI* *CKO-Dlx5/6* embryos (Fig. 4*E–F'*). Interestingly, the ratio of proliferating (BrdU+) cells was significantly higher in the MGE, and tends to increase in the CGE without, however, reaching statistical significance (Fig. 4*G*) [WT: MGE, $25.7 \pm 2.2\%$; CGE, $30.2 \pm 2.0\%$; CKO: MGE, $47.8 \pm 3.9\%$; CGE, $45.0 \pm 4.2\%$; $p(\text{MGE}) = 0.040$; $p(\text{CGE}) = 0.097$]. Similar results were obtained after immunofluorescence of the proliferation marker Ki67, in which the thickness of the Ki67-positive region, relative to the total ventricular-to-pial thickness of the basal telencephalon, results larger in the MGE than CGE of mutant embryos (Fig. 4*H, I*) [WT: MGE, $34.2 \pm 4.1\%$; CGE, $27.0 \pm 2.0\%$; CKO: MGE, $47.3 \pm 0.4\%$; CGE, $33.8 \pm 1.8\%$; $p(\text{MGE}) = 0.033$; $p(\text{CGE}) = 0.062$]. Thus, increased proliferation, particularly in the MGE region, was detected in *COUP-TFI* *CKO-Dlx5/6* embryos. To further investigate whether cell cycle progression was affected in the absence of COUP-TFI in cortical interneurons, we assessed expression of the G_1 -active cell cycle marker cyclinD2, known to promote SVZ divisions in the telencephalon (Glickstein et al., 2007b). Strikingly, we found that expression of *cyclinD2* was increased in SVZ progenitors of E13.5 and E15.5 *COUP-TFI* *CKO-Dlx5/6* embryos, predominantly at rostromedial levels (Fig. 4*J–K'*). Since COUP-TFI is maintained in VZ progenitors of mutant embryos, we found accordingly no differences in the expression of *cyclinD1* (data not shown) (Glickstein et al., 2007a). Together, these data strongly suggest that COUP-TFI regulates cell cycle progression by modulating

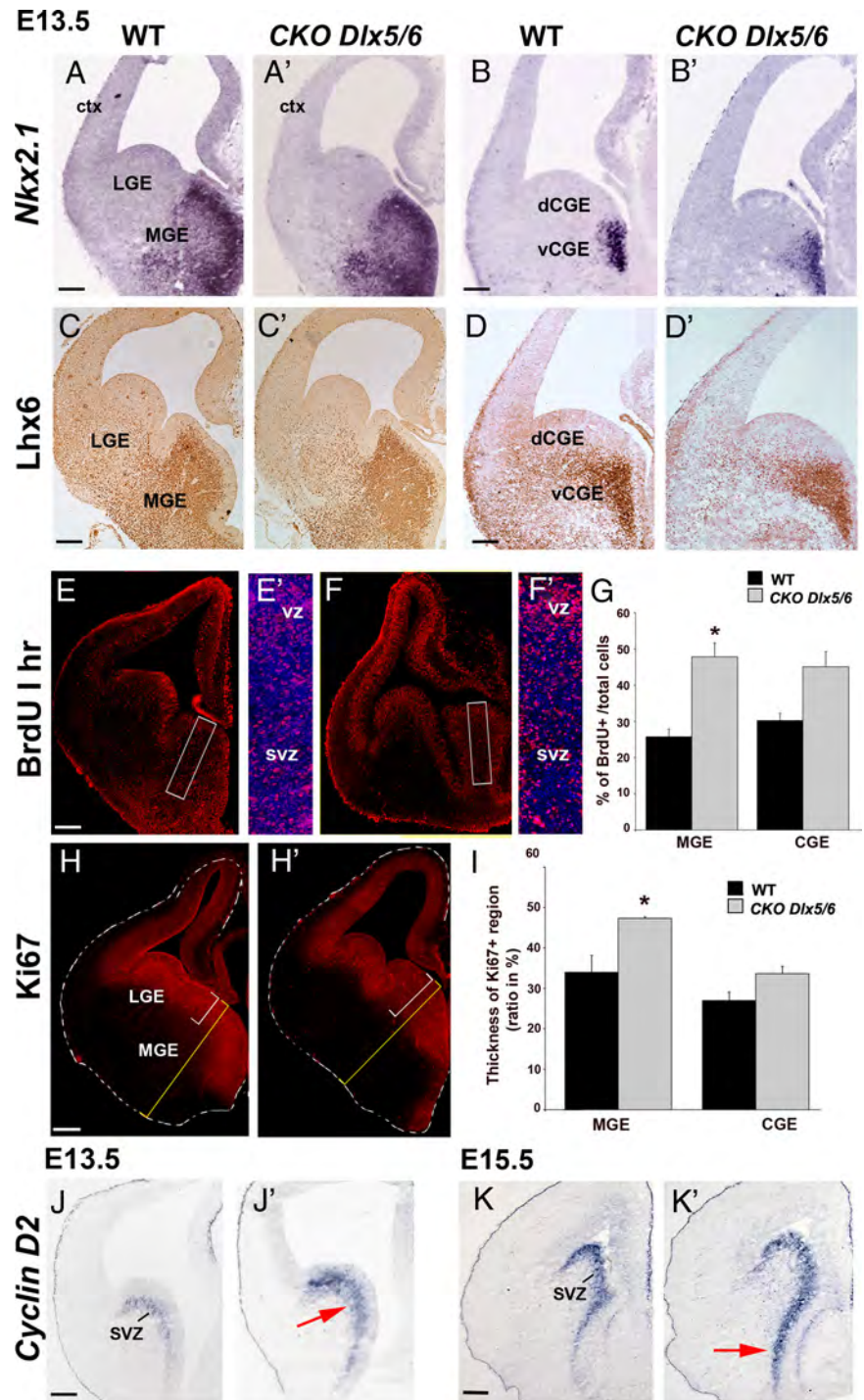

Figure 4. Normal molecular identity but increased rates of proliferation in *COUP-TFI* conditional mutants. *A–B'*, *C–D'*, *In situ* hybridization of *Nkx2.1* (*A–B'*) and immunohistochemistry of *Lhx6* (*C–D'*) on E13.5 coronal sections on intermediate (*A, A'*, *C, C'*) and caudal (*B, B'*, *D, D'*) levels indicate no relevant changes in the expression profiles of *Nkx2.1* and *Lhx6* in *CKO-Dlx5/6* embryos. *E, F*, BrdU immunofluorescence on DAPI-stained intermediate coronal sections indicate increased proliferation in the MGE of E13.5 *CKO-Dlx5/6* embryos. *E', F'*, High-magnification views on the boxes depicted on *E* and *F*. *G*, Graphical representation demonstrates a statistically significant increase of BrdU-positive cells in the MGE ($*p = 0.040$), but not CGE ($p = 0.097$), although the percentage of BrdU-positive cells tends to increase in the CGE. *H, H'*, Ki67 immunofluorescence labels highly proliferating cells in intermediate coronal sections of E13.5 of WT and *CKO-Dlx5/6* embryos. *I*, Graphical representation indicates a statistically significant increase in the size of the Ki67-positive region of the MGE (white brackets) relative to the total ventricular-to-pial thickness of mutant embryos (yellow brackets) ($*p = 0.03$). Error bars indicate SEM. *J'–K'*, Expression of the cell cycle protein *cyclinD2* is upregulated in the SVZ of E13.5 (*J'*, arrow) and E15.5 *CKO-Dlx5/6* embryos (*K'*, arrow). Abbreviations: dCGE, Dorsal caudal ganglionic eminence; vCGE, ventral caudal ganglionic eminence; ctx, cortex. Scale bars, 200 μm .

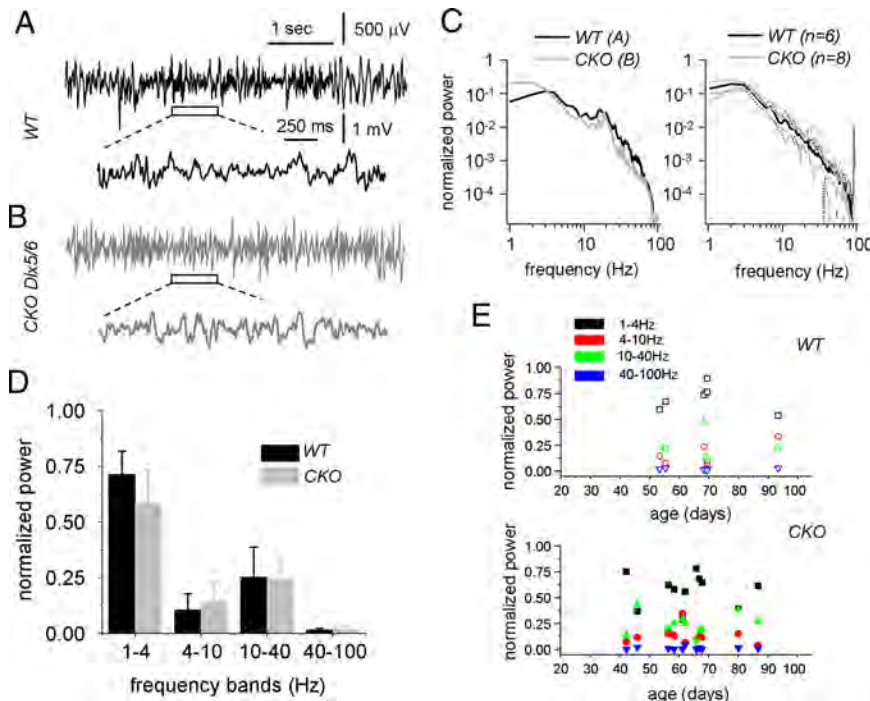

Figure 5. Normal basal EEG recordings in *COUP-TFI* conditional mutants. **A**, Cortical EEG recorded from awake WT mice shows normal activity at 3–7 Hz with episodes of beta activity at 15–20 Hz. Higher resolution trace shows details from the upper traces. **B**, EEG recordings from awake *COUP-TFI CKO-Dlx5/6* mice exhibit approximately similar features than WT animals. **C**, Normalized power spectra from the representative examples shown in **A** and **B** (left) and for the population means (right). No differences were found between groups. A 95% confidence interval is represented with dotted lines for each group. **D**, Mean spectral power per frequency bands was not different between groups. Error bars indicate SEM. **E**, Age dependence of the spectral content at the different frequency bands.

divisions of SVZ interneuron precursors without affecting the identity of MGE determinant genes.

Basal EEG recordings show no apparent abnormalities in mutant mice

Previous reports have shown that altered balance of interneuronal subtypes correlate with epileptic phenotypes and disruption of cortical EEG rhythms (Powell et al., 2003; Cobos et al., 2005; Glickstein et al., 2007b; Butt et al., 2008; Batista-Brito et al., 2009). We therefore chose to obtain long-lasting recordings of basal EEG activity from adult WT ($n = 6$) and *COUP-TFI CKO-Dlx5/6* mice ($n = 8$). Cortical EEGs from awake WT mice were characterized by rhythmic activity at 3–7 Hz interspersed by episodes of beta activity at 15–20 Hz (Fig. 5A). Strikingly, *COUP-TFI CKO-Dlx5/6* mice showed approximately similar EEG patterns compared with WT (Fig. 5B). Seizures, and other types of epileptic-like activity, were never observed in mutants, and no statistical difference was evident from the normalized mean power spectra from both groups (Fig. 5C) ($U = 25$; $p > 0.491$). In a group of mice ($n = 6$ WT; $n = 10$ CKO), we obtained simultaneous cortical and hippocampal EEG recordings to check for signs of ictal activity confined to the hippocampus with little cortical manifestation. Again, we did not observe signs of hyperexcitability in the hippocampus of *COUP-TFI CKO-Dlx5/6* mice (data not shown), discarding the possibility of nonconvulsive subclinical seizures in these animals.

We also looked for differences in the typical frequency bands of the cortical EEG spectrum [i.e., 1–4 Hz (delta), 4–10 Hz (theta), 10–40 Hz (beta), and 40–100 Hz (gamma)] (Fig. 5D). We found no difference between groups using a two-way

ANOVA comparison for the delta ($F = 1.45$; $p = 0.25$), theta ($F = 0.78$; $p = 0.39$), and beta bands ($F = 0.26$; $p = 0.62$), and the Kruskal–Wallis test for the gamma band ($U = 25$; $p = 0.49$). Finally, we checked for a possible functional compensation in *COUP-TFI* mutants, as reflected in an age dependence of the cortical EEG activity. We found no correlation with age of the cortical EEG power in the different frequency bands over the course of 40 to ~90 d postnatal (Fig. 5E). Furthermore, no gender differences were present in the spectra ($U = 19.5$; $p > 0.203$). Thus, alterations in the distribution of PV+, VIP+, and CR+ interneuron subpopulations result in no obvious abnormalities in the gross cortical EEG of *COUP-TFI* mutant mice.

COUP-TFI mutants are more resistant to seizures induced by lithium-pilocarpine

The preceding data suggest that reduced number of VIP+ and CR+ cortical interneurons has no discernible effect on the basal cortical activity of *COUP-TFI* mutants. This was surprising because a similar reduction in the presence of normal numbers of PV+ interneurons results in dysrhythmia and epilepsy (Cobos et al., 2005). We thus reasoned that the increase of PV+ and possibly NPY+ interneurons observed in our mutants might be functionally compensating the reduction of CGE-derived interneuronal subtypes.

To test this hypothesis, we used the muscarinic receptor agonist pilocarpine to unspecifically increase the excitatory level at doses of 100 mg/kg that induce tonic-clonic seizures and status epilepticus in wild-type mice (see Materials and Methods) (Gröticke et al., 2007). We found that *COUP-TFI CKO-Dlx5/6* mice ($n = 7$) were more resistant to seizures and to developing status epilepticus than WT ($n = 7$), as reflected in both the cortical EEG recordings and clinical manifestations (Fig. 6A,B). Progression to the status was characterized by the early appearance of body and tail rigidity, and multiple spikes in the cortical EEG between 2 and 3 min after pilocarpine injection (Fig. 6A,B). There was no significant difference between groups in the latency to the first EEG spikes (Fig. 6C). This was followed by whole-body clonic spasms and secondary generalized tonic-clonic seizures with forelimb automatisms, which were associated with ictal EEG patterns. The mean latency to the first electroclinical manifestation of a tonic-clonic seizure was 39.9 ± 6.9 min in mutants versus 14.9 ± 1.6 min in WT animals (Fig. 6C) ($F_{(1,12)} = 12.48$; $p = 0.004$). Similarly, the onset of the status epilepticus, defined from EEG recordings (Fig. 6A,B), was significantly delayed in *COUP-TFI CKO-Dlx5/6* versus WT mice (Fig. 6C) (CKO, 50.4 ± 6.9 min, vs WT, 22.8 ± 3.3 min; $F_{(1,12)} = 13.17$; $p = 0.003$). Together, these data indicate that *COUP-TFI CKO-Dlx5/6* mice are more resistant to seizures induced by pilocarpine, probably reflecting a functional effect of the increased number of PV-, and eventually, NPY-expressing interneurons in counteracting a decreased number of VIP- and CR-positive neurons.

Seizure resistance in mutant mice is mediated by GABA_A and GABA_B signaling

To further confirm that the seizure-resistant character of these mice was GABA dependent, we used PTZ at 90 mg/kg, a GABA_A receptor antagonist that is widely used for testing seizure susceptibility in mice (Powell et al., 2003). Similarly to pilocarpine, we found an early appearance of body and tail rigidity in both WT ($n = 22$) and *COUP-TFI* *CKO-Dlx5/6* ($n = 12$) mice and a larger latency of *COUP-TFI* mutants to the first tonic-clonic seizure (Fig. 6D) (WT, 24 ± 2.7 min, vs CKO, 38 ± 3.3 min; $F_{(1,32)} = 9.59$; $p = 0.004$).

Together, this indicates that *COUP-TFI* *CKO-Dlx5/6* brains are less excitable than WT brains to produce seizures induced by the cholinergic convulsant pilocarpine and the GABA_A antagonist pentylenetetrazole. However, latency difference to tonic-clonic seizures can be accounted by other mechanisms, like a different excitability level at the glutamatergic circuits or residual presynaptic and postsynaptic GABA_B receptor-mediated inhibition after PTZ injection. To ascertain that the seizure-resistant feature of these mice are indeed GABA dependent, we preinjected WT ($n = 7$) and mutant animals ($n = 8$) with the GABA_B receptor antagonist CGP 35348 at the nonconvulsive dose of 136 mg/kg intraperitoneally (Karlsson et al., 1992) 30 min before PTZ (Fig. 6D). CGP pretreatment significantly [genotype ($F_{(1,45)} = 1.96$; $p = 0.168$); pretreatment ($F_{(1,45)} = 20.77$; $p < 0.0001$); genotype by pretreatment ($F_{(1,45)} = 6.93$; $p = 0.01$)] reduced the latency to the first tonic-clonic seizure in *COUP-TFI* *CKO-Dlx5/6* mice (CGP 35348 vs vehicle pretreated, $p < 0.0001$) and eliminated latency difference with the WT group ($p = 0.38$) (Fig. 6D). Thus, these data indicate that blockage of GABA_B receptor abolishes resistance to seizures induced by the GABA_A receptor antagonist PTZ, and confirm that the seizure-resistant phenotype observed in *COUP-TFI* *CKO-Dlx5/6* mice is dependent on an altered balance of MGE- versus CGE-derived interneurons acting through both GABA_A and GABA_B receptors.

Discussion

In this study, we show that COUP-TFI regulates the balance between distinct cortical interneuron subtypes in a spatiotemporal controlled manner during corticogenesis, thereby enabling proper cortical microcircuitry and functional activity. Conditional inactivation of COUP-TFI solely in interneuron SVZ progenitors leads to a decreased number of CR- and VIP-bipolar GABAergic cells in superficial cortical layers and a concomitant increase of PV- and NPY-expressing interneurons in deep cortical layers of the mature cortex, without affecting the total number of GABAergic cortical interneurons. Physiologically, this alters the balance of both GABA_A and GABA_B receptor-mediated inhibition so that mutants become more resistant to pharmacologically induced seizures. To our knowledge, this study describes for the first time an epilepsy-resistant phenotype

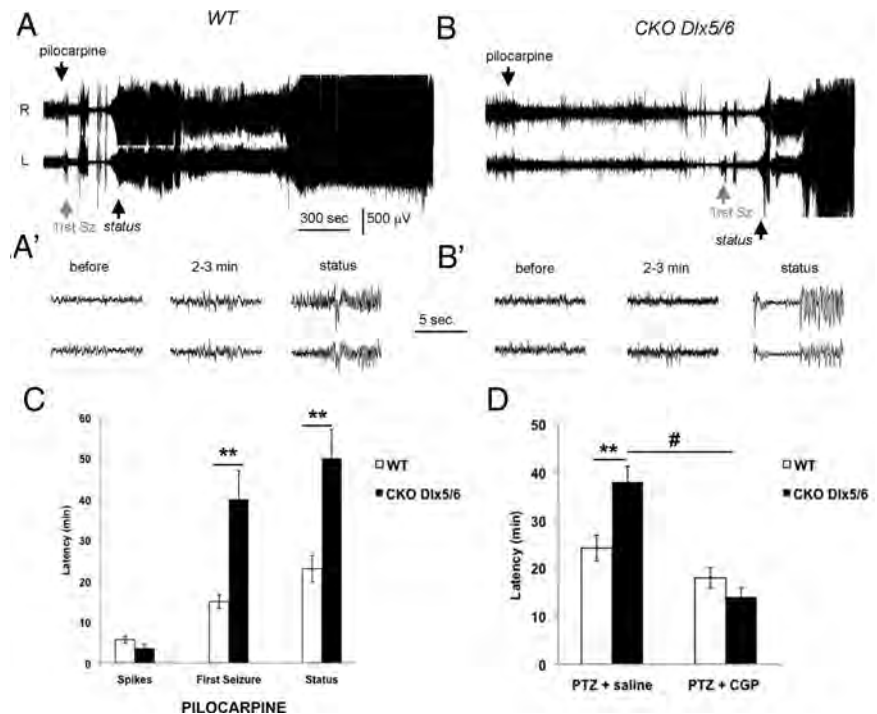

Figure 6. Seizure resistance of *COUP-TFI* *CKO-Dlx5/6* mice. **A**, Bilateral cortical EEG recordings obtained from a representative WT mouse during the progression to a status epilepticus induced by intraperitoneal injection of the muscarinic receptor agonist pilocarpine. The arrows indicate the timing of pilocarpine injections; the first generalized tonic-clonic seizure (first Sz) and the onset of status epilepticus, as defined by electroclinical information. **A'**, Expanded traces highlight EEG epochs recorded before, after 2–3 min of pilocarpine injection, and at the status onset. **B**, Bilateral cortical EEG from a representative *COUP-TFI* *CKO-Dlx5/6* mouse. Note the long latency to the first generalized tonic-clonic seizure (first Sz) and the onset of the status epilepticus. **B'**, Expanded traces similar to that shown in **A'** for *COUP-TFI* *CKO-Dlx5/6* (*CKO-Dlx5/6*) mice. **C**, Mean latency to first spikes recorded after pilocarpine injections. Note latency difference to the first generalized tonic-clonic seizure (first Sz) and the status epilepticus between groups. **D**, Latency difference to the first tonic-clonic seizure induced by subcutaneous injection of the GABA_A receptor antagonist PTZ. Pretreatment with the GABA_B receptor antagonist CGP 35348 significantly reduces the latency to the first tonic-clonic seizures and eliminates latency difference between WT and mutants. $^{**}p < 0.01$, *CKO-Dlx5/6* versus WT, within treatment; $^{\#}p < 0.0001$, CGP 35348 versus saline pretreatment, within genotype. Error bars indicate SEM.

after genetic manipulation of interneuronal subtypes and suggests a potential role for increased PV+ and NPY+ interneurons in controlling seizures.

COUP-TFI controls the balance between MGE- and CGE-derived interneurons

Until recently, the CGE was not considered a distinct anatomical and molecular entity, mainly because of the absence of a morphologically definite sulcus demarcating the CGE from the MGE and LGE, and to the lack of CGE-restricted molecular markers (Flames et al., 2007). However, a series of experimental evidence including *in vivo* transplantation studies, *in vitro* migratory assays, and fate-mapping analyses have established the CGE as a separate molecular territory and confirmed that CGE-derived cortical interneurons contribute to a subset of interneuron subtypes with distinct morphological and electrophysiological interneurons (Nery et al., 2002; Yozu et al., 2005; Kanatani et al., 2008; Willi-Monnerat et al., 2008; Miyoshi et al., 2010). Still, no functional studies on genes required for the specification of CGE-derived cortical interneurons have been described to date.

Differently from COUP-TFII, COUP-TFI is expressed in precursors of the basal telencephalon along the whole rostrocaudal extent at early stages (Armentano et al., 2007; Faedo et al., 2008), before getting restricted to the dorsal MGE and CGE at E13.5, and to CGE-derived cortical interneurons, such as VIP- and

CR-expressing bipolar interneurons (~80 and 90%, respectively). Furthermore, 56% of COUP-TFI+ express SST, most presumably originating from the dMGE, whereas 70% express NPY+, which might derive from the dMGE, the CGE, and, in a small contribution, the preoptic area (Fogarty et al., 2007; Gelman et al., 2009; Karagiannis et al., 2009; Sousa et al., 2009).

Interestingly, although COUP-TFI is expressed in the MGE at early stages during the production of PV+ interneurons, its expression is not maintained in this cell type at P21. In this study, we demonstrate that loss of COUP-TFI function affects the generation, but not maturation of PV+ interneurons. Differently from *Nkx2.1*, which normally acts as a cell fate switch between PV+ (MGE-derived) and CR+/VIP+ (CGE-derived) interneurons (Butt et al., 2008), COUP-TFI acts in the opposite way by limiting generation of PV+ precursors and promoting specification of CR+ and VIP+ cells. However, the imbalance between MGE- and CGE-derived interneurons induced by loss of COUP-TFI function is not attributable to a change of cell fate, as observed for *Nkx2.1* mutants (Butt et al., 2008), but rather to a control on precursor cell divisions mainly within the MGE, as seen by increased proliferation and expression levels of the cell cycle protein cyclinD2 in SVZ precursors (Glickstein et al., 2007a,b). Null mutant mice for cyclinD2 have a selective deficit in cortical PV-expressing interneurons and increased excitability, without affecting other MGE-derived subtypes, such as SST+ interneurons (Glickstein et al., 2007b). Accordingly, overexpression of *cyclinD2* in COUP-TFI conditional mutants results in an increase of PV+ neurons (Glickstein et al., 2007b), implying that negative control of SVZ divisions by COUP-TFI normally limits the number of PV+ interneurons. Thus, in the absence of COUP-TFI function, this repression is released and an excess of PV+ interneurons is produced. Since COUP-TFI is expressed in the MGE from E10.5 to E12.5 (Armentano et al., 2006, 2007; this study), and production of PV+ interneurons occurs from E9.5 to E15.5 (Miyoshi et al., 2007), it is reasonable to assume that presumptive PV+ cells express COUP-TFI while proliferating and that COUP-TFI normally controls early SVZ progenitor divisions during generation of PV+ interneurons.

However, in addition to the increase of PV+ interneurons, loss of COUP-TFI function also affects correct specification of late-born CR+ and VIP+ interneurons. We hypothesize that overproduction of PV+ (and in part NPY+ cells) at a time when normally VIP+ and CR+ cells are generated (from E14.5 to E18.5) (Miyoshi et al., 2010), depletes the progenitor pool resulting in a decrease of VIP+ and CR+ bipolar interneuron precursors in the CGE. Thus, we propose that COUP-TFI normally regulates the number of PV+ cells during generation of CR+ and VIP+ neurons by controlling sequential cell divisions in SVZ progenitors. Excessive cell divisions during the time of PV+ interneuron generation would affect the sequential production of VIP/CR bipolar interneurons. In support of this mechanism, increased PV+ interneurons are found in deep cortical layers (appropriately for their MGE origin), and decreased CR+ and VIP+ interneurons are still located in superficial layers (appropriate for their CGE origin) in COUP-TFI conditional mutants.

Together, our data support a model by which COUP-TFI regulates the fine balance between MGE- and CGE-derived interneurons by ensuring proper generation and specification of different subsets of cortical interneurons. This is in accordance with the control of pyramidal projection neurons by COUP-TFI, which is required to balance motor and sensory cortical areas by repressing corticospinal motor neuron generation during production of corticofugal pyramidal neurons in an area- and

temporal-specific manner (Armentano et al., 2007; Tomassy et al., 2010). Moreover, both COUP-TFs regulate the switch between neurogenesis (early corticogenesis) and gliogenesis (late corticogenesis), and in their absence, neurogenesis is sustained and the generation of early-born neurons is prolonged (Naka et al., 2008). Finally, the *Drosophila* COUP-TF ortholog, SVP, controls neuroblast diversity in a temporally controlled mode by regulating the balance between early- and late-born neuroblasts during neurogenesis (Kanai et al., 2005). Overall, we propose that in the basal telencephalon COUP-TFI plays a critical temporal and spatial control over the differentiation of different subtypes of cortical interneurons, thereby enabling the temporal and spatial specification of PV-, and bipolar CR- and VIP-expressing interneurons.

Increased inhibition mediated by altered balance of cortical interneuronal types might account for epilepsy resistance

The role of GABAergic interneurons in the proper operation of cortical circuitry is widely recognized. By means of a precise somatodendritic arrangement of their synaptic contacts, diverse types of interneurons specifically control excitability of principal cells and other neuronal types (Markram et al., 2004; Ascoli et al., 2008), being responsible of setting brain rhythms and local field potential oscillations (Buzsáki and Draguhn, 2004). We know that GABAergic cell dysfunction is associated primarily with epilepsy, one of the most frequent neurological disorders occurring in the young population (Cossart et al., 2005; Baraban, 2007). However, we still lack a comprehensive understanding of what determines the expression of a particular phenotype and whether interneuronal dysfunction is cause or consequence of epileptic seizures.

Recent genetic models aimed to study the development of cortical interneurons have given us additional cues to draw this picture (Fig. 7). They constitute a unique tool because in most cases changes of subtype proportions precede pathological manifestations (Fig. 7B). Mice lacking the transcription factor *Dlx1* suffer from an apoptotic loss of SST+, CR+, and NPY+ subtypes, whereas PV+ interneurons were spared (Cobos et al., 2005). This reduction was associated with decreased GABAergic synaptic activity, distorted theta oscillations, and generalized spontaneous seizures, suggesting that less SST-, CR-, and NPY-expressing subtypes alone can account for seizures when the number of PV+ cells remains constant. Interestingly, *Sox6* mutants, which have a reduction of PV+ and SST+ interneurons and a constant number of the VIP+ and CR+ subtypes, exhibit pathological oscillations in the delta and beta bands and an early epileptic phenotype onset, that is not compensated by increased number of NPY+ interneurons (Azim et al., 2009; Batista-Brito et al., 2009). This critical role of PV+ and SST+ subtypes is confirmed by early loss-of-function experiments of *Nkx2.1* in which an excess of VIP+ and CR+ cells are generated at the expense of PV- and SST-expressing interneuronal populations (Butt et al., 2008). As a consequence, juvenile mice exhibit generalized seizures. A late (E12.5) loss of *Nkx2.1* function leaves SST+ cells unaffected and causes the same interneuronal shift exclusively at the upper layers. Remarkably, although their seizure susceptibility was not directly tested, these mice did not exhibit spontaneous seizures (Butt et al., 2008).

Very interestingly, mice lacking cyclinD2, which have reduced density of PV+ interneurons but normal density of SST+ and other CGE-derived interneurons, display decreased inhibitory synaptic activity and enhanced cortical excitability, although no spontaneous seizures were recorded (Glickstein et al., 2007b). In contrast,

mice with mutation of the gene encoding *uPAR* (urokinase plasminogen activator receptor) display a large reduction of PV+ cells exclusively, and have spontaneous generalized seizures, being also more susceptible to PTZ-induced seizures (Powell et al., 2003).

All these mouse models argue for a differential role of diverse interneuronal types in controlling cortical excitability and seizures. Our study moves forward and demonstrates that, in the presence of a higher number of PV+ and NPY+ interneurons, COUP-TFI mutants show no discernible cortical EEG abnormalities, but on the contrary are more resistant to pharmacologically induced seizures. Such a resistance is dependent on GABAergic signaling because it is abolished by blockage of GABA_A and GABA_B receptors. Surprisingly, we found no changes in the gamma region of the spectrum despite the increased number of PV+ interneurons. However, we must keep in mind that coarse wire EEG recordings are not well suited to look at the local organization of cortical gamma rhythms, and probably our recordings remained too superficial to detect changes caused by increased numbers of PV+ cells at deep layers in mutants. Obviously, the cortical microcircuit is extremely complex, and other factors, such as the layer specificity of interneuronal loss and the total number of affected cells, can constrain the emergence of epileptic phenotypes and rhythm distortion. Future detailed studies of the local field potentials using multisite recordings would help to look at the finest spatial scale of the neocortex.

Another potential source of enhanced inhibition in our *COUP-TFI CKO-Dlx5/6* mice is the reduction of the control exerted by fewer CR+ and VIP+ interneurons acting over other superficial layer interneurons. CR+ and VIP+ interneurons are known to preferentially target other interneurons (Staiger et al., 2004; Dávid et al., 2007). Thus, under conditions of reduced number of CR+ and VIP+ interneurons, pyramidal cells would not be relieved from inhibition, being less excitable in *COUP-TFI* mutant mice. However, this is unlikely because (1) similar decrease of CR+ interneurons in the *Dlx1* mutants results in hyperexcitability and seizures, probably aided by concomitant reduction in the number of NPY+ and SST+ cells (Cobos et al., 2005); and (2) increased CR+ and VIP+ cells, in the presence of reduced number of PV+ interneurons, failed to rescue the epileptic phenotype of *Nkx2.1* mutants (Butt et al., 2008). Indeed, synaptic potentials elicited by CR+ multipolar and bipolar interneurons on their few cortical pyramidal targets are weaker than potentials initiated by PV+ interneurons, which dominate thalamocortical and intralaminar feedforward inhibition (Sun et al., 2006; Caputi et al., 2009; Xu and Callaway, 2009).

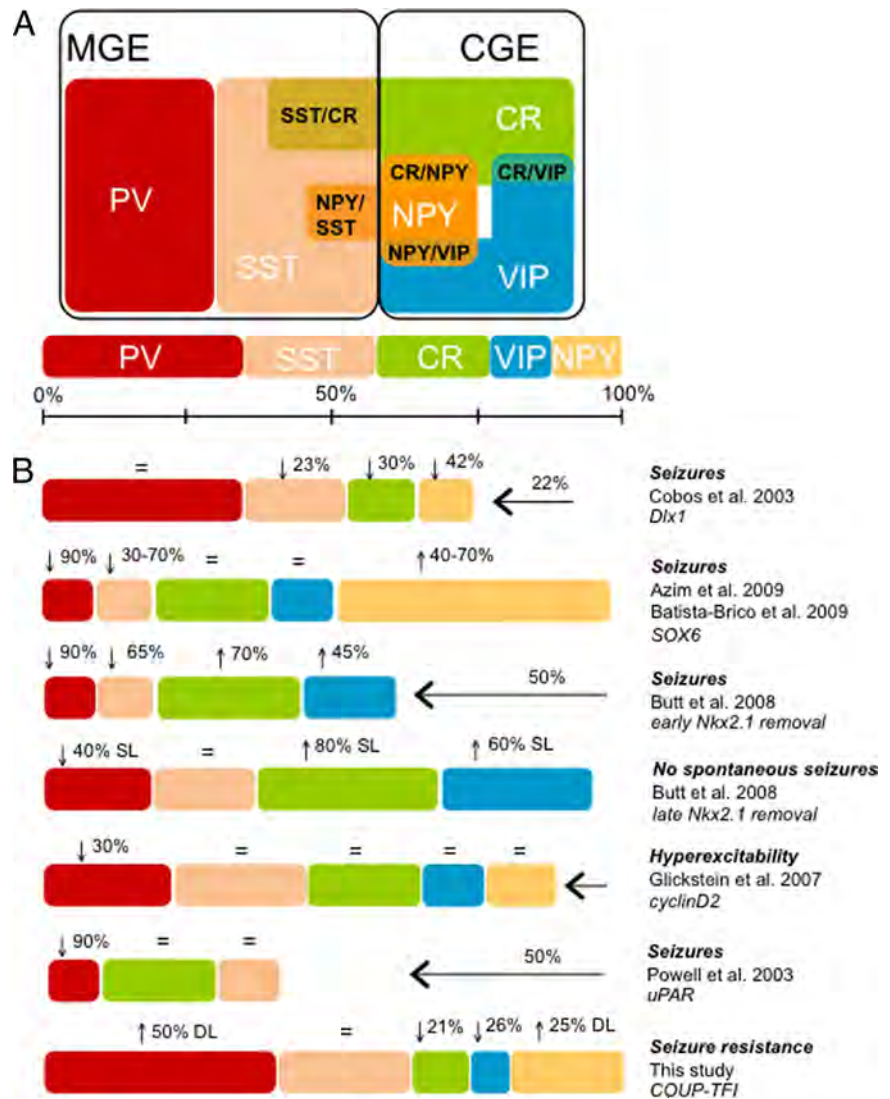

Figure 7. Summary on the relationship between different interneuronal subpopulations and epileptic phenotypes. **A**, Schematic showing the proportion of the different cortical interneuronal subpopulations classified according to their molecular expression profiles. In the normal mouse neocortex, PV-positive interneurons represent ~40% of the total numbers of interneurons, which together with SST-positive cells (~18%) mainly derive from the MGE. Instead, CR and VIP-expressing interneurons originate from the CGE and together contribute ~25% to the total number of cortical interneurons. Interneurons expressing the neurotransmitter peptide NPY are known to derive mainly from the MGE and the CGE and constitute ~9%. Many interneuronal markers colocalize, with SST/CR, SST/NPY, VIP/CR, and VIP/NPY being the most common. Data are from Gonchar and Burkhalter (1999) and Xu and Callaway (2009). **B**, Schematic showing the percentage of interneuron subtypes affected by different genetic manipulations in the different papers cited at right and the corresponding clinical phenotype. =, Similar proportions compared with control; ↑, an increased proportion; ↓, decrease.

We also detected an increase of NPY+ interneurons in the deep neocortical layers of *COUP-TFI* mutants. This probably reflects a population of NPY+ interneurons, which derive from the dorsal MGE (Fogarty et al., 2007). NPY+ interneurons constitute a heterogeneous group, as this protein has been detected in a variety of cortical interneurons (Karagiannis et al., 2009), although a more homogeneous fraction appears to be generated from the preoptic area (Gelman et al., 2009). Interestingly, NPY+ interneurons known to coexpress nitric oxide synthase (NOS) can be morphologically and physiologically identified as neurogliaform cells and share mainly an MGE origin, although a subpopulation of NPY+ neurogliaform cells do not express NOS and derive from the CGE (Tricoire et al., 2010). Neurogliaform interneurons are a unique source of GABA_B-mediated inhibition

for pyramidal cells (Tamás et al., 2003). If some of the exceeding NPY+ interneurons detected in the lower cortical layers of COUP-TFI mutants correspond with neurogliaform cells, their possible role in controlling cortical excitability is intriguing. Indeed, we found that removal of GABA_B inhibition in the presence of a GABA_A antagonist was required to abolish differences of seizure onset between *COUP-TFI* mutants and WT mice. Although other sources of GABA_B-mediated inhibition operate at both presynaptic and postsynaptic levels, the specific role of this recently discovered interneuron population remains unknown. Future studies will be essential to overcome the origin, identity, and function of this miscellaneous interneuronal subtype.

References

- Anderson SA, Eisenstat DD, Shi L, Rubenstein JL (1997) Interneuron migration from basal forebrain to neocortex: dependence on Dlx genes. *Science* 278:474–476.
- Armentano M, Filosa A, Andolfi G, Studer M (2006) COUP-TFI is required for the formation of commissural projections in the forebrain by regulating axonal growth. *Development* 133:4151–4162.
- Armentano M, Chou SJ, Tomassy GS, Leingärtner A, O'Leary DD, Studer M (2007) COUP-TFI regulates the balance of cortical patterning between frontal/motor and sensory areas. *Nat Neurosci* 10:1277–1286.
- Ascoli GA, Alonso-Nanclares L, Anderson SA, Barrionuevo G, Benavides-Picciono R, Burkhalter A, Buzsáki G, Cauli B, Defelipe J, Fairén A, Feldmeyer D, Fishell G, Fregnac Y, Freund TF, Gardner D, Gardner EP, Goldberg JH, Helmstaedter M, Hestrin S, Karube F, et al. (2008) Petilla terminology: nomenclature of features of GABAergic interneurons of the cerebral cortex. *Nat Rev Neurosci* 9:557–568.
- Azim E, Jabaudon D, Fame RM, Macklis JD (2009) SOX6 controls dorsal progenitor identity and interneuron diversity during neocortical development. *Nat Neurosci* 12:1238–1247.
- Baraban SC (2007) Emerging epilepsy models: insights from mice, flies, worms and fish. *Curr Opin Neurol* 20:164–168.
- Batista-Brito R, Fishell G (2009) The developmental integration of cortical interneurons into a functional network. *Curr Top Dev Biol* 87:81–118.
- Batista-Brito R, Rossignol E, Hjerling-Leffler J, Denaxa M, Wegner M, Lefebvre V, Pachnis V, Fishell G (2009) The cell-intrinsic requirement of Sox6 for cortical interneuron development. *Neuron* 63:466–481.
- Butt SJ, Fuccillo M, Nery S, Noctor S, Kriegstein A, Corbin JG, Fishell G (2005) The temporal and spatial origins of cortical interneurons predict their physiological subtype. *Neuron* 48:591–604.
- Butt SJ, Sousa VH, Fuccillo MV, Hjerling-Leffler J, Miyoshi G, Kimura S, Fishell G (2008) The requirement of Nkx2-1 in the temporal specification of cortical interneuron subtypes. *Neuron* 59:722–732.
- Buzsáki G, Draguhn A (2004) Neuronal oscillations in cortical networks. *Science* 304:1926–1929.
- Caputi A, Rozov A, Blatov M, Monyer H (2009) Two calretinin-positive GABAergic cell types in layer 2/3 of the mouse neocortex provide different forms of inhibition. *Cereb Cortex* 19:1345–1359.
- Cobos I, Calcagnotto ME, Vilaythong AJ, Thwin MT, Noebels JL, Baraban SC, Rubenstein JL (2005) Mice lacking Dlx1 show subtype-specific loss of interneurons, reduced inhibition and epilepsy. *Nat Neurosci* 8:1059–1068.
- Cobos I, Long JE, Thwin MT, Rubenstein JL (2006) Cellular patterns of transcription factor expression in developing cortical interneurons. *Cereb Cortex* 16 [Suppl 1]:i82–i88.
- Corbin JG, Nery S, Fishell G (2001) Telencephalic cells take a tangent: non-radial migration in the mammalian forebrain. *Nat Neurosci* 4 [Suppl]:1177–1182.
- Cossart R, Bernard C, Ben-Ari Y (2005) Multiple facets of GABAergic neurons and synapses: multiple fates of GABA signalling in epilepsies. *Trends Neurosci* 28:108–115.
- Dávid C, Schleicher A, Zuschratter W, Staiger JF (2007) The innervation of parvalbumin-containing interneurons by VIP-immunopositive interneurons in the primary somatosensory cortex of the adult rat. *Eur J Neurosci* 25:2329–2340.
- Du T, Xu Q, Ocbina PJ, Anderson SA (2008) NKX2.1 specifies cortical interneuron fate by activating Lhx6. *Development* 135:1559–1567.
- Faedo A, Tomassy GS, Ruan Y, Teichmann H, Krauss S, Pleasure SJ, Tsai SY, Tsai MJ, Studer M, Rubenstein JL (2008) COUP-TFI coordinates cortical patterning, neurogenesis, and laminar fate and modulates MAPK/ERK, AKT, and beta-catenin signaling. *Cereb Cortex* 18:2117–2131.
- Flames N, Pla R, Gelman DM, Rubenstein JL, Puelles L, Marín O (2007) Delineation of multiple subpallial progenitor domains by the combinatorial expression of transcriptional codes. *J Neurosci* 27:9682–9695.
- Fogarty M, Grist M, Gelman D, Marín O, Pachnis V, Kessar N (2007) Spatial genetic patterning of the embryonic neuroepithelium generates GABAergic interneuron diversity in the adult cortex. *J Neurosci* 27:10935–10946.
- Gelman DM, Martini FJ, Nóbrega-Pereira S, Pierani A, Kessar N, Marín O (2009) The embryonic preoptic area is a novel source of cortical GABAergic interneurons. *J Neurosci* 29:9380–9389.
- Glickstein SB, Alexander S, Ross ME (2007a) Differences in cyclin D2 and D1 protein expression distinguish forebrain progenitor subsets. *Cereb Cortex* 17:632–642.
- Glickstein SB, Moore H, Slowinska B, Racchumi J, Suh M, Chuhma N, Ross ME (2007b) Selective cortical interneuron and GABA deficits in cyclin D2-null mice. *Development* 134:4083–4093.
- Gonchar Y, Burkhalter A (1999) Connectivity of GABAergic calretinin-immunoreactive neurons in rat primary visual cortex. *Cereb Cortex* 9:683–696.
- Grötcke I, Hoffmann K, Löscher W (2007) Behavioral alterations in the pilocarpine model of temporal lobe epilepsy in mice. *Exp Neurol* 207:329–349.
- Kanai MI, Okabe M, Hiromi Y (2005) *seven-up* controls switching of transcription factors that specify temporal identities of *Drosophila* neuroblasts. *Dev Cell* 8:203–213.
- Kanatani S, Yozu M, Tabata H, Nakajima K (2008) COUP-TFII is preferentially expressed in the caudal ganglionic eminence and is involved in the caudal migratory stream. *J Neurosci* 28:13582–13591.
- Karagiannis A, Gallop T, Dávid C, Battaglia D, Geoffroy H, Rossier J, Hillman EM, Staiger JF, Cauli B (2009) Classification of NPY-expressing neocortical interneurons. *J Neurosci* 29:3642–3659.
- Karlsson G, Kolb C, Hausdorf A, Portet C, Schmutz M, Olpe HR (1992) GABA_B receptors in various in vitro and in vivo models of epilepsy: a study with the GABA_B receptor blocker CGP 35348. *Neuroscience* 47:63–68.
- Kawaguchi Y, Kubota Y (1997) GABAergic cell subtypes and their synaptic connections in rat frontal cortex. *Cereb Cortex* 7:476–486.
- Liodis P, Denaxa M, Grigoriou M, Akufo-Addo C, Yanagawa Y, Pachnis V (2007) Lhx6 activity is required for the normal migration and specification of cortical interneuron subtypes. *J Neurosci* 27:3078–3089.
- Löscher W, Hönack D, Fassbender CP, Nolting B (1991) The role of technical, biological and pharmacological factors in the laboratory evaluation of anticonvulsant drugs. III. Pentylenetetrazole seizure models. *Epilepsy Res* 8:171–189.
- Marín O, Rubenstein JL (2001) A long, remarkable journey: tangential migration in the telencephalon. *Nat Rev Neurosci* 2:780–790.
- Marín O, Rubenstein JL (2003) Cell migration in the forebrain. *Annu Rev Neurosci* 26:441–483.
- Markram H, Toledo-Rodriguez M, Wang Y, Gupta A, Silberberg G, Wu C (2004) Interneurons of the neocortical inhibitory system. *Nat Rev Neurosci* 5:793–807.
- Miyoshi G, Butt SJ, Takebayashi H, Fishell G (2007) Physiologically distinct temporal cohorts of cortical interneurons arise from telencephalic Olig2-expressing precursors. *J Neurosci* 27:7786–7798.
- Miyoshi G, Hjerling-Leffler J, Karayannis T, Sousa VH, Butt SJ, Battiste J, Johnson JE, Machold RP, Fishell G (2010) Genetic fate mapping reveals that the caudal ganglionic eminence produces a large and diverse population of superficial cortical interneurons. *J Neurosci* 30:1582–1594.
- Naka H, Nakamura S, Shimazaki T, Okano H (2008) Requirement for COUP-TFI and II in the temporal specification of neural stem cells in CNS development. *Nat Neurosci* 11:1014–1023.
- Nery S, Fishell G, Corbin JG (2002) The caudal ganglionic eminence is a source of distinct cortical and subcortical cell populations. *Nat Neurosci* 5:1279–1287.
- Nóbrega-Pereira S, Kessar N, Du T, Kimura S, Anderson SA, Marín O (2008) Postmitotic Nkx2-1 controls the migration of telencephalic interneurons by direct repression of guidance receptors. *Neuron* 59:733–745.
- Powell EM, Campbell DB, Stanwood GD, Davis C, Noebels JL, Levitt P (2003) Genetic disruption of cortical interneuron development causes

- region- and GABA cell type-specific deficits, epilepsy, and behavioral dysfunction. *J Neurosci* 23:622–631.
- Sousa VH, Miyoshi G, Hjerling-Lefler J, Karayannis T, Fishell G (2009) Characterization of Nkx6–2-derived neocortical interneuron lineages. *Cereb Cortex* 19 [Suppl 1]:i1–i10.
- Staiger JF, Masannek C, Schleicher A, Zuschratter W (2004) Calbindin-containing interneurons are a target for VIP-immunoreactive synapses in rat primary somatosensory cortex. *J Comp Neurol* 468:179–189.
- Stenman J, Toresson H, Campbell K (2003) Identification of two distinct progenitor populations in the lateral ganglionic eminence: implications for striatal and olfactory bulb neurogenesis. *J Neurosci* 23:167–174.
- Sun QQ, Huguenard JR, Prince DA (2006) Barrel cortex microcircuits: thalamocortical feedforward inhibition in spiny stellate cells is mediated by a small number of fast-spiking interneurons. *J Neurosci* 26:1219–1230.
- Sussel L, Marín O, Kimura S, Rubenstein JL (1999) Loss of Nkx2.1 homeobox gene function results in a ventral to dorsal molecular respecification within the basal telencephalon: evidence for a transformation of the pallidum into the striatum. *Development* 126:3359–3370.
- Tamás G, Lorincz A, Simon A, Szabadics J (2003) Identified sources and targets of slow inhibition in the neocortex. *Science* 299:1902–1905.
- Tomassy GS, De Leonibus E, Jabaudon D, Lodato S, Alfano C, Mele A, Macklis JD, Studer M (2010) Area-specific temporal control of corticospinal motor neuron differentiation by COUP-TFI. *Proc Natl Acad Sci U S A* 107:3576–3581.
- Tricoire L, Pelkey KA, Daw MI, Sousa VH, Miyoshi G, Jeffries B, Cauli B, Fishell G, McBain CJ (2010) Common origins of hippocampal Ivy and nitric oxide synthase expressing neurogliaform cells. *J Neurosci* 30:2165–2176.
- Tripodi M, Filosa A, Armentano M, Studer M (2004) The COUP-TF nuclear receptors regulate cell migration in the mammalian basal forebrain. *Development* 131:6119–6129.
- Willi-Monnerat S, Migliavacca E, Surdez D, Delorenzi M, Luthi-Carter R, Terskikh AV (2008) Comprehensive spatiotemporal transcriptomic analyses of the ganglionic eminences demonstrate the uniqueness of its caudal subdivision. *Mol Cell Neurosci* 37:845–856.
- Wonders CP, Anderson SA (2006) The origin and specification of cortical interneurons. *Nat Rev Neurosci* 7:687–696.
- Xu Q, Cobos I, De La Cruz E, Rubenstein JL, Anderson SA (2004) Origins of cortical interneuron subtypes. *J Neurosci* 24:2612–2622.
- Xu X, Callaway EM (2009) Laminar specificity of functional input to distinct types of inhibitory cortical neurons. *J Neurosci* 29:70–85.
- Yozu M, Tabata H, Nakajima K (2005) The caudal migratory stream: a novel migratory stream of interneurons derived from the caudal ganglionic eminence in the developing mouse forebrain. *J Neurosci* 25:7268–7277.

References

- Retinoid X receptor-COUP-TF interactions modulate retinoic acid signaling. *Proceedings of the National Academy of Sciences of the United States of America* **89**, 1448 (1992).
- Acsády L., Görös T.J., Freund T.F., Different populations of vasoactive intestinal polypeptide-immunoreactive interneurons are specialized to control pyramidal cells or interneurons in the hippocampus. *Neuroscience* **73**, 317 (1996).
- Alfano C., Magrinelli E., Harb K., Studer M., The nuclear receptors COUP-TF: a long-lasting experience in forebrain assembly. *Cellular and molecular life sciences : CMLS* **71**, 43 (2014).
- Anderson S.A., Kaznowski C.E., Horn C., Rubenstein J.L., McConnell S.K., Distinct origins of neocortical projection neurons and interneurons in vivo. *Cerebral cortex (New York, N.Y. : 1991)* **12**, 702 (2002).
- Anderson S.A., Marín O., Horn C., Jennings K., Rubenstein J.L., Distinct cortical migrations from the medial and lateral ganglionic eminences. *Development (Cambridge, England)* **128**, 353 (2001).
- Armentano M., Chou S.-J.J., Tomassy G.S., Leingärtner A., O'Leary D.D., Studer M., COUP-TFI regulates the balance of cortical patterning between frontal/motor and sensory areas. *Nature neuroscience* **10**, 1277 (2007).
- Armstrong C., Krook-Magnuson E., Soltesz I., Neurogliaform and Ivy Cells: A Major Family of nNOS Expressing GABAergic Neurons. *Frontiers in neural circuits* **6**, 23 (2012).
- Ascoli G.A., Alonso-Nanclares L., Anderson S.A., Barrionuevo G., Benavides-Piccione R., Burkhalter A., Buzsáki G., Cauli B., Defelipe J., Fairen A., Feldmeyer D., Fishell G., Fregnac Y., Freund T.F., Gardner D., Gardner E.P., Goldberg J.H., Helmstaedter M., Hestrin S., Karube F., Kisvarday Z.F., Lambolez B., Lewis D.A., Marin O., Markram H., Muñoz A., Packer A., Petersen C.C., Rockland K.S., Rossier J., Rudy B., Somogyi P., Staiger J.F., Tamas G., Thomson A.M., Toledo-Rodriguez M., Wang Y., West D.C., Yuste R., Petilla terminology: nomenclature of features of GABAergic interneurons of the cerebral cortex. *Nat Rev Neurosci* **9**, 557 (Jul, 2008).
- Attardo A., Calegari F., Haubensak W., Wilsch-Bräuninger M., Huttner W.B., Live imaging at the onset of cortical neurogenesis reveals differential appearance of the neuronal phenotype in apical versus basal progenitor progeny. *PLoS one* **3**, (2008).
- Avram D., Ishmael J.E., Nevriy D.J., Peterson V.J., Lee S.H., Dowell P., Leid M., Heterodimeric interactions between chicken ovalbumin upstream promoter-transcription factor family members ARP1 and ear2. *The Journal of biological chemistry* **274**, 14331 (1999).
- Bayer S.A., Altman J., Neocortical development. *Neocortical development*, (1991).
- Bedogni F., Hodge R.D., Elsen G.E., Nelson B.R., Daza R.A., Beyer R.P., Bammler T.K., Rubenstein J.L., Hevner R.F., Tbr1 regulates regional and laminar identity of postmitotic neurons in developing neocortex. *Proceedings of the National Academy of Sciences of the United States of America* **107**, 13129 (2010).
- Beierlein M., Gibson J.R., Connors B.W., Two dynamically distinct inhibitory networks in layer 4 of the neocortex. *Journal of neurophysiology* **90**, 2987 (2003).
- Bell S.M., Schreiner C.M., Waclaw R.R., Campbell K., Potter S.S., Scott W.J., Sp8 is crucial for limb outgrowth and neuropore closure. *Proceedings of the National Academy of Sciences* **100**, 12195 (2003).
- Borello U., Madhavan M., Vilinsky I., Faedo A., Pierani A., Rubenstein J., Campbell K., Sp8 and COUP-TF1 reciprocally regulate patterning and Fgf signaling in cortical progenitors. *Cerebral cortex (New York, N.Y. : 1991)* **24**, 1409 (2014).
- Bulchand S., Grove E.A., Porter F.D., Tole S., LIM-homeodomain gene Lhx2 regulates the formation of the cortical hem. *Mechanisms of development* **100**, 165 (2001).
- Butt S.J., Fuccillo M., Nery S., Noctor S., Kriegstein A., Corbin J.G., Fishell G., The temporal and spatial origins of cortical interneurons predict their physiological subtype. *Neuron* **48**, 591 (2005).
- Butt S.J., Sousa V.H., Fuccillo M.V., Hjerling-Leffler J., Miyoshi G., Kimura S., Fishell G., The requirement of Nkx2-1 in the temporal specification of cortical interneuron subtypes. *Neuron* **59**, 722 (2008).
- Cai Y., Zhang Q., Wang C., Zhang Y., Ma T., Zhou X., Tian M., Rubenstein J.L., Yang Z., Nuclear receptor COUP-TFII-expressing neocortical interneurons are derived from the medial and lateral/caudal ganglionic eminence and define specific subsets of mature interneurons. *The Journal of comparative neurology* **521**, 479 (2013).
- Caputi A., Rozov A., Blatow M., Monyer H., Two calretinin-positive GABAergic cell types in layer 2/3 of the mouse neocortex provide different forms of inhibition. *Cerebral cortex (New York, N.Y. : 1991)* **19**, 1345 (2009).
- Cauli B., Audinat E., Lambolez B., Angulo M.C., Ropert N., Tsuzuki K., Hestrin S., Rossier J., Molecular and physiological diversity of cortical nonpyramidal cells. *The Journal of neuroscience : the official journal of the Society for Neuroscience* **17**, 3894 (1997).
- Cauli B., Porter J.T., Tsuzuki K., Lambolez B., Rossier J., Quenet B., Audinat E., Classification of fusiform neocortical interneurons based on unsupervised clustering. *Proceedings of the National Academy of Sciences*, (2000).

- Cauli B., Zhou X., Tricoire L., Toussay X., Staiger J.F., Revisiting enigmatic cortical calretinin-expressing interneurons. *Front Neuroanat* **8**, 52 (2014).
- Cavanagh M.E., Parnavelas J.G., Development of vasoactive-intestinal-polypeptide-immunoreactive neurons in the rat occipital cortex: a combined immunohistochemical-autoradiographic study. *The Journal of comparative neurology* **284**, 637 (1989).
- Caviness V.S., Takahashi T., Proliferative events in the cerebral ventricular zone. *Brain & development* **17**, 159 (1995).
- Chameau P., Inta D., Vitalis T., Monyer H., Wadman W.J., van Hooft J.A., The N-terminal region of reelin regulates postnatal dendritic maturation of cortical pyramidal neurons. *Proceedings of the National Academy of Sciences of the United States of America* **106**, 7227 (2009).
- Chan S.M., Xu N., Niemeyer C.C., SpCOUP-TF: a sea urchin member of the steroid/thyroid hormone receptor family. *Proceedings of the ...*, (1992).
- Chenn A., McConnell S.K., Cleavage orientation and the asymmetric inheritance of Notch1 immunoreactivity in mammalian neurogenesis. *Cell* **82**, 631 (1995).
- Cobos I., Long J.E., Thwin M.T., Rubenstein J.L., Cellular patterns of transcription factor expression in developing cortical interneurons. *Cerebral cortex (New York, N.Y. : 1991)* **16 Suppl 1**, 8 (2006).
- Connors B.W., Gutnick M.J., Intrinsic firing patterns of diverse neocortical neurons. *Trends in neurosciences* **13**, 99 (1990).
- Cooney A.J., Leng X., Tsai S.Y., O'Malley B.W., Tsai M.J., Multiple mechanisms of chicken ovalbumin upstream promoter transcription factor-dependent repression of transactivation by the vitamin D, thyroid hormone, and retinoic acid receptors. *The Journal of biological chemistry* **268**, 4152 (1993).
- Cooney A.J., Tsai S.Y., O'Malley B.W., Tsai M.J., Chicken ovalbumin upstream promoter transcription factor (COUP-TF) dimers bind to different GGTC A response elements, allowing COUP-TF to repress hormonal induction of the vitamin D3, thyroid hormone, and retinoic acid receptors. *Molecular and cellular biology* **12**, 4153 (1992).
- Corbin J.G., Nery S., Fishell G., Telencephalic cells take a tangent: non-radial migration in the mammalian forebrain. *Nature neuroscience* **4 Suppl**, 1177 (2001).
- Cruikshank S.J., Lewis T.J., Connors B.W., Synaptic basis for intense thalamocortical activation of feedforward inhibitory cells in neocortex. *Nature neuroscience* **10**, 462 (2007).
- Daniëlle B., Nienke F.B., Claudia G.-J., Mafei X., Joep de L., Shalini J., Wojciech W., Donna M.M., Helger G.Y., Rolph P., Lisenka V., Liesbeth S., Ellen B., Chun-An C., Richard A.L., Sophia Y.T., Richard A.G., Ming-Jer T., James R.L., Huda Y.Z., Frans C., Bert de V., Christian P.S., NR2F1 Mutations Cause Optic Atrophy with Intellectual Disability. *The American Journal of Human Genetics* **94**, (2014).
- Dávid C., Schleicher A., Zuschratter W., Staiger J.F., The innervation of parvalbumin-containing interneurons by VIP-immunopositive interneurons in the primary somatosensory cortex of the adult rat. *The European journal of neuroscience* **25**, 2329 (2007).
- DeFelipe J., López-Cruz P.L., Benavides-Piccione R., Bielza C., Larrañaga P., Anderson S., Burkhalter A., Cauli B., Fairén A., Feldmeyer D., Fishell G., Fitzpatrick D., Freund T.F., González-Burgos G., Hestrin S., Hill S., Hof P.R., Huang J., Jones E.G., Kawaguchi Y., Kisvárdy Z., Kubota Y., Lewis D.A., Marín O., Markram H., McBain C.J., Meyer H.S., Monyer H., Nelson S.B., Rockland K., Rossier J., Rubenstein J.L., Rudy B., Scanziani M., Shepherd G.M., Sherwood C.C., Staiger J.F., Tamás G., Thomson A., Wang Y., Yuste R., Ascoli G.A., New insights into the classification and nomenclature of cortical GABAergic interneurons. *Nature reviews. Neuroscience* **14**, 202 (2013).
- Elena C., Daniel G.-D., David M.-L., Beatriz G., François L., Jose M.I., Fiona F., Liset de la P., Dampened hippocampal oscillations and enhanced spindle activity in an asymptomatic model of developmental cortical malformations. *Frontiers in systems neuroscience*, (2014).
- Fanselow E.E., Richardson K.A., Connors B.W., Selective, state-dependent activation of somatostatin-expressing inhibitory interneurons in mouse neocortex. *Journal of neurophysiology* **100**, 2640 (2008).
- Férezou I., Cauli B., Hill E.L., Rossier J., Hamel E., Lambollez B., 5-HT₃ receptors mediate serotonergic fast synaptic excitation of neocortical vasoactive intestinal peptide/cholecystokinin interneurons. *The Journal of neuroscience : the official journal of the Society for Neuroscience* **22**, 7389 (2002).
- Fjose A., Nornes S., Weber U., Mlodzik M., Functional conservation of vertebrate seven-up related genes in neurogenesis and eye development. *The EMBO journal* **12**, 1403 (1993).
- Flames N., Pla R., Gelman D.M., Rubenstein J.L., Puelles L., Marín O., Delineation of multiple subpallial progenitor domains by the combinatorial expression of transcriptional codes. *The Journal of neuroscience : the official journal of the Society for Neuroscience* **27**, 9682 (2007).
- Fogarty M., Grist M., Gelman D., Marín O., Pachnis V., Kessar N., Spatial genetic patterning of the embryonic neuroepithelium generates GABAergic interneuron diversity in the adult cortex. *The Journal of neuroscience : the official journal of the Society for Neuroscience* **27**, 10935 (2007).

- Franco S.J., Müller U., Shaping our minds: stem and progenitor cell diversity in the mammalian neocortex. *Neuron* **77**, 19 (2013).
- Gabernet L., Jadhav S.P., Feldman D.E., Carandini M., Scanziani M., Somatosensory integration controlled by dynamic thalamocortical feed-forward inhibition. *Neuron* **48**, 315 (2005).
- Galarreta M., Erdélyi F., Szabó G., Hestrin S., Electrical coupling among irregular-spiking GABAergic interneurons expressing cannabinoid receptors. *The Journal of neuroscience : the official journal of the Society for Neuroscience* **24**, 9770 (2004).
- Gelman D., Griveau A., Dehorter N., Teissier A., Varela C., Pla R., Pierani A., Marín O., A wide diversity of cortical GABAergic interneurons derives from the embryonic preoptic area. *The Journal of neuroscience : the official journal of the Society for Neuroscience* **31**, 16570 (2011).
- Gelman D.M., Martini F.J., The embryonic preoptic area is a novel source of cortical GABAergic interneurons. *The Journal of ...*, (2009).
- Gibson J.R., Beierlein M., Connors B.W., Two networks of electrically coupled inhibitory neurons in neocortex. *Nature* **402**, 75 (1999).
- Glickstein S.B., Moore H., Slowinska B., Racchumi J., Suh M., Chuhma N., Ross M.E., Selective cortical interneuron and GABA deficits in cyclin D2-null mice. *Development (Cambridge, England)* **134**, 4083 (2007).
- Goldberg E.M., Clark B.D., Zagha E., Nahmani M., Erisir A., Rudy B., K⁺ channels at the axon initial segment dampen near-threshold excitability of neocortical fast-spiking GABAergic interneurons. *Neuron* **58**, 387 (2008).
- Gorski J.A., Talley T., Qiu M., Puelles L., Rubenstein J.L., Jones K.R., Cortical excitatory neurons and glia, but not GABAergic neurons, are produced in the Emx1-expressing lineage. *The Journal of neuroscience : the official journal of the Society for Neuroscience* **22**, 6309 (2002).
- Gotz M., Huttner W.B., The cell biology of neurogenesis. *Nature reviews. Molecular cell biology* **6**, 777 (Oct, 2005).
- Guo J., Anton E.S., Decision making during interneuron migration in the developing cerebral cortex. *Trends in cell biology* **24**, 342 (2014).
- Haider B., McCormick D.A., Rapid neocortical dynamics: cellular and network mechanisms. *Neuron* **62**, 171 (2009).
- Hansen D.V., Lui J.H., Parker P.R., Kriegstein A.R., Neurogenic radial glia in the outer subventricular zone of human neocortex. *Nature* **464**, 554 (2010).
- Hartfuss E., Galli R., Heins N., Götz M., Characterization of CNS precursor subtypes and radial glia. *Developmental biology* **229**, 15 (2001).
- Hasenstaub A., Shu Y., Haider B., Kraushaar U., Duque A., McCormick D.A., Inhibitory postsynaptic potentials carry synchronized frequency information in active cortical networks. *Neuron* **47**, 423 (2005).
- Haubensak W., Attardo A., Denk W., Huttner W.B., Neurons arise in the basal neuroepithelium of the early mammalian telencephalon: a major site of neurogenesis. *Proceedings of the National Academy of Sciences of the United States of America* **101**, 3196 (2004).
- He W., Ingraham C., Rising L., Goderie S., Temple S., Multipotent stem cells from the mouse basal forebrain contribute GABAergic neurons and oligodendrocytes to the cerebral cortex during embryogenesis. *The Journal of neuroscience : the official journal of the Society for Neuroscience* **21**, 8854 (2001).
- Helmstaedter M., Sakmann B., Feldmeyer D., Neuronal correlates of local, lateral, and translaminar inhibition with reference to cortical columns. *Cerebral cortex (New York, N.Y. : 1991)* **19**, 926 (2009).
- Hensch T.K., Critical period plasticity in local cortical circuits. *Nature reviews. Neuroscience* **6**, 877 (2005).
- Huang Z.J., Di Cristo G., Ango F., Development of GABA innervation in the cerebral and cerebellar cortices. *Nature reviews. Neuroscience* **8**, 673 (2007).
- Inan M., Welagen J., Anderson S.A., Spatial and temporal bias in the mitotic origins of somatostatin- and parvalbumin-expressing interneuron subgroups and the chandelier subtype in the medial ganglionic eminence. *Cerebral cortex (New York, N.Y. : 1991)* **22**, 820 (2012).
- Inta D., Alfonso J., von Engelhardt J., Kreuzberg M.M., Meyer A.H., van Hooft J.A., Monyer H., Neurogenesis and widespread forebrain migration of distinct GABAergic neurons from the postnatal subventricular zone. *Proceedings of the National Academy of Sciences of the United States of America* **105**, 20994 (2008).
- Isaacson J.S., Scanziani M., How inhibition shapes cortical activity. *Neuron* **72**, 231 (2011).
- Iwano T., Masuda A., Kiyonari H., Enomoto H., Matsuzaki F., Prox1 postmitotically defines dentate gyrus cells by specifying granule cell identity over CA3 pyramidal cell fate in the hippocampus. *Development* **139**, (2012).
- Jiménez D., López-Mascaraque L.M., Valverde F., De Carlos J.A., Tangential migration in neocortical development. *Developmental biology* **244**, 155 (2002).

- Johnson N.C., Dillard M.E., Baluk P., McDonald D.M., Harvey N.L., Frase S.L., Oliver G., Lymphatic endothelial cell identity is reversible and its maintenance requires Prox1 activity. *Genes & Development* **22**, (2008).
- Kanatani S., Yozu M., Tabata H., Nakajima K., COUP-TFII is preferentially expressed in the caudal ganglionic eminence and is involved in the caudal migratory stream. *The Journal of neuroscience : the official journal of the Society for Neuroscience* **28**, 13582 (2008).
- Kapfer C., Glickfeld L.L., Atallah B.V., Scanziani M., Supralinear increase of recurrent inhibition during sparse activity in the somatosensory cortex. *Nature neuroscience* **10**, 743 (2007).
- Karalay O., Doberauer K., Vadodaria K.C., Knobloch M., Berti L., Miquelajauregui A., Schwark M., Jagasia R., Taketo M.M., Tarabykin V., Lie D.C., Jessberger S., Prospero-related homeobox 1 gene (Prox1) is regulated by canonical Wnt signaling and has a stage-specific role in adult hippocampal neurogenesis. *Proceedings of the National Academy of Sciences* **108**, (2011).
- Kastner P., Mark M., Chambon P., Nonsteroid nuclear receptors: what are genetic studies telling us about their role in real life? *Cell* **83**, 859 (1995).
- Kawaguchi Y., Selective cholinergic modulation of cortical GABAergic cell subtypes. *Journal of neurophysiology* **78**, 1743 (1997).
- Kawaguchi Y., Katsumaru H., Kosaka T., Heizmann C.W., Hama K., Fast spiking cells in rat hippocampus (CA1 region) contain the calcium-binding protein parvalbumin. *Brain research* **416**, 369 (1987).
- Kawaguchi Y., Kubota Y., GABAergic cell subtypes and their synaptic connections in rat frontal cortex. *Cerebral cortex (New York, N.Y. : 1991)* **7**, 476 (1997).
- Kelsom C., Lu W., Development and specification of GABAergic cortical interneurons. *Cell & bioscience* **3**, 19 (2013).
- Kliwer S.A., Umesono K., Heyman R.A., Mangelsdorf D.J., Dyck J.A., Evans R.M., Retinoid X receptor-COUP-TF interactions modulate retinoic acid signaling. *Proc Natl Acad Sci U S A* **89**, 1448 (Feb 15, 1992).
- Kriegstein A.R., Noctor S.C., Patterns of neuronal migration in the embryonic cortex. *Trends in neurosciences* **27**, 392 (2004).
- Ladias J.A., Karathanasis S.K., Regulation of the apolipoprotein AI gene by ARP-1, a novel member of the steroid receptor superfamily. *Science (New York, N.Y.)* **251**, 561 (1991a).
- Ladias J.A., Karathanasis S.K., Regulation of the apolipoprotein AI gene by ARP-1, a novel member of the steroid receptor superfamily. *Science*, (1991b).
- Lavado A., Lagutin O.V., Chow L.M.L., Baker S.J., Oliver G., Prox1 is required for granule cell maturation and intermediate progenitor maintenance during brain neurogenesis. *PLoS biology*, (2010).
- Lavdas A.A., Grigoriou M., Pachnis V., Parnavelas J.G., The medial ganglionic eminence gives rise to a population of early neurons in the developing cerebral cortex. *The Journal of neuroscience : the official journal of the Society for Neuroscience* **19**, 7881 (1999).
- Lawrence J.J., McBain C.J., Interneuron diversity series: containing the detonation--feedforward inhibition in the CA3 hippocampus. *Trends in neurosciences* **26**, 631 (2003).
- Lazzaro D., Price M., de Felice M., Di Lauro R., The transcription factor TTF-1 is expressed at the onset of thyroid and lung morphogenesis and in restricted regions of the foetal brain. *Development (Cambridge, England)* **113**, 1093 (1991).
- Lee S., Hjerling-Leffler J., Zagha E., Fishell G., Rudy B., The largest group of superficial neocortical GABAergic interneurons expresses ionotropic serotonin receptors. *The Journal of neuroscience : the official journal of the Society for Neuroscience* **30**, 16796 (2010).
- Leingärtner A., Thuret S., Kroll T.T., Chou S.-J.J., Leasure J.L., Gage F.H., O'Leary D.D., Cortical area size dictates performance at modality-specific behaviors. *Proceedings of the National Academy of Sciences of the United States of America* **104**, 4153 (2007).
- Leng X., Cooney A.J., Tsai S.Y., Molecular mechanisms of COUP-TF-mediated transcriptional repression: evidence for transrepression and active repression. *Molecular and cellular ...*, (1996).
- Letinic K., Zoncu R., Rakic P., Origin of GABAergic neurons in the human neocortex. *Nature* **417**, 645 (2002).
- Li X., Sun C., Lin C., Ma T., Madhavan M.C., The transcription factor Sp8 is required for the production of parvalbumin-expressing interneurons in the olfactory bulb. *The Journal of ...*, (2011).
- Li Y., Lambert M.H., Xu H.E., Activation of nuclear receptors: a perspective from structural genomics. *Structure (London, England : 1993)* **11**, 741 (2003).
- Lin F.-J.J., Qin J., Tang K., Tsai S.Y., Tsai M.-J.J., Coup d'Etat: an orphan takes control. *Endocrine reviews* **32**, 404 (2011).
- Liu F., You Y., Li X., Ma T., Nie Y., Wei B., Li T., Lin H., Yang Z., Brain injury does not alter the intrinsic differentiation potential of adult neuroblasts. *J Neurosci* **29**, 5075 (Apr 22, 2009).

- Liu Q., Dwyer N.D., O'Leary D.D., Differential expression of COUP-TFI, CHL1, and two novel genes in developing neocortex identified by differential display PCR. *The Journal of neuroscience : the official journal of the Society for Neuroscience* **20**, 7682 (2000).
- Lodato S., Tomassy G.S., De Leonibus E., Uzcategui Y.G., Andolfi G., Armentano M., Touzot A., Gaztelu J.M., Arlotta P., Menendez de la Prida L., Studer M., Loss of COUP-TFI alters the balance between caudal ganglionic eminence- and medial ganglionic eminence-derived cortical interneurons and results in resistance to epilepsy. *The Journal of neuroscience : the official journal of the Society for Neuroscience* **31**, 4650 (2011).
- Lois C., Alvarez-Buylla A., Long-distance neuronal migration in the adult mammalian brain. *Science (New York, N.Y.)* **264**, 1145 (1994).
- Luskin M.B., Restricted proliferation and migration of postnatally generated neurons derived from the forebrain subventricular zone. *Neuron* **11**, 173 (1993).
- Ma J., Yao X.-H.H., Fu Y., Yu Y.-C.C., Development of Layer 1 Neurons in the Mouse Neocortex. *Cerebral cortex (New York, N.Y. : 1991)*, (2013).
- Ma T., Zhang Q., Cai Y., You Y., Rubenstein J.L., Yang Z., A subpopulation of dorsal lateral/caudal ganglionic eminence-derived neocortical interneurons expresses the transcription factor sp8. *Cerebral cortex (New York, N.Y. : 1991)* **22**, 2120 (2012).
- Ma Y., Hu H., Agmon A., Short-term plasticity of unitary inhibitory-to-inhibitory synapses depends on the presynaptic interneuron subtype. *The Journal of neuroscience : the official journal of the Society for Neuroscience* **32**, 983 (2012).
- Ma Y., Hu H., Berrebi A.S., Mathers P.H., Agmon A., Distinct subtypes of somatostatin-containing neocortical interneurons revealed in transgenic mice. *The Journal of neuroscience : the official journal of the Society for Neuroscience* **26**, 5069 (2006).
- Malatesta P., Hack M.A., Hartfuss E., Kettenmann H., Klinkert W., Kirchhoff F., Götz M., Neuronal or glial progeny: regional differences in radial glia fate. *Neuron* **37**, 751 (2003).
- Marín O., Interneuron dysfunction in psychiatric disorders. *Nature reviews. Neuroscience* **13**, 107 (2012).
- Marín O., Anderson S.A., Rubenstein J.L., Origin and molecular specification of striatal interneurons. *J Neurosci* **20**, 6063 (Aug 15, 2000).
- Marín O., Rubenstein J.L., A long, remarkable journey: tangential migration in the telencephalon. *Nature reviews. Neuroscience* **2**, 780 (2001).
- Marín O., Yaron A., Bagri A., Tessier-Lavigne M., Rubenstein J.L., Sorting of striatal and cortical interneurons regulated by semaphorin-neuropilin interactions. *Science (New York, N.Y.)* **293**, 872 (2001).
- Markram H., Toledo-Rodriguez M., Wang Y., Gupta A., Silberberg G., Wu C., Interneurons of the neocortical inhibitory system. *Nature reviews. Neuroscience* **5**, 793 (2004).
- Matharu P.J., Sweeney G.E., Cloning and sequencing of a COUP transcription factor gene expressed in *Xenopus* embryos. *Biochimica et biophysica acta* **1129**, 331 (1992).
- McGarry L.M., Packer A.M., Fino E., Nikolenko V., Sippy T., Yuste R., Quantitative classification of somatostatin-positive neocortical interneurons identifies three interneuron subtypes. *Frontiers in neural circuits* **4**, 12 (2010).
- McKinsey G.L., Lindtner S., Trzcinski B., Visel A., Pennacchio L.A., Huylebroeck D., Higashi Y., Rubenstein J.L., Dlx1&2-Dependent Expression of Zfhx1b (Sip1, Zeb2) Regulates the Fate Switch between Cortical and Striatal Interneurons. *Neuron* **77**, 83 (2013).
- Miller L.M., Escabí M.A., Schreiner C.E., Feature selectivity and interneuronal cooperation in the thalamocortical system. *The Journal of neuroscience : the official journal of the Society for Neuroscience* **21**, 8136 (2001).
- Miyajima N., Kadowaki Y., Fukushige S., Shimizu S., Semba K., Yamanashi Y., Matsubara K., Toyoshima K., Yamamoto T., Identification of two novel members of erbA superfamily by molecular cloning: the gene products of the two are highly related to each other. *Nucleic acids research* **16**, 11057 (1988).
- Miyoshi G., Butt S.J., Takebayashi H., Fishell G., Physiologically distinct temporal cohorts of cortical interneurons arise from telencephalic Olig2-expressing precursors. *The Journal of neuroscience : the official journal of the Society for Neuroscience* **27**, 7786 (2007).
- Miyoshi G., Hjerling-Leffler J., Karayannis T., Sousa V.H., Butt S.J., Battiste J., Johnson J.E., Machold R.P., Fishell G., Genetic fate mapping reveals that the caudal ganglionic eminence produces a large and diverse population of superficial cortical interneurons. *The Journal of neuroscience : the official journal of the Society for Neuroscience* **30**, 1582 (2010).
- Mlodzik M., Hiromi Y., Weber U., Goodman C.S., Rubin G.M., The *Drosophila* seven-up gene, a member of the steroid receptor gene superfamily, controls photoreceptor cell fates. *Cell* **60**, 211 (1990).
- Molyneaux B.J., Arlotta P., Menezes J.R., Macklis J.D., Neuronal subtype specification in the cerebral cortex. *Nature reviews. Neuroscience* **8**, 427 (2007).

- Monuki E.S., Porter F.D., Walsh C.A., Patterning of the dorsal telencephalon and cerebral cortex by a roof plate-Lhx2 pathway. *Neuron* **32**, 591 (2001).
- Muzio L., Di Benedetto B., Stoykova A., Boncinelli E., Gruss P., Mallamaci A., Conversion of cerebral cortex into basal ganglia in Emx2(-/-) Pax6(Sey/Sey) double-mutant mice. *Nat Neurosci* **5**, 737 (Aug, 2002).
- Nadarajah B., Alifragis P., Wong R.O., Parnavelas J.G., Neuronal migration in the developing cerebral cortex: observations based on real-time imaging. *Cerebral cortex (New York, N.Y. : 1991)* **13**, 607 (2003).
- Nery S., Corbin J.G., Fishell G., Dlx2 progenitor migration in wild type and Nkx2.1 mutant telencephalon. *Cerebral cortex (New York, N.Y. : 1991)* **13**, 895 (2003).
- Nery S., Fishell G., Corbin J.G., The caudal ganglionic eminence is a source of distinct cortical and subcortical cell populations. *Nature neuroscience* **5**, 1279 (2002).
- Noctor S.C., Martínez-Cerdeño V., Ivic L., Kriegstein A.R., Cortical neurons arise in symmetric and asymmetric division zones and migrate through specific phases. *Nature neuroscience* **7**, 136 (2004).
- O'Leary D.D., Sahara S., Genetic regulation of arealization of the neocortex. *Current opinion in neurobiology* **18**, 90 (2008).
- Oláh S., Komlósi G., Szabadics J., Varga C., Tóth É., Barzó P., Tamás G., Output of neurogliaform cells to various neuron types in the human and rat cerebral cortex. *Frontiers in neural circuits* **1**, (2007).
- Parent J.M., Murphy G.G., Ganglionic eminence graft pre-eminence in epilepsy. *Nature neuroscience* **16**, 656 (2013).
- Park J.-I.I., Tsai S.Y., Tsai M.-J.J., Molecular mechanism of chicken ovalbumin upstream promoter-transcription factor (COUP-TF) actions. *The Keio journal of medicine* **52**, 174 (2003).
- Parnavelas J.G., The origin of cortical neurons. *Brazilian Journal of Medical and Biological Research*, (2002).
- Pastorcic M., Wang H., Elbrecht A., Tsai S.Y., Tsai M.J., O'Malley B.W., Control of transcription initiation in vitro requires binding of a transcription factor to the distal promoter of the ovalbumin gene. *Molecular and cellular biology* **6**, 2784 (1986).
- Pereira F.A., Qiu Y., Zhou G., Tsai M.J., Tsai S.Y., The orphan nuclear receptor COUP-TFII is required for angiogenesis and heart development. *Genes & development* **13**, 1037 (1999).
- Pereira F.A., Tsai M.J., Tsai S.Y., COUP-TF orphan nuclear receptors in development and differentiation. *Cellular and molecular life sciences : CMLS* **57**, 1388 (2000).
- Pinto D.J., Brumberg J.C., Simons D.J., Circuit dynamics and coding strategies in rodent somatosensory cortex. *Journal of neurophysiology* **83**, 1158 (2000).
- Pinto D.J., Hartings J.A., Brumberg J.C., Simons D.J., Cortical damping: analysis of thalamocortical response transformations in rodent barrel cortex. *Cerebral cortex (New York, N.Y. : 1991)* **13**, 33 (2003).
- Pleasure S.J., Anderson S., Hevner R., Bagri A., Marin O., Lowenstein D.H., Rubenstein J.L., Cell migration from the ganglionic eminences is required for the development of hippocampal GABAergic interneurons. *Neuron* **28**, 727 (2000).
- Porter J.T., Cauli B., Staiger J.F., Lambolez B., Rossier J., Audinat E., Properties of bipolar VIPergic interneurons and their excitation by pyramidal neurons in the rat neocortex. *The European journal of neuroscience* **10**, 3617 (1998).
- Pouille F., Scanziani M., Enforcement of temporal fidelity in pyramidal cells by somatic feed-forward inhibition. *Science (New York, N.Y.)* **293**, 1159 (2001).
- Price C.J., Cauli B., Kovacs E.R., Kulik A., Lambolez B., Shigemoto R., Capogna M., Neurogliaform neurons form a novel inhibitory network in the hippocampal CA1 area. *The Journal of neuroscience : the official journal of the Society for Neuroscience* **25**, 6775 (2005).
- Price M., Lazzaro D., Pohl T., Mattei M.G., Rütther U., Olivo J.C., Duboule D., Di Lauro R., Regional expression of the homeobox gene Nkx-2.2 in the developing mammalian forebrain. *Neuron* **8**, 241 (1992).
- Qiu Y., Cooney A.J., Kuratani S., DeMayo F.J., Tsai S.Y., Tsai M.J., Spatiotemporal expression patterns of chicken ovalbumin upstream promoter-transcription factors in the developing mouse central nervous system: evidence for a role in segmental patterning of the diencephalon. *Proceedings of the National Academy of Sciences of the United States of America* **91**, 4451 (1994a).
- Qiu Y., Pereira F.A., DeMayo F.J., Lydon J.P., Tsai S.Y., Tsai M.J., Null mutation of mCOUP-TFI results in defects in morphogenesis of the glossopharyngeal ganglion, axonal projection, and arborization. *Genes & development* **11**, 1925 (1997).
- Qiu Y., Tsai S.Y., Tsai M.J., COUP-TF an orphan member of the steroid/thyroid hormone receptor superfamily. *Trends in Endocrinology & Metabolism*, (1994b).
- Rakic P., Neurons in rhesus monkey visual cortex: systematic relation between time of origin and eventual disposition. *Science (New York, N.Y.)* **183**, 425 (1974).
- Rallu M., Corbin J.G., Fishell G., Parsing the prosencephalon. *Nat Rev Neurosci* **3**, 943 (Dec, 2002).

- Rallu M., Machold R., Gaiano N., Corbin J.G., McMahon A.P., Fishell G., Dorsoventral patterning is established in the telencephalon of mutants lacking both Gli3 and Hedgehog signaling. *Development (Cambridge, England)* **129**, 4963 (2002).
- Reinchisi G., Ijichi K., Glidden N., Jakovcevski I., Zecevic N., COUP-TFII Expressing Interneurons in Human Fetal Forebrain. *Cerebral cortex (New York, N.Y. : 1991)*, (2011).
- Renaud J.P., Rochel N., Ruff M., Vivat V., Chambon P., Crystal structure of the RAR- γ ligand-binding domain bound to all-trans retinoic acid. *Nature*, (1995).
- Reyes A., Lujan R., Rozov A., Burnashev N., Somogyi P., Sakmann B., Target-cell-specific facilitation and depression in neocortical circuits. *Nature neuroscience* **1**, 279 (1998).
- Ritchie H.H., Wang L.H., Tsai S., O'Malley B.W., COUP-TF gene: a structure unique for the steroid/thyroid receptor superfamily. *Nucleic acids ...*, (1990).
- Rubin A.N., Kessaris N., PROX1: a lineage tracer for cortical interneurons originating in the lateral/caudal ganglionic eminence and preoptic area. *PLoS one* **8**, (2013).
- Rudy B., Fishell G., Lee S., Hjerling-Leffler J., Three groups of interneurons account for nearly 100% of neocortical GABAergic neurons. *Developmental neurobiology* **71**, 45 (2011).
- Sahara S., Kawakami Y., Izpisua Belmonte J.C., O'Leary D.D., Sp8 exhibits reciprocal induction with Fgf8 but has an opposing effect on anterior-posterior cortical area patterning. *Neural development* **2**, 10 (2007).
- Seuntjens E., Nityanandam A., Miquelajaugue A., Sip1 regulates sequential fate decisions by feedback signaling from postmitotic neurons to progenitors. *Nature ...*, (2009).
- Shitamukai A., Konno D., Matsuzaki F., Oblique radial glial divisions in the developing mouse neocortex induce self-renewing progenitors outside the germinal zone that resemble primate outer subventricular zone progenitors. *The Journal of neuroscience : the official journal of the Society for Neuroscience* **31**, 3683 (2011).
- Silberberg G., Markram H., Disynaptic inhibition between neocortical pyramidal cells mediated by Martinotti cells. *Neuron* **53**, 735 (2007).
- Simon A., Oláh S., Molnár G., Szabadics J., Tamás G., Gap-junctional coupling between neurogliaform cells and various interneuron types in the neocortex. *The Journal of neuroscience : the official journal of the Society for Neuroscience* **25**, 6278 (2005).
- Smart I.H., Proliferative characteristics of the ependymal layer during the early development of the mouse neocortex: a pilot study based on recording the number, location and plane of cleavage of mitotic figures. *Journal of anatomy* **116**, 67 (1973).
- Sousa V.H., Miyoshi G., Hjerling-Leffler J., Karayannis T., Fishell G., Characterization of Nkx6-2-derived neocortical interneuron lineages. *Cerebral cortex (New York, N.Y. : 1991)* **19 Suppl 1**, 10 (2009).
- Southwell D.G., Nicholas C.R., Basbaum A.I., Stryker M.P., Kriegstein A.R., Rubenstein J.L., Alvarez-Buylla A., Interneurons from embryonic development to cell-based therapy. *Science (New York, N.Y.)* **344**, 1240622 (2014).
- Stenman J., Toresson H., Campbell K., Identification of two distinct progenitor populations in the lateral ganglionic eminence: implications for striatal and olfactory bulb neurogenesis. *The Journal of neuroscience* **23**, 167 (2003).
- Sussel L., Marin O., Kimura S., Rubenstein J.L., Loss of Nkx2.1 homeobox gene function results in a ventral to dorsal molecular respecification within the basal telencephalon: evidence for a transformation of the pallidum into the striatum. *Development (Cambridge, England)* **126**, 3359 (1999).
- Swindell E.C., Bailey T.J., Loosli F., Liu C., Amaya-Manzanares F., Mahon K.A., Wittbrodt J., Jamrich M., Rx-Cre, a tool for inactivation of gene expression in the developing retina. *Genesis (New York, N.Y. : 2000)* **44**, 361 (2006).
- Tamamaki N., Fujimori K., Nojyo Y., Kaneko T., Takauji R., Evidence that Sema3A and Sema3F regulate the migration of GABAergic neurons in the developing neocortex. *The Journal of comparative neurology* **455**, 238 (2003).
- Tamás G., Lorincz A., Simon A., Szabadics J., Identified sources and targets of slow inhibition in the neocortex. *Science (New York, N.Y.)* **299**, 1902 (2003).
- Tang K., Rubenstein J.L., Tsai S.Y., Tsai M.-J.J., COUP-TFII controls amygdala patterning by regulating neuropilin expression. *Development (Cambridge, England)* **139**, 1630 (2012).
- Tang K., Tsai S.Y., Tsai M.-J.J., COUP-TFs and eye development. *Biochimica et biophysica acta*, (2014).
- Taniguchi H., Genetic dissection of GABAergic neural circuits in mouse neocortex. *Frontiers in cellular neuroscience* **8**, 8 (2014).
- Taniguchi H., Lu J., Huang Z.J., The spatial and temporal origin of chandelier cells in mouse neocortex. *Science (New York, N.Y.)* **339**, 70 (2013).
- Thummel C.S., From embryogenesis to metamorphosis: the regulation and function of Drosophila nuclear receptor superfamily members. *Cell* **83**, 871 (1995).

- Tochitani S., Kondo S., Immunoreactivity for GABA, GAD65, GAD67 and Bestrophin-1 in the meninges and the choroid plexus: implications for non-neuronal sources for GABA in the developing mouse brain. *PLoS one* **8**, (2013).
- Tomassy G.S., De Leonibus E., Jabaudon D., Lodato S., Alfano C., Mele A., Macklis J.D., Studer M., Area-specific temporal control of corticospinal motor neuron differentiation by COUP-TFI. *Proceedings of the National Academy of Sciences of the United States of America* **107**, 3576 (2010).
- Tran P., Zhang X.K., Salbert G., Hermann T., COUP orphan receptors are negative regulators of retinoic acid response pathways. ... *and cellular biology*, (1992).
- Treichel D., Schöck F., Jäckle H., Gruss P., mBtd is required to maintain signaling during murine limb development. ... *& development*, (2003).
- Tricoire L., Pelkey K.A., Daw M.I., Sousa V.H., Miyoshi G., Jeffries B., Cauli B., Fishell G., McBain C.J., Common origins of hippocampal Ivy and nitric oxide synthase expressing neurogliaform cells. *The Journal of neuroscience : the official journal of the Society for Neuroscience* **30**, 2165 (2010).
- Tripodi M., Filosa A., Armentano M., Studer M., The COUP-TF nuclear receptors regulate cell migration in the mammalian basal forebrain. *Development (Cambridge, England)* **131**, 6119 (2004).
- Tsai M.J., O'Malley B.W., Molecular mechanisms of action of steroid/thyroid receptor superfamily members. *Annual review of biochemistry* **63**, 451 (1994).
- Tsai S.Y., Sagami I., Wang H., Tsai M.J., O'Malley B.W., Interactions between a DNA-binding transcription factor (COUP) and a non-DNA binding factor (S300-II). *Cell* **50**, 701 (1987).
- Tsai S.Y., Tsai M.J., Chick ovalbumin upstream promoter-transcription factors (COUP-TFs): coming of age. *Endocrine reviews* **18**, 229 (1997a).
- Tsai S.Y., Tsai M.J., Chick Ovalbumin Upstream Promoter-Transcription Factors (COUP-TFs): Coming of Age 1. *Endocrine Reviews*, (1997b).
- Uematsu M., Hirai Y., Karube F., Ebihara S., Kato M., Abe K., Obata K., Yoshida S., Hirabayashi M., Yanagawa Y., Kawaguchi Y., Quantitative chemical composition of cortical GABAergic neurons revealed in transgenic venus-expressing rats. *Cerebral cortex (New York, N.Y. : 1991)* **18**, 315 (2008).
- Valcanis H., Tan S.-S.S., Layer specification of transplanted interneurons in developing mouse neocortex. *The Journal of neuroscience : the official journal of the Society for Neuroscience* **23**, 5113 (2003).
- van den Berghe V., Stappers E., Vandesande B., Dimidschstein J., Kroes R., Francis A., Conidi A., Lesage F., Dries R., Cazzola S., Berx G., Kessaris N., Vanderhaeghen P., van Ijcken W., Grosveld F.G., Goossens S., Haigh J.J., Fishell G., Goffinet A., Aerts S., Huylebroeck D., Seuntjens E., Directed migration of cortical interneurons depends on the cell-autonomous action of sip1. *Neuron* **77**, 70 (2013).
- van der Wees J., Matharu P.J., de Roos K., Developmental expression and differential regulation by retinoic acid of *Xenopus* COUP-TF-A and COUP-TF-B. ... *of development*, (1996).
- Vogt D., Hunt R.F., Mandal S., Sandberg M., Silberberg S.N., Nagasawa T., Yang Z., Baraban S.C., Rubenstein J.L., Lhx6 directly regulates Arx and CXCR7 to determine cortical interneuron fate and laminar position. *Neuron* **82**, 350 (2014).
- Vucurovic K., Gallopin T., Ferezou I., Rancillac A., Chameau P., van Hooft J.A., Geoffroy H., Monyer H., Rossier J., Vitalis T., Serotonin 3A receptor subtype as an early and protracted marker of cortical interneuron subpopulations. *Cerebral cortex (New York, N.Y. : 1991)* **20**, 2333 (2010).
- Vyas A., Saha B., Lai E., Tole S., Paleocortex is specified in mice in which dorsal telencephalic patterning is severely disrupted. *The Journal of comparative neurology* **466**, 545 (2003).
- Waclaw R.R., Allen Z.J., Bell S.M., Erdélyi F., Szabó G., Potter S.S., Campbell K., The zinc finger transcription factor Sp8 regulates the generation and diversity of olfactory bulb interneurons. *Neuron* **49**, 503 (2006).
- Wang L.H., Ing N.H., Tsai S.Y., O'Malley B.W., Tsai M.J., The COUP-TFs compose a family of functionally related transcription factors. *Gene expression* **1**, 207 (1991).
- Wang L.H., Tsai S.Y., Cook R.G., Beattie W.G., Tsai M.J., O'Malley B.W., COUP transcription factor is a member of the steroid receptor superfamily. *Nature* **340**, 163 (1989).
- Wang L.H., Tsai S.Y., O'Malley B.W., Tsai M.J., The COUP-TFs compose a family of functionally related transcription factors. *Gene expression*, (1990).
- Wang L.H., Tsai S.Y., Sagami I., Tsai M.J., O'Malley B.W., Purification and characterization of chicken ovalbumin upstream promoter transcription factor from HeLa cells. *The Journal of biological chemistry* **262**, 16080 (1987).
- Wang X., Tsai J.-W.W., LaMonica B., Kriegstein A.R., A new subtype of progenitor cell in the mouse embryonic neocortex. *Nature neuroscience* **14**, 555 (2011).
- Wang Y., Toledo-Rodriguez M., Gupta A., Wu C., Silberberg G., Luo J., Markram H., Anatomical, physiological and molecular properties of Martinotti cells in the somatosensory cortex of the juvenile rat. *The Journal of physiology* **561**, 65 (2004).

- Wei B., Nie Y., Li X., Wang C., Ma T., Huang Z., Tian M., Sun C., Cai Y., You Y., Liu F., Yang Z., Emx1-expressing neural stem cells in the subventricular zone give rise to new interneurons in the ischemic injured striatum. *The European journal of neuroscience* **33**, 819 (2011).
- Wichterle H., Garcia-Verdugo J.M., Herrera D.G., Alvarez-Buylla A., Young neurons from medial ganglionic eminence disperse in adult and embryonic brain. *Nature neuroscience* **2**, 461 (1999).
- Wichterle H., Turnbull D.H., Nery S., Fishell G., Alvarez-Buylla A., In utero fate mapping reveals distinct migratory pathways and fates of neurons born in the mammalian basal forebrain. *Development (Cambridge, England)* **128**, 3759 (2001).
- Willi-Monnerat S., Migliavacca E., Surdez D., Delorenzi M., Luthi-Carter R., Terskikh A.V., Comprehensive spatiotemporal transcriptomic analyses of the ganglionic eminences demonstrate the uniqueness of its caudal subdivision. *Molecular and cellular neurosciences* **37**, 845 (2008).
- Wonders C.P., Anderson S.A., The origin and specification of cortical interneurons. *Nature reviews. Neuroscience* **7**, 687 (2006).
- Wonders C.P., Taylor L., Welagen J., Mbata I.C., Xiang J.Z., Anderson S.A., A spatial bias for the origins of interneuron subgroups within the medial ganglionic eminence. *Developmental biology* **314**, 127 (2008).
- Xianming Y., Janet E.M., Critical Roles of Nuclear Receptor Response Elements in Replication of Hepatitis B Virus. *Journal of Virology* **75**, 11354 (2001).
- Xiaoren T., Hai-Ou L., Osamu S., Tomohiro O., Hatsumi T., Arian F.A.S., Masami H., Phillippe K., Alain I., Gabriel G., Kazushige Y., Cooperativity between an Upstream TATA-like Sequence and a CAA Repeated Element Mediates E1A-dependent Negative Repression of the H-2K Class I Gene. *Journal of Biological Chemistry* **270**, 2327 (1995).
- Xu H., Jeong H.-Y.Y., Tremblay R., Rudy B., Neocortical somatostatin-expressing GABAergic interneurons disinhibit the thalamorecipient layer 4. *Neuron* **77**, 155 (2013).
- Xu Q., Cobos I., De La Cruz E., Rubenstein J.L., Anderson S.A., Origins of cortical interneuron subtypes. *The Journal of neuroscience : the official journal of the Society for Neuroscience* **24**, 2612 (2004).
- Xu Q., de E., Anderson S.A., Cortical interneuron fate determination: diverse sources for distinct subtypes? *Cerebral Cortex*, (2003).
- Xu Q., Tam M., Anderson S.A., Fate mapping Nkx2.1-lineage cells in the mouse telencephalon. *The Journal of comparative neurology* **506**, 16 (2008).
- Xu X., Callaway E.M., Laminar specificity of functional input to distinct types of inhibitory cortical neurons. *The Journal of neuroscience : the official journal of the Society for Neuroscience* **29**, 70 (2009).
- Xu X., Roby K.D., Callaway E.M., Immunohistochemical characterization of inhibitory mouse cortical neurons: three chemically distinct classes of inhibitory cells. *The Journal of comparative neurology* **518**, 389 (2010).
- Yozu M., Tabata H., Nakajima K., The caudal migratory stream: a novel migratory stream of interneurons derived from the caudal ganglionic eminence in the developing mouse forebrain. *The Journal of neuroscience : the official journal of the Society for Neuroscience* **25**, 7268 (2005).
- Zembrzycki A., Griesel G., Stoykova A., Mansouri A., Genetic interplay between the transcription factors Sp8 and Emx2 in the patterning of the forebrain. *Neural development* **2**, 8 (2007).
- Zhou C., Qiu Y., Pereira F.A., Crair M.C., Tsai S.Y., Tsai M.J., The nuclear orphan receptor COUP-TFI is required for differentiation of subplate neurons and guidance of thalamocortical axons. *Neuron* **24**, 847 (1999).
- Zsiros V., Maccaferri G., Electrical coupling between interneurons with different excitable properties in the stratum lacunosum-moleculare of the juvenile CA1 rat hippocampus. *The Journal of neuroscience : the official journal of the Society for Neuroscience* **25**, 8686 (2005).