



**HAL**  
open science

# The timing of oligodendrocyte cell death determines the potential of myelin recovery during brain postnatal development.

Asghar Shabbir

► **To cite this version:**

Asghar Shabbir. The timing of oligodendrocyte cell death determines the potential of myelin recovery during brain postnatal development.. Biochemistry, Molecular Biology. Université de Strasbourg, 2013. English. NNT: 2013STRAJ089 . tel-01410528

**HAL Id: tel-01410528**

**<https://theses.hal.science/tel-01410528>**

Submitted on 6 Dec 2016

**HAL** is a multi-disciplinary open access archive for the deposit and dissemination of scientific research documents, whether they are published or not. The documents may come from teaching and research institutions in France or abroad, or from public or private research centers.

L'archive ouverte pluridisciplinaire **HAL**, est destinée au dépôt et à la diffusion de documents scientifiques de niveau recherche, publiés ou non, émanant des établissements d'enseignement et de recherche français ou étrangers, des laboratoires publics ou privés.



UNIVERSITÉ DE STRASBOURG



**ÉCOLE DOCTORALE 414**

[Biopathologie de la Myéline, Neuroprotection et Stratégies Thérapeutiques INSERM U 1119]

**THÈSE** présentée par :

**[ Asghar SHABBIR ]**

soutenue le : 1<sup>er</sup> Juillet 2013

pour obtenir le grade de : **Docteur de l'université de Strasbourg**

Discipline/ Spécialité : Neurosciences

**LE PROGRAMME D'INDUCTION DE LA MORT  
CELLULAIRE DES OLIGODENDROCYTES DETERMINE  
LE POTENTIEL DE REPARATION DE LA MYÉLINE AU  
COURS DU DÉVELOPPEMENT**

**THÈSE dirigée par :**

**M. GHANDOUR Said** (Directeur de recherche au CNRS, Université de Strasbourg)

**RAPPORTEURS :**

**M. SCHUMACHER Michael** (Directeur de recherche, INSERM, Université Paris-Sud)

**M. MASSAAD Charbel** (Professeur, Université Paris Descartes)

**AUTRES MEMBRES DU JURY :**

**Mme. BOEHM Nelly** (Professeur, Université de Strasbourg) Examineur

**M. MENSAH-NYAGAN Guy** (Professeur, Université de Strasbourg) Membre invité

*I Dedicte this Humble Effort to my Parents  
and all the Family*

## **ACKNOWLEDGMENTS**

I feel enormous delight to convey my honest gratitude to my supervisor, Dr. Said GHANDOUR, for making it possible for me to work in such a prestigious scientific environment. He has been very supportive, encouraging and kind. I owe a great deal of appreciation for his valuable advice, constructive criticism and extensive discussions around my work. It has been a great honor to work under his supervision.

I wish to express my cordial appreciation to the examiners, Dr. Michael SCHUMACHER and Prof. Charbel MASSAAD, Prof. Nelly BOEHM and Prof. Guy MENSAH-NYAGAN for the acceptance of being members of the examination committee.

I feel immense pleasure to gratefully acknowledge to Prof. Guy MENSAH-NYAGAN, director of our present INSERM U 1119 laboratory and Dr. Christian KELCHE, director of the former laboratory and to all the members of the two laboratories.

I am greatly thankful particularly to Elisabeth TRIFILIEFF, Jérôme DE SEZE, Jérôme STEIBEL, Gabrielle RUDOLF, Laurence MEYER, Christine PATTE-MENSAH, Brigitte SAMAMA, Cristina ANTAL, Nicolas COLLONGUES, Jean-Baptiste CHANSON and Susana BRUN and for their valuable suggestions as members of the laboratory. I extend my admiration and appreciation to Julien GRAFF, Dao LAM and Roland BURY for all their assistance and support.

No acknowledgment could ever adequately express my obligation and humble thanks to my Pakistani friends Ghulam HUSSAIN, Rizwan ASLAM, Sultan ALI, Adnan NIAZI, Azhar AYZ, Rashad HUSSAIN, Nauman ZAHID, Sarfraz SHAFIQ and Muhammad AZEEM who always stood beside me in the hour of need.

I am unable to find appropriate words to express my deep gratitude for Higher Education Commission of Pakistan, for providing me this opportunity to work in this reputed scientific community to learn and improve my scientific skills, knowledge and rational thinking.

I am perpetually grateful to my beloved parents and all the family members for their unconditional love, loyalty, endurance, countless prayers and endless efforts. They have always been a source of inspiration for me.

**Asghar SHABBIR**

# Table of Contents

Title	Page No
Aknowlegements	3
List of contents	5
List of figures	11
List of abbreviations	13
Résumé	16
Summary	25
I. Introduction	32
I-1 Central Nervous System (CNS)	33
1.1 Functions of CNS	33
1.1.1 Integration of information	33
1.1.2 Homeostasis	33
1.1.3 Mental Activity	33
1.1.4 Control of muscles and glands	34
1.2 Cells of CNS	34
1.2.1 Neurons	34
1.2.2 Neuroglia	34
1.2.2.1 History and discovery of Neuroglial cells	34
1.2.2.1.1 Pre-Cajalian period	35
1.2.2.1.2 Cajalian period	36
1.2.2.1.3 Post-Cajalian period	37
I-2 Astrocytes	39
2.1 Morphology	39
2.1.1 Fibrous and Protoplasmic astrocytes	39
2.1.2 Radial glia during development	40
2.2 Identification	41
2.3 General Functions of Astrocytes	41
2.3.1 Synapse transmission and neuron survival	41
2.3.2 Synapse stabilization and elimination	41
2.3.3 Blood brain barrier	42
2.3.4 Support	42
2.3.5 Astrocytes and inflammatory response	43
2.3.6 Astrocytes as energy regulators	43
2.4 Astrocytes and myelin	43

2.4.1	Role in myelination	44
2.4.2	Inhibition of remyelination	45
2.4.2.1	Formation of glial scar	45
2.4.2.2	Astrocytes prevent OPC migration and maturation	45
2.4.3	Protective effects of astrocytes that promote neuroprotection and myelin repair	46
2.4.4	Release of extracellular matrix related Factors	46
2.4.5	Astrocyte-Derived Chemokines production	47
I-3	Microglia	49
3.1	Origin of microglia	49
3.2	Morphology	50
3.3	Identification	52
3.4	Activation of microglia	52
3.5	General functions of microglia	53
3.5.1	Regulators of CNS immunity	53
3.5.2	Maintenance of microenvironment	54
3.5.3	Cytotoxic effects	54
3.5.4	Microglia and development	54
3.5.5	Neuroprotection	55
3.5.6	Housekeepers	55
3.5.7	Antigen presentation	55
3.5.8	Promotion of repair	55
3.6	Microglia and myelination	56
3.6.1	Interaction with oligodendrocytes	56
3.6.2	Microglial activation	56
3.6.3	T-cells infiltration	56
3.6.4	Microglia as macrophages	58
I-4	Oligodendrocytes	60
4.1	Oligodendrocyte morphology	60
4.2	Classification of oligodendrocytes	61
4.3	Origin and differentiation of Oligodendrocytes	62
4.3.1	Common precursors for neurons and glia: pluripotentiality of stem cells	64

4.3.2	Oligodendrocyte precursors in the ventricular zone	65
4.3.3	Oligodendrocyte progenitors in the SVZ	66
4.4	Oligodendrocyte migration	68
4.5	Oligodendrocyte maturation	70
4.6	Factors necessary for oligodendrocyte maturation and survival	73
4.6.1	Growth Factors	74
4.6.1.1	Platelet derived growth factor (PDGF)	74
4.6.1.2	Basic fibroblast growth factor (bFGF)	74
4.6.1.3	Insulin-like growth factor I	75
4.6.1.4	Neurotrophin-3. (NT-3)	76
4.6.1.5	Glial growth factor (GGF)	76
4.6.1.5	Ciliary neurotrophic factor (CNTF)	76
4.6.1.6	Interleukin-6 and Interleukin 2 (IL-6, IL-2)	76
4.6.1.8	Transforming growth factor (TGF)	76
4.6.1.9	Vascular endothelial growth factor (VEGF-A)	77
4.6.1.10	Hepatocyte growth factor (HGF)	77
4.6.1.11	Fibroblast growth factor receptor 1(FGFR1)	77
4.6.1.12	Pigment epithelium-derived factor (PEDF)	78
4.6.2	Other proteins and receptors	78
4.6.2.1	Poly Sialic Acid Neural Cell Adhesion Molecule (PSA- NCAM)	78
4.6.2.2	NG2	79
4.6.2.3	Erythropoietin	79
4.6.2.4	Glutamate and their receptors (NMDA)	80
4.6.2.5	Semaphorin 3F	80
4.6.2.6	Semaphorin 6A (Sema6A)	80
4.6.2.7	Sema4D	81
4.6.2.8	Cellular prion protein (PrPc)	81
4.6.2.9	Slit 2	81
4.6.3	Genes and Transcription factors	82
4.6.3.1	Sonic hedgehog	84
4.6.3.2	Transcription factors Olig1 and Olig2	84
4.6.3.2.1	Olig2 Phosphorylation	86



4.6.3.3 Sox 9 and 10	87
4.7 Markers of oligodendrocyte lineage	87
4.8 Functions of oligodendrocytes	89
4.10.1 Saltatory conduction	89
4.10.2 Source of CNS iron	90
4.10.3 Maintenance of functional structure	90
4.10.4 Axon survival	91
I-5 Myelin	92
5.1 Nodes of Ranvier	92
5.2 Myelin architecture	92
5.3 Myelin Biochemistry	93
5.3.1 Lipids	95
5.3.2 Proteins	96
5.3.2.1 Proteolipid protein (PLP).	97
5.3.2.2 Myelin basic proteins (MBP)	98
5.3.2.3 2', 3'-Cyclic nucleotide 3'-phosphodiesterase (CNP)	99
5.3.2.4 Myelin-associated glycoprotein (MAG)	100
5.3.2.5 Myelin oligodendrocyte glycoprotein (MOG)	101
5.3.2.6 Oligodendrocyte-myelin glycoprotein (OMgp)	102
5.3.2.7 Paranodal proteins	102
5.3.3 Enzymes associated with myelin	103
5.4 Steps and timing of myelination	105
5.5 Myelin Function	106
5.5.1 Physiology	106
5.5.2 Pathophysiology	107
5.6 Myelin associated disorders	108
5.6.1 Multiple sclerosis (MS)	108
5.6.1.1 Types of MS	108
5.6.1.2 Factors involved in MS	110
5.6.1.3 Clinico-pathological characteristics of MS	111
5.6.2 Leukodystrophies	111
5.6.2.1 Adrenoleukodystrophy (ALD)	112
5.6.2.2 Globoid Cell Leukodystrophy (Krabbe's Disease)	112

5.6.2.3	Metachromatic Leukodystrophy	112
5.6.2.4	Pelizaeus-Merzbacher Disease (PMD)	113
5.6.2.5	Alexander's Disease	113
5.6.3	Demyelination and axonal injury	114
5.6.3.1	Axonal injury in multiple sclerosis	114
5.6.3.1.1	Early axonal transaction in brain MS lesions	115
5.6.3.1.2	Inflammation mediated axonal degeneration in MS	116
5.6.3.2	Axonal Damage in Leukodystrophies	117
5.6.3.2.1	X-linked adrenoleukodystrophy	117
5.6.3.2.2	Metachromatic leukodystrophy	117
5.6.3.2.3	Krabbe's disease	117
5.6.3.2.4	Pelizaeus-Merzbacher	117
5.7	Therapeutic strategies to promote remyelination	118
5.7.1	Transplantation of exogenous cells	118
5.7.2	Promoting endogenous remyelination	119
5.7.2.1	Growth factors and related molecules	120
5.7.2.2	Hormones	122
I-6	Animal models of demyelination	124
6.1	Immune mediated mouse models	124
6.1.1	Experimental autoimmune encephalomyelitis (EAE)	124
6.2	Virus-induced demyelinating disease	125
6.2.1	Theiler's murine encephalomyelitis virus (TMEV)	125
6.2.2	Mouse hepatitis virus (MHV)	126
6.3	Toxic models of demyelination and remyelination	126
6.3.1	Cuprizone mouse model	126
6.3.2	Etidium bromide	127
6.3.3	Lysolecithin (Lysophosphatidyl Choline)	128
6.4	Mutant mice	128
6.4.1	MPB mutant mice	129
6.4.1.1	Shiverer mice	129
6.4.1.2	Myelin-deficient mutant mice (mld)	129
6.4.2	PLP mutations	130
6.4.2.1	Shaking pups (Sh pup)	130

6.4.2.2	Jimpy mouse model	131
6.4.2.3	Myelin-deficient (md) rats	132
6.4.2.4	The rumpshaker mice	132
6.4.3	Qkl mutation	133
6.4.4	Twicher mouse model	133
6.5	Genetic models of demyelination	134
6.5.1	Diphtheria toxin induced demyelination	134
6.5.2	Knockout mice models	135
6.5.3	Conditional killing of oligodendrocytes expressing HSV1 thymidine kinase in transgenic mice	136
VI.	List of publications and presentations	137
VII.	Literature Cited	138
VIII	Publication	----

## List of Figures

Figure 1	Structure of HSV1-TTK transgene	21
Figure 2	Structure of PLP-eGFP transgene	21
Figure 3	Mechanism of action of Ganciclovir (GCV)	22
Figure 4	A schematic representation of mice groups used	23
Figure 5	Oligodendrocytes (CA II <sup>+</sup> cells) in the corpus callosum of Oligo-TTK mice	25
Figure 6	Green fluorescent expressing oligodendrocytes in the corpus callosum of Oligo-TTK-eGFP mice	26
Figure I-1	Santiago Ramon y Cajal (1852–1934)	40
Figure I-2	Astrocytes	43
Figure I-3	Morphological forms of astrocytes	44
Figure I-4	Astrocyte functions in healthy CNS	46
Figure I-5	Effects of astrocytes on demyelination	48
Figure I-6	Dual role of astrocytes in remyelination	51
Figure I-7	Microglia	53
Figure I-8	Discovery of microglial cells by Pio del Rio-Hortega	55
Figure I-9	Stepwise activation of microglial cells along with expression of markers	57
Figure I-10	Positive effects of microglia on demyelination	61
Figure I-11	Oligodendrocytes	64
Figure I-12	Origin of oligodendrocytes originate in the rodent spinal cord	67
Figure I-13	Origin of OPCs in the forebrain ventricular zone	67
Figure I-14	Oligodendrocytes development from embryonic life to adult stage	70
Figure I-15	Migration of OPCs along optic nerve	73
Figure I-16	Different stages of oligodendrocyte development	75
Figure I-17	Oligodendrocyte specification in the spinal cord	87
Figure I-18	Structural representation of human Olig1 and Olig2	89
Figure I-19	Oligodendrocyte markers specific for each developmental stage	92
Figure I-20	Salutatory conduction along a myelinated axon	94
Figure I-21	Oligodendrocyte along with its unwrapped myelin	98
Figure I-22	Myelin structure and its major constituents	102
Figure I-23	Schematic representation of NgR and P75 receptors	106
Figure I-24	Electron micrograph of an axon with surrounding compact myelin	108

Figure I-25	MS disease progression	113
Figure I-26	Possible mechanisms for demyelination in multiple sclerosis	114
Figure I-27	Axonal transection in MS lesion	118
Figure I-28	Sever axon loss in the spinal cord of a paralyzed MS patient	119
Figure I-29	Axonal loss in the ventral spinal cord of the chronic-relapsing EAE mouse	120
Figure I-30	Application of stem cells to stimulate myelin regeneration	124
Figure I-31	Different mechanisms involved in the stimulation of remyelination	125
Figure I-32	Mutation of <i>mld</i> mouse	133
Figure I-33	Mutations in the coding region of PLP/DM20 gene	135
Figure I-34	Tamoxifen mediated oligodenrocyte ablation in <i>DTA</i> mice	139

## List of abbreviations

ALD	Adrenoleukodystrophy
ALS	Amyotrophic lateral sclerosis
AMN	Adrenomyeloneuropathy
APP	Axonal amyloid precursor protein
BBB	Blood brain barrier
BDNF	Brain-derived neuro- trophic factor
bHLH	Basic- helix-loop-helix
CA II	Carbonic anhydrase ii
Caspr	Contactin -associated protein
CNP	2', 3'-cyclic nucleotide 3'-phosphodiesterase
CNS	Central nervous system
CNTF	Ciliary neurotrophic factor
CRs	Complement receptors
DT-A	Diphtheria toxin-a
EAE	Experimental autoimmune encephalomyelitis
ECM	Extracellular matrix
Epo	Erythropoietin
ERK	Extracellular signal-regulated kinases
FcRs	Fc receptors
FGF	Fibroblast growth factor
FGFR1	Fibroblast growth factor receptor 1
GABA	$\gamma$ -Aminobutyric acid
GALC	Galactocerebrosidase
GalC	Galactosylceramides
gcm	Glial cells missing
GCV	Ganciclovir
GD3	Ganglioside
GFAP	Glial fibrillary acidic protein
GGF	Glial growth factor
GLD	Globoid cell leukodystrophy
GLUT5	Glucose transporter 5
GPI	Glycosyl-phosphatidylinositol
GRP	Glial restricted precursors
HGF	Hepatocyte growth factor
Iba1	Ionized calcium binding adaptor molecule 1
IFN- $\gamma$	Interferon- $\gamma$
IGF-I	Insulin-like growth factor-1
IL	Interleukin
IL1Rs	Interleukin-1 receptors
ILB4	isolectin B4
iNOS	Inducible nitric oxide synthase

LDs	Leukodystrophies
MAG	Myelin-associated glycoprotein
MBP	Myelin basic protein
MCT-1	Monocarboxylate transporter
md	Myelin-deficient
MHC II	Major histocompatibility complex class ii
MHV	Mouse hepatitis virus
mld	Myelin-deficient mutant mice
MMP	Metalloproteinases
MOG	Myelin oligodendroglial glycoprotein
MRI	Magnetic resonance imaging
MS	Multiple sclerosis
NG2	neuron-glia antigen 2
NGF	Nerve growth factor
NgRs	Nogo receptors
NRP2	Neuropilin-2
NSCs	Neuroepithelial stem cells
NT-3	Neurotrophin-3
Olig1	Transcription factor 1
OMgp	Oligodendrocyte-myelin glycoprotein
OPCs	Oligodendrocytes
PCP	Phencyclidine
PDGF	Platelet derived growth factor
PDGFR- $\alpha$	Platelet derived growth factor receptor- $\alpha$
PEDF	Pigment epithelium-derived factor
PLP	Proteolipid protein
PMD	Pelizaeus-merzbacher disease
PNS	Peripheral nervous system
PrP <sup>c</sup>	Cellular prion protein
PRRs	Pattern recognition receptors
PSA-NCAM	Poly sialic acid neural cell adhesion molecule
qk	Quaking
qkv	Quaking viable
rhEpo	Recombinant human epo
RIP	Repeat induced point-mutation
RRMS	Relapsing-remitting ms
sema3F	Semaphorin 3f
Sema4D	Semaphorin4d
Sema6A	Semaphorin 6a
Sh pup	Shaking pups
Shh	Sonic hedgehog
Sox10	Transcription factor
SPMS	Secondary progressive MS

SRs	Scavenger receptors
SVZ	Subventricular zone
T3	Triiodothyronine
TGF $\beta$	Transforming growth factor- $\beta$
Th1	T helper cells
TLR	Toll-like receptors
TMEV	Theiler's murine-encephalomyelitis virus
TNF-a	Tumor necrosis factor-a
TNFR2	Tumor necrosis factor receptor-2
TREM2	Triggering receptor expressed on myeloid cells-2
VEGF-A	Vascular endothelial growth factor



# Résumé

## 1. Introduction

Les oligodendrocytes (OLs) sont les cellules responsables de la myélinisation dans le système nerveux central (SNC). Ils soutiennent le métabolisme des axones et leur protection pour assurer une fonction physiologique normale du SNC. L'oligodendrogliose est également impliquée dans le développement et le maintien des axones et donc dans la croissance axonale et la régénération. Les modèles animaux sont des outils indispensables pour étudier la myélinisation et les anomalies de la myéline au cours du développement postnatal. Dans cette étude, nous avons utilisé un modèle de souris permettant d'induire des lésions de sévérité variable afin de mimer différentes anomalies de la myéline du cerveau que l'on peut rencontrer chez l'homme.

## 2. Objectifs

Le projet a été conçu pour faire la lumière sur les anomalies du développement postnatal des oligodendrocytes et la capacité endogène de réparation de la myéline. Deux modèles de dysmyélinisation ont été précédemment générés par l'application de deux procédés d'ablation des OLs chez des souris transgéniques. Le premier modèle, obtenu après 3-4 semaines d'ablation des oligodendrocytes, se caractérise par une hypomyélinisation sévère et irréversible. Le deuxième modèle, obtenu après 2 semaines d'ablation des OLs, se caractérise par une hypomyélinisation sévère mais réversible. Ces deux modèles ont été produits grâce à une lignée de souris transgénique générée précédemment dans notre laboratoire (Jalabi et al., 2005).

## 3. Matériel et méthodes

Nous avons utilisé la souris transgénique Oligo-TTK préalablement développée dans notre laboratoire (Jalabi et al., 2005). Cette souris exprime une forme tronquée du gène de la thymidine kinase (TTK) du virus 1 de l'herpès simplex, sous le contrôle du promoteur de la protéine basique de la myéline (MBP) spécifique de la myéline du SNC.

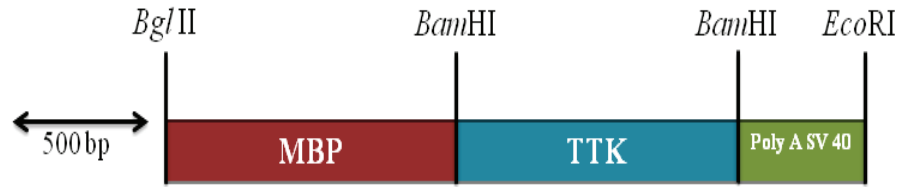

Figure 1: Structure du transgène HSV1-TTK. Le transgène comporte une séquence tronquée du gène HSV1-TTK sous le contrôle d'une séquence promotrice de 1.3kb du gène MBP et terminée par la séquence poly-adénillée du virus SV40. Les sites de restriction sont présentés également (Jalabi *et al.*, 2005).

De plus, nous avons développé une nouvelle souris hybride qui exprime à la fois le gène TTK et le gène de la protéine fluorescente verte (eGFP), sous le contrôle du promoteur de la protéine protéolipide (PLP) de la myéline afin de faciliter l'identification des oligodendrocytes.



Figure 2: Structure du transgène PLP-eGFP. L'expression de eGFP est contrôlée par le promoteur modifié du gène PLP portant un remplacement de la séquence TAG par la séquence GAG dans l'exon 1. Le transgène contient également la partie polyA du virus SV40. Les sites de restriction sont indiqués (Fuss *et al.*, 2000).

L'ablation des oligodendrocytes chez les souris transgéniques est obtenue à l'aide du ganciclovir (GCV), qui est un analogue synthétique de la 2'-désoxyguanosine. Le GCV est phosphorylé en désoxyguanosine-triphosphate (dGTP) par l'activité enzymatique de la thymidine kinase virale. L'incorporation de la guanosine phosphorylée dans l'ADN en

réplication, provoque le blocage de la synthèse de l'ADN et induit ainsi la mort des oligodendrocytes dans la phase active de mitose.

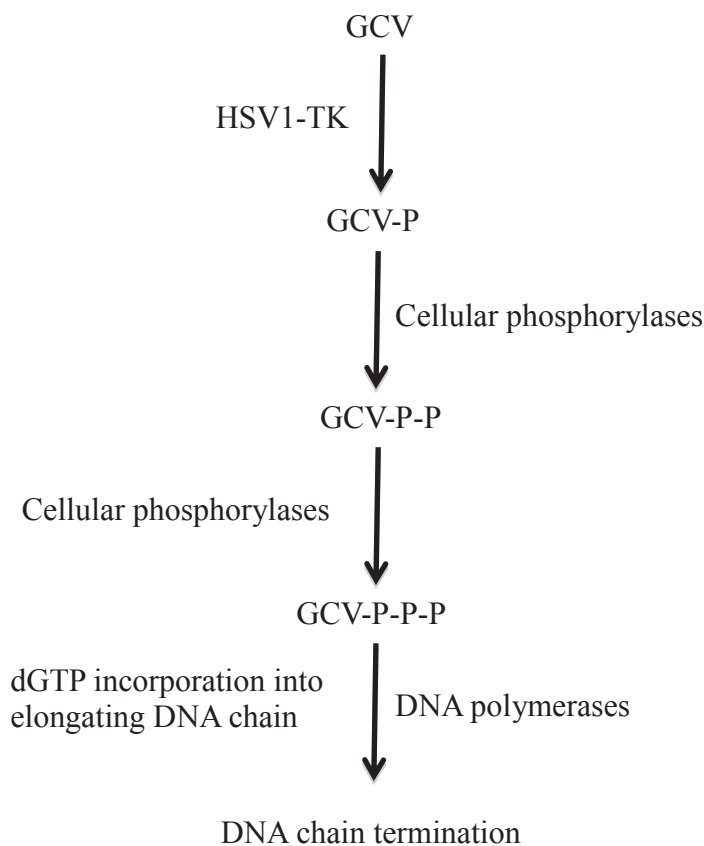
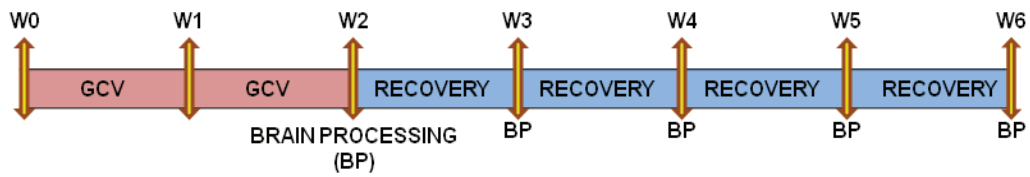

Figure 3: Mécanisme d'action du gancyclovir dans le modèle murin Oligo-TTK et Oligo-TTK-EGFP. L'enzyme virale TK est le seul à pouvoir phosphoryler le gancyclovir. Suite à cette première étape, les phosphorylases endogènes peuvent rajouter des radicaux phosphoryl. Le gancyclovir triphosphorylé est intégrée dans l'ADN en cours de synthèse et arrête l'élongation de la chaîne entraînant ainsi la mort cellulaire.

Les souris ont été divisées en trois groupes en fonction de la durée du traitement au GCV. Les souris ont reçu des injections sous-cutanées quotidiennes du GCV dans une solution physiologique (50 µg /g de poids corporel).

### GROUP 1 (GCV1-14)



### GROUP 2 (GCV1-21)

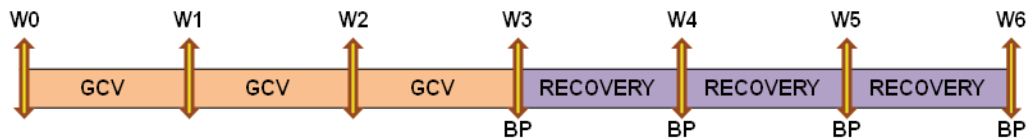

### GROUP 3 (CONTROL)

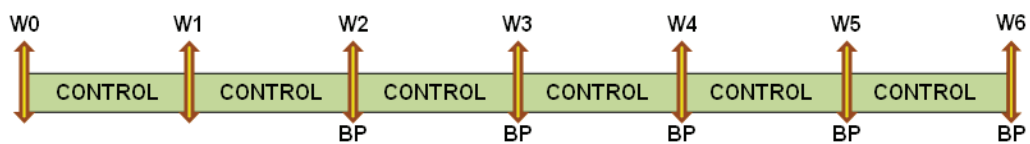

Figure 4: Représentation schématique du protocole expérimental. Le groupe 1 comporte des souris traitées par le gancyclovir pendant les 2 premières semaines suivant la naissance (GCV1-14). Les animaux du groupe 2 ont été traités par le gancyclovir pendant les 3 premières semaines suivant la naissance (GCV1-21). Le traitement par le gancyclovir a été suivi par une période de récupération allant jusqu'à 6 semaines de vie pour l'ensemble des groupes expérimentaux. Le groupe témoin (groupe 3) est formé par des souris n'ayant pas reçu de gancyclovir. Des prélèvements ont été effectués à partir de la 2<sup>em</sup> semaine de vie, comme indiqué (BP, prélèvement du cerveau).

A différents temps, les souris ont été anesthésiées puis perfusées par voie intracardiaque avec une solution tamponnée de paraformaldéhyde à 4% (4% PFA). Les cerveaux sont ensuite post-fixés dans le même fixateur à 4°C. Les cerveaux fixés ont été traités pour l'obtention de sections au vibratome où bien après inclusion en paraffine. Les coupes de tissus ont ensuite été utilisées pour des immunomarquages avec des anticorps dirigés contre différents marqueurs des oligodendrocytes, des cellules microgliales et des astrocytes. Le nombre de cellules colorées et l'intensité de la coloration ont été évalués à l'aide du logiciel Image J. L'état axonal a été évalué en mesurant l'expression de l'ARNm de la protéine associée contactin (Caspr) et des récepteurs Nogo (NgR), p75 NTR, les

Neurofilaments 68 (NF68) et la Neurofascin 186 (NFN186). Les ARN totaux ont été extraits de cerveaux frais.

Afin d'évaluer les changements de la fonction de coordination motrice, le teste "beam-walking" a été utilisé. Les données obtenues à partir de toutes les expériences ont subi une analyse statistique ANOVA deux facteur et Tukey's test pour évaluer la signification des données.

## **4. Résultats**

### **4.1 Statut des oligodendrocytes sous traitement au GCV**

#### 4.1.1 Evaluation de la population d'oligodendrocytes

Les oligodendrocytes ont été marqués à l'aide d'un anticorps dirigé contre un marqueur spécifique des OLs immatures et matures, l'anhydrase carbonique II (CA II). Les cellules CA II<sup>+</sup> ont été comptées dans le corps calleux et la substance blanche du cervelet. La perte des OLs a été de 80% après 2 semaines de traitement au GCV (GCV1-14). Après l'arrêt du traitement, les processus de récupération ont conduit à une augmentation significative de la population OLs à 65% à la semaine 4 (W4) et à 80% à la semaine 6 (W6). L'extension du traitement GCV à 3 semaines (GCV1-21) a entraîné une perte de 85% de la population OLs. Cependant la récupération est limitée à 25% à W4 et reste à 40% du niveau de contrôle à W6. Des résultats similaires ont été obtenus chez les souris transgéniques hybrides Oligo-TTK-eGFP lorsqu'elles ont été évaluées pour l'expression de eGFP.

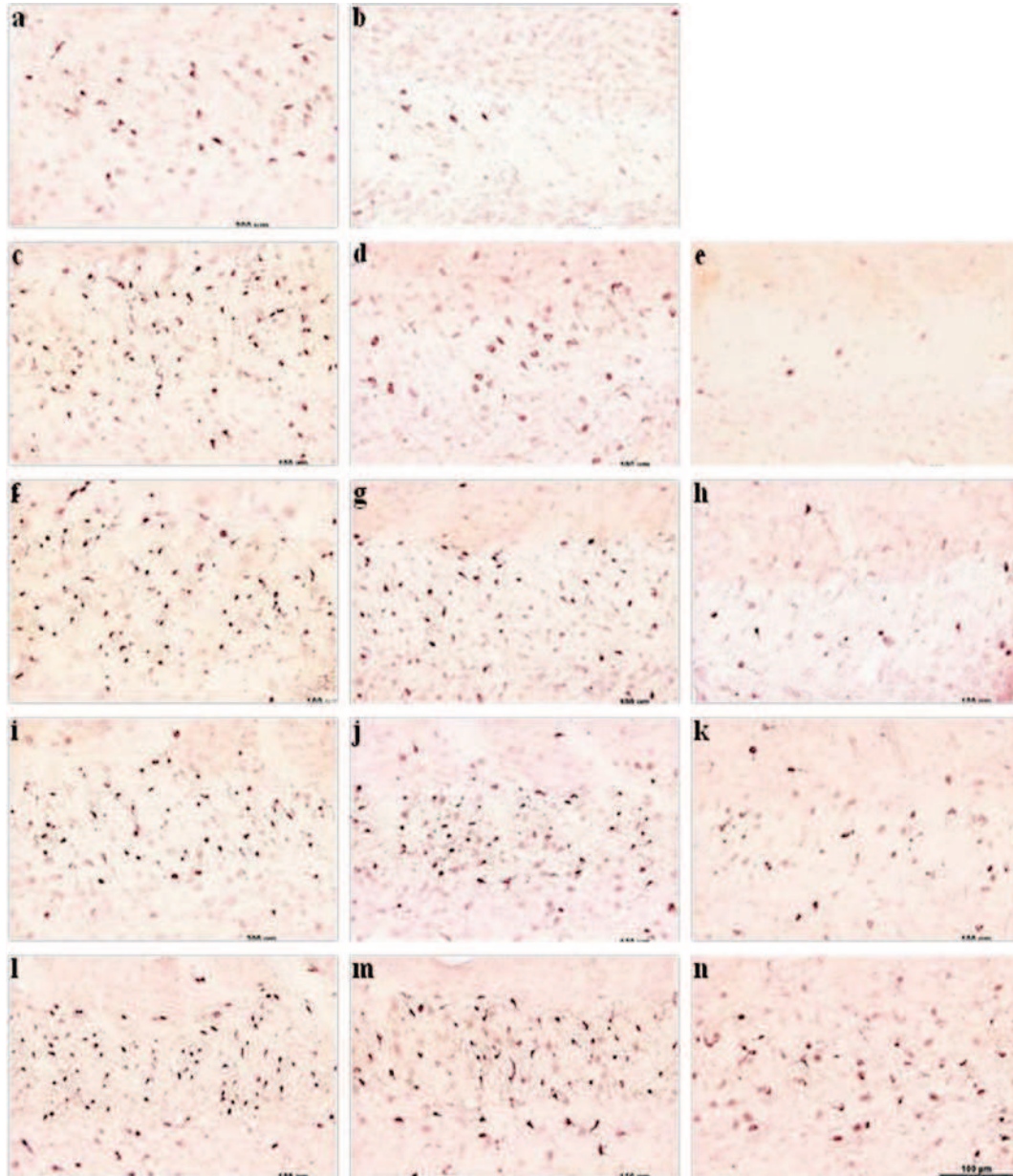

Figure 5: Oligodendrocytes (cellules CA II+) dans le corps calleux des souris Oligo-TTK témoins et traitées au GCV. Les souris témoins possèdent une population nombreuse d'oligodendrocytes comparées aux souris traitées au GCV. La récupération en oligodendrocytes est limitée chez la souris GCV1-21. a, P14 contrôle; b, P14 GCV1-14; c, P21 contrôle; d, P21 GCV1-14; e, P21 GCV1-21; f, P28 contrôle; g, P28 GCV1-14; H P28 GCV1-21; i, P35 contrôle; j, P35 GCV1-14; k, P35 GCV1-21; l, P42 contrôle; m, P42 GCV1-14 et n, P42 GCV1-21. Grossissement de X40. Bar = 100  $\mu$ m.

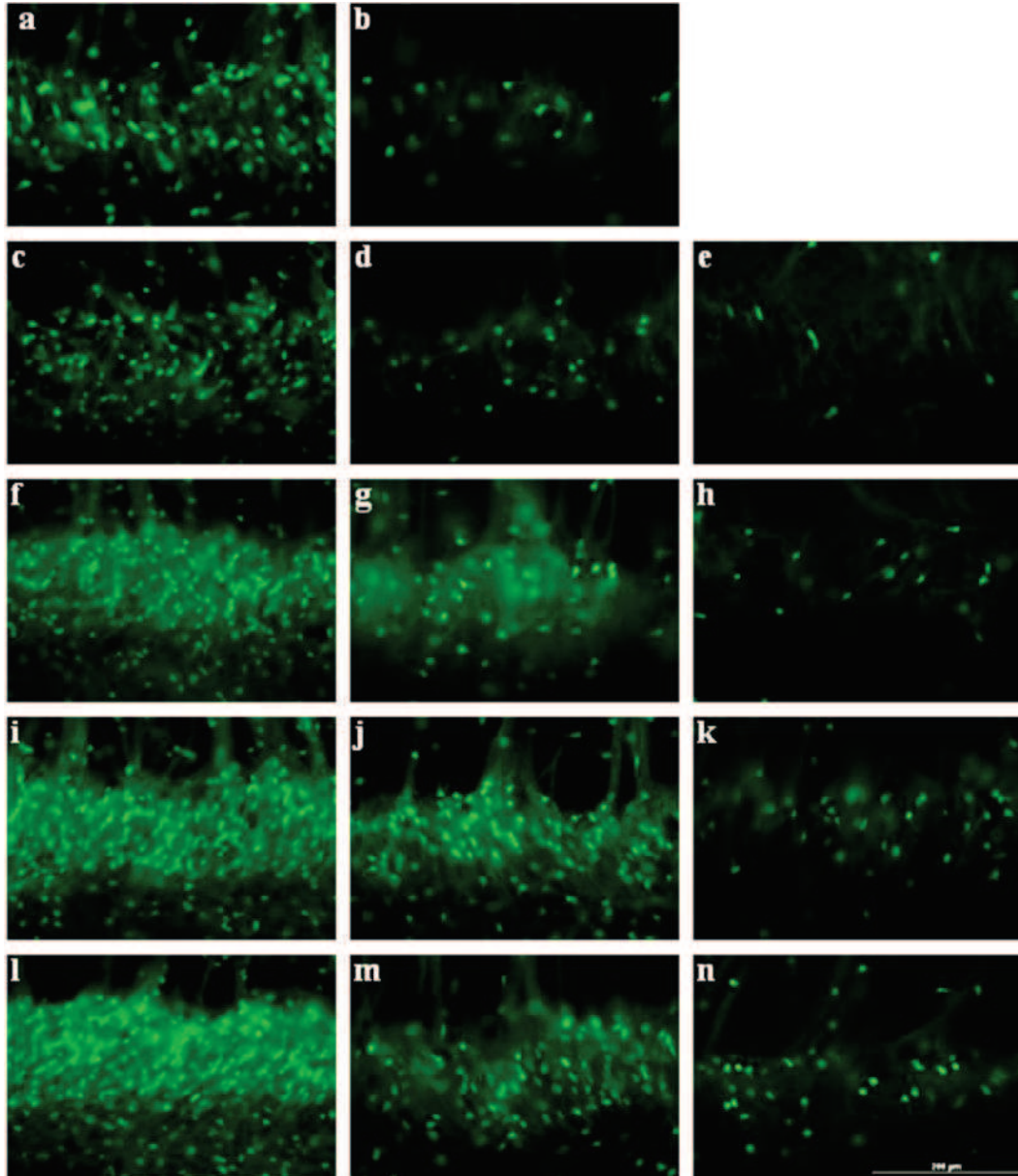

Figure 6: Oligodendrocytes exprimant la fluorescence verte dans le corps calleux des souris Oligo-TTK-EGFP. Les coupes de cerveau des souris témoins contiennent un plus grand nombre d'oligodendrocytes comparées aux souris GCV à tous les âges. Les souris GCV1-14 montrent une récupération efficace en oligodendrocytes comparées aux souris GCV1-21. a, P14 contrôle; b, P14 GCV1-14; c, P21 contrôle; d, P21 GCV1-14; e, P21GCV1-21; f, P28 contrôle; g, P28 GCV1-14; h, P28 GCV1-21; i, P35 contrôle; j, P35GCV1-14; k, P35 GCV1-21; l, P42 contrôle; m, P42 GCV1-14 et n, P42 GCV1-21. Grossissement 40X. Bar = 200  $\mu$ m.

#### 4.1.2 Régénération des oligodendrocytes

Afin d'étudier l'état de régénération des oligodendrocytes après ablation, nous avons utilisé un anticorps dirigé contre le facteur de transcription Oligodendrocyte 2 (Olig2) pour l'immunomarquage combiné avec le marquage CA II et le marqueur de prolifération Ki67. Olig2 est un facteur de transcription exprimé dans les cellules précurseurs des OLs (OPCs), OL prémyélinisants, et les OL matures. Ensuite, nous avons utilisé le double marquage pour Olig2 et CA II afin d'évaluer le rapport OPCs/OLs.

Les souris témoins ont présenté une densité cellulaire des cellules Olig2+ de  $5,5 \pm 0,61$  cellules par unité de surface à la semaine 2 (W2),  $6,28 \pm 0,52$  à la semaine 3 (W3) et  $9,98 \pm 0,70$  à W6. Le rapport Olig2/CA II a été plus élevé (2 à 3) pendant la phase de génération/régénération des oligodendrocytes. Ce rapport diminue pour atteindre une valeur proche de 1 à partir de W3 chez le témoin et W4 chez les souris traitées. Dans le modèle GCV1-14 le nombre des cellules Olig2+ a été de 35% du contrôle à W2, puis a augmenté de façon spectaculaire pour atteindre 90% du niveau normal à W4. Alors que dans le modèle GCV1-21, les cellules Olig2+ a été de 29% du niveau normal à W3, et seulement de 60% à W4. Aucune augmentation au cours des semaines suivantes n'a été enregistrée. Nous avons remarqué une augmentation rapide (de 2 fois) des cellules Olig2+ chez la souris GCV1-14 à W4. Alors que dans le modèle GCV1-21, nous avons observé une augmentation limitée à 1,5 fois. Après W4, le nombre des cellules Olig2+ a augmenté plus lentement dans ce modèle. Ces résultats suggèrent que de nouvelles cellules doivent être générées activement pour atteindre un nombre critique nécessaire pour mener à bien une myélinisation efficace.

Par ailleurs, nous nous sommes davantage focalisé sur l'expression de Olig2 dans les OLs. Olig2 stimule la prolifération des OPCs au cours du développement précoce et induit la différenciation des oligodendrocytes à des stades ultérieurs. Ce commutateur de fonction est régulé par la phosphorylation ou déphosphorylation de motifs triple sérine dans le domaine amino-terminal. L'activité proliférative des OPCs semble causée par la phosphorylation d'Olig2, alors que la déphosphorylation prend en charge la spécification des cellules. Nos résultats ont montré une augmentation significative des cellules Olig2-phosphorylé chez la souris GCV1-14 entre W3 et W4 après l'arrêt du traitement GCV. A l'opposé, dans le modèle GCV1-21, un très faible niveau de Olig2 phosphorylé a été



observé. Nos résultats démontrent clairement que le faible niveau de phosphorylation d'Olig2 ou son absence dans les OPCs chez la souris GCV1-21, représente un défaut majeur qui empêche la néo oligodendrogenèse.

#### **4.2 Réaction des astrocytes à l'ablation des OLs et à la dysmyélinisation**

Les astrocytes sont les cellules du cerveau qui interagissent très étroitement avec les oligodendrocytes et les neurones. La protéine acide des gliofilaments (GFAP) a été utilisée comme marqueur des astrocytes. Nous avons observé une augmentation significative mais modérée de l'intensité de la coloration chez les souris traitées à W4 et W5. Cependant les deux groupes traités, GCV1-14 et GCV1-21, ne diffèrent pas de manière significative dans l'intensité de coloration. A W6, la différence d'intensité de coloration entre les groupes témoins et traités a été sensiblement réduite. Toutefois, le nombre d'astrocytes ne diffère pas entre les témoins et les souris traitées malgré l'augmentation de nombre de branchements des astrocytes.

#### **4.3 Réaction des cellules microgliales à l'ablation des OLs et à la dysmyélinisation**

La microglie est un autre type cellulaire ayant aussi une relation étroite avec les oligodendrocytes et la myéline. Ce sont principalement des macrophages résidents du cerveau et de la moelle épinière et distribués dans toutes les régions du cerveau. La réponse de la microglie à la dysmyélinisation a été évaluée en utilisant un anticorps dirigé contre un marqueur spécifique de ces cellules (Iba1) pour l'immunomarquage. La quantification des cellules colorées a montré qu'il existe une réduction de la population microgliale cours du développement postnatal des souris normales. Un nombre légèrement plus élevé de cellules microgliales a été observé pour les deux souris GCV1-14 et GCV1-21. Toutefois cette différence est inférieure de 10-15% par rapport au témoin à tout âge. Finalement, l'inflammation développée chez les souris dysmyélinisantes est un événement mineur. A l'opposé, la démyélinisation dans le cerveau adulte est toujours accompagnée d'une augmentation significative du nombre de cellules microgliales ce qui traduit une inflammation très prononcée.

#### **4.4 Evaluation du statut axonal**

Le statut axonal a été évalué en mesurant l'expression de l'ARNm de plusieurs marqueurs axonaux y compris Caspr, NgR et p75NTR, NF68 et NFN186. L'expression de p75NTR est restée inchangée chez les souris traitées par rapport aux témoins. Toutefois, les deux marqueurs, Caspr et NgR ont montré une augmentation d'expression modérée à W3 pour ensuite retourner à la normale au cours des semaines suivantes. Ces résultats suggèrent que l'altération des composants de l'axone représente un événement mineur à W3 en réponse à la perte des oligodendrocytes.

#### **4.5 Essai de Motricité**

Nous avons effectué le ‘‘beam-walking test’’ pour étudier si la remyélinisation, obtenue après 2 semaines de déficit en myéline au cours du développement postnatal, pouvait rétablir un fonctionnement normal de la motricité des animaux. Ce test a été appliqué sur des souris GCV1-14 âgées de 2 mois. Les souris normales ont montré des scores moyens significativement plus élevés en comparaison des souris GCV1-14. Ces résultats suggèrent que, malgré une apparente myéline normale, les fonctions motrices des souris traitées restent déficientes à W10.

### **5. Conclusion**

L'ablation des oligodendrocytes au cours des 2 premières semaines postnatales induit des dommages réversibles à la population oligodendrocytaire, alors que son ablation durant 3 semaines consécutives se traduit par une perte irréversible des oligodendrocytes et de la myéline. Un nombre d'OPCs doit atteindre un seuil critique avant la fin de la semaine postnatale 3, pour effectuer une remyélinisation efficace. En particulier, la phosphorylation d'Olig2 est indispensable dans la période W3 et W4 pour induire la formation d'un nombre suffisant d'OLs après une perte importante de ceux-ci. Nous avons démontré que l'absence de phosphorylation Olig2 pendant la période W3-W4 est la principale cause de défaut de régénération des oligodendrocytes et de la myéline. La réponse inflammatoire à l'hypomyélinisation est modérée comme en témoigne l'évaluation de la réactivité des cellules de la microglie. De même, une Astroglie modérée a été mise en évidence lors de l'ablation des oligodendrocytes au cours des 2 premières semaines de développement postnatal. Sur la base de nos observations, il est important de noter que le

statut de la microglie et des astrocytes dans l'hypomyélinisation diffère sensiblement comparé à la démyélinisation du cerveau adulte. Une forte réaction de la microglie et une astrogliose élevée sont caractéristiques de la démyélinisation chez l'adulte. Fait intéressant, plusieurs marqueurs axonaux ont montré une modification légère et transitoire au cours de W3 et W4 à la suite de l'ablation des oligodendrocytes. Un test de motricité a montré que malgré la restauration de plus de 80% des oligodendrocytes, les animaux ne récupèrent pas complètement une activité motrice normale. Malgré une remyélinisation importante chez les GCV1-14, la myélinisation retardée pendant le développement du cerveau pourrait causer un déficit comportemental temporaire ou permanent. Ces résultats ouvrent de nouvelles perspectives de stratégies thérapeutiques visant à favoriser la protection et réparation de la myéline au cours du développement postnatal.

# Summary

## 1. Introduction

Oligodendrocytes (OLs) are the myelin forming cells in the central nervous system (CNS). They are metabolically supporting axons, protecting them and responsible for normal physiological functions of the CNS. Oligodendroglia is also involved in the development and maintenance of axons and regulation of axonal caliber as well as axonal growth and regeneration. Animal models are required to study myelination and repair potential of myelin abnormalities during postnatal development. In the present study we used a valuable mouse model allowing variable severity of induced lesions in order to mimic various human brain myelin disorders.

## 2. Aims

This study was designed to shed light on the plasticity of oligodendrocytes during postnatal development and to study the endogenous capacity of myelin repair and eventual axonal abnormalities caused by oligodendrocyte killing during the same postnatal period. Two dysmyelination models were generated by the application of two programs of oligodendrocyte ablation in transgenic mice. The first model was obtained after 3 weeks of oligodendrocyte ablation, characterized by severe and irreversible hypomyelination. The second model was obtained after 2 weeks of oligodendrocyte obliteration, characterized by a severe but reversible hypomyelination. In the two models, a specific conditional killing of oligodendrocytes was achieved.

## 3. Material and methods

We used the transgenic Oligo-TTK mouse, previously developed in our laboratory (Jalabi et al., 2005). This mouse expresses a truncated form of the herpes simplex virus 1 thymidine kinase (TTK) gene under the control of oligodendrocyte specific myelin basic protein (MBP).

Moreover we developed a new hybrid mouse that expresses in addition to TTK gene a fluorescent marker, the enhanced green fluorescent protein (eGFP), under the control of proteolipid protein (PLP) promoter to facilitate the identification of oligodendrocytes.

Oligodendrocyte ablation in the transgenic mice was mediated by ganciclovir (GCV) treatment. GCV is a synthetic analog of 2'-deoxyguanosine and it can be phosphorylated to a deoxyguanosine triphosphate (dGTP) by the activity of the viral thymidine kinase. The incorporation of phosphorylated guanosine into replicating DNA causes chain termination and thus inducing cell death in mitotically active oligodendrocytes. Mice were divided into three groups based on the duration GCV treatment. Mice received subcutaneous daily injections of 50µg/g of body weight GCV in physiological solution.

Anaesthetized mice were perfused intracardially with a buffered 4% paraformaldehyde solution (4% PFA). Brains were then post-fixed in the same fixative at 4°C. The fixed brains were processed further for vibratome sections or paraffin embedded sections. The tissue sections were then stained with different antibodies to oligodendrocyte markers, microglial cells and astrocytes. The number of stained cells and the intensity of staining were assessed using image J software. Axonal status was evaluated by measuring the expression of mRNA for Contactin associated protein (Caspr), Nogo receptor (NgR) and low-affinity neurotrophin receptor (p75), Neurofilament-68 (NF68) and Neurofascin 186 (NFN 186). Total RNAs were extracted from fresh brains for RT-PCR. In order to evaluate changes in motor coordination function, the beam-walking assay was used.

## **4. Results**

### **4.1 Oligodendrocytes status under GCV treatment**

#### **4.1.1 Oligodendrocyte population assessment**

Oligodendrocytes were labeled by using anti-carbonic anhydrase enzyme II (anti-CA II) antibody. The CA II<sup>+</sup> cells (oligodendrocytes) showed a loss of 70 % in brain and 80% in cerebellum after 2 weeks of GCV treatment (GCV1-14). Following GCV treatment arrest, recovery process lead to restoration of 75 and 80 % oligodendrocytes in brain and cerebellum respectively at week 6 (W6). Extension of GCV treatment to 3 weeks (GCV1-

21) resulted in 80% reduction in oligodendrocytes of brain and 85% in cerebellum. A moderate recovery restricted their number to 40% in brain and 45% in cerebellum at W6. Similar results were obtained from the hybrid transgenic mice Oligo-TTK-eGFP when evaluated for the expression of eGFP.

#### 4.1.2 Oligodendrocyte regeneration

In order to investigate the status of oligodendrocyte regeneration after depletion, we used oligodendrocyte transcription factor 2 (Olig2) antibody for immunostaining in combination with CA II and the proliferation marker Ki67. Control mice showed  $5.5 \pm 0.61$  cell density per unit area at week 2 (W2),  $6.28 \pm 0.52$  at week 3 (W3) and  $9.98 \pm 0.70$  at week 6. The ratio values of Olig2/CA II was higher (2-3) during the generation/regeneration of oligodendrocytes, then decreased to 1 at W4 and remained at this level during the following weeks. In GCV1-14 model the number of olig2+ cells was 35% of control at W2 and then increased dramatically to reach 90% of normal level at W4. While in GCV1-21 model, Olig2+ cells were 29% of normal level at W3, reached only to 60% at W4 but no further increase during the following weeks. We noticed a rapid 2-fold increase in Olig2+ cells in GCV1-14 mice during W4 while GCV1-21 mice showed a limited increase of 1.5 fold during same time. After W4, Olig2+ cells showed a slower increase and remained low for GCV1-21 model. These results suggest that OPCs must be actively generated to reach a critical number necessary to carry out the myelination/remyelination efficiently.

To uncover the origin of the deficiency in the regeneration of oligodendrocytes in GCV1-21 mice, we focused on the study of phosphorylated-Olig2+ (p-Olig2+) in OPCs at W3 and W5 mice of all groups. The p-Olig2 is responsible for promoting proliferation of OPCs during normal development. Our results showed the presence of significant number of p-Olig2+ cells in GCV1-14 mice at W3. Oppositely, in GCV1-21 mice, p-Olig2+ cells were scarce at the same time point. Our results clearly demonstrate that the low level of p-Olig2 or its absence from OPCs in GCV1-21 mice represents a major defect preventing a neo oligodendrogenesis.

## **4.2 Astrocytes reaction to OL ablation and dysmyelination**

The Glial Fibrillary Acidic Protein (GFAP) was used as a marker of astrocytes. We observed a moderate but significant increase in the staining intensity of GFAP and augmentation of astrocyte branching in GCV-treated mice at W3 and W4. However both treated groups, GCV1-14 and GCV1-21, did not differ significantly in staining intensity during the following weeks. Moreover, the number of astrocytes remained similar in experimental and control mice.

## **4.3 Microglial cell reaction to OL ablation and dysmyelination**

Microglial response to demyelination was assessed by using ionized calcium-binding adapter molecule 1 (Iba1) antibody for immunostaining. Quantification of the stained cells showed that there was no significant difference in the number of microglial cells between control and GCV treated mice at any age even though it is slightly higher in the GCV treated mice.

The results of astrocyte and microglia status evaluation suggest that inflammation process in dysmyelination during postnatal development of transgenic mice is very mild. Oppositely, demyelination in adult brain is always accompanied by a significant increase of the number of microglial cells and pronounced inflammation and astrogliosis or astrocyte hypertrophy.

## **4.4 Axonal status evaluation**

Axonal status was evaluated by measuring the expression of mRNA of several axonal components including Caspr, NgR, p75, NF68 and NFN186. The expression of p75 remained unchanged in control and treated mice. However both Caspr and NgR showed a higher transient expression (moderate) at week 3 as compared to control and then returned to normal level at W5. Similarly no significant changes in the expression of NF68 and NFN186 were observed at different ages. These results suggest that alteration of axonal components represent a minor event at W3 in response to oligodendrocyte loss.

## 4.5 Motricity test

We conducted a beam-walking test to study whether the myelin recovery restore a normal motricity functioning of animals after 2 weeks of myelin deficiency during postnatal development. This test was applied to 10W old control and GCV1-14 mice. Normal mice showed significantly higher and maximum average scores in comparison with GCV1-14 mice in both Oligo-TTK and Oligo-TTK-eGFP mouse models. These results suggest that despite an apparent myelin recovery, the motor functions of the treated mice remained deficient at least at week10.

## 5. Conclusion

Oligodendrocyte ablation during the first 2 postnatal weeks induced reversible damage to oligodendrocyte population while GCV1-21 program resulted in irreversible loss of oligodendrocyte accompanied by limited myelin recovery. A critical number of OPCs must be generated by the end of postnatal week 3, necessary to achieve efficient remyelination. Importantly, the phosphorylation of Olig2 was required during W3 and W4 to induce the formation of a sufficient number of oligodendrocytes after their severe loss. We demonstrated that the absence of p-Olig2+ cells during W3-W4 period is the major cause of oligodendrocyte regeneration defect and the subsequent myelin deficit. Inflammation response to hypomyelination was mild as attested by the evaluation of the reaction of microglia cells. Similarly, a mild astrogliosis was developed upon oligodendrocyte ablation during the first 4 weeks of postnatal development. Interestingly, several axonal markers showed a mild and transient modification during W3 and W4 as a result of oligodendrocyte removal.

Importantly, despite an apparent myelin recovery of GCV1-14 mice, the delayed myelination during brain development might cause temporary or permanent behavioral deficit. These results provide new insights into dysmyelination disorders and the application of therapeutic strategies aiming to promote recovery from myelin deficit during postnatal development.



# **INTRODUCTION**

# I. INTRODUCTION

## 1. Central nervous system (CNS)

Mammalian nervous system is comprised of two parts, the central nervous system (CNS) and the peripheral nervous system (PNS). The CNS is basically consisted of brain and spinal cord while nerves, ganglia, plexuses and sensory receptors constitute the PNS. These two systems function in harmony to carry out virtually all life activities. However, CNS is much more complex and represents the control center of endless functions.

### 1.1 Functions of CNS

#### 1.1.1 Integration of information

Brain and spinal cord function together for the processing of information received from the peripheral nervous system. Based on the information obtained they decide the nature and timing of responses. In some cases, response is instantaneous while at other places it is either stored in memory or eliminated without any response.

#### 1.1.2 Homeostasis

A body must maintain homeostasis in order to function properly. The CNS is responsible for controlling and coordinating all activities of body. These activities involve trillions of cells whose activity is CNS-dependent. The CNS increases the rate of a certain activity such as heart beat in case of emergency and then brings it back to normal when situation stabilized.

#### 1.1.3 Mental Activity

Mental activities as memory, thinking, emotions and consciousness are regulated by brain in the CNS.

### 1.1.4 Control of muscles and glands

Brain directly controls the movements of skeletal muscles with the help of PNS. Same is the case with some smooth muscles as those of blood vessels, which strictly follow the instructions of the brain. Even in autorythmic cardiac muscles CNS can increase or decrease the speed of muscle contraction. Glands of digestive system, salivary glands and sweat glands release their secretions only after receiving signals from the brain. Similarly, brain is the center for controlling the production of hormones.

## 1.2 Cells of CNS

### 1.2.1 Neurons

Neurons or nerve cells receive signals from the PNS and send out action potentials to other cells and effector organs. They are further classified into sensory, motor and interneurons based on the nature of function they performed. Morphologically they can be unipolar, bipolar or multipolar (Seeley et al., 2003).

### 1.2.2 Neuroglia

The neuroglia constitute practically more than half of the brain weight with multiple functions ranging from support to protection.

#### 1.2.2.1 History and discovery of Neuroglial cells

Glial cells outweigh the number of neural cells in nervous system. They are also physiological active part of brain and play crucial role in development but they were ignored until recently. Virchow (1854) identified cells other than neurons and gave them the name “nervenkitt” (nerve glue) hence neuroglia, considering that these cells constitute a connective tissue in brain. Although the concept about glial cells have changed since their first description but they still retain same name.

Microscopic studies in combination with metallic impregnation technique made it possible to distinguish various types of glial cells. Raman Y Cajal and Rio Hortega were the pioneers of this metallic impregnation technique. Cajal (1913) used gold impregnation to identify astrocytes in brain. He also described another cell type, which was not impregnated by gold.

Later on Rio Hortega (1928) used silver carbonate impregnation to identify oligodendroglia and named them as interfascicular glia. He also described the third type of glial cells (1921), smaller than both astrocytes and oligodendroglia, and called them as microglia.

Evolution of glial cell number showed an increasing trend from early ancestral forms to present more developed mammals. In *Drosophila* glial cells are 25% of all the brain cells, in rodents they increase to 65% and humans show as much as 90% glial cells. Brain white matter is consisted of glial cells and axons without neuronal cell bodies. The overall ratio of glial to brain is higher as white matter volumetrically equalizes grey matter (Pfrieger and Barres, 1995).

The science of neuroglia flourished in last 100 years when different neuroglial cells were discovered and characterized. A figure of central stage value during this era is Santiago Ramon y Cajal, the founder of the modern neurobiology. So, this time can be divided into pre-Cajalian, Cajalian, and post-Cajalian era. Each time is different with respect to staining techniques used and hence knowledge produced.

#### 1.2.2.1.1 Pre-Cajalian period

Virchow (1846, 1854) noticed the presence of neuroglia in the ependyma of the cerebral ventricles and described it as a connective material of the nervous tissue. Several years later, he narrated that connective material is present in brain, spinal cord and sensory nerves serves as kitt (neuroglia) for the nervous element (Virchow, 1856). Few years later, neuroglia was identified as constituent of nervous tissue and described as connective tissue cells (Deiters, 1865). The term neuroglia is a derivative of Greek word “gloia” which stands for clammy or sticky but not in the sense of glue (Somjen, 1988). The cells narrated by Virchow contain filamentous extensions (Bidder et al., 1857) and thought as fibers of connective tissue (Ranvier, 1873). Metallic staining of silver chromate helped Golgi (1886) to find out morphological differences in the glial cells of white and grey matter and close association of blood vessels and neuroglial processes (Golgi, 1894). At the same time two different types of glial cells were recognized in the spinal cord grey matter (Kolliker, 1891, 1896) and their distribution pattern were identified in grey and white matter (Lenhossek, 1891). These two types were named as fibrous and protoplasmic glial cells, the terms, which are in use even today (Andriezen 1893a, 1893b).

### 1.2.2.1.2 Cajalian period

Cajal used the name astrocytes for satellite neuroglial cells as previously given by Lenhossek (1891). He not only observed clearly both types of astrocytes but also epithelial neuroglial cells and even some intermediate forms. He described the function of neuroglia as insulating as well as supporting cells in grey matter. Few years later it was thought that neuroglia possess an antitoxic activity with the potential of removing deleterious substances (Lugaro, 1907).

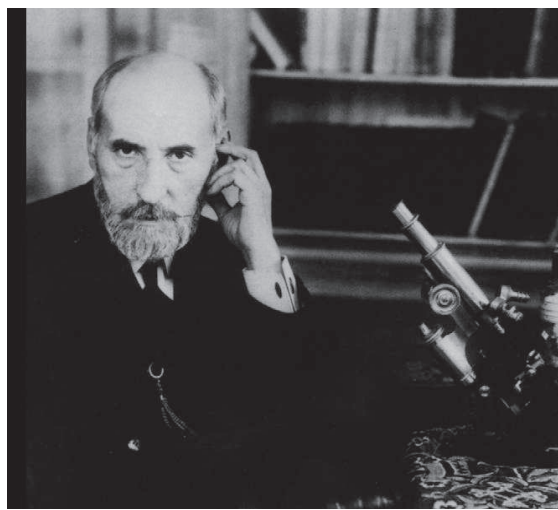

Figure I-1: Santiago Ramon y Cajal (1852–1934; photo circa 1912), he formulated the modern neurobiology by describing his observations on glial cells (Lazzarini et al., 2004).

Figure I-1: Santiago Ramon y Cajal (1852–1934; photo circa 1912), a jeté les bases de la neurobiologie moderne par la description des cellules gliales (Lazzarini et al., 2004).

Rod like cells can be found around the injured area and they adopt shape to adjust in the environment (Achucarro, 1909). He further elaborated the work of Nageotte (1910) about the secretary function of neuroglial. They cells release some chemicals to develop contact with blood vessels.

Cajal was able to label the protoplasmic astrocytes with a modification in his silver nitrate method. He observed the branches ended freely to and from a polygenic pelexus (Cajal, 1912). Then he developed gold sublime method facilitating the grey and white matter specific

glial cells impregnation (Cajal, 1916, 1920b). Cajal then described the 'third element' of nervous system and named them apolar or adendritic cells. These are neither neuron nor astrocytes as they are not sensitive to astroglial staining. However no distinction was made between oligodendrocytes and microglial cells. These elements were found around neurons (nonglial perineuronal satellites), glia (satellites of the glia) and blood vessels (perivascular satellites) of the white matter in the form of cellular packets or columns.

#### 1.2.2.1.3 Post-Cajalian period

The most significant contribution towards the discovery of glial cells is from Rio Hortega who was a student of Cajal. Similarly to Cajal, he continued to modify the staining procedures and developed his own method with silver carbonate (Rio Hortega, 1917). He made four different modifications in the method of Achucarro that helped in the identification of neuroglia fibers resembling to protoplasmic reticule (Rio Hortega, 1916b). At the same time he observed neuroglial changes in post ischemic infarcts human brain. Besides accumulation of astroglia he found an increase in the number of third elements. These cells possess phagocytic activity from the very onset of injury. Furthermore he reported that the apolar or dendritic cells of Cajal do contain processes indeed. Then, he identified two different types of third elements and named them as microglia and interfascicular glia (oligodendroglia). He concluded from his studies on microglia in various species that they differ from fibrous glia as they lack gliofibrils and gliosomes. He provided evidences about the mesodermal origin of microglia and so called them mesoglia. He insisted that microglia are indeed third elements. Microglia assume amoeboid, pseudopodic, globular and ramified shapes during their stay in the interstices of nervous tissue (Rio Hortega, 1921a).

In the same way he characterized glia of scarce radiation or oligodendroglia (Rio Hortega, 1921b). These cells are normally present around the blood vessels (vascular satellites), in the proximity of neurons (neuronal satellites) and as a long sequences along nerve fibres (interfascicular glia). These cells increase in population around birth and have large gliosoma when the myelination starts. Original description of oligodendroglia was made in 1924 by Penfield. This was followed by a comprehensive morphological description of oligodendroglia as satellite cells in grey matter and 3 other variants in white matter with myelinating Schwann cells like appearance. Furthermore these cells form laminar rings around axons to give a reticulate appearance (Rio Hortega, 1928).

Few years later sources of new microglia were recognized in human embryos. These young microglial cells move from the site where choroid plexus unite with brain and from large blood capillaries in the proximity of tract and meninges (Kershman, 1939).

Rio Hortega (1942) introduced the terms “angiogliona” (association of astrocyte with neurons and blood vessels) and “neurogliona” (oligodendroglial connection with myelin fibers). Meanwhile the initial concept of Cajal and Oloriz and Lenhossek about the location of intracapsular cells in the spinal ganglia was restructured by the determination of the fact that these cells are oligodendroglia and they wrap around axons in a spiral fashion (Rio Hortega et al., 1942).

There are three types of glial cells which are being described in next portions.

## 2. Astrocytes

Astrocytes are star shaped cells which perform a variety of functions in the CNS. Astrocytes constitute the highest glial population with occupy 20-25% brain volume (Tower et al., 1973). There is an increase in the astrocyte to neuron ratio with increased brain complexity (Nedergaard et al., 2003). They differ morphologically based on their localization in either white matter or grey matter.

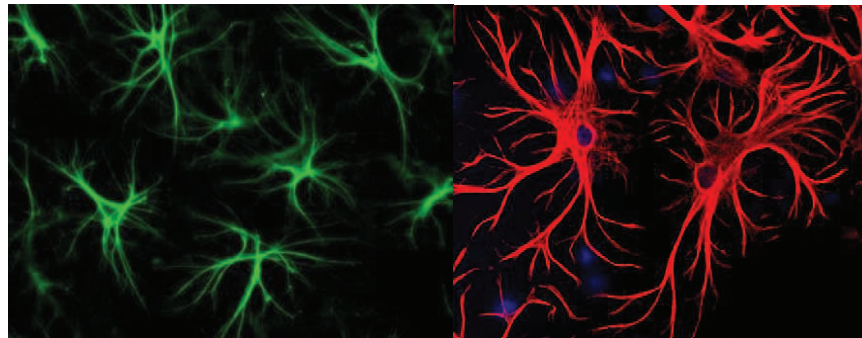

Figure I-2: Astrocytes

Figure I-2: Les astrocytes

1. <http://astrocyte.info>.
2. <http://www.fitzgerald-fii.com/gfp-antibody-70r-10652.html>.

### 2.1 Morphology

#### 2.1.1 Fibrous and Protoplasmic astrocytes

White matter hosts fibrous astrocytes which are characterized by their star shaped look. They have regular boundaries, give rise to cylindrical branches and contain dense glial filament. In contrast protoplasmic astrocytes are situated in the grey matter and display irregular branching pattern with a few glial filament (Vaughn and Pease, 1967; Freeman, 2010).

They surround synapses by elongation of their numerous branches while merely one or two processes are reserved to get attach with either blood vessels or border of the CNS (Bushong et al., 2002). It is probable that fibrous and protoplasmic astrocytes develop differently (Miller and Raff, 1984; Nishiyama et al., 2009).



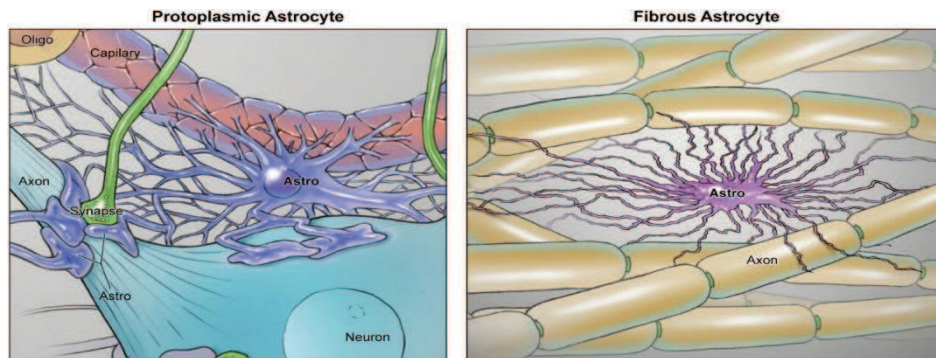

Figure I-3: There are two morphological forms of astrocytes. A protoplasmic astrocyte is involved in the formation of a neurovascular unit in which astrocyte interact with a neuron and a capillary to form a BBB. A fibrous astrocyte is normally localized in the white matter tract where it contacts with oligodendrocytes and promotes myelination (Molofsky et al., 2012).

Figure I-3: Il existe deux formes morphologiques des astrocytes. Les astrocytes protoplasmiques qui contribuent à la formation d'une unité neurovasculaire dans laquelle l'astrocyte interagit avec un neurone et un capillaire pour former la barrière hémato-encéphalique (BHE). Les astrocytes fibreux normalement localisés dans la substance blanche où ils sont en contact avec les oligodendrocytes pour promouvoir la myélinisation (Molofsky et al., 2012).

### 2.1.2 Radial glia during development

Additionally, CNS contains two different kinds of specialized radial astroglia. One of them the Bergman glia is located in the cerebellum and spans across three cerebellar layers. Cell body of a Bergman glia rests in Purkinje cell layer and gives rise to branches which traverse molecular layer to be terminated at the pial surface. Muller cells originate in the retina and radially extend through photoreceptor layer to the inner surface of retina (Metea and Newman, 2006).

These two types of glia arise from the radial glia during development and even Bergman glia shows a functional analogy by facilitating the movement of granule precursors. They are functionally more close to protoplasmic astrocytes in the adult brain as they reside in the vicinity of synapses and regulate synaptic activity (Saijo et al., 2009). Study of the

developmental patterns and *in vitro* experiments demonstrate that astrocytes differ in many other ways besides morphologically (Prochiantz et al., 1987; Vangeison and Rempe, 2009).

## **2.2 Identification**

During past few years many markers for astrocyte and their precursor cells were used. These markers include nuclear factor1/A (NF1/A) (Deneen et al., 2006), Glutamate/aspartate transporter (GLAST) (Shibata et al., 1997), Brain lipid binding protein (BLBP) (Anthony et al., 2004), Fatty acid binding protein 7 (FABP7) (Wolburg et al., 2009), Sox9 (Rakic, 2007), Protein 100% soluble in ammonium sulfate-calcium binding protein (S100-b) (Ghandour et al. 1980a, 1981) and Fibroblast growth factor receptor 3 (FGFR3) (Ihrie and Alvarez- Buylla, 2008). However most commonly used marker for astrocyte identification is GFAP (glial fibrillary acidic protein) which is present in fully differentiated astrocytes (Bignami et al., 1972).

## **2.3 General Functions of Astrocytes**

### **2.3.1 Synapse transmission and neuron survival**

Astrocytes facilitate synapse transmission by regulating homeostasis around axons (Parpura and Haydon, 2009). In this way they are able to promote survival of neurons in the prevailing inflammatory conditions (Saijo et al. 2009) and hypoxia (Vangeison and Rempe, 2009). They modify neurotransmission by secretion of neuromodulatory factors in the vicinity of axons (Martin, 1992). They control synaptic interactions using gap junctions between neurons and astrocytes (Haydon, 2000).

### **2.3.2 Synapse stabilization and elimination**

Based on functional requirements, new synapses are made and break in a vibrant process (Luo and O'Leary, 2005). One mechanism, which leads to the development of schizophrenia, involved the unnecessary removal of synapses in the region of prefrontal cortex (Keshavan et al., 1994; Insel, 2010). In *Drosophila*, glia remove rapidly growing neurons during metamorphosis (Awasaki et al., 2006, 2011). Similar activity is exhibited by glia, with similar protein profile, in mouse embryonic dorsal root ganglia (Wu et al., 2009).

### 2.3.3 Blood brain barrier

Astrocytes are important constituents and regulators of blood brain barrier (BBB). They develop a sheath using distal endings of the processes around glia limitans to take care of blood supply to brain. This astrocytic sheath further recruits pericytes and endothelial cells to form BBB which inhibits the free transport of molecules, ions and cells to and from the blood or brain (Wolburg et al., 2009). Astrocytes act as regulator of cerebral blood flow with this arrangement (Simard et al., 2003; Takano et al., 2006). Many neurodegenerative and neuroinflammatory disorders are associated with the disruption of BBB (Zlokovic, 2008).

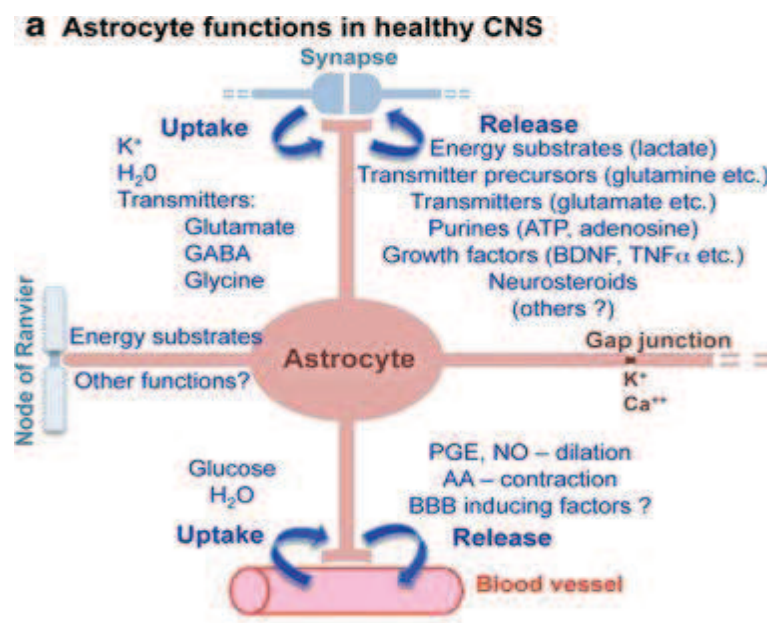

Figure I-4: Astrocytes perform numerous functions in healthy CNS (Sofroniew and Vinters, 2010).

Figure I-4: Les astrocytes assurent de nombreuses fonctions dans le SNC normal (Sofroniew and Vinters, 2010).

### 2.3.4 Support

Astrocytes protect axons by regulating pH, ion balance, glycogen storage and elimination of neuronal wastes (Nedergaard et al., 2003; Brown et al., 2007). At the site of injury astrocytes express increased levels of glutamate receptors and accelerate glutamine production. In this way they consume hazardous glutamate to convert it into glutamine to promote neuron and oligodendrocyte survival (Liberto et al., 2004). Release of factors like brain-derived neuro-

trophic factor (BDNF) and neurotrophin-3 (NT-3) under normal conditions improve neuron survival (Dreyfus et al., 1999). In case of injury there is an additional secretion of nerve growth factor (NGF) (Schwartz et al., 1994). Production of growth factors NT-3, insulin-like growth factor-1 (IGF-I), and ciliary neurotrophic factor (CNTF) stimulates oligodendrocyte survival (Barres et al., 1993; Chernauskis et al., 1993)

### 2.3.5 Astrocytes and inflammatory response

When encounter an infection, astrocytes produce pattern recognition receptors (PRRs) like toll-like receptors (TLR) (Carpentier et al., 2005) to identify viral dsRNA. Additionally they also up-regulate scavengers, mannose and complement receptors (Farina et al., 2007). Astrocytes release IL-1, IL-6, TNF- $\alpha$ , IL-10 and TGF- $\beta$  cytokines when exposed to inflammation to elicit a TH1, TH 2 or TH17 mediated T cells response. They act as chemo attractants for T cells by secretion of chemokines RANTES (CCL5), MCP-1 (CCL2), IL-8 (CXCL8) and IP-10(CXCL10) (Dong et al., 2001).

### 2.3.6 Astrocytes as energy regulators

Astrocytes are reservoirs of CNS glycogen and granules are concentrated in areas near the synapses (Peters et al., 1991). This glycogen helps in maintaining neuronal functions in case of hypoglycemia and high activity (Suh et al., 2007). Glutamate transmitters modify glycogen to glucose and increase its transport through gap junctions during neuronal activity (Rouach et al., 2008). Some studies demonstrate that in conditions of hypoglycemia, glycogen is converted into lactate to serve as aerobic fuel for the neighboring neurons (Pellerin et al., 2007).

## 2.4 Astrocytes and myelin

Astrocytes have a dual role with regards to myelination. They promote demyelination and inhibit remyelination while inducing positive effects on remyelination at the same time using different mechanisms.

## 2.4.1 Role in myelination

Astrocyte development is contemporary to that of oligodendrocyte (Ghandour et al., 1980a). Astrocytes exercise a critical role in myelin development. Abnormal functioning of astrocyte leads to the development of Alexander's disease of leukodystrophy. *In vitro* estimation of this relationship revealed that astrocytes are involved in the alignment of oligodendrocyte processes around axons to promote myelination (Meyer-Franke, 1999). They speed up the wrapping of myelin (Watkins et al., 2008) and even stimulate myelin synthesis (Ishibashi et al., 2006).

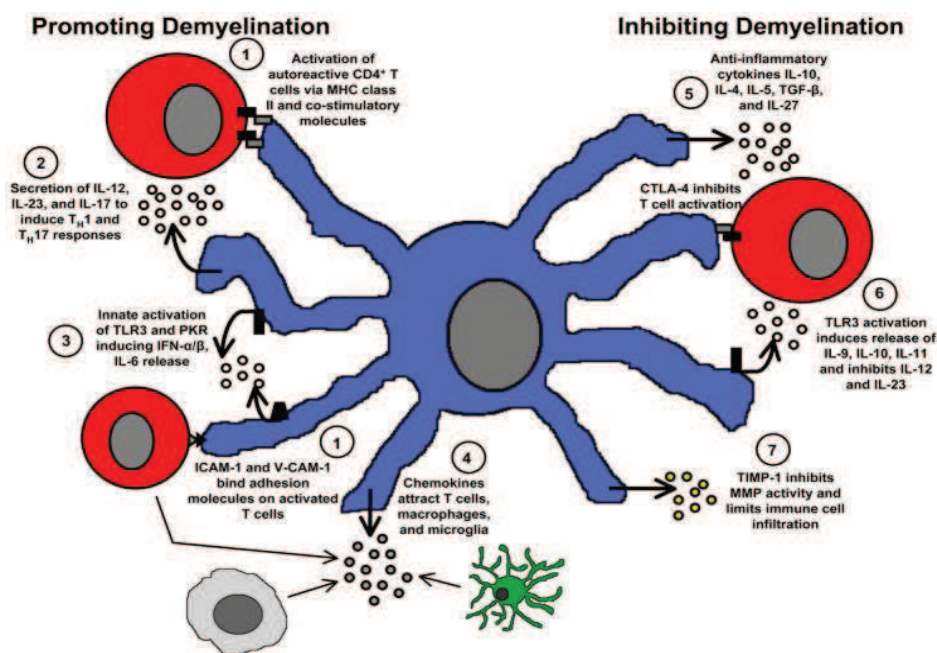

Figure I-5: Astrocytes exert their effect on demyelination in two contrasting ways. They enhance immune response which in turn supports demyelination. Expression of MHC class II along with co-stimulatory molecules activates T-cells. TH1 and TH17 response is evoked by respective action of astrocytic cytokines IL-12 and IL-23. Viral attack on myelin activates toll-like receptor 3 (TLR3) and dsRNA-dependent protein kinase (PKR), which are associated with the release of type-I interferons (IFN- $\alpha/\beta$ ) and IL-6. Besides cell-mediated autoimmune response astrocytes attract microglia, macrophages and T cells by releasing chemokines. Astrocytes are potential inhibitors of some parts of immune response and hence prevent the process of demyelination. They release anti-inflammatory cytokines like IL-10, IL-4, IL-5, TGF- $\beta$ , and IL-27 and express CTLA-4 receptors to weaken Th1 and Th17 responses. Production of anti-inflammatory cytokines increases while that of pro-inflammatory cytokines IL-12 and IL-23 decreases as a result of TLR3 activation. Migratory potential of autoreactive T cells to reach demyelinating lesion decrease in the presence of

tissue inhibitors of metalloproteinases (TIMPs) which impairs MMPs activity (Nair et al., 2008).

Figure I-5: Les astrocytes agissent sur la démyélinisation suivant 2 voies différentes. L'expression des molécules du CMH-II en association avec des molécules co-stimulatrices les permettent l'activation des cellules-T pour mener à des réponses Th1 et Th17 sous l'action des cytokines astrocytaires IL-21 et IL-23. Une attaque virale de la myéline active le récepteur Toll-like (TLR3) et la protéine kinases des RNA dépendante (PKR) qui sont associées à la production des interférons de type I (IFN- $\alpha$  /  $\beta$ ) et à l'IL6. En plus des réponses immunitaires, les astrocytes attirent la microglie, les macrophages et les cellules T en sécrétant des chimiokines. Les astrocytes peuvent être des inhibiteurs potentiels d'une partie de la réponse immunitaire et ainsi prévenir la démyélinisation. La production de cytokines anti-inflammatoires comme IL10, IL-4, IL-5, TGF- $\beta$  et IL-27 et l'expression des récepteurs CTLA-4 diminuent les réponses Th1 et Th17. La production de cytokines anti-inflammatoires augmente alors que les cytokines proinflammatoires IL12 et IL 23 diminuent sous l'effet de l'activation du TLR3. Le potentiel migratoire des cellules T autoréactives vers les lésions démyélinisantes diminuent en présence des inhibiteurs tissulaires des métalloprotéinases (ITMP) qui altèrent l'activité des MMPs (Nair et al., 2008).

## 2.4.2 Inhibition of remyelination

### 2.4.2.1 Formation of glial scar

Astrocytes form a glial scar around demyelinated lesions which serves as a physical barrier for oligodendrocyte precursor cells (OPCs) movement into the demyelinated areas. This scar is a collection of firmly interconnected astrocyte branches (Eng et al., 1987; Reier et al., 1988). Filament contents are higher in these astrocytes with higher levels of GFAP, nestin and vimentin (Norton et al., 1988). Glial scars can be detected in animal models EAE as well as MS patients around the area of demyelination (Holley et al., 2003).

### 2.4.2.2 Astrocytes prevent OPC migration and maturation

Astrocytes block the migration of OPCs and astrocytes *in vitro* conditions (Wilby et al., 1999). This behavior remains same even *in vivo* conditions as OPCs are unable to travel through astrocyte loaded environment in CNS parenchyma (Franklin et al., 1997). In the

proximity of demyelinated lesion, many OPCs can be detected around the glial scar but very few pass through this barrier to reach their target site (Bannerman et al., 2007)

OPCs undergo maturation after reaching their destination to synthesis myelin. Astrocytes obstruct this process by release of fibroblast growth factor 2 (FGF-2) which enhances mitosis and survival of OPCs but prevents maturation (Messersmith et al., 2000). Likewise overproduction of FGF-2 is harmful for remyelination (Goddard et al., 1999). In EAE model, astrocytes were found to produce hyaluronan (Back, et al., 2005). Hyaluronan recognizes CD44 receptor which is expressed by astrocytes, OPCs and T-cells (Soilu-Hanninen et al., 2005). Exposure of OPCs to hyaluronan interrupts maturation process by an unknown mechanism resulting in the development of immature phenotypes (Back, et al., 2005).

### 2.4.3 Protective effects of astrocytes that promote neuroprotection and myelin repair

In mice animal model GFAP-TK, ablation of astrocytes demonstrated that they promote neuron survival and prevent tissue damage by restoration of BBB to inhibit the entry of lymphocytes in order to reduce inflammation (Bush et al., 1999).

### 2.4.4 Release of extracellular matrix related Factors

Astrocytes produce extracellular matrix associated molecules, matrix metalloproteinases (MMPs) (Gardner et al., 2003). Some of these MMPs are detrimental for CNS as they exacerbate immune response. However, MMP-9 promotes branch formation in OPCs (Uhm et al., 1998) and stimulates remyelination after demyelination (Larsen et al., 2003). Astrocytes release tissue inhibitors of metalloproteinases (TIMPs) to check the negativity of MMPs (Pagenstecher et al., 1998). These proteinases have a neuroprotective function besides maintenance of BBB (Crocker et al., 2006). Presence of two molecules with contrasting properties suggests that a balance must be maintained for the proper functioning of CNS. Animal models of demyelination and patients with MS have disrupted balance between MMPs and TIMP because of reduction in TIMP synthesis (Williams et al., 2007).

## 2.4.5 Astrocyte-Derived Chemokines production

Chemokines secreted by astrocytes attract immune cells, neural progenitor cells and OPCs towards the site of injury and induce differentiation of these migrating cells. One product is monocyte chemoattractant protein-1 (MCP1) which facilitates migration and differentiation of neural progenitor cells (Xu et al., 2007). Presence of Stromal cell-derived factor-1 (SDF1) was detected in MS patients. This chemokine inhibits migration of OPCs and induces their differentiation *in vitro* (Maysami et al., 2006).

Another factor expressed by astrocytes in MS patients is growth related oncogene-a (GRO-a) which stimulates OPCs differentiation and myelination (Padovani-Claudio et al., 2006). Astrocyte product IL-6, a cytokine, functions as a neuroprotectant as well as myelin protectant (Willenborg et al., 1995). Additionally IL-6 induces the secretion of neurotrophins like NT-3, NT-4/5, and nerve growth factor (NGF) from astrocytes in order to promote neuronal regeneration (Marz et al., 1999). Similar effects on OPCs maturation and survival can be induced by IL-11 (a member of IL-6 family) which is produced by astrocytes during astrogliosis (Zhang et al., 2006). Other astrocytic compounds that effect OPCs maturation and survival include IL-1B (Herx et al., 2001), ciliary neurotrophic factor (CNTF) (Stockli et al., 1991; Richardson et al., 1994) and insulin-like growth factor (IGF-I) (Mason et al., 2001). However majority of these cytokines do affect immune cells in one way or the other. So, their application for therapeutic purposes demands a lot of attention to rule out their harmful effects (Nair et al., 2008).

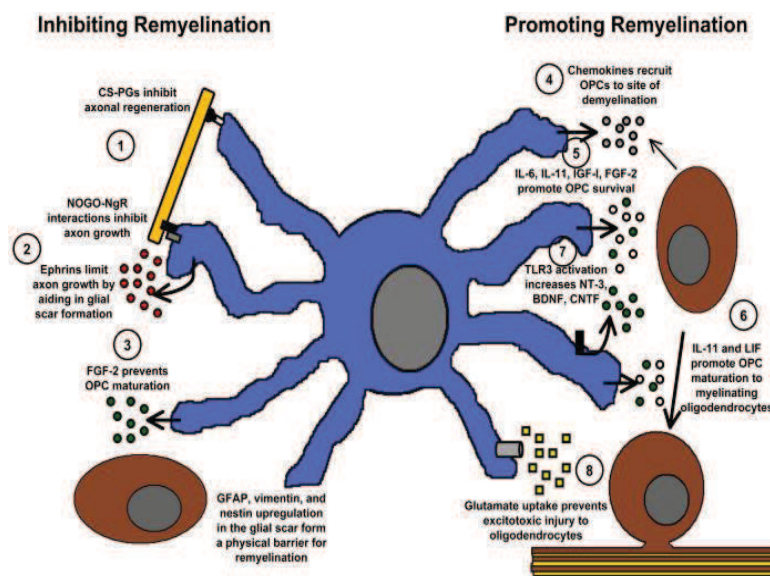



Figure I-6: Astrocytes play a dual role in remyelination both by acting on axon regeneration and OPCs. Glial scars contain chondroitin sulphate proteoglycans (CS-PGs) and NOGO-A receptor (NgR) which have inhibitory effects on axonal regeneration. Production of ephrins from astrocytes followed by their attachment with the receptors of axons causes the disintegration of growth cones. Similarly fibroblast growth factor-2 (FGF-2) prevents remyelination by inhibiting OPCs maturation. OPCs are responsible for the formation of myelin after reaching the demyelinated site. Astrocytes released chemokines promote OPCs migration, IL-6, IL-11, IGF-I stimulate proliferation and IL-11 and LIF are involved in the maturation. Neurotrophic factors NT-3, BDNF and CNTF enhance OPCs survival. They protect myelin damage by consuming extra cellular glutamate which is detrimental for myelin (Nair et al., 2008).

Figure I-6: Les astrocytes jouent un double rôle dans le remyélinisation soit en agissant sur la régénération de l'axone, soit au niveau de OPCs. Les cicatrices gliales contiennent des protéoglycane à chondroïtine sulfate (CS-PGS) et le récepteur NOGO-A (NgR) qui ont des effets inhibiteurs sur la régénérescence axonale. La production d'éphrines par les astrocytes et leur interaction avec les récepteurs des axons conduit à la désintégration des cônes de croissance. De la même façon le facteur de croissance fibroblastique-2 (FGF-2) empêche la rémyélinisation en inhibant la maturation des OPCs. Les OPCs sont responsables de la formation de la myéline après avoir atteint les sites de démyélinisation. Les chimiokines sécrétées par les astrocytes aident la migration des OPCs, IL-6, IL-11, IGF1 stimulent la prolifération et IL-11 et LIF interviennent dans la maturation. Les facteurs neurotrophiques NT3, BDNF et CNTF augmentent la survie des OPCs. Ils protègent le myéline de la destruction au consommant le glutamate extracellulaire (Nair et al., 2008).

### 3. Microglia

Microglia are important constituents of brain that control a variety of functions including development, injury, inflammation, regulation of microenvironment and repair.

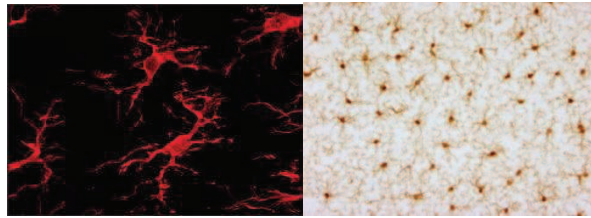

Figure I-7: Microglia

Figure I-7: La microglie

1. <http://alsn.mda.org/article/nine-new-mda-grants-focus-stopping-als>
2. <http://www.tumblr.com/tagged/microglia>

#### 3.1 Origin of microglia

There was a long debate about the origin of microglial cells but now a general consensus has been developed according to which mesodermal/mesenchymal derived peripheral progenitor cells give rise to microglial cells after migration (Chan et al., 2007). In rodents these cells originate from the monocyte-macrophage lineage of bone marrow cells (Davoust et al., 2008). Then they migrate into the brain during postnatal development before day 10 postnatal and can be detected as amoeboid shaped cells (Hass et al., 1996). However normal adult brain shows negligible infiltration (Ajami et al., 2007; Mildner et al., 2007). Disruption to blood-brain-barrier allows monocytes to enter brain where they are converted into microglial cells (Mildner et al., 2007). Microglia represent a steady state population under normal conditions.

A group of microglia arises from monocytes which continue to exist in brain during embryonic development (Chan et al., 2007). This migration takes place during embryonic day 10-19 in rodents while in human it continues from second half of the first trimester to the beginning of second trimester. Two different populations of microglia can be identified in brain. One population develops from myeloid/mesenchymal derived progenitors. Whereas

fetal macrophages either in developmental or transitory form constitute the second group of microglial population. This population originates from amoeboid microglial cells (Rezaie et al., 2005).

Primitive myeloid progenitor cells that emerge prior to embryonic day 8 (E8) give rise to adult microglia as well as majority of adult hematopoietic compartment. These precursor cells are localized in the brain before birth and are responsible for maintaining the population of postnatal microglia. The emergence of primitive myeloid cells was detected by the expression by fractalkine receptor (CX3CR1) which is a marker for early myeloid progenitors (Liu et al., 2009) and microglia (Harrison et al., 1998). In the developing brain myeloid cells, mainly recognized by the presence of myeloid cell marker CD45 and microglial markers CD11b, F4/80, and CX3CR1, can be found as early as E9.5. Microglial cells can be detected in the cephalic mesenchyme and neuroepithelium at E10.5. These cells display high rate of proliferation during embryonic life as evident from live cell imaging and microglial DNA analysis. So, it can be inferred that primitive myeloid progenitor cells that are generated after E7.5 are the main contributors of adult microglial population.

Colony stimulating factor-1 (CSF-1) and its receptor CSF-1R are important regulators of microglial development during all the stages of life. This finding was further confirmed by the presence of microglia in very low numbers in *Csf-1<sup>op/op</sup>* mice which carry a natural mutation in *Csf-1* gene. However, microglia are absent altogether in the mice that lack CSF-1R (Ginhoux et al., 2010). Microglial cells undergo process formation after reaching the brain under the action of factors like transforming growth factor- $\beta$  (TGF- $\beta$ ), macrophage colony-stimulating factor (M-CSF) and granulocyte/macrophage colony-stimulating factor (GM-CSF) (Schilling et al., 2000).

### **3.2 Morphology**

A microglial cell, during resting phase, is consisted of a small cell body which gives rise to many long branches resulting in ramified cellular appearance (Streit et al., 1999). The soma is motionless but processes are motile (Davalos et al., 2005). Morphology of microglia change during the activation phase when they start withdrawal of their branches inside the cell bodies thus simplifying their shape. This retraction completes in several steps which is followed by the development of new extensions with motile characteristics to facilitate locomotion (Lynch et al., 2009).

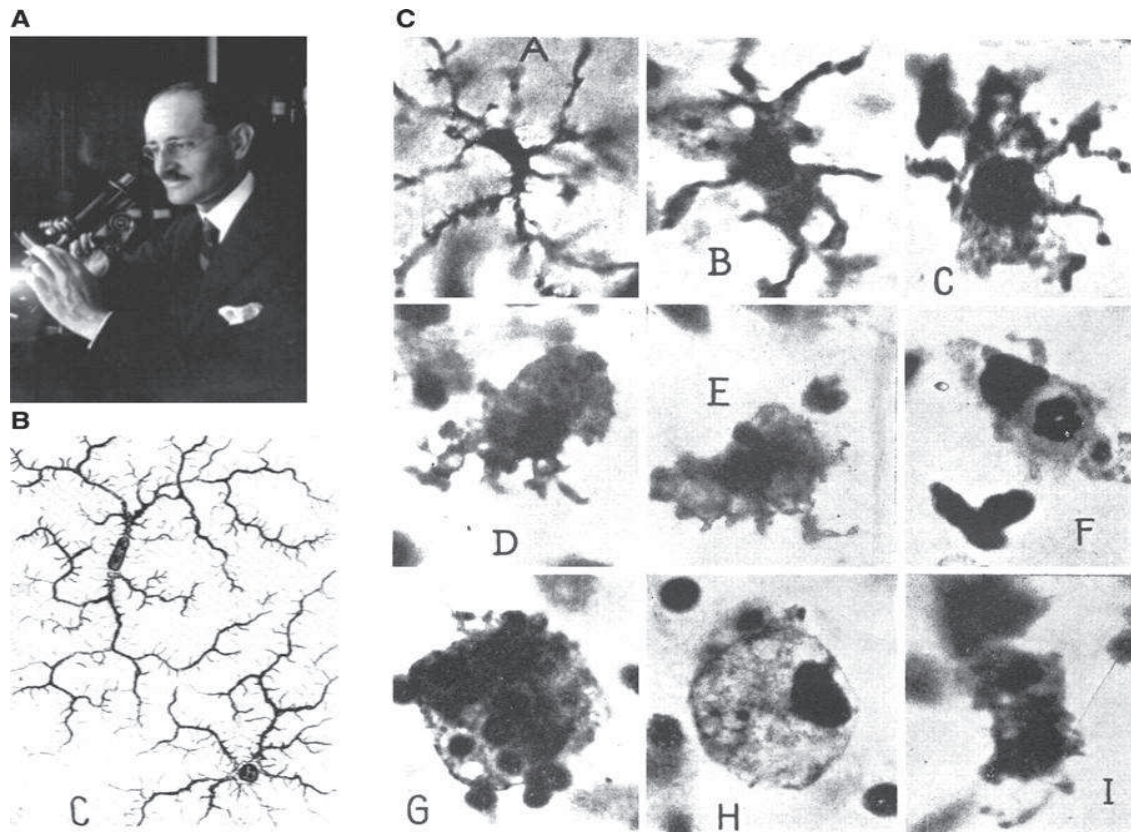

Figure I-8: Pio del Rio-Hortega discovered microglial cells. *A*: Pio del Rio-Hortega (1882–1945). *B*: Hortega’s drawings of ramified microglial cells. *C*: Changes in the shapes of microglia during its phagocytic activity. *A*, Cells have long coarse branches; *B*, increase in the size of cell body and reduction in the length of processes; *C*, pseudopodia containing hypertrophic cell; *D* and *E*, amoeboid shaped cells; *F*, cell containing phagocytosed leukocyte; *G*, cell containing several phagocytosed erythrocytes; *H*, fat-granule cell; *I*, proliferating cell. [Photomicrographs from del Rio-Hortega (Kettenmann et al., 2011).

Figure I-8: Pio del Rio-Hortega a découvert les cellules microgliales. *A*: Pio del Rio-Hortega (1882-1945). *B*: dessins de microglie ramifiée. *C*: Les changements de forme de la microglie pendant des activités phagocytose. *A*, Cellules avec des longues et épaisses branches; *B*, accroissement de la taille du corps cellulaire et réduction de la longueur des branches; *C*, cellules hypertrophique avec des pseudopodes; *D* et *E*, cellules au forme d’amibes; *F*, cellules contenant des leucocytes phagocytés; *G*, cellule qui présent plusieurs érythrocytes phagocytés; *H*, cellules granulaire graisseuses; *I*, cellules en phase de prolifération. [Photomicrographies del Rio-Hortega] (Kettenmann et al., 2011).

au cours de Microglial cells do not have complex branching when grown in vitro and may have spindle or rod shaped appearance (Abd-el-Basset et al., 1996). Nature of the lesion determines the morphology of cells (Streit et al., 1999). The rapid modifications in the shape of cells under different conditions suggest a correlation between morphology and function. For instance development of filopodial extensions supports cellular movement whereas presence of lipid and or myelin rich organelles in foamy microglial represents a cell with phagocytic activity. However this is not always true as certain genes possess their function without any change in the morphology (Eskes et al., 2003). Similarly process formation can be stimulated even when it is not suitable (Ilschner et al., 1996). So, mere transformation of a branched cell into an amoeboid cell is not enough to describe the functioning potential of the cell (Markovic et al., 2009).

### **3.3 Identification**

Microglia are identified by immune-histochemical staining of various cellular molecules and receptors using specific antigens. Some markers which are generally used for microglial identification include Griffonia simplicifolia isolectin B4 (ILB4) or tomato lectin (Boya et al., 1991), M 2 integrin receptors (CD11b/ CD18) (Ma et al., 2003), immunoglobulin receptors CD45, CD68, F4/80 (Chen et al., 2002) and major histocompatibility complex II (MHC II) which labels activated microglia (McGeer et al., 1993). The glucose transporter 5 (GLUT5) has been implicated in human for microglia detection (Horikoshi et al., 2003). Iba1 (Ionized calcium binding adaptor molecule 1), a protein related to calcium regulation, is widely used marker for improved sighting of microglia (Imai et al., 2002).

### **3.4 Activation of microglia**

Several mechanisms were proposed to explain the activation of microglial cells including the involvement of potassium (K<sup>+</sup>) channels (Kettenmann et al., 1993), adenosine triphosphate receptors (Langosch et al., 1994), calcitonin gene-related peptide (Priller et al., 1995) and receptors for various neurotransmitters (Pocock and Kettenmann, 2007).

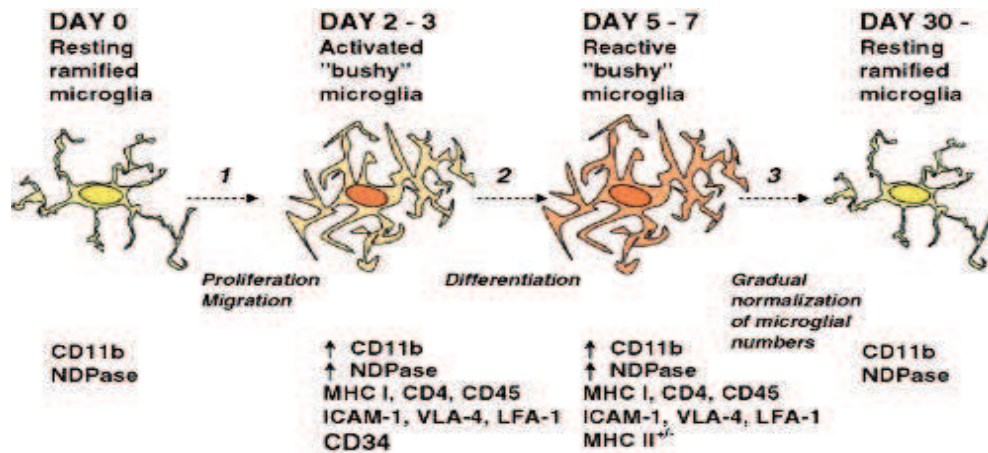

Figure I-9: A schematic presentation of various steps involved in the activation of microglial cells along with the markers expressed at each stage. Interestingly CD34 is expressed temporarily 3 days post lesion contrary to other markers which are present in high levels at days 5–7 (Ladeby et al., 2005).

Figure I-9: Représentation schématique des différents stades d'activation des cellules microgliales en indiquant des marqueurs à différents stades. De façon intéressante, CD34 est exprimé de façon temporaire à 3 jours après apparition de la lésion contrairement aux autres marqueurs qui sont présents à des niveaux élevés les jours 5-7 (Ladeby et al., 2005).

Microglia contain receptors for pattern recognition which facilitate quick reaction in case of damage (Van Rossum and Hanisch, 2004). In some cases absence of signals or loss of receptors induces the activation of microglia (Biber et al., 2007). Neurodegenerative disease (Amor et al., 2010) and neurotoxicity (Harry and Kraft, 2008) elicits an inflammatory reaction which is associated with microglial activation and addition of perivascular monocytes, leukocytes and macrophages.

### 3.5 General functions of microglia

Microglia perform diverse functions in the CNS either alone or in combination with other cells to maintain homeostasis and generate immune reaction. Here are some of the major known functions carried out by these cells.

### 3.5.1 Regulators of CNS immunity

Microglia are constituents of brain immune system and regulate innate immunity. Contrary to other macrophages they are comparatively quiet and have a strong influence of surrounding micro-environment. Microglial cell body is relatively inert so they assess the neighboring environment by the movement of their processes (Nimmerjahn et al., 2005). Microglia sense the changes in their environment and react in no time. This response could be in the form of modifications to brain functions or interference to brain parenchyma. Microglia make the first line of defense in case of microbial attack where they work in coordination with neurons to identify the changes in the neuron function and health.

### 3.5.2 Maintenance of microenvironment

Microglial function is not limited to the surveillance of the surroundings but they actively participate in the regulation and maintenance of their environment thereby removing any dead or damaged cellular debris. They behave differently in the presence of tissue damage depending upon many factors. They promote healing in some injuries like trauma, stroke and chemical damage but in long term tissue damage they may induce harmful effects (Harry and Kraft, 2012).

### 3.5.3 Cytotoxic effects

Microglia produce many compounds with cytotoxic potential. In vitro growth of microglia results in the release of substances like  $H_2O_2$  and NO which are lethal for neurons. However release of these free radical in brain is crucial for development. They secrete cytokines like IL-1, glutamate and aspartate to induce demyelination and cellular damage in bacteria, viruses and infected neurons and even in many normal neurons (Gehrmann et al., 1995).

### 3.5.4 Microglia and development

Microglia stimulate proliferation and differentiation of neurons during development. Fetal microglia achieve this feat by release factors like cytokine IL1 and TNF- $\alpha$  (Giulian et al., 1988; Munoz-Fernandez and Fresno, 1998). They facilitate neuronal migration by thrombospondin induced alterations in extracellular matrix (Chamak et al., 1994).

### 3.5.5 Neuroprotection

Microglia produce various neurotrophic factors e.g. neuronal growth factor (NGF), brain derived neurotrophic factor (BDNF), neurotrophin-3 (NT3), glial derived neurotrophic factor (GDNF) and neurotrophic cytokines to promote neuroprotection (Garden and Moller, 2006). Furthermore they indirectly increase neuron survival and stimulate neurite outgrowth through the release of macrophage colony stimulating factor which is neurotrophic in nature (Michaelson et al., 1996).

### 3.5.6 Housekeepers

Microglia act as housekeepers to remove unwanted material i.e., dead cells, DNA pieces, damaged cells in their neighborhood (Aloisi, 2001). This potential is particularly applied during development to remove extra cellular material. Cerebral cortex and subcortical white matter contain a large number of apoptotic cells during postnatal development which are effectively eliminated by microglia (Ferrer et al., 1990).

### 3.5.7 Antigen presentation

Microglia in the resting stage are unable to present antigens because they do not express MHC 1 and II proteins. As soon as they are activated they take MHC 1 and II to become antigen presenting cells. They may be activated by other factors like IFN- $\gamma$  but in that case antigen presentation function is less efficient. These antigens activate T cells after coming in contact with them during inflammation. Activated T cells then perform a number of functions like attack on foreign cells, production of cytotoxic compounds and accumulation of pro-inflammatory substances and promotion of immunememory (Aloisi, 2001).

### 3.5.8 Promotion of repair

Microglia promote neural repair by a variety of activities after inflammation. They facilitate synaptic stripping, release anti-inflammatory cytokines, stimulation of astrocytes, neurons and oligodendrocytes at the site of injury besides production of gitter cells (Gehrmann et al., 1995).



## 3.6 Microglia and myelination

### 3.6.1 Interaction with oligodendrocytes

During the early developmental stages microglia are present in the white matter of the brain. They are closely related to oligodendrocytes and execute an inflammatory activity in response to changes in myelin or oligodendrocyte progenitor cells and receptor mediated action (Deng et al., 2008). A group of microglial cells expresses TREM2 receptor which inhibits pro-inflammatory macrophage activity and promotes the production of T-lymphocytes activating antigens. Myelination is disrupted in the absence of TREM2 (Klunemann et al., 2005). TREM2 intracellular signaling is facilitated by trans-membrane adaptor molecule DAP12 (Prada et al., 2006). TREM2+/DAP12+ microglia are located in the proximity of oligodendrocytes before the onset of myelination in postnatal day 1 mice (Thrash et al., 2009). So, based on the functioning of TREM2+/DAP12+ microglia, their close association with oligodendrocytes suggests an impact on the development (Takahashi et al., 2007).

### 3.6.2 Microglial activation

Morphological modifications along with increase in population of microglial cells can be found in white matter after demyelination in Long Evans shaker (*les*) rat at postnatal week-4. They transformed into an active state characterized by the presence MHC II. There is an increase in the mRNA levels of interleukin-1 $\beta$  (IL-1 $\beta$ ), tumor necrosis factor- $\alpha$  (TNF- $\alpha$ ), and inducible nitric oxide synthase (iNOS). Ultra structural observation showed active phagocytosis of myelin debris by microglia (Zhang et al., 2001).

### 3.6.3 T-cells infiltration

In Multiple Sclerosis (MS), acute inflammatory lesion is thought to be induced by infiltration and activation of T cells (Hickey, 1999). These observations are in agreement with established hypothesis that T cell mediated macrophage invasion leads to the development of characteristic disease pathophysiology (Sriram and Rodriguez, 1997). This fact is offset by the finding that in newly formed lesions oligodendrocyte death continues even when T cell and peripheral microglia are not present which in turn activates and accumulates local microglia (Henderson et al., 2009).

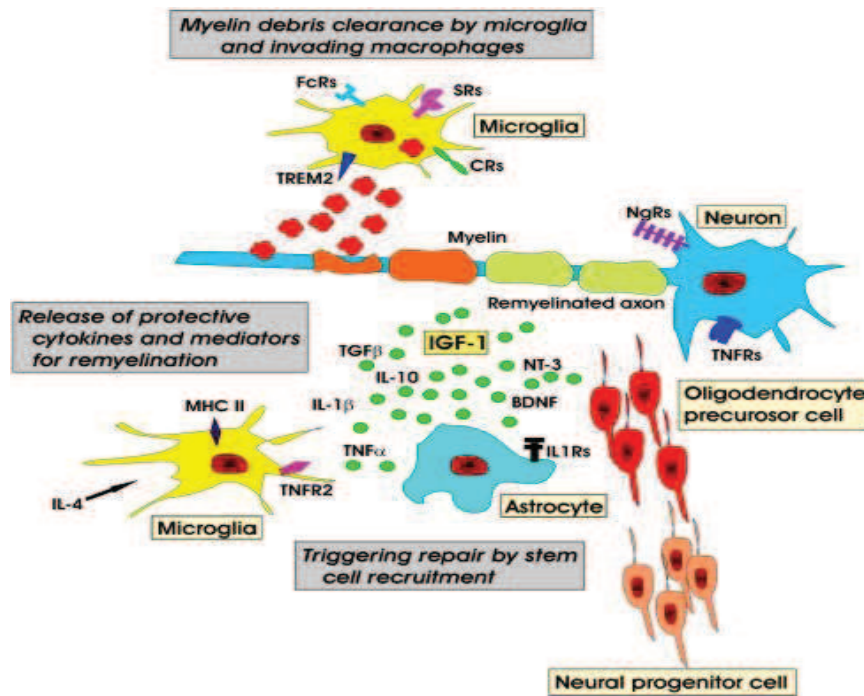

Figure I-10: Microglia exercise positive effects on demyelination by promoting neuroprotection and facilitating repair process. They stimulate repair process through the removal of myelin debris, production of protective cytokines and release of remyelination mediators. Additionally they recruit oligodendrocyte precursors and induce neurogenesis. Abbreviations: BDNF, brain-derived neurotrophic factor; NT3, neurotrophin-3; IGF-1, insulin-like growth factor-1; IL-10, interleukin-10; IL-1, interleukin-1; TNF $\alpha$ , tumor necrosis factor- $\alpha$ ; TGF $\beta$ , transforming growth factor- $\beta$ . Membrane receptors: TREM2, triggering receptor expressed on myeloid cells-2; TNFR2, tumor necrosis factor receptor-2; MHC II, major histocompatibility complex class II; FcRs, Fc receptors; SRs, scavenger receptors; CRs, complement receptors; NgRs, Nogo receptors; TNFR, tumor necrosis factor receptors; IL1Rs, Interleukin-1 receptors (Napoli and Neumann, 2010).

Figure I-10: La microglie exerce des effets positifs sur la démyélinisation en favorisant la neuroprotection et facilitant le processus de réparation en éliminant les débris de la myéline et en produisant des cytokines protecteurs et en relargant des médiateurs de la remyélinisation. De plus, la microglie recrute les précurseurs des oligodendrocytes (OPCs) et induit la neurogenèse. Abréviations: BDNF, brain-derived neurotrophic factor; NT3, neurotrophin-3; IGF-1, insulin-like growth factor-1; IL-10, interleukin-10; IL-1, interleukin-1; TNF $\alpha$ , tumor necrosis factor- $\alpha$ ; TGF $\beta$ , transforming growth factor- $\beta$ . Membrane receptors: TREM2, triggering receptor expressed on myeloid cells-2; TNFR2, tumor necrosis factor receptor-2;

MHC II, major histocompatibility complex class II; FcRs, Fc receptors; SRs, scavenger receptors; CRs, complement receptors; NgRs, Nogo receptors; TNFR, tumor necrosis factor receptors; IL1Rs, Interleukin-1 receptors (Napoli and Neumann, 2010).

#### 3.6.4 Microglia as macrophages

Microglia control immune reaction of CNS mainly because of their phagocytic potential, capability to expose antigen, production of immunomodulatory factors like growth factors, cytokines and chemokines. There are two subtypes of peripheral macrophages i.e., M1 and M2 (Gordon, 2003). M1 macrophages promote the activity of T helper cells (Th1) and eliminate microorganisms. The responsibilities of M2 macrophages include the synthesis of anti-inflammatory compounds, phagocytic removal of debris and promotion of tissue repair. Whether microglia are beneficial or harmful in CNS diseases is still a disputed issue (Block et al., 2007). However, microglia seem to function in both ways by contributing towards various de and regenerative activities. They adopt a variety of phenotypes in addition to local microglial variations to perform different functions and contribute towards disease pathophysiology of CNS diseases (de Haas et al., 2008).

The extent to which demyelination or remyelination occurs is variable and displays different patterns (Patrikios et al., 2006). The cause of remyelination failure and resultant damage in MS patients is not known (Franklin, 2002). One possible reason could be inefficiency of microglia and macrophage to remove myelin debris which is crucial to start myelin regeneration (Neumann et al., 2009). Remyelination efficacy was affected in lysolecithin mouse model in the absence of macrophages. Additionally presence of myelin debris prevents the differentiation of oligodendrocyte precursor cells (Kotter et al., 2006). Anti-inflammatory cytokine production is enhanced by the phagocytic removal of dead cell in some instances (Liu et al., 2006). Some earlier studies found tumour necrosis factor alpha (TNF- $\alpha$ ) as a factor which contribute to the worsening of demyelination and hence disease progression. Later on studies in cuprizone model established that TNF- $\alpha$  as well as interleukin-1 $\beta$  (IL-1 $\beta$ ) stimulate remyelination process (Arnett et al., 2003).

Microglial phagocytosis, characterized by increased expression of phagocytic receptors in particular TREM-2b, is enhanced during demyelination. Similar increase in the level of proinflammatory cytokine TNF- $\alpha$  can be observed. However MHC II and anti-inflammatory cytokines IL-10 and transforming growth factor- $\beta$  (TGF- $\beta$ ) expression does not alter

significantly. There is a significant increase in the levels of growth factors IGF-1 and FGF-2 which are associated with remyelination. Elevated TREM-2b levels promote removal of myelin debris whereas TNF- $\alpha$ , IGF-1 and FGF-2 prepare conditions that promote myelination (Voss et al., 2012).

## 4. Oligodendrocytes

Oligodendrocytes are the myelin forming cells in the CNS. Besides myelinating oligodendrocytes there exists a satellite type which is not necessarily linked to myelin sheath (Penfield, 1932). These cells are located around the neurons and maintain the microenvironment of neighboring neurons (Ludwin, 1997).

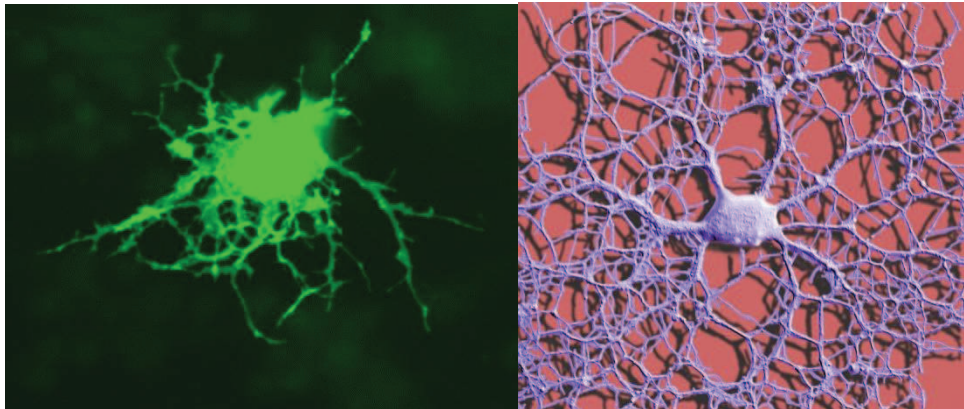

Figure I-11: Oligodendrocytes

Figure I-11: Un oligodendrocyte

1.<http://readtiger.com/wkp/en/Neuroglia>

2.<http://www.udel.edu/biology/Wags/histopage/wagnerart/coloredempage/coloredems.html>

### 4.1 Oligodendrocyte morphology

Oligodendrocytes are different than astrocytes in many respects; they are smaller than astrocytes, with dense nucleus and cytoplasm lacking intermediate filaments (fibrils) and of glycogen. Their processes contain large number of microtubules (25nm), thought to be involved in stability of the cells (Peters et al, 1991).

Electron microscopic studies revealed them to be consisted of a population of heterogeneous cells (Bansal et al., 1996) that share common features in the lights of oval or spherical nucleus, normal cytoplasmic organelles, highly developed rough endoplasmic reticulum and specialized Golgi complex both in peri-nuclear and protoplasmic processes (Mori and Leblond, 1970; Wawrzyniak-Gacek, 2002).

Every myelinating oligodendrocyte gives rise to many processes each of which contacts a short stretch of axon to develop a compact multilayered myelin membrane (Bunge, 1968). Usually the number of processes that arise from a single oligodendrocyte depends upon the area of CNS and the species involved like in the region of rat optic nerve there may be 40 processes (Peters et al, 1991) as compared to only one in the spinal cord of cat. In this way an axon receives processes from multiple oligodendrocytes hence neighboring myelin processes may belong to different oligodendrocytes (Bunge et al., 1961).

Morphological analysis of oligodendrocytes in Sprague–Dawley rats at postnatal day 12 showed that they myelinate approximately 10 axons in the corpus callosum and about 7 in cerebellum. However in corpus callosum, internodal distance is shorter than that of cerebellum, whereas cell bodies have similar size in both corpus callosum and cerebellum (Bakiri et al., 2011).

## **4.2 Classification of oligodendrocytes**

Rio Hortega (1921, 1928) classified oligodendrocytes into four different types that myelinate from 1 to 30 axons (Bakiri et al., 2011). Electron microscopic studies combined with light microscopic examination for the evaluation of oligodendroglial cells revealed 3 distinct groups in the corpus callosum of rat. Light oligodendrocytes constitute 6% of the glial population in corpus callosum and are large cells with many fine branches, which undergo cell division at a rapid pace. Medium-shade oligodendrocytes are relatively smaller cells with considerable number of fine processes. These cells with fair mitotic activity are one fourth of the total glial cells. Approximately 40% glial population is consisted of dark oligodendrocytes, non-mitotic small cells with few thin processes. It is most likely that they arise from medium shade oligodendrocytes (Mori and Leblond, 1970).

Oligodendrocytes are a mixed population of three distinct types that differ in cytoplasmic properties i.e., light, medium and dark. They arrange themselves in the vicinity of axons and blood vessels. There is a reduction in the number of light oligodendrocyte as the animal grows while cells with dark cytoplasm follow opposite pattern of increase. This color of cytoplasm is developed by the end product iron metabolism which distributes itself in the cytoplasm and branches (Wawrzyniak-Gacek, 2002).

In another instance oligodendrocytes were grouped on the bases of their biochemical and morphological characteristics. Type I cells myelinate numerous small diameter axons, type II and III are responsible to form myelin around intermediate axons, while merely 1-3 large diameter axons are myelinated by type IV oligodendrocytes (Butt et al., 1995).

### **4.3 Origin and differentiation of Oligodendrocytes**

There have been several debates concerning the origin of oligodendrocytes during brain development. This issue was settled with the advent of new molecular techniques which enabled us to perform gene mapping of specific cell lines in developing mouse brain (Kessaris et al., 2006). Several studies were performed on animal models to locate the exact origin of oligodendrocytes that put forwarded different concepts. One theory says that oligodendrocytes are generated in the ventral side of the neural tube under the direction of sonic hedgehog (Shh) and then they migrate to the dorsal part as oligodendrocyte progenitors (Spassky et al., 2000). Later on, it was observed that initial burst of ventral oligodendrocytes is short term and is taken over and substituted by dorsally derived oligodendrocytes (Kessaris et al., 2006; Jakovcevski et al., 2009).

Gene mapping of oligodendrocyte lineage specific mRNA depicts that oligodendrocyte progenitors come into view in specific neuroectodermal regions during embryogenesis. These findings were further confirmed by determination of regenerative potential of various parts of embryonic CNS using oligodendrocyte specific lac Z expressing MBP transgenic mouse as a donor. This transgenic mouse contains *lacZ* gene of *E. coli* under the control of a 1.9 kb promoter sequence from the MBP gene. Neural tube portions from hindbrain, cervical and lumbar spinal cord without dorsal telencephalon at E14.5 and E12.5 stage were transplanted in postnatal (1-3 day) mice cerebral subcortical white matter near lateral ventricle resulted in oligodendrocyte production. Similar results were obtained after the transplantation of E10.5 embryonic parts pointing to the fact that oligodendrocyte progenitor cells are located throughout the neuroectoderm. Furthermore mitotically inactive myelin producing oligodendrocytes first appear at E14.5 in the area close to midline of the medulla. This production of oligodendrocytes is limited to certain region that follows a tract-specific pattern (Hardy and Friedrich, 1996).

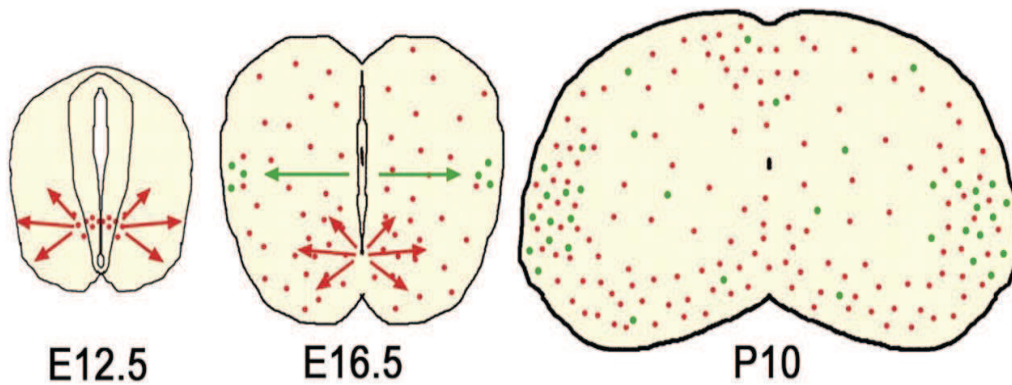

Figure I-12: Oligodendrocytes originate in the embryonic rodent spinal cord. Oligodendrocyte progenitor cells arise from ventral VZ (red) at E12.5 in the mouse spinal cord. Around E 16.5 a subset of cells arise from radial glial cells in the dorsoventral midline (green). These cells migrate after their origin and disperse throughout the spinal cord (P10) (Fogarty et al., 2005).

Figure I-12: Les oligodendrocytes sont originaires de la moelle épinière de l'embryon. Les cellules progénitrices des oligodendrocytes émergent de la zone ventriculaire (VZ) ventrale (rouge) dans la moelle épinière de souris à E (jour embryonnaire) 12,5. Une sous-groupe de cellules proviennent de cellules gliales radiales sur la ligne médiane dorso-ventral (vert) à environ E16,5. Ces cellules migrent après leur origine et se dispersent dans tout le long de la moelle épinière (P10= jour postnatal) (Fogarty et al., 2005).

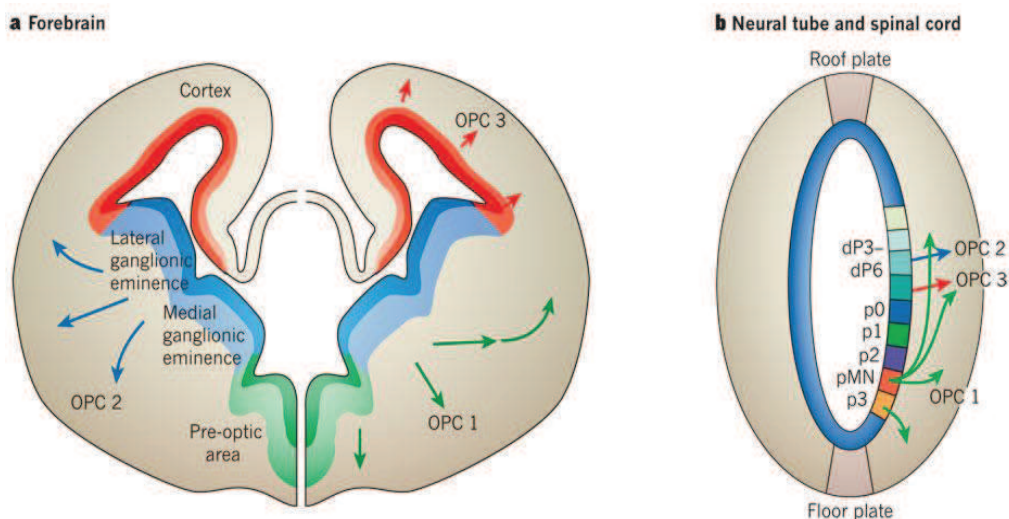

Figure I-13: Les cellules précurseurs d'oligodendrocytes (OPCs) proviennent successivement de trois régions différentes de la zone ventriculaire dans le cerveau antérieur:



Figure I-13: In the forebrain ventricular zone OPCs arise from three different areas in succession: At E12.5 first series of OPCs (OPC 1: green) arises from the medial ganglionic eminence; Second series (OPC 2: blue) appears from the lateral and medial ganglionic eminences at E 15.5; while OPC 3 (red) emerge from the cortex after birth (Rowitch and Kriegstein, 2010).

A E12,5 première série d'OPC (OPC 1: vert) découle de l'éminence ganglionnaire médiane; Deuxième série (OPC 2: bleu) émerge de l'éminence ganglionnaire latérale et médiane à E 15,5, et troisième série, OPC 3 (rouge) provient du cortex après la naissance (Rowitch and Kriegstein, 2010).

Early gestation is the time period when mammals receive their quota of cortical neurons. Neurogenesis begins at the very start of gestation and gives rise to radial glial cells, which migrate to cortex and give rise to neurons during migration (Rakic, 1995). Oligodendrocytes and astrocytes usually originate from the subventricular zone (SVZ) that continues to exist from late gestation stage and onwards. However maturation of oligodendrocytes and astrocytes takes place during early postnatal life

#### 4.3.1 Common precursors for neurons and glia: pluripotentiality of stem cells

Glial cells develop by binary genetic switch of a protein glial cells missing (*gcm*) of presumptive glial cells during neurogenesis in the CNS of *Drosophila*. The maturation of *gcm* protein leads to the development of glial cells while the absence of this protein induces the generation of neurons from presumptive glial cells (Hosoya et al., 1995). The presence of protein with similar functions in vertebrates has not been recognized yet.

Mammalian telencephalic ventricular and SVZ contain mitotically active neuroepithelial cells that are capable of giving rise to both neurons and glial cells (Doetsch et al., 1997). The cells present in SVZ are either multipotent or lineage restricted precursors (Levison and Goldman, 1993; Skoff, 1996). A number of studies delineate E15-E18 as the important time for the generation of various progenitor cells from ventricular/subventricular zone of the forebrain. At this stage some progenitor cells have already been transformed into specialized clones while others represent mixed clones which are capable of giving rise to different types of progenitor cells (Skoff, 1996).

Environmental factors play an important role in determining the fate, choice and survivability of the remaining cells (Jensen and Raff, 1997). Actual fate of a progenitor or multipotent cell is determined by a variety of trophic factors and this fate may be pole apart from the developmental potential of the cell (Yandava et al., 1999). This significance of trophic factors can be seen very clearly in case of neuronal development which is restricted to prenatal stage as the factors produced postnatal do not support neuron survival (Levison and Goldman, 1993).

It is a well-established that adult tissues contain progenitors and stem cells and thought that Notch pathway may play a role in maintaining a small population of undifferentiated cells in a fully developed tissue in order to carry out repair process during injury or tissue damage (Artavanis-Tsakonas et al., 1995).

#### 4.3.2 Oligodendrocyte precursors in the ventricular zone

The origin of oligodendrocyte precursor cells was traced by pursuing expression of specific markers of oligodendrocyte lineage including myelin proteins such as CNP, MBP and PLP. These studies showed that oligodendrocyte precursor cells arise in the ventricular zone from neuroepithelial cells (Yu et al., 1994). During development oligodendrocytes precursor cells first make their appearance in the ventral region of spinal cord followed by their migration into the dorsal spinal cord (Warf et al., 1991). Later on, oligodendrogenesis starts in dorsal region resulted from intrinsic generation as well as supply of ventral region arrived after migration (Cameron-Curry and Le Douarin, 1995). This was confirmed by the results of *in vivo* studies using thoraco-lumbar spinal cord cultures to show that oligodendrogenesis is limited to ventral spinal cord until E14 and then begins in dorsal region (Warf et al., 1991). Several studies suggest the involvement of sonic hedgehog (Shh) signaling to induce oligodendrogenesis in ventral neural tube (Orentas and Miller, 1996, Orentas et al., 1999).

Oligodendrocyte proteins related to maturation were used for *in situ* hybridization studies to locate the presence of oligodendrocyte at different developmental stages. In this way PDGF- $\alpha$  (Pringle and Richardson, 1993), CNP (Yu et al., 1994), DM20 (PLP) mRNA (Timsit et al., 1992) expressing populations were identified in ventral ventricular area of developing spinal cord. Likewise ventral and mantle regions of ventricular diencephalon of rat contain PDGFR- $\alpha$  mRNA positive population at cells E13. A strong signal for DM20 mRNA was detected in the diencephalon basal plate of mouse at E10 (Timsit et al., 1992). Interestingly different

markers are not expressed by one population of cells in the same region indicating the presence of different developmental stage at such an early stage. Embryonic cells that transform into oligodendrocyte precursor cells express DM20 in the spinal cord (Dickinson et al., 1996).

Oligodendrocyte precursor cells localized in ventral neural tube during early stages are not merely restricted to spinal cord (Yu et al., 1994) but also show their presence in mid and forebrain (Timsit et al., 1992). Other vertebrates like human (Hajihosseini et al., 1996), chickens (Ono et al., 1997) and xenopus (Yoshida, 1997) also show similar localized regions of oligodendrogenesis. In murines cerebral cortex of developing embryo received oligodendrocyte population derived from diencephalon and most likely telencephalon restricted oligodendrocyte precursor cells (Price, 1994).

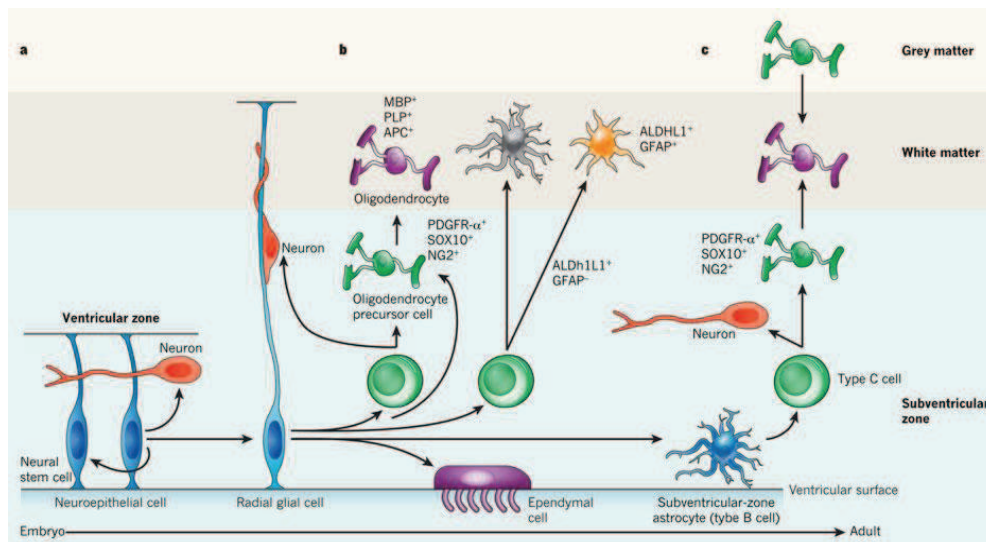

Figure I-14: Oligodendrocytes development from embryonic life to adult stage from left to right: differentiation and cell renewal is presented in the form of black arrows. (a) Neuroepithelial cells produce new cells by self-renewal, converted to radial glial cells during neurogenesis. (b) These radial glial cells give rise to OPCs (oligodendrocytes) and intermediate progenitors (neurons) during embryonic life. Additionally, radial glial cells can also be transformed into astrocytes. Both fibrous and protoplasmic astrocytes may share their progenitors. (c) There are two sources of oligodendrocytes in adults: transit-amplifying cells (type C cells) in the subventricular zone and OPCs (Rowitch and Kriegstein, 2010).

Figure I-14: Développement des oligodendrocytes de la vie embryonnaire à l'âge adulte (de gauche à droite): la différenciation et le renouvellement des cellules sont indiquées par des

flèches noires. (a) les cellules neuroepitheliales produisent de nouvelles cellules par autorenouvellement, sont transformées en cellules radiales pendant la neurogénèse. (b) Ces cellules radiales donnent naissances aux OPCs (oligodendrocytes) et aux progéniteurs intermédiaires pendant la vie embryonnaire. De plus, des cellules radiales transformées en astrocytes fibreux et protoplasmiques peuvent avoir le même progéniteur. (c) Chez l'adultes il existe deux sources d'oligodendrocytes: les cellules d'amplification-transit (cellules de type C) dans la zone sous-ventriculaire et les OPCs (Rowitch and Kriegstein, 2010).

### 4.3.3 Oligodendrocyte progenitors in the SVZ

Forebrain contains a SVZ rich in germinal cells. In murine, SVZ develops during late gestation and is most active from P5 to P20 after which it reduces in size but present throughout adult life (Doetsch et al., 1997). The SVZ contains glial precursor cells, responsible for the production of astrocytes and oligodendrocytes as detected by lineage tracing studies using retrovirus (Luskin et al., 1988). A great majority of cells in SVZ give rise to homogenous cell population of either astrocytes or oligodendrocytes. Among these cells some are capable of producing both astrocytes and oligodendrocytes and even a few can give rise to both neurons and oligodendrocytes (Levison and Goldman, 1993).

Retroviral studies and other techniques showed that during embryogenesis and postnatal corticogenesis, cells diffuse considerably and tangentially (Price, 1994). As a result, cells from two different clones can reside at a particular place. Moreover, retroviral studies, tritiated thymidine and immunocytochemical studies established that almost all the oligodendrocytes arise from SVZ cells which are not involved in the generation of astrocytes (Skoff, 1996). Oligodendrocytes are generated postnatly from SZ of lateral ventricles in neonatal rat cerebrum (Levison and Goldman, 1993). Likewise SVZ of fourth ventricle is responsible for postnatal oligodendrocyte production in the cerebellum (Reynolds and Wilkin, 1988). Developmental (Frost et al., 1996) and transplantation (Lachapelle et al., 1983) studies showed that oligodendrocyte progenitor cells travel long distance to form white matter of brain.

The number of oligodendrocytes increases from their first appearance in optic nerve round birth to postnatal week 6 in rodents (Skoff et al., 1976; Barres and Raff, 1994). The evidence about the generation of these oligodendrocytes are indirect like *in vitro* culture from chiasma end of neural tube (E15) give rise to oligodendrocytes but retinal end is unresponsive. This

suggests that oligodendrocytes arise from progenitors that migrate from brain and not from neuroepithelial cells of neural tube during the embryonic development (Small et al., 1987).

Subventricular zone of adult brain contains few glial fibrillary acidic protein (GFAP)-positive astrocytes (type B cells). These cells have high potential to give rise to both NG2-positive OPCs and mature oligodendrocytes, fully capable of myelinating axons. Additionally small number of these type B cells along with few type C (transit amplifying) cells expressed OPCs specific transcription factor Olig2 indicating that oligodendrocyte lineage starts differentiation at quite early stage in SVZ. The cells of SVZ origin positive for Olig2, polysialylated neural cell adhesion molecule (PSA-NCAM) and PDGF- $\alpha$  receptor and negative for tubulin move into corpus callosum, striatum and fimbria fornix, where they transformed either into mature oligodendrocytes or nonmyelinating NG2 expressing cells. A remarkable fourfold increase in the number of type B derived oligodendrocytes was observed upon the induction of demyelination in corpus callosum. This proves that SVZ type B astrocytes are a source of oligodendrocytes in normal as well as injured adult brain (Menn et al., 2006).

#### **4.4 Oligodendrocyte migration**

Majority of oligodendrocytes arise from restricted periventricular germinal areas during embryonic and early postnatal development (Olivier et al., 2001). Oligodendrocyte progenitor cells migrate long distances from their site of origin to populate grey and white matter of brain (Qi et al., 2002). They follow specific cues and proliferate extensively in response to growth factors such as PDGF (Bogler et al., 1990). Most of the NG2 expressing oligodendrocyte precursor cells proliferate in the presence of platelet-derived growth factor (PDGF) (Richardson et al., 1988) to give rise to myelinating oligodendrocytes while remaining cells transform into immature cells with slow mitotic potential and reside in different areas of adult brain (Polito and Reynolds, 2005). These cells generate new oligodendrocytes throughout adulthood to perform myelin repair (Chari and Blakemore, 2002). A number of studies suggested the presence of oligodendrocyte progenitor cells in the SVZ of adult brain. Neurospheres derived from SVZ adult neural stem cells develop into oligodendrocytes (Pluchino et al., 2003). Likewise new oligodendrocytes are produced by the adult SVZ upon induction of demyelination in corpus callosum or seizures (Parent et al., 2006). In the adult SVZ the primary progenitors that generate new oligodendrocytes are still

unidentified (Menn et al., 2006). Importantly, many oligodendrocytes can be generated *in situ* from OPCs in myelinated tracts during development (Jalabi et al., 2005) and in adult white matter after chronic demyelination (Harsan et al., 2008; Husain et al., 2013).

Oligodendrocyte progenitor cells migrate a long distance in CNS from their site of origin before transforming into mature myelin-forming oligodendrocytes (Small et al., 1987). In order to become mature cells they need to extend their processes. They follow the same pattern of process extension as the neurites formation by neuronal cell bodies. Oligodendrocyte migration is controlled by a number of extracellular matrix (ECM) molecules playing an inhibitory or acceleratory role. Tenascin-C possesses an inhibitory effect in oligodendrocyte migration at the rat retina-optic nerve junction, where it is produced in large quantities to prevent myelinating oligodendrocytes access to retina (Ffrench-Constant et al., 1988). Consequently, tenascin-C serves as a barrier for oligodendrocyte migration to the retinal end of the optic nerve (Bartsch et al., 1994). It was found that substrate nature controls the inhibitory action of tenascin-C, like presence of fibronectin prevent migration but the existence of merosin have no effect on migration (Frost et al., 1996). Oligodendrocytes use metalloproteinases (MMP) for the development of processes through the ECM produced by astrocytes. This was confirmed *in vivo* where higher levels of MMP in oligodendrocytes and myelin rich tissue increased postnatal myelination. On the other hand oligodendrocytes culture from MMP-9 null mice showed significant reduction in process formation indicating the role of MMP in process extension (Oh et al., 1999). Similar decrease in process outgrowth was observed with the application of MMP inhibitors (Uhm et al., 1998).

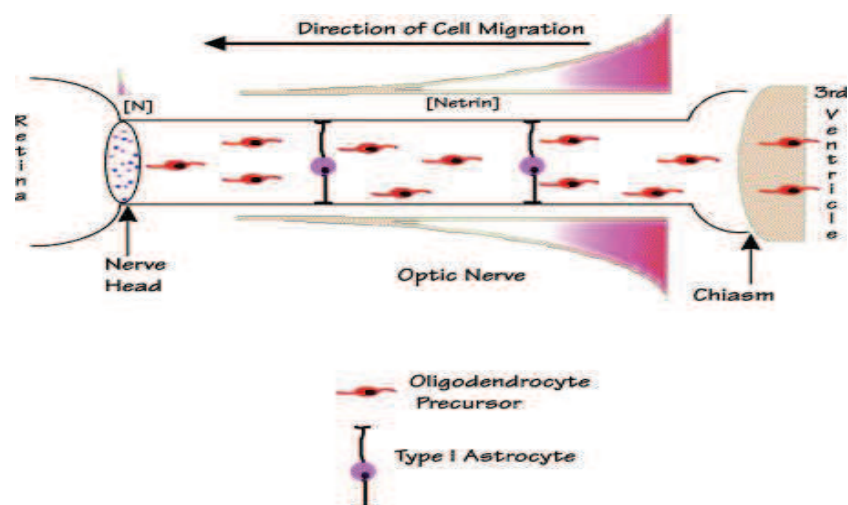

Figure I-15: Oligodendrocyte precursors migrate along optic nerve from the chiasm towards retina following their generation in the floor of the 3<sup>rd</sup> ventricle. This movement is mediated by chemo repellent signals like netrin. Some species develop a barrier to prevent the entry of precursors in the retina. Type 1 astrocytes develop along the length of optic nerve and are mostly non motile (Miller, 2002).

Figure I-15: Les précurseurs d'oligodendrocyte migrent le long du nerf optique du chiasme vers la rétine après leur formation dans le plancher du 3ème ventricule. Ce mouvement se fait grâce à des signaux chimio-répulsifs comme la nétrine. Certains espèces développent une barrière pour empêcher l'entrée des précurseurs dans la rétine. Les astrocytes de type I se développent le long du nerf optique et ne sont pas mobiles (Miller, 2002).

Migrating oligodendrocyte progenitors express PSA-NCAM, as observed in explants cultures from newborn rat hypophysis (Wang et al., 1994). Application of endoneuraminidase to remove PSA-NCAM from cell surface completely obstructed the movement of oligodendrocyte progenitor cells from the explants. PSA-NCAMs on cell surface of neurons and astrocytes do not itself provide signals for migration but function as flexible gate to permit the cells to react to external signals at suitable time and space (Rutishauser and Landmesser, 1996). However, PSA-NCAM removal does not affect the migration of oligodendrocyte precursor cells along the axons of optic nerve (Ono et al., 1997). This shows that oligodendrocyte progenitor cells, undergoing migration, use different mechanisms to make their way to their final destination. Oligodendrocyte progenitor cells use a group of integrin receptors present on their surfaces to develop a particular type of contact with the components of ECM like thrombospondin-1 that may participate in regulation of migration (Scott-Drew and Frebcg-Constant, 1997).

#### **4.5 Oligodendrocyte maturation**

In rodents oligodendrocyte peogenitor cells are morphologically bipolar with the expression of their specific markers, glycolipids (GD3) (Hardy and Reynolds, 1991), unidentified glycolipids recognized by A2B5 antibody (Fredman and Magnani et al., 1984) and chondroitin sulfate proteoglycan (NG2) (Nishiyama and Lin et al. 1996). These cells are not only mitotically active but are quite capable of migrating to long distances as shown by in vitro experiments and transplantation studies (Pfeiffer et al., 1993). Oligodendrocyte progenitor cells proliferate *in vitro* in the presence of growth factors like fibroblast growth

factor (FGF) and platelet derived growth factor (PDGF) (Milner et al., 1997). At the end of migration progenitor cells occupy places around the tracks of future white matter fibers and are converted to preoligodendrocytes in CNS of mammals. These newly formed cells of oligodendrocyte lineage express O4 marker and carbonic anhydrase II (CA II, Jalabi et al., 2005) and bear many processes still retaining the ability to proliferate (Sommer and Schachner, 1981). However their motility reduces (Nave and Boespflug-Tanguy, 1996) during post migration phase and they do not show any response to the mitogenic activity of PDGF (Gao et al., 1998). Pr-eoligodendrocytes transform into immature oligodendrocyte by losing GD3 and A2B5 markers and expressing a new marker GalC.

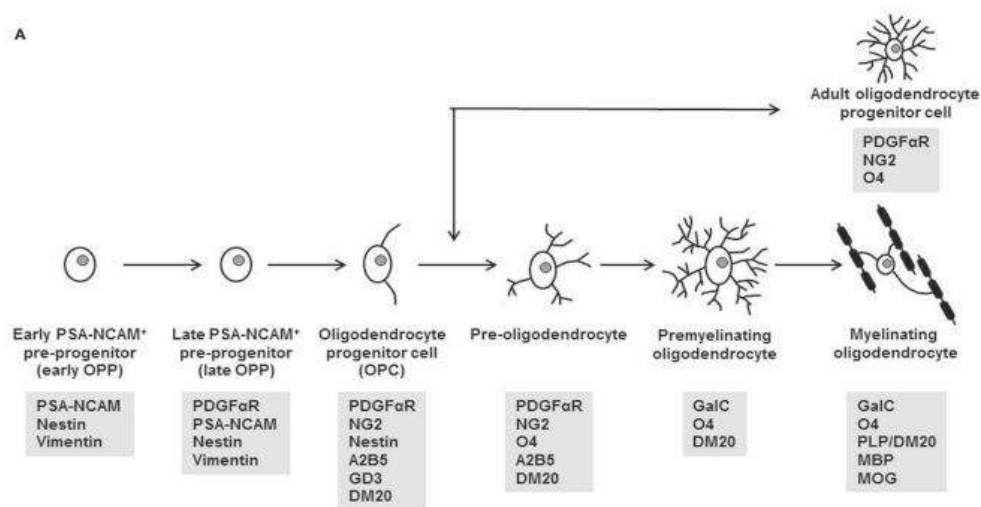

Fig I-16: Oligodendrocytes pass through different stages of development before transforming into adult myelinating oligodendrocytes. These stages are recognized by the expression of specific markers (Shumacher et al., 2012).

Fig I-16: Les oligodendrocytes passent par plusieurs stades de développement avant de former les oligodendrocyte myélinisants. Les différents stades se reconnaissent par l'expression de marqueurs spécifiques (Shumacher et al., 2012).

The first myelin protein that appears in developing oligodendrocytes is CNP (Reynolds and Wilkin, 1988) followed by appearance of other marker like RIP (Friedman and Hockfield et al., 1989), CA II ( Ghandour et al, 1980), and MBP (Butt and Ibrahim et al., 1995). There seems to exist an intermediate stage between GD3/GalC as shown by some *in vivo* investigations (Curtis and Cohen et al., 1988). CNP and GalC appear at the same time, while MBP and PLP come to exist 2-3 days later with the synthesis of myelin in rat cerebellum



(Reynolds and Wilkin, 1988). These findings were confirmed by *in vitro* studies where these molecules follow same pattern of succession. GalC and CNP are contemporary whereas MBP, MAG and PLP are expressed later to become mature oligodendrocytes in culture conditions as well *as in vivo* (Pfeiffer et al., 1993).

It is interesting that oligodendrocyte maturation follow same sequence in culture conditions both in the presence and absence of neurons. So, oligodendrocyte progenitor differentiation is inherent potential present in oligodendrocyte lineage (Temple and Raff, 1986). Oligodendrocytes form myelin like membranes even if neurons are absent (Sarlieve and Fabre et al., 1983), in the co-culture with neurons however PLP, MAG and MBP are present excessively (Matsuda et al., 1997). At the late stages of maturation oligodendrocytes express another myelin specific protein MOG (Solly et al., 1996). However neuronal contact with oligodendrocyte modulates myelin gene expression (Kidd et al., 1990). Expression of the isoform of PLP by DM-20 gene in the individual processes of premyelinating oligodendrocyte signifies the beginning of myelination (Trapp et al., 1997). Meanwhile Neuron-oligodendrocyte contact also induces morphological changes in oligodendrocytes which results in the loss of processes that fail to develop contact with neurons (Hardy and Friedrich, 1996).

Interaction between different developmental stages of oligodendrocyte is critical for regulation of oligodendrocyte maturation. It was observed in slice culture system that A2B5+ and O4+ cells removal resulted in a delayed appearance of MBP+-cells (mature myelinating oligodendrocytes), whereas elimination of O1+ cells caused permanent failure to develop mature MBP+ cell. This data propose the significance of oligodendrocytes in promoting the maturation of OPCs (Yang et al., 2011).

Cells at each developmental stage express specific morphology, proliferation and migration potential (Lubetzki et al., 1991). A number of hypotheses were proposed regarding transformation of oligodendrocyte precursor cells to myelinating cells. Studies involving clones support the presence of an intrinsic timing mechanism regulating oligodendrocyte differentiation (Temple and Raff, 1986; Barres et al., 1994). Recently a transcription factor GM98 was proposed to be a constituent of this system (Emery et al., 2009), additionally there are evidences for the partial involvement of p57<sup>Kip2</sup> (a member of Cip/Kip family of cyclin-dependent kinase inhibitor proteins) in cell proliferation (Dugas et al., 2007). Besides internal mechanisms, external factors play a key role in controlling oligodendrocyte differentiation.

Oligodendrocyte precursor cells do not differentiate in the vicinity of fibroblast growth Factor (FGF) and PDGF and keep dividing (Raff et al., 1988). Removal of growth factors retards proliferation and promote differentiation of oligodendrocyte precursor cells.

Several studies suggest the importance of oligodendrocyte lineage cell interactions in maintaining the final population of oligodendrocytes. In vitro investigations propose that total number of oligodendrocytes is not associated with the number of initially generated oligodendrocytes precursors rather a balance is maintained between lineage cells (Zhang and Miller, 1996). Despite higher production of oligodendrocyte precursor cells in animals over expressing PDGF total number of oligodendrocyte remains normal (Calver et al., 1998). This regulation of normal oligodendrocyte population suggests an inhibitory control on cell division of oligodendrocyte precursor cells in a density dependent manner involving P27KIP1 and Rb phosphorylation (Nakatsuji and Miller, 2001) and increased oligodendrocyte apoptosis (Calver et al., 1998). Characterization of transplanted OPCs from different origins in developing forebrains showed an internal competition between newly generated and already persisted OPCs lead to the removal of cohort of cells (Kessaris et al., 2006; Yang et al., 2011).

These adult OPCs display unique physiological characteristics by virtue of which they can regulate excitability of neurons (De Biase et al., 2010). It is still unknown whether these adult oligodendrocyte precursor cells can regenerate myelin after demyelination in adult brain. Pathological conditions as in multiple sclerosis results in the formation of chronic demyelination plaques, which cannot be remyelinated despite the presence of OPCs in nearby area (Rudick and Trapp, 2009). Presently we are unaware of the reasons which prevent these oligodendrocyte precursor cells to form myelin sheath around naked axons in their neighborhood (Yang et al., 2011). Recently, the recovery from chronic demyelination in adult mouse brain can be induced by thyroid hormones or androgen treatments (Harsan et al., 2008; Hussain et al., 2013)

#### **4.6 Factors necessary for oligodendrocyte maturation and survival**

Oligodendrocyte maturation and differentiation regulated by many factors, signaling molecules and activation of certain genes.

## 4.6.1 Growth Factors

Many growth factors have been found to be involved in the proliferation, differentiation, and maturation of the oligodendrocyte lineage (; Pfeiffer et al., 1993; Barres et al., 1994, Canoll et al., Canoll et al., 1999). Most of these studies have been performed *in vitro*. It is extremely difficult to extrapolate to *in vivo* conditions, as multiple factors may act in concert to achieve the exquisitely fine regulation of the complex process of oligodendrocyte development and myelination. Combinations of factors often produce effects that are significantly different from those seen with any one factor alone (McMorris and Mckinnon, 1996). Furthermore, these factors have multiple effects during development. In contrast to experiments on rodent cells, growth factors that act on human cells have not as yet been fully determined.

### 4.6.1.1 Platelet derived growth factor (PDGF)

PDGF is produced by astrocytes and neurons during development (Yeh et al., 1991; Mudhar et al., 1993). It affects oligodendrocyte development by multiple ways. *In vitro* analyses demonstrate their involvement in mitogenesis (Raff et al., 1988; Gao et al., 1998) survival and migration (Grinspan and Franceschini, 1995). PDGF produces its effect by blocking or inducing intracellular signaling from PDGFR- $\alpha$  and nucleus (Hart et al., 1989). Developmental defects to PDGFR- $\alpha$  lead to significant reduction in the number of oligodendrocyte progenitors and oligodendrocytes (Fruttiger et al., 1999)

PDGF acts as a chemo- attractant for OPC facilitating their distribution in developing CNS. It is interesting that presence of PDGF is not always required and merely initial stimulation is enough to induce OPC migration. Following this PDGF- $\alpha$  stimulus, activated OPCs contain a self-maintaining extracellular regulation of kinase signaling pathway which can drive their migration for as long as 72 hours. It seems that PDGF- $\alpha$  function is to activate OPCs which then follow signals from different regions to spread throughout CNS (Frost and Armstrong, 2009).

### 4.6.1.2 Basic fibroblast growth factor (bFGF)

Basic FGF, also known as FGF 2, promotes cell division in neonatal oligodendrocyte progenitors by elevating the expression of PDGFR- $\alpha$  hence elongating the period of exposure to PDGF. Nervous system was found to contain bFGF during development (Ernfors et al.,

1990). Molecular analysis for the detection of bFGF/FGF-2 receptors 1, 2 and 3 mRNA at different developmental stages of oligodendrocyte lineage showed differential expression providing reasons for variable responses to same ligand (Bansal et al., 1996).

FGF-2/ bFGF in combination with PDGF promotes oligodendrocyte precursor cell proliferation and differentiation despite stronger migratory effect of PDGF as compared to bFGF/FGF-2 (de Castro and Bribián, 2005). Additionally both can induce spontaneous remyelination in demyelinated lesions (Murtie et al., 2005). FGF2/bFGF controls migratory activity of plp/dm20+ cells derived from oligodendrocyte precursor cells of mouse embryonic optic nerve. This effect is mediated by FGF-1 receptors that appear on the surface of oligodendrocyte precursor cells. Application of Anosmin-1, an antagonist of FGFR-1 inhibits oligodendrocyte precursor cells migration. Interestingly optic nerve contains both Anosmin-1 and FGF-2 suggesting a concentration gradient of these two factors control cell migration (Bribian et al., 2006). However two injections of FGF2 into cerebrospinal fluid (CSF) for 3 consecutive days, causes irreversible damage to oligodendrocytes leading to demyelination. Administration of bFGF/FGF-2 at this stage worsens the situation by formation abnormal buildup of premyelinating cells immature oligodendrocytes. Although axons are available in these myelin deficient areas but oligodendrocytes, premyelinating oligodendrocyte or oligodendrocyte precursors are unable to contact or myelinate them. In conclusion higher levels of bFGF/FGF-2 not only promote demyelination but also play a key role in the modification of remyelination in multiple sclerosis (Butt and Dinsdale, 2005).

Growth factors PDGF and FGF2 act both via ERK and non ERK signaling pathway to regulate oligodendrocyte precursor cell migration. Moreover the effect depends upon threshold limit as well as time (Vora et al., 2011).

#### **4.6.1.3 Insulin-like growth factor I**

IGF-I promotes mitosis in both oligodendrocyte progenitors and preoligodendrocytes. Oligodendrocyte lineage cells express receptors for IGF-I (McMorris and Dubois-Dalcq, 1988). The presence of IGF-I was detected in brain SVZ during the active generation of progenitor cells (Bartlett et al., 1992). IGF-I also play an important role in oligodendrocyte survival as shown by the use of transgenic mice overexpressing IGF-I and mice with deficiency of IGF binding protein-1 (IGFBP-1), a protein inhibitor of IGF-I. These mice

demonstrate increased percentage of myelinated axons and myelin thickness. Hence IGF-I increases both the number and myelin contents of oligodendrocytes (Carson et al., 1993).

#### **4.6.1.4 Neurotrophin-3. (NT-3)**

Neurotrophin-3 is produced by astrocytes in optic nerve and induces proliferation of oligodendroglial precursors in combination with other mitogens like insulin, PDGF and brain-derived neurotrophic factor (BDNF) in optic nerve and spinal cord (McTigue et al., 1998). NT-3 also promotes survival of oligodendrocytes (Barres et al., 1992) as deficiency of NT-3 or TrkC (NT-3 receptor) in mice causes severe damage to CNS glia and reduction in the size of spinal cord (Kahn et al., 1999). Administration of NT-3 in adult demyelinated rat results in increased production of MBP+ cells associated with loss of less than 3% axons and absence of astrocytic gliosis. So, *in vivo* NT-3 directly stimulates oligodendrocyte lineage cells to promote myelination (Jean et al., 2003).

#### **4.6.1.5 Glial growth factor (GGF)**

The glial growth factor (GGF) is a member of the neuregulin family of growth factors expressed by neuronal cells. It promotes replication of oligodendrocyte precursors on one hand and survival on the other (Canoll et al., 1996, Milner et al., 1997). At the same time it functions as an inhibitor of mature oligodendrocyte differentiation (Canoll et al., 1999). In the absence of neuregulin, oligodendrocytes are unable to develop in spinal cord of transgenic mice (Vartanian et al., 1999). This signifies the importance of neuregulin as an axonal promoter of oligodendrocyte development (Barres and Raff, 1999).

#### **4.6.1.6 Ciliary neurotrophic factor (CNTF)**

The ciliary neurotrophic factor possesses mitogenic activity on oligodendrocyte precursor cells only in combination with PDGF as mice lacking CNTF have lower number of proliferating glial progenitor cells. Additional role of CNTF in oligodendrocyte survival was observed *in vivo* (Barres et al., 1993).

#### **4.6.1.7 Interleukin-6 and Interleukin 2 (IL-6, IL-2)**

IL-6 is involved in oligodendrocyte survival (Barres et al., 1993) while IL-2 plays a role in cell division, differentiation and induction of cell death (Otero and Merrill, 1997).

#### **4.6.1.8 Transforming growth factor (TGF)**

It is an inhibitor of cell division but promoter of differentiation of oligodendrocyte progenitor cells (McMorris and McKinnon, 1996).

#### **4.6.1.9 Vascular endothelial growth factor (VEGF-A)**

Vascular endothelial growth factor (VEGF-A) is a trophic factor secreted by cerebral endothelial cells in white matter. This factor induces oligodendrocyte precursor cell migration without any impact on their mitotic activity. Oligodendrocyte precursor cells from neonatal rat cortex were grown in culture media from cerebral endothelial cells showed increased oligodendrocyte precursors cell division and migration. However blocking Flk-1 (VEGF-receptor 2) by neutralizing antibody has no effect on proliferation of oligodendrocyte precursor cells but make them stagnant. So, VEGF-A seemed to be involved in endothelium–OPC cell signaling, possibly playing a role in maintaining white matter homeostasis (Hayakawa et al., 2012).

#### **4.6.1.10 Hepatocyte growth factor (HGF)**

Hepatocyte growth factor (HGF) is a pleiotrophic cytokine which induces the proliferation, migration, and differentiation in a number of non-neural cells (Stella and Comoglio, 1999). It is also thought to have an impact in nervous system development. In vitro analysis, using oligodendrocyte precursors from neonatal rat cerebra, demonstrated the presence of both HGF and HGF receptor (c-Met) in oligodendrocytes. Addition of HGF in culture doubles oligodendrocyte precursor cell proliferation and causes 2.5 times increase in their migration. HGF alter the cytoskeleton of oligodendrocytes by modifying the distribution pattern of F-actin and  $\beta$ -tubulin and increasing the levels of actin and  $\beta$ -tubulin. Thus HGF influences growth, development and cytoskeletal organization of oligodendrocytes (Yan and Rivkees, 2002).

#### **4.6.1.11 Fibroblast growth factor receptor 1 (FGFR1)**

Activation of fibroblast growth factor receptor 1 (FGFR1) signaling prevents oligodendrocyte precursor cells to differentiate into mature oligodendrocyte in vitro. As a result of cuprizone induced demyelination in corpus callosum, an increase in the expression of FGFR1 can be detected in oligodendrocyte precursor cells. Tamoxifen treatment for one week in

Plp/CreERT:Fgfr1fl/fl mice after chronic demyelination leads to decrease FGFR1 levels in oligodendrocyte precursor cells without any change in the number of oligodendrocyte precursor cells or their mitotic activity. However, in mice that are given 6 week time to recover after cuprizone treatment along with one week administration of tamoxifen, significantly higher number of differentiated oligodendrocytes but fewer oligodendrocyte precursors were observed. Furthermore tamoxifen enhance remyelination and axonal integrity in demyelinated mice. Based on these findings it can be inferred that activation of FGFR1 signaling oligodendrocyte precursors results in the failure of remyelination process after chronic demyelination in adult CNS 9 (Zhou et al., 2012).

#### **4.6.1.12 Pigment epithelium-derived factor (PEDF)**

Pigment epithelium-derived factor (PEDF) is an inhibitor of serine protease (serpin) and performs neuroprotective and anti-angiogenic functions. This factor has been identified as an inducer of adult subventricular zone derived oligodendrocyte precursor cells proliferation *in vitro*. There was an increase in oligodendrocyte lineage associated NG2 and PDGF- $\alpha$  markers with up regulation of the transcription factors Olig1, Olig2 and Sox10. Receptors for PEDF are expressed by different types of cells in the adult SVZ as well as corpus callosum. PEDF administration promotes survival and maturation of new born oligodendrocyte progenitor cells in normal brain. Higher concentration of PEDF was detected in lysolecithin induced demyelination model where enhances OPCs production. Based on this information it can be inferred that PEDF is endogenously produced during demyelination to promote remyelination (Sohn et al., 2012).

### **4.6.2 Other proteins and receptors**

#### **4.6.2.1 Poly Sialic Acid Neural Cell Adhesion Molecule (PSA-NCAM)**

PSA-NCAM is expressed by oligodendrocytes during development mainly in regions associated with plasticity. Removal of PSA from NCAM by application of endoneuraminidase-N reduces the migration and promotes differentiation (Decker et al., 2000).

#### **4.6.2.2 NG2**

The NG2 chondroitin sulfate proteoglycan is commonly used marker of oligodendrocyte progenitor cells (OPCs) in the central nervous system (CNS). A variety of cells have shown improved proliferation and migration in response to NG2. Likewise NG2 influences the proliferation and distribution of OPCs as seen in NG2 null mice which have low numbers of OPCs in the white matter. NG2 null mice possess lower number of OPCs in the postnatal cerebellum as compared to control mice. Proliferation rate of OPCs is reduced and peak is delayed by 4-5 days in mice lacking NG2 which resulted in late maturation of oligodendrocytes and myelination (Kucharova and Stallcup, 2010).

NG2 positive cells predominately produce oligodendrocytes with a portion of protoplasmic astrocytes. Cell fate in NG2 cells is regulated by the expression of transcription factor olig2. In the presence of olig2, NG2 cells develop into oligodendrocytes while lower levels of olig2 lead to astrocyte generation. Elimination of olig2 via knocking olig2 gene or pharmacological inhibition of transcriptional factor by tamoxifen results in the generation of astrocyte and reduction in oligodendrocyte number with associated deficiency of myelin. Thus NG2 cells can regulate its fate merely regulating the levels of olig2 transcription factor (Zhu et al., 2012).

#### **4.6.2.3 Erythropoietin**

Erythropoietin (Epo) is a cytokine produced by astrocytes in CNS (Masuda et al., 1994) mainly responsible for proliferation and differentiation of erythroid progenitor. Analysis of mRNA levels of Epo showed much higher expression in oligodendrocytes as compared to neurons and astrocytes. Both O4-positive immature oligodendrocytes and glial fibrillary acidic protein positive astrocytes express Epo-R. Increased numbers of MBP positive mature oligodendrocytes were detected upon application of recombinant human Epo (rhEpo). Same effect was observed when mixed cultures of oligodendrocytes and astrocytes were grown together. Addition of anti-Epo antibody to this mixed culture partially interferes with oligodendrocyte maturation. Based upon these findings it can be inferred that probably Epo induces differentiation of oligodendrocytes during development and remyelination (Sugawa et al., 2002). In lyssolecithin-induced demyelination, application of EPO not only increases the number of oligodendrocyte progenitor cells but also myelin forming oligodendrocytes.



Additionally it guides EpoR expressing neural progenitor cells towards oligodendrocyte lineage by activating cyclin E and Janus kinase 2 pathways (Cho et al., 2012).

#### **4.6.2.4 Glutamate and their receptors (NMDA)**

Glutamate and their receptors (NMDA) effect the development of oligodendrocytes. In prenatal rats, functioning of NMDA receptors was inhibited by application of phencyclidine (PCP). This blockage results in reduction of both early stage oligodendrocyte progenitors and mature oligodendrocytes. However the number of intermediate, immature cells increased in postnatal brain indicating that interruption of NMDA receptors inhibits the production of progenitor cells and surviving cells restrict themselves to immature stage. As a result very few cells differentiate to myelin forming cells (Lindahl et al., 2008).

#### **4.6.2.5 Semaphorin 3F**

CNS produce semaphorin 3F (sema3F) during normal development as well as in the repair and healing periods. They regulate axonal growth and cell migration of neural cells including OPCs. Sema3F induces its affect by activation of neuropilin-2 (NRP2) and plexin A3 co-receptors. Blocking the expression of these receptors using NRP2 and plexin A3 siRNA resulted in reduced OPCs response towards sema3F. These findings show the importance of plexin A and NRP2 receptors in the migration of OPCs and immature oligodendrocytes (Xiang et al., 2012).

#### **4.6.2.6 Semaphorin 6A (Sema6A)**

Semaphorins family is comprised of secreted and membrane-bound glycoproteins carrying a 500 amino acid long sema domain. In the CNS these proteins were found to negative regulators of axon guidance (Kolodkin et al., 1993). The trans-membrane sema6A is involved in oligodendroglial-axon interaction and play a vital role in the migration of OPCs during normal development and remyelination phase. Sema6A is produced by oligodendrocytes during normal postnatal life as well as in case of remyelination. Reduced levels of sema6A delay the differentiation in optic nerve and anterior commissure. Similarly pure oligodendrocyte cultures with the deficiency of sema6A do not differentiate and have very low levels of MBP. Oligodendrocyte are somewhat de-shaped and bear few and less complex processes. Moreover co-cultures of dorsal root ganglia and oligodendrocytes lacking sema6A

displayed abnormal myelination. Based on these findings sema6A is involved in the differentiation of oligodendrocytes and hence myelin formation (Bernard et al., 2012).

#### **4.6.2.7 Sema4D**

Semaphorin4D is an intrinsic inhibitor of oligodendrocyte differentiation found in the postnatal brain. An increase in the number of oligodendrocytes without any change in OPCs number was observed both in the cerebral cortex of sema4D knockout mice from postnatal day 14 onwards and cell cultures. These mice and culture contain significantly lower apoptotic oligodendrocytes. Sema4D introduction from an outside source increases apoptotic oligodendrocytes suggesting that sema4D prevents oligodendrocyte differentiation by inducing apoptosis (Yamaguchi et al., 2012).

#### **4.6.2.8 Cellular prion protein (PrP<sup>c</sup>)**

Cellular prion protein (PrP<sup>c</sup>) is a glycosyl-phosphatidylinositol (GPI)-linked glycoprotein which takes part in a variety of cellular processes in CNS during the development and maturation. The absence of PrP<sup>c</sup> on OPCs promotes OPCs proliferation by inhibiting their differentiation. There was an associated increase in NG2<sup>+</sup> cells without any significant increase in myelination suggesting that spare cells are lost during development. This data suggests that PrP<sup>c</sup> is involved in the differentiation of OPCs (Bribián et al., 2012).

#### **4.6.2.9 Slit2**

Slit2 is a protein which play a crucial role in the migration of neural precursors, glia and other cells and extension of axons in nervous. It is expressed by midline cells as early as E11-13 in rat embryos near motor neurons, a place where OPCs originate. Slit2 facilitates OPCs spreading by acting through roundabout (Robo1) receptors which are expressed by OPCs both *in vitro* and *in vivo*. Application of RoboN, which blocks the activity of Robos, considerably decreased OPCs migration. In addition, slit2 deactivated fyn with an elevation in the level of activated RhoA-GTP. It was found that Slit2 inhibits the formation of complexes between Fyn and Robo1. So, slits2 promotes migration of OPCs through Fyn and RhoA signaling (Liu et al., 2012).

## 4.6.3 Genes and Transcription factors

### 4.6.3.1 Sonic hedgehog

Sonic hedgehog (shh) is a glycoprotein produced by notochord and floor plate. It regulates the specification and maintenance of different types of neurons and oligodendrocytes (Orentas et al., 1999). Shh induce its functions through two related genes *olig1/2* which give rise to basic-helix-loop-helix (bHLH) transcription factors (Lu et al. 2000).

Shh can be traced in the ventral spinal cord just before the generation of OPCs and persist during their production. *In vitro* and *in vivo* blockage of shh signaling impairs OPCs production. Similarly shh induces the production of oligodendrocytes and motor neurons from the explants of dorsal spinal cord (Orentas et al., 1999). Shh regulates the timing of OPCs appearance and subsequently their final differentiation. It is also involved in neuron-glia shifting of fates during development (Oh et al., 2005).

OPCs first emerge in the ventral ventricular zone of metencephalon near the midline which persists in spinal cord. Later on new OPCs appear in the specific domains of lateral and dorsal metencephalic ventricular zone. All these OPC generating domains are located in the proximity of Shh production region. Interruption of Shh activity proves its necessity for the production of OPCs in metencephalon. Shh administration *in vitro* showed increase in the number of OPCs in a dose dependent manner as well as improved proliferation and survival. It can be inferred on the basis of these data that localized OPCs production in CNS is perhaps regulated by Shh (Davies and Miller, 2001).

Shh regulates the migration of OPCs in the optic nerve beside their production in the preoptic area. *In vitro* analysis of optic nerve explants from mouse embryo depicts the involvement of shh in proliferation and migration. Inhibition of shh expression by the application of hybridomas which secrete shh blocking antibody reduces the production of OPCs in the chick optic nerve especially in the retinal region (Merchan et al., 2007).

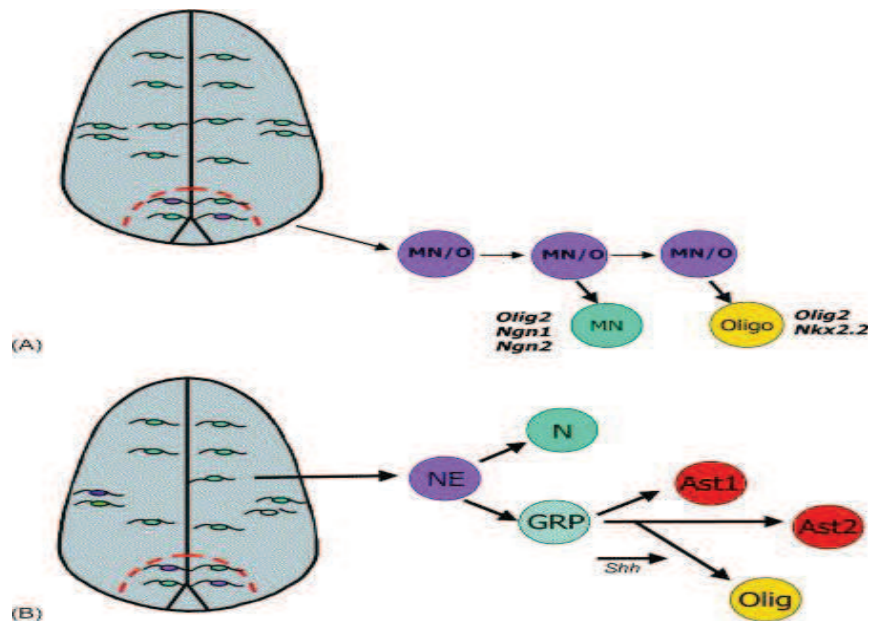

Figure I-17: In the spinal cord oligodendrocyte specification takes place by two different mechanisms. (A) Local signals like sonic hedgehog stimulate the conversion of the neuroepithelial cells of the ventral spinal cord into motor neurons or oligodendrocyte precursors. A combination of olig2 and Nkx 2.2 regulates oligodendroglial cell fate. (B) Neuronal precursors (N) and glial restricted precursors (GRP) arise from the dorso-ventral neuroaxis of the spinal cord. GRP of the ventral region of the spinal cord become oligodendrocytes under the action of sonic hedgehog while those of intermediate and dorsal region are transformed into astrocytes (Miller, 2002).

Figure I-17: Il existe deux mécanismes différents pour la spécification des oligodendrocytes dans la moelle épinière. (A) Des signaux locaux comme la "sonic hedgehog" qui stimulent la conversion des cellules neuro-épithéliales de la région ventrale de la moelle épinière en motoneurones ou en précurseurs d'oligodendrocytes. Une combinaison d'Olig2 et Nkx 2.2 détermine le destin des cellules oligodendrogliales. (B) Les précurseurs neuronaux (N) et les précurseurs gliaux restreints (GRP) proviennent de l'axe dorso-ventral de la moelle épinière. Les "GRP" de la zone ventrale de la moelle épinière se transforment en oligodendrocytes sous l'action de la "sonic hedgehog" alors que ceux de la région intermédiaire et ventrale sont transformés en astrocytes (Miller, 2002).

#### 4.6.3.2 Transcription factors Olig1 and Olig2

Olig1 and olig2 genes express bHLP proteins and are closely linked to oligodendrocytes development in the vertebrate CNS. In rat cortical progenitor cell cultures ectopic expression of olig1 stimulate OPCs production. Olig genes make their appearance before any other oligodendrocyte lineage specific markers during normal development of mouse embryos. Interestingly olig genes are detected near the floor plate and at the border of telencephalon–diencephalon which is the region of shh production. Studies using transgenic mice to analyze gain and loss of functions *in vivo* demonstrate the necessity of shh for the expression of olig genes (Lu et al., 2000).

An insight into the function of olig2 came from the studies on homozygous Olig2 mutant mice which died on the day of birth without feeding. Spinal cord analysis of these brains demonstrate very low numbers of both motor neurons and oligodendrocytes as neuroepithelial cell containing mutant olig2 were unable to differentiate into either motoneurons or oligodendrocytes. The resultant cells expressed GFAP which is an astrocytic marker while their descendants contain olig1 and olig3 in place of olig2 (Takebayashi et al., 2002).

Olig 1 spreads from the basal forebrain to the hindbrain rostrally and is coexpressed with vimentin at 5<sup>th</sup> gestational week in humans. At about mid gestation olig1 can be traced in the spinal cord, ventricular–subventricular zone of the ganglionic eminences, telencephalic proliferative zones as well as the emerging white matter. This olig1 was found to be expressed by early OL progenitor cells and radial glia as confirmed by double labeling studies (Jakovcevski and Zecevic, 2005).

In human gestational week 5 olig2 expresses in ventral spinal cord alongside microtubule associated protein 2 which is a neuronal marker. At gestational week 15 olig2 spreads throughout the spinal cord and the ganglionic eminence ventricular–subventricular zone. In the following 5 weeks they spread further in the telencephalic proliferative zones and the emerging white matter. Double labeling results showed the presence of olig2 in mature oligodendrocytes, neural progenitors and mature neurons (Jakovcevski and Zecevic, 2005).

Retroviral expression of olig1 and olig2 in the stem cells of adult subventricular zone promotes the generation of functional oligodendrocytes. Both of these factors specifically

influence differentiation of oligodendrocytes minimizing the generation of other cell lineages. These differentiated oligodendrocytes have the potential to migrate and myelinate the axons (Adams, 2012).

It was found that hedgehog and notch signaling regulates the generation of oligodendrocytes while olig1 expression is under the control of hedgehog. Myelin synthesis was uninfluenced by over expression of olig1, however the absence of hedgehog can not be compensated by the over expression of olig1 and Olig2 thus suggesting the necessity of hedgehog signaling for oligodendrocyte differentiation. Likewise defective myelination was observed upon elimination of olig1 in an olig2-sensitized background indicating an overlap in the functioning of olig1 and olig2 (Schebesta and Serluca, 2009).

In the postnatal SVZ gliogenic progenitors along with all their descendents specific olig2 expression can be detected. Olig2 activity is necessary and sufficient to inhibit neural differentiation and promote the generation of astrocytes and oligodendrocytes. So, olig2 is an intrinsic decision maker working at first level for fate determination of SVZ progenitor cells in the early postnatal life (Marshall et al., 2005).

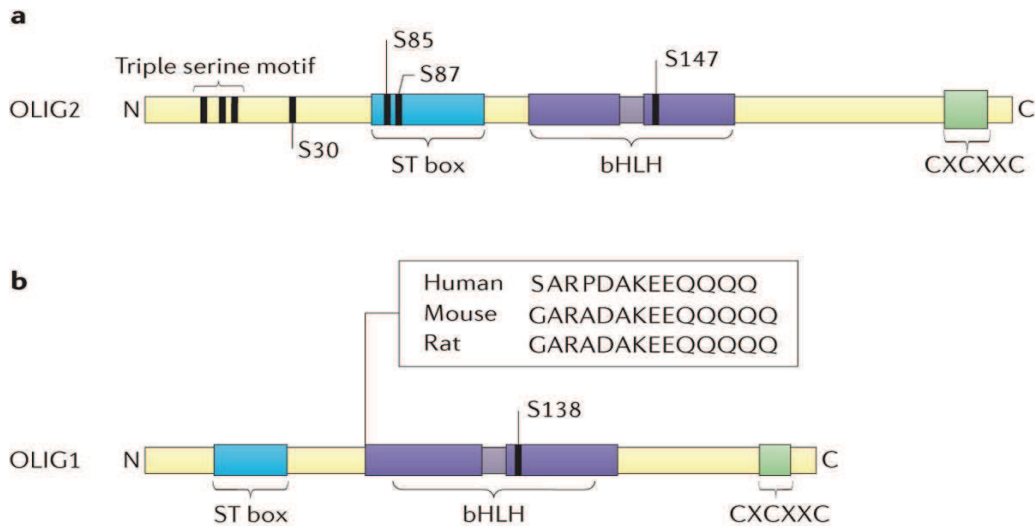

Figure I-18: Structural representation of human olig2 and olig1: olig2 consists of several serine phosphorylation sites out of which phosphorylation of serine 147 and triple serine motif towards the N terminal are important for the regulation of oligodendrocyte precursor cells production. Human olig1 contains serine at 138 which is highly conserved in mouse and rats (Dimphna et al., 2012).

Figure I-18: Structures d'Olig2 et Olig1 humain: Olig2 contient plusieurs sites de phosphorylation de sérines et parmi eux la phosphorylation de la sérine 147 et la motif triple de sérine du côté N-terminale sont importants pour la régulation de la production de précurseurs d'oligodendrocytes. L'Olig1 humain contient en particulier la sérine 138 qui est très conservée chez la souris et le rat (Dimphna et al., 2012).

#### 4.6.3.2.1 Olig2 Phosphorylation

Neurons are the first cells appear during CNS development followed by glial cells. It is interesting that neuroepithelial stem cells (NSCs) produce motor neurons (MN) in the beginning but later on become oligodendrocytes precursor cells. This switch from one fate to the other is regulated by dephosphorylation of Olig2. Phosphorylation of Serine 147 located in helix-loop-helix domain of olig2 brings about normal MN production but dephosphorylation of this residue initiates the production of oligodendrocytes. Replacement of Serine147 by Alanine 147 leads to uninterrupted production of oligodendrocyte precursor cells in chick, mice and in vitro cell culture at P19. So, MN production from NSCs is dependent on the phosphorylation of olig2 but oligodendrogenesis proceeds without phosphorylation (Li et al., 2011).

There exist two groups of bHLH transcriptions factors i.e., antineural and proneural, that control the early developmental in CNS. Anti-neural factors promote early cell proliferation thus building up a pool of neural progenitor cells whereas pro-neural factors support the specification and differentiation of progenitors. However, expression of olig2 in oligodendrocyte lineage cells violates this classification by working as anti-neural factor in the early stages to stimulate the proliferation of OPCs but shift to pro-neural activity later on to induce the differentiation of oligodendrocytes. Olig2 makes its appearance in the embryonic spinal cord in pMN domain to regulate pattern formation during early development (Lu et al., 2002) and act as an antineural factor to support the mitotic activity of pMN progenitors which are responsible to give rise to second generation of glial cells (Lee et al., 2005).

Olig2 begins to function as pro-neural factor at more advanced stages of development. In order to perform their dual function they exist both in progenitor as well as in differentiated oligodendrocytes (Lu et al., 2000). This switch in function is regulated by phosphorylation or dephosphorylation of triple serine motif in the amino terminal domain. Proliferative activity is

caused by phosphorylation of olig2 while dephosphorylation supports cell specification (Sun et al., 2011).

#### **4.6.3.3 Sox 9 and 10**

Sox9 and sox10 are two closely related transcription factors which regulate the specification and terminal differentiation of oligodendrocyte precursor cells respectively. Both of these factors exist together between specification and terminal differentiation to exert other functions which were determined by stepwise removal of these factors. Removal of sox9 from specified oligodendrocyte does not bring about any change in the development of oligodendrocytes. However additional elimination of sox10 resulted in increased apoptosis of oligodendrocyte precursor cells and aberrant migration. Although remaining cells manifest oligodendrocyte specific markers however PDGF-R $\alpha$  is absent suggesting their association with sox 9 and 10. This PDGF-R $\alpha$  promotes survival and migration in OPCs. Hence, sox 9 and sox 10 function together to enhance survival and migration of OPCs through PDGF-R $\alpha$  (Finzsch et al., 2008).

Sox10 transcription factor stimulates the expression of myelin gene during differentiation. Other functions of sox10 were determined in sox10 negative zebra fish and larvae where a portion of oligodendrocyte population divides, migrates and form myelin around axons before death. Contrarily non myelinating oligodendrocyte progenitors survive and maintain a constant number of oligodendrocytes. Newly generated oligodendrocytes which arise from these progenitors normally wrap axons but have lower level of myelin genes. So, sox 10 promotes survival and expression of myelin genes in myelinating oligodendrocytes but is not involved in the existence of non-myelinating OPCs (Takada et al., 2010).

In CNS sox10 is confined to myelin forming oligodendrocyte and its absence causes impaired terminal differentiation despite normal progenitor cells development. Administration of neural stem cells lacking sox10 into wild type mice did not produce any myelin which illustrates the persistent and autonomous nature of the defect (Stolt et al., 2002).

### **4.7 Markers of oligodendrocyte lineage**

Different stages of oligodendrocyte lineage express various markers on the basis of which they are identified. Oligodendrocyte precursor cells and progenitor cells express Nestin



protein (Gallo and Armstrong, 1995) and polysialylated form of neural cell adhesion molecule (NCAM), PSA-NCAM (Hardy and Reynolds, 1991; Grinspan and Franceschini, 1995) are expressed by oligodendrocyte precursor cells during proliferation phase.

The mRNA transcripts for platelet-derived growth factor receptor (PDGFR- $\alpha$ ) (Spassky et al. 2000) can be detected in the early stages of oligodendrocyte lineage. DM-20, coding for an isoform of PLP (Timsit et al 1995; Peyron et al., 1997) and 2, 3-Cyclic nucleotide-3-phosphohydrolase (CNP) are present in all stages of the developmental maturation.

Carbonic anhydrase II (CA II) enzyme catalyzes reversible hydration of carbon dioxide. CA II is partly soluble and partly membranous. This enzyme was detected in the brain (Limozin et al., 1979) and cerebellum (Ghandour et al., 1980b) of rat by radioimmunoassay. It was detected in the cell body as well as branches of oligodendrocytes (Ghandour et al. 1979). This antibody was used to describe the maturation process of oligodendrocytes in the cerebellum of rat using immunohistochemical technique (Ghandour et al., 1980c). This is a widely used oligodendrocyte marker and has been implicated in a variety of studies since then including some very recent (Hussain et al., 2013).

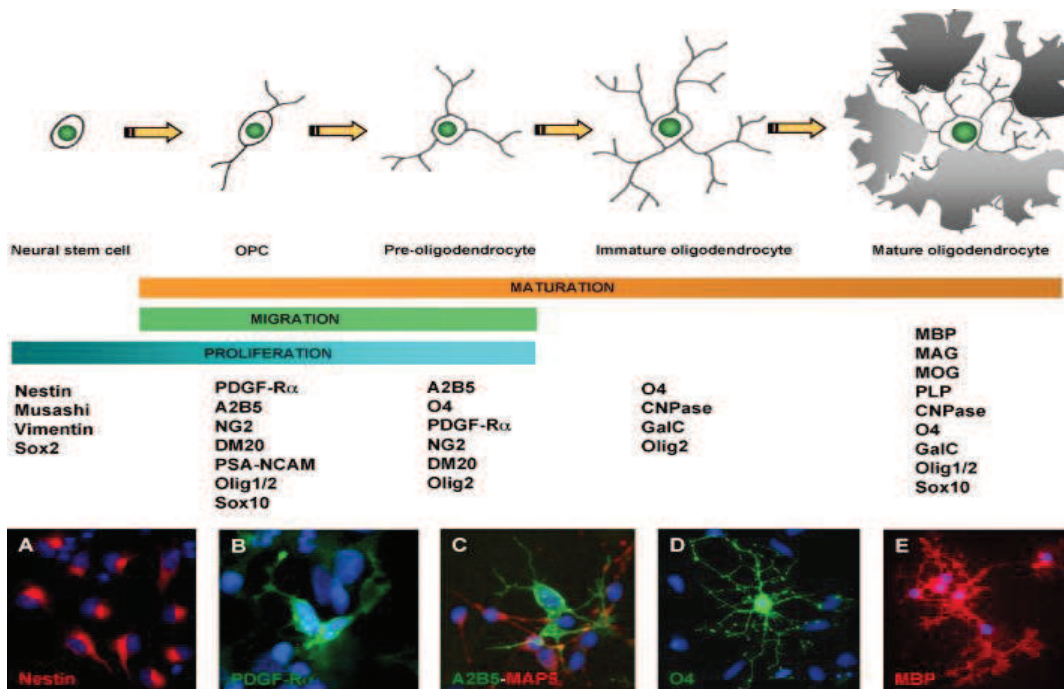

Figure I-19: Oligodendrocyte markers specific to each developmental stage are presented: Four stages of maturation namely oligodendrocyte progenitor cells (OPCs), pre-oligodendrocytes, immature oligodendrocytes and mature (myelinating) oligodendrocytes

differ from each other in their expression of markers. (A–E) illustrate maturation of human oligodendroglia generated from neural stem cells (Buchet and Baron-Van Evercooren, 2009).

Figure I-19: Marqueurs spécifiques de chacun des stades de développement des oligodendrocytes: les quatre stades de maturation des précurseurs de cellules d'oligodendrocytes (OPC) c'est à dire, les pré-oligodendrocytes, oligodendrocytes immatures et les oligodendrocytes matures (myélinisant) diffèrent des uns des autres par l'expression de marqueurs différent. (A-E) illustration de la maturation des oligodendrocytes à partir des cellules souches neurales (Buchet and Baron-Van Evercooren, 2009).

Ganglioside GD3 (Hardy and Reynolds, 1991) monoclonal antibody A2B5 recognising different gangliosides (Farrer and Quarles, 1999) and NG2, an integral membrane chondroitin sulfate proteoglycan (Nishiyama et al., 1999, Nishiyama et al. 1996) can be detected in oligodendrocyte progenitor cells as well as preoligodendrocytes.

O4 marks pre as well as mature oligodendrocytes (Sommer and Schachner, 1981). A variety of protein markers are expressed by mature oligodendrocytes like galactosylceramides (GalC) (Pfeiffer et al., 1993; Rakic 1995), RIP antigen which recognizes an unknown cytosolic epitope (Berger and Frotscher, 1994) and NI-35/250 transmembrane proteins (Caroni and Schwab, 1988). Mature oligodendrocyte cells also express some myelin specific markers like MBP, MAG and MOG (Baumann and Pham-Dinh, 2001).

## **4.8 Functions of oligodendrocytes**

### **4.8.1 Saltatory conduction**

Most important and primary function of oligodendrocytes is to increase the velocity of action potential by forming myelin sheath around nerve axons. They conduct 100 times faster than that of an unmyelinated axon (Baumann and Pham-Dinh, 2001).

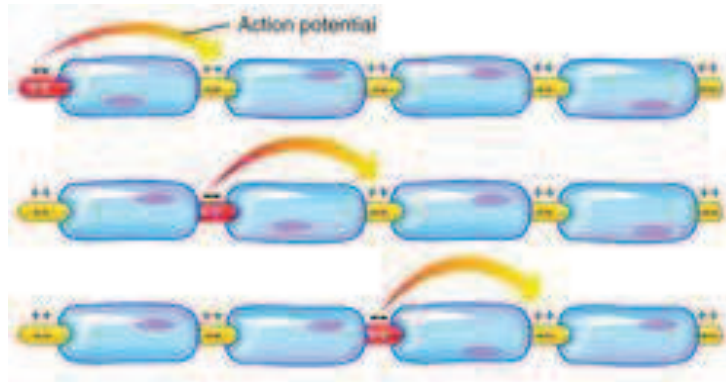

Figure I-20: Schematic view of salutatory conduction along a myelinated axon.

Figure I-20: Schéma de la conduction saltatoire le long d'un axone myélinisé.

<http://medical-dictionary.thefreedictionary.com/saltatory+conduction>

#### 4.8.2 Source of CNS iron

Oligodendrocyte is a source of iron in CNS. The presence of iron was reported in the oligodendrocytes of mammals by various histochemical studies. Primarily iron was detected in weekly myelinated regions of CNS which was later on confirmed in densely myelinated areas by some other studies. Presence of three different cytoplasmic types of oligodendrocytes, based on the end product of the iron metabolism formed, showed that oligodendrocytes are the CNS cells involved in iron metabolism. Moreover higher concentrations of oligodendrocyte iron were observed in the regions of CNS where GABA regulates neural activities suggesting the possible involvement of iron in GABA metabolism (Wawrzyniak-Gacek, 2002).

#### 4.8.3 Maintenance of functional structure

Myelinated axons facilitate conduction of impulse at a fast rate with high accuracy. This is achieved by the maintenance of specific protein structures in the region of node, juxtapanode and paranode. In the node of Ranvier sodium ( $\text{Na}^+$ ) channel aggregates are present while potassium ( $\text{K}^+$ ) channels accumulate in the juxtapanode. Likewise paranodal region contains neurexin, caspr and paranodin. Oligodendrocytes are able to maintain  $\text{Na}^+$  clusters in the nodal region through various mechanisms even in the absence of myelin. Moreover removal of  $\text{Na}^+$  channels in a demyelination model leads to the re-establishment of sodium channels as the remyelination progresses (Dupree et al., 2004).

#### 4.8.4 Axon survival

Oligodendrocytes produce energy metabolites for neurons like glucose and lactate. Neurons receive lactate through monocarboxylate transporter (MCT-1 also known as SLC16A1) located on oligodendrocyte surfaces. Any damage to this glial MCT1 receptor results in degeneration of neurons in animals as well as cell culture condition. Moreover the number of MCT1 receptors is significantly lower in mouse models of amyotrophic lateral sclerosis (ALS) signifying their role in disease pathology (Lee et al., 2012).

## **5. Myelin**

Oligodendrocytes produce great quantities of plasma membrane to tightly encircle CNS axons (Simons et al., 2007). This is achieved by arrangement of several layers of membranes above each other with tight connection at their external or cytosolic endings. This organization allows myelin to serve as an insulating layer and accumulate sodium channels in the region of nodes of Ranvier to conduct action potential in salutatory fashion (Waxman et al., 2006). This salutatory mode of action potential is the fastest way to transmit information in the reduced space. Myelinating disorders like multiple sclerosis (MS) very clearly demonstrate the inevitability of myelin.

### **5.1 Nodes of Ranvier**

The nonmyelinated axonal region between two neighboring myelin segments is called node of Ranvier. Generally cytoplasmic surfaces of myelin are not compacted in the area of paranode. These cytoplasmic regions are filled with cytoplasm. A myelin membrane when stretched out becomes flat, spade shaped sheath enclosed which is by cytoplasmic cylinders. In the region of the paranode, cytoplasmic containing edges of the sheath become wider to form major dense line. The endings of the sheath give loop like appearance at the nodes so they are known as lateral loops. These lateral loops interact with axolemma in the region of internode to form transverse bands however there is a gap between axolemma and myelin called periaxonal space in the region of internode. The transverse bands are arranged in helical fashion to form a connection between myelin and axolemma. This organization creates a convoluted path from the extracellular space present between loops and periaxonal gap (Quarles et al., 2002).

### **5.2 Myelin architecture**

The architecture and molecular make up of myelin make it unique. Electron microscopic observation of myelin membrane demonstrate that it is a multilayered stack of homogeneously thick and contains distinctive periodic structures of alternate light and dense layers (the major dense line and the intra-period line) (Hartline et al., 2008). In this structure condensed cytoplasmic membrane constitutes the major dense line contrary to intra-period line which is formed by tightly apposed outer membranes. There is a distance of 12 nm between two tightly

compacted layers. Myelination around the axons is segmented and each segment is about 150 mm in length.

With the application of diffusible water-soluble fluorescent dye Lucifer Yellow a 3D model of myelin was created which demonstrated that outer cytoplasmic layer is engulfing shaped and contains complex network of cytoplasmic pockets (1.9 pockets per 10 $\mu$ m sheath length) (Velumian et al., 2010). These cytoplasmic channels develop connections with inner cytoplasmic layer and paranodal loop to form an organized setup of tunnels which facilitates the movement of molecules through internode. This network can further be expanded to astrocytes as they are continues with oligodendrocytes with the help of gap junctions (Maglione et al., 2010). Recently it has been found that myelin contains extracellular spaces besides internal complex cytoplasmic network (Mierzwa et al., 2010).

Molecules of various sizes can cross paranodal junctions by diffusing through the paranodal loops into the internodal periaxonal space (Mierzwa et al., 2010). Generally paranodal loops form tight connections with axons with the help of junctions to facilitate transportation of materials. Additionally they constitute small sized triangular gap junctions on the axonal surface at the site where paranodal membranes get separated from each other. Further experiments with the diffusion of tracers confirmed that they use extracellular space to move across paranodal loops (Shroff et al., 2011). These transportation pathways can be very useful for the transfer of nutrients and metabolites (Aggarwal et al., 2011).

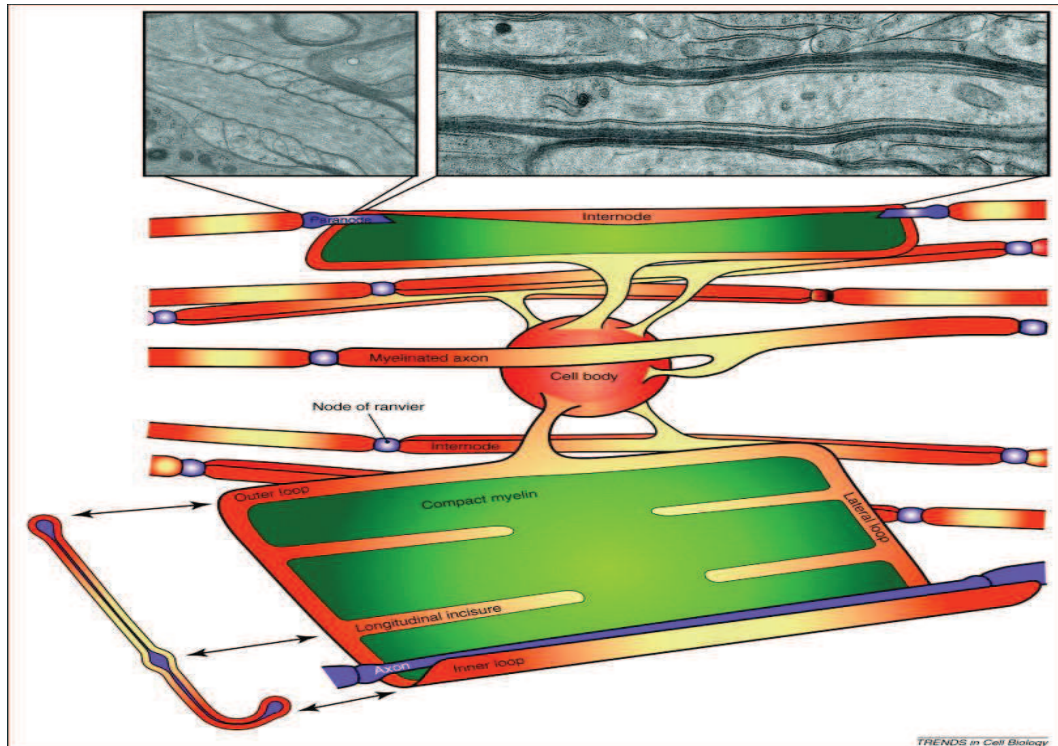

Figure I-21: Schematic representation of an oligodendrocyte along with its unrapped myelin. Cytoplasm is concentrated in the channels which occupy border places. These channels exist in continuation and are involved in the formation of paranodal loops. The top of the figure contains electron micrographs of intact myelin in a longitudinal section (right) and paranodal loops (left) (Aggarwal et al., 2011).

Figure I-21: Représentation schématique d'un oligodendrocyte avec des prolongements cytoplasmiques non enroulés autour de l'axone. Le cytoplasme est concentré dans des canaux en bordure qui sont impliqués dans la formation des boucles paranodales. Au dessus sont représentées la micrographie électronique de une coupe longitudinale (à droite) et les boucles paranodales (à gauche) (Aggarwal et al., 2011).

### 5.3 Myelin Biochemistry

Water constitutes 40% of myelin by weight. The dry weight is composed of two main components i.e., lipids (60-80%) and proteins (15-30%). Myelin differs from other biological membranes because of low protein to lipid ratio.

### 5.3.1 Lipids

Myelin does not contain any specific lipids but cerebroside (galactosyl ceramide) may be considered as a typical myelin lipid. Generally the quantity of cerebroside is directly proportional to the amount of myelin once the early stages of development are over. About 20% of the total galactocerebrocides are sulfated at the 3-hydroxyl moiety. Glycolipids are generally situated in the extracellular myelin membrane at the intraperiod line. Although galactocerebrocides are essential components of myelin but they are not required for myelin synthesis. Experiments with UDP-galactose: ceramide galactosyltransferase knockout mice demonstrated that myelin synthesis is normal even in the absence of cerebroside. However, resultant myelin does contain some anomalies like slight variations in structure of myelin. These mild changes give rise to severe problems as the age increases (Marcus et al., 2002). In these mice paranodal structure is particularly defective which is in turn associated with the disruption of axon-glia gap junctions. Similar, defects in the paranodal region of sulfotransferase (transforms cerebroside to sulfatide) null mouse was observed. This clearly demonstrates the significance of sulfatides for the normal axon-oligodendroglial contact in the paranodal region (Marcus et al., 2002; Taylor et al., 2004). The structural arrangement of Na<sup>+</sup> and K<sup>+</sup> channels in paranodal area is disturbed when sulfatide is absent. Oligodendrocyte differentiation is ameliorated in the presence of sulfatide as well as galactocerebroside (Taylor et al., 2004).

Cholesterol and phospholipids are also main lipids of myelin alongside sulfatide and cerebroside (Morell, 1984). Cholesterols are 27%, of total myelin lipids (Jackman et al., 2009). Cholesterol, phospholipids and galactolipids are generally present in molar ratios of either 4:3:2 or 4:2:2. This implies that myelin have more molecules of cholesterol than any other lipid. However, weight of the glycolipids is comparable to cholesterol while phospholipids are most abundant. Ethanolamine containing plasmalogen is the most well-known phospholipid. Another main contributor of myelin lipids is lecithin. Sphingomyelin is present in relatively low concentration. Extracellular membrane of lipid bilayer is heavily loaded with cholesterol while ethanolamine plasmalogen is mainly concentrated on the cytoplasmic surface.

Apart from specific classes of lipids present in myelin there is specificity in the composition of fatty acids of individual lipids. Myelin forms the most part of the total white matter lipid.



Additionally lipid contents of white matter greatly differ from those of grey matter. Interestingly myelin composition of brain is greatly similar in different species with few minor exceptions. Different regions of the brain may also vary in their myelin lipid contents. Brain myelin usually has a low lipid to protein ratio than the spinal cord myelin.

Several lipids constitute a small percentage of myelin. These include poly-phosphoinositides, two galactosyldi- glycerides, fatty acid esters of galactocerebroside and gangliosides (Morell, 1984).

### 5.3.2 Proteins

CNS myelin protein composition is simple as compared to other membranes of brain. In most of the species myelin basic protein (MBP) and proteolipid protein (PLP) constitute 60-80% of total proteins, while the contribution of other proteins and glycoproteins is small. Here is the description of some important myelin proteins.

#### 5.3.2.1 Proteolipid protein (PLP)

This 30 kDa protein is also called as the Folch–Lees protein (Greer et al., 2002; Hudson, 2004). This protein is highly conserved in its amino acid sequence evolutionarily. It is a tetraspan protein with four trans-membrane domains. In this structure both the N and C terminals of the protein are located towards the cytoplasm.

This protein is thought to have a role in the stabilization of CNS intraperiod lines as these lines have a contact with extracellular loops. This regulation of membrane spacing at the intermodal lines was confirmed in the PLP knock out as well as spontaneous PLP mutant mice where intraperiod line showed anomalous condensation (Campagnoni et al., 2001).

PLP has an isoform DM20 which is a 20 kDa protein which is formed as a result of alternative splicing of PLP gene. However DM20 levels are much lower than the PLP in CNS. Structurally and functionally DM20 is similar to PLP except the absence of 35 amino acids in the extracellular domain (Greer et al., 2002; Hudson, 2004).

PLP/DM20 contains fatty acid chains connected at the numerous cysteines through ester bonds. Generally each 1 mol of protein carries 4-6 mols of fatty acids. DM20 mRNA becomes visible during very early stages of development in mature oligodendrocytes much

before the appearance of myelin (Hudson, 2004). This early expression of DM20 suggests its possible role in cell migration and differentiation.

The presence of PLP/DM20 is not necessary for the compaction of myelin as PLP null mouse contain normally compacted myelin, however intraperiod line spacing is disturbed. Nevertheless this protein is crucial for the stabilization of myelin probably by the formation of 'zipper-like' structures after myelin compaction. PLP knockout mice were found more prone to osmotic shock during fixation. PLP/DM20 is necessary for the normal functioning of myelin. Although myelination is normal in mice lacking PLP they however display significantly higher axonal degeneration as they grow in age. DM20 fails to replace PLP despite similarity in structures. In transgenic mice without PLP, over expression of DM20 does not improve the conditions of mice (Stecca et al., 2000).

A possible explanation could be the unique characteristic of PLP to simultaneously bind with inositol hexakisphosphate (regulate vesicle transport) and integrins (extracellular protein) (Yamaguchi et al., 1996; Gudz et al., 2002). This suggests the PLP Performs more significant functions than DM20. Interestingly mutation in PLP gene or its duplication produces more adverse effects than complete loss of PLP. Absence of PLP produces axon loss in the old age mice but in humans and animal models, PLP mutation or duplication leads to hypomyelination and in even death in some instances (Hudson, 2004).

### **5.3.2.2 Myelin basic proteins (MBP)**

Analysis of MBP gene from different species indicates that it is highly conserved like PLP. Alternative splicing of MBP gene to produce variable products is another common similarity with PLP gene (Aruga et al., 1991; Campagnoni et al., 2004). The classical MBP protein is 21.5 kDa although it is expressed in low quantities. It is the product of full length MBP gene which consists of 7 exons. Alternative arrangement of these exons gives rise to four other subtypes of myelin MBP. Among the various subtypes 18.5 kDa and 14 kDa constitute the most abundant MBP subtypes in rodents while in humans 18.5 kDa is the dominant isoform. The relative expression of various subtypes alters depending on the developmental stage. Mature rodent tissue contains predominantly 14kDa subtype.

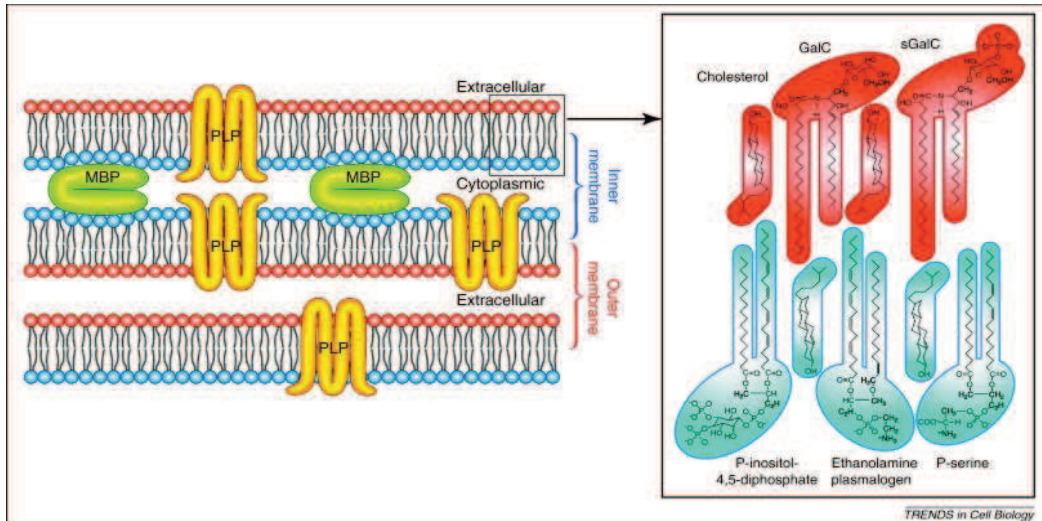

Figure I-22: A schematic presentation of myelin structure with its major constituents: internal and external surfaces of lipid bilayer come close to each other to form major dense line and intraperiodic line of compact myelin. Proteins are asymmetrically dispersed in the lipid bilayer. Some important lipids of myelin are shown on the right side of diagram (Aggarwal et al., 2011).

Figure I-22: Représentation schématique de la structure de la myéline avec ses principaux constituants: l'opposition des surfaces internes et externes de la bicouche lipidique pour former respectivement la ligne dense majeure et la ligne intraperiodique de la myéline compacte. Les protéines sont distribuées asymétriquement dans la couche lipidique. Des lipides majeurs de la myéline sont représentés dans la figure de droite (Aggarwal et al., 2011).

Interestingly MBP mRNA is confined to the cell body in immature oligodendrocytes but once the cell is mature mRNA moves in to the myelin processes. This arrangement possibly allows the production of large quantities of MBP for immediate incorporation into myelin (Trapp et al., 2004).

The MBP proteins are extrinsic in nature as they are localized on the cytoplasmic surface in the major dense line. There are some studies which support the formation of MBP dimers. MBP is a crucial molecule which promotes stabilization of major dense lines probably by contacting with negatively charged lipids. This function is confirmed by studies in MBP mutant shiverer mice which display severe hypomyelination with defective compaction in the

major dense line. The MBP in this case is extremely unfolded and unable to develop tertiary structure. There is an increase in the phosphorylation, C-terminal arginine loss and deamidation. These changes point out that post translational modification in the structure of MBP inhibit the molecules of opposite cytoplasmic membranes to come in contact with each other (Eichberg et al., 1996).

The classical MBP gene is a part of a large gene called golli (gene of the oligodendrocyte lineage). This gene is 100kb in length and contains 3 transcriptional sites (Campagnoni et al., 2004). Two of these sites give rise to MBP mRNA while the remaining one transcribes golli mRNAs. The products of this golli gene are non-specific and hence expressed in various tissues namely oligodendrocytes, neurons and T cells. The expression of golli proteins is higher during embryonic and postnatal developmental stages. These proteins are localized at different subcellular positions like nucleus, cytoplasm and cellular processes. Their function is still unknown but possibly they play a role in the formation of neural cell extensions (Campagnoni et al., 2004).

### **5.3.2.3 2', 3'-Cyclic nucleotide 3'-phosphodiesterase (CNP)**

Myelin contains many proteins with higher molecular weights other than MBP and PLP. They have variable expression depending on the species and age. Generally lower animals have higher quantities of these proteins than mammals. CNP is one such protein which functionally acts as an enzyme. This protein is a doublet with  $\approx 46$  kDa and 48 kDa (Braun et al., 2004). Small quantities of CNP may be found in other tissue but it is mainly expressed in higher concentrations in CNS myelin therefore it serves as marker of myelin.

2', 3'-cAMP as well as cGMP, cCMP and cUMP are the substrates for the CNP. CNP hydrolyses these compounds to their respective 2'-isomers. However, all these products are biologically inactive as merely 3':5' cyclic nucleotides perform some functions of biological significance. Despite many years of research after its discovery its function is still unknown.

There are two variants of this protein that differ by mere elongation of 20 amino acids at N-terminal of longer polypeptide. CNP is mainly found in the specified areas related to cytoplasm as oligodendroglial processes, lateral loops, inner and outer tongue processes with no contribution in the compacted myelin. It is located in cytoplasm but it develops relationship with membranes by acylation of C-terminus.

CNP contacts with cytoskeletal components F-actin and tubulin, probably to perform its function. This hypothesis is further strengthened by the promotion of process outgrowth in non-neural cell culture after over expression of CNP. This indicates the possible functional involvement of CNP in the regulation of cytoskeletal dynamics to promote oligodendroglial processes outgrowth and differentiation. Additionally it may have a significant role in the various cellular processes related to myelin synthesis. It was evidenced in the over expressed transgenic mice which develops anomalous myelin.

The amino acid sequence of CNP proposes that it belongs to a group of enzymes related to RNA- processing. But the physiological functions of this group have not been explored yet so we are unable to establish this kind of CNP role in myelination. Some more possibilities arise from the findings of studies using CNP null mouse. These mice develop normally and have complete myelination but during adult life they display neurodegeneration, axonal swelling and premature death.

So, it can be inferred that CNP may have multiple roles starting from differentiation of oligodendrocytes where its functional absence can be replaced by some other proteins. Then it affects the axon-oligodendrocyte association which results in axon loss (Braun et al., 2004).

#### **5.3.2.4 Myelin-associated glycoprotein (MAG)**

MAG is a 100 kDa protein which is expressed in low levels in CNS as well as PNS (Quarles et al., 2002; Georgiou et al., 2004). It is a single trans-membrane protein with richly glycosylated extracellular domain (five Ig-like domains and eight or nine N-terminal glycosylation sites) and a C-terminal intracellular domain.

MAG have structural resemblance with neural- cell adhesion molecule (N-CAM). MAG exists in two isoforms which are generated by alternative splicing and vary in their cytoplasmic domains. The isoform L-MAG carries a long C-terminal tail and usually expressed in high concentrations during development at the time of active myelin synthesis. Second isoform S-MAG contains short C-terminal tail and continue to increase during development and are present in high levels in the adults. In compact myelin MAG is absent but found in the periaxonal glial membranes of myelin sheaths.

MAG is a member of Ig superfamily and its position close to axon indicates that it may regulate axon-oligodendrocyte attachment and their signaling. Its role in two ways signaling between oligodendrocyte and axon has been proved experimentally. MAG is placed in siglec (sialic acid –binding, immunoglobulin-like lectins) subgroup of Ig-superfamily. So, they can develop connections with terminal  $\alpha 2-3$  linked sialic acid moieties containing glycoproteins and gangliosides. Likewise they can contact other HNK-1 epitope carrier adhesion proteins like N-CAM and MAG.

Although MAG is not required for myelin synthesis, it is vital for many other myelin related functions. It was verified in studies on MAG knockout mice where myelination appeared late, developed defects in periaxonal and paranodal structures and showed redundancy in myelin loops. Aged MAG null mice show deterioration in periaxonal oligodendroglial processes. So, MAG deficiency interferes with normal myelin formation during development and promotes dystrophy in older age.

These mild affects, produced by single MAG knockout mice, get worse in double knockout mice involving MOG in combination with some other proteins. These results indicate the significance of MAG regulated signaling from axon to oligodendrocytes for the synthesis and maintenance of myelin. Genetically engineered mouse lacking L-MOG was found to induce the same defects as those of null mice. This clearly demonstrates that L-isoform is involved in the regulation of all these activities.

### **5.3.2.5 Myelin oligodendrocyte glycoprotein (MOG)**

Myelin oligodendrocyte glycoprotein (MOG) is a single trans-membrane protein with a molecular weight of 26 kDa (Pham-Dinh et al., 2004). It contains an Ig like domain, a site for N-linked glycosylation and HNK1 epitope. It is situated on the outer surface of myelin and oligodendrocytes which render it antigen characteristics. This antigenic capability has been applied in the immune aspects of demyelinating disorders like multiple sclerosis.

They may have involvement in signal transduction by transfer of information from outer environment to the interior of oligodendrocytes. This was confirmed *in vitro* by inhibition of MOG activity with anti- MOG antibodies (Taylor et al., 2004). Their physiological functions are still not recognized as MOG null mice display normal phenotype hence offer no clues about MOG activity.

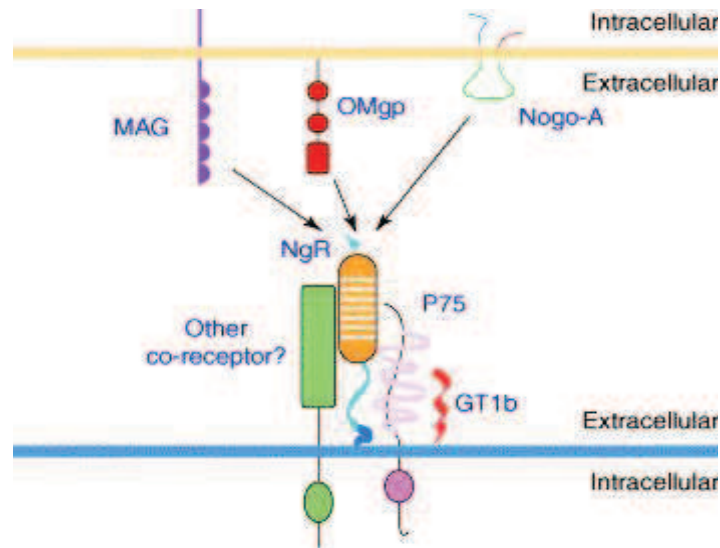

Figure I-23: Schematic representation of NgR and P75 receptors related with myelin proteins and glycoproteins MAG, OMgp and Nogo-A (Yiu and He, 2003).

Figure I-23: Représentation schématique des récepteurs NgR et P75 associé aux protéines de la myéline et des glycoprotéines MAG, OMgp et Nogo-A (Yiu and He, 2003).

### 5.3.2.6 Oligodendrocyte-myelin glycoprotein (OMgp)

OMgp is a p phosphatidylinositol- associated glycoprotein which was first recognized in human white matter (Quarles et al., 2002; Vourch et al., 2004). It does not belong to Ig super family but its N terminal contains a cysteine-rich moiety, repeated leucine-loaded chains and HNK-1 epitopes. This structural organization proposes a cell-cell attachment function for this vary glycoprotein. Neurons contain this glycoprotein just like oligodendrocytes hence expression of OMag is not restricted to myelin forming cells. Their role in myelin synthesis or maintenance is unknown however they have been found to have an inhibitory effect on the axonal regeneration.

### 5.3.2.7 Paranodal proteins

Normal axonal firing depends on the axonal lamella at the node of Ranvier. This structure is maintained by the proteins and lipids of paranodal myelin membrane. Both the axonal and glial membranes are highly specialized in this region with specific domains to support transmission of action potential. Sodium channels are clustered in the nodal region and avoid

internodes to produce action potential while Potassium channels occupy juxtaparanodal membranous area.

This area is richly populated by membranous proteins including some members of Ig super family. These proteins are organized in a special formation which allows them to participate in the complex and intricate process taking place at this site. Axonal membrane contains contactin -associated protein (Caspr) which interacts with neurofascin 155, a protein of glial membrane, to constitute septate-like junctions (Quarles et al., 2002).

### 5.3.3 Enzymes associated with myelin

In the beginning it was thought that myelin is a biochemically inactive membrane. However recent research has revealed the presence of several enzymes in myelin (Ledeen et al., 1992). This is a clear indication that myelin is capable of producing, processing and metabolically regulating some of its elements. It can further facilitate the transport of ions to maintain its own structure as well as the ion balance in its neighborhood. CNP is one enzyme which is associated with myelin and oligodendrocytes. pH 7.2 cholesterol ester hydrolase is a unique protein found in myelin in high concentrations.

Besides, these myelin specific enzymes there are some non-specific enzymes which appear to function for myelin. This group of enzymes is consisted of cAMP-stimulated kinase, protein kinase C, calcium/calmodulin- dependent kinase and phosphoprotein phosphatases. Two of these enzymes i.e., protein kinase C and phosphoprotein phosphatases bring about the phosphorylation of MBP protein. Myelin also contains enzymes responsible for PLP acylation.

Myelin brings about metabolism of structural lipids with the help of steroid-modifying enzymes and cholesterol-esterifying enzymes, UDP-galactose: ceramide galactosyl-transferase and several enzymes involved in the metabolism of glycerophospholipid. It is probable that myelin produces phosphatidylcholine and brings together some structural components and lipids. Being a carrier of Acyl-coenzyme A (CoA) synthetase myelin can recruit free fatty acid into its lipid components.



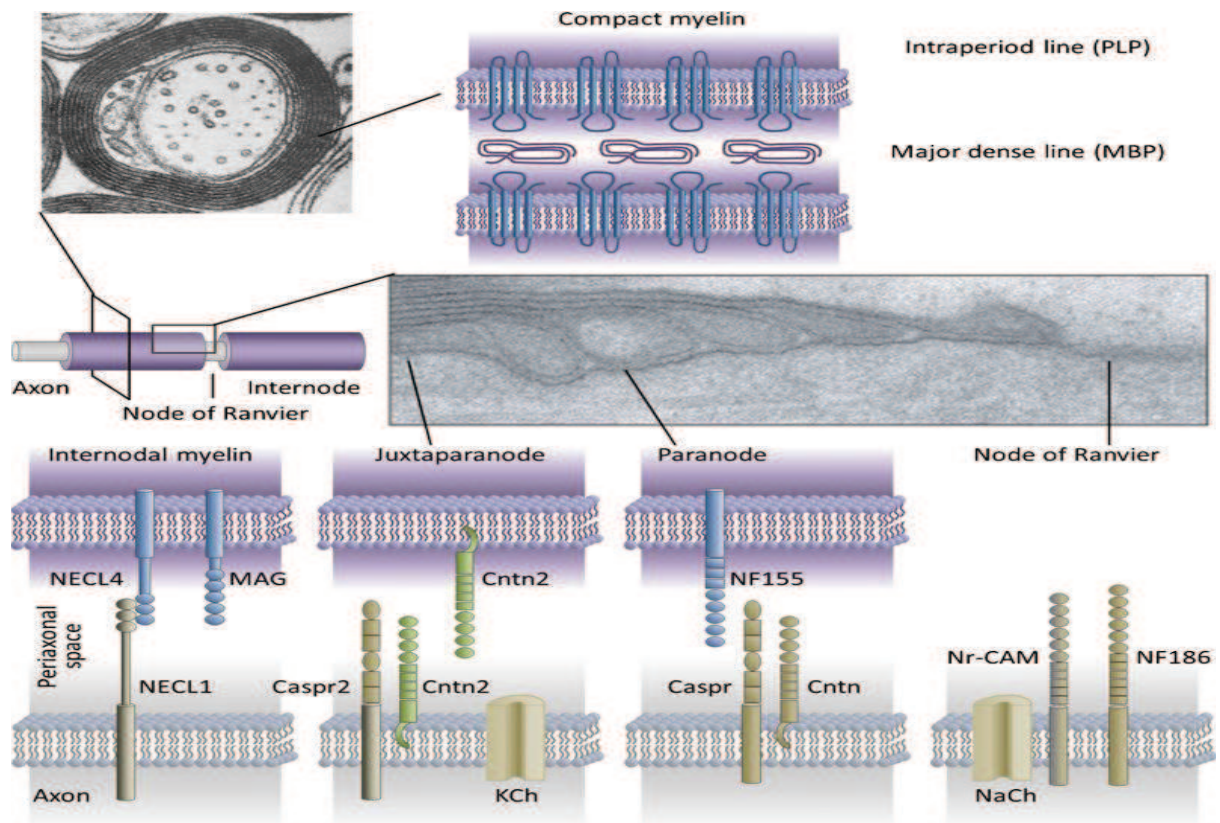

Figure I-24: Micrographie électronique d'un axone entouré de multicouches myéliniques avec une alternance de lignes denses majeures et lignes intrapériodiques. La MBP interagit avec la surface cytoplasmique de la bicouche lipidique pour former la ligne dense majeure alors que l'interaction des boucles extérieures du PLP avec la bicouche lipidique suivante forme la ligne interapériodique. La myéline non compacte contenant de cytoplasme se trouve au bord des manchons de myéline pour former une complexe junctionnel. On a ainsi plusieurs domaines de la myéline en contact avec l'axone: le nœud, le paranoëud, le juxtaparanoëud et l'interoëud. Chacun de ces domaines possède des protéines spécifiques associées à des fonctions particuliers. Abbreviations Caspr, contactin-associated protein; Cntn, contactin; KCh, fast potassium channels; MAG, myelin-associated glycoprotein; MBP, myelin basic protein; NaCh, voltage-gated sodium channels; NECL, nectin-like protein/synCAM; NF155/186, neurofascin 155 kDa/186 kDa; Nr-CAM, neuronal cell adhesion molecule; PLP, proteolipid protein (Nave et al., 2010).

Figure I-24: Electron micrograph of an axon surrounded by compact myelin. This compact myelin contains electron-dense (major dense line) and electron-light (intraperiod line) layers arranged in an alternate manner. Interaction of MBP with cytoplasmic surface gives rise to major dense line while fusion of PLP with the outer membrane creates intraperiod line.

Myelin forms junctional complex where myelin is non-compacted and contains cytoplasm at the lateral end of each segment. This organization divides the myelin axon contact into four different regions namely node, paranode, juxtaparanode and internode. Each of these regions in turn contains specialized proteins which help them perform a particular function. Abbreviations Caspr, contactin-associated protein; Cntn, contactin; KCh, fast potassium channels; MAG, myelin-associated glycoprotein; MBP, myelin basic protein; NaCh, voltage-gated sodium channels; NECL, nectin-like protein/synCAM; NF155/186, neurofascin 155 kDa/186 kDa; Nr-CAM, neuronal cell adhesion molecule; PLP, proteolipid protein (Nave et al., 2010).

A group of kinase enzymes, including phosphatidylinositol kinase, some associated diglyceride kinases and diphosphoinositide kinase, is present in myelin to regulate metabolism of phosphoinositide. These enzymes have significant value, because of their involvement in the rapid turnover of phosphate group, in polyphosphoinositides rich myelin.

Additionally myelin contains membrane bound form of oligodendroglial marker carbonic anhydrase enzyme. The presence of this enzyme eliminates carbonic acid from metabolically active axons. Low levels of 5'-nucleotidase and K<sup>+</sup>, Na<sup>+</sup> ATPases are found in myelin and actively participate in the transportation K<sup>+</sup> and Na<sup>+</sup> cations (Hudson et al., 2004).

Water constitutes the 40% of myelin membrane while the dry components include lipids and proteins. Lipids contribute majorly (70–85%) while proteins present 15–30% of the myelin dry weight. This composition suggests that myelin is different than other biological membranes in protein to lipid ratio. This myelin structure is composed of a lipid bilayer with integral proteins embedded into it while other proteins are attached to the internal or external surface through weak bonds. Myelin membrane displays asymmetrical distribution of proteins and lipid elements (Quarles et al., 2002).

#### **5.4 Steps and timing of myelination**

There are three main steps involved in the myelination. First step involves the movement of oligodendrocytes towards their target axons and their identification. In the second step branches of oligodendrocytes come into contact with axons. Finally processes elongate to spirally arrange around axon with specific number of turns (Baumann and Pham-Dinh, 2001).

Myelination follows a caudo-rostral route in brain and rostral-caudal. In a given species myelin strictly follow same path. In mice it begins in the spinal cord after birth and completes in approximately 2 month time. Contrarily human myelination starts in the second trimester and continues till the age of 20 years with highest rate observed during first year of development (Willard et al., 1985).

## **5.5 Myelin Function**

### **5.5.1 Physiology**

Initially myelin was considered an inactive membrane which merely transmits action potential at a faster rate due to its high resistance and low capacitance. However, this concept has changed altogether and now it is well established that myelin is a dynamic membrane with multiple functions. Besides transmission of nerve impulse myelin is involved in the clustering of ion channels in the nodes of Ranvier. This arrangement allows 100 fold increase in the velocity of transmission in myelinated neurons.

Myelin provides trophic support and signaling molecules to axons to regulate their survival, maturation and regeneration. It controls axonal caliber by bring about changes in the cytoskeleton (Windebank et al., 1985; Sánchez et al., 1996). An interesting finding in the recent years is the transference of energy in the form of ATP from myelin to axons (Morelli et al., 2011). Myelin is very efficient in preventing neurite outgrowth and axonal sprouting as well as maintaining the axonal synapses intact. These functions are facilitated by Nogo-A surface proteins (Craveiro et al., 2008). Some other relatives of Nogo-A can also be found with proapoptotic functions (Chen et al., 2006). Thus myelin has developed different mechanisms to communicate with axon and with its microenvironment (Nave et al., 2008).

This communication between myelin and axons can have far reaching consequences considering the fact that oligodendrocytes are linked with each other as well as with astrocytes with the help of gap junctions (Kamasawa et al., 2005). Composition of myelin lipid contents has important implications in cellular communication. Activation of receptors and signal molecules is required to induce maturation of oligodendrocytes, regulate myelin production, mediate axonal development and maintain axonal integrity.

These molecules and receptors are transported to appropriate sites during development to make them available for the transduction of signals. Myelin contains high levels of glycosphingolipids and cholesterol which facilitate the creation of membrane microdomains (lipid rafts). These lipid rafts accumulate molecules involved in the transduction of signals. Generally the molecules which occupy this area include G proteins, adapter proteins, tyrosine kinase receptors, GPI-anchored proteins (Baron et al., 2003; Bryant et al., 2009). Some of these mechanisms are involved in the maturation of white matter. This maturation can regulate the connectivity of network either by promoting or blocking synaptic interactions (Hagmann et al., 2010). This regulatory function is clearly demonstrated in one of the recent studies where myelin and oligodendrocyte abnormality leads to the development of defective neural circuitry (Takahashi et al., 2011).

### 5.5.2 Pathophysiology

Myelin synthesis is an intricate process which requires cell differentiation, production of myelin specific proteins and lipids, appropriate environmental signals and synchronized morphological changes. All these individual process are so important that failure of any one can result in a dysmyelinating disorder. Oligodendrocyte proliferation and differentiation depends upon the availability of variable trophic signals at appropriate stages. Similarly several molecules, availability of energy and efficient vascular transport work in coordination under a tight regulation for the synthesis of myelin. Elongation of myelin around axons requires establishment of connections between oligodendrocytes and axons with signals from environment.

Presence of many specific proteins renders myelin prone to inflammatory immune response in the incident of demyelination. Normal myelin is in a very steady state with the recycling of its components in appropriate time (Saher et al., 2010). However, demyelination demands an abrupt increase in the synthesis of myelin components and energy supply. Oligodendrocyte loss and decreased number of progenitor cells are associated with demyelination. Although reduced number of oligodendrocytes try to overcome myelin loss by giving rise to more myelin segments but certainly they have limitations in the number of segments they can support. The proof of this fact lies in the finding that an oligodendrocyte produces more internodes around small axons and less around large (Fanarraga et al., 1998). Myelination and axonal support are the two functions associated with oligodendrocytes. These two activities

are highly impaired in myelinating disorders. Knowledge about the structure, function and synthesis and repair of myelination can help us in treating demyelinating disorder after characterization of various disease pathophysiologies (Soldán and Pirko, 2012).

## **5.6 Myelin associated disorders**

Myelin abnormalities do exist and most of them have genetic bases. Some of these are very severe leading to death while others are mild in effect. These disorders are discussed under three headings. Multiple sclerosis is the most prevalent of all demyelinating diseases. Other diseases are mostly genetic based leukodystrophies. These demyelinated or dysmyelinated disorders are associated with axonal injury.

### **5.6.1 Multiple sclerosis (MS)**

MS is a demyelinating disorder of CNS which is associated with inflammation and is the main source of non-traumatic neurological abnormalities in young adults (Noseworthy et al., 2000). MS is among the most extensive demyelinating disorders with higher frequencies in North America and Europe especially in Caucasian populations. The pathophysiology of this disease is known from approximately 150 years since the narration of Shako and associates in the middle of 19<sup>th</sup> century. The name multiple sclerosis was ascribed by Professor Jean-Martin Charcot of university of Paris. He used the term ‘la sclerose en plaques’ to describe the disease plaques after analyzing the brain of a young woman (Charcot, 1868). The critical process associated with MS is the demyelination of nerve fibers and their processes which interferes with the transmission of action potential. Although enormous literature is available on various aspects of MS but the exact mechanism responsible for the induction of disease is not known completely (Antel et al., 2005).

#### **5.6.1.1 Types of MS**

It follows a variable and biphasic disease path. In vast majority (85%) of the infected individuals it begins as a relapsing-remitting MS (RRMS). This phase is characterized by the repeated occurrence of rapid attacks followed by a reversal of neurological defects. Neurological abnormality during RRMS arises because of the presence of distinct

inflammatory demyelination regions and oedema. Generally patient recovers once the inflammation subsides and oedema disappears. This phase persists from 8-15 years and ultimately transforms into second phase known as secondary progressive MS (SPMS). This severe phase of disease is linked with progressive and irreversible neurological defects. This phase is incurable yet and induces physical, cognitive and psychiatric disabilities. The main reason behind this irreversible neuronal dysfunction is axonal degeneration (Waxman et al., 2005; Trapp et al., 2008).

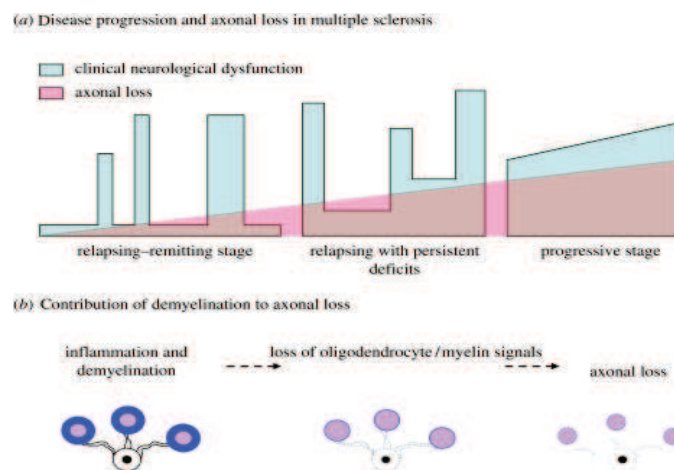

Figure I-25: Schematic view of disease progression in MS. (a) in relapsing remitting phase temporary neurological defects are reversed and become normal. With the passage of time relapse increases and neuronal abnormalities persist for longer duration which then leads to permanent deficits. This stage is associated with axon loss. (b) MS initiates with the loss of oligodendrocytes which results in the withdrawal of trophic support for axons causing them to degenerate as seen during progressive phase of MS (Chandran et al., 2008).

Figure I-25: Les différentes formes de progression de la sclérose en plaques (SEP). (a) forme rémittente dans laquelle les déficits neurologiques disparaissent après une attaque. (b) forme rémittente progressive où après chaque attaque les déficits neurologiques persistent pour mener à des déficits permanents associés à une perte axonale. Le début de la SEP est caractérisée par une perte des oligodendrocytes qui mène à une déficience en facteurs trophiques causant la dégénérescence des axones comme on le voit dans la forme progressive de la SEP (Chandran et al., 2008).

### 5.6.1.2 Factors involved in MS

There are several factors which are responsible MS development. They can be broadly divided into two groups i.e., internal and external. Internal factors include genetics, autoimmune and abnormality in hormonal functions. Geographical location and viruses are external factors which can play a role in the development of MS. So, measles, rubella, and herpes virus can be a potential threat. Environmental factors like weather, climate, soil topography and natural water may have some interaction with MS (Bernard et al., 1992).

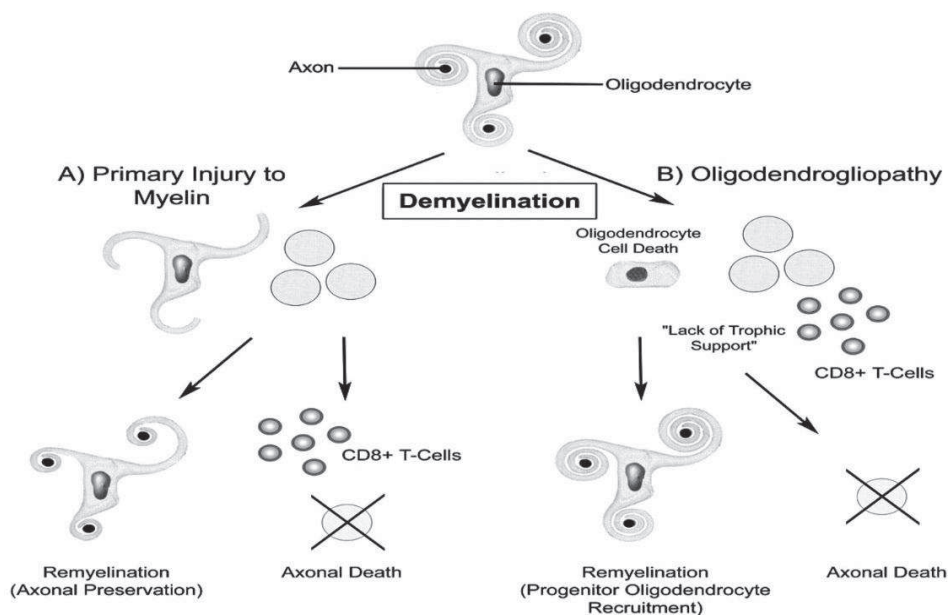

Figure I-26: In multiple sclerosis there are two possible mechanisms involved in the demyelination. (A) Demyelination arises from the damage of myelin without any harm to oligodendrocyte (B) damage to oligodendrocyte leading to loss of oligodendrocytes. This is followed by two possibilities (i) either remyelination which in turn preserves axons (ii) axon degeneration. Remyelination is accomplished by either intact surviving oligodendrocyte (case 1) or regeneration from OPCs arriving demyelinated area after lesion (case 2) (Rodriguez, 2003).

Figure I-26: Dans la SEP il existe deux mécanismes possibles impliqués dans la démyélinisation. (A) Démyélinisation sans perte notable d'oligodendrocytes (B) Dommages aux oligodendrocytes qui conduit à leur perte suivi : (i) par une remyélinisation qui préserve les axones ou (ii) par une atteinte axonale. La remyélinisation peut se faire soit par les

oligodendrocytes survivants soit par la régénération des OPCs et leur déplacement vers les zones de demyélinisation (Rodriguez, 2003).

### **5.6.1.3 Clinico-pathological characteristics of MS**

In the brain and spinal cord of MS patients there are specialized compacted areas of variable shapes and sizes with characteristic rose/grey or grey-tint. These areas are called sclerotic plaques. These plaques are more numerous in the white matter of the spinal cord and brain. Based on the distribution frequency of demyelinated areas in a particular CNS region MS can be clinically divided into three types (cerebral, spinal, and cerebrospinal). As a result of active demyelination during the severe phase of MS axonal lesions can be detected. However in RRMS axonal injuries do not develop (Kornek et al., 2000).

MS is considered an autoimmune disorder of CNS. This processes is accomplished by infiltration of macrophages and T cells into the brain, activation of astrocytes and microglia, development of several regions of inflammation in nervous tissue, oligodendrocyte destruction, severe demyelination of nerve fibers and occurrence axonal injury (Murray, 2000; Zajicek, 2007). This disease generally appears during 20-40 years of age and characterized by clinical symptoms like motor dis-coordination, nystagmus, tremor, speech abnormalities, ataxia, sensory and autonomic disabilities as well as mental disturbance. Intellectual capabilities decline, depressive syndrome and constant fatigue syndrome make their appearance (Vinnichouk, 2001).

### **5.6.2 Leukodystrophies**

Leukodystrophies (LDs) group of inherited, rare, progressive and generally fatal disorders in which molecular abnormalities of glial cells are responsible for exclusive or predominant defects in myelin formation or its maintenance in the CNS. This term was coined by Bielschowski and Henneberg (1928) to describe these diseases however their concept has been greatly modified. Initially LDs were classified on the bases of immuno-histochemical characterization of breakdown products of myelin. With the advancement of magnetic resonance imaging (MRI) now it is easy to group leukodystrophies based on their white matter MRI analysis (Schiffmann et al., 2009). MRI has even helped in the identification of new genetic leukoencephalopathies even in cases where white matter defect develops as a secondary defect after neuronal and axonal abnormalities (Kohlschutter et al., 2010).



### **5.6.2.1 Adrenoleukodystrophy (ALD)**

Schilder (1913) was the first one to describe this X-linked AD in males. It has a range of clinical phenotypes with childhood cerebral and adrenomyeloneuropathy (AMN) are the most common (Naidu et al., 1999). Interestingly 10-15% heterozygous females display AMN phenotype between thirties and fifties. Cerebral phenotype develops in response to infiltration of perivascular lymphocytes which produce demyelinating lesions in the white matter. Normally ALD patients contain excessive lengths of very long chain unbranched fatty acids (VLCFA) C24-C30 chains in the cholesterol ester portion of white matter (Igarashi et al., 1976). These fatty acids are activated by VLCFA- CoA synthetase enzyme. This enzyme becomes active when present in peroxisome which is facilitated by ALD protein. ALD patients contain mutation in the gene for ALDP which in turn disrupts the localization of VLCFA- CoA synthetase and hence their activity (Yamada et al., 1999).

### **5.6.2.2 Globoid cell leukodystrophy (Krabbe's Disease)**

It is an autosomal recessive disorder associated with defects in the storage of glycosphingolipids which cause leukodystrophy. Clinically, patients have swollen optic nerve, progressive spastic tetraplegia, demyelinating neuropathy in sensory-motor neurons, white matter hypodensity without any loss of mental function in at least 50% cases. The disease appears in individuals lacking galactosylceramide  $\beta$ -galactosidase which is a lysosomal enzyme. This enzyme brings about the breakdown of galactosylceramide lipids (Malone, 1970). A special feature of this disease is that lipid contents of the brain do not increase and are restricted to globoid cells which are specific microglia. These cells contain higher levels of galactosylceramide (Austin, 1963). Additionally, galactosylceramide  $\beta$ -galactosidase degrades another important metabolite galactosylsphingosine. Galactosylsphingosine is believed to be a causative agent of disease pathologies as it act as toxin for oligodendrocytes (Suzuki, 1998). This disease appears during the first 6 months of the life (Lyon et al., 1996) but maximum viability varies.

### **5.6.2.3 Metachromatic leukodystrophy**

Metachromatic leukodystrophy is also related to the glycosphingolipid storage defects which results in the accumulation of lipids in different cells like Kupffer's cells, hepatocytes, gallbladder epithelial cells, bile duct epithelial cells and renal epithelial cells. Same lipids pile

up in microglia, oligodendrocytes and few neurons of CNS. Demyelination begins after the accumulation of sulfatides in oligodendrocytes (Suzuki et al., 1998). Patients with ML have variable symptoms and age of appearance (MacFaul et al., 1982). It starts with ataxia and walking difficulties followed by speech loss and spasticity which ultimately leads to vision loss and quadriplegia (Shapiro et al., 1994).

#### **5.6.2.4 Pelizaeus-Merzbacher Disease (PMD).**

PMD represents the best example of hypomyelinating leukodystrophy. The first description of this X-linked disease came from Pelizaeus (1885) and more detailed analysis was given by Merzbacher (1910). This disease manifests in three distinct forms based on the severity and age of patient. These forms include connatal, transitional, and classical. These patients have defects in eye movement, feeding abnormalities, hypotonia, developmental delays, ataxia, spasticity and choreoathetosis. X-linked type-2 spastic paraplegia is an allelic form of PMD. Mutations in the X-linked PLP gene are responsible for the development both type 2 spastic paraplegia and PMD. The nature of mutation in the PLP gene determines the degree of demyelination. The connatal PMD is the most intense form with different degrees of demyelination ranging from considerable demyelination to complete loss of myelin in all region of brain and spinal cord. Oligodendrocytes number is greatly decreased or absent altogether. As PMD is X-linked recessive disease so males are affected and female are merely carriers. Genetic analysis show that in more than half of the patients duplication of genomic area or even complete duplication of PLP1 is responsible for the development of disease (Mimault et al., 1999). Duplication segment could vary from 100Kbs to 9 Mbs in size (Lee et al., 2006). However duplication size has no correlation with the severity of disease (Shimojima et al., 2010). The deletions account for 15-20% of the cases (Mimault et al., 1999).

#### **5.6.2.5 Alexander's Disease**

It is a rare, sporadic and progressive disease of the CNS which occurs in three different forms based on age and severity i.e., infantile, juvenile, and adult. This disorder is characterized by delay in development, seizures and macrocephaly affects the infants (Alexander, 1949). It generally infects both males and females with manifestaion of clinical symptoms like cognitive inabilities, abnormal feeding and spastic quadriparesis. Pathological investigation displays the presence of astrocyte associations in the form of Rosenthal fibers in the brain.

The patients show severe myelin deficiency damage to white matter which is represented in the form of white matter cavities. Recent data demonstrate the accumulation of GFAP in affected brains (Johnson et al., 1998).

### 5.6.3 Demyelination and axonal injury

A generally accepted notion is that axons remain unaffected by the loss of myelin but studies have shown that axonal damage occurs as a secondary effect in dysmyelinating or demyelinating disorders. Axonal diameter is reduced in the region of demyelination (Perkins et al., 1981).

#### 5.6.3.1 Axonal injury in multiple sclerosis

MRI and electron microscopic comparison of brains from MS patients revealed axonal loss with the progression of disease (Barnes et al., 1991). In the ultrastructural analysis it was found that MS lesion contains decreased axonal density with an increased number of astroglial branches. Neurological abnormality is correlated with brain and spinal cord atrophy and may contribute towards disease development as seen during longitudinal investigations (Losseff and Miller, 1998). These results were verified by the magnetic resonance spectroscopic (MRS) observations on the estimation of an axonal marker N-acetyl aspartic acid (NAA) in the brain of MS patients. Interestingly NAA levels were reversibly lower in the lesion area during acute phase of the disease (Matthews et al., 1996). Chronic phase of the disease represents permanent reduced NAA in the area of injury and even in the unaffected regions which indicates the propagation of axonal damage or Wallerian degeneration in the neighborhood of MS injury (Fu et al., 1998).

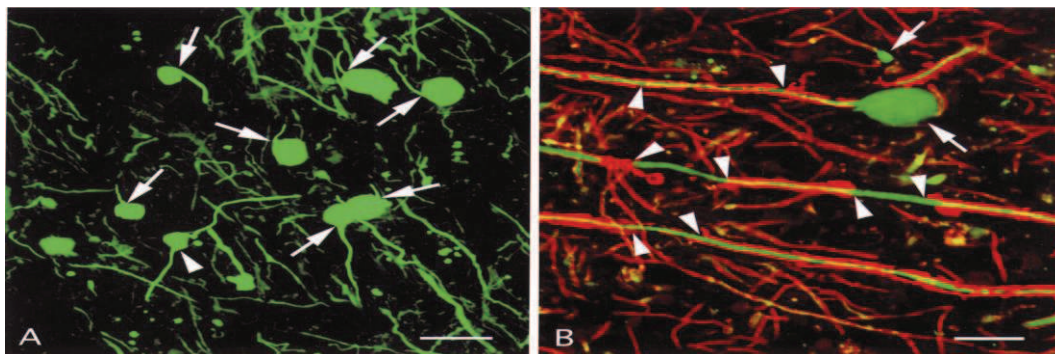

Figure I-27: MS lesion contains axonal transection. (A, B: green) staining of free floating sections with neurofilament and (B: red) myelin antibodies. Large terminal ovoids can be

seen in a MS lesion (A) arrow heads show that some axons are undergoing active demyelination (B) (Trapp et al., 1998).

Figure I-27: Les lésions SEP contiennent des transections axonales. (A, B: vert) coloration de sections flottantes avec neurofilaments et (B: rouge) la myéline. (A) Des formes ovoïdes peuvent être observées dans les lésions de la SEP (B) On voit aussi des axones en cours d'une démyélinisation active (têtes de flèche) (Trapp et al., 1998).

#### 5.6.3.1.1 Early axonal transaction in brain multiple sclerosis lesions

In the active lesions of MS, axonal amyloid precursor protein (APP) build up can be observed (Ferguson et al., 1997). Axons with impaired axonal transport are immunohistochemically positive for APP (Koo et al., 1990). Axonal transaction results in the development of terminal axonal swellings in APP+ structures. It is interesting to note that the number of swellings correspond to the extent of inflammation in the lesion (Ferguson et al., 1997). Studies on MS patients demonstrated an increase in the number of terminal swellings with progression of disease (Trapp et al., 1998).

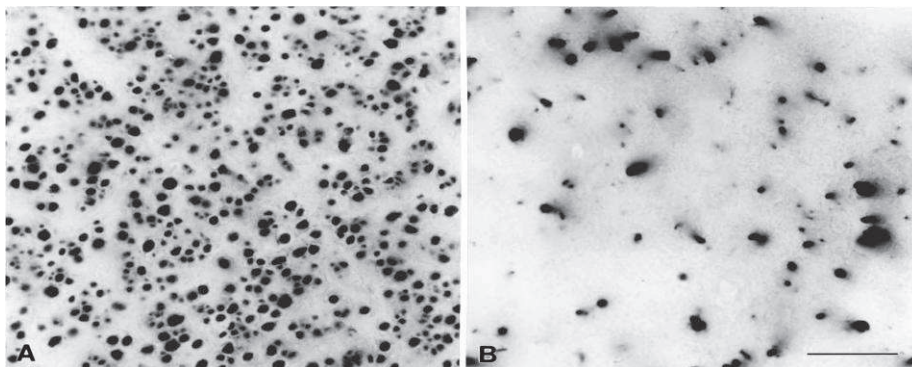

Figure I-28: Severe axon loss in the spinal cord of a paralyzed MS patient as compared to control (Bjartmar et al., 2000).

Figure I-28: Perte axonale dans la moelle épinière d'un patient SEP comparé au contrôle (Bjartmar et al., 2000).

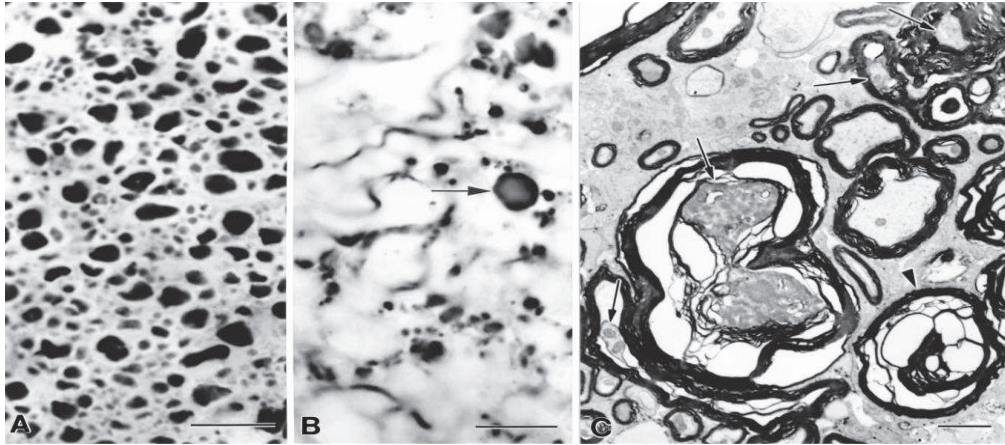

Figure I-29: Chronic-relapsing EAE mouse model displays severe axonal loss in the ventral spinal cord (B) as Compared to control (A). (C) Electron micrographic illustration of an EAE lesion showing both degenerating neurons and myelin (Bjartmar et al., 2000).

Figure I-29: Modèle EAE chronique-rémittente de souris affiche une perte axonale sévère dans la partie ventrale de la moelle épinière (B) comparé au contrôle (A). (C) Microscopie électronique d'une lésion dans l'EAE illustrant à la fois une démyélinisation et une dégénérescence axonale (Bjartmar et al., 2000).

#### 5.6.3.1.2 Inflammation mediated axonal degeneration in MS

In MS axonal injury depends on the extent of inflammation in the brain (Kuhlmann et al., 2002). Activated T cells move into the brain through BBB where they combine and undergo replication after getting expose to stimulatory signals. These cells further promote the accumulation of more macrophages and B cells by the production of proinflammatory substances. This enhanced inflammation induces demyelination and axonal injury via antigen specific and bystander mechanisms (Weiner et al., 2009). The exact mechanisms by which T cells induce neuronal toxicity are currently unknown. T cells release a variety of neurodegenerative factors like proinflammatory molecules and proapoptotic factors (FasL, granzyme B, soluble TRAIL, and free radicals). All these factors have the potential to promote injury (Aktas et al., 2005). It was found that subpopulation of CD4<sup>+</sup> and CD8<sup>+</sup> T cells have neurotoxic activity mainly through FasL, LFA-1, and CD40 surface molecules (Giuliani et al., 2003). Similarly Th1 and Th17 CD<sup>+</sup> cells are neurotoxic.

### 5.6.3.2 Axonal Damage in Leukodystrophies

Different types of leukodystrophies behave differently with respect to axonal damage.

#### 5.6.3.2.1 X-linked adrenoleukodystrophy

Axonal damage can be detected both in adrenoleukodystrophy (in children) and with adrenomyeloneuropathy (in adults). Adrenoleukopathy is associated with axon loss induced by inflammatory demyelination. Patients with adrenomyeloneuropathy have severely affected axons in spinal cord and dorsal columns. This effect is not related to inflammatory lesion (Powers et al., 2001). Studies for the determination of mechanisms involved in the axonopathy in X-linked adrenoleukodystrophy have not yet reached on a definite conclusion. However oxidative stress is proposed as a causative agent in most of the instances (Lin et al., 2006). Demyelinating lesions in the brains of adrenoleukodystrophy patients demonstrate this relationship immunohistochemically. ABCD1 gene regulates the homeostasis of oxidative stress and transcribed transporters of peroxisomal transporter. Hence loss of this gene induces X-linked adrenoleukodystrophy as well as axon loss (Gilg et al., 2000).

#### 5.6.3.2.2 Metachromatic leukodystrophy

This disease is associated with shortage of arylsulfatase-A enzyme or its activator protein saposin-B (Acardi, 1998). Axonal damage is directly proportional to the storage of sulfatide in arylsulfatase A knockout mice (Matzner et al., 2002).

#### 5.6.3.2.3 Krabbe's disease

Studies with proton magnetic resonance spectroscopy demonstrate severe axon loss in patients with infantile globoid-cell leukodystrophy. While occurrence of disease in either juvenile or adult patients produces little or no axon loss which indicates that axon loss is linked with the severity of disease (Brockmann et al., 2003).

#### 5.6.3.2.4 Pelizaeus-Merzbacher

Animal models as well as some patients of PMD show axonal degeneration. PLP knockout mice very clearly demonstrate the involvement of PLP in the regulation of axonal integrity (Griffiths et al., 1998). Age is an important factor in determining the degree of axonal

damage. Axonal damage becomes more severe as animal grow old, a situation which corresponds to PMD patients (Garbern, 2007).

Interestingly all these leukodystrophies have different genetics and etiology but their axonal damage is not associated with the absence of myelin or oligodendrocytes. Moreover axonal degeneration regulates the development of neurological signs of the disease.

Many possible mechanisms were proposed to explain axonal degeneration in the white matter disorders. Axonal damage in multiple sclerosis and other inflammatory leukodystrophies is caused by the disturbed homeostasis of glutamate and nitric oxide generation (Moreno-Lopez et al., 2006). In case of chronic demyelination absence of trophic support from myelin and abnormality in the ion balance could result in axonal injury (Bjartmar et al., 1999). Blockage of glutamate receptors, inhibition of Na channels by anticonvulsant and remyelination promoting approaches promote neuroprotection (Peru et al., 2008).

## **5.7 Therapeutic strategies to promote remyelination**

The main focus of research in the present is to promote remyelination in animal models and humans using various strategies. These strategies have been implicated with some success. These approaches include the introduction of stem cells from exogenous sources and inducing endogenous OPCs to start remyelination.

### **5.7.1 Transplantation of exogenous cells**

A variety of foreign cells such as neural stem cells, mesenchymal stem cells, embryonic stem cell and OPCs were administered to stimulate remyelination in demyelinated lesions. However use of these cells is accompanied by a number of difficulties such as inability of introduced cells to travel long distances, isolation of cells from their sources, scarcity of sources, immunological incompatibility and risk of tumor development. Another problem of concern is the mode of administration like injection of stem cells in parenchyma may not be a suitable option in arbitrarily dispersed MS lesions. Similarly intravenous or intra-arterial introduction may be more fruitful but it is linked with the problem of tissue targeting (Chu et al., 2004). Progenitor cells from adult CNS are more efficient than embryonic stem cells in stimulating remyelination (Windrem et al., 2004). In leukodystrophic animal models

introduced human OPCs can integrate into host white matter tissue, myelinate axons and remain viable for long durations. Clinical symptoms and disease pathology of EAE was improved along with remyelination after the administration of embryonic neurospheres (Einstein et al., 2003; Reynolds et al., 2005).

Interestingly mere accumulation of OPCs around demyelinated axons is not adequate for the promotion of remyelination (Barres et al., 1999). Remyalination failed in case of chronic demyelinated axons where OPCs are unable to differentiate even after a long stay (Pluchino et al., 2005).

Adult CNS stem cells application via systemic route may induce positive effects by modification of peripheral immune response instead of remyelination (Pluchino et al., 2005). These cells accommodate in lymphoid organs where they decrease the release of pro-inflammatory cytokine and modulate the response of auto-reactive cytotoxic T cell. Additionally transplanted stem cells can release trophic factors to induce a neuroprotective effect (Hung et al., 2007).

Systemically applied neural stem cells distribute to the lymphoid organs and reduce pro-inflammatory cytokine production and auto-reactive cytotoxic T cell responses. Transplanted cells also have neuroprotective properties via release of trophic factors (Hung et al., 2007).

### 5.7.2 Promoting endogenous remyelination

A parallel strategy is the activation of endogenous stem cells to stimulate myelin regeneration. This purpose is achieved by the administration of factors that could stimulate OPCs activity. Several factors like growth factors and hormones have been found have positive effects on the activation of OPCs.



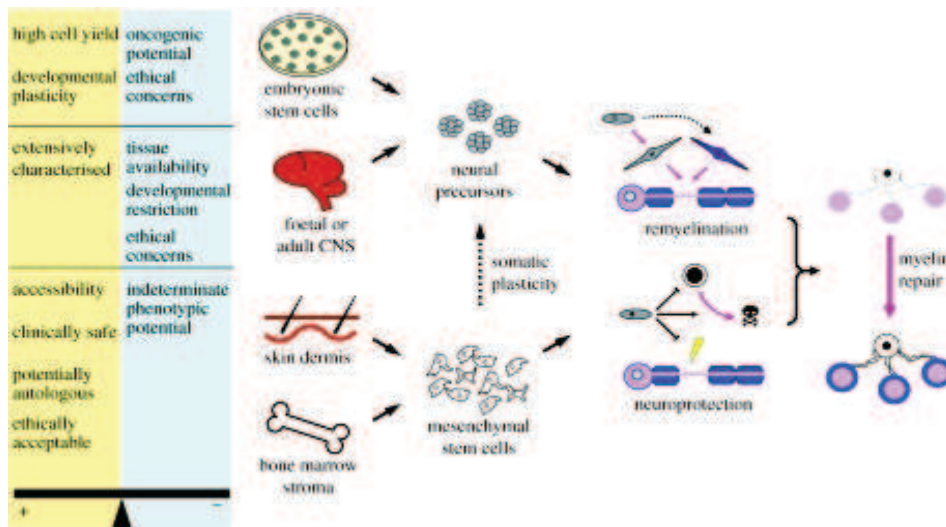

Figure I-30: Application of stem cells derived from exogenous sources to stimulate myelin regeneration. Embryonic, fetal and adult stem cells from different body parts are transplanted into myelin deficient individuals. These cells after getting incorporated into host tissue, synthesize myelin to reduce lesion or release neurotrophic factors to promote axon survival (Chandran et al., 2008).

Figure I-30: Utilisation de cellules souches de source exogène pour stimuler régénération de la myéline. Des cellules souches d'embryon, de foetus ou d'adulte de différentes origines sont transplantées chez les individus déficients en myéline. Les cellules après incorporation chez l'hôte synthétisent de la myéline pour réduire la lésion ou larguer des facteurs neurotrophiques nécessaires à la survie des axones (Chandran et al., 2008).

### 5.7.2.1 Growth factors and related molecules

Indigenous levels of growth hormones increase during disorders as trauma, ischemia and spinal cord injury which is an indication of their involvement in the process of repair (Seiwa et al., 2007). Neurotrophic factors such as CNTF, IGF-1, and glia growth factor (GGF)-2 promote oligodendrocyte survival and improve EAE pathological conditions (Kuhlmann et al., 2006). These factors act through peripheral mechanism of action as direct injection into CNS does fail to produce any effect (Genoud et al., 2005). However clinical trials with IGF1 showed that they are ineffective in promoting MS recovery (Frank et al., 2002). Administration of Immunoglobulin M (IgM) auto-antibodies directed against oligodendrocytes stimulates remyelination process in the toxic and viral induced

demyelination models. It is probable that they act through the initiation of signal cascade which induces remyelination (Bieber et al., 2002).

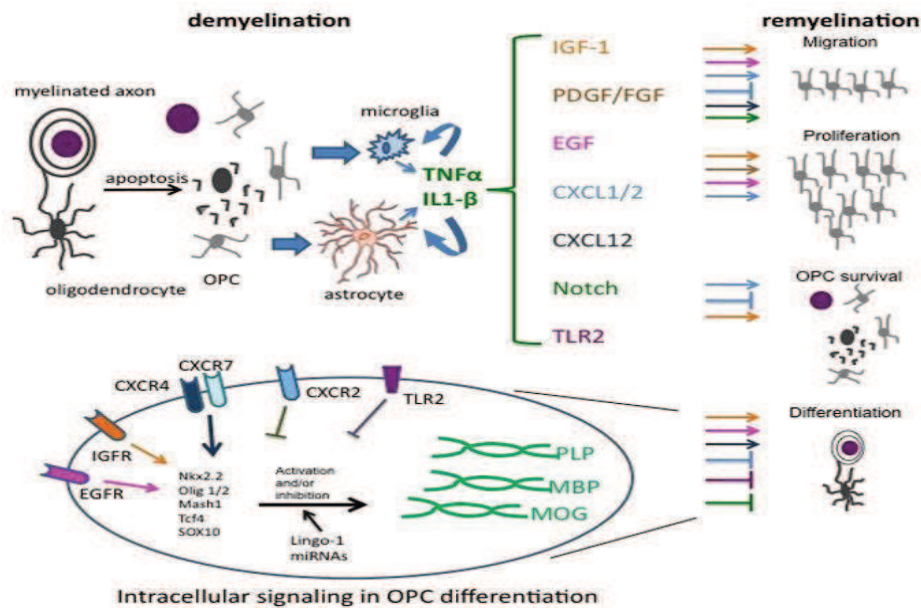

Figure I-31: A schematic description of involvement of different mechanisms for the stimulation of remyelination. Oligodendrocyte death activates astrocytes and microglia which release cytokines ( $\text{TNF-}\alpha$ ,  $\text{IL-1}\beta$ ). These cytokines modify the expression of chemokines ( $\text{CXCL1}$ ,  $\text{CXCL2}$ ,  $\text{CXCL12}$ ) and growth factors ( $\text{IGF-1}$ ,  $\text{PDGF}$ ,  $\text{FGF}$ ,  $\text{EGF}$ ). Growth factors stimulate proliferation of OPCs and enhance their survival whereas chemokines regulate migration and differentiation of OPCs. There are many intra cellular signaling molecules which are required for the remyelination.  $\text{TLR2}$ ,  $\text{Notch-1}$  block differentiation and promote migration likewise chemokine receptors ( $\text{CXCR4/7}$ ,  $\text{CXCR2}$ ) and growth factor ( $\text{IGF-1R}$ ,  $\text{EGFR}$ ) receptors, miRNAs, Lingo-1 and several transcription factors ( $\text{Nkx2.2}$ ,  $\text{Olig1/2}$ ,  $\text{Mash1}$ ,  $\text{Tcf4}$ ,  $\text{SOX10}$ ) have either inhibitory or stimulatory role for the OPCs differentiation and migration (Patel and Klein, 2011).

Figure I-31: Description schématique des différents mécanismes impliqués dans la stimulation de la remyélinisation. La mort des oligodendrocytes active les astrocytes et la microglie, qui libèrent des cytokines ( $\text{TNF-}\alpha$ ,  $\text{IL-1}\beta$ ). Ces cytokines modifient l'expression de chimiokines ( $\text{CXCL1}$ ,  $\text{CXCL2}$ ,  $\text{CXCL12}$ ) et les facteurs de croissance ( $\text{IGF-1}$ ,  $\text{PDGF}$ ,  $\text{FGF}$ ,  $\text{EGF}$ ). Les facteurs de croissance stimulent la prolifération des OPC et améliorent leur survie. Les chimiokines régulent, d'autre part, la migration et la différenciation des OPCs. De nombreuses molécules intracellulaires de signalisation sont nécessaires à la remyélinisation.

TLR2 et Notch-1 bloquent la différenciation et favorisent la migration. Même les récepteurs de chimiokines (CXCR4 / 7, CXCR2), les récepteurs des facteurs de croissance (IGF-1R, EGFR), miRNA, Lingo-1 et plusieurs facteurs de transcription (Nkx2.2, Olig1 / 2, Mash1, Tcf4, SOX10) inhibent ou stimulent la différenciation et la migration de les OPCs.

### **5.7.2.2 Hormones**

In the recent years hormonal therapy has emerged as a promising approach to treat demyelinating disorders. An important finding in this regard came from the observations that females are more prone to MS than males, remission frequency increases during pregnancy while prolonged relapses occur postpartum (Voskuhl, 2003). This clearly indicates an involvement of hormones in the regeneration process. In murine, pregnant females contain increased number of oligodendrocytes, OPCs and myelinated axons and display increased remyelination after lysolecithin-induced demyelination in the spinal cord (Gregg et al., 2007). It was observed that cholesterol dependent hormone synthesis continue both in the adrenal glands and CNS (Baulieu et al., 2001). They can penetrate BBB and have neuroprotective activity as well. They have been found to promote oligodendrocyte survival and stimulate myelination (Ghoumari et al., 2003).

The expression of hormone receptors on the surface of cells is highly dependent on the sex and the levels of hormones. However both males and females respond to hormonal treatment in rats (Yu et al., 2004). Synthetic analogues of estradiol and progestin were able to produce neuroprotective effects in the EAE and CNS injury (Wise et al., 2000). They have also been implicated with some success in non-pregnant and post-partum relapse-remitting MS patients (Sicotte et al., 2002). Estrogen hormone  $17\beta$ -estradiol protects oligodendrocytes from oxidative stress and stimulates myelin synthesis (Gerstner et al., 2007). Similarly progesterone is very efficient in promoting myelination and branch formation in oligodendrocytes (Marin-Husstege et al., 2004; Gago et al., 2001). The mechanisms of action for these hormones are not known however they promote IGF-1 release from the astrocytes and thus stimulate IGF-1 mediated remyelination (Kipp and Beyer, 2009).

Thyroid hormone not only plays an important role in the synthesis of myelin during development but behave in the same fashion during remyelination (Franco et al., 2008). Administration of triiodothyronine (T3) hormone at 3 weeks gap after the withdrawal of cuprizone progressively reestablishes oligodendrocyte population, restores myelin,

normalizes DT-MRI phenotype and ameliorated clinical signs. T3 treatment elevated the levels of sonic hedgehog and increased the number of olig2+ and PSA-NCAM+ precursor cells. These results establish T3 as a promoter of oligodendrocyte progenitors proliferation in adult mouse brain after chronic demyelination (Harsan et al., 2008). Thyroid hormone takes active part in the mechanisms of cell-cycle inhibition and timing of OPCs differentiation. Additionally they maintain oligodendrocyte lineage cells *in vivo* (Jagannathan et al., 1998). Moreover they contribute towards the survival of developing oligodendrocytes by inhibiting the inflammatory cytokines, tumor necrosis factor  $\alpha$  and interleukin-1 mediated apoptosis (Jones et al., 2003).

In a clinical trial involving 10 MS patients testosterone administration proved useful in preventing brain atrophy without affecting gadolinium-enhancing lesion numbers (Sicotte et al., 2007). It decreases immune inflammatory response by modification in the composition of peripheral lymphocyte reduction in CD4+ T cells and enhancing NK cells (Gold et al., 2008). Testosterone promotes the release of IL-5 and IL-10 and inhibits the production of IFN $\gamma$  in T cell *in vitro* thus inducing a Th2-like shift (Bebo et al., 1999). In addition to the immune modulatory functions, testosterone protects oligodendrocytes and induces remyelination in a very efficient manner (Cerghet et al., 2006). An important advancement in this regards has been made in a recent finding that androgen receptors are involved in the remyelination (Hussain et al., 2013). Testosterone promotes remyelination and reduces immunoinflammatory response in cuprizone induced demyelination mouse model. This effect is induced through neural androgen receptors located on the surface of oligodendrocytes. The involvement of androgen receptor was confirmed by application of 7 $\alpha$ -methyl-19-nortestosterone, a synthetic analog of testosterone. This analog produces same effects as those of testosterone. Contrarily removal of androgen receptors makes testosterone inefficient. Based on these results it can be inferred that testosterone is a potent therapeutic agent for demyelinating disorder (Hussain et al., 2013).

## **6. Animal models of demyelination and dysmyelination**

A variety of animal models were developed during past 40 years or so to understand the process and mechanisms of demyelination, remyelination and failure of remyelination in CNS. These models made use of different techniques ranging from viral induction to chemical (Toxic) administration and immune mediation to genetic manipulation for mimicking demyelination or dysmyelination in both mice and rats. Some of these models are being described herefor CNS demyelination.

### **6.1 Immune mediated mouse models**

#### **6.1.1 Experimental autoimmune encephalomyelitis (EAE)**

EAE is most widely used animal model to study multiple sclerosis. EAE mimics MS histopathology showing more severe effects on myelin in white matter as compared to grey matter (Waksman et al., 1962). Many components of myelin like myelin basic protein (MBP), proteolipid protein (PLP) and myelin oligodendroglial glycoprotein (MOG) have antigenic properties. Administration of cellular components, rather than serum, into a normal host leads to the development of disease by activation of T cells which in turn induces paralytic inflammation (Yasuda et al., 1975; Steinman et al., 2006).

Although EAE research started in non-human primates and larger rodents but over the years focus has shifted towards the mice in order to make full use of genetic tools. However, application of mice model is associated with certain disadvantages as mice display less severe complexity of disease and behavioral changes (Uccelli et al., 2003). C57BL/6 mouse is generally used for MOG (35-55), mixed with Freund's adjuvant carrying extract of *Mycobacterium tuberculosis*, induced immunization. Additionally pertussis toxin is administered on the day of injection and 2 days post injection. It is genetically advantageous to use C57BL/6 mouse but it represents monophasic EAE with spinal cord affected more severely than brain (Paterson et al., 1979). EAE models have significantly improved our knowledge about autoimmunity, neuroinflammation, biology of cytokine and immunogenetics (Waksman et al., 1999).

However there are some serious problems associated with the application of EAE model. Long term demyelination exposes axons to surrounding environment thus their viability is at stake. EAE is poor model to study remyelinations as lesions develop temporally and spatially in a random fashion. This situation is worsened by the fact that very little data is available for the damage of myelin in EAE mice model. Furthermore this model was found unsuitable for therapeutical application of neuronal and oligodendroglial growth and survival factors. Likewise administration of neurobiological compounds has so profound effects on the inflammatory system that interpretation of any treatment becomes impossible (Ransohoff et al., 2002).

## **6.2 Virus-induced demyelinating disease**

In mice CNS, viral infections can induce demyelination. The picornavirus Theiler's murine-encephalomyelitis virus (TMEV) and few strains of the coronavirus mouse hepatitis virus (MHV) are two representative examples.

### **6.2.1 Theiler's murine encephalomyelitis virus (TMEV)**

TMEV induces a biphasic neuronal disorder in mice (Lipton et al., 1975). In the first phase, which is acute in nature, virus induces an acute encephalomyelitis in 2 week time after introduction into the cerebrum. Virus continues to replicate in spinal cord grey matter neurons during this stage. In the next step they move leave grey matter to occupy white matter of the spinal cord (Brahic et al., 1981). Here they reside in macrophage, microglia and rarely in oligodendrocytes. Afterwards they stay there for the remaining life of their host animal (Clatch, 1990). This chronic infection is characterized by meningitis, inflammation in the white matter parenchyma and demyelination (Dal Canto et al., 1979). TMEV exerts neurological effects by inducing cytopathic damage in gray matter neurons during acute phase. This effect then shifts to white matter where T cells carry out CNS demyelination during chronic stage (Rodriguez et al., 1986; Miller et al., 1990). Studies using TMEV have provided information about the factors involved in the delayed, inducible autoimmunity in response to immune reaction against neurotrophic virus (Miller et al., 1997). Additionally TMEV induced demyelination provokes some new behavioral responses in murine CNS (Rivera-Quinones et al., 1998).

## 6.2.2 Mouse hepatitis virus (MHV)

JHM strain of hepatitis virus (JHMV) is injected intracranially into mouse model. These mice display severe oligodendrocyte destruction during acute phase. Virus inflicts damage both by direct action as well as indirectly through activation of inflammatory reaction (Wang et al., 1990). Local immune system is efficient enough to inhibit viral proliferation but unable to eradicate them completely as a result virus resides in the white matter permanently.

Presence of virus attracts activated T cells and macrophages towards the CNS white matter to induce demyelination. Remyelination does not start instantaneously after myelin loss as local conditions are unfavorable for this process. This property can be used to study the cases of limited oligodendrocyte and myelin recovery after of immune mediated demyelination (Wang et al., 1990; Bergmann et al., 2006).

## 6.3 Toxic models of demyelination and remyelination

Toxin application helps us to induce demyelination in a much more control way with reference to time and space in contrast to EAE model. Remyelination is the absolute requirement to restore neuronal functions and prevent disease progression. In this regards toxin induced models of demyelination are center of focus for translational research. There are two generally used toxic induced demyelination models;

### 6.3.1 Cuprizone mouse model

Cuprizone intoxication forces cell death in oligodendrocyte, vacuolization of myelin and demyelination in specified regions of brain like corpus callosum, anterior commissure and cerebellar peduncles (Komoly et al., 2005). However treatment does not interfere with the white matter of spinal cord or optic nerve. It can thus be proposed that different brain areas vary in their response to cuprizone treatment. Remyelination starts immediately after the arrest of cuprizone administration in and around demyelinated plaques (Matsushima et al., 2001). Interestingly proliferation of OPCs and their movement towards affected area begins when cuprizone is still being administered showing that both demyelination and regeneration of myelin coincide (Irvine et al., 2006). Demyelination in this model is associated with considerable infiltration in the region of lesion, microglial and astrocyte

activation but T lymphocytes do not come into play and BBB remain intact (Kondo et al., 1987)

Mice from a susceptible strain can be demyelinated by a copper chelator, cuprizone (oxalic acid bis (cyclohexylidene hydrazide)). These mice receive food consisting of 2% cuprizone for a period of 4-6 weeks. Cuprizone induces oligodendrocyte death by making mitochondrial complex IV non-functional (Matsushima et al., 2001). Continuous treatment for three weeks induces oligodendrocyte death in the region of corpus callosum and hippocampus (Skripuletz et al., 2011).

For the identification of factors associated with oligodendrocyte death this model can be a very useful tool (Liu et al., 2010). This model has helped in the exploration of mechanisms and factors linked to remyelination (Hussain et al., 2013). One obvious disadvantage associated with the use of this model is that changes surrounding the process of demyelination and remyelination are vibrant and interconnected. This complexity makes it difficult to accurately study the behavior of neural stem cells, oligodendrocyte progenitor cells and other moderators of remyelination (Liu et al., 2010). Cuprizone model can potentially be used to study demyelination in hippocampal region as well as for the characterization of mechanisms involved in the survival and degeneration of permanently demyelinated axons (Ransohoff, 2012).

### 6.3.2 Etidium bromide

This mouse model is developed by introduction of ethidium bromide or lysophosphatidylcholine into the white matter for induction of demyelination which is followed by remyelination. Although this model is not commonly used today but it has improved our understanding about the cellular and molecular mediators of remyelination (Blakemore et al., 1975; Foote et al., 2005). The positive point with the use of this system is that it allows us time and space controlled infliction of demyelination by direct administration of toxin (Miller et al., 2010) and facilitate study of OPCs mediated remyelination 4 weeks postinjection.

The apparent drawback of this system is that toxin severely induces axonal damage, breakage of BBB and mild traumatic lesion which permits the entry of immune cells at the site of infection (Dousset et al., 1995)



Taken together these two toxin mediated models offer great promise for the development of new approaches to promote remyelination (Ransohoff, 2012).

### 6.3.3 Lysolecithin (Lysophosphatidyl Choline)

Lysolecithin is a membrane dissolving chemical which can induce demyelination (Hall et al., 1972). Since then it has been applied in a variety of animals like mouse, rats, cats and rabbits to induce demyelination. Generally it is administered as 1% saline solution into the spinal cord of rat or mouse where it induces ellipsoid-shaped demyelination of variable size based on the needle opening and speed of injection. This treatment removes a vast majority of oligodendrocytes and myelin (Arnett et al., 2004). Besides oligodendrocytes there are few progenitor cells among survivors. Additionally astrocytes and axons are also damaged to some extent. Oligodendrocytes synthesize new myelin around most of the demyelinated axons but some axons in particular those occupying the centre of demyelinated injury are myelinated by Schwann cells. Contributions of Schwann cells increase with the area of demyelination. Age plays a vital role in remyelination as aged animals display slow regeneration of myelin (Shields et al., 1999). Incomplete remyelination occurs in rabbits even 6 months after the demyelination (Blakemore, 1978). This remyelination potential is variable for different brain regions for example in monkeys remyelination in spinal cord is faster than in optic nerve after lysolecithin induced lesion (Lachapelle et al., 2005).

## 6.4 Mutant mice

Several models of demyelination have been developed by mutation in the genes of PLP and MBP, two of the major myelin protein. Mutations in these genes are at the bases of several human and animal diseases. These mutant mice have increased our understanding about the functioning of various proteins and their importance for myelin.

## 6.4.1 MPB mutant mice

### 6.4.1.1 Shiverer mice

This mutant mouse lacks last 5 axons on MBP gene which are about 20Kb long (Molineaux et al., 1986). Mutant mice are unable to produce majority of MBPs with the exception of short 3 axon long MBP which is regulated by upstream promoter. Although oligodendrocytes population remains unchanged in homozygous mutant but myelin contents are reduced with anomalous ultra myelin structure. Clinically these mice manifest shivering behavior which gets worse with age. Heterozygous mice display 50% decrease in MBP contents but myelin structure remains intact. Moreover they are clinically normal (Privat et al., 1979; Nagara et al., 1983).

### 6.4.1.2 Myelin-deficient mutant mice (mld)

In *mld* mutation MBP gene gets duplicated first followed by inversion in copy located upstream as shown in Figure I-32 (Popko et al., 1988). Myelin-deficient mutant mice (*mld*) express hind limb tremor, infrequent seizures during adult hood with reduced fertility and life expectancy. This mutation is recessive and follows Mendelian laws of heredity. These mice show severe myelin deficiency in the CNS (Mikoshiha et al., 1987). The reminiscent myelin is thin and non-compacted due to the absence of MBP functions (Tosic et al., 1990).

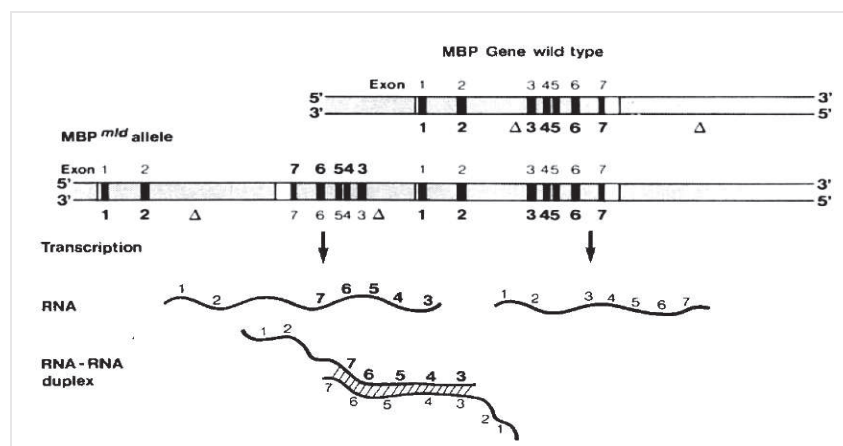

Figure I-32: Schematic description of mutation in *mld* mouse which contains an MBP allele mutant in comparison with wild type allele. The product of mutant allele form abnormal mRNA duplexes (Matthieu et al., 1992).

Figure I-32: Représentation schématique de la mutation *mld* chez la souris possédant un allèle mutant MBP. Le produit de l'allèle mutant forme des duplexes anormaux du mRNA (Matthieu et al., 1992).

In the *mld* mouse MBP is present in the form of traces which clearly demonstrate problem with MBP production (Ginalski-Winkelmann et al., 1983). This abnormally lower production is associated with lower levels of mRNA for MBP which is merely 2% of the normal mice (Okano et al., 1987). However transcribed mRNA is normal and translates properly into MBP *in vitro* conditions. Lower level of mRNA is not linked with mutation in promoter region (Okano et al., 1988). Heterozygous *mld* mice express intermediate levels of MBP mRNA suggesting that normal intact allele undergo normal transcription to synthesize MBP mRNA during development (Roch et al., 1987). The *mld* mutation belongs to a type of post transcriptional interference to gene expression by production of an antisense RNA. This antisense RNA binds with the sense RNA and inhibits its activities like processing and migration out of cytoplasm (Matthieu et al., 1992).

## 6.4.2 PLP mutations

Based on different PLP mutations various animal models were developed. Each of which represents a different mutation in PLP structure. These models include jimpy, rumpshaker mice, myelin deficient rats and shaking pups. PLP/DM20 mutations are at the base of a number of X-linked disorders ranging from severely affected PMD to moderately affected SPG2 (Garbern, 2002). Majority of PLP/DM20 mutations are entire gene duplications (60–70%), a handsome (15–20%) mutations involved either the modification or loss of a nucleotide and a few (1–2%) are associated with the loss of entire gene (Shy et al., 2003).

### 6.4.2.1 Shaking pups (Sh pup)

Sh pup is a canine demyelination model characterized by myelin scarcity with intact axonal structure and absence of inflammation and astrocytic activity. This phenotypes characterized by severe hypomyelination of CNS develops as a consequence of a point mutation in PLP gene which then interrupts maturation of oligodendrocytes (Nadon et al., 1990). These pups have significantly lower expression of PLP and MBP (Nadon and Duncan, 1996). A vast majority of axons are nonmyelinated and even myelinated fibers contain very thin myelin at all ages however axon diameter remains unaffected. Different brain regions vary in their

response to mutation as cerebral white matter and optic nerve show severe damage whereas spinal cord is less affected (Bray et al., 1983; Duncan et al., 1983). This system offers valuable advantage by simultaneously providing myelinated and hypomyelinated conditions in control and treated sh pups besides avoiding overlap with other pathologies like astrogliosis and inflammation.

#### 6.4.2.2 Jimpy mouse model

Jimpy is the first and so far the best established PLP mutation (Phillips et al., 1954). It is an X-linked mutation of recessive nature hence affected males display severe hypomyelination (Sidman et al., 1964; Privat et al., 1979). These mice (jp/Y) begin to show tremors 10 days postnatal particularly in hind limbs and trunk where it is more severe. These cubs have reduced body weight, less ultrasonic vocalizations and decreased coordination functions as compared to normal (Bolivar et al., 1994). The conditions become more severe after 3-4 weeks when mice express tonic seizures very frequently with hind limb paralysis and ultimately develop respiratory paralysis which forces their death around 25-30 days postnatal. Heterozygous (jp/+) females on the other hand show moderate effects with fractional myelin deficit which recovers in five months time and they have normal life span (Bartlett et al., 1986; Benjamins et al., 1986).

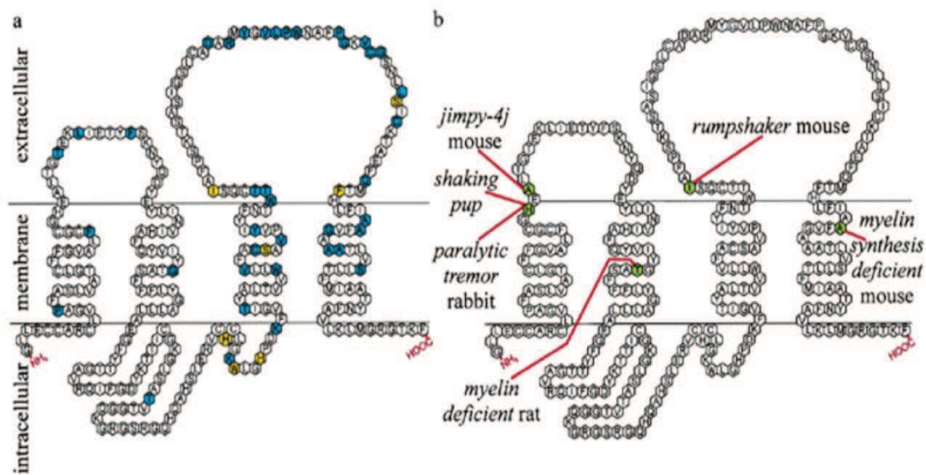

Figure I-33: Mutations in the coding region of PLP/DM20 gene at specified places are at the base of various animal models (Yool et al., 2000).

Figure I-33: Mutations dans le région codante du gène PLP/DM20 sont à la base de différents modèles animaux. (Yool et al., 2000).

Jimpy mice contain a point mutation in exon 5 of PLP gene which is induced by replacement of adenosine by guanine at splice acceptor site. This leads to abnormal mRNA synthesis and loss of exon 5 which after translation develops into shortened PLP and DM20 (Hudson et al., 1987). Biochemical analysis for CNS myelin contents of jimpy mice shows 90-98% loss (Hogan et al., 1984). No myelin was detected after histological evaluation at various ages (Sidman et al., 1964). There were few myelinated axons with reduced myelin thickness (Robain et al., 1974). Myelin deficit is moderate in heterozygous female with only 30-60% loss of myelin contents. This deficiency gives myelin a mosaic appearance in which small hypomyelinated areas can be observed (Skoff et al., 1981). Besides this huge myelin and oligodendrocyte loss significant astrogliosis and microgliosis can be observed in jimpy mice (Billings-Gagliardi et al., 1980)

#### **6.4.2.3 Myelin-deficient (md) rats**

The mouse model was widely used to understand the mechanisms of CNS myelination and functioning of glial cells since their first narration (Csiza and de Lahunta, 1979; Duncan et al., 1993). This model carries a point mutation which gives rise to an abnormal PLP and DM20 product after translation in which Thr 75 is replaced by Pro in the region of second trans-membrane (Boison and Stoffel, 1989).

Although they have some myelinated fibers but myelin in these structures is anomalous. This myelin is thin and lack intraperiod line (Duncan et al., 1987). The frequency of disease is higher in males because of its association with X chromosome. These rats have high frequency of full body tremors around postnatal day 12, by day 17 the situation becomes worse with the appearance of seizures which takes them to death in the fourth week of their age (Csiza and de Lahunta, 1979). It was observed that oligodendrocytes in these mice become apoptotic after maturity (Grinspan et al., 1998).

#### **6.4.2.4 The rumpshaker mice**

The *rumpshaker* (*Plp jp-rsh*) is a point mutation in PLP arises as a consequence of Isoleucine 186 substitution by threonine (Schneider et al., 1992). The rumpshaker (*Plpjp-rsh*) mutation has a variable effect on mice based on the genetic background of animal. In mice with C3H background moderate damage can be observed in the presence of mutation but no change in the duration of life. C57BL/6 mice on the other hand, have serious consequences of

rumpshaker mutation (Al-Saktawi et al., 2003). These mice display severe clinical disabilities in the form of tremors and seizures with short lifespan of 5 weeks. These mice not only suffer from myelin deficiency but also have higher population of astrocytes and increased number of microglia and macrophages. The link between demyelination and glial death is still unknown. Loss of function studies demonstrate that absence of PLP does not result in dysmyelination or death of glial cells (Klugmann et al., 1997).

### 6.4.3 Qkl mutation

Quaking (qk) or quaking viable (qkv) mutation of mouse is associated with dysmyelination (Sidman et al., 1964). This qk locus generates a number of proteins using the alternative splicing technique (Kondo et al., 1999). A number of RNA-binding proteins encoded by qk locus differ in their nuclear ribonucleoprotein K-type homology. Three proteins QKI-5, 6 and 7 demonstrated same 311-aa body but variable carboxyl tails. The level of QKI proteins diminishes in myelin forming cells in mutant mice (qkv) around postnatal day 14. Interestingly the extent of dysmyelination correlates with QKI-5 level (Hardy et al., 1996). Myelin associated genes MBP, PLP and MAG undergo alternative splicing in these mutant mice (Tropak et al., 1988). However, few incidents of anomalous splicing do occur in these qkv mice. Abnormal splicing of MAG protein disturbs the ratio of L-MAG to S-MAG causing dysmyelination in qkv (Fujita et al., 1990). It is quite possible that other myelin genes like MBP and PLP may also undergo such deleterious splicing but it has not reported in any of the studies that focused on MBP and PLP in qkv (Konat et al., 1987).

### 6.4.4 Twicher mouse model

The twicher mouse carries a mutation in *twi* allele and is a model of Krabbe disease or globoid cell leukodystrophy (GLD) which is characterized by absence of a lysosomal enzyme galactocerebrosidase (GALC). This deficiency results in piling up of galactosyl ceramide which leads to demyelination of axons both in CNS and PNS (Kobayashi et al., 1980; Suzuki et al., 1998). These mice live a normal life till day 20 after which they begin to show clinical signs like tremors and weakening of hind legs which leads to the death of mice in the age of 40 days postnatal (De Gasperi et al., 2004). This model is very useful to study human Krabbe disease and for the therapeutic investigations aiming at the rectification of galactocerebrosidase deficiency (Suzuki et al., 1995).

## 6.5 Genetic models of demyelination

Genetic tools have been used very smartly in the recent time to develop new models of demyelination and remyelination.

### 6.5.1 Diphtheria toxin induced demyelination

This model facilitates oligodendrocyte removal in adult mice by oligodendrocyte specific expression of DT-A (Diphtheria toxin-A). In this ROSA26-eGFP-DTA mouse model DT-A gene is introduced into the ROSA26 locus where it is located next to eGFP and Neo cassette genes. Additionally a powerful stop transcriptional sequence is inserted to inhibit the expression of DT-A (Ivanova et al., 2005). Administration of tamoxifen initiates PLP/CreERT evoked recombination to remove coding sequences of loxP-flanked eGFP-PGK-Neo-tpA from the ROSA26-eGFP-DTA allele. This modification allows the expression of DT-A gene which results in oligodendrocyte death and demyelination.

These mice contain only DT-A subunit and lack B subunit, so propagation of toxin to the neighboring cells is inhibited (Collier, 2001). This model eliminates the possibility of unrelated cell loss as DT-A is specifically expressed in oligodendrocytes. This specificity property is absent in viral and toxic induced demyelination models as well as EAE. Specific removal of oligodendrocytes makes it a good model to study their effects on the organization and rearrangement of myelin. It is an equally good model to study remyelination and OPCs response as newly formed OPCs do not express PLP/CreERT transgene so they are not harmed by tamoxifen administration. This model can be used for therapeutic assessments of new approaches directed towards demyelinating disorders mainly because of their properties of oligodendrocytes specific apoptosis and temporally controlled ablation (Traka et al., 2010; Pohl et al., 2012).

This model has been developed recently so, no information is available concerning the positive or negative aspects of this system (Miller et al., 2010). This model can be very attractive and valuable if demyelination could provoke an immune response by presenting myelin antigens (Ransohoff, 2012).

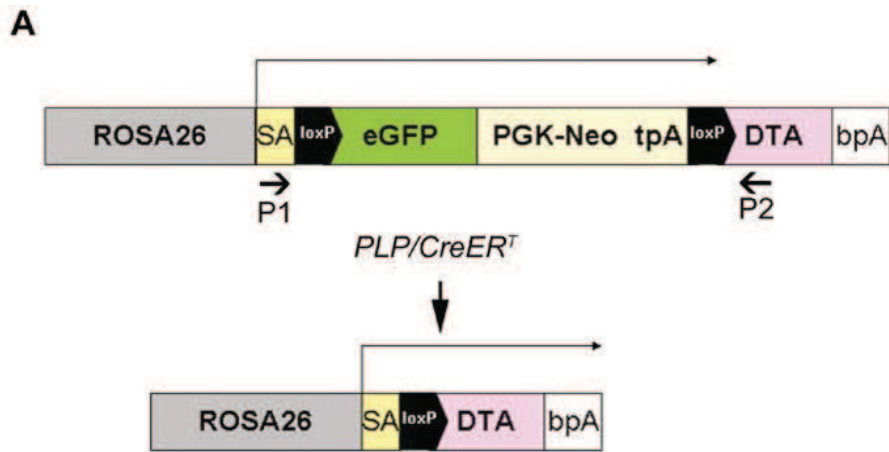

Figure I-34: Oligodendrocyte ablation is mediated through tamoxifen in *DTA* mice. (A) After injection tamoxifen removes loxP-flanked eGFP, PGK-Neo and tp A coding sequences from the *ROSA26-eGFP-DTA* allele facilitating the expression of DT-A in oligodendocyte (Traka et al., 2010).

Figure I-34: Ablation des oligodendrocytes à l'aide de tamoxifène chez les souris *DTA*. (A) Après l'injection du tamoxifène, loxP-flanked eGFP, PGK-Neo et tp A (séquences codantes de l'allèle *ROSA26-eGFP-DTA*) sont supprimées pour faciliter l'expression du DT-A dans les oligodendrocytes (Traka et al., 2010).

## 6.5.2 Knockout mice models

A variety of knock out animal models were developed to assess the functioning of various myelin protein. Mostly widely used proteins are PLP (Kagawa et al. 1994), MPB (Yoshizawa et al., 1998) and MOG (Delarasse et al., 2003). A number of studies showed that PLP gene duplication causes a rare demyelinating disorder Pelizaeus-Merzbacher disease (PMD) (Kagawa et al., 1994; Inoue et al., 1996). Construction of two null mouse i.e., PLP and DM20 showed that oligodendrocyte are not affected and they myelinate efficiently distinguishing between large and small axons. However these mice show gradual loss of axon. Moreover apparently normal myelin may lose compactness if tissue fixation conditions are not proper (Klugmann et al., 1997; Griffiths et al., 1998).



### 6.5.3 Conditional killing of oligodendrocytes expressing HSV1 thymidine kinase in transgenic mice

The Oligo-TTK is new mouse model which was developed to investigate the effect of oligodendrocyte loss on the development of brain (Jalabi et al., 2005). This mouse model allows the removal of oligodendrocyte during the postnatal development with the help of a synthetic drug Ganciclovir (GCV). This strategy is applied to induce death in proliferating oligodendrocytes during the first three to four postnatal weeks of life. This model is very flexible as it permits us to control the extent of oligodendrocyte loss. This model is very useful to study long term effects of oligodendrocyte ablation during postnatal life. These effects include motor coordination functions, axonal injury and recovery potential of oligodendrocyte as well as myelin. However this model finds no application for the assessment of oligodendrocyte loss during adult life. This model has been discussed in more details in the material and method section.

## **VI. Publications and presentations**

### **1. Publications**

-Shabbir A et al. The timing of oligodendrocyte ablation determines the potential of myelin recovery in developing brain (In preparation).

-Collongues N, Chanson JB, Blanc F, Steibel J, Lam CD, Shabbir A, Trifilieff E, Honnorat J, Pham-Dinh D, Ghandour MS, de Seze J. 2012. The Brown Norway opticospinal model of demyelination: Does it mimic multiple sclerosis or neuromyelitis optica? *Int J Dev Neurosci*; 30(6): 487-97.

### **2. Oral presentation**

-Shabbir A, Macklin WB and Ghandour S (2012). The timing of oligodendrocyte killing determines the potential of myelin repair in postnatal brain. Mini symposia presented in the 43rd annual meeting of society for neurosciences (SfN) held on 13-17 October 2012 in New Orleans, USA.

### **3. Poster presentation**

-Shabbir A, Mensah-Nyagan G and Ghandour S (2013). Plasticity of oligodendrocytes is defined within a critical time-window necessary for efficient myelin repair in postnatal brain.

7th International Meeting: Steroids and Nervous System, February 16-20, 2013, Torino, Italy

## VII. Literature Cited

- Abd-el-Basset E, Fedoroff S. Effect of bacterial wall lipopoly- saccharide (LPS) on morphology, motility, cytoskeletal organiza- tion of microglia in cultures. *J Neurosci Res* 1995; 41: 222-237.
- Aboul-Enein F, Weiser P, Höftberger R, Lassmann H, Bradl M. Transient axonal injury in the absence of demyelination: a correlate of clinical disease in acute experimental autoimmune encephalomyelitis. *Acta Neuropathol.* 2006 ;111:539-547.
- Achucarro N. Cellules allongees et Stabchenzellen, cellules nevrogliques et cellules granulo-adipeuses a` la corne d'Ammon du lapin. *Trab Lab Invest Biol* 1909; 7: 201-216.
- Adams TL. Olig1 and Olig2 promotes oligodendrocyte differentiation of neural stem cells in adult mice injured by EAE. *Adv Biosci Biotec* 2012; 03: 567-573.
- Aggarwal S, Yurlova L, Simons M. Central nervous system myelin: structure, synthesis and assembly. *Trends Cell Biol* 2011; 21: 585-593.
- Ajami B, Bennett JL, Krieger C, Tetzlaff W, Rossi FM. Local self-renewal can sustain CNS microglia maintenance and function throughout adult life. *Nat Neurosci* 2007; 10: 1538-1543.
- Aktas O, Smorodchenko A, Brocke S, Infante-Duarte C, Schulze Topphoff U, Vogt J, Prozorovski T, Meier S, Osmanova V, Pohl E, Bechmann I, Nitsch R, Zipp F. Neuronal damage in autoimmune neuroinflammation mediated by the death ligand TRAIL. *Neuron* 2005; 46: 421-432.
- Alexander's WS. Progressive fibrinoid degeneration of fibrillary astrocytes associated with mental retardation in a hydrocephalic infant. *Brain* 1949; 72: 373-381.
- Aloisi F. Immune Function of Microglia. *Glia* 2001; 36: 165-179.
- Al-Saktawi K, McLaughlin M, Klugmann M, Schneider A, Barrie JA, McCulloch MC, Montague P, Kirkham D, Nave K-A, Griffiths IR. Genetic background determines phenotypic severity of the Plp rumpshaker mutation. *J Neurosci Res* 2003; 72: 12-24.
- Amor S, Puentes F, Baker D, van der Valk P. Inflammation in neurodegenerative diseases. *Immunology* 2010; 129: 154-69.
- Andriezen WL. The neuroglia elements in the human brain. *Brit Med J* 1893a; 3: 227-230.
- Andriezen WL. On a system of Wbre-celles surrounding the blood-vessels of the brain of man and mammals and its physiological signiWcance. *Internat Monatsschr Anat Physiol* 1893b; 10: 532-540.
- Antel J, Arnold D. "Multiple sclerosis," in: *Neuroglia*, Oxford Univ. Publ., New York 2005.
- Anthony TE, Klein C, Fishell G, Heintz N. Radial glia serve as neuronal progenitors in all regions of the central nervous system. *Neuron* 2004; 41: 881-890.
- Arnett HA, Fancy SP, Alberta JA, Zhao C, Plant SR, Kaing S, Raine CS, Rowitch DH, Franklin RJ, Stiles CD. Bhlh transcription factor olig1 is required to repair demyelinated lesions in the CNS. *Science* 2004; 306: 2111-2115.
- Arnett HA, Wang Y, Matsushima GK, Suzuki K, Ting JP. Functional genomic analysis of remyelination reveals importance of inflammation in oligodendrocyte regeneration. *J Neurosci* 2003; 23: 9824-9832.
- Artavanis-Tsakonas S, Matsuno K, Fortini ME. Notch signaling. *Science* 1995; 268: 225-232.
- Aruga J, Okano H, Mikoshiba K. Identification of the new isoforms of mouse myelin basic protein: the existence of exon 5a. *J Neurochem* 1991; 56:1222-1226.

- Austin JH. Studies in globoid (Krabbe's) leukodystrophy. II. Controlled thin layer chromatographic studies of globoid fractions in seven patients. *J Neurochem* 1963; 10: 921-930.
- Awasaki T, Tatsumi R, Takahashi K, Arai K, Nakanishi Y, Ueda R, Ito K. Essential role of the apoptotic cell engulfment genes draper and ced-6 in programmed axon pruning during *Drosophila* metamorphosis. *Neuron* 2006; 50: 855-867.
- Back SA, Tuohy TM, Chen H, Wallingford N, Craig A, Struve J, Luo NL, Banine F, Liu Y, Chang A, Trapp BD, Bebo BF, Jr. Rao MS, Sherman LS. Hyaluronan accumulates in demyelinated lesions and inhibits oligodendrocyte progenitor maturation. *Nat Med* 2005; 11: 966-972.
- Bakiri Y, Káradóttir R, Cossell L, Attwell D. Morphological and electrical properties of oligodendrocytes in the white matter of the corpus callosum and cerebellum. *The Journal of physiology* 2011; 589: 559-573.
- Bannerman P, Hahn A, Soulika A, Gallo V, Pleasure D. Astrogliosis in EAE spinal cord: derivation from radial glia, and relationships to oligodendroglia. *Glia* 2007; 55: 57-64.
- Bansal R, Kumar M, Murrat K, Morrison RS, Pfeiffer SE. Regulation of FGF receptors in the oligodendrocyte lineage. *Mol Cell Neurosci* 1996; 7: 263-275.
- Barnes D, Munro PMG, Youl BD, Prineas JW, McDonald WI. The longstanding MS lesion. *Brain* 1991; 114: 1271-1280.
- Baron W, Decker L, Colognato H, French-Constant C. Regulation of integrin growth factor interactions in oligodendrocytes by lipid raft microdomains. *Curr Biol* 2003; 13(2): 151-155
- Barres BA, Hart IK, Coles HSR, Burne JF, Voyvodic JT, Richardson WD, Raff MC. Cell death and control of cell survival in the oligodendrocyte lineage. *Cell* 1992; 70: 31-46.
- Barres BA, Schmid R, Sendter M, Raff MC. Multiple extracellular signals are required for long-term oligodendrocyte survival. *Development* 1993; 118: 283-295.
- Barres BA, Raff MC. Control of oligodendrocyte number in the developing rat optic nerve. *Neuron* 1994; 12: 935-942.
- Barres BA, Raff MC. Axonal control of oligodendrocyte development. *J Cell Biol* 1999; 147: 1123-1128.
- Bartlett WP, Skoff RP. Expression of the jimpy gene in the spinal cords of heterozygous female mice: I. An early deficit followed by compensation *J Neurosci* 1986; 6: 2802-2812.
- Bartlett WP, Li X, Williams M. Expression of IGF1 mRNA in the murine subventricular zone during postnatal development. *Mol Brain Res* 1992; 12: 285-291.
- Bartsch U, Faissner A, Trotter J, Dörries U, Bartsch S, Mohajeri H, Schachner M. Tenascin demarcates the boundary between the myelinated and non-myelinated part of the retinal ganglion cell axons in the developing and adult mouse. *J Neurosci* 1994; 14: 4756-4768.
- Baulieu EE, Robel P, Schumacher M. Neurosteroids: beginning of the story. *Int Rev Neurobiol* 2001; 46: 1-32.
- Baumann N, Pham-Dinh D. Biology of oligodendrocyte and myelin in the mammalian central nervous system. *Physiological reviews* 2001; 81: 871-927
- Bebo BF, Jr, Schuster JC, Vandenbark AA, Offner H. Androgens alter the cytokine profile and reduce encephalitogenicity of myelin-reactive T cells. *Journal of Immunology* 1999; 162: 35-40.
- Beltinger C, Fulda S, Kammertoens T, Meyer E, Uckert W, Debatin KM. Herpes simplex virus thymidine kinase/ganciclovir-induced apoptosis involves ligand-independent death receptor aggregation and activation of caspases. *Proc Natl Acad Sci USA* 1999; 96: 8699-8704.
- Benjamins JA, Studzinski DM, Skoff RP. Biochemical correlates of myelination in brain and spinal cord of mice heterozygous for the jimpy gene. *J Neurochem* 1986; 47: 1857-1863.

- Berger T, Frotscher M. Distribution and morphological characteristics of oligodendrocytes in the rat hippocampus in situ and in vitro: an immunocytochemical study with the monoclonal Rip antibody. *J Neurocytol* 1994; 23: 61-74.
- Bergmann CC, Lane TE, Stohlman SA. Coronavirus infection of the central nervous system: Host-virus stand-off. *Nat Rev Microbiol* 2006; 4: 121-132.
- Bernard CCC, de Rosbo NK. Multiple sclerosis: an autoimmune disease of multifactorial etiology." *Curr Opin Immunol* 1992; 4: 760-765.
- Biber K, Neumann H, Inoue K, Boddeke HW. Neuronal "On" and "Off" signals control microglia. *Trends Neurosci* 2007; 30: 596-602.
- Bernard F, Moreau-Fauvarque C, Heitz-Marchaland C, Zagar Y, Dumas L, Fouquet S, Lee X, Shao Z, Mi S, Chédotal A. Role of transmembrane semaphorin Sema6A in oligodendrocyte differentiation and myelination. *Glia* 2012; 60: 1590-1604
- Bidder FH, Kupfer C. "Untersuchungen über die Textur des Rückenmarks und die Entwicklung seiner Formelemente." Breitkopf and Hartel, Leipzig 1857; 121.
- Bieber AJ, Warrington A, Asakura K, Ciric B, Kaveri SV, Pease LR, Rodriguez M. Human antibodies accelerate the rate of remyelination following lyssolecithin-induced demyelination in mice. *Glia* 2002; 37:241-249.
- Bielschowski M, Henneberg R. Über familiäre diffuse sklerose (leukodystrophia cerebri progressiva hereditaria). *J Psychol Neurol* 1928; 36: 131-81.
- Bignami A, Eng LF, Dahl D, Uyeda CT. Localization of the glial fibrillary acidic protein in astrocytes by immunofluorescence. *Brain Res* 1972; 43: 429-435.
- Billings-Gagliardi S, Adcock LH, Wolf MK. Hypomyelinated mutant mice: description of *jp<sup>msd</sup>* and comparison with *jp* and *qk* on their present genetic backgrounds. *Brain Res* 1980; 194: 325-338.
- Bjartmar C, Yin X, Trapp BD. Axonal pathology in myelin disorders. *J Neurocytol* 1999; 28: 383-395.
- Bjartmar C, Kidd G, Mörk S, Rudick R, Trapp BD. Neurological disability correlates with spinal cord axonal loss and reduced N-acetyl aspartate in chronic multiple sclerosis patients. *Ann Neurol* 2000; 48(6): 893-901.
- Bjartmar C, Wujek JR, Trapp BD. Axonal loss in the pathology of MS: consequences for understanding the progressive phase of the disease. *J Neurol Sci.* 2003 Feb 15;206(2):165-171.
- Blakemore WF, Eames RA, Smith KJ, McDonald WI. Remyelination in the spinal cord of the cat following intraspinal injections of lyssolecithin. *J Neurol Sci* 1977; 33: 31-43.
- Blakemore WF. Observations on remyelination in the rabbit spinal cord following demyelination induced by lyssolecithin. *Neuropathol Appl Neurobiol* 1978; 4: 47-59.
- Block ML, Zecca L, Hong JS. Microglia-mediated neurotoxicity: uncovering the molecular mechanisms. *Nat Rev Neurosci* 2007; 8: 57-69.
- Bogler O, Wren D, Barnett SC, Land H, Noble M. Cooperation between two growth factors promotes extended self-renewal and inhibits differentiation of oligodendrocyte-type-2 astrocyte (O-2A) progenitor cells. *Proc Natl Acad Sci USA* 1990; 87: 6368-6372
- Boison D, Stoffel W. Myelin-deficient rat: a point mutation in exon III (A = C, Thr75 = Pro) of the myelin proteolipid protein causes dysmyelination and oligodendrocyte death. *EMBO* 1989; 8: 3295-3302.
- Bolivar VJ, Brown RE. The ontogeny of ultrasonic vocalizations and other behaviors in male jimpy (*jp/Y*) mice and their normal male littermates. *Dev Psychobiol* 1994; 27: 101-110.
- Boya J, Calvo JL, Carbonell AL, Borregon A. A lectin histo-chemistry study on the development of rat microglial cells. *J Anat* 1991; 175: 229-236.

- Brahic M, Stroop WG, Baringer JR. Theiler's virus persists in glial cells during demyelinating disease. *Cell* 1981; 26: 123-128.
- Braun PE, Lee J, Gravel M. 2',3'-cyclic nucleotide 3'-phosphodiesterase: Structure, biology and function. In R. A. Lazzarini (ed.), *Myelin biology and disorders*. San Diego, CA: Elsevier Academic Press 2004; 499-522.
- Bray GM, Duncan ID, Griffiths IR. 'Shaking pups': a disorder of central myelination in the spaniel dog. IV. Freeze-fracture electron microscopic studies of axons, oligodendrocytes and astrocytes in the spinal cord white matter. *Neuropathol Appl Neurobiol* 1983; 9: 369-378.
- Bribian A, Barallobre MJ, Soussi-Yanicostas N, De Castro F. Anosmin-1 modulates the FGF-2-dependent migration of oligodendrocyte precursors in the developing optic nerve. *Molecular and cellular neurosciences* 2006; 33: 2-14.
- Bribian A, Fontana X, Llorens F, Gavín R, Reina M, García-Verdugo JM, Torres JM, De Castro F, Del Río JA. Role of the cellular prion protein in oligodendrocyte precursor cell proliferation and differentiation in the developing and adult mouse CNS. *PloS one* 2012; 7: e33872.
- Brockmann K, Brockmann K, Dechent P, et al. Proton MRS profile of cerebral metabolic abnormalities in Krabbe disease. *Neurology* 2003; 60: 819-825.
- Brooks, SP, and Dunnett, SB. Tests to assess motor phenotype in mice: a user's guide. *Nat Rev Neurosci* 2009; 10: 519-529.
- Brown AM, Ransom BR. Astrocyte glycogen and brain energy metabolism. *Glia* 2007; 55: 1263-1271.
- Bryant MR, Marta CB, Kim FS, Bansal R. Phosphorylation and lipid raft association of fibroblast growth factor receptor-2 in oligodendrocytes. *Glia* 2009; 57(9): 935-946
- Buchet D, Baron-Van Evercooren A. In search of human oligodendroglia for myelin repair. *Neuroscience letters* 2009; 456:112-119
- Buddeberg BS, Kerschensteiner M, Merkler D, Stadelmann C, Schwab ME. Behavioral testing strategies in a localized animal model of multiple sclerosis. *J Neuroimmunol* 2004; 153(1-2): 158-170.
- Bunge MB, Bunge RP, Ris H. Ultrastructural study of remyelination in an experimental lesion in adult cat spinal cord. *J Biophys Biochem Cytol* 1961; 10: 67-94.
- Bunge RP. Glial cells and the central myelin sheath. *Physiol Rev* 1968; 48: 197-210.
- Bush TG, Puvanachandra N, Horner CH, Polito A, Ostensfeld T, Svendsen CN, Mucke L, Johnson MH, Sofroniew MV. Leukocyte infiltration, neuronal degeneration, and neurite outgrowth after ablation of scar-forming, reactive astrocytes in adult transgenic mice. *Neuron* 1999; 23: 297-308.
- Bushong EA, Martone ME, Jones YZ, Ellisman MH. Protoplasmic astrocytes in CA1 stratum radiatum occupy separate anatomical domains. *J Neurosci* 2002; 22: 183-192.
- Butt AM, Dinsdale J. Fibroblast growth factor 2 induces loss of adult oligodendrocytes and myelin in vivo. *Experimental neurology* 2005; 192: 125-133
- Butt AM, Ibrahim M, Ruge FM, Berry M. Biochemical subtype of oligodendrocyte in the anterior medullary velum of the rat as revealed by the monoclonal antibody Rip. *Glia* 1995; 14: 185-97.
- Cajal RY. Contribucion al conocimiento de la meuroglia del cerebro humano. *Trab Lab Invest Biol* 1913; 11: 254.
- Cajal Ry. El proceder del oro sublimado para la coloración de la neuroglia. *Trab Lab Invest Biol* 1916; 14: 155-162.
- Cajal Ry. Formula de Wjacion para la demostracion facil del aparato de Golgi y apuntes sobre la disposicion de dicho aparato en la retina, en los nervios y algunos estados patologicos. *Trab Lab Invest Biol* 1912; 10: 209-220.

Cajal, Ry. Una modificación del método de Bielschowsky para la impregnación de la neuroglia común y mesoglia y algunos consejos acerca de la técnica del oro-sublimado. *Trab Lab Invest Biol* 1920b; 18: 129-141.

Calver AR, Hall AC, Yu WP, Walsh FS, Heath JK, Betsholtz C, Richardson WD. Oligodendrocyte population dynamics and the role of PDGF in vivo. *Neuron* 1998; 20: 869–882.

Cameron-Curry P, Le Douarin N. Oligodendrocyte precursors originate from both the dorsal and the ventral parts of the spinal cord. *Neuron* 1995; 15: 1299-1310.

Campagnoni AT, Skoff RP. The pathobiology of myelin mutants reveal novel biological functions of the MBP and PLP genes. *Brain Pathol* 2001; 11: 74-91.

Campagnoni AT, Campagnoni CW. Myelin basic protein gene. In R. A. Lazzarini (ed.), *Myelin biology and disorders*. San Diego, CA: Elsevier Academic Press 2004; 387-400.

Canoll PD, Musacchio JM, Hardy R, Reynolds R, Marchionni MA, Salzer JL. GGF/neuregulin is a neuronal signal that promotes the proliferation and survival and inhibits the differentiation of oligodendrocyte progenitors. *Neuron* 1996; 17: 229-243.

Canoll PD, Kraemer R, Teng KK, Marchionni MA, Salzer JL. GGF/neuregulin induces a phenotypic reversion of oligodendrocytes. *Mol Cell Neurosci* 1999; 13: 79-94.

Caroni P, Schwab ME. Two membrane protein fractions from rat central myelin with inhibitory properties for neurite growth and fibroblast spreading. *J Cell Biol* 1988; 106: 1281–1288.

Carpentier PA, Begolka WS, Olson JK, Elhofy A, Karpus WJ, Miller SD. Differential activation of astrocytes by innate and adaptive immune stimuli. *Glia* 2005; 49: 360–374.

Carson MJ, Behringer RR, Brinster RL, McMorris FA. Insulinlike growth factor 1 increases brain growth and central nervous system myelination in transgenic mice. *Neuron* 1993; 10: 729-740.

Cerghet M, Skoff RP, Bessert D, Zhang Z, Mullins C, Ghandour MS. Proliferation and death of oligodendrocytes and myelin proteins are differentially regulated in male and female rodents. *J Neurosci* 2006; 26: 1439-1447.

Chamak B, Morandi V, Mallat M. Brain macrophages stimulate neurite growth and regeneration by secreting thrombospondin. *J Neurosci Res* 1994; 38: 221-33.

Chan WY, Kohsaka S, Rezaie P. The origin and cell lineage of microglia: new concepts. *Brain Res Rev* 2007; 53: 344-354.

Chandran S, Hunt D, Joannides A, Zhao C, Compston A, Franklin RJ. Myelin repair: the role of stem and precursor cells in multiple sclerosis. *Philos Trans R Soc Lond B Biol Sci* 2008; 363: 171-183.

Chandran S. What are the prospects of stem cell therapy for neurology? *BMJ* 2008; 337:a1934.

Charcot M. Histologie de la sclérose en plaques. *Gaz Hosp* 1868 ; 141: 554-5,-557-8.

Chari DM, Blakemore WF. Efficient recolonisation of progenitor-depleted areas of the CNS by adult oligodendrocyte progenitor cells. *Glia* 2002; 37:307–313.

Chen L, Yang P, Kijlstra A. Distribution, markers, and functions of retinal microglia. *Ocul Immunol Inflamm* 2002; 10: 27-39.

Chen Y, Tang X, Cao X, Chen H, Zhang X. Human Nogo-C over-expression induces HEK293 cell apoptosis via a mechanism that involves JNK-c-Jun pathway. *Biochem Biophys Res Commun* 2006; 348(3): 923-928

Chernausk SD. Insulin-like growth factor-I (IGF-I) production by astroglial cells: regulation and importance for epidermal growth factor-induced cell replication. *J Neurosci Res* 1993; 34: 189–197.

- Cho YK, Kim G, Park S, Sim JH, Won YJ, Hwang CH, Yoo JY, Hong HN. Erythropoietin promotes oligodendrogenesis and myelin repair following lysolecithin-induced injury in spinal cord slice culture. *Biochemical and biophysical research communications* 2012; 417: 753-759
- Chu K, Kim M, Chae SH, Jeong SW, Kang KS, Jung KH, Kim J, Kim YJ, Kang L, Kim SU, Yoon BW. Distribution and in situ proliferation patterns of intravenously injected immortalized human neural stem-like cells in rats with focal cerebral ischemia. *Neurosci Res* 2004; 50: 459-465.
- Clatch RJ, Miller SD, Metzner R, Dal Canto MC, Lipton HL. Monocytes/macrophages isolated from the mouse central nervous system contain infectious Theiler's murine encephalomyelitis virus (TMEV). *Virology* 1990; 176: 244-254.
- Collier RJ. Understanding the mode of action of diphtheria toxin: a perspective on progress during the 20th century. *Toxicon* 2001; 39: 1793-803.
- Craveiro LM, Hakkoum D, Weinmann O, Montani L, Stoppini L, Schwab ME. Neutralization of the membrane protein Nogo-A enhances growth and reactive sprouting in established organotypic hippocampal slice cultures. *Eur J Neurosci* 2008; 28: 1808-1824
- Crawford DK, Mangiardi M, Xia X, López-Valdés HE, Tiwari-Woodruff SK. Functional recovery of callosal axons following demyelination: a critical window. *Neuroscience* 2009; 164:1407-1421.
- Csiza CK, de Luhunta A. Myelin deficiency (md): A neurological mutant in the Wistar rat. *Am J Pathol* 1979; 95: 215-224.
- Dal Canto MC, Lipton HL. Recurrent demyelination in chronic central nervous system infection produced by Theiler's murine encephalomyelitis virus. *J Neurol Sci* 1979; 42: 391-405.
- Davalos D, Grutzendler J, Yang G, Kim JV, Zuo Y, Jung S, Littman DR, Dustin ML, Gan WB. ATP mediates rapid microglial response to local brain injury in vivo. *Nat Neurosci* 2005; 8: 752-758.
- Davies JE, Miller RH. Local sonic hedgehog signaling regulates oligodendrocyte precursor appearance in multiple ventricular zone domains in the chick metencephalon. *Developmental biology* 2001; 233: 513-525
- Davoust N, Vauillat C, Androdias G, Nataf S. From bone marrow to microglia: barriers and avenues. *Trends Immunol* 2008; 29: 227-234.
- De Biase LM, Nishiyama A, Bergles DE. Excitability and synaptic communication within the oligodendrocyte lineage. *J Neurosci* 30: 3600-3611.
- de Castro F, Bribián A. The molecular orchestra of the migration of oligodendrocyte precursors during development. *Brain Res Brain Res Rev* 2005; 49: 227-241.
- De Gasperi R, Friedrich VL, Perez GM, Senturk E, Wen PH, Kelley K, Elder GA, Gama Sosa MA. Transgenic rescue of Krabbe disease in the twitcher mouse. *Gene Ther* 2004; 11: 1188-1194.
- De Haas AH, Boddeke HW, Biber K. Region-specific expression of immunoregulatory proteins on microglia in the healthy CNS. *Glia* 2008; 56: 888-894
- Decker L, Avellana-Adalid V, Nait-Oumesmar B, Durbec P, Baron-Van Evercooren a. Oligodendrocyte precursor migration and differentiation: combined effects of PSA residues, growth factors, and substrates. *Molecular and cellular neurosciences* 2000; 16: 422-439
- Deiters OFK. "Untersuchungen über Gehirn und Rückenmark des Menschen und der Säugethiere"(M. Schultze, ed.). Vieweg, Braunschweig 1865; pp. 318.
- Delarasse C, Daubas P, Mars LT, Vizler C, Litzenburger T, Iglesias A, Bauer J, Gaspera B Della, Schubart A, Decker L, Dimitri D, Roussel G, Dierich A, Amor S, Dautigny A, Liblau R, Pham-dinh D. Myelin/oligodendrocyte glycoprotein – deficient (MOG-deficient) mice reveal lack of immune tolerance to MOG in wild-type mice. 2003; 112: 544-553.
- Deneen B, Ho R, Lukaszewicz A, Hochstim CJ, Gronostajski RM, Anderson DJ. The transcription factor NFIA controls the onset of gliogenesis in the developing spinal cord. *Neuron* 2006; 52: 953-968.



- Deng W, Pleasure J, Pleasure D. Progress in periventricular leukomalacia. *Arch Neurol* 2008; 65: 1291-5.
- Dickinson PJ, Fanarraga ML, Griffiths IR, Barrie JM, Kyriakides E, Montague P. Oligodendrocyte progenitors in the embryonic spinal cord express DM-20. *Neuropathol Appl Neurobiol* 1996; 22: 188-198.
- Dimphna H, Meijer, Michael F, Kane, Mehta S, Liu H, Harrington E, Christopher M. Taylor, Charles D. Stiles & David H. Rowitch. Separated at birth? The functional and molecular divergence of OLIG1 and OLIG2. *Nature Reviews Neuroscience* 2012; 13: 819-831.
- Doetsch F, Garcia-Verdugo JM, Alvarez-Buylla A. Cellular composition and three-dimensional organization of the subventricular germinal zone in the adult mammalian brain. *J Neurosci* 1997; 17: 5046-5061.
- Dong Y, Benveniste EN. Immune function of astrocytes. *Glia* 2001; 36: 180-190.
- Dousset V, Brochet B, Vital A, Gross C, Benazzouz A, Boullerne A, Bidabe AM, Gin AM, Caille JM. Lysolecithin-induced demyelination in primates: preliminary in vivo study with MR and magnetization transfer. *AJNR Am J Neuroradiol* 1995; 16: 225-231.
- Dreyfus CF, Dai X, Lercher LD, Racey BR, Friedman WJ, Black IB. Expression of neurotrophins in the adult spinal cord in vivo. *J Neurosci Res* 1999; 56: 1-7.
- Dugas JC, Ibrahim A, Barres BA. A crucial role for p57(Kip2) in the intracellular timer that controls oligodendrocyte differentiation. *J Neurosci* 2007; 27: 6185-6196.
- Duncan ID, Griffiths IR, Munz M. 'Shaking pups': a disorder of central myelination in the spaniel dog. III. Quantitative aspects of glia and myelin in the spinal cord and optic nerve. *Neuropathol. Appl Neurobiol* 1983; 9: 355-368.
- Duncan ID, Hammang JP, Trapp BD. Abnormal compact myelin in the myelin-deficient rat: absence of proteolipid protein correlates with a defect in the intraperiod line. *Proc Natl Acad Sci USA* 1987; 84:6287-6291.
- Duncan ID, Jackson KF, Hammang JP, Marren D, Hoffman R. Development of myelin mosaicism in the optic nerve of heterozygotes of the X-linked myelin-deficient (md) rat mutant. *Dev Biol* 1993; 157: 334-347.
- Dupree JL, Mason JL, Marcus JR, Stull M, Levinson R, Matsushima GK, Popko B. Oligodendrocytes assist in the maintenance of sodium channel clusters independent of the myelin sheath. *Neuron Glia Biol* 2004; 1:179-92.
- Eichberg J, Iyer S. Minireview: Phosphorylation of myelin proteins: Recent Advances. *Neurochem Res* 1996; 21: 527-535.
- Einstein O, Karussis D, Grigoriadis N, Mizrachi-Kol R, Reinhartz E, Abramsky O, Ben-Hur T. Intraventricular transplantation of neural precursor cell spheres attenuates acute experimental allergic encephalomyelitis. *Mol Cell Neurosci* 2003; 24: 1074-1082.
- Emery B, Agalliu D, Cahoy JD, Watkins TA, Dugas JC, Mulinyawe SB, Ibrahim A, Ligon KL, Rowitch DH, Barres BA. Myelin gene regulatory factor is a critical transcriptional regulator required for CNS myelination. *Cell* 2009; 138: 172-185.
- Eng LF, Reier PJ, Houle JD. Astrocyte activation and fibrous gliosis: glial fibrillary acidic protein immunostaining of astrocytes following intraspinal cord grafting of fetal CNS tissue. *Prog Brain Res* 1987; 71: 439-455.
- Ernfors P, Lonnerberg P, Ayer-Lelievre C, Persson P. Developmental and regional expression of basic fibroblast growth factor mRNA in the rat central nervous system. *J Neurosci Res* 1990; 27: 10-15.
- Eskes C, Juillerat-Jeanneret L, Leuba G, Honegger P, Monnet-Tschudi F. Involvement of microglia-neuron interactions in the tumor necrosis factor-alpha release, microglial activation, and neurodegeneration induced by trimethyltin. *J Neurosci Res* 2003; 71: 583-590.
- Fanarraga ML, Griffiths IR, Zhao M, Duncan ID. Oligodendrocytes are not inherently programmed to myelinate a specific size of axon. *J Comp Neurol* 1998; 399: 94-100.

- Farina C, Aloisi F, Meinl E. Astrocytes are active players in cerebral innate immunity. *Trends Immunol* 2007; 28: 138–145.
- Farrer RG, Quarles RH. GT3 and its O-acetylated derivative are the principal A2B5-reactive gangliosides in cultured O2A lineage cells and are down-regulated along with O-acetyl GD3 during differentiation to oligodendrocytes. *J Neurosci Res* 1999; 57: 371-380.
- Ferguson B, Matyszak MK, Esiri MM, Perry VH. Axonal damage in acute multiple sclerosis lesions. *Brain* 1997; 120: 393–399.
- Ferrer I, Bernet E, Soriano E, Del Rio T, Fonseca M. Naturally occurring cell death in the cerebral cortex of the rat and removal of dead cells by transitory phagocytes. *Neuroscience* 1990; 39: 451-458.
- Ffrench-Constant C, Miller RH, Burne JF, Raff MC. Evidence that migratory oligodendrocyte-type-2 astrocyte (O-2A) progenitor cells are kept out of the rat retina by a barrier at the eye-end of the optic nerve. *J Neurocytol* 1988; 17: 13-25.
- Finzsch M, Stolt CC, Lommes P, Wegner M. Sox9 and Sox10 influence survival and migration of oligodendrocyte precursors in the spinal cord by regulating PDGF receptor alpha expression. *Development* 2008; 135: 637-646.
- Fogarty M, William D, Richardson, Kessaris N. A subset of oligodendrocytes generated from radial glia in the dorsal spinal cord. *Development* 2005; 132: 1951-1959.
- Foote AK, Blakemore WF. Inflammation stimulates remyelination in areas of chronic demyelination. *Brain* 2005; 128: 528-539.
- Franco PG, Silvestroff L, Soto EF, Pasquini JM. Thyroid hormones promote differentiation of oligodendrocyte progenitor cells and improve remyelination after cuprizone-induced demyelination. *Exp Neurol* 2008; 212: 458-467.
- Frank JA, Richert N, Lewis B, Bash C, Howard T, Civil R, Stone R, Eaton J, McFarland H, Leist T. A pilot study of recombinant insulin-like growth factor-1 in seven multiple sclerosis patients. *Mult Scler* 2002; 8: 24-29.
- Franklin RJ, Gilson JM, Blakemore WF. Local recruitment of remyelinating cells in the repair of demyelination in the central nervous system. *J Neurosci Res* 1997; 50: 337–344
- Franklin RJ. Why does remyelination fail in multiple sclerosis? *Nat Rev Neurosci* 2002; 3: 705-714.
- Fredman P, Magnani JL, Nirenberg M, Ginsburg V. Monoclonal antibody A2B5 reacts with many gangliosides in neuronal tissue. *Arch Biochem Biophys* 1984; 233: 661-666.
- Freeman MR. Specification and morphogenesis of astrocytes. *Science* 2010; 330: 774–778.
- Friedman B, Hockfield S, Black J, Woodruff KA, Waxman SG. In situ demonstration of mature oligodendrocytes and their processes: an immunocytochemical study with a new monoclonal antibody. *Glia* 1989; 2: 380-390.
- Frost E, Kiernan BW, Faissner A, Ffrench-Constant C. Regulation of oligodendrocyte precursor migration by extracellular matrix: evidence for substrate-specific inhibition of migration by tenascin-C. *Dev Neurosci* 1996; 18: 266-273.
- Frost EE, Armstrong RC. Initiation of oligodendrocyte progenitor cell migration by a PDGF-A activated extracellular regulated kinase (ERK) signaling pathway. 2009; 34: 169-181.
- Fruttiger M, Karlsson L, Hall AC, Abramsson A, Calver AR, Bostrom H, Willetts K, Bertold CH, Heath JK, Betsholtz C, Richardson WD. Defective oligodendrocyte development and severe hypomyelination in PDGF-A knock-out mice. *Development* 1999; 126: 457-467.
- Fu L, Matthews PM, De Stefano N, Worsley KJ, Narayanan S, Francis GS, Antel JP, Wolfson C, Arnold DL. Imaging axonal damage of normal-appearing white matter in multiple sclerosis. *Brain* 1998; 121: 103–113.

- Fujita N, Sato S, Ishiguro H, Inuzuka T, Baba H, Kurihara T, Takahashi Y, Miyatake T. J. The large isoform of myelin-associated glycoprotein is scarcely expressed in the quaking mouse brain. *Neurochem* 1990; 55: 1056-1059.
- Fuss B, Mallon B, Phan T, Ohlemeyer C, Kirchhoff F, Nishiyama A, Macklin WB. Purification, analysis of in vivo-differentiated oligodendrocytes expressing the green fluorescent protein. *Dev Biol* 2000; 218: 259-274.
- Gallo V, Armstrong RC. Developmental and growth factor-induced regulation of nestin in oligodendrocyte lineage cells. *J Neurosci* 1995; 15: 394-406.
- Gao FB, Apperly J, Raff M. Cell-intrinsic timers and thyroid hormone regulate the probability of cell-cycle withdrawal and differentiation of oligodendrocyte precursor cells. *Dev Biol* 1998; 197: 54-66.
- Garbern JY, Yool DA, Moore GJ, Wilds IB, Faulk MW, Klugmann M, Nave KA, Siermans EA, van der Knaap MS, Bird TD, Shy ME, Kamholz JA, Griffiths IR. Patients lacking the major CNS myelin protein, proteolipid protein 1, develop length-dependent axonal degeneration in the absence of demyelination and inflammation. *Brain* 2002; 125: 551-561.
- Garbern JY. Pelizaeus-Merzbacher disease: Genetic and cellular pathogenesis. *Cell Mol Life Sci* 2007; 64: 50-65.
- Garden GC, Moller T. Microglia biology in health and disease. *J Neuroimmune Pharmacol* 2006; 1: 127-37.
- Gardner J, Ghorpade A. Tissue inhibitor of metalloproteinase (TIMP)-1: the TIMPed balance of matrix metalloproteinases in the central nervous system. *J Neurosci Res* 2003; 74: 801-806.
- Gehrmann J, Matsumoto Y, Kreutzberg GW. Microglia: intrinsic immunoeffector cell of the brain. *Brain Research Reviews* 1995; 20: 269-287.
- Genoud S, Maricic I, Kumar V, Gage FH. Targeted expression of IGF-1 in the central nervous system fails to protect mice from experimental autoimmune encephalomyelitis. *J Neuroimmunol* 2005; 168: 40-45.
- Georgiou J, Tropak MP, Roder JC. Myelin-associated glycoprotein gene. In R. A. Lazzarini (ed.), *Myelin biology and disorders*. San Diego, CA: Elsevier Academic Press 2004; 421-467.
- Gerstner B, Sifringer M, Dzierko M, Schüller A, Lee J, Simons S, Obladen M, Volpe JJ, Rosenberg PA, Felderhoff-Mueser U. Estradiol attenuates hyperoxia-induced cell death in the developing white matter. *Ann Neurol* 2007; 61: 562-573.
- Ghandour MS, Langley OK, Vincendon G, Gombos G. Double labeling immunohistochemical technique provides evidence of the specificity of glial cell markers. *J Histochem Cytochem* 1979; 27: 1634-1637.
- Ghandour MS, Vincendon G, Gombos G. Astrocyte and oligodendrocyte distribution in adult rat cerebellum: an immunohistological study. *J Neurocytol* 1980a; 9: 637-646.
- Ghandour MS, Langley OK, Vincendon G, Gombos G, Filippi D, Limozin N, Dalmaso C, Laurent G. Immunohistochemical and immunohistochemical study of carbonic anhydrase II in adult rat cerebellum. A marker for oligodendrocytes. *Neuroscience* 1980b; 5: 559-571.
- Ghandour MS, Vincendon G, Gombos G, Limozin N, Filippi D, Dalmaso C, Laurent G. Carbonic anhydrase and oligodendroglia in developing rat cerebellum: a biochemical and immunohistological study. *Dev Biol* 1980c; 77: 73-83.
- Ghandour MS, Langley OK, Labourdette G, Vincendon G, Gombos G. Specific and artefactual cellular localizations of S 100 protein: an astrocyte marker in rat cerebellum. *Dev Neurosci* 1981; 4: 66-78.
- Ghandour MS, Langley OK, Clos J. Immunohistochemical and biochemical approaches to the development of neuroglia in the CNS, with special reference to cerebellum. *Int J Dev Neurosci* 1983; 1: 411-425.
- Ghoumari AM, Ibanez C, El-Etr M, Leclerc P, Eychenne B, O'Malley BW, Baulieu EE, Schumacher M. Progesterone and its metabolites increase myelin basic protein expression in organotypic slice cultures of rat cerebellum. *J Neurochem* 2003; 86: 848-859.

- Gilg AG, Singh AK, Singh I. Inducible nitric oxide synthase in the central nervous system of patients with X-adrenoleukodystrophy. *J Neuropathol Exp Neurol* 2000; 59: 1063-1069.
- Gilmore SA. Neuroglial population in the spinal white matter of neonatal and early postnatal rats: an autoradiographic study of numbers of neuroglia and changes in their proliferative activity. *Anat Rec* 1971; 171: 283-291.
- Ginalski-Winkelmann AG, Lmazan A, Matthieu J-M. In vitro myelin basic protein synthesis in the PNS and CNS of myelin deficient (mld) mutant mice. *Brain Res* 1983; 277: 386-388.
- Ginhoux F, Greter M, Leboeuf M, Nandi S, See P, Gokhan S, Mehler MF, Conway SJ, Ng LG, Stanley ER, Samokhvalov IM, Merad M. Fate mapping analysis reveals that adult microglia derive from primitive macrophages. *Science* 2010; 330: 841-845.
- Giuliani F, Goodyer CG, Antel JP, Yong VW. Vulnerability of human neurons to T cell-mediated cytotoxicity. *J Immunol* 2003; 171: 368-379.
- Givogri MI, Kampf K, Schonmann V, Campagnoni AT. Identification of a novel silencer that regulates the myelin basic protein gene in neural cells. *Gene*. 2000; 252: 183-193.
- Goddard DR, Berry M, Butt AM. In vivo actions of fibroblast growth factor-2 and insulin-like growth factor-I on oligodendrocyte development and myelination in the central nervous system. *J Neurosci Res* 1999; 57: 74-85.
- Gold SM, Chalifoux S, Giesser BS, Voskuhl RR. Immune modulation and increased neurotrophic factor production in multiple sclerosis patients treated with testosterone. *J Neuroinflammation* 2008; 5: 32.
- Golgi C. "Sulla Wne anatomia degli organi centrali del sistema nervoso." Hoepli, Milano 1886; pp. 214.
- Golgi C. "Untersuchungen u"ber den feineren Bau des centralen und peripherischen Nervensystems." Fischer, Jena 1894; pp. 272.
- Gordon S. Alternative activation of macrophages. *Nat Rev Immunol* 2003; 3: 23-35.
- Greer JM, Lees MB. Myelin proteolipid protein—the first 50 years. *Int J Biochem Cell Biol* 2002; 34:211-215.
- Gregg C, Shikar V, Larsen P, Mak G, Chojnacki A, Yong VW, Weiss S. White matter plasticity and enhanced remyelination in the maternal CNS. *J Neurosci* 2007; 27: 1812-1823.
- Griffiths I, Klugmann M, Anderson T, et al. Axonal swellings and degeneration in mice lacking the major proteolipid of myelin. *Science* 1998; 280: 1610-1613.
- Grinspan J, Franceschini B. Platelet-derived growth factor is a survival factor for PSA-NCAM1 oligodendrocyte pre-progenitor cells. *J Neurosci Res* 1995; 41: 540-545
- Grinspan JB, Coulalaglou M, Beesley JS, Carpio DF, Scherer SS. Maturation-dependent apoptotic cell death of oligodendrocytes in myelin-deficient rats. *J Neurosci Res* 1998; 54(5): 623-34.
- Groebe A, Clarner T, Baumgartner W, Dang J, Beyer C, Kipp M. Cuprizone treatment induces distinct demyelination, astrogliosis, and microglia cell invasion or proliferation in the mouse cerebellum. *Cerebellum*. 2009 ;8:163-174.
- Gudz TI, Schneider TE, Haas TA, Macklin WB. Myelin proteo- lipid protein forms a complex with integrins and may participate in integrin receptor signaling in oligodendrocytes. *J Neurosci* 2002; 22: 7398-7407.
- Haas S, Brockhaus J, Verkhratsky A, Kettenmann H. ATP- induced membrane currents in amoeboid microglia acutely isolated from mouse brain slices. *Neuroscience* 1996; 75: 257-261.
- Hagmann P, Sporns O, Madan N, et al. White matter maturation reshapes structural connectivity in the late developing human brain. *Proc Natl Acad Sci U S A* 2010; 107: 19067-19072

- Hajihosseini M, Tham TN, Dubois-Dalcq M. Origin of oligodendrocytes within the human spinal cord. *J Neurosci* 1996; 16: 7981-7994.
- Hall SM. The effect of injections of lysophosphatidyl choline into white matter of the adult mouse spinal cord. *J Cell Sci* 1972; 10:535-546.
- Halloran PJ, Fenton RG. Irreversible G<sub>2</sub>-M arrest and cytoskeletal reorganization induced by cytotoxic nucleoside analogues. *Cancer Res* 1998; 58: 3855-3865.
- Hardy R, Reynolds R. Proliferation and differentiation potential of rat forebrain oligodendroglial progenitors both in vitro and in vivo. *Development* 1991; 111: 1061-1080.
- Hardy R, Loushin C, Friedrich V, Chen Q, Ebersole T, Lazzarini R, Artzt K. Neural cell type-specific expression of QKI proteins is altered in quakingviable mutant mice. *J Neurosci* 1996; 16: 7941-7949.
- Hardy RJ, Friedrich VL. Oligodendrocyte progenitors are generated throughout the embryonic mouse brain, but differentiate in restricted foci. *Development* 1996; 122: 2059-2069.
- Harrison JK, Jiang Y, Chen S, Xia Y, Maciejewski D, McNamara RK, Streit WJ, Salafranca MN, Adhikari S, Thompson DA, Botti P, Bacon KB, Feng L. Role for neuronally derived fractalkine in mediating interactions between neurons and CX3CR1-expressing microglia. *Proc Natl Acad Sci U S A*. 1998; 95: 10896-10901.
- Harry GJ, Kraft AD. Neuroinflammation and microglia: considerations and approaches for neurotoxicity assessment. *Expert Opin Drug Metab Toxicol* 2008; 4: 1266-77.
- Harry GJ, Kraft AD. Microglia in the developing brain: a potential target with lifetime effects. *Neurotoxicology* 2012; 33: 191-206.
- Harsan LA, Poulet P, Guignard B, Steibel J, Parizel N, de Sousa PL, Boehm N, Grucker D, Ghandour MS. Brain dysmyelination and recovery assessment by noninvasive in vivo diffusion tensor magnetic resonance imaging. *J Neurosci Res*. 2006; 83: 392-402.
- Harsan LA, Poulet P, Guignard B, Parizel N, Skoff RP, Ghandour MS. Astrocytic hypertrophy in dysmyelination influences the diffusion anisotropy of white matter. *J Neurosci Res*. 2007; 85: 935-44.
- Harsan L-A, Steibel J, Zaremba A, Agin A, Sapin R, Poulet P, Guignard B, Parizel N, Grucker D, Boehm N, Miller RH, Ghandour MS. Recovery from chronic demyelination by thyroid hormone therapy: myelinogenesis induction and assessment by diffusion tensor magnetic resonance imaging. *The Journal of neuroscience: the official journal of the Society for Neuroscience* 2008; 28: 14189-14201
- Hart IK, Richardson WD, Bolsover SR, Raff MC. PDGF and intracellular signaling in the timing of oligodendrocyte differentiation. *J Cell Biol* 1989; 109: 3411-3417.
- Hartline DK. What is myelin? *Neuron Glia Biol* 2008; 4: 153-163.
- Hayakawa K, Seo JH, Pham L-DD, Miyamoto N, Som AT, Guo S, Kim K-W, Lo EH, Arai K. Cerebral endothelial derived vascular endothelial growth factor promotes the migration but not the proliferation of oligodendrocyte precursor cells in vitro. *Neuroscience letters* 2012; 513: 42-46
- Haydon PG. Neuroglial networks: neurons and glia talk to each other. *Curr Biol* 2000; 10: R712-714.
- Henderson AP, Barnett MH, Parratt JD, Prineas JW. Multiple sclerosis: distribution of inflammatory cells in newly forming lesions. *Ann Neurol* 2009; 66: 739-753.
- Herx LM, Yong VW. Interleukin-1 beta is required for the early evolution of reactive astrogliosis following CNS lesion. *J Neuropathol Exp Neurol* 2001; 60: 961-971.
- Heyman RA, Borrelli E, Lesley J, Anderson D, Richman DD, Baird SM, Hyman R, Evans RM. Thymidine kinase obliteration: creation of transgenic mice with controlled immune deficiency. *Proc Natl Acad Sci USA* 1989; 86: 2698-2702.

- Hibbitts N, Yoshino J, Le TQ, Armstrong RC. Astrogliosis during acute and chronic cuprizone demyelination and implications for remyelination. *ASN Neuro*. 2012; 4: 393-408.
- Hickey WF. The pathology of multiple sclerosis: a historical perspective. *J Neuroimmunol* 1999; 98: 37-44.
- Hogan EL, Greenfield S. Animal models of genetic disorders of myelin, in: P. Morell (Ed.), *Myelin*, 2nd edn., Plenum, New York 1984; 489-534.
- Holley JE, Gveric D, Newcombe J, Cuzner ML, Gutowski NJ. Astrocyte characterization in the multiple sclerosis glial scar. *Neuropathol Appl Neurobiol* 2003; 29: 434-444.
- Horikoshi Y, Sasaki A, Taguchi N, Maeda M, Tsukagoshi H, Sato K, Yamaguchi H. Human GLUT5 immunolabeling is useful for evaluating microglial status in neuropathological study using paraffin sections. *Acta Neuropathol* 2003; 105: 157-162.
- Hosoya T, Takizawa K, Nitta K, Hotta Y. Glial cells missing: a binary switch between neuronal and glial determination in *Drosophila*. *Cell* 1995; 82: 1025-1036.
- Hudson LD, Berndt J, Puckett C, Kozak CA, Lazzarini RA. Aberrant splicing of proteolipid protein mRNA in the dysmyelinating jimpy mouse. *Proc Natl Acad Sci USA* 1987; 84: 1454-1458.
- Hudson LD. Proteolipid protein gene. In R. A. Lazzarini (ed.), *Myelin biology and disorders*. San Diego, CA: Elsevier Academic Press 2004; 401-420.
- Hung KS, Tsai SH, Lee TC, Lin JW, Chang CK, Chiu WT. Gene transfer of insulin-like growth factor-I providing neuroprotection after spinal cord injury in rats. *J Neurosurg Spine* 2007; 6: 35-46.
- Hussain R, Ghomari AM, Bielecki B, Steibel J, Boehm N, Liere P, Macklin WB, Kumar N, Habert R, Mhaouty-Khodja S, et al. The neural androgen receptor: A therapeutic target for myelin repair in chronic demyelination. *Brain* 2013; 136: 132-146.
- Igarashi M, Schaumburg HH, Powers J, Kishimoto Y, Kolodny E, Suzuki K. Fatty acid abnormalities in adrenoleukodystrophy. *J Neurochem* 1976 ; 26: 851-860.
- Ilshner S, Brandt R. The transition of microglia to a ramified phenotype is associated with the formation of stable acetylated and detyrosinated microtubules. *Glia* 1996; 18: 129-140.
- Imai Y, Ibata I, Ito D, Ohsawa K, Kohsaka S. A novel gene *iba1* in the major histocompatibility complex class III region encoding an EF hand protein expressed in a monocytic lineage. *Biochem Biophys Res Commun* 1996; 224: 855-862.
- Inoue K, Osaka H, Sugiyama N, Kawanishi C, Onishi H, Nezu a, Kimura K, Yamada Y, Kosaka K. A duplicated PLP gene causing Pelizaeus-Merzbacher disease detected by comparative multiplex PCR. *American journal of human genetics* 1996; 59: 32-39.
- Insel TR. Rethinking schizophrenia. *Nature* 2010; 468: 187-193.
- Irvine KA, Blakemore WF. Age increases axon loss associated with primary demyelination in cuprizone-induced demyelination in C57BL/6 mice. *J Neuroimmunol* 2006; 175: 69-76.
- Ishibashi T, Dakin KA, Stevens B, Lee PR, Kozlov SV, Stewart CL, Fields RD. Astrocytes promote myelination in response to electrical impulses. *Neuron* 2006; 49: 823-832.
- Ivanova A, Signore M, Caro N, Greene ND, Copp AJ, Martinez- Barbera JP. In vivo genetic ablation by Cre-mediated expression of diphtheria toxin fragment A. *Genesis* 2005; 43: 129-35.
- Jagannathan NR, Tandon N, Raghunathan P, Kochupillai N. Reversal of abnormalities of myelination by thyroxine therapy in congenital hypothyroidism: localized in vivo proton magnetic resonance spectroscopy (MRS) study. *Brain Res Dev Brain Res* 1998; 109: 179-186.
- Jakovcevski I, Zecevic N. Olig transcription factors are expressed in oligodendrocyte and neuronal cells in human fetal CNS. *The Journal of neuroscience: the official journal of the Society for Neuroscience* 2005; 25: 10064-10073.

- Jakovcevski I, Filipovic R, Mo Z, Rakic S, Zecevic N. Oligodendrocyte development and the onset of myelination in the human fetal brain. *Frontiers in neuroanatomy* 2009; 3: 5.
- Jalabi W, Boehm N, Grucker D, Ghandour MS. Recovery of Myelin after Induction of Oligodendrocyte Cell Death in Postnatal Brain. *The J Neurosci* 2005; 25 : 2885–2894.
- Jean I, Lavielle C, Barthelaix-Pouplard A, Fressinaud C. Neurotrophin-3 specifically increases mature oligodendrocyte population and enhances remyelination after chemical demyelination of adult rat CNS. *Brain research* 2003; 972: 110-118.
- Jensen AB, Raff MC. Continuous observation of multipotential retinal progenitor cells in clonal density culture. *Dev Biol* 1997; 188: 267-279.
- Johnson AB, Patel N, Chiu F-C. High molecular weight, GFAP aggregates in Alexander's disease. *J Neuropathol Exp Neurol* 1998; 57: 483.
- Jones SA, Jolson DM, Cuta KK, Mariash CN, Anderson GW. Triiodothyronine is a survival factor for developing oligodendrocytes. *Mol Cell Endocrinol* 2003; 199: 49-60.
- Kagawa T, Ikenaka K, Inoue Y, Kuriyama S, Tsujii T, Nakao J, Nakajima K, et al. Glial cell degeneration and hypo- myelination caused by overexpression of myelin proteolipid protein gene. *Neuron* 1994; 13: 427-442.
- Kahn MA, Kumar S, Liebl D, Chang R, Parada LF, De Vellis J. Mice lacking NT-3, and its receptor TrkC, exhibit profound deficiencies in CNS glial cells. *Glia* 1999; 26: 153-165.
- Kamasawa N, Sik A, Morita M, Yasumura T, Davidson KG, Nagy JI, Rash JE. Connexin-47 and connexin-32 in gap junctions of oligodendrocyte somata, myelin sheaths, paranodal loops and Schmidt–Lanterman incisures: implications for ionic homeostasis and potassium siphoning. *Neurosci* 2005; 136:65-86.
- Katsuki M, Sato M, Kimura M, Yokoyama M, Kobayashi K, Nomura T. Conversion of normal behavior to shiverer by myelin basic protein antisense cDNA in transgenic mice. *Science* 1988 ; 241: 593-595.
- Kershman J. Genesis of microglia in the human brain. *Arch Neurol Psychiat* 1939; 41: 24-50.
- Keshavan MS, Anderson S, Pettegrew JW. Is schizophrenia due to excessive synaptic pruning in the prefrontal cortex? The Feinberg hypothesis revisited. *J Psychiatr Res* 1994; 28: 239– 265.
- Kessaris N, Fogarty M, Iannarelli P, Grist M, Wegner M, Richardson WD. Competing waves of oligodendrocytes in the forebrain and postnatal elimination of an embryonic lineage. *Nat Neurosci* 2006; 9: 173-179.
- Kettenmann H, Banati R, Walz W. Electrophysiological behavior of microglia. *Glia* 1993; 7: 93-101.
- Kettenmann H, Hanisch U, Noda M, Verkhratsky A. Physiology of Microglia. *Physiol Rev.* 2011; 91:461–553.
- Kidd GJ, Hauer PE, Trapp BD. Axons modulate myelin protein messenger RNA levels during central nervous system myelination in vivo. *J Neurosci Res* 1990; 26:409-418.
- Kipp M, Beyer C. Impact of sex steroids on neuroinflammatory processes and experimental multiple sclerosis. *Front Neuroendocrinol* 2009; 30:188-200.
- Klugmann M, Schwab MH, Pühhlofer A, Schneider A, Zimmermann F, Griffiths IR, Nave K-A. Assembly of CNS myelin in the absence of proteolipid protein. *Neuron* 1997; 18: 59-70.
- Klunemann HH, Ridha BH, Magy L, Wherrett JR, Hemelsoet DM, Keen RW, et al. The genetic causes of basal ganglia calcification, dementia, and bone cysts: DAP12 and TREM2. *Neurology* 2005; 64: 1502-7.
- Kobayashi T, Yamanaka T, Jacobs JM, Teixeira F, Suzuki K. The twitcher mouse: an enzymatically authentic model of human globoid cell leukodystrophy (Krabbe disease). *Brain Res* 1980; 202: 479-483.

- Kohlschutter A, Bley A, Brockmann K, Gartner J, Krageloh-mann I, Rolfs A, Schols L. Leukodystrophies and other genetic metabolic leukoencephalopathies in children and adult. *Brain Dev* 2010; 32: 82-89.
- Kolliker AV. Zur feineren Anatomie des centralen Nervensystems. Zweiter Beitrag. Das Rückenmark. *Z wissensch Zool* 1891; 51: 1-54.
- Kolliker AV. "Handbuch der Gewebelehre des Menschen." 6th ed, Vol II. Nervensystem des Menschen und der Thiere. Engelmann, Leipzig 1896; pp. 874.
- Kolodkin AL, Matthes DJ, Goodman CS. The semaphorin genes encode a family of transmembrane and secreted growth cone guidance molecules. *Cell* 1993; 75: 1389-1399.
- Komoly S. Experimental demyelination caused by primary oligodendrocyte dystrophy. Regional distribution of the lesions in the nervous system of mice [corrected]. *Ideggyogy Sz* 2005; 58: 40-43.
- Konat G, Gantt G, Hogan EL. Increased turnover of myelin proteolipid protein in quaking mouse brain. *Metab Brain Dis* 1987; 2: 113-116.
- Kondo A, Nakano T, Suzuki K. Blood-brain barrier permeability to horseradish peroxidase in twitcher and cuprizone-intoxicated mice. *Brain Res* 1987; 425: 186-190.
- Kondo T, Furuta T, Mitsunaga K, Ebersole TA, Shichiri M, Wu J, Artzt K, Yamamura K, Abe K. Genomic organization and expression analysis of the mouse qKI locus. *Mamm. Genome* 1999; 10: 662-669.
- Koo EH, Sisodia SS, Archer DR, Martin LJ, Weidemann A, Beyreuther K, Fischer P, Masters CL, Price DL. Precursor of amyloid protein in Alzheimer disease undergoes fast anterograde axonal transport. *PNAS* 1990; 87: 1561-1565.
- Kornek B, Storch MK, Weissert R, Wallstroem E, Stefferl A, Olsson T, Lington C, Schmidbauer M, Lassmann H. "Multiple sclerosis and chronic autoimmune encephalomyelitis: a comparative quantitative study of axonal injury in active, inactive, and remyelinated lesions." *Am J Pathol* 2000; 157: 267-276.
- Kotter MR, Li WW, Zhao C, Franklin RJ. Myelin impairs CNS remyelination by inhibiting oligodendrocyte precursor cell differentiation. *J Neurosci* 2006; 26: 328-332.
- Kucharova K, Stallcup WB. The NG2 proteoglycan promotes oligodendrocyte progenitor proliferation and developmental myelination. *Neuroscience* 2010; 166: 185-194
- Kuhlmann T, Lingfeld G, Bitsch A, Schuchardt J, Bruck W. Acute axonal damage in multiple sclerosis is most extensive in early disease stages and decreases over time. *Brain* 2002; 125: 2202-2212.
- Kuhlmann T, Remington L, Cagnet I, Bourbonniere L, Zehntner S, Guilhot F, Herman A, Guay-Giroux A, Antel JP, Owens T, Gauchat JF. Continued administration of ciliary neurotrophic factor protects mice from inflammatory pathology in experimental autoimmune encephalomyelitis. *Am J Pathol* 2006; 169: 584-598.
- Lachapelle F, Gumpel M, Baulac M, Jacque C, Duc P, Baumann N. Transplantation of CNS fragments into the brain of shiverer mutant mice: extensive myelination by implanted oligodendrocytes. I. Immunohistochemical studies. *Dev Neurosci* 1983; 6: 325-334.
- Lachapelle F, Bachelin C, Moissonnier P, Nait-Oumesmar B, Hidalgo A, Fontaine D, Baron-Van Evercooren A. Failure of remyelination in the nonhuman primate optic nerve. *Brain Pathol* 2005; 15: 198-207.
- Ladeby R, Wirenfeldt M, Garcia-Ovejero D, Fenger C, Dissing-Olesen L, Dalmau I, Finsen B. Microglial cell population dynamics in the injured adult central nervous system. *Brain Res Brain Res Rev* 2005; 48: 196-206.
- Langosch JM, Gebicke-Haerter PJ, Norenberg W, Illes P. Characterization and transduction mechanisms of purinoceptors in activated rat microglia. *Br J Pharmacol* 1994; 113: 29-34.
- Langui D, Delaunoy JP, Ghandour MS, Sensenbrenner M. Immunocytochemical demonstration of both carbonic anhydrase isoenzyme II and glial fibrillary acidic protein in some immature rat glial cells in primary culture. *Neurosci Lett* 1985; 60: 151-156.



Larsen PH, Wells JE, Stallcup WB, Opdenakker G, Yong VW. Matrix metalloproteinase-9 facilitates remyelination in part by processing the inhibitory NG2 proteoglycan. *J Neurosci* 2003; 23: 11127–11135.

Ledeer RW. Enzymes and receptors of myelin. In R. E. Martenson (ed.), *Myelin: biology and chemistry*. Boca Raton, FL: CRC Press 1992; pp. 531-570.

Lee JA, Inoue K, Cheung SW, Shaw CA, Stankiewicz P, Lupski JR. Role of genomic architecture in PLP1 duplication causing Pelizaeus-Merzbacher disease. *Hum Mol Genet* 2006; 15: 2250-2265.

Lee SK, Lee B, Ruiz EC, Pfaff SL. Olig2 and Ngn2 function in opposition to modulate gene expression in motor neuron progenitor cells. *Genes Dev* 2005; 19: 282–294.

Lee Y, Morrison BM, Li Y, Lengacher S, Farah MH, Hoffman PN, Liu Y, Tsingalia A, Jin L, Zhang P-W, Pellerin L, Magistretti PJ, Rothstein JD. Oligodendroglia metabolically support axons and contribute to neurodegeneration. *Nature* 2012; 487: 443-448

Lenhossek MV. Zur Kenntniss der Neuroglia des menschlichen Ru"ckenmarkes. *Verhandl d anat Gesellsch* 1891; 5: 193-221.

Levison SW, Goldman JE. Both oligodendrocytes and astrocytes develop from progenitors in the subventricular zone of postnatal rat brain. *Neuron* 1993; 10: 201-212.

Li H, De Faria JP, Andrew P, Nitarska J, Richardson WD. Phosphorylation regulates OLIG2 cofactor choice and the motor neuron-oligodendrocyte fate switch. *Neuron* 2011; 69: 918-929

Liberto CM, Albrecht PJ, Herx LM, Yong VW, Levison, SW. Pro-regenerative properties of cyto- kine-activated astrocytes. *J Neurochem* 2004; 89: 1092–1100.

Limozin N, Filippi D, Dalmaso C, Laurent G. Radioimmunoassay of carbonic anhydrase I and II in rats. Application to the central nervous system during ontogeny. *Biochimie* 1979; 61: 115-119.

Lin MT, Beal MF. Mitochondrial dysfunction and oxidative stress in neurodegenerative diseases. *Nature* 2006; 443: 787-795.

Lindahl JS, Kjellsen BR, Tigert J, Miskimins R. In utero PCP exposure alters oligodendrocyte differentiation and myelination in developing rat frontal cortex. *Brain research* 2008; 1234: 137-147.

Lindner M, Fokuhl J, Linsmeier F, Trebst C, Stangel M. Chronic toxic demyelination in the central nervous system leads to axonal damage despite remyelination. *Neurosci Lett*. 2009 3;453:120-125.

Lipton HL. Theiler's virus infection in mice: an unusual biphasic disease process leading to demyelination. *Infect Immun* 1975; 11: 1147-1155.

Liu L, Belkadi A, Darnall L, Hu T, Drescher C, Coteleur AC, Padovani-Claudio D, He T, Choi K, Lane TE, Miller RH, Ransohoff RM. CXCR2-positive neutrophils are essential for cuprizone-induced demyelination: relevance to multiple sclerosis. *Nat Neurosci* 2010; 13: 319-326.

Liu Y, Hao W, Letiembre M, Walter S, Kulanga M, Neumann H, et al. Suppression of microglial inflammatory activity by myelin phagocytosis: role of p47-PHOX-mediated generation of reactive oxygen species. *J Neurosci* 2006; 26: 12904-12913.

Losseff NA, Miller DH. Measures of brain and spinal cord atrophy in multiple sclerosis. *Journal of Neurology, Neurosurgery, and Psychiatry* 1998; 64: S102–S105.

Lu QR, Yuk D, Alberta J a, Zhu Z, Pawlitzky I, Chan J, McMahon a P, Stiles CD, Rowitch DH. Sonic hedgehog--regulated oligodendrocyte lineage genes encoding bHLH proteins in the mammalian central nervous system. *Neuron* 2000; 25: 317-329.

Lu QR, Sun T, Zhu Z, Ma N, Garcia M, Stiles CD, Rowitch DH. Common developmental requirement for Olig function indicates a motor neuron/oligodendrocyte connection. *Cell* 2002; 109: 75–86.

- Lubetzki C, Goujet-Zalc C, Gansmuller A, Monge M, Brillat A, Zalc B. Morphological, biochemical, and functional characterization of bulk isolated glial progenitor cells. *J Neurochem* 1991; 56: 671–680.
- Ludwin SK. The pathobiology of the oligodendrocyte. *J Neuropathol Exp Neurol* 1997; 56: 111-124.
- Lugaro E. Sulle funzioni della nevroglia. *Riv Patol Nerv Ment* 1907; 12: 225-233.
- Luo L, O’Leary DDM. Axon retraction and degeneration in development and disease. *Annu Rev Neurosci* 2005; 28: 127–156.
- Luong TN, Carlisle HJ, Southwell A, Patterson PH. Assessment of motor balance and coordination in mice using the balance beam. *J Vis Exp*. 2011; 10: pii: 2376.
- Luskin MB, Pearlman AL, Sanes JR. Cell lineage in the cerebral cortex of the mouse studied in vivo and in vitro with a recombinant retrovirus. *Neuron* 1988; 1: 635-647.
- Lynch MA. The multifaceted profile of activated microglia. *Mol Neurobiol* 2009; 40: 139-156.
- Lyon G, Adams RD, Kolodny EH. *Neurology of hereditary metabolic diseases*, 2nd ed. New York: McGraw-Hill, 1996.
- Ma J, Chen T, Mandelin J, Ceponis A, Miller NE, Hukkanen M, Ma GF, Konttinen YT. Regulation of macrophage activation. *Cell Mol Life Sci* 2003; 60: 2334-2346.
- MacFaul R, Cavanagh N, Lake BD, Stephens R, Whitfield AE. Metachromatic leucodystrophy: Review of 38 cases. *Arch Dis Child* 1982; 57: 168-175.
- Maglione M, Tress O, Haas B, Karram K, Trotter J, Willecke K, Kettenmann H. Oligodendrocytes in mouse corpus callosum are coupled via gap junction channels formed by connexin47 and connexin32. *Glia* 2010; 58:1104-1117.
- Maire CL, Wegener A, Kerninon C, Nait Oumesmar B. Gain-of-function of Olig transcription factors enhances oligodendrogenesis and myelination. *Stem Cells*. 2010;28:1611-1622.
- Malone MJ. Deficiency in a degradative enzyme system in globoid leukodystrophy. *Trans Am Soc Neurochem* 1970; 1:56.
- Marcus J, Popko B. Galactolipids are molecular determinants of myelin development and axo-glial organization. *Biochim Biophys Acta* 2002; 1573: 406-413.
- Marin-Husstege M, Muggirone M, Liu A, Casaccia-Bonnel P. Histone deacetylase activity is necessary for oligodendrocyte lineage progression. *The Journal of neuroscience: the official journal of the Society for Neuroscience* 2002; 22: 10333-10345
- Markovic DS, Vinnakota K, Chirasani S, Synowitz M, Raguet H, Stock K, Sliwa M, Lehmann S, Kalin R, van Rooijen N, Holmbeck K, Heppner FL, Kiwit J, Matyash V, Lehnardt S, Kaminska B, Glass R, Kettenmann H. Gliomas induce and exploit microglial MT1-MMP expression for tumor expansion. *Proc Natl Acad Sci USA* 2009; 106: 12530-12535.
- Marshall CA, Novitsch BG, Goldman JE. Olig2 directs astrocyte and oligodendrocyte formation in postnatal subventricular zone cells. *The Journal of neuroscience: the official journal of the Society for Neuroscience* 2005; 25: 7289-7298
- Martin DL. Synthesis and release of neuroactive substances by glial cells. *Glia* 1992; 5: 81–94.
- Marz P, Heese K, Dimitriadis-Schmutz B, Rose-John S, Otten U. Role of interleukin-6 and soluble IL-6 receptor in region-specific induction of astrocytic differentiation and neurotrophin expression. *Glia* 1999; 26: 191–200.
- Mason JL, Suzuki K, Chaplin DD, Matsushima GK. Interleukin-1beta promotes repair of the CNS. *J Neurosci* 2001; 21: 7046–7052.

- Matsuda Y, Koito H, Yamamoto H. Induction of myelin-associated glycoprotein expression through neuron-oligodendrocyte contact. *Dev Brain Res* 1997; 100: 110-116.
- Matsushima GK, Morell P. The neurotoxicant, cuprizone, as a model to study demyelination and remyelination in the central nervous system. *Brain Pathol* 2001; 11: 107-116.
- Matthews PM, Pioro E, Narayanan S, De Stefano N, Fu L, Francis G, Antel J, Wolfson C, Arnold DL. Assessment of lesion pathology in multiple sclerosis using quantitative MRI morphometry and magnetic resonance spectroscopy. *Brain* 1996; 119: 715-722.
- Mathieu J-M, Tomic M, Roach A. Myelin-Deficient Mutant Mice. *Annals of the New York Academy of Sciences* 1992; 660: 188-192.
- Matzner U, Hartmann D, Lullmann-Rauch R, et al. Bone marrow stem cell-based gene transfer in a mouse model for metachromatic leukodystrophy: Effects on visceral and nervous system disease manifestations. *Gene Ther* 2002; 9: 53-63.
- Maysami S, Nguyen D, Zobel F, Pitz C, Heine S, Hopfner M, Stangel M. Modulation of rat oligodendrocyte precursor cells by the chemokine CXCL12. *Neuroreport* 2006; 17: 1187-1190.
- McGeer PL, Kawamata T, Walker DG, Akiyama H, Tooyama I, McGeer EG. Microglia in degenerative neurological disease. *Glia* 1993; 7: 84-92.
- Mckinnon RD, Matsui T, Dubois-Dalq M, Aronson SA. FGF modulates the PDGF-driven pathway of oligodendrocyte development. *Neuron* 1990; 5: 603-614.
- McMorris A, Dubois-Dalq M. Insulin-like growth factor 1 promotes cell proliferation and oligodendroglial commitment in rat glial progenitor cells developing in vitro. *J Neurosci Res* 1988; 21: 199-209.
- McMorris FA, Mckinnon RD. Regulation of oligodendrocyte development and CNS myelination by growth factors: prospects for therapy of demyelinating diseases. *Brain Pathol* 1996; 6: 313-329.
- Mctigue DM, Horner PJ, Stokes BT, Gage FH. Neurotrophin-3 and brain-derived neurotrophic factor induce oligodendrocyte proliferation and myelination of regenerating axons in the contused adult rat spinal cord. *J Neurosci* 1998; 18: 5354-5365.
- Menn B, Garcia-Verdugo JM, Yaschine C, Gonzalez-Perez O, Rowitch D, Alvarez-Buylla A. Origin of oligodendrocytes in the subventricular zone of the adult brain. *J neurosci* 2006; 26: 7907-7918
- Merchan P, Bribián A, Sánchez-Camacho C, Lezameta M, Bovolenta P, De Castro F. Sonic hedgehog promotes the migration and proliferation of optic nerve oligodendrocyte precursors. *Molecular and cellular neurosciences* 2007; 36: 355-368
- Merzbacher L. Eine eigenartige familiäre Erkrankungsform (aplasia axialis extracorticalis congenita). *Z ges Neurol Psychiat* 1910; 3: 1-138.
- Messersmith DJ, Murtie JC, Le TQ, Frost EE, Armstrong RC. Fibroblast growth factor 2 (FGF2) and FGFreceptor expression in an experimental demyelinating disease with extensive remyelination. *J Neurosci Res* 2000; 62: 241-256.
- Metea MR, Newman EA. Calcium signaling in specialized glial cells. *Glia* 2006; 54: 650-655.
- Meyer-Franke A. Astrocytes induce oligodendrocyte processes to align with and adhere to axons. *Mol Cell Neurosci* 1999; 14: 385-397.
- Michaelson MD, Bieri PL, Mehler MF, Xu H, Arezzo JC, Pollard JW. CSF-1 deficiency in mice results in abnormal brain development. *Development* 1996; 122: 2661-72.
- Mierzwa A, Shroff S, Rosenbluth J. Permeability of the paranodal junction of myelinated nerve fibers. *J Neurosci* 2010; 30: 15962-15968.

- Mikoshiha K, Okano H, Inoue Y, Fujishiro M, Takamatsfu K, Achapellne L, Bauman, Tsukada NY. Immunohistochemical, biochemical and electron microscopic analysis of myelin formation in the central nervous system of myelin deficient (rnld) mutant mice. *Dev Brain Res* 1987; 35: 111-121.
- Mildner A, Schmidt H, Nitsche M, Merkler D, Hanisch UK, Mack M, Heikenwalder M, Bruck W, Priller J, Prinz M. Microglia in the adult brain arise from Ly-6ChiCCR2 monocytes only under defined host conditions. *Nat Neurosci* 2007; 10: 1544-1553.
- Miller RH, Raff MC. Fibrous and protoplasmic astrocytes are biochemically and developmentally distinct. *J Neurosci* 1984; 4: 585-592.
- Miller RH. Regulation of oligodendrocyte development in the vertebrate CNS. *Prog Neurobiol* 2002; 67: 451-467.
- Miller RH, Fyffe-Maricich SL. Restoring the balance between disease and repair in multiple sclerosis: insights from mouse models. *Dis Model Mech* 2010; 3: 535-539.
- Miller SD, Gerety SJ. Immunologic aspects of Theiler's murine encephalomyelitis virus (TMEV)-induced demyelinating disease. *Semin Virol* 1990; 1: 263.
- Miller SD, Vanderlugt CL, Begolka WS, Pao W, Yauch RL, Neville KL, Katz-Levy Y, Carrizosa A, Kim BS. Persistent infection with Theiler's virus leads to CNS autoimmunity via epitope spreading. *Nat Med* 1997; 3: 1133-1136.
- Milner R, Anderson HJ, Rippon RF, McKay JS, Franklin RJ, Marchionni MA, Reynolds R, French-Constant C. Contrasting effects of mitogenic growth factors on oligodendrocyte precursor cell migration. *Glia* 1997; 19: 85-90.
- Mimault C, Giraud G, Courtois V. The Clinical European Network on Brain Demyelinating Disease. Proteolipoprotein gene analysis in 82 patients with sporadic Pelizaeus-Merzbacher disease: duplications, the major cause of the disease, originate more frequently in male germ cells, but point mutations do not. *Am J Hum Genet* 1999; 65: 360-369.
- Molineaux SM, Engh H, De Ferra F, Hudson L, Lazzarini RA. Recombination within the myelin basic protein gene created the dysmyelinating shiverer mouse mutation. *Proc Natl Acad Sci USA* 1986; 83:7542-7546.
- Molofsky AV, Krencik R, Ullian EM, Tsai HH, Deneen B, Richardson WD, Barres BA, Rowitch DH. Astrocytes and disease: a neurodevelopmental perspective. *Genes Dev* 2012; 26: 891-907.
- Morell P. Myelin. Plenum Press, New York, 1984.
- Morelli A, Ravera S, Panfoli I. Hypothesis of an energetic function for myelin. *Cell Biochem Biophys* 2011; 61(1): 179-187
- Moreno-Lopez B, Gonzalez-Forero D. Nitric oxide and synaptic dynamics in the adult brain: Physiopathological aspects. *Rev Neurosci* 2006; 17: 309-357.
- Mori S, Leblond CP. Electron microscopic identification of three classes of oligodendrocytes and a preliminary study of their proliferative activity in the corpus callosum of young rats. *J Comp Neurol* 1970; 139: 1-30.
- Mudhar HS, Pollock RA, Wang C, Stiles CD, Richardson WD. PDGF and its receptors in the developing rodent retina and optic nerve. *Development* 1993; 118: 539-552.
- Munoz-Fernandez MA, Fresno M. The role of tumour necrosis factor, interleukin 6, interferon-gamma and inducible nitric oxide synthase in the development and pathology of the nervous system. *Prog Neurobiol* 1998; 56: 307-40.
- Murray TJ. "The history of multiple sclerosis," in: *Multiple Sclerosis: Diagnosis, Medical Management, and Rehabilitation*, Demos Medical, New York 2000.

- Murtie JC, Zhou YX, Le TQ, Armstrong RC. In vivo analysis of oligodendrocyte lineage development in postnatal FGF2 null mice. *Glia* 2005; 49: 542-554
- Nadon NL, Duncan ID, Hudson LD. A point mutation in the proteolipid protein gene of the 'shaking pup' interrupts oligodendrocyte development. *Development* 1990; 110: 529-537.
- Nadon NL, Duncan ID. Molecular analysis of glial cell development in the canine 'shaking pup' mutant. *Dev Neurosci* 1996; 18: 174-184.
- Nagara H, Suzuki K, Tateishi J. Radial component of central myelin in shiverer mouse. *Brain Res* 1983; 263: 336-339.
- Nageotte J. Phe'nome'nes de se'cre'tion dans le protoplasma des cellules ne'vrogliales de la substance grise. *C R Se'an Soc Biol Paris* 1910; 68: 1068-1069.
- Naidu S, Theda C, Moser HW. Peroxisomal disorders. In: Swaiman KF, Ashwal S, eds. *Pediatric neurology: Principles and practice*, vol. 1. St. Louis, Missouri: Mosby 1999; 510:529.
- Nair A, Frederick TJ, Miller SD. Astrocytes in multiple sclerosis: a product of their environment. *Cell Mol Life Sci* 2008; 65: 2702-2720.
- Nakatsuji Y, Miller RH. Density dependent modulation of cell cycle protein expression in astrocytes. *J Neurosci Res* 2001; 66: 487-496.
- Napoli I, Neumann H. Protective effects of microglia in multiple sclerosis. *Experimental neurology* 2010; 225: 24-28.
- Nave KA, Boespflug-Tanguy O. X-linked developmental defects of myelination: from mouse mutants to human genetic diseases. *Neuroscientist* 1996; 2: 33-43.
- Nave KA, Trapp BD. Axon-glial signaling and the glial support of axon function. *Annu Rev Neurosci* 2008; 31: 535-561
- Nave KA. Myelination and support of axonal integrity by glia. *Nature* 2010; 468(7321): 244-252
- Nedergaard M, Ransom B, Goldman SA. New roles for astrocytes: redefining the functional architecture of the brain. *Trends Neurosci* 2003; 26: 523-530
- Neumann H, Kotter MR, Franklin RJ. Debris clearance by microglia: an essential link between degeneration and regeneration. *Brain* 2009; 132: 288-295.
- Nimmerjahn A, Kirchhoff F, Helmchen F. Resting microglial cells are highly dynamic surveillants of brain parenchyma in vivo. *Science* 2005; 308: 1314-1318
- Nishiyama A, Lin XH, Giese N, Heldin CH, Stallcup WB. Colocalization of NG2 proteoglycan and PDGF a-receptor on O-2A progenitor cells in the developing rat brain. *J Neurosci Res* 1996; 43: 299-314.
- Nishiyama A. NG2 cells in the brain: a novel glial cell population. *Hum Cell* 2001; 14: 77-82.
- Nishiyama A, Komitova M, Suzuki R, Zhu X. Polyden- drocytes (NG2 cells): Multifunctional cells with lineage plasticity. *Nat Rev Neurosci* 2009; 10: 9-22.
- Norkute A, Hieble A, Braun A, Johann S, Clarner T, Baumgartner W, Beyer C, Kipp M. Cuprizone treatment induces demyelination and astrocytosis in the mouse hippocampus. *J Neurosci Res*. 2009; 87:1343-1355.
- Norton WT, Aquino DA, Hozumi I, Chiu FC, Brosnan CF. Quantitative aspects of reactive gliosis: a review. *Neurochem Res* 1992; 17: 877-885.
- Noseworthy JH, Lucchinetti C, Rodriguez M, Weinshenker BG. Multiple sclerosis. *N Engl J Med* 2000; 343: 938-952.

- Oh LYS, Larsen PH, Krekoski CA, Edwards DE, Donovan F, Werb Z, Lee VW. Matrix metalloproteinase-9/Gelatinase B is required for process outgrowth by oligodendrocytes. *J Neurosci* 1999; 19: 8464-8475.
- Oh S, Huang X, Chiang C. Specific requirements of sonic hedgehog signaling during oligodendrocyte development. *Developmental dynamics: an official publication of the American Association of Anatomists* 2005; 234: 489-496
- Okano H, Miura MA, Moriguchi K, Ikenaka, TsukadaY, Mikoshiba K. Inefficient transcription of the myelin basic protein gene possibly causes hypomyelination in myelin-deficient mutant mice. *J Neurochem* 1987; 48: 470-476.
- Olivier C, Cobos I, Perez Villages EM, Spassky N, Zalc B, Martinez S, Thomas JL. Monofocal origin of telencephalic oligodendrocytes in the anterior entopenduncular areas of the chick embryo. *Development* 2001; 128: 1757-1769.
- Oluich LJ, Stratton JA, Xing YL, Ng SW, Cate HS, Sah P, Windels F, Kilpatrick TJ, Merson TD. Targeted ablation of oligodendrocytes induces axonal pathology independent of overt demyelination. *J Neurosci* 2012; 32: 8317-8330.
- Ono K, Yasui Y, Rutishauser U, Miller RH. Focal ventricular origin and migration of oligodendrocyte precursors into the chick optic nerve. *Neuron* 1997; 19: 283-292.
- Orentas DM, Hayes JE, Dyer KL, Miller RH. Sonic hedgehog signaling is required during the appearance of spinal cord oligodendrocyte precursors. *Development (Cambridge, England)* 1999; 126: 2419-2429
- Otero GC, Merrill JE. Response of human oligodendrocytes to interleukin-2. *Brain Behav Immun* 1997; 11: 24-38.
- Padovani-Claudio DA, Liu L, Ransohoff RM, Miller RH. Alterations in the oligodendrocyte lineage, myelin, and white matter in adult mice lacking the chemokine receptor CXCR2. *Glia* 2006; 54: 471-483.
- Pagenstecher A, Stalder AK, Kincaid CL, Shapiro SD, Campbell IL. Differential expression of matrix metalloproteinase and tissue inhibitor of matrix metalloproteinase genes in the mouse central nervous system in normal and inflammatory states. *Am J Pathol* 1998; 152: 729-741.
- Parent JM, von dem Bussche N, Lowenstein DH. Prolonged seizures recruit caudal subventricular zone glial progenitors into the injured hippocampus. *Hippocampus* 2006; 16:321-328.
- Parpura V, Haydon PG. *Astrocytes in (patho)physiology of the nervous system*. Springer, New York 2009.
- Patel JR, Klein RS. Mediators of oligodendrocyte differentiation during remyelination. *FEBS Lett* 2011; 585: 3730-3737.
- Paterson PY, Joseph E. Smadel Memorial Lecture: neuroimmunologic diseases of animals and humans. *Rev Infect Dis* 1979; 1: 468-482.
- Patrikios P, Stadelmann C, Kutzelnigg A, Rauschka H, Schmidbauer M, Laursen H, et al. Remyelination is extensive in a subset of multiple sclerosis patients. *Brain* 2006; 129: 3165-3172.
- Pelizaeus F. *Über eine eigentümliche form spastischer Lahmung mit Zerebralerscheinungen auf hereditärer Grundlage (multiple Sklerose)*. *Arch Psychiat Nervenkr* 1885; 16: 698-710.
- Pellerin L, Bouzier-Sore AK, Aubert A, Serres S, Merle M, Costalat R, Magistretti PJ. Activity-dependent regulation of energy metabolism by astrocytes: an update. *Glia* 2007; 55: 1251-1262.
- Penfield, W. Oligodendroglia and its relation to classical neuroglia. *Brain* 1924 ; 47 : 430-452.
- Perkins S, Aguayo A, Bray G. Behaviour of Schwann cells from Trembler mouse unmyelinated fibers transplanted into myelinated nerves. *Experimental Neurology* 1981; 71: 515-526.
- Peru RL, Mandrycky N, Nait-Oumesmar B, Lu QR. Paving the axonal highway: From stem cells to myelin repair. *Stem Cell Rev* 2008; 4: 304-318.

- Peters A, Palay S, Webster HD. *The Fine Structure of the Nervous System: the Neuron and the Supporting Cells*. Oxford, UK: Oxford Univ. Press, 1991; p 115-120.
- Peyron F, Timsit S, Thomas JL, Kagawa T, Ikenaka K, Zalc B. In situ expression of PLP/DM-20, MBP, and CNP during embryonic and postnatal development of the jimpy mutant and of transgenic mice overexpressing PLP. *J Neurosci Res* 1997; 50: 190-201.
- Pfeiffer SE, Warrington AE, Bansal R. The oligodendrocyte and its many cellular processes. *Trends Cell Biol* 1993; 3: 191-197.
- Pfriegeer FW, Barres BA. What the fly's glia tell the fly's brain. *Cell* 1995; 83: 671-674.
- Pham-Dinh D, Dautigny A, Linington C. Myelin oligodendrocyte glycoprotein gene. In R. A. Lazzarini (ed.), *Myelin biology and disorders*. San Diego, CA: Elsevier Academic Press, 2004; 469-497.
- Phillips RJS. Jimpy, a new totally sex-linked gene in the house mouse. *Z Vererbungsl* 1954; 86: 322-326.
- Pluchino S, Quattrini A, Brambilla E, Gritti A, Salani G, Dina G, Galli R, Del Carro U, Amadio S, Bergami A, Furlan R, Comi G, Vescovi AL, Martino G (2003) Injection of adult neurospheres induces recovery in a chronic model of multiple sclerosis.
- Pluchino S, Zanotti L, Rossi B, Brambilla E, Ottoboni L, Salani G, Martinello M, Cattalini A, Bergami A, Furlan R, Comi G, Constantin G, Martino G. Neurosphere-derived multipotent precursors promote neuroprotection by an immunomodulatory mechanism. *Nature* 2005; 436: 266-271.
- Pocock JM, Kettenmann H. Neurotransmitter receptors on microglia. *Trends Neurosci* 2007; 30: 527-35.
- Pohl HB, Porcheri C, Mueggler T, Bachmann LC, Martino G, Riethmacher D, Franklin RJ, Rudin M, Suter U. Genetically induced adult oligodendrocyte cell death is associated with poor myelin clearance, reduced remyelination, and axonal damage. *J Neurosci* 2011; 31: 1069-1080.
- Polito A, Reynolds R. NG2-expressing cells as oligodendrocyte progenitors in the normal and demyelinated adult central nervous system. *J Anat* 2005; 207:707-716.
- Popko B, Puckett C, Hood L. A novel mutation in myelin-deficient mice results in unstable myelin basic protein gene transcripts. *Neuron* 1988; 1: 221-225.
- Powers JM, DeCiero DP, Cox C, et al. The dorsal root ganglia in adrenomyeloneuropathy: Neuronal atrophy and abnormal mitochondria. *J Neuropathol Exp Neurol* 2001; 60: 493-501.
- Prada I, Ongania GN, Buonsanti C, Panina-Bordignon P, Meldolesi J. Triggering receptor expressed in myeloid cells 2 (TREM2) trafficking in microglial cells: continuous shuttling to and from the plasma membrane regulated by cell stimulation. *Neuro- science* 2006; 140: 1139-48.
- Price J. Glial cell lineage and development. *Curr Opin Neurobiol* 1994; 4: 680-686.
- Priller J, Haas CA, Reddington M, Kreutzberg GW. Calcitonin gene-related peptide and ATP induce immediate early gene ex- pression in cultured rat microglial cells. *Glia* 1995; 15: 447-457.
- Privat A, Drian MJ, Escaig J. Jimpy mouse myelin revisited with freeze-fracture *Acta Neuropathol* 1979; 45: 129-131.
- Privat A, Jacque C, Bourre JM, Dupouey P, Baumann N. Absence of the major dense line in myelin of the mutant mouse shiverer. *Neurosci Lett* 1979; 12: 107-112.
- Prochiantz A, Barbin G, Rousset A, Chamak B, Fetler L. Further studies on the role of astroglia in brain neurons maturation and morphogenesis. *J Physiol* 1987; 82: 291-293.
- Qi Y, Stapp D, Qiu M. Origin and molecular specification of oligodendrocytes in the telencephalon. *Trends Neurosci* 2002; 25:223-225.
- Qian X, Davis AA, Goderie SK, Temple S. FGF2 concentration regulates the generation of neurons and glia from multipotential cortical stem cells. *Neuron* 1997; 18: 81-93.

- Quarles RH. Myelin sheaths: glycoproteins involved in their formation, maintenance and degeneration. *Cell Mol Life Sci* 2002; 59: 1851-1871.
- Raff MC, Lillien LE, Richardson WD, Burne JF, Noble MD. Platelet-derived growth factor from astrocytes drives the clock that times oligodendrocyte development in culture. *Nature* 1988; 333: 562-565.
- Rakic P. Radial cells: scaffolding for brain construction. In: *Neuroglia*, edited by Kettenmann H and Ransom BR. Oxford, UK: Oxford Univ. Press, 1995; p. 746-762.
- Rakic P. The radial edifice of cortical architecture: From neuronal silhouettes to genetic engineering. *Brain Res Brain Res Rev* 2007; 55: 204-219.
- Ransohoff RM, Howe CL, Rodriguez M. Growth factor treatment of demyelinating disease: at last, a leap into the light. *Trends Immunol* 2002; 23: 512-516.
- Ransohoff RM. Animal models of multiple sclerosis: the good, the bad and the bottom line. *Nature neuroscience* 2012; 15: 1074-1077.
- Ranvier L-A. Sur les éléments conjonctifs de la moelle épinière. *Compt Rend Hebd Se'an Acad Sc* 1873; 77: 1299-1302.
- Reichenbach A, Derouiche A, Kirchhoff F. Morphology and dynamics of perisynaptic glia. *Brain Res Brain Res Rev* 2010; 63: 11-25.
- Reier PJ, Houle JD. The glial scar: its bearing on axonal elongation and transplantation approaches to CNS repair. *Adv Neurol* 1988; 47: 87-138.
- Reynolds BA, Rietze RL. Neural stem cells and neurospheres—re-evaluating the relationship. *Nat Methods* 2005; 2: 333-336.
- Reynolds R, Wilkin GP. Development of macroglial cells in rat cerebellum. II. An in situ immunohistochemical study of oligodendroglial lineage from precursor to mature myelinating cell. *Development* 1988; 102: 409-425.
- Rezaie P, Dean A, Male D, Ulfing N. Microglia in the cerebral wall of the human telencephalon at second trimester. *Cerebral Cortex* 2005; 15: 938-949.
- Richardson WD, Pringle N, Mosley MJ, Westermarck B, Dubois-Dalcq M. A role for platelet-derived growth factor in normal gliogenesis in the central nervous system. *Cell* 1988; 53: 309-319.
- Richardson PM. Ciliary neurotrophic factor: a re- view. *Pharmacol. Ther* 1994; 63: 187-198.
- Rio Hortega P del. Nuevas reglas para la coloracion constante de las formaciones conectivas, por el metodo de Achucarro. *Trab Lab Invest Biol* 1916b; 14: 181-188.
- Rio Hortega P del. Noticia de un nuevo y facil metodo para la coloracion de la neuroglia y del tejido conjuntivo. *Trab Lab Invest Biol* 1917; 15: 367-378.
- Rio Hortega P del. Tercera aportacion al conocimiento morfológico e interpretacion funcional de la oligodendroglia. *Mem R Soc Espan Hist Nat* 1928; 14: 5-122.
- Rio Hortega P del. Histogénesis y evolución normal, éxodo y distribución regional de la microglía. *Mem R Soc Espan Hist Nat* 1921a; 11: 213-268.
- Rio Hortega P del. La glía de escasas radiaciones (oligodendroglía). *Bol R Soc Espan Hist Nat* 1921b; 21: 63-92.
- Rio Hortega P del. La neuroglia normal. Conceptos de angiogliona y neurogliona. *Arch Histol Norm Patol* 1942; 1: 5-71.
- Rio Hortega P del, Polak M, Prado JM. Investigaciones sobre la neuroglia de los ganglios sensitivos. *Arch Histol Norm Patol* 1942; 1: 234-275.



- Rivera-Quinones C, McGavern D, Schmelzer JD, Hunter SF, Low PA, Rodriguez M. Absence of neurological deficits following extensive demyelination in a class I-deficient murine model of multiple sclerosis. *Nat Med* 1998; 4: 187-193.
- Robain O, Mandel P. Etude quantitative de la myélinisation et de la croissance axonale dans le corps calleux et le cordon postérieur de la moëlle chez la souris jimpy. *Acta Neuropathol* 1974; 29: 293-309.
- Robert Lazzarini A, John W, Griffin, Hans Lassman, Klaus-Armin Nave, Robert Miller, Bruce D Trapp. *Myelin Biology and Disorders*. Academic Press, New York 2004; pp xxiii-xli
- Roch J-M, Cooper BJ, Ramirez M, Matthieu J-M. Expression of only one myelin basic protein allele in mouse is compatible with normal myelination. *Mol. Brain Res* 1987; 3: 61-68.
- Rodriguez M. A function of myelin is to protect axons from subsequent injury: implications for deficits in multiple sclerosis. *Brain* 2003; 126: 751-752.
- Rouach N, Koulakoff A, Abudara V, Willecke K, Giaume C. Astroglial metabolic networks sustain hippocampal synaptic transmission. *Science* 2008; 322:1551-1555
- Rowitch DH, Kriegstein AR. Developmental genetics of vertebrate glial-cell specification. *Nature* 2010; 468: 214-222.
- Rudick RA, Trapp BD. Gray-matter injury in multiple sclerosis. *N Engl J Med*. 2009; 361: 1505-1506.
- Rutishauser U, Landmesser L. Polysialic acid in the vertebrate nervous system: a promoter of plasticity in cell-cell interactions. *Trends Neurosci* 1996; 19: 422-427.
- Saher G, Simons M. Cholesterol and myelin biogenesis. *Subcell Biochem* 2010; 51: 489-508
- Saijo K, Winner B, Carson CT, Collier JG, Boyer L, Rosenfeld MG, Gage FH, Glass CK. A Nurr1/CoREST pathway in microglia and astrocytes protects dopaminergic neurons from inflammation-induced death. *Cell* 2009; 137: 47-59.
- Salomon B, Maury S, Loubiere L, Caruso M, Onclercq R, Klatzmann D. A truncated herpes simplex virus thymidine kinase phosphorylates thymidine and nucleoside analogs and does not cause sterility in transgenic mice. *Mol Cell Biol* 1995; 15:5322-5328.
- Sanchez I, Hassinger L, Paskevich PA, Shine HD, Nixon RA. Oligo- dendroglia regulate the regional expansion of axon caliber and local accumulation of neurofilaments during development independently of myelin formation. *J Neurosci* 1996; 16: 5095-5105
- Sarlieve LL, Fabre M, Susz J, Matthieu JM. Investigations on myelination in vitro. IV. "Myelin-like" or premyelin structures in cultures of dissociated brain cells from 14- to 15-day-old embryonic mice. *J Neurosci Res* 1983; 10: 191-210.
- Schebesta M, Serluca FC. olig1 Expression identifies developing oligodendrocytes in zebrafish and requires hedgehog and notch signaling. *Developmental dynamics: an official publication of the American Association of Anatomists* 2009; 238: 887-898
- Schiffmann R, van der Knaap MS. An MRI-based approach to the diagnosis of white matter disorders. *Neurology* 2009; 72: 750-759.
- Schilder P. Zur Frage der Encephalitis Periaxialis Diffusa. *Z Gesamte Neurol Psychiatr* 1913; 15: 359-376.
- Schilling T, Quandt FN, Cherny VV, Zhou W, Heinemann U, Decoursey TE, Eder C. Upregulation of Kv1.3 channels in microglia deactivated by TGF-beta. *AmJ Physiol Cell Physiol* 2000; 279: C1123-C1134.
- Schneider A, Montague P, Griffiths IR, Fanarraga ML, Kennedy PGE, Brophy PJ, Nave K-A. Uncoupling of hypomyelination and glial cell death by a mutation in the proteolipid protein gene. *Nature* 1992; 358: 758-761.
- Schumacher M, Hussain R, Gago N, Oudinet JP, Mattern C, Ghomari AM. Progesterone synthesis in the nervous system: implications for myelination and myelin repair. *Front Neurosci* 2012; 6: 10.

- Schwartz JP, Nishiyama N. Neurotrophic factor gene expression in astrocytes during development and following injury. *Brain Res Bull* 1994; 35: 403–407.
- Scott-Drew S, French-Constant C. Expression and function of thrombospondin-1 in myelinating glial cells of the central nervous system. *J Neurosci Res* 1997; 50: 202-214.
- Scott-Drew S, French-Constant C. Expression and function of thrombospondin-1 in myelinating glial cells of the central nervous system. *J Neurosci Res* 1997; 50: 202-214.
- Seeley RR, Stephens TD, Tate P. *Anatomy and Physiology*. 6<sup>th</sup> edition, McGraw-Hill, New York 2003; 364-369.
- Seiwa C, Yamamoto M, Tanaka K, Fukutake M, Ueki T, Takeda S, Sakai R, Ishige A, Watanabe K, Akita M, Yagi T, Tanaka K, Asou H. Restoration of FcRgamma/Fyn signaling repairs central nervous system demyelination. *J Neurosci Res* 2007; 85: 954-966
- Shapiro EG, Lockman LA, Knopman D, Krivit W. Characteristics of the dementia in late-onset metachromatic leukodystrophy. *Neurology* 1994; 44: 662-665.
- Shibata T, Yamada K, Watanabe M, Ikenaka K, Wada K, Tanaka K, Inoue Y. Glutamate transporter GLAST is expressed in the radial glia–astrocyte lineage of developing mouse spinal cord. *J Neurosci* 1997; 17: 9212–9219.
- Shields SA, Gilson JM, Blakemore WF, Franklin RJM. Remyelination occurs as extensively but more slowly in old rats compared to young rats following gliotoxin-induced CNS demyelination. *Glia* 1999; 28: 77-83.
- Shimajima K, Inoue T, Hoshino A, et al. Comprehensive genetic analyses of PLP1 in patients with Pelizaeus-Merzbacher disease applied by array-CGH and fiber-FISH analyses identified new mutations and variable sizes of duplications. *Brain Dev* 2010; 32: 171-179
- Shroff S, Mierzwa A, Scherer SS, Peles E, Arevalo JC, Chao MV, Rosenbluth J. Paranodal permeability in ‘myelin mutants’. *Glia* 2011; DOI: 10.1002/glia.21188
- Shy ME, Hobson G, Jain M, Boespflug-Tanguy O, Garbern J, Sperle K, Li W, Gow A, Rodriguez D, Bertini E, Mancias P, Krajewski K, Lewis R, Kamholz J. Schwann cell expression of PLP1 but not DM20 is necessary to prevent neuropathy. *Ann Neurol* 2003; 53: 354-365.
- Sicotte NL, Liva SM, Klutch R, Pfeiffer P, Bouvier S, Odesa S, Wu TC, Voskuhl RR. Treatment of multiple sclerosis with the pregnancy hormone estriol. *Ann Neurol* 2002; 52: 421-428.
- Sicotte NL, Giesser BS, Tandon V, Klutch R, Steiner B, Drain AE, Shattuck DW, Hull L, Wang HJ, Elashoff RM, Swerdloff RS, Voskuhl RR. Testosterone treatment in multiple sclerosis: a pilot study. *Arch Neurol* 2007; 64: 683-688.
- Sidman RL, Dickie MM, Appel SH. Mutant mice (quaking and jimpy) with deficient myelination in central nervous system. *Science* 1964; 144: 309-311.
- Simard M, Arcuino G, Takano T, Liu QS, Nedergaard M. Signaling at the gliovascular interface. *J Neurosci* 2003; 23: 9254–9262.
- Simons M, Trotter J. Wrapping it up: the cell biology of myelination. *Curr Opin Neurobiol* 2007; 17: 533-540
- Skoff RP, Price DL, Stocks A. Electron microscopic autoradiographic studies of gliogenesis in rat optic nerve. I. Cell proliferation. *J Comp Neurol* 1976; 169: 291-312.
- Skoff RP, Montgomery IN. Expression of mosaicism in females heterozygous for jimpy. *Brain Res* 1981; 212: 175-181.
- Skoff RP, Ghandour MS, Knapp PE. Postmitotic oligodendrocytes generated during postnatal cerebral development are derived from proliferation of immature oligodendrocytes. *Glia* 1994; 12: 12-23.

- Skripuletz T, Miller E, Grote L, Gudi V, Pul R, Voss E, Skuljec J, Moharreggh-Khiabani D, Trebst C, Stangel M. Lipopolysaccharide delays demyelination and promotes oligodendrocyte precursor proliferation in the central nervous system. *Brain, behavior, and immunity* 2011; 25: 1592-1606
- Small RK, Riddle P, Noble M. Evidence for migration of oligodendrocyte-type-2 astrocyte progenitor cells into the developing rat optic nerve. *Nature* 1987; 328: 155-157
- Sofroniew MW, Vinters HV. Astrocytes: biology and pathology. *Acta Neuropathol* 2010; 119:7-35.
- Sohn J, Selvaraj V, Wakayama K, Orosco L, Lee E, Crawford SE, Guo F, Lang J, Horiuchi M, Zarbalis K, Itoh T, Deng W, Pleasure D. PEDF is a novel oligodendrogenic morphogen acting on the adult SVZ and corpus callosum. *The Journal of neuroscience : the official journal of the Society for Neuroscience* 2012; 32: 12152-12164
- Soilu-Hanninen M, Laaksonen M, Hanninen A. Hyaluronate receptor (CD44) and integrin alpha4 (CD49d) are up-regulated on T cells during MS relapses. *J Neuro- immunol* 2005; 166: 189–192.
- Soldán MM, Pirko I. Biogenesis and significance of central nervous system myelin. *Semin Neurol* 2012; 32: 9-14.
- Solly SK, Thomas JL, Monge M, Demerens C, Lubetzki C, Gardinier MV, Matthieu JM, Zalc B. Myelin/oligodendrocyte glycoprotein (MOG) expression is associated with myelin deposition. *Glia* 1996; 18: 39-48.
- Somjen GG. Nervenkitz: Notes on the history of the concept of neuroglia. *Glia* 1988; 1: 2-9.
- Sommer I, Schachner M. Monoclonal antibodies (01 to 04) to oligodendrocyte cell surfaces: an immunocytological study in the central nervous system. *Dev Biol* 1981; 83: 311-327.
- Spassky N, Olivier C, Perez-Villegas E, Goujet-Zalc C, Martinez S, Thomas JL, Zalc B. Single or multiple oligodendroglial lineages: a controversy. *Glia* 2000; 29: 143-148.
- Sriram S, Rodriguez M. Indictment of the microglia as the villain in multiple sclerosis. *Neurology* 1997; 48: 464-470.
- Stecca B, Southwood CM, Gragerov A. et al. The evolution of lipophilin genes from invertebrates to tetrapods: DM-20 cannot replace proteolipid protein in CNS myelin. *J Neurosci* 2000; 20:4002-4010.
- Steelman AJ, Thompson JP, Li J. Demyelination and remyelination in anatomically distinct regions of the corpus callosum following cuprizone intoxication. *Neuroscience Res* 2012; 72: 32-42.
- Steinman L, Zamvil SS. How to successfully apply animal studies in experimental allergic encephalomyelitis to research on multiple sclerosis. *Ann Neurol* 2006; 60: 12-21.
- Stockli KA, Lillien LE, Naher-Noe M, Breitfeld G, Hughes RA, Raff MC, Thoenen H, Sendtner M. Regional distribution, developmental changes, and cellular localization of CNTF-mRNA and protein in the rat brain. *J Cell Biol* 1991; 115: 447–459.
- Stolt CC, Rehberg S, Ader M, Lommes P, Riethmacher D, Schachner M, Bartsch U, Wegner M. Terminal differentiation of myelin-forming oligodendrocytes depends on the transcription factor Sox10. *Genes & development* 2002; 16:165-170.
- Streit WJ, Walter SA, Pennell NA. Reactive microgliosis. *Prog Neurobiol* 1999; 57: 563-581.
- Sturrock RR, McRae DA. Mitotic division of oligodendrocytes which have begun myelination. *J Anat* 1980; 131: 577-582.
- Sugawa M, Sakurai Y, Ishikawa-Ieda Y, Suzuki H, Asou H. Effects of erythropoietin on glial cell development; oligodendrocyte maturation and astrocyte proliferation. *Neuroscience research* 2002; 44: 391-403
- Suh SW, Bergher JP, Anderson CM, Treadway JL, Fosgerau K, Swanson RA. Astrocyte glycogen sustains neuronal activity during hypoglycemia: studies with the glycogen phosphorylase inhibitor CP-316, 819 ([R-

- R\*, S\*]-5-chloro-N- [2-hydroxy-3-(methoxymethylamino)-3-oxo-1-(phenylmethyl) propyl]-1H-indole-2-carboxamide). *J Pharmacol Exp Ther* 2007; 321:45–50.
- Sun Y, Meijer DH, Alberta J a, Mehta S, Kane MF, Tien A-C, Fu H, Petryniak M a, Potter GB, Liu Z, Powers JF, Runquist IS, Rowitch DH, Stiles CD. Phosphorylation state of Olig2 regulates proliferation of neural progenitors. *Neuron* 2011; 69: 906-917
- Suzuki K. The twitcher mouse: a model for Krabbe disease and for experimental therapies. *Brain Pathol* 1995; 5: 249-258.
- Suzuki K. Twenty five years of the “psychosine hypothesis”: a personal perspective of its history and present status. *Neurochem Res* 1998; 23: 251-259.
- Takada N, Kucenas S, Appel B. Sox10 is necessary for oligodendrocyte survival following axon wrapping. *Glia* 2010; 58: 996-1006
- Takahashi K, Prinz M, Stagi M, Chechneva O, Neumann H. TREM2-transduced myeloid precursors mediate nervous tissue debris clearance and facilitate recovery in an animal model of multiple sclerosis. *PLoS Med* 2007; 4: e124.
- Takahashi N, Sakurai T, Davis KL, Buxbaum JD. Linking oligodendrocyte and myelin dysfunction to neurocircuitry abnormalities in schizophrenia. *Prog Neurobiol* 2011; 93(1): 13-24
- Takano T, Tian GF, Peng W, Lou N, Libionka W, Han X, Nedergaard M. Astrocyte-mediated control of cerebral blood flow. *Nat Neurosci* 2006; 9: 260-267
- Takebayashi H, Nabeshima Y, Yoshida S, Chisaka O, Ikenaka K, Nabeshima Y. The basic helix-loop-helix factor olig2 is essential for the development of motoneuron and oligodendrocyte lineages. *Current biology* 2002; 12: 1157-1163
- Taylor CM, Marta CB, Bansal R. et al. The Transport, Assembly and Function of Myelin Lipids. In R. A. Lazzarini (ed.), *Myelin biology and disorders*. San Diego, CA: Elsevier Academic Press 2004; 57:88.
- Temple S, Raff M. Clonal analysis of oligodendrocyte development in culture: evidence for a developmental clock that counts cell divisions. *Cell* 1986; 44: 773-779.
- Thrash JC, Torbett BE, Carson MJ. Developmental regulation of TRAM2 and DAP12 expression in the mouse CNS: implications for Nasu-Hakola disease. *Neurochem Res* 2009; 34: 38-45.
- Timsit S, Bally-Cuif L, Colman D, Zalc B. Dm-20 mRNA is expressed during the embryonic development of the nervous system in the mouse. *J Neurochem* 1992; 58: 1172-1175.
- Timsit S, Martinez S, Allinquant B, Peyron F, Puelles L, Zalc B. Oligodendrocytes originate from a restricted zone of the embryonic ventral neural tube defined by DM-20 mRNA. *J Neurosci* 1995; 15: 1012-1024.
- Tosic M, Matthieu J-M. From myelin basic protein to myelin deficient mice. In *Cellular and Molecular Biology of Myelination*. G. Jeserich et al., eds. NATO ASI Series 1990; 43: 489-503.
- Tower DB, Young OM. The activities of butyrylcholinesterase and carbonic anhydrase, the rate of anaerobic glycolysis, and the question of a constant density of glial cells in cerebral cortices of various mammalian species from mouse to whale. *J Neurochem* 1973; 20: 269–278.
- Traka M, Arasi K, Avila RL, Podojil JR, Christakos A, Miller SD, Soliven B, Popko B. A genetic mouse model of adult-onset, pervasive central nervous system demyelination with robust remyelination. *Brain: a journal of neurology* 2010; 133: 3017-3029.
- Trapp BD, Nishiyama A, Cheng D, Macklin W. Differentiation and death of premyelinating oligodendrocytes in developing rodent brain. *J Cell Biol* 1997; 137: 459-468.
- Trapp BD, Peterson J, Ransohoff RM, Rudick R, Mörk S, Bö L. Axonal transection in the lesions of multiple sclerosis. *N Engl J Med* 1998; 338: 278-285.

- Trapp BD, Pfeiffer SE, Anitei M. et al. Cell biology of myelin assembly. In R. A. Lazzarini (ed.), *Myelin biology and disorders*. San Diego, CA: Elsevier Academic Press 2004; 29-55.
- Trapp BD, Nave K-A. Multiple sclerosis: an immune or neurodegenerative disorder? *Annu Rev Neurosci* 2008; 31: 247-269.
- Tropak MB, Johnson PW, Dunn RJ, Roder JC. Differential splicing of MAG transcripts during CNS and PNS development. *Brain Res* 1988; 464: 143-155.
- Uccelli A, Giunti D, Capello E, Roccatagliata L, Mancardi GL. EAE in the common marmoset *Callithrix jacchus*. *Int MS J* 2003; 10: 6-12.
- Uhm JH, Dooley NP, Oh LY, Yong VW. Oligodendrocytes utilize a matrix metalloproteinase, MMP-9, to extend processes along an astrocyte extracellular matrix. *Glia* 1998; 22: 53-63.
- Van Rossum D, Hanisch UK. Microglia. *Metab Brain Dis* 2004; 19: 393-411.
- Vartanian T, Fischbach G, Miller R. Failure of spinal cord oligodendrocyte development in mice lacking neuregulin. *Proc Natl Acad Sci USA* 1999; 96: 731-735.
- Vaughn JE, Pease DC. Electron microscopy of classically stained astrocytes. *J Comp Neurol* 1967; 131: 143-154.
- Velumian AA, SamoiloVA M, Fehlings MG. Visualization of cytoplasmic diffusion within living myelin sheaths of CNS white matter axons using microinjection of the fluorescent dye Lucifer Yellow. *Neuroimage* 2010; 56: 27-34.
- Vinnichouk SM, Myalovitskaya OA. *Multiple Sclerosis [in Russian]*, Kompolis, Kyiv 2001.
- Virchow R. Ueber das granulirte Ansehen der Wandungen der Gehirn-ventrikel. *Allg Z Psychiat psychgericht Med* 1846; 3: 242-250.
- Virchow R. Ueber eine im Gehirn und Ru"ckenmark des Menschen aufgefundenene Substanz mit der chemischen Reaction der Cellulose. *Arch pathol Anat Physiol klin Med* 1854; 6: 135-138.
- Virchow R. "Gesammelte Abhandlungen zur wissenschaftlichen Medizin." Meidinger, Frankfurt 1856; pp.1024.
- Vora P, Pillai PP, Zhu W, Mustapha J, Namaka MP, Frost EE. Differential effects of growth factors on oligodendrocyte progenitor migration. *European journal of cell biology* 2011; 90: 649-656
- Voskuhl RR. Hormone-based therapies in MS. *Int MS J* 2003; 10: 60-66.
- Voss EV, Skuljec J, Gudi V, Skripuletz T, Pul R, Trebst C, Stangel M. Characterisation of microglia during de- and remyelination: can they create a repair promoting environment? *Neurobiology of disease* 2012; 45: 519-528.
- Vourch P, Andres C. Oligodendrocyte myelin glyco- protein (OMgp): evolution, structure and function. *Brain Res Rev* 2004; 45: 115-124.
- Waksman BH. Demyelinating disease: evolution of a paradigm. *Neurochem. Res* 1999; 24: 491-495.
- Waksman BH, Adams RD. A histologic study of the early lesion in experimental allergic encephalomyelitis. *Am J Pathol* 1962; 41: 135-162.
- Wang C, Rougon G, Kiss JZ. Requirement of polysialic acid for the migration of the O-2A glial progenitor cell from neurohypophysial explants. *J Neurosci* 1994; 14: 4446-4457.
- Wang FI, Stohlman SA, Fleming JO. Demyelination induced by murine hepatitis virus JHM strain (MHV-4) is immunologically mediated. *J Neuroimmunol* 1990; 30: 31-41.
- Warf BC, Fok-Seang J, Miller RH. Evidence for the ventral origin of oligodendrocyte precursors in the rat spinal cord. *J Neurosci* 1991; 11: 2477-2488.

- Watkins TA, Emery B, Mulinyawe S, Barres BA. Distinct stages of myelination regulated by g-secretase and astrocytes in a rapidly myelinating CNS coculture system. *Neuron* 2008; 60: 555–569.
- Wawrzyniak-Gacek A. Distribution of various types of oligodendrocytes and cellular localisation of iron in the frontal cortex of the adult rat. *Folia morphologica* 2002; 61: 115-121.
- Waxman SG. Axonal conduction and injury in multiple sclerosis: the role of sodium channels. *Nat Rev Neurosci* 2006; 7: 932-941.
- Weiner HL. The challenge of multiple sclerosis: how do we cure a chronic heterogeneous disease? *Ann Neurol* 2009; 65: 239–248.
- Wilby MJ, Muir EM, Fok-Seang J, Gour BJ, Bla-schuk OW, Fawcett JW. N-Cadherin inhibits Schwann cell migration on astrocytes. *Mol Cell Neurosci* 1999; 14: 66–84.
- Willard HF, Riordan JR. Assignment of the gene for myelin proteolipid protein to the X-chromosome: implication for X-linked myelin disorders. *Science* 1985; 230: 940-942.
- Willenborg DO, Fordham SA, Cowden WB, Ramshaw IA. Cytokines and murine autoimmune encephalomyelitis: inhibition or enhancement of disease with antibodies to select cytokines, or by delivery of exogenous cytokines using a recombinant vaccinia virus system. *Scand J Immunol* 1995; 41: 31–41.
- Williams A, Piaton G, Lubetzki C. Astrocytes friends or foes in multiple sclerosis? *Glia* 2007; 55: 1300–1312.
- Windebank AJ, Wood P, Bunge RP, Dyck PJ. Myelination determines the caliber of dorsal root ganglion neurons in culture. *J Neurosci* 1985; 5: 1563-1569
- Windrem MS, Nunes MC, Rashbaum WK, Schwartz TH, Goodman RA, McKhann G, Roy NS, Goldman SA. Fetal and adult human oligodendrocyte progenitor cell isolates myelinate the congenitally dysmyelinated brain. *Nat Med* 2004; 10: 93-97.
- Wise PM, Dubal DB. Estradiol protects against ischemic brain injury in middle- aged rats. *Biol Reprod* 2000; 63: 982–985.
- Wolburg H, Noell S, Mack A, Wolburg-Buchholz K, Fallier- Becker P. Brain endothelial cells and the glio-vascular complex. *Cell Tissue Res* 2009; 335: 75–96.
- Wu H-H, Bellmunt E, Scheib JL, Venegas V, Burkert C, Reichardt LF, Zhou Z, Fariñas I, Carter BD. Glial precursors clear sensory neuron corpses during development via Jedi-1, an engulfment receptor. *Nat Neurosci* 2009; 12: 1534–1541.
- Xiang X, Zhang X, Huang Q-L. Plexin A3 is involved in semaphorin 3F-mediated oligodendrocyte precursor cell migration. *Neuroscience letters* 2012; 530: 127-132
- Xu Q, Wang S, Jiang X, Zhao Y, Gao M, Zhang Y, Wang X, Tano K, Kanehara M, Zhang W, Ishida T. Hypoxia-induced astrocytes promote the migration of neural progenitor cells via vascular endothelial factor, stem cell factor, stromal-derived factor-1alpha and monocyte chemoattractant protein-1 upregulation in vitro. *Clin Exp Pharmacol Physiol* 2007; 34: 624–631.
- Yamada T, Taniwaki T, Shinnoh N, et al. Adrenoleukodystrophy protein enhances association of very long-chain acyl-coenzyme A synthetase with the peroxisome. *Neurology* 1999; 52: 614-616.
- Yamaguchi W, Tamai R, Kageura M, Furuyama T, Inagaki S. Sema4D as an inhibitory regulator in oligodendrocyte development. *Molecular and cellular neurosciences* 2012; 49: 290-299
- Yamaguchi Y, Ikenaka K, Niinobe M, Yamada H, Mikoshiba K. Myelin proteolipid protein (PLP), but not DM-20, is an inositol hexakisphosphate-binding protein. *J Biol Chem* 1996; 271: 27838-27846.
- Yan H, Rivkees S a. Hepatocyte growth factor stimulates the proliferation and migration of oligodendrocyte precursor cells. *Journal of neuroscience research* 2002; 69: 597-606

- Yandava BD, Billingham LL, Snyder EY. "Global" cell replacement is feasible via neural stem cell transplantation: evidence from the dysmyelinated shiverer mouse brain. *Proc Natl Acad Sci USA* 1999; 96: 7029-7034.
- Yang Y, Lewis R, Miller RH. Interactions between oligodendrocyte precursors control the onset of CNS myelination. *Developmental biology* 2011; 350: 127-138
- Yiu G, He Z. Signaling mechanisms of the myelin inhibitors of axon regeneration. *Curr Opin Neurobiol* 2003; 13: 545-551.
- Yool DA, Edgar JM, Montague P, Malcolm S. The proteolipid protein gene and myelin disorders in man and animal models. *Hum Mol Genet.* 2000; 9: 987-92.
- Yoshida M. Oligodendrocyte maturation in *Xenopus laevis*. *J Neurosci Res* 1997; 50: 169-176.
- Yoshizawa I, Bronson R, Dorf ME, Abromson-Leeman S. T-cell responses to myelin basic protein in normal and MBP-deficient mice. *Journal of neuroimmunology* 1998; 84:131-138.
- Yu N, Lariosa-Willingham KD, Lin FF, Webb M, Rao TS. Characterization of lysophosphatidic acid and sphingosine-1-phosphate-mediated signal transduction in rat cortical oligodendrocytes. *Glia* 2004; 45: 17-27.
- Yu WP, Collarini EJ, Pringle NP, Richardson WD. Embryonic expression of myelin genes: evidence for a focal source of oligodendrocyte precursors in the ventricular zone of the neural tube. *Neuron* 1994; 12: 1353-1362.
- Zajicek J. "The epidemiology of multiple sclerosis." *J Neurol* 2007; 254: 1742
- Zhang H, Miller RH. Density-dependent feedback inhibition of oligodendrocyte precursor expansion. *J Neurosci* 1996; 16: 6886-6895.
- Zhang SC, Goetz BD, Carré JL, Duncan ID. Reactive microglia in dysmyelination and demyelination. *Glia.* 2001; 34: 101-9.
- Zhang Y, Taveggia C, Melendez-Vasquez C, Einheber S, Raine CS, Salzer JL, Brosnan CF, John GR.
- Zhou Y-X, Pannu R, Le TQ, Armstrong RC. Fibroblast growth factor 1 (FGFR1) modulation regulates repair capacity of oligodendrocyte progenitor cells following chronic demyelination. *Neurobiology of disease* 2012; 45: 196-205.
- Zhu X, Zuo H, Maher BJ, Serwanski DR, LoTurco JJ, Lu QR, Nishiyama A. Olig2-dependent developmental fate switch of NG2 cells. *Development* 2012; 139: 2299-2307.
- Zlokovic BV. The blood-brain barrier in health and chronic neurodegenerative disorders. *Neuron* 2008; 57: 178-201.



## The Brown Norway opticospinal model of demyelination: Does it mimic multiple sclerosis or neuromyelitis optica?

N. Collongues<sup>a,b,c,\*</sup>, J.B. Chanson<sup>a,b</sup>, F. Blanc<sup>a,b</sup>, J. Steibel<sup>a</sup>, C.D. Lam<sup>a</sup>, A. Shabbir<sup>a</sup>, E. Trifilieff<sup>a</sup>, J. Honnorat<sup>d</sup>, D. Pham-Dinh<sup>e,f</sup>, M.S. Ghandour<sup>a</sup>, J. de Seze<sup>a,b,c</sup>

<sup>a</sup> Laboratoire d'Imagerie et de Neurosciences Cognitives, UMR 7237 CNRS/UDS, Université de Strasbourg, Faculté de Médecine, 4 rue Kirschleger, Strasbourg, France

<sup>b</sup> Centre Hospitalier Universitaire et Département de Neurologie, Hôpital de Hautepierre, 1 avenue Molière, Strasbourg, France

<sup>c</sup> Centre d'Investigation Clinique INSERM 1002, 1 place de l'Hôpital, Strasbourg, France

<sup>d</sup> INSERM U842, 7-11 rue Guillaume Paradin, Lyon, France

<sup>e</sup> INSERM U546, Hôpital Armand Trousseau, Paris, France

<sup>f</sup> AP-HP Service de neuropédiatrie, Hôpital Armand Trousseau, Paris, France

### ARTICLE INFO

#### Article history:

Received 31 August 2011

Received in revised form 16 May 2012

Accepted 16 May 2012

#### Keywords:

Neuromyelitis optica  
Experimental autoimmune  
encephalomyelitis  
Aquaporin-4  
MOG  
Brown Norway rat

### ABSTRACT

Opticospinal demyelinating diseases in humans are mostly characterized by the opticospinal form of multiple sclerosis (MS) and neuromyelitis optica (NMO). Increasing attention has recently focused on astrocyte markers, aquaporin-4 (AQP4) and glial fibrillary acidic protein (GFAP) in these diseases. We induced opticospinal demyelination in Brown Norway rats with soluble recombinant rat myelin oligodendrocyte glycoprotein (1–116) and incomplete Freund's adjuvant. Clinical, MRI, neuropathological and immunological evaluations were performed, with a focus on AQP4 and GFAP. We confirmed the opticospinal phenotype, including extensive myelitis, but also showed the MRI-characterized involvement of the periventricular area. Expression levels of myelin, AQP4 and GFAP showed the early involvement of astrocytes before demyelination in the optic nerve. The overexpression of AQP4 was particularly pronounced in the spinal cord and was concomitant with demyelination and astrocyte apoptosis. The disability scores were correlated with demyelination and inflammation but not with AQP4/GFAP expression. No antibodies against the linear and conformational epitopes of AQP4 were detected. Whereas a NMO-like phenotype was observed in this model, the AQP4/GFAP expression during the disease process was more closely related to opticospinal MS than NMO. However, this model raises the question of a continuum between opticospinal MS and the seronegative NMO subtype.

© 2012 ISDN. Published by Elsevier Ltd. All rights reserved.

### 1. Introduction

Opticospinal inflammatory/demyelinating diseases in humans are mostly characterized by two distinct entities, the opticospinal form of multiple sclerosis (MS) and neuromyelitis optica (NMO). NMO is usually a more severe pathology than MS, characterized by disabling optic neuritis and longitudinally extensive transverse myelitis. Autopsies have shown that NMO was characterized

by extensive demyelination of the optic nerves and spinal cord, owing to a massive myelin protein loss that occurs in both the white and gray matter. Contrary to MS, brain MRI is often normal at disease onset in NMO, but brain lesions appear in about 50% of patients during the disease, with the involvement of periependymal regions such as the hypothalamus, corpus callosum, periaqueductal brainstem and periventricular areas (Pittock et al., 2006).

Recently, the involvement of astrocyte aquaporin-4 (AQP4), the dominant central nervous system (CNS) water channel protein, has been demonstrated in NMO. A specific and pathogenic serum autoantibody, called NMO-IgG, recognizing AQP4, has been reported in 50–70% of NMO patients but only in 10% of MS patients (Kira, 2011; Lennon et al., 2004; Mata and Lohi, 2011). Neuropathological studies of glial fibrillary acidic protein (GFAP), a specific marker of astrocytes, and AQP4, particularly abundant in the optic nerves, spinal cord and periependymal regions (Nagelhus et al., 1998; Pittock et al., 2006; Vitellaro-Zuccarello et al., 2005), have demonstrated a decreased expression of AQP4 and GFAP in the optic

*Abbreviations:* AQP4, aquaporin-4; BN, Brown Norway; CSF, cerebrospinal fluid; EAE, experimental autoimmune encephalomyelitis; ELISA, enzyme-linked immunosorbent assay; GFAP, glial fibrillary acidic protein; HE, haematoxylin/eosin; IFA, incomplete Freund's adjuvant; LFB/c, luxol fast blue/cresyl violet; MBP, myelin basic protein; MOG, myelin oligodendrocyte glycoprotein; MS, multiple sclerosis; NMO, neuromyelitis optica; OD, optical density; ON, optic nerve.

\* Corresponding author at: Department of Neurology, University Hospital of Strasbourg, 1, Place de l'Hôpital, 67091 Strasbourg, France. Tel.: +33 88116670; fax: +33 88116343.

E-mail address: [nicolas.collongues@chru-strasbourg.fr](mailto:nicolas.collongues@chru-strasbourg.fr) (N. Collongues).



**Table 1**  
Synthetic peptides of AQP4 used in this study.

1. IP1 = p.2–21	SDGAAARRWGKSGHSSSRQS	
2. IP2 = p.96–115	INPAVTVAMVCTRKISIAKS	
3. EP1 = p.137–156	TPPSVVGGLGVTMVHGNLTA	
4. EP 2 = p.207–231	YTGASMNPARSFGPAVIMGNWENHW	
5. IP 3 = p.251–269	VFCPDVEFKRRFKEAFSKA	
6. IP 4 = p.267–285	SKAAQQTGKGSYMEVEDNRS	
7. IP 5 = p.301–319	VIDVDRGEEKKGGKQDSGEV	

IP 1–5: intracellular peptides 1 to 5. EP 1 and 2: extracellular peptides 1 and 2.

nerve and spinal cord of NMO patients before demyelination (Misu et al., 2007; Roemer et al., 2007; Sinclair et al., 2007). This pattern of immunoreactivity seems different from that encountered in MS where loss of AQP4 has been found mainly in strongly demyelinated regions in intensive and acute MS lesions, whereas overexpression of AQP4 has mostly been observed in other chronic demyelinated tissue due to astrogliosis.

Animal models of experimental autoimmune encephalomyelitis (EAE) suggest that myelin oligodendrocyte glycoprotein (MOG) plays an important role in opticospinal demyelination (Sakuma et al., 2004; Stefferl et al., 1999; Storch et al., 1998). A model in a Brown Norway (BN) rat strain was induced by immunization with rat MOG (1–125) (rMOG) in incomplete Freund's adjuvant (IFA) (Storch et al., 1998). This animal model, characterized by major antibody-mediated inflammation, results in myelitis and optic neuritis between 30 and 70 days post immunization (PI). Furthermore, as in NMO, a perivascular deposition of immunoglobulin and complement C9 antigen occurs in this model. Another model, involving Lewis rats immunized with rMOG in complete Freund's adjuvant (CFA), also results in myelitis and optic neuritis (Sakuma et al., 2004), but with a lower anti-MOG antibody titer than the BN model (Stefflerl et al., 1999). More recently, a double-transgenic mouse strain TCR<sup>MOG</sup> and IgH<sup>MOG</sup> was engineered, which spontaneously develops a form of EAE similar to NMO (Bettelli et al., 2006; Krishnamoorthy et al., 2006). Besides the role of MOG antigen in inducing opticospinal demyelination, the BN animal model differs from the others by its particular immunological process. It has been demonstrated that activation of B lymphocytes was less pronounced in Lewis rats than in BN rats (Stefflerl et al., 1999) and that MOG antigen was more abundant in the optic nerves and spinal cord of BN rats than of Lewis rats (Pagany et al., 2003). Unlike the Lewis or Dark Agouti rat models, the BN rat model with its capacity to trigger an antibody response to MOG, induces NMO-like lesions. However, none of the above-mentioned animal models has been characterized by MRI or with respect to AQP4/GFAP expression during pathogenesis.

In view of the reported similarities between the BN MOG-induced model and opticospinal disease in humans, we used it to explore the opticospinal phenotype, to report neuropathological measurements of myelin, AQP4 and GFAP expression and to look for correlations with disability. We also explored the hypothesis of MOG immunization-induced epitope spreading in reporting immunization against linear and conformational AQP4 epitopes.

## 2. Experimental procedures

### 2.1. Animals

Immunization with MOG: experiments were performed on 8- to 10-week-old female BN rats (130–150 g) obtained from Janvier

(France). A total of 32 rats were analyzed in the present study. During the observation period the rats were kept under environmentally controlled conditions. The experiments were carried out in accordance with the National Institutes of Health Guide for the Care and Use of Laboratory Animals (NIH Publications no. 80–23, revised 1996); the Institutional Animal Care and Use Committee of Strasbourg University approved all the experiments.

### 2.2. Reagents

Recombinant rat MOG protein corresponding to the N-terminal sequence of rat MOG (1–116) (rMOG) was prepared as previously described (Delarasse et al., 2003). IFA was purchased from Sigma–Aldrich (France). Recombinant rMOG and AQP4 peptides were used for the enzyme-linked immunoassay (ELISA). Seven AQP4 peptide sequences were selected (Table 1): intracellular peptides (IP1 to IP5) and two extracellular peptides (EP1 and EP2). The peptides were synthesized by the proteomic platform of Neuroscience IFR 37 (Strasbourg, France) and purified by RP-HPLC. The purity of the peptides was above 95% and their identities were confirmed by mass spectrometry.

### 2.3. Induction and evaluation of EAE

Twenty-five rats were immunized at the base of the tail with 100 µl of rMOG emulsified with the same volume of IFA in a total volume of 200 µl, corresponding to 100 µg of rMOG per rat. Anesthesia for immunization and blood collection was induced by intra-peritoneal injection of 37 mg/kg of ketamine (Ketalar, Parke-Davis) and 5.5 mg/kg of xylazine (Rompun, Bayer). Seven rats were used as controls and were immunized with IFA alone.

The animals were weighed and examined daily for EAE clinical signs and scored on the following scale: 0 = no weakness; 1 = weakness of the tail only; 2 = walking disability without any motor dysfunction; 3 = walking disability with motor dysfunction; 4 = paraplegia; 5 = tetraplegia; 6 = death. Relapse and remission were defined respectively as an increase or a decrease in clinical score of at least one point for at least two days. Consecutive relapses or remissions were considered as a single event.

### 2.4. MRI

The brains, optic nerves and spinal cords were assessed *in vivo* by MRI at different time intervals. Three time-points were chosen on the basis of clinical disability as described in the literature (Storch et al., 1998), corresponding to the early stage (days 0 to 29), the disease stage when clinical signs were visible (days 30 to 70) and the late stage (after 70 days), when no further clinical signs were noted. Four MOG-immunized rats were examined by MRI and then sacrificed during the early stage of the disease at day 10 and day 25 and during the disease stage at day 45. Longitudinal follow-up by

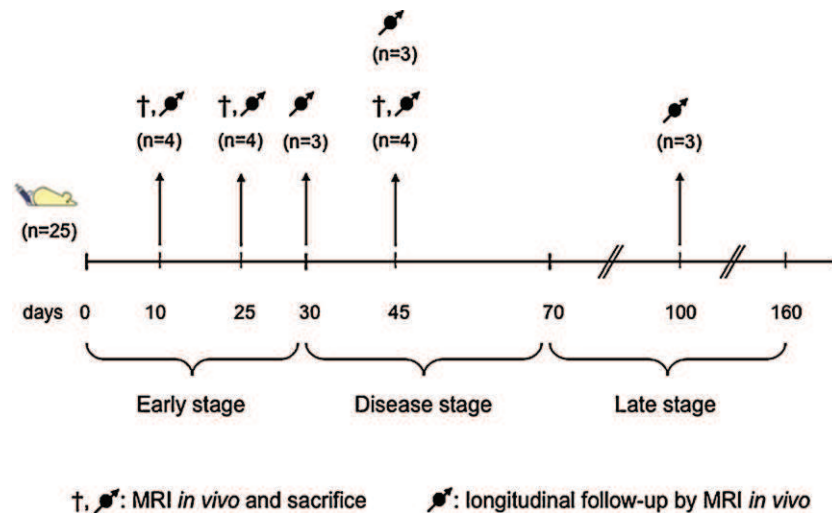

**Fig. 1.** A work plan summarizing the MRI experimental procedure for the groups of rats immunized with MOG. Two IFA-injected rats were used as controls at each stage of the disease course.

MRI was performed for three rats from the disease stage, at day 30 and day 45 until the late stage, at day 100 (Fig. 1). Two IFA-injected rats were used as controls for each MRI time-point. The rats were anaesthetized with a mixture of isoflurane and oxygen at 5% for induction and 1.5% for maintenance. Imaging was performed using a 4.7 T MR magnet, equipped with self-shield gradient coils from Magnex Sci. Ltd. (Oxford, United Kingdom) and an MR spectrometer from S.M.I.S. Ltd. (now M.R.R.S., Guildford, United Kingdom). The animals were placed in a stereotaxic device to immobilize the head, with integrated heating facility to maintain the body temperature at 37 °C. An anatomically shaped  $^1\text{H}$  surface coil for small animals (Rapid Biomedical GmbH, Würzburg, Germany) was placed over the head to serve as a receiver for the magnetic resonance signal. The system was then placed into a  $^1\text{H}$  resonator (Rapid Biomedical GmbH) for rats and mice, which was slid into the magnet. Multiparametric T2-weighted MRI was performed with a repetition time of 3800 ms and an echo time of 30 ms in the control and MOG-immunized rats. The slice thickness was 1 mm and the field of view (FOV) ranged from 25 to 50 mm depending on the anatomic areas explored. For an FOV 25 mm  $\times$  25 mm with a data matrix 256  $\times$  256 (zero filled to 512  $\times$  512), the in-plane resolution was 50  $\mu\text{m}$ .

### 2.5. Histopathology and immunohistochemistry

After MOG injection, rats were sacrificed at different time-points: eight at the early stage, eight at the disease stage and nine at the late stage. Seven control rats were terminated as follows: two at the early and disease stages, respectively, and three at the late stage. For tissue fixation, the rats were perfused via the heart with 4% paraformaldehyde. Brains, optic nerves and spinal cords were removed and postfixed in the same fixative. Paraffin-embedded tissues were then processed for conventional light microscopy. Eight-micrometer-thick sections were used for demyelination evaluation stained with luxol fast blue/cresyl violet (LFB/c) and inflammation was evaluated with hematoxylin/eosin (HE).

In adjacent serial sections, immunohistochemistry was performed on paraffin-embedded sections using indirect immunofluorescence or a peroxidase-biotinylated antibody for the amplification technique (Vector VIP SK-4600, Vector Laboratories). The primary antibodies used are listed in Table 2. The anti-MOG monoclonal antibody was a gift from Dr. Linnington (Linnington et al.,

1984). Control sections were incubated without primary antibody or with non-immune rabbit serum.

LFB/c and antibodies against Myelin basic protein (MBP) were used to quantify demyelination, definite as extensive when a transverse spinal cord or bilateral optic nerve demyelination was observed. HE and ED1 were used to characterize the extent of inflammation. A marked inflammation was noted when the number of infiltrating cells was  $\geq 20$  cells in a 100  $\mu\text{m}$   $\times$  100  $\mu\text{m}$  area, determined by using the NIS. Elements D3.2 imaging software (Nikon Inc., New York, USA). AQP4 and GFAP expression was evaluated using the following scores: -2, marked decreased expression; -1, mild decreased expression; 0, similar to control; +1, mild increased expression; +2, marked increased expression.

Antibodies against caspase3 were used to determine apoptotic cells. The number of caspase3 positive cells was counted in a 100  $\mu\text{m}$   $\times$  100  $\mu\text{m}$  area, determined by using the NIS. Elements D3.2 imaging software (Nikon Inc., New York, USA). The mean number of apoptotic cells was determined for each animal on an average of 10 complete cross sections of spinal cord. Histological scores were established compared to controls IFA-injected rats. For each rat, three sections/areas (including the optic nerves, the spinal cord and the periventricular areas) were used. This scale was calculated from results obtained from blind tests of tissue sections by two independent observers.

### 2.6. Enzyme-linked immunoassay

Blood was collected either from the tail vein or by cardiac puncture immediately before perfusion with the fixative. After clotting at 4 °C the sera were collected by centrifugation and stored at -20 °C. Antigens were coated on 96-well plates. Antigens were diluted at 20  $\mu\text{g}/\text{ml}$  in a coating buffer solution and incubated for 1 h at 37 °C. Antigen-coated plates were incubated with 1:10–1:1000 serial dilutions of sera from normal and immunized animals for 1 h at 37 °C. After washing, an appropriate dilution of peroxidase-conjugated anti-rat IgG (A9037, Sigma) was applied at 1:10000 for 1 h. The reaction product was then visualized after incubation of the substrate ortho-phenylene-diamine diluted at 1.5 mg/ml, for 30 min. The optical density (OD) was measured at 450 nm. The results are given as a mean of triplicate values. Cut-off was determined as the mean OD in the IFA group with three standard deviations. Separate assays were carried-out for each individual

**Table 2**  
Antibodies used for immunohistochemistry.

Antigen	Ab type	Target	Dilution	Ab anti-rat/revelation	Source
AQP4	Polyclonal	Astrocytes/endothelium/ependymocytes	1:20	Rabbit IgG/DAB	Sigma
Caspase3	Polyclonal	Apoptotic cells	1:200	Rabbit IgG/DAB	USbiological
ED1	Monoclonal	Macrophages/activated microglia	1:200	Mouse IgG/DAB	Serotec
GFAP	Polyclonal	Astrocytes	1:200	Rabbit IgG/VIP	DAKO
MBP	Monoclonal	Myelin	1:50	Mouse IgG/fluor.	Home made
MOG	Monoclonal	Myelin/oligodendrocytes	1:10	Mouse IgG/DAB	(Linnington et al., 1984)

AQP4: aquaporin-4, GFAP: glial fibrillary acidic protein, MBP: myelin basic protein, MOG: myelin oligodendrocyte glycoprotein.

AQP4 peptide noted in Table 1. Control wells were incubated without primary antibodies.

### 2.7. AQP4-Ig assay

All serum samples were examined for the presence of NMO-IgG using the described immunofluorescence technique on AQP4 transfected cells, developed by INSERM U842 laboratory (Lyon, France) (Marignier et al., 2010) with a sensitivity of 60% and specificity of 100%. Briefly, a full-length human AQP4-M1 cDNA (NM.001650, Origene, Rockville, USA) was amplified by PCR and inserted directionally into the Bgl2 and Kpn1 restriction sites of the pEGFP-C1 vector (Clontech, France). The identity of AQP4 was confirmed by protein sequencing. The purified plasmid was used to transfect human embryonic kidney cells (HEK 293) using the calcium phosphate method in compliance with the manufacturer's protocol (Invitrogen, France). Twenty-four hours post transfection, the cells were fixed with 4% paraformaldehyde, washed in PBS and blocked with PBS containing 2% BSA and 0.1% Triton X-100. Rat sera were incubated overnight at a dilution of 1:50. Alexa fluor 546 anti-human IgG (Invitrogen, France) was used as secondary antibody. Positive controls were performed using a rabbit anti-rat AQP4 polyclonal antibody (Millipore, France) and a human serum clearly positive for NMO-IgG.

**Table 3**  
Clinical and histological evaluations of the MOG-injected rats.

Rats	Days post-immunization			Scores		Optic nerves				Spinal cords				Periventricular areas			
	CS $\geq 1$	Max. CS	Sac.	Max.	Sac.	DM	INF	AQP4 <sup>a</sup>	GFAP <sup>a</sup>	DM	INF	AQP4 <sup>a</sup>	GFAP <sup>a</sup>	DM	INF	AQP4 <sup>a</sup>	GFAP <sup>a</sup>
1.	-	-	10	0	0	-	-	0	0	-	+	0	0	-	-	+1	0
2.	-	-	10	0	0	-	-	0	0	-	-	0	0	-	-	+1	+1
3.	-	-	10	0	0	-	-	-1	-1	-	-	0	0	-	-	0	0
4.	-	-	10	0	0	-	-	0	0	-	-	0	0	-	-	0	0
5.	-	-	25	0	0	-	-	-1	-1	-	-	+1	+1	-	-	0	0
6.	-	-	25	0	0	-	-	0	-1	-	-	+1	+1	-	-	0	0
7.	-	-	25	0	0	-	-	-1	0	-	-	+1	+1	-	-	0	0
8.	-	-	25	0	0	-	-	0	0	-	-	0	0	-	-	0	0
9.	19	21	35	5	5	+, ext.	+, marked	-1	0	+, ext.	+, marked	+2	+1	-	-	0	0
10.	45	45	45	1	1	+	+, marked	-1	+1	+	+	+1	+2	-	-	+1	+1
11.	32	34	45	4	4	+	+, marked	-1	+1	+	+	+1	+2	-	-	1	0
12.	45	45	45	4	4	+	+	0	+1	+	+	+1	+2	-	-	0	+1
13.	-	-	45	0	0	-	+	-1	+1	+	+	+1	+1	-	-	+1	+1
14.	22	37	50	2	1	+, ext.	+	-2	-1	+, ext.	+, marked	+1	+2	-	-	+1	0
15.	45	58	60	3	3	+	-	-2	-2	+, ext.	+, marked	+1	0	-	-	+1	+1
16.	58	58	60	1	1	+	-	-1	+1	-	-	0	0	-	-	0	0
17.	64	64	100	1	0	+	+	-1	-2	+	-	+2	+1	-	-	0	0
18.	49	79	100	1	0	+	-	-2	-1	-	-	+2	+2	-	-	0	+1
19.	64	64	100	1	1	+	-	-2	-2	+	-	+1	+1	-	-	+1	0
20.	30	31	160	1	0	-	-	0	+1	-	-	0	+1	-	-	0	0
21.	-	-	160	0	0	+	-	+1	+2	-	-	0	+1	-	-	0	+1
22.	30	33	160	4	0	+, ext.	-	+1	+2	-	-	0	+1	-	-	+1	+1
23.	32	32	160	1	0	+, ext.	-	+1	+2	-	-	+1	+1	-	-	0	+1
24.	-	-	160	0	0	-	-	0	+2	-	-	+1	+1	-	-	0	0
25.	37	37	160	4	0	-	-	0	0	-	-	0	0	-	-	0	0

Three time-points were chosen for sacrifice on the basis of clinical disability as described in the literature, corresponding to the early stage (days 0–29), the disease stage when clinical signs were visible (days 30–70) and the late stage (after 70 days), when no further clinical signs were noted.

<sup>a</sup> For AQP4/GFAP, histological scores were assessed as follows: 1, -2 graduated decreased expression, 0 no modification compared to IFA-injected rats, +1, +2 graduated increased expression (for details see Experimental procedures). CS: clinical score; DM: demyelination; INF: inflammation. Max.: maximal; Sac.: sacrifice; Ext.: extensive.

### 2.8. Statistical analysis

A Mann–Whitney *U* test was used to analyze MOG immunoreactivity in serum samples of rat immunized with MOG, as a function of postimmunization time. Spearman's rank correlation test and coefficients (*r*) were used to test a sequence of pairs of values including the clinical score, the OD, the presence of demyelination, inflammation and the histological AQP4 and GFAP scores in the optic nerves, spinal cord and periventricular areas for all the rats at each stage of the disease. Bonferroni correction was made because of multiple comparisons performed for statistical correlation. Two-sided *p* values <0.005 were considered statistically significant. Statistical analysis was performed using SPSS 14.0 for Windows (SPSS Inc., Chicago, USA).

## 3. Results

### 3.1. Clinical course of MOG-induced EAE

All animals were evaluated daily using the clinical scale described in Section 2.3. In the control groups, no disability was detected. Clinical data for MOG-immunized rats at different time points (early, disease and late stages) are summarized in Table 3. After immunization with MOG, the mean time to the first clinical

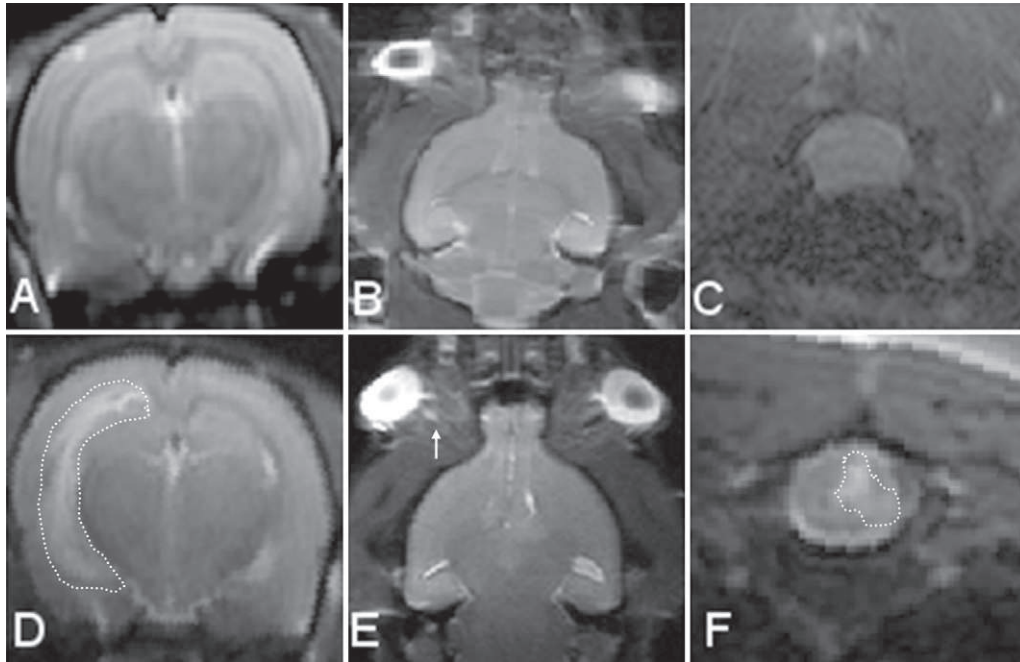

**Fig. 2.** Brain, optic nerve and spinal cord MRI in control and MOG-immunized rats. The figure shows brain, optic nerve and spinal cord in control rats (A–C) and MOG-immunized rats (D–F). During the disease stage at day 30 in the three rats examined by MRI, T2-hypersignals were detected in the periventricular area and optic nerves of two rats (D and E) and the spinal cord in one rat (F). The dotted lines in D and F delineate the T2-hypersignal in the periventricular area and spinal cord, respectively. The arrow in E shows T2-hypersignal in the optic nerve.

score  $\geq 1$  was  $41 \pm 14$  days and  $46 \pm 16$  days to the maximal clinical score. As expected, only two MOG-immunized rats developed clinical signs during the early stage of the disease. MOG-induced EAE was observed in 82% of rats at the two subsequent stages of the disease. A single clinical event was observed in 93% of rats, followed by an onset of recovery. Only one rat experienced a relapsing course, with two distinct clinical events five days apart. No progressive course was noted. No rats died during the clinical course.

### 3.2. Lesion topography

#### 3.2.1. Topography of the lesions by MRI

No abnormality was observed in control rats at the different stages of the experimental procedure. In MOG-injected rats, during the early stage, the animals were healthy and the MRI scans were similar to controls (Fig. 2A–C). Out of the three rats examined in the disease stage at day 30, T2-hypersignal abnormalities were observed in the periventricular zone (Fig. 2D) and optic nerve (Fig. 2E) in two rats and one rat showed abnormalities in the spinal cord (Fig. 2F). MRI follow-up of these rats showed a persisting T2-hypersignal in the spinal cord whereas other abnormalities disappeared after day 45, when the clinical disability score was dramatically reduced. MRI examination of four additional rats at day 45 showed T2-hypersignal in the spinal cord of two rats only. After day 70, no abnormal T2-hypersignal was identified in these regions of interest.

#### 3.2.2. Topography of demyelination and inflammation

No histopathological signs of EAE were observed in the control group. Chronological evaluation of demyelination and inflammation in the rats immunized with MOG is reported in Table 3. In these rats, the brain was always spared whereas signs of demyelination were found in the spinal cord, optic nerves/tracts and optic chiasmata at the disease and late disease stages. None of the rats sacrificed at the early stage presented demyelination or inflammation

in the optic nerve. During the disease stage, demyelination was noted in more than 80% of the optic nerves (Fig. 3A and B) and spinal cords (Fig. 3G–I). Most of them were strongly infiltrated by inflammatory ED1 positive cells in demyelinated areas of the optic nerve (Fig. 3C–F) and spinal cord (Fig. 3J–M). Out of seven animals with optic nerve involvement, demyelination was bilateral in two animals. In the spinal cord, three rats experienced extensive demyelination with transverse myelitis affecting the cervical, thoracic and lumbosacral regions. At the late stage, we mainly observed isolated demyelination without inflammatory cells and bilateral optic nerve demyelination was noted in two rats whereas no extensive myelitis was observed.

### 3.3. Expression of AQP4 and GFAP

The analysis of the intensity of immunostaining was performed using antibodies against AQP4 to examine AQP4 expression during the development of the disease, whereas antibodies against GFAP were used to evaluate astrocyte expression. Scores were calculated on the basis of AQP4 and GFAP immunostaining in IFA rats at the different stages of experimentation (see Experimental procedures). AQP4 and GFAP histological scores are presented in Table 3. In the optic nerve, immunoreactivity to AQP4 and GFAP was mildly decreased at the early stage, before the onset of visible demyelination and inflammation. During the disease stage, AQP4 levels continued to decrease while GFAP levels increased significantly and remained high until the late stage of the disease. AQP4 and GFAP levels in the spinal cord and periventricular area were increased constantly throughout all three stages but the level in the periventricular area showed lower scores when compared with the spinal cord.

Optic nerve transverse sections of MOG-immunized rats, at the early stage, showed reduced AQP4 and GFAP immunostaining in 3/8 rats examined (Fig. 4B and F). At the disease stage, a decrease

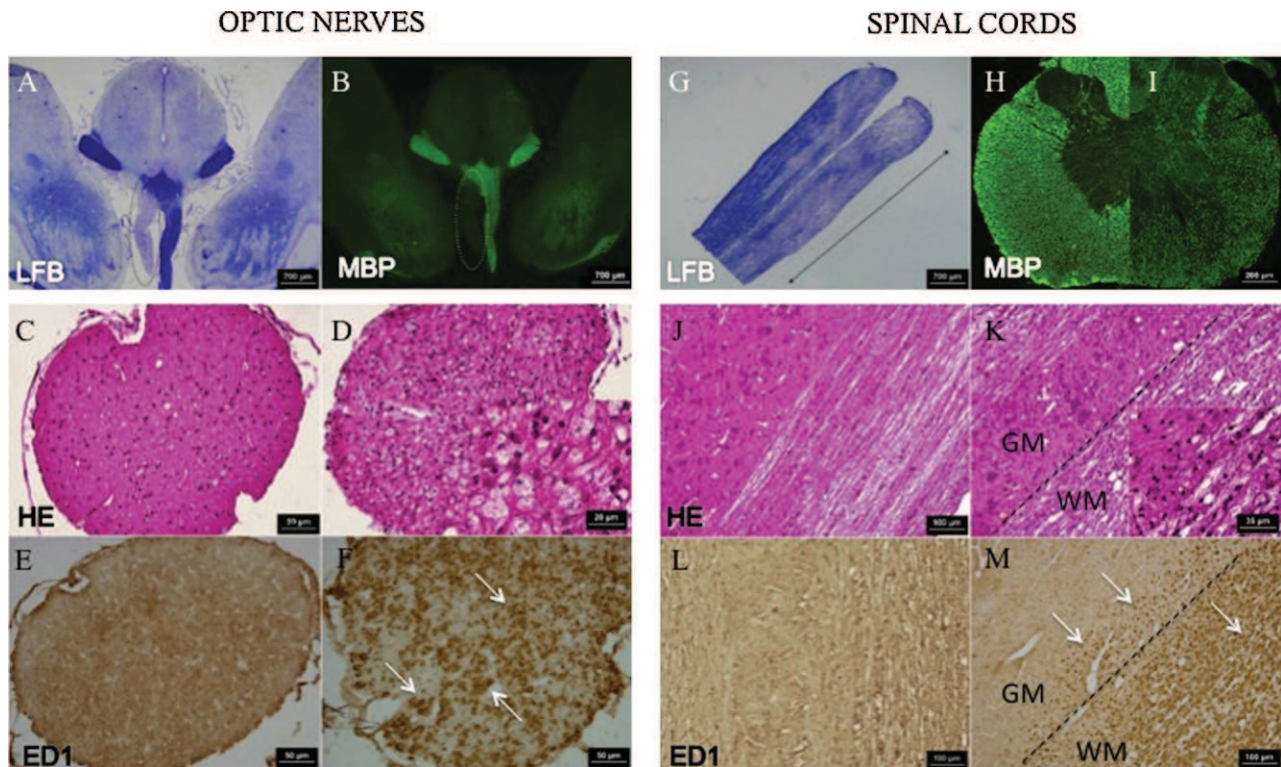
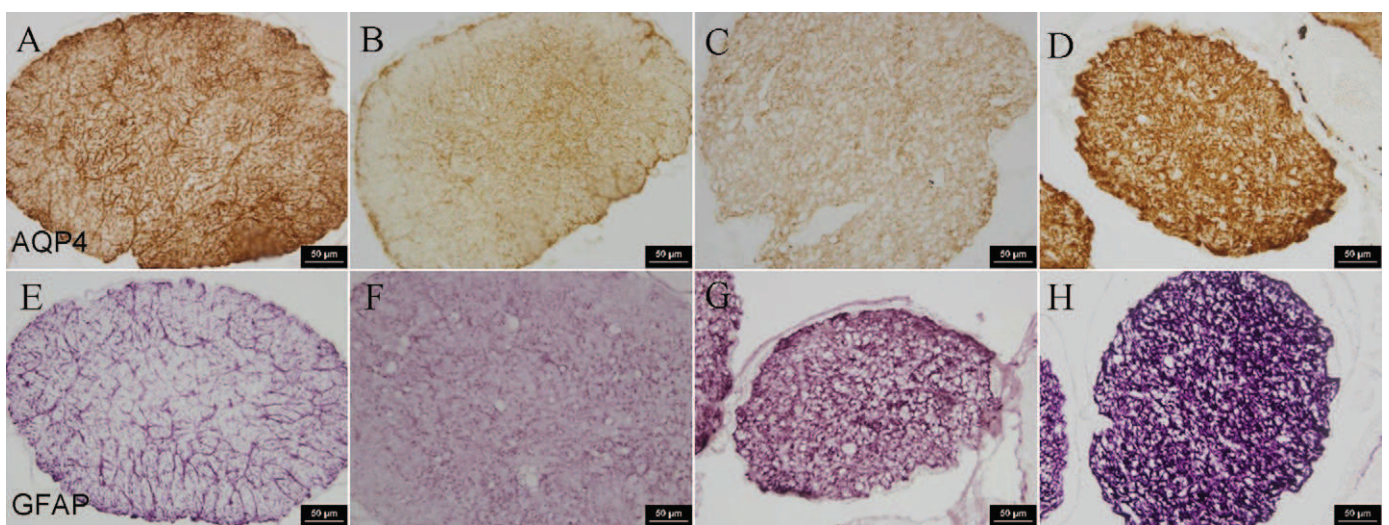

**Fig. 3.** Optic neuritis and myelitis at the disease stage in MOG-immunized rats. The longitudinal diencephalic section reveals a defect in blue staining with LFB/c in the left optic nerve (A, dotted line). The same section of the same rat confirms a loss of myelin, as shown by a loss of MBP immunostaining, corresponding to a whole unilateral demyelination of the optic nerve (B, dotted line). Compared to control rats (C), transverse sections of a demyelinated optic nerve (D) stained with HE shows marked mononuclear cell infiltration with phagocytic activity in the whole section, as shown at higher magnification in box D and attested by the ED1 immunostaining. Compared to control (E), infiltrating cells (arrows) were revealed by ED1 immunostaining in (F). The longitudinal section of thoracic spinal cord in a rat at the disease stage shows a defect in blue staining with LFB/c, corresponding to extensive myelitis, over 6 mm (G, double arrow). The transverse section of the same rat confirms the loss of myelin through reduced MBP immunostaining and shows transverse demyelination (I, right side) compared to control rats (H, left side). Compared to control rats (J), coloration with HE in a demyelinated spinal cord area shows cell infiltration in the gray and white matter (K). Higher magnification in this box shows marked cells infiltration, ED1 positive (M, arrows) compared to control (L).

in the expression of AQP4 was observed in 7/8 rats (Fig. 4C). In comparison, GFAP expression increased in 5/8 and 5/9 animals at the disease (Fig. 4G) and late stages (Fig. 4H) respectively. AQP4 immunostaining intensity remained lower for a longer time than

GFAP in some animals, with 3/9 rats showing decreased levels and 3/9 showing increased levels at the late stage (Fig. 4D).

In spinal cord of affected rats, an increased AQP4 immunostaining level was accompanied by an increase in GFAP



**Fig. 4.** AQP4 and GFAP immunostaining in the optic nerve of control and MOG-immunized rats with histological scores (HS) (for detail of the histological score, see Experimental procedures) during the disease process. The figure illustrates AQP4 and GFAP immunostaining in the optic nerve of control (A and E) and MOG-immunized rats (B–D, F–H). In the optic nerve, decreased expression of AQP4 (–1) was noted at the early stage (B), with a maximal decrease at the disease stage (–2) (C). AQP4 overexpression was delayed until the late stage of the disease (+2) (D). A decreased expression of GFAP (–1) was observed at the early stage (F). A progressive overexpression of GFAP was noted from the disease stage (+1) (G) to the late stage of disease (+2) (H).

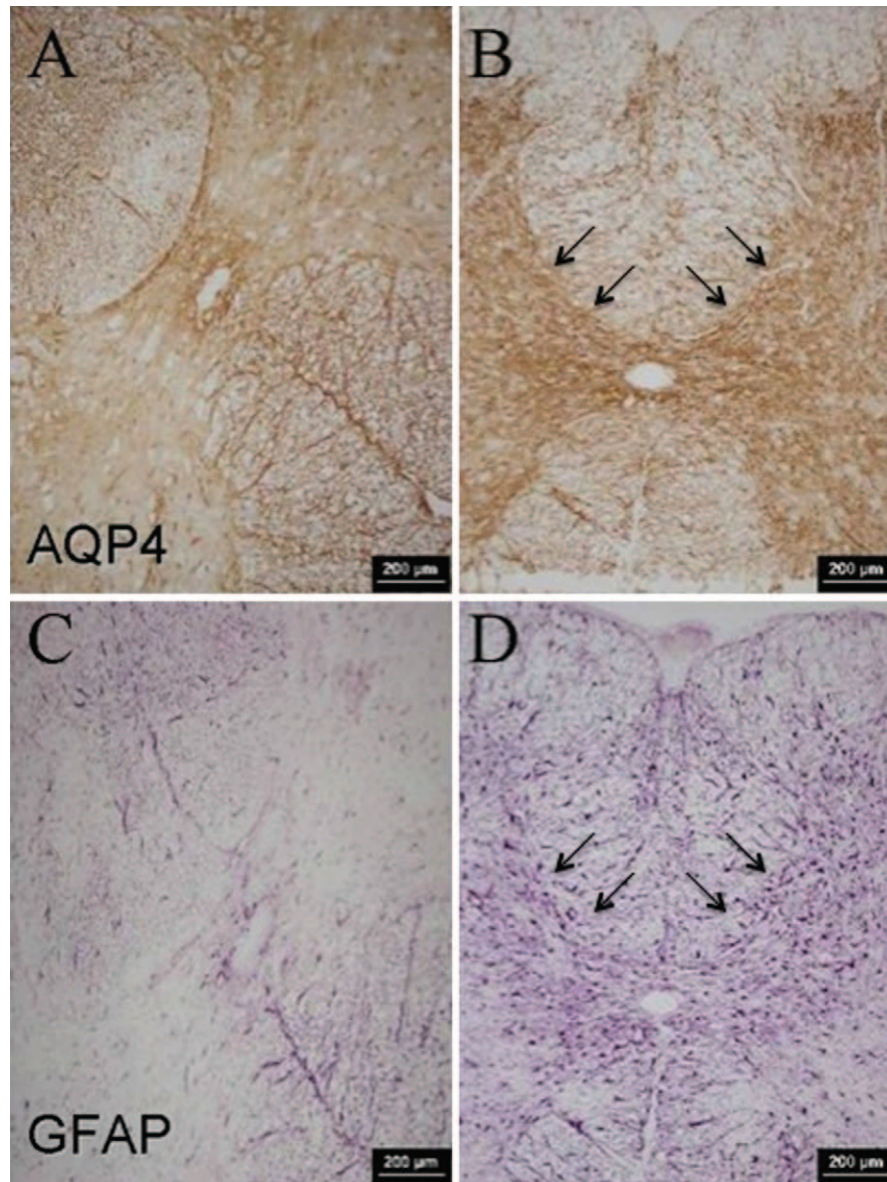

**Fig. 5.** Disease stage: AQP4 and GFAP immunostaining in the spinal cord of control and MOG-immunized rats with histological scores (HS) (for detail of the histological score, see Experimental procedures). The figure illustrates AQP4 and GFAP immunostaining in the spinal cord of control (A and C) and MOG-immunized rats at the disease stage (B and D) at the same spinal cord level. In the spinal cord, a continuous increase in expression of AQP4 (+2, arrows in B) and GFAP (+2, arrows in D) associated with gliosis and astrocytic hypertrophy was observed during demyelination.

immunoreactivity at the early stage in 3/8 rats. At the disease stage, both AQP4 and GFAP immunostaining intensities were increased in 7/8 rats and 6/8 rats, and was observed in both the gray and white matter of the spinal cord (Fig. 5B and D). The immunoreactivity was particularly strong at the disease stage and accompanied by astrocytic hypertrophy (Fig. 5D) when compared to controls (Fig. 5C). At the late stage, both AQP4 and GFAP immunostaining intensities were increased in 5/9 rats and 8/9 rats. Brain periventricular areas showed a slight increase in AQP4 and GFAP immunostaining at the early stage. The level of both markers continued to increase during the disease stage (Fig. 6B and D) and remained high until the late stage.

#### 3.4. Expression of caspase3

The analysis of apoptosis was performed using antibodies against caspase3, a protein which plays a central role in the

execution-phase of cell apoptosis. Whereas no significant apoptosis was observed in the optic nerves during the disease process (data not shown), a statistically significant increase of apoptotic cells was noted in the spinal cord at the disease stage compared to controls and rats at early stage (Fig. 7A–C). At the disease stage, the majority of caspase3 positive cells are GFAP positive (Fig. 7D–E). At the late stage, the cell death of astrocyte/GFAP positive is observed at higher rate.

#### 3.5. Immunological evaluation

##### 3.5.1. ELISA detection of immunoreactivity against MOG and AQP4

ELISA experiments confirmed that immunization with rMOG induced an antibody response increasing from day 0 to day 46, when the maximal OD was noted (Fig. 8). No significant

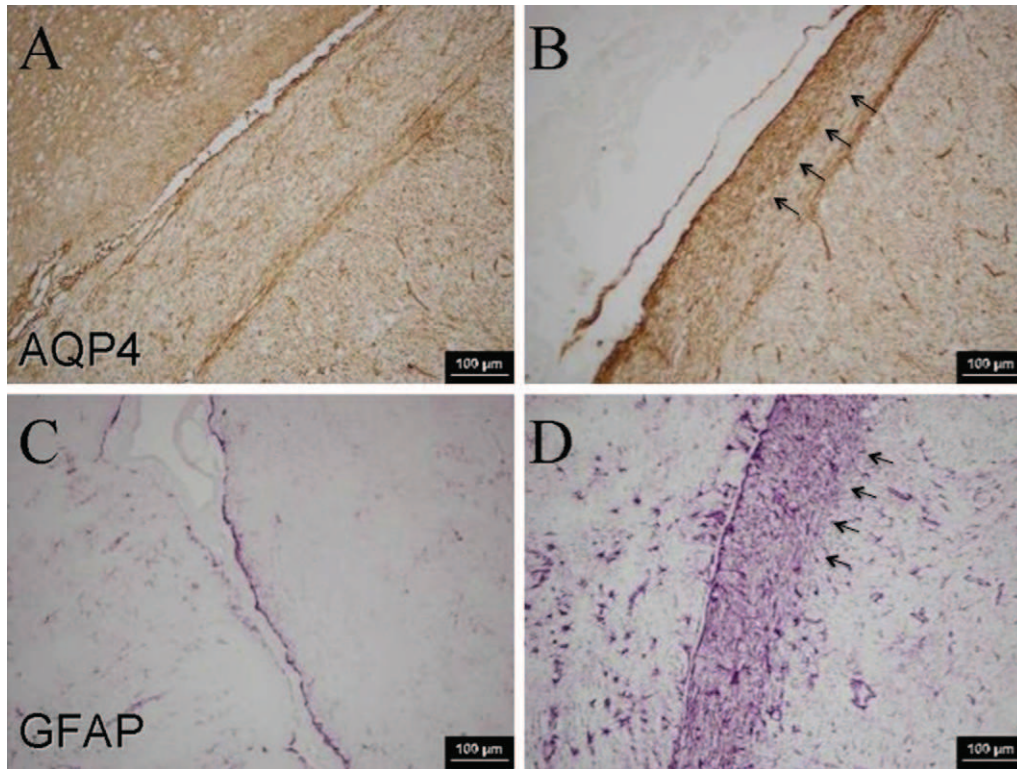

**Fig. 6.** Disease stage: AQP4 and GFAP immunostaining in periventricular areas of control and MOG-immunized rats with histological scores (HS) (for detail of the histological score, see Experimental procedures). The figure illustrates AQP4 and GFAP immunostaining in periventricular areas of control (A and C) and MOG-immunized rats at the disease stage (B and D). In the brain, a moderate, continuous increase in expression of AQP4 (+1, arrows in B) and GFAP (+1, arrows in D), accompanied by gliosis and astrocytic hypertrophy was observed without demyelination.

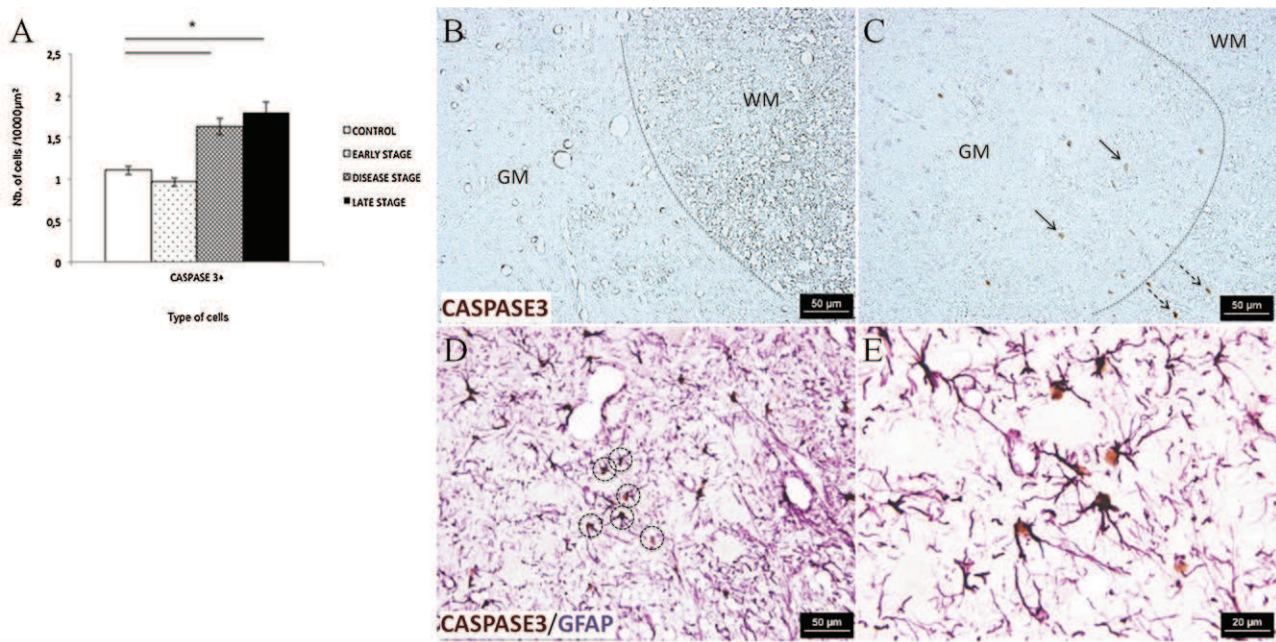

**Fig. 7.** Evaluation of GFAP and caspase3 immunostaining in spinal cords of control and MOG-immunized rats. Mean number of caspase3 positive cells is increased in the rats at the disease and late stage compared to controls (A). Compared to control (B), caspase3 marked cells in MOG-immunized rat at the disease stage were localized in gray (solid arrows) and white matter (dotted arrows) of the spinal cord (C). Double immunostaining with GFAP and caspase3 revealed a pronounced astrocytic apoptosis at the disease stage (D). Cells delineated with dotted circles in D are presented at higher magnification in E. \*  $p < 0.001$ ; GM = gray matter; WM = white matter.

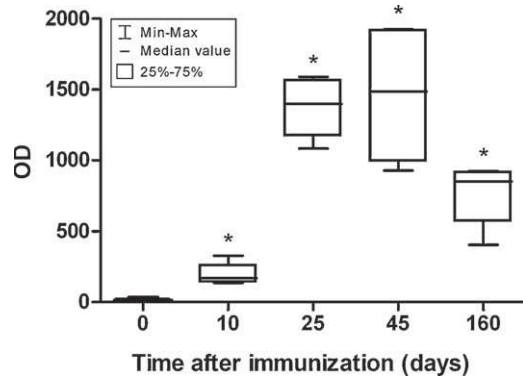

**Fig. 8.** Boxplot of MOG immunoreactivity (ELISA) in serum samples of MOG-immunized rat, as a function of post-immunization time. Before immunization (day 0), the mean optical density (OD) was (mean  $\pm$  standard deviation)  $14 \pm 8$  ( $n=7$ ). After immunization, the mean OD was  $200 \pm 89$  at day 10 ( $n=4$ ) and  $1368 \pm 242$  at day 25 ( $n=4$ ) for the early stage of the disease and  $1456 \pm 539$  at day 45 ( $n=4$ ) at the disease stage. At the late stage, the mean OD was  $779 \pm 196$  at day 160 ( $n=6$ ). \* Statistical difference compared to day 0.

immunoreactivity against individual AQP4 peptides described in Table 1 was found by ELISA.

### 3.5.2. AQP4-Ig assay detection of immunoreactivity against AQP4

Rat sera tested against conformational AQP4 using the immunofluorescence and immunocytochemical techniques with human AQP4 transfected cell line were also negative (data not shown).

### 3.6. Correlations between the clinical and histological scores and MOG antibody level

Using a nonparametric test, we observed a correlation between the high clinical score at sacrifice and the increase in histological scores for demyelination and inflammation in the optic nerve ( $r=0.6$ ;  $p<0.001$ ) and spinal cord ( $r=0.8$ ;  $p<0.001$ ). The modification of histological scores for AQP4 was not correlated with clinical scores in the spinal cord ( $r=0.3$ ;  $p=0.02$ ), optic nerve ( $r=-0.5$ ;  $p=0.02$ ) or periventricular area ( $r=0.3$ ;  $p=0.1$ ). The modification of histological scores for GFAP was not correlated with clinical scores in the spinal cord ( $r=0.3$ ;  $p=0.51$ ), optic nerve ( $r=-0.1$ ;  $p=0.74$ ) or periventricular area ( $r=0.03$ ;  $p=0.84$ ). No correlation was found between the clinical scores and the level of MOG antibodies in immunized rat sera ( $r=0.4$ ;  $p=0.1$ ).

## 4. Discussion

In this study, we characterized by MRI and histology the optospinal phenotype of the BN MOG-induced model of demyelination. We added to its previous description the involvement of the periventricular area and we recorded the expression of myelin, AQP4 and GFAP in the optic nerves, spinal cords and periventricular areas. The modification of AQP4 level and astrocyte apoptosis occurred despite the absence of antibodies tested against linear and conformational epitopes of AQP4. Furthermore, the elevation of disability scores in rats was only synchronized with the severity of demyelination/inflammation in the optic nerve and spinal cord but not with the modification of AQP4 or GFAP expression.

In the present study, we added the involvement of the periventricular area to the optospinal phenotype in the BN MOG-induced animal model. This area was free of demyelination during the disease process but showed T2-hypersignal on MRI at the disease stage. This observation indicated a water flux abnormality in this area and was supported by a local modification of AQP4 expression,

playing a crucial role in water transport across the blood–brain barrier. With the optic nerve and spinal cord, the periventricular area underlines the implication of regions containing high levels of AQP4 in this model (Nielsen et al., 1997; Venero et al., 1999).

AQP4 immunostaining showed different patterns of expression in the three regions of interest. During the disease process in the optic nerve, we observed a transiently low level of AQP4, which starts before demyelination, and can be attributed to vasogenic edema, blood–brain barrier impairment and/or inflammation that may result in astrocyte degeneration (Ke et al., 2001; Sattler et al., 2008). In view of the excess fluid seen in the white matter and the regressive T2-hypersignal observed at the disease stage in the optic nerve, vasogenic edema seems to be the main actor in the AQP4 physiopathological process. During the later stage, a healing process may explain the extensive gliosis and increased AQP4 expression. In contrast, astrocytes in the spinal cord and the periventricular areas of the brain became hypertrophic early on in the gray and white matter and expressed higher immunoreactivity to AQP4 throughout the disease course. This finding may have resulted from cytotoxic edema fluid, characterized by astrocyte hypertrophy, which is known to accumulate in both the gray and white matter (Papadopoulos et al., 2004). This hypothesis is also supported by the persistent T2-hypersignal MRI in the spinal cord at the late stage, whereas the course of the vasogenic edema is usually regressive after the inflammatory process. Further experimentation with diffusion and gadolinium MRI is in progress in our laboratory to try to resolve this question.

Analysis of apoptotic cells showed a pronounced astrocytic death in spinal cord at the disease stage. Oppositely to classical EAE in which massive oligodendrocyte cell death was observed (Hisahara et al., 2003), the cell death in this model involves mainly astrocytes. In human, this data argues for an antibody-independent AQP4 astrocytopathy in the MOG-induced model of demyelination, as observed in heterogenous demyelinating conditions including Baló's disease, NMO and MS (Kira, 2011).

As expected, disability was correlated with the presence of demyelinating and inflammatory lesions. On the opposite, disability was not correlated with the AQP4 response as attested by the increasing immunostaining level of AQP4 in the spinal cord and the decreasing immunostaining level in the optic nerve. No correlation was found between disability and the level of GFAP expression in the spinal cord because astrogliosis at the late stage of the disease may represent the glial scar in a monophasic disease without sequelae at the late stage. Nevertheless, the expected differences between the type of edema in the spinal cord and optic nerve suggest that there may also be differences in the physiological functions of the blood–brain barrier and the blood–spinal cord barrier (Saadoun and Papadopoulos, 2010).

In EAE animal models, few studies reported an increase in AQP4 expression in the spinal cord and brain using RT-PCR (Miyamoto et al., 2009) or a strong astrocyte reactivity in the spinal cord by immunohistochemistry (Pham et al., 2009). No data were available about modifications in the expression of both AQP4 and GFAP in the reported EAE models in the optic nerve or the location of acute AQP4 overexpression in the brain. A recent study in a MOG-induced EAE model showed the attenuation of disease progression in AQP4 knockout mice (Li et al., 2009). Other experimental data were obtained with a MOG-induced EAE model in NOD/Lt and C57BL/6 mice, known to develop a diffuse inflammatory process not limited to the optospinal location. Furthermore, CFA and pertussis toxin were largely used, which are known to alter the blood–brain barrier permeability (Lu et al., 2008; Namer et al., 1994).

Comparison with optospinal demyelinating diseases in humans suggests that whereas an NMO-like phenotype is observed in this model, the course of AQP4/GFAP expression during the disease process is closer to optospinal MS than NMO. Effectively, the



overexpression of AQP4 in the spinal cord has been observed in MS but not in NMO. Furthermore, no antibody against linear and conformational epitopes of AQP4 was found. On the other hand, 50% of patients with NMO experienced brain involvement (including the periventricular region) during the disease course, and 30–50% of patients test negative to NMO antibodies. Lastly, the decrease of AQP4 expression before demyelination in the optic nerve fits what is observed in NMO. Altogether, our experimental data raise the question of a continuum between opticospinal MS and the seronegative NMO subtype, reported in several countries (Cabre et al., 2009; Collongues et al., 2010; Misu et al., 2002).

## 5. Conclusion

At this point, several authors have attempted to reproduce NMO lesions in an animal model. In the animal models involving the injection of anti-AQP4 antibody (Bradl et al., 2009; Kinoshita et al., 2009), the pathogenicity of such antibodies has been clearly demonstrated but no animal has concomitantly developed opticospinal demyelination. The animals of our BNMog-induced model develop an NMO-phenotype, an early implication of AQP4 in the optic nerves due to vasogenic edema and a pronounced astrocytic apoptosis in spinal cord during the disease process. Disability was correlated with the intensity of the inflammatory process in the demyelinated spinal cord and optic nerve. Despite these similarities with NMO in humans, the cytotoxic edema with AQP4 overexpression in the spinal cord during the disease process, the involvement of periventricular area and the absence of anti-AQP4 antibodies are closer to what is observed in MS. We think that this model raises the question of a continuum between opticospinal MS and the seronegative NMO subtype.

## Acknowledgments

This work was supported by the Société Française de Neurologie (Nicolas Collongues) and the Académie de Médecine (Jean-Baptiste Chanson). We thank Veronique Rogemond and Gaelle Cavaillon for their technical assistance in NMO-IgG and AQP4 transfected cell assays, Blandine Guignard for her technical support in MRI scan acquisitions, Prof. Pierre Meyer for his contribution to the statistical analysis and Nathalie Heider for correcting the English.

## References

- Bettelli, E., Baeten, D., Jager, A., Sobel, R.A., Kuchroo, V.K., 2006. Myelin oligodendrocyte glycoprotein-specific T and B cells cooperate to induce a Devic-like disease in mice. *Journal of Clinical Investigation* 116, 2393–2402.
- Bradl, M., Misu, T., Takahashi, T., Watanabe, M., Mader, S., Reindl, M., Adzemovic, M., Bauer, J., Berger, T., Fujihara, K., Itoyama, Y., Lassmann, H., 2009. Neuromyelitis optica: pathogenicity of patient immunoglobulin in vivo. *Annals of Neurology* 66, 630–643.
- Cabre, P., Gonzalez-Quevedo, A., Bonnan, M., Saiz, A., Olindo, S., Graus, F., Smadja, D., Merle, H., Thomas, L., Cabrera-Gomez, J.A., 2009. Relapsing neuromyelitis optica: long term history and clinical predictors of death. *Journal of Neurology, Neurosurgery and Psychiatry* 80, 1162–1164.
- Collongues, N., Marignier, R., Zephir, H., Papeix, C., Blanc, F., Ritzler, C., Tchikviladze, M., Outteryck, O., Vukusic, S., Fleury, M., Fontaine, B., Brassat, D., Clanet, M., Milh, M., Pelletier, J., Audoin, B., Ruet, A., Lebrun-Frenay, C., Thouvenot, E., Camu, W., Debouverie, M., Creange, A., Moreau, T., Labauge, P., Castelnovo, G., Edan, G., Le Page, E., Defer, G., Barroso, B., Heinzlef, O., Gout, O., Rodriguez, D., Wiertlewski, S., Laplaud, D., Borgel, F., Tournaire, P., Grimaud, J., Brochet, B., Vermersch, P., Confavreux, C., de Seze, J., 2010. Neuromyelitis optica in France: a multicenter study of 125 patients. *Neurology* 74, 736–742.
- Delarasse, C., Daubas, P., Mars, L.T., Vizler, C., Litztenburger, T., Iglesias, A., Bauer, J., Della Gaspera, B., Schubart, A., Decker, L., Dimitri, D., Roussel, G., Dierich, A., Amor, S., Dautigny, A., Liblau, R., Pham-Dinh, D., 2003. Myelin/oligodendrocyte glycoprotein-deficient (MOG-deficient) mice reveal lack of immune tolerance to MOG in wild-type mice. *Journal of Clinical Investigation* 112, 544–553.
- Hisahara, S., Okano, H., Miura, M., 2003. Caspase-mediated oligodendrocyte cell death in the pathogenesis of autoimmune demyelination. *Neuroscience Research* 46, 387–397.
- Ke, C., Poon, W.S., Ng, H.K., Pang, J.C., Chan, Y., 2001. Heterogeneous responses of aquaporin-4 in oedema formation in a replicated severe traumatic brain injury model in rats. *Neuroscience Letters* 301, 21–24.
- Kinoshita, M., Nakatsuji, Y., Kimura, T., Moriya, M., Takata, K., Okuno, T., Kumanogoh, A., Kajiyama, K., Yoshikawa, H., Sakoda, S., 2009. Neuromyelitis optica: passive transfer to rats by human immunoglobulin. *Biochemical and Biophysical Research Communications* 386, 623–627.
- Kira, J., 2011. Autoimmunity in neuromyelitis optica and opticospinal multiple sclerosis: astrocytopathy as a common denominator in demyelinating disorders. *Journal of the Neurological Sciences* 311, 69–77.
- Krishnamoorthy, G., Lassmann, H., Wekerle, H., Holz, A., 2006. Spontaneous opticospinal encephalomyelitis in a double-transgenic mouse model of autoimmune T cell/B cell cooperation. *Journal of Clinical Investigation* 116, 2385–2392.
- Lennon, V.A., Wingerchuk, D.M., Kryzer, T.J., Pittock, S.J., Lucchinetti, C.F., Fujihara, K., Nakashima, I., Weinshenker, B.G., 2004. A serum autoantibody marker of neuromyelitis optica: distinction from multiple sclerosis. *Lancet* 364, 2106–2112.
- Li, L., Zhang, H., Verkman, A.S., 2009. Greatly attenuated experimental autoimmune encephalomyelitis in aquaporin-4 knockout mice. *BMC Neuroscience* 10, 94.
- Linington, C., Webb, M., Woodhams, P.L., 1984. A novel myelin-associated glycoprotein defined by a mouse monoclonal antibody. *Journal of Neuroimmunology* 6, 387–396.
- Lu, C., Pelech, S., Zhang, H., Bond, J., Spach, K., Noubade, R., Blankenhorn, E.P., Teuscher, C., 2008. Pertussis toxin induces angiogenesis in brain microvascular endothelial cells. *Journal of Neuroscience Research* 86, 2624–2640.
- Marignier, R., Nicolle, A., Watrin, C., Touret, M., Cavagna, S., Varrin-Doyer, M., Cavillon, G., Rogemond, V., Confavreux, C., Honnorat, J., Giraudon, P., 2010. Oligodendrocytes are damaged by neuromyelitis optica immunoglobulin G via astrocyte injury. *Brain* 133, 2578–2591.
- Mata, S., Loll, F., 2011. Neuromyelitis optica: an update. *Journal of the Neurological Sciences* 303, 13–21.
- Misu, T., Fujihara, K., Kakita, A., Konno, H., Nakamura, M., Watanabe, S., Takahashi, T., Nakashima, I., Takahashi, H., Itoyama, Y., 2007. Loss of aquaporin 4 in lesions of neuromyelitis optica: distinction from multiple sclerosis. *Brain* 130, 1224–1234.
- Misu, T., Fujihara, K., Nakashima, I., Miyazawa, I., Okita, N., Takase, S., Itoyama, Y., 2002. Pure optic-spinal form of multiple sclerosis in Japan. *Brain* 125, 2460–2468.
- Miyamoto, K., Nagaosa, N., Motoyama, M., Kataoka, K., Kusunoki, S., 2009. Upregulation of water channel aquaporin-4 in experimental autoimmune encephalomyelitis. *Journal of the Neurological Sciences* 276, 103–107.
- Nagelhus, E.A., Veruki, M.L., Torp, R., Haug, F.M., Laake, J.H., Nielsen, S., Agre, P., Ottersen, O.P., 1998. Aquaporin-4 water channel protein in the rat retina and optic nerve: polarized expression in Muller cells and fibrous astrocytes. *Journal of Neuroscience* 18, 2506–2519.
- Namer, J.J., Steibel, J., Poulet, P., Mauss, Y., Mohr, M., Chambron, J., 1994. The role of Mycobacterium tuberculosis in experimental allergic encephalomyelitis. *European Neurology* 34, 224–227.
- Nielsen, S., Nagelhus, E.A., Amiry-Moghaddam, M., Bourque, C., Agre, P., Ottersen, O.P., 1997. Specialized membrane domains for water transport in glial cells: high-resolution immunogold cytochemistry of aquaporin-4 in rat brain. *Journal of Neuroscience* 17, 171–180.
- Pagany, M., Jagodic, M., Bourquin, C., Olsson, T., Linington, C., 2003. Genetic variation in myelin oligodendrocyte glycoprotein expression and susceptibility to experimental autoimmune encephalomyelitis. *Journal of Neuroimmunology* 139, 1–8.
- Papadopoulos, M.C., Manley, G.T., Krishna, S., Verkman, A.S., 2004. Aquaporin-4 facilitates reabsorption of excess fluid in vasogenic brain edema. *FASEB Journal* 18, 1291–1293.
- Pham, H., Ramp, A.A., Klonis, N., Ng, S.W., Klopstein, A., Ayers, M.M., Orian, J.M., 2009. The astrocytic response in early experimental autoimmune encephalomyelitis occurs across both the grey and white matter compartments. *Journal of Neuroimmunology* 208, 30–39.
- Pittock, S.J., Lennon, V.A., Krecke, K., Wingerchuk, D.M., Lucchinetti, C.F., Weinshenker, B.G., 2006. Brain abnormalities in neuromyelitis optica. *Archives of Neurology* 63, 390–396.
- Roemer, S.F., Parisi, J.E., Lennon, V.A., Benarroch, E.E., Lassmann, H., Bruck, W., Mandler, R.N., Weinshenker, B.G., Pittock, S.J., Wingerchuk, D.M., Lucchinetti, C.F., 2007. Pattern-specific loss of aquaporin-4 immunoreactivity distinguishes neuromyelitis optica from multiple sclerosis. *Brain* 130, 1194–1205.
- Saadoun, S., Papadopoulos, M.C., 2010. Aquaporin-4 in brain and spinal cord oedema. *Neuroscience* 168, 1036–1046.
- Sakuma, H., Kohyama, K., Park, I.K., Miyakoshi, A., Tanuma, N., Matsumoto, Y., 2004. Clinicopathological study of a myelin oligodendrocyte glycoprotein-induced demyelinating disease in LEW.1AV1 rats. *Brain* 127, 2201–2213.
- Sattler, M.B., Togni, M., Gadajski, I., Suhs, K.W., Meyer, N., Bahr, M., Diem, R., 2008. Strain-specific susceptibility for neurodegeneration in a rat model of autoimmune optic neuritis. *Journal of Neuroimmunology* 193, 77–86.
- Sinclair, C., Kirk, J., Herron, B., Fitzgerald, U., McQuaid, S., 2007. Absence of aquaporin-4 expression in lesions of neuromyelitis optica but increased expression in multiple sclerosis lesions and normal-appearing white matter. *Acta Neuropathologica* 113, 187–194.
- Steffler, A., Brehm, U., Storch, M., Lambrecht-Washington, D., Bourquin, C., Wonigeit, K., Lassmann, H., Linington, C., 1999. Myelin oligodendrocyte glycoprotein induces experimental autoimmune encephalomyelitis in the “resistant” Brown Norway rat: disease susceptibility is determined by MHC and MHC-linked effects on the B cell response. *Journal of Immunology* 163, 40–49.

- Storch, M.K., Stefferl, A., Brehm, U., Weissert, R., Wallstrom, E., Kerschensteiner, M., Olsson, T., Linington, C., Lassmann, H., 1998. Autoimmunity to myelin oligodendrocyte glycoprotein in rats mimics the spectrum of multiple sclerosis pathology. *Brain Pathology* 8, 681–694.
- Venero, J.L., Vizuete, M.L., Ilundain, A.A., Machado, A., Echevarria, M., Cano, J., 1999. Detailed localization of aquaporin-4 messenger RNA in the CNS: preferential expression in periventricular organs. *Neuroscience* 94, 239–250.
- Vitellaro-Zuccarello, L., Mazzetti, S., Bosisio, P., Monti, C., De Biasi, S., 2005. Distribution of Aquaporin 4 in rodent spinal cord: relationship with astrocyte markers and chondroitin sulfate proteoglycans. *Glia* 51, 148–159.