



HAL
open science

The role of ROS signaling in adult regeneration and development

Francesca Meda

► **To cite this version:**

Francesca Meda. The role of ROS signaling in adult regeneration and development. Biochemistry, Molecular Biology. Université Paris sciences et lettres, 2016. English. NNT : 2016PSLEE007 . tel-01413425

HAL Id: tel-01413425

<https://theses.hal.science/tel-01413425>

Submitted on 9 Dec 2016

HAL is a multi-disciplinary open access archive for the deposit and dissemination of scientific research documents, whether they are published or not. The documents may come from teaching and research institutions in France or abroad, or from public or private research centers.

L'archive ouverte pluridisciplinaire **HAL**, est destinée au dépôt et à la diffusion de documents scientifiques de niveau recherche, publiés ou non, émanant des établissements d'enseignement et de recherche français ou étrangers, des laboratoires publics ou privés.

THÈSE DE DOCTORAT

de l'Université de recherche Paris Sciences et Lettres
PSL Research University

Préparée au Collège de France

The role of ROS signaling in adult regeneration and development

Ecole doctorale n°515

COMPLEXITÉ DU VIVANT

Soutenue par **FRANCESCA MEDA**
le 06 Juillet 2016

Dirigée par **Sophie VRIZ**
et **Alain JOLIOT**

COMPOSITION DU JURY :

M. BESSIS Alain
École Normale Supérieure (IBENS), Président

Mme. GALLIOT Brigitte
Université de Genève, Rapporteur

M. MASSAAD Charbel
Université Paris 5, Rapporteur

Mme. SCHNEIDER-MAUNOURY Sylvie
Université Paris 6, Membre du jury

Mme. VRIZ Sophie
Université Paris 7, Directrice de thèse

M. JOLIOT Alain
Collège de France, Co-directeur de thèse



COLLÈGE
DE FRANCE
—1530—



PSL
RESEARCH UNIVERSITY PARIS

*“Discovery consists in seeing what everyone else has seen
and thinking what no one else has thought”*

Albert Szent-Györgyi de Nagyrápolt
(Nobel Prize in Physiology or Medicine 1937)

MANY THANKS TO...

... all the members of my thesis defense committee, for having accepted to be here today and to evaluate my work: Prof. Brigitte Galliot and Prof. Charbel Massaad who revised this manuscript, the president Dr. Alain Bessis, and the examiner Dr. Sylvie Schneider-Maunoury.

... my thesis directors, Prof. Sophie Vríz and Dr. Alain Joliot, for having welcomed me in their newly-formed joined group and given me the opportunity to work in parallel with zebrafish and cell culture, learning from the expertise of both of them. Thank you for your supervision of my work and your support.

... all the present and past members of the “Homeoproteins and Plasticity” group, for the practical help and the time spent together at the bench, for the (not always) scientific discussions, for the “petit goûter” breaks and for all the nice time spent together.

... the members of the office C2.7, the “best office in the world”, for the daily laughs, the French lessons and the serious discussions. Special thanks to our fantastic printer: without that beautiful singing the office would not have been the same.

... Matthieu, for taking care of our aquatic little friends, but also for appreciating my tiramisù.

... the imaging facility, for the help with microscopes, acquisitions and image treatment.

... all the people of the neighboring labs, because even just a smile in the corridor could make each day a better day.

... the friends I met in Paris, for the relaxing time spent outside of the lab.

... the friends who are PhD students, for having shared with me the difficulties but especially the joys on the way to become a “Doctor”.

GRAZIE A...

... la mia famiglia, mamma Giuliana, papà Luigi e “la sore” Ilaria, per avermi sempre aiutato e supportato nelle mie scelte di studio, anche quando queste mi hanno portato a trasferirmi prima in un'altra città e poi addirittura in un altro Stato, e per essermi sempre stati vicini, anche quando eravamo fisicamente lontani.

... le mie coinquiline, le “padovane” e la “parigina”, per aver creato con me una piccola famiglia lontano da casa, per le spedizioni all’Ikea, per le serate karaoke e per le serate telefilm, per i turni di pulizia scritti sul calendario, per i nomi assurdi dati ad ogni oggetto della casa, per le chiacchierate in terrazzo, per gli esperimenti in cucina... e per tutti gli altri momenti passati insieme.

... gli amici che ho lasciato in Italia, perché rendono sempre più bello il tornare a casa, e quelli che sono in giro per il mondo, perché mi danno un motivo in più per fare la valigia e partire.

... “les italiens” del Master di Genetica, per i pranzi, le cene, gli aperitivi e le serate insieme, per il primo anno a Parigi passato a Porte de Clignancourt, per i pomeriggi al parco, per il supporto alla Nazionale Italiana anche in terra straniera, ma soprattutto per avermi fatto sentire “a casa” anche lontano da casa.

... Giacomo, per tante tante cose, ma soprattutto perché mi sopporti... e perché sei disposto a farlo per il resto della vita!

TABLE OF CONTENTS

<u>TABLE OF FIGURES</u>	6
<u>General context and aims of the thesis project</u>	7
1. INTRODUCTION.....	9
1.1. The regeneration process	10
1.1.1. The history of regeneration research	10
1.1.2. Regeneration among metazoans	12
1.1.3. Regeneration and asexual reproduction	17
1.1.4. Regeneration and cellular pluripotentiality	18
1.1.5. Regeneration and development	19
1.1.6. Regeneration and homeostasis	22
1.1.7. Regeneration and scarring	22
1.1.8. A general scheme for the regeneration process.....	23
1.2. Zebrafish and its caudal fin regeneration ability	25
1.2.1. The structure of the adult caudal fin.....	26
1.2.2. The regeneration process of the adult caudal fin.....	27
1.2.3. The signaling pathways involved in the tail regeneration process	29
1.3. The role of nerves during regeneration	33
1.3.1. The neurotrophic hypothesis and the factor X	35
1.4. Reactive Oxygen Species	39
1.4.1. ROS signaling: the mechanisms.....	42
1.4.2. ROS signaling targets: molecules, signaling pathways and cellular processes.....	45
1.4.3. ROS and regeneration	48
1.4.4. ROS as possible mediator between nerves and regeneration process	52
1.4.5. How to visualise ROS (and in particular H ₂ O ₂): HyPer	53
1.5. Hedgehog (Hh) proteins and signaling pathway	56
1.5.1. Expression, processing and secretion of the Hh active peptide	58
1.5.2. Hh signaling pathway	61
1.5.3. Hh signaling during zebrafish fin regeneration.....	66
1.6. Palmitoylation	69
1.6.1. S-palmitoylation: features and targets	71
1.6.2. S-palmitoylation: regulatory effects	72

1.6.3.	S-palmitoylation: the mechanisms	76
1.6.4.	N-palmitoylation of Shh: mechanism and functions	80
1.6.5.	Protein palmitoylation: regulation of axonal growth and synaptic plasticity	83
2.	RESULTS.....	89
2.1.	Nerves control redox levels in mature tissues through Schwann cells and Hedgehog signaling	90
2.2.	Hydrogen peroxide (H ₂ O ₂) controls axon pathfinding during zebrafish development .	110
2.3.	H ₂ O ₂ gradients control protein S-acylation during morphogenesis.....	127
3.	DISCUSSION	141
3.1.	Similarities and differences among different reactive oxygen species	142
3.2.	Gradient formation: a different process between development and regeneration.....	143
3.3.	The relationship between nerves and H ₂ O ₂ (and Sonic Hedgehog)	146
3.3.1.	nAG is a thioredoxin	147
3.4.	Perspectives	149
4.	BIBLIOGRAPHY	151

TABLE OF FIGURES

Figure 1: Regeneration among metazoans.	12
Figure 2: Different regeneration strategies in metazoans.....	14
Figure 3: Increasing regulation of cellular pluripotentiality with increasing morphological complexity.	18
Figure 4: Scaling differences in limb regeneration and development.....	20
Figure 5: Scheme of the tri-modular composition of the regeneration process.	24
Figure 6: Different time scales in the regeneration process of different organisms.....	26
Figure 7: Zebrafish caudal fin skeleton structure.....	27
Figure 8: Schematic representation of the events occurring from fin amputation to blastema formation.	29
Figure 9: Nerve dependence of regeneration.	34
Figure 10: Nerve independence of regeneration in aneurogenic limbs.....	36
Figure 11: Intracellular sources of ROS.....	40
Figure 12: Hydrogen peroxide production and degradation within the cell.....	41
Figure 13: H ₂ O ₂ -mediated cysteine oxidation of redox-sensitive proteins.	43
Figure 14: Possible mechanisms for H ₂ O ₂ -dependent signal transduction.	45
Figure 15: ROS and regeneration.....	50
Figure 16: Genetically encoded fluorescent biosensor HyPer for H ₂ O ₂ measuring.....	54
Figure 17: Shh controls mouse development from an embryo to an adult.....	57
Figure 18: Hedgehog protein maturation.	59
Figure 19: Hh signal transduction in <i>Drosophila</i> and mammalian systems.....	62
Figure 20: Major lipid modifications of proteins.	69
Figure 21: Location of sites of S-acylation in transmembrane and peripheral-membrane proteins.	73
Figure 22: S-acylation regulates multiple steps in the life cycle of membrane and peripheral-membrane proteins.	75
Figure 23: S-palmitoylation process.	78
Figure 24: N-palmitoylation of Shh.	82
Figure 25: Sustained ROS production is essential for regeneration to proceed in adult zebrafish.	90
Figure 26: Gradients formation.....	144
Figure 27: <i>catalase</i> expression in zebrafish embryos.	145
Figure 28: Schematic model for H ₂ O ₂ -nerves interactions during appendage regeneration.....	146
Figure 29: The RUSH system.	150

General context and aims of the thesis project

For long time the reactive oxygen species have been considered only as deleterious compounds for the living organisms, because of their capability to irreversibly damage all biological molecules (nucleic acids, lipids, proteins). However, in the last years it is becoming evident how different ROS possess different characteristics, which lead them to act differently on target biological compounds: whereas the more reactive superoxide anion (O_2^-) and hydroxyl radical (OH^\bullet) are still considered potential dangerous molecules for the cells, the less reactive and more diffusible hydrogen peroxide (H_2O_2) is thought to be a good candidate to act as a signaling molecule and play a role in different cellular pathways.

The main aim of my thesis project was to study the role of hydrogen peroxide signaling during the processes of morphogenesis and adult regeneration.

In the recent years, hydrogen peroxide (H_2O_2) has been found to be a necessary signaling molecule for the processes of regeneration in different species. Moreover, it has also been demonstrated that H_2O_2 promotes axon growth in wounded caudal fin of zebrafish larvae. Since also innervation is known to play a crucial role during the regeneration process, I first wondered if H_2O_2 and nerves could cooperate to promote a successful regeneration process; adult zebrafish caudal fin regeneration appeared to be the good model to study their possible interplay.

I found that H_2O_2 and nerves interact during the regeneration process in a positive feedback loop and that their interaction seems to be mediated by Schwann cells that express Shh signaling.

A similar interaction between nerves and H_2O_2 could take place also during development. Indeed, we observed in the lab that H_2O_2 levels are very dynamic during zebrafish development and, interestingly, relatively high during morphogenesis. In particular, H_2O_2 is present at important concentrations in the optic tectum of the two days post fertilisation embryo. Since at this time of the zebrafish embryo development the retinal ganglion cells (RGCs) start to project their axons precisely toward the optic tectum, we wondered if also in this case H_2O_2 and axonal projections could interact each other.

We found that also during development this interaction takes place and, even in this case, Shh signaling seems to be play a role in the interplay between H_2O_2 and axonal projections.

Finally, another objective of the thesis was to try to understand how H_2O_2 could act specifically at the cellular level and which could be its target during regeneration and development.

It is generally thought that ROS signaling acts on proteins whose activity relies upon active cysteine residues, modifying the oxidation state of the sulphur group of this amino acid. Interestingly, the process of S-acylation, which is important for both the processes of axonal projections growth and Shh protein maturation, consists in the covalent attachment of a fatty acid, often a palmitate, onto a cysteine residue sulphur group. Moreover, similarly to the ROS signaling that induces very rapid and reversible modifications, the process of S-palmitoylation provides rapid and reversible responses to metabolic changes and to cellular environment modifications. For all these reasons, the S-palmitoylation process appears to be a possible target of the ROS signaling.

I then wondered if a relationship between H_2O_2 levels and S-palmitoylation could exist and I found through cell culture experiments that the augmentation of H_2O_2 levels leads to the inhibition of the S-palmitoylation process. This project is still ongoing and the relevance of this result is currently being tested also *in vivo* in zebrafish developing embryos.

1. INTRODUCTION

1.1.The regeneration process

As Charles E. Dinsmore says in his introduction of *A History of Regeneration Research: Milestones in the Evolution of a Science* (Dinsmore Editor, 1991), “regeneration means many things to many people”: the term regeneration is then a diverse concept that can be defined differently depending on the context and that can be linked to different processes as tissue repair, asexual reproduction or cellular pluripotentiality. In general terms, regeneration can be defined as a well-coordinated process that lead to the restoration of cells, tissues, organs or even entire body extremities that have been damaged or lost, recapitulating the missing structures, without the formation of scar tissue, and simultaneously achieving functional integration between the new-formed and the pre-existing tissues (Oviedo and Beane, 2009).

This process has been - and continues to be - very fascinating to many people and nowadays all we know about regeneration is due to our curious and open-minded ancestors who decided to point their attention to the observation and the study of this amazing process. That is why I decided to start this manuscript with a brief overview on the history of the discoveries about regeneration.

1.1.1. The history of regeneration research

The idea of regenerating body parts has probably captured human mind since the beginning of history. The first evidences that prehistoric people realised that they could not regenerate missing body parts date back to the Paleolithic art found in French and Spanish caves, where our ancestors used their own hands as stencil to paint silhouettes on the stones: in some cases, parts of the fingers are missing (Giedion, 1962). Whether this was the result of accidents, ritual amputation or primitive regeneration experiments is not known (Kuhn, 1955).

Long time after, the curiosity for the regeneration process was testified by the Greek mythology, where we can find many allusions to regenerative events (Hamilton, 1942). The most famous example might be the legend of the Hydra, the second labor of Hercules, who could grow back two heads in place of one; we cannot know if Greeks were aware of the regenerative power of cnidarians, but nowadays one of the best-known examples of regeneration has been named after the Greek mythological creature.

Another example is the legend of Prometheus (Hesiod) who was punished by Zeus for a big act of insubordination, the gift of fire to mankind: Prometheus was chained to a rock in Caucasus, where his liver was daily eaten by an eagle, symbol of the furious god, only to be regenerated during night, due to his immortality. We now know that the liver does have this extraordinary capacity of regeneration and it is fascinating to wonder whether Greek biologist could have carried out hepatectomy experiments.

One last example could be the tale of the three hags in the legend of Mercury: the hags had only one eyeball among them, which they used in turn inserting it into her orbit to have a look around. Did Greeks already know that scallops can regrow the eyes that adorn the margins of their shells or that some species of amphibian can regenerate the lens and retina? Unfortunately, we will never know.

Taking into account this very old interest and fascination for the regeneration processes, it is then very surprising to note that the first scientific experiments focused to investigate this phenomenon were carried out “only” in the eighteenth century. It is at that time that Swiss naturalist Abraham Trembley (1710-1784) discovered an almost microscopic animal with tentacles decorating its apical end, which was able to regenerate its head after amputation. The morphological appearance and the extraordinary regeneration ability induced Trembley to name this animal after the mythological Hydra (Lenhoff and Lenhoff, 1986).

Trembley’s work with *Hydra* encouraged the European scientific community to further investigate into the regeneration process. In the second half of the century, the German naturalist Peter Simon Pallas (1741-1811) reported the regenerative properties of a new species, known today as planarians (Pallas, 1766). Only a couple of years later, the Italian naturalist Lazzaro Spallanzani (1729-1799) published his work on amphibian tadpole tail regeneration and the ability of salamander to regenerate jaws, limbs, tails and eyes (Spallanzani, 1768).

We should then wait almost two centuries before that Ingle and Baker, maybe inspired by Prometheus legend, demonstrated that liver can regenerate, performing partial hepatectomies on rats (Ingle and Baker, 1957), even if not at the extraordinary speed described by Hesiod. Few years later the scientific research showed that also human liver is capable of regenerating itself (Widmann and Fahimi, 1975). In the same years, Stone performed eyeball transplantation in newts, grafting them back into the orbit and following the visual recovery (Stone, 1963), recalling us the story of the three hags.

At the end of this brief historical overview on regeneration studies, it is worth to notice that even if the phenomenon of regeneration has been known to scientists for over two centuries and in the last decades more regenerating species have been discovered, we still know little about the molecular mechanisms underling this process. Unfortunately, the classical model organisms used in biology - which cannot represent all the complex diversity of life - display limited powers of regeneration or no regenerative abilities at all, whereas the model organisms most extensively used to study regeneration are refractory to genetics and molecular manipulations. But with our incessant curiosity and the development of new technologies we are now trying to discover each day a little more about this amazing capacity that has intrigued men’s mind throughout all human history.

1.1.2. Regeneration among metazoans

The first thing that we should ask about regeneration is if this phenomenon is an exclusive feature of few animal species or if it is more generally distributed in the metazoans. The analysis of phylogenetic trees reveals that regeneration is widely distributed and more common than one could think; in fact, almost every phylum possesses one or more species with regenerative capacities (Sanchez-Alvarado, 2000). The species capable to regenerate can be separated into two groups: in the first group, we observe only the ability to regenerate missing body parts or injured organs, whereas in the other we find the organisms that are able to completely regenerate from parts of their bodies. The latter group is composed only by cnidarians and a limited subset of lophotrochozoans (planarians, some annelids); instead, the regeneration of organs and appendices is more widely spread (Figure 1).

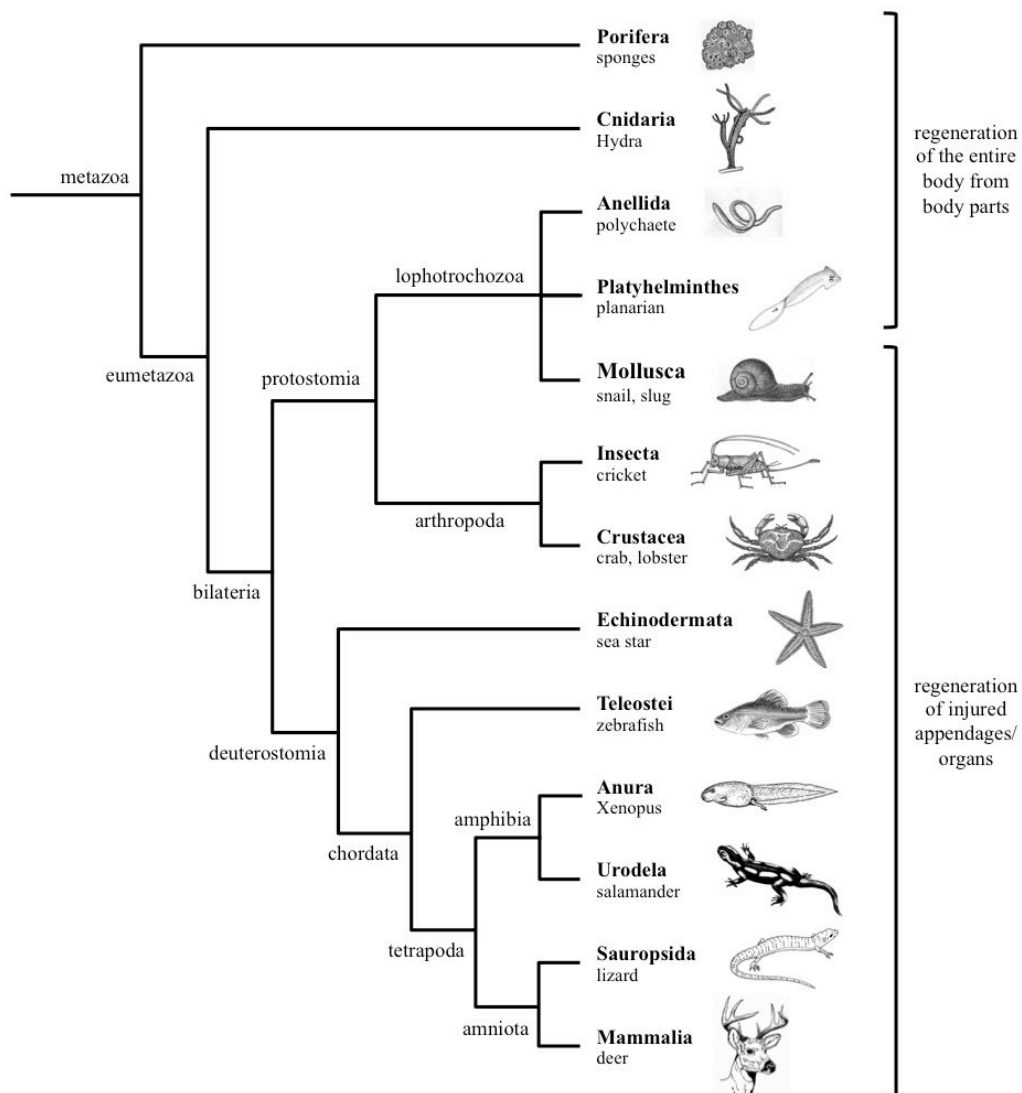

Figure 1: Regeneration among metazoans. Several laboratory model organisms are used to study the regeneration process in adults. In particular, Hydra and planarian can regenerate their entire body starting from a single fragment derived from their bodies sectioning. On the contrary, *Xenopus*, zebrafish and salamander can regenerate only body appendages that have been amputated, as the tail or the limb.

Another characteristic that allows a distinction among all the species able to regenerate is the persistence of this ability along the entire life of the animal: for some species it is conserved throughout the whole organism life, whereas for some others it decreases during development and it is completely lost in the adult. For example, the anuran *Xenopus laevis* tadpole is able to completely regenerate the limbs but this ability is then progressively lost in the froglet after morphogenesis, starting from the most posterior part of the body (Muneoka et al., 1986). Thanks to grafting experiments it has also been demonstrated that the ability to regenerate is an intrinsic property of the young tadpole limb cells that is lost during ontogenesis: when the tadpole limb bud is grafted onto a froglet limb stump, the limb bud becomes vascularized and innervated and, after amputation, is able to regenerate; *vice versa*, the graft of a froglet forelimb blastema onto tadpole hindlimb stump results in the formation of a cartilaginous spike typical of froglet forelimb regeneration (Sessions and Bryant, 1988). The members of the clade of amniotes - sauropsids and mammals - seem to lose the capacity to regenerate limbs even earlier during ontogenesis: in mice, it is observed *in utero* only before cartilage condensation (Wanek et al., 1989; Chan et al., 1991); in chick, limb regeneration can occur *in ovo* only if the amputation takes place in non-differentiated extremities and the FGF signaling is artificially stimulated, but not spontaneously (Taylor et al., 1994; Kostakopoulou et al., 1996). If we focus the attention to the regeneration of the most distal part of the limbs, the fingers and the toes, in the newborn mice we can observe the regeneration of the tips of foretoes (Borgens, 1982) and the bone regrowth after amputation is equivalent also in adults (Neufeld and Zhao, 1995), whereas in humans the regeneration of the fingers most distal phalanx can occur only until seven years old (Illingworth, 1974): in both cases, the regeneration takes place thanks to the nail stem cells which are able to proliferate and, in a more general view, can stimulate bone growth (Zhao and Neufeld, 1995; Mohammad et al., 1999). Interestingly, more recent studies on mouse myotubes in culture revealed that these differentiated cells treated with a newt “regeneration extract” are able to de-differentiate, reduce the muscle differentiated proteins content and re-enter cell cycle (McGann et al., 2001), suggesting that mammalian cells have not lost the capacity to de-differentiate, necessary for the regeneration process in different species of urodelans (as newts) and teleost fish (as zebrafish).

Lazzaro Spallanzani, after his discovery on salamander limb regeneration, already started to wonder why the regeneration process is restricted only to some species (Dinsmore, 1996). Moreover, if we also consider that the evolutionary distances that exist among the animals capable of undergoing regeneration are relatively large, it is natural to wonder if the regeneration process is an analogous trait resulting from convergent evolution or if, on the other side, it is a

homologous trait that arose very early in the evolution of metazoans. To try to answer this question is necessary to look more closely at the different strategies used by different animals to regenerate (Sanchez-Alvarado, 2000).

The different regeneration processes observed in the different organisms can be subdivided into two categories: non-blastemal and blastemal based regeneration (Sanchez-Alvarado, 2000) (Figure 2). Non-blastemal regeneration can occur as consequences of different processes: first, transdifferentiation of the remaining cells into the missing parts, as in the case of lens regeneration in urodele amphibians (Reyer, 1954); second, limited dedifferentiation and proliferation of the surviving cells after damage, as for human liver regeneration (Michalopoulos and DeFrances, 1997); third, proliferation and differentiation of stem cells already present in the injured tissue, as for human bone regrowth (Prockop, 1997). Conversely, blastemal regeneration requires the formation of the blastema, a specialised structure composed by a superficial sheet of cells of epithelial origin that covers an underlying mass of cells of mesenchymal origins; this structure is very similar to the embryonic limb bud produced by vertebrates during embryogenesis and it can form either within hours or days after amputation. The missing part is regenerated by proliferation and differentiation of the blastema. Examples of this mode of regeneration are found in planarians (Brønsted, 1969), molluscs (Needham, 1952; Lange, 1920), echinoderms (Candia Carnevali et al., 1995), urochordates (Huxley, 1921) and vertebrate limb (Brockes, 1997) and tail (Iten and Bryant, 1976) regeneration.

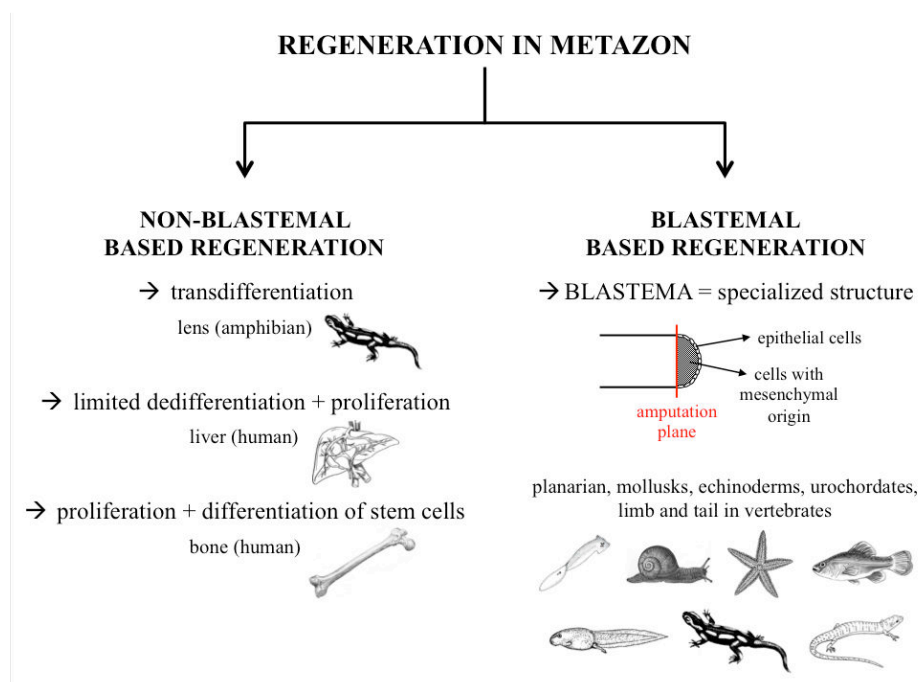

Figure 2: Different regeneration strategies in metazoans. In different species the regeneration process takes place with or without the formation of the blastema, a specialised structure composed by an external layer of epithelial cells that covers an underlying mass of mesenchymal cells and whose proliferation and differentiation allow the regeneration of the missing body part.

It seems very strange to find this common mechanism of regeneration in such a different phyla, but it is even more astonishing to note that the different organism blastemas are really very similar (Sanchez Alvarado and Newmark, 1998). Noting this high degree of similarity between epimorphic regeneration of many different species, in 1927 the German zoologist Eugen Korschelt (1858-1946) suggested that regeneration must have been a primordial attribute of all metazoans (Korschelt, 1927). But, if it is true, then why do not all animals have the capacity to epimorphically regenerate missing body parts? Also Richard J. Goss (1925-1996) is in agreement with the ancestral origin of the regeneration capacities (Goss and Holt, 1992) and he proposed that regeneration must have been selected against during evolution of the Metazoa (Goss R.J. in: Dinsmore Editor, 1991): in this scenario the remarkable conservation of blastema structures between distant phyla would be explained by the common evolutionary origin, as Korschelt has already suggested, but at the same time the negative selection would justify the non-uniform distribution of the regeneration capacity because different species would have experienced different selective pressures, leading to the maintenance or to the elimination of this ability.

Even if nowadays there are not strong molecular evidences proving the existence of a common ancestor, the comparison of the regenerative events with their developmental counterparts could offer some clues. Already in 1952 Needham noted that the characteristics shared by development and regeneration are highlighted by the final product of each events: any or few differences can be found between embryonically derived limbs and regenerated limb in adult organism (Needham, 1952). Indeed, even if there are differences between the two processes (as we will see later in this chapter), they deploy similar sets of regulatory genes to carry out their morphogenetic purposes (Gardiner et al., 1995; Gardiner and Bryant, 1996; Imokawa and Yoshizato, 1997; Simon et al., 1997; Logan et al., 1998). The functional conservation of key molecular events regulating the embryogenesis in both related and unrelated taxa suggests that the developmental mechanisms should have evolved only once (Wolpert, 1994; De Robertis and Sasai, 1996). The natural implication of this reasoning is that both development and regeneration must share evolutionary conserved mechanisms, again supporting the idea of a common ancestor for the different regenerating species. Only molecular evidences obtained from different organisms able to regenerate will finally clarify the evolutionary origin of regeneration. For the moment, the analysis of the mechanisms involved in the regeneration process could help us to determine why this ability has been lost in some phyla, and in particular in mammals (Brockes et al., 2001).

In the last years, different hypothesis have been proposed to explain why regeneration has been maintained in some species but lost in others, as reviewed in Bely and Nyberg, 2010.

The maintenance of the regenerative capacities of a given structure could derive from a positive selection of this ability, which is feasible to happen if the structure is frequently lost, if the absence of this structure results in fitness-related costs and if the benefits of replacing the lost structure outweigh the costs of regeneration. In species that experience high frequencies of structure loss in nature, commonly from predation, regeneration is then likely to be maintained. However, it is surprising to notice that for some of the most highly regenerative animals, as Hydra and planarians, there is no evidence of high amputation frequencies in nature. Their extraordinary regeneration abilities should then be maintained by mechanisms other than direct selection. Pleiotropy and phylogenetic inertia could be two explanations for the retention of regeneration, especially in species experiencing infrequent tissue loss in nature. The pleiotropy hypothesis proposes that the ability to regenerate a particular structure is retained because it is developmentally tightly coupled with a related phenomenon, such as asexual reproduction or development. On the other side, the phylogenetic inertia hypothesis posits that regeneration is retained simply for historical reasons, although it is neither selectively advantageous nor retained by pleiotropy.

Restriction or loss of regenerative abilities has been common across animal phylogeny: if regeneration confers no selective advantage, it could be lost as a neutral trait. This is feasible to happen if the tissue loss is uncommon in nature, if the functional importance of the structure decreases along evolution (as could be for redundant structures) or if previously tight pleiotropic interactions between regeneration and another developmental process break down. Moreover, regeneration could be directly selected against if the parameters on which depend energy allocation, as longevity or reproductive mode, change and no longer favour regeneration or if some aspects of regeneration directly decrease the animal fitness.

To conclude, we can wonder how regeneration has been lost. Available data suggest phylogenetic patterns in how regeneration tends to fail. Annelids, for example, tend to evolve an early, complete block to regeneration, whereas some amphibians and teleost fish produce non-functional malformed outgrowths upon amputation. Regeneration might also be lost by gradual reduction in regeneration speed or, finally, by having regenerative ability become increasingly restricted to particular ontogenetic stages (Bely and Nyberg, 2010).

1.1.3. Regeneration and asexual reproduction

But why did regeneration originate in evolution? And did it originate as an independent property? Or has it originate together with life, as one of its intrinsic property? If we think at the regeneration as a restoration of body components, it becomes the equivalent of physiological maintenance, which is required to all living organism to survive. That is why Morgan and Korschelt considered the regeneration process as a primordial attribute of life. This idea was reinforced by Needham, who defined regeneration as “identical to life itself” (Needham, 1952) since in the organisms who reproduce themselves by asexual reproduction, this process is indistinguishable from their mode of regeneration.

If we take as example the protozoan *Bursaria*, the only difference that we can find between asexual reproduction and regeneration is the stimulus triggering the two events: in the first case, the favourable environmental conditions and, in the second case, an injury. Therefore, asexual reproduction and regeneration in protozoans appear to be different manifestations of the same ability: reverse their morphogenetic processes (Lund, 1917).

Could, then, regeneration have its origin in asexual reproduction? If the only difference between the two processes is the stimulus needed to trigger the process, it is sufficient that the stimulus necessary to induce regeneration activate the same messenger molecules that mediate asexual reproduction. And hydra provides a supporting example: during asexual reproduction it has been observed a localised increase of the secreted peptide head activator (HA), necessary for the budding process (Schaller, 1973); similarly, the amputation of this organism induce the release of high levels of HA, necessary for the formation of the regeneration bud that will differentiate into the missing body part (Galliot, 1997). Then, in both case we have the activation of the same genetic cascade.

Clearly, the explanation cannot be so easy. In fact, there are animals able to regenerate the entire organism from body parts in which asexual reproduction and regenerative abilities are not associated. This is the case of the planarians *Dendrocoelum lacteum* and *Bdelocephalla punctata*. Contrary to other planarian species, these two organisms are unable to regenerate if the amputation occurs at the level of the pharynx or below; this is also accompanied by a lack of asexual reproduction (Brønsted, 1969). Why do they reproduce exclusively by sexual means even if they have the potential for asexual reproduction, evidenced by the ability of pharyngeal fragments to regenerate complete animals? Cases such as these need to be further study to identify the relationship between regeneration and asexual reproduction, and the factors necessary either to allow or prevent the reversion of the morphogenetic processes.

1.1.4. Regeneration and cellular pluripotentiality

Important differences exist between the regeneration processes of simple and histologically more complex organisms. These differences rely on the different ability of the animals to reverse their morphogenetic processes, which depends on the regulation of cellular pluripotentiality. If we then consider two very different examples of regeneration, as they can be the amputation of the salamander hand or of the planarian tail, it is however clear that in both cases the regenerating fragments have in common the property to be pluripotent; the main difference among them lies in how this potential is controlled in the adult organism (Figure 3). Then, if the ability of animals to reproduce missing body parts depends on the availability of a source of pluripotent cells, it is not a coincidence that in more complex animals, in which it is harder to induce cell differentiation and reveal the hidden pluripotentiality of the cells, we observe less regenerative abilities (Sanchez-Alvarado, 2000).

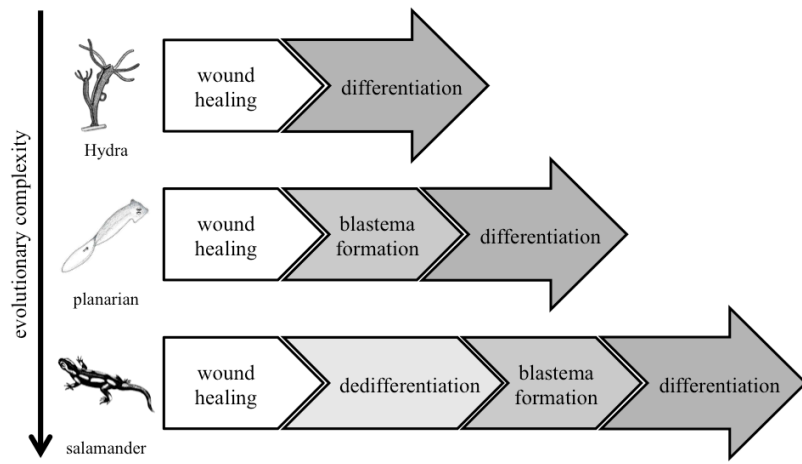

Figure 3: Increasing regulation of cellular pluripotentiality with increasing morphological complexity. The addition of several regulatory steps (wound healing, dedifferentiation, blastema formation and differentiation) as evolutionary complexity increases is here illustrated taking as example three representative organisms: Hydra, planarian and salamander. The regeneration process starts always with the wound healing and culminates in the fully regenerated structure. Adapted from Sanchez-Alvarado, 2000.

In the simple diploblastic hydra, we observe the presence of undifferentiated and constantly dividing cells in the body column (David and Campbell, 1972; Campbell and David, 1974); moreover, the pluripotent cells of the gastric column (Gierer et al., 1972) continuously change their position in an apical or basal direction, reaching the whole organism body. The gastric column can then be functionally linked to a blastema because it serves as a source of pluripotent cells (Galliot, 1997). Therefore, in this animal the cellular proliferation and the creation of the blastema are not needed thanks to a constant source of pluripotent cells in the body column and, in this way, the regeneration process can directly start with the post-blastemal stages observed in higher animals, as determination and differentiation.

Tripoblasts, instead, possess a more tight regulation of cell pluripotentiality, which is severely restricted even in animals with extensive regeneration power. In planarians, for example, we find only one population of undifferentiated and mitotically active cells, the neoblasts (Brønsted, 1969); after amputation, these cells have first to proliferate to form the blastema, which can after direct the determination and differentiation processes. In the more complex salamanders, the pluripotentiality is restricted even further: in these animals there are no reserves of pluripotent cells in the body; on the contrary, they are produced de-novo by pre-existing terminally differentiated cells after amputation. Therefore, in these organism there is the addition of a new step in the regeneration process: the de-differentiation of differentiated cells that then undergo mitosis and proliferate to form the blastema (Brockes, 1997).

In conclusion of this paragraph, it is evident that with the increase of animal complexity, more and more regulatory checkpoints have been added to control the inherent pluripotentiality of cells; this augmented control of pluripotent cells might be a reflection of selective forces that may have been acting on the evolutionary origins of the regeneration blastema itself (Sanchez-Alvarado, 2000).

1.1.5. Regeneration and development

For long time the researcher wondered if the process of limb regeneration could recapitulate the events observed during limb development. Effectively, as already mentioned, the two processes deploy similar sets of regulatory genes to carry out their morphogenetic purposes (Gardiner et al., 1995; Gardiner and Bryant, 1996; Imokawa and Yoshizato, 1997; Simon et al., 1997; Logan et al., 1998). However, in the last years new data suggest the existence of important differences between the two processes (Nacu and Tanaka, 2011).

First of all it is important to notice that the spatial and temporal scale in which the two processes take place is completely different (Figure 4): even if a molecule is necessary for both processes (and there are several examples: Hh, Wnt, Fgf, ...), the levels of expression and the time required to the formation of a signal gradient have to be adapted to really different dimensions (Brockes and Kumar, 2005). On the other hand, the sequential expression of hox genes seems to be conserved, at least in the axolotl, between the developing and regenerating limb (Roensch et al., 2013).

In this context, also the codification of the positional information has to adapt to different spatial and temporal scales, even if the same patterning molecules are used. Some decades ago, it has been proposed that, contrary to the development process in which the cells acquire position identity in a proximal-to-distal sequence, during regeneration occurs an intercalation process: the blastema cells acquire distal identity, creating a gap with the more proximal identity stump cells

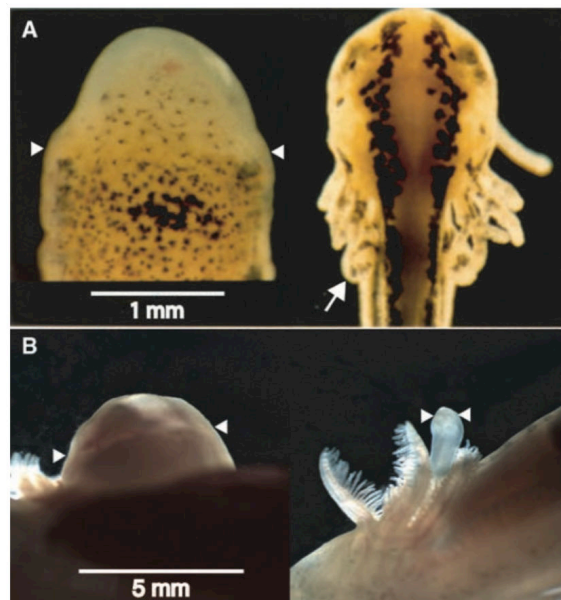

Figure 4: Scaling differences in limb regeneration and development. (A) An adult newt limb blastema (left) (arrowheads mark the original plane of amputation) next to a newt embryo (right) showing the developing limb bud (arrowed). (B) An adult axolotl limb blastema (left) (from an animal 16 cm in length) next to a 4 cm larval axolotl limb blastema (right) (arrowheads mark the amputation plane). The scale bars apply to the pair of (A) or (B) images, respectively. From Brockes and Kumar, 2005.

that triggers regeneration of the intervening regions; then, when a salamander hand blastema is grafted onto an upper limb stump, intercalation occurs, whereby the upper arm stump regenerates the missing lower arm segment and the grafted hand blastema regenerates the hand (Stocum, 1975; Iten and Bryant, 1975; Pescitelli and Stocum, 1980). The intercalation is unidirectional, because the hand blastema cells do not contribute to restoration of the missing lower arm. Unidirectional intercalation reflects a cellular determination state, called “the rule of distal transformation,” in which connective tissue-derived blastema cells can only form limb segments more distal to their original identity (Pescitelli and Stocum, 1980). However, in the last years, the already mentioned studies on *hox* genes expression during axolotl regeneration, coupled with transplantation assay, showed that blastema cells acquire positional identity in a proximal-to-distal sequence, suggesting a progressive specification rather than an intercalation process during limb regeneration of this animal (Roensch et al., 2013). Then, the intervention of one or both the intercalation and progressive specification mechanisms during regeneration has still to be clarified.

In any case, it is important to understand how the cells can determine their position along the proximal-distal axis and use this information to regenerate the missing body part. The positional information has to possess two characteristics: first, it has to be present in the adult before the amputation and, second, its perturbation has to be transmitted to regulate the regeneration process. Nowadays, only few factors controlling the positional information during limb

regeneration have been identified. The best example is Prod1 (Proximo-distal 1), the newt ortholog of CD59; it is a glycoprotein located at the cell membrane with a GPI (glycosylphosphatidylinositol) anchor and its expression forms a gradient in adult limb, conferring the positional information to the cells (Kumar et al., 2007a; da Silva et al., 2002). The role of Prod1 during development, if it exists, is not yet clear (Nacu and Tanaka, 2011). Looking for potential ligands of Prod1, the team of J. Brockes discovered the factor nAG (newt Anterior Gradient), which is responsible for the nerve dependence of limb regeneration and for the interdependence between the wound epithelium and the nervous fibres during regeneration (Kumar et al., 2007b). After amputation, injured axons firstly retract in the stump, before to regrow, surrounded by Schwann cells. At the same time nAG starts to be expressed: firstly, in the Schwann cells of the stump, where we find the retracted axons, to confer the positional information corresponding to the level of amputation and, secondly, in the wound epithelium, to give the positional information corresponding to the most distal extremity of the structure that has to be regenerated. Brockes team also found that nAG expression in both locations is abrogated by denervation and that its the ectopic expression is sufficient to rescue a denervated blastema and regenerate the distal structures, linking together for the first time the positional identity of the blastema and the classical nerve dependence of limb regeneration necessity (Kumar et al., 2007b). nAG is very conserved during evolution; on the contrary Prod1 is identified for the moment only in the newt (Kumar et al., 2007a).

Another important difference between development and regeneration processes is the proliferation of stem cells, which is sustained during development, whereas in many cases stem cells are not present in mature tissues. As already said, the ability of animals to regenerate body parts depends on the availability of pluripotent cells or on the ability to reprogram terminally differentiated cells (Brockes and Kumar, 2002; Odelberg, 2005; Poss, 2007; Birnbaum and Sanchez Alvarado, 2008); these cells, which have different origins but at this point are all committed in the regeneration process, proliferate to form the blastema with a behaviour that has been studied in several species, as amphibians, zebrafish and planarian (Wagner et al., 2011). In this context, the comparison between adult regeneration and regeneration of the embryo - or its development - is difficult, and maybe also devoid of significance, because in organisms that are still in development the process of pluripotent cells mobilisation is not necessary (Galliot, 2011). Finally, a last difference between development and regeneration is the nerve dependance: if in embryos limbs are able to develop even in absence of nerves, in adult the innervation is essential to launch the regenerative program. I will come back later in this manuscript on the relationship between nerves and regeneration.

1.1.6. Regeneration and homeostasis

The tissue homeostasis is the result of three different processes - cell death, proliferation and differentiation - and the same processes are found during regeneration.

In mammals, the cell renewal has been studied in different tissues and the time to obtain a complete renewal is very variable, from few day for the intestinal epithelium to some months for the epithelium of the lungs (Blanpain et al., 2007); in organs as the brain and the heart the renewal is very limited and very slow and then also very difficult to study. Also the regeneration process requires the proliferation of progenitor cells but with some important differences compared to homeostasis. First, the regeneration needs to start a “massive renewal process” to allow the formation of the blastema, later responsible for the orchestration of the morphogenesis. Second, pluripotent mitotically-active cells are not always present in the tissue and then during regeneration could be necessary an additional step of dedifferentiation; different studies of cell lineage in transgenic animals have demonstrated that all differentiated cells can turn into progenitors cells, maintaining the memory of their origin and finally re-differentiating according to it (Kragl et al., 2009; Knopf et al., 2011; Tu and Johnson, 2011). Third, participating cells must be precisely guided to needed areas, and once regeneration is complete specific cues are required to report regenerative success and signal termination, otherwise the initial response would continue indefinitely (Oviedo and Beane, 2009).

The studies to better understand the link between homeostasis and regeneration are very important for regenerative medicine. For example, recent results in planarian show that the signal involved in stem cells renewal are also involved in stem cells activation after amputation (Forsthoefel et al., 2012; Newmark, 2005).

1.1.7. Regeneration and scarring

Before to conclude this first part of the introduction on the regeneration process and go on with the manuscript, I think that is also important to clarify the difference between the terms regeneration and wound healing/scarring, being both commonly used to indicate the process that leads to recover the tissue integrity after an injury caused by the environment or diseases. The process of wound healing is included in the process of regeneration and consists in very rapid mechanisms that allow to cover the wound with a layer of epithelial cells, leading to the protection of the injured tissue as soon as possible. In mammals, this process is more and more inefficient with aging: the embryo and the foetus have healing capacities definitely more important than the adult (Redd et al., 2004). On the contrary, the cell layer that is formed during the healing phase of the regeneration process is very characteristic and has similarities with the apical epidermal layer that is formed in embryos during limb development (Christensen and

Tassava, 2000; Nye et al., 2003); moreover, it produces signals necessary for the formation and the maintenance of the blastema (Thornton, 1957; Nye et al., 2003). Contrary to normal wound healing/scarring, the regeneration process allows the complete reconstitution of a functional tissue without the formation of the scar.

RNAi experiments on planarians and other experiments on other organisms allowed the identification of different genes involved in the regeneration process, as for example some genes important for the signalisation occurring just after healing (Reddien et al., 2005). These findings allow the analysis of the loss of these genes or problems in their functionality in organisms that are not able to regenerate. In fact, it has been proposed that some genes necessary for regeneration to take place would be present only in the specie effectively able to regenerate (Brookes and Kumar, 2008). An example is the already mentioned Prod1, responsible for the positional identity and probably for the nerve dependence of the regeneration process, that is found only in the pleurodeles (Kumar et al., 2007b).

1.1.8. A general scheme for the regeneration process

The regeneration of missing body parts in response to tissue injury, degeneration or amputation requires the succession of three modules (Figure 5):

1. the immediate response to the injury/amputation with the activation of repair genes;
2. the regeneration-induction module, with the formation of the blastema;
3. the regeneration re-development module, consisting in morphogenesis, differentiation and growth processes.

The second module is composed by a variety of cellular processes that trigger the structure-specific developmental process; these cellular processes arise as a response to injury, in some contexts via the wound epidermis, and can be combined or not, providing multiple ways to bridge injury to regeneration (Galliot and Ghila, 2010). As consequence, this module is very variable: if we only think at how progenitor cells can be recruited, we have already a relatively long list of possible options (stem cell proliferation, dedifferentiation or the not mentioned above apoptosis-induced compensatory proliferation, direct proliferation of differentiated cells and transdifferentiation). This variability is reflected by the facts that different organisms could follow different ways to regenerate homologous structures or that the same organism could use different mechanisms to regenerate different body structures or even the same structure. An example of this large variability is given, for example, by the evolutionary divergent mechanisms of muscle regeneration observed during limb regeneration in two closely related salamander species, *Notophthalmus viridescens* (newt) and *Ambystoma mexicanum* (axolotl). In newt, the new skeletal muscle is formed by proliferation of mononuclear cells originated from

myofibers fragmentation and dedifferentiation; on the contrary, myofibers in axolotl do not dedifferentiate to generate proliferating cells and do not contribute to newly regenerated muscle, which is formed by contribution of resident satellite cells (Sandoval-Guzmán et al., 2014).

The variability of the second module is due to both the developmental status of the organism and the homeostatic conditions of the tissue before the injury (Galliot and Chera, 2010). Indeed, the length of the module is directly influenced by the developmental and aging processes ongoing in the organism (Carlson and Conboy, 2007; Auger et al., 2010): for the embryos there is no need to have a bridge between wound healing and re-development, whereas in the adult the bridge is required and it becomes longer with the closing of the developmental processes and the appearance of aging. The homeostatic status at the time and place of injury, on its side, influences the cellular tools that can be activated upon injury (Galliot and Chera, 2010). The recruitment of these tools leads to the activation of the third module, which is less plastic because the re-development of the missing structure often relies on the same signaling pathways used during organogenesis.

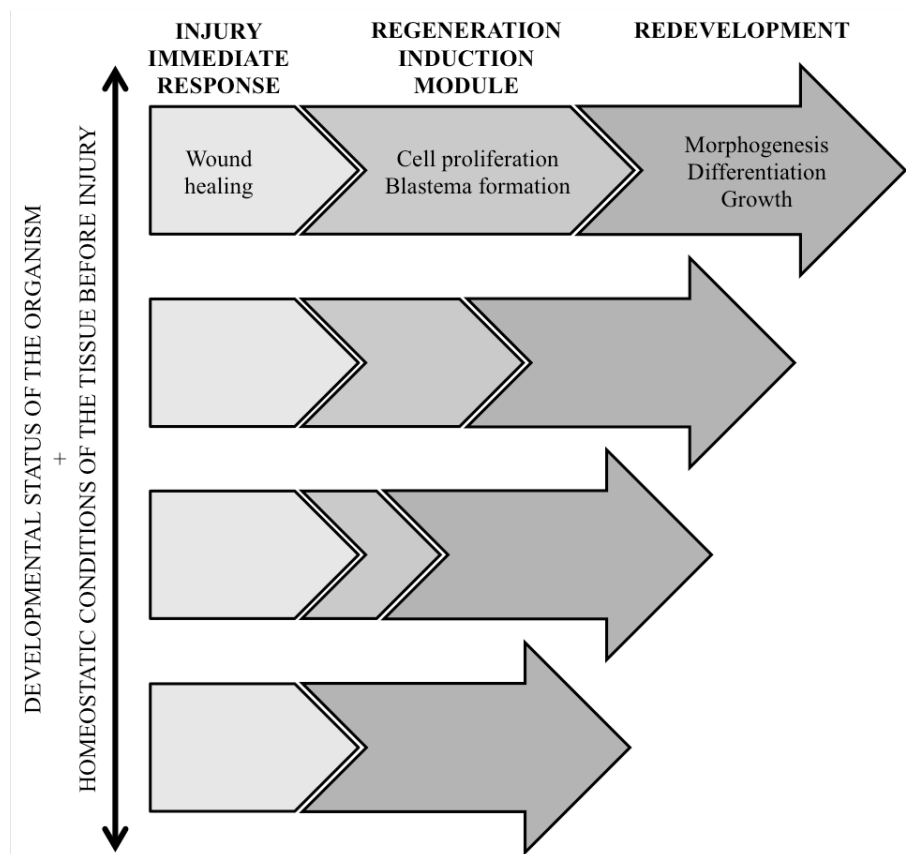

Figure 5: Scheme of the tri-modular composition of the regeneration process. To regenerate a given structure, a variety of cellular processes, which form the “induction module”, induce a structure-specific developmental process; these processes can be combined or not, providing multiple routes to bridge injury to regeneration. The developmental stage of the organism and the homeostatic context at the time of injury largely influence this second module. Adapted from Galliot and Chera, 2010 and Galliot and Ghila, 2010.

1.2. Zebrafish and its caudal fin regeneration ability

Danio rerio, or zebrafish, is a teleost fish first described by Francis Hamilton, a surgeon with the British East India Company, stationed principally in West Bengal at the beginning of the 19th Century. He published *An Account of the Fishes Found in the River Ganges and its Branches* in 1822 that included ten *Danio* species. It is characterized by the presence of a distinctive colour pattern based on alternating dark and light horizontal stripes.

Zebrafish is one of the most important vertebrate model organisms in genetics, developmental biology, neurophysiology and biomedicine, thanks to some of its characteristics that make it particularly suitable to experimental manipulation: it is small, then easy and cheap to maintain in the laboratory; it breeds all year round and females can spawn every 2-3 day hundreds of eggs; generation time is short, around 3-4 months, making it suitable for selection experiments; the eggs are large relative to other fish and transparent; fertilisation is external and live embryos are accessible to manipulation and can be monitored through all developmental stages; finally, the development is rapid, with major organs precursors developing within 36 hours post fertilisation and larvae displaying food seeking and active behaviour within 5 days post fecundation (Kimmel et al., 1995; Spence et al., 2008).

The zebrafish is increasingly important in biomedical research (Dooley and Zon, 2000; Shin and Fishman, 2002), particularly as a model of human disease (Berghmans et al., 2005; Guyon et al., 2007) and for screening of therapeutic drugs (Rubinstein, 2003, 2006); its strength as a model organism is that as vertebrate it is more comparable to humans than invertebrate model species as *Drosophila melanogaster*, while being more tractable to genetic and embryological manipulation than mammalian model species as mice, in which such procedures are both more complicated and costly (Spence et al., 2008).

Zebrafish is particularly interesting because, as other teleost fish, is able to regenerate many organs and structures at the adult age: the retina, the spinal cord, the liver, the pancreas, the heart and all its fins. Even if it is a relatively “new” model organism, it is more and more present in the research laboratories and its spread utilisation in developmental biology has allowed the development of many genetic tools and the *in vivo* imaging.

During my thesis, I worked on the process of epimorphic regeneration of the caudal fin in the adult zebrafish. It is a recent model to study the regeneration of body appendages, compared to the regeneration of urodelans limb regeneration, and they share many similitudes, in particular regarding the blastema formation. On the contrary, the morphogenesis of the new-formed zebrafish caudal fin is faster than the re-formation of the urodelans limb (Figure 6).

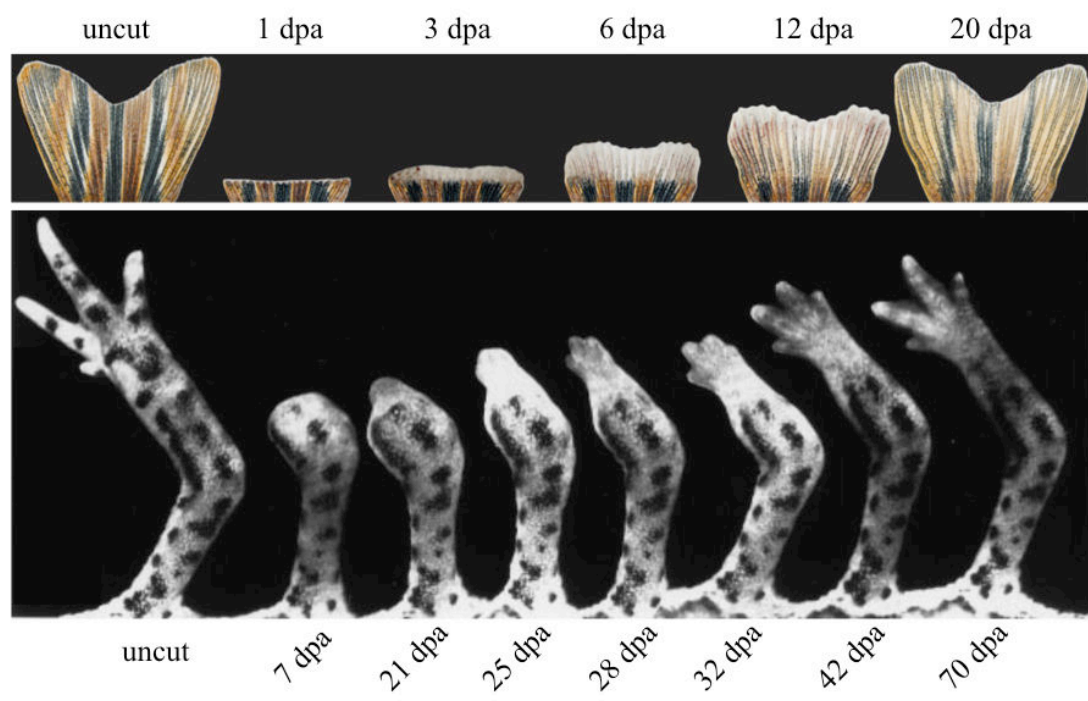

Figure 6: Different time scales in the regeneration process of different organisms. The regeneration of the zebrafish caudal fin is completed in 20 days, whereas salamander limb takes more than 70 days to completely regenerate. Adapted from Pfefferli and Jaźwińska, 2015 (zebrafish) and Brockes, 1997 (salamander).

1.2.1. The structure of the adult caudal fin

Zebrafish possesses five sets of fins divided into two types: the paired fins (pectoral and pelvic) and the median fins (dorsal, anal and caudal), structurally comparable (Figure 7). These fins are traversed by dermal bone rays, which are segmented along the whole fin length: the lepidotrichia. These lepidotrichia arise at the base of the fin and extend to the distal extremity, where they are terminated by elastoidin non-mineralised fibrils, the actinotrichia. Each segment is constituted by two concave hemi-segments that form in this way a tubular structure traversed by arteries, nerves and connective tissue; each hemi-segment is embedded in a monolayer of bone secretory cells, the osteoblasts. Between the different rays there are the connective tissue, the veins and the sensory neurons. All the structure is kept together by ligaments, which confer cohesion and flexibility at the fin (Becerra et al., 1983). In the fin there are no muscles, but at the base of the fin we find some tendons that connect the most proximal segment of each ray with the adductor and abductor muscles of the fish body (Akimenko et al., 2003).

The adult caudal fin is composed by 18 rays; all of them, except the most dorsal and the most ventral, have a bifurcation at the half of their length (Montes et al., 1982; Becerra et al., 1983). After amputation, at the standard temperature of 28°C, the regeneration of the caudal fin is completely finished in less than three weeks.

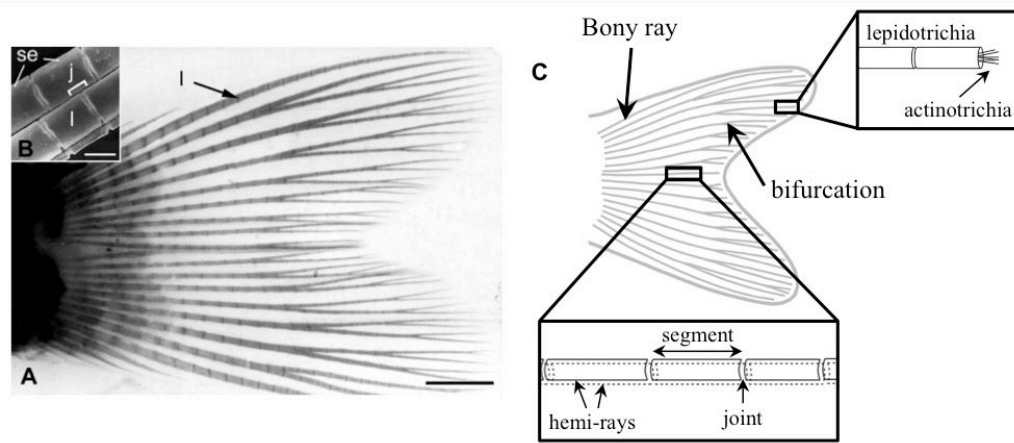

Figure 7: Zebrafish caudal fin skeleton structure. (A) Alizarin-red/alcian-blue staining of lepidotrichia and cartilage of the adult zebrafish caudal fin. The fin is constituted of segmented bony lepidotrichia (l), which form dichotomously branching points along the proximodistal axis of the fin. Scale bar 1mm. (B) SEM of lepidotrichia showing that each lepidotrichium (l) is made of two parallel segmented hemi-rays. Two adjacent segments (se) are separated by a narrow space and connected to each other by collagenous ligaments making a joint (j). Scale bar 100µm. Adapted from Borday et al., 2001. (C) Scheme of the fin and magnifications to better show the actinotrichia at the tip of each ray (top, right) and the segmented lepidotrichia formed by two hemi-rays and connected by a joint (bottom). Adapted from Rolland-Lagan et al., 2012.

1.2.2. The regeneration process of the adult caudal fin

The tail of teleost fish has been very used in the last decades to study the regeneration process and the histological mechanisms intervening in it have been carefully described.

When the majority or even the whole fin are amputated, the regeneration process allows the re-formation of a well-shaped and functional fin (Shao et al., 2009). Histological studies have suggested that zebrafish caudal fin regeneration is similar to the ephimorphic regeneration of urodelans limbs; as the latter, the process can be subdivided into four steps:

- wound closure;
- wound epithelium formation;
- blastema formation;
- cell differentiation and morphogenesis, leading to the missing tissue restoration.

After the injury, the connective tissue is rapidly sealed by a clot, formed by blood cells, while the entire wound is covered by lateral epithelial cells rearrangement and migration; this process occurs without cellular proliferation to be as rapid as possible, in order to avoid excessive bleeding and the risk of infection. This first step is concluded about 6 hours post amputation and the new-formed epithelium, the wound epithelium, is first a thin layer but it becomes faster a thick multilayer tissue, distinguishable by the later epithelium (Santos-Ruiz et al., 2002). The wound epithelium is also characterised by the expression of some genes, as *fgf24* (Poss et al., 2000a; Kawakami et al., 2004) and *dlx5a* (Miyama et al., 1999).

After the wound closure and the formation of the wound epithelium, the proliferation starts first in the lateral epithelial cells; successively, also the mesenchymal cells of the stump de-organise and these quiescent cells re-enter the cell cycle. Nowadays there are not specific markers for these cells, which could derive from differentiated cells, as osteoblasts and endothelial cells, or fibroblasts, whose differentiation state is still debated. These cycling cells are then visualised with proliferation markers as phosphorylated Histone 3 (pH3) and Proliferating Cell Nuclear Antigen (PCNA). These progenitors cells successively start their migration toward the wound, where they accumulate as a mass of mesenchymal proliferating cells covered by the wound epithelium: the blastema.

The proliferation of the blastema cells is maintained until a sufficient number of cells are produced to re-form the missing fin. It has been suggested that in urodelans the blastema would be formed by dedifferentiated cells coming from the surrounding tissues (Lo et al., 1993; Kumar et al., 2000; Velloso et al., 2000; Brockes and Kumar, 2002; McHedlishvili et al., 2007); moreover, studies conducted with axolotl suggested that the dedifferentiated blastema cells are able to re-differentiate in a different type of cell compared to their origin (Echeverri and Tanaka, 2002). On the contrary, more recent studies propose that these cells lose temporarily their markers of differentiation, but then re-differentiate in the same cell type from where they originated (Kragl et al., 2009). Similar observations have been done during *Xenopus* tadpole tail regeneration, in which cells derived from muscles, spinal cord and notochord re-differentiate only in their respective cellular types in the regenerated tissue (Ryffel et al., 2003; Gargioli and Slack, 2004; Slack et al., 2004), demonstrating that the regeneration process can occur without a complete dedifferentiation to the pluripotent state.

In zebrafish, cell lineage studies have demonstrated that each cell of the stump is able to dedifferentiate to take part at the blastema formation; these cells maintain the memory of their origin and then re-differentiate according to the cell type they were at the beginning of the process (Knopf et al., 2011; Tu and Johnson, 2011; Singh et al., 2012b; Sousa et al., 2011, 2012; Stewart and Stankunas, 2012), suggesting also a conservation in the process of ephimorphic regeneration between fish and amphibians.

Finally, there are still some opens questions. For example, even if it has been demonstrated that differentiated cells can participate in the blastema formation, their proportion compared to fibroblasts or stem cells is not known; moreover, cell lineage experiments with cellular differentiation marker have shown that cell differentiation occurs in the first two segments adjacent the amputation plane (Knopf et al., 2011), whereas other histological experiments and of cell lineage with colorants proposed that cell recruitment happens in the first six segments (Poleo et al., 2001; Santos-Ruiz et al., 2002; Gauron et al., 2013; Rampon et al., 2014).

The first part of the fin regeneration process, from fin amputation to blastema formation, is schematized in Figure 8.

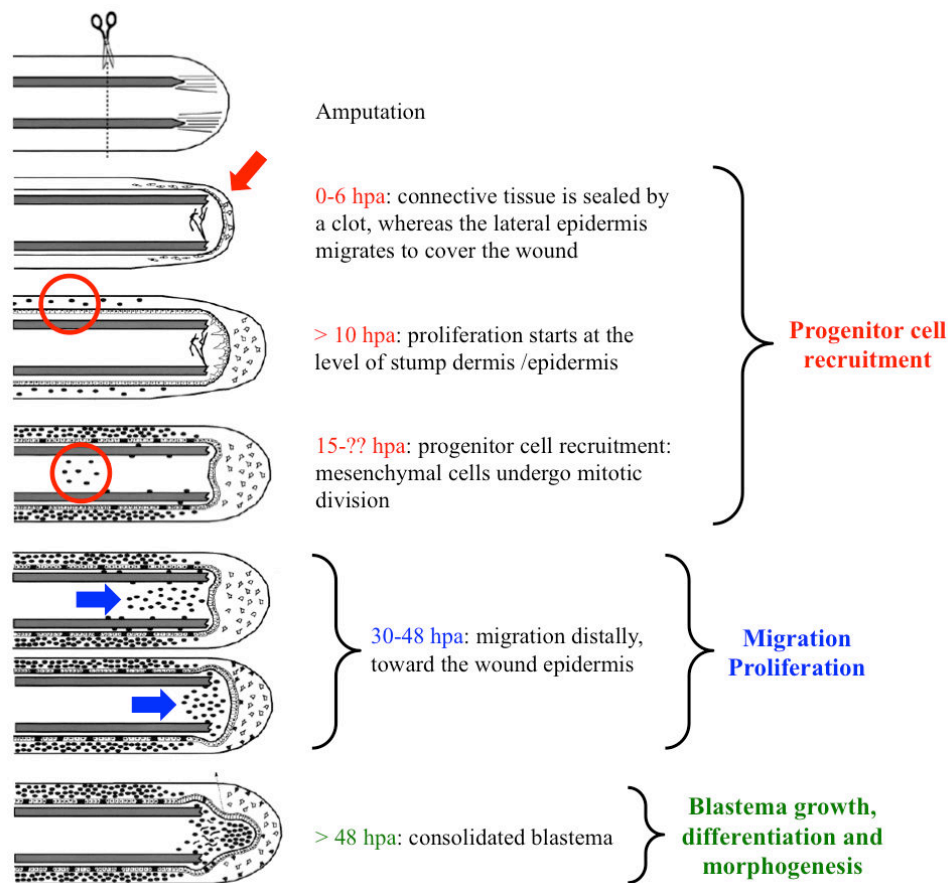

Figure 8: Schematic representation of the events occurring from fin amputation to blastema formation. After amputation, the connective tissue is sealed by a clot and the lateral epidermal cells migrate to form the wound epithelium. Successively, proliferation starts first in the lateral epidermis and then also in the mesenchyme. These mesenchymal cycling cells continue to proliferate and then start to migrate toward the tip of the fin, where they form the blastema. Blastema cells proliferation and differentiation finally lead to the restoration of the amputated fin. Adapted from Santos-Ruiz et al., 2002.

1.2.3. The signaling pathways involved in the tail regeneration process

In the last years the signaling pathways involved in the blastema growth have been the objects of several studies; on the contrary, the early signals that could be involved in the activation of the regeneration module following the amputation/injury are not well known, even if there are several candidate signals.

The studies of these early signals have been conducted in different tissues and in different organisms, vertebrates and invertebrates. Since several years, it is known that amphibian limb and teleost fish fins regeneration processes start with the formation of the wound epithelium; before its maturation in a thick multilayer tissue, it has to secrete several factors that would be essential for the organization of the forming blastema. It has been shown that the rapid and

continuous elimination of the wound epithelium as soon as it forms impairs the progression of the regeneration process, in particularly affecting the blastema formation (Stocum and Cameron, 2011).

As already mentioned, the process of blastema formation shows similarities with the development of the embryonic bud. A number of factors involved in the development process have been identified also in the wound epithelium, both in amphibians and zebrafish (Suzuki et al., 2006; Yoshinari et al., 2009); these factors are expressed very early after injury and their role in blastema growth is well documented, but there are also some evidences suggesting their implication in the wound healing and the blastema formation processes. In the fish, for example, *fgf20a* and *wnt10a* are expressed within the first six hours after amputation (Whitehead et al., 2005; Stoick-Cooper et al., 2007a); loss-of-function studies for both FGF and Wnt/ β -catenin pathways showed that cells migrate to cover the wound but the formed wound epithelium is abnormal and incorrectly specified (Whitehead et al., 2005; Kawakami et al., 2006; Stoick-Cooper et al., 2007a); they are also involved in the process of blastema formation because their inhibition after wound healing leads to the non expression of *msx* gene and absence of blastema (Poss et al., 2000a; Stoick-Cooper et al., 2007a). The Wnt/ β -catenin pathway seems to act upstream the FGF signaling because its inhibition induces the loss of *fgf20a* expression (Stoick-Cooper et al., 2007a); however, it is also possible that FGF signaling also induces Wnt/ β -catenin pathway in a positive feed-back loop (Stoick-Cooper et al., 2007b). However, there are also other factors that inhibit blastema formation when overexpressed, as the chemokine stromal cell-derived factor (SDF-1) and Wnt5b (Dufourcq and Vriza, 2006; Stoick-Cooper et al., 2007a).

Other potential signals for the induction of the regeneration process are the bioelectric signals. In planarians, the polarity of regeneration can be manipulated thanks to an electric field, because it has been demonstrated that the head is always formed at the cathode side (Carlson, 2007); moreover, different studies have shown that the diminution of β -catenin expression or the dysfunction of a Wnt agonist interfere on head regeneration (Gurley and Sanchez Alvarado, 2008; Petersen and Reddien, 2008), leading for the first time to find a relationship between an electric field and the signal transduction. Other studies conducted on the regeneration of the *Xenopus* tadpole tail have demonstrated the implication of the V-ATPase H^+ pump in the regeneration process but not in the wound healing (Adams et al., 2007; Levin, 2007): the pump inhibition by concanamycin inhibits regeneration, whereas the expression of a pump insensitive to the drug can rescue the inhibition. More recently, similar studies on zebrafish adult fin have shown that this H^+ pump is necessary for the expression of the gene *aldh1a2*, responsible for retinoic acid synthesis, and MAP Kinase Phosphatase 3 (MKP3): its inhibition blocks the blastema formation in the adult but, interestingly, has no effect on the larvae tail regeneration,

suggesting the existence of different mechanisms intervening in the larvae or adult regeneration processes (Monteiro et al., 2014). Altogether, these studies suggest that the V-ATPase H⁺ pump has a central role in the regulation of the membrane potential of the stump cells and then it would be interesting to understand how voltage gradients are detected and transduced during the regeneration process. In this context, the implication of nerves seems to be determinant (Stewart and Stankunas, 2012) and, indeed, the innervation is essential for the regeneration process (Brockes and Kumar, 2008). I will speak more precisely about the role of nerves during the regeneration process in the next chapter.

Finally, another signal that could be involved in the induction of the blastema formation could be the activation of the thrombin, necessary to seal the wound just after the injury. It has been shown in the urodelans that the local activation of the thrombin is a signal for the regeneration process and that thrombin is necessary for muscle cell dedifferentiation *in vitro* (Tanaka et al., 1999; Lööf et al., 2007; Stocum and Cameron, 2011). Moreover, the thrombin-dependent activation of platelets plays a role in serotonin secretion after hepatectomy, acquiring an essential role for hepatocytes proliferation process (Lesurtel et al., 2006).

After the formation of the blastema, this structure starts to grow to allow the regeneration process to proceed and the involved signaling pathways have been carefully studied in different species, as reviewed for example in Stoick-Cooper et al., 2007b. At this point, the cell cycle speeds up (Nechiporuk and Keating, 2002) and the fin begins to rapidly growth back. Blastema cells differentiate into sceroblasts that start to secrete the matrix that will form the new lepidotrichia (Geraudie and Singer, 1992; Santamaria et al., 1992; Becerra et al., 1996; Mari-Beffa et al., 1996). Both FGF and Wnt/ β -catenin pathways are still active and now required for expression of *shh*, which becomes an important player during this phase (Laforest et al., 1998; Poss et al., 2000a; Stoick-Cooper et al., 2007a), in the cells of the basal layer of the epidermis, adjacent to the newly forming bone structures (Laforest et al., 1998). The ectopic expression of *shh* or *bmp2* in the blastema induces excess bone deposition and mispatterning of the regenerate (Quint et al., 2002); interestingly, both the inhibitions of BMP and Shh pathways through *chordin* overexpression or cyclopamine treatment, respectively, block the fin outgrowth, suggesting that both BMP and Shh are involved in sceroblasts proliferation and/or differentiation (Quint et al., 2002). Also the retinoic acid receptors are expressed during fin regeneration and exogenous retinoic acid application causes bifurcating bones to fuse together, suggesting that retinoic acid is involved in the process of bone patterning (White et al., 1994).

The regenerating fins display positional memory: they grow back to the correct length, independently where on the proximodistal axis they were amputated, with fins amputated more

proximally growing back faster than fins amputated more distally (Akimenko et al., 1995; Lee et al., 2005b). It has been shown that the FGF signaling determines regenerative growth rates, being then involved in the positional memory of the fin (Lee et al., 2005b). Because it is known that FGF signaling regulates *msxb* expression (Poss et al., 2000a) and that the levels of expression depend on where along the proximodistal axis the fin is amputated, with the rapidly proliferating cells of the proximal blastema expressing higher levels than the less rapidly proliferating cells of the distal blastema (Akimenko et al., 1995; Lee et al., 2005b), the positional memory could be conferred precisely through Msxb.

Finally, at the end of the regeneration process, the fin has to stop to grow. To achieve this, there are two possible mechanisms: the gradual extinction of positive regulators or the activation of negative regulators. The latter seems to be the case of Wnt5b, which activates the β -catenin independent Wnt pathway (Stoick-Cooper et al., 2007a): the overexpression of Wnt5b inhibits β -catenin target genes expression and cell proliferation and leads to the failure of the regeneration process; moreover, the fish that are homozygous mutants for *wnt5b* regenerate faster than the wild type. Wnt5b is a negative regulator of the β -catenin signaling, and it has been demonstrated that β -catenin induce *wnt5b* expression to regulate itself, as the inhibition of β -catenin results also in the suppression of *wnt5b* expression (Stoick-Cooper et al., 2007a). Altogether these results lead to the conclusion that Wnt5b acts in a negative feedback loop to regulate Wnt/ β -catenin signaling during the regrowth of proper sized fin. However, it is also interesting to notice that *wnt5b* is expressed throughout the regeneration and then it may also play other roles that are still to be uncovered. Another factor that has been recently involved in the termination process of fin outgrowth is calcineurin. Indeed, calcineurin activity gradually increases as the fin final size and shape are recovered, indicating that its activity could slow or stop the regenerative process. Moreover, calcineurin inhibition results in continued disproportionate fin outgrowth beyond its original dimensions because this inhibition shifts fin regeneration from a distal growth program to a proximal program, probably with the promotion of retinoic acid signaling. Calcineurin inhibition has a similar effect in juvenile developing fins and induces fins outgrowth in adult (Kujawski et al., 2014). Therefore, also calcineurin can be considered as a negative factor that regulates the termination of the regeneration process in order to obtain a proper sized regenerated fin (Tornini and Poss, 2014).

1.3.The role of nerves during regeneration

The nerve dependence of the regeneration process has been first observed studying the regeneration of the salamander limb by Tweedy John Todd (Todd, 1823). He observed that after transection of the sciatic nerve in the salamander limb, the animal experienced defaults in the regeneration process: if the denervation was performed before the amputation, the healing resulted in the formation of a scar tissue, whereas, if the denervation was performed after the wound healing, the regeneration was inhibited or retarded; finally, if the limb was denervated after blastema formation, the regenerated remained static or regressed (Figure 9B).

Only more than one century later new experiments on this topic has been conducted. In the 1940s, Butler and Schotté performed experiments on larval urodelans limb and found that denervation followed by amputation results in regression of the limb tissue, accompanied by the formation of an unstable mass of blastema cells that eventually stabilise as the axons regenerate back into the regressing limb tip and regeneration proceeds; however, if the reinnervation does not occur, the limb regresses completely and a scar tissue is formed (Butler and Schotté, 1941; Schotté and Butler, 1944).

In the same years, Marcus Singer performed lots of experiments on the importance of nerves during limb regeneration. One of his most important finding is that it is not the type of innervation - sensorial, motor or sympathetic - to be important but rather the amount of nerve fibres that influences and supports the regeneration process (Singer, 1952; Singer et al., 1976) (Figure 9A): the innervation density has to be higher than a certain threshold to continue the regeneration process (Sidman and Singer, 1951) and this threshold varies at the different proximodistal levels of the limb (Singer, 1952). Recent studies in zebrafish have demonstrated that, in absence of nerves, the fin is unable to form a blastema, whereas, in presence of a reduced amount of nerves, the regeneration is affected but a residual blastema is formed, giving rise to a small and abnormal fin (Simões et al., 2014). These results support the idea of Singer that a certain amount of nerves is necessary for successful limb/fin regeneration (Geraudie and Singer, 1977; Simões et al., 2014).

Therefore, not only limbs, but also tails depend on nerve presence for successful regeneration: studies on different species of salamanders and lizards have demonstrated that, if the spinal cord is injured or destroyed, fin regeneration does not occur because the number of peripheral nerve fibres is too low to support the process (Kamrin and Singer, 1955; Holtzer, 1956; Carlson, 2007). Another variable in the interaction between nerves and regeneration is the time at which denervation occurs (Figure 9B), as already observed by T. J. Todd and further investigated in other studies (Singer and Craven, 1948; Singer, 1952, 1978; Simões et al., 2014). If denervation occurs before the amputation, the regeneration process is completely inhibited; on the contrary,

if denervation occurs during blastema formation but after the formation of the wound epithelium, the regenerate outgrowth is diminished; finally, if denervation is performed after blastema formation, the size of the regenerate is normal, but the patterning is affected, suggesting that the innervation is essential not only during the initial phases of regeneration, but also for the tissue morphogenesis processes (Singer and Craven, 1948; Singer, 1952, 1978; Simões et al., 2014).

A) A threshold of nerves is necessary for regeneration to proceed

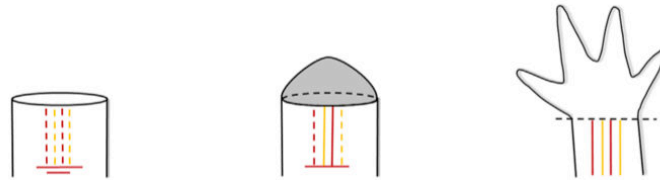

B) The time point of denervation affects the regeneration outcome

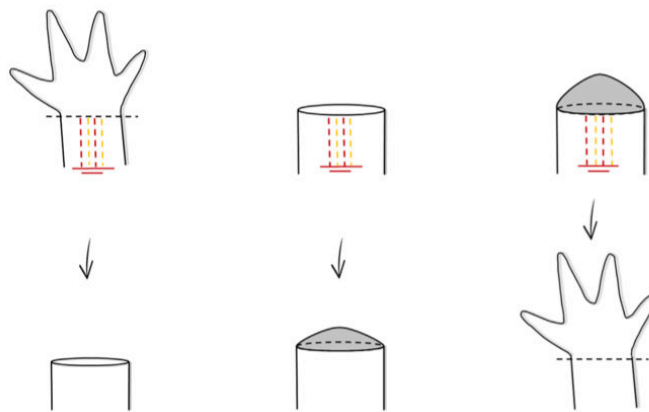

Figure 9: Nerve dependence of regeneration. The dotted lines represent degrading neurons, whereas the full lines represent intact neurons. **(A)** A threshold of nerve fibres is necessary for regeneration to proceed. Complete absence of nerves completely inhibits regeneration, while a reduction in the number of nerve fibres results in diminished regeneration. **(B)** The time point in the regeneration process at which denervation is performed affects the outcome of regeneration. If denervation is performed before amputation, the regeneration process is completely inhibited. If denervation arises after proper formation of the wound epithelium, regeneration is diminished. Denervation after the blastema is successfully formed does not affect the outgrowth of the regenerate, but can result in patterning defects. Adapted from Pirotte et al., 2016.

Even if different experiments have been conducted in other species of fish, amphibians and reptiles, the importance of nerves for tissue replacement in mammals is still unclear. Recent studies on mice have shown that cellular turnover, replacement, and differentiation from tissue progenitors cells is not affected by denervation, even if denervation causes retards in the regeneration of the digits tip and problems of patterning in the bone and nail matrix (Mohammad and Neufeld, 2000; Takeo et al., 2013; Rinkevich et al., 2014). Interestingly, these effects on mice resemble to complications observed in response to spinal cord injury in humans: the patients develop dermal fibrosis, progressive skin thickening and nail hypertrophy, suggesting a role of nerves not only during regeneration, but also during the processes of skin and nail

maintenance, in which progenitor cells need to replace damaged or worn-out cells. Moreover, the severity of these complications is progressive and directly correlates with the degree of injury (Stover et al., 1994a, 1994b).

Altogether, these observations lead to the hypothesis, already proposed by Singer, of the existence of a neurotrophic factor, the “factor X”, produced by the nerves and that has to be present at a certain levels to initiate and guide the progression of the regeneration process (Singer, 1954, 1965)

1.3.1. The neurotrophic hypothesis and the factor X

The neurotrophic hypothesis proposed by Singer regarding the existence of one or more “factor(s) X” which have to be present in sufficient quantity to allow regeneration has been confirmed by *in vitro* experiments in which the application of neural extracts promote proliferation of blastema cells in culture (Albert and Boilly, 1988; Boilly and Albert, 1988; Boilly and Bauduin, 1988; Stocum, 2011); moreover, these experiments suggest that the “factor X” should be a protein, because treatments with trypsin or heating, but not with RNase, abolish the activity of the extracts (Choo et al., 1978; Stocum, 2011).

It has been shown that nerve dependence arises during development. Indeed, in axolotl, limbs which have never been innervated are able to regenerate without nerves (Yntema, 1959) (Figure 10A) and, during urodelans limb development, the bud is able to regenerate in absence of axons until the moment to form the digits, in which it becomes highly innervated and then the regeneration becomes nerve-dependant (Brockes, 1987). Other experiments in axolotl on aneurogenic limbs were performed by Thornton (Thornton, 1970). He grafted aneurogenic limbs on normal hosts, replacing the normal innervated limb: in the beginning, the aneurogenic limb maintained its ability to regenerate in absence of innervation but, when the host nerves started to innervate the aneurogenic limb, the ability of nerve-independent regeneration was lost (Thornton and Thornton, 1970). These results suggest the idea that the aneurogenic limbs are able to produce themselves the “factor X”; once innervated, this autonomous production is suppressed and the trophic factor becomes to be produced dependently on nerves. In this context, the denervation of the newly innervated limb results in nerve-independent regeneration in about half of the limbs (Thornton and Thornton, 1970) (Figure 10B). On the contrary, more recent studies have demonstrated that aneurogenic tissues do not promote the regeneration of normal, denervated limbs: when the aneurogenic limb is grafted under the skin at the distal end of a normal limb, after amputation it is not able to stimulate the regeneration in normal, denervated limbs and moreover it also fails to regenerate itself (Tassava and Olsen-Winner, 2003) (Figure 10C). These results indicates that aneurogenic tissues are not able to produce themselves the

neurotrophic factor and, since the regeneration of the aneurogenic limb is also prevented, it appears that the nerve-dependent limb blastema produces a regeneration-inhibiting factor after denervation.

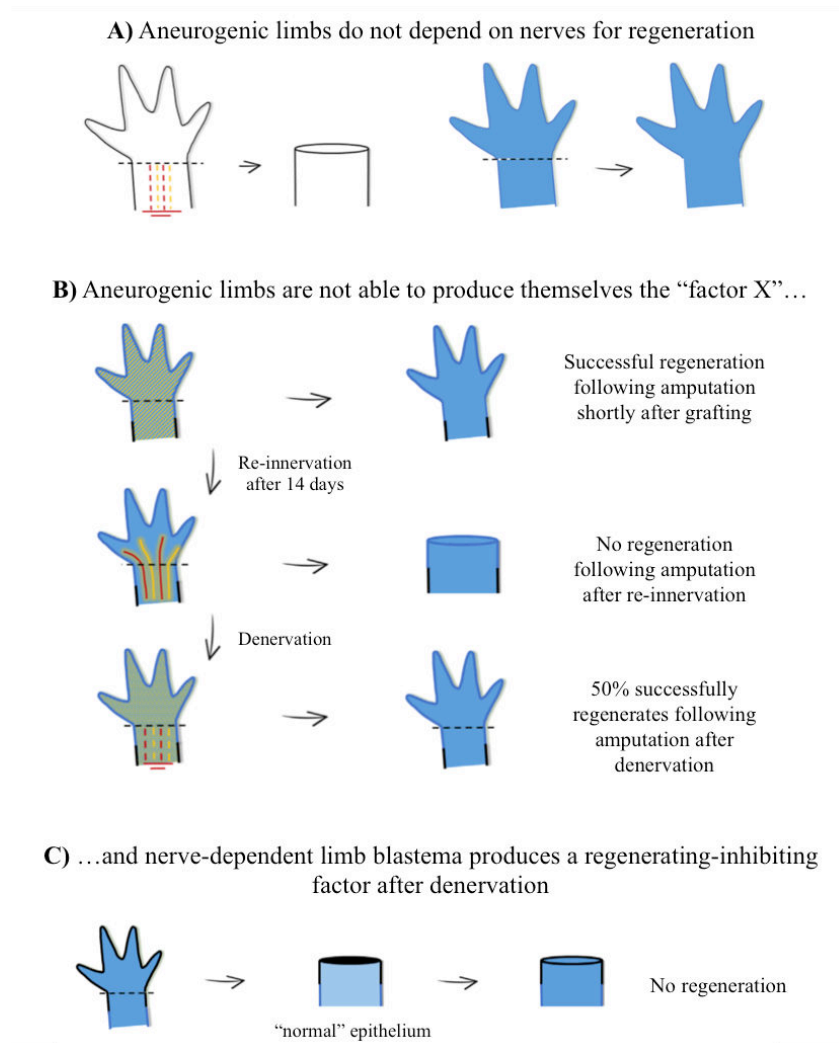

Figure 10: Nerve independence of regeneration in aneurogenic limbs. The dotted lines represent degrading neurons, whereas the full lines represent intact neurons. (A) Nerve dependence arises during development and limbs that have never been innervated (aneurogenic limbs, in blue) are not dependent on neural signaling for their regeneration. (B) Aneurogenic limbs are able to regenerate in absence of nerves, even when they are grafted on a normal host and amputated within several days. Therefore, it is likely that they produce the neurotrophic factors themselves (yellow). But when the aneurogenic limb becomes re-innervated (after approximately 14 days), regeneration becomes nerve dependent and denervation will lead to failed regeneration. This indicates that after innervation, the neurons will produce the regeneration-promoting factors. When these limbs are again denervated and maintained in this state, about half of the limbs regain their nerve-independent regeneration capacities. (C) If an aneurogenic limb (in blue) is covered with normal skin (black lines) and amputated, the wound epithelium is formed from normal epidermis (in black) and will then result in failure of regeneration. Adapted from Pirotte et al., 2016.

To sum up, it is clear that nerve dependence is acquired during development, whereas it remains not known whether aneurogenic limbs produce the neurotrophic factor or whether they may not need it to regenerate in a nerve-independent manner.

Since the “factor X”-producing axons degrade after amputation, they first need to respond to the signals emanated from the epithelial cells and the blastema which guide their patterning (Kumar and Brockes, 2012) and then, once reached the wound site, the action of the “factor X” can promote the proliferation and the differentiation of the progenitor cells. It then exists a reciprocal interaction between the neuronal cells and the cells of the blastema: on one side, the blastema cells guide the axon regeneration and elongation; on the other side, neural signaling is necessary for proper blastema formation, proliferation and differentiation, through the production of neurotrophic substances. It is still not clear if these substances are continuously produced by nerves or if they are a direct response to the amputation (Pirotte et al., 2016).

To be elected as “factor X”, the candidate substances must then possess some characteristics:

- they have to be present in the blastema and their presence has to be affected by denervation;
- they have to cause a mitogenic effect on blastema cells;
- they need to be able to substitute the nerves in support the regeneration;
- finally, regeneration has to be impaired in their absence.

Several researches have been performed to try to unravel the identity of this mysterious factor.

One of the first substances proposed to be the “factor X” was the fibroblast growth factor (FGF) (Gospodarowicz et al., 1978; Gospodarowicz and Mescher, 1980, 1981); in particular FGF2 and the glial growth factor 2 (GGF2) are produced by nerves and stimulate the regeneration of denervated limbs (Brockes, 1984; Brockes and Kintner, 1986; Mullen et al., 1996; Wang et al., 2000c). The exact *in vivo* role of FGFs during regeneration is still not clear; it seems possible that they could interact with the anterior gradient protein (AGP) to perform their proliferation-promoting functions and they also may need AGP for their production (Stocum, 2011). However, since several FGFs are produced in different tissues from different sources, it seems improbable that their axonal release leads to the nerve-dependence for blastema formation (Mescher, 1996).

Another candidate is the anterior gradient protein (AGP), a secreted factor whose secretion is regulated by nerves and already implicated in determining the positional identity of blastema cells, as it interacts with Prod-1 (Kumar et al., 2007a, 2007b; Blassberg et al., 2011). AGP is able to promote the regeneration in salamander and newt denervated limbs; unfortunately, it does not the same during zebrafish fin regeneration (Kumar et al., 2007b; Simões et al., 2014). Experiments conducted in the newt have shown that during development the newt Anterior Gradient (nAG) is first expressed in the epidermis and then switched off by nerve arrival; after lesioning, the nerves induce the re-expression of this protein first in Schwann cells and after also in cells of the wound epithelium: this re-expression is nerve-dependent because it is completely abrogated by denervation. On the other hand, the prevention of appendage innervation during

development induces a continuous nAG expression, leading to a nerve-independent regeneration process (Kumar et al., 2011).

Also the iron transporter transferrin is a good “factor X” candidate, as it is abundant in regenerating peripheral nerves and it is released by nerve terminals in regenerating limbs (Kiffmeyer et al., 1991; Mescher, 1996). It has been demonstrated that denervation reduces the transferrin content in the blastema and *in vitro* experiments showed that the inhibition of iron ions uptake performed by transferrin causes a rapid cell cycle arrest (Kühn et al., 1990). Moreover, the promoting activity of brain extracts on blastema cultured cells is completely abolished by removing either iron or transferrin and rescued by their re-addition (Mescher et al., 1997).

One last potential candidate is the insulin-like growth factor-1 (IGF-1). This protein is involved in the blastema formation and, interestingly, its ectopic application in amputated salamander limbs leads to a more rapid blastema formation (Fahmy and Sicard, 1998). Unfortunately, IGF-1 exact activity is still unknown.

Therefore, although all the efforts made to identify the “factor X”, at the moment we do not have a clear answer. The fact that rescue experiments not always result in normal regeneration (Mescher, 1996; Carlson, 2007) induced some scientists to propose an alternative, negative model of neural influence on regeneration, in which an inhibitory factor is produced by degenerating axons and/or Schwann cells to inhibit the regeneration process (Ferretti and Brockes, 1991; Simões et al., 2014). Nonetheless the original positive model is still prevailing and it is also supported by the fact that the neurons secretory activity changes during the regeneration process, modifying the production and transportation of different neurotrophic factors (Simões et al., 2014). Finally, it is probable that not a single molecule but a mix of neurotrophic factors would be involved in the control of the regeneration process (Carlson, 2007), explaining why the addition of a single factor can not always result in a complete rescue of the regeneration ability.

1.4.Reactive Oxygen Species

In aerobic organisms, oxygen plays a central role in the maintenance of the vital reactions. Its most known function is linked to the cellular respiration process, where it acts as final acceptor of electrons in the respiratory electron transport chain. But this is not its only function: regulatory functions of oxygen are carried out by reactive oxygen species, or ROS, through ROS signaling. ROS are highly reactive ions and free radicals derived from partial reduction of oxygen; they include the superoxide anion (O_2^-), hydrogen peroxide (H_2O_2) and the hydroxyl radical (OH^\cdot). ROS generally have a short life and are unstable. They are produced by virtually all cells as byproduct of many biochemical and biological processes, synthesized by enzymes or derived from the exposure to radiations or toxic compounds.

Superoxide anion radical O_2^- is the precursor of all other type of ROS. Cellular electron transport chains are one of the major sources of O_2^- in the cell. In the eukaryotes, oxygen can undergo a one-electron reduction to generate superoxide anion at the levels of complex I (NADH:ubiquinone oxidoreductase) and complex III (ubiquinol:cytochrome c oxidoreductase) of the mitochondrial respiratory chain (Boveris, 1977; Murphy, 2009). Little is known about the regulation of mitochondria oxidants production, although various factors are proposed to influence ROS generation (Holmström and Finkel, 2014). One of them is the proton-motive force, the combination of the electrical and chemical pH gradients across the inner mitochondrial membrane: increase in the proton-motive force is associated with increased ROS production, whereas a decrease in the proton-motive force is thought to result in decreased ROS generation (Mailloux and Harper, 2012). Another potential regulator of mitochondrial ROS production is oxygen availability: there are evidences that ROS levels increase under both hyperoxic and hypoxic conditions (Sena and Chandel, 2012).

The other major intracellular source of ROS is the family of NOX (nicotinamide adenine dinucleotide phosphate oxidase, or NADPH oxidase) enzymes. These membrane enzyme complexes transfer electron across biological membranes using NADPH as an electron donor; oxygen serves as an electron acceptor, leading to the formation of substantial amounts of O_2^- (Bedard and Krause, 2007). These family of enzymes has been first described in neutrophils, which are activated by various inflammatory mediators and produce large amount of ROS as part of their role in host defence (Hampton et al., 1998). In accordance with their conserved function, the NOX enzymes share also conserved structural properties: (1) a NADPH-binding site at the COOH terminus, (2) a FAD-binding region in proximity of the most COOH-terminal transmembrane domain, (3) six conserved transmembrane domains, and (4) four highly conserved heme-binding histidine residues, two in the third and two in the fifth transmembrane domain. Additional features, such as EF hands, additional NH_2 -terminal transmembrane domain,

and a peroxidase homology domain, are limited to some of the family members. Some data also suggest that some members of the family could be selective for NADH or NADPH (Bedard and Krause, 2007).

Mitochondria and NOX enzymes are the best-characterised intracellular sources of O_2^- , but also other enzymes, as xanthine oxidase, nitric oxide synthase, cyclooxygenase, cytochrome P450 enzymes and lipoxygenases, can all produce ROS. Similarly, also other organelles, as the peroxisome and the endoplasmic reticulum, can be a source of oxidants (Figure 11). For example, both the protein oxidation in the endoplasmic reticulum and the β -oxidation of very long-chain fatty acids in the peroxisomes produce hydrogen peroxide (H_2O_2) (Holmström and Finkel, 2014; Reczek and Chandel, 2015). Moreover, H_2O_2 can be also directly produced by many nonphagocytic cell types in response to a variety of extracellular stimuli such as cytokines, neurotransmitters, peptide growth factors and hormones (Finkel, 1998; Rhee et al., 2000; Thannickal and Fanburg, 2000; Martindale and Holbrook, 2002). The relative contribution of these additional sources of ROS varies according the cell type (Holmström and Finkel, 2014).

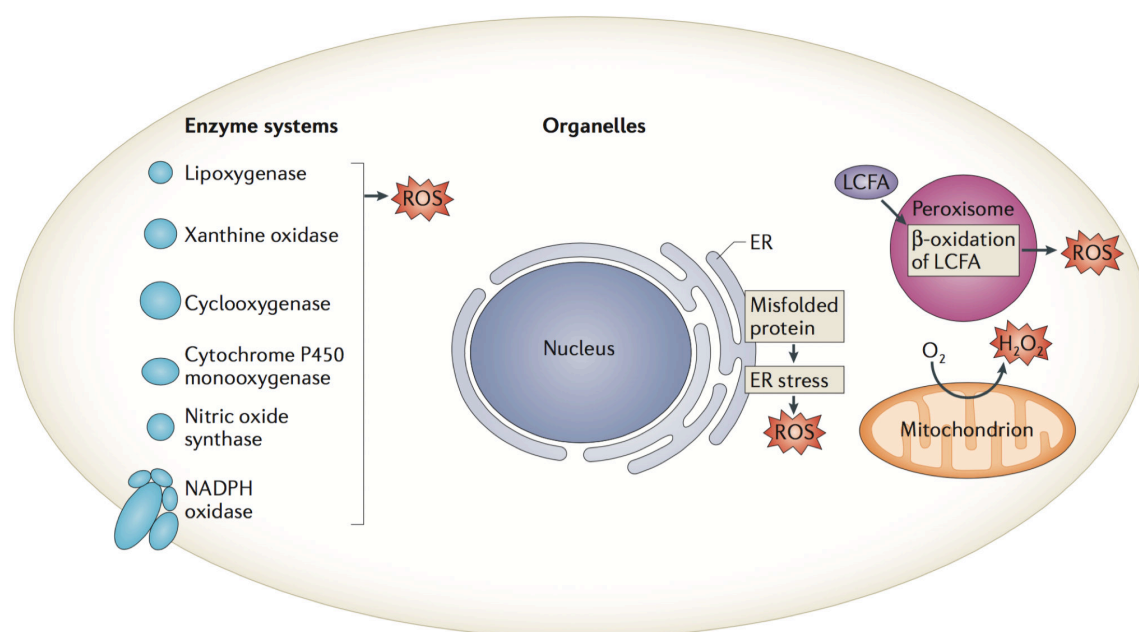
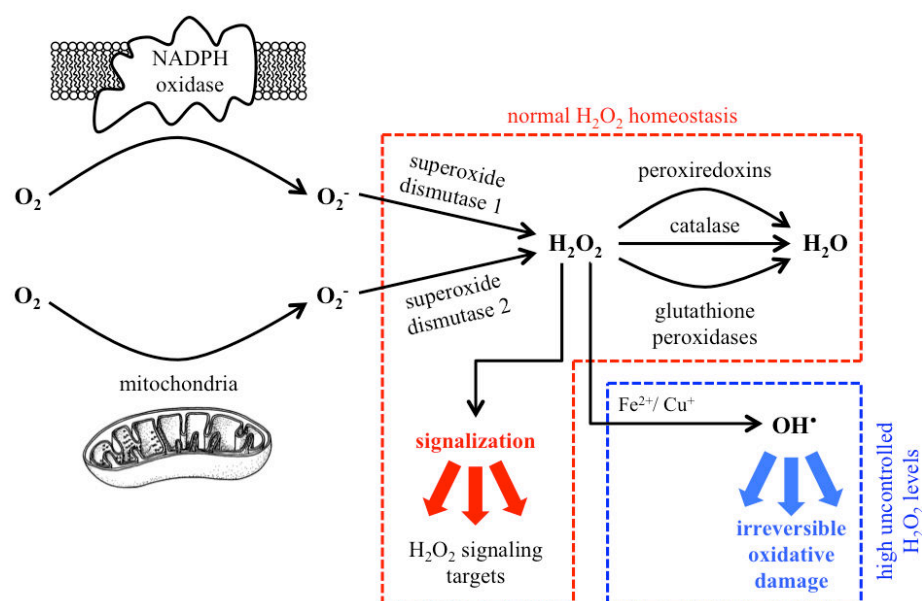

Figure 11: Intracellular sources of ROS. Various organelles within the cell can generate reactive oxygen species. These include mitochondria, the endoplasmic reticulum (ER; particularly in the setting of ER stress) and peroxisomes (as part of their role in metabolizing long-chain fatty acids (LCFAs)). In addition, various enzymes, including oxidases and oxygenases, generate ROS as part of their enzymatic reaction cycles. From Holmström and Finkel, 2014.

Even if both mitochondria and NOX enzymes produce the superoxide anion O_2^- , this ROS is rapidly converted into hydrogen peroxide (H_2O_2) by the highly specialised enzyme superoxide dismutase (SOD) to prevent the dangerous effects that the free radical could have on the cells (McCord and Fridovich, 1969) (Figure 12): cytosolic O_2^- is converted by the enzymatic activity

of the superoxide dismutase 1 (SOD1), whereas mitochondrial produced O_2^- is released into the matrix where it is dismutated by the superoxide dismutase 2 (SOD2) (Murphy, 2009; Reczek and Chandel, 2015). However, also H_2O_2 can be dangerous for the cells. Indeed, the third type of ROS, the extremely reactive hydroxyl radical (OH^\bullet), is produced when uncontrolled, very high levels of H_2O_2 react with metal cations, as Fe^{2+} or Cu^+ , via Fenton reaction (Figure 12). Given its very short half-life, strong oxidizing potential and lipid insolubility, hydroxyl radical causes irreversible oxidative damage to virtually all biological molecule with the vicinity of its production (Reczek and Chandel, 2015). Therefore, H_2O_2 cellular levels are controlled by several enzymatic systems, as catalase (Chance et al., 1979; Chelikani et al., 2004), peroxiredoxins (Hofmann et al., 2002; Wood et al., 2003; Rhee et al., 2005) and glutathione peroxidases (Flohe et al., 1973) (Figure 12).



Superoxide dismutase

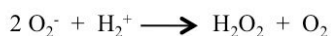

Catalase



Peroxiredoxins

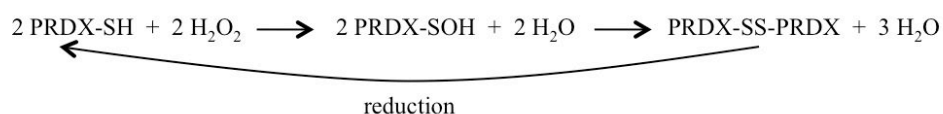

Glutathione peroxidases

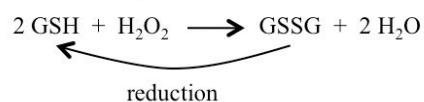

Figure 12: Hydrogen peroxide production and degradation within the cell. O_2^- dismutation by superoxide dismutase enzymes (SOD1 in the cytosol and SOD2 in the mitochondrial matrix) results in H_2O_2 production. Normal H_2O_2 homeostasis is maintained by the action of the enzymes catalase, peroxiredoxins and glutathione peroxidases, which reduce it into water. In these conditions H_2O_2 can act as a molecular messenger to mediate ROS signaling (red box). However, high H_2O_2 levels, in presence of metal cations as Fe^{2+} or Cu^+ , lead to OH^\bullet formation and irreversible oxidative damages to all cellular components (lipids, proteins and nucleic acids) (blue box).

For many years ROS have been considered only as deleterious molecules because of their ability to cause oxidative damage to different cellular molecules and structures (Storz and Imlay, 1999; Dröge, 2002) and their clear involvement in the induction and progression of many pathologies as well as in the aging process. However, in the last years it is becoming evident that only high uncontrolled ROS levels are dangerous (Covarrubias et al., 2008; Schieber and Chandel, 2014; Bigarella et al., 2014; Watson, 2014; Ye et al., 2015) and, on the contrary, controlled low ROS levels are normally produced in all cells, contributing to different physiological processes through the regulation of different molecules acting in the cellular pathways (Chiarugi and Cirri, 2003; Covarrubias et al., 2008; Finkel, 2011; Holmström and Finkel, 2014; Reczek and Chandel, 2015). In particular, H₂O₂ is a good candidate to mediate cellular signalling (Neill et al., 2002; Rhee et al., 2005; Veal et al., 2007; Grant, 2011; Fomenko et al., 2011; van der Vliet and Janssen-Heininger, 2014) thanks to its characteristics: half-life relatively long and high diffusion properties (Reczek and Chandel, 2015). It has also been noticed that the specific targets of the ROS signaling are located close to the ROS generating systems, favouring ROS regulative functions (Reczek and Chandel, 2015).

1.4.1. ROS signaling: the mechanisms

Considering the importance of switchability between ON and OFF states in intracellular signaling, proteins that can be sensitively and reversibly oxidized by ROS are candidates for mediating the signaling functions of ROS. Among the 20 amino acids that comprise proteins, cysteine (Cys) is of particular interest, because the thiol moiety (SH) in the side chain of Cys is very sensitive to oxidation and can form disulphide bonds with another thiol moiety. It is also known that disulphide bonds can be reduced back to the free thiol moiety under physiological intracellular conditions. Therefore, it has been proposed that the mechanism by which ROS act as signaling molecules is through the oxidation of critical cysteine residues within redox-sensitive proteins (D'Autréaux and Toledano, 2007; Miki and Funato, 2012; Ray et al., 2012). This oxidative reaction has been thought to occur non-specifically, but recent studies revealed the presence of highly reactive Cys residues selectively oxidized by ROS (Miki and Funato, 2012) (Figure 13). The oxidation of the Cys residues forms reactive sulfenic acid (–SOH) that can form disulphide bonds with nearby cysteines (–S–S–) or undergo further oxidation to sulfinic (–SO₂H) or sulfonic (–SO₃H) acid. These oxidative modifications result in changes in the structure of the target protein, affecting also its function. With the exception of sulfonic acid, and in part sulfinic acid, these redox modification are reversible by classical reducing systems as thioredoxin and peroxiredoxin (Miki and Funato, 2012; Ray et al., 2012).

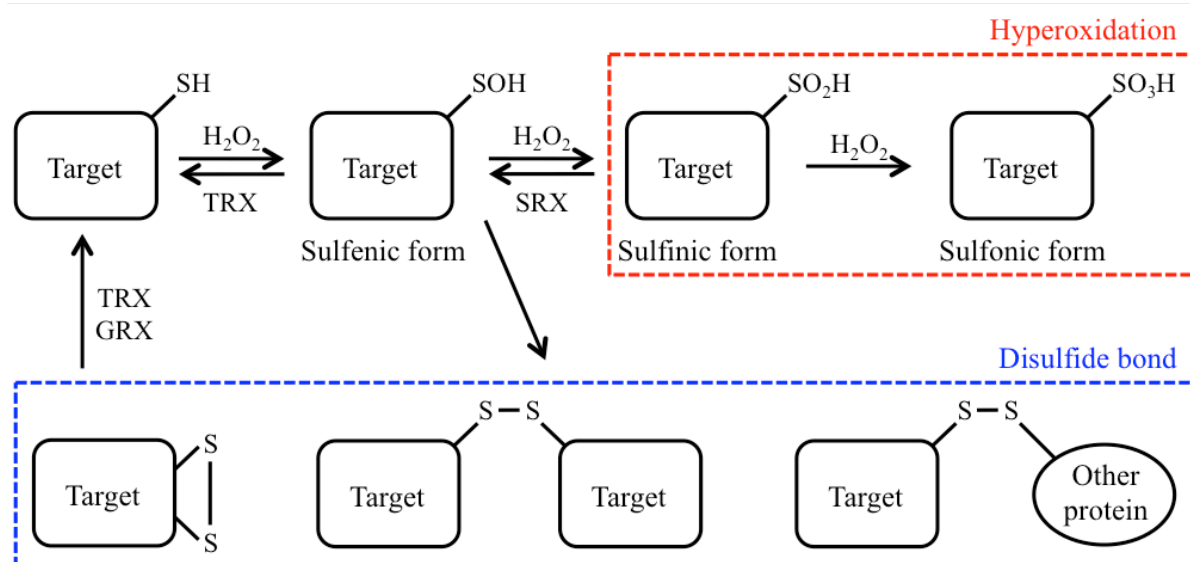

Figure 13: H₂O₂-mediated cysteine oxidation of redox-sensitive proteins. Critical cysteine thiol groups of target proteins are oxidized by H₂O₂ to yield sulfenic acid (-SOH), a reversible modification that can modify protein activity. When H₂O₂ levels are high, -SOH can be hyperoxidized to generate sulfinic (-SO₂H) and sulfonic (-SO₃H) acids (red box). While -SO₃H generally represents an irreversible oxidative modification, -SO₂H can be converted back to the -SOH intermediate by the enzymatic activity of sulfiredoxin (SRX). To protect the target protein from irreversible oxidation, the -SOH intermediate commonly forms reversible disulfide (S-S) bonds (blue box). -SOH can either form a disulfide bond by reacting with an intramolecular or intermolecular cysteine. The enzymatic activity of glutaredoxin (GRX) and thioredoxin (TRX) restore protein function by returning the oxidized protein back to its reduced state. Adapted from Reczek and Chandel, 2015.

However, it has also to be noticed that the reversible oxidation and reduction of other amino acids can occur. Indeed, increasing evidence indicates that methionine (Met) residues, the other sulphur-containing amino acid, might provide an analogous redox-dependent system. The rate constant for the oxidation of Met residues by H₂O₂ is fourfold slower than the analogous reaction for Cys residues, but the rates of oxidation of these two amino acids are similar when more powerful oxidants are studied (Drazic and Winter, 2014). Recent evidences indicate that some physiological processes, as actin polymerisation and the activity of the calcium/calmodulin-dependent kinase (CaMKII) can be reversibly regulated by Met residues specific oxidation (Erickson et al., 2008; Hung et al., 2013; Lee et al., 2013). Finally, also tyrosine (Tyr), tryptophan (Trp) and histidine (His) residues seem to be possibly oxidised (Dröge, 2002).

Nowadays, the mechanism(s) by which ROS, and in particular H₂O₂, transmits their signal to oxidize the target proteins is still not full understood. How does H₂O₂ find its target protein given the high reactivity and abundance of the antioxidants present in the cell? How is the signal transmitted? Several mechanisms have been proposed (Figure 14).

The mechanism called redox relay proposes that scavenging enzymes, as the glutathione peroxidase or the peroxiredoxins, receive first the oxidation by H₂O₂ and subsequently transfer the oxidation to the target protein (Winterbourn, 2013). This mechanism has been observed in

Saccharomyces cerevisiae where the oxidant receptor peroxidase-1 (Orp-1) enzyme, a glutathione peroxidase-like antioxidant, mediates the oxidation of the transcription factor Yap1 (Delaunay et al., 2002; Azevedo et al., 2003): this modification induces Yap1 protein conformation change and nuclear import, leading to the initiation of a transcriptional response involving the upregulation of the thioredoxin (Gulshan et al., 2005). Moreover, the oxidation of Yap1 by Orp1 requires the Yap1-Ybp1 interaction (Veal et al., 2003): it is possible that Ybp1 acts as a scaffold to bring Yap1 in close proximity to Orp1; in this way Orp1 can oxidise Yap1 before Orp1 is reduced by thioredoxin, completing the typical peroxidase catalytic cycle. Interestingly, the redox relay mechanism has been observed also in human cells: the H₂O₂ oxidation of the apoptosis signaling kinase (ASK1) protein and subsequent phosphorylation of its substrate p38 MAPK is dependent on the formation of a peroxiredoxin 1 (PRX1)–ASK1 disulphide intermediate (Jarvis et al., 2012).

A second proposed mechanism, the floodgate model, involves the inactivation of scavenging enzymes, thereby flooding the area with H₂O₂ and allowing the H₂O₂-mediated oxidation of specific thiol within the target protein (Toledano et al., 2010). A unique characteristic of eukaryotic peroxiredoxins is their ability to be reversibly inactivated by hyperoxidation to sulfinic acid (–SO₂H); in addition, the scavenging enzymes may be transiently inactivated posttranslational modifications, as phosphorylation, to allow H₂O₂ accumulation and cell signaling. An example of this mechanism has been recently described in mammalian cells: growth factor stimulation induces the localised production of H₂O₂ by NADPH oxidase and the simultaneous Src-mediated peroxiredoxin 1 (PRX1) phosphorylation and inactivation, allowing the colocalisation of elevated H₂O₂ levels with numerous signaling molecules without induce oxidative stress in the rest of the cell (Woo et al., 2010).

Even if these two mechanisms are the most supported, other two mechanisms have been proposed. One of them proposes that the scavenging enzymes could accept H₂O₂ oxidation and then transfer the oxidation to target protein not directly, but through an intermediate step involving the oxidation of thioredoxin or glutathione molecules (Hansen et al., 2006). For example, the interaction of AMPK with the thioredoxin 1 (TRX1) is essential for its activation during ischemia (Shao et al., 2014).

Finally, a last mechanism could involve the dissociation and resultant activation of a target protein following H₂O₂ oxidation of a scavenger enzyme. This process has been observed with the apoptosis signaling kinase (ASK1) protein and thioredoxin: H₂O₂-induced oxidation of thioredoxin changes the protein conformation and disrupts the ASK1–TRX interaction, activating ASK1 kinase activity (Saitoh et al., 1998; Sekine et al., 2012).

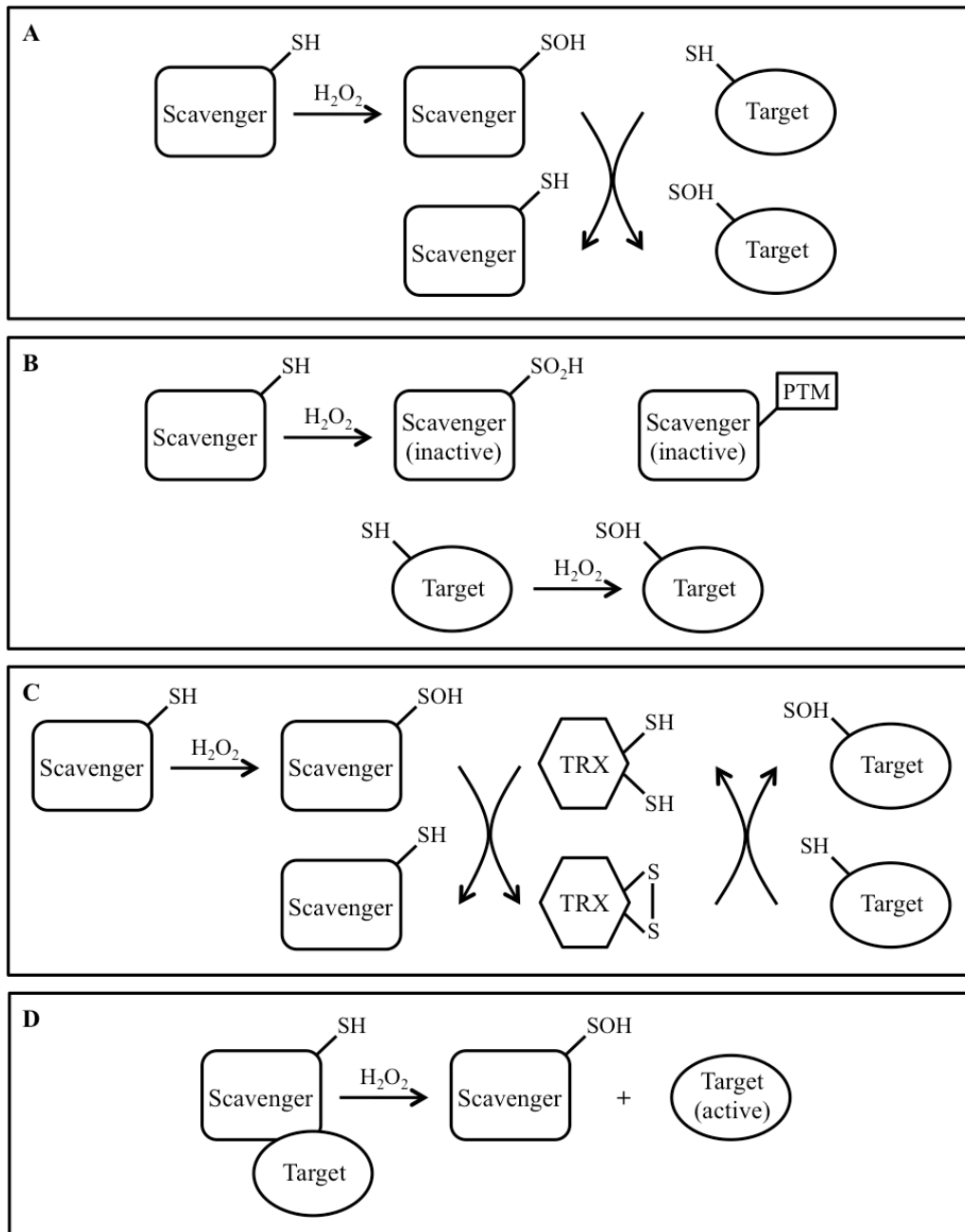

Figure 14: Possible mechanisms for H₂O₂-dependent signal transduction. (A) The redox relay mechanism uses a scavenging enzyme such as glutathione peroxidase (GPX) or peroxiredoxin (PRX) to transduce the H₂O₂ signal and oxidize the target protein. (B) With the floodgate model, H₂O₂ inactivates the scavenger, perhaps through hyperoxidation to sulfinic (-SO₂H) acid or through a posttranslational modification (PTM), to allow for H₂O₂-mediated oxidation of the target protein. (C) The scavenging enzyme accepts H₂O₂ oxidation and transfers the oxidation to an intermediate redox protein such as thioredoxin (TRX), which subsequently oxidizes the target protein. (D) Dissociation of the target protein from the oxidized scavenging enzyme results in target protein activation. Adapted from Reczek and Chandel, 2015.

1.4.2. ROS signaling targets: molecules, signaling pathways and cellular processes

It is now well accepted that ROS are signaling molecules that act as second messengers to transduce messages from the extracellular environment to generate specific cellular responses. To do this they cause the reversible oxidation of a great diversity of molecules participating in

almost all the known signaling pathway: the variety of macromolecules sensitive to redox modification by ROS is incredible, from extracellular matrix protein, to kinase, phosphatase and lot of transcription factors (Covarrubias et al., 2008).

Regulation of protein phosphorylation is essential in many developmental processes; for example, the activation of kinases is recurrent in the control of cellular proliferation and differentiation that follow growth factors signals. It is then essential to understand how the intracellular redox state can modify the activities of kinase and phosphatase proteins. Several protein tyrosine kinases (PTK) and protein tyrosine phosphatases (PTP) have been found to be redox sensitive because of conserved cysteine residues: indeed, in 81 out of 82 PTK we can find a conserved Cys987, in the majority of the cases inserted in the CXXXXXXXXMXXCW motif (Nakashima et al., 2005), whereas the PTP possess the conserved motif CXXXXXR (Rhee, 2006). An example of the kinase activity modulation by redox-regulated phosphatase is the action of the MAP kinase phosphatase (Mkp) on Jun kinase (Jnk): the inactivation of Jnk by Mkp is avoided when Mkp is oxidised (Kamata et al., 2005). Another example is the PIP3 phosphatase PTEN, whose activity contrasts the PI3 kinase activity: upon oxidation PTEN is inactivated and then PI3 kinase activity is up-regulated (Lee et al., 2002).

In addition to kinases and phosphatases, also transcription factors have an important role in almost every developmental process. Transcription factors are considered as the end target of all signaling pathways, activating the expression of specific genes; this transcriptional activation is the result of a multi-proteic complex in which the contribution of a transcription factor is influenced by its stability, processing and posttranslational modifications. The classical posttranslational modification that regulates transcription factors activity is phosphorylation. However, in the last years several redox-regulated transcription factors have been documented (Fomenko et al., 2011; Grant, 2011). Interestingly, various redox-regulated transcription factors possess highly evolutionary conserved Cys residues. An example is the paired domain-containing protein (Pax) who bear two conserved cysteines, Cys37 and Cys49, surrounded by a basic local environment that favours the redox regulation (Tell et al., 1998a, 1998b, 2000). Also the homeoprotein HoxB5 has been find to be regulated in a redox-dependant mechanism *in vitro*, with an effect opposite to other transcription factors: the oxidation enhances the homeoprotein DNA-binding ability (Galang and Hauser, 1993). HoxB5 redox-sensitive amino acids is Cys232; interestingly, many other homeoproteins in several species contain a highly conserved Cys residue, which corresponds to Cys39 in the homeodomain, (Gehring et al., 1994) suggesting that also other homeoproteins could be redox-regulated. One last example is given by Oct proteins, members of the POU-containing transcription factors that possess a highly conserved Cys50 (Herr and Cleary, 1995). This residue has been proved to be redox-sensitive at least in Oct2 and

Oct4 (Rigoni et al., 1993; Smith et al., 1998); Oct4 is of special interest because it acts in the maintenance of stem cells pluripotency, a process that seems to be very influenced by the redox environment (Bigarella et al., 2014).

The importance of the redox regulation of the transcription factors is highlighted also by existence of mechanism for the restoration of the normal transcriptional activity after the oxidative stress. The combined action of thioredoxin (Trx) and Apel–Ref1 complex lead to the return to a reduced state level of different transcription factors: Trx can reduce the oxidized Ref1 that, in turn, reduces in the nucleus the Cys residues of several transcription factors (Hirota et al., 1997).

The modulation of protein activity by the environmental redox-state is reflected also in the effects that ROS could have on entire signaling pathways. The Wnt pathway, for example, can be regulated by a thioredoxin-related protein named nucleoredoxin (Nrx) that, when reduced, binds to Dishevelled (Dlv), suppressing the Wnt signalling (Funato et al., 2006); H₂O₂ can oxidise Nrx, leading to release of Dvl and β-catenin accumulation to activate the signaling pathway. It is then likely that H₂O₂ might play an important role in the activation of the Wnt pathway and, in consequence, in all the processes in which it is involved.

However, the different signaling pathways not only respond to cellular redox changes, but they can also actively participate in promoting redox changes inside the cells. This is the case, for example, of an integrin-dependent signaling identified in the last years: after the extracellular matrix contacts the cells, ROS are first released from the mitochondria and, in a second time, strongly produced by the enzyme 5-lipoxygenase (Taddei et al., 2007). Two important characteristics of this process have to be underlined: first, a single type of receptor is able to promote ROS production from two different sources and, second, ROS formation can occur at different times upon signaling input. Src appears to be one potential ROS target and its consequent activation leads to focal adhesion and cytoskeleton rearrangement; also the focal adhesion kinase (Fak) seems to be activated by ROS and this could explain the role of ROS in cell migration and in all the other processes that require extracellular matrix-cell adhesion (Ben Mahdi et al., 2000).

If ROS can regulate different proteins and different signaling pathways, it is obvious that they can also influence various cellular and developmental processes.

In general, different levels of ROS can induce specific cellular processes: low levels of ROS are mitogenic or promote differentiation, higher levels favour growth arrest, and even higher ROS concentrations induce apoptosis (Covarrubias et al., 2008).

Very low levels of ROS stimulate proliferation of different type of cells. However, the presence of ROS is necessary to maintain cell proliferation; indeed, overexpression of antioxidants inhibits the proliferation of vascular smooth muscle cells in response to Egf (Brown et al., 1999; Shi et al., 2004). On the other hand, higher concentration of H₂O₂ can temporarily arrest cell growth, accompanied by stress-induced gene expression; after a while cells can exhibit an adaptive response, with the expression of gene involved in oxidant protection and DNA repair. However, at even higher H₂O₂ concentrations mammalian fibroblasts are not able to adapt and enter in a permanently growth-arrested state similar to senescence (Davies, 1999). If oxidation levels are further increased, cells die.

Then, rather than being a consequence of cell death, ROS are molecules with the ability to turn on the cell death machinery. As for the proliferation process, different ROS levels can result in different kind of cell death: lowest levels promote type 1 cell death (i.e., apoptosis), intermediate levels induce type 2 cell death (i.e., autophagy) (Scherz-Shouval and Elazar, 2007), and the highest concentrations cause necrotic cell death (Bras et al., 2005).

Regarding the differentiation process, it has been demonstrated that ROS can modulate, for example, the processes of neurogenesis (Tsatmali et al., 2005, 2006) and osteoclast differentiation (Lee et al., 2005a). Embryonic stem (ES) cells are well suited to study differentiation within all lineages; for instance, using ES-derived embryo bodies, it has been shown that also cardiomyogenesis is regulated by the intracellular redox state (Sauer et al., 2000; Sauer and Wartenberg, 2005; Li et al., 2006). Interestingly, also during spontaneous human ES cells differentiation we can observe ROS generation; moreover, the expression of antioxidant enzymes as superoxide dismutases, catalase and peroxiredoxins change during early differentiation (Cho et al., 2006).

Finally, in consequence of this ROS regulation of different cellular processes, also many developmental processes are influenced and regulated by variations in the oxidation levels: this is the case, for example, of processes as spermatogenesis, oogenesis, fertilisation, early development, morphogenesis, angiogenesis and cell migration (Covarrubias et al., 2008). All these processes have been carefully studied in the last years and the different influence that ROS can have in embryos more or less advanced in their development processes is becoming more and more clear.

1.4.3. ROS and regeneration

Tissue injury and inflammation are associated with increased production of ROS. Recent observations indicate that formation of ROS, and in particular H₂O₂, during tissue injury is an essential feature to ensure wound healing response, and functions as an early damage signal to

control several aspects of the wound healing process (Niethammer et al., 2009; van der Vliet and Janssen-Heininger, 2014). In some cases, the mechanisms by which ROS are produced or act in the wounded tissue during healing have been identified. For example, laser wounding of the *Drosophila* embryo epidermis triggers an instantaneous calcium flash that activates the NADPH oxidase Duox via an EF hand calcium-binding motif; the increased H₂O₂ production allows the recruitment of inflammatory cells at the wound site within minutes (Razzell et al., 2013). In the nematode *C. elegans*, instead, the ROS involved in the wound repair process is the superoxide anion (O₂⁻). In this case, the wounding triggers the elevation of the intracellular calcium concentration and the successive Ca²⁺ uptake by mitochondria induces the production of O₂⁻. The superoxide anion, in turn, locally blocks the action of the small GTPase RHO-1 via redox-sensitive cysteine, thus promoting actin accumulation specifically at the wound site and the successive wound closure (Xu and Chisholm, 2014).

In the last years, the role of ROS has been then studied also in the regenerative processes, and it has been found that in many species ROS signaling not only controls but is even necessary to have a proper regeneration process.

The data that will be presented are summarized in Figure 15.

The first findings emerged from studies conducted in *Xenopus* and zebrafish. During *Xenopus* tadpole tail regeneration, the amputation-induced ROS formation is necessary for the activation of Wnt/ β -catenin and FGF signaling pathways (Love et al., 2013; Chen et al., 2014) and for the inhibition of glucose combustion via the Krebs cycle and the promotion of glycolysis and anabolic processes necessary for tissue growth, via activation of target genes (Chen et al., 2014; Love et al., 2014). The amputation-induced ROS production has been recently involved also in the acetylation of the lysine 9 of the histone 3 (H3K9ac) in the regenerating notochord at the onset of tail regeneration (Suzuki et al., 2016).

In zebrafish, it has first been demonstrated that inhibition of ROS production around the time of larvae fin amputation (treatment from 1 hour before amputation to 1 hour after amputation) impaired the regeneration process; on the contrary, a treatment from 3 to 5 hours post amputation did not have any effect, suggesting that the specific signals that occur within the first hours after amputation are critical for late regeneration processes (Yoo et al., 2012). Successively, it has been shown that in adult fin regeneration ROS production is tightly regulated in time and space for at least 24 hours, in contrast with the wound healing process in which only a transient ROS production for 2 hours is observed. In the regenerating tissue, ROS signaling triggers two distinct parallel pathways: one that is responsible for apoptosis and one that is responsible for JNK activation; both events are involved in the compensative proliferation of the stump epidermal

cells and then necessary for the progression of the regeneration process (Gauron et al., 2013). ROS, and in particular H₂O₂, have been found to be required also for heart regeneration in adult zebrafish through promotion of Dusp6 ubiquitination and degradation, and the following Erk1/2 activity activation (Han et al., 2014). In addition, a very recent work on superficial epithelial cells (SECs) in adult zebrafish found that exfoliation injury causes a rapid increase in ROS levels in the fin epithelium, with a peak at 2-12 hours post exfoliation; the oxidation then gradually decreases to background levels by 48 hours post exfoliations. Interestingly, this kinetics correlates with the kinetics of SEC regeneration. Inhibition of ROS production reduces SEC regeneration; on the other side, exogenous application of H₂O₂ increases SEC coverage and individual cell surface area. Altogether, this data suggests the exfoliation-induced ROS production is necessary for the SEC regeneration process, at least in part regulating cell hypertrophy (Chen et al., 2016).

Species	Organ / Appendage	Target	Reference
<i>Xenopus</i> (tadpole)	tail	Wnt/ β -catenin pathway FGF pathway	Love et al., 2013 Chen et al., 2014
		Glycolysis	Chen et al., 2014 Love et al., 2014
	notochord (during tail regeneration)	Acetylation of H3K9	Suzuki et al., 2016
Zebrafish (larvae)	caudal fin	/	Yoo et al., 2012
Zebrafish (adult)	caudal fin	Apoptosis JNK pathway	Gauron et al., 2013
	heart	ERK pathway	Han et al., 2014
	superficial epithelial cells (SECs)	/	Chen et al., 2016
Planarian	central nervous system	/	Pirotte et al., 2015
Newt	neurons	/	Hameed et al., 2015
Mice	liver	ERK pathway p38 pathway	Bai et al. 2015
Gecko	tail	/	Zhang et al., 2016
<i>Drosophila</i>	Epithelial disc cells (to promote AiP)	macrophages	Fogarty et al., 2016

Figure 15: ROS and regeneration. In this table are summarized the species in which ROS play an important role during regeneration, the appendage/organ involved in the regeneration process and, if known, the molecular target of the ROS signaling.

Similar studies have been conducted also in other species. In planarian, amputation-induced ROS have been found to be necessary to promote body regeneration and in particular for the regeneration of the central nervous system, providing a first evidence for ROS necessity in the regeneration of anterior body parts (Pirotte et al., 2015).

In red spotted newts, the regeneration of neurons is due to the activation, and the subsequent neurogenesis, of neural stem cells called ependymoglia cells; modulation of oxygen tension (hypoxia followed by re-oxygenation) leads to loss of neurons and ROS accumulation in ependymoglia cells, concomitant with their cell cycle re-entry and increased neurogenesis, suggesting that ROS are necessary for ependymoglia cell cycle re-entry and then for neuronal regeneration (Hameed et al., 2015).

H₂O₂ is also necessary for liver regeneration in mice after partial hepatectomy and its levels have to be tightly regulated: sustained elevated levels of H₂O₂ are necessary for ERK signaling activation that triggers the shift from quiescence to proliferation, whereas sustained decreased levels of H₂O₂ are necessary for p38 signaling activation that triggers the shift from proliferation to quiescence; both events act through cyclin D regulation and Rb pathway. Then, an increase in H₂O₂ levels is necessary for the initiation of the regeneration program and the artificial increase of H₂O₂ at late phases impairs the hepatocellular re-entry into quiescence, delaying the regeneration termination; on the contrary, lowering H₂O₂ levels at early phases reduces hepatocyte proliferation and delays the onset of liver regeneration (Bai et al., 2015).

A recent work on spontaneous tail regeneration using gecko model suggests that ROS produced by skeletal muscles are required for the successful tail regeneration also in this animal. In this case, ROS has been found to control the formation of autophagy in the skeletal muscles and, as consequence, the length of the regenerating tail (Zhang et al., 2016).

Finally, H₂O₂ has recently been associated in *Drosophila melanogaster* with the apoptosis-induced proliferation (AiP), the process by which apoptotic cells actively stimulate surviving cells to divide; this compensatory mechanism helps to maintain tissue size and morphology following unexpected cell loss and allows the regeneration of the lost tissue via additional or accelerated cell division. In epithelial disc cells, the Caspase-9 ortholog Dronc promotes the activation of the NADPH oxidase Duox, which generates extracellular H₂O₂; the extracellular H₂O₂ activates the *Drosophila* macrophages, which in turn trigger JNK activity in epithelial cells through the tumour necrosis factor (TNF) ortholog Eiger, thus promoting the apoptosis-induced proliferation process (Fogarty et al., 2016).

1.4.4. ROS as possible mediator between nerves and regeneration process

Several researches in the last years underlined the relationship between the redox imbalances, or oxidative stress, and neuropathies or neurodegenerative diseases (Feldman, 2003; Barnham et al., 2004; Vincent et al., 2004; Halliwell, 2006; Figueroa-Romero et al., 2008). However, even if a correlation between ROS signaling and neuronal development and maintenance was observed, the existence of an interaction between ROS signaling and neural signaling during the regenerative process is still not proved. Anyway, the possibility that ROS could interact with nerves to regulate the regeneration process is clearly fascinating.

Many studies, both *in vitro* and *in vivo*, have demonstrated the importance of ROS signaling in neuroregeneration. In neuronal stem cells, ROS production is associated with numb-interacting protein 1 (Nip1) expression, which regulates neuronal differentiation (Suzukawa et al., 2000; Bedard and Krause, 2007; Kennedy et al., 2010, 2012). In cultures of hippocampal cell lines, H₂O₂ induces neurite outgrowth (Min et al., 2006). In *Caenorhabditis elegans*, the mutation of a gene that encodes for an extracellular peroxidase, *pxn-2*, improves the regeneration capacities of mechanosensory axons (Gotenstein et al., 2010).

Since proper neuroregeneration and innervation are necessary for a successful regeneration and since neuroregeneration is redox-regulated, it is then not surprising that, as already seen, ROS play important roles during the regeneration process. Rieger and Sagasti were the first to show a link between ROS signaling and nerves regrowth during a regenerative process: increased H₂O₂ levels at the wound site are necessary for peripheral sensory axon regeneration following skin injury in zebrafish larvae (Rieger and Sagasti, 2011).

It is interesting to notice that, during the regeneration process, the inhibition of ROS production has similar effects than denervation: interference of the progenitor cells proliferation. Indeed, diminished ROS levels impairs the Wnt/ β -catenin pathway and FGF signaling (Love et al., 2013) and affects also JNK MAPK cascade and apoptosis, thereby affecting cell proliferation and the expression of various signaling factors that are also deregulated following denervation (*fgf20*, *sdf1*, *wnt5b*, *wnt10*, and *igf2b*) (Gauron et al., 2013).

Finally, a clue on the possible link between ROS and nerves signaling during regeneration comes from the already mentioned newt Anterior Gradient (nAG) protein. In newts, the regeneration process of a denervated appendage can be rescued by nAG overexpression (Kumar et al., 2007b). The interesting thing is that nAG is a protein disulphide isomerase, which catalyses the formation and breakage of disulphide bonds between cysteine residues, a role that could be functionally linked to regulation of cysteines redox state operated by the ROS signaling.

1.4.5. How to visualise ROS (and in particular H₂O₂): HyPer

The increasing interest for ROS in biological research led the scientists to find out how to visualise and follow ROS dynamics both *in vitro* and *in vivo* during physiological processes. In the last years several synthetic indicators have been developed. Just to mention some of them, we can name 2,7-dichlorodihydrofluorescein (DCFH), dihydrorhodamine 123 (DHR), Peroxy Green 1 (PG1) and Peroxy Crimson 1 (PC1) (Crow, 1997; Gomes et al., 2005; Miller et al., 2007; Freitas et al., 2009; Rhee et al., 2010). However, many of these probes can be use only *in vitro*. Moreover, many of them are not specific for an individual form of ROS and their reaction is irreversible. Finally, their signals can be affected by artefacts associated with nonspecific reaction (Gomes et al., 2005; Freitas et al., 2009). For example, the oxidation of DCFH to the fluorescent compound dichlorofluorescein (DCF) initially was thought to be useful as specific indicator for H₂O₂ (Keston and Brandt, 1965) but it has been successively demonstrated that DCFH can be oxidized also by other ROS, such as OH[•] (Crow, 1997; Wang and Joseph, 1999). Anyway, indicators for specific form of ROS actually exist, such as the hydroethidine (HE) that is oxidised to fluorescent ethidium (E⁺) specifically by O₂⁻ (Benov et al., 1998).

Many problems for the detection of H₂O₂ have been overcome by the genetically encoded fluorescent biosensors. Nowadays, two types of genetically encoded sensors for H₂O₂ exist: HyPer, first developed in 2006 (Belousov et al., 2006) and then followed by other HyPer family members (Bilan and Belousov, 2016), and roGFP2-Orp1 (Gutscher et al., 2009). I will now focus more in detail on HyPer, which has been used during my thesis.

The genetically encoded biosensor HyPer allows real-time imaging of H₂O₂ dynamics within cells and even individual compartments of the cell, without inducing the formation of aspecific products. It is composed by the H₂O₂-sensitive regulatory domain of the *Escherichia coli* transcription factor OxyR, in which it has been integrated the circularly permuted yellow fluorescent protein (cpYFP) (Belousov et al., 2006) (Figure 16A).

In *E. coli*, OxyR activates the expression of antioxidant genes in response to increasing concentrations of H₂O₂, thus protecting the cells from oxidative stress. The C-terminal domain of OxyR functions as a sensor for H₂O₂, selectively and reversibly reacting with H₂O₂. Oxidation of OxyR by H₂O₂ causes the formation of a disulphide bond between the cysteine residues Cys199 and Cys208 of the regulatory domain, which leads to conformational changes in the DNA-binding domain of the protein; the disulphide bond can be successively reduced enzymatically by glutaredoxins and other enzymes. The selectivity of OxyR toward H₂O₂ is determined by the low pKa of Cys199 and its hydrophobic environment (Zheng et al., 1998).

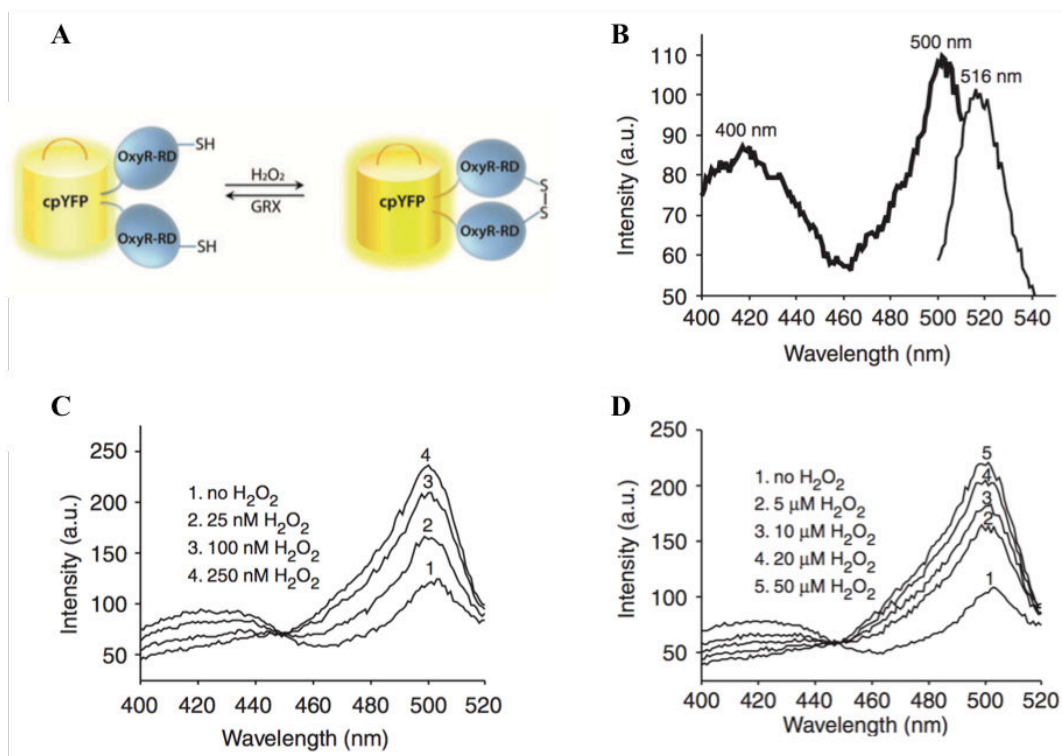

Figure 16: Genetically encoded fluorescent biosensor HyPer for H_2O_2 measuring. (A) The scheme of HyPer structure and its oxidation and reduction reactions. (B-D) Spectral properties of HyPer. (B) The excitation spectrum has two maxima at 420nm and 500nm; the emission spectrum has a maximum at 516nm. (C) Excitation spectrum of HyPer in Tris-HCl (pH 7,5), 150mM NaCl, 0,5mM 2.mercaptoethanol, upon addition of indicated concentrations of H_2O_2 . Emission was measured at 530nm. (D) Excitation spectrum of HyPer in *E. coli* cells suspensions upon addition of indicated concentrations of H_2O_2 . Emission was measured at 530nm. Adapted from Belousov et al., 2006 and Bilan and Belousov, 2016.

In the HyPer molecule, the OxyR domain performs the same function. Additionally, cpYFP is integrated into the sequence of the C-terminal regulatory domain of OxyR, in a position between the amino acids 205 and 206, via short peptide linkers; this region is particularly affected by the structural changes that occur upon oxidation-reduction cycles. When OxyR domain of HyPer is specifically oxidized by H_2O_2 , the induced conformational changes are transmitted to the fluorescent protein. Moreover, the spectral characteristics of HyPer change as a result of these intramolecular reorganizations. The fluorescence excitation spectrum of HyPer has two maxima at 420 and 500 nm and a single emission peak with a maximum at 516nm (Figure 16B). Upon oxidation of HyPer in the presence of H_2O_2 , the intensity of the 420 nm excitation peak decreases proportionally to the increase in the 500 nm peak. Therefore, HyPer is a ratiometric sensor: the HyPer signal is defined as the ratio of fluorescence intensities separately excited at 500 and 420nm (F_{500}/F_{420}). Increasing of H_2O_2 concentration results in oxidation of the biosensor, and the F_{500}/F_{420} signal increases (Belousov et al., 2006).

In vitro, the addition of 25 nM of H_2O_2 to a fully reduced solution of HyPer protein has minimal effects; on the contrary, the addition of 250 nM of H_2O_2 leads to full oxidation of the biosensor (Figure 16C). The same sensitivity was confirmed also in *E. coli* cells suspension (Figure 16D)

and in the cytoplasm of mammalian cells: in the latter case, the minimal concentration of externally added H_2O_2 that induces minimal detectable changes in HyPer fluorescence is $5 \mu\text{M}$ (Belousov et al., 2006).

Thanks to its specificity to H_2O_2 and its other features (possible use *in vitro* and *in vivo*, in living cells and living organisms; reversibility of the signal; no induction of aspecific products or reactions), HyPer is currently being successfully used in many laboratories to study the roles of H_2O_2 in living systems.

1.5.Hedgehog (Hh) proteins and signaling pathway

The origin of the name Hedgehog derives from the phenotype of the *Hh* mutant *Drosophila melanogaster* larvae, which display short and spiked cuticles. The mutation was first identified in 1980 during a screening for mutations that impair or change the development of the fruit fly larval body plan; the *Hh* gene was successively cloned in the 1990s. In the same years, Hh orthologs were discovered in different vertebrate species, as *Mus musculus* (mice), *Rattus rattus* (rat), *Danio rerio* (zebrafish) and *Gallus gallus* (chicken), and even in humans (Varjosalo and Taipale, 2008).

The vertebrate genome duplication (Wada and Makabe, 2006) has resulted in the expansion of *Hh* genes, which can be subdivided into three groups: the *Desert Hedgehog (Dhh)*, *Indian Hedgehog (Ihh)* and *Sonic Hedgehog (Shh)* subgroups (Echelard et al., 1993). The Shh and Ihh subgroups are more closely related to each other than to the Dhh subgroup, which in turn is closest to *Drosophila* Hh. Avians and mammals have only one *Hh* gene in each subgroup, whereas due to another whole-genome duplication (Jaillon et al., 2004) and further rearrangements, zebrafish has three additional Hh homologs: one in the Shh subgroup, tigglywinkle hedgehog (Twhh) (Ekker et al., 1995), and two in the Ihh subgroup, echidna hedgehog (Ehh) (Currie and Ingham, 1996) and qiqihar hedgehog (Qhh) (Ingham and McMahon, 2001).

The components of the Hh signal transduction pathway have been identified in *Drosophila* and the mechanism by which Hh signal is transduced has been studied in *Drosophila* and mouse cell culture models. In both vertebrate and invertebrates, the binding of Hh to its receptor Patched (Ptc) activates a signaling cascade that leads to the activation of a zinc-finger transcription factor (Ci in *Drosophila*, GLI1-3 in mammals) and the following expression of specific target genes (Varjosalo and Taipale, 2007, 2008). Although many of the key components are conserved in vertebrates, the mammalian Hh signaling pathway is not completely understood. It was thought that the main difference between *Drosophila* and mammalian Hh signaling was that mammals have multiple orthologs of many pathway components, including Hh, Ptc and Ci. However, the role of at least two mammalian orthologs, the protein kinase Fused (Fu) and the atypical kinesin Costal2 (Cos2), does not appear to be conserved (Varjosalo et al., 2006), suggesting that the mechanism of Hh signal transduction from the receptor to the Ci/GLI transcription factors has been evolved differently after separation of vertebrate and invertebrate lineages (Hedges, 2002; Varjosalo and Taipale, 2007).

The Hh proteins act as morphogenes controlling different developmental processes (Figure 17). It is thought that all mammalian Hh proteins have similar physiological effects and the

differences in their roles should derive from diverse pattern of expression (McMahon et al., 2003; Sagai et al., 2005). Dhh expression is restricted to gonads; consistent with this very restricted expression, Dhh-deficient mice are viable, even if infertile (Bitgood et al., 1996). On the contrary, Ihh is expressed in a more various even if limited number of tissues, including primitive endoderm (Dyer et al., 2001), gut (van den Brink, 2007), and prehypertrophic chondrocytes in the growth plates of bones (Vortkamp et al., 1996; St-Jacques et al., 1999). Due to its more extensive roles, about 50% of the Ihh-deficient embryos die during early embryogenesis for the poor development of the yolk-sac vasculature, whereas the survivors display cortical bone defects and aberrant chondrocyte development in long bones (St-Jacques et al., 1999; Colnot et al., 2005).

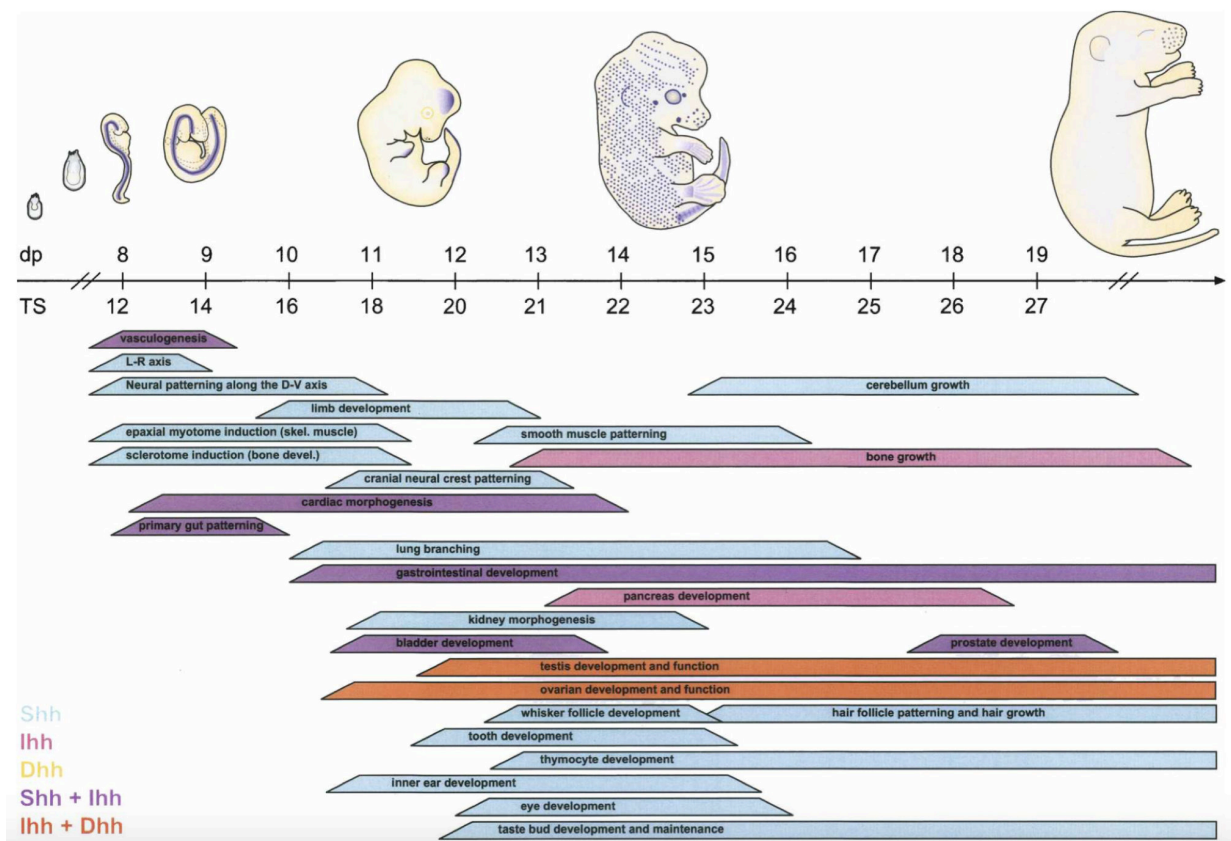

Figure 17: Shh controls mouse development from an embryo to an adult. The embryo cartoons show aspects of expression of the Hh target gene *patched* (blue) during mouse embryonic development (top). Bars show approximate embryonic stages when Shh, Ihh, and/or Dhh (color code in bottom left) control developmental processes in the indicated tissues or cell types (bottom). From Varjosalo and Taipale, 2008.

Shh is the most broadly expressed mammalian Hh signaling molecule. During early vertebrate embryogenesis, it is expressed in midline tissues, such as node, notochord and floor plate, and controls the patterning of the left-right and dorso-ventral axes of the embryo (Sampath et al., 1997; Pagán-Westphal and Tabin, 1998; Schilling et al., 1999; Watanabe and Nakamura, 2000; Meyer and Roelink, 2003). Shh is also expressed in the zone of polarizing activity (ZPA) of the

limb bud, being involved in the process of patterning of the distal elements of the limb (Riddle et al., 1993; Chang et al., 1994; Johnson et al., 1994; Martí et al., 1995). Later in development, *Shh* is expressed during organogenesis in most epithelial tissues, affecting their development. *Shh* deficiency leads to cyclopia and defects in ventral neural tube, somite and foregut patterning, as well as in distal limb malformation, absence of vertebrae and ribs and failure of lung branching (Chiang et al., 1996; Litingtung et al., 1998; Pepicelli et al., 1998).

It is also worth to notice that different Hh ligands can act in the same tissue during development, with partially redundant functions (Figure 17). For example, *Shh* and *Ihh* act together in early embryonic development and the loss of both of them phenocopies the loss of Hh receptor Smoothed (Smo), leading to embryonic lethality due to defects in heart morphogenesis and extraembryonic vasculature formation (Zhang et al., 2001; Astorga and Carlsson, 2007).

1.5.1. Expression, processing and secretion of the Hh active peptide

The expression of the different Hh isoforms is tightly controlled by complex and divergent transcriptional enhancers that assure a regulated and differential expression of the different Hh proteins in the different tissues and at different time during the developmental processes. On the contrary, the mechanisms for the subsequent Hh processing and secretion appear to be conserved in evolution and are likely to apply to all Hh isoforms (Varjosalo and Taipale, 2007).

Of the mammalian *Hh* genes, only the mechanisms controlling *Shh* expression have been studied. The expression of this gene is the result of the action of multiple enhancers, which act independently to control *Shh* expression in different tissues; these enhancers are both local and distal elements compare to *Shh* gene position.

The expression of *Shh* in the floor plate of the hindbrain and spinal cord is regulated by the two enhancers *Shh* floor plate enhancer 1 (SFPE1) and 2 (SFPE2), located, respectively, at -8 kb and in intron 2 (Epstein et al., 1999). Another element present in intron 2, the *Shh* brain enhancer 1 (SBE1), on the contrary, induce the expression in the ventral midbrain and caudal diencephalon. Moreover, the distal elements SBE2, SBE3 and SBE4, located more than 400 kb upstream of the *Shh* transcription start site, direct the expression of *Shh* to the ventral forebrain. The combined action of these elements seems to cover all regions in which *Shh* is expressed along the anterior-posterior axis of the mouse neural tube (Jeong et al., 2006).

As already said, *Shh* is also expressed in the zone of polarizing activity (ZPA) of the limb bud. In this case the expression is regulated by the mammals-fish conserved sequence 1 (MFCS1), located even further upstream of the start site, at -1 Mb, in intron 5 of the *Lmbr1* gene (Lettice et al., 2003; Sagai et al., 2004). It is also interesting to notice that the MFCS1 sequence is not conserved in limbless vertebrates, such as snake, limbless lizards and newt (Sagai et al., 2005).

Even if the SBE2-4 and MFCS1 elements are far from the *Shh* transcription starting site, the upstream region contains very few genes; given the diverse expression pattern of Shh, it is possible that a number of other regulatory elements could be located in this “gene-poor” region (Varjosalo and Taipale, 2008).

Although many enhancers have been identified, it is not the same for the specific transcription factors that control their activity. Nevertheless, there are some possible candidates. The spatio-temporal expression pattern of FoxA2 suggests that it could be involved in Shh expression regulation in the midline (Chang et al., 1997; Epstein et al., 1999). Consistently, the activity of SFPE2 requires the presence of conserved binding sites for FoxA2 and Nkx6 (Jeong and Epstein, 2003). Also the homeoprotein Nkx2.1 has been suggested to be involved in Shh expression regulation in ventral forebrain (Jeong et al., 2006).

After translation, the Hh peptide undergoes several processing steps required for the generation and release of the active ligand from the producing cell (Figure 18). This mechanisms of Hh processing and secretion are very conserved along evolution (Ingham and McMahon, 2001).

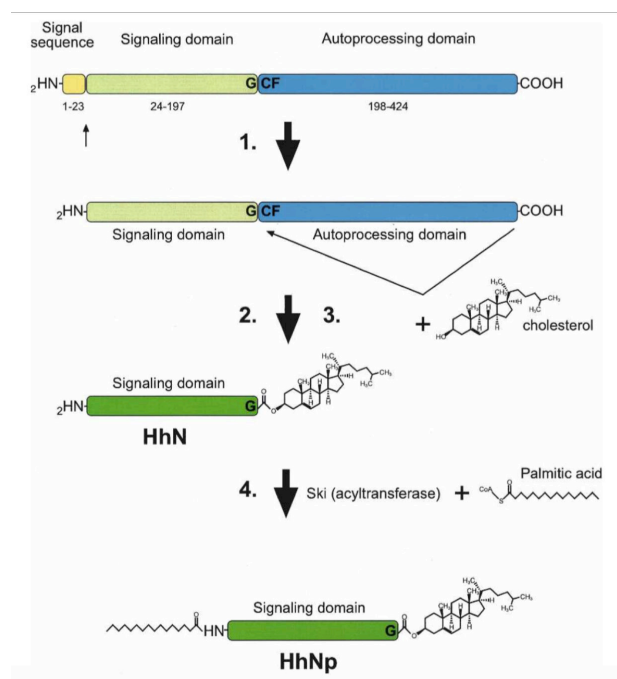

Figure 18: Hedgehog protein maturation. Hh protein undergoes multiple processing steps: (1) the signal sequence is cleaved; (2) the C-terminal domain of the Hh polypeptide catalyses an intramolecular cholesteroyl transfer reaction, resulting in (3) the formation of a C-terminally cholesterol-modified N-terminal Hh signaling domain (HhN). This causes association of HhN with membranes, which facilitates the final modification (4), the addition of a palmitic acid moiety to the N terminus by the acyltransferase Skinny hedgehog, resulting in the formation of dually modified Hh signaling domain (HhNp). From Varjosalo and Taipale, 2008.

Hh proteins are synthesized as ~45 kDa precursor proteins that undergo intramolecular cleavage: the C-terminal domain catalyses the division of the peptide, which occurs between conserved

glycine and cysteine residues (Lee et al., 1994; Porter et al., 1996a). The peptide bond between the two residues is first rearranged to form a thioester and, successively, a hydroxyl-oxygen group of a cholesterol molecule attacks the carbonyl of the thioester, displacing the sulfur and cleaving the Hh protein into two parts: a 25 kDa C-terminal fragment with no known signaling activity and a ~19 kDa N-terminal Hh signaling domain with an ester-linked cholesterol at its C-terminus (Porter et al., 1996a). The cholesterol modification results in the association of the active peptide with the plasma membrane. Subsequently, a palmitic acid moiety (Pepinsky et al., 1998) that is required for Hh activity is added to the N terminal cysteine residue by the acyltransferase Skinny hedgehog (Ski, or HHAT in humans) (Chamoun et al., 2001; Lee et al., 2001; Buglino and Resh, 2008). To sum up, the resulting N-terminal Hh signaling domain, doubly modified by addition of a cholesterol moiety to its C terminus and a palmitate to its N terminus, is the fully active Hh molecule (Chamoun et al., 2001; Lee and Treisman, 2001).

Even if the active Hh peptide is tightly associated with the plasma membrane, it is able to act directly over a long range (Roelink et al., 1995; Briscoe et al., 2001; Wijgerde et al., 2002) thanks to the secretion from the producing cells that occurs, for both *Drosophila* and vertebrates, through the transmembrane transport protein Dispatched (Disp). Loss of Disp leads to Hh accumulation in the producing cells and failure of long-range signaling (Burke et al., 1999; Ma et al., 2002). In vertebrates, the secretion is regulate also by the glycoprotein Scube/You (Creanga et al., 2012).

It has been shown that Hh can act over a distance of ~50 μm in *Drosophila* wing imaginal disc and ~300 μm in vertebrate limb bud (Zhu and Scott, 2004). The mechanisms that allow these incredible diffusion properties are not yet clear, and could involve passive diffusion, active transport and/or transcytosis (Varjosalo and Taipale, 2008). Heparan sulfate proteoglycans seem to have a role in this process, as Hh can not be transported across a field of cells lacking the heparan sulfate synthesizing enzymes (Bellaiche et al., 1998; Lin et al., 2000; Bornemann et al., 2004; Han et al., 2004a; Koziel et al., 2004).

Another unsolved question is whether Hh is transported as an individual molecule or assembled into larger particles. The latter hypothesis seems to be more supported by experimental evidences (Varjosalo and Taipale, 2008). Moreover, recent results suggest that Hh may be secreted into two different forms, one poorly diffusible for a short range action and another “packaged” form for long-range transport, the formation of which requires the cytoplasmic membrane-scaffolding protein Reggie-1/flottilin-2 (Katanaev et al., 2008).

The role of cholesterol in Hh transport *in vivo* is still debated, as different studies suggest diverse, and even opposite, roles for this modification. These studies are complicated by the fact

that Hh protein lacking cholesterol is soluble and can be secreted in absence of Disp and without to be palmitoylated (Mann and Beachy, 2004), becoming successively palmitoylated during the transport or even in the receiving cell. On the contrary, the role of the palmitate modification in Hh transport can be studied by inhibition of palmitoylation through mutation of either Ski or the N-terminal palmitoylated cysteine. Such experiments indicate that palmitoylation is required for Hh activity in *Drosophila* (Burke et al., 1999) and for the generation of soluble multimeric Hh protein complexes and long-range signaling in vertebrates (Chen et al., 2004).

Finally, the organisms developed several mechanisms to control the shape and the size of the Hh gradient. Very high levels of Hh can induce Hh expression in responding cells both in *Drosophila* and in mammals (Tabata et al., 1992; Roelink et al., 1995; Méthot and Basler, 1999), increasing the local concentration of Hh near to its the source. However, Hh induces also the expression of its receptor Ptc that internalizes Hh and targets it to lysosomes for degradation (Chen and Struhl, 1996; Incardona et al., 2000; Gallet and Therond, 2005); this negative feedback loop reduce Hh spreading through tissues. In addition, the transmembrane Hedgehog-interacting protein (HIP), present only in vertebrates and induced by Hh signaling, provides another way to reduce the range of Hh diffusion by binding to Hh protein (Chuang and McMahon, 1999; Jeong and McMahon, 2005).

1.5.2. Hh signaling pathway

The Hh signaling pathway culminates in the activation of the zinc-finger transcription factor Cubitus interruptus (Ci) or Gli in vertebrates (Figure 19). Vertebrates contain three Gli proteins: Gli1, Gli2 and Gli3; Gli2 and Gli3 are the mediators of Hh signaling, whereas Gli1 is a target of the Hh pathway that acts in a positive feedback loop to reinforce the signal (Hui and Angers, 2011). In absence of Hh, Ci/Gli (mainly Gli3 and less Gli2) is processed to obtain a truncated form (Ci^R/Gli^R) that acts as a transcriptional repressor for a subset Hh target genes. When Hh signal is present, the Ci/Gli processing, and thus the Ci^R/Gli^R production, is inhibited and, on the contrary, there is the accumulation of the full-length Ci/Gli (Ci^F/Gli^F), which is converted into the active form Ci^A/Gli^A that stimulates Hh target genes expression.

The membrane components that allow the transmission of the signal in presence of extracellular Hh ligand are the receptor Patched (Ptc) and the signal transducer Smoothed (Smo) (Chen and Struhl, 1996; Stone et al., 1996) (Figure 19). Ptc is a twelve-transmembrane protein structurally related to the bacterial RND family of proton-driven transporters (Hooper and Scott, 1989), whereas Smo is a seven-transmembrane protein structurally related to G-protein-coupled receptors (GPCRs) (Alcedo et al., 1996; van den Heuvel and Ingham, 1996; Stone et al., 1996). In contrast with most signaling pathways, here the receptor Ptc function as a negative regulator

of the Hh pathway by inhibiting Smo in absence of the ligand (Ingham et al., 1991); binding of Hh to Ptc, facilitated by the Ihog/Cdo family of co-receptors (Zheng et al., 2010), leads to the release of Smo from the inhibition, allowing its phosphorylation and consequent activation (Deneff et al., 2000). Several conserved proteins function to link Smo to Ci/Gli, including the kinesin-like protein Costal2 (Cos2)/Kif7 and Sufu and several Ser/Thr kinases as Fused (Fu), PKA, GSK3 and CK1.

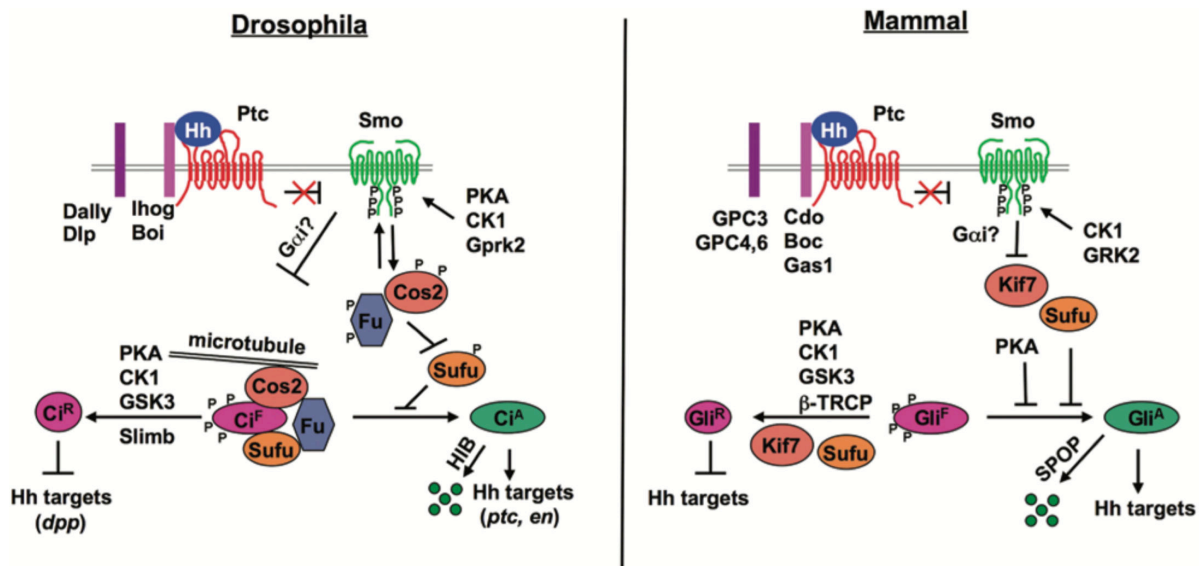

Figure 19: Hh signal transduction in *Drosophila* and mammalian systems. In the absence of Hh, Ptc inhibits Smo, allowing Ci^F/Gli^F to be phosphorylated by multiple kinases and targeted for Slimb/ β -TRCP-mediated proteolysis to generate Ci^R/Gli^R . In *Drosophila*, the kinesin-like protein Cos2 acts as a molecular scaffold to bridge Ci to its kinases. In the presence of Hh, Ptc inhibition of Smo is released; this triggers Smo phosphorylation by PKA, CK1 and Gprk2/GRK2, leading to its cell surface accumulation and activation. Smo recruits Cos2-Fu complex to the cell surface, and dissociates Cos2-Ci-kinase complexes to inhibit Ci phosphorylation and processing. In the presence of high levels of Hh, Fu converts Ci^F into Ci^A by antagonizing Sufu inhibition. Ci^A is unstable and degraded by the HIB-mediated Ub/proteasome pathway. In mammals, Hh induces Smo phosphorylation by CK1 and GRK2, leading to its activation. Sufu is a major whereas Kif7 a minor inhibitor of Gli proteins. The HIB homolog SPOP is responsible for degrading Gli proteins in the absence of Sufu. Ci^F/Gli^F : full length Ci/Gli; Ci^A/Gli^A : activator form of Ci/Gli; Ci^R/Gli^R : repressor form of Ci/Gli. From Chen and Jiang, 2013.

In *Drosophila*, in absence of Hh, Cos2 acts as a molecular scaffold to bridge Ci to the kinase Fu, inhibiting Ci nuclear translocation and promoting Ci processing (Sisson et al., 1997; Robbins et al., 1997; Wang et al., 2000b; Wang and Holmgren, 2000; Wang and Jiang, 2004; Zhang et al., 2005) by the multiple phosphorylation of Ci by PKA, CK1 and GSK3. These three kinases phosphorylate Ci sequentially at three clusters of sites, with PKA serving as the priming kinase for GSK3 and CK1; these phosphorylation events create the docking site for Slimb (Jia et al., 2005; Smelkinson and Kalderon, 2006), which functions as a substrate recognition component of the SCF family of E3 ubiquitin ligases (Jiang and Struhl, 1995, 1998; Li et al., 1995; Pan and Rubin, 1995). These events lead to Ci proteolysis to generate Ci^R .

In vertebrates, similar phosphorylation events mediated by PKA, GSK3 and CK1 regulate the proteolysis of Gli2 and Gli3 by recruiting β -TRCP (Wang et al., 2000a; Wang and Li, 2006; Pan et al., 2006; Tempé et al., 2006; Bhatia et al., 2006; Pan and Wang, 2007; Wen et al., 2010). In contrast to Gli3 where β -TRCP-mediated proteolysis leads to partial degradation and Gli^R formation, Gli2 proteolysis results in the complete degradation of the protein, consistently with the genetic studies suggesting that Gli3 is the major contributor of Gli^R (Hui and Angers, 2011). Thanks to this difference, it has also been identified a processing determinant domain (PDD) that is responsible for the differentially regulated proteolysis of Gli2/3 (Pan and Wang, 2007).

Also Sufu form a complex with Ci to impede its nuclear translocation and block Ci^A activity (Ohlmeyer and Kalderon, 1998; Méthot and Basler, 2000; Wang et al., 2000b). In the absence of Sufu, Ci is still converted into Ci^R, and Ci^F is sequestered in the cytoplasm by Cos2 so that *Sufu* mutation does not cause discernable activation of the Hh pathway (Ohlmeyer and Kalderon, 1998). In contrast, *Sufu* knockout (KO) in mice leads to ectopic Hh pathway activation (Svärd et al., 2006; Chen et al., 2009), suggesting that Sufu plays a major role in restricting Gli activity downstream of Smo in the vertebrate system. One explanation could be that in the mammalian Hh pathway, Sufu is required not only for inhibiting Gli^A formation but also for the production of Gli^R (Humke et al., 2010).

In the presence of Hh, Ptc inhibition of Smo is released and this triggers Smo phosphorylation by PKA, CK1 and Gpr2/GRK2, leading to its cell surface accumulation and activation.

It has been demonstrated that PKA and CK1 sequentially phosphorylate three clusters of Ser/Thr residues in the Smo C-terminal cytoplasmic tail (C-tail), with PKA serving as the priming kinase for CK1 phosphorylation (Jia et al., 2004; Zhang et al., 2004; Apionishev et al., 2005). It has been also observed that Smo variants unable to be phosphorylated exhibit reduced cell surface expression and diminished Hh signaling activity, whereas phospho-mimetic Smo variants exhibit increased cell surface levels and constitutive activity (Jia et al., 2004; Zhang et al., 2004; Apionishev et al., 2005). Interestingly, the number of phospho-mimetic mutations in Smo is proportional to the elevation of Smo activity, suggesting that graded Hh signals may induce different levels of Smo activity through differential phosphorylation (Jia et al., 2004). Indeed, a recent study has demonstrated that Hh induces Smo phosphorylation in a dose- dependent manner (Fan et al., 2012).

Recent studies have suggested that phosphorylation promotes Smo cell surface expression by inhibiting ubiquitination-mediated endocytosis and degradation (Li et al., 2012; Xia et al., 2012). In addition, phosphorylation also controls Smo C-tail conformation, inducing Smo activation (Zhao et al., 2007).

Mammalian Smo (mSmo) diverges significantly from *Drosophila* Smo (dSmo) in the primary sequence of its C-tail and does not contain the three PKA/CK1 phosphorylation clusters, suggesting that mSmo and dSmo could be regulated by distinct mechanisms (Huangfu and Anderson, 2005; Varjosalo et al., 2006). However, a recent study has revealed that, as dSmo, also mSmo is regulated by multi-site phosphorylation in a dose-dependent manner, and phosphorylation regulates both its subcellular localization and its conformation. The kinases required for mSmo phosphorylation in response to Hh stimulation are CK1 α and GRK2, which bind to and phosphorylate mSmo C-tail at six Ser/Thr clusters (Chen et al., 2011).

Activated Smo can function as a GPCR to directly activate G α i in frog melanophores as well as in *Drosophila* and mammalian cultured cells (DeCamp et al., 2000; Riobo et al., 2006; Ogden et al., 2008); however, a physiological role for G α i in Shh signaling has not been demonstrated (Low et al., 2008). On the other hand, Smo can act via a G-protein-independent mechanism to relay the Hh signal to downstream signaling components (Jiang and Hui, 2008; Wilson and Chuang, 2010). To do this, it interacts with the Cos2-Fu complex through its C-tail (Hooper, 2003; Jia et al., 2003; Lum et al., 2003; Ogden et al., 2003; Ruel et al., 2003; Ogden et al., 2008); unfortunately, the regulatory mechanisms of this interaction are still poorly understood. It has been proposed that Smo and Cos2-Fu form distinct complexes depending on the phosphorylation status of individual components, and that pathway activation may rely on changes in the location, composition and conformation of the complexes (Chen and Jiang, 2013).

The Ser/Thr kinase Fu contains an amino-terminal catalytic domain (Fu-KD) and a C-terminal regulatory domain (Fu-RD) that mediates Fu interaction with other proteins including Cos2 and Sufu (Robbins et al., 1997; Monnier et al., 1998). In addition, Fu-RD can interact with Fu-KD, and this intramolecular interaction may provide a mechanism for Fu autoinhibition (Ascano and Robbins, 2004). In response to Hh signals or activated Smo, Fu is hyperphosphorylated by CK1; moreover, also a possible mechanism of auto-phosphorylation has been proposed (Lum et al., 2003; Shi et al., 2011; Thérond et al., 1996; Zhou and Kalderon, 2011). Indeed, the Hh-induced conformational switch and dimerization of the Smo C-tail, at which Fu is linked through Cos2, causes dimerization of the Fu kinase domains, leading to dimerization-induced transphosphorylation of the kinase domains (Shi et al., 2011; Zhang et al., 2011). The activated Fu can now phosphorylate Cos2, leading to the disassembly of the Cos2-Ci-kinase complexes required for Ci phosphorylation and processing (Ruel et al., 2007; Shi et al., 2011; Zhou and Kalderon, 2011; Ranieri et al., 2012). Activated forms of Fu can also phosphorylate Sufu and dissociate Sufu from Ci, leading to Ci^A formation (Shi et al., 2011; Zhang et al., 2011).

In mice, Sufu is a major negative regulator of Shh signaling downstream of Smo (Cooper et al., 2005; Svärd et al., 2006), forming complexes with Gli proteins to inhibit their nuclear

localization and transcriptional activity (Ding et al., 1999; Cheng and Bishop, 2002; Merchant et al., 2004; Barnfield et al., 2005). Recent studies using mammalian cultured cells revealed that Shh signaling induces dissociation of full-length Gli proteins from Sufu (Humke et al., 2010; Tukachinsky et al., 2010), suggesting that inhibition of Sufu-Ci/Gli complex formation could be a conserved mechanism for Ci/Gli activation. However, the mammalian Fu homolog is not required for Hh signaling because *Fu*^{-/-} mice do not exhibit any phenotype indicative of the Hh pathway activity defect (Chen et al., 2005; Merchant et al., 2005), but other several kinases have been implicated in the regulation of Gli activity. In addition, to regulate Sufu/Gli association, Shh has been demonstrated also to influence Sufu stability through the ubiquitin/proteasome pathway, and thus indirectly regulates Sufu/Gli complex formation (Yue et al., 2009).

In presence of Hh, then, the full-length (Ci^F/Gli^F) is released from the Cos2/Kif7-kinases complex and converted into the active form Ci^A/Gli^A, now able to translocate into the nucleus and induce the expression of Hh target genes.

Some mechanisms to control the Hh pathway have also been discovered. For example, in *Drosophila*, Hh signaling induces also the expression of the BTB family protein HIB; this protein is contained in the Cul3-based E3 ubiquitin ligase that mediate the degradation of Ci^A, creating a negative feedback loop to attenuate Hh activity (Kent et al., 2006; Zhang et al., 2006). SPOP, which is the vertebrate homolog of HIB, may play an analogous role in fine-tuning Hh signaling by degrading Gli2/3 proteins (Chen et al., 2009; Wang et al., 2010; Wen et al., 2010).

Finally, another major difference between the mammalian and *Drosophila* pathways is that mammalian but not *Drosophila* Hh signaling depends on the primary cilium, a microtubule-based membrane protrusion and antenna-like cellular structure (Goetz and Anderson, 2010). Most Hh signaling pathway components including Ptc, Smo, Kif7, Sufu, PKA and Gli proteins are present in the primary cilium and have different behaviors following Hh signaling (Corbit et al., 2005; Haycraft et al., 2005; Rohatgi et al., 2007; Chen et al., 2009; Tukachinsky et al., 2010; Tuson et al., 2011): for example, Hh promotes ciliary exit of Ptc but accumulation of Smo (Corbit et al., 2005; Rohatgi et al., 2007); Hh also stimulates the accumulation of Gli proteins at the cilium tip. Moreover, disruption of primary cilia impedes the formation of both Gli^R and Gli^A (Haycraft et al., 2005; Huangfu and Anderson, 2005; Liu et al., 2005). Thus, the primary cilium may function as a signaling center to orchestrate the molecular events leading to Gli processing in the absence of Hh and Gli activation in response to Hh, although the exact biochemical mechanisms remain poorly understood.

1.5.3. Hh signaling during zebrafish fin regeneration

Several studies have shown the involvement of Shh, Wnt and Fgf signaling in the regulation of the proliferative response and patterning process during appendage development (Imokawa and Yoshizato, 1997; Hadzhiev et al., 2007; Lin and Slack, 2008; Singh et al., 2012a); these signaling factors and others as Bmp2/4, Gremlin1, retinoic acid (RA) and Notch have also been shown to regulate the regenerative process (Scadding and Maden, 1994; Brockes and Kumar, 2002; Selever et al., 2004; Stoick-Cooper et al., 2007b).

Despite the high number of *Hh* genes present in the genome of zebrafish, only *shh* and *twhh* are expressed during fin bud development and only *shh* seems to be required for their proper development. During fin regeneration, both *shh* and *ihh* are expressed, and functional data indicates that the Hh signaling pathway is involved in blastema formation and maintenance, and later in fin ray patterning (Avaron et al., 2006a, 2006b).

As already mentioned, fin regeneration occurs in three distinct stages, characterized, respectively, by wound healing, blastema formation and regrowth from the plane of amputation. Transcriptional analysis revealed a differential gene expression during these three phases, including a number of developmental transcripts and signaling factors (Padhi et al., 2004; Lee et al., 2005b). *shh* is first expressed in the cells beneath the wound epithelium (Lee et al., 2005b) and Fgf signaling in the adjacent layer helps to localize and maintain *shh* expression in the proximal region of the regenerating fin, whereas in the distal region the expression of *shh* is reduced by Ras-Wnt5b signaling mechanism (Lee et al., 2005b; Iovine, 2007).

Successively, during fin regrowth, both *shh* and *ihh* are activated in the blastemal tissue and regulate blastemal proliferation, maintenance and tissue growth (Iovine, 2007).

The regrowth of the bony rays is particularly influenced by Shh pathway; indeed, laser ablation of *shh* expressing cells during fin regeneration results in aberrant osteoblast differentiation and defective branching morphogenesis (Zhang et al., 2012). At 2 days post amputation, *shh* expression is localized in the epithelial cells that cover the whole surface of the amputated ray; then, during the outgrowth phase, *shh* expression becomes restricted to a subset of epithelial cells adjacent to the newly formed lepidotrichia (Laforest et al., 1998; Poss et al., 2000b). As regeneration proceeds, the domain of expression of *shh* splits into two discrete cell populations in each hemiray, preceding the morphological bifurcation of the fin and, then, suggesting a possible role for Shh in the specification of the bifurcation. On the contrary, *ptc1*, which is expressed in the Shh-expressing cells and also in the adjacent sceroblasts, always show a single domain of expression spanning the entire width of the hemiray, raising the possibility that factors expressed in between the two domain of expression of *shh* would inhibit Shh signal in the central region of the hemiray in the early steps of branching formation. On the other side, *ihh* is

expressed in the differentiating scleroblasts expressing *ptc1* and adjacent to *shh*-expressing epithelial cells, suggesting a more direct role for this factor in bone formation than Shh (Avaron et al., 2006b). Further evidences of the involvement of Hh pathway in bone patterning are given by the observation that ectopic presence of Shh between ray branches induces the ectopic expression of *ptc1* and the fusion of the two branches; the fusion is caused by the ectopic deposition of bone material between the basal epidermal layer and the mesenchyme of the interray region. However, no bone formation is observed in the deeper mesenchyme, where *shh* is also expressed, suggesting that only the cells present at the epithelial-mesenchyme interface have the potential to differentiate into scleroblasts (Quint et al., 2002).

During the execution of their activities, Hh proteins also interact with other signaling pathways, as Wnt, Fgf and Bmp (Singh et al., 2015). For example, the expression of Shh in the later basal epithelial cells layer that covers the amputation regulates the expression of *bmp2b*. The inhibition of both Shh and Bmp signaling results in loss of scleroblast differentiation and bone formation (Lee et al., 2005b; Smith et al., 2006; Iovine, 2007); on the contrary, ectopic presence of Bmp2b leads to increased expression of osteoblast transcription factors required for differentiation (Smith et al., 2006) and bone fusion, as observed following ectopic *shh* expression (Quint et al., 2002). However, the ectopic expression of *shh* fails to produce bone fusion in presence of chordin, a Bmp signal inhibitor. Altogether, these results support the hypothesis that Shh activity is mediated via Bmp signaling (Quint et al., 2002; Smith et al., 2006; Iovine, 2007).

The interactions between Shh and Fgf or Wnt signaling pathways have been shown to amplify the regenerative response (Iovine, 2007; Lee et al., 2005b, 2009).

For example, the dedifferentiation of osteoblast cells has been demonstrated to be essential for cell proliferation during blastema outgrowth (Knopf et al., 2011); these dedifferentiated cells proliferation is Fgf-dependent and multiple studies have established that Shh acts downstream of Fgf signaling to regulate cell division and growth (Akimenko et al., 2003; Lee et al., 2005b; Iovine, 2007; Stoick-Cooper et al., 2007b; Lee et al., 2009).

On the other side, several member of the Wnt signaling pathway, as β -catenin, Wnt3a, Wnt5 and the transcription factor Lef1, are expressed during fin regeneration in the wound epidermis. In the early phases, *β -catenin* is expressed in the distal blastema whereas *wnt5* and *lef1* transcripts are detected in the more proximal cells. Successively, during fin outgrowth, *wnt5* is expressed distally, whereas *lef1* is found in the more proximal *shh*-expressing cells (Poss et al., 2000b). Both RA treatment and Fgf signaling inhibition downregulate *lef1* and *shh* expression, suggesting a participation of the two pathways in similar processes and a common regulatory mechanism (Poss et al., 2000b; Lee et al., 2005b; Iovine, 2007; Lee et al., 2009; Zhang et al.,

2012). Moreover, Wnt signaling seems to act downstream of Shh signaling, as the activation of β -catenin could rescue the Shh inhibition phenotype (Singh et al., 2012a).

Finally, also retinoic acid interferes with Hh signaling. RA treatments of zebrafish undergoing fin regeneration cause the inhibition of the regenerate growth and ray patterning defects (Géraudie et al., 1994). A 12 hours transient treatment inhibits regenerate outgrowth and downregulate *shh* expression; after the end of the treatment, the regenerate outgrowth resumes almost immediately, whereas *shh* transcripts are detected only 3 days later. Once reinitiated, *shh* expression occurs at the distal limit of the bone matrix deposition, suggesting again a role for Shh in scleroblast differentiation and patterning (Hoffman et al., 2002).

The general effects of a loss of Hh signaling in the fin regenerate have been analyzed using the cyclopamine, a steroidal alkaloid inhibitor of Hh signaling (Incardona et al., 1998). Cyclopamine treatments of regenerating fins initially causes a proximal extension of the expression domain of *shh*, with reduction of the regenerate outgrowth; in a second time, the outgrowth is completely inhibited and *shh* is no longer expressed, leading to 5 days-treated fins much shorter than untreated fins, with a characteristic accumulation of pigmented cells in the distal region and absence of ray bifurcation. The progressive arrest of fin regeneration correlates with an inhibition of blastema cell proliferation, both in the epidermis and in the mesenchyme, strongly indicating that the Hh pathway is necessary for blastema maintenance and outgrowth. Interestingly, bone deposition is still taking place but with abnormal patterns, leading to the hypothesis that inhibition of Hh signaling does not affect already differentiated scleroblasts, but rather the proliferation, survival, and/or differentiation into specialized cell types - as scleroblasts - of undifferentiated blastema cells (Avaron et al., 2006a). Another possible role for the Hh signals could be the regulation of the distribution of scleroblasts, as suggested by the phenotype of the temperature-sensitive regeneration mutant, *emmental* (*emm*). This mutant, in which *sly1* (a gene coding for a protein involved in protein trafficking) is disrupted when fish are subjected to a heat shock at 33°C, displays blastema formation defects, downregulation of *shh* expression and scleroblasts randomly dispersed throughout the blastema rather than ordered against the basal epithelial layer (Nechiporuk et al., 2003).

1.6.Palmitoylation

The covalent attachment of lipids to protein amino acids is a common feature of many eukaryotic proteins. Lipid-modified proteins can be found in many different cellular and extracellular compartments: nucleus, cytoplasm, cell membrane, associated with the cytoskeleton or in the extracellular matrix (Dunphy and Linder, 1998). The various modifying groups can affect various protein characteristics, as charge, hydrophobicity and other aspect of protein chemistry, resulting in protein behaviour changes and then control of physiological mechanisms (Chamberlain and Shipston, 2015).

For example, the glycosylphosphatidylinositol (GPI) groups anchor many cellular proteins to the outer surface of the plasma membrane and cholesterol is attached to certain secreted proteins (Fujita and Kinoshita, 2010; Heal et al., 2011), as we have seen for Hh proteins.

The most common lipid moieties found in intracellular proteins are fatty acids and isoprenoids (Resh, 2006) (Figure 20).

Modification		Lipid species		Amino acid	Linkage	Structure
stable	isoprenylation	isoprenoids	farnesyl	Cys	thioester	
			geranylgeranyl	Cys	thioester	
	N-acylation	fatty acids	myristate	H ₂ N-Gly	amide	
			palmitate	H ₂ N-Cys	amide	
			palmitoleic	Ser / Thr	oxyester	
reversible	S-acylation		palmitate	HS-Cys	thioester	

Figure 20: Major lipid modifications of proteins. Isoprenylation, the stable attachment of farnesyl or geranylgeranyl groups is catalysed by the prenyl transferases, farnesyl transferase (FTase) and geranylgeranyl transferase I and II (GGTase I and II) respectively. Also N-acylation is a stable modification; it results from stable bond formation between the NH₂-terminal amino acid and the fatty acid. Distinct enzyme families control these lipid modifications: N-myristoyltransferase (NMT) controls myristoylation, whereas N-palmitoylation is mediated by acyltransferases (Hhat, in the case of Hh). S-acylation is reversible due to the labile thioester bond between the lipid (typically, but not exclusively, palmitate) and a cysteine amino acid of a protein; this modification is mediated by the DHHC family of palmitoyl acyltransferases.

The isoprenylation involves the posttranslational attachment of farnesyl and geranylgeranyl chains onto COOH-terminal cysteine residues via an irreversible thioester linkage (Resh, 2006; Wright and Philips, 2006). The enzymes responsible for this modification, the farnesyl transferase and the geranylgeranyl transferase I, recognize the CAAX consensus motif present at the C-terminus of the protein, where A is any aliphatic amino acid and X is any amino acid

(Lane and Beese, 2006; Wright and Philips, 2006). Rab proteins are an exception, possessing a different geranylgeranylation signal that is recognized by the enzyme geranylgeranyl transferase II (Leung et al., 2006).

Fatty acylation, on the contrary, can occur through either amide linkage (N-acylation) or thioester linkage (S-acylation). There are three major classes of protein fatty acid acylation in eukaryotic cells: N-myristoylation, S-palmitoylation and N-palmitoylation (Linder and Deschenes, 2003).

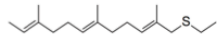
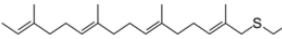
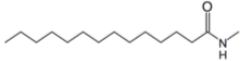
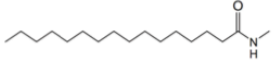
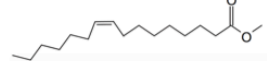
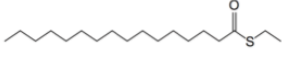
Protein N-myristoylation corresponds to the covalent attachment of myristate, a 14-carbon saturated fatty acid, through amide linkage to the N-terminal glycine residue of proteins. In most of the cases it occurs cotranslationally and it is a stable modification (Farazi et al., 2001). The consensus sequence for this posttranslational modification is MGXXXS/T, where M is the initiating methionine and X is any amino acid (Aitken et al., 1982; Carr et al., 1982; Resh, 2006). As this modification occurs at the amine group of the glycine, it requires the previous removal of the initiating methionine (Giglione et al., 2004). N-myristoylation can also take place post-translationally when the NH₂-terminal glycine residue is exposed following protein cleavage, as for example during apoptosis (Vilas et al., 2006).

S-Palmitoylation is the addition of palmitate, a 16-carbon saturated fatty acid, to proteins at cysteine residues via a thioester linkage and it is reversible (Linder and Deschenes, 2003). This process is exclusively posttranslational and may be dynamic and reversible (Resh, 2006; Chamberlain and Shipston, 2015), as we will see later.

In general, whereas protein N-myristoylation and isoprenylation are almost exclusively present on proteins that lack transmembrane domains, S-palmitoylation is found both on integral and peripheral membrane proteins, the latter associated with the inner surface of the plasma membrane and functioning in signal transduction pathways, either as signal transducers or as organizers of protein complexes at cellular membranes (Dunphy and Linder, 1998).

Dual lipid modifications are possible and occur sequentially. For example, N-myristoylation is cotranslational, occurring as the protein is synthesized on soluble ribosomes, and the successive palmitoylation follows the initial processing and takes place on cellular membranes. Indeed, for many proteins, palmitoylation requires prior modification by the prenyl or myristoyl group (Dunphy and Linder, 1998).

N-Palmitoylation consists in the palmitate addition to the N-terminal residue of protein through amide linkage and it is irreversible. This process was first described for Sonic Hedgehog, in which the palmitate is bound to a cysteine residue, (Pepinsky et al., 1998) and then observed also in the G-protein G_{sα}, in which palmitoylation occurs at the N-terminal glycine (Kleuss and Krause, 2003).

Finally, a less frequent but not less important type of fatty acid acylation is the O-acylation. It consists in the addition of a lipid moiety to the hydroxyl group of serine or threonine residues through ester linkage. For example, Wnt is modified by addition of a palmitate on a conserved cysteine residue and a monounsaturated palmitoleate on a conserved serine residue (Takada et al., 2006).

1.6.1. S-palmitoylation: features and targets

S-palmitoylation is a highly conserved process occurring in all eukaryotic organisms that have been examined and, in the same way, the enzymes that govern the process are conserved from yeast to humans (Mitchell et al., 2006; Roth et al., 2006; Kang et al., 2008; Greaves and Chamberlain, 2011a). On the contrary, there are no evidences for the S-palmitoylation process in prokaryotes, whereas many viral proteins can undergo S-palmitoylation catalyzed by the host cell machinery (Chamberlain and Shipston, 2015).

A very important characteristic of S-palmitoylation that distinguishes this process from the other kind of lipid modifications is its reversibility: the thioester linkage is labile and many proteins can undergo rapid cycles of acylation and deacylation (Salaun et al., 2010). This process can be then considered more similar to other posttranslational modifications that can have rapid turnover rates, such as phosphorylation, and that allow to carry out a rapid response in consequence of different external stimuli. Indeed, cycles of S-acylation and deacylation are now known to play a fundamental role in regulating the intracellular localization and function of many diverse proteins (Salaun et al., 2010). However, it has to be noticed that rapid cycling of palmitate on S-palmitoylated proteins is not universal, and the turnover rate can be very different in different proteins (Martin et al., 2012) and also in different sites of the same protein (Zuckerman et al., 2011).

The process of S-palmitoylation can target a variety of proteins, which can be broadly classified as transmembrane or peripheral membrane proteins, the latter requiring palmitoylation to stable attach to the membrane (Chamberlain and Shipston, 2015). Peripheral membrane S-palmitoylated proteins often undergo dual lipid modification, and thus can be further classified as either N-myristoylated/S-palmitoylated, isoprenylated/S-palmitoylated, or exclusively S-palmitoylated (Smotrys and Linder, 2004). They include chaperones and signaling adapters, as the postsynaptic scaffolding protein PSD95 (Topinka and Brecht, 1998; Fukata et al., 2004, 2013), transcription regulators, as some histone 3 variants (in this case the S-palmitoylation induces perinuclear localisation) (Wilson et al., 2011), kinases, as many components of the Src family of tyrosine kinases (Koegl et al., 1994; Sato et al., 2009), and other enzymes, as for

example the superoxide dismutase 1 (SOD1) (Marin et al., 2012). Transmembrane proteins that are modified by S-palmitoylation are equally as diverse in nature as the S-palmitoylated peripheral membrane proteins (Kang et al., 2008; Chamberlain and Shipston, 2015). They include membrane receptors, as the G-protein coupled receptors (Qanbar and Bouvier, 2003; Chini and Parenti, 2009) and receptors for steroid hormones (Pedram et al., 2007, 2012), proteins required for vesicle trafficking and exocytosis, as some components of the SNARE complex (Kang et al., 2008; Prescott et al., 2009) and regulatory proteins of the molecular motor dynein (Shmueli et al., 2010), ion channels, and transporters of neurotransmitters or lipids (Chamberlain and Shipston, 2015).

1.6.2. S-palmitoylation: regulatory effects

The S-palmitoylation can have different effects on the target proteins.

For peripheral membrane proteins, the major function of S-palmitoylation is to mediate stable membrane attachment (Salaun et al., 2010) (Figure 21B); even in the case of dual lipidated proteins, the palmitate addition is necessary to promote stable membrane binding, as the single myristoyl or prenyl groups are not sufficient in this task. Several studies revealed that single myristoyl or prenyl groups only provide a weak membrane affinity, sufficient for transient membrane binding, whereas closely positioned dual lipid anchors (either myristate/palmitate or farnesyl/palmitate) mediate strong, essentially irreversible, membrane-peptide interaction (Figure 21C). This process, termed “kinetic trapping” (Shahinian and Silviu, 1995) appears to be particularly important in relation to the intracellular distribution of lipidating enzymes: N-myristoyl and farnesyl transferases are localized in the cytosol (Towler and Glaser, 1986; Casey, 1992; King and Sharma, 1992) and their action provides a weak membrane affinity that mediates transient interaction with cellular membranes, where the enzymes that mediate the S-palmitoylation process are exclusively located, leading to a subsequent palmitate addition and stable membrane binding of the protein. In the case of proteins that are exclusively S-palmitoylated, it has been suggested that such proteins rely upon a weak intrinsic membrane affinity to access intracellular membranes and undergo S-palmitoylation (Greaves et al., 2008, 2009).

In addition, in the case of transmembrane proteins, S-palmitoylation cannot interfere with the membrane localisation of these protein, but, however, can promote the membrane proximity of the their cytoplasmic domains, affecting the overall structure/topology of the proteins relative to the membrane (Chamberlain and Shipston, 2015) (Figure 21A).

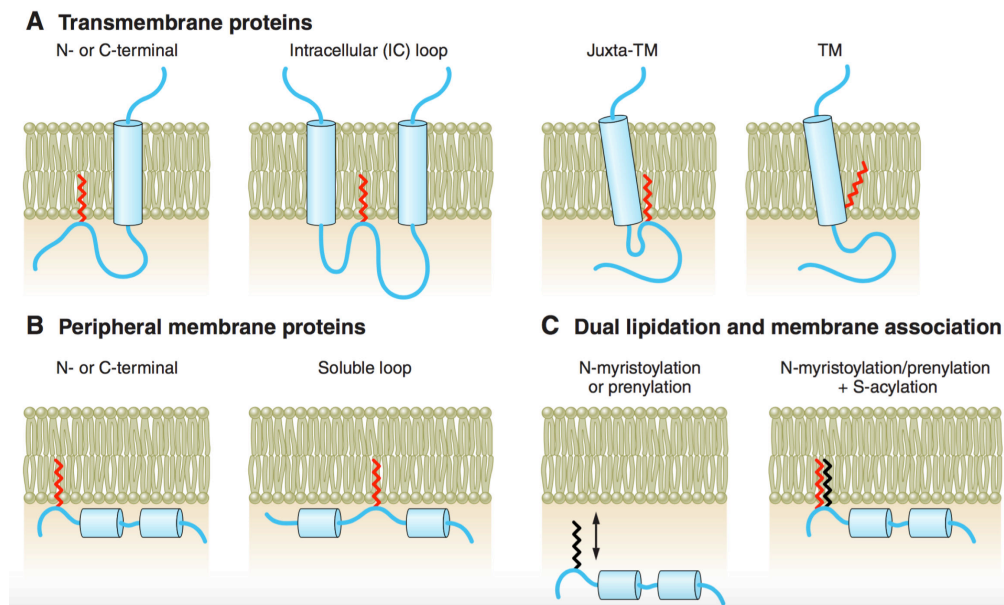

Figure 21: Location of sites of S-acylation in transmembrane and peripheral-membrane proteins. (A) For transmembrane proteins, S-acylation may allow a cytosolic NH₂ or COOH terminus or intracellular (IC) loop of a protein to associate with the membrane interface. S-acylation can also confer structural constraints in particular when located close to, or within, transmembrane (TM) domains. In several cases, S-acylation near a TM domain has been proposed to control transmembrane orientation that may be important for controlling hydrophobic mismatch in different subcellular membrane compartments. (B) For peripheral membrane proteins, S-acylation of NH₂ or COOH terminus or soluble loops may control membrane association of the protein. In many cases, membrane interaction is promoted through other membrane affinity domains (such as hydrophobic or polybasic domains) of the protein. (C) Alternatively, dual lipidation is required for membrane association, including prenylation or myristoylation at sites close to the S-acylated cysteine residue. From Chamberlain and Shipston, 2015.

A second major role of protein S-palmitoylation is the targeting of proteins to membrane microdomains (Figure 22). The lipids within the cellular membrane are organized into microdomains as result of packaging preference; we can observe, for example, cholesterol-rich or saturated phospholipid-rich microdomains (Simons and Ikonen, 1997). Experiments of membrane microdomains purification based on the different detergent solubility characteristics of membrane proteins have shown that S-palmitoylated proteins co-purify with cholesterol-enriched membranes (Melkonian et al., 1999), suggesting that the process of S-palmitoylation could be an important signal for sequestration into lipid raft microdomains, and then an important regulator of the lateral distribution of proteins within membranes (Levental et al., 2010). Following these findings, it has also been proposed that the S-palmitoylation-dependent association of proteins to membrane microdomains could regulate processes as exocytosis (Salaun et al., 2005a) and actin cytoskeleton remodelling and membrane organization (Navarro-Lérida et al., 2012).

The regulation of the protein targeting to membrane microdomains seems to be important not only at the level of the plasma membrane but also for intracellular compartments. For example, the diversification of the endoplasmic reticulum (ER) into several distinct subdomains facilitates

its role as a multifunctional organelle (Lynes and Simmen, 2011) and S-palmitoylation appears to be an important factor in targeting proteins to specific subdomains: the prevention of S-palmitoylation of calnexin, for example, decreases its association with the ribosome-studded rough ER surrounding the nuclear envelope, probably as consequence of a wrong orientation of the cytoplasmic tail with respect to the axis of the transmembrane helix that seems to be regulated by S-palmitoylation (Lakkaraju et al., 2012).

A third important function of the S-palmitoylation process is the regulation of protein trafficking and intracellular localisation (Figure 22). For the localisation of peripheral membrane proteins, it can accomplish this role simply by promoting accumulation of modified proteins on membranes containing the palmitoylation enzymes.

In addition to this, S-palmitoylation can also function as an active protein-sorting signal. It has been shown that short peptides from the lipidated C-terminus of H/N-Ras protein display similar localisation to the full-length proteins, implying that lipid signal might be sufficient to specify the movement of Ras proteins from endomembranes to the plasma membrane (Hancock et al., 1991). This could involve the effect of S-palmitoylation on microdomains targeting. Indeed, cholesterol-rich domains at the Golgi have been proposed to act as platforms for the budding of transport vesicles delivering cargo to the plasma membrane (Patterson et al., 2008).

Moreover, it has also been suggested that the extent of S-palmitoylation in multiply-palmitoylated proteins regulates the cycling of these proteins between the plasma membrane and intracellular compartments. An example is the endosome-to-plasma membrane trafficking of the SNARE protein SNAP25: mutant SNAP25 proteins with three rather than four S-palmitoylation acceptor sites exhibited a marked accumulation on endosomal membranes (Greaves and Chamberlain, 2011b); also in this case, lipid rafts seems to have a role in this cycling pathway, as the number of palmitoylation acceptor sites affects the association of the protein with cholesterol-rich membranes (Salaun et al., 2005b).

The importance of S-palmitoylation for protein trafficking can be better analysed in transmembrane proteins, as they do not require this posttranslational modification for stable membrane binding. An example, it is the study of the protein LRP6, a transmembrane protein co-receptor for Wnt, which is palmitoylated close to the cytoplasmic side of the membrane-spanning domain: when the S-palmitoylated sites were mutated, the protein was retained at the ER and failed to traffic to the plasma membrane. Interestingly, this forward trafficking block was alleviated by reducing the length of the transmembrane domain of the protein, suggesting that S-palmitoylation could have the role of “reducing” the apparent length of the transmembrane domain. The authors proposed that non-palmitoylated protein is trapped at the ER because of

hydrophobic mismatching between the long transmembrane domain and the thin ER bilayer, whereas the palmitate addition improves the hydrophobic matching (Abrami et al., 2008).

Finally, one last S-palmitoylation function involves protein stability (Figure 22). Increased ubiquitination and degradation are commonly observed when S-acylation of specific proteins is blocked. For example, preventing the S-palmitoylation of the yeast SNARE protein Tlg1, normally modified by fatty acid addition in proximity to its single transmembrane domain, increases its ubiquitination and vacuole targeting. It was suggested that the palmitate could fix the position of the transmembrane domain to prevent acidic residues coming in contact with the membrane, which would lead to ubiquitination of the protein (Valdez-Taubas and Pelham, 2005). Another example is the anthrax toxin receptor TEM8. In this case S-palmitoylation controls the lateral distribution in membranes of the receptor, preventing its lipid rafts association and its consequent degradation (Abrami et al., 2006).

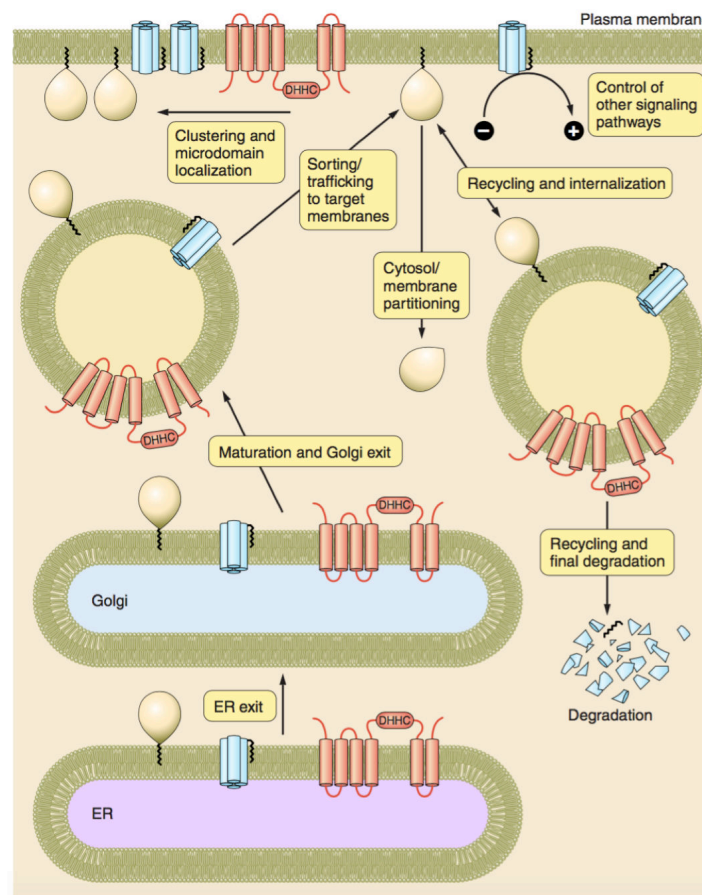

Figure 22: S-acylation regulates multiple steps in the life cycle of membrane and peripheral-membrane proteins. S-acylation can occur at multiple membranes including the ER, Golgi apparatus, trafficking and recycling vesicles/endosomes, as well as the plasma membrane. Different DHHCs have been reported to be resident on these distinct membranes. S-acylation thus controls multiple aspects of membrane and peripheral membrane protein life cycle including assembly and 1) ER exit, 2) maturation and Golgi exit, 3) sorting and trafficking to target membranes, 4) recycling and internalization, 5) clustering and localization in membrane microdomains, 6) control of properties and regulation by other signaling pathways, 7) partitioning of peripheral membrane proteins between the cytosol and membranes, and 8) recycling and final degradation. From Chamberlain and Shipston, 2015.

1.6.3. S-palmitoylation: the mechanisms

Since the discovery of S-palmitoylation, several studies have focused in the understanding of how palmitate is transferred to target proteins and two mechanisms have been proposed. One is through the action of enzymes called protein acyltransferases (PATs), identified for the first time in yeast (Lobo et al., 2002; Roth et al., 2002) (Figure 23A). The other mechanism is non-enzymatic and involves the spontaneous acylation of a protein in presence of long-chain acyl-coenzymes A (CoAs). Examples of this mechanism have been reported for two mitochondrial enzymes (Berthiaume et al., 1994; Corvi et al., 2001). Then, the two mechanisms seem to be operational in cells.

Acylation of peptides and proteins can occur *in vitro* in absence of enzymes. Indeed, it has been shown that short lipid-modified peptides, mimicking myristoylated or isoprenylated proteins, can be acylated in presence of lipid vesicles and acyl-CoAs (Quesnel and Silvius, 1994). For this process, the presence of a membrane surface and affinity for that surface are essential (Quesnel and Silvius, 1994).

The amino acid context of cysteines is important for the rate of autoacylation *in vitro*, influencing the proximity and the orientation of these residues to a membrane as well as the ability of their thiol groups to ionize. It was demonstrated that basic and hydrophobic residues promote autoacylation, whereas acidic residues are inhibitory (Bélanger et al., 2001); in addition to this, basic and aromatic residues have been found to favors autoacylation, decreasing the pK_a of the cysteine residues (Bizzozero et al., 2001). Moreover, also the pH seems to affect the rate of palmitoylation of a myristoylated peptide *in vitro*, suggesting that autoacylation is more efficient under conditions that favor the formation of thiolate ion in the cysteine (Quesnel and Silvius, 1994).

The autoacylation *in vitro* has been demonstrated not only for peptides, but also for proteins. For example, myristoylated $G_{i\alpha}$ can be palmitoylated by reaction with palmitoyl-CoA (palm-CoA); this autoacylation process requires myristoylation and its rate is accelerated by $G_{\beta\gamma}$ binding, in parallel with what is observed *in vivo* (Duncan and Gilman, 1996). It is interesting to notice that not all tested proteins are able to autoacylate (Duncan and Gilman, 1996).

It is then clear that autoacylation can occur *in vitro*, but can this process take place also *in vivo*? The concentration of acyl-CoAs in cells is regulated by their binding to acyl-CoA binding protein (ACBP), that reduces their concentrations at the membrane surface; it has been found that the addition of ACBP to peptide or protein palmitoylation reactions decreases autoacylation in a concentration-dependent manner (Leventis et al., 1997; Dunphy et al., 2000). As consequence, it has been calculated that at physiological concentrations of lipids, acyl-CoA, and

ACBP, autoacylation in cells would occur with halftimes on the order of days (Leventis et al., 1997); this is in contrast with the palmitoylation halftimes observed *in vivo* for some proteins that are on the order of hours (Wedegaertner and Bourne, 1994). Altogether these data suggest that autoacylation is not likely to be responsible for the rapidly cycling palmitoylation process *in vivo* (Leventis et al., 1997). However, it has to be noticed that the estimation of the concentration of acyl-CoAs is very variable (Gossett et al., 1996), and then better information about the concentration and spatial distribution of acyl-CoAs in cells would be necessary to determine if non-enzymatic mechanisms of fatty acylation *in vivo* could occur.

In this perspective, autoacylation is likely to take place in the regulation of mitochondrial enzymes. Indeed, S-palmitoylation of purified carbamoyl-phosphate synthetase 1 (CPS1) within its active site, which results in the inhibition of its enzymatic activity, occurs at palm-CoA concentrations within the physiological range found in mitochondria, indicating that autoacylation may also occur *in vivo* and might regulate mitochondrial metabolism (Corvi et al., 2001).

The more important discovery in the S-palmitoylation field in recent years was the discovery of the enzymes that control this process. Independent studies in the yeast *Saccharomyces cerevisiae* identified proteins that were required for S-palmitoylation of Ras2p and Yck1p (Bartels et al., 1999; Lobo et al., 2002; Roth et al., 2002; Zhao et al., 2002). Genetic analysis of these two PATs, Erf2p and Akr1p, revealed a common 51 amino acid cysteine-rich zinc finger domain with a conserved “DHHC” motif (DHHC-CRD) (Mitchell et al., 2006). These works open the way for the successive discovery of a large family (24 members in humans) of mammalian genes encoding proteins containing the DHHC domain (Fukata et al., 2004; Huang et al., 2004; Keller et al., 2004): the majority of these proteins have been proved to be PATs (Iwanaga et al., 2009; Greaves and Chamberlain, 2011a), and some other functions have been associated to some members of the family, as membrane transport, intracellular signaling, and cytoskeletal regulation (Dighe and Kozminski, 2008; Goytain et al., 2008; Hines et al., 2010; Yang and Cynader, 2011). The proteins proven to be PATs catalyse the transfer of different fatty acids with different efficiencies, for example favouring C14/C16 lipids over C18/C20 lipids (Jennings and Linder, 2012), but the structural basis for these differences in fatty acid specificity are not yet known.

Even if the mechanism involved in the process of S-palmitoylation is still poorly understood, experiments performed with purified DHHC proteins support the idea that the reaction consists in two steps: first, the autopalmitoylation of the enzyme with the addition of the palmitate to the cysteine residue of the DHHC motif to create a palmitoyl-PAT intermediate, and, second, the

transfer of the palmitoyl moiety to the target protein; palmitoyl-CoA serves as palmitate donor in this process (Mitchell et al., 2010; Jennings and Linder, 2012) (Figure 23B).

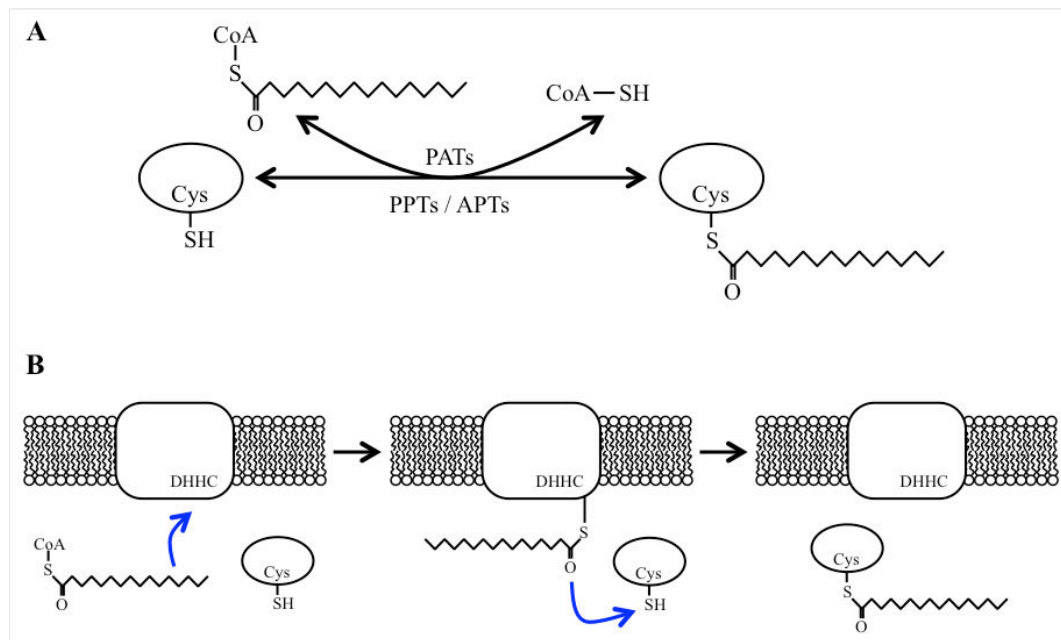

Figure 23: S-palmitoylation process. (A) The S-palmitoylation is a reversible process; protein palmitoylation is catalysed by protein acyltransferases (PATs), whereas protein depalmitoylation is catalysed by protein palmitoyl thioesterases (PPTs) and acyl protein thioesterases (APT). The palmitoyl-CoA functions as donor of the palmitate. (B) The S-palmitoylation process occurs in two phases: first, the autopalmitoylation of the PAT creates an intermediate palmitoyl-PAT and, secondly, the palmitate is transferred to the target protein.

All the members of the DHHC family characterized to date are predicted transmembrane proteins with the catalytic DHHC domain located close to a transmembrane domain, then in juxtaposition to the membrane, and facing the cytosol (Politis et al., 2005). The majority of these proteins are localized to ER and Golgi membranes, with a small number present on post-Golgi compartments (Ohno et al., 2006).

While DHHC enzymes are likely to display a certain grade of redundancy and have partially overlapping substrate, there are also some substrate that are dependent on individual DHHC enzymes for their efficient palmitoylation (Roth et al., 2006). Moreover, specific DHHC enzymes are required for the S-palmitoylation of different sites on the same protein (Tian et al., 2010, 2012). Anyway, it has to be noticed that, even if several DHHC enzymes are able to S-palmitoylate a specific target, the same target could be specifically palmitoylated by different enzymes in different cell types and then the importance of the different enzymes depends on their levels of expression *in vivo* in the cell type that is under consideration (Chamberlain and Shipston, 2015).

Several studies have been conducted also for identify domains and residues important for interaction specificity in both substrates and enzymes. In the latter, the DHHC-CR domain does

not appear to be sufficient for substrate S-palmitoylation or to specify substrate selectivity, but requires the coordinated activities of the DHHC domain and other regions of the enzyme. For example, the enzymes DHHC17 and DHHC13 are the only ones to contain the N-terminal ankyrin repeat domains, which appear to specify substrate binding (Young et al., 2012). Indeed, the addition of ankyrin repeat domains from DHHC17 to another DHHC enzyme leads to S-palmitoylation of DHHC17 substrates, highlighting the importance of this protein interaction domain for substrate recognition (Huang et al., 2009). Moreover, the *S. cerevisiae* ortholog of DHHC17, Akr1p, also contains an ankyrin-repeat extension, and although mutants lacking this domain are able to S-palmitoylate the target Yck2p, the extent of the palmitoylation is reduced (Hemsley and Grierson, 2011). Thus, at least some DHHC enzymes recognize their substrate via additional domains that are S-palmitoylated through the action of the DHHC-CR domain.

On the other side, also in some target proteins have been identified some elements required for specific recognition of DHHC enzymes. For example, a proline residue 25 amino acids downstream of the palmitoylated cysteine of SNAP25 (Greaves et al., 2009) and a phenylalanine residue within the cysteine cluster of SNAP25b isoform (Greaves et al., 2010) are required for S-palmitoylation by DHHC3 and DHHC15, respectively. Moreover, it has been shown that domains downstream from modified cysteines can also function to prevent promiscuous DHHC enzyme-substrate interactions: full-length Vac8 is specifically S-palmitoylated by Pfa3 *in vitro*, but the isolated palmitoylated domain is also modified by four other yeast DHHC enzymes (Nadolski and Linder, 2009).

We still do not know all about the process of S-palmitoylation, but even less is known about the enzymes and mechanisms that mediate protein depalmitoylation, although candidate thioesterases were identified many years prior to the realization that DHHC enzymes function as PATs. Protein palmitoyl thioesterase 1 and 2 (PPT1 and PPT2) are targeted to lysosomes and catalyse depalmitoylation during protein degradation (Camp and Hofmann, 1993; Camp et al., 1994; Hellsten et al., 1996; Verkruyse and Hofmann, 1996; Soyombo and Hofmann, 1997), whereas acyl protein thioesterase 1 (APT1) is a cytoplasmic enzyme, implicated in dynamic S-acylation cycling of proteins (Duncan and Gilman, 1998) (Figure 23A). Another related protein APT2 (64% identical at amino acid level to APT1) (Tomatis et al., 2010; Tian et al., 2012) and an APT1-like thioesterase (Tian et al., 2012) have also been discovered.

The research into the role of APT proteins in dynamic S-palmitoylation is being supported in the last years by the development of thioesterase inhibitors, as the palmostatin B, a broad-spectrum inhibitor of APT proteins and other serine hydrolases. Recent studies using broad-spectrum serine lipase inhibitors have revealed that a significant subset of the large serine hydrolase

family, which includes the ATPs and PPTs (Zeidman et al., 2009; Bachovchin et al., 2010), are responsible for cellular depalmitoylation (Martin et al., 2012). It has also been reported that the blockade of depalmitoylation could lead to a redistribution of the protein from the plasma membrane onto endomembrane compartments (Jia et al., 2014).

These thioesterases seem to play an important role in the palmitate turnover of lipidated proteins. For example, in mammalian cells the basal rate of turnover of the thioester-linked palmitate linked on the $G_{S\alpha}$ subunit occurs with a $t_{1/2}$ of 20-90 minutes (Degtyarev et al., 1993a; Mumby et al., 1994; Wedegaertner and Bourne, 1994); this rate is increased more than 10 fold when $G_{S\alpha}$ is activated or locked in the GTP-bound form. In stable cells line expressing APT1, the rate of palmitate removal from $G_{S\alpha}$ is faster than that of control lines, suggesting that G-protein α subunit is substrate of APT1 (Duncan and Gilman, 1998). Although APT1 has acyl-CoA hydrolase activity, its expression does not significantly increase acyl-CoA hydrolase activity in cell extracts, nor does it perturb incorporation of [3 H]palmitate into cellular lipids in cells overexpressing APT1. Thus, the effects of APT1 on palmitate turnover on $G_{S\alpha}$ are not due to effects on the rate of turnover of palmitoyl-CoA.

Finally, it has to be noticed that experiments of RNAi knockdown of both *apt1* and *apt2* in cell culture (Jia et al., 2014) as well as the test of the activity of cell extracts from *apt1-null* cell lines (Duncan and Gilman, 2002) revealed the persistence of depalmitoylation activity, suggesting the existence of other enzymes with deacylation activity that have still to be discovered.

1.6.4. N-palmitoylation of Shh: mechanism and functions

The Hh family is the best-studied example of palmitoylated, secreted signaling molecules. All Hh family members are thought to be palmitoylated; however, direct incorporation of palmitate to hedgehog proteins in cells has only been documented for Hh in *Drosophila* and Shh in mammals (Buglino and Resh, 2008; Pepinsky et al., 1998).

As already said, after translation, the Hh precursor is autocleaved and the process results in the addition of a cholesterol moiety at the C-terminal of the cleaved amino terminal fragment (Porter et al., 1996a, 1996b). After that, a molecule of palmitate is covalently attached via amide linkage to the N-terminal cysteine residue (Pepinsky et al., 1998), and the resulting doubly modified Hh protein represents the mature signaling molecule.

Genetic studies in *Drosophila melanogaster* suggested that palmitoylation of Hh is catalyzed by a member of the membrane bound O-acyltransferase (MBOAT) family, Skinny Hedgehog (Chamoun et al., 2001). Several evidences confirm this hypothesis. First, the *skinny hedgehog* null phenotype closely phenocopies mutation of the palmitate acceptor site cysteine within Hh.

Second, its activity is essential in cells that produce Hh but is not required for Hh transcription or secretion, suggesting that Skinny Hedgehog functions in the maturation of Hh signal (Chamoun et al., 2001; Lee and Treisman, 2001; Micchelli et al., 2002). Third, Skinny Hedgehog mutant organisms display defects in Hh signaling independent of both autoprocessing and cholesterol incorporation, implying that Rasp does not play a role in these processes (Amanai and Jiang, 2001). And last, Hh is significantly less hydrophobic when isolated from rasp null cells than when isolated from WT cells (Chamoun et al., 2001).

The human homologue of Skinny hedgehog is known as Hhat (Hedgehog acyltransferase). Also in this case, loss of Hhat function in the mouse closely phenocopies the mutant phenotype resulting from mutation of the palmitoylation site within Shh (Chen et al., 2004). In addition, [³H]-palmitate labeling of Shh is reduced when Shh is isolated from Hhat null murine embryonic fibroblasts, consistent with Hhat putative role in Shh palmitoylation (Chen et al., 2004). But the definitive evidence that Hhat is a palmitoyl acyltransferase for Shh was achieved when Hhat was purified: incubation of purified Hhat with purified, recombinant Shh results in the incorporation of palmitate onto the N-terminal cysteine via amide linkage (Buglino and Resh, 2008). The reaction uses palmitoyl CoA as the palmitate donor. Moreover, Hhat appears to be specific for Shh, as other palmitoylated proteins are not substrates for palmitoylation by Hhat *in vitro*. Finally, it has been shown that the first 11 amino acids of the mature Shh sequence are the minimal sequence for Shh palmitoylation, which requires also an N-terminal cysteine with a free amino terminus, as purified Hhat cannot palmitoylate Shh peptides or proteins if the N-terminus is blocked by acetylation or by a hexa-histidine tag (Buglino and Resh, 2008).

Palmitoylation of Shh is thought to occur during passage of Shh through the secretory pathway, as Shh and Hhat colocalize in the ER and Golgi. Moreover, the Shh N-terminal signal sequence that addresses the protein to the secretory pathway has been shown to be necessary for Hhat-mediated palmitoylation: Shh constructs that lack the N-terminal signal sequence are not palmitoylated. In addition to this, the pH values of ER and Golgi are near to the pH optimum measured for Hhat (Buglino and Resh, 2008). Altogether these findings suggest that palmitoylation of Shh by Hhat occurs intracellularly, in the lumen of secretory organelles.

Palmitoylation of Hh/Shh depends on the presence of a cysteine residue (position 85 in *Drosophila*, position 24 in human Shh, and position 25 in mouse Shh) immediately following the signal peptide cleavage site and on a functional form of Skinny Hedgehog or Hhat activity (Pepinsky et al., 1998; Chamoun et al., 2001). Indeed, the palmitoylation process of Shh in cells occurs following cleavage of the signal sequence, which is necessary to generate the N-terminal cysteine residue. It is thought to be a two steps process: first, the palmitate is added to the

cysteine via thioester linkage and, second, the thioester intermediate then rearranges to an amide linkage via an intramolecular S-to-N shift, producing an amide N-linked palmitate (Pepinsky et al., 1998; Mann and Beachy, 2004) (Figure 24A). However, at the end of this process a cysteine sulfhydryl group would be regenerated and it could be the target for a second addition of palmitate via thioester bond by Hhat; therefore, also a thioesterase activity to remove the second palmitate would be required to produce the final active form of Shh. It has been proposed an alternative mechanism involving the direct attachment of the palmitate moiety to the N-terminal amide via amide linkage, analogous to N-myristoylation (Farazi et al., 2001) (Figure 24B). The facts that N-terminally blocked Shh proteins are not substrates for Hhat and that thioester linked palmitoylated intermediates of Shh cannot be detected support the second model (Buglino and Resh, 2008).

The attachment of palmitate has been documented on both the 45 kDa Shh precursor protein as well as on the mature 19 kDa form of Shh. Moreover, a Shh mutant that is defective in autoprocessing and cholesterol attachment can still efficiently incorporate palmitate. Thus, the two reactions of lipid moieties addition occur independently (Buglino and Resh, 2008).

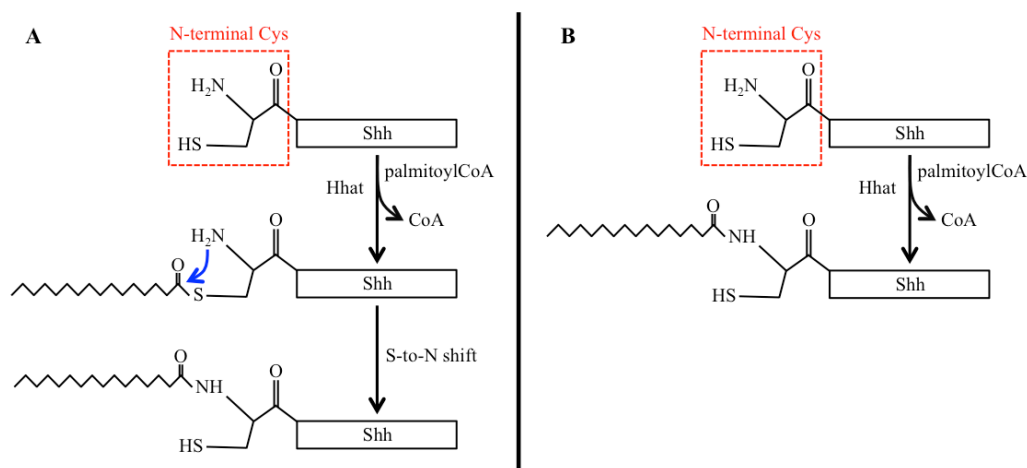

Figure 24: N-palmitoylation of Shh. Two possible mechanisms have been proposed. (A) The first is a two-steps mechanism: first, the palmitate is added to the Cys residues via thioester linkage and, second, the thioester intermediate rearranges to form an amide linkage via an intramolecular S-to-N shift. (B) On the contrary, the second mechanism proposes the direct attachment of the palmitate moiety to the N-terminal amide via amide linkage.

Palmitoylation of Hh is required for proper signaling in *Drosophila*. Mutation of the acceptor site cysteine produces a protein that has little to no patterning activity in flies (Lee et al., 2001; Dawber et al., 2005): misexpression of wild-type Hh in the posterior compartment of the wing disk leads to expansion of the anterior compartment, expanded expression of Hh target genes and patterning defects in the adult wing; instead, misexpression of Hh C85A does not result in expansion of the anterior compartment or expanded expression of Hh target genes in the wing disk, indicating that it has severely attenuated signaling capacity (Lee et al., 2001).

Mutation of the acceptor cysteine results in a reduction of Shh signaling also in mammalian tissues (Chen et al., 2004). For example, injection of retroviruses encoding wild type Shh into the forebrains of E9.5 rats results in severe brain deformities, while retroviruses that encode nonpalmitoylated forms of Shh are unable to cause such defects (Kohtz et al., 2001). However, nonpalmitoylated forms of Shh appear to be more active than their *Drosophila* counterparts: ectopic overexpression of Shh C25S is still able to cause polydactyly in the mouse limb (Lee et al., 2001).

Studies in the mouse embryonic fibroblast line, C3H10T1/2, have revealed that palmitoylation also affects Shh potency *in vitro*. Treatment of C3H10T1/2 cells with Shh causes a dose-dependent increase in alkaline phosphatase activity, a marker of differentiation into the bone lineage, frequently used as readout of Shh activity *in vitro*. Palmitoylated forms of Shh are highly more active compared to unmodified Shh in this assay (Pepinsky et al., 1998). This effects is not due to differences in receptor binding, as palmitoylated and nonpalmitoylated forms of Shh bind equally well to cells expressing Ptc (Pepinsky et al., 1998). On the contrary, the palmitate feature responsible for enhancing Shh signaling seems to be its hydrophobicity. Indeed, increasing the hydrophobic character of the amino terminus of Shh, either by introducing a stretch of hydrophobic amino acids or by chemical modification, results in increased potency over wild-type unmodified forms, whereas the introduction of hydrophilic residues at the N-terminus of Shh results in reduced signaling in a cell-based differentiation assay (Taylor et al., 2001).

Palmitoylation influences also Hh/Shh release. Active Hh/Shh is released from the producing cell as a multimeric protein; this process is facilitated by multimerization of Hh proteins on the cell surface and, indeed, dual lipidation enables Hh proteins to form nanoscale oligomers (Buglino and Resh, 2012).

Finally, proper palmitoylation is required for the formation and maintenance of the Hh signaling signal gradient: the lipophilic modification influences the accumulation Hh proteins into lipoprotein particles, which have been implicated as playing an important role in long range Hh signaling (Panakova et al., 2005; Callejo et al., 2008), as well as the formation of soluble multimeric forms of Hh that are freely diffusible, accumulate in a gradient, and enable even in this case to signal over long distances (Zeng et al., 2001; Chen et al., 2004; Goetz et al., 2006).

1.6.5. Protein palmitoylation: regulation of axonal growth and synaptic plasticity

Several neuron proteins are palmitoylated. Some examples are the receptor rhodopsin (Papac et al., 1992), some G-protein-coupled receptors (GPCRs) (Bouvier et al., 1995), the α subunits of the heteromeric G proteins (Degtyarev et al., 1993b; Linder et al., 1993; Wedegaertner and

Bourne, 1994), many members of the Src family of non-receptor tyrosine kinases (Shenoy-Scaria et al., 1994; Robbins et al., 1995), and proteins that mediate the interactions between the plasma membrane and the neuronal cytoskeleton, and thereby regulate membrane dynamics or organization of protein complexes, as growth-associated protein 43 (GAP43) that regulates growth cone dynamics (Skene and Virág, 1989) and postsynaptic density 95 (PSD95) that favours the assembly of receptors and signaling enzymes at the synapse (Topinka and Bredt, 1998).

It is not surprising, then, that the process of protein palmitoylation has been found to be important for the regulation of neuronal development and synaptic functions. For example, in developing neurons, protein palmitoylation in the neural growth cone regulates some aspects of neurite outgrowth and axon pathfinding (Hess et al., 1993), whereas the palmitoylation of Shh controls neuron differentiation (Pepinsky et al., 1998; Chamoun et al., 2001); in adults, palmitoylation of synaptic proteins modulates neurotransmission, both at the presynaptic and postsynaptic terminals, modifying the neurotransmitter release (Hess et al., 1992; Washbourne et al., 2001) and the signal transduction (Bizzozero, 1997; Dunphy and Linder, 1998), respectively. In addition to this, several synaptic scaffolding proteins are palmitoylated, and this regulates their membrane association and then also the formation of cluster of proteins important for the signal transduction (Topinka and Bredt, 1998; Gray et al., 1998; DeSouza et al., 2002).

A first function for protein palmitoylation in neurons, as in all the other type of cells, is to target cytosolic proteins to the cell membrane, specifically in subdomains that are enriched in cholesterol and sphingomyelin (Simons and Ikonen, 1997; McCabe and Berthiaume, 2001); these rafts are insoluble in non-ionic detergents, and then are termed detergent-insoluble, glycolipid-enriched complexes (DIGs). The palmitate chain favours the protein incorporation in these DIGs (Schroeder et al., 1994).

DIGs from the brain have been found to be enriched in signaling molecules and they seem to help to organize signal transduction. Moreover, they could be involved in the control of polarized sorting of proteins to axons as opposed to dendrites (Dotti and Simons, 1990; Ledesma et al., 1999). Indeed, many proteins that are associated with DIGs are sorted specifically to axons (Dotti et al., 1991) and the disruption of DIGs formation randomizes their distribution (Ledesma et al., 1998).

In addition to this, it seems that specific palmitoylation motifs might determine trafficking, sorting different proteins either toward the axons or the dendrites. For example, the palmitoylation motif of GAP43, which contains two adjacent cysteines and nearby basic residues, mediates targeting to DIGs and sorting to axons, whereas the distinct palmitoylation

motif of PSD95 is necessary for sorting to dendrites, leading to the formation of postsynaptic densities in spines. Altogether these data suggests that the spacing of the palmitoylated cysteines and the presence of nearby basic amino acids determine polarized protein sorting by these motifs (El-Husseini et al., 2001).

A second important role for protein palmitoylation is to control axon growth and transmitter release at axon terminals.

The first axonal protein to be found to be palmitoylated was GAP43, a phosphoprotein that modulates G-protein signaling cascades in growth cones (Strittmatter et al., 1990), and subsequently regulates neurite outgrowth and axon pathfinding (Benowitz and Routtenberg, 1997). GAP43 growth cone membranes localisation (Zuber et al., 1989) and interaction with G proteins (Sudo et al., 1992) are regulated by the palmitoylation of two close cysteines present in the N-terminal domain of the protein. The palmitate turnover on these cysteine residues is very high (Baker and Storm, 1997), and the levels of palmitoylation of GAP43 decrease as growth cones stabilize and mature (Patterson and Skene, 1999).

Another example is the neural cell-adhesion molecule (NCAM140), which localizes to lipid rafts at the growth cone membrane, acting both as an adhesion molecule and as a regulator of tyrosine kinases to induce neurite outgrowth. Elimination of NCAM140 palmitoylation sites prevents its association with lipid rafts and completely blocks neurite outgrowth (Niethammer et al., 2002).

Moreover, many palmitoylated proteins are found at the terminals of mature axons, where they can help to target synaptic vesicles to the site of transmitter release, mediate the synaptic vesicle fusion with the plasma membrane and regulate the subsequent neurotransmitter secretion. Some examples are synaptotagmin (Veit et al., 1996), vesicle-associated membrane protein (VAMP) (Veit et al., 2000), and SNAP25 (Hess et al., 1992).

Palmitoylation has a role also in the regulation of G-protein signaling, virtually modifying all the components of this pathway, activated by many neurotransmitters in the brain, including glutamate, GABA, serotonin and dopamine.

As already said, both GPCRs and G_{α} are palmitoylated. This modification has an important role, first, in the localisation of GPCRs in DIGs (Prior et al., 2001) and, second, for the regulation of protein interactions in the pathway: for example, it can increase the affinity of G_{α} for $G_{\beta\gamma}$ (Iiri et al., 1996). Importantly, it has to be noticed that receptor activation dynamically regulates the palmitoylation of some of the pathway components.

The activation of the pathway seems to favour the depalmitoylation of G_{α} , which then moves to the cytosol, turning off the G-protein signaling (Wedegaertner and Bourne, 1994). Moreover,

this depalmitoylation also increases G_{α} interactions with regulators of G-protein signaling (RGS) proteins, further accelerating the termination of G-protein signaling (Tu et al., 1997).

In the case of receptors, the effects of palmitoylation depend on the individual receptor. For example, the agonist-stimulated depalmitoylation of β_2 -adrenoceptor promotes receptor phosphorylation and internalization (Moffett et al., 2001), leading to downregulation of signaling. On the contrary, depalmitoylation of the α_{2A} -adrenoceptor strongly inhibits receptor-bound downregulation (Eason et al., 1994).

Protein palmitoylation also regulate several signaling cascades at postsynaptic sites to modulate signal transmission and synaptic plasticity. In the dendritic spines, the receptors and the downstream signaling machinery are clustered in thickenings of the cytoskeleton beneath the synaptic plasma membrane, called postsynaptic densities (Kennedy, 2000), which accelerate and specify cellular signal transduction. The clustering is mediated by a family of scaffolding proteins containing PDZ domains, which are modular protein-protein interaction motifs that often bind to the cytosolic tails of ion channels or to other PDZ domains (Kornau et al., 1997; Craven and Brecht, 1998; Garner et al., 2000; Sheng and Sala, 2001).

The most abundant PDZ protein at excitatory synapses is PSD95, a membrane-associated guanylyl kinase (MAGUK) that contains three PDZ domains. PSD95 directly bind the cytosolic tails of NMDA (N-methyl-D-aspartate)-type glutamate receptors (Cho et al., 1992; Kistner et al., 1993; Kornau et al., 1997) and also cytoskeletal (Kim et al., 1997; Brenman et al., 1998) and cell-adhesion molecules (Brenman et al., 1998), controlling the maturation of excitatory synapses and regulate synaptic morphology and strength (El-Husseini et al., 2002; Fukata et al., 2013). It has been found that this clustering requires two cysteine residues of the amino-terminal domain of PSD95 that are sites of palmitoylation (Topinka and Brecht, 1998): mutations of these two cysteines lead to inhibition of clustering at the membrane and consequent accumulation of both PSD95 and ion channels in perinuclear endosomal structures derived from the ER/Golgi apparatus (Tiffany et al., 2000). Palmitoylation might be important for ion channel clustering because it promotes the membrane association and oligomerization of PSD95 (El-Husseini and Brecht, 2002). Moreover, palmitoylation is essential for trafficking of PSD95 to postsynaptic sites (Craven et al., 1999) and live cell video-imaging studies showed that palmitoylation initially targets PSD95 to endosomal structures that traffic in a microtubule-dependent fashion and that intercept ion-channel-containing vesicles, undergoing pronounced shape changes before clustering at the plasma membrane (El-Husseini et al., 2000a).

The MAGUK family includes also other proteins with amino-terminal cysteines. Mutagenesis studies in PSD95 have identified five hydrophobic residues necessary, including the modified

cysteines, necessary for protein palmitoylation (El-Husseini et al., 2000a). Interestingly, other members of the family that contain these hydrophobic residues, as postsynaptic density 93 (PSD93), can be palmitoylated, whereas, in protein as synapse-associated protein 102 (SAP102), where the cysteines are surrounded by hydrophilic residues, they form a zinc-finger motif (El-Husseini et al., 2000b). There are also MAGUKs without N-terminal cysteine residues, which cannot be palmitoylated and fail to cluster ion channels at postsynaptic sites, as synapse-associated protein 97 (SAP97) (El-Husseini et al., 2000b). Finally, also alternative splicing can regulate the palmitoylation of PSD95-family proteins. For example, the isoform PSD95 β lacks the N-terminal cysteine residues and its trafficking resembles that of SAP97 (Chetkovich et al., 2002).

In addition to the PSD95 family, other ion-channel-associated proteins are modified by palmitoylation. One important class is the ABP/GRIP (glutamate-receptor-interacting protein) family of PDZ- domain-containing proteins, which contain multiple PDZ domains and organize signal-transduction pathways at excitatory synapses as PSD95 (Dong et al., 1997; Srivastava et al., 1998). However, they bind directly to AMPA (α -amino-3-hydroxy- 5-methyl-4-isoxazole propionic acid) receptors rather than to NMDA receptors. Similarly to PSD95, amino-terminal alternative splicing generates two isoforms of ABP/GRIP and only the palmitoylated isoforms cluster at synapses, whereas the non-palmitoylated versions form intracellular clusters (Yamazaki et al., 2001; DeSouza et al., 2002).

At the postsynaptic level, palmitoylation is particularly important also in the regulation of voltage-dependent calcium and potassium channels. For example, the palmitoylation of an accessory calcium channel subunit enhances currents by slowing channel inactivation (Qin et al., 1998). Calcium channels are also regulated by protein kinase A (PKA) phosphorylation, which enhances channel activity (Sculptoreanu et al., 1993). This regulation occurs thanks to the A-kinase-anchoring protein (AKAP18), which tethers PKA to the calcium channel. Interestingly, AKAP18 is subjected to amino-terminal myristoylation and palmitoylation, which are necessary for the membrane targeting and enzyme scaffolding (Gray et al., 1998). On the other side, the regulation of certain voltage-dependent potassium channels is mediated by the potassium-channel-interacting proteins (KChIPs) and relies upon this protein palmitoylation for plasma membrane localisation and enhancement of the density of potassium currents (Takimoto et al., 2002).

Last but not least, protein palmitoylation is involved also in the process of postsynaptic plasticity, through use-dependent modulation of the synaptic strength. This modulation has been correlated with the number of synaptic AMPA receptors on the postsynaptic membrane: strong

synaptic stimuli that augment synaptic strength (induce long-term potentiation) increase AMPA receptor numbers, whereas prolonged and graded stimuli that depress synaptic strength (induce long-term depression) stimulate AMPA receptors internalization (Malenka and Nicoll, 1999; Malinow et al., 2000).

The finding that in hippocampal neurons the PSD95 overexpression increases synaptic AMPA receptors number, resembling to activity-dependent synaptic potentiation, suggested a role for PSD95 (El-Husseini et al., 2000c). This is actually surprising, as PSD95 binds to NMDA receptors but not to AMPA receptors (Kornau et al., 1995). The mediator of this regulatory mechanism could be the transmembrane protein stargazin, which associates with AMPA receptors to mediate their delivery to the cell surface but also contains a C-terminal PDZ binding site that interacts with PSD95 and is required for synaptic targeting of AMPA receptors by stargazin (Chen et al., 2000).

In neurons culture, it has been shown that the palmitoyl-transferase inhibitor 2-bromopalmitate blocks the palmitoylation of PSD95 and disperses PSD95/AMPA receptor clusters, indicating that palmitate continuously turns over on PSD95, and that AMPA receptor clustering requires this ongoing palmitoylation of PSD95. This is also an indication that PSD95/stargazin/AMPA receptor clusters are not stable structures and they can undergo structural and functional reorganization (El-Husseini et al., 2002).

Interestingly, the modulation of synaptic activity enhances palmitate turnover on PSD95: prolonged synaptic stimuli accelerate PSD95 depalmitoylation and cause AMPA receptor endocytosis (El-Husseini et al., 2002). Moreover, expressing a PSD95 mutant protein containing an isoprenylated C-terminus, which permanently bind the protein to the plasma membrane, prevents activity-dependent AMPA receptor endocytosis (El-Husseini et al., 2002), consistently with the fact that mice with a PSD95 mutation show a selective absence of long-term depression (Migaud et al., 1998). Altogether, these data confirms the importance of palmitate turnover for the regulation of the number of AMPA receptor present on the postsynaptic plasma membrane, and then for the regulation of the synaptic plasticity.

2. RESULTS

2.1. Nerves control redox levels in mature tissues through Schwann cells and Hedgehog signaling

In the last years it is becoming more and more evident that ROS signaling is very important for the modulation of cellular plasticity and the regeneration process in different organisms, as described in the introduction. A previous work of the lab has demonstrated that ROS production is essential for adult caudal fin regeneration in zebrafish. Indeed, the inhibition of hydrogen peroxide production by NADPH oxidase inhibitors leads to the impairment of blastema growth and then the failure of tail regrowth (Figure 25) (Gauron et al., 2013).

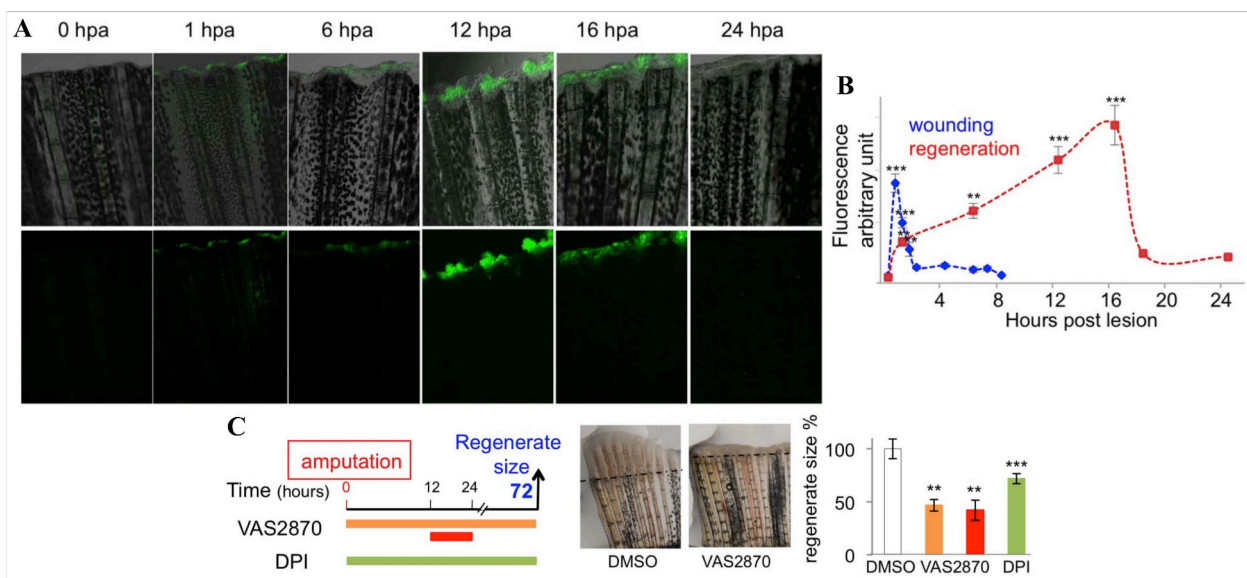

Figure 25: Sustained ROS production is essential for regeneration to proceed in adult zebrafish. ROS were detected with the fluorescent probe H₂DCFDA during regeneration (A) and wound healing (not shown). The quantification in B describes the amount of ROS detected during healing and regeneration. The inhibition of NADPH oxidase with the inhibitors VAS2870 1 μ M or DPI 1 μ M reduces the size of the regenerate; the efficiency of regeneration was quantified at 3 days post amputation and here expressed as percentage of the control (C). Error bars represent the SEM (**p<0.01, ***p<0.001). Adapted from Gauron et al., 2013.

Another important factor for adult regeneration is the nerve presence. In fact, nerves are required to have an efficient epidermal wound healing (Stelnicki et al., 2000; Harsum et al., 2001) and innervation is essential to launch the regenerative program in adults (Singer, 1974; Geraudie and Singer, 1985; Kumar and Brockes, 2012). Moreover, there are also evidences of a relationship between nerves and hydrogen peroxide, as this ROS has been found to promote axon growth in wounded zebrafish larvae caudal fin (Rieger and Sagasti, 2011).

For these reasons, we decided to further investigate this relationship between nerves and the redox status of the tissue, using as model the regeneration of the adult zebrafish caudal fin. The comprehension of the mechanisms that control ROS levels in mature tissue would be also very useful for the modulation of cellular plasticity and remodelling in adults for therapeutic aims.

In this work we first demonstrated that the reactive oxygen species involved in the regeneration process of the adult zebrafish caudal fin is hydrogen peroxide. We then used a denervation strategy to demonstrate that tissue redox levels are controlled by nerves both in normal conditions and after injury. Our results suggest that, after amputation, injured nerves induce Shh signaling in Schwann cells and that this signaling is responsible for hydrogen peroxide production in the wounded epidermis. Finally, we also discovered the existence of a reciprocal action of hydrogen peroxide on nerves: its presence at the tip of the regenerating fin is essential for sensory neurons regrowth, similarly to what was already been found in larvae skin regeneration.

Altogether, these findings support the existence of a positive feedback loop between nerves and hydrogen peroxide, in which nerves control the presence of hydrogen peroxide in the tissue but the hydrogen peroxide itself is necessary for axons regrowth after injury. The data also leads to hypothesise that redox environment of peripheral nerves could be a good target for the manipulation of cell plasticity in adults.



ORIGINAL RESEARCH COMMUNICATION

Nerves Control Redox Levels in Mature Tissues Through Schwann Cells and Hedgehog Signaling

Francesca Meda,^{1,3,*} Carole Gauron,^{1,3,*} Christine Rampon,^{1,3,4,*} Jérémie Teillon,^{1,3} Michel Volovitch,¹⁻³ and Sophie Vriz^{1,3,4}

Abstract

Aims: Recent advances in redox biology have emphasized the role of hydrogen peroxide (H_2O_2) in the modulation of signaling pathways and revealed that H_2O_2 plays a role in cellular remodeling in adults. Thus, an understanding of the mechanisms that control H_2O_2 levels in mature tissue would be of great interest. **Results:** We used a denervation strategy to demonstrate that sensory neurons are responsible for controlling H_2O_2 levels under normal conditions and after being lesioned. Moreover, we demonstrate that severed nerves respond to appendage amputation *via* the induction of Hedgehog signaling and that this signaling is responsible for H_2O_2 production in the wounded epidermis. Finally, we show that H_2O_2 and nerve growth are regulated *via* reciprocal action in adults. **Innovation and Conclusion:** These data support a new paradigm for the regulation of tissue homeostasis: H_2O_2 attracts nerves and nerves control H_2O_2 levels in a positive feedback loop. This finding suggests that the peripheral nerve redox environment could be a target for manipulating cell plasticity in adults. *Antioxid. Redox Signal.* 24, 299–311.

Introduction

REACTIVE OXYGEN SPECIES (ROS) have long been considered deleterious compounds that induce pathological situations by damaging biological molecules (DNA, proteins, and lipids). It is becoming increasingly clear that ROS, which are constantly produced at various levels by virtually all cells, also contribute to physiological processes (11, 43, 47, 54), mainly by causing cysteine modifications in signaling proteins (14, 41). The redox state of a tissue results from a complex balance between the production and degradation of oxidative molecules (58). Unchecked ROS levels have been identified in many pathological conditions, including neurodegenerative disorders, aging, and cancer, as illustrated by the development of pro- and antioxidant therapeutic strategies to treat cancer (2, 18).

Of the ROS, hydrogen peroxide (H_2O_2) has a long life span and participates in redox signaling, and it has recently been demonstrated that a transient increase in H_2O_2 is necessary for inducing a regenerative program in *Xenopus* larvae (29), adult zebrafish (15, 20), and mice (1), as well as for enhancing cell plasticity (4, 53). Reciprocal interactions between H_2O_2 and nerves are suggested by two observations: H_2O_2 enhances peripheral sensory axon growth in wounded caudal fins of zebrafish larvae (44), and efficient epidermal wound healing requires the presence of sensory neurons (21, 52). In addition, innervation has been demonstrated to be essential for launching a regenerative program in adults (16, 25, 50). Caudal fin regeneration in adult zebrafish therefore appears to be a suitable model in which to study the relationship between nerves and tissue redox status. Indeed, H_2O_2 production starts soon after fin amputation, and it is necessarily

¹Centre Interdisciplinaire de Recherche en Biologie (CIRB) CNRS UMR 7241/INSERM U1050/Collège de France, Paris, France.

²École Normale Supérieure, Institute of Biology at the Ecole Normale Supérieure (IBENS), CNRS UMR8197, INSERM U1024, Paris, France.

³PSL Research University, Paris, France.

⁴Biology Department, Université Paris Diderot, Sorbonne Paris Cité, Paris Cedex 13, France.

*These authors contributed equally to this work.

Innovation

The present study demonstrates that redox levels in mature tissue are controlled by sensory nerves *via* Hedgehog signaling. In a positive feedback loop, hydrogen peroxide (H_2O_2) stimulates nerve growth and the Shh pathway. This finding not only identifies cooperation between nerves, H_2O_2 , and Hedgehog signaling to ensure tissue homeostasis and repair in adults but also provides a tractable mechanism for the wound healing deficiency associated with neuropathies.

maintained while cells of various lineages in the stump respond to the injury by dedifferentiating and acquiring progenitor identities (15, 20).

We previously showed that in this context, ROS induce apoptosis, which in turn stimulates progenitor recruitment and proliferation through a purinergic signaling pathway (40). Progenitor cells subsequently accumulate at the damaged surface underneath the wound epithelium from 15 to 36 hours postamputation (hpa) and form a mass of proliferating cells, the blastema that is clearly visible at 48 hpa (38). The missing fin is then replaced through blastema growth, differentiation, and morphogenesis.

The present article addresses the control of H_2O_2 levels by nerves and the reciprocal action of H_2O_2 on nerve growth in adults in normal conditions and after lesioning. To determine the relationship between H_2O_2 and nerves, we first developed a model in which we measure levels of ROS (specifically H_2O_2) after denervation of the adult caudal fin, and we then coupled this assay with manipulation of H_2O_2 levels and signaling pathway analysis. In this study, we demonstrate that in adult zebrafish, sensory nerves are involved in the control of redox levels both in normal mature tissue and following injury. Moreover, we show that Schwann cells (SCs), through Shh signaling, mediate this control of redox status by nerves. Finally, we also demonstrate that H_2O_2 stimulates nerve growth in adults. Our results suggest that nerves control tissue redox levels and H_2O_2 attracts nerves in a positive feedback loop and that this feedback loop is involved in tissue homeostasis.

Results

Nerve remodeling after injury

Adult zebrafish caudal fins primarily contain sensory neurons as the fin does not contain muscle. Axons, which are fasciculated inside the rays in the uninjured fin, defasciculate as early as 6 hpa when Wallerian degeneration begins (Fig. 1). This tip degeneration of the sectioned nerves, which is ac-

companied by axonal skeleton disintegration and the disappearance of acetylated tubulin staining, is much faster than in mammals; in zebrafish, axon regrowth is clearly visible at 15 hpa. Before 18 hpa, cell proliferation occurs mostly in the epidermis/dermis of the stump and mainly involves epidermal cells and SCs (40). We therefore used an antiphosphorylated histone H3 antibody to count proliferating Schwann and epidermal cells during nerve remodeling (Fig. 1D–I). Proliferation is strongly enhanced during axon regrowth (Fig. 1F–H). Nerve remodeling involves systemic activation of Sox10 in SCs shortly after amputation (Fig. 2) and local activation after lesion (Supplementary Fig. S1; Supplementary Data are available online at www.liebertpub.com/ars). It is worth noting that in uncut fins, only some of the most distal SCs are positive for Sox10 (Fig. 2B). By 18–24 hpa, the axons (Fig. 1G, H) and the first blastemal cells (40) have reached the wound epidermis, and ROS levels in the wound epidermis have decreased (15). These data reveal dynamic degeneration and regrowth of sensory axons, as well as activation of SCs, within the first 24 h of amputation.

Nerves control redox levels in mature tissue

To dissect the involvement of nerve tracks in H_2O_2 regulation and the establishment of a regenerative field, we developed a denervation assay (Fig. 3A–C). At the base of the caudal fin, sensory neurons are fasciculated and split into two branches, with one branch innervating the dorsal part and one innervating the ventral part of the fin. We performed a resection of the dorsal branch at the time of amputation (Fig. 3A) and verified the efficiency of the surgery by testing for the presence of axons with acetylated tubulin staining 3 days postamputation (dpa) (Fig. 3B) and quantifying the effect of denervation on the size of the regenerated fin (Fig. 3C). Denervation abolished the regenerative capacity of the amputated caudal fin. We then used this assay to determine whether peripheral nerves influence the tissue redox status in mature tissue. ROS detection was performed 16 h postdenervation in nonamputated fins. The nondenervated part of the adult caudal fin is mainly in a reduced state (Fig. 3E, G), but denervation induced a twofold increase in the ROS levels in the tissue (Fig. 3F, G). Thus, peripheral nerves control redox status in this mature tissue.

Nerves control redox levels after amputation

When the caudal fin was amputated, a substantial and sustained production of H_2O_2 was observed (15) (Fig. 3H). To test the involvement of nerves in this lesion-induced ROS production, we combined the denervation assay with amputation and measured ROS production over time (experimental scheme presented in Supplementary Fig. S2). We

FIG. 1. Wallerian degeneration and axon growth after amputation are very rapid in adult fish. (A) Scheme of the experiment. (B–I) Caudal fins of adult fish were amputated ($t=0$, blue arrow), and the axon cytoskeleton (green) and mitosis (white) were visualized over time through immunofluorescence staining for the axonal marker, acetylated tubulin (green), and phosphorylated histone H3 (white), respectively. (D', E', H') Show higher magnifications of the distal parts of (D, E, H), respectively. At 6 hpa, the extremities of the axons begin to be fragmented, and the nerves begin to defasciculate; at 10 hpa, defasciculation is more pronounced. During Wallerian degeneration (10–12 hpa), epidermal and SCs start to proliferate. At 15 hpa, axons have regrown, and some axons cross the amputation plane at 18 hpa. Dotted line: amputation plane. Dashed line: distal part of the fin. Before 24 hpa, the amputation plane corresponds to the distal part of the fin. For each time point, the most distal part of the fin (upper panel) and a proximal part (lower panel) are shown. Scale bars = 50 μ M. hpa, hours postamputation; SCs, Schwann cells. To see this illustration in color, the reader is referred to the web version of this article at www.liebertpub.com/ars

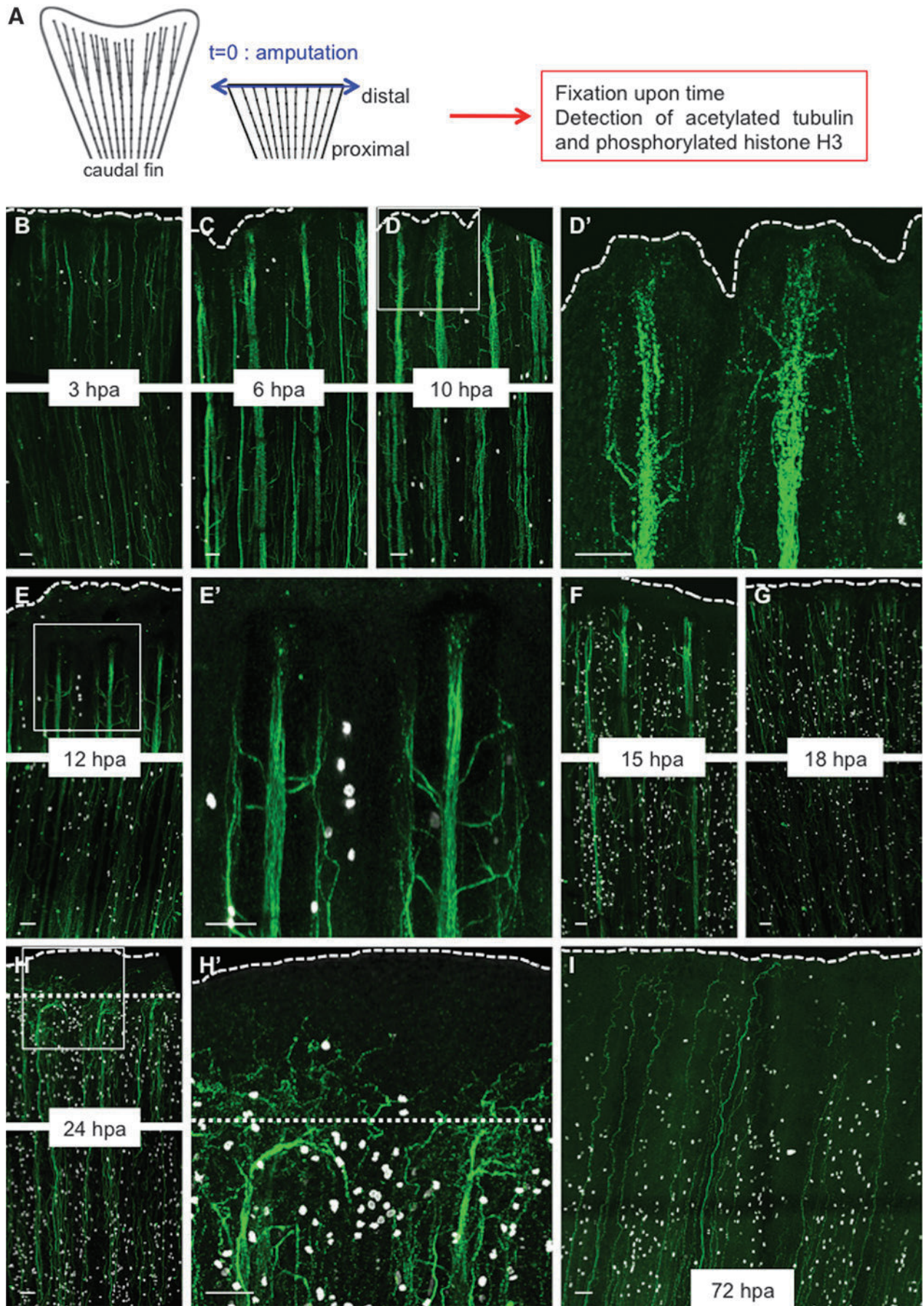

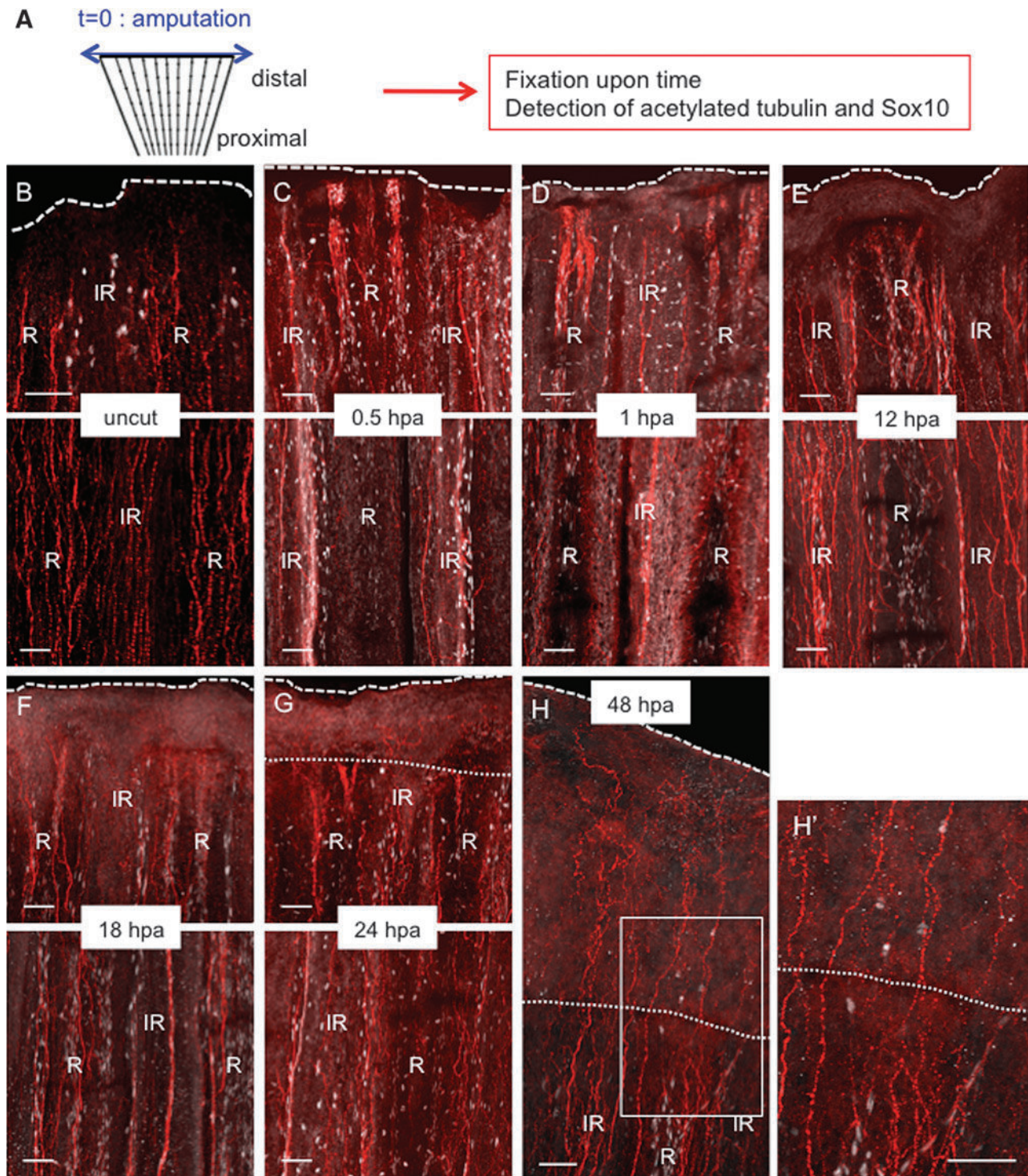

FIG. 2. Systemic Sox10 activation in SCs following amputation. (A) Scheme of the experiment. (B–H) Caudal fin of adult fish was amputated ($t=0$, blue arrow), and the axon cytoskeleton (red) and immature SCs (white) were visualized over time through immunofluorescence staining for the axonal marker, acetylated tubulin (red), and the immature SC marker, Sox10 (white), respectively. Immunostaining in uncut fin (B) or after amputation (C–H). (B–G) The upper panel shows the distal part of the amputated fin, and the lower panel shows a more proximal part. (H') Shows a higher magnification of (H). Dotted line: amputation plane. Dashed line: distal part of the fin. Scale bars = $50 \mu\text{M}$. R, ray; IR, inter-ray. To see this illustration in color, the reader is referred to the web version of this article at www.liebertpub.com/ars

subsequently denervated the dorsal part of the caudal fin and examined the ROS induced by amputation at 1 hpa (fin amputated 16 h postdenervation; Supplementary Fig. S2C and Fig. 3J) and 17 hpa (fin amputated at the time of denervation;

Supplementary Fig. S2B and Fig. 3H, I, K). Denervation reduced the redox levels at the tip of the fin, the major site of ROS production after amputation, during both the immediate response (1 hpa) and the sustained production of ROS

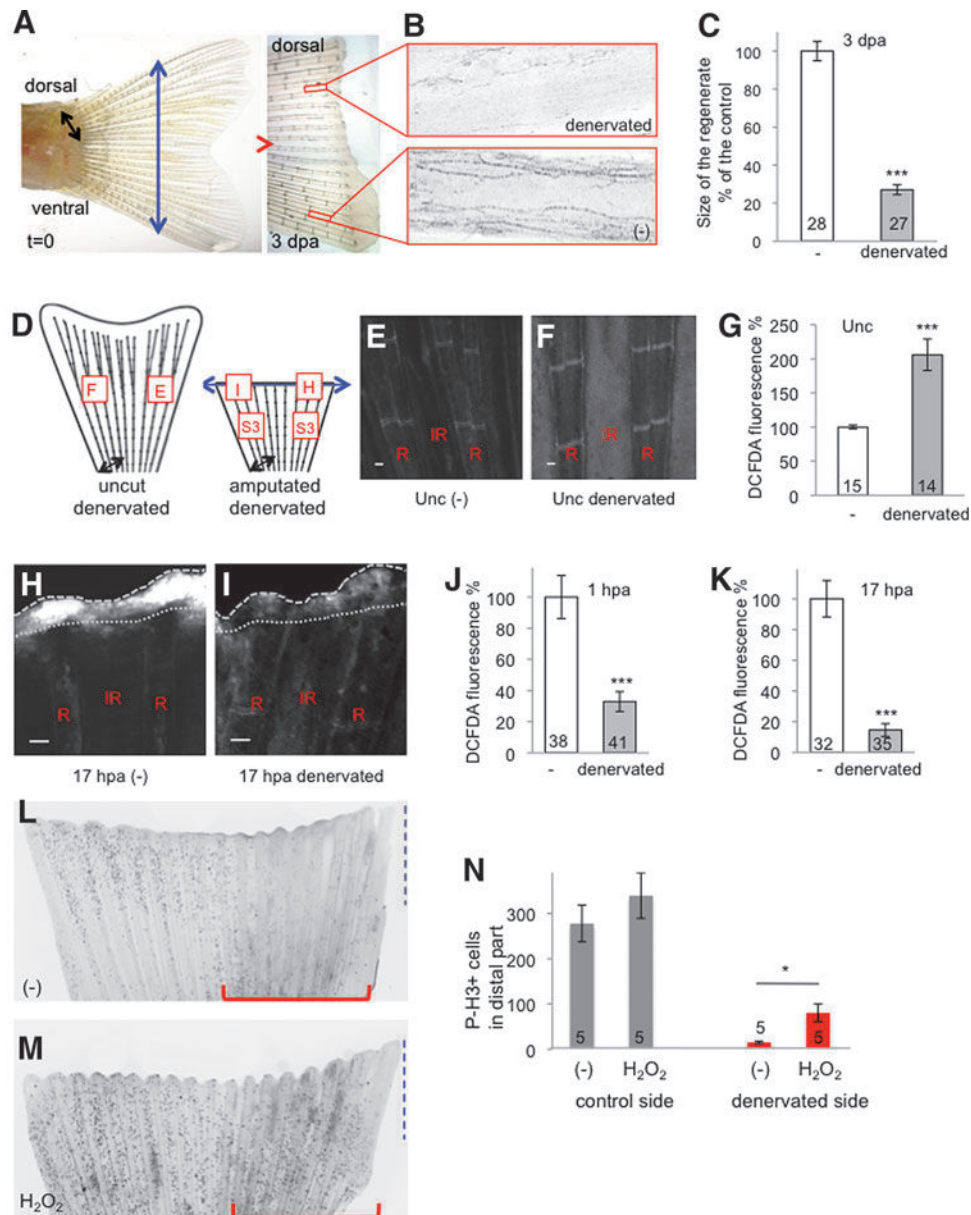

FIG. 3. Sensory neurons control ROS levels in the adult caudal fin. (A) The dorsal part of the caudal fin was denervated (*black arrow*) at the time of amputation (*blue arrow*). At 3 dpa, the dorsal part (denervated) had not regenerated compared with the ventral part (-) (representative image). (B) At 3 dpa, antiacetylated tubulin staining indicates the absence of axons in the denervated part. (C) Quantification of the size of the regenerated tissue at 3 dpa in the control (-) and denervated parts. The efficiency of regeneration is expressed as a percentage of the control. (D) Schematic representation of ROS detection in fin denervated in the dorsal part, with and without amputation. The *squares* indicate the position of ROS measurement, and the *letters* refer to *panels* in this figure or Supplementary Figure S3. (E–G) ROS detection at the level of the first ray bifurcation in an uncut fin. (H–K) ROS detection at the level of the amputation plane at 1 and 17 hpa. (H, I) Representative images at 17 hpa. (L–N) Mitotic cells were stained with antiphosphorylated histone H3 at 24 hpa in fins denervated at the time of amputation on the dorsal part (*red line*) and incubated in water (L) or 1 mM (H₂O₂) (M). Quantification of proliferation was performed on the distal part of the fin (*blue dashed line*) in the control part or the denervated part (*red line*) (N). The *red line* indicates the denervated part. (H, I) *Dotted line*: amputation plane. *Dashed line*: distal part of the fin. Error bars represent the SEM (**p* < 0.05; ****p* < 0.001). *n* Values are indicated at the bottom of each column of the graphs. Scale bars = 50 μm. A scheme of the different conditions in which ROS were measured is given in Supplementary Figure 2. dpa, days post amputation; H₂O₂, hydrogen peroxide; ROS, reactive oxygen species; SEM, standard error of the mean. To see this illustration in color, the reader is referred to the web version of this article at www.liebertpub.com/ars

(17 hpa) (Fig. 3H–K). However, far from the amputation plane, that is, in the stump, denervation had the same effect as in the uncut fins; it induced a mild increase in the redox levels at all stages (Supplementary Fig. S3). Cell proliferation in the epidermal compartment is a prerequisite to regeneration (40). At 24 hpa, proliferation concerned dermal and epidermal cells of the distal part of the fin (six segments from the amputation plane). Cell proliferation in the stump at 24 hpa was strongly inhibited by denervation (Fig. 3L, N). Addition of H₂O₂ in water enhanced proliferation in the control part of the fin (nondenervated) and extended the domain of proliferation to the more proximal part of the fin, suggesting that the entire epidermis is able to answer to H₂O₂ (Fig. 3M). Moreover, addition of H₂O₂ was sufficient to partially reverse the inhibition of proliferation induced by denervation (Fig. 3M, N). In conclusion, denervation of the appendage induced a twofold increase in oxidative levels on a global scale, while it strongly inhibited the large and sustained injury-induced increase in ROS in the wound epidermis. As expected, denervation in zebrafish also inhibited further steps of regeneration (*i.e.*, proliferation in the stump), and this inhibition could be reversed by addition of H₂O₂ (Fig. 3N). Thus, peripheral nerves constrain the tissue redox level in mature tissue and they are also involved in the modification of ROS levels induced by wounding and amputation.

Hedgehog signaling and SCs participate in redox control

The vertebrate peripheral nervous system is able to regenerate (10). This remarkable property is mainly dependent on SCs, which have a high degree of plasticity and dedifferentiate to progenitor or stem cells after nerve damage (46). During dedifferentiation, SCs provide signals that transform the environment to one that supports axon growth and guides axons to the distal stump (35). Several signals are likely to be involved in the rapid reprogramming and proregenerative properties of glial cells after neuronal injury. For instance, Hedgehog signaling appears to be a good candidate because it has been proven to be a key element in the definition of a niche that favors activation of glial cells or, more generally, stem cells in both central and peripheral axon regeneration (7, 42, 51). Furthermore, Hedgehog is regulated by Sox10, the expression of which is induced shortly after nerve lesions (Fig. 2 and Supplementary Fig. S1). Moreover, Hedgehog signaling is directly involved in osteoblast proliferation during late stages of caudal fin regeneration (from 2 to 7 dpa) (39, 60) and in heart regeneration (55), and it has recently been proposed that peripheral nerve-derived Hedgehog might be involved in non-neuronal tissue regeneration (7, 36, 61).

We took advantage of a transgenic line that recapitulates sonic hedgehog expression in adult fish (*shh:green fluorescent protein* [GFP]) (13, 60) to follow *shh* expression after amputation. To enable the very early detection of *shh* locus activity, we resorted to anti-GFP staining rather than imaging direct reporter fluorescence. In agreement with previous observations (60), a group of Shh-positive cells was localized at the end of each ray in the mature uncut fin (Fig. 4B). Axon staining with an antiacetylated tubulin antibody indicated that the Shh-positive cells crown the axons of peripheral sensory neurons (Fig. 4B). This group of cells disappeared

after denervation (Fig. 4C, D), which suggests that they are nerve dependent or part of the nerve. It is unclear whether these cells originate from the mesoderm or the neural crest (19). To test whether they could be derived from SCs, we performed coimmunostaining for GFP and Sox10 shortly after amputation of the adult caudal fin (at 0.5 hpa [Fig. 4E–G] or at 12 hpa [Fig. 4H, I]). The adult caudal fin contains few types of neural crest-derived cells, including SCs and melanophores (Supplementary Fig. S4). To avoid confusion, the coimmunostaining was performed in the nacre strain of fish, which lack neural crest-derived melanophores. Confocal images of the whole fin (Fig. 4E–G) or cryosections (Fig. 4H, I) indicated that the Shh-positive cells were also Sox10 positive and therefore were derived from the neural crest. We subsequently analyzed the behavior of these cells during regeneration (Fig. 5). GFP was detected in a subpopulation of activated SCs shortly after amputation (Fig. 5B). This *shh* expression was also observed in SCs activated by skin lesions as soon as 15 min after lesion (Supplementary Fig. S1). After amputation, Shh-expressing cells changed shape and position during Wallerian degeneration, and some cells in the inter-rays migrated to the tip of the amputated fin while the axons regrew (Fig. 5E, F). By 72 hpa, most of the Shh-expressing cells were localized at the tip of the hemirays and reformed the pools of cells (Fig. 5H) that were later responsible for osteoblast proliferation (39). Thus, shortly after amputation or lesioning, activated SCs begin to express Sox10 and some cells induce Shh expression. Shh-positive cells migrate to the tip of the fin while axons regrow and they form groups of cells that crown the axons.

To test the role of Shh in the very first events following amputation (before 24 hpa), we disrupted Hedgehog signaling with cyclopamine (HH-i) (Fig. 6). HH-i treatment during the first 24 hpa impaired blastema formation, which could be rescued by a Smoothed agonist (Smo-A) (Fig. 6A–C and Supplementary Fig. S5). It is worth noting that Shh likely has distinct and opposite effects during healing (0–8 hpa) and during the subsequent steps of regeneration (8–24 hpa) because the inhibition of regeneration is stronger when Shh is inhibited only after 8 hpa (Fig. 6C). To more precisely examine the output of Hedgehog signaling, we analyzed the first signs of regenerative tissue, that is, (i) ROS production at 16 hpa, (ii) cell proliferation, and (iii) axon growth in the regenerating fin in the presence of HH-i. At 16 hpa, HH-i strongly reduced ROS production (Fig. 6D–F) and cell proliferation (Fig. 6G, H), mimicking the effects of denervation (Fig. 3K–N). We detected far fewer Shh-positive cells in denervated regenerating fins than in nondenervated regenerating fins (Supplementary Fig. S6). This result, which corresponds to an inhibition of Shh expression or an inhibition of the migration of Shh-expressing cells, was expected for SCs.

Next, to test whether a reduction in ROS levels could modify Shh expression, we inspected Shh-positive cells in fish incubated with a pan-NADPH oxidase inhibitor (VAS-2870, Nox-i). We previously showed that Nox-i treatment significantly reduces ROS production at 6 hpa, the size of the regenerated tissue at 72 hpa, and cell proliferation at 24 hpa (15). We therefore visualized the Shh-positive cells at 48 hpa, when they reform a specific structure at the tip of each ray, in fish challenged to regenerate in the presence of Nox-i. Under these conditions, the expression of Shh was strongly inhibited (Fig. 6I). This result suggests that ROS partially control Shh

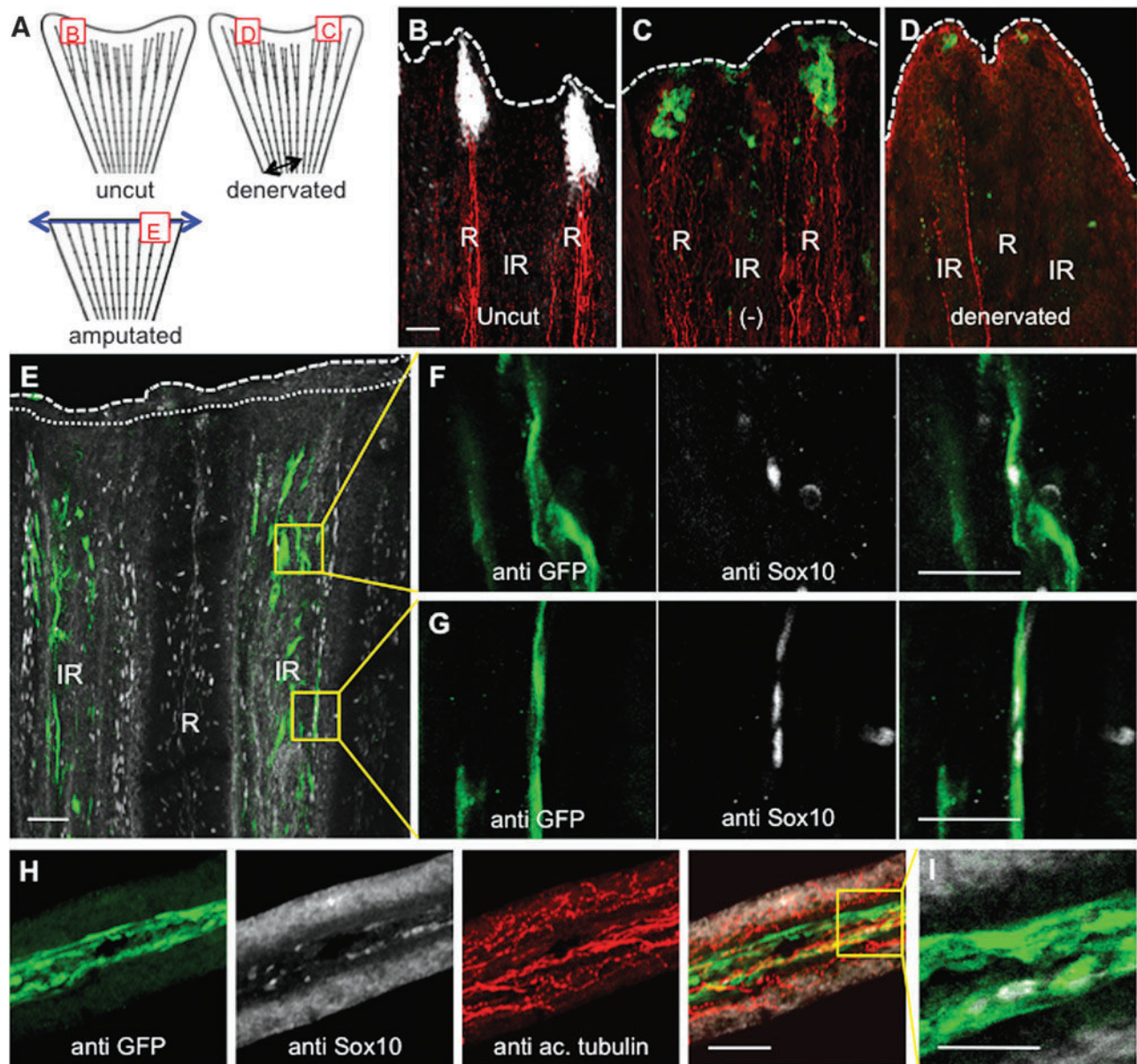

FIG. 4. Activated SCs express Shh and form a specific structure at the tip of the axon. (A) Schematic representation of the intact fin or the fin after amputation. The *squares* indicate the position of the acquisitions, and the *letters* refer to the figure panels of this figure. The dorsal part of the caudal fin was denervated (*black arrow*) or the fin was amputated (*blue arrow*). (B) Immunofluorescence staining for GFP in *shh*:GFP fish (*white*) and axon cytoskeleton (*red*) in uncut fin. (C, D) Immunofluorescence staining for GFP in *shh*:GFP fish (*green*) and for the axon cytoskeleton (*red*) in control side (-) and denervated part of a nonamputated fin 2 days postdenervation. (E–G) Immunofluorescence staining for GFP in *shh*:GFP fish (*green*) and Sox10 (*white*) in the whole fin at 0.5 hpa. (F, G) Magnification of (E). (H, I) Immunofluorescence staining for GFP in *shh*:GFP fish (*green*), axon cytoskeleton (*red*), and Sox10 (*white*) in a cryosection of a regenerating fin at 12 hpa. (I) Magnification of (H). Confocal images, 1–3 μm. Dotted line: amputation plane. Dashed line: distal part of the fin. Scale bars = 50 μm in (B–H) and 25 μm in (I). GFP, green fluorescent protein. To see this illustration in color, the reader is referred to the web version of this article at www.liebertpub.com/ars

signaling *via* activation of Shh transcription. Together, our results strongly suggest that nerve control of redox levels operates through activated SCs that express Shh and that redox levels also influence the Shh pathway (Fig. 7H).

Shh controls nerve growth through H_2O_2

It has been demonstrated in zebrafish larvae that H_2O_2 stimulates axon growth after lesion (44). We therefore examined the nature of the ROS involved in adult ap-

pendage regeneration. We already knew that NADPH oxidase inhibition impairs the process of regeneration and reduces DCFDA staining (15), which is in favor of H_2O_2 . We then designed a transgenic fish expressing the HyPer biosensor for H_2O_2 (3) under a ubiquitous promoter (*ubi*:HyPer). The detection of H_2O_2 in regenerating fins mimicked the DCFDA staining (Fig. 7B, C), and Nox-i reduced H_2O_2 levels to the same extent as ROS levels detected with DCFDA fluorescent probe (Fig. 7D). On the contrary, Nox-i had a mild effect if any on the

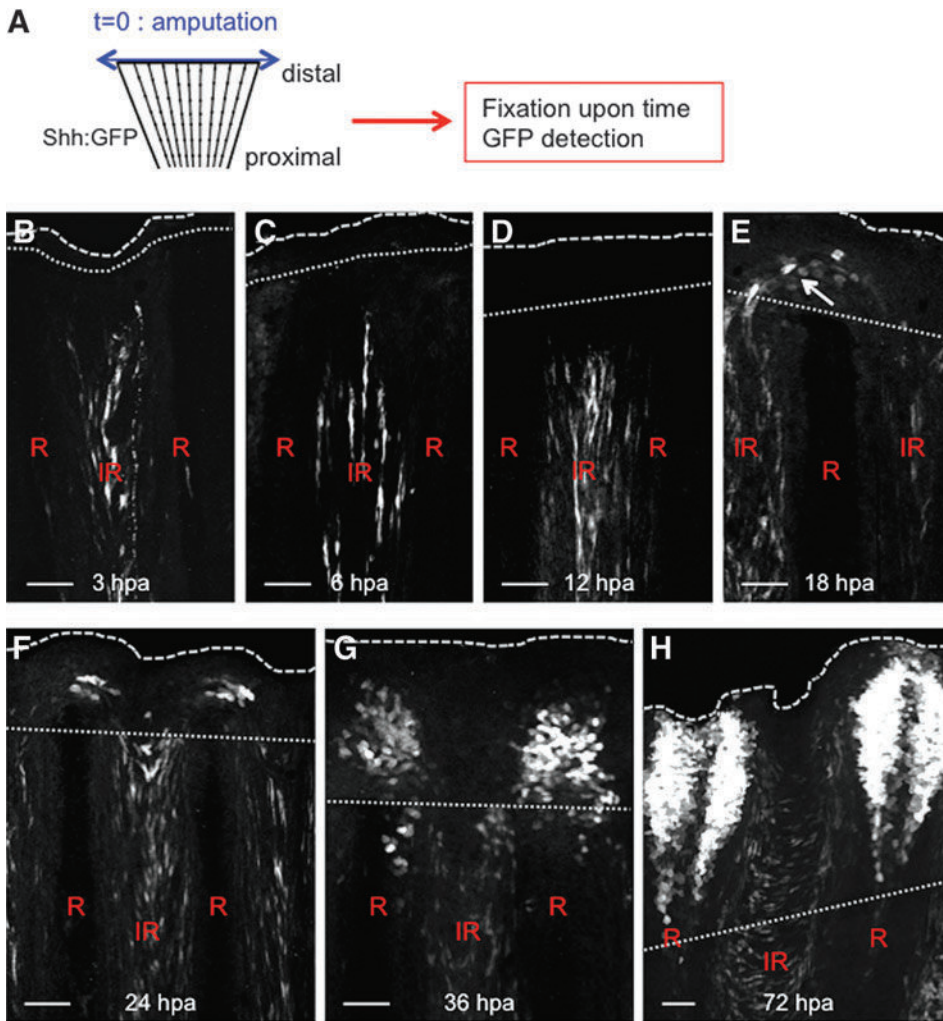

FIG. 5. Behavior of Shh-expressing cells during regeneration. (A) Cells expressing Shh were visualized during the time course of regeneration by immunodetection of the GFP in *shh:GFP* transgenic fish. Until 12 hpa, Shh-positive cells were detected in the inter-ray of the stump (B–D). At 18 hpa, some Shh-positive cells were present at the tip of the regenerating ray (arrow) (E) and their numbers increased over time to reform the structure present in the uncut fin by 48–72 hpa (F–H). Scale bars = 50 μ M. Dotted line: amputation plane. Dashed line: distal part of the fin. To see this illustration in color, the reader is referred to the web version of this article at www.liebertpub.com/ars

mitochondrial ROS level (Supplementary Fig. S7). These experiments suggest that the ROS detected with DCFDA and involved in adult appendage regeneration is H_2O_2 . We then investigated the potential role of Hedgehog signaling and H_2O_2 in nerve growth during appendage regeneration in adults. We assessed nerve growth in fish exposed to NADPH oxidase inhibition (Nox-i) or Hedgehog signaling inhibition (HH-i) during adult caudal fin regeneration (Fig. 7E–G). First, adult fish were incubated with Nox-i or HH-i at the time of amputation, and then axon growth was scored at 24 hpa (Fig. 7E, F). Nox-i significantly reduced axon regrowth in adults (Fig. 7F, G), which suggests a positive feedback loop by which H_2O_2 stimulates nerve growth in adults, similar to what was found in larvae. Furthermore, HH-i inhibited axon growth to approximately the same extent as Nox-i (Fig. 7G). This last result suggests that Shh partially contributes to H_2O_2 signaling. These data identify a positive feedback loop in which H_2O_2 attracts nerves and nerves control H_2O_2 homeostasis during regeneration (Fig. 8).

Discussion

We first established that denervation abolishes the regenerative capacities of the amputated caudal fin, consis-

tent with previous experiments performed on the pectoral fins of other teleost fish (16) and on newt appendages (50). We were led to examine a possible link between nerves and redox status by the demonstration that regeneration of a denervated appendage in newts can be rescued by overexpression of newt anterior gradient (nAG, AGR2 in mammals) (27), a protein disulfide isomerase that is expressed successively in SCs and in the wound epidermis. Additional results underlined the central role of this disulfide isomerase in the nerve dependence of fin regeneration: during development, nAG is first expressed in the epidermis, then switched off by nerve arrival, and later reinduced by the nerves themselves after lesioning (26). By contrast, prevention of appendage innervation during development leads to continuous nAG expression and regeneration becomes nerve independent (26). Although the relationship between ROS levels and nAG expression was not addressed at that time, those results pointed to the relevance of redox balance in the control of appendage regeneration by nerves.

We then proved that nerves control the dynamic redox levels in the adult fin and after amputation and that implementing this control involves SCs and Hedgehog signaling. These results support a new paradigm for the regulation of tissue homeostasis. We have identified two unexpected

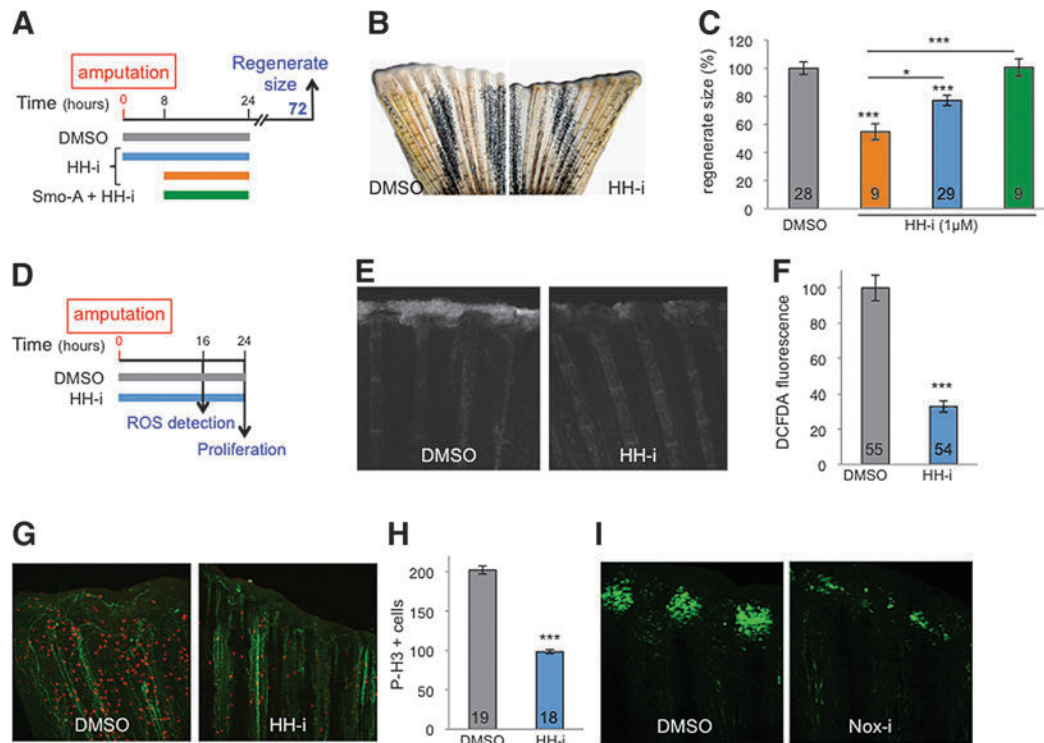

FIG. 6. Early HH signaling is necessary for ROS production. (A–C) HH-i added to the water bath from 0 to 24 hpa (blue) or from 8 to 24 hpa (orange) inhibits regeneration, which can be rescued by Smo-A (green). (D–H) Hedgehog inhibition with HH-i (cyclopamine) (D) reduced ROS levels at the amputation plane at 16 hpa (E, F) and stump proliferation at 24 hpa (G, H). (G, H) Immunofluorescence staining for the axonal marker, acetylated tubulin (green), and for the mitotic cell marker, phosphorylated histone H3 (red). (I) Nox-i added to the water bath from 0 to 24 hpa reduced the number of Shh-positive cells detected at 48 hpa. Shh-positive cells were visualized by immunodetection of the GFP in *shh:GFP* transgenic fish. Error bars represent the SEM (* $p < 0.05$; *** $p < 0.001$). *n* Values are indicated at the bottom of each column of the graphs. HH-i, hedgehog inhibitor, cyclopamine; Smo-A, smoothened agonist. To see this illustration in color, the reader is referred to the web version of this article at www.liebertpub.com/ars

feedback loops (Fig. 7H) between H_2O_2 and Hedgehog signaling in injured growing nerves, which cooperate to ensure tissue growth and coordination for the regeneration of a properly innervated appendage (Fig. 8). The findings that peripheral nerves control redox levels and that in turn H_2O_2 regulates nerve growth support the idea that organ size and regeneration are intimately dependent on this positive interaction.

The crowning of axons by Schwann-derived cells expressing Shh has not previously been described in vertebrates, although the importance of Hedgehog signaling in SC behavior was demonstrated a long time ago (31). In mammals, Dhh is expressed in glial cells and is a key element in maintaining peripheral nerve integrity (49). It will be interesting to determine whether Dhh is also involved in redox homeostasis and whether Dhh and Shh are commutable in SCs for ensuring nerve maintenance and regeneration. The involvement of Shh in the control of nerve growth has been known for a decade (reviewed in Bovolenta and Sanchez-Arrones⁵ and Yam and Charron⁵⁷) and its role in neuroprotection *via* its secretion by SCs has also been documented (22). The importance of SCs for nerve regeneration is also well known (reviewed in Glenn and Talbot¹⁷ and Jessen et al.²³), as is the fact that SCs are sensitive to the redox environment (30, 45, 48). However, our results demonstrate for the first time that these different pathways are mechanistically linked by reciprocal interactions during appendage regeneration.

Our findings demonstrate the translational potential of the extracellular application of H_2O_2 in diseases involving axonal degeneration. Neuropathies are often associated with chronic wounds or tumor irradiation, and in both cases, nerve degeneration is due to miscommunication between axons and glia (12, 59). Manipulation of Hedgehog signaling can reverse diabetic neuropathy (8), and a few reports have addressed the involvement of H_2O_2 in this kind of neurological complication (34, 37). However, these studies did not consider a possible interaction of the Hedgehog pathway with H_2O_2 , and our results lead for the first time to the idea that cross talk between neurons and glia operating in vertebrate regeneration involves the regulation of H_2O_2 homeostasis.

Cellular redox homeostasis mediates a plethora of cellular pathways, as indicated by the roles of ROS in cell plasticity, tissue regeneration, and wound healing, as well as the imbalance of ROS homeostasis in pathogenesis (*e.g.*, tumorigenesis, autoimmunity, degenerative diseases, and diabetes) (4, 28, 47, 54, 56). Our observations put Shh on the list of redox targets. Taking into account that Shh signaling has a central role in various human pathologies such as degenerative diseases, cancer, and autoimmunity (reviewed in Briscoe and Therond,⁶ Carney and Ingham,⁹ and Petrova and Joyner³⁶), in which the balance between oxidants and antioxidants is often perturbed (54, 58), our results provide a new mechanism that may be of crucial importance in controlling these biological processes. Consequently, targeting the Hedgehog pathway with topical

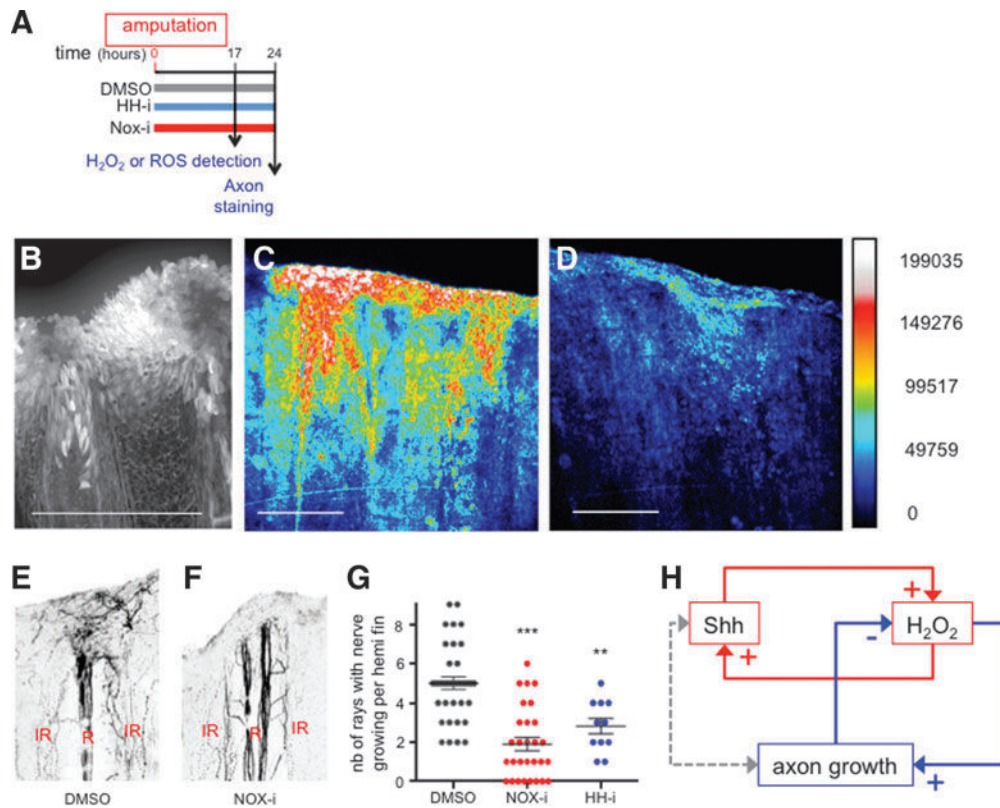

FIG. 7. H_2O_2 stimulates axon growth in a positive feedback loop. (A) Scheme of the experiments. (B) ROS detection with DCFDA fluorescent probe. (C, D) Detection of H_2O_2 in ubi:HyPer fish. Fish were incubated in water (C) or Nox-i (D) and fluorescence of HyPer analyzed on adult anesthetized fish. [H_2O_2] is inferred from the YFP₅₀₀/YFP₄₂₀ excitation ratio of HyPer. Pseudocolor calibration bars: HyPer ratio (YFP₅₀₀/YFP₄₂₀). (E, F) Growing nerves were detected in the regenerating fin at 24 hpa by immunodetection of acetylated tubulin in fish incubated in vehicle (E), Nox-i (F), or HH-i (not shown). The quantification presented in (G) corresponds to the number of rays with growing nerves per half fin (maximum 9). *n* Values: dimethyl sulfoxide = 36; NOX-i = 29; HH-i = 11. (H) This article reveals the interaction between two feedback loops in the regulation of axon growth. Error bars represent the SEM (** $p < 0.01$; *** $p < 0.001$). Scale bars = 200 μ M. YFP, yellow fluorescent protein. To see this illustration in color, the reader is referred to the web version of this article at www.liebertpub.com/ars

application of H_2O_2 may be a novel therapeutic strategy outside the field of peripheral neuropathy.

Materials and Methods

Fish care, surgery, and quantification of regeneration

Zebrafish colonies (AB-Tu and nacre fish) and transgenic fish [*sox10(7.2):mrfp* (24) and *2.4shh:GFP:ABC#15* (13)] were maintained using standard methods. The animal facility obtained approval from the French agreement from the Ministère de l'agriculture (No. C75-05-12), and the protocols were approved by the Ministère de l'éducation nationale de l'enseignement supérieur et de la recherche (00477.02). To maintain a healthy colony, a cycle of 14-h light–10-h dark was used, and a water temperature of 28°C was maintained, with a maximal density of five fish per liter. Water filtration depended on Aquatic Habitat stand-alone fish housing and operated automatically (Aquatic Habitat, Inc., Apopka, FL). Fish were fed twice per day with live 2-day-old artemia. For manipulation and amputation, the adult zebrafish (5–10 months of age) were anesthetized in 0.1% tricaine (ethyl-m-aminobenzoate), the caudal fins were amputated at the level of the first ray bifurcation and the fins were allowed to regenerate for various

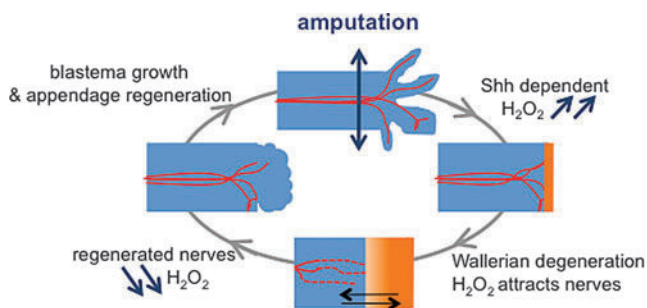

FIG. 8. Synthetic model for H_2O_2 /nerve interaction during appendage regeneration. In adults, tissues are mainly in a reduced state (top, blue). Amputation induces an increase in H_2O_2 levels (orange) that is nerve dependent and involves Shh signaling (right). Following Wallerian degeneration (dashed lines), regions of high H_2O_2 levels attract axons (red) and are essential for progenitor cell recruitment and blastema formation (bottom). H_2O_2 levels decrease upon reinnervation (left). To see this illustration in color, the reader is referred to the web version of this article at www.liebertpub.com/ars

lengths of time. Denervation was performed on the dorsal part of the caudal fin using a trapezoidal microknife (Bausch & Lomb, Rochester, NY). The efficiency of regeneration was quantified at 3 dpa. The surface of the blastema was measured and subsequently divided by the square length of the amputation plane for each fish. The efficiency of regeneration is expressed as a percentage of the control.

Transgenic line

The sequence coding for HyPer (3) was introduced into a vector suitable for transgenesis under a ubiquitous promoter (ubi) (33). The details of the cloning procedures are available upon request. Stable transgenic lines with ubiquitous expression of the fluorescent proteins were selected.

ROS detection

The compound, 2',7'-dichlorodihydrofluorescein diacetate (H2DCFDA; Calbiochem, San Diego, CA), was used to monitor the accumulation of ROS in adult zebrafish fins. Fluorescent DCF was formed through ROS oxidation. Zebrafish were incubated with H2DCFDA (50 μ M) 2 h before confocal imaging. Spinning-disk images were acquired using a 4 \times /0.15 N.A. objective on a Nikon Eclipse Ti microscope equipped with a CoolSnap HQ2/CCD camera (Princeton Instruments, Trenton, NJ) and a CSUX1-A1 (Yokogawa, Tokyo, Japan) confocal scanner. MetaMorph software (Molecular Devices, Sunnyvale, CA) was used to collect the data. Fluorescence was excited with a 491 nm laser and detected with a 525/39 nm filter. Quantification of fluorescence intensity was performed using ImageJ software. Oxidation of MitoSOXTM Red (Molecular Probes, Eugene, OR) reagent by superoxide produces red fluorescence specifically targeted to mitochondria in live cells. For double detection of mitochondrial superoxide and cellular ROS, adult zebrafish were incubated with MitoSOX Red (0.5 μ M) and H2DCFDA (50 μ M) 2 h before confocal imaging. Leica SP5-MP images were acquired using a Leica PL APO 25 \times objective (Leica Microsystems GmbH, Wetzlar, Germany). Acquisitions were made in 1024 \times 1024 pixels with a line average of 4 and a scanning speed of 400 Hz. H2DCFDA acquisitions used a spectral band from 495 to 535 nm and MitoSOX from 610 to 750 nm.

H₂O₂ detection with the HyPer probe

HyPer fluorescence was excited with 501/16 and 420/40 bandpass excitation filters, and the corresponding yellow fluorescent protein (YFP) emission was acquired using a 530/35 bandpass emission filter. Spinning-disk images were acquired using a 4 \times \pm -1.5 \times objective on a Nikon Eclipse Ti microscope (Nikon Instruments, Melville, NY) equipped with an EvolveTM 512 EMCCD camera (Photometrics, Tucson, AZ). To calculate the HyPer ratio, images were treated as previously described (32).

Immunofluorescence and imaging

The fins were fixed in 4% paraformaldehyde overnight at 4°C and used for whole-mount immunohistochemistry with antiphospho-histone H3 (No. SC-8656-R; Santa Cruz Biotechnology, Inc., Dallas, TX) to detect proliferative cells, antiacetylated tubulin (No. T7451; Sigma-Aldrich, Saint Louis, MO) to detect axons, anti-GFP to detect GFP in

Shh:GFP fish (No. ab13970; Abcam, Cambridge, MA), anti-mCherry (No. 6332543; Clontech Laboratories, Inc., Mountain View, CA) to detect mRFP in sox10:RFP fish, and anti-Sox10 (No. GTX128374; GeneTex, Inc., Irvine, CA). The P-H3-positive cells were counted in ray and inter-ray two in all segments. Immunofluorescence images were acquired using an inverted Leica SP5 with a Leica PL APO 20 \times /N.A. = 0.7 oil immersion objective. For coimmunolabeling of Sox10 and HH-positive cells, the fins were snap-frozen in optimal cutting temperature compound and sectioned at 20 μ M with a cryomicrotome (No. HM560; Thermo Fisher Scientific, Waltham, MA).

Pharmacological treatments

A maximum of five adult fish were incubated in 200 ml of water for all pharmaceutical treatments. VAS-2870 (Nox-i) was purchased from Enzo Life Sciences (No. BML-EI395-0010; Enzo Life Sciences, Inc., Farmingdale, NY), and cyclopamine V (HH-i) (No. 239803) and Smo-A (No. 566660) were obtained from Calbiochem and H₂O₂ from Merck Millipore (Darmstadt, Germany). Fish incubated in dimethyl sulfoxide comprised the control group. The fish were maintained in the dark and returned to the light for 1 h per day for feeding and water change.

Statistical analysis

Continuous variables are expressed as the mean \pm standard error of the mean. Comparisons between multiple groups were performed using one-way analysis of variance, followed by Tukey's post-tests. Comparisons between the two groups were performed using Student's *t*-tests. *p* Values <0.05 were considered significant.

Acknowledgments

This work was performed in the Collège de France and benefited from Alain Prochiantz's constant support. The authors thank Matthieu Boukaissi and Tiphaine Vallée for technical assistance and Bruce Appel and Uwe Strähle for sharing the transgenic lines used in this work. The authors benefited from fruitful discussions with Alain Joliot and Piotr Topilko. This work was supported by the program "Investissements d'Avenir" launched by the French Government and implemented by the ANR, with the references ANR-10-LABX-54 MEMO LIFE—ANR-11-IDEX-0001-02 Paris sciences et Lettres (PSL) Research University.

Author Disclosure Statement

No competing financial interests exist.

References

- Bai H, Zhang W, Qin XJ, Zhang T, Wu H, Liu JZ, and Hai CX. Hydrogen peroxide modulates the proliferation/quiescence switch in the liver during embryonic development and post-hepatectomy regeneration. *Antioxid Redox Signal* 22: 921–937, 2015.
- Bauer G. Targeting extracellular ROS signaling of tumor cells. *Anticancer Res* 34: 1467–1482, 2014.
- Belousov VV, Fradkov AF, Lukyanov KA, Staroverov DB, Shakhbazov KS, Terskikh AV, and Lukyanov S. Genetically encoded fluorescent indicator for intracellular hydrogen peroxide. *Nat Methods* 3: 281–286, 2006.

4. Bigarella CL, Liang R, and Ghaffari S. Stem cells and the impact of ROS signaling. *Development* 141: 4206–4218, 2014.
5. Bovolenta P and Sanchez-Arrones L. Shh goes multidirectional in axon guidance. *Cell Res* 22: 611–613, 2012.
6. Briscoe J and Therond PP. The mechanisms of hedgehog signalling and its roles in development and disease. *Nat Rev Mol Cell Biol* 14: 416–429, 2013.
7. Brownell I, Guevara E, Bai CB, Loomis CA, and Joyner AL. Nerve-derived sonic hedgehog defines a niche for hair follicle stem cells capable of becoming epidermal stem cells. *Cell Stem Cell* 8: 552–565, 2011.
8. Calcutt NA, Allendoerfer KL, Mizisin AP, Middlemas A, Freshwater JD, Burgers M, Ranciato R, Delcroix JD, Taylor FR, Shapiro R, Strauch K, Dudek H, Engber TM, Galdes A, Rubin LL, and Tomlinson DR. Therapeutic efficacy of sonic hedgehog protein in experimental diabetic neuropathy. *J Clin Invest* 111: 507–514, 2003.
9. Carney TJ and Ingham PW. Drugging hedgehog: signaling the pathway to translation. *BMC Biol* 11: 37, 2013.
10. Chen ZL, Yu WM, and Strickland S. Peripheral regeneration. *Annu Rev Neurosci* 30: 209–233, 2007.
11. Covarrubias L, Hernandez-Garcia D, Schnabel D, Salas-Vidal E, and Castro-Obregon S. Function of reactive oxygen species during animal development: passive or active? *Dev Biol* 320: 1–11, 2008.
12. Delanian S, Lefaix JL, and Pradat PF. Radiation-induced neuropathy in cancer survivors. *Radiother Oncol* 105: 273–282, 2012.
13. Ertzer R, Muller F, Hadzhiev Y, Rathnam S, Fischer N, Ras-tegar S, and Strahle U. Cooperation of sonic hedgehog enhancers in midline expression. *Dev Biol* 301: 578–589, 2007.
14. Finkel T. Signal transduction by reactive oxygen species. *J Cell Biol* 194: 7–15, 2011.
15. Gauron C, Rampon C, Bouzaffour M, Ipendey E, Teillon J, Volovitch M, and Vriza S. Sustained production of ROS triggers compensatory proliferation and is required for regeneration to proceed. *Sci Rep* 3: 2084, 2013.
16. Geraudie J and Singer M. Necessity of an adequate nerve supply for regeneration of the amputated pectoral fin in the teleost *Fundulus*. *J Exp Zool* 234: 367–374, 1985.
17. Glenn TD and Talbot WS. Signals regulating myelination in peripheral nerves and the Schwann cell response to injury. *Curr Opin Neurobiol* 23: 1041–1048, 2013.
18. Gorrini C, Harris IS, and Mak TW. Modulation of oxidative stress as an anticancer strategy. *Nat Rev Drug Discov* 12: 931–947, 2013.
19. Hadzhiev Y, Lele Z, Schindler S, Wilson SW, Ahlberg P, Strahle U, and Muller F. Hedgehog signaling patterns the outgrowth of unpaired skeletal appendages in zebrafish. *BMC Dev Biol* 7: 75, 2007.
20. Han P, Zhou XH, Chang N, Xiao CL, Yan S, Ren H, Yang XZ, Zhang ML, Wu Q, Tang B, Diao JP, Zhu X, Zhang C, Li CY, Cheng H, and Xiong JW. Hydrogen peroxide primes heart regeneration with a derepression mechanism. *Cell Res* 24: 1091–1107, 2014.
21. Harsum S, Clarke JD, and Martin P. A reciprocal relationship between cutaneous nerves and repairing skin wounds in the developing chick embryo. *Dev Biol* 238: 27–39, 2001.
22. Hashimoto M, Ishii K, Nakamura Y, Watabe K, Kohsaka S, and Akazawa C. Neuroprotective effect of sonic hedgehog up-regulated in Schwann cells following sciatic nerve injury. *J Neurochem* 107: 918–927, 2008.
23. Jessen KR, Mirsky R, and Lloyd AC. Schwann cells: development and role in nerve repair. *Cold Spring Harb Perspect Biol* 7: a020487, 2015.
24. Kucenas S, Takada N, Park HC, Woodruff E, Broadie K, and Appel B. CNS-derived glia ensheath peripheral nerves and mediate motor root development. *Nat Neurosci* 11: 143–151, 2008.
25. Kumar A and Brockes JP. Nerve dependence in tissue, organ, and appendage regeneration. *Trends Neurosci* 35: 691–699, 2012.
26. Kumar A, Delgado JP, Gates PB, Neville G, Forge A, and Brockes JP. The aneurogenic limb identifies developmental cell interactions underlying vertebrate limb regeneration. *Proc Natl Acad Sci U S A* 108: 13588–13593, 2011.
27. Kumar A, Godwin JW, Gates PB, Garza-Garcia AA, and Brockes JP. Molecular basis for the nerve dependence of limb regeneration in an adult vertebrate. *Science* 318: 772–777, 2007.
28. Loo AE, Wong YT, Ho R, Wasser M, Du T, Ng WT, and Halliwell B. Effects of hydrogen peroxide on wound healing in mice in relation to oxidative damage. *PLoS One* 7: e49215, 2012.
29. Love NR, Chen Y, Ishibashi S, Kritsiligkou P, Lea R, Koh Y, Gallop JL, Dorey K, and Amaya E. Amputation-induced reactive oxygen species are required for successful *Xenopus* tadpole tail regeneration. *Nat Cell Biol* 15: 222–228, 2013.
30. Lu C, Schoenfeld R, Shan Y, Tsai HJ, Hammock B, and Cortopassi G. Frataxin deficiency induces Schwann cell inflammation and death. *Biochim Biophys Acta* 1792: 1052–1061, 2009.
31. Mirsky R and Jessen KR. The neurobiology of Schwann cells. *Brain Pathol* 9: 293–311, 1999.
32. Mishina NM, Markvicheva KN, Bilan DS, Matlashov ME, Shirmanova MV, Liebl D, Schultz C, Lukyanov S, and Belousov VV. Visualization of intracellular hydrogen peroxide with HyPer, a genetically encoded fluorescent probe. *Methods Enzymol* 526: 45–59, 2013.
33. Mosimann C, Kaufman CK, Li P, Pugach EK, Tamplin OJ, and Zon LI. Ubiquitous transgene expression and Cre-based recombination driven by the ubiquitin promoter in zebrafish. *Development* 138: 169–177, 2011.
34. Papanas N and Ziegler D. Efficacy of alpha-lipoic acid in diabetic neuropathy. *Expert Opin Pharmacother* 15: 2721–2731, 2014.
35. Parrinello S, Napoli I, Ribeiro S, Wingfield Digby P, Fedorova M, Parkinson DB, Doddrell RD, Nakayama M, Adams RH, and Lloyd AC. EphB signaling directs peripheral nerve regeneration through Sox2-dependent Schwann cell sorting. *Cell* 143: 145–155, 2010.
36. Petrova R and Joyner AL. Roles for hedgehog signaling in adult organ homeostasis and repair. *Development* 141: 3445–3457, 2014.
37. Pop-Busui R, Stevens MJ, Raffel DM, White EA, Mehta M, Plunkett CD, Brown MB, and Feldman EL. Effects of triple antioxidant therapy on measures of cardiovascular autonomic neuropathy and on myocardial blood flow in type 1 diabetes: a randomised controlled trial. *Diabetologia* 56: 1835–1844, 2013.
38. Poss KD, Keating MT, and Nechiporuk A. Tales of regeneration in zebrafish. *Dev Dyn* 226: 202–210, 2003.
39. Quint E, Smith A, Avaron F, Laforest L, Miles J, Gaffield W, and Akimenko MA. Bone patterning is altered in the regenerating zebrafish caudal fin after ectopic expression of

- sonic hedgehog and *bmp2b* or exposure to cyclopamine. *Proc Natl Acad Sci U S A* 99: 8713–8718, 2002.
40. Rampon C, Gauron C, Meda F, Volovitch M, and Vriza S. Adenosine enhances progenitor cell recruitment and nerve growth via its A2B receptor during adult fin regeneration. *Purinergic Signal* 10: 595–602, 2014.
 41. Reczek CR and Chandel NS. ROS-dependent signal transduction. *Curr Opin Cell Biol* 33: 8–13, 2015.
 42. Reimer MM, Kuscha V, Wyatt C, Sorensen I, Frank RE, Knuwer M, Becker T, and Becker CG. Sonic hedgehog is a polarized signal for motor neuron regeneration in adult zebrafish. *J Neurosci* 29: 15073–15082, 2009.
 43. Rhee SG. Cell signaling. H2O2, a necessary evil for cell signaling. *Science* 312: 1882–1883, 2006.
 44. Rieger S and Sagasti A. Hydrogen peroxide promotes injury-induced peripheral sensory axon regeneration in the zebrafish skin. *PLoS Biol* 9: e1000621, 2011.
 45. Sato K, Yama K, Murao Y, Tatsunami R, and Tampo Y. Epalrestat increases intracellular glutathione levels in Schwann cells through transcription regulation. *Redox Biol* 2: 15–21, 2013.
 46. Scheib J and Hoke A. Advances in peripheral nerve regeneration. *Nat Rev Neurol* 9: 668–676, 2013.
 47. Schieber M and Chandel NS. ROS function in redox signaling and oxidative stress. *Curr Biol* 24: R453–R462, 2014.
 48. Shan Y, Schoenfeld RA, Hayashi G, Napoli E, Akiyama T, Iodi Carstens M, Carstens EE, Pook MA, and Cortopassi GA. Frataxin deficiency leads to defects in expression of antioxidants and Nrf2 expression in dorsal root ganglia of the Friedreich's ataxia YG8R mouse model. *Antioxid Redox Signal* 19: 1481–1493, 2013.
 49. Sharghi-Namini S, Turmaine M, Meier C, Sahni V, Umehara F, Jessen KR, and Mirsky R. The structural and functional integrity of peripheral nerves depends on the glial-derived signal desert hedgehog. *J Neurosci* 26: 6364–6376, 2006.
 50. Singer M. Trophic functions of the neuron. VI. Other trophic systems. Neurotrophic control of limb regeneration in the newt. *Ann N Y Acad Sci* 228: 308–322, 1974.
 51. Sirko S, Behrendt G, Johansson PA, Tripathi P, Costa M, Bek S, Heinrich C, Tiedt S, Colak D, Dichgans M, Fischer IR, Plesnila N, Staufenbiel M, Haass C, Snapyan M, Saghatelyan A, Tsai LH, Fischer A, Grobe K, Dimou L, and Gotz M. Reactive glia in the injured brain acquire stem cell properties in response to sonic hedgehog. [corrected]. *Cell Stem Cell* 12: 426–439, 2013.
 52. Stelnicki EJ, Doolabh V, Lee S, Levis C, Baumann FG, Longaker MT, and Mackinnon S. Nerve dependency in scarless fetal wound healing. *Plast Reconstr Surg* 105: 140–147, 2000.
 53. Ushio-Fukai M and Rehman J. Redox and metabolic regulation of stem/progenitor cells and their niche. *Antioxid Redox Signal* 21: 1587–1590, 2014.
 54. van der Vliet A and Janssen-Heininger YM. Hydrogen peroxide as a damage signal in tissue injury and inflammation: murderer, mediator, or messenger? *J Cell Biochem* 115: 427–435, 2014.
 55. Wang J, Cao J, Dickson AL, and Poss KD. Epicardial regeneration is guided by cardiac outflow tract and Hedgehog signalling. *Nature* 522: 226–230, 2015.
 56. Watson JD. Type 2 diabetes as a redox disease. *Lancet* 383: 841–843, 2014.
 57. Yam PT and Charron F. Signaling mechanisms of non-conventional axon guidance cues: the Shh, BMP and Wnt morphogens. *Curr Opin Neurobiol* 23: 965–973, 2013.
 58. Ye ZW, Zhang J, Townsend DM, and Tew KD. Oxidative stress, redox regulation and diseases of cellular differentiation. *Biochim Biophys Acta* 1850: 1607–1621, 2014.
 59. Zenker J, Ziegler D, and Chrast R. Novel pathogenic pathways in diabetic neuropathy. *Trends Neurosci* 36: 439–449, 2013.
 60. Zhang J, Jeradi S, Strahle U, and Akimenko MA. Laser ablation of the sonic hedgehog-a-expressing cells during fin regeneration affects ray branching morphogenesis. *Dev Biol* 365: 424–433, 2012.
 61. Zhao H, Feng J, Seidel K, Shi S, Klein O, Sharpe P, and Chai Y. Secretion of shh by a neurovascular bundle niche supports mesenchymal stem cell homeostasis in the adult mouse incisor. *Cell Stem Cell* 14: 160–173, 2014.

Address correspondence to

Prof. Sophie Vriza

Centre Interdisciplinaire de Recherche en Biologie (CIRB)

CNRS UMR 7241/INSERM U1050/Collège de France

11, Place Marcelin Berthelot

75231 Paris

France

E-mail: vriza@univ-paris-diderot.fr

Date of first submission to ARS Central, May 15, 2015; date of final revised submission, September 17, 2015; date of acceptance, October 6, 2015.

Abbreviations Used

- AB-Tu = AB x Tübingen hybrid zebrafish line
 AGR2 = anterior gradient 2
 ANR = agence nationale de la recherche
 CCD = charged coupled device
 DCF = dichlorofluorescein
 Dhh = desert hedgehog gene
 DNA = deoxyribonucleic acid
 dpa = days postamputation
 GFP = green fluorescent protein
 H2DCFDA = 2',7'-dichlorodihydrofluorescein diacetate
 H₂O₂ = hydrogen peroxide
 HH = hedgehog protein
 HH-i = hedgehog inhibitor, cyclopamine
 hpa = hours postamputation
 hpl = hours postlesion
 HyPer = Hydrogen Peroxide sensor
 mRFP = monomeric red fluorescent protein
 N.A. = numeric aperture
 NADPH = reduced form of nicotinamide adenine dinucleotide phosphate
 nAG = newt anterior gradient
 Nox-i = VAS-2870
 P-H3 = phospho-histone H3
 ROS = reactive oxygen species
 SCs = Schwann cells
 SEM = standard error of the mean
 Shh = sonic hedgehog gene
 Smo-A = smoothed agonist
 Sox10 = SRY-related HMG-box 10
 VAS-2870 = pan-NADPH oxidase inhibitor

Supplementary Data

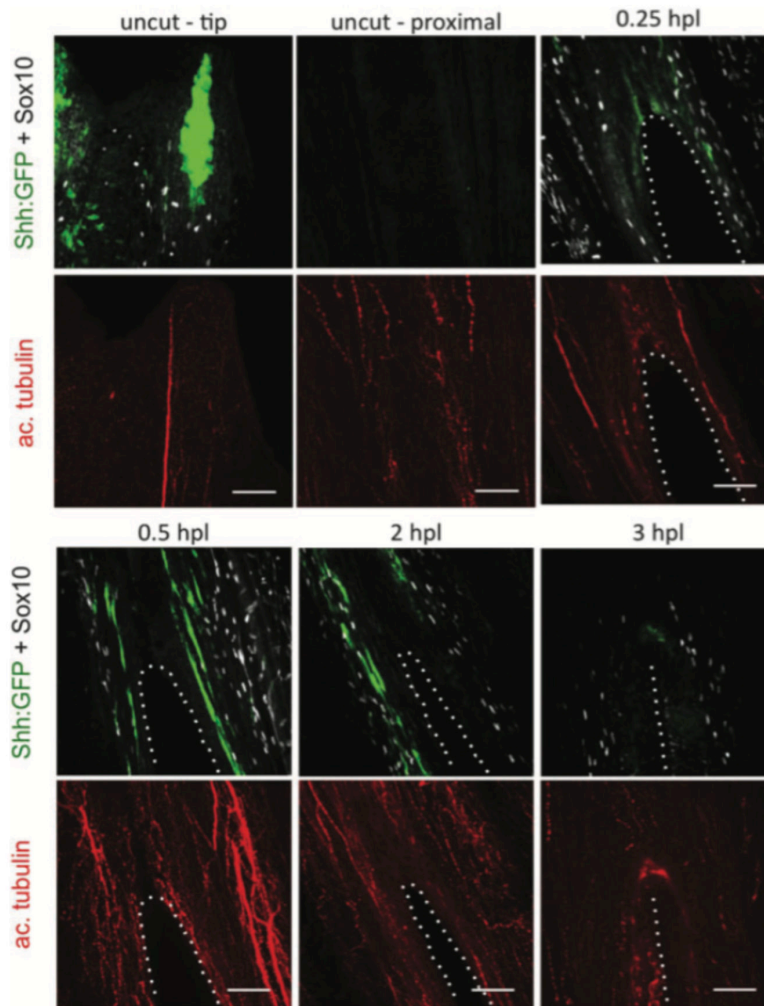

SUPPLEMENTARY FIG. S1. Sox10 and Shh are activated shortly after lesion. Immunofluorescence staining for immature SC marker, Sox10 (*white*), Shh-expressing cells (anti-GFP, Shh:GFP fish) (*green*), and the axonal marker, acetylated tubulin (*red*). A lesion was performed in between the rays. As soon as 0.25 hpl, Sox10-positive and Shh-expressing cells are detected surrounding the lesion. Once the wound is healed (3 hpl), Shh-expressing cells are no longer detectable, whereas several Sox10-positive cells continue to set along the wound. Scale bars = 50 μ M. *Dotted lines* represent the hole generated by the lesion. GFP, green fluorescent protein; hpl, hours postlesion; SC, Schwann cell.

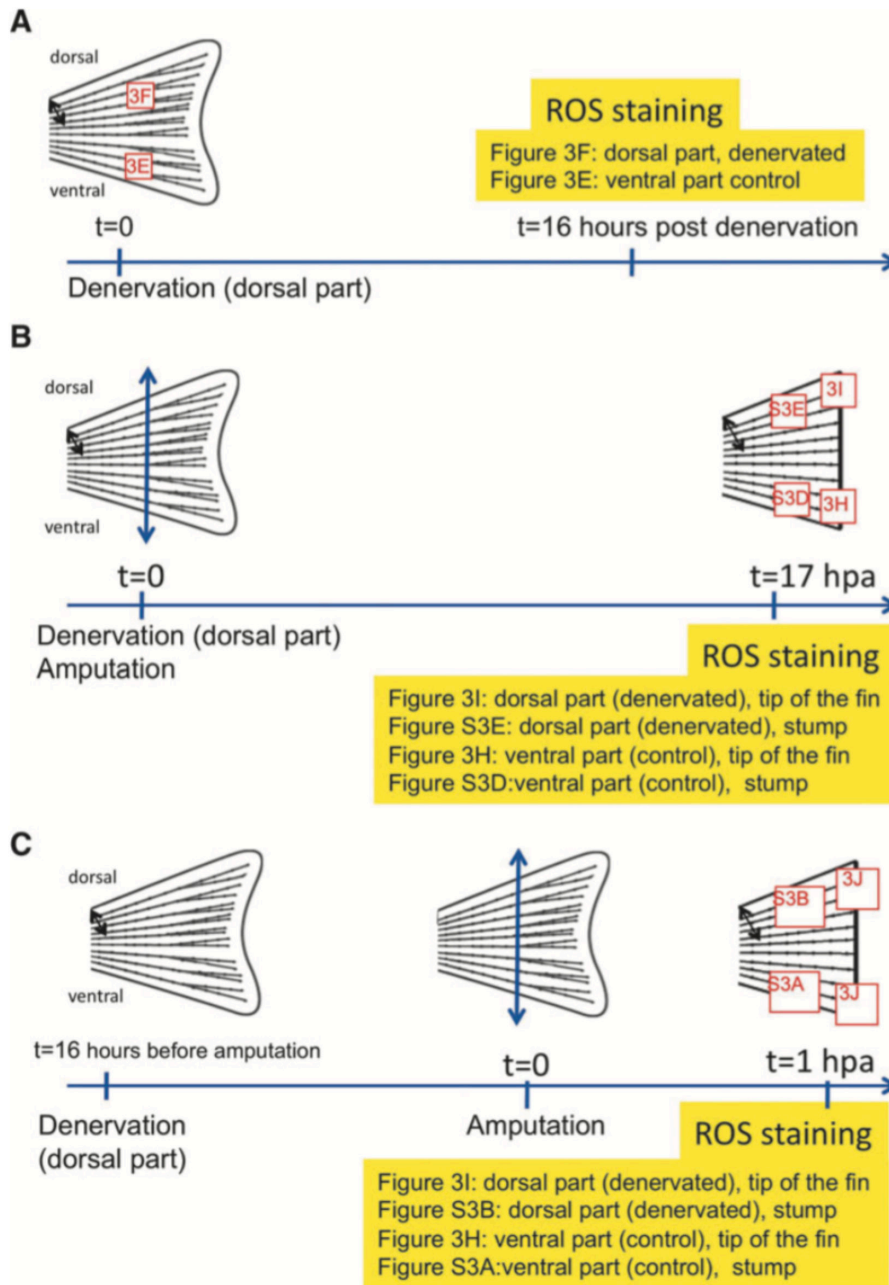

SUPPLEMENTARY FIG. S2. Schemes of the experiments presented in Figure 3 and Supplementary Figure S3. (A) Denervation without amputation; **(B)** Denervation and amputation at the same time. **(C)** Denervation 16 hours before amputation.

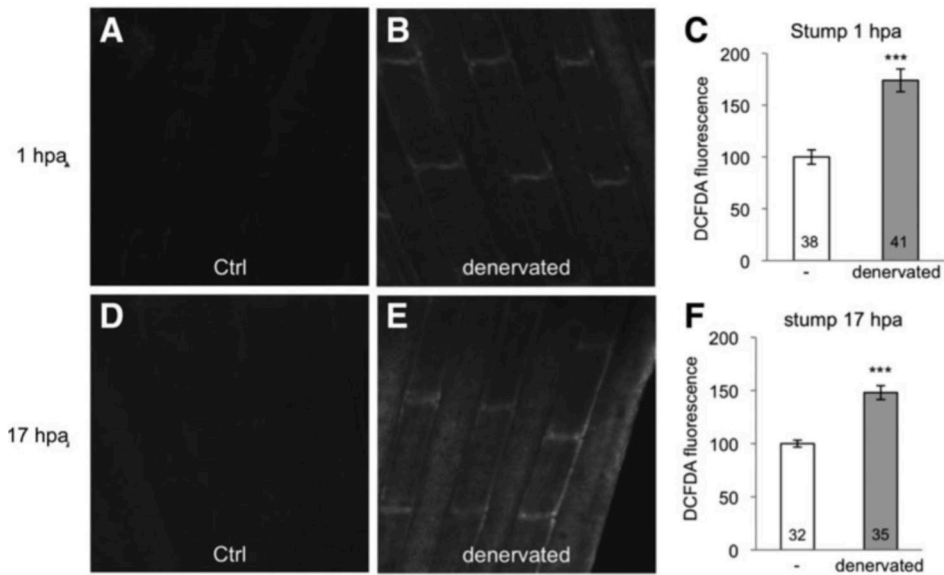

SUPPLEMENTARY FIG. S3. Denervation enhances ROS levels in the stump of amputated fins. The dorsal part of the caudal fin was denervated, and ROS were detected in the stump 1 hpa (A–C) or 17 hpa (D–F) in the denervated or control part. A scheme of the different conditions in which ROS have been measured is given in Supplementary Fig. S2. Error bars represent the SEM (** $p < 0.001$). hpa, hours postamputation; ROS, reactive oxygen species.

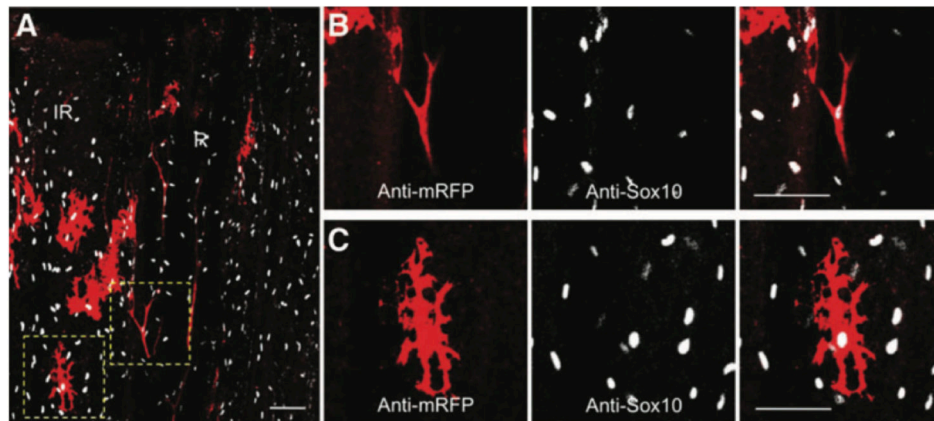

SUPPLEMENTARY FIG. S4. After amputation, Sox10 is detected in neural crest-derived cells (melanocytes and SCs). The caudal fin of a pigmented *sox10:mRFP* transgenic fish was amputated, and the samples were fixed at 0.5 hpa. (A) Immunofluorescence staining for RFP (*sox10:mRFP*) (red) and Sox10 (anti-Sox10) (white) was performed. (B, C) Magnifications of (A). (B) Colocalization of mRFP and Sox10 in an SC. (C) Colocalization of mRFP and Sox10 in a melanocyte. Confocal images 1–2 μM ; scale bar = 50 μM .

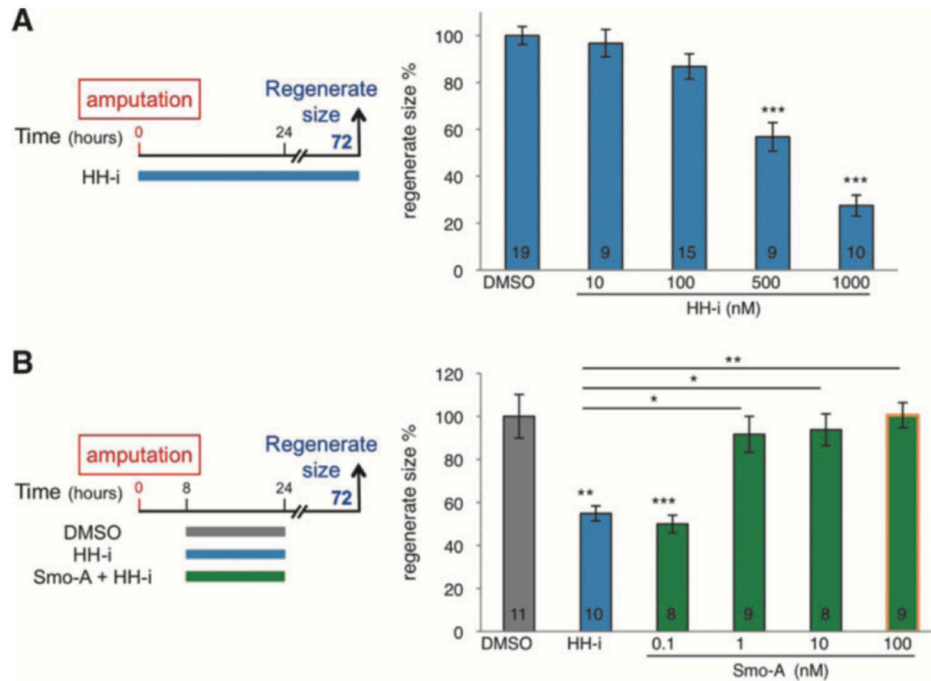

SUPPLEMENTARY FIG. S5. Cyclopamine (HH-i) and Smo-A dose response. (A) Cyclopamine (HH-i) dose response. (B) Smoothened agonist (Smo-A) dose response. Quantification of the size of the regenerate at 3 days postamputation. The efficiency of regeneration is expressed as a percentage of the control. Error bars represent the SEM (* $p < 0.05$; ** $p < 0.01$; *** $p < 0.001$). HH-I, hedgehog inhibitor, cyclopamine; Smo-A, smoothened agonist.

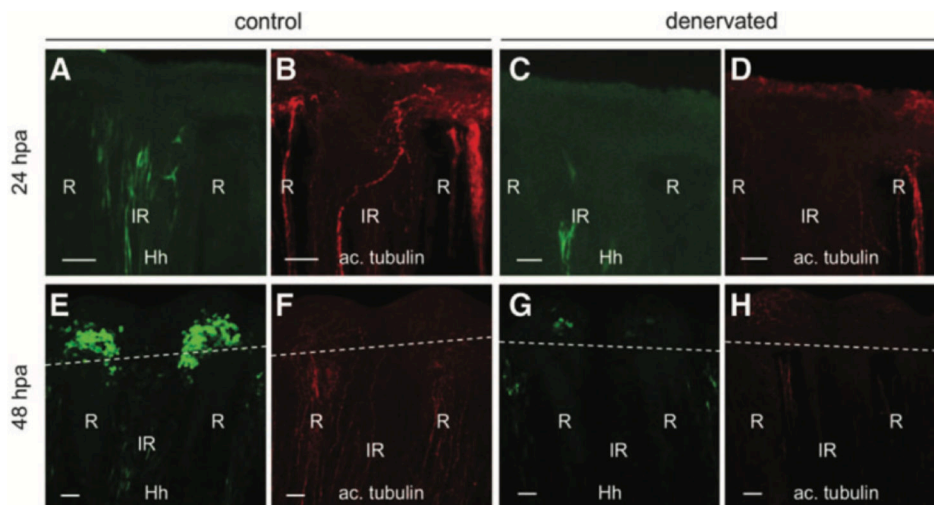

SUPPLEMENTARY FIG. S6. Shh-expressing cell behavior in the time course of regeneration after denervation. Immunofluorescence staining for GFP (shh:GFP) and axons (antiacetylated tubulin) in a control fin (A, B, E, F) and fin denervated in the dorsal part (C, D, G, H) at 24 hpa (A–D) or 48 hpa (E–H). Scale bars = 50 μM . R, ray; IR, inter-ray. Dashed line: amputation plane.

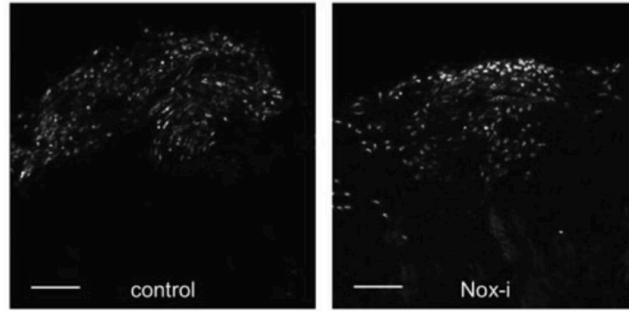

SUPPLEMENTARY FIG. S7. Superoxide detection with mitoSOX. Fish challenged to regenerate were incubated in mitoSOX with or without Nox-i and fluorescence detected at 17 hpa. Superoxides were detected at the level of the amputation plane. Inhibition of NADPH oxidase does not modify superoxide levels detected with mitoSOX. Scale bars = 50 μ M.

2.2. Hydrogen peroxide (H₂O₂) controls axon pathfinding during zebrafish development

Appendage and organ regeneration are often described as a replay of the developmental process. However, little is known regarding the levels of ROS and the functions of the ROS signaling in the embryo, although many factors that play essential roles during morphogenesis seem to be regulated by hydrogen peroxide (Covarrubias et al., 2008).

Another factor that plays a key role during morphogenesis is Shh. This factor has never been studied as a potential hydrogen peroxide target, even if the maturation of the active peptide depends on cysteine residues (Pepinsky et al., 1998; Resh, 2006; Varjosalo and Taipale, 2008).

In this work, therefore, we addressed the role of hydrogen peroxide during morphogenesis and, following our previous results obtained during adult regeneration, we focused on its impact on axonal growth and its relationship with Shh signaling.

We first developed a transgenic fish line expressing HyPer under a ubiquitous promoter to visualise hydrogen peroxide levels *in vivo*. We found that hydrogen peroxide levels are very variable also during development and that these levels are particularly high during the early developmental stages, in particular during somitogenesis and organogenesis, reaching the low values found in adults at the end of morphogenesis. Moreover, we demonstrated through pharmacological and biochemical approaches that the presence of hydrogen peroxide is controlled at the degradation step.

One of the regions that display particular high levels of hydrogen peroxide is the brain. We showed that here hydrogen peroxide participates in axonal guidance, as reduction of hydrogen peroxide levels impairs retinal ganglion cells axonal projections toward the tectum. Interestingly, this defect can be rescued by both exogenous application of hydrogen peroxide or activation of the Shh pathway.

Finally, results obtained through *ex vivo* experiments suggest that different hydrogen peroxide levels modify Shh secretion.

Altogether, these results suggest that hydrogen peroxide plays an essential developmental role during morphogenesis, regulating retinal ganglion cells axonal growth through modulation of Shh pathway, and also further strengthen the relationship observed in adult regeneration between hydrogen peroxide and Shh signaling.



ELSEVIER

Contents lists available at ScienceDirect

Developmental Biology

journal homepage: www.elsevier.com/locate/developmentalbiology

Hydrogen peroxide (H₂O₂) controls axon pathfinding during zebrafish development

Carole Gauron^{a,e}, Francesca Meda^{a,b,e}, Edmond Dupont^{a,e}, Shahad Albadri^{d,e},
Nicole Quenech'Du^{a,e}, Eliane Ipendey^{a,b,e}, Michel Volovitch^{a,b,e}, Filippo Del Bene^{d,e},
Alain Joliot^{a,e}, Christine Rampon^{a,c,e}, Sophie Vriz^{a,c,e,*}

^a Centre Interdisciplinaire de Recherche en Biologie (CIRB), CNRS UMR 7241/INSERM U1050/Collège de France, 11, Place Marcelin Berthelot, 75231 Paris Cedex 05, France

^b École Normale Supérieure, Institute of Biology at the Ecole Normale Supérieure (IBENS), CNRS UMR8197, INSERM U1024, F-75005 Paris, France

^c Université Paris Diderot, Sorbonne Paris Cité, Biology Department, 75205 Paris Cedex 13, France

^d Institut Curie CNRS UMR3215, INSERM U934, F-75248, France

^e PSL Research University, 75005 Paris, France

ARTICLE INFO

Article history:

Received 24 November 2015

Received in revised form

2 May 2016

Accepted 3 May 2016

Keywords:

Hydrogen peroxide

Axon pathfinding

Hedgehog

ABSTRACT

It is now becoming evident that hydrogen peroxide (H₂O₂), which is constantly produced by nearly all cells, contributes to *bona fide* physiological processes. However, little is known regarding the distribution and functions of H₂O₂ during embryonic development. To address this question, we used a dedicated genetic sensor and revealed a highly dynamic spatio-temporal pattern of H₂O₂ levels during zebrafish morphogenesis. The highest H₂O₂ levels are observed during somitogenesis and organogenesis, and these levels gradually decrease in the mature tissues. Biochemical and pharmacological approaches revealed that H₂O₂ distribution is mainly controlled by its enzymatic degradation. Here we show that H₂O₂ is enriched in different regions of the developing brain and demonstrate that it participates to axonal guidance. Retinal ganglion cell axonal projections are impaired upon H₂O₂ depletion and this defect is rescued by H₂O₂ or ectopic activation of the Hedgehog pathway. We further show that *ex vivo*, H₂O₂ directly modifies Hedgehog secretion. We propose that physiological levels of H₂O₂ regulate RGCs axonal growth through the modulation of Hedgehog pathway.

© 2016 Elsevier Inc. All rights reserved.

1. Introduction

Hydrogen peroxide (H₂O₂) has long been exclusively considered a deleterious molecule that damages cellular integrity and function. It is now becoming increasingly evident that H₂O₂ also contributes to *bona fide* physiological processes. It is known that H₂O₂ is an important mediator of cell proliferation and cell death, primarily through the regulation of MAP kinase activity (Ray et al., 2012). The potential H₂O₂ targets may include proteins that rely upon active cysteine because the oxidation status of this amino acid depends on the H₂O₂ levels (Finkel, 2011; Reczek and Chandel, 2015). H₂O₂ regulates several key signalling pathways that govern morphogenesis. Transcription factors are a class of proteins that are privileged targets of redox signalling (Galang and Hauser, 1993; Guo et al., 2004; Marinho et al., 2014; Suh et al., 1994; Wang

and Jin, 2010); another classical example is the Wnt pathway, which is suppressed upon binding of the reduced form of the antioxidant protein nucleoredoxin to a Wnt effector, Dishevelled (Funato et al., 2006). The Hedgehog protein has never been studied as a potential H₂O₂ target, although the maturation of the active Hedgehog peptide is cysteine-dependent (Hardy and Resh, 2012; Jeong and McMahon, 2002; Pepinsky et al., 1998).

Cellular redox homeostasis mediates a plethora of cellular pathways, as indicated by the roles of H₂O₂ in cell plasticity, tissue regeneration, wound healing and by the imbalance of reactive oxygen species homeostasis in aging and pathogenesis (e.g., tumourigenesis, autoimmunity, degenerative diseases, and diabetes) (Bigarella et al., 2014; Covarrubias et al., 2008; Rhee, 2006; Schieber and Chandel, 2014; van der Vliet and Janssen-Heininger, 2014; Watson, 2014). In particular, a transient elevation of H₂O₂ is necessary to induce regenerative programs (Bai et al., 2015; Gauron et al., 2013; Love et al., 2013; Meda et al., 2016; Pirote et al., 2015), enhance cell plasticity (Bigarella et al., 2014) and promote wound healing (Loo et al., 2012; Niethammer et al., 2009) as well as peripheral sensory axon growth after lesion (Meda et al., 2016; Rieger and Sagasti, 2011). Furthermore

* Corresponding author at: Centre Interdisciplinaire de Recherche en Biologie (CIRB), CNRS UMR 7241/INSERM U1050/Collège de France, 11, Place Marcelin Berthelot, 75231 Paris Cedex 05, France.

E-mail address: vriz@univ-paris-diderot.fr (S. Vriz).

it has been recently demonstrated that during zebrafish adult regeneration H_2O_2 controls Shh expression (Meda et al., 2016). Appendage and organ regeneration are often presented as a replay of developmental programs. However, little is known regarding the levels and functions of H_2O_2 during embryonic development, although it has been shown that H_2O_2 could regulate various factors that have a key role during morphogenesis (Covarrubias et al., 2008). We thus addressed the role of H_2O_2 during morphogenesis and more specifically its impact on axonal growth and its relationship with Shh signalling. We developed a transgenic zebrafish to measure H_2O_2 levels *in vivo*. Here, we show that the H_2O_2 levels are very high during early development and reach the low value found in adults after morphogenesis. Pharmacological and biochemical approaches demonstrate that the levels of H_2O_2 are controlled at the degradation step. Furthermore, a reduction of H_2O_2 levels impairs axon projections, and this phenotype can be rescued by Shh signalling. Finally *ex vivo* experiments demonstrate that H_2O_2 regulates Shh secretion. Altogether, our results reveals a key developmental role of H_2O_2 in regulating morphogenesis, and further strengthen the close relationship between H_2O_2 and Shh signalling pathways, as observed during regeneration in adult (Meda et al., 2016).

2. Materials and methods

2.1. Fish care

Zebrafish colonies (nacre strain) were maintained using standard methods. The animal facility obtained an agreement from the French Ministère de l'Agriculture (no. C75-05-12), and the protocols were approved by the Ministère de l'Education Nationale de l'Enseignement Supérieur et de la Recherche (00477.02). To maintain a healthy colony, a 14 h light to 10 h dark cycle was adopted, and a water temperature of 28 °C was maintained, with a maximal density of five fish per litre. Water filtration depended on the aquatic habitat stand-alone fish housing and was operated automatically (Aquatic Habitat Inc, FL, USA). The fish were fed twice a day with live 2-day-old paramecia.

2.2. Transgenic fish and HeLa cell lines

The coding sequence of HyPer (Belousov et al., 2006) was introduced into a vector suitable for fish transgenesis under an ubiquitous promoter (ubi) (Mosimann et al., 2011), and stable zebrafish lines with ubiquitous expression of the fluorescent protein were selected. Other transgenic lines were used in this study: mp311b:GFP (Xu et al., 2012); 2.4shh:GFP:ABC#15 (Ertzer et al., 2007); Islet:GFP (Higashijima et al., 2000); vmat2:GFP (Wen et al., 2008); p2rx:GFP (Kucenas et al., 2006). The HeLa-HyPer stable cell line in which HyPer expression is controlled by doxycycline was prepared using the HeLa Flp-In cell line that was kindly provided by Stephen Taylor (Tighe et al., 2008). Details of the cloning and transgenesis procedures are available upon request.

2.3. H_2O_2 detection with the HyPer probe

The F2 transgenic embryos or larvae were anesthetized in tricaine solution and embedded in low-melt agarose (0.8%). HyPer fluorescence was excited with 501/16 and 420/40 bandpass excitation filters, and the corresponding YFP emission was acquired using a 530/35 bandpass emission filter. Spinning-disk images were acquired using either a $4 \times \pm 1.5 \times$ objective for embryos and larvae or a $60 \times$ objective for the HeLa cells on a Nikon Eclipse Ti microscope (Nikon Instruments, Melville, NY, USA) equipped with an Evolve™ 512 EMCCD Camera (Photometrics, Tucson, AZ, USA). To calculate the HyPer ratio, the images were treated as

previously described (Mishina et al., 2013).

2.4. Detection of retinal ganglion cells (RGCs)

Retinotectal projections were visualized through DiO injection in the retina of 3 dpf fixed larvae, or RGCs were detected in the *pou4f3:GAL4, UAS:GAP-GFP* transgenic larvae via GFP expression at 3 dpf (Xiao and Baier, 2007). The images were acquired using a Leica SP5 microscope with a Leica PL APQ 25 \times and a 2 \times zoom (Leica Microsystems GmbH, Wetzlar, Germany). Neuron reconstruction and branch quantification were performed using the NeuroLucida/NeuroExplorer software (MBF Bioscience, Williston, VT, USA).

2.5. Superoxide dismutase and catalase activity

Catalase (CAT) and superoxide dismutase (SOD) activities were measured using commercially available kits (#707002 and #706002, respectively, Cayman Chemical, Ann Arbor, USA). For each time point, 30 frozen embryos or larvae were resuspended and sonicated with a bioruptor. The assay protocols were performed according to the manufacturer's instructions.

2.6. Pharmacological treatments

Embryos were incubated in VAS-2870 (Nox-i) (100 nM) from Enzo Life Sciences (# BML-EI395-0010, Enzo Life Science, Inc.; Farmingdale, NY, USA), cyclopamine V (HH-i) (20 μ M) (#239803, Merck Millipore; Darmstadt, Germany), a Smoothed agonist (Smo-A) (2.5 μ M) obtained from Calbiochem (#566660, Calbiochem, San Diego, CA, USA) or an equivalent amount of DMSO as a control.

2.7. Cell culture and transfection

Cell culture experiments were performed using HeLa cells grown in DMEM supplemented with 10% fetal bovine serum (FBS). For experiments involving the manipulation of H_2O_2 levels, the HeLa-HyPer cells were seeded on polyornithine-coated ibiTreat 8-well μ -slides (#80826, ibidi, Martinsried, Germany). HeLa cells transfected with Shh constructs (1 μ g of either mouse Shh, a kind gift of A. Ruiz i Altaba, Geneva CH, or mouse Shh::GFP, a kind gift of A.P. McMahon, Harvard USA, or secGFP using Lipofectamine 2000 transfection reagent, Life Technologies, according to the manufacturer's instructions) were grown at a starting density of 3×10^5 cells per well in 6-well culture dishes. After 24 h, the medium was replaced, and treatment was initiated by adding glucose oxidase (#G2133, Sigma-stock solution 100 U/ml diluted 1:1000 in the culture medium) for 1 h (HeLa-Hyper cells) or for 15, 30, or 60 min (Shh-expressing HeLa cells); alternatively, some cells were not treated. The HeLa-HyPer cells were then directly imaged (z-stack acquisition to detect the signal throughout the cell), and the Shh-transfected HeLa cells were incubated for 3 additional hours in DMEM without FBS. The medium was then harvested and centrifuged for 10 min at 14,000g. Proteins in the supernatant were precipitated with trichloroacetic acid (TCA) and re-suspended in Laemmli buffer. In parallel, cells were rinsed twice with phosphate-buffered saline (PBS) with Ca^{2+}/Mg^{2+} , directly lysed in Laemmli buffer, treated for 5 min at 85 °C and then centrifuged and frozen at -20 °C until the Western blot analysis was performed. Golgi and endoplasmic reticulum staining were performed with BODIPY™ TR Ceramide complexed to BSA or ER-Tracker™ Blue-White DPX (#B-34400 and #E12353, Molecular Probes™, ThermoFisher Scientific), respectively, following the manufacturer's instructions.

2.8. Western blotting and immunochemistry

All proteins were analyzed via 12% sodium dodecyl sulphate-polyacrylamide gel electrophoresis (SDS-PAGE) followed by Western blotting onto polyvinylidene difluoride (PVDF) membranes. The gels were stained with SYPRO orange as a loading control. Blotted proteins

were detected with anti-sonic Hedgehog antibodies (polyclonal rabbit IgG, ab#19897, Abcam, Cambridge, UK), followed by incubation with horseradish peroxidase (HRP)-conjugated anti-rabbit IgG (#NA934, GE Healthcare, Little Chalfont, UK) and subsequent chemiluminescence detection with the Super Signal West Femto substrate (#34095, Life Technologies, ThermoFisher Scientific Waltham, MA, USA) using a FUJI

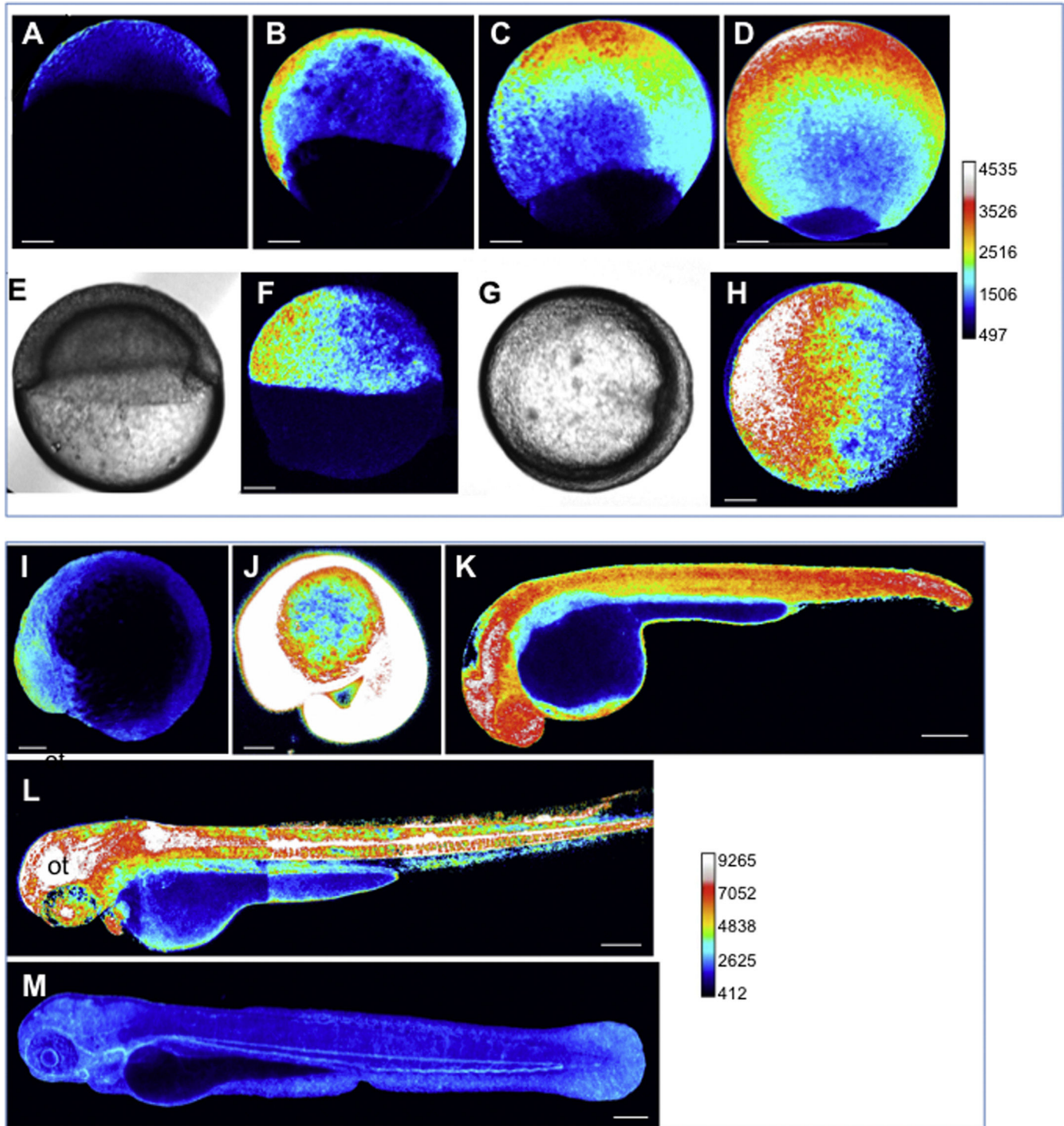

Fig. 1. Dynamics of the H₂O₂ levels during development. HyPer imaging in developing zebrafish embryos. The H₂O₂ levels are inferred from the YFP₅₀₀/YFP₄₂₀ excitation ratio of HyPer. (A) Blastula, (B–H) gastrulation. (E–H) During gastrulation, H₂O₂ is detected at the opposite side of the shield (E–H). (E, G) Bright-field images corresponding to F and H, respectively. (I) Early somitogenesis, (J) 20 somites (K) 30 hpf, (L) 48 hpf, (M) 72 hpf. Representative images are shown as lateral views, except for those in G–H (animal view). Pseudo-colour calibration bars: HyPer ratio (YFP₅₀₀/YFP₄₂₀). The bar common for A–H and the bar common for I–M allow the H₂O₂ levels in each group to be compared. Scale bars, 100 μm (A–J) and 200 μm (K–M). ot: optic tectum.

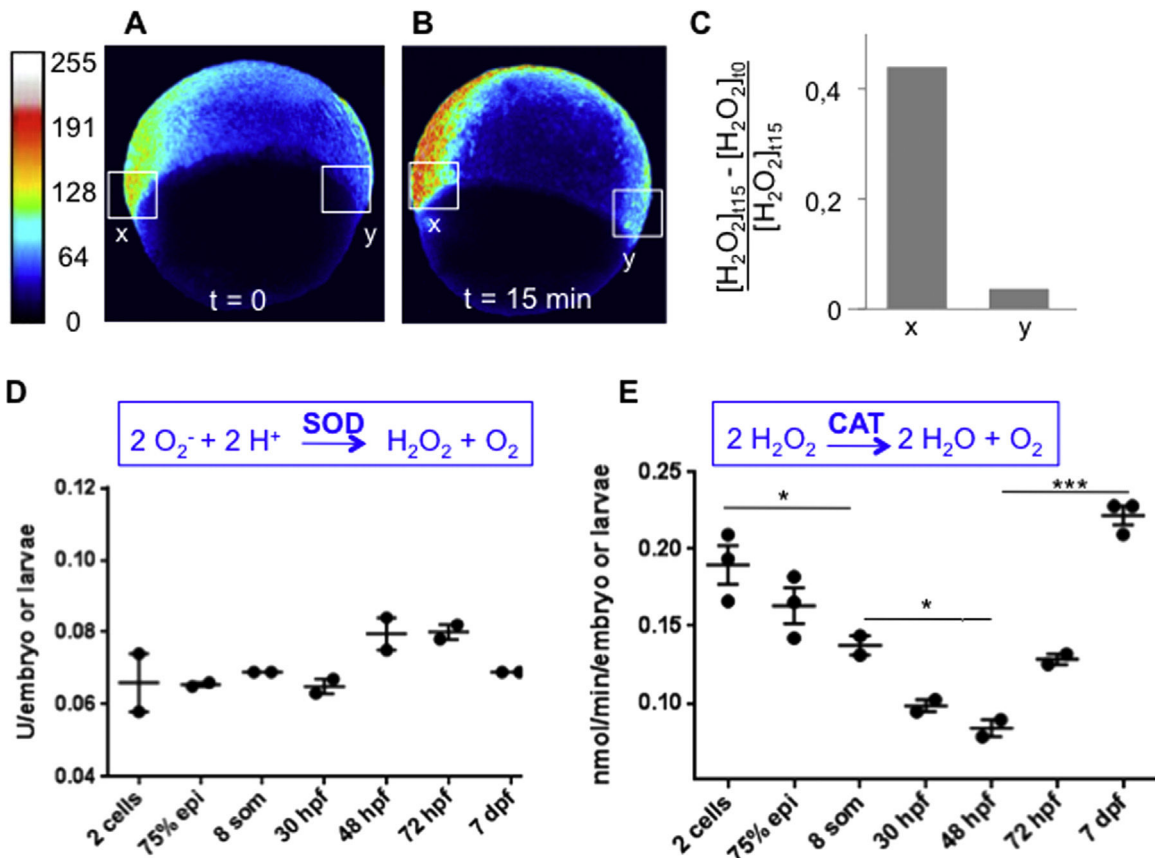

Fig. 2. The H_2O_2 levels are regulated at the degradation step. (A–C) HyPer imaging during gastrulation. The embryos were incubated in 1 mM H_2O_2 and the HyPer signal was measured prior to incubation and 15 min after the addition of H_2O_2 . Exogenous H_2O_2 enhanced the H_2O_2 signal in the tissues with high endogenous H_2O_2 levels (region x), but has a minimal, if any, effect on cells without H_2O_2 (region y). $n = 3$; representative lateral views are shown. (D) Superoxide dismutase (SOD) activity (E) and Catalase (CAT) activity during development. Legends: 75% epi = gastrulation, 8 som = somitogenesis. The error bars represent the standard error of the mean (SEM) (* $p < 0.05$; *** $p < 0.001$).

LAS-4000 imager (Fujifilm Corporation, Tokyo, Japan). Signal intensities were quantified with the FIDJI software. After normalization, the fraction of secreted Shh-Np was calculated for glucose oxidase-treated and untreated samples as $M/M+C$ (M and C were the normalized signals in the media and cells, respectively).

2.9. Catalase ISH

The *catalase* antisense probe was generated directly by a first detection PCR step using a total cDNA library extracted from zebrafish embryos of mixed stages and 5'-GGTCATCAGATACTGTCCGATCC-3' forward primer and 5'-GGCATGTTACTGGGATCAAACGCC-3' reverse primer followed by a second PCR using the generated purified PCR product as template and T7-tailed 5'-CCAAGCTTCTAATACGACTACTATAGGGAGAGGCATGTTACTGGGATCAAACGCC-3' reverse primer. Single probe *in situ* hybridization was done as previously described (Thisse and Thisse, 2008); with minor modifications. After fixation into a 4% PFA solution, embryos underwent a stepwise dehydration series into 100% Methanol and subsequent rehydration into 0.1% Tween20 in PBS. Permeabilization was achieved using age-dependent concentrations of proteinase K treatment at room temperature, followed by post-fixation in 4% PFA in PBS for 2 h. After prehybridization, hybridization with the *catalase* digoxigenin-UTP-labeled probe was performed overnight at 68 °C. The signal was detected with nitroblue tetrazolium chloride/5-bromo-4-chloro-3-indolyl-phosphate, toluidine salt (NBT/BCIP stock solution, Roche). After probe detection, embryos were fixed in 4% PFA and treated with 100% Methanol for clearance and transferred into 87% glycerol overnight. Image acquisition was performed using the Zeiss discovery V20 microscope, the Plan Apo S 1.0 × FWD 60 mm

objective and the Zen lite 2012 software for processing.

2.10. Statistical analysis

Continuous variables are expressed as the mean \pm SEM. Comparisons between multiple groups were performed *via* one-way analysis of variance (ANOVA) followed by Tukey's post-tests. Comparisons between two groups were performed using Student's *t*-test. P -values < 0.05 were considered to be statistically significant.

3. Results

3.1. Spatio-temporal dynamics of H_2O_2 during development

To assess the variations in H_2O_2 levels during development, we constructed a transgenic fish expressing a genetically encoded ratiometric probe (Belousov et al., 2006) under the control of an ubiquitous promoter (ubi:HyPer). H_2O_2 was first detected at the beginning of gastrulation on the side opposite to the shield (Fig. 1A–H). After gastrulation, the H_2O_2 levels increased dramatically during somitogenesis (Fig. 1J), particularly in the head and the tail (Fig. S1), and then decreased in most tissues (Fig. 1L and M), with the notable exceptions of the heart and neural tissues. At 48 hours post-fertilization (hpf), high H_2O_2 levels were detected in the optic tectum, the spinal cord and the notochord (Fig. 1L). At 72 hpf, most of the organs exhibited low levels of H_2O_2 (Figs. 1M and S1), which remained low in the adult (not shown).

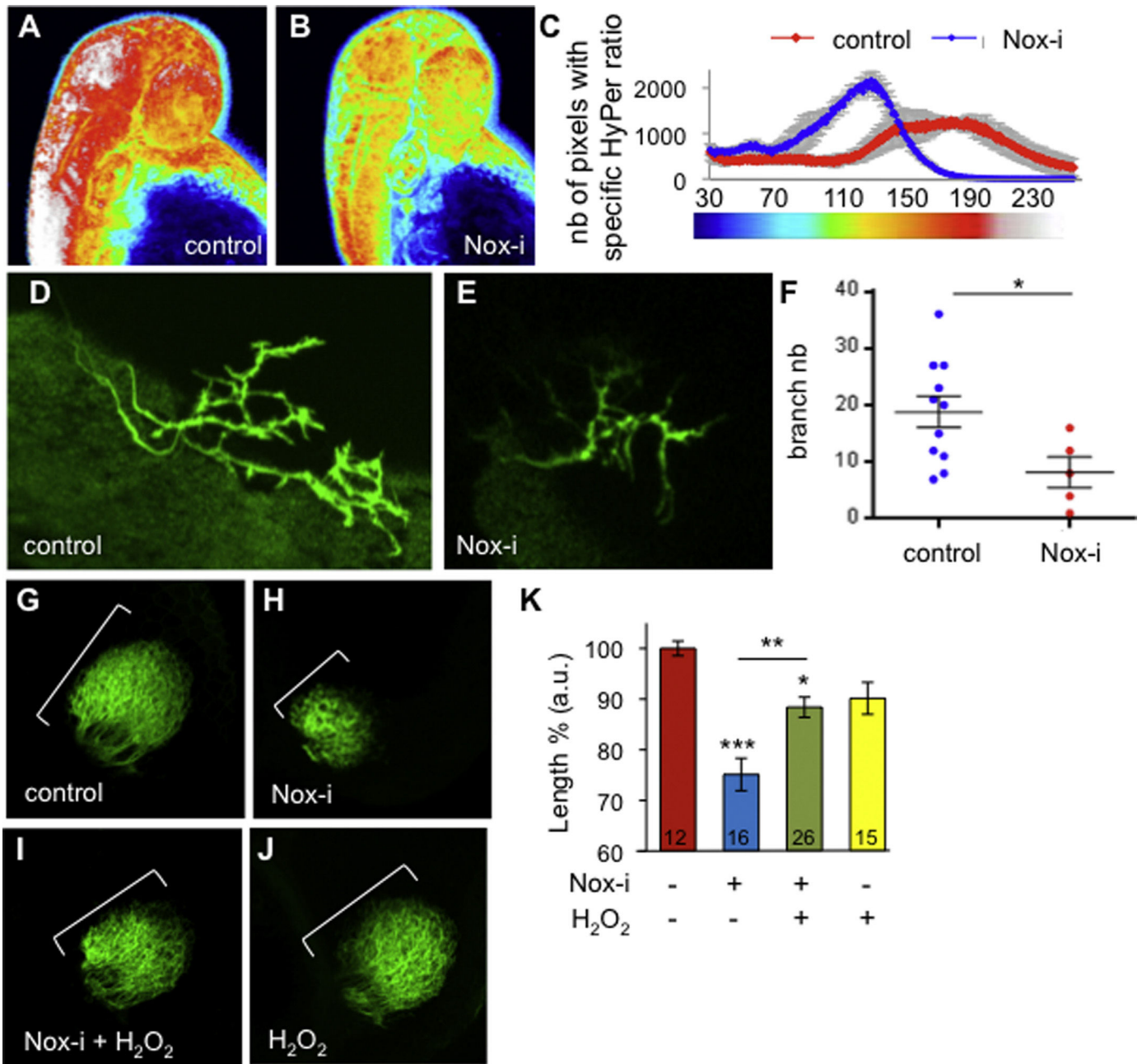

Fig. 3. A reduction of the H₂O₂ levels impairs the RGC projections. (A, B) HyPer imaging at 2 dpf in the control (n=3), or Nox-i-treated larvae (n=3). (C) Number of pixels corresponding to the pseudo-colour (HyPer ratio). (D–K) RGC arborization at 3 dpf in control embryos (D, G), embryos treated with Nox-i (E, H), Nox-i+H₂O₂ (I) or H₂O₂ (J) from 2 to 3 dpf. (D, E) GFP expression in the [pou4f3:GAL4, UAS:GAP-GFP] larvae with or without Nox-i treatment. (F) Branch number per axon in this transgenic line. (G–J) DiO RGC labelling at 3 dpf. The maximum length of the projections was quantified (K). The n values are indicated at the bottom of each column of the graph. Representative images are shown. The error bars represent the standard error of the mean (SEM) (*p < 0.05; ***p < 0.001).

3.2. H₂O₂ levels are regulated at the degradation step

Taking advantage of the HyPer sensor, we next assessed whether H₂O₂ homeostasis, which results from the balance between production and degradation, could be manipulated through pharmacological treatments. The embryos were bathed in 1 mM H₂O₂ and scored for the HyPer signal prior and 15 min after H₂O₂ treatment (Fig. 2A and B). The H₂O₂ levels were significantly increased (by approximately 40%) in regions harboring high endogenous H₂O₂ levels (region x) but remained unchanged in the ones devoid of endogenous H₂O₂ (region y) (Fig. 2C). This result suggests that the spatio-temporal control of H₂O₂ levels primarily depends on its degradation. To test this hypothesis we directly

measured the activity of enzymes involved in H₂O₂ homeostasis over time. We focused on the activities of two major players that control H₂O₂ levels, superoxide dismutase (H₂O₂ production) and catalase (H₂O₂ degradation). Superoxide dismutase activity remained stable throughout development (Fig. 2D). In contrast, low catalase activity was observed during morphogenesis, at the time of the highest H₂O₂ levels. Then, catalase activity increased after morphogenesis and reached a plateau comparable to the activity observed in adult tissues (Fig. 2E). The inverse correlation between catalase activity and H₂O₂ levels strongly suggests that the degradation activity predominantly regulates H₂O₂ homeostasis during development. We then used a pharmacological approach to reduce H₂O₂ levels. Embryos and larvae were incubated in a pan-

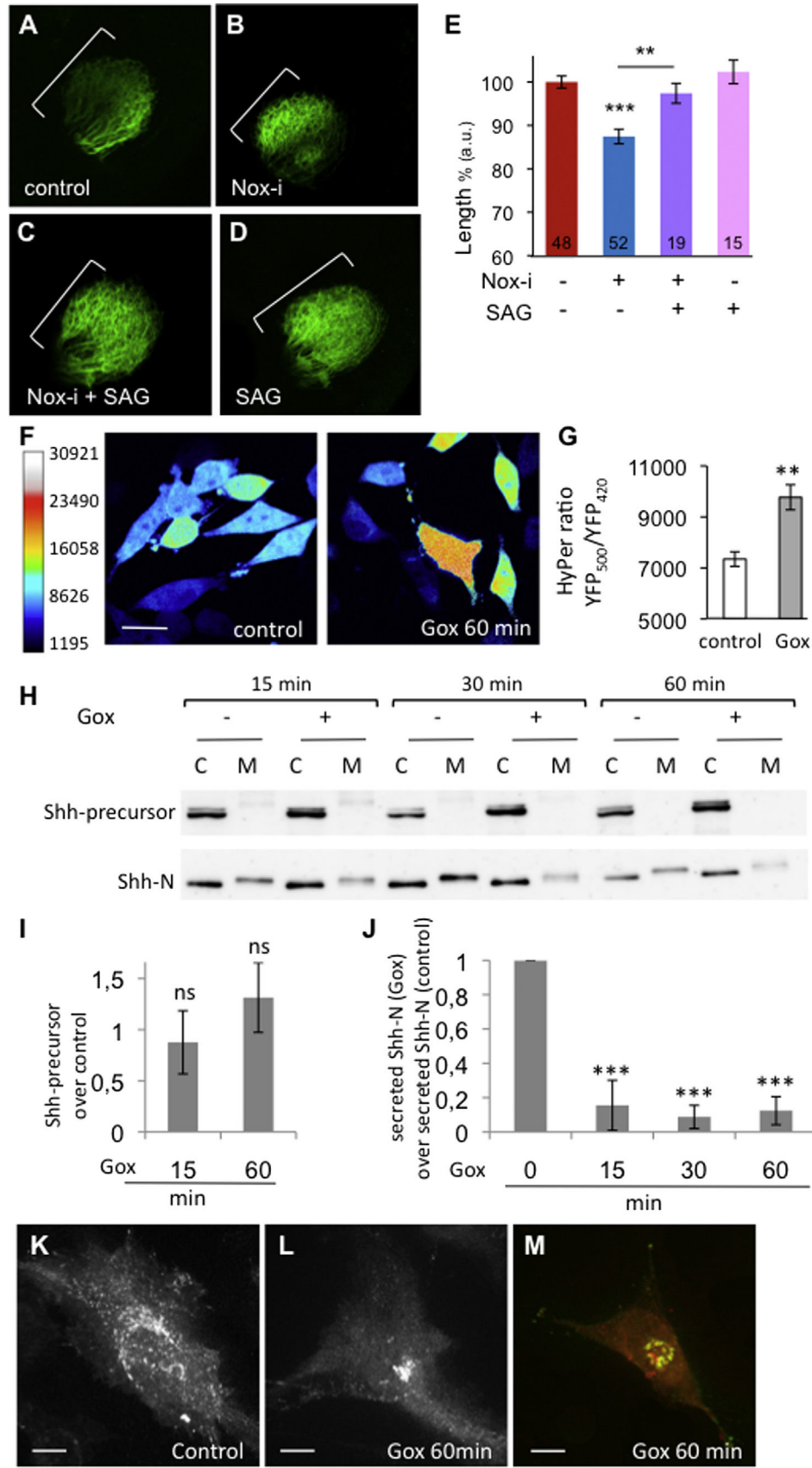

Fig. 4. H₂O₂ controls Shh secretion. (A–D) DiO RGC labelling at 3 dpf in control embryos (A), embryos treated with Nox-i (B), Nox-i+SAG (C) or SAG (D) from 2 to 3 dpf. The maximum length of the projections was quantified (E). The n values are indicated at the bottom of each column of the graph. Representative images are shown. (F) HyPer imaging in the glucose oxidase (Gox)-treated HeLa-HyPer cells. Scale bar, 20 μ m. (G) Quantification of the H₂O₂ levels in the control and glucose oxidase-treated HeLa-HyPer cells. Control: n=10; Gox: n=15. (H) Western blot analysis of Shh in the cell lysates (C) or culture medium (M) upon glucose oxidase treatment. (I) Quantification of the Shh precursor following Gox treatment. Shh-precursor (Gox)/Shh-precursor (control). (J) Quantification of the amount of N-terminal Shh peptide in the medium (cf Experimental Procedures) following Gox treatment. The quantifications were performed on 5 independent experiments; a representative western blot is shown in H. (K, L) Shh-GFP fluorescence subcellular distribution in control or Gox-treated cells. Scale bar, 10 μ m. (M) Shh-GFP (green) colocalized with the BODIPY TR ceramide Golgi marker (red) in Gox-treated cells. The error bars represent the standard error of the mean (SEM) (*p < 0.05; **p < 0.01; ***p < 0.001).

NADPH oxidase inhibitor (Nox-i) and global morphological defects were analyzed under a dissecting microscope or the patterns of selected GFP reporter transgenic lines (Figs. S2 and S3). Starting the treatment during gastrulation had no detectable effect (not shown). Moreover, H₂O₂ reduction between 10 and 24 hpf had no macroscopic effect and did not modify GFP expression in specific transgenic lines (mp311b:GFP (Xu et al., 2012); 2.4shh:GFP:ABC#15 (Ertzer et al., 2007); Islet:GFP (Higashijima et al., 2000)) (Fig. S2A–F). H₂O₂ reduction from 24 to 48 hpf had no or minor effects either, as seen using other transgenic lines (vmat2:GFP (Wen et al., 2008); p2rx:GFP (Kucenas et al., 2006)) (Fig. S3A–F). In summary, a reduction of H₂O₂ levels had no macroscopic effect during embryonic development.

3.3. Reduced H₂O₂ levels impair RGC projections

Due to the absence of obvious defects, we decided to target more specific processes. It has been shown recently that H₂O₂ enhances peripheral sensory axon growth in the wounded zebrafish larvae (Rieger and Sagasti, 2011) and during adult regeneration (Meda et al., 2016). Moreover, H₂O₂ levels remain surprisingly high in the nervous system over long periods in a territory with catalase expression that allows fine-tuning of H₂O₂ degradation (Fig. S6). This was particularly striking in the presumptive optic tectum at 2 days post-fertilization (see Fig. 1L), at the time when retinal ganglion cells (RGC) begin to project toward the tectum (Stuermer, 1988). We thus decided to assess whether H₂O₂ participate in axonal growth during embryogenesis. H₂O₂ levels were artificially reduced in larvae by incubating the embryos in a pan-NADPH oxidase inhibitor (Nox-i) beginning at 48 hpf (Fig. 3A–C) and the RGC axonal projections were scored at 3 dpf using two distinct approaches: (1) individual RGC axonal tracks were visualized using the pou4f3:GAL4, UAS:GAP-GFP transgenic line (Xiao and Baier, 2007), in which only a subset of RGCs are randomly labeled (Fig. 3D–F); (2) total RGC arborization was revealed by diocetadecyl-oxycarbocyanine (DiO) injections in the retina at 3 dpf (Fig. 3G–K). In both cases, the reduction of H₂O₂ levels decreased the length, branching and overall tectal projection of the RGC axons. We took advantage of the observation that bathing embryos in H₂O₂ enhanced H₂O₂ levels in specific areas (Fig. 2A–C) to try to rescue H₂O₂ levels in Nox-i treated larvae. Indeed following H₂O₂ treatment, RGC growth was rescued in Nox-i treated larvae (Fig. 3I and K). Therefore, we conclude that appropriate H₂O₂ levels are required for correct axon growth and guidance during normal development, as observed after lesion in adults.

Shh is directly involved in RGC projection to the tectum in *Xenopus* (Gordon et al., 2010) and plays multiple roles in RGC axonal development in mice (Sanchez-Camacho and Bovolenta, 2008). In addition, H₂O₂ activates Shh signalling during adult fin regeneration (Meda et al., 2016). We thus hypothesized that H₂O₂ could interfere with Shh activity. Shh signalling is involved in RGC progenitor proliferation before 46 hpf (Shkumatava et al., 2004). In addition Shh has a well established role in axon growth later in the development of the retinotectal system (Sanchez-Camacho and Bovolenta, 2008). To focus only on axon growth, Shh signalling and Nox activity were blocked after 48 hpf. We first verified that Hedgehog activity was also required for proper retinal projections in zebrafish (Fig. S4), similar to what occurs in other species. The inhibition of Hedgehog signalling with cyclopamine (HH-i) and pharmacological reduction of H₂O₂ levels induced strikingly similar phenotypes (compare Fig. S4B and Fig. 3H). Hence, we assessed whether H₂O₂ and Hedgehog signalling belong to a common pathway by testing the ability of a Hedgehog agonist to counteract the H₂O₂-dependent RGC axon growth defects. Larvae at 2 dpf were incubated with Nox-i in the presence of a Smoothed-receptor agonist (SAG) (Chen et al., 2002), and RGC

projections were analyzed 24 h later (Fig. 4A–E). SAG activation of the Hedgehog pathway fully rescued the RGC axon length defects induced by the reduction of H₂O₂ levels. These data suggest that H₂O₂ regulates the projection of RGCs to the tectum through Hedgehog signalling.

3.4. H₂O₂ controls Shh trafficking

Cysteine residues, which constitute the main target of redox signalling within proteins, are critical for producing the Shh signal, as they are first required for the processing of the active Hedgehog N-terminal peptide (Jeong and McMahon, 2002; Lee et al., 1994) and subsequently for the N-terminal palmitoylation that regulates its diffusion properties (Hardy and Resh, 2012; Pepinsky et al., 1998). To assess the impact of H₂O₂ levels on the distribution and processing of Shh, we first established a stable HeLa cell line expressing HyPer and defined the conditions that allow a non-toxic, sustained increase in H₂O₂ levels by adding glucose oxidase (Gox) in the culture medium (Marinho et al., 2013) (Fig. 4F and G). The kinetic of location and maturation of Shh was then monitored after Gox treatment (Fig. 4H–J). Increasing the intracellular concentrations of H₂O₂ had no significant effect on the pool of the Shh-precursor (Fig. 4H and I) but decreased the accumulation of the processed N-terminal Shh peptide in the medium (Fig. 4H and J). We conclude that increased H₂O₂ levels regulate the availability of the free extracellular active Shh peptide by decreasing its secretion or increasing its cell binding properties. To address this question, we directly visualized a Shh-GFP fusion protein (Chamberlain et al., 2008) in living cells. Increasing the intracellular concentration of H₂O₂ modified the intracellular distribution of the Shh-GFP protein, concentrating the cytoplasmic Shh-positive vesicles into juxta-nuclear clusters (Fig. 4K and L), which co-localized with the BODIPY TR ceramide Golgi marker (Fig. 4M). Importantly, the same treatment had no obvious effect on a control secreted GFP (secGFP) (Fig. S5). The intracellular redistribution of Shh-GFP suggests that H₂O₂ primarily acts on the early phase of the intracellular journey of Shh and not on the extracellular pool.

4. Discussion

The production of H₂O₂ at the time of fertilization was described more than a century ago by Otto Warburg, and for many years, was attributed to an increase in respiration, reflecting the transition from a quiescent egg to an active zygote (reviewed in Finkel (2011)). It has been demonstrated only recently that this burst of H₂O₂ is due to a NADPH-dependent oxidase activity (Wong et al., 2004). Our study reveals a highly dynamic pattern of H₂O₂ levels throughout embryonic development and morphogenesis in zebrafish corroborating observations made in a non-vertebrate model, *Caenorhabditis elegans* where H₂O₂ levels are high during morphogenesis and drop off in adult (Knoefler et al., 2012). The source of H₂O₂ during morphogenesis remain unknown as it could be attributed to mitochondrial and/or membrane-bound NADPH-oxidase activity (Covarrubias et al., 2008) and can vary in space and time. In the developing nervous system, it is likely dependent on NADPH-oxidase activity, because H₂O₂ levels are efficiently reduced by a pan-Nox inhibitor. However, we cannot exclude that mitochondrial source of H₂O₂ contribute to H₂O₂ production at specific stages.

Our results indicate that H₂O₂ accumulation is controlled at the degradation level. Indeed, it is almost impossible to increase H₂O₂ levels in territories with low levels of H₂O₂ during morphogenesis. We found that the Catalase activity measured in total embryos is inversely correlated with the H₂O₂ levels. We wondered whether these changes in catalase activity over time were reflected by its

spatial distribution. Since it was not possible to reveal catalase activity *in situ*, we analyzed catalase expression by *in situ* hybridization. In fact, catalase mRNA is not uniformly distributed over the embryo but, it is more abundant in the anterior region, where H₂O₂ reaches high level (Fig. S6). The simplest explanation is that the protein is predominantly expressed in the brain where fine-tuning of H₂O₂ degradation is the most important, and that its activity is dynamically regulated by still unknown ways. Along with catalase, several other proteins likely contribute to H₂O₂ degradation, and their functional redundancy could account for the viability of their individual gain- and loss-of-function mutants (Hernandez-Garcia et al., 2010). After lesion, H₂O₂ attracts the lesioned axons and participates in their regeneration (Meda et al., 2016; Rieger and Sagasti, 2011). We demonstrate here that H₂O₂ has a similar action on axon growth during development and thus participate to the formation of the neuronal network, at least in the tectum. Whether this property of H₂O₂ can be generalized to other territories remains an open question, both in normal and pathological development. Conversely, it has been recently demonstrated that sensory neurons themselves modulates redox levels in both normal and injured adult tissues (Meda et al., 2016). The identification of this feedback loop during development may offer a tractable mechanism to understand the relationship between axon and tissue growth.

Searching for H₂O₂ molecular effectors, we show that intracellular trafficking of Shh is sensitive to physiological H₂O₂ levels variations. Further experiments will be needed to identify which step (or steps) is directly targeted by H₂O₂, taking into account the complexity of Shh processing and journey, which are still highly debated (reviews in Guerrero and Kornberg (2014) and Therond (2012)). For instance, lipid modifications of Shh appear more sophisticated than previously thought and can clearly influence the intracellular distribution of Shh (Long et al., 2015), but it is worth noting that they all depends on cysteines residues, which are likely targets of H₂O₂. Indeed other signalling pathways are or could be sensitive to H₂O₂ levels variation: several protein tyrosine kinases and phosphatases involved in growth factor response are sensitive to intracellular redox states, which is also the case for several transcription factors of the Pax, Hox and POU families; on the other hand, integrin-mediated cell adhesion is also sensitive to ROS, and Wnt signalling is controlled by Nr_x, a Trx-related protein {Covarrubias, 2008 #458}.

Taken together, our results support a role for H₂O₂ in the growth of RGC projections to the tectum *via* the regulation of Hedgehog protein trafficking. Our results reveal a new link between two key regulatory pathways, Hedgehog and redox signalling. Shh signalling has a central role in multiple aspects of embryonic development and in various human pathologies, such as degenerative diseases, cancer and autoimmunity (reviews in Briscoe and Therond (2013), Carney and Ingham (2013) and Petrova and Joyner (2014)), in which the balance between oxidants and anti-oxidants is often perturbed (van der Vliet and Janssen-Heininger, 2014; Ye et al., 2014). Our results not only uncover the link between H₂O₂ and Hedgehog signalling in the context of axon growth but also suggest a new strategy to target pathological actions of Hedgehog signalling by the pharmacological modulation of H₂O₂ levels.

Acknowledgements

This work was performed at the Collège de France and benefited from Alain Prochiantz's constant support. The authors thank Matthieu Boukaissi for technical assistance and Thomas Oliver Auer and Philippe Mailyly for their technical advice. The authors are

grateful to Stephen Taylor (University of Manchester) for providing the HeLa Flp-In cell and to Ariel Ruiz i Altaba (Université de Genève, CH) for providing mouse Shh and mouse Shh::GFP expressing plasmids, the second one being derived from an original construct from Andrew McMahon's laboratory (Harvard, USA). We are also grateful to Jean-Paul Concordet (Muséum National d'Histoire Naturelle, Paris) for stimulating discussions. This work received support under the program "Investissements d'Avenir" launched by the French Government and implemented by the ANR with the following references: ANR-10-LABX-54 MEMO LIFE-ANR-11-IDEX-0001-02 PSL* Research University.

Appendix A. Supplementary material

Supplementary data associated with this article can be found in the online version at <http://dx.doi.org/10.1016/j.ydbio.2016.05.004>.

References

- Bai, H., Zhang, W., Qin, X.J., Zhang, T., Wu, H., Liu, J.Z., Hai, C.X., 2015. Hydrogen peroxide modulates the proliferation/quiescence switch in the liver during embryonic development and posthepatectomy regeneration. *Antioxid. Redox Signal.* 22, 921–937.
- Belousov, V.V., Fradkov, A.F., Lukyanov, K.A., Staroverov, D.B., Shakhbazov, K.S., Terskikh, A.V., Lukyanov, S., 2006. Genetically encoded fluorescent indicator for intracellular hydrogen peroxide. *Nat. Methods* 3, 281–286.
- Bigarella, C.L., Liang, R., Ghaffari, S., 2014. Stem cells and the impact of ROS signaling. *Development* 141, 4206–4218.
- Briscoe, J., Therond, P.P., 2013. The mechanisms of Hedgehog signalling and its roles in development and disease. *Nat. Rev. Mol. Cell Biol.* 14, 416–429.
- Carney, T.J., Ingham, P.W., 2013. Drugging Hedgehog: signaling the pathway to translation. *BMC Biol.* 11, 37.
- Chamberlain, C.E., Jeong, J., Guo, C., Allen, B.L., McMahon, A.P., 2008. Notochord-derived Shh concentrates in close association with the apically positioned basal body in neural target cells and forms a dynamic gradient during neural patterning. *Development* 135, 1097–1106.
- Chen, J.K., Taipale, J., Young, K.E., Maiti, T., Beachy, P.A., 2002. Small molecule modulation of smoothened activity. *Proc. Natl. Acad. Sci. USA* 99, 14071–14076.
- Covarrubias, L., Hernandez-Garcia, D., Schnabel, D., Salas-Vidal, E., Castro-Obregon, S., 2008. Function of reactive oxygen species during animal development: passive or active? *Dev. Biol.* 320, 1–11.
- Ertzer, R., Muller, F., Hadzhiev, Y., Rathnam, S., Fischer, N., Rastegar, S., Strahle, U., 2007. Cooperation of sonic hedgehog enhancers in midline expression. *Dev. Biol.* 301, 578–589.
- Finkel, T., 2011. Signal transduction by reactive oxygen species. *J. Cell Biol.* 194, 7–15.
- Funato, Y., Michiue, T., Asashima, M., Miki, H., 2006. The thioredoxin-related redox-regulating protein nucleoredoxin inhibits Wnt-beta-catenin signalling through dishevelled. *Nat. Cell Biol.* 8, 501–508.
- Galang, C.K., Hauser, C.A., 1993. Cooperative DNA binding of the human HoxB5 (Hox-2.1) protein is under redox regulation *in vitro*. *Mol. Cell Biol.* 13, 4609–4617.
- Gauron, C., Rampon, C., Bouzaffour, M., Ipendey, E., Teillon, J., Volovitch, M., Vriza, S., 2013. Sustained production of ROS triggers compensatory proliferation and is required for regeneration to proceed. *Sci. Rep.* 3, 2084.
- Gordon, L., Mansh, M., Kinsman, H., Morris, A.R., 2010. Xenopus sonic hedgehog guides retinal axons along the optic tract. *Dev. Dyn.* 239, 2921–2932.
- Guerrero, I., Kornberg, T.B., 2014. Hedgehog and its circuitous journey from producing to target cells. *Semin. Cell Dev. Biol.* 33, 52–62.
- Guo, Y., Einhorn, L., Kelley, M., Hirota, K., Yodoi, J., Reinbold, R., Scholer, H., Ramsey, H., Hromas, R., 2004. Redox regulation of the embryonic stem cell transcription factor oct-4 by thioredoxin. *Stem Cells* 22, 259–264.
- Hardy, R.Y., Resh, M.D., 2012. Identification of N-terminal residues of Sonic Hedgehog important for palmitoylation by Hedgehog acyltransferase. *J. Biol. Chem.* 287, 42881–42889.
- Hernandez-Garcia, D., Wood, C.D., Castro-Obregon, S., Covarrubias, L., 2010. Reactive oxygen species: a radical role in development? *Free Radic. Biol. Med.* 49, 130–143.
- Higashijima, S., Hotta, Y., Okamoto, H., 2000. Visualization of cranial motor neurons in live transgenic zebrafish expressing green fluorescent protein under the control of the islet-1 promoter/enhancer. *J. Neurosci.* 20, 206–218.
- Jeong, J., McMahon, A.P., 2002. Cholesterol modification of Hedgehog family proteins. *J. Clin. Investig.* 110, 591–596.
- Knoefler, D., Thamsen, M., Konieczek, M., Niemuth, N.J., Diederich, A.K., Jakob, U., 2012. Quantitative *in vivo* redox sensors uncover oxidative stress as an early event in life. *Mol. Cell* 47, 767–776.
- Kucenas, S., Soto, F., Cox, J.A., Voigt, M.M., 2006. Selective labeling of central and

- peripheral sensory neurons in the developing zebrafish using P2X(3) receptor subunit transgenes. *Neuroscience* 138, 641–652.
- Lee, J.J., Ekker, S.C., Vonkessler, D.P., Porter, J.A., Sun, B.I., Beachy, P.A., 1994. Autoproteolysis in Hedgehog protein biogenesis. *Science* 266, 1528–1537.
- Long, J., Tokhunts, R., Old, W.M., Houel, S., Rodrigue-Blanco, J., Singh, S., Schilling, N., Capobianco, A.J., Ahn, N.G., Robbins, D.J., 2015. Identification of a family of fatty-acid-speciated sonic hedgehog proteins, whose members display differential biological properties. *Cell Rep.* 10, 1280–1287.
- Loo, A.E., Wong, Y.T., Ho, R., Wasser, M., Du, T., Ng, W.T., Halliwell, B., 2012. Effects of hydrogen peroxide on wound healing in mice in relation to oxidative damage. *PLoS One* 7, e49215.
- Love, N.R., Chen, Y., Ishibashi, S., Kritsiligkou, P., Lea, R., Koh, Y., Gallop, J.L., Dorey, K., Amaya, E., 2013. Amputation-induced reactive oxygen species are required for successful *Xenopus* tadpole tail regeneration. *Nat. Cell Biol.* 15, 222–228.
- Marinho, H.S., Cyrne, L., Cadenas, E., Antunes, F., 2013. H₂O₂ delivery to cells: steady-state versus bolus addition. *Methods Enzymol.* 526, 159–173.
- Marinho, H.S., Real, C., Cyrne, L., Soares, H., Antunes, F., 2014. Hydrogen peroxide sensing, signaling and regulation of transcription factors. *Redox Biol.* 2, 535–562.
- Meda, F., Gauron, C., Rampon, C., Teillon, J., Volovitch, M., Vríz, S., 2016. Nerves control Redox level in mature tissues through Schwann cells and Hedgehog signaling. *Antioxid. Redox Signal.* 24, 299–311.
- Mishina, N.M., Markvicheva, K.N., Bilan, D.S., Matlashov, M.E., Shirmanova, M.V., Liebl, D., Schultz, C., Lukyanov, S., Belousov, V.V., 2013. Visualization of intracellular hydrogen peroxide with HyPer, a genetically encoded fluorescent probe. *Methods Enzymol.* 526, 45–59.
- Mosimann, C., Kaufman, C.K., Li, P., Pugach, E.K., Tamplin, O.J., Zon, L.I., 2011. Ubiquitous transgene expression and Cre-based recombination driven by the ubiquitin promoter in zebrafish. *Development* 138, 169–177.
- Niethammer, P., Grabher, C., Look, A.T., Mitchison, T.J., 2009. A tissue-scale gradient of hydrogen peroxide mediates rapid wound detection in zebrafish. *Nature* 459, 996–999.
- Pepinsky, R.B., Zeng, C.H., Wen, D.Y., Rayhorn, P., Baker, D.P., Williams, K.P., Bixler, S.A., Ambrose, C.M., Garber, E.A., Miatkowski, K., Taylor, F.R., Wang, E.A., Galdes, A., 1998. Identification of a palmitic acid-modified form of human Sonic hedgehog. *J. Biol. Chem.* 273, 14037–14045.
- Petrova, R., Joyner, A.L., 2014. Roles for Hedgehog signaling in adult organ homeostasis and repair. *Development* 141, 3445–3457.
- Pirotte, N., Stevens, A.S., Fraguas, S., Plusquin, M., Van Roten, A., Van Belleghem, F., Paesen, R., Ameloot, M., Cebria, F., Artois, T., Smeets, K., 2015. Reactive oxygen species in planarian regeneration: an upstream necessity for correct patterning and brain formation. *Oxid. Med. Cell Longev.* 2015, 392476.
- Ray, P.D., Huang, B.W., Tsuji, Y., 2012. Reactive oxygen species (ROS) homeostasis and redox regulation in cellular signaling. *Cell Signal* 24, 981–990.
- Reczek, C.R., Chandel, N.S., 2015. ROS-dependent signal transduction. *Curr. Opin. Cell Biol.* 33, 8–13.
- Rhee, S.G., 2006. Cell signaling. H₂O₂, a necessary evil for cell signaling. *Science* 312, 1882–1883.
- Rieger, S., Sagasti, A., 2011. Hydrogen peroxide promotes injury-induced peripheral sensory axon regeneration in the zebrafish skin. *PLoS Biol.* 9, e1000621.
- Sanchez-Camacho, C., Bovolenta, P., 2008. Autonomous and non-autonomous Shh signalling mediate the in vivo growth and guidance of mouse retinal ganglion cell axons. *Development* 135, 3531–3541.
- Schieber, M., Chandel, N.S., 2014. ROS function in redox signaling and oxidative stress. *Curr. Biol.* 24, R453–R462.
- Shkumatava, A., Fischer, S., Müller, F., Strahle, U., Neumann, C.J., 2004. Sonic hedgehog, secreted by amacrine cells, acts as a short-range signal to direct differentiation and lamination in the zebrafish retina. *Development* 131, 3849–3858.
- Stuermer, C.A., 1988. Retinotopic organization of the developing retinotectal projection in the zebrafish embryo. *J. Neurosci.* 8, 4513–4530.
- Suh, E., Chen, L., Taylor, J., Traber, P.G., 1994. A homeodomain protein related to caudal regulates intestine-specific gene transcription. *Mol. Cell Biol.* 14, 7340–7351.
- Therond, P.P., 2012. Release and transportation of Hedgehog molecules. *Curr. Opin. Cell Biol.* 24, 173–180.
- Thisse, C., Thisse, B., 2008. High-resolution in situ hybridization to whole-mount zebrafish embryos. *Nat. Protoc.* 3, 59–69.
- Tighe, A., Staples, O., Taylor, S., 2008. Mps1 kinase activity restrains anaphase during an unperturbed mitosis and targets Mad2 to kinetochores. *J. Cell Biol.* 181, 893–901.
- van der Vliet, A., Janssen-Heininger, Y.M., 2014. Hydrogen peroxide as a damage signal in tissue injury and inflammation: murderer, mediator, or messenger? *J. Cell Biochem.* 115, 427–435.
- Wang, P., Jin, T., 2010. Hydrogen peroxide stimulates nuclear import of the POU homeodomain protein Oct-1 and its repressive effect on the expression of Cdx-2. *BMC Cell Biol.* 11, 56.
- Watson, J.D., 2014. Type 2 diabetes as a redox disease. *Lancet* 383, 841–843.
- Wen, L., Wei, W., Gu, W., Huang, P., Ren, X., Zhang, Z., Zhu, Z., Lin, S., Zhang, B., 2008. Visualization of monoaminergic neurons and neurotoxicity of MPTP in live transgenic zebrafish. *Dev. Biol.* 314, 84–92.
- Wong, J.L., Creton, R., Wessel, G.M., 2004. The oxidative burst at fertilization is dependent upon activation of the dual oxidase Udx1. *Dev. Cell* 7, 801–814.
- Xiao, T., Baier, H., 2007. Lamina-specific axonal projections in the zebrafish tectum require the type IV collagen Dragnet. *Nat. Neurosci.* 10, 1529–1537.
- Xu, L., Feng, Z., Sinha, D., Ducos, B., Ebenstein, Y., Tadmor, A.D., Gauron, C., Le Saux, T., Lin, S., Weiss, S., Vríz, S., Jullien, L., Bensimon, D., 2012. Spatiotemporal manipulation of retinoic acid activity in zebrafish hindbrain development via photo-isomerization. *Development* 139, 3355–3362.
- Ye, Z.W., Zhang, J., Townsend, D.M., Tew, K.D., 2014. Oxidative stress, redox regulation and diseases of cellular differentiation. *Biochim. Biophys. Acta* 1850, 1607–1621.

Supplementary Figures

Figure S1: HyPer imaging in developing zebrafish embryos (20 somites) and larvae (3dpf).

The H_2O_2 levels are inferred from the $\text{YFP}_{500}/\text{YFP}_{420}$ excitation ratio of HyPer. The calibration bar has been changed compared to Figure 1 to avoid signal saturation (**A**) or to be more informative for low levels of H_2O_2 (**B**).

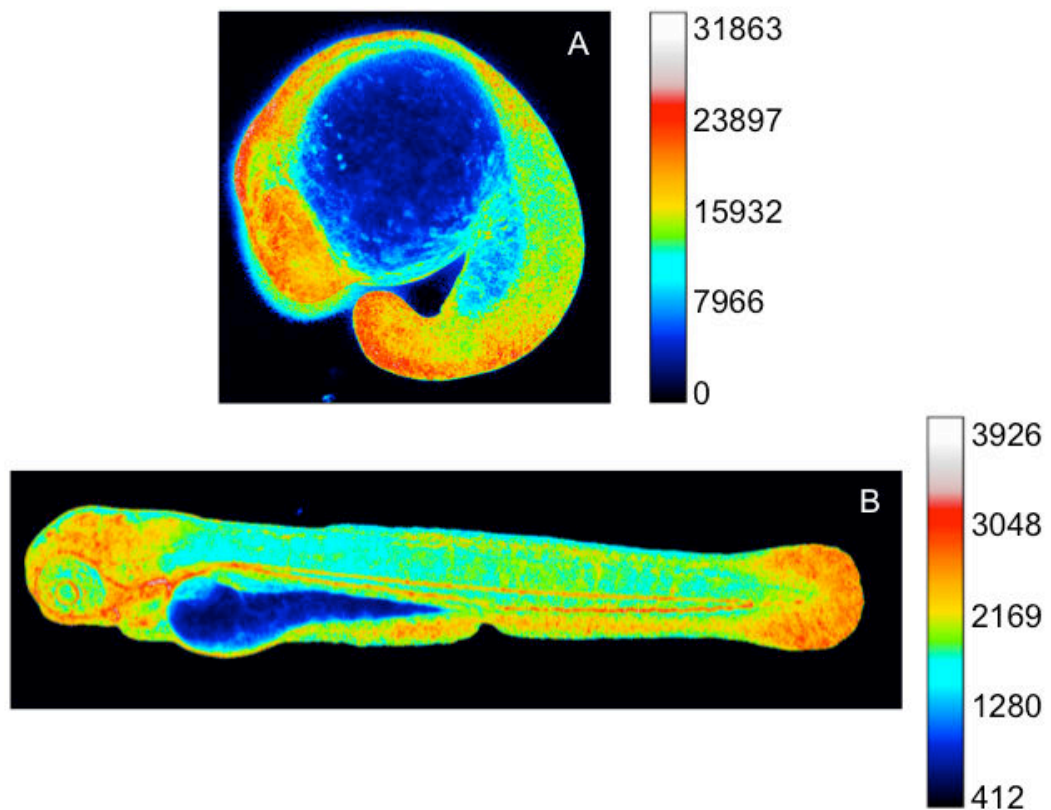

Figure S2: GFP expression pattern at 24 hpf in different transgenic lines upon Nox-i treatment.

Embryos were incubated in 100 nM Nox-i or DMSO (control) from bud to 24 hpf. Rhombomeres 3 and 5 (R3 and R5) were visualized in mp311b:GFP (**A-B**); notochord in 2.4shh:GFP:ABC#15 (**C-D**); lateral line in islet:GFP (**E-F** and higher magnification in **E'** and **F'**). n indicates the notochord in **C** and v the vitellus in **E-F'**.

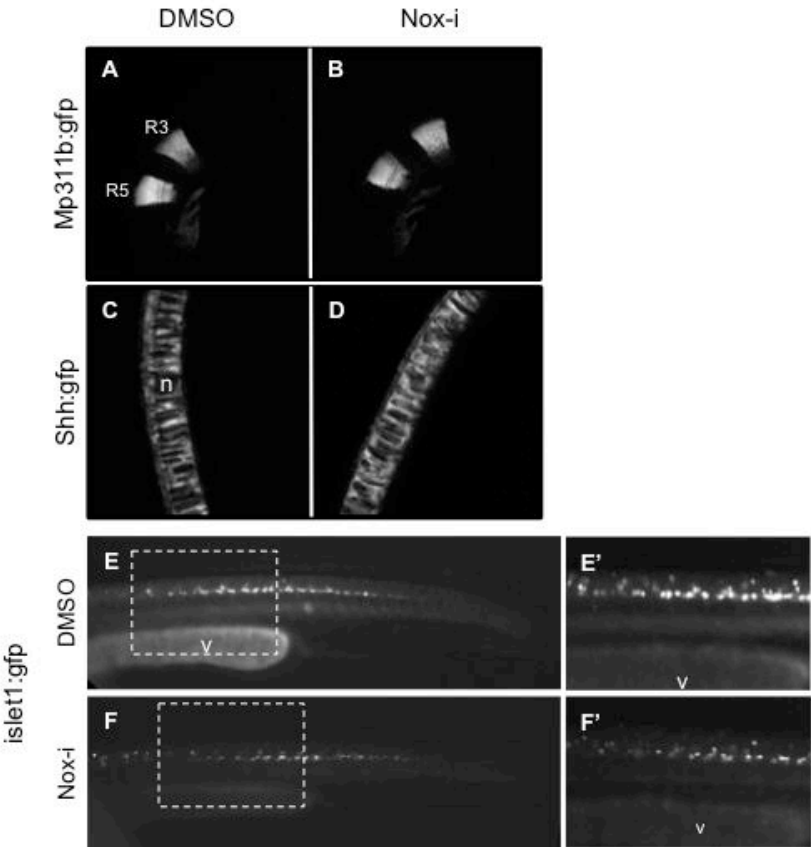

Figure S3: GFP expression pattern at 48 hpf in different transgenic lines upon Nox-i treatment.

Embryos were incubated in 100 nM Nox-i or DMSO (control) from 24 hpf to 48 hpf. Monoaminergic neurons were visualized at 48 hpf in *vmat2:GFP* larvae (**A-B**). Dorsal views with the anterior part on the right. GFP positive neurons in the locus coeruleus (LC) (**C**) or GFP positive sympathetic neurons (Sym) (**D**) were counted. No significant differences were observed. Peripheral and central sensory neurons were detected in *p2rx:GFP* larvae at 48 hpf (**E-F**). Lateral views with the anterior part on the right. The *triangle* marks the sensory afferent of *gVII*; *asterisk* marks the afferent projection of *gIX*. The *dotted line* indicates the margins of the eye, *gV* trigeminal ganglia, *gVII* facial ganglia, *gIX* glossopharyngeal ganglia, *gX* vagal ganglia.

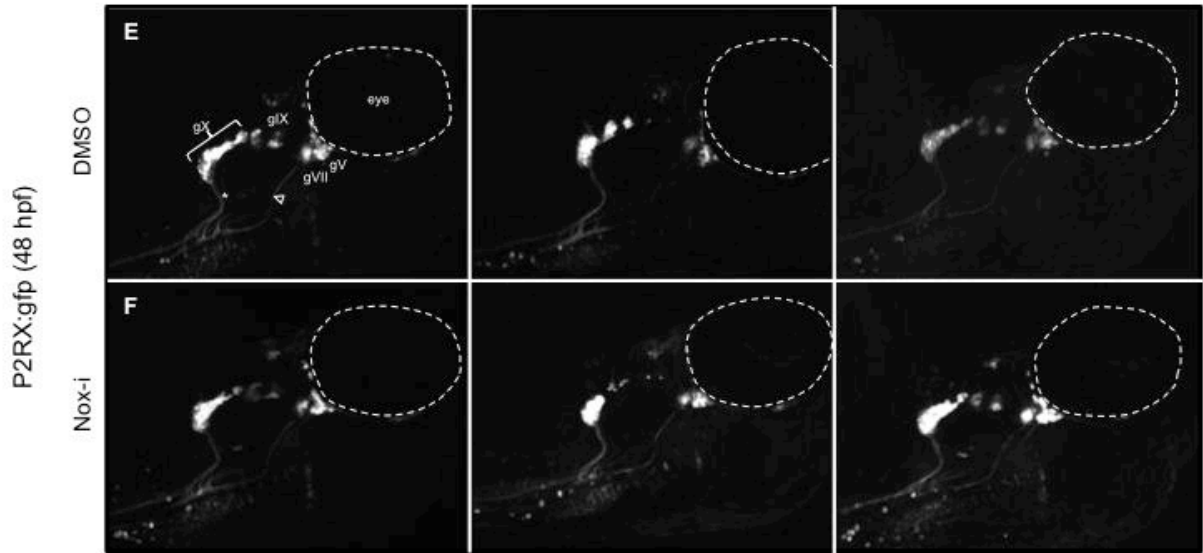
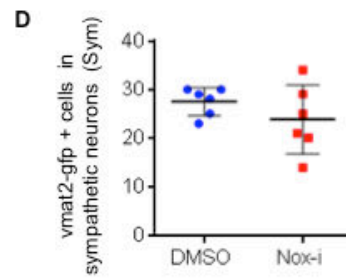
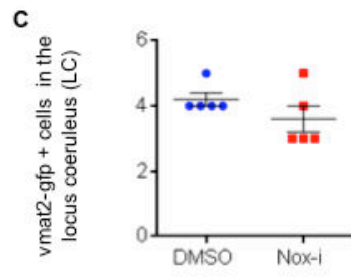
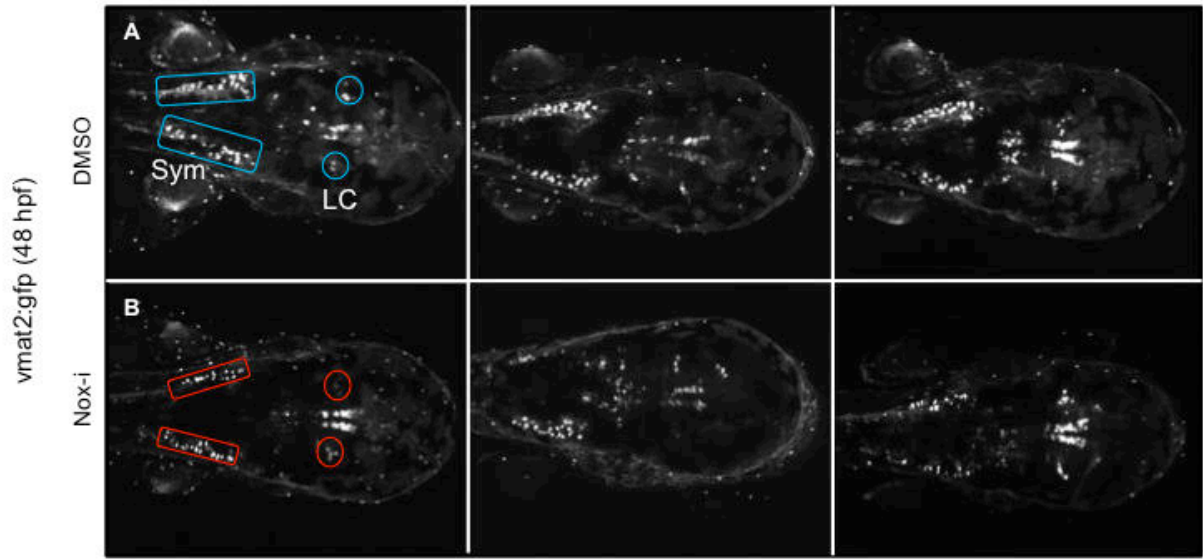

Figure S4: RGC projections upon cyclopamine treatment.

The retinotectal projections were visualized via DiO injection in the retinas of fixed 3 dpf larvae. RGC arborization in the controls (**A**) and in embryos treated with cyclopamine (HH-i) (**B**). The maximum length of the projections was quantified (**C**). The n values are indicated at the bottom of each column of the graph. Representative images are shown. The errors bars represent the SEM ($***p < 0.001$).

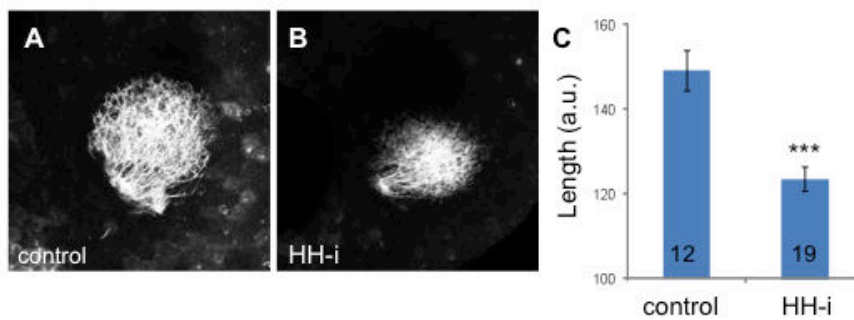

Figure S5: Secretion of secGFP and Shh in control and Gox-treated cells.

(A) Western blot analysis of Shh and secGFP in the cell lysates (C) or culture medium (M) upon glucose oxidase treatment. (B) Quantification of the amount of N-terminal Shh peptide or the secGFP in the medium following 15 minutes glucose oxidase treatment (Gox). The quantification was performed on 4 independent experiments; a representative western blot is shown in (A). The errors bars represent the SEM.

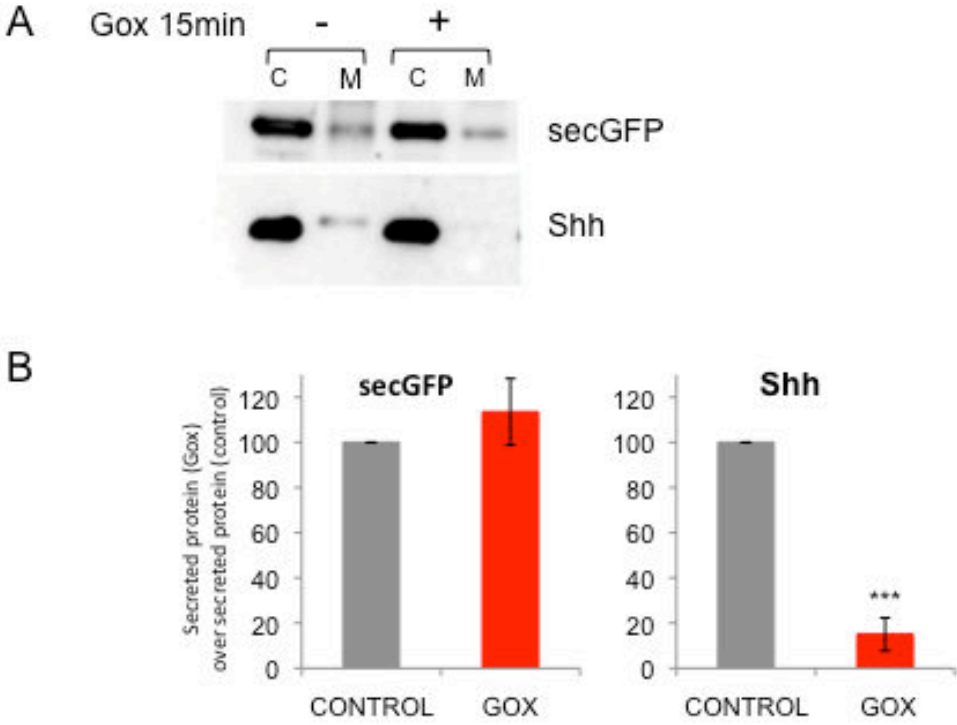
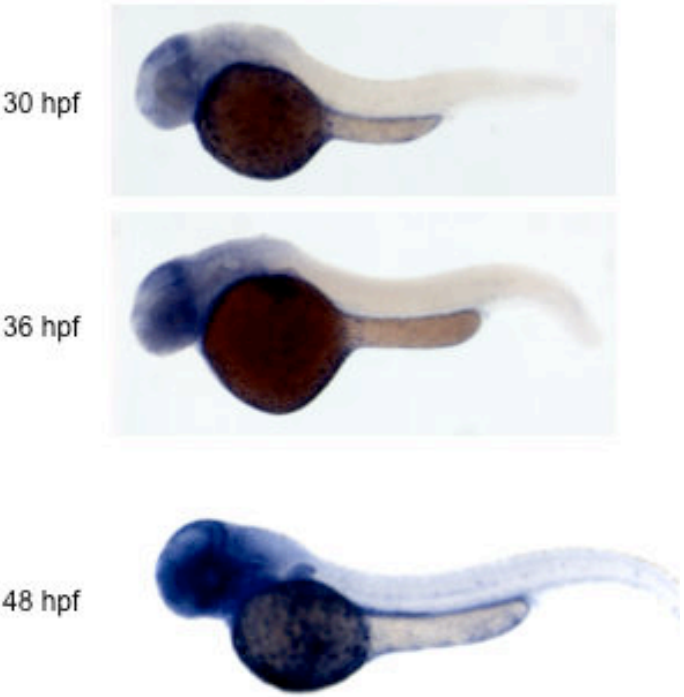

Figure S6: *catalase* expression analyzed by *in situ* hybridization



2.3.H₂O₂ gradients control protein S-acylation during morphogenesis

The modifications induced by the ROS signaling are very dynamic and reversible, as they have to rapidly respond to cellular environment variations. Also the process of S-palmitoylation can quickly relay a transient and dynamic response to metabolic changes or cellular environment redox modifications (Chamberlain and Shipston, 2015) and, interestingly, it targets cysteine residues, as the ROS signaling.

In this work, still in preparation, we then wondered if a relationship between hydrogen peroxide levels and protein S-palmitoylation could exist.

We first developed an *ex vivo* cellular model system in which we are able to finely tune intracellular hydrogen peroxide levels to study the impact of redox state variations on cellular physiology and protein behavior. The model consists in HeLa cell line stably expressing HyPer upon induction with doxycycline; to modulate hydrogen peroxide levels, we induce the expression of enzymes participating in cellular redox homeostasis or we add chemical compounds into the cell medium.

Using this model system, we demonstrated that physiological levels of hydrogen peroxide modulate the S-palmitoylation process, which is progressively downregulated as the cells become more oxidized.

To check the biological relevance of this regulation *in vivo*, we tested if it occurs in developing zebrafish embryos, in which we can observe the formation of hydrogen peroxide gradients during morphogenesis. We found that along these gradients the localisation of palmitoylated proteins is different, as consequence of a different efficiency in the S-palmitoylation process. These results are thus in agreement with those obtained *ex vivo* in cell culture.

Finally, preliminary results also suggest that dually lipidated proteins are less sensitive to hydrogen peroxide levels variations.

H₂O₂ gradients control protein S-acylation during morphogenesis

**Francesca Meda^{1,2,4}, Carole Gauron^{1,4}, Edmond Dupont^{1,4}, Eliane Ipendey^{1,2,4},
Michel Volovitch^{1,2,4}, Alain Joliot^{1,4} and Sophie Vriz^{1,3,4,*}**

Affiliations:

¹ Centre Interdisciplinaire de Recherche en Biologie (CIRB)

CNRS UMR 7241 / INSERM U1050 / Collège de France

11, Place Marcelin Berthelot - 75231 Paris Cedex 05 – France

² École Normale Supérieure, Institute of Biology at the Ecole Normale Supérieure (IBENS),
CNRS UMR8197, INSERM U1024, F-75005 Paris, France

³ Université Paris Diderot, Sorbonne Paris Cité

Biology Department - 75205 Paris Cedex 13 – France

⁴ PSL Research University, 75005 Paris, France

*Correspondence to: Prof. Sophie Vriz,

Centre Interdisciplinaire de Recherche en Biologie (CIRB)
CNRS UMR 7241 / INSERM U1050 / Collège de France
11, Place Marcelin Berthelot - 75231 Paris Cedex 05 – France
Tel. 33 (1) 4427 1454
E-mail: vriz@univ-paris-diderot.fr

Abstract

In the last year, it is becoming evident how hydrogen peroxide (H_2O_2) can modulate a variety of cellular processes. Potential H_2O_2 targets include all proteins whose activity relies upon active cysteine residues, as the oxidative status of this amino acid depends on H_2O_2 levels and it can quickly and dynamically adapt to cellular environment variations. Also S-acylation can relay a rapid and reversible response to cell metabolic changes or environment modifications and, consisting in the covalent attachment of a fatty acid (often a palmitate) onto a cysteine residue, it is also a possible target of H_2O_2 .

In this work, we addressed the effects of different H_2O_2 levels on the process of S-palmitoylation. We first developed an *ex vivo* system to be able to observe and finely modulate the intracellular levels of H_2O_2 . Successively, we demonstrated that the progressive augmentation of H_2O_2 levels gradually inhibits S-palmitoylation process. The relevance of this result has been confirmed *in vivo*: in developing zebrafish embryos, which naturally display H_2O_2 gradients during morphogenesis, we observed that the efficiency of S-palmitoylation is modulated along H_2O_2 gradients. Finally, we found that dually lipidated proteins are less sensitive to H_2O_2 levels variations.

Introduction

S-acylation corresponds to the post-translational attachment of fatty acids onto a cysteine residue via a labile thioester linkage. Even though different fatty acids can be incorporated (stearate (C18:0), oleate (C18:1)), the most frequent one is a palmitate (C16:0) ¹ and therefore we will concentrate on palmitoylation. S-palmitoylation is needed for both tethering proteins to membranes and more specific localization to membrane microdomains. It is reversible, allowing dynamic regulation of protein membrane localization ². It is also the most common protein lipid modification in neural tissues and serves as a mean of regulation of neuronal substrates, not only for proteins that control firing at the synapse, but also for proteins involved in development, regeneration and neuronal survival ³. Many human pathologies including neurological disorders have been associated with palmitoylation abnormalities ⁴⁻⁶ and recent palmitoylome studies have refined the targeted proteins ⁷. Indeed protein S-palmitoylation can relay a prompt and transient

response to cell stress i.e. metabolic changes or cellular environment redox modifications⁸.

Cellular redox homeostasis mediates a plethora of cellular pathways, as indicated by the diverse roles of H₂O₂ in cell plasticity, tissue regeneration, wound healing and by the imbalance of reactive oxygen species homeostasis in aging and pathogenesis (e.g., tumorigenesis, autoimmunity, degenerative diseases, and diabetes)⁹⁻¹⁴. A transient elevation of H₂O₂ is necessary to induce regenerative programs¹⁵⁻¹⁹, enhance cell plasticity¹³ and promote wound healing^{20,21} as well as peripheral sensory axon growth after lesion^{18,22}. It has been recently demonstrated that in adult tissue, nerves control H₂O₂ levels and in a positive feedback loop H₂O₂ stimulates axon growth after lesion¹⁸. Furthermore, during development H₂O₂ is directly involved in axon pathfinding²³. The potential H₂O₂ targets may include proteins whose activity rely upon active cysteine because the oxidation status of this amino acid depends on the H₂O₂ levels^{24,25} and must be dynamic to adapt to cellular environment modifications.

Here we report the effects of different H₂O₂ levels on protein palmitoylation. We first set up conditions to finely tune H₂O₂ levels in cell culture and demonstrated that physiological levels of H₂O₂ can modulate S-palmitoylation and thus protein location. The biological relevance of this regulation was tested in developing zebrafish embryos. We first showed that H₂O₂ gradients are present during morphogenesis and that along these gradients the efficiency of palmitoylation is modulated. As a result the location and function of palmitoylated protein is different. Proteins with dual lipidation are less sensitive to H₂O₂ levels.

Results

We first established a cellular model system to control H₂O₂ levels and study the impact of a modified redox status on cellular physiology and protein behavior. It consists in HeLa cell line stably expressing HyPer upon induction with doxycycline. HyPer is a fluorescent sensor able to detect in live cells the dynamics of intracellular level of H₂O₂, without inducing artificial and aspecific ROS generation. HyPer is specific for H₂O₂ and insensitive to other oxidants²⁶. The H₂O₂ levels are inferred from the YFP₅₀₀/YFP₄₂₀ excitation ratio of HyPer (Figure 1a). Then, the HeLa-HyPer

cell line allows the visualization of the intracellular H_2O_2 levels and their fluctuations along time. Having monitored the basal level of H_2O_2 in normal conditions of cell culture, we screened for compounds that can modify the redox state of the cells. The ROS scavenger TIRON or the pan-NADPH oxidase inhibitor VAS2870, as well as the intracellularly induced expression of the enzyme catalase that catalyzes the degradation of H_2O_2 into water and molecular oxygen, lead to a reduction in the levels of oxidation of the cells (Figure 1b, Figure S1). On the contrary, glucose oxidase, which catalyzes the formation of H_2O_2 using as substrate the glucose present in the cell culture medium, augments the level of oxidation of the cells (Figure 1b; Figure S1). In principle, being a process that relies on cysteine residues, S-palmitoylation should be sensitive to H_2O_2 levels, even though this has never been addressed.

To test this hypothesis, we designed a sensor for S-palmitoylation in which the palmitoylation sequence of GAP43 was linked to a mCherry fluorescent protein (Figure S2a). When palmitoylated, the reporter sits at the cytoplasmic membrane otherwise it localizes in the cytoplasm, similarly to GAP43 protein. The mutated version (CC>SS) of this reporter cannot be palmitoylated because it lacks the cysteine residues in which the palmitate groups are attached and accordingly localizes in the cytoplasm (Figure 1c). Augmentation of H_2O_2 levels modified the intracellular distribution of the reporter maintaining it in the cytosol and preventing its binding to the membrane (Figure 1d-f), suggesting a possible defect in the S-palmitoylation process. Quantification of protein localization showed a progressive reduction of the membrane bound protein related to progressive increase of intracellular oxidation and after a threshold of H_2O_2 the reporter localized exclusively in the cytoplasm (Figure 1g).

It seems then that small modification in H_2O_2 levels could have a large impact on protein S-palmitoylation and subsequent localisation. To test the impact of H_2O_2 levels on S-palmitoylation *in vivo*, an mRNA coding for the S-palmitoylation reporter was injected in HyPer transgenic embryos and the correlation between H_2O_2 levels and reporter localization was quantified (Figure 2a-d). Epithelial cells with low level of H_2O_2 showed a clear localization of the mCherry at the membrane (Figure 2a) whereas flanking neural cells with different levels of H_2O_2 displayed different proportion of membrane bound mCherry (Figure 2b-c), which is in perfect agreement with the result obtained in cell culture. The range of H_2O_2 levels observed *in vivo* is

less extended than the one artificially obtained in HeLa cells but precisely corresponds to the amount of H_2O_2 for which the reversibility of palmitoylation process takes place (Figure 2d).

To test the physiological relevance of this feature, we analyzed H_2O_2 distribution during morphogenesis. We used a zebrafish transgenic line that drives an ubiquitous expression of HyPer²³ to decipher H_2O_2 distribution during regeneration and morphogenesis. Gradients of H_2O_2 are observed in lesioned tissue (Figure 3b-b') and in developing neuronal structure (Figure 2c-g').

References

- 1 Towler, D. & Glaser, L. Acylation of cellular proteins with endogenously synthesized fatty acids. *Biochemistry* **25**, 878-884 (1986).
- 2 Salaun, C., Greaves, J. & Chamberlain, L. H. The intracellular dynamic of protein palmitoylation. *J Cell Biol* **191**, 1229-1238, doi:10.1083/jcb.201008160 (2010).
- 3 Fukata, Y. & Fukata, M. Protein palmitoylation in neuronal development and synaptic plasticity. *Nat Rev Neurosci* **11**, 161-175, doi:10.1038/nrn2788 (2010).
- 4 Greaves, J. & Chamberlain, L. H. DHHC palmitoyl transferases: substrate interactions and (patho)physiology. *Trends Biochem Sci* **36**, 245-253, doi:10.1016/j.tibs.2011.01.003 (2011).
- 5 Young, F. B., Butland, S. L., Sanders, S. S., Sutton, L. M. & Hayden, M. R. Putting proteins in their place: palmitoylation in Huntington disease and other neuropsychiatric diseases. *Prog Neurobiol* **97**, 220-238, doi:10.1016/j.pneurobio.2011.11.002 (2012).
- 6 Fukata, Y., Murakami, T., Yokoi, N. & Fukata, M. Local Palmitoylation Cycles and Specialized Membrane Domain Organization. *Curr Top Membr* **77**, 97-141, doi:10.1016/bs.ctm.2015.10.003 (2016).
- 7 Wan, J. *et al.* Tracking brain palmitoylation change: predominance of glial change in a mouse model of Huntington's disease. *Chem Biol* **20**, 1421-1434, doi:10.1016/j.chembiol.2013.09.018 (2013).
- 8 Chamberlain, L. H. & Shipston, M. J. The physiology of protein S-acylation. *Physiol Rev* **95**, 341-376, doi:10.1152/physrev.00032.2014 (2015).
- 9 Rhee, S. G. Cell signaling. H₂O₂, a necessary evil for cell signaling. *Science* **312**, 1882-1883, doi:10.1126/science.1130481 [pii] 10.1126/science.1130481 (2006).
- 10 Covarrubias, L., Hernandez-Garcia, D., Schnabel, D., Salas-Vidal, E. & Castro-Obregon, S. Function of reactive oxygen species during animal development: passive or active? *Dev Biol* **320**, 1-11, doi:10.1016/j.ydbio.2008.04.041S0012-1606(08)00851-8 [pii] (2008).
- 11 van der Vliet, A. & Janssen-Heininger, Y. M. Hydrogen peroxide as a damage signal in tissue injury and inflammation: murderer, mediator, or messenger? *J Cell Biochem* **115**, 427-435, doi:10.1002/jcb.24683 (2014).
- 12 Schieber, M. & Chandel, N. S. ROS function in redox signaling and oxidative stress. *Curr Biol* **24**, R453-462, doi:10.1016/j.cub.2014.03.034S0960-9822(14)00326-1 [pii] (2014).
- 13 Bigarella, C. L., Liang, R. & Ghaffari, S. Stem cells and the impact of ROS signaling. *Development* **141**, 4206-4218, doi:10.1242/dev.107086141/22/4206 [pii] (2014).
- 14 Watson, J. D. Type 2 diabetes as a redox disease. *Lancet* **383**, 841-843, doi:10.1016/S0140-6736(13)62365-XS0140-6736(13)62365-X [pii] (2014).
- 15 Love, N. R. *et al.* Amputation-induced reactive oxygen species are required for successful *Xenopus* tadpole tail regeneration. *Nat Cell Biol* **15**, 222-228, doi:10.1038/ncb2659ncb2659 [pii] (2013).
- 16 Gauron, C. *et al.* Sustained production of ROS triggers compensatory proliferation and is required for regeneration to proceed. *Sci Rep* **3**, 2084, doi:10.1038/srep02084 srep02084 [pii] (2013).
- 17 Bai, H. *et al.* Hydrogen peroxide modulates the proliferation/quiescence switch in the liver during embryonic development and posthepatectomy regeneration. *Antioxid Redox Signal* **22**, 921-937, doi:10.1089/ars.2014.5960 (2015).
- 18 Meda, F. *et al.* Nerves Control Redox Levels in Mature Tissues Through Schwann Cells and Hedgehog Signaling. *Antioxid Redox Signal* **24**, 299-311, doi:10.1089/ars.2015.6380 (2016).
- 19 Pirotte, N., Leynen, N., Artois, T. & Smeets, K. Do you have the nerves to regenerate? The importance of neural signalling in the regeneration process. *Dev Biol* **409**, 4-15, doi:10.1016/j.ydbio.2015.09.025 (2016).
- 20 Niethammer, P., Grabher, C., Look, A. T. & Mitchison, T. J. A tissue-scale gradient of hydrogen peroxide mediates rapid wound detection in zebrafish. *Nature* **459**, 996-999, doi:10.1038/nature08119 [pii] 10.1038/nature08119 (2009).

- 21 Loo, A. E. *et al.* Effects of hydrogen peroxide on wound healing in mice in relation to oxidative damage. *PLoS One* **7**, e49215, doi:10.1371/journal.pone.0049215PONE-D-12-24793 [pii] (2012).
- 22 Rieger, S. & Sagasti, A. Hydrogen peroxide promotes injury-induced peripheral sensory axon regeneration in the zebrafish skin. *PLoS Biol* **9**, e1000621, doi:10.1371/journal.pbio.100062110-PLBI-RA-9260R3 [pii] (2011).
- 23 Gauron, C. *et al.* Hydrogen peroxide (H₂O₂) controls axon pathfinding during zebrafish development. *Dev Biol In press* (2016).
- 24 Finkel, T. Signal transduction by reactive oxygen species. *J Cell Biol* **194**, 7-15, doi:jcb.201102095 [pii] 10.1083/jcb.201102095 (2011).
- 25 Reczek, C. R. & Chandel, N. S. ROS-dependent signal transduction. *Current Opinion in Cell Biology* **33**, 8-13 (2015).
- 26 Belousov, V. V. *et al.* Genetically encoded fluorescent indicator for intracellular hydrogen peroxide. *Nat Methods* **3**, 281-286, doi:nmeth866 [pii] 10.1038/nmeth866 (2006).
- 27 Politis, E. G., Roth, A. F. & Davis, N. G. Transmembrane topology of the protein palmitoyl transferase Akr1. *J Biol Chem* **280**, 10156-10163, doi:10.1074/jbc.M411946200 (2005).
- 28 Holland, S. M. *et al.* Palmitoylation controls DLK localization, interactions and activity to ensure effective axonal injury signaling. *Proc Natl Acad Sci U S A* **113**, 763-768, doi:10.1073/pnas.1514123113 (2016).
- 29 Fukata, Y. *et al.* Local palmitoylation cycles define activity-regulated postsynaptic subdomains. *J Cell Biol* **202**, 145-161, doi:10.1083/jcb.201302071 (2013).
- 30 Shahinian, S. & Silvius, J. R. Doubly-lipid-modified protein sequence motifs exhibit long-lived anchorage to lipid bilayer membranes. *Biochemistry* **34**, 3813-3822 (1995).
- 31 Sandilands, E., Brunton, V. G. & Frame, M. C. The membrane targeting and spatial activation of Src, Yes and Fyn is influenced by palmitoylation and distinct RhoB/RhoD endosome requirements. *J Cell Sci* **120**, 2555-2564, doi:10.1242/jcs.003657 (2007).
- 32 Sato, I. *et al.* Differential trafficking of Src, Lyn, Yes and Fyn is specified by the state of palmitoylation in the SH4 domain. *J Cell Sci* **122**, 965-975, doi:10.1242/jcs.034843 (2009).
- 33 Levental, I., Grzybek, M. & Simons, K. Greasing their way: lipid modifications determine protein association with membrane rafts. *Biochemistry* **49**, 6305-6316, doi:10.1021/bi100882y (2010).
- 34 Yoo, S. K., Starnes, T. W., Deng, Q. & Huttenlocher, A. Lyn is a redox sensor that mediates leukocyte wound attraction in vivo. *Nature* **480**, 109-112, doi:10.1038/nature10632 (2011).
- 35 Routtenberg, A., Cantalops, I., Zaffuto, S., Serrano, P. & Namgung, U. Enhanced learning after genetic overexpression of a brain growth protein. *Proc Natl Acad Sci U S A* **97**, 7657-7662 (2000).
- 36 Strittmatter, S. M., Fankhauser, C., Huang, P. L., Mashimo, H. & Fishman, M. C. Neuronal pathfinding is abnormal in mice lacking the neuronal growth cone protein GAP-43. *Cell* **80**, 445-452 (1995).
- 37 Mishina, N. M. *et al.* Visualization of intracellular hydrogen peroxide with HyPer, a genetically encoded fluorescent probe. *Methods Enzymol* **526**, 45-59, doi:10.1016/B978-0-12-405883-5.00003-XB978-0-12-405883-5.00003-X [pii] (2013).

Figure Legends

Figure 1: H₂O₂ modulates protein S-palmitoylation

(a) The H₂O₂ levels are inferred from the YFP₅₀₀/YFP₄₂₀ excitation ratio of HyPer. (b) HyPer sensor allows the quantification of H₂O₂ levels. The image represents the effects of different treatments on the redox state of the cell compared to control non-treated cells. * corresponds to cell expressing catalase. (c-f) Wild-type (d-f) or mutated form of palmitoylation sensor (CC>SS) (c) were transfected in HyPer stable line and quantification of H₂O₂ level as well as reporter fluorescence profile determined. mCherry fluorescent profile was determined along the red line for each cell. (g) Quantification of the membrane bound palmitoylation reporter in function of H₂O₂ level.

Figure 2: H₂O₂ levels modulate S-palmitoylation during morphogenesis

(a) Epidermal cells during somitogenesis. (b) Neural tube and muscle cells of 33 hpf embryo; (c) magnification of b. In each sample, mCherry fluorescent profile was determined along the red line and correlates to HyPer signal. (d) Quantification of the membrane bound palmitoylation reporter in function of H₂O₂ level. Scale bar = 20µm.

Figure 3: H₂O₂ gradient during morphogenesis and regeneration

(a) The H₂O₂ levels are inferred from the YFP₅₀₀/YFP₄₂₀ excitation ratio of HyPer. (b-g) HyPer imaging in lesionated tissue (b) or during morphogenesis (c-g). (b', d', e', g') H₂O₂ gradients in developing tissue. (b-b') H₂O₂ gradient in adult fin 15 hours post amputation. (c-e') H₂O₂ gradient in developing brain at 24 hpf. (f-g') H₂O₂ gradient in the rhombomeres at 48 hpf. In each image the black arrow indicates the position of HyPer signal measurement.

Figure 1

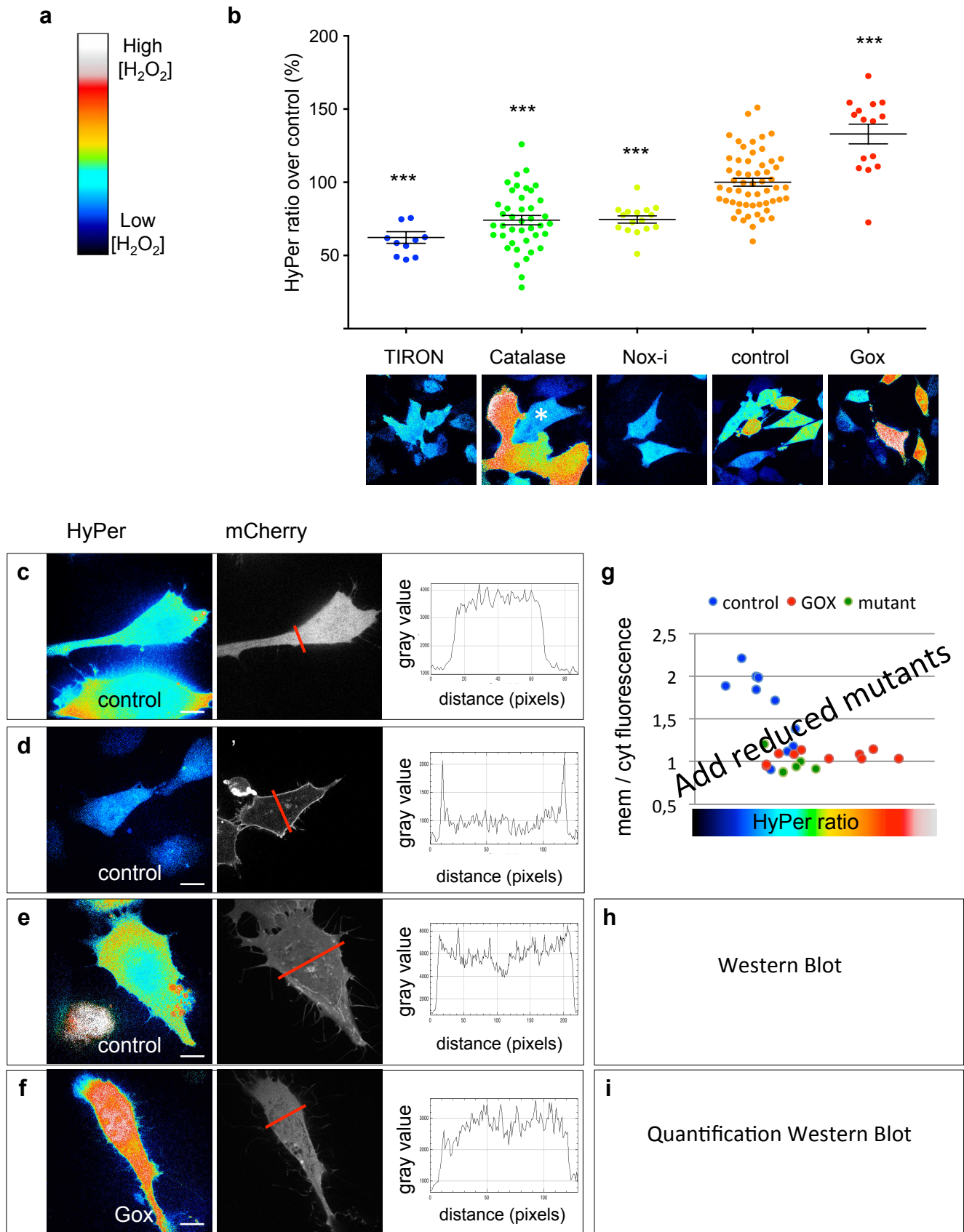

Figure 2

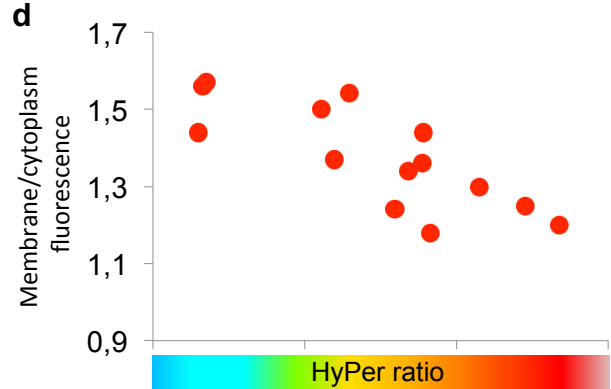
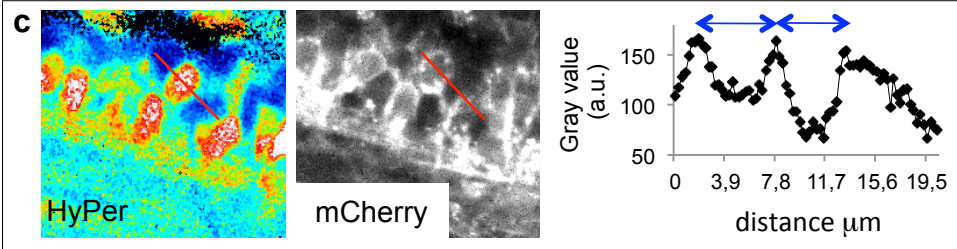
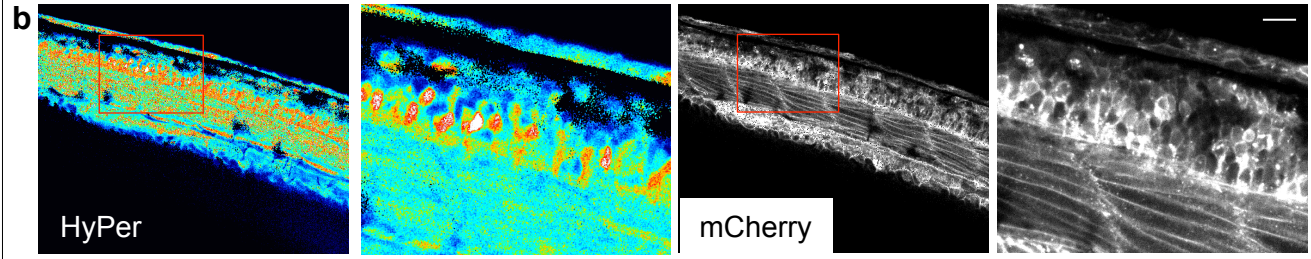
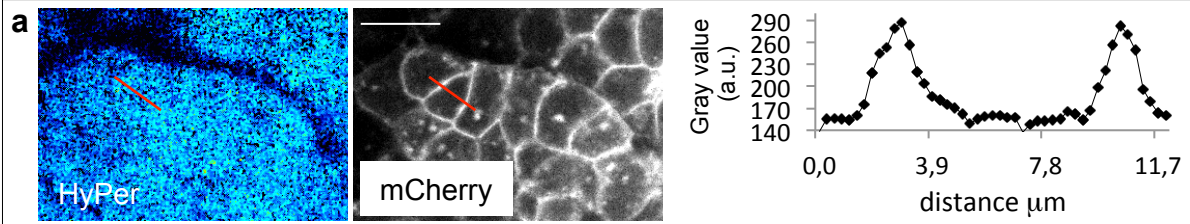

Figure 3

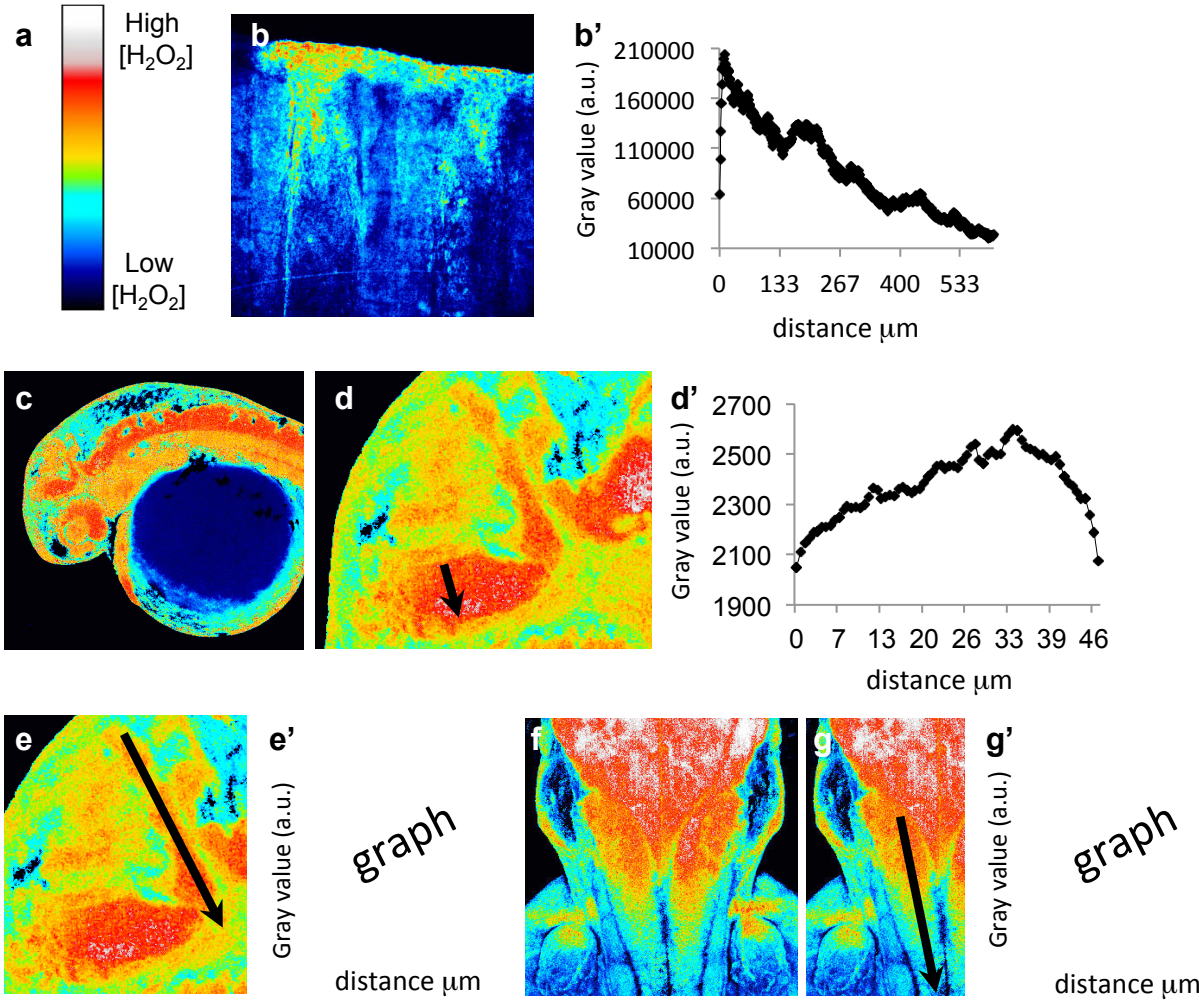

Figure S1

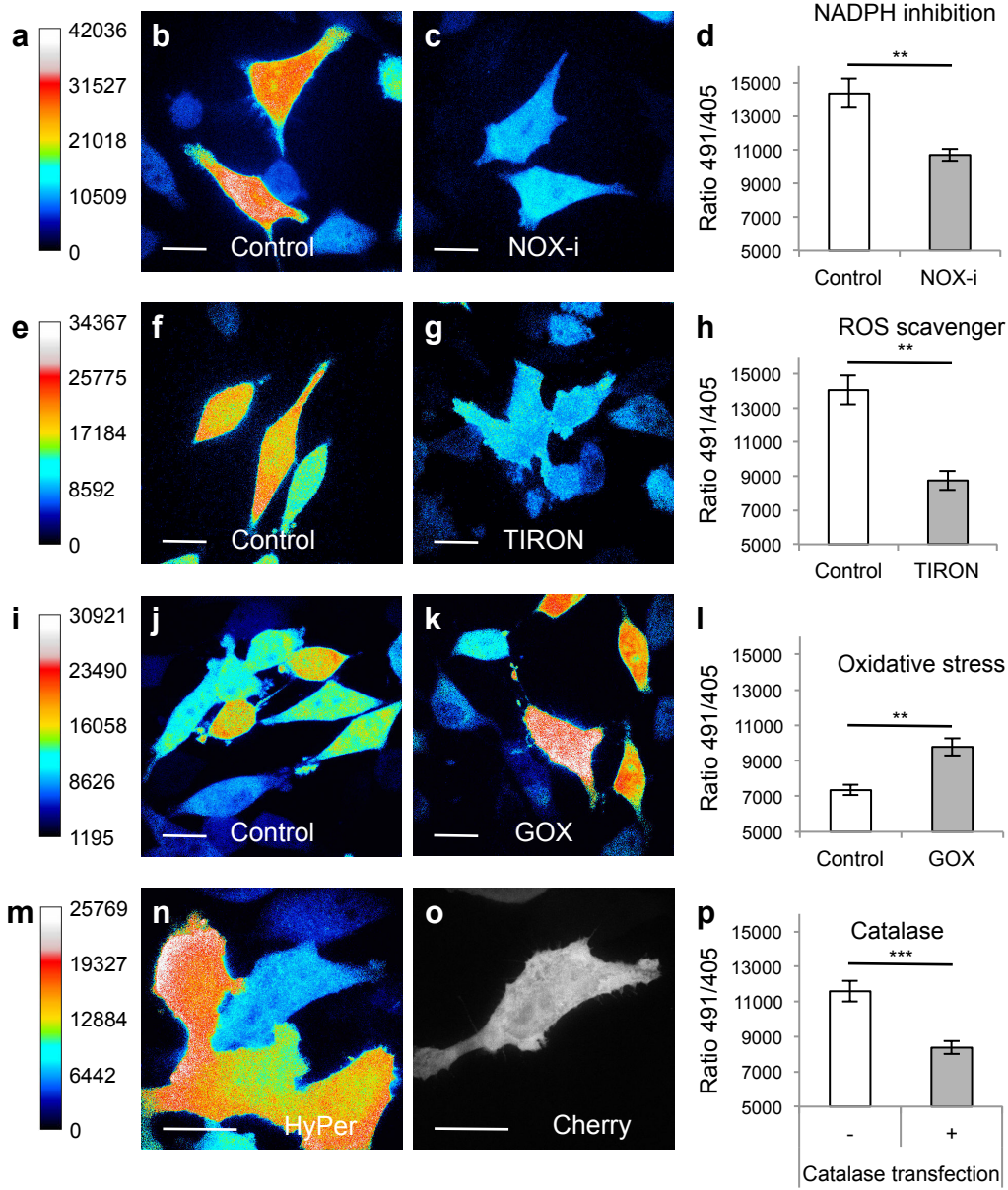
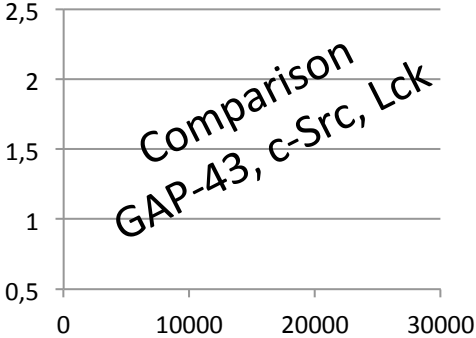
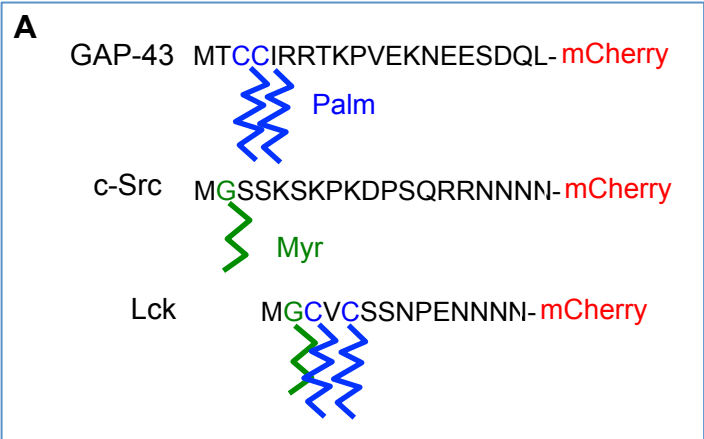

Figure S2



3. DISCUSSION

3.1. Similarities and differences among different reactive oxygen species

While working with ROS and ROS signaling, it has to be clear that the terms “reactive oxygen species” cannot be used as synonym of the different species that are comprised in this group of molecules: ROS is not equal to hydrogen peroxide as it is not equal to superoxide anion or any other ion or free radical derived from oxygen partial reduction. Indeed, different ROS possess different characteristics, which lead to very different results in their actions. As consequence, they cannot be considered as one single entity, and each species has to be studied separately in relation to its specific oxidant activity and half-life, which influences its diffusion ability and then its role in signals spreading over different distances (Giorgio et al., 2007; Veal et al., 2007; Koopman et al., 2010; Forkink et al., 2010).

In the same way, a molecule or an enzyme that causes the degradation of a single reactive oxygen species cannot be categorized directly as antioxidant. An example of this wrong nomenclature is given by the enzyme superoxide dismutase (Monk et al., 1989; Hussain et al., 1995; Kim and Lee, 1997; Ambrosone et al., 1999; Mruk et al., 2002; Serra et al., 2003; Li et al., 2005). Indeed, even if it catalyses the degradation of the superoxide anion and then avoids all the oxidative damages that this highly reactive ROS could cause to the cellular molecules, it also produce the hydrogen peroxide, which is actually another oxidant molecule.

The different characteristics of the different ROS imply that not all of them are suitable to participate in ROS signaling. Superoxide anion and hydroxyl radicals are very reactive species but they have also a very short half-life (Giorgio et al., 2007), implying bad diffusion properties. Therefore, they are not good candidates to mediate ROS signaling. On the contrary, hydrogen peroxide is still able to oxidise biological molecules but also possess a longer half-life (Giorgio et al., 2007) and higher free aqueous diffusion distance (Koopman et al., 2010), allowing better diffusion capacities than the other ROS. It has also been demonstrated that aquaporins facilitate hydrogen peroxide diffusion across membranes (Bienert et al., 2007; Bienert and Chaumont, 2014). Moreover, hydrogen peroxide is also present in the cells at higher concentrations than the other oxidant species (Giorgio et al., 2007). For these reasons, hydrogen peroxide is the best candidate to mediate ROS signaling.

The results presented in this manuscript, in which hydrogen peroxide has been specifically visualised with HyPer probe and targeted with dedicated pharmacological treatments, provide further evidence that it is the species involved in ROS signaling.

3.2.Gradient formation: a different process between development and regeneration

As already said in the introduction, development and regeneration deploy similar sets of genes to carry out their morphogenetic purposes. However, the different spatial and temporal scales in which they take place necessarily modify the level of expression of the morphogens and the time required for the formation of the signals gradients, which have to be larger in the case of regeneration to be able to cover the longer distances of the adult organism compared to the small developing embryo (Figure 4 in the introduction) (Brockes and Kumar, 2005).

How morphogens gradients are formed in target tissues is a key question for understanding the mechanisms of morphological patterning (Wartlick et al., 2009).

The general idea is that the morphogen is produced by a single cell or a group of cell and then diffuses in the neighbouring cells forming a gradient: close to the source there is a higher concentration of morphogen, where the concentration gradually decreases distancing from the source. Along the gradient, the cells experiment different concentration of the morphogen and respond with the expression of different kinds of gene, leading to the patterning of the tissue (Figure 26). This kind of gradient can cover relatively long distances and depends on the half-life of the morphogen: longer is the half-life, longer is the space that it can travel before to be degraded, leading to the formation of spatially larger signal gradient.

Anyway, the morphogen concentration could be regulated also by enzymes that catalyse its degradation, inhibitors or by scavenging molecules. In the presence of a degrading enzyme close to the source of the morphogen, the morphogen cannot travel until its spontaneous degradation but it is enzymatically and prematurely degraded; as consequences, its concentration diminishes more rapidly and we can observe a spatially smaller signal gradient. The expression of these morphogen-inhibiting molecules is then a way to better control the shape of the gradient.

Another way to fine-tune the gradient formation is the presence of morphogen-interacting molecules, as receptors or extracellular matrix components, because their presence interferes with the normal diffusion of the morphogen. In the case of Hh, for example, the heparan sulphate proteoglycans (HSPGs) can bind and affect the diffusion of Hh (Han et al., 2004b; Takei et al., 2004). The shape of Hh gradient is also controlled by interaction with the receptor Patched: the presence of the receptor leads to the sequestration of Hh, restricting its signaling range, whereas loss of Patched function causes Hh target gene domain expansion (Chen and Struhl, 1996).

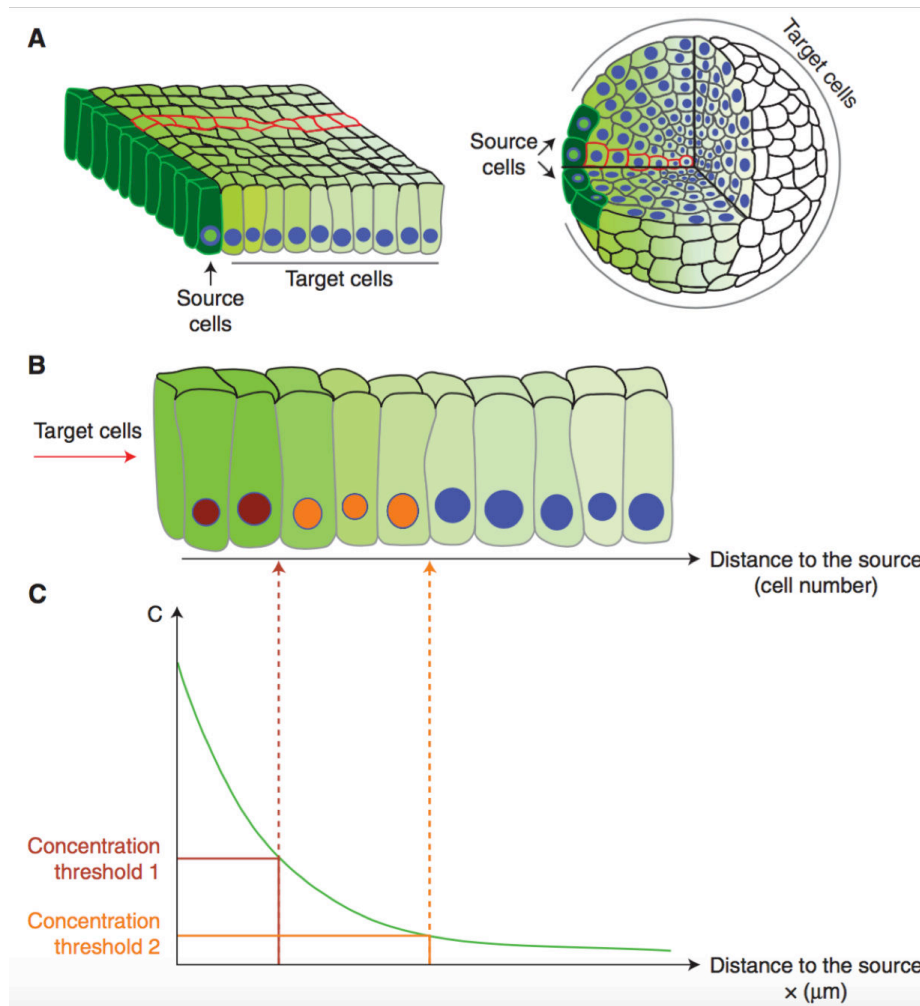

Figure 26: Gradients formation. (A) Gradient formation in a monolayer tissue, as the epithelial tissue (left) and in a more complex tissue, as the mesenchymal tissue (right); because of symmetry considerations, one row of cells (red outline) is representative for the whole gradient. (B) Magnified view of the red row of cells shown in A; cells with differently coloured nuclei express different genes. (C) The concentration of the morphogen along the gradient is expressed in function of the distance x from the source; the morphogen activates different target genes above different concentration thresholds. From Wartlick et al., 2009.

Also the formation of hydrogen peroxide gradient in zebrafish follows these mechanisms and in the two model studied in this manuscript, the caudal fin of adult zebrafish and the head of 2-3 days post fertilisation embryos, we can hypothesise the action of two different gradient-regulating processes. Indeed, the catalase, which degrades hydrogen peroxide, is expressed only in the head and not in the tail (Figure 27).

It is feasible that the gradient formed in the small and complex embryonic brain during retinal projections development should be precisely defined; this finely regulated shape control could then derive from the action of the catalase, which enzymatically degrades hydrogen peroxide. On the contrary, the relatively spatially large hydrogen peroxide gradient formed during caudal fin regeneration could be the result of the production of this oxidant species by the superoxide dismutase followed by its simple diffusion and the successive spontaneous degradation, which depends on its half-life.

Therefore, we can conclude that not only the production of the morphogen signal, but also the way in which the signal gradient is controlled and shaped by other factors, are important to precisely modulate the effects induced in the responding cells.

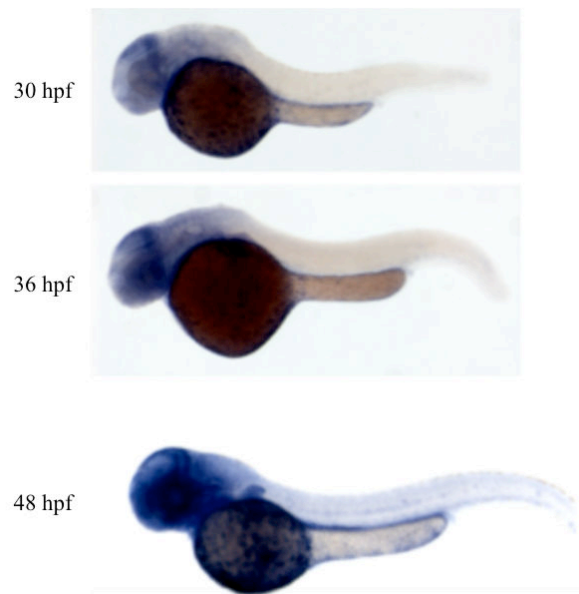

Figure 27: *catalase* expression in zebrafish embryos. The *catalase* expression is detected in 30-48 hours post fertilisation embryos only in the anterior part of the embryo (brain ventricular zone, retina proliferative zone, liver and intestinal bulb).

3.3. The relationship between nerves and H₂O₂ (and Sonic Hedgehog)

The work performed in this manuscript describes the relationship between the nerves and the levels of hydrogen peroxide in the tissue. Indeed, the results suggest that nerves are able to control hydrogen peroxide levels both in normal uninjured tissues and after lesioning; in particular, this mechanism seems to involve Schwann cells that express Shh. Moreover, appropriate hydrogen peroxide levels are necessary to induce axons growth both during development and adult regeneration; also in this case Shh plays an essential role. Altogether, these data suggest then the existence of a positive feedback loop between nerves and hydrogen peroxide that involves also Shh signaling.

During adult caudal fin regeneration, the amputation induces a Shh-dependent increase in hydrogen peroxide production at the tip of the amputated fin; the new-formed gradient of hydrogen peroxide attracts peripheral sensory axons toward the regenerating blastema. When the re-growing nerves pass the amputation plain and reach the regenerating blastema, they cause the diminution of hydrogen peroxide levels, similarly to what they do in the uninjured fin, where they maintain the tissue in a more reduced state. The reduction of hydrogen peroxide at nerves arrival is then followed by blastema growth, patterning and therefore appendage regeneration (Figure 28). In the same way, during development the retinal ganglion cells projections are attracted toward the tectum in a hydrogen peroxide-dependent and Sonic hedgehog-dependent manner, providing further evidence of the relationship between nerves, hydrogen peroxide and Sonic hedgehog.

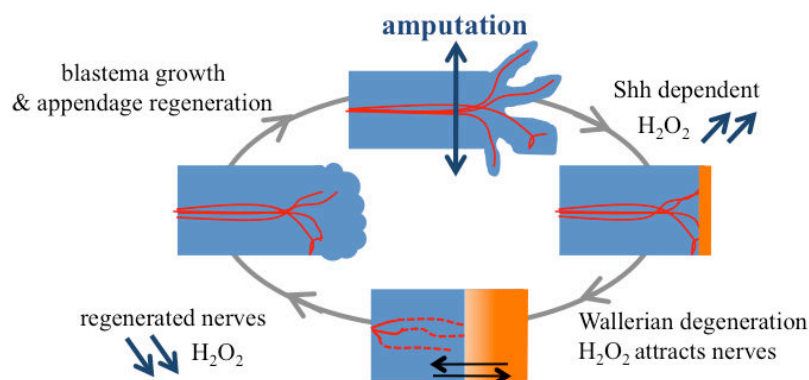

Figure 28: Schematic model for H₂O₂-nerves interactions during appendage regeneration. In adults, tissues are mainly in a reduced state (blue, top). Amputation induces an increase in H₂O₂ levels (orange) that is nerve dependent and involves Shh signaling (right). Following Wallerian degeneration (red dashed lines), regions of high H₂O₂ levels attract axons (red lines) and are essential for progenitor cell recruitment and blastema formation (bottom). H₂O₂ levels decreases upon innervation (left).

The relationship between peripheral sensory axons growth and hydrogen peroxide had already been demonstrated during skin regeneration after injury in zebrafish larvae (Rieger and Sagasti,

2011) but not in adult regeneration or development. Also the involvement of Schwann cells in neuroprotection through Shh secretion (Hashimoto et al., 2008) and their essential role in nerve regeneration were already demonstrated (Glenn and Talbot, 2013; Jessen et al., 2015), as it was the fact that Schwann cells are sensitive to the redox environment (Lu et al., 2009; Sato et al., 2013; Shan et al., 2013). Moreover, the involvement of Shh in the control of nerve growth is a very old discovery (Bovolenta and Sanchez-Arrones, 2012; Yam and Charron, 2013). However, here, for the first time, all these different signaling pathways are mechanistically linked together by reciprocal interactions during fin adult regeneration.

The existence of a positive feedback loop in which peripheral nerves control redox levels and in turn hydrogen peroxide regulates nerves growth has been observed only during regeneration. However, even if this double interaction is not yet been proved to occur during development, also tissue growth and organ size could be dependent on this positive feedback loop.

Finally, these results also point out peripheral nerves redox environment as a target to manipulate cell plasticity in adult, with possible medical implications for the treatment of neuropathies and neurodegenerative diseases.

3.3.1. nAG is a thioredoxin

The existence of a possible link between nerves and redox status was predicted by the role of the newt Anterior Gradient (nAG) protein.

This protein plays an essential role in the nerve dependence of newt appendage regeneration. During development, nAG is expressed in the epidermis and then switched off by nerve arrival. Its expression is successively re-induced following amputation: when the axons regenerate, nAG is up-regulated first in the Schwann cells of the distal nerve sheath and then in gland cells underlying the wound epidermis (Kumar et al., 2007b). These gland cells express nAG in their secretory granules, which are apparently discharged into the blastema by holocrine mechanism (Kumar et al., 2010). Denervation impairs nAG re-expression by Schwann cells during regeneration and also glands formation; however, if the protein is expressed by electroporation of a plasmid into the distal stump, this induces the formation of nAG-positive glands and rescues the denervation phenotype, allowing the regeneration process to take place (Kumar et al., 2007b). nAG protein activity is probably exerted directly on blastema cells, as cultured newt blastema cells respond to it by entering S phase (Kumar et al., 2007b). In addition to this, prevention of appendage innervation during development leads to a continuous nAG expression and the regeneration process becomes nerve-independent (Kumar et al., 2011).

Interestingly, AG proteins are members of the protein disulphide isomerase (PDI) family. These proteins, normally present in the endoplasmic reticulum, act as molecular chaperones for protein

oxidative folding, catalysing the formation and breakage of disulphide bonds between cysteines residues within proteins (Wilkinson and Gilbert, 2004; Gruber et al., 2006). Some members of this family has already been found to serve as redox sensors in (Trebitsh et al., 2000) and to play an essential role in the formation of regulatory disulphide bonds in chloroplasts (Wittenberg and Danon, 2008). Therefore, even if the direct relationship between ROS levels and AG proteins expression has not yet been addressed, nAG role in the nerve dependence of regeneration process points out the relevance of redox status in the control of appendage regeneration by nerves.

In addition, AGR2 has been found to be essential for the maintenance of the endoplasmic reticulum homeostasis (Higa et al., 2011) and then it could influence the secretion process of all the proteins that transit through the ER, perhaps in a redox dependent manner; among these secreted proteins, we can find not only Shh, but also many other morphogens that possibly play a role in the regeneration process. Finally, it is also interesting to notice that AGR2 has already been found to promote growth processes, even if in tumorigenic tissues, by affecting the Hippo and EGF pathways (Gupta et al., 2012).

3.4.Perspectives

ROS signaling is thought to target active cysteine residues, modifying their redox status, and regulate the conformation, and then the function, of the protein in which these residues are present (Finkel, 2011; Reczek and Chandel, 2015).

The last part of the work here presented is focused on the comprehension of how different redox levels can modify the process of S-palmitoylation, which depend on conserved Cys residues and, as the redox processes, is reversible and can rapidly adapt to the modifications of the environment. Nowadays, the results obtained suggest that the process of S-palmitoylation *ex vivo* is specifically regulated by hydrogen peroxide levels, differently from other kind of protein acylation that seem to be insensible to redox status variations, and this regulation seems to take place also *in vivo*, as we observe different palmitoylation profiles in regions more or less oxidised. However, to have a better comprehension on this topic more studies both *ex vivo*, with the test of other S-palmitoylated proteins, dually acylated proteins or proteins modified by addition of a fatty acid other than palmitate, and *in vivo*, looking more precisely to the effects of redox variations on palmitoylated proteins (for example blocking the action of one of the enzymes involved in hydrogen peroxide homeostasis) and the consequences for the organism, need to be done.

Interestingly, also the process of maturation of Shh molecule could be the target of ROS signaling. Indeed, both the intramolecular cleavage of the Shh precursor and the N-palmitoylation of Shh involve cysteine residues; both these processes are necessary to obtain an active and properly secreted Shh peptide. The impairment of one or both these mechanisms is feasible to lead to modifications in the intracellular journey of Shh. A well established tool that allows to control the intracellular trafficking of proteins is the retention using selective hooks (RUSH) system (Boncompain et al., 2012). It is based on the reversible interaction of a hook protein fused to core streptavidin and stably anchored in the donor compartment with a reporter protein of interest fused to streptavidin-binding peptide (SBP): the reporter protein is then blocked in the donor compartment until the biotin addition causes a synchronous release of the reporter from the hook and the continuation of its intracellular journey (Figure 29). Moreover, it has been widely used *ex vivo* but also its application *in vivo* seems to be possible, allowing the control of protein trafficking in more physiological conditions. This system could be then very useful to investigate the sensitivity of Shh intracellular journey to hydrogen peroxide.

Finally, also *shh* expression seems to be influenced by different ROS levels even if this hypothesis needs to be further tested. Our data suggests that the inhibition of hydrogen peroxide production reduces Shh expression, but more precise answers could derive from the analysis of

the transcription factors. For example, Nkx2.1, involved in Shh expression in ventral forebrain (Jeong et al., 2006), belong to the Nk-2 homeoproteins family. The proteins of this family contain, in addition to the homeodomain, also the conserved NK2-SD sequence (Harvey, 1996); interestingly, a conserved cysteine residue is present in the NK2-SD peptide and, then, it could be a possible target for the ROS signaling.

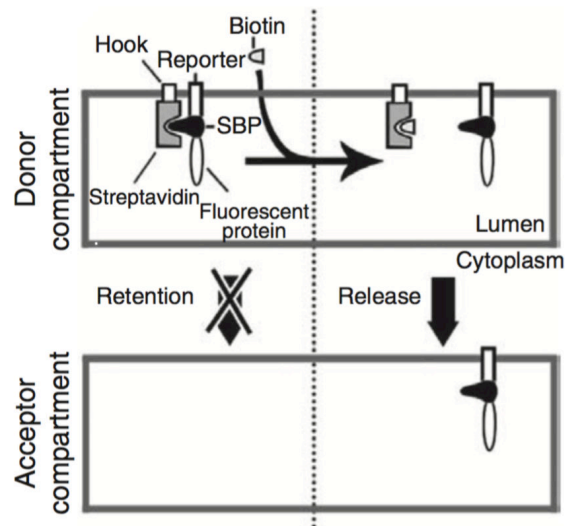

Figure 29: The RUSH system. The reporter, fused to a streptavidin-binding peptide (SBP) is retained in the donor compartment via its interaction with the hook, which includes a core streptavidin. The release is induced by addition of biotin; this allows the trafficking of the reporter to its acceptor compartment. To visualise the reporter, it is normally fused with a fluorescent protein. From Boncompain et al., 2012.

To conclude, it is worth to remember that the idea the ROS are also important signaling molecules and not only deleterious compounds for the cells is relatively new. This imply that there is still a lot to be discovered because, for example, many other processes that rely upon conserved cysteine residues are possible targets of the ROS signaling.

4. BIBLIOGRAPHY

- Abrami, L., Kunz, B., Iacovache, I., and van der Goot, F.G. (2008). Palmitoylation and ubiquitination regulate exit of the Wnt signaling protein LRP6 from the endoplasmic reticulum. *Proc. Natl. Acad. Sci. U. S. A.* *105*, 5384–5389.
- Adams, D.S., Masi, A., and Levin, M. (2007). H⁺ pump-dependent changes in membrane voltage are an early mechanism necessary and sufficient to induce *Xenopus* tail regeneration. *Dev. Camb. Engl.* *134*, 1323–1335.
- Aitken, A., Cohen, P., Santikarn, S., Williams, D.H., Calder, A.G., Smith, A., and Klee, C.B. (1982). Identification of the NH₂-terminal blocking group of calcineurin B as myristic acid. *FEBS Lett.* *150*, 314–318.
- Akimenko, M.A., Johnson, S.L., Westerfield, M., and Ekker, M. (1995). Differential induction of four *msx* homeobox genes during fin development and regeneration in zebrafish. *Dev. Camb. Engl.* *121*, 347–357.
- Akimenko, M.-A., Marí-Beffa, M., Becerra, J., and Géraudie, J. (2003). Old questions, new tools, and some answers to the mystery of fin regeneration. *Dev. Dyn. Off. Publ. Am. Assoc. Anat.* *226*, 190–201.
- Albert, P., and Boilly, B. (1988). Effect of transferrin on amphibian limb regeneration: a blastema cell culture study. *Roux Arch. Dev. Biol.* *197*, 193–196.
- Alcedo, J., Ayzenzon, M., Von Ohlen, T., Noll, M., and Hooper, J.E. (1996). The *Drosophila* smoothed gene encodes a seven-pass membrane protein, a putative receptor for the hedgehog signal. *Cell* *86*, 221–232.
- Amanai, K., and Jiang, J. (2001). Distinct roles of Central missing and Dispatched in sending the Hedgehog signal. *Dev. Camb. Engl.* *128*, 5119–5127.
- Ambrosone, C.B., Freudenheim, J.L., Thompson, P.A., Bowman, E., Vena, J.E., Marshall, J.R., Graham, S., Laughlin, R., Nemoto, T., and Shields, P.G. (1999). Manganese superoxide dismutase (MnSOD) genetic polymorphisms, dietary antioxidants, and risk of breast cancer. *Cancer Res.* *59*, 602–606.
- Apionishev, S., Katanayeva, N.M., Marks, S.A., Kalderon, D., and Tomlinson, A. (2005). *Drosophila* Smoothened phosphorylation sites essential for Hedgehog signal transduction. *Nat. Cell Biol.* *7*, 86–92.
- Ascano, M., and Robbins, D.J. (2004). An intramolecular association between two domains of the protein kinase Fused is necessary for Hedgehog signaling. *Mol. Cell. Biol.* *24*, 10397–10405.
- Astorga, J., and Carlsson, P. (2007). Hedgehog induction of murine vasculogenesis is mediated by Foxf1 and Bmp4. *Dev. Camb. Engl.* *134*, 3753–3761.
- Auger, H., Sasakura, Y., Joly, J.-S., and Jeffery, W.R. (2010). Regeneration of oral siphon pigment organs in the ascidian *Ciona intestinalis*. *Dev. Biol.* *339*, 374–389.
- Avaron, F., Smith, A., and Akimenko, M.-A. (2006a). Sonic Hedgehog signalling in the developing and regenerating fins of zebrafish. In *Shh and Gli Signalling and Development*, (Springer), pp. 93–106.
- Avaron, F., Hoffman, L., Guay, D., and Akimenko, M.A. (2006b). Characterization of two new zebrafish members of the hedgehog family: atypical expression of a zebrafish indian hedgehog gene in skeletal elements of both endochondral and dermal origins. *Dev. Dyn. Off. Publ. Am. Assoc. Anat.* *235*, 478–489.
- Azevedo, D., Tacnet, F., Delaunay, A., Rodrigues-Pousada, C., and Toledano, M.B. (2003). Two redox centers within Yap1 for H₂O₂ and thiol-reactive chemicals signaling. *Free Radic. Biol. Med.* *35*, 889–900.
- Bachovchin, D.A., Ji, T., Li, W., Simon, G.M., Blankman, J.L., Adibekian, A., Hoover, H., Niessen, S., and Cravatt, B.F. (2010). Superfamily-wide portrait of serine hydrolase inhibition achieved by library-versus-library screening. *Proc. Natl. Acad. Sci. U. S. A.* *107*, 20941–20946.
- Bai, H., Zhang, W., Qin, X.-J., Zhang, T., Wu, H., Liu, J.-Z., and Hai, C.-X. (2015). Hydrogen Peroxide Modulates the Proliferation/Quiescence Switch in the Liver During Embryonic Development and Posthepatectomy Regeneration. *Antioxid. Redox Signal.* *22*, 921–937.

- Baker, L.P., and Storm, D.R. (1997). Dynamic palmitoylation of neuromodulin (GAP-43) in cultured rat cerebellar neurons and mouse N1E-115 cells. *Neurosci. Lett.* *234*, 156–160.
- Barnfield, P.C., Zhang, X., Thanabalasingham, V., Yoshida, M., and Hui, C. (2005). Negative regulation of Gli1 and Gli2 activator function by Suppressor of fused through multiple mechanisms. *Differ. Res. Biol. Divers.* *73*, 397–405.
- Bartels, D.J., Mitchell, D.A., Dong, X., and Deschenes, R.J. (1999). Erf2, a novel gene product that affects the localization and palmitoylation of Ras2 in *Saccharomyces cerevisiae*. *Mol. Cell. Biol.* *19*, 6775–6787.
- Becerra, J., Montes, G.S., Bexiga, S.R., and Junqueira, L.C. (1983). Structure of the tail fin in teleosts. *Cell Tissue Res.* *230*, 127–137.
- Becerra, J., Junqueira, L.C., Bechara, I.J., and Montes, G.S. (1996). Regeneration of fin rays in teleosts: a histochemical, radioautographic, and ultrastructural study. *Arch. Histol. Cytol.* *59*, 15–35.
- Bedard, K., and Krause, K.-H. (2007). The NOX Family of ROS-Generating NADPH Oxidases: Physiology and Pathophysiology. *Physiol. Rev.* *87*, 245–313.
- Bélanger, C., Ansanay, H., Qanbar, R., and Bouvier, M. (2001). Primary sequence requirements for S-acylation of beta(2)-adrenergic receptor peptides. *FEBS Lett.* *499*, 59–64.
- Bellaiche, Y., The, I., and Perrimon, N. (1998). Tout-velu is a *Drosophila* homologue of the putative tumour suppressor EXT-1 and is needed for Hh diffusion. *Nature* *394*, 85–88.
- Belousov, V.V., Fradkov, A.F., Lukyanov, K.A., Staroverov, D.B., Shakhbazov, K.S., Terskikh, A.V., and Lukyanov, S. (2006). Genetically encoded fluorescent indicator for intracellular hydrogen peroxide. *Nat. Methods* *3*, 281–286.
- Bely, A.E., and Nyberg, K.G. (2010). Evolution of animal regeneration: re-emergence of a field. *Trends Ecol. Evol.* *25*, 161–170.
- Ben Mahdi, M.H., Andrieu, V., and Pasquier, C. (2000). Focal adhesion kinase regulation by oxidative stress in different cell types. *IUBMB Life* *50*, 291–299.
- Benov, L., Szejnberg, L., and Fridovich, I. (1998). Critical evaluation of the use of hydroethidine as a measure of superoxide anion radical. *Free Radic. Biol. Med.* *25*, 826–831.
- Benowitz, L.I., and Routtenberg, A. (1997). GAP-43: an intrinsic determinant of neuronal development and plasticity. *Trends Neurosci.* *20*, 84–91.
- Berghmans, S., Jette, C., Langenau, D., Hsu, K., Stewart, R., Look, T., and Kanki, J.P. (2005). Making waves in cancer research: new models in the zebrafish. *BioTechniques* *39*, 227–237.
- Berthiaume, L., Dechaite, I., Peseckis, S., and Resh, M.D. (1994). Regulation of enzymatic activity by active site fatty acylation. A new role for long chain fatty acid acylation of proteins. *J. Biol. Chem.* *269*, 6498–6505.
- Bhatia, N., Thiyagarajan, S., Elcheva, I., Saleem, M., Dlugosz, A., Mukhtar, H., and Spiegelman, V.S. (2006). Gli2 is targeted for ubiquitination and degradation by beta-TrCP ubiquitin ligase. *J. Biol. Chem.* *281*, 19320–19326.
- Bienert, G.P., and Chaumont, F. (2014). Aquaporin-facilitated transmembrane diffusion of hydrogen peroxide. *Biochim. Biophys. Acta* *1840*, 1596–1604.
- Bienert, G.P., Møller, A.L.B., Kristiansen, K.A., Schulz, A., Møller, I.M., Schjoerring, J.K., and Jahn, T.P. (2007). Specific aquaporins facilitate the diffusion of hydrogen peroxide across membranes. *J. Biol. Chem.* *282*, 1183–1192.
- Bigarella, C.L., Liang, R., and Ghaffari, S. (2014). Stem cells and the impact of ROS signaling. *Development* *141*, 4206–4218.

- Bilan, D.S., and Belousov, V.V. (2016). HyPer Family Probes: State of the Art. *Antioxid. Redox Signal.*
- Birnbaum, K.D., and Sanchez Alvarado, A. (2008). Slicing across kingdoms: regeneration in plants and animals. *Cell* *132*, 697–710.
- Bitgood, M.J., Shen, L., and McMahon, A.P. (1996). Sertoli cell signaling by Desert hedgehog regulates the male germline. *Curr. Biol. CB* *6*, 298–304.
- Bizzozero, O.A. (1997). The mechanism and functional roles of protein palmitoylation in the nervous system. *Neuropediatrics* *28*, 23–26.
- Bizzozero, O.A., Bixler, H.A., and Pastuszyn, A. (2001). Structural determinants influencing the reaction of cysteine-containing peptides with palmitoyl-coenzyme A and other thioesters. *Biochim. Biophys. Acta* *1545*, 278–288.
- Blanpain, C., Horsley, V., and Fuchs, E. (2007). Epithelial stem cells: turning over new leaves. *Cell* *128*, 445–458.
- Blassberg, R.A., Garza-Garcia, A., Janmohamed, A., Gates, P.B., and Brockes, J.P. (2011). Functional convergence of signalling by GPI-anchored and anchorless forms of a salamander protein implicated in limb regeneration. *J. Cell Sci.* *124*, 47–56.
- Boilly, B., and Albert, P. (1988). Blastema cell proliferation in vitro: effects of limb amputation on the mitogenic activity of spinal cord extracts. *Biol. Cell Auspices Eur. Cell Biol. Organ.* *62*, 183–187.
- Boilly, B., and Bauduin, B. (1988). Production in vitro by spinal cord of growth factor(s) acting on newt limb regeneration: influence of regeneration of the nerve fibers. *Brain Res.* *466*, 155–160.
- Boncompain, G., Divoux, S., Gareil, N., de Forges, H., Lescure, A., Latreche, L., Mercanti, V., Jollivet, F., Raposo, G., and Perez, F. (2012). Synchronization of secretory protein traffic in populations of cells. *Nat. Methods* *9*, 493–498.
- Borday, V., Thaëron, C., Avaron, F., Brulfert, A., Casane, D., Laurenti, P., and Géraudie, J. (2001). *evx1* transcription in bony fin rays segment boundaries leads to a reiterated pattern during zebrafish fin development and regeneration. *Dev. Dyn. Off. Publ. Am. Assoc. Anat.* *220*, 91–98.
- Borgens, R.B. (1982). Mice regrow the tips of their foretoes. *Science* *217*, 747–750.
- Bornemann, D.J., Duncan, J.E., Staatz, W., Selleck, S., and Warrior, R. (2004). Abrogation of heparan sulfate synthesis in *Drosophila* disrupts the Wingless, Hedgehog and Decapentaplegic signaling pathways. *Dev. Camb. Engl.* *131*, 1927–1938.
- Bouvier, M., Moffett, S., Loisel, T.P., Mouillac, B., Hebert, T., and Chidiac, P. (1995). Palmitoylation of G-protein-coupled receptors: a dynamic modification with functional consequences. *Biochem. Soc. Trans.* *23*, 116–120.
- Boveris, A. (1977). Mitochondrial production of superoxide radical and hydrogen peroxide. *Adv. Exp. Med. Biol.* *78*, 67–82.
- Bovolenta, P., and Sanchez-Arrones, L. (2012). Shh goes multidirectional in axon guidance. *Cell Res.* *22*, 611–613.
- Bras, M., Queenan, B., and Susin, S.A. (2005). Programmed cell death via mitochondria: different modes of dying. *Biochem. Biokhimii* *70*, 231–239.
- Brenman, J.E., Topinka, J.R., Cooper, E.C., McGee, A.W., Rosen, J., Milroy, T., Ralston, H.J., and Bredt, D.S. (1998). Localization of postsynaptic density-93 to dendritic microtubules and interaction with microtubule-associated protein 1A. *J. Neurosci. Off. J. Soc. Neurosci.* *18*, 8805–8813.

- van den Brink, G.R. (2007). Hedgehog signaling in development and homeostasis of the gastrointestinal tract. *Physiol. Rev.* 87, 1343–1375.
- Briscoe, J., Chen, Y., Jessell, T.M., and Struhl, G. (2001). A hedgehog-insensitive form of patched provides evidence for direct long-range morphogen activity of sonic hedgehog in the neural tube. *Mol. Cell* 7, 1279–1291.
- Brockes, J.P. (1984). Mitogenic growth factors and nerve dependence of limb regeneration. *Science* 225, 1280–1287.
- Brockes, J.P. (1987). The nerve dependence of amphibian limb regeneration. *J. Exp. Biol.* 132, 79–91.
- Brockes, J.P. (1997). Amphibian limb regeneration: rebuilding a complex structure. *Science* 276, 81–87.
- Brockes, J.P., and Kintner, C.R. (1986). Glial growth factor and nerve-dependent proliferation in the regeneration blastema of Urodele amphibians. *Cell* 45, 301–306.
- Brockes, J.P., and Kumar, A. (2002). Plasticity and reprogramming of differentiated cells in amphibian regeneration. *Nat. Rev. Mol. Cell Biol.* 3, 566–574.
- Brockes, J.P., and Kumar, A. (2005). Appendage regeneration in adult vertebrates and implications for regenerative medicine. *Science* 310, 1919–1923.
- Brockes, J.P., and Kumar, A. (2008). Comparative aspects of animal regeneration. *Annu. Rev. Cell Dev. Biol.* 24, 525–549.
- Brockes, J.P., Kumar, A., and Velloso, C.P. (2001). Regeneration as an evolutionary variable. *J. Anat.* 199, 3–11.
- Brønsted, H.V. (1969). *Planarian regeneration* (London: Pergamon Press).
- Brown, M.R., Miller, F.J., Li, W.G., Ellingson, A.N., Mozena, J.D., Chatterjee, P., Engelhardt, J.F., Zwacka, R.M., Oberley, L.W., Fang, X., et al. (1999). Overexpression of human catalase inhibits proliferation and promotes apoptosis in vascular smooth muscle cells. *Circ. Res.* 85, 524–533.
- Buglino, J.A., and Resh, M.D. (2008). What is a palmitoyltransferase with specificity for N-palmitoylation of Sonic Hedgehog. *J. Biol. Chem.* 283, 22076–22088.
- Buglino, J.A., and Resh, M.D. (2012). Palmitoylation of Hedgehog Proteins. In *Vitamins & Hormones*, (Elsevier), pp. 229–252.
- Burke, R., Nellen, D., Bellotto, M., Hafen, E., Senti, K.A., Dickson, B.J., and Basler, K. (1999). Dispatched, a novel sterol-sensing domain protein dedicated to the release of cholesterol-modified hedgehog from signaling cells. *Cell* 99, 803–815.
- Butler, E.G., and Schotté, O.E. (1941). Histological alterations in denervated non-regenerating limbs of urodele larvae. *J. Exp. Zool.* 88, 307–341.
- Callejo, A., Culi, J., and Guerrero, I. (2008). Patched, the receptor of Hedgehog, is a lipoprotein receptor. *Proc. Natl. Acad. Sci. U. S. A.* 105, 912–917.
- Camp, L.A., and Hofmann, S.L. (1993). Purification and properties of a palmitoyl-protein thioesterase that cleaves palmitate from H-Ras. *J. Biol. Chem.* 268, 22566–22574.
- Camp, L.A., Verkruyse, L.A., Afendis, S.J., Slaughter, C.A., and Hofmann, S.L. (1994). Molecular cloning and expression of palmitoyl-protein thioesterase. *J. Biol. Chem.* 269, 23212–23219.
- Campbell, R.D., and David, C.N. (1974). Cell cycle kinetics and development of *Hydra attenuata*. II. Interstitial cells. *J. Cell Sci.* 16, 349–358.

- Candia Carnevali, M.D., Bonasoro, F., Lucca, E., and Thorndyke, M.C. (1995). Pattern of cell proliferation in the early stages of arm regeneration in the feather star *Antedon mediterranea*. *J. Exp. Zool.* 272, 464–474.
- Carlson, B.M. (2007). *Principles of Regenerative Biology* (London: Academic Press).
- Carlson, M.E., and Conboy, I.M. (2007). Loss of stem cell regenerative capacity within aged niches. *Aging Cell* 6, 371–382.
- Carr, S.A., Biemann, K., Shoji, S., Parmelee, D.C., and Titani, K. (1982). n-Tetradecanoyl is the NH₂-terminal blocking group of the catalytic subunit of cyclic AMP-dependent protein kinase from bovine cardiac muscle. *Proc. Natl. Acad. Sci. U. S. A.* 79, 6128–6131.
- Casey, P.J. (1992). Biochemistry of protein prenylation. *J. Lipid Res.* 33, 1731–1740.
- Chamberlain, L.H., and Shipston, M.J. (2015). The physiology of protein S-acylation. *Physiol. Rev.* 95, 341–376.
- Chamoun, Z., Mann, R.K., Nellen, D., von Kessler, D.P., Bellotto, M., Beachy, P.A., and Basler, K. (2001). Skinny hedgehog, an acyltransferase required for palmitoylation and activity of the hedgehog signal. *Science* 293, 2080–2084.
- Chan, W.Y., Lee, K.K., and Tam, P.P. (1991). Regenerative capacity of forelimb buds after amputation in mouse embryos at the early-organogenesis stage. *J. Exp. Zool.* 260, 74–83.
- Chance, B., Sies, H., and Boveris, A. (1979). Hydroperoxide metabolism in mammalian organs. *Physiol. Rev.* 59, 527–605.
- Chang, B.E., Blader, P., Fischer, N., Ingham, P.W., and Strähle, U. (1997). Axial (HNF3beta) and retinoic acid receptors are regulators of the zebrafish sonic hedgehog promoter. *EMBO J.* 16, 3955–3964.
- Chang, D.T., López, A., von Kessler, D.P., Chiang, C., Simandl, B.K., Zhao, R., Seldin, M.F., Fallon, J.F., and Beachy, P.A. (1994). Products, genetic linkage and limb patterning activity of a murine hedgehog gene. *Dev. Camb. Engl.* 120, 3339–3353.
- Chelikani, P., Fita, I., and Loewen, P.C. (2004). Diversity of structures and properties among catalases. *Cell. Mol. Life Sci. CMLS* 61, 192–208.
- Chen, Y., and Jiang, J. (2013). Decoding the phosphorylation code in Hedgehog signal transduction. *Cell Res.* 23, 186–200.
- Chen, Y., and Struhl, G. (1996). Dual roles for patched in sequestering and transducing Hedgehog. *Cell* 87, 553–563.
- Chen, C.-H., Puliafito, A., Cox, B.D., Primo, L., Fang, Y., Di Talia, S., and Poss, K.D. (2016). Multicolor Cell Barcoding Technology for Long-Term Surveillance of Epithelial Regeneration in Zebrafish. *Dev. Cell* 36, 668–680.
- Chen, L., Chetkovich, D.M., Petralia, R.S., Sweeney, N.T., Kawasaki, Y., Wenthold, R.J., Brecht, D.S., and Nicoll, R.A. (2000). Stargazin regulates synaptic targeting of AMPA receptors by two distinct mechanisms. *Nature* 408, 936–943.
- Chen, M.-H., Li, Y.-J., Kawakami, T., Xu, S.-M., and Chuang, P.-T. (2004). Palmitoylation is required for the production of a soluble multimeric Hedgehog protein complex and long-range signaling in vertebrates. *Genes Dev.* 18, 641–659.
- Chen, M.-H., Gao, N., Kawakami, T., and Chuang, P.-T. (2005). Mice deficient in the fused homolog do not exhibit phenotypes indicative of perturbed hedgehog signaling during embryonic development. *Mol. Cell. Biol.* 25, 7042–7053.

- Chen, M.-H., Wilson, C.W., Li, Y.-J., Law, K.K.L., Lu, C.-S., Gacayan, R., Zhang, X., Hui, C., and Chuang, P.-T. (2009). Cilium-independent regulation of Gli protein function by Sufu in Hedgehog signaling is evolutionarily conserved. *Genes Dev.* *23*, 1910–1928.
- Chen, Y., Sasai, N., Ma, G., Yue, T., Jia, J., Briscoe, J., and Jiang, J. (2011). Sonic Hedgehog dependent phosphorylation by CK1 α and GRK2 is required for ciliary accumulation and activation of smoothed. *PLoS Biol.* *9*, e1001083.
- Chen, Y., Love, N.R., and Amaya, E. (2014). Tadpole tail regeneration in *Xenopus*. *Biochem. Soc. Trans.* *42*, 617–623.
- Cheng, S.Y., and Bishop, J.M. (2002). Suppressor of Fused represses Gli-mediated transcription by recruiting the SAP18-mSin3 corepressor complex. *Proc. Natl. Acad. Sci. U. S. A.* *99*, 5442–5447.
- Chetkovich, D.M., Bunn, R.C., Kuo, S.-H., Kawasaki, Y., Kohwi, M., and Bredt, D.S. (2002). Postsynaptic targeting of alternative postsynaptic density-95 isoforms by distinct mechanisms. *J. Neurosci. Off. J. Soc. Neurosci.* *22*, 6415–6425.
- Chiang, C., Litingtung, Y., Lee, E., Young, K.E., Corden, J.L., Westphal, H., and Beachy, P.A. (1996). Cyclopia and defective axial patterning in mice lacking Sonic hedgehog gene function. *Nature* *383*, 407–413.
- Chiarugi, P., and Cirri, P. (2003). Redox regulation of protein tyrosine phosphatases during receptor tyrosine kinase signal transduction. *Trends Biochem. Sci.* *28*, 509–514.
- Chini, B., and Parenti, M. (2009). G-protein-coupled receptors, cholesterol and palmitoylation: facts about fats. *J. Mol. Endocrinol.* *42*, 371–379.
- Cho, K.O., Hunt, C.A., and Kennedy, M.B. (1992). The rat brain postsynaptic density fraction contains a homolog of the *Drosophila* discs-large tumor suppressor protein. *Neuron* *9*, 929–942.
- Cho, Y.M., Kwon, S., Pak, Y.K., Seol, H.W., Choi, Y.M., Park, D.J., Park, K.S., and Lee, H.K. (2006). Dynamic changes in mitochondrial biogenesis and antioxidant enzymes during the spontaneous differentiation of human embryonic stem cells. *Biochem. Biophys. Res. Commun.* *348*, 1472–1478.
- Choo, A.F., Logan, D.M., and Rathbone, M.P. (1978). Nerve trophic effects: an in vitro assay for factors involved in regulation of protein synthesis in regenerating amphibian limbs. *J. Exp. Zool.* *206*, 347–354.
- Christensen, R.N., and Tassava, R.A. (2000). Apical epithelial cap morphology and fibronectin gene expression in regenerating axolotl limbs. *Dev. Dyn. Off. Publ. Am. Assoc. Anat.* *217*, 216–224.
- Chuang, P.T., and McMahon, A.P. (1999). Vertebrate Hedgehog signalling modulated by induction of a Hedgehog-binding protein. *Nature* *397*, 617–621.
- Colnot, C., de la Fuente, L., Huang, S., Hu, D., Lu, C., St-Jacques, B., and Helms, J.A. (2005). Indian hedgehog synchronizes skeletal angiogenesis and perichondrial maturation with cartilage development. *Dev. Camb. Engl.* *132*, 1057–1067.
- Cooper, A.F., Yu, K.P., Brueckner, M., Brailey, L.L., Johnson, L., McGrath, J.M., and Bale, A.E. (2005). Cardiac and CNS defects in a mouse with targeted disruption of suppressor of fused. *Dev. Camb. Engl.* *132*, 4407–4417.
- Corbit, K.C., Aanstad, P., Singla, V., Norman, A.R., Stainier, D.Y.R., and Reiter, J.F. (2005). Vertebrate Smoothed functions at the primary cilium. *Nature* *437*, 1018–1021.
- Corvi, M.M., Soltys, C.L., and Berthiaume, L.G. (2001). Regulation of mitochondrial carbamoyl-phosphate synthetase 1 activity by active site fatty acylation. *J. Biol. Chem.* *276*, 45704–45712.
- Covarrubias, L., Hernández-García, D., Schnabel, D., Salas-Vidal, E., and Castro-Obregón, S. (2008). Function of reactive oxygen species during animal development: Passive or active? *Dev. Biol.* *320*, 1–11.

- Craven, S.E., and Brecht, D.S. (1998). PDZ proteins organize synaptic signaling pathways. *Cell* 93, 495–498.
- Craven, S.E., El-Husseini, A.E., and Brecht, D.S. (1999). Synaptic targeting of the postsynaptic density protein PSD-95 mediated by lipid and protein motifs. *Neuron* 22, 497–509.
- Creanga, A., Glenn, T.D., Mann, R.K., Saunders, A.M., Talbot, W.S., and Beachy, P.A. (2012). Scube/You activity mediates release of dually lipid-modified Hedgehog signal in soluble form. *Genes Dev.* 26, 1312–1325.
- Crow, J.P. (1997). Dichlorodihydrofluorescein and dihydrorhodamine 123 are sensitive indicators of peroxynitrite in vitro: implications for intracellular measurement of reactive nitrogen and oxygen species. *Nitric Oxide Biol. Chem. Off. J. Nitric Oxide Soc.* 1, 145–157.
- Currie, P.D., and Ingham, P.W. (1996). Induction of a specific muscle cell type by a hedgehog-like protein in zebrafish. *Nature* 382, 452–455.
- D'Autréaux, B., and Toledano, M.B. (2007). ROS as signalling molecules: mechanisms that generate specificity in ROS homeostasis. *Nat. Rev. Mol. Cell Biol.* 8, 813–824.
- David, C.N., and Campbell, R.D. (1972). Cell cycle kinetics and development of *Hydra attenuata*. I. Epithelial cells. *J. Cell Sci.* 11, 557–568.
- Davies, K.J. (1999). The broad spectrum of responses to oxidants in proliferating cells: a new paradigm for oxidative stress. *IUBMB Life* 48, 41–47.
- Dawber, R.J., Hebbes, S., Herpers, B., Docquier, F., and van den Heuvel, M. (2005). Differential range and activity of various forms of the Hedgehog protein. *BMC Dev. Biol.* 5, 21.
- DeCamp, D.L., Thompson, T.M., de Sauvage, F.J., and Lerner, M.R. (2000). Smoothed activates Galphai-mediated signaling in frog melanophores. *J. Biol. Chem.* 275, 26322–26327.
- Degtyarev, M.Y., Spiegel, A.M., and Jones, T.L. (1993a). Increased palmitoylation of the Gs protein alpha subunit after activation by the beta-adrenergic receptor or cholera toxin. *J. Biol. Chem.* 268, 23769–23772.
- Degtyarev, M.Y., Spiegel, A.M., and Jones, T.L. (1993b). The G protein alpha s subunit incorporates [³H]palmitic acid and mutation of cysteine-3 prevents this modification. *Biochemistry (Mosc.)* 32, 8057–8061.
- Delaunay, A., Pflieger, D., Barrault, M.B., Vinh, J., and Toledano, M.B. (2002). A thiol peroxidase is an H₂O₂ receptor and redox-transducer in gene activation. *Cell* 111, 471–481.
- Denef, N., Neubüser, D., Perez, L., and Cohen, S.M. (2000). Hedgehog induces opposite changes in turnover and subcellular localization of patched and smoothed. *Cell* 102, 521–531.
- De Robertis, E.M., and Sasai, Y. (1996). A common plan for dorsoventral patterning in Bilateria. *Nature* 380, 37–40.
- DeSouza, S., Fu, J., States, B.A., and Ziff, E.B. (2002). Differential palmitoylation directs the AMPA receptor-binding protein ABP to spines or to intracellular clusters. *J. Neurosci. Off. J. Soc. Neurosci.* 22, 3493–3503.
- Dighe, S.A., and Kozminski, K.G. (2008). Swf1p, a member of the DHHC-CRD family of palmitoyltransferases, regulates the actin cytoskeleton and polarized secretion independently of its DHHC motif. *Mol. Biol. Cell* 19, 4454–4468.
- Ding, Q., Fukami, S. i, Meng, X., Nishizaki, Y., Zhang, X., Sasaki, H., Dlugosz, A., Nakafuku, M., and Hui, C. c (1999). Mouse suppressor of fused is a negative regulator of sonic hedgehog signaling and alters the subcellular distribution of Gli1. *Curr. Biol. CB* 9, 1119–1122.
- Dinsmore, C.E. (1991). *A History of Regeneration Research: Milestones in the Evolution of a Science* (Cambridge University Press).

- Dinsmore, C.E. (1996). Urodele limb and tail regeneration in early biological thought: an essay on scientific controversy and social change. *Int. J. Dev. Biol.* *40*, 621–627.
- Dong, H., O'Brien, R.J., Fung, E.T., Lanahan, A.A., Worley, P.F., and Huganir, R.L. (1997). GRIP: a synaptic PDZ domain-containing protein that interacts with AMPA receptors. *Nature* *386*, 279–284.
- Dooley, K., and Zon, L.I. (2000). Zebrafish: a model system for the study of human disease. *Curr. Opin. Genet. Dev.* *10*, 252–256.
- Dotti, C.G., and Simons, K. (1990). Polarized sorting of viral glycoproteins to the axon and dendrites of hippocampal neurons in culture. *Cell* *62*, 63–72.
- Dotti, C.G., Parton, R.G., and Simons, K. (1991). Polarized sorting of glypiated proteins in hippocampal neurons. *Nature* *349*, 158–161.
- Drazic, A., and Winter, J. (2014). The physiological role of reversible methionine oxidation. *Biochim. Biophys. Acta* *1844*, 1367–1382.
- Dröge, W. (2002). Free radicals in the physiological control of cell function. *Physiol. Rev.* *82*, 47–95.
- Dufourcq, P., and Vríz, S. (2006). The chemokine SDF-1 regulates blastema formation during zebrafish fin regeneration. *Dev. Genes Evol.* *216*, 635–639.
- Duncan, J.A., and Gilman, A.G. (1996). Autoacylation of G protein alpha subunits. *J. Biol. Chem.* *271*, 23594–23600.
- Duncan, J.A., and Gilman, A.G. (1998). A cytoplasmic acyl-protein thioesterase that removes palmitate from G protein alpha subunits and p21(RAS). *J. Biol. Chem.* *273*, 15830–15837.
- Duncan, J.A., and Gilman, A.G. (2002). Characterization of *Saccharomyces cerevisiae* acyl-protein thioesterase 1, the enzyme responsible for G protein alpha subunit deacylation in vivo. *J. Biol. Chem.* *277*, 31740–31752.
- Dunphy, J.T., and Linder, M.E. (1998). Signalling functions of protein palmitoylation. *Biochim. Biophys. Acta* *1436*, 245–261.
- Dunphy, J.T., Schroeder, H., Leventis, R., Greentree, W.K., Knudsen, J.K., Silvius, J.R., and Linder, M.E. (2000). Differential effects of acyl-CoA binding protein on enzymatic and non-enzymatic thioacylation of protein and peptide substrates. *Biochim. Biophys. Acta* *1485*, 185–198.
- Dyer, M.A., Farrington, S.M., Mohn, D., Munday, J.R., and Baron, M.H. (2001). Indian hedgehog activates hematopoiesis and vasculogenesis and can respecify prospective neurectodermal cell fate in the mouse embryo. *Dev. Camb. Engl.* *128*, 1717–1730.
- Eason, M.G., Jacinto, M.T., Theiss, C.T., and Liggett, S.B. (1994). The palmitoylated cysteine of the cytoplasmic tail of alpha 2A-adrenergic receptors confers subtype-specific agonist-promoted downregulation. *Proc. Natl. Acad. Sci. U. S. A.* *91*, 11178–11182.
- Echelard, Y., Epstein, D.J., St-Jacques, B., Shen, L., Mohler, J., McMahon, J.A., and McMahon, A.P. (1993). Sonic hedgehog, a member of a family of putative signaling molecules, is implicated in the regulation of CNS polarity. *Cell* *75*, 1417–1430.
- Echeverri, K., and Tanaka, E.M. (2002). Ectoderm to mesoderm lineage switching during axolotl tail regeneration. *Science* *298*, 1993–1996.
- Ekker, S.C., Ungar, A.R., Greenstein, P., von Kessler, D.P., Porter, J.A., Moon, R.T., and Beachy, P.A. (1995). Patterning activities of vertebrate hedgehog proteins in the developing eye and brain. *Curr. Biol. CB* *5*, 944–955.

- El-Husseini, A.E.-D., and Brecht, D.S. (2002). Protein palmitoylation: a regulator of neuronal development and function. *Nat. Rev. Neurosci.* *3*, 791–802.
- El-Husseini, A.E., Craven, S.E., Chetkovich, D.M., Firestein, B.L., Schnell, E., Aoki, C., and Brecht, D.S. (2000a). Dual palmitoylation of PSD-95 mediates its vesiculotubular sorting, postsynaptic targeting, and ion channel clustering. *J. Cell Biol.* *148*, 159–172.
- El-Husseini, A.E., Topinka, J.R., Lehrer-Graiwer, J.E., Firestein, B.L., Craven, S.E., Aoki, C., and Brecht, D.S. (2000b). Ion channel clustering by membrane-associated guanylate kinases. Differential regulation by N-terminal lipid and metal binding motifs. *J. Biol. Chem.* *275*, 23904–23910.
- El-Husseini, A.E., Schnell, E., Chetkovich, D.M., Nicoll, R.A., and Brecht, D.S. (2000c). PSD-95 involvement in maturation of excitatory synapses. *Science* *290*, 1364–1368.
- El-Husseini, A.E.-D., Schnell, E., Dakoji, S., Sweeney, N., Zhou, Q., Prange, O., Gauthier-Campbell, C., Aguilera-Moreno, A., Nicoll, R.A., and Brecht, D.S. (2002). Synaptic strength regulated by palmitate cycling on PSD-95. *Cell* *108*, 849–863.
- El-Husseini, A. el-D., Craven, S.E., Brock, S.C., and Brecht, D.S. (2001). Polarized targeting of peripheral membrane proteins in neurons. *J. Biol. Chem.* *276*, 44984–44992.
- Epstein, D.J., McMahon, A.P., and Joyner, A.L. (1999). Regionalization of Sonic hedgehog transcription along the anteroposterior axis of the mouse central nervous system is regulated by Hnf3-dependent and -independent mechanisms. *Dev. Camb. Engl.* *126*, 281–292.
- Erickson, J.R., Joiner, M.A., Guan, X., Kutschke, W., Yang, J., Oddis, C.V., Bartlett, R.K., Lowe, J.S., O'Donnell, S.E., Aykin-Burns, N., et al. (2008). A dynamic pathway for calcium-independent activation of CaMKII by methionine oxidation. *Cell* *133*, 462–474.
- Fahmy, G.H., and Sicard, R.E. (1998). Acceleration of amphibian forelimb regeneration by polypeptide growth factors. *Journal of the Minnesota Academy of Science.*
- Fan, J., Liu, Y., and Jia, J. (2012). Hh-induced Smoothed conformational switch is mediated by differential phosphorylation at its C-terminal tail in a dose- and position-dependent manner. *Dev. Biol.* *366*, 172–184.
- Farazi, T.A., Waksman, G., and Gordon, J.I. (2001). The biology and enzymology of protein N-myristoylation. *J. Biol. Chem.* *276*, 39501–39504.
- Ferretti, P., and Brockes, J.P. (1991). Cell origin and identity in limb regeneration and development. *Glia* *4*, 214–224.
- Finkel, T. (1998). Oxygen radicals and signaling. *Curr. Opin. Cell Biol.* *10*, 248–253.
- Finkel, T. (2011). Signal transduction by reactive oxygen species. *J. Cell Biol.* *194*, 7–15.
- Flohe, L., Günzler, W.A., and Schock, H.H. (1973). Glutathione peroxidase: a selenoenzyme. *FEBS Lett.* *32*, 132–134.
- Fogarty, C.E., Diwanji, N., Lindblad, J.L., Tare, M., Amcheslavsky, A., Makhijani, K., Brückner, K., Fan, Y., and Bergmann, A. (2016). Extracellular Reactive Oxygen Species Drive Apoptosis-Induced Proliferation via *Drosophila* Macrophages. *Curr. Biol.* *26*, 575–584.
- Fomenko, D.E., Koc, A., Agisheva, N., Jacobsen, M., Kaya, A., Malinouski, M., Rutherford, J.C., Siu, K.-L., Jin, D.-Y., Winge, D.R., et al. (2011). Thiol peroxidases mediate specific genome-wide regulation of gene expression in response to hydrogen peroxide. *Proc. Natl. Acad. Sci. U. S. A.* *108*, 2729–2734.
- Forkink, M., Smeitink, J.A.M., Brock, R., Willems, P.H.G.M., and Koopman, W.J.H. (2010). Detection and manipulation of mitochondrial reactive oxygen species in mammalian cells. *Biochim. Biophys. Acta* *1797*, 1034–1044.

- Forsthoefel, D.J., James, N.P., Escobar, D.J., Stary, J.M., Vieira, A.P., Waters, F.A., and Newmark, P.A. (2012). An RNAi screen reveals intestinal regulators of branching morphogenesis, differentiation, and stem cell proliferation in planarians. *Dev. Cell* 23, 691–704.
- Freitas, M., Lima, J.L.F.C., and Fernandes, E. (2009). Optical probes for detection and quantification of neutrophils' oxidative burst. A review. *Anal. Chim. Acta* 649, 8–23.
- Fujita, M., and Kinoshita, T. (2010). Structural remodeling of GPI anchors during biosynthesis and after attachment to proteins. *FEBS Lett.* 584, 1670–1677.
- Fukata, M., Fukata, Y., Adesnik, H., Nicoll, R.A., and Brecht, D.S. (2004). Identification of PSD-95 palmitoylating enzymes. *Neuron* 44, 987–996.
- Fukata, Y., Dimitrov, A., Boncompain, G., Vielemeyer, O., Perez, F., and Fukata, M. (2013). Local palmitoylation cycles define activity-regulated postsynaptic subdomains. *J. Cell Biol.* 202, 145–161.
- Funato, Y., Michiue, T., Asashima, M., and Miki, H. (2006). The thioredoxin-related redox-regulating protein nucleoredoxin inhibits Wnt-beta-catenin signalling through dishevelled. *Nat. Cell Biol.* 8, 501–508.
- Galang, C.K., and Hauser, C.A. (1993). Cooperative DNA binding of the human HoxB5 (Hox-2.1) protein is under redox regulation in vitro. *Mol. Cell. Biol.* 13, 4609–4617.
- Gallet, A., and Therond, P.P. (2005). Temporal modulation of the Hedgehog morphogen gradient by a patched-dependent targeting to lysosomal compartment. *Dev. Biol.* 277, 51–62.
- Galliot, B. (1997). Signaling molecules in regenerating hydra. *BioEssays News Rev. Mol. Cell. Dev. Biol.* 19, 37–46.
- Galliot, B. (2011). Entre homéostasie et développement, quelles stratégies pour régénérer ? *Biol. Aujourd'hui* 205, 125–137.
- Galliot, B., and Chera, S. (2010). The Hydra model: disclosing an apoptosis-driven generator of Wnt-based regeneration. *Trends Cell Biol.* 20, 514–523.
- Galliot, B., and Ghila, L. (2010). Cell plasticity in homeostasis and regeneration. *Mol. Reprod. Dev.* 77, 837–855.
- Gardiner, D.M., and Bryant, S.V. (1996). Molecular mechanisms in the control of limb regeneration: the role of homeobox genes. *Int J Dev Biol* 40, 797–805.
- Gardiner, D.M., Blumberg, B., Komine, Y., and Bryant, S.V. (1995). Regulation of HoxA expression in developing and regenerating axolotl limbs. *Development* 121, 1731–1741.
- Gargioli, C., and Slack, J.M.W. (2004). Cell lineage tracing during *Xenopus* tail regeneration. *Dev. Camb. Engl.* 131, 2669–2679.
- Garner, C.C., Nash, J., and Haganir, R.L. (2000). PDZ domains in synapse assembly and signalling. *Trends Cell Biol.* 10, 274–280.
- Gauron, C., Rampon, C., Bouzaffour, M., Ipendey, E., Teillon, J., Volovitch, M., and Vríz, S. (2013). Sustained production of ROS triggers compensatory proliferation and is required for regeneration to proceed. *Sci. Rep.* 3.
- Gehring, W.J., Affolter, M., and Bürglin, T. (1994). Homeodomain proteins. *Annu. Rev. Biochem.* 63, 487–526.
- Geraudie, J., and Singer, M. (1977). Relation between nerve fiber number and pectoral fin regeneration in the teleost. *J. Exp. Zool.* 199, 1–8.

- Geraudie, J., and Singer, M. (1985). Necessity of an adequate nerve supply for regeneration of the amputated pectoral fin in the teleost *Fundulus*. *J. Exp. Zool.* *234*, 367–374.
- Geraudie, J., and Singer, M. (1992). The fish fin regenerate. *Monogr. Dev. Biol.* *23*, 62–72.
- Géraudie, J., Brulfert, A., Monnot, M.J., and Ferretti, P. (1994). Teratogenic and morphogenetic effects of retinoic acid on the regenerating pectoral fin in zebrafish. *J. Exp. Zool.* *269*, 12–22.
- Giedion, S. (1962). *The Eternal Present: The Beginnings of Art.* (Pantheon, New York).
- Gierer, A., Berking, S., Bode, H., David, C.N., Flick, K., Hansmann, G., Schaller, H., and Trenkner, E. (1972). Regeneration of hydra from reaggregated cells. *Nature. New Biol.* *239*, 98–101.
- Giglione, C., Boularot, A., and Meinnel, T. (2004). Protein N-terminal methionine excision. *Cell. Mol. Life Sci. CMLS* *61*, 1455–1474.
- Giorgio, M., Trinei, M., Migliaccio, E., and Pelicci, P.G. (2007). Hydrogen peroxide: a metabolic by-product or a common mediator of ageing signals? *Nat. Rev. Mol. Cell Biol.* *8*, 722–728.
- Glenn, T.D., and Talbot, W.S. (2013). Signals regulating myelination in peripheral nerves and the Schwann cell response to injury. *Curr. Opin. Neurobiol.* *23*, 1041–1048.
- Goetz, S.C., and Anderson, K.V. (2010). The primary cilium: a signalling centre during vertebrate development. *Nat. Rev. Genet.* *11*, 331–344.
- Goetz, J.A., Singh, S., Suber, L.M., Kull, F.J., and Robbins, D.J. (2006). A highly conserved amino-terminal region of sonic hedgehog is required for the formation of its freely diffusible multimeric form. *J. Biol. Chem.* *281*, 4087–4093.
- Gomes, A., Fernandes, E., and Lima, J.L.F.C. (2005). Fluorescence probes used for detection of reactive oxygen species. *J. Biochem. Biophys. Methods* *65*, 45–80.
- Gospodarowicz, D., and Mescher, A.L. (1980). Fibroblast growth factor and the control of vertebrate regeneration and repair. *Ann. N. Y. Acad. Sci.* *339*, 151–174.
- Gospodarowicz, D., and Mescher, A.L. (1981). Fibroblast growth factor and vertebrate regeneration. *Adv. Neurol.* *29*, 149–171.
- Gospodarowicz, D., Mescher, A.L., and Birdwell, C.R. (1978). Control of cellular proliferation by the fibroblast and epidermal growth factors. *Natl. Cancer Inst. Monogr.* 109–130.
- Goss, R.J., and Holt, R. (1992). Epimorphic vs. tissue regeneration in *Xenopus* forelimbs. *J. Exp. Zool.* *261*, 451–457.
- Gossett, R.E., Frolov, A.A., Roths, J.B., Behnke, W.D., Kier, A.B., and Schroeder, F. (1996). Acyl-CoA binding proteins: multiplicity and function. *Lipids* *31*, 895–918.
- Gotenstein, J.R., Swale, R.E., Fukuda, T., Wu, Z., Giurumescu, C.A., Goncharov, A., Jin, Y., and Chisholm, A.D. (2010). The *C. elegans* peroxidase PXN-2 is essential for embryonic morphogenesis and inhibits adult axon regeneration. *Dev. Camb. Engl.* *137*, 3603–3613.
- Goytain, A., Hines, R.M., and Quamme, G.A. (2008). Huntingtin-interacting proteins, HIP14 and HIP14L, mediate dual functions, palmitoyl acyltransferase and Mg²⁺ transport. *J. Biol. Chem.* *283*, 33365–33374.
- Grant, C.M. (2011). Regulation of Translation by Hydrogen Peroxide. *Antioxid. Redox Signal.* *15*, 191–203.
- Gray, P.C., Johnson, B.D., Westenbroek, R.E., Hays, L.G., Yates, J.R., Scheuer, T., Catterall, W.A., and Murphy, B.J. (1998). Primary structure and function of an A kinase anchoring protein associated with calcium channels. *Neuron* *20*, 1017–1026.

- Greaves, J., and Chamberlain, L.H. (2011a). DHHC palmitoyl transferases: substrate interactions and (patho)physiology. *Trends Biochem. Sci.* *36*, 245–253.
- Greaves, J., and Chamberlain, L.H. (2011b). Differential palmitoylation regulates intracellular patterning of SNAP25. *J. Cell Sci.* *124*, 1351–1360.
- Greaves, J., Salaun, C., Fukata, Y., Fukata, M., and Chamberlain, L.H. (2008). Palmitoylation and membrane interactions of the neuroprotective chaperone cysteine-string protein. *J. Biol. Chem.* *283*, 25014–25026.
- Greaves, J., Prescott, G.R., Fukata, Y., Fukata, M., Salaun, C., and Chamberlain, L.H. (2009). The hydrophobic cysteine-rich domain of SNAP25 couples with downstream residues to mediate membrane interactions and recognition by DHHC palmitoyl transferases. *Mol. Biol. Cell* *20*, 1845–1854.
- Greaves, J., Gorleku, O.A., Salaun, C., and Chamberlain, L.H. (2010). Palmitoylation of the SNAP25 protein family: specificity and regulation by DHHC palmitoyl transferases. *J. Biol. Chem.* *285*, 24629–24638.
- Gruber, C.W., Cemazar, M., Heras, B., Martin, J.L., and Craik, D.J. (2006). Protein disulfide isomerase: the structure of oxidative folding. *Trends Biochem. Sci.* *31*, 455–464.
- Gulshan, K., Rovinsky, S.A., Coleman, S.T., and Moye-Rowley, W.S. (2005). Oxidant-specific folding of Yap1p regulates both transcriptional activation and nuclear localization. *J. Biol. Chem.* *280*, 40524–40533.
- Gupta, A., Dong, A., and Lowe, A.W. (2012). AGR2 gene function requires a unique endoplasmic reticulum localization motif. *J. Biol. Chem.* *287*, 4773–4782.
- Gurley, K.A., and Sanchez Alvarado, A. (2008). Stem cells in animal models of regeneration. In *StemBook*, (Cambridge (MA): Harvard Stem Cell Institute),.
- Gutscher, M., Sobotta, M.C., Wabnitz, G.H., Ballikaya, S., Meyer, A.J., Samstag, Y., and Dick, T.P. (2009). Proximity-based protein thiol oxidation by H₂O₂-scavenging peroxidases. *J. Biol. Chem.* *284*, 31532–31540.
- Guyon, J.R., Steffen, L.S., Howell, M.H., Pusack, T.J., Lawrence, C., and Kunkel, L.M. (2007). Modeling human muscle disease in zebrafish. *Biochim. Biophys. Acta* *1772*, 205–215.
- Hadzhiev, Y., Lele, Z., Schindler, S., Wilson, S.W., Ahlberg, P., Strähle, U., and Müller, F. (2007). Hedgehog signaling patterns the outgrowth of unpaired skeletal appendages in zebrafish. *BMC Dev. Biol.* *7*, 75.
- Hameed, L.S., Berg, D.A., Belnoue, L., Jensen, L.D., Cao, Y., and Simon, A. (2015). Environmental changes in oxygen tension reveal ROS-dependent neurogenesis and regeneration in the adult newt brain. *eLife* *4*.
- Hamilton, E. (1942). *Mythology* (Little, Brown, Boston).
- Hampton, M.B., Kettle, A.J., and Winterbourn, C.C. (1998). Inside the neutrophil phagosome: oxidants, myeloperoxidase, and bacterial killing. *Blood* *92*, 3007–3017.
- Han, C., Belenkaya, T.Y., Khodoun, M., Tauchi, M., Lin, X., and Lin, X. (2004a). Distinct and collaborative roles of Drosophila EXT family proteins in morphogen signalling and gradient formation. *Dev. Camb. Engl.* *131*, 1563–1575.
- Han, C., Belenkaya, T.Y., Wang, B., and Lin, X. (2004b). Drosophila glypicans control the cell-to-cell movement of Hedgehog by a dynamin-independent process. *Dev. Camb. Engl.* *131*, 601–611.
- Han, P., Zhou, X.-H., Chang, N., Xiao, C.-L., Yan, S., Ren, H., Yang, X.-Z., Zhang, M.-L., Wu, Q., Tang, B., et al. (2014). Hydrogen peroxide primes heart regeneration with a derepression mechanism. *Cell Res.* *24*, 1091–1107.
- Hancock, J.F., Cadwallader, K., Paterson, H., and Marshall, C.J. (1991). A CAAX or a CAAL motif and a second signal are sufficient for plasma membrane targeting of ras proteins. *EMBO J.* *10*, 4033–4039.

- Hansen, J.M., Go, Y.-M., and Jones, D.P. (2006). Nuclear and mitochondrial compartmentation of oxidative stress and redox signaling. *Annu. Rev. Pharmacol. Toxicol.* *46*, 215–234.
- Harsum, S., Clarke, J.D.W., and Martin, P. (2001). A Reciprocal Relationship between Cutaneous Nerves and Repairing Skin Wounds in the Developing Chick Embryo. *Dev. Biol.* *238*, 27–39.
- Harvey, R.P. (1996). Nk-2 homeobox genes and heart development. *Dev. Biol.* *178*, 203–216.
- Hashimoto, M., Ishii, K., Nakamura, Y., Watabe, K., Kohsaka, S., and Akazawa, C. (2008). Neuroprotective effect of sonic hedgehog up-regulated in Schwann cells following sciatic nerve injury. *J. Neurochem.* *107*, 918–927.
- Haycraft, C.J., Banizs, B., Aydin-Son, Y., Zhang, Q., Michaud, E.J., and Yoder, B.K. (2005). Gli2 and Gli3 localize to cilia and require the intraflagellar transport protein polaris for processing and function. *PLoS Genet.* *1*, e53.
- Heal, W.P., Jovanovic, B., Bessin, S., Wright, M.H., Magee, A.I., and Tate, E.W. (2011). Bioorthogonal chemical tagging of protein cholesterylation in living cells. *Chem. Commun. Camb. Engl.* *47*, 4081–4083.
- Hedges, S.B. (2002). The origin and evolution of model organisms. *Nat. Rev. Genet.* *3*, 838–849.
- Hellsten, E., Vesa, J., Olkkonen, V.M., Jalanko, A., and Peltonen, L. (1996). Human palmitoyl protein thioesterase: evidence for lysosomal targeting of the enzyme and disturbed cellular routing in infantile neuronal ceroid lipofuscinosis. *EMBO J.* *15*, 5240–5245.
- Hemsley, P.A., and Grierson, C.S. (2011). The ankyrin repeats and DHHC S-acyl transferase domain of AKR1 act independently to regulate switching from vegetative to mating states in yeast. *PloS One* *6*, e28799.
- Herr, W., and Cleary, M.A. (1995). The POU domain: versatility in transcriptional regulation by a flexible two-in-one DNA-binding domain. *Genes Dev.* *9*, 1679–1693.
- Hesiod Theogony (lines 521-525).
- Hess, D.T., Slater, T.M., Wilson, M.C., and Skene, J.H. (1992). The 25 kDa synaptosomal-associated protein SNAP-25 is the major methionine-rich polypeptide in rapid axonal transport and a major substrate for palmitoylation in adult CNS. *J. Neurosci. Off. J. Soc. Neurosci.* *12*, 4634–4641.
- Hess, D.T., Patterson, S.I., Smith, D.S., and Skene, J.H. (1993). Neuronal growth cone collapse and inhibition of protein fatty acylation by nitric oxide. *Nature* *366*, 562–565.
- van den Heuvel, M., and Ingham, P.W. (1996). *smoothed* encodes a receptor-like serpentine protein required for hedgehog signalling. *Nature* *382*, 547–551.
- Higa, A., Mulot, A., Delom, F., Bouche-careilh, M., Nguyễn, D.T., Boismenu, D., Wise, M.J., and Chevet, E. (2011). Role of pro-oncogenic protein disulfide isomerase (PDI) family member anterior gradient 2 (AGR2) in the control of endoplasmic reticulum homeostasis. *J. Biol. Chem.* *286*, 44855–44868.
- Hines, R.M., Kang, R., Goytain, A., and Quamme, G.A. (2010). Golgi-specific DHHC zinc finger protein GODZ mediates membrane Ca²⁺ transport. *J. Biol. Chem.* *285*, 4621–4628.
- Hirota, K., Matsui, M., Iwata, S., Nishiyama, A., Mori, K., and Yodoi, J. (1997). AP-1 transcriptional activity is regulated by a direct association between thioredoxin and Ref-1. *Proc. Natl. Acad. Sci. U. S. A.* *94*, 3633–3638.
- Hoffman, L., Miles, J., Avaron, F., Laforest, L., and Akimenko, M.-A. (2002). Exogenous retinoic acid induces a stage-specific, transient and progressive extension of Sonic hedgehog expression across the pectoral fin bud of zebrafish. *Int. J. Dev. Biol.* *46*, 949–956.
- Hofmann, B., Hecht, H.-J., and Flohé, L. (2002). Peroxiredoxins. *Biol. Chem.* *383*, 347–364.

- Holmström, K.M., and Finkel, T. (2014). Cellular mechanisms and physiological consequences of redox-dependent signalling. *Nat. Rev. Mol. Cell Biol.* *15*, 411–421.
- Holtzer, S.W. (1956). The inductive activity of the spinal cord in urodele tail regeneration. *J. Morphol.* *99*, 1–39.
- Hooper, J.E. (2003). Smoothed translates Hedgehog levels into distinct responses. *Dev. Camb. Engl.* *130*, 3951–3963.
- Hooper, J.E., and Scott, M.P. (1989). The *Drosophila* patched gene encodes a putative membrane protein required for segmental patterning. *Cell* *59*, 751–765.
- Huang, K., Yanai, A., Kang, R., Arstikaitis, P., Singaraja, R.R., Metzler, M., Mullard, A., Haigh, B., Gauthier-Campbell, C., Gutekunst, C.-A., et al. (2004). Huntingtin-interacting protein HIP14 is a palmitoyl transferase involved in palmitoylation and trafficking of multiple neuronal proteins. *Neuron* *44*, 977–986.
- Huang, K., Sanders, S., Singaraja, R., Orban, P., Cijssouw, T., Arstikaitis, P., Yanai, A., Hayden, M.R., and El-Husseini, A. (2009). Neuronal palmitoyl acyl transferases exhibit distinct substrate specificity. *FASEB J. Off. Publ. Fed. Am. Soc. Exp. Biol.* *23*, 2605–2615.
- Huangfu, D., and Anderson, K.V. (2005). Cilia and Hedgehog responsiveness in the mouse. *Proc. Natl. Acad. Sci. U. S. A.* *102*, 11325–11330.
- Hui, C.-C., and Angers, S. (2011). Gli proteins in development and disease. *Annu. Rev. Cell Dev. Biol.* *27*, 513–537.
- Humke, E.W., Dorn, K.V., Milenkovic, L., Scott, M.P., and Rohatgi, R. (2010). The output of Hedgehog signaling is controlled by the dynamic association between Suppressor of Fused and the Gli proteins. *Genes Dev.* *24*, 670–682.
- Hung, R.-J., Spaeth, C.S., Yesilyurt, H.G., and Terman, J.R. (2013). SelR reverses Mical-mediated oxidation of actin to regulate F-actin dynamics. *Nat. Cell Biol.* *15*, 1445–1454.
- Hussain, S., Slikker, W., and Ali, S.F. (1995). Age-related changes in antioxidant enzymes, superoxide dismutase, catalase, glutathione peroxidase and glutathione in different regions of mouse brain. *Int. J. Dev. Neurosci. Off. J. Int. Soc. Dev. Neurosci.* *13*, 811–817.
- Huxley, J. (1921). Studies in dedifferentiation. II. Dedifferentiation and resorption in *Perophora*. *Q J Microsc Sci* *65*, 643–698.
- Iiri, T., Backlund, P.S., Jones, T.L., Wedegaertner, P.B., and Bourne, H.R. (1996). Reciprocal regulation of Gs alpha by palmitate and the beta gamma subunit. *Proc. Natl. Acad. Sci. U. S. A.* *93*, 14592–14597.
- Illingworth, C.M. (1974). Trapped fingers and amputated finger tips in children. *J. Pediatr. Surg.* *9*, 853–858.
- Imokawa, Y., and Yoshizato, K. (1997). Expression of Sonic hedgehog gene in regenerating newt limb blastemas recapitulates that in developing limb buds. *Proc. Natl. Acad. Sci.* *94*, 9159–9164.
- Incardona, J.P., Gaffield, W., Kapur, R.P., and Roelink, H. (1998). The teratogenic *Veratrum* alkaloid cyclophamide inhibits sonic hedgehog signal transduction. *Dev. Camb. Engl.* *125*, 3553–3562.
- Incardona, J.P., Lee, J.H., Robertson, C.P., Enga, K., Kapur, R.P., and Roelink, H. (2000). Receptor-mediated endocytosis of soluble and membrane-tethered Sonic hedgehog by Patched-1. *Proc. Natl. Acad. Sci. U. S. A.* *97*, 12044–12049.
- Ingham, P.W., and McMahon, A.P. (2001). Hedgehog signaling in animal development: paradigms and principles. *Genes Dev.* *15*, 3059–3087.
- Ingham, P.W., Taylor, A.M., and Nakano, Y. (1991). Role of the *Drosophila* patched gene in positional signalling. *Nature* *353*, 184–187.

- Ingle, D.J., and Baker, B.L. (1957). Histology and regenerative capacity of liver following multiple partial hepatectomies. *Proc. Soc. Exp. Biol. Med. Soc. Exp. Biol. Med. N. Y.* **95**, 813–815.
- Iovine, M.K. (2007). Conserved mechanisms regulate outgrowth in zebrafish fins. *Nat. Chem. Biol.* **3**, 613–618.
- Iten, L.E., and Bryant, S.V. (1975). The interaction between the blastema and stump in the establishment of the anterior–posterior and proximal–distal organization of the limb regenerate. *Dev. Biol.* **44**, 119–147.
- Iten, L.E., and Bryant, S.V. (1976). Stages of tail regeneration in the adult newt, *Notophthalmus viridescens*. *J. Exp. Zool.* **196**, 283–292.
- Iwanaga, T., Tsutsumi, R., Noritake, J., Fukata, Y., and Fukata, M. (2009). Dynamic protein palmitoylation in cellular signaling. *Prog. Lipid Res.* **48**, 117–127.
- Jaillon, O., Aury, J.-M., Brunet, F., Petit, J.-L., Stange-Thomann, N., Mauceli, E., Bouneau, L., Fischer, C., Ozouf-Costaz, C., Bernot, A., et al. (2004). Genome duplication in the teleost fish *Tetraodon nigroviridis* reveals the early vertebrate proto-karyotype. *Nature* **431**, 946–957.
- Jarvis, R.M., Hughes, S.M., and Ledgerwood, E.C. (2012). Peroxiredoxin 1 functions as a signal peroxidase to receive, transduce, and transmit peroxide signals in mammalian cells. *Free Radic. Biol. Med.* **53**, 1522–1530.
- Jennings, B.C., and Linder, M.E. (2012). DHHC protein S-acyltransferases use similar ping-pong kinetic mechanisms but display different acyl-CoA specificities. *J. Biol. Chem.* **287**, 7236–7245.
- Jeong, J., and McMahon, A.P. (2005). Growth and pattern of the mammalian neural tube are governed by partially overlapping feedback activities of the hedgehog antagonists patched 1 and Hhip1. *Dev. Camb. Engl.* **132**, 143–154.
- Jeong, Y., and Epstein, D.J. (2003). Distinct regulators of Shh transcription in the floor plate and notochord indicate separate origins for these tissues in the mouse node. *Dev. Camb. Engl.* **130**, 3891–3902.
- Jeong, Y., El-Jaick, K., Roessler, E., Muenke, M., and Epstein, D.J. (2006). A functional screen for sonic hedgehog regulatory elements across a 1 Mb interval identifies long-range ventral forebrain enhancers. *Dev. Camb. Engl.* **133**, 761–772.
- Jessen, K.R., Mirsky, R., and Lloyd, A.C. (2015). Schwann Cells: Development and Role in Nerve Repair. *Cold Spring Harb. Perspect. Biol.* **7**, a020487.
- Jia, J., Tong, C., and Jiang, J. (2003). Smoothed transduces Hedgehog signal by physically interacting with Costal2/Fused complex through its C-terminal tail. *Genes Dev.* **17**, 2709–2720.
- Jia, J., Tong, C., Wang, B., Luo, L., and Jiang, J. (2004). Hedgehog signalling activity of Smoothed requires phosphorylation by protein kinase A and casein kinase I. *Nature* **432**, 1045–1050.
- Jia, J., Zhang, L., Zhang, Q., Tong, C., Wang, B., Hou, F., Amanai, K., and Jiang, J. (2005). Phosphorylation by double-time/CKIepsilon and CKIalpha targets cubitus interruptus for Slimb/beta-TRCP-mediated proteolytic processing. *Dev. Cell* **9**, 819–830.
- Jia, L., Chisari, M., Maktabi, M.H., Sobieski, C., Zhou, H., Konopko, A.M., Martin, B.R., Mennerick, S.J., and Blumer, K.J. (2014). A mechanism regulating G protein-coupled receptor signaling that requires cycles of protein palmitoylation and depalmitoylation. *J. Biol. Chem.* **289**, 6249–6257.
- Jiang, J., and Hui, C.-C. (2008). Hedgehog signaling in development and cancer. *Dev. Cell* **15**, 801–812.
- Jiang, J., and Struhl, G. (1995). Protein kinase A and hedgehog signaling in *Drosophila* limb development. *Cell* **80**, 563–572.
- Jiang, J., and Struhl, G. (1998). Regulation of the Hedgehog and Wingless signalling pathways by the F-box/WD40-repeat protein Slimb. *Nature* **391**, 493–496.

- Johnson, R.L., Laufer, E., Riddle, R.D., and Tabin, C. (1994). Ectopic expression of Sonic hedgehog alters dorsal-ventral patterning of somites. *Cell* 79, 1165–1173.
- Kamata, H., Honda, S.-I., Maeda, S., Chang, L., Hirata, H., and Karin, M. (2005). Reactive oxygen species promote TNF α -induced death and sustained JNK activation by inhibiting MAP kinase phosphatases. *Cell* 120, 649–661.
- Kamrin, R.P., and Singer, M. (1955). The influence of the spinal cord in regeneration of the tail of the lizard, *Anolis carolinensis*. *J. Exp. Zool.* 128, 611–627.
- Kang, R., Wan, J., Arstikaitis, P., Takahashi, H., Huang, K., Bailey, A.O., Thompson, J.X., Roth, A.F., Drisdell, R.C., Mastro, R., et al. (2008). Neural palmitoyl-proteomics reveals dynamic synaptic palmitoylation. *Nature* 456, 904–909.
- Katanaev, V.L., Solis, G.P., Hausmann, G., Buestorf, S., Katanayeva, N., Schrock, Y., Stuermer, C.A.O., and Basler, K. (2008). Reggie-1/flotillin-2 promotes secretion of the long-range signalling forms of Wingless and Hedgehog in *Drosophila*. *EMBO J.* 27, 509–521.
- Kawakami, A., Fukazawa, T., and Takeda, H. (2004). Early fin primordia of zebrafish larvae regenerate by a similar growth control mechanism with adult regeneration. *Dev. Dyn. Off. Publ. Am. Assoc. Anat.* 231, 693–699.
- Kawakami, Y., Rodriguez Esteban, C., Raya, M., Kawakami, H., Martí, M., Dubova, I., and Izpisua Belmonte, J.C. (2006). Wnt/ β -catenin signaling regulates vertebrate limb regeneration. *Genes Dev.* 20, 3232–3237.
- Keller, C.A., Yuan, X., Panzanelli, P., Martin, M.L., Alldred, M., Sassoè-Pognetto, M., and Lüscher, B. (2004). The $\gamma 2$ subunit of GABA(A) receptors is a substrate for palmitoylation by GODZ. *J. Neurosci. Off. J. Soc. Neurosci.* 24, 5881–5891.
- Kennedy, M.B. (2000). Signal-processing machines at the postsynaptic density. *Science* 290, 750–754.
- Kennedy, K.A.M., Ostrakhovitch, E.A., Sandiford, S.D.E., Dayarathna, T., Xie, X., Waese, E.Y.L., Chang, W.Y., Feng, Q., Skerjanc, I.S., Stanford, W.L., et al. (2010). Mammalian numb-interacting protein 1/dual oxidase maturation factor 1 directs neuronal fate in stem cells. *J. Biol. Chem.* 285, 17974–17985.
- Kennedy, K.A.M., Sandiford, S.D.E., Skerjanc, I.S., and Li, S.S.-C. (2012). Reactive oxygen species and the neuronal fate. *Cell. Mol. Life Sci. CMLS* 69, 215–221.
- Kent, D., Bush, E.W., and Hooper, J.E. (2006). Roadkill attenuates Hedgehog responses through degradation of *Cubitus interruptus*. *Dev. Camb. Engl.* 133, 2001–2010.
- Keston, A.S., and Brandt, R. (1965). The fluorimetric analysis of ultramicro quantities of hydrogen peroxide. *Anal. Biochem.* 11, 1–5.
- Kiffmeyer, W.R., Tomusk, E.V., and Mescher, A.L. (1991). Axonal transport and release of transferrin in nerves of regenerating amphibian limbs. *Dev. Biol.* 147, 392–402.
- Kim, K.B., and Lee, B.M. (1997). Oxidative stress to DNA, protein, and antioxidant enzymes (superoxide dismutase and catalase) in rats treated with benzo(a)pyrene. *Cancer Lett.* 113, 205–212.
- Kim, E., Naisbitt, S., Hsueh, Y.P., Rao, A., Rothschild, A., Craig, A.M., and Sheng, M. (1997). GKAP, a novel synaptic protein that interacts with the guanylate kinase-like domain of the PSD-95/SAP90 family of channel clustering molecules. *J. Cell Biol.* 136, 669–678.
- Kimmel, C.B., Ballard, W.W., Kimmel, S.R., Ullmann, B., and Schilling, T.F. (1995). Stages of embryonic development of the zebrafish. *Dev. Dyn. Off. Publ. Am. Assoc. Anat.* 203, 253–310.
- King, M.J., and Sharma, R.K. (1992). Demonstration of multiple forms of bovine brain myristoyl CoA:protein N-myristoyl transferase. *Mol. Cell. Biochem.* 113, 77–81.

- Kistner, U., Wenzel, B.M., Veh, R.W., Cases-Langhoff, C., Garner, A.M., Appeltauer, U., Voss, B., Gundelfinger, E.D., and Garner, C.C. (1993). SAP90, a rat presynaptic protein related to the product of the *Drosophila* tumor suppressor gene *dlg-A*. *J. Biol. Chem.* *268*, 4580–4583.
- Kleuss, C., and Krause, E. (2003). Galpha(s) is palmitoylated at the N-terminal glycine. *EMBO J.* *22*, 826–832.
- Knopf, F., Hammond, C., Chekuru, A., Kurth, T., Hans, S., Weber, C.W., Mahatma, G., Fisher, S., Brand, M., Schulte-Merker, S., et al. (2011). Bone regenerates via dedifferentiation of osteoblasts in the zebrafish fin. *Dev. Cell* *20*, 713–724.
- Koegl, M., Zlatkine, P., Ley, S.C., Courtneidge, S.A., and Magee, A.I. (1994). Palmitoylation of multiple Src-family kinases at a homologous N-terminal motif. *Biochem. J.* *303* (Pt 3), 749–753.
- Kohtz, J.D., Lee, H.Y., Gaiano, N., Segal, J., Ng, E., Larson, T., Baker, D.P., Garber, E.A., Williams, K.P., and Fishell, G. (2001). N-terminal fatty-acylation of sonic hedgehog enhances the induction of rodent ventral forebrain neurons. *Dev. Camb. Engl.* *128*, 2351–2363.
- Koopman, W.J.H., Nijtmans, L.G.J., Dieteren, C.E.J., Roestenberg, P., Valsecchi, F., Smeitink, J.A.M., and Willems, P.H.G.M. (2010). Mammalian mitochondrial complex I: biogenesis, regulation, and reactive oxygen species generation. *Antioxid. Redox Signal.* *12*, 1431–1470.
- Kornau, H.C., Schenker, L.T., Kennedy, M.B., and Seeburg, P.H. (1995). Domain interaction between NMDA receptor subunits and the postsynaptic density protein PSD-95. *Science* *269*, 1737–1740.
- Kornau, H.C., Seeburg, P.H., and Kennedy, M.B. (1997). Interaction of ion channels and receptors with PDZ domain proteins. *Curr. Opin. Neurobiol.* *7*, 368–373.
- Korschelt, E. (1927). *Regeneration und transplantation* (Berlin: Borntraeger).
- Kostakopoulou, K., Vogel, A., Brickell, P., and Tickle, C. (1996). “Regeneration” of wing bud stumps of chick embryos and reactivation of *Msx-1* and *Shh* expression in response to FGF-4 and ridge signals. *Mech. Dev.* *55*, 119–131.
- Koziel, L., Kunath, M., Kelly, O.G., and Vortkamp, A. (2004). *Ext1*-dependent heparan sulfate regulates the range of *Ihh* signaling during endochondral ossification. *Dev. Cell* *6*, 801–813.
- Kragl, M., Knapp, D., Nacu, E., Khattak, S., Maden, M., Epperlein, H.H., and Tanaka, E.M. (2009). Cells keep a memory of their tissue origin during axolotl limb regeneration. *Nature* *460*, 60–65.
- Kuhn, H. (1955). *On the Track of Prehistoric Man* (Random House, New York).
- Kühn, L.C., Schulman, H.M., and Ponka, P. (1990). Iron-transferrin requirements and transferrin receptor expression in proliferating cells. *Iron Transp. Storage* 149–191.
- Kujawski, S., Lin, W., Kitte, F., Börmel, M., Fuchs, S., Arulmozhivarman, G., Vogt, S., Theil, D., Zhang, Y., and Antos, C.L. (2014). Calcineurin regulates coordinated outgrowth of zebrafish regenerating fins. *Dev. Cell* *28*, 573–587.
- Kumar, A., and Brockes, J.P. (2012). Nerve dependence in tissue, organ, and appendage regeneration. *Trends Neurosci.* *35*, 691–699.
- Kumar, A., Velloso, C.P., Imokawa, Y., and Brockes, J.P. (2000). Plasticity of retrovirus-labelled myotubes in the newt limb regeneration blastema. *Dev. Biol.* *218*, 125–136.
- Kumar, A., Gates, P.B., and Brockes, J.P. (2007a). Positional identity of adult stem cells in salamander limb regeneration. *C. R. Biol.* *330*, 485–490.
- Kumar, A., Godwin, J.W., Gates, P.B., Garza-Garcia, A.A., and Brockes, J.P. (2007b). Molecular Basis for the Nerve Dependence of Limb Regeneration in an Adult Vertebrate. *Science* *318*, 772–777.

- Kumar, A., Nevill, G., Brockes, J.P., and Forge, A. (2010). A comparative study of gland cells implicated in the nerve dependence of salamander limb regeneration. *J. Anat.* *217*, 16–25.
- Kumar, A., Delgado, J.-P., Gates, P.B., Neville, G., Forge, A., and Brockes, J.P. (2011). The aneurogenic limb identifies developmental cell interactions underlying vertebrate limb regeneration. *Proc. Natl. Acad. Sci.* *108*, 13588–13593.
- Laforest, L., Brown, C.W., Poleo, G., Géraudie, J., Tada, M., Ekker, M., and Akimenko, M.A. (1998). Involvement of the sonic hedgehog, patched 1 and bmp2 genes in patterning of the zebrafish dermal fin rays. *Dev. Camb. Engl.* *125*, 4175–4184.
- Lakkaraju, A.K., Abrami, L., Lemmin, T., Blaskovic, S., Kunz, B., Kihara, A., Dal Peraro, M., and van der Goot, F.G. (2012). Palmitoylated calnexin is a key component of the ribosome-translocon complex. *EMBO J.* *31*, 1823–1835.
- Lane, K.T., and Beese, L.S. (2006). Thematic review series: lipid posttranslational modifications. Structural biology of protein farnesyltransferase and geranylgeranyltransferase type I. *J. Lipid Res.* *47*, 681–699.
- Lange, M.M. (1920). On the regeneration and finer structure of the arms of the cephalopods. *J. Exp. Zool.* *31*, 1–57.
- Ledesma, M.D., Simons, K., and Dotti, C.G. (1998). Neuronal polarity: essential role of protein-lipid complexes in axonal sorting. *Proc. Natl. Acad. Sci. U. S. A.* *95*, 3966–3971.
- Ledesma, M.D., Brügger, B., Bünning, C., Wieland, F.T., and Dotti, C.G. (1999). Maturation of the axonal plasma membrane requires upregulation of sphingomyelin synthesis and formation of protein-lipid complexes. *EMBO J.* *18*, 1761–1771.
- Lee, J.D., and Treisman, J.E. (2001). Sightless has homology to transmembrane acyltransferases and is required to generate active Hedgehog protein. *Curr. Biol. CB* *11*, 1147–1152.
- Lee, B.C., Péterfi, Z., Hoffmann, F.W., Moore, R.E., Kaya, A., Avanesov, A., Tarrago, L., Zhou, Y., Weerapana, E., Fomenko, D.E., et al. (2013). MsrB1 and MICALs regulate actin assembly and macrophage function via reversible stereoselective methionine oxidation. *Mol. Cell* *51*, 397–404.
- Lee, J.D., Kraus, P., Gaiano, N., Nery, S., Kohtz, J., Fishell, G., Loomis, C.A., and Treisman, J.E. (2001). An acylatable residue of Hedgehog is differentially required in *Drosophila* and mouse limb development. *Dev. Biol.* *233*, 122–136.
- Lee, J.J., Ekker, S.C., von Kessler, D.P., Porter, J.A., Sun, B.I., and Beachy, P.A. (1994). Autoproteolysis in hedgehog protein biogenesis. *Science* *266*, 1528–1537.
- Lee, N.K., Choi, Y.G., Baik, J.Y., Han, S.Y., Jeong, D.-W., Bae, Y.S., Kim, N., and Lee, S.Y. (2005a). A crucial role for reactive oxygen species in RANKL-induced osteoclast differentiation. *Blood* *106*, 852–859.
- Lee, S.-R., Yang, K.-S., Kwon, J., Lee, C., Jeong, W., and Rhee, S.G. (2002). Reversible inactivation of the tumor suppressor PTEN by H₂O₂. *J. Biol. Chem.* *277*, 20336–20342.
- Lee, Y., Grill, S., Sanchez, A., Murphy-Ryan, M., and Poss, K.D. (2005b). Fgf signaling instructs position-dependent growth rate during zebrafish fin regeneration. *Dev. Camb. Engl.* *132*, 5173–5183.
- Lee, Y., Hami, D., De Val, S., Kagermeier-Schenk, B., Wills, A.A., Black, B.L., Weidinger, G., and Poss, K.D. (2009). Maintenance of blastemal proliferation by functionally diverse epidermis in regenerating zebrafish fins. *Dev. Biol.* *331*, 270–280.
- Lenhoff, S.G., and Lenhoff, H.M. (1986). *Hydra and the birth of experimental biology - 1744: Abraham Trembley's Mémoires concerning the polyps*. Boxwood Press Pac. Grove CA.
- Lesurtel, M., Graf, R., Aleil, B., Walther, D.J., Tian, Y., Jochum, W., Gachet, C., Bader, M., and Clavien, P.-A. (2006). Platelet-derived serotonin mediates liver regeneration. *Science* *312*, 104–107.

- Lettice, L.A., Heaney, S.J.H., Purdie, L.A., Li, L., de Beer, P., Oostra, B.A., Goode, D., Elgar, G., Hill, R.E., and de Graaff, E. (2003). A long-range Shh enhancer regulates expression in the developing limb and fin and is associated with preaxial polydactyly. *Hum. Mol. Genet.* *12*, 1725–1735.
- Leung, K.F., Baron, R., and Seabra, M.C. (2006). Thematic review series: lipid posttranslational modifications. geranylgeranylation of Rab GTPases. *J. Lipid Res.* *47*, 467–475.
- Levental, I., Grzybek, M., and Simons, K. (2010). Greasing their way: lipid modifications determine protein association with membrane rafts. *Biochemistry (Mosc.)* *49*, 6305–6316.
- Leventis, R., Juel, G., Knudsen, J.K., and Silvius, J.R. (1997). Acyl-CoA binding proteins inhibit the nonenzymic S-acylation of cysteinyl-containing peptide sequences by long-chain acyl-CoAs. *Biochemistry (Mosc.)* *36*, 5546–5553.
- Levin, M. (2007). Large-scale biophysics: ion flows and regeneration. *Trends Cell Biol.* *17*, 261–270.
- Li, H., Kantoff, P.W., Giovannucci, E., Leitzmann, M.F., Gaziano, J.M., Stampfer, M.J., and Ma, J. (2005). Manganese superoxide dismutase polymorphism, prediagnostic antioxidant status, and risk of clinical significant prostate cancer. *Cancer Res.* *65*, 2498–2504.
- Li, J., Stouffs, M., Serrander, L., Banfi, B., Bettioli, E., Charnay, Y., Steger, K., Krause, K.-H., and Jaconi, M.E. (2006). The NADPH oxidase NOX4 drives cardiac differentiation: Role in regulating cardiac transcription factors and MAP kinase activation. *Mol. Biol. Cell* *17*, 3978–3988.
- Li, S., Chen, Y., Shi, Q., Yue, T., Wang, B., and Jiang, J. (2012). Hedgehog-regulated ubiquitination controls smoothed trafficking and cell surface expression in *Drosophila*. *PLoS Biol.* *10*, e1001239.
- Li, W., Ohlmeyer, J.T., Lane, M.E., and Kalderon, D. (1995). Function of protein kinase A in hedgehog signal transduction and *Drosophila* imaginal disc development. *Cell* *80*, 553–562.
- Lin, G., and Slack, J.M.W. (2008). Requirement for Wnt and FGF signaling in *Xenopus* tadpole tail regeneration. *Dev. Biol.* *316*, 323–335.
- Lin, X., Wei, G., Shi, Z., Dryer, L., Esko, J.D., Wells, D.E., and Matzuk, M.M. (2000). Disruption of gastrulation and heparan sulfate biosynthesis in EXT1-deficient mice. *Dev. Biol.* *224*, 299–311.
- Linder, M.E., and Deschenes, R.J. (2003). New Insights into the Mechanisms of Protein Palmitoylation †. *Biochemistry (Mosc.)* *42*, 4311–4320.
- Linder, M.E., Middleton, P., Hepler, J.R., Taussig, R., Gilman, A.G., and Mumby, S.M. (1993). Lipid modifications of G proteins: alpha subunits are palmitoylated. *Proc. Natl. Acad. Sci. U. S. A.* *90*, 3675–3679.
- Litingtung, Y., Lei, L., Westphal, H., and Chiang, C. (1998). Sonic hedgehog is essential to foregut development. *Nat. Genet.* *20*, 58–61.
- Liu, A., Wang, B., and Niswander, L.A. (2005). Mouse intraflagellar transport proteins regulate both the activator and repressor functions of Gli transcription factors. *Dev. Camb. Engl.* *132*, 3103–3111.
- Lo, D.C., Allen, F., and Brockes, J.P. (1993). Reversal of muscle differentiation during urodele limb regeneration. *Proc. Natl. Acad. Sci. U. S. A.* *90*, 7230–7234.
- Lobo, S., Greentree, W.K., Linder, M.E., and Deschenes, R.J. (2002). Identification of a Ras palmitoyltransferase in *Saccharomyces cerevisiae*. *J. Biol. Chem.* *277*, 41268–41273.
- Logan, M., Simon, H.G., and Tabin, C. (1998). Differential regulation of T-box and homeobox transcription factors suggests roles in controlling chick limb-type identity. *Development* *125*, 2825–2835.
- Lööf, S., Straube, W.L., Drechsel, D., Tanaka, E.M., and Simon, A. (2007). Plasticity of mammalian myotubes upon stimulation with a thrombin-activated serum factor. *Cell Cycle Georget. Tex* *6*, 1096–1101.

- Love, N.R., Chen, Y., Ishibashi, S., Kritsiligkou, P., Lea, R., Koh, Y., Gallop, J.L., Dorey, K., and Amaya, E. (2013). Amputation-induced reactive oxygen species are required for successful *Xenopus* tadpole tail regeneration. *Nat. Cell Biol.* *15*, 222–228.
- Love, N.R., Ziegler, M., Chen, Y., and Amaya, E. (2014). Carbohydrate metabolism during vertebrate appendage regeneration: What is its role? How is it regulated?: A postulation that regenerating vertebrate appendages facilitate glycolytic and pentose phosphate pathways to fuel macromolecule biosynthesis. *BioEssays* *36*, 27–33.
- Low, W.-C., Wang, C., Pan, Y., Huang, X.-Y., Chen, J.K., and Wang, B. (2008). The decoupling of Smoothed from Galphai proteins has little effect on Gli3 protein processing and Hedgehog-regulated chick neural tube patterning. *Dev. Biol.* *321*, 188–196.
- Lu, C., Schoenfeld, R., Shan, Y., Tsai, H.-J., Hammock, B., and Cortopassi, G. (2009). Frataxin deficiency induces Schwann cell inflammation and death. *Biochim. Biophys. Acta* *1792*, 1052–1061.
- Lum, L., Zhang, C., Oh, S., Mann, R.K., von Kessler, D.P., Taipale, J., Weis-Garcia, F., Gong, R., Wang, B., and Beachy, P.A. (2003). Hedgehog signal transduction via Smoothed association with a cytoplasmic complex scaffolded by the atypical kinesin, Costal-2. *Mol. Cell* *12*, 1261–1274.
- Lund, E.J. (1917). Reversibility of morphogenetic processes in *Bursaria*. *J. Exp. Zool.* *24*, 1–33.
- Lynes, E.M., and Simmen, T. (2011). Urban planning of the endoplasmic reticulum (ER): how diverse mechanisms segregate the many functions of the ER. *Biochim. Biophys. Acta* *1813*, 1893–1905.
- Ma, Y., Erkner, A., Gong, R., Yao, S., Taipale, J., Basler, K., and Beachy, P.A. (2002). Hedgehog-mediated patterning of the mammalian embryo requires transporter-like function of Dispatched. *Cell* *111*, 63–75.
- Mailloux, R.J., and Harper, M.-E. (2012). Mitochondrial proteotoxicity and ROS signaling: lessons from the uncoupling proteins. *Trends Endocrinol. Metab.* *TEM* *23*, 451–458.
- Malenka, R.C., and Nicoll, R.A. (1999). Long-term potentiation—a decade of progress? *Science* *285*, 1870–1874.
- Malinow, R., Mainen, Z.F., and Hayashi, Y. (2000). LTP mechanisms: from silence to four-lane traffic. *Curr. Opin. Neurobiol.* *10*, 352–357.
- Mann, R.K., and Beachy, P.A. (2004). Novel lipid modifications of secreted protein signals. *Annu. Rev. Biochem.* *73*, 891–923.
- Mari-Beffa, M., Mateos, I., Palmqvist, P., and Becerra, J. (1996). Cell to cell interactions during teleosts fin regeneration. *Int. J. Dev. Biol. Suppl* *1*, 179S – 180S.
- Marin, E.P., Derakhshan, B., Lam, T.T., Davalos, A., and Sessa, W.C. (2012). Endothelial cell palmitoylproteomic identifies novel lipid-modified targets and potential substrates for protein acyl transferases. *Circ. Res.* *110*, 1336–1344.
- Martí, E., Takada, R., Bumcrot, D.A., Sasaki, H., and McMahon, A.P. (1995). Distribution of Sonic hedgehog peptides in the developing chick and mouse embryo. *Dev. Camb. Engl.* *121*, 2537–2547.
- Martin, B.R., Wang, C., Adibekian, A., Tully, S.E., and Cravatt, B.F. (2012). Global profiling of dynamic protein palmitoylation. *Nat. Methods* *9*, 84–89.
- Martindale, J.L., and Holbrook, N.J. (2002). Cellular response to oxidative stress: signaling for suicide and survival. *J. Cell. Physiol.* *192*, 1–15.
- McCabe, J.B., and Berthiaume, L.G. (2001). N-terminal protein acylation confers localization to cholesterol, sphingolipid-enriched membranes but not to lipid rafts/caveolae. *Mol. Biol. Cell* *12*, 3601–3617.

- McCord, J.M., and Fridovich, I. (1969). Superoxide dismutase. An enzymic function for erythrocyte hemocuprein (hemocuprein). *J. Biol. Chem.* *244*, 6049–6055.
- McGann, C.J., Odelberg, S.J., and Keating, M.T. (2001). Mammalian myotube dedifferentiation induced by newt regeneration extract. *Proc. Natl. Acad. Sci. U. S. A.* *98*, 13699–13704.
- McHedlishvili, L., Epperlein, H.H., Telzerow, A., and Tanaka, E.M. (2007). A clonal analysis of neural progenitors during axolotl spinal cord regeneration reveals evidence for both spatially restricted and multipotent progenitors. *Dev. Camb. Engl.* *134*, 2083–2093.
- McMahon, A.P., Ingham, P.W., and Tabin, C.J. (2003). Developmental roles and clinical significance of hedgehog signaling. *Curr. Top. Dev. Biol.* *53*, 1–114.
- Melkonian, K.A., Ostermeyer, A.G., Chen, J.Z., Roth, M.G., and Brown, D.A. (1999). Role of lipid modifications in targeting proteins to detergent-resistant membrane rafts. Many raft proteins are acylated, while few are prenylated. *J. Biol. Chem.* *274*, 3910–3917.
- Merchant, M., Vajdos, F.F., Ultsch, M., Maun, H.R., Wendt, U., Cannon, J., Desmarais, W., Lazarus, R.A., de Vos, A.M., and de Sauvage, F.J. (2004). Suppressor of fused regulates Gli activity through a dual binding mechanism. *Mol. Cell. Biol.* *24*, 8627–8641.
- Merchant, M., Evangelista, M., Luoh, S.-M., Frantz, G.D., Chalasani, S., Carano, R.A.D., van Hoy, M., Ramirez, J., Ogasawara, A.K., McFarland, L.M., et al. (2005). Loss of the serine/threonine kinase fused results in postnatal growth defects and lethality due to progressive hydrocephalus. *Mol. Cell. Biol.* *25*, 7054–7068.
- Mescher, A.L. (1996). The cellular basis of limb regeneration in urodeles. *Int. J. Dev. Biol.* *40*, 785–795.
- Mescher, A.L., Connell, E., Hsu, C., Patel, C., and Overton, B. (1997). Transferrin is necessary and sufficient for the neural effect on growth in amphibian limb regeneration blastemas. *Dev. Growth Differ.* *39*, 677–684.
- Méthot, N., and Basler, K. (1999). Hedgehog controls limb development by regulating the activities of distinct transcriptional activator and repressor forms of Cubitus interruptus. *Cell* *96*, 819–831.
- Méthot, N., and Basler, K. (2000). Suppressor of fused opposes hedgehog signal transduction by impeding nuclear accumulation of the activator form of Cubitus interruptus. *Dev. Camb. Engl.* *127*, 4001–4010.
- Meyer, N.P., and Roelink, H. (2003). The amino-terminal region of Gli3 antagonizes the Shh response and acts in dorsoventral fate specification in the developing spinal cord. *Dev. Biol.* *257*, 343–355.
- Micchelli, C.A., The, I., Selva, E., Mogila, V., and Perrimon, N. (2002). Rasp, a putative transmembrane acyltransferase, is required for Hedgehog signaling. *Dev. Camb. Engl.* *129*, 843–851.
- Michalopoulos, G.K., and DeFrances, M.C. (1997). Liver regeneration. *Science* *276*, 60–66.
- Migaud, M., Charlesworth, P., Dempster, M., Webster, L.C., Watabe, A.M., Makhinson, M., He, Y., Ramsay, M.F., Morris, R.G., Morrison, J.H., et al. (1998). Enhanced long-term potentiation and impaired learning in mice with mutant postsynaptic density-95 protein. *Nature* *396*, 433–439.
- Miki, H., and Funato, Y. (2012). Regulation of intracellular signalling through cysteine oxidation by reactive oxygen species. *J. Biochem. (Tokyo)* *151*, 255–261.
- Miller, E.W., Tulyathan, O., Tulyanthan, O., Isacoff, E.Y., and Chang, C.J. (2007). Molecular imaging of hydrogen peroxide produced for cell signaling. *Nat. Chem. Biol.* *3*, 263–267.
- Min, J.Y., Park, M.H., Park, M.K., Park, K.W., Lee, N.W., Kim, T., Kim, H.J., and Lee, D.H. (2006). Staurosporin induces neurite outgrowth through ROS generation in HN33 hippocampal cell lines. *J. Neural Transm. Vienna Austria 1996* *113*, 1821–1826.
- Mitchell, D.A., Vasudevan, A., Linder, M.E., and Deschenes, R.J. (2006). Protein palmitoylation by a family of DHHC protein S-acyltransferases. *J. Lipid Res.* *47*, 1118–1127.

- Mitchell, D.A., Mitchell, G., Ling, Y., Budde, C., and Deschenes, R.J. (2010). Mutational analysis of *Saccharomyces cerevisiae* Erf2 reveals a two-step reaction mechanism for protein palmitoylation by DHHC enzymes. *J. Biol. Chem.* *285*, 38104–38114.
- Miyama, K., Yamada, G., Yamamoto, T.S., Takagi, C., Miyado, K., Sakai, M., Ueno, N., and Shibuya, H. (1999). A BMP-inducible gene, *dlx5*, regulates osteoblast differentiation and mesoderm induction. *Dev. Biol.* *208*, 123–133.
- Moffett, S., Rousseau, G., Lagacé, M., and Bouvier, M. (2001). The palmitoylation state of the beta(2)-adrenergic receptor regulates the synergistic action of cyclic AMP-dependent protein kinase and beta-adrenergic receptor kinase involved in its phosphorylation and desensitization. *J. Neurochem.* *76*, 269–279.
- Mohammad, K.S., and Neufeld, D.A. (2000). Denervation retards but does not prevent toetip regeneration. *Wound Repair Regen. Off. Publ. Wound Heal. Soc. Eur. Tissue Repair Soc.* *8*, 277–281.
- Mohammad, K.S., Day, F.A., and Neufeld, D.A. (1999). Bone growth is induced by nail transplantation in amputated proximal phalanges. *Calcif. Tissue Int.* *65*, 408–410.
- Monk, L.S., Fagerstedt, K.V., and Crawford, R.M.M. (1989). Oxygen toxicity and superoxide dismutase as an antioxidant in physiological stress. *Physiol. Plant.* *76*, 456–459.
- Monnier, V., Dussillol, F., Alves, G., Lamour-Isnard, C., and Plessis, A. (1998). Suppressor of fused links fused and *Cubitus interruptus* on the hedgehog signalling pathway. *Curr. Biol. CB* *8*, 583–586.
- Monteiro, J., Aires, R., Becker, J.D., Jacinto, A., Certal, A.C., and Rodríguez-León, J. (2014). V-ATPase proton pumping activity is required for adult zebrafish appendage regeneration. *PloS One* *9*, e92594.
- Montes, G.S., Becerra, J., Toledo, O.M., Gordilho, M.A., and Junqueira, L.C. (1982). Fine structure and histochemistry of the tail fin ray in teleosts. *Histochemistry* *75*, 363–376.
- Mruk, D.D., Silvestrini, B., Mo, M., and Cheng, C.Y. (2002). Antioxidant superoxide dismutase - a review: its function, regulation in the testis, and role in male fertility. *Contraception* *65*, 305–311.
- Mullen, L.M., Bryant, S.V., Torok, M.A., Blumberg, B., and Gardiner, D.M. (1996). Nerve dependency of regeneration: the role of Distal-less and FGF signaling in amphibian limb regeneration. *Dev. Camb. Engl.* *122*, 3487–3497.
- Mumby, S.M., Kleuss, C., and Gilman, A.G. (1994). Receptor regulation of G-protein palmitoylation. *Proc. Natl. Acad. Sci. U. S. A.* *91*, 2800–2804.
- Muneoka, K., Holler-Dinsmore, G., and Bryant, S.V. (1986). Intrinsic control of regenerative loss in *Xenopus laevis* limbs. *J. Exp. Zool.* *240*, 47–54.
- Murphy, M.P. (2009). How mitochondria produce reactive oxygen species. *Biochem. J.* *417*, 1–13.
- Nacu, E., and Tanaka, E.M. (2011). Limb regeneration: a new development? *Annu. Rev. Cell Dev. Biol.* *27*, 409–440.
- Nadolski, M.J., and Linder, M.E. (2009). Molecular recognition of the palmitoylation substrate Vac8 by its palmitoyltransferase Pfa3. *J. Biol. Chem.* *284*, 17720–17730.
- Nakashima, I., Takeda, K., Kawamoto, Y., Okuno, Y., Kato, M., and Suzuki, H. (2005). Redox control of catalytic activities of membrane-associated protein tyrosine kinases. *Arch. Biochem. Biophys.* *434*, 3–10.
- Navarro-Lérida, I., Sánchez-Perales, S., Calvo, M., Rentero, C., Zheng, Y., Enrich, C., and Del Pozo, M.A. (2012). A palmitoylation switch mechanism regulates Rac1 function and membrane organization. *EMBO J.* *31*, 534–551.
- Nechiporuk, A., and Keating, M.T. (2002). A proliferation gradient between proximal and *msxb*-expressing distal blastema directs zebrafish fin regeneration. *Dev. Camb. Engl.* *129*, 2607–2617.

- Nechiporuk, A., Poss, K.D., Johnson, S.L., and Keating, M.T. (2003). Positional cloning of a temperature-sensitive mutant *emmental* reveals a role for *sly1* during cell proliferation in zebrafish fin regeneration. *Dev. Biol.* 258, 291–306.
- Needham, A.E. (1952). *Regeneration and Wound Healing* (New York: John Wiley & Sons, Inc).
- Neill, S., Desikan, R., and Hancock, J. (2002). Hydrogen peroxide signalling. *Curr. Opin. Plant Biol.* 5, 388–395.
- Neufeld, D.A., and Zhao, W. (1995). Bone regrowth after digit tip amputation in mice is equivalent in adults and neonates. *Wound Repair Regen. Off. Publ. Wound Heal. Soc. Eur. Tissue Repair Soc.* 3, 461–466.
- Newmark, P.A. (2005). Opening a new can of worms: a large-scale RNAi screen in planarians. *Dev. Cell* 8, 623–624.
- Niethammer, P., Delling, M., Sytnyk, V., Dityatev, A., Fukami, K., and Schachner, M. (2002). Cosignaling of NCAM via lipid rafts and the FGF receptor is required for neuritegenesis. *J. Cell Biol.* 157, 521–532.
- Niethammer, P., Grabher, C., Look, A.T., and Mitchison, T.J. (2009). A tissue-scale gradient of hydrogen peroxide mediates rapid wound detection in zebrafish. *Nature* 459, 996–999.
- Nye, H.L.D., Cameron, J.A., Chernoff, E.A.G., and Stocum, D.L. (2003). Regeneration of the urodele limb: a review. *Dev. Dyn. Off. Publ. Am. Assoc. Anat.* 226, 280–294.
- Odelberg, S.J. (2005). Cellular plasticity in vertebrate regeneration. *Anat. Rec. B. New Anat.* 287, 25–35.
- Ogden, S.K., Ascano, M., Stegman, M.A., Suber, L.M., Hooper, J.E., and Robbins, D.J. (2003). Identification of a functional interaction between the transmembrane protein Smoothened and the kinesin-related protein Costal2. *Curr. Biol. CB* 13, 1998–2003.
- Ogden, S.K., Fei, D.L., Schilling, N.S., Ahmed, Y.F., Hwa, J., and Robbins, D.J. (2008). G protein Galphai functions immediately downstream of Smoothened in Hedgehog signalling. *Nature* 456, 967–970.
- Ohlmeyer, J.T., and Kalderon, D. (1998). Hedgehog stimulates maturation of *Cubitus interruptus* into a labile transcriptional activator. *Nature* 396, 749–753.
- Ohno, Y., Kihara, A., Sano, T., and Igarashi, Y. (2006). Intracellular localization and tissue-specific distribution of human and yeast DHHC cysteine-rich domain-containing proteins. *Biochim. Biophys. Acta* 1761, 474–483.
- Oviedo, N.J., and Beane, W.S. (2009). Regeneration: The origin of cancer or a possible cure? *Semin. Cell Dev. Biol.* 20, 557–564.
- Padhi, B.K., Joly, L., Tellis, P., Smith, A., Nanjappa, P., Chevrette, M., Ekker, M., and Akimenko, M.-A. (2004). Screen for genes differentially expressed during regeneration of the zebrafish caudal fin. *Dev. Dyn. Off. Publ. Am. Assoc. Anat.* 231, 527–541.
- Pagán-Westphal, S.M., and Tabin, C.J. (1998). The transfer of left-right positional information during chick embryogenesis. *Cell* 93, 25–35.
- Pallas, P.S. (1766). *Miscellanea zoologica: quibus novae imprimis atque obscurae animalium species describuntur et observationibus iconibusque illustrantur.* (Hagae Comitum, apud Petrum van Cleef).
- Pan, D., and Rubin, G.M. (1995). cAMP-dependent protein kinase and hedgehog act antagonistically in regulating decapentaplegic transcription in *Drosophila* imaginal discs. *Cell* 80, 543–552.
- Pan, Y., and Wang, B. (2007). A novel protein-processing domain in Gli2 and Gli3 differentially blocks complete protein degradation by the proteasome. *J. Biol. Chem.* 282, 10846–10852.

- Pan, Y., Bai, C.B., Joyner, A.L., and Wang, B. (2006). Sonic hedgehog signaling regulates Gli2 transcriptional activity by suppressing its processing and degradation. *Mol. Cell. Biol.* 26, 3365–3377.
- Panakova, D., Sprong, H., Marois, E., Thiele, C., and Eaton, S. (2005). Lipoprotein particles are required for Hedgehog and Wingless signalling. *Nature* 435, 58–65.
- Papac, D.I., Thornburg, K.R., Büllsbach, E.E., Crouch, R.K., and Knapp, D.R. (1992). Palmitoylation of a G-protein coupled receptor. Direct analysis by tandem mass spectrometry. *J. Biol. Chem.* 267, 16889–16894.
- Patterson, S.I., and Skene, J.H. (1999). A shift in protein S-palmitoylation, with persistence of growth-associated substrates, marks a critical period for synaptic plasticity in developing brain. *J. Neurobiol.* 39, 423–437.
- Patterson, G.H., Hirschberg, K., Polishchuk, R.S., Gerlich, D., Phair, R.D., and Lippincott-Schwartz, J. (2008). Transport through the Golgi apparatus by rapid partitioning within a two-phase membrane system. *Cell* 133, 1055–1067.
- Pedram, A., Razandi, M., Sainson, R.C.A., Kim, J.K., Hughes, C.C., and Levin, E.R. (2007). A conserved mechanism for steroid receptor translocation to the plasma membrane. *J. Biol. Chem.* 282, 22278–22288.
- Pedram, A., Razandi, M., Deschenes, R.J., and Levin, E.R. (2012). DHHC-7 and -21 are palmitoyltransferases for sex steroid receptors. *Mol. Biol. Cell* 23, 188–199.
- Pepicelli, C.V., Lewis, P.M., and McMahon, A.P. (1998). Sonic hedgehog regulates branching morphogenesis in the mammalian lung. *Curr. Biol. CB* 8, 1083–1086.
- Pepinsky, R.B., Zeng, C., Wen, D., Rayhorn, P., Baker, D.P., Williams, K.P., Bixler, S.A., Ambrose, C.M., Garber, E.A., Miatkowski, K., et al. (1998). Identification of a palmitic acid-modified form of human Sonic hedgehog. *J. Biol. Chem.* 273, 14037–14045.
- Pescitelli, M.J., and Stocum, D.L. (1980). The origin of skeletal structures during intercalary regeneration of larval *Ambystoma* limbs. *Dev. Biol.* 79, 255–275.
- Petersen, C.P., and Reddien, P.W. (2008). Smed-betacatenin-1 is required for anteroposterior blastema polarity in planarian regeneration. *Science* 319, 327–330.
- Pfefferli, C., and Jaźwińska, A. (2015). The art of fin regeneration in zebrafish: The Art of Fin Regeneration. *Regeneration* 2, 72–83.
- Pirrotte, N., Stevens, A.-S., Fraguas, S., Plusquin, M., Van Roten, A., Van Belleghem, F., Paesen, R., Ameloot, M., Cebrià, F., Artois, T., et al. (2015). Reactive Oxygen Species in Planarian Regeneration: An Upstream Necessity for Correct Patterning and Brain Formation. *Oxid. Med. Cell. Longev.* 2015, 1–19.
- Pirrotte, N., Leynen, N., Artois, T., and Smeets, K. (2016). Do you have the nerves to regenerate? The importance of neural signalling in the regeneration process. *Dev. Biol.* 409, 4–15.
- Poleo, G., Brown, C.W., Laforest, L., and Akimenko, M.A. (2001). Cell proliferation and movement during early fin regeneration in zebrafish. *Dev. Dyn. Off. Publ. Am. Assoc. Anat.* 221, 380–390.
- Politis, E.G., Roth, A.F., and Davis, N.G. (2005). Transmembrane topology of the protein palmitoyl transferase Akr1. *J. Biol. Chem.* 280, 10156–10163.
- Porter, J.A., Young, K.E., and Beachy, P.A. (1996a). Cholesterol modification of hedgehog signaling proteins in animal development. *Science* 274, 255–259.
- Porter, J.A., Ekker, S.C., Park, W.J., von Kessler, D.P., Young, K.E., Chen, C.H., Ma, Y., Woods, A.S., Cotter, R.J., Koonin, E.V., et al. (1996b). Hedgehog patterning activity: role of a lipophilic modification mediated by the carboxy-terminal autoprocessing domain. *Cell* 86, 21–34.
- Poss, K.D. (2007). Getting to the heart of regeneration in zebrafish. *Semin. Cell Dev. Biol.* 18, 36–45.

- Poss, K.D., Shen, J., Nechiporuk, A., McMahon, G., Thisse, B., Thisse, C., and Keating, M.T. (2000a). Roles for Fgf signaling during zebrafish fin regeneration. *Dev. Biol.* 222, 347–358.
- Poss, K.D., Shen, J., and Keating, M.T. (2000b). Induction of *lef1* during zebrafish fin regeneration. *Dev. Dyn. Off. Publ. Am. Assoc. Anat.* 219, 282–286.
- Prescott, G.R., Gorleku, O.A., Greaves, J., and Chamberlain, L.H. (2009). Palmitoylation of the synaptic vesicle fusion machinery. *J. Neurochem.* 110, 1135–1149.
- Prior, I.A., Harding, A., Yan, J., Sluimer, J., Parton, R.G., and Hancock, J.F. (2001). GTP-dependent segregation of H-ras from lipid rafts is required for biological activity. *Nat. Cell Biol.* 3, 368–375.
- Prockop, D.J. (1997). Marrow stromal cells as stem cells for nonhematopoietic tissues. *Science* 276, 71–74.
- Qanbar, R., and Bouvier, M. (2003). Role of palmitoylation/depalmitoylation reactions in G-protein-coupled receptor function. *Pharmacol. Ther.* 97, 1–33.
- Qin, N., Platano, D., Olcese, R., Costantin, J.L., Stefani, E., and Birnbaumer, L. (1998). Unique regulatory properties of the type 2a Ca²⁺ channel beta subunit caused by palmitoylation. *Proc. Natl. Acad. Sci. U. S. A.* 95, 4690–4695.
- Quesnel, S., and Silviu, J.R. (1994). Cysteine-containing peptide sequences exhibit facile uncatalyzed transacylation and acyl-CoA-dependent acylation at the lipid bilayer interface. *Biochemistry (Mosc.)* 33, 13340–13348.
- Quint, E., Smith, A., Avaron, F., Laforest, L., Miles, J., Gaffield, W., and Akimenko, M.-A. (2002). Bone patterning is altered in the regenerating zebrafish caudal fin after ectopic expression of sonic hedgehog and *bmp2b* or exposure to cyclophamide. *Proc. Natl. Acad. Sci. U. S. A.* 99, 8713–8718.
- Rampon, C., Gauron, C., Meda, F., Volovitch, M., and Vriza, S. (2014). Adenosine enhances progenitor cell recruitment and nerve growth via its A2B receptor during adult fin regeneration. *Purinergic Signal.* 10, 595–602.
- Ranieri, N., Ruel, L., Gallet, A., Raisin, S., and Théron, P.P. (2012). Distinct phosphorylations on kinesin *costal-2* mediate differential hedgehog signaling strength. *Dev. Cell* 22, 279–294.
- Ray, P.D., Huang, B.-W., and Tsuji, Y. (2012). Reactive oxygen species (ROS) homeostasis and redox regulation in cellular signaling. *Cell. Signal.* 24, 981–990.
- Razzell, W., Evans, I.R., Martin, P., and Wood, W. (2013). Calcium Flashes Orchestrate the Wound Inflammatory Response through DUOX Activation and Hydrogen Peroxide Release. *Curr. Biol.* 23, 424–429.
- Reczek, C.R., and Chandel, N.S. (2015). ROS-dependent signal transduction. *Curr. Opin. Cell Biol.* 33, 8–13.
- Redd, M.J., Cooper, L., Wood, W., Stramer, B., and Martin, P. (2004). Wound healing and inflammation: embryos reveal the way to perfect repair. *Philos. Trans. R. Soc. Lond. B. Biol. Sci.* 359, 777–784.
- Reddien, P.W., Bermange, A.L., Murfitt, K.J., Jennings, J.R., and Sánchez Alvarado, A. (2005). Identification of genes needed for regeneration, stem cell function, and tissue homeostasis by systematic gene perturbation in planaria. *Dev. Cell* 8, 635–649.
- Resh, M.D. (2006). Palmitoylation of ligands, receptors, and intracellular signaling molecules. *Sci. STKE Signal Transduct. Knowl. Environ.* 2006, re14.
- Reyer, R.W. (1954). Regeneration of the lens in the amphibian eye. *Q. Rev. Biol.* 29, 1–46.
- Rhee, S.G. (2006). Cell signaling. H₂O₂, a necessary evil for cell signaling. *Science* 312, 1882–1883.
- Rhee, S.G., Bae, Y.S., Lee, S.R., and Kwon, J. (2000). Hydrogen peroxide: a key messenger that modulates protein phosphorylation through cysteine oxidation. *Sci. STKE Signal Transduct. Knowl. Environ.* 2000, pe1.

- Rhee, S.G., Kang, S.W., Jeong, W., Chang, T.-S., Yang, K.-S., and Woo, H.A. (2005). Intracellular messenger function of hydrogen peroxide and its regulation by peroxiredoxins. *Curr. Opin. Cell Biol.* *17*, 183–189.
- Rhee, S.G., Chang, T.-S., Jeong, W., and Kang, D. (2010). Methods for detection and measurement of hydrogen peroxide inside and outside of cells. *Mol. Cells* *29*, 539–549.
- Riddle, R.D., Johnson, R.L., Laufer, E., and Tabin, C. (1993). Sonic hedgehog mediates the polarizing activity of the ZPA. *Cell* *75*, 1401–1416.
- Rieger, S., and Sagasti, A. (2011). Hydrogen Peroxide Promotes Injury-Induced Peripheral Sensory Axon Regeneration in the Zebrafish Skin. *PLoS Biol.* *9*, e1000621.
- Rigoni, P., Xu, L., Harshman, K., Schaffner, W., and Arnosti, D.N. (1993). Conserved cysteine residues of Oct-2 POU domain confer sensitivity to oxidation but are dispensable for sequence-specific DNA binding. *Biochim. Biophys. Acta* *1173*, 141–146.
- Rinkevich, Y., Montoro, D.T., Muhonen, E., Walmsley, G.G., Lo, D., Hasegawa, M., Januszkyk, M., Connolly, A.J., Weissman, I.L., and Longaker, M.T. (2014). Clonal analysis reveals nerve-dependent and independent roles on mammalian hind limb tissue maintenance and regeneration. *Proc. Natl. Acad. Sci. U. S. A.* *111*, 9846–9851.
- Riobo, N.A., Saucy, B., Dilizio, C., and Manning, D.R. (2006). Activation of heterotrimeric G proteins by Smoothed. *Proc. Natl. Acad. Sci. U. S. A.* *103*, 12607–12612.
- Robbins, D.J., Nybakken, K.E., Kobayashi, R., Sisson, J.C., Bishop, J.M., and Théron, P.P. (1997). Hedgehog elicits signal transduction by means of a large complex containing the kinesin-related protein costal2. *Cell* *90*, 225–234.
- Robbins, S.M., Quintrell, N.A., and Bishop, J.M. (1995). Myristoylation and differential palmitoylation of the HCK protein-tyrosine kinases govern their attachment to membranes and association with caveolae. *Mol. Cell. Biol.* *15*, 3507–3515.
- Roelink, H., Porter, J.A., Chiang, C., Tanabe, Y., Chang, D.T., Beachy, P.A., and Jessell, T.M. (1995). Floor plate and motor neuron induction by different concentrations of the amino-terminal cleavage product of sonic hedgehog autoproteolysis. *Cell* *81*, 445–455.
- Roensch, K., Tazaki, A., Chara, O., and Tanaka, E.M. (2013). Progressive specification rather than intercalation of segments during limb regeneration. *Science* *342*, 1375–1379.
- Rohatgi, R., Milenkovic, L., and Scott, M.P. (2007). Patched1 regulates hedgehog signaling at the primary cilium. *Science* *317*, 372–376.
- Rolland-Lagan, A.-G., Paquette, M., Tweedle, V., and Akimenko, M.-A. (2012). Morphogen-based simulation model of ray growth and joint patterning during fin development and regeneration. *Development* *139*, 1188–1197.
- Roth, A.F., Feng, Y., Chen, L., and Davis, N.G. (2002). The yeast DHHC cysteine-rich domain protein Akr1p is a palmitoyl transferase. *J. Cell Biol.* *159*, 23–28.
- Roth, A.F., Wan, J., Bailey, A.O., Sun, B., Kuchar, J.A., Green, W.N., Phinney, B.S., Yates, J.R., and Davis, N.G. (2006). Global analysis of protein palmitoylation in yeast. *Cell* *125*, 1003–1013.
- Rubinstein, A.L. (2003). Zebrafish: from disease modeling to drug discovery. *Curr. Opin. Drug Discov. Devel.* *6*, 218–223.
- Rubinstein, A.L. (2006). Zebrafish assays for drug toxicity screening. *Expert Opin. Drug Metab. Toxicol.* *2*, 231–240.

- Ruel, L., Rodriguez, R., Gallet, A., Lavenant-Staccini, L., and Théron, P.P. (2003). Stability and association of Smoothed, Costal2 and Fused with Cubitus interruptus are regulated by Hedgehog. *Nat. Cell Biol.* 5, 907–913.
- Ruel, L., Gallet, A., Raisin, S., Truchi, A., Staccini-Lavenant, L., Cervantes, A., and Théron, P.P. (2007). Phosphorylation of the atypical kinesin Costal2 by the kinase Fused induces the partial disassembly of the Smoothed-Fused-Costal2-Cubitus interruptus complex in Hedgehog signalling. *Dev. Camb. Engl.* 134, 3677–3689.
- Ryffel, G.U., Werdien, D., Turan, G., Gerhards, A., Goosses, S., and Senkel, S. (2003). Tagging muscle cell lineages in development and tail regeneration using Cre recombinase in transgenic *Xenopus*. *Nucleic Acids Res.* 31, e44.
- Sagai, T., Masuya, H., Tamura, M., Shimizu, K., Yada, Y., Wakana, S., Gondo, Y., Noda, T., and Shiroishi, T. (2004). Phylogenetic conservation of a limb-specific, cis-acting regulator of Sonic hedgehog (Shh). *Mamm. Genome Off. J. Int. Mamm. Genome Soc.* 15, 23–34.
- Sagai, T., Hosoya, M., Mizushima, Y., Tamura, M., and Shiroishi, T. (2005). Elimination of a long-range cis-regulatory module causes complete loss of limb-specific Shh expression and truncation of the mouse limb. *Dev. Camb. Engl.* 132, 797–803.
- Saitoh, M., Nishitoh, H., Fujii, M., Takeda, K., Tobiume, K., Sawada, Y., Kawabata, M., Miyazono, K., and Ichijo, H. (1998). Mammalian thioredoxin is a direct inhibitor of apoptosis signal-regulating kinase (ASK) 1. *EMBO J.* 17, 2596–2606.
- Salaun, C., Gould, G.W., and Chamberlain, L.H. (2005a). Lipid raft association of SNARE proteins regulates exocytosis in PC12 cells. *J. Biol. Chem.* 280, 19449–19453.
- Salaun, C., Gould, G.W., and Chamberlain, L.H. (2005b). The SNARE proteins SNAP-25 and SNAP-23 display different affinities for lipid rafts in PC12 cells. Regulation by distinct cysteine-rich domains. *J. Biol. Chem.* 280, 1236–1240.
- Salaun, C., Greaves, J., and Chamberlain, L.H. (2010). The intracellular dynamic of protein palmitoylation. *J. Cell Biol.* 191, 1229–1238.
- Sampath, K., Cheng, A.M., Frisch, A., and Wright, C.V. (1997). Functional differences among *Xenopus* nodal-related genes in left-right axis determination. *Dev. Camb. Engl.* 124, 3293–3302.
- Sanchez-Alvarado, A. (2000). Regeneration in the metazoans: why does it happen? *Bioessays* 22, 578590.
- Sanchez Alvarado, A., and Newmark, P.A. (1998). The use of planarians to dissect the molecular basis of metazoan regeneration. *Wound Repair Regen. Off. Publ. Wound Heal. Soc. Eur. Tissue Repair Soc.* 6, 413–420.
- Sandoval-Guzmán, T., Wang, H., Khattak, S., Schuez, M., Roensch, K., Nacu, E., Tazaki, A., Joven, A., Tanaka, E.M., and Simon, A. (2014). Fundamental Differences in Dedifferentiation and Stem Cell Recruitment during Skeletal Muscle Regeneration in Two Salamander Species. *Cell Stem Cell* 14, 174–187.
- Santamaria, J.A., Mari-Beffa, M., and Becerra, J. (1992). Interactions of the lepidotrichial matrix components during tail fin regeneration in teleosts. *Differ. Res. Biol. Divers.* 49, 143–150.
- Santos-Ruiz, L., Santamaría, J.A., Ruiz-Sánchez, J., and Becerra, J. (2002). Cell proliferation during blastema formation in the regenerating teleost fin. *Dev. Dyn. Off. Publ. Am. Assoc. Anat.* 223, 262–272.
- Sato, I., Obata, Y., Kasahara, K., Nakayama, Y., Fukumoto, Y., Yamasaki, T., Yokoyama, K.K., Saito, T., and Yamaguchi, N. (2009). Differential trafficking of Src, Lyn, Yes and Fyn is specified by the state of palmitoylation in the SH4 domain. *J. Cell Sci.* 122, 965–975.
- Sato, K., Yama, K., Murao, Y., Tatsunami, R., and Tampo, Y. (2013). Epalrestat increases intracellular glutathione levels in Schwann cells through transcription regulation. *Redox Biol.* 2, 15–21.

- Sauer, H., and Wartenberg, M. (2005). Reactive oxygen species as signaling molecules in cardiovascular differentiation of embryonic stem cells and tumor-induced angiogenesis. *Antioxid. Redox Signal.* *7*, 1423–1434.
- Sauer, H., Rahimi, G., Hescheler, J., and Wartenberg, M. (2000). Role of reactive oxygen species and phosphatidylinositol 3-kinase in cardiomyocyte differentiation of embryonic stem cells. *FEBS Lett.* *476*, 218–223.
- Scadding, S.R., and Maden, M. (1994). Retinoic acid gradients during limb regeneration. *Dev. Biol.* *162*, 608–617.
- Schaller, H.C. (1973). Isolation and characterization of a low-molecular-weight substance activating head and bud formation in hydra. *J. Embryol. Exp. Morphol.* *29*, 27–38.
- Scherz-Shouval, R., and Elazar, Z. (2007). ROS, mitochondria and the regulation of autophagy. *Trends Cell Biol.* *17*, 422–427.
- Schieber, M., and Chandel, N.S. (2014). ROS Function in Redox Signaling and Oxidative Stress. *Curr. Biol.* *24*, R453–R462.
- Schilling, T.F., Concordet, J.P., and Ingham, P.W. (1999). Regulation of left-right asymmetries in the zebrafish by Shh and BMP4. *Dev. Biol.* *210*, 277–287.
- Schotté, O.E., and Butler, E.G. (1944). Phases in regeneration of the urodele limb and their dependence upon the nervous system. *J. Exp. Zool.* *97*, 95–121.
- Schroeder, R., London, E., and Brown, D. (1994). Interactions between saturated acyl chains confer detergent resistance on lipids and glycosylphosphatidylinositol (GPI)-anchored proteins: GPI-anchored proteins in liposomes and cells show similar behavior. *Proc. Natl. Acad. Sci. U. S. A.* *91*, 12130–12134.
- Sculptoreanu, A., Scheuer, T., and Catterall, W.A. (1993). Voltage-dependent potentiation of L-type Ca²⁺ channels due to phosphorylation by cAMP-dependent protein kinase. *Nature* *364*, 240–243.
- Sekine, Y., Hatanaka, R., Watanabe, T., Sono, N., Iemura, S., Natsume, T., Kuranaga, E., Miura, M., Takeda, K., and Ichijo, H. (2012). The Kelch repeat protein KLHDC10 regulates oxidative stress-induced ASK1 activation by suppressing PP5. *Mol. Cell* *48*, 692–704.
- Selever, J., Liu, W., Lu, M.-F., Behringer, R.R., and Martin, J.F. (2004). Bmp4 in limb bud mesoderm regulates digit pattern by controlling AER development. *Dev. Biol.* *276*, 268–279.
- Sena, L.A., and Chandel, N.S. (2012). Physiological Roles of Mitochondrial Reactive Oxygen Species. *Mol. Cell* *48*, 158–167.
- Serra, V., Zglinicki, T. von, Lorenz, M., and Saretzki, G. (2003). Extracellular Superoxide Dismutase Is a Major Antioxidant in Human Fibroblasts and Slows Telomere Shortening. *J. Biol. Chem.* *278*, 6824–6830.
- Sessions, S.K., and Bryant, S.V. (1988). Evidence that regenerative ability is an intrinsic property of limb cells in *Xenopus*. *J. Exp. Zool.* *247*, 39–44.
- Shahinian, S., and Silviu, J.R. (1995). Doubly-lipid-modified protein sequence motifs exhibit long-lived anchorage to lipid bilayer membranes. *Biochemistry (Mosc.)* *34*, 3813–3822.
- Shan, Y., Schoenfeld, R.A., Hayashi, G., Napoli, E., Akiyama, T., Iodi Carstens, M., Carstens, E.E., Pook, M.A., and Cortopassi, G.A. (2013). Frataxin deficiency leads to defects in expression of antioxidants and Nrf2 expression in dorsal root ganglia of the Friedreich's ataxia YG8R mouse model. *Antioxid. Redox Signal.* *19*, 1481–1493.
- Shao, D., Oka, S.-I., Liu, T., Zhai, P., Ago, T., Sciarretta, S., Li, H., and Sadoshima, J. (2014). A redox-dependent mechanism for regulation of AMPK activation by Thioredoxin1 during energy starvation. *Cell Metab.* *19*, 232–245.

- Shao, J., Qian, X., Zhang, C., and Xu, Z. (2009). Fin regeneration from tail segment with musculature, endoskeleton, and scales. *J. Exp. Zool. B Mol. Dev. Evol.* *312*, 762–769.
- Sheng, M., and Sala, C. (2001). PDZ domains and the organization of supramolecular complexes. *Annu. Rev. Neurosci.* *24*, 1–29.
- Shenoy-Scaria, A.M., Dietzen, D.J., Kwong, J., Link, D.C., and Lublin, D.M. (1994). Cysteine3 of Src family protein tyrosine kinase determines palmitoylation and localization in caveolae. *J. Cell Biol.* *126*, 353–363.
- Shi, M., Yang, H., Motley, E.D., and Guo, Z. (2004). Overexpression of Cu/Zn-superoxide dismutase and/or catalase in mice inhibits aorta smooth muscle cell proliferation. *Am. J. Hypertens.* *17*, 450–456.
- Shi, Q., Li, S., Jia, J., and Jiang, J. (2011). The Hedgehog-induced Smoothed conformational switch assembles a signaling complex that activates Fused by promoting its dimerization and phosphorylation. *Dev. Camb. Engl.* *138*, 4219–4231.
- Shin, J.T., and Fishman, M.C. (2002). From Zebrafish to human: modular medical models. *Annu. Rev. Genomics Hum. Genet.* *3*, 311–340.
- Shmueli, A., Segal, M., Sapir, T., Tsutsumi, R., Noritake, J., Bar, A., Sapoznik, S., Fukata, Y., Orr, I., Fukata, M., et al. (2010). Ndel1 palmitoylation: a new mean to regulate cytoplasmic dynein activity. *EMBO J.* *29*, 107–119.
- Sidman, R.L., and Singer, M. (1951). Stimulation of forelimb regeneration in the newt, *Triturus viridescens*, by a sensory nerve supply isolated from the central nervous system. *Am. J. Physiol.* *165*, 257–260.
- da Silva, S.M., Gates, P.B., and Brockes, J.P. (2002). The newt ortholog of CD59 is implicated in proximodistal identity during amphibian limb regeneration. *Dev. Cell* *3*, 547–555.
- Simões, M.G., Bensimon-Brito, A., Fonseca, M., Farinho, A., Valério, F., Sousa, S., Afonso, N., Kumar, A., and Jacinto, A. (2014). Denervation impairs regeneration of amputated zebrafish fins. *BMC Dev. Biol.* *14*, 49.
- Simon, H.G., Kittappa, R., Khan, P.A., Tsilfidis, C., Liversage, R.A., and Oppenheimer, S. (1997). A novel family of T-box genes in urodele amphibian limb development and regeneration: candidate genes involved in vertebrate forelimb/hindlimb patterning. *Development* *124*, 1355–1366.
- Simons, K., and Ikonen, E. (1997). Functional rafts in cell membranes. *Nature* *387*, 569–572.
- Singer, M. (1952). The influence of the nerve in regeneration of the amphibian extremity. *Q. Rev. Biol.* *27*, 169–200.
- Singer, M. (1954). Induction of regeneration of the forelimb of the postmetamorphic frog by augmentation of the nerve supply. *J. Exp. Zool.* *126*, 419–471.
- Singer, M. (1965). A theory of the trophic nervous control of amphibian limb regeneration, including a re-evaluation of quantitative nerve requirements. In *Regeneration in Animals and Related Problems.*, V. Kiortsis, and H.A.L. Trampusch, eds. (Amsterdam: North-Holland Pub. Co.),.
- Singer, M. (1974). NEUROTROPHIC CONTROL OF LIMB REGENERATION IN THE NEWT*. *Ann. N. Y. Acad. Sci.* *228*, 308–321.
- Singer, M. (1978). On the Nature of the Neurotrophic Phenomenon in Urodele Limb Regeneration. *Am. Zool.* *18*, 829–841.
- Singer, M., and Craven, L. (1948). The growth and morphogenesis of the regenerating forelimb of adult *Triturus* following denervation at various stages of development. *J. Exp. Zool.* *108*, 279–308.
- Singer, M., Maier, C.E., and McNutt, W.S. (1976). Neurotrophic activity of brain extracts in forelimb regeneration of the urodele, *Triturus*. *J. Exp. Zool.* *196*, 131–150.

- Singh, B., Koyano-Nakagawa, N., Donaldson, A., Weaver, C., Garry, M., and Garry, D. (2015). Hedgehog Signaling during Appendage Development and Regeneration. *Genes* 6, 417–435.
- Singh, B.N., Doyle, M.J., Weaver, C.V., Koyano-Nakagawa, N., and Garry, D.J. (2012a). Hedgehog and Wnt coordinate signaling in myogenic progenitors and regulate limb regeneration. *Dev. Biol.* 371, 23–34.
- Singh, S.P., Holdway, J.E., and Poss, K.D. (2012b). Regeneration of amputated zebrafish fin rays from de novo osteoblasts. *Dev. Cell* 22, 879–886.
- Sisson, J.C., Ho, K.S., Suyama, K., and Scott, M.P. (1997). Costal2, a novel kinesin-related protein in the Hedgehog signaling pathway. *Cell* 90, 235–245.
- Skene, J.H., and Virág, I. (1989). Posttranslational membrane attachment and dynamic fatty acylation of a neuronal growth cone protein, GAP-43. *J. Cell Biol.* 108, 613–624.
- Slack, J.M.W., Beck, C.W., Gargioli, C., and Christen, B. (2004). Cellular and molecular mechanisms of regeneration in *Xenopus*. *Philos. Trans. R. Soc. Lond. B. Biol. Sci.* 359, 745–751.
- Smelkinson, M.G., and Kalderon, D. (2006). Processing of the *Drosophila* hedgehog signaling effector Ci-155 to the repressor Ci-75 is mediated by direct binding to the SCF component Slimb. *Curr. Biol. CB* 16, 110–116.
- Smith, A., Avaron, F., Guay, D., Padhi, B.K., and Akimenko, M.A. (2006). Inhibition of BMP signaling during zebrafish fin regeneration disrupts fin growth and scleroblasts differentiation and function. *Dev. Biol.* 299, 438–454.
- Smith, A.G., Brightwell, G., Smit, S.E., Parsons, P.G., and Sturm, R.A. (1998). Redox regulation of Brn-2/N-Oct-3 POU domain DNA binding activity and proteolytic formation of N-Oct-5 during melanoma cell nuclear extraction. *Melanoma Res.* 8, 2–10.
- Smotrys, J.E., and Linder, M.E. (2004). Palmitoylation of intracellular signaling proteins: regulation and function. *Annu. Rev. Biochem.* 73, 559–587.
- Sousa, S., Afonso, N., Bensimon-Brito, A., Fonseca, M., Simões, M., Leon, J., Roehl, H., Cancela, M.L., and Jacinto, A. (2011). Differentiated skeletal cells contribute to blastema formation during zebrafish fin regeneration. *Dev. Camb. Engl.* 138, 3897–3905.
- Sousa, S., Valerio, F., and Jacinto, A. (2012). A new zebrafish bone crush injury model. *Biol. Open* 1, 915–921.
- Soyombo, A.A., and Hofmann, S.L. (1997). Molecular cloning and expression of palmitoyl-protein thioesterase 2 (PPT2), a homolog of lysosomal palmitoyl-protein thioesterase with a distinct substrate specificity. *J. Biol. Chem.* 272, 27456–27463.
- Spallanzani, L. (1768). *Prodromo di un'opera da imprimersi sopra le riproduzioni animali* (Montanari).
- Spence, R., Gerlach, G., Lawrence, C., and Smith, C. (2008). The behaviour and ecology of the zebrafish, *Danio rerio*. *Biol. Rev. Camb. Philos. Soc.* 83, 13–34.
- Srivastava, S., Osten, P., Vilim, F.S., Khatri, L., Inman, G., States, B., Daly, C., DeSouza, S., Abagyan, R., Valtschanoff, J.G., et al. (1998). Novel anchorage of GluR2/3 to the postsynaptic density by the AMPA receptor-binding protein ABP. *Neuron* 21, 581–591.
- Stelnicki, E.J., Doolabh, V., Lee, S., Levis, C., Baumann, F.G., Longaker, M.T., and Mackinnon, S. (2000). Nerve dependency in scarless fetal wound healing. *Plast. Reconstr. Surg.* 105, 140–147.
- Stewart, S., and Stankunas, K. (2012). Limited dedifferentiation provides replacement tissue during zebrafish fin regeneration. *Dev. Biol.* 365, 339–349.

- St-Jacques, B., Hammerschmidt, M., and McMahon, A.P. (1999). Indian hedgehog signaling regulates proliferation and differentiation of chondrocytes and is essential for bone formation. *Genes Dev.* *13*, 2072–2086.
- Stocum, D.L. (1975). Regulation after proximal or distal transposition of limb regeneration blastemas and determination of the proximal boundary of the regenerate. *Dev. Biol.* *45*, 112–136.
- Stocum, D.L. (2011). The role of peripheral nerves in urodele limb regeneration. *Eur. J. Neurosci.* *34*, 908–916.
- Stocum, D.L., and Cameron, J.A. (2011). Looking proximally and distally: 100 years of limb regeneration and beyond. *Dev. Dyn. Off. Publ. Am. Assoc. Anat.* *240*, 943–968.
- Stoick-Cooper, C.L., Weidinger, G., Riehle, K.J., Hubbert, C., Major, M.B., Fausto, N., and Moon, R.T. (2007a). Distinct Wnt signaling pathways have opposing roles in appendage regeneration. *Dev. Camb. Engl.* *134*, 479–489.
- Stoick-Cooper, C.L., Moon, R.T., and Weidinger, G. (2007b). Advances in signaling in vertebrate regeneration as a prelude to regenerative medicine. *Genes Dev.* *21*, 1292–1315.
- Stone, L.S. (1963). Vision in eyes of several species of adult newts transplanted to adult *Triturus V. viridescens*. *J. Exp. Zool.* *153*, 57–67.
- Stone, D.M., Hynes, M., Armanini, M., Swanson, T.A., Gu, Q., Johnson, R.L., Scott, M.P., Pennica, D., Goddard, A., Phillips, H., et al. (1996). The tumour-suppressor gene patched encodes a candidate receptor for Sonic hedgehog. *Nature* *384*, 129–134.
- Storz, G., and Imlay, J.A. (1999). Oxidative stress. *Curr. Opin. Microbiol.* *2*, 188–194.
- Stover, S.L., Hale, A.M., and Buell, A.B. (1994a). Skin complications other than pressure ulcers following spinal cord injury. *Arch. Phys. Med. Rehabil.* *75*, 987–993.
- Stover, S.L., Omura, E.F., and Buell, A.B. (1994b). Clinical skin thickening following spinal cord injury studied by histopathology. *J. Am. Paraplegia Soc.* *17*, 44–49.
- Strittmatter, S.M., Valenzuela, D., Kennedy, T.E., Neer, E.J., and Fishman, M.C. (1990). G0 is a major growth cone protein subject to regulation by GAP-43. *Nature* *344*, 836–841.
- Sudo, Y., Valenzuela, D., Beck-Sickinger, A.G., Fishman, M.C., and Strittmatter, S.M. (1992). Palmitoylation alters protein activity: blockade of G(o) stimulation by GAP-43. *EMBO J.* *11*, 2095–2102.
- Suzukawa, K., Miura, K., Mitsushita, J., Resau, J., Hirose, K., Crystal, R., and Kamata, T. (2000). Nerve growth factor-induced neuronal differentiation requires generation of Rac1-regulated reactive oxygen species. *J. Biol. Chem.* *275*, 13175–13178.
- Suzuki, M., Yakushiji, N., Nakada, Y., Satoh, A., Ide, H., and Tamura, K. (2006). Limb regeneration in *Xenopus laevis* froglet. *ScientificWorldJournal* *6 Suppl 1*, 26–37.
- Suzuki, M., Takagi, C., Miura, S., Sakane, Y., Suzuki, M., Sakuma, T., Sakamoto, N., Endo, T., Kamei, Y., Sato, Y., et al. (2016). In vivo tracking of histone H3 lysine 9 acetylation in *Xenopus laevis* during tail regeneration. *Genes Cells Devoted Mol. Cell. Mech.* *21*, 358–369.
- Svärd, J., Heby-Henricson, K., Henricson, K.H., Persson-Lek, M., Rozell, B., Lauth, M., Bergström, A., Ericson, J., Toftgård, R., and Teglund, S. (2006). Genetic elimination of Suppressor of fused reveals an essential repressor function in the mammalian Hedgehog signaling pathway. *Dev. Cell* *10*, 187–197.
- Tabata, T., Eaton, S., and Kornberg, T.B. (1992). The *Drosophila* hedgehog gene is expressed specifically in posterior compartment cells and is a target of engrailed regulation. *Genes Dev.* *6*, 2635–2645.

- Taddei, M.L., Parri, M., Mello, T., Catalano, A., Levine, A.D., Raugeri, G., Ramponi, G., and Chiarugi, P. (2007). Integrin-mediated cell adhesion and spreading engage different sources of reactive oxygen species. *Antioxid. Redox Signal.* 9, 469–481.
- Takada, R., Satomi, Y., Kurata, T., Ueno, N., Norioka, S., Kondoh, H., Takao, T., and Takada, S. (2006). Monounsaturated fatty acid modification of Wnt protein: its role in Wnt secretion. *Dev. Cell* 11, 791–801.
- Takei, Y., Ozawa, Y., Sato, M., Watanabe, A., and Tabata, T. (2004). Three *Drosophila* EXT genes shape morphogen gradients through synthesis of heparan sulfate proteoglycans. *Dev. Camb. Engl.* 131, 73–82.
- Takeo, M., Chou, W.C., Sun, Q., Lee, W., Rabbani, P., Loomis, C., Taketo, M.M., and Ito, M. (2013). Wnt activation in nail epithelium couples nail growth to digit regeneration. *Nature* 499, 228–232.
- Takimoto, K., Yang, E.-K., and Conforti, L. (2002). Palmitoylation of KChIP splicing variants is required for efficient cell surface expression of Kv4.3 channels. *J. Biol. Chem.* 277, 26904–26911.
- Tanaka, E.M., Drechsel, D.N., and Brockes, J.P. (1999). Thrombin regulates S-phase re-entry by cultured newt myotubes. *Curr. Biol. CB* 9, 792–799.
- Tassava, R.A., and Olsen-Winner, C.L. (2003). Responses to amputation of denervated ambystoma limbs containing aneurogenic limb grafts. *J. Exp. Zool. A Comp. Exp. Biol.* 297, 64–79.
- Taylor, F.R., Wen, D., Garber, E.A., Carmillo, A.N., Baker, D.P., Arduini, R.M., Williams, K.P., Weinreb, P.H., Rayhorn, P., Hronowski, X., et al. (2001). Enhanced potency of human Sonic hedgehog by hydrophobic modification. *Biochemistry (Mosc.)* 40, 4359–4371.
- Taylor, G.P., Anderson, R., Reginelli, A.D., and Muneoka, K. (1994). FGF-2 induces regeneration of the chick limb bud. *Dev. Biol.* 163, 282–284.
- Tell, G., Pellizzari, L., Cimarosti, D., Pucillo, C., and Damante, G. (1998a). Ref-1 controls pax-8 DNA-binding activity. *Biochem. Biophys. Res. Commun.* 252, 178–183.
- Tell, G., Scaloni, A., Pellizzari, L., Formisano, S., Pucillo, C., and Damante, G. (1998b). Redox potential controls the structure and DNA binding activity of the paired domain. *J. Biol. Chem.* 273, 25062–25072.
- Tell, G., Zecca, A., Pellizzari, L., Spessotto, P., Colombatti, A., Kelley, M.R., Damante, G., and Pucillo, C. (2000). An “environment to nucleus” signaling system operates in B lymphocytes: redox status modulates BSAP/Pax-5 activation through Ref-1 nuclear translocation. *Nucleic Acids Res.* 28, 1099–1105.
- Tempé, D., Casas, M., Karaz, S., Blanchet-Tournier, M.-F., and Concordet, J.-P. (2006). Multisite protein kinase A and glycogen synthase kinase 3beta phosphorylation leads to Gli3 ubiquitination by SCFbetaTrCP. *Mol. Cell. Biol.* 26, 4316–4326.
- Thannickal, V.J., and Fanburg, B.L. (2000). Reactive oxygen species in cell signaling. *Am. J. Physiol. Lung Cell. Mol. Physiol.* 279, L1005–L1028.
- Thérond, P.P., Knight, J.D., Kornberg, T.B., and Bishop, J.M. (1996). Phosphorylation of the fused protein kinase in response to signaling from hedgehog. *Proc. Natl. Acad. Sci. U. S. A.* 93, 4224–4228.
- Thornton, C.S. (1957). The effect of apical cap removal on limb regeneration in *Amblystoma* larvae. *J. Exp. Zool.* 134, 357–381.
- Thornton, C.S. (1970). Amphibian limb regeneration and its relation to nerves. *Am. Zool.* 10, 113–118.
- Thornton, C.S., and Thornton, M.T. (1970). Recuperation of regeneration in denervated limbs of *Ambystoma* larvae. *J. Exp. Zool.* 173, 293–301.
- Tian, L., McClafferty, H., Jeffries, O., and Shipston, M.J. (2010). Multiple palmitoyltransferases are required for palmitoylation-dependent regulation of large conductance calcium- and voltage-activated potassium channels. *J. Biol. Chem.* 285, 23954–23962.

- Tian, L., McClafferty, H., Knaus, H.-G., Ruth, P., and Shipston, M.J. (2012). Distinct acyl protein transferases and thioesterases control surface expression of calcium-activated potassium channels. *J. Biol. Chem.* 287, 14718–14725.
- Tiffany, A.M., Manganas, L.N., Kim, E., Hsueh, Y.P., Sheng, M., and Trimmer, J.S. (2000). PSD-95 and SAP97 exhibit distinct mechanisms for regulating K(+) channel surface expression and clustering. *J. Cell Biol.* 148, 147–158.
- Todd, T.J. (1823). On the process of reproduction of the members of the aquatic salamander. In *Quarterly Journal of Science Literature and the Arts*, (London: John Murray),.
- Toledano, M.B., Planson, A.-G., and Delaunay-Moisan, A. (2010). Reining in H₂O₂ for safe signaling. *Cell* 140, 454–456.
- Tomatis, V.M., Trenchi, A., Gomez, G.A., and Daniotti, J.L. (2010). Acyl-protein thioesterase 2 catalyzes the deacylation of peripheral membrane-associated GAP-43. *PLoS One* 5, e15045.
- Topinka, J.R., and Brecht, D.S. (1998). N-terminal palmitoylation of PSD-95 regulates association with cell membranes and interaction with K⁺ channel Kv1.4. *Neuron* 20, 125–134.
- Tornini, V.A., and Poss, K.D. (2014). Keeping at arm's length during regeneration. *Dev. Cell* 29, 139–145.
- Towler, D., and Glaser, L. (1986). Protein fatty acid acylation: enzymatic synthesis of an N-myristoylglycyl peptide. *Proc. Natl. Acad. Sci. U. S. A.* 83, 2812–2816.
- Trebitsh, T., Levitan, A., Sofer, A., and Danon, A. (2000). Translation of chloroplast psbA mRNA is modulated in the light by counteracting oxidizing and reducing activities. *Mol. Cell. Biol.* 20, 1116–1123.
- Tsatmali, M., Walcott, E.C., and Crossin, K.L. (2005). Newborn neurons acquire high levels of reactive oxygen species and increased mitochondrial proteins upon differentiation from progenitors. *Brain Res.* 1040, 137–150.
- Tsatmali, M., Walcott, E.C., Makarenkova, H., and Crossin, K.L. (2006). Reactive oxygen species modulate the differentiation of neurons in clonal cortical cultures. *Mol. Cell. Neurosci.* 33, 345–357.
- Tu, S., and Johnson, S.L. (2011). Fate restriction in the growing and regenerating zebrafish fin. *Dev. Cell* 20, 725–732.
- Tu, Y., Wang, J., and Ross, E.M. (1997). Inhibition of brain Gz GAP and other RGS proteins by palmitoylation of G protein alpha subunits. *Science* 278, 1132–1135.
- Tukachinsky, H., Lopez, L.V., and Salic, A. (2010). A mechanism for vertebrate Hedgehog signaling: recruitment to cilia and dissociation of SuFu-Gli protein complexes. *J. Cell Biol.* 191, 415–428.
- Tuson, M., He, M., and Anderson, K.V. (2011). Protein kinase A acts at the basal body of the primary cilium to prevent Gli2 activation and ventralization of the mouse neural tube. *Dev. Camb. Engl.* 138, 4921–4930.
- Valdez-Taubas, J., and Pelham, H. (2005). Swf1-dependent palmitoylation of the SNARE Tlg1 prevents its ubiquitination and degradation. *EMBO J.* 24, 2524–2532.
- Varjosalo, M., and Taipale, J. (2007). Hedgehog signaling. *J. Cell Sci.* 120, 3–6.
- Varjosalo, M., and Taipale, J. (2008). Hedgehog: functions and mechanisms. *Genes Dev.* 22, 2454–2472.
- Varjosalo, M., Li, S.-P., and Taipale, J. (2006). Divergence of hedgehog signal transduction mechanism between *Drosophila* and mammals. *Dev. Cell* 10, 177–186.
- Veal, E.A., Ross, S.J., Malakasi, P., Peacock, E., and Morgan, B.A. (2003). Ybp1 is required for the hydrogen peroxide-induced oxidation of the Yap1 transcription factor. *J. Biol. Chem.* 278, 30896–30904.

- Veal, E.A., Day, A.M., and Morgan, B.A. (2007). Hydrogen Peroxide Sensing and Signaling. *Mol. Cell* 26, 1–14.
- Veit, M., Söllner, T.H., and Rothman, J.E. (1996). Multiple palmitoylation of synaptotagmin and the t-SNARE SNAP-25. *FEBS Lett.* 385, 119–123.
- Veit, M., Becher, A., and Ahnert-Hilger, G. (2000). Synaptobrevin 2 is palmitoylated in synaptic vesicles prepared from adult, but not from embryonic brain. *Mol. Cell. Neurosci.* 15, 408–416.
- Velloso, C.P., Kumar, A., Tanaka, E.M., and Brockes, J.P. (2000). Generation of mononucleate cells from post-mitotic myotubes proceeds in the absence of cell cycle progression. *Differ. Res. Biol. Divers.* 66, 239–246.
- Verkruyse, L.A., and Hofmann, S.L. (1996). Lysosomal targeting of palmitoyl-protein thioesterase. *J. Biol. Chem.* 271, 15831–15836.
- Vilas, G.L., Corvi, M.M., Plummer, G.J., Seime, A.M., Lambkin, G.R., and Berthiaume, L.G. (2006). Posttranslational myristoylation of caspase-activated p21-activated protein kinase 2 (PAK2) potentiates late apoptotic events. *Proc. Natl. Acad. Sci. U. S. A.* 103, 6542–6547.
- van der Vliet, A., and Janssen-Heininger, Y.M.W. (2014). Hydrogen Peroxide as a Damage Signal in Tissue Injury and Inflammation: Murderer, Mediator, or Messenger?: Hydrogen Peroxide in Tissue Damage Responses. *J. Cell. Biochem.* 115, 427–435.
- Vortkamp, A., Lee, K., Lanske, B., Segre, G.V., Kronenberg, H.M., and Tabin, C.J. (1996). Regulation of rate of cartilage differentiation by Indian hedgehog and PTH-related protein. *Science* 273, 613–622.
- Wada, H., and Makabe, K. (2006). Genome duplications of early vertebrates as a possible chronicle of the evolutionary history of the neural crest. *Int. J. Biol. Sci.* 2, 133–141.
- Wagner, D.E., Wang, I.E., and Reddien, P.W. (2011). Clonogenic neoblasts are pluripotent adult stem cells that underlie planarian regeneration. *Science* 332, 811–816.
- Wanek, N., Muneoka, K., and Bryant, S.V. (1989). Evidence for regulation following amputation and tissue grafting in the developing mouse limb. *J. Exp. Zool.* 249, 55–61.
- Wang, B., and Li, Y. (2006). Evidence for the direct involvement of β TrCP in Gli3 protein processing. *Proc. Natl. Acad. Sci. U. S. A.* 103, 33–38.
- Wang, G., and Jiang, J. (2004). Multiple Cos2/Ci interactions regulate Ci subcellular localization through microtubule dependent and independent mechanisms. *Dev. Biol.* 268, 493–505.
- Wang, H., and Joseph, J.A. (1999). Quantifying cellular oxidative stress by dichlorofluorescein assay using microplate reader. *Free Radic. Biol. Med.* 27, 612–616.
- Wang, Q.T., and Holmgren, R.A. (2000). Nuclear import of cubitus interruptus is regulated by hedgehog via a mechanism distinct from Ci stabilization and Ci activation. *Dev. Camb. Engl.* 127, 3131–3139.
- Wang, B., Fallon, J.F., and Beachy, P.A. (2000a). Hedgehog-regulated processing of Gli3 produces an anterior/posterior repressor gradient in the developing vertebrate limb. *Cell* 100, 423–434.
- Wang, C., Pan, Y., and Wang, B. (2010). Suppressor of fused and Spop regulate the stability, processing and function of Gli2 and Gli3 full-length activators but not their repressors. *Dev. Camb. Engl.* 137, 2001–2009.
- Wang, G., Amanai, K., Wang, B., and Jiang, J. (2000b). Interactions with Costal2 and suppressor of fused regulate nuclear translocation and activity of cubitus interruptus. *Genes Dev.* 14, 2893–2905.
- Wang, L., Marchionni, M.A., and Tassava, R.A. (2000c). Cloning and neuronal expression of a type III newt neuregulin and rescue of denervated, nerve-dependent newt limb blastemas by rhGGF2. *J. Neurobiol.* 43, 150–158.

- Wartlick, O., Kicheva, A., and González-Gaitán, M. (2009). Morphogen gradient formation. *Cold Spring Harb. Perspect. Biol.* *1*, a001255.
- Washbourne, P., Cansino, V., Mathews, J.R., Graham, M., Burgoyne, R.D., and Wilson, M.C. (2001). Cysteine residues of SNAP-25 are required for SNARE disassembly and exocytosis, but not for membrane targeting. *Biochem. J.* *357*, 625–634.
- Watanabe, Y., and Nakamura, H. (2000). Control of chick tectum territory along dorsoventral axis by Sonic hedgehog. *Dev. Camb. Engl.* *127*, 1131–1140.
- Watson, J.D. (2014). Type 2 diabetes as a redox disease. *The Lancet* *383*, 841–843.
- Wedegaertner, P.B., and Bourne, H.R. (1994). Activation and depalmitoylation of Gs alpha. *Cell* *77*, 1063–1070.
- Wen, X., Lai, C.K., Evangelista, M., Hongo, J.-A., de Sauvage, F.J., and Scales, S.J. (2010). Kinetics of hedgehog-dependent full-length Gli3 accumulation in primary cilia and subsequent degradation. *Mol. Cell. Biol.* *30*, 1910–1922.
- White, J.A., Boffa, M.B., Jones, B., and Petkovich, M. (1994). A zebrafish retinoic acid receptor expressed in the regenerating caudal fin. *Dev. Camb. Engl.* *120*, 1861–1872.
- Whitehead, G.G., Makino, S., Lien, C.-L., and Keating, M.T. (2005). fgf20 is essential for initiating zebrafish fin regeneration. *Science* *310*, 1957–1960.
- Widmann, J.J., and Fahimi, H.D. (1975). The regenerative response of Kupffer cells and endothelial cells after partial hepatectomy. In: R. Lesch and W. Reutter editors. *Liver regeneration after experimental injury*. N. Y. Strat. Intercont. Med. Book Corp 89–98.
- Wijgerde, M., McMahon, J.A., Rule, M., and McMahon, A.P. (2002). A direct requirement for Hedgehog signaling for normal specification of all ventral progenitor domains in the presumptive mammalian spinal cord. *Genes Dev.* *16*, 2849–2864.
- Wilkinson, B., and Gilbert, H.F. (2004). Protein disulfide isomerase. *Biochim. Biophys. Acta* *1699*, 35–44.
- Wilson, C.W., and Chuang, P.-T. (2010). Mechanism and evolution of cytosolic Hedgehog signal transduction. *Dev. Camb. Engl.* *137*, 2079–2094.
- Wilson, J.P., Raghavan, A.S., Yang, Y.-Y., Charron, G., and Hang, H.C. (2011). Proteomic analysis of fatty-acylated proteins in mammalian cells with chemical reporters reveals S-acylation of histone H3 variants. *Mol. Cell. Proteomics MCP* *10*, M110.001198.
- Winterbourn, C.C. (2013). The biological chemistry of hydrogen peroxide. *Methods Enzymol.* *528*, 3–25.
- Wittenberg, G., and Danon, A. (2008). Disulfide bond formation in chloroplasts: Formation of disulfide bonds in signaling chloroplast proteins. *Plant Sci.* *175*, 459–466.
- Wolpert, L. (1994). The evolutionary origin of development: cycles, patterning, privilege and continuity. *Dev. Camb. Engl. Suppl.* 79–84.
- Woo, H.A., Yim, S.H., Shin, D.H., Kang, D., Yu, D.-Y., and Rhee, S.G. (2010). Inactivation of peroxiredoxin I by phosphorylation allows localized H₂O₂ accumulation for cell signaling. *Cell* *140*, 517–528.
- Wood, Z.A., Schröder, E., Robin Harris, J., and Poole, L.B. (2003). Structure, mechanism and regulation of peroxiredoxins. *Trends Biochem. Sci.* *28*, 32–40.
- Wright, L.P., and Philips, M.R. (2006). Thematic review series: lipid posttranslational modifications. CAAX modification and membrane targeting of Ras. *J. Lipid Res.* *47*, 883–891.

- Xia, R., Jia, H., Fan, J., Liu, Y., and Jia, J. (2012). USP8 promotes smoothed signaling by preventing its ubiquitination and changing its subcellular localization. *PLoS Biol.* *10*, e1001238.
- Xu, S., and Chisholm, A.D. (2014). *C. elegans* Epidermal Wounding Induces a Mitochondrial ROS Burst that Promotes Wound Repair. *Dev. Cell* *31*, 48–60.
- Yam, P.T., and Charron, F. (2013). Signaling mechanisms of non-conventional axon guidance cues: the Shh, BMP and Wnt morphogens. *Curr. Opin. Neurobiol.* *23*, 965–973.
- Yamazaki, M., Fukaya, M., Abe, M., Ikeno, K., Kakizaki, T., Watanabe, M., and Sakimura, K. (2001). Differential palmitoylation of two mouse glutamate receptor interacting protein 1 forms with different N-terminal sequences. *Neurosci. Lett.* *304*, 81–84.
- Yang, G., and Cynader, M.S. (2011). Palmitoyl acyltransferase zD17 mediates neuronal responses in acute ischemic brain injury by regulating JNK activation in a signaling module. *J. Neurosci. Off. J. Soc. Neurosci.* *31*, 11980–11991.
- Ye, Z.-W., Zhang, J., Townsend, D.M., and Tew, K.D. (2015). Oxidative stress, redox regulation and diseases of cellular differentiation. *Biochim. Biophys. Acta BBA - Gen. Subj.* *1850*, 1607–1621.
- Yntema, C.L. (1959). Blastema formation in sparsely innervated and aneurogenic forelimbs of amblystoma larvae. *J. Exp. Zool.* *142*, 423–439.
- Yoo, S.K., Freisinger, C.M., LeBert, D.C., and Huttenlocher, A. (2012). Early redox, Src family kinase, and calcium signaling integrate wound responses and tissue regeneration in zebrafish. *J. Cell Biol.* *199*, 225–234.
- Yoshinari, N., Ishida, T., Kudo, A., and Kawakami, A. (2009). Gene expression and functional analysis of zebrafish larval fin fold regeneration. *Dev. Biol.* *325*, 71–81.
- Young, F.B., Butland, S.L., Sanders, S.S., Sutton, L.M., and Hayden, M.R. (2012). Putting proteins in their place: palmitoylation in Huntington disease and other neuropsychiatric diseases. *Prog. Neurobiol.* *97*, 220–238.
- Yue, S., Chen, Y., and Cheng, S.Y. (2009). Hedgehog signaling promotes the degradation of tumor suppressor Sufu through the ubiquitin-proteasome pathway. *Oncogene* *28*, 492–499.
- Zeidman, R., Jackson, C.S., and Magee, A.I. (2009). Protein acyl thioesterases (Review). *Mol. Membr. Biol.* *26*, 32–41.
- Zeng, X., Goetz, J.A., Suber, L.M., Scott, W.J., Schreiner, C.M., and Robbins, D.J. (2001). A freely diffusible form of Sonic hedgehog mediates long-range signalling. *Nature* *411*, 716–720.
- Zhang, C., Williams, E.H., Guo, Y., Lum, L., and Beachy, P.A. (2004). Extensive phosphorylation of Smoothed in Hedgehog pathway activation. *Proc. Natl. Acad. Sci. U. S. A.* *101*, 17900–17907.
- Zhang, J., Jeradi, S., Strähle, U., and Akimenko, M.-A. (2012). Laser ablation of the sonic hedgehog-expressing cells during fin regeneration affects ray branching morphogenesis. *Dev. Biol.* *365*, 424–433.
- Zhang, Q., Zhang, L., Wang, B., Ou, C.-Y., Chien, C.-T., and Jiang, J. (2006). A hedgehog-induced BTB protein modulates hedgehog signaling by degrading Ci/Gli transcription factor. *Dev. Cell* *10*, 719–729.
- Zhang, Q., Wang, Y., Man, L., Zhu, Z., Bai, X., Wei, S., Liu, Y., Liu, M., Wang, X., Gu, X., et al. (2016). Reactive oxygen species generated from skeletal muscles are required for gecko tail regeneration. *Sci. Rep.* *6*, 20752.
- Zhang, W., Zhao, Y., Tong, C., Wang, G., Wang, B., Jia, J., and Jiang, J. (2005). Hedgehog-regulated Costal2-kinase complexes control phosphorylation and proteolytic processing of Cubitus interruptus. *Dev. Cell* *8*, 267–278.

- Zhang, X.M., Ramalho-Santos, M., and McMahon, A.P. (2001). Smoothed mutants reveal redundant roles for Shh and Ihh signaling including regulation of L/R asymmetry by the mouse node. *Cell* *105*, 781–792.
- Zhang, Y., Mao, F., Lu, Y., Wu, W., Zhang, L., and Zhao, Y. (2011). Transduction of the Hedgehog signal through the dimerization of Fused and the nuclear translocation of Cubitus interruptus. *Cell Res.* *21*, 1436–1451.
- Zhao, W., and Neufeld, D.A. (1995). Bone regrowth in young mice stimulated by nail organ. *J. Exp. Zool.* *271*, 155–159.
- Zhao, L., Lobo, S., Dong, X., Ault, A.D., and Deschenes, R.J. (2002). Erf4p and Erf2p form an endoplasmic reticulum-associated complex involved in the plasma membrane localization of yeast Ras proteins. *J. Biol. Chem.* *277*, 49352–49359.
- Zhao, Y., Tong, C., and Jiang, J. (2007). Hedgehog regulates smoothed activity by inducing a conformational switch. *Nature* *450*, 252–258.
- Zheng, M., Aslund, F., and Storz, G. (1998). Activation of the OxyR transcription factor by reversible disulfide bond formation. *Science* *279*, 1718–1721.
- Zheng, X., Mann, R.K., Sever, N., and Beachy, P.A. (2010). Genetic and biochemical definition of the Hedgehog receptor. *Genes Dev.* *24*, 57–71.
- Zhou, Q., and Kalderon, D. (2011). Hedgehog activates fused through phosphorylation to elicit a full spectrum of pathway responses. *Dev. Cell* *20*, 802–814.
- Zhu, A.J., and Scott, M.P. (2004). Incredible journey: how do developmental signals travel through tissue? *Genes Dev.* *18*, 2985–2997.
- Zuber, M.X., Strittmatter, S.M., and Fishman, M.C. (1989). A membrane-targeting signal in the amino terminus of the neuronal protein GAP-43. *Nature* *341*, 345–348.
- Zuckerman, D.M., Hicks, S.W., Charron, G., Hang, H.C., and Machamer, C.E. (2011). Differential regulation of two palmitoylation sites in the cytoplasmic tail of the beta1-adrenergic receptor. *J. Biol. Chem.* *286*, 19014–19023.

Résumé

Ces dernières années, il est apparu que les espèces réactives de l'oxygène (ROS) ne sont pas seulement des substances délétères qui induisent des dommages de molécules biologiques, mais qu'elles sont également impliquées dans la signalisation cellulaire. Des niveaux contrôlés de H_2O_2 sont en particulier impliqués dans le processus de régénération chez différentes espèces. Nous avons donc étudié la régulation de la signalisation de H_2O_2 au cours de régénération de la nageoire caudale chez le poisson zèbre adulte. Nous avons montré que les nerfs contrôlent les niveaux de H_2O_2 à la fois dans les tissus normaux et après blessure; ce processus est médié par les cellules de Schwann qui expriment Shh. En plus, H_2O_2 stimule la croissance des nerfs, ce qui suggère la présence d'une boucle de rétrocontrôle positif. Les niveaux redox sont très dynamiques non seulement lors de la régénération, mais aussi au cours du développement. Nous avons ensuite examiné le rôle de H_2O_2 pendant la morphogenèse et plus précisément, son impact sur la croissance axonale et sa relation avec la signalisation Shh. Nous avons constaté que la réduction des niveaux de H_2O_2 , normalement très élevé au cours de la morphogenèse, altère les projections axonales et que cet effet peut être sauvé par l'activation de la voie de signalisation de Shh. Les cibles de la signalisation redox comprennent des protéines dont l'activité est dépendante d'une cystéine, car l'état d'oxydation de cet acide aminé peut être modifié par les niveaux de H_2O_2 . Le processus de S-acylation, qui est très important pour le processus de croissance des projections axonales et pour la voie de signalisation de Shh, consiste en la fixation covalente d'un acide gras, souvent le palmitate, au group sulfurique d'une cystéine et il est donc une cible potentielle de signalisation de ROS. Nous avons mis en évidence une corrélation entre le niveau de palmitoylation d'une protéine et les niveaux de H_2O_2 dans la cellule. La pertinence de cette observation est actuellement testée *in vivo*.

Mots Clés

régénération, développement, H_2O_2 , Shh, nerfs, S-palmitoylation

Abstract

In the recent years it is becoming evident that reactive oxygen species (ROS) are not only deleterious compounds that induce damage of biological molecules, but are also important molecules that can mediate different signaling pathways. Controlled ROS, and in particular H_2O_2 , levels have been found to be involved in the regenerative process of different species. We then focused on the regulation of H_2O_2 signaling during regeneration of the adult zebrafish caudal fin and we showed that nerves control H_2O_2 levels both in normal tissue and after lesioning; this process is mediated by Schwann cells, through Shh signaling. In addition, there is also a reciprocal action of H_2O_2 on nerve growth, suggesting the presence of a positive feedback loop.

Redox levels are highly dynamic not only during regeneration, but also during development. We then looked at the role of H_2O_2 during morphogenesis and more specifically, its impact on axonal growth and its relationship with Shh signaling. We found that reduction of H_2O_2 levels, normally very high during morphogenesis, impairs axon projections and that this effect can be rescued by the activation of Shh signaling. Moreover, we found that different redox levels modify the intracellular distribution of Shh protein and also its extracellular availability. These results further strengthen the relationship between H_2O_2 and Shh signaling pathways.

It is widely accepted that targets of redox signaling include proteins whose activity is dependent on an active cysteine because the oxidative status of this amino acid can be modified by H_2O_2 levels. The process of S-acylation, which is very important for both the processes of axonal projections growth and Shh signaling, consists in the covalent attachment of a fatty acid, often palmitate, to a cysteine sulphur and it is then a possible target of ROS signaling. We asked whether a relationship between H_2O_2 levels and protein S-palmitoylation could exist and we found that augmentation of H_2O_2 levels downregulates the S-palmitoylation process. The relevance of this observation is currently being tested *in vivo*.

Keywords

regeneration, development, H_2O_2 , Shh, nerves, S-palmitoylation