



HAL
open science

Neutrophils in IgG- and endotoxin-induced systemic inflammation: protective or pathological agents?

Caitlin Gillis

► **To cite this version:**

Caitlin Gillis. Neutrophils in IgG- and endotoxin-induced systemic inflammation: protective or pathological agents?. Immunology. Université Pierre et Marie Curie - Paris VI, 2016. English. NNT: 2016PA066279 . tel-01446484

HAL Id: tel-01446484

<https://theses.hal.science/tel-01446484>

Submitted on 26 Jan 2017

HAL is a multi-disciplinary open access archive for the deposit and dissemination of scientific research documents, whether they are published or not. The documents may come from teaching and research institutions in France or abroad, or from public or private research centers.

L'archive ouverte pluridisciplinaire **HAL**, est destinée au dépôt et à la diffusion de documents scientifiques de niveau recherche, publiés ou non, émanant des établissements d'enseignement et de recherche français ou étrangers, des laboratoires publics ou privés.



**THESE DE DOCTORAT DE
L'UNIVERSITE PIERRE ET MARIE CURIE**

Ecole Doctorale ED394 Physiologie et Physiopathologie
Spécialité : Immunologie

Présentée par

Caitlin M. Gillis

Pour obtenir le grade de

DOCTEUR de l'UNIVERSITÉ PIERRE ET MARIE CURIE

Sujet de la thèse :

**Neutrophils in IgG- and endotoxin-induced systemic inflammation:
protective or pathological agents?**

Soutenance le 30/09/2016 devant le jury composé de:

Dr Behazine Combadiere	President
Dr Andres Hidalgo	Rapporteur
Dr Timo K. van den Berg	Rapporteur
Dr Luc de Chaisemartin	Examineur
Prof. Dan Longrois	Examineur
Dr Pierre Bruhns	Directeur de Thèse

*This work was achieved in INSERM U1222
Unit of Antibodies in Therapy and Pathology, Institut Pasteur*



**THESE DE DOCTORAT DE
L'UNIVERSITE PIERRE ET MARIE CURIE**

Ecole Doctorale ED394 Physiologie et Physiopathologie
Spécialité : Immunologie

Présentée par

Caitlin M. Gillis

Pour obtenir le grade de

DOCTEUR de l'UNIVERSITÉ PIERRE ET MARIE CURIE

Sujet de la thèse :

**Neutrophils in IgG- and endotoxin-induced systemic inflammation:
protective or pathological agents?**

Soutenance le 30/09/2016 devant le jury composé de:

Dr Behazine Combadiere	President
Dr Andres Hidalgo	Rapporteur
Dr Timo K. van den Berg	Rapporteur
Dr Luc de Chaisemartin	Examineur
Prof. Dan Longrois	Examineur
Dr Pierre Bruhns	Directeur de Thèse

*This work was achieved in INSERM U1222
Unit of Antibodies in Therapy and Pathology, Institut Pasteur*

Acknowledgments / Remerciement

I owe my heartfelt thanks to many, many people.

First and foremost, to my supervisor Pierre, thank you for inspiring me to think and motivating me to do, for tolerating my propensity to break things and occasionally over-consume, for dancing and karaoke, for our engaging discussions, your patient corrections (in science, frenchiness and life), and most of all for giving me courage and confidence in my own work and granting me the freedom to pursue all these different projects.

Thank you for your critical reading and encouraging feedback in the writing of this manuscript. I am extremely grateful for your direction, support and guidance throughout these years.

Thank you to all the members of my jury for accepting to evaluate my thesis work: Timo van den Berg, Andres Hidalgo, Luc de Chaisemartin, Dan Longrois and Behazine Combadiere.

Thanks especially to Timo and Andres for taking the time and energy to review this manuscript and to journey to Paris for my thesis defence, and for your positive appraisals.

Merci à Luc also for your collaboration in the NASA study, and for your expedient comments on the anaphylaxis discussion.

Thanks particularly also to Dan for your ongoing engagement in my project, your participation in the committee meetings, and your time to assist me with the mouse anaesthesia and curare project, along with the NASA study.

Big thanks & *un grand, grand merci* to all the past and current members of ATP:

To Freddie, who has been there from the start, an endless source of advice, answers and constructive criticism. I've appreciated so much to be able to ask you anything and have an honest discussion – whether it be about science or about life outside. Thank you for your work to put the *Frontiers* review together; thanks for all the 'behind the scenes' work you did in making the lab go, especially in its infancy; for your contributions to the MRP8-DTR project; and for your untiring efforts on the NASA study.

To David, who welcomed me to the lab with such warmth, taught me to do my first i.v. injections and who started the 15-- mice studies. To Marcello, who taught me to be a rockstar.

To Heloise – your calm radiant presence next to me for 3 years has been a blessing. Thank you for listening to my chatter, and for sharing my 'carreau' and PhD woes - and most particularly for all the shared dance-floors and good times outside of the lab. Je te remercie beaucoup.

À Bruno, merci pour ton aide avec la biologie moléculaire et les PCRs, pour produisant des grands quantités d'anticorps, pour le chocolat et les moments drôles. À Odile, merci pour ton soutien et tous tes mots encourageants, t'as toujours eu une oreille pour moi au moment où j'en ai besoin – merci pour ton aide avec les anticorps et les souris, et merci pour les brioches!

À Ophélie, je te remercie pour tous, tous les blagues et mots du jour, ton sourire et ton rire, le bonheur que tu portes au labo, les bières du soir et les soirées pétanque – et bien pour tout ton aide pour les manips, même si parfois on passe trop du temps à la plage !

À Aurélie, je te remercie pour ta gentillesse et ton soutien; pour tout ton travail sur l'étude NASA et pour les discussions et idées sur les anticorps curare. To Biliانا, it has been lovely to have you in the lab and a pleasure to work and discuss with you - thank you for your work on the Gfi anaphylaxis experiments. To Priscila, a great bench neighbour and late-night company, thanks for your work on the 1505 tumour experiments.

To Laurent, thank you very much for the collaboration and all your work on the MRP8-DTR project, and for driving the LPS story forward. It has been a valuable experience to work with you, and I'm happy to have had you join the lab.

To Bianca, la nouvelle thésarde, I'm so very glad that I've had the chance to meet and spend time with you this year, you've brought some of the smiles, laughter and sun from Brazil into the lab! Thanks to Carlos, for your cheerful whistle and light-hearted banter, and for reminding me of the fun to be had outside of the lab.

À Guillaume, le koala, je te remercie pour ton aide avec des figures, pour tous les bons questions tu m'apportes, et bien sûr tes bons avis sur le vin.

À Daniele, je te remercie pour ton aide administratif, les commandes passées au dernier moment, et pour tes mots encourageants.

A huge thank you to the co-authors of LPS / PMNDTR story and to the lab of Steve Galli.

Je remercie Sylvie Chollet-Martin et Vanessa Granger, et toutes les personnes engagés dans l'étude NASA, et évidemment tous les patients.

Un grand merci à Sylvie Bay et Christelle Ganneau pour le côté chimique. Sauf vous, nous aurions jamais si progressés dans les études curares avec des souris. Je vous remercie de votre conseil et d'avoir m'accueilli dans votre labo.

Merci beaucoup à Marie-Anne Nicola, Laurence Fiette, Marion Berard et tout l'équipe de les animaleries Metchnikoff -3, BIME et Axénique pour votre aide, assistance et travail. Je remercie Francois Traincard and Sylvie Darteville pour leur travail au premier sur les fusions des rates.

Thanks to the PPUIDP program for supporting me in my time in Paris, it has been an excellent experience for me. Special thanks to the current and past members of the PPU committee who donate their time and energy to the program – it is truly a great thing to be a part of as a student, and I am so happy to see it expanding every year.

Thank you to Olivier Schwartz for your mentoring and your ongoing participation in my thesis committee, and also to David Saadoun.

Thanks to all the members of the Department of Immunology who have ever offered a helpful piece of advice, a smile in passing or an antibody when in need. Most particular thanks to Molly Ingersoll for teaching me about monocytés, to Susanna Celli for the liver surgeries, and to Philippe Bousso and his Unit

for advice and collaboration. Thanks to the department heads Matthew Albert and Gerard Eberl for supporting the Forest Seminars and for listening to the requests of the students.

To my previous scientific mentors Scott Byrne and Manuela Florido thank you: the skills that I gained under your excellent supervision and guidance continue to serve me well.

To my family, Mum and Dad, thank you for your endless and never-wavering support and encouragement, love, advice and consolation, and a home I will always miss and always belong to. To Alex - the coolest person I know – thanks for tolerating me (!), inspiring me to talk about greater things, and giving me reasons to explore - from the alps to the chateaus - and for always always making me laugh.

To my Paris family: Carmen and Umeshree, my sisters mothers and dearest friends, words cannot express my gratitude for everything (Dear Dog/ I found myself a cheerleader/ is all that I can say/ don't lwoff at me/ but Ti Amo/ nous etions formidable / au soleil et sous la pluie); to Eva, for your dear friendship, your messages of support and encouragement, and most especially for cooking and Christmas, for welcoming me into your family in Graz and for giving me a second home in Paris; to Victor, for the laughs, the drinks, the heavy and light conversations, for dreaming to change the science world together (one Pasteurian at a time), for picking me up every time I fall and for your total acceptance (It's not time to make a change/just relax take it easy...).

To Joy, thank you honeykin skywalker, for late night chats and afternoon debriefs and morning coffees, for being a constant presence to make me laugh or smile, or to console me in the stressful moments, for all the post-its, lollies, food and wine, the music and the dancing; cimer for teaching me to speak comme une racaille – merci ma cherie pour tout cela et plus!

Thanks must go also to all those who helped make Paris home. To Playback Pasteur – Ben, Claire, Iryna, Glenda, Fabrizia, Andrea, Shruthi, Lucie, Imen, Anncharlott, Solène, Trisha, Javier, and most importantly to Allon who brought us all together – for all the shared moments, lessons outside of science and playback magic. To Angeline, for International adventures in France (sous la pluie); to Jason, a kindred spirit, for discussions over wine, beers and running. To Isidro, Kerstin, Thomas, Reid and Enrica for your friendship. To the other members of the class Lwoff, and all the old and new members of the PPU who made life at Pasteur and on our retreats such excellent fun. To Lucas and Diana, my newest coloc family, for listening to my rambling stressed-out chatter, and providing me with delicious nourishment at critical moments. To Netball Paris – especially Lynsey, Kate and Jayne-Louise – for making me sweat on the court and on the dancefloor, and the excellent fun had at tournaments.

Finally, to my dear friends on the other side of the world who have not yet forgotten me; especially Rhiannon, Donherra and Divya, Karen, Ella, Nick and Libby, who always had an encouraging message or a skype window open, an open house to visit, and whose visits and shared adventures were amongst the highlights of my time in Paris.

Enfin je remercie particulièrement toutes les souris!

For my family

*Nothing in life is to be feared, it is only to be understood.
Now is the time to understand more, so that we may fear less.*

Marie Curie

Table of Contents

Abstract	1
Resumé	2
1 Introduction	3
<i>1.1 Myeloid cells of the innate immune system</i>	5
1.1.1 Neutrophils	6
1.1.2 Monocytes, Macrophages and Mononuclear Phagocytes	18
1.1.3 Mast cells, Basophils and Eosinophils	20
<i>1.2 Neutrophil death & inflammation resolution: a focus on lipid mediators</i>	22
<i>1.3 Antibodies & their receptors: conferring innate immune cells with adaptive specificity</i>	23
1.3.1 B cells and the BCR	23
1.3.2 Antibodies and their classes	24
1.3.3 IgG antibody receptors (FcγR)	25
<i>1.4 Systemic Inflammation</i>	32
1.4.1 Inflammation-associated circulatory shock	32
1.4.2 Endotoxemia	33
1.4.3 Anaphylaxis	38
2 Summary and objectives	45
3 A novel model of inducible neutropenia reveals a protective role for neutrophils during systemic inflammation	47
<i>3.1 PAPER I</i>	49
4 Neutrophils contribute to IgG-dependent anaphylaxis in FcγR-humanised mice	79
<i>4.1 PAPER II</i>	81
<i>4.2 Considering high affinity FcγRI: the Audrey mouse</i>	145
4.2.1 Audrey mice exhibit hFcγRI expression patterns comparable to that of humans, and retain hFcγRIIA/IIB/III expression of VG1543 mice	145
4.2.2 hFcγRI does not contribute to IVIG-PSA in Audrey mice, which proceeds via a dominant pathway involving hFcγRIIA, Neutrophils and PAF	148

4.2.3	Supplemental Methodology and Data	151
5	Discussion	153
5.1	<i>Part I: A protective role for neutrophils in LPS endotoxemia</i>	153
5.2	<i>Part II: The inflammatory effects of neutrophils: novel mouse models to study neutrophil function in vivo</i>	163
5.2.1	A novel model of inducible neutropenia: <i>PMN^{DTR}</i> mice	163
5.2.2	<i>PMN^{DTR}</i> mice to study neutrophils in antibody-dependent pathologies: deciphering the contribution of neutrophils to systemic anaphylaxis	167
5.2.3	Audrey & humanised mouse models to study FcγR: limitations and potential	177
5.3	<i>Part III: Neutrophils as protective or pathological agents of systemic inflammation</i>	185
5.4	<i>Part IV: Towards the clinic: systemic anaphylaxis to neuromuscular blocking drugs</i>	188
5.4.1	Developing a mouse model of systemic anaphylaxis to Rocuronium Bromide	190
5.4.2	Evidence from the clinical study NASA: Neutrophil activation in systemic anaphylaxis	199
5.5	<i>Final Considerations and Perspectives</i>	205
6	References	209
7	Annex	231
7.1	<i>IgG subclasses determine pathways of anaphylaxis in mice</i>	231
7.2	<i>In vivo effector functions of high-affinity mouse IgG receptor FcγRI in disease and therapy models</i>	231
7.3	<i>Review – Contribution of human FcγRs to disease with evidence from human polymorphisms and transgenic animal studies</i>	232
7.4	<i>Book chapter - Anaphylaxis (Immediate hypersensitivity): from old to new mechanisms</i>	232

Abstract

Neutrophils are agents of protective and pathological inflammation. This thesis work aimed to determine the role of neutrophils during severe, potentially fatal models of systemic inflammation induced by lipopolysaccharide (LPS, endotoxemia) or by IgG immune complexes (anaphylaxis). Anaphylaxis is a severe allergic reaction that may proceed via IgE- or IgG-dependant pathways. Endotoxemia is a model relevant to inflammation during critical illness. To study neutrophils *in vivo*, we employed a new mouse model of inducible neutropenia. We found, surprisingly, that neutrophils and neutrophil-derived MPO protect against the severity of endotoxic shock, independently of the microbiological environment, suggesting that neutrophils limit inflammation during endotoxemia. Conversely, neutrophils can contribute to IgG-induced anaphylaxis in mice. As mice and human IgG receptors (Fc γ R) are very different, we developed a novel mouse strain in which targeted insertion of human Fc γ R into the murine loci recapitulated hFc γ R expression. Herein, using these mice, this work demonstrates that anaphylaxis induced by hIgG proceeds within a native context of activating and inhibitory hFc γ Rs, and that neutrophil activation via Fc γ RIIA is a dominant pathological pathway, involving the mediators PAF and histamine. Finally, we describe ongoing development of a mouse model of anaphylaxis in response to Rocuronium, a curare-based neuromuscular blocking agent (NMBA). In addition, as part of a collaborative clinical study we analysed blood samples from patients suspected of NMBA-induced anaphylaxis, finding evidence for the activation of a neutrophil- and IgG-dependent axis during human anaphylaxis.

Resumé

Les neutrophiles contribuent à l'inflammation protectrice et pathologique. Ce projet de thèse consiste à déterminer le rôle des neutrophiles dans des modèles d'inflammation systémique graves et potentiellement mortelles, induite par le lipopolysaccharide (LPS, endotoxémie) ou par des complexes immuns antigène-anticorps (anaphylaxie). L'anaphylaxie est une réaction allergique qui peut être IgE- et/ou IgG-dépendante. L'endotoxémie est un modèle pertinent de l'inflammation au cours de maladies graves. Pour étudier les neutrophiles *in vivo*, nous avons utilisé un nouveau modèle murin de neutropénie inductible. Nous montrons que les neutrophiles et la Myéloperoxydase qu'ils produisent ont un rôle protecteur dans le choc endotoxique, indépendamment de l'environnement microbiologique. A l'inverse, les neutrophiles peuvent contribuer à l'anaphylaxie induite par les IgG chez la souris. Comme les récepteurs pour les IgG (FcγR) murins sont très différents des humains, nous avons développé un modèle de souris knock-in dans lequel les FcγR murins a été remplacé par les FcγR humains, activateurs et inhibiteur. Chez ces souris, nous montrons que des IgG humaines peuvent induire une anaphylaxie: le FcγRIIA a un rôle dominant, via l'activation des neutrophiles, et les médiateurs PAF et histamine. En parallèle, nous développons un modèle murin d'anaphylaxie à un curare, le Rocuronium, utilisé en clinique. Au même temps, dans une étude clinique, les résultats d'analyses des échantillons sanguins des patients suspectés d'avoir subi une anaphylaxie au curare soutien notre hypothèse de travail: que l'activation des neutrophiles par des IgG spécifiques est impliquée dans l'anaphylaxie humaine.

1 Introduction

The immune system of higher vertebrates is a highly developed cell and tissue network that integrates across all body compartments and serves to defend the host from pathogen invasion, infection and disease. The innate, primordial components of the immune system comprise physical barriers, such as the skin and mucous membranes, effector leukocytes and soluble factors with evolutionarily conserved methods of self versus non-self recognition and pathogen eradication. Soluble factors may have direct antimicrobial actions, flag pathogens for elimination, or facilitate the actions of effector cells; leukocytes engulf bacteria, kill virus-infected cells and attack parasites. Inflammation is a cardinal feature of the innate immune response, as vascular changes permit the swift delivery of effector cells and molecules to the site of infection.

The development of adaptive immunity occurred with the evolution of jawed vertebrates. Leukocytes of the adaptive immune system, B and T lymphocytes, have the capacity to generate a diverse repertoire of receptors with a targeted specificity. These receptors may be cell-bound, or released by B cells as humoral factors, called antibodies. The exquisite specificity of adaptive immunity permits a tailored response to antigens, and thus the precise recognition of a pathogen elicits an appropriate response to eliminate it. Moreover, the retention of this specificity over time as a form of memory provides life-long defence against the invader, which strengthens upon subsequent encounters. Adaptive immunity, with its specificity and memory, developed as an adjunct to innate immunity, and is therefore intrinsically informed by the innate response. Conversely, components of adaptive immunity can dictate the response of innate effector molecules and cells.

Immunity as a whole may be viewed as a dynamic state of protected homeostasis of the organism. That is, the maintenance of systems and organ function in the face of invasion or insult. In this context, mechanisms to promote immunity entail both inflammatory and resolving pathways, and act synergistically with processes to maintain vascular, neuroendocrine and organ-specific tissue integrity. Inappropriate or excessive immune activation or failure of inflammation resolution can cause pathology. This is apparent in allergic and autoimmune diseases, and during systemic inflammatory responses associated with either infection or sterile injury. In rare cases, circulatory shock can result: the most dramatic consequence of homeostatic failure.

Neutrophils are innate effector leukocytes comprising the first line of defence against invading pathogens. These polymorphonuclear cells express an array of cell surface receptors that enable innate pathogen recognition by binding conserved microbial structures, or link to adaptive recognition by

binding to antibodies, or even recognise the inflammatory environment. The capacity of neutrophils to mount an immediate and rapid response and efficiently kill microbes via an arsenal of different mechanisms is critical for host defence, but may also contribute to tissue injury during inflammation, particularly in the context of dysregulated immunity. In addition, neutrophils have diverse emerging roles in the regulation of immune function and inflammation resolution. This thesis will examine the protective and pathological roles of neutrophils during systemic inflammation associated with the development of shock. In the first instance, a model of endotoxic shock induced by high dose lipopolysaccharide (LPS) and, secondly, IgG-dependent anaphylactic shock.

1.1 Myeloid cells of the innate immune system

Myeloid cells are, in the most part, derived from precursors in the bone marrow. A common myeloid progenitor cell gives rise to granulocytes, including neutrophils, monocytes, erythrocytes and platelets. Recent data suggests an early developmental separation of a neutrophil and monocyte precursor (NMP), at the same time as the common lymphoid precursor (CLP), from an alternate lineage giving rise to megakaryocytes and erythrocytes (MEP) and eosinophils, mast cells and basophils (EMP) [2, 3]. At different stages of development myeloid cells can migrate to take up residence in the tissues; resident tissue cell populations coexist with those recruited during inflammation or injury.

Considering the function of myeloid cells in immunity, it is apparent that the diverse and specialised roles of phagocytes and granulocytes create an intricate network of host defence. Significant phenotypic plasticity is afforded between homeostatic and inflammatory conditions, as well as between tissue resident cells and those that are recruited during an inflammatory response [4]. Nearly every cell type has its canonical function, or that for which it was originally identified; yet most do far more than that. This introduction will address some of the most pertinent aspects of the innate myeloid system to provide a context for the studies of this thesis work. Firstly, neutrophils as a major focus, secondly monocyte/macrophages, and thirdly other granulocyte populations mast cells, basophils and eosinophils. Each of these populations has been suggested to contribute to local and systemic pathological inflammation.

It is particularly relevant to appreciate how myeloid cells can detect and respond to inflammatory stimuli, whether derived from pathogen associated molecular patterns (PAMPs) or host-derived danger associated molecular patterns (DAMPs). PAMP recognition is achieved primarily by pattern recognition receptors (PRRs), which may be expressed on the cell surface or as soluble opsonising factors: for example Toll-like receptor 4 (TLR4) that recognises the lipopolysaccharide (LPS) of gram-negative bacteria. Antibodies represent a crucial link between adaptive and innate immunity: they confer the innate myeloid cell system with an adaptive specificity, and myeloid cells express numerous cell surface antibody receptors.

1.1.1 Neutrophils

Fifty to seventy percent of circulating leukocytes in human blood are neutrophils. In mice housed in Specific Pathogen Free (SPF) conditions this figure is closer to ten to twenty-five percent, yet neutrophil numbers can increase dramatically during infection or following an inflammatory stimulus. Mature neutrophils have a diameter of 7–10 μ m and possess a segmented nucleus, leading to their alternate alias PolyMorphoNuclear cells (PMNs). As granulocytes, their cytoplasm is enriched with granules and secretory vesicles. Neutrophils are defined in human blood by CD66 and CD15 expression. In the mouse, neutrophils are distinguished by high levels of expression of CD11b, a component of Mac-1 integrin expressed by the majority of myeloid cells, and the surface marker Granulocyte antigen 1 (Gr-1), which comprises two molecules Ly-6C and Ly-6G. Neutrophils express intermediate levels of Ly-6C, which can also be prominently expressed by monocytes, but distinctively high levels of Ly-6G, and therefore the latter is considered a unique surface marker.

In order to examine the role of neutrophils in inflammation, several important aspects of these cells will be introduced in the following sections: firstly, neutrophil development and granule formation and release; then, their lifespan in circulation, release from the bone marrow and turnover; and their recruitment and migration. Furthermore, the mechanisms of microbial killing by neutrophils will be described, as well as the perceived phenotypic heterogeneity of these cells; the former which is associated with inflammatory cues or tissue damaging effects, and the latter which may determine neutrophil involvement in an ongoing inflammatory response.

1.1.1.1 Neutrophil development and granulopoiesis

Mature neutrophils differentiate from hematopoietic precursors (HSCs) in the bone marrow. The daily production of neutrophils is up to 10^{11} in healthy individuals, a figure that can increase several-fold during infection [5]. Granulocyte colony stimulating factor (G-CSF) supports neutrophil production and is essential for increasing this production during infection; yet is not absolutely required for neutrophil development as G-CSF knock-out mice still generate mature neutrophils at about 25% of normal levels. A transcriptional regulatory network governed mostly by the transcription factors PU.1 and C/EBP α controls the differentiation of HSCs towards granulocytes. PU.1 is necessary for myeloid commitment, and thereafter the balance between PU.1 and C/EBP α controls lineage commitment [6, 7]. The transcription factor growth factor independent-1 (Gfi-1) is necessary for neutrophil differentiation [8, 9]. Upregulated during commitment to the granulocyte lineage, Gfi-1 represses the monocyte-promoting transcription factor Egr2 [10] and the gene Csf1,

coding for the cytokine CSF-1 which supports monocyte development [11] (Figure 1.1). Mutations in *Gfi1* that affect its transcriptional repressor activity lead to severe neutropenia, in humans [12] and mice [9, 13], a phenotype which has been applied to study the effect of neutrophil absence in different mouse models. After 4-6 days in the bone marrow, neutrophils are released into the circulation from the post-mitotic pool (**Figure 1.1**) (see section *Neutrophil lifespan and aging*).

Neutrophils are filled with granules and secretory vesicles, which play a pivotal role in neutrophil function [14, 15]. Granules are stores of proteins containing membrane surface receptors, antimicrobial products, and enzymes to degrade the extracellular matrix, encapsulated within a phospholipid bilayer membrane and an intragranular membrane. Their contents may be destined for exocytosis or fusion with the phagosome [14, 15]. The large majority of neutrophil functions, from migration to extravasation to microbial killing, are guided by the mobilization of cytoplasmic granules and secretory vesicles [5].

The developing neutrophil passes through several stages: myeloblast, promyelocyte, myelocyte, metamyelocyte, band cell and, finally, polymorphonuclear (segmented) cell (Figure 1.1). Granule biogenesis is intrinsically linked with neutrophil development: the heterogeneity of granule subsets can be described based on their protein content as well as their sequential formation. According to the ‘targeted by timing’ model of granulopoiesis, different granule proteins are synthesised during different stages of development, resulting in discrete granule subsets with different composition, of which at least three major subsets have been defined [16-20] (**Figure 1.1**).

Primary granules, appearing first, have a high content of myeloperoxidase (MPO) and have been designated alternatively “peroxidase positive” or “azurophil” granules. As well as MPO, primary granules contain alpha-defensins, bacteriocidal proteins, and serine proteases [14]. The three neutrophil serine proteases, proteinase-3, cathepsin G, and elastase are structurally similar, exhibit proteolytic activity against components of the extracellular matrix, and induce the activation of other leukocytes, endothelial and epithelial cells, and platelets [21]. Primary granules appear to undergo limited exocytosis and predominantly mediate microbe killing in the phagolysomes.

As MPO synthesis stops at the promyelocyte/myelocyte transition, granules that form later are peroxidase negative. Secondary, or specific, granules contain high levels of lactoferrin and collagenase and form at the myelocyte or metamyelocyte stage, whereas tertiary granules have a high gelatinase content and form in band cells and hypersegmented neutrophils (**Figure 1.1**).

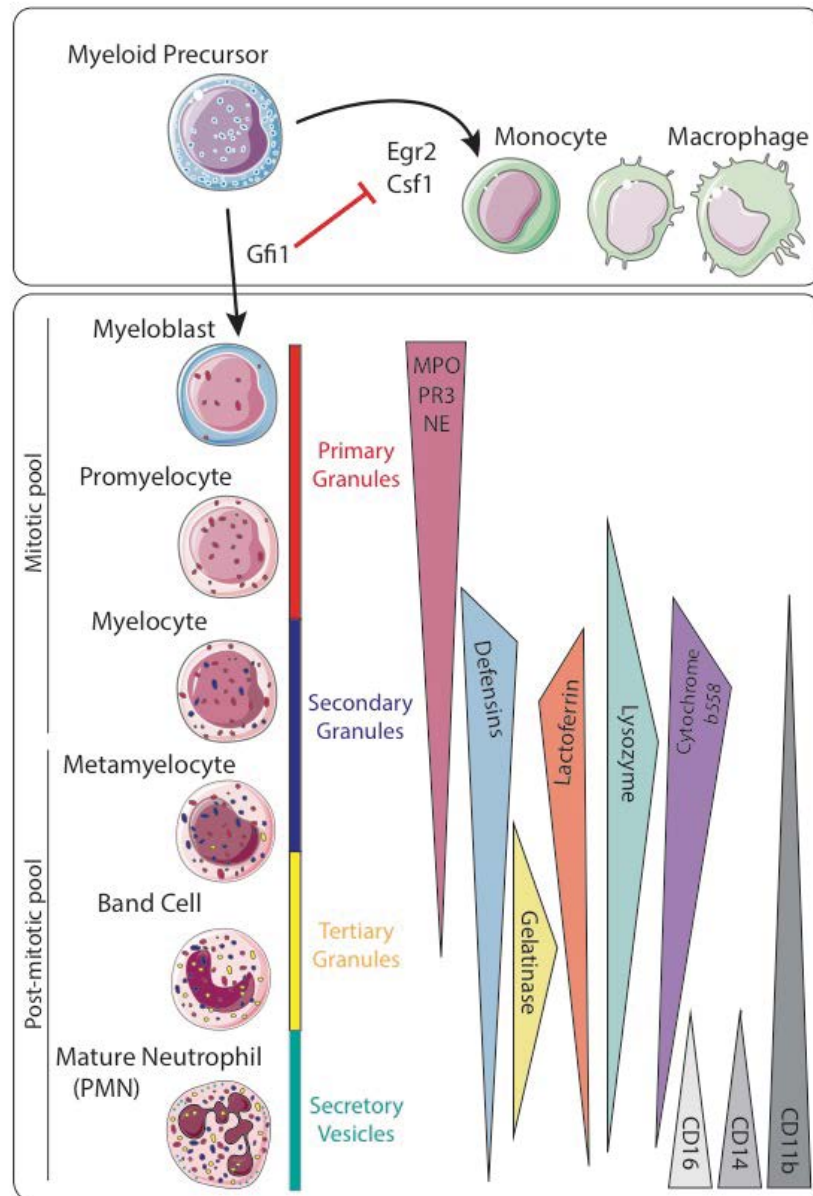


Figure 1.1: Neutrophil development and granulopoiesis. Neutrophils and monocytes develop from a common myeloid precursor; the transcriptional repressor Gfi1 inhibits Egr2 and Csf1 to promote development of the neutrophil lineage (upper panel). From the myeloblast to the mature neutrophil stage, granules are formed chronologically, and biosynthetic windows of granule protein synthesis determine the composition of primary (red) secondary (blue) and tertiary (yellow) granules (lower panel). Secretory vesicles (green) are formed only during the last stages of neutrophil maturation, and contain numerous cell surface receptors synthesised at that time, including CD14, CD16 and CD11b. MPO, myeloperoxidase; PR3, proteinase 3; NE, neutrophil elastase. *Adapted from [5, 14] using the online resource Servier Medical Art.*

Moreover, secondary granules are larger and full of antibiotic agents such as lactoferrin and lysozyme. Neutrophil matrix metalloproteinases (MMPs) include collagenase (MMP8) of secondary granules [22], gelatinase (MMP9) of tertiary granules, and leukolysin (MT6-MMP/MMP- 25), which is distributed across these two subsets and is also contained in secretory vesicles [23]. These MMPs enable degradation of the vascular basement membrane and interstitial structures to facilitate neutrophil recruitment and migration. The exocytosis of granules is a tightly regulated hierarchical process [15], which occurs inversely to their formation: as such, tertiary granules are more easily exocytosed than secondary granules. This aligns with a general model whereby tertiary granules are a reservoir of enzymes (gelatinase) and surface receptors necessary for neutrophil extravasation and migration, while secondary granules are mobilised for migration within the tissue (collagenase) and antimicrobial functions, whether by fusion to the phagosome or to the exterior of the cell [14, 21, 24]. Thus, although neutrophils are armed with an arsenal of cytotoxic and potentially tissue-damaging agents, in an inflammatory response the regulated exocytosis of granules permits the targeted release of their contents, minimizing collateral damage.

Secretory vesicles, on the contrary to granules, are formed by endocytosis during the late stages of neutrophil maturation, and are rapidly released upon chemotactic stimulation [25, 26]. Upon release, their membrane is incorporated with the surface membrane of the neutrophil; thereby, secretory vesicles are seen to be critical reservoirs of membrane surface receptors necessary for the early stages of neutrophil activation and adherence to the vasculature. These include β 2-integrin CD11b/CD18 (Mac-1, CR3) [27], the complement receptor 1 (CR1)[28], the receptor for endotoxin CD14 and the IgG receptor Fc γ III (CD16) [29]. In this manner, secretory vesicles can transform a resting neutrophil, with few surface receptors and minimal responsiveness to soluble mediators, to an extremely responsive cell [30].

1.1.1.2 Lifespan, margination and aging

Always considered as short lived cells, with a half-life of just several hours in the blood, 1.5h for mice and 8h for humans, recent evidence suggests that neutrophils can in fact live much longer in the circulation, with a lifespan up to 12.5h for mice and 5.4 days for humans; although the latter findings have been subjected to criticism [31]. Certainly the real figure lies somewhere in between, yet the lifespan of neutrophils is extended after activation, by inhibition of apoptosis pathways [32]. Some data also suggests that mature neutrophils have a limited proliferation potential after exiting the bone marrow; but, most importantly, a prolonged neutrophil lifespan endows them with the capacity to engage in more complex activities within the tissue [33].

Neutrophil release from the bone marrow is under differential control during steady state or inflammation. The retention of neutrophils in the bone marrow is controlled by the CXCL12/CXCR4 chemokine axis and VLA-4/VCAM-1 interactions. G-CSF stimulates neutrophil release from the bone marrow, in part by inhibiting macrophage expression of VCAM-1 and CXCL12. One paradigm of maintaining leukocyte homeostasis considers that phagocytosis of dying neutrophils in the periphery provides negative feedback for their mobilisation from the bone marrow via an IL-23/IL-17/G-CSF cytokine axis [34]. A model of antagonistic signalling via CXCR4 and CXCR2 accounts for the rapid mobilisation of neutrophils during inflammation and infection [35, 36]: ligands for CXCR2, CXCL1 and CXCL2, expressed by bone marrow endothelial cells promote neutrophil retention in the steady state; whereas inflammatory mediators and chemokines in the periphery promote dominant CXCR2 signalling and release, and G-CSF signalling further favours neutrophil release [5, 37]. Dendritic cells can regulate neutrophil distribution between the bone marrow and peripheral organs, regulating the production of G-CSF, CXCL1 and CCL2 [38].

An alternative paradigm removes the distinction between ‘steady state’ and ‘emergency’ granulopoiesis, and postulates rather that signalling via pattern recognition molecules modulates both [39]. Healthy mice in normal conditions have more circulating neutrophils than those raised in aseptic housing; and neutropenia induced by antibody-mediated depletion raises G-CSF and stimulates granulopoiesis, but not in TLR4-deficient animals [40]. This model aligns with recent data indicating that the microbiome also regulates neutrophil aging [41].

Neutrophils can be found abundantly in the lung, spleen, liver and bone marrow under physiological conditions. The concentration of neutrophils in peripheral organs is referred to as ‘organ-marginated’ pools, and these may represent important neutrophil reservoirs for rapid deployment, in addition to the bone marrow. In the case of the lung-marginated pool, neutrophils persist in the pulmonary vasculature much longer than accounted for by mean intravascular transit time, and it appears that these cells are actively patrolling the tissue, rather than merely trapped in the microvasculature [33]. Certainly neutrophils can be rapidly mobilised from the lung: adherence to the pulmonary vasculature is mediated by CXCR4-CXCL12 interactions, and the numbers of neutrophils in circulation can be boosted by CXCR4 blockade, which both mobilises neutrophils from the lung and blocks their return to the bone marrow [42].

CXCR4 is expressed at low levels on circulating neutrophils, and its upregulation is posited to promote return to the bone marrow and clearance therein. In mice, a senescent or ‘aged’ neutrophil population is characterised by the up regulation of surface CXCR4 and CD11b, decrease in CD62L,

reduced size and nucleus hypersegmentation [43]. The homeostatic turnover of neutrophils fluctuates throughout the day, and controls circadian oscillations in hematopoietic stem cell mobilisation [43]. The increase in CXCR4 on aged neutrophils would seem to suggest that these cells preferentially populate the pulmonary marginal pool. Neutrophil aging is regulated by the microbiota, and signalling via TLRs; as such, aging predisposes to neutrophil overactivation, indicated by high CD11b expression and a greater propensity for the formation of neutrophil extracellular traps (NETs) [41]. Altogether, it is important to bear in mind that models of constitutive or inducible neutrophil depletion, such as will be used herein, likely have systemic effects on cytokine release and the hematopoietic niche. Furthermore, that depending on the age of the neutrophil these cells may exhibit different reactivity *in vivo*.

1.1.1.3 Neutrophil recruitment into the tissue

The neutrophil inflammatory recruitment cascade and the mechanisms underlying neutrophil extravasation from the bloodstream into the tissues have been well elucidated, and classically involve the steps of tethering, rolling, adhesion, crawling, and finally transmigration [33]. Changes to the vascular endothelium comprising the upregulation of P-selectin and L-selectin occurs following the release of inflammatory mediators by local leukocytes, including histamine, cysteinyl-leukotrienes and cytokines, or by direct endothelial cell PRR engagement. P-selectin and L-selectin on endothelial cells bind to their ligands on neutrophils, including P-selectin glycoprotein ligand 1 (PSGL-1), to capture neutrophils from the blood flow. This manner of tethering leads to neutrophils rolling along the endothelium, under shear stress, and associated expression of lymphocyte function-associated antigen 1 (LFA1), which binds to intercellular adhesion molecule 1 (ICAM1) and ICAM2 on the endothelium to promote cell arrest.

Firm adhesion of tethered neutrophils to the endothelium occurs following neutrophil priming by inflammatory cytokines, chemoattractants, or PAMPs. Neutrophils express the integrins LFA1 ($\alpha 1 \beta 2$; that is $\beta 2$ integrin CD11a complexed with CD18) and Mac1 ($\alpha M \beta 2$; $\beta 2$ integrin CD11b with CD18), which bind endothelial surface molecules ICAM1 and ICAM2. Chemokine receptor signalling on neutrophils induces changes in the conformation of these integrins, a phenomenon referred to as inside-out signalling, to increase their affinity for their respective ligands, as well as an increase in surface CD11b from intracellular stores. Adherent neutrophils initiate probing behaviour, and crawl along the endothelium to reach an appropriate site for extravasation, likely guided by chemokines immobilised on the endothelium.

Extravasation of neutrophils involves the crossing of the endothelium, and then the basement membrane, a process referred to as transmigration and dependent on integrins, ICAM1 and ICAM2, and vascular cell adhesion protein 1 (VCAM1) as well as interactions with a variety of junctional proteins. Endothelial cells may also undergo cytoskeletal changes to facilitate neutrophil transmigration. One common model is that neutrophils cross the basement membrane via the release of granules containing active proteases – yet evidence for a protease requirement in this process is in fact scarce [5, 33]. Rather, neutrophils may emigrate through more porous and less dense regions of the basement membrane [44].

Unique strategies for neutrophil extravasation evidently correspond to different specific vascular beds. In the pulmonary circulation, low blood velocity means that neutrophil extravasation can occur in the small capillaries. The liver sinusoidal endothelium is particularly porous, and the narrow vasculature also results in a large marginated pool of neutrophils. Recruitment via the portal venules is distinct to the sinusoidal capillaries. Finally, described above are the strategies for transendothelial neutrophil migration, much of which has been observed by *in vivo* imaging, however transepithelial migration also occurs and is particularly relevant at mucosal surfaces, for example the lung and the gut. Transepithelial migration requires the leukocyte integrins Mac1 and LFA1, but not the apically expressed ICAM-1/VCAM-1 [45]. The triggering receptor expressed on myeloid cells (TREM)-1 was implicated in transepithelial migration associated with acute lung injury [46]. Together these considerations imply that neutrophils in the tissue, and indeed different tissues, having undergone the sequential steps of extravasation and migration, have a different phenotypic and activation profile compared to naïve cells in the circulation.

1.1.1.4 *Multidirectional migration*

Neutrophil reverse transmigration, that is the capacity for neutrophils to migrate from the tissue back to the bloodstream, was originally demonstrated *in vitro*: after abluminal to luminal migration, neutrophils exhibited an ICAM-1^{hi} phenotype, prolonged lifespan, and increased capacity for superoxide production, and phenotypically similar neutrophils could be found in the circulation [47]. Thereafter, *in vivo* neutrophil reverse transmigration was described in the context of ischemia-reperfusion injury or high levels of leukotriene B₄ (LTB₄) [48, 49]. The capacity for neutrophils to migrate out of the tissue and rejoin the circulation suggests a capacity to transmit inflammatory signals and systemically influence responses. Indeed, ICAM-1^{hi} neutrophils were identified in organs distal to the site of inflammation [48, 49].

Neutrophils can also exit the tissue via the lymphatics, and thereby shuttle antigen from sites of exposure, such as the skin, to secondary lymphoid organs following infection or immunisation [50-52]. Lymph node migration by neutrophils is in accordance with their capacity to promote some T cell responses, as well as to regulate antigen presentation and the extent of lymphocyte proliferation [51-55].

1.1.1.5 Killing mechanisms of neutrophils: phagocytosis, oxidative burst, MPO & NETs

Phagocytosis is the hallmark of innate immune defence, involving the engulfment of living pathogens or other targets, most notably by macrophages, but also by neutrophils. Pathogen recognition via direct PRRs or ligation of receptors for humoral factors (such as receptors for IgG, FcγR) results in actin polymerization and cytoskeletal remodelling such that the phagocyte can extend its plasma membrane. The resulting pseudopodia structure surrounds the target and fuses to encapsulate the target within an intracellular vesicle called a phagosome. In macrophages, phagosomal acidification and fusion with lysosomes, oxidative compartments filled with antimicrobial enzymes and proteins, leads to the killing, degradation and elimination of the engulfed target [56]. In neutrophils, the phagosomal pH remains alkaline or neutral, facilitating the enzymatic action of neutrophil serine proteases. The coordinated fusion of neutrophil granules with phagosomes permits the targeting of potent and toxic granule proteins to the ingested target, minimizing release into the extracellular milieu [15]. Conversely, engagement of neutrophil phagocytic receptors by IgG or complement deposited on large surfaces, which cannot be engulfed, results in ‘frustrated phagocytosis’, and the extracellular release of granule contents and oxidative products: a highly inflammatory and potentially damaging outcome [45].

The generation of reactive oxidants via the **NADPH oxidase** system is vital for optimal neutrophil microbicidal activity [39]. Its assembly and activity in phagocytes requires the translocation of a cytoplasmic complex containing p47^{phox}, p67^{phox} and p40^{phox} to the membrane bound heterodimer of gp91^{phox} and p22^{phox} [57, 58]. In a resting state, the gp91^{phox}-p22^{phox} heterodimer (the flavocytochrome b558) resides predominantly in the membrane of neutrophil secondary (specific) granules (**Figure 1.1**). Regulation of the NADPH oxidase is thereby achieved by spatial segregation of its components, and no activity is detected in resting cells. Activation of the phagocyte triggers phosphorylation of p47^{phox} to permit full assembly of the entire NADPH oxidase. Sustained NADPH oxidase activity requires a continual translocation of the cytosolic components to the membrane, and in neutrophils continual furnishing by membrane components derived from granule fusion. The NADPH oxidase generates reactive superoxide anion (O₂⁻) as an immediate product, and hydrogen

peroxidase (H_2O_2) by dismutation of the superoxide. The rapid agonist- and activation-dependent assembly of the NADPH oxidase to generate reactive oxygen species (ROS) is referred to as the 'respiratory burst'. The NADPH oxidase can also assemble at the plasma membrane, and thereby generate ROS in the surrounding tissue environment. The serious requirement for the NADPH oxidase in host defence is exemplified by patients with chronic granulomatous disease (CGD), in which mutations in components of the oxidase complex result in its impaired or absent function in phagocytes. CGD patients are predisposed to chronic and recurrent bacterial and fungal infections.

Myeloperoxidase (MPO), the major component of neutrophil primary granules, is a crucial additional weapon in the neutrophil antimicrobial arsenal. MPO catalyses the conversion of hydrogen peroxide generated by the NADPH oxidase into hypochlorous acid (HOCl), which has much greater antimicrobial potency. H_2O_2 has a greater redox potential than HOCl, but HOCl can kill bacteria such as *E.Coli* ~1000 times faster, presumably due to its extremely rapid reaction kinetics [59]. The MPO- H_2O_2 -Cl system requires a source of chloride, provided by various phagosome-associated transporters, primarily the cystic fibrosis transmembrane conductance regulator (CFTR). CFTR is associated with neutrophil secretory vesicles, but not the plasma membrane, and is recruited by vesicle fusion during phagocytosis: another layer of regulation to direct the cytotoxic effects of neutrophils to targets within. MPO deficient neutrophils are capable of killing bacteria, and MPO deficient patients do not exhibit the severe phenotype of CGD patients. Yet the killing by MPO-deficient neutrophils is slower, depending on the pathogen, and although in many cases the pathogen is eventually eliminated, MPO-deficient animals do exhibit an increased susceptibility to bacterial and fungal infections; findings that indicate an impact of pathogen load. The lack of a strong patient phenotype is more suggestive of compensatory mechanisms. Indeed, the MPO- H_2O_2 -Cl system has downstream effects on the collective antimicrobial activity of other neutrophil granule proteins: notably, serine proteases are inactivated by oxidation. Moreover, since MPO catalyses the consumption of H_2O_2 , in its absence the concentration of H_2O_2 is increased [59].

Neutrophils have the capacity to form structures called **neutrophil extracellular traps (NETs)**. The nucleus swells and the chromatin dissolves, and the neutrophil extrudes large strands of decondensed DNA, decorated with associated histone proteins, as well as neutrophil cytosolic and granule-derived proteins. More than 24 proteins have been reported to be associated with NETs, mainly cationic and therefore DNA binding; defensins, elastase, proteinase 3, heparin binding protein, cathepsin G, calprotectin, lactoferrin, and myeloperoxidase, as well as pattern recognition molecules (eg Pentraxin 3) [5, 60]. Neutrophil death by NET formation is referred to NETosis, an alternative

cell death pathway to apoptosis and necrosis. NETosis mechanisms are as yet incompletely elucidated. The enzyme PAD4 (peptidylarginine deiminase 4) is highly expressed in neutrophils and catalyses histone modifications important for chromatin decondensation. Neutrophil elastase, MPO and NADPH-derived hydrogen peroxidase have all been identified as important agents to facilitate the histone degradation and chromatin decondensation necessary for NET formation [5, 39]. The absolute requirement for MPO, or indeed ROS, in NET formation is likely stimulus dependent [61-63]. A variety of inflammatory mediators and pathogens can stimulate NETosis, and certainly the strength and combination of stimuli is important. The general model considers that NETosis is important to 'trap' pathogens, and prevent dissemination of infection [45]. Emerging data identifies that NETs are also a major source of auto-antigens and may thereby contribute to autoimmune pathology.

The antimicrobial killing mechanisms of neutrophils described here are critical for host defence yet entail potent inflammatory signals. During severe inflammation, the damaging side effects of neutrophil extravasation, or even activation within the vasculature may drive pathology. Changes in neutrophil phenotype during the course of an inflammatory response, or plasticity of this cell population to context dependent stimuli will be described below.

1.1.1.6 Heterogeneous neutrophil phenotypes and regulatory functions

Neutrophil phenotypes may change over time: whether as a product of activation, and up regulation of membrane proteins by the fusion of intracellular vesicles with the plasma membrane; or as a product of aging, and the expression of receptors (eg CXCR4) to promote homing to sites of clearance; or as a product of migratory patterns, for example the ICAM-1^{hi} phenotype that seems to distinguish neutrophils after reverse transmigration from the tissues. Emerging concepts of neutrophil subsets or subpopulations, discretely defined by phenotypic markers, and with distinct functional characteristics, aligns with a more general view of neutrophils as highly heterogeneous cells with functional plasticity according to context and stimulus [64].

Despite their limited lifespan, it is now understood that neutrophils are capable of transcriptional and translational control. Neutrophils have a low mRNA content per cell [65], yet their recruitment in large numbers results in, all the same, a potentially large net impact of *de novo* protein synthesis, of cytokines for example [66]. There is now considerable evidence for neutrophil epigenetic and genetic regulation of gene expression [67-69]. Not limited to the release of cytokines and chemokines, novel protein synthesis can also extend to membrane surface receptors, for example Fc γ

RI (CD64; refer to section Antibodies and their receptors), which affects the capacity of neutrophils to engage and respond to IgG containing immune complexes.

In diverse ways, neutrophils can influence the activity of other innate cells. For example, by the production of cytokines neutrophils can guide the immune response to pathogens: IL-13 and IL-33 during helminth infection, IL-17 after fungal stimulation, or IFN γ during bacterial infection [70]. Neutrophils can enhance the responses of macrophages via TNF α and superoxide production [71], while neutrophil-derived microparticles or ectosomes can exert activating or anti-inflammatory effects on macrophages and other neutrophils [72-75]. Neutrophils can promote T cell responses by rapid communication between tissue sites and the draining lymph node and modulation of antigen presentation [52, 76], while also restricting the amplitude of T cell proliferation [53]. Activated neutrophils can produce B cell activating cytokines BAFF and APRIL in physiological and pathological contexts [77, 78]. Taken together, the early responses of neutrophils can have profound impacts on the evolution and later phases of the immune response.

In addition to influencing immune effector outcomes, neutrophils have several mechanisms to directly regulate the inflammatory environment, and to promote inflammation resolution [79]. Localised consumption of oxygen by the neutrophil respiratory burst results in micro-environmental hypoxia; in the intestine, this stabilises hypoxia inducible factor (HIF) in the intestinal epithelium, thereby promoting the resolution of inflammation – if neutrophils are deficient in NADPH oxidase, chronic inflammatory diseases of the gut manifest [80]. Apoptosis-associated neutrophil release of lactoferrin release inhibits ongoing granulocyte recruitment [81] and promotes dendritic cell recruitment [82].

Interleukin-10 (IL-10) is a cytokine with broad anti-inflammatory properties and pleiotropic, largely counter-regulatory effects across the immune system. Certainly mouse neutrophils can produce IL-10 [83, 84], although IL-10 production by human neutrophils is controversial [85-87]. IL-10 production by human neutrophils has been detected in response to serum amyloid A, an acute phase and abundant protein secreted during inflammation [87, 88], and directly following LPS stimulation [89]. Other authors postulate, however, that the IL-10 locus in human neutrophils is under an inactive chromatin configuration, therefore resisting inducible expression of this gene [90]. Interestingly, it was recently demonstrated that LPS-stimulated Tregs can induce IL-10 production by human neutrophils, which was associated with a changing chromatin configuration, IL-10 receptor upregulation, an IL-10 autocrine and paracrine loop and the induction of neutrophil apoptosis [86].

Moreover, IL-10⁺ neutrophils were found in periodontal abscesses of patients with gram-negative bacterial infections, providing some *in vivo* validation of neutrophil-associated IL-10.

In many aspects, neutrophils are self-limiting. Neutrophil functions are modulated by both activating and inhibitory cell surface receptors [91, 92]). Products of the oxidative burst (HOCl) can inhibit neutrophil proteases by oxidation, while proteases themselves can catabolise various mediators and generate anti-inflammatory peptides [5]. Neutrophils are a major source of lipid mediators of inflammation: prostaglandins and leukotrienes, products of the arachadonic acid biosynthesis pathway, are rapidly synthesised by lipoxygenases and cyclooxygenases of activated and tissue infiltrating neutrophils. These have also chemoattractant properties for neutrophils, as well as diverse effects on the inflammatory milieu and endothelial and epithelial cells. Yet the initial phase of proinflammatory mediator production is followed by a 'switch' in eicosanoid synthesis by infiltrated neutrophils, to the production of pro-resolving lipid mediators [93], including lipoxins and resolvins [94, 95] (see section *Neutrophil death and inflammation resolution*).

1.1.2 Monocytes, Macrophages and Mononuclear Phagocytes

Macrophages are professional phagocytes, leading members of the so-called ‘mononuclear phagocyte system’, which also includes monocytes and monocyte-derived dendritic cells [96, 97]. These cells are not only important for the phagocytosis of pathogens but also the clean up of dead, dying and senescent cells throughout the body, and they contribute critically to tissue remodelling and repair. Thereby, monocytes and macrophages can be implicated in systemic inflammation either during its propagation or resolution. This section will introduce briefly monocytes and macrophages, and their role in inflammation will be described in the respective section *Systemic inflammation*.

Monocytes arise in the bone marrow from a myeloid progenitor common with neutrophils, and circulate in the blood at frequencies of about 5-10%. Macrophage colony stimulating factor (M-CSF) is the major cytokine for their development and proliferation. Following inflammatory insult or infection, monocytes are recruited from the blood to the tissues and undergo differentiation into macrophages and dendritic cells, forming specialised populations within the tissue microenvironment [96].

Tissue macrophages can also have prenatal origins, more recently confirmed by fate mapping studies. Tissue resident macrophages can derive from precursors originating in the embryonic yolk sac and seeded into the tissue before birth, and their local proliferation has a considerable role in self-renewal of resident cells [98-100]. Both blood-borne monocyte precursors and yolk-sac derived cells may be equally important to replenish tissue macrophage populations during inflammation resolution [101]. The complex nomenclature of monocyte and macrophage subsets is amplified by their differences in origin and tissue location, and the functional plasticity of these cells in response to different environmental stimuli [102, 103].

The function of macrophages in different tissues has been recently well reviewed [101, 102]. The bone marrow contains stromal macrophages, which have an important function in clearing the nuclei of erythrocyte precursors [104, 105], and osteoclasts, that work with osteoblasts to control bone resorption and remodelling, and regulate the movement of HSCs [106]. The spleen contains several diverse macrophage subsets, including F4/80⁺ red pulp macrophages that, along with Kupffer cells of the liver, are important for erythrocyte turnover and iron recycling [107]. Phagocytic macrophages in the marginal zone of the spleen express DC-SIGN and the scavenger receptor MARCO, important for apoptotic cell clearance and capture of blood antigens [108]. As well as lymphoid tissues, specialised macrophages are abundant in all organs including the liver (Kupffer cells), lung (alveolar macrophages),

skin (Langerhans's cells), nervous system (microglia), adipose tissue and body cavities (peritoneal and pleural). Tissue specific factors and environmental cues guide transcriptional control of gene expression and therefore the diverse functional specialisation of these cells [101, 102]. Macrophages have fundamental roles in homeostatic clearance of apoptotic cells in multiple tissues, and defects in this clearance contribute to autoimmune and chronic inflammatory diseases [109].

Circulating blood monocytes exhibit also some heterogeneity. The two major populations in humans are CD14^{hi}CD16⁻ and CD14^{low}CD16⁺; the latter comprises between 10% and 50% of blood monocytes, as it is expanded during inflammation, leading to the descriptor 'inflammatory' or 'non-classical' monocytes, as distinct from CD14^{hi}CD16⁻ 'classical' or 'resident' monocytes [110]. The analogous populations in the mouse are Ly6C^{hi}CD43⁺ classical monocytes and Ly6C^{low}CD43^{hi} non-classical monocytes [111], usually defined as subsets of the CD115 (CSF-1) positive population, although this monocyte marker can be down-regulated during inflammation. A splenic reservoir of undifferentiated monocytes has been also described [112]. Generally, a model has emerged whereby bone marrow derived monocytes are released into the circulation with a Ly6C^{hi} phenotype: in the absence of inflammation these cells pass through a Ly6C^{med} phenotype and switch to Ly6C^{low} resident monocytes, which can enter the tissues and replenish resident populations. On the other hand, both Ly6C^{hi} and Ly6C^{med} monocytes can migrate into inflamed tissues and differentiate to macrophages and dendritic cells following pro-inflammatory cues [96].

At a certain point, two main polarised macrophage subsets were delineated; M1 'classical' versus M2 'alternatively' activated macrophages, to reflect the nomenclature of T helper cell subsets (reviewed in [113, 114]). Prototypical inflammatory signatures elicit M1 macrophages, including the cytokine IFN γ and TLR4 ligation, associated with macrophage production of IL-6, TNF and IL-1 β . M2-type macrophages, on the other hand, have been described to be elicited via a spectrum of alternative signatures, including IL-4, Fc γ R ligation, glucocorticoids and IL-10 [115]. The M1/M2 concept reflects also the metabolic programming of the cells [116]. Yet this dichotomous view of macrophage activation is at odds with the considerable amount of evidence that macrophages do not form stable subsets *in vivo*, and that the activation status may change according to environment and stimuli, creating complex and mixed phenotypes [115, 117]. Rather than discrete subsets, M1 and M2 signatures are not mutually exclusive and form part of a spectrum of possible activation profiles, representing a modulation of macrophage critical functions [115].

1.1.3 Mast cells, Basophils and Eosinophils

Mast cells, basophils and eosinophils derive from a common precursor [2], and have key roles in inflammatory responses, particularly initiated at epithelial barriers such as the skin, lung, and gastrointestinal tract. These granulocyte populations contribute to classical type 2 immunity, comprising also T helper 2 cells (Th2) and innate lymphoid cells type 2 (ILC-2), which is critical for barrier defence, particularly against parasitic helminths, or airborne pathogens, but can drive chronic inflammation in the context of allergic asthma or dermatitis. Mast cell and basophil activation is particularly implicated in the classical pathway of systemic anaphylaxis induction by IgE antibodies (see section *Systemic inflammation: Anaphylaxis*), whereas eosinophils are heavily implicated in allergic airway inflammation.

Mast cells

Mast cells derive from bone marrow progenitor cells that migrate into tissues wherein they complete their maturation, under the synergistic influence of stem cell factor (SCF) and locally produced cytokines [118-120]. The phenotype of the mature mast cell thereby depends upon the tissue in which differentiation occurs, and the microenvironmental signals accorded [121]. Mature mast cells reside in virtually all vascularised tissue, are particularly prevalent in the skin and mucosa of the genitourinary, respiratory and gastrointestinal tracts, and are found in close proximity to blood vessels, nerves, smooth muscle cells, epithelial cells, mucous producing glands and hair follicles [122, 123].

Tissue-resident mast cells are a long-lived population of large cells (6-12 μ m) identifiable by a common morphology, prominent electron-dense cytoplasmic granules, and high levels of expression of c-kit (CD117), the receptor for stem cell factor (SCF) [124] and Fc ϵ RI, the high affinity IgE receptor. Mast cell specific serine proteases (tryptase and chymase) account for the majority of protein present in mast cell granules. Beside these, mast cell granules contain preformed mediators such as histamine, proteoglycans (including heparin) and carboxypeptidase A. Histamine is a potent mediator causing bronchoconstriction, bronchial smooth muscle contraction and vasodilation, and reactions such as urticaria and itch. A wide range of ligands and cytokines can activate mast cells. Fc ϵ RI aggregation results from recognition of a polyvalent antigen by IgE bound to the surface; mast cells express also receptors for IgG (Fc γ R) and TLR, C5a and C3a receptors. Activation can result in degranulation: the rapid release of packaged mediators into the surrounding tissue. If activated through surface c-kit or Fc ϵ RI, mast cells can rapidly synthesise eicosanoid mediators from endogenous stores of arachidonic

acid. Mast cells can produce cytokines, including $\text{TNF } \alpha$, IL-3, GM-CSF, IL-5, IL-6, IL-10 and IL-13 [125]. Mast cells and their products can thereby influence immune responses in diverse modulatory, stimulatory or suppressive ways [126].

Basophils

Basophils share several features of mast cells, including high levels of Fc ϵ RI expression and granulocytic morphology, yet are smaller (5-8 μm) and have a lifespan of days rather than months. Contrary to mast cells, basophils mature in the bone marrow and have a predominantly intravascular location, constituting less than 1% of leukocytes in the peripheral blood [127]. IL-3 is an important basophil pro-growth and survival factor. Basophils can also be activated by Fc ϵ RI aggregation or C5a and C3a receptor ligation, and may be primed by cytokines (IL-3, IL-5 and GM-CSF). TLR2 or TLR4 ligation leads to basophil production of IL-4 and IL13 and also potentiates their activation. Histamine is the major component of basophil granules, and is packaged complexed with proteoglycans. The heparin and tryptase content of basophil granules is thought to be much lower than that of mast cells. Basophils can rapidly synthesise the three cysteinyl leukotrienes LTC₄, LTD₄ and LTE₄. Notably, basophils are a major source of IL-4, which they can rapidly secrete at high levels. [125, 128]

Eosinophils

Eosinophil development occurs in the bone marrow, and mature eosinophils are released into the circulation after IL-5 stimulation, although a prominent pool remains in the bone marrow: their half-life in circulation is akin to that of neutrophils, around 8-18h. The cationic proteins contained within their specific granules determine the unique staining properties of eosinophils. These comprise major basic protein, eosinophil peroxidase, eosinophil cationic protein and eosinophil-derived neurotoxin, and are toxic to microbes and particularly parasites. Eosinophils also contain lipid bodies, which are not vesicles but cytoplasmic structures that are major sites of eicosanoid synthesis. Unlike basophils and mast cells, eosinophils express Fc ϵ RI at very low levels, but exhibit prominent expression of IgG and IgA receptors (Fc γ RIIA/III and Fc α RI), and crosslinking of antibody receptors is most potently effected by secretory IgA. Exocytosis can be complete or piecemeal. Like basophils, eosinophils can be primed by cytokines (IL-3, IL-5, GM-CSF), chemokines and PAF. Eosinophils can produce a very wide range of cytokines, but at low levels compared to other leukocytes, and their effector mediators are more prominently lipid-derived: LTC₄, PGE₂, thromboxane and PAF [125].

1.2 Neutrophil death & inflammation resolution: a focus on lipid mediators

It is now well established that controlled cell death and clean up is critical to initiate pro-resolving pathways: immunologically quiescent removal of dead cells is critical to normal development and homeostasis, as well as to inflammation resolution [129]. Neutrophil apoptosis, in particular, is an important aspect [130]. Once infiltrated into the tissue, neutrophils can reverse transmigrate or return via the lymphatics, as described above, however neutrophil apoptosis and uptake by macrophages is the dominant pathway of clearance. In the context of infection, exposure to bacterial products prolongs neutrophil survival, but phagocytosis triggers apoptosis, and apoptotic cells are taken up by both resident and recruited macrophages [131].

Macrophage uptake of aging or apoptotic neutrophils is an important mechanism to limit inflammation and potential tissue injury induced by neutrophil products, as well as to dampen the inflammatory responses of macrophages themselves. After ingestion, macrophages adopt an anti-inflammatory phenotype [132]. Indeed apoptotic cells influence phagocyte reprogramming through pleiotropic immune regulatory pathways, [133, 134]. Not only do neutrophils switch from synthesis of inflammatory to pro-resolving lipid mediators [93], lipoxin production by neutrophils promotes their uptake by macrophages, and macrophage production of specialised proresolving mediators resolvins, protectins and maresins [94].

From proinflammatory mediators to agonists that actively promote resolution: the temporal regulation of lipid mediator production has become a new paradigm of inflammation resolution. This is a critical point as we go on to consider the role of neutrophils in systemic inflammation. Firstly, that neutrophil production of lipid mediators can be associated with both inflammatory and resolving signatures; and secondly, that the initial inflammatory signature initiates biosynthesis pathways that also actively promote resolution.

1.3 Antibodies & their receptors: conferring innate immune cells with adaptive specificity

Antibodies, or B cell-derived immunoglobulins, represent the potent humoral arm of adaptive immunity and are critical for host defence; yet the effective function of antibodies is equivalently implicated in disease pathogenesis, from autoimmunity to allergy. Antibody receptors, including receptors for IgG (FcγR) and receptors for IgE (FcεR), have diverse *in vivo* functions and patterns of expression, and control antibody-induced activation and/or recruitment of immune cells, which can mediate inflammation and disease progression, or resolution. One major component of this thesis is the role of IgG antibodies and their receptors in driving the systemic inflammation associated with anaphylactic shock. This section will describe the production of antibodies, their subclasses, and their receptors, with a focus on classical cell surface receptors for IgG (FcγR) and their differences between mice and humans, which informs how we can apply mouse models to study IgG-dependent inflammation.

1.3.1 B cells and the BCR

Adaptive immunity encompasses B and T lymphocytes with specific antigen recognition receptors, the B cell receptor (BCR) and the T cell receptor (TCR). These lymphocytes develop from a common lymphoid progenitor; T cells undergo maturation in the thymus and B cells mature in the bone marrow [135]. The antigen receptors of B and T cells develop by way of numerous enzymes which coordinate to rearrange the genes coding for the variable regions of these receptors, in a process called V(D)J recombination. Successful rearrangement of genetic elements within the immunoglobulin (Ig) or Tcr loci permits the functional expression of a BCR or the TCR, respectively, containing a variable region with a unique specificity. The power of this system is to generate an enormous diversity of receptor specificities from a small region of DNA, thereby facilitating the generation of a wide range of potential immune reactivities. Immune checkpoints and balances during cell development control the emergence of mature T and B cell clones with distinct reactivities and a tolerance to self, or host-derived molecules.

The coordinated activation of B and T cells occurs for the most part in specialized lymphoid structures, most notably the spleen and the lymph nodes. Whereas T cell activation absolutely depends on other cells presenting antigen, for example macrophages or DCs, in the context of antigen presentation molecules (major histocompatibility complex; MHC), B cells can directly interact with

antigen via the BCR. Importantly, the BCR provides the direct template for subsequent antibody production. When a B cell encounters its cognate antigen, it receives activating signals, and the addition of costimulatory signals via PRRs, proinflammatory factors or cytokines permit full cellular activation. Rapid clonal expansion of activated B and T cell populations permits a full and potent adaptive immune response. Critically, however, the activation of these adaptive lymphocytes takes time, and this lag phase contrasts with the rapid activation of leukocytes of the innate immune system.

B cells can undergo additional changes to their BCR prior to differentiation to become an antibody-secreting plasma cell. This process is referred to as affinity maturation, as the affinity of the BCR becomes greater for its respective epitope, the site of antigen binding, by way of small modifications within the variable region. After receiving appropriate helper signals from interaction with a T cell of shared specificity (T-dependent antigens), or suitable PRR and cytokine signalling (T-independent antigens), B cells experience somatic hypermutation, achieved by a different set of enzymes than the original V(D)J arrangement. Within the germinal centre of a secondary lymphoid organ, after somatic hypermutation B cells test their modified BCRs on antigens presented to them by follicular dendritic cells. The population undergoes affinity maturation, as more high affinity clones are selected for with survival signals, and clones of lower affinity undergo apoptosis. B cells can undergo multiple rounds of affinity maturation, both within a single immune response and over several antigen exposures over the lifetime of the individual. A high affinity B cell clone can differentiate to become a memory B cell, and thereby preserve the fine antigen recognition for subsequent encounter; the hallmark of adaptive immunity. Most of the B cell clones, however, differentiate to become plasma cells, or antibody-producing cell factories [136, 137].

1.3.2 Antibodies and their classes

Antibodies are composed of two light chains and two heavy chains, connected by disulphide bridges. Each chain contains several immunoglobulin domains: a variable domain, plus one or several constant domains. The variable domains of one light chain and one heavy chain come together to form the antigen-binding portion of the BCR or antibody molecule. Antibody diversification is not limited to the variable region, described above. Naive B cells express only IgM and IgD, but other immunoglobulin classes or subclasses (isotypes) can be elicited. Immunoglobulin class switching is the process by which B cells can change the isotype of the antibody they produce: that is, the constant region of the antibody molecule can be changed while retaining the binding specificity conferred by

the variable region. While the variable regions determine the exquisite specificity of antibodies, the constant regions of the antibody molecule enable and determine the *in vivo* functionality.

Changing constant regions occurs by class switch recombination (CSR), a genomic modification that replaces the expressed μ constant region ($C\mu$) of the heavy chain with a downstream region $C\gamma$, $C\epsilon$ or $C\alpha$, thereby determining B cell production of antibody isotypes IgG, IgE or IgA. Notably, IgD is generated by alternative splicing of the germline transcript, and not by CSR. CSR is central to the maturation of the antibody response, because different immunoglobulin isotypes can promote a specialised immune response to different pathogens, engaging different effector functions. The engagement of B cell PRRs and the local production of cytokines critically determine the type of CSR that occurs. Synergy between PRR and cytokine receptors within the B cell informs the targeting of the CSR machinery [138].

IgM is secreted as pentamers or hexamers, with a high avidity for antigens with repetitive motifs, and a strong potential for activation of the complement cascade. It is effectively released in the early phases of B cell responses, where prior to affinity maturation the avidity of the antibody-antigen interaction is of greater importance. Yet IgM molecules cannot pass into the extravascular space, and do not recruit cellular effectors as efficiently as other isotypes. Conversely, monomeric IgG, IgE and IgA can be distributed systemically to tissues, to therein mediate a large variety of effector functions. IgG is the most dominant antibody subclass, exhibits the highest rate of synthesis and longest biological half-life: IgG1 antibodies are present at serum concentrations of 5-12mg/ml with a half-life of 21 days. Classically speaking, in humans, IgG1 and IgG3 are effective against viruses, IgG2 against encapsulated bacteria, IgG4 and IgE against large extracellular parasites, and IgA1 and IgA2 against pathogenic bacteria at the mucosa.

1.3.3 IgG antibody receptors (Fc γ R)

The Fc receptors of mice and humans endow myeloid cells, as well as NK cells and B cells, and human platelets, with the capacity to interact directly with antibodies of each of the different subclasses (reviewed in [139]). Mice and humans express a single IgM receptor (Fc μ R), two receptors for IgM and IgA (PolyIgR and Fc α / μ R) and two IgE receptors (Fc ϵ RI and Fc ϵ RII/CD23). Humans express uniquely an IgA-specific receptor hFc α RI/CD89. Mice express four classical surface receptors for IgG: the activating mFc γ RI, mFc γ RIII and mFc γ RIV, and the inhibitory mFc γ RIIB; as well as the recycling receptor mFcRn (**Figure 1.2**). Humans, on the other hand, express six classical IgG surface receptors: hFc γ RI (CD64), hFc γ RIIA (CD32A), hFc γ RIIB (CD32B), hFc γ RIIC (CD32C),

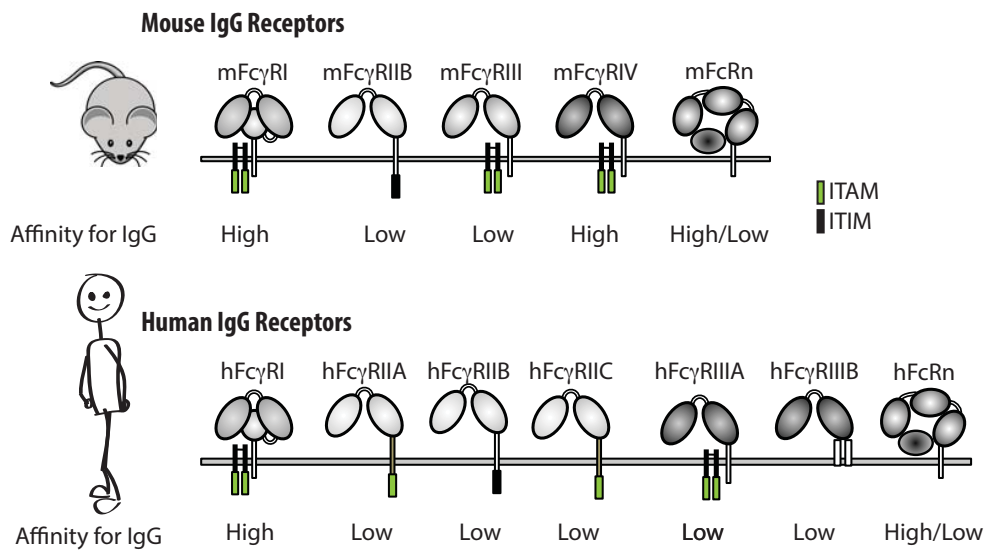


Figure 1.2: Mouse and human IgG receptors (Fc γ R). Schematic representation of classical cell surface expressed mouse and human Fc γ R. The grey bar represents the cell membrane. Associated intracellular signalling motifs are indicated: ITAM, immunoreceptor tyrosine-based activation motif (green); ITIM, immunoreceptor tyrosine-based inhibitory motif (black).

hFc γ RIIIA (CD16A) and hFc γ RIIIB (CD16B), and the recycling receptor hFcRn. Intracellularly, mice and humans express TRIM21, which is critical to viral degradation within the proteasome [140]. Humans express additionally FcRL4 and FcRL5, which are Fc-like receptors for IgG with homology to Fc γ R, expressed on B cells. Thus, considerable differences in IgG receptors exist between mice and human species, impacting how we can use mouse models to understand the role of antibodies in immune defence and pathology.

1.3.3.1 High and low affinity FcR

The association constants of Ig-FcR interactions range from $2 \times 10^4 \text{ M}^{-1}$ to $1 \times 10^{10} \text{ M}^{-1}$. The notion of **high affinity** and **low affinity** FcRs, although relative, is practical to consider the way in which these receptors can interact with a ligand (Figure 1.2). High affinity receptors can bind free or monomeric Ig, and thus their binding sites are theoretically occupied *in vivo*, whereas low affinity receptors can only bind Ig when present in a multivalent context: in an immune complex, aggregated, or opsonised. The canonical example of a high affinity receptor is Fc ϵ RI, which can be sensitised or ‘armed’ by administration of a specific IgE, and thereafter rapidly aggregated by administration of a

specific antigen, both *in vitro* and *in vivo*. Fc ϵ RI-bound IgE can remain for about a day, with an interaction half-life of 19h, and thereby retention of specific IgE on the cell surface can persist as a type of ‘memory’.

The high affinity IgG receptors, mFc γ RI, mFc γ RIV and hFc γ RI, although capable of binding monomeric IgG, have a reduced affinity of interaction compared to the high-affinity IgE receptor. These former are also theoretically occupied *in vivo*, yet with a shorter half-life of interaction. Studies of the *in vivo* function of mFc γ RIV and hFc γ RI clearly indicate that they are available for interaction with IgG to promote cell activation, whether by engagement with circulating IgG immune complexes in the context of systemic inflammation, or IgG deposited in the tissue, exemplified in the context of inflammatory arthritis [141, 142]. Fc receptor ‘inside-out’ signalling, initiated by cytokines or PRR ligation, has been postulated to change the relative affinity of high affinity hFc γ RI for multivalent compared to monovalent engagement ([143] and reviewed in [144]). These concepts are important to bear in mind when considering the induction of inflammation by circulating immune complexes or opsonised cells, as opposed to monomeric ligation.

1.3.3.2 Activating versus inhibitory: ITAMs and ITIMs

Activating antibody receptors for IgG and IgE mediate intracellular signalling via immunoreceptor tyrosine-based activation motifs (ITAMs). hFc γ RIIA and hFc γ RIIC contain an ITAM situated within the receptor cytoplasmic tail. Conversely, mouse mFc ϵ RI, mFc γ RI, mFc γ RIII and mFc γ RIV and human hFc γ RI and hFc γ RIIIA lack intrinsic signalling motifs and associate with the transmembrane adapter molecule Ig-FcR common γ -chain (FcR γ). Upon receptor ligation and aggregation, Src family kinases (Hck, Lyn, Fgr and Src) phosphorylate the tyrosine residues of these receptor-associated ITAMs, which thereafter act as a docking site for the intracellular kinase Syk (Spleen tyrosine kinase). Syk initiates an intracellular signalling cascade that drives FcR-dependent cell activation: which may involve phagocytosis, endocytosis, and cytokine production or cell migration.

Mouse and human inhibitory receptors Fc γ RIIB contain within their cytoplasmic tails, signalling motifs that mediate rather cell inhibition; these are referred to as ITIMs (immunoreceptor tyrosine-based inhibition motifs). ITIMs are similarly phosphorylated by Src family kinases, however in the case of ITIMs the phosphatases SHP1 or SHP2, or SHIP or SHIP2, are recruited. These

phosphatases counterbalance the activating pathways initiated by kinases such as Syk and can inhibit cell activation upon co-engagement with an activating receptor.

Most FcRs are triggered following multivalent immunoglobulin engagement, whether present in an immune complex with soluble antigen or opsonising a cell, virus or bacteria. In certain contexts of low affinity interactions of FcRs with monovalent antigen, ITAMs can in fact transmit inhibitory signals, a novel regulatory mechanism referred to as ITAMi. This has been demonstrated for human Fc α RI, Fc γ RIIIA and more recently for Fc γ RIIA in the context of arthritis [145-147].

1.3.3.3 Mouse Fc γ R expression and function

mFc γ R exhibit differential expression on immune cell populations, which can be positively and negatively regulated by cytokines. mFc γ RI is expressed in a restricted fashion on monocytes, some monocyte-derived cells and macrophages; inhibitory mFc γ RIIB is highly expressed on B cells, monocyte/macrophages, mast cells, basophils, dendritic cells and eosinophils, and low on neutrophils, plus considerably expressed on endothelial cells in the liver; mFc γ RIII is highly expressed on monocyte/macrophages, neutrophils, mast cells, basophils, dendritic cells and eosinophils, and low on NK cells; mFc γ RIV is highly expressed on Ly6C^{low} monocytes, macrophages and neutrophils, and absent on other cells.

The function of these receptors *in vivo* has been extensively studied using different receptor knock-out animals, as well as the administration of specific blocking antibodies, in the context of models of infection and immune challenge (reviewed in [139]). mFc γ RIII is the major activating IgG receptor, and in its absence mice are more susceptible to infection, resistant to the anti-inflammatory effects of intravenous immunoglobulin therapy, and have impaired tumour clearance with therapeutic antibody treatment. Furthermore, mFc γ RIII contributes to several models of antibody-dependent pathologies including the Arthus reaction, passive cutaneous anaphylaxis and passive systemic anaphylaxis, autoimmune anaemia, thrombocytopenia and arthritis. Similarly, the high affinity receptor mFc γ RIV can contribute to nephritis, autoimmune thrombocytopenia and arthritis, lung inflammation, anti-melanoma therapy, and systemic anaphylaxis. These ranges of functions for mFc γ RIII and mFc γ RIV in defence and pathology align with the broad expression profile of these receptors: on neutrophils and macrophages, important inflammatory and phagocytic cells. mFc γ RI, too, has been reported to contribute to the severity of arthritis, anaphylaxis and the Arthus reaction, in addition to the elimination of tumour metastases; yet this is at odds with the restricted expression pattern of this receptor on monocytes and some monocyte-derived resident cells. mFc γ RI^{-/-} mice also

experience impaired clearance of pathogenic bacteria and helminth infection. Clarification of the *in vivo* function of mFcγRI in antibody-dependent pathologies, using mFcγRI^{only} mice, is the subject of a supplemental project to this main thesis work (Annex 7.2).

The importance of the inhibitory receptor mFcγRIIB is highlighted in knockout mice, which experience increased resistance to infection, greater bacterial clearance, and enhanced antibody-mediated tumour therapy, yet also a much greater susceptibility to various autoimmune manifestations [148-150]. Indeed, on the C57Bl/6 background, mFcγRIIB^{-/-} mice spontaneously develop glomerulonephritis [151]. Attempts at blocking this receptor by the *in vivo* administration of blocking antibodies have been deterred by the rapid internalisation of such antibodies after binding to the target, mFcγRIIB, which is highly expressed on the liver sinusoidal epithelium, and probably ‘soaks up’ these blocking antibodies before they can reach immune cell targets [139].

Interestingly, mFcγRIIB, mFcγRIII and mFcγRIV exhibit dual specificity for IgE and IgG. Although these receptors have only low affinity for IgE, and their affinity for IgG is considerably higher, this factor is important to keep in mind, particularly in the context of anaphylaxis models, as the IgE interactions can have biological consequences. Human IgG receptors are more ‘strict’ in their binding to this subclass alone. Finally, mFcRn has a primary function in recycling IgG and thereby protecting it from catabolism, and as an antenatal IgG transporter, but also transports IgG into the tissues of adults, thereby facilitating both autoimmunity and anti-tumour therapy [152].

1.3.3.4 Human FcγR expression and function

Not only do mouse and human FcγR exhibit significant structural diversity (**Figure 1.2**), these receptors have considerably different patterns of expression on immune cell populations, thereby determining potentially disparate contributions to immune pathologies. hFcγRI (CD64) is restricted to monocytes/macrophages and DCs, but is highly inducible, compared to its murine counterpart, and can also be expressed on neutrophils. The uniquely human hFcγRIIA is expressed on all myeloid cells but not on lymphocytes, and is crucially also expressed on platelets. Inhibitory hFcγRIIB is highly expressed only on circulating B cells and basophils, expressed at low levels on monocytes and neutrophils, and expressed on tissue macrophages and DCs but not mast cells. hFcγRIIC is expressed on NK cells, monocytes, and neutrophils in only 20-25% of individuals those who carry the polymorphism Q13 or ORF; in the remaining persons, a SNP at position 13 generates a stop codon (stop13), in which case *FCGR2C* represents a pseudogene [153]. hFcγRIIIA is expressed on NK cells and monocytes/ macrophages; and hFcγRIIIB is highly expressed on neutrophils and exhibits low

expression on some basophils. Finally, hFcRn is expressed on antigen-presenting cells, monocytes/macrophages, neutrophils, vascular endothelial cells, intestinal epithelial cells, and on syncytiotrophoblasts, the latter which permits antenatal transfer of IgG from mother to fetus.

The multiplicity of human FcγRs is increased by a series of genetic polymorphisms. Several *FCGR* polymorphisms modify the affinity between FcγRs and human IgG, and different polymorphisms may predispose to the development of disease, or determine responsiveness to therapy; these associations in humans can provide some insight of the role of these receptors *in vivo* (Reviewed in [154], included as Annex 7.3). Transgenic mouse studies have likewise greatly enhanced our understanding of the *in vivo* function of hFcγRs. In particular, these studies have highlighted the respective contributions of FcγR, to antibody-mediated inflammatory and allergic diseases, albeit with some major caveats according to reproducibility of transgene expression in the mice compared to the human, ligation by non-physiological ligands (mouse IgG), and confounding effects of expression in conjunction with mouse FcγR (Reviewed in [139]).

hFc γ RI in transgenic mice retains its high affinity properties, can mediate phagocytosis *in vitro* and antibody-mediated cell destruction (ADCC) and clearance of opsonized red blood cells or platelets *in vivo* [142, 155, Heijnen, 1996 #277, 156]. hFc γ RI seems to have important roles in antigen presentation, amplifying antibody production and T cell responses via DC cross priming.[157, 158].

hFc γ RIIA is a promiscuously expressed and dominant activating human IgG receptor. Expressed alone, it can restore susceptibility to autoimmune thrombocytopenia, arthritis, airway inflammation, and local and systemic IgG-dependent allergic inflammation [159-161]. Dramatically, hFc γ RIIA expression on neutrophils alone, driven by a transgene associated with the restrictive hMRP8 promoter, or by adoptive transfer of human neutrophils, was sufficient to mediate IgG-dependent pathologies arthritis, glomerulonephritis, and reverse passive arthus reaction, as well as restoring susceptibility to systemic IgG-dependent anaphylaxis [161-163]. *In vitro*, hFc γ RIIA can mediate uptake of immune complexes, and can trigger the formation of NETs *in vivo* [164]. The only hFc γ R expressed on platelets, hFc γ RIIA endows human platelets with the capacity to interact with soluble immune complexes, and to be activated to promote thrombus formation or thrombocytopenia [159, 165, 166].

hFc γ RIIIA has been investigated using transgenic mice predominantly for its involvement in anti-tumour therapy: hFc γ RIIIA can promote tumour cell destruction via ADCC, and antibodies

[167, 168] with enhanced binding to hFc γ RIIIA demonstrated improved efficacy *in vivo*. hFc γ RIIIA and hFc γ RIIIB share a homologous extracellular domain, but whereas hFc γ RIIIA contains an ITAM motif in its intracellular tail, **hFc γ RIIIB** is a GPI-linked membrane receptor whose function is less well elucidated. Originally viewed as a decoy receptor, it is clear that hFc γ RIIIB can affect neutrophil migration and interaction with immune complexes [162, 164, 169], perhaps by association with surface integrins [170].

The differential roles of hFc γ RIIA and hFc γ RIIIB on neutrophils were studied using hMRP8cre promoter to restrict transgene expression only to neutrophils and some monocytes [162, 164]. hFc γ RIIIB-dependent neutrophil accumulation in the kidney or skin, during nephritis or passive Arthus models respectively, occurred in the absence of prominent edema, macrophage recruitment or tissue injury [162]. On the other hand, hFc γ RIIA and hFc γ RIIIB co-expression cooperatively promoted tissue injury. In particular, neutrophil slow rolling and adhesion responses to immune complexes deposited within the vasculature were mediated by hFc γ RIIIB, followed by ‘quiescent’ immune complex uptake and clearance, in direct contrast to proinflammatory NET formation that was triggered by hFc γ RIIA engagement of soluble immune complexes [164]. These studies serve to highlight particularly the cooperative effects of hFc γ R during inflammation *in vivo*, albeit in an artificial context with a false transgene promoter.

In an attempt to recapitulate the full range of classical hFc γ R diversity in a mouse model, individual transgenic mouse strains were bred to create hFc γ RI^{tg}IIA^{tg}IIB^{tg}IIIA^{tg}IIIB^{tg} mice on a background deficient in endogenous mouse Fc γ R (Fc γ R^{null}) [171]. This approach unfortunately preserves the aberrant expression of individual transgenes, including exceptionally high hFc γ RIIB on monocytes, erroneous expression of hFc γ RIIB and hFc γ RIIA on eosinophils, hFc γ RIIA and hFc γ RIIB on some DCs, hFc γ RIIB on monocytes, and constitutive expression of hFc γ RI on neutrophils [171-173]. Still, this study demonstrated that hFc γ RI^{tg}IIA^{tg}IIB^{tg}IIIA^{tg}IIIB^{tg} mFc γ R^{null} mice had normal spleen architecture, and could generate specific IgM and IgG antibody responses upon immunisation with a hapten-protein conjugate. In addition, these mice could mount cytotoxic effector functions via human IgG targeting B cells, T cells or platelets for depletion, or to eliminate tumour cells. Crucially, the injection of immune complexes formed by aggregated human IgG could trigger severe hypothermia and systemic shock in hFc γ RI^{tg}IIA^{tg}IIB^{tg}IIIA^{tg}IIIB^{tg} mFc γ R^{null} mice: that is, IgG-dependent anaphylaxis [171] (see section *Systemic inflammation: Anaphylaxis*). This previous study did not, however, address the receptors, cells or mediators responsible for the models used therein.

1.4 Systemic Inflammation

This thesis work examines the role of neutrophils in severe systemic inflammation, associated with the development of shock, in two distinct immune contexts: LPS-induced endotoxemia, and IgG-dependent anaphylaxis.

1.4.1 Inflammation-associated circulatory shock

Shock is an acute and widespread reduction in effective tissue perfusion, a systemic syndrome with organ-specific signs and symptoms as a result of dysregulated hemodynamics and imbalance of oxygen supply and demand. Subsequent cellular and organ dysfunction can lead to irreversible damage and death. Shock can be invoked as the most severe manifestation of systemic inflammation. Endothelial dysfunction and increased vascular permeability associated with significant oedema can drive subsequent hypotension and hypovolemia. Cardiac difficulties can result from defective hemodynamics, and respiratory difficulties arise from poor ventilation-perfusion matching and lung-specific oedema.

Oedema is indeed a cardinal sign of inflammation and is canonically associated also with the presence of neutrophils [174]. Under basal conditions the microvascular endothelium has a low permeability, but in response to injury or pathogenic insult endothelial barrier permeability increases, permitting the delivery of plasma proteins and innate and adaptive humoral components to the extravascular compartment to participate in host defence and tissue repair. This process is permissive also for the extravasation of innate immune effector cells, including neutrophils. Histamine, bradykinin, leukotrienes, platelet-activating factor, and Vascular Endothelial Growth Factor (VEGF) can all modify the junctional interactions of endothelial cells to promote vascular leakage. In particular, neutrophil chemoattractants C5a, fMLP and leukotriene B₄ (LTB₄), as well as neutrophil-derived TNF [175] and heparin-binding protein (HBP) [176, 177] contribute to increased vascular permeability. Neutrophils may contribute to tissue swelling in the later stages of inflammation by releasing substances that damage the endothelium, such as proteases and reactive oxygen species. Vascular leakage is important in local inflammation and host defence, but can be pathogenic if in excess, such as in the context of systemic inflammation.

Not only vascular leakage, but also a loss of vascular tone and endothelial function contributes to the shock phenotype. Nitric oxide (NO) is an important endogenous mediator of vascular tone, and has a crucial involvement also in systemic shock. Three enzymes (nitric oxide synthases, NOS) are

responsible for its production: the constitutively expressed neuronal nNOS and endothelial eNOS, as well as the inducible and inflammation-associated iNOS. Inhibition of NO can restore vasomotor tone in both septic and anaphylactic shock, however in septic shock this restorative function is complicated by a greater risk of mortality [178, 179]. The specific role of NO is not addressed in this study, but may underlie some of our findings, as will be discussed later.

1.4.2 Endotoxemia

Endotoxins are bacteria-derived lipopolysaccharides (LPS), the major component of the outer cell membrane of gram-negative bacteria, and potent stimulators of innate immune sensing. LPS is composed of a polysaccharide external domain anchored in the bacterial membrane by a hydrophobic moiety called lipid A, and it is this lipid A component that is strongly immunostimulatory. Lipid A molecules of different bacteria are diverse according to the number of fatty-acid side chains and the presence of terminal phosphate residues, yet picomolar concentrations are sufficient to induce macrophage production of proinflammatory cytokines TNF α and IL-1 β . Indeed, endotoxin exposure alone is sufficient to induce inflammatory shock.

Endotoxemia can result from sepsis consequent to a gram-negative bacterial infection. Sepsis is a highly complex pathology, which can be broadly described as a deleterious non-resolving inflammatory response to an initial infection or pathogen trigger [180]. Efforts to understand sepsis pathogenesis are complicated by huge variability in eliciting infectious agents and patient cohorts. Originally thought to be driven by innate inflammatory pathways, it is now clear that sepsis immune pathology is composed of both inflammatory and counter-inflammatory components, and indeed that immune dysregulation is a crucial driver of morbidity and mortality [181, 182]. Patients rarely die from the original infection, but rather from the severe inflammatory response, or moreover secondary infections subsequent to immune dysregulation. In the first instance, therefore, endotoxemia is a model of severe inflammation relevant to the septic state, yet decoupled from the presence of a pathogen.

Secondly, however, endotoxemia is also a prominent component of other infectious conditions and critical illness. Systemic inflammation is frequently associated with a loss of gut barrier function and increased permeability of the intestinal endothelium, permitting the translocation of gut-derived bacterial products, including LPS, which can contribute to the perpetration of inflammation even as a result of sterile injury. The systemic inflammatory response to non-infectious agents - trauma, pancreatitis and surgery - often leads to multi-organ dysfunction with an immunopathology similar to

sepsis. Therefore one may employ high-dose LPS challenge as a model of severe and acute systemic inflammation, simultaneously relevant to understanding systemic inflammation as it relates to multiple triggers.

1.4.2.1 LPS sensing

The hydrophobic lipid A component of LPS is chiefly recognised by Toll-like receptor 4 (TLR4) [183, 184], yet this interaction is guided and permitted by a series of recognition molecules. In the serum, LPS-binding protein (LBP) can bind and solubilize circulating LPS [185], and the GPI-linked membrane surface receptor on leukocytes CD14 binds to LPS-LBP complexes [186]. Notably, CD14 can also be present in a soluble form. CD14-KO mice are resistant to endotoxic shock [187]. CD14 transfers LPS to the adapter molecule MD2, which associates with TLR4 on the cell membrane, and this complex permits LPS recognition by the cell [188, 189]. Dimerisation of the LPS-MD2-TLR4 complex recruits cytoplasmic adaptor molecules, through the interaction with Toll-interleukin-1 receptor (TIR) domains [190]. Signalling occurs either via Myd88 adapter molecules, downstream signalling kinases and NF κ B activation to promote inflammatory cytokine release; or the TRIF (TIR-domain containing adaptor inducing interferon- β) signalling pathway to activate interferon response factors to produce and secrete type-I interferons [191]. Thereby, LPS can induce the production of a number of proinflammatory cytokines including IL-8 (MIP1 α), IL-6, IL-1 β , IL-1, IL-12, and IFN γ .

The ability of LPS to bind to and signal via the TLR4-MD2 complex can be modulated by the host. Not only LBP but also other proteins within the plasma can bind LPS. Several different lipoproteins, chiefly HDL (high density lipoprotein), can bind to LPS in a way that prevents its interaction with the MD2-TLR4 complex [192, 193]. Up to 50% of circulating LPS is thereby rapidly sequestered, and this probably represents a key route of LPS clearance via the liver [194]. Host enzymes, including phosphatases and lipases produced by neutrophils, monocytes, kupffer cells, as well as the small intestine and renal tubules of the kidney can degrade LPS [195-197]. Moreover, deacetylated LPS competes with native LPS for binding to LBP, soluble CD14, and MD2-TLR4, thereby antagonising immune signalling pathways [198].

Intracellular LPS may also be detected by caspase 11 (mice) or its orthologs caspases 4 and 5 (humans) to induce non-canonical inflammasome activation, and promote cellular pyroptosis [199-201]. Human caspase 4 confers LPS susceptibility in cell culture, while caspase 11 knockout mice are resistant to lethal shock, demonstrating the relevance of this intracellular detection to systemic endotoxemia.

1.4.2.2 The pathogenesis of endotoxic shock and the role of neutrophils

TLR4 expression on monocyte/macrophages and neutrophils drives the inflammatory cytokine response during mouse sepsis models: specific deletion of TLR on these cells demonstrated its requirement for effective bacterial clearance, but also ameliorated morbidity when combined with microbe clearance by antibiotics [202]. Both monocyte/macrophages and neutrophils can produce the numerous inflammatory cytokines involved in the systemic response to endotoxin exposure: IL-1 β , IL-8, IL-6, TNF α and IFN γ . These cells are also important sources of lipid mediators (PAF and eicosanoids) as well as nitric oxide, which can contribute to increased vascular permeability and a loss of vasomotor tone. The relative cell-specific source of cytokines and inflammatory mediators is difficult to delineate. However, considering that monocyte/macrophages express high levels of CD14, exhibit great capacity for pro inflammatory cytokine production, and are the dominant cell population in the peritoneal cavity, where systemic endotoxemia models are initiated, it is likely that these cells are the initial major source. Neutrophils may contribute to the inflammatory milieu after their recruitment following chemokine release by macrophages, cytokine stimulation, and accordingly increased CD14, whether expressed on neutrophils themselves or soluble CD14 in the environment.

Macrophages, as well as endothelial cells, smooth muscle cells, hepatocytes, and myocardiocytes, can synthesise NO from iNOS following LPS or inflammatory cytokine stimulation. iNOS-derived NO has a critical contribution to the vascular dysfunction associated with endotoxic shock. iNOS deficient mice were found to be resistant to endotoxin lethality [203], although this was refuted by others [204]. Altogether the beneficial effects of NO inhibition during endotoxemia are highly debated, likely reflecting a functional multiplicity for this vasoactive compound during shock.

Of all the inflammatory cytokines released during systemic inflammation, TNF α is critical to the pathology of shock after endotoxin exposure [205, 206]. Despite this, TNF inhibitors are not under widespread usage to treat clinical shock, due to lack of efficacy in clinical trials. HMGB1 is a DAMP released in the later stages of shock and was observed to amplify LPS-induced inflammation [207], although recently it was shown that, contrary to antibody-mediated blockade, conditional HMGB1 ablation does not affect the shock phenotype following LPS challenge [208]. Still, HMGB1 remained critically implicated in the amplification of neutrophil-mediated tissue injury during sterile inflammation. These findings exemplify many that highlight the complexity of unravelling inflammatory pathways during systemic endotoxemia.

Anti-inflammatory pathways are also engaged during endotoxemia: IL-4, IL-10, IL-13, transforming growth factor β (TGF- β), glucocorticoids and prostaglandin (PGE₂) are all highly

induced, and suppress the synthesis and action of proinflammatory mediators. In addition, soluble cytokine receptors antagonise the proinflammatory effects of IL-1 and TNF. IL-10-deficient mice or mice treated with a monoclonal antibody against IL-10 showed higher plasma levels of proinflammatory cytokines and increased mortality after LPS challenge [209, 210], whereas recombinant IL-10 was protective [211].

Exposure to low or moderate doses of LPS can result in a state of “endotoxin tolerance”, rendering the host hypo-responsive to a subsequent LPS challenge [212]. Pro-inflammatory cytokines are attenuated, and anti-inflammatory mediators are enhanced, which can facilitate survival from a second challenge. The underlying mechanisms are incompletely determined, but probably result from changes in several molecules involved in TLR4 signaling, as well as epigenetic modifications of inducible loci. Conversely, exposure to ultralow doses of LPS can prime the host to mount an exaggerated inflammatory response. Several studies indicate that LPS can augment innate responses to infection and enhance clearance of several pathogens [202]. Thus it is clear that there is a strong beneficial effect of the inflammatory response to endotoxin exposure, as well as numerous intrinsic immune mechanisms to limit the resulting systemic inflammation.

Neutrophils have been heavily implicated in the organ damage associated with endotoxin exposure, as well as during mouse models of sepsis (cecal ligation and puncture, CLP). These models are crucially associated with neutrophil infiltration into the lung, liver and the kidney, and oedema. Leukocyte infiltration can be damaging to the tissue, in particular neutrophil-derived proteases and ROS can damage cells and matrix proteins of the tissue architecture. Mice deficient in neutrophil elastase and cathepsin G have increased survival after LPS challenge [213]. Neutrophil-derived NETs can be extremely detrimental [214]. The degradation of NETs using recombinant DNase during endotoxic shock in mice restricts systemic cytokine release, reduces MPO in the lung, and signs of lung and liver damage, and positively impacts survival [215]. PAD4-KO mice, which lack the enzyme necessary for chromatin decondensation and cannot form NETs, are resistant to lethal endotoxemia [216].

Integrins are essential to neutrophil extravasation and tissue recruitment, as described in Section 1.1. Antibody-mediated blockade of integrins CD11b (Mac1) or LFA1 [217], or constitutive inhibition of CD11b [218] can reduce pulmonary neutrophil accumulation and lung oedema during microbial challenge associated with systemic inflammation. CD11b-KO mice, however, are much more susceptible to systemic endotoxemia: a complicated picture because CD11b can negatively regulate TLR-4 signalling in macrophages [219]. These mice experience enhanced inflammatory

cytokine production, reduced ROS, and increased macrophage-derived NO after endotoxin challenge. On the other hand, blockade of ICAM-1 ameliorates renal injury after LPS [220] and ICAM-1 deficient mice were resistant to endotoxic shock, associated with reduced neutrophil infiltration into the liver and hepatocyte damage [221]. The immunoglobulin receptor TREM-1 is up regulated on neutrophils and monocytes after LPS stimulation [222] and seems to have a role in the inflammation pathology as TREM-1 blockade protects against endotoxic shock [223]. Furthermore, TREM-1 is critical for neutrophil transepithelial migration into the lung [46].

Together these data emphasise that neutrophil infiltration into the tissues can be a pathological mechanism of systemic inflammation. At the same time, blockade of various surface receptors necessary for this movement can promote enhanced inflammatory cytokine signatures. Moreover, receptor-targeting approaches are not specific to neutrophils, and implicate several other myeloid cell populations (eg CD11b-KO phenotype, as above, or LysMCre specific TLR4-KO, targeting macrophages and neutrophils [202]). Many studies of endotoxin challenge examine organ-specific effects, but rarely assess systemic outcomes, in particular survival. Considering that the lethal shock phenotype manifests primarily as a result of systemic vascular and hemodynamic dysfunction, this is an important criteria. Neutrophil-derived TNF can contribute to micro-vascular leakage [175], though what role this may play in the systemic context is unclear. Surprisingly, few studies have examined the effect of neutropenia on endotoxic shock. Some have in fact associated neutropenia with enhanced susceptibility to endotoxemia and lethal shock [220, 224]; however the first used the cytotoxic agent cyclophosphamide, which has potent lymphoblastic effects, and the second did not provide any in depth analysis or mechanistic insight.

Neutrophils have known and emerging roles in inflammation resolution [79, 80] and can provide an important source of proresolving and protective lipid mediators [93]. In humans, systemic LPS exposure was found to induce the emergence of an immunosuppressive neutrophil subset, capable of inhibiting T cell responses [225]. Furthermore, immune suppression, particularly pertaining to neutrophil dysfunction, is a secondary component of systemic inflammatory responses in septic and critically ill patients [226]. These findings highlight the incomplete understanding of neutrophil function during endotoxemia: they may on the one hand contribute to pathological manifestations, but on the other hand have an immunoregulatory role; or alternatively neutrophil dysfunction may be an important inflammation-limiting outcome.

1.4.3 Anaphylaxis

Anaphylaxis, or allergic shock, is a systemic, acute and potentially fatal allergic reaction, the incidence of which is increasing worldwide. In Europe, the incidence of anaphylaxis is estimated to be between 1.5 and 7.9 per 100 000 person-years; alternatively, that 0.3% of the population will experience anaphylaxis in their lives [227]. In individuals who develop antibodies against an allergen, re-exposure can trigger antibody-dependent cellular activation and release of vasoactive mediators, inducing systemic symptoms of shock. The most common causative agent of anaphylaxis in children is food and in adults, drugs. Anaphylaxis is classically understood to rely on IgE antibodies and FcεRI expressed on mast cells and basophils. Yet mouse models have identified alternative pathways involving IgG antibodies and FcγR expressed on other myeloid cells, particularly monocytes and neutrophils, to drive systemic inflammation associated with anaphylactic shock (reviewed in [228], included as Annex 7.4, and [229]). Indeed, in human patients multiple inflammatory pathways contribute to reaction severity [230]. Anaphylactic reactions are unpredictable and can be rapidly life threatening.

1.4.3.1 The classical pathway of IgE-dependent mast cell and basophil activation: from the local reaction to systemic shock

High affinity IgE receptors FcεRI, expressed on mast cells and basophils, can bind monomeric IgE. In allergic individuals, it is understood that sensitisation elicits the production of allergen-specific IgE. Upon allergen re-exposure, the recognition of bivalent or multivalent antigen by FcεRI-bound IgE causes aggregation of FcεRI and triggers the activation of mast cells and basophils, resulting in the rapid and sustained release of diverse vasoactive mediators, including mast cell tryptase and histamine, and cytokine release [231]. Certainly IgE has a prominent role in the development and maintenance of allergic inflammation, and activation of mast cells and eosinophils via specific IgE is a central event in many acute allergic reactions: highlighted by the diverse anti-inflammatory effects of anti-IgE treatment in patients with allergic asthma or allergic rhinitis, both of which are linked to reactions at mucosal or barrier surfaces.

The widely accepted paradigm of a systemic anaphylactic reaction considers that the pathophysiology is driven by IgE-dependent mast cell and basophil activation and histamine release. In animal models, the transfer or passive sensitisation with specific IgE prior to challenge with the corresponding antigen can recapitulate the systemic signs of shock (passive systemic anaphylaxis, PSA): oedema, hypotension, loss of mobility, and severe hypothermia. IgE-induced PSA observed in wild-

type (wt) mice was abrogated in mice deficient for FcεRI [232] and in mast cell-deficient W/W^v mice [233]. It was also abrogated by pharmaceutical or genetic histamine inhibition, while intravenous injection of histamine alone can induce anaphylactic shock in mice. Anaphylaxis can proceed also through the human IgE receptor, as has been demonstrated using FcεRI^{tg} mice [234], and IgE-dependent mast cell activation can contribute to severe passive systemic reactions in humanised mouse models [235].

The passive transfer of hypersensitivity can be achieved in humans, in 1921 Prausnitz and Künster demonstrated that intradermal injection of a serum reagent (later identified as IgE) could transfer sensitivity to a reaction elicited by injection of a corresponding allergen (reviewed in [228]; Annex 7.4). As a test for patient allergy, a modified form of the cutaneous reaction is still used today: cutaneous anaphylaxis thereby results from a specific sensitisation protocol and route of allergen exposure. Systemic anaphylaxis in patients results from exposure not only at cutaneous surfaces (insect stings) but also at mucosal linings (gut epithelium) and systemically (injectable drugs). Indeed, systemic allergen absorption is necessary for anaphylactic shock to ingested allergens [236]. Considering that food and drug exposure accounts for the majority of anaphylactic reactions, and studies have indicated that drug and medication-induced anaphylaxis is the most common cause of anaphylaxis fatalities [237, 238] it is necessary to understand the immunological mechanisms underlying these systemic reactions. IgE is only a very minor proportion of the total systemic immunoglobulin, present in the serum at less than 0.002 mg/mL, and with a very short half-life of several hours in circulation. IgG on the other hand is the most dominant antibody subclass, exhibits the highest synthetic rate and longest biological half-life: IgG1 concentrations can range from 5-12mg/mL.

1.4.3.2 Clinical aspects

Anaphylaxis has a highly variable presentation, and heterogeneity in terminology, criteria and definitions has led to inconsistent diagnoses. To define the diagnostic criteria for an anaphylactic reaction, recent harmonisation efforts deem that anaphylaxis involves multiple organ systems: primarily the skin or mucosal tissue, along with simultaneous respiratory or cardiovascular compromise, or persistent gastrointestinal symptoms (**Box 1** and [1]) Interestingly, cutaneous symptoms are often absent in the more severe cases, likely due to the rapid onset of hypotension and insufficient bloodflow, because they can often appear only when an adequate perfusion pressure has been re-established.

Box 1: Clinical criteria for diagnosing anaphylaxis

- Any one of the three following criteria indicates likely anaphylaxis
- (1) Acute onset of an illness (minutes to hours) with involvement of:
 - Skin/mucosal tissue (e.g., hives, generalized itch/flush, swollen lips/tongue/uvula)
 - AND Airway compromise (e.g., dyspnea, wheeze/bronchospasm)
 - OR Reduced BP or associated symptoms (e.g., hypotonia, syncope)
 - (2) Two or more of the following after exposure to a known allergen for that patient (minutes to hours)
 - History of severe allergic reaction
 - Skin/mucosal tissue
 - Airway compromise
 - Reduced BP or associated symptoms
 - In suspected food allergy: gastrointestinal symptoms (e.g. crampy abdominal pain, vomiting)
 - (3) Hypotension after exposure to known allergen for that patient (minutes to hours)
(>30% drop from baseline)

When anaphylactic shock is suspected, levels of circulating histamine and mast cell tryptase are measured, and immunological tests are later performed to confirm the diagnosis. These tests include a skin prick test with the suspected allergen, measurement of allergen-specific IgE in the patient's serum, and sometimes an assessment of basophil degranulation *ex vivo* in the presence of the suspected allergen. None of the cutaneous or immunological tests performed reaches a sensitivity or specificity of 100%. In the absence of allergen specific IgE, mast cell tryptase, or other classical markers of basophil and mast cell activation, reactions are often classed as 'anaphylactoid' or 'non-immune mediated' or indeed discounted as anaphylactic reactions. Thus the immunological dogma heavily informs the diagnostic approach, and there is a need to elucidate and emphasise the potential contribution of other pathways of anaphylaxis induction.

Current treatments for allergic anaphylaxis remain primarily limited to prophylactic allergen avoidance and medications to reverse the physiological effects of mediator release. Adrenaline (epinephrine) is the frontline agent of anaphylaxis therapy, increasing vascular tone, myocardial contractility, and cardiac output to ameliorate the shock, along with bronchodilatory effects to relieve respiratory symptoms. Fluid resuscitation is used to ameliorate the hypovolemic aspects and increase venous return [239]. Despite widespread use of antihistamines in the management of anaphylaxis, there is little evidence to support their usage [240]. As an adjunct to adrenaline, antihistamines may be of use only to treat cutaneous symptoms [241]. Methylene blue, a selective nitric oxide cyclic GMP inhibitor, prevents vasodilation and can rapidly reverse the course of anaphylaxis refractory to epinephrine, oxygen, and fluid resuscitation. Its use in anaphylaxis is based on case reports and extrapolated from use in septic shock [242], but is supported by studies in rat models [243].

Emphatically, the early administration of adrenaline is advocated as the primary treatment for anaphylaxis: delay in adrenaline is a primary contributor to fatal reactions [244, 245].

1.4.3.3 IgG-dependent anaphylaxis in mice

IgG-induced passive systemic anaphylaxis (PSA) can be elicited either by injecting mice systemically with IgG antibodies before an intravenous challenge with the corresponding antigen, or by injection of preformed IgG-immune complexes (IC), consisting of antibody bound to soluble antigen, or aggregated IgG. PSA induced by mouse IgG1 proceeds by activation of Fc γ RIII, also expressed by mast cells and basophils. Yet IgG1-PSA was not abolished in mast cell- [233] or basophil-deficient mice [246]. We examined the pathways of anaphylaxis in mice induced by different IgG subclasses ([247], included as Annex 7.1), demonstrating that IgG-induced PSA variably depends on neutrophils, monocyte/macrophages and basophils, according to the subclass.

Moreover, active systemic anaphylaxis (ASA), in which mice are immunised against a model antigen, and develop a polyclonal IgG and IgE response before challenge, can proceed in the absence of IgE [248], Fc ϵ RI [233], and even mast cells and basophils [232, 249]. Some studies identify a prominent role for monocyte/macrophages in inducing severe anaphylactic shock [250], whereas our lab has identified that neutrophils are necessary and sufficient for the induction of ASA via immunisation and intravenous challenge with bovine serum albumin (BSA) [251].

1.4.3.4 IgG-dependent anaphylaxis in humanised mice

As described above, the mouse and human IgG receptor systems are very different, in terms of both expression and function. Although it is well established that IgG-dependent anaphylaxis can proceed in mice, it is important to understand how these findings can translate to the human system. To address this, previous studies have employed transgenic mice expressing either hFc γ RI or hFc γ RIIA on a background deficient in endogenous mouse Fc γ R. Agonistic antibodies directed against these receptors could induce anaphylactic symptoms and hypothermia when injected intravenously into mice expressing the respective transgene. Furthermore, hFc γ RI and hFc γ RIIA were each individually sufficient to mediate PSA induced by the transfer of IgG immune complexes, the symptoms of which may be alleviated by pre-treatment with blocking antibodies [142, 161].

PSA mediated by hFc γ RIIA was found to be independent of mast cells and basophils, but rather dependant on the presence of neutrophils and monocytes/ macrophages. hFc γ RIIA expressed alone was capable of triggering active systemic anaphylaxis resulting in both hypothermia and death [161]. hFc γ RI was also sufficient to induce ASA in transgenic mice, dependent on neutrophils and the

release of platelet activating factor (PAF). Blockade of either hFcγRI or PAF receptors, or depletion of neutrophils with targeting antibodies, inhibited hFcγRI-mediated anaphylactic hypothermia and abolished mortality [142]. These findings using hFcγRI^{tg} or hFcγRIIA^{tg} mice have demonstrated that hFcγR expressed on neutrophils and monocyte/macrophages can mediate fatal anaphylactic reactions in vivo, and identify an important role for PAF as a responsible mediator.

Crucially, the transfer of purified human neutrophils into mice lacking activating Fc receptor expression, and resistant to anaphylaxis, was sufficient to restore sensitivity to severe hypothermia [251]. Indeed human neutrophils can be activated in culture by IgG immune complexes to release PAF [161]. Finally, hFcγRI^{tg} IIA^{tg} IIB^{tg} IIIA^{tg} IIB^{tg} mFcγR^{null} mice were susceptible to anaphylaxis triggered by the administration of human IgG immune complexes, indicating that anaphylaxis can proceed in a context of activating and inhibitory IgG receptor expression [171]. These studies provide considerable evidence to suggest the activation of IgG-dependent pathways, and of neutrophils in particular, can also occur during human anaphylaxis.

1.4.3.5 Human IgE-independent anaphylaxis:

It remains under debate whether IgG can contribute to anaphylaxis in humans, and the relative importance of this immunopathological mechanism. Importantly, in the mouse anaphylaxis models described above, challenge is by administration of a relatively large amount of antigen via the intravenous route. The most likely case in which IgG-dependent anaphylaxis pathways may be invoked in humans, accordingly, is via intravenous exposure to injectable drugs and therapeutic agents. Indeed, patients with antigen-specific IgG antibodies in the absence of IgE have been reported to experience anaphylactic reactions to mAb therapeutics [252, 253], aprotinin [254], dextran [255] or even total serum transfer [256] (reviewed in [257]). Anaphylaxis to the fluid resuscitation agent dextran, in particular, seems a prototypical IgG-dependent reaction, since dextran-specific IgE are rarely detected, and serum levels of IgG subclasses correlate highly with anaphylaxis severity [258]. Anaphylaxis following serum transfer resulted from IgG antibodies directed against IgA antibodies, in IgA-deficient individuals [256]. Moreover, anaphylaxis associated with anti-IgA IgG has been documented in patients with common variable immunodeficiency (CVID) that received intravenous immunoglobulin therapy (IVIG) [259]. Critically, a gain-of-function allele in FcγRIIA was associated with increased risk of anaphylaxis in CVID patients receiving IVIG therapy [260].

Platelet activating factor (PAF) is the dominant mediator responsible for mouse models of IgG- dependent anaphylaxis [250, 251] and is particularly associated with fatal outcomes [261, 262]. PAF has been proposed also as a central mediator in human anaphylaxis pathogenesis (reviewed in

[263]). Patient studies indicate that PAF levels strongly correlate with anaphylaxis severity, and indeed that PAF provides a more specific and sensitive diagnostic marker than either mast cell tryptase or histamine [264]. Furthermore, activity of its inactivating enzyme PAF acetylhydrolase was significantly lower in patients with severe and fatal reactions [230, 265]. A broad range of cells can release PAF, including leukocytes, lymphocytes and endothelial cells, and it can be secreted by mast cells and basophils following antibody-dependent activation. Neutrophils, however, are a major source of PAF, but also express PAF-R on the surface, thus PAF can have an autocrine effect on these cells to enhance release of other lipid mediators. PAF is therefore critically implicated in putative pathways of neutrophil-dependent anaphylaxis.

1.4.3.6 Patient anaphylaxis to neuromuscular blocking agents (NMBAs)

Particularly owing to the variability in presentation and eliciting agents, as well as the emergency nature of the reaction, anaphylaxis is very difficult to study in human patients. In cases of anaphylaxis arising in a clinical setting, however, more homogenous groups of patients may facilitate clinical studies, *ie* by controlled allergen exposure with defined route, dose and timing. Immediate hypersensitivity reactions during the perioperative period have been reported with increasing frequency, and may be attributable to anaesthetic drugs, antibiotics, latex, antiseptics, radio-contrast agents, colloids for intravascular volume expansion, blood products or disinfectants. The most common causes are neuromuscular blocking agents (NMBAs, 60-70%), followed by latex (12-18%) and antibiotics (8-15%) [266].

To investigate the potential contribution of IgG-mediated pathways to anaphylaxis in a patient cohort, one may therefore consider anaphylaxis to drugs, *e.g.* curare-based NMBA. The most common cause of anaphylaxis during surgery, the incidence of NMBA-dependent reactions lies between 1 in 1,250 and 1 in 18,000 surgeries, with substantial geographical variability [267], and moreover, these reactions are fatal in up to 10% of cases [268-270]. Specific IgE, and also specific IgG, have been detected in the sera of patients who developed shock to NMBAs. In addition, allergen-specific IgE may be absent in 10-15% of patients [271, 272].

2 Summary and objectives

Neutrophils are central to inflammatory pathologies. As potent microbicidal effector cells of innate immunity, neutrophils have for a long time been viewed as well-armed and trigger-happy perpetrators of both protective and pathological inflammation. Conversely, neutrophils also have prominent roles in guiding inflammation resolution, suggesting more nuanced functions for these cells in the balance of proinflammatory and regulatory pathways to promote immunity at a systemic level. This thesis work examines the role of neutrophils in severe systemic inflammation, associated with the development of shock, in two distinct immune contexts: LPS-induced endotoxemia, and IgG-dependent anaphylaxis.

- **Chapter 3** (Paper I) AIM: examine the effect of neutropenia on systemic inflammation following endotoxin challenge using a model of inducible neutropenia.
- **Chapter 4** (Paper II) AIM: determine the contribution of neutrophils and other myeloid cells to IgG-dependent anaphylaxis using a novel mouse model of human FcγR expression.
- **Chapter 5 Discussion / Part I** evaluates and discusses the protective role of neutrophils in endotoxemia.
- **Chapter 5 Discussion / Part II** evaluates the utility of the novel mouse models presented herein to study neutrophil function; and discusses the dominant pathogenic role of neutrophils in our mouse models of IgG-dependent anaphylaxis.
- **Chapter 5 Discussion / Part III** discusses the divergent protective versus pathological roles of neutrophils in models of systemic inflammation used herein.
- **Chapter 5 Discussion / Part IV** extends to the outcomes of our **ongoing work** to address the role of human IgG antibodies, antibody receptors, and neutrophils in anaphylaxis to neuromuscular blocking agents (NMBA):
 - AIM 1: to develop and characterise a mouse model of anaphylaxis in response to the human drug allergen, NMBA Rocuronium Bromide.
 - AIM 2: to investigate evidence an IgG-dependant pathway of neutrophil activation in a multicentric prospective cohort of patients suspected of perioperative anaphylaxis to NMBA; achieved in a large collaboration with a clinical consortium.

3 A novel model of inducible neutropenia reveals a protective role for neutrophils during systemic inflammation

Neutrophils, the most abundant leukocytes in the peripheral blood, are cardinaly involved in driving the immediate innate response to pathogens. Expressing a diverse panel of immunoreceptors and pattern recognition receptors (PRRs), neutrophils can achieve efficient bacterial killing using multiple strategies, including phagocytosis, production of reactive oxygen species (ROS), release of an array of enzymes (*e.g.* myeloperoxidase [MPO], elastase, cathepsin G) and antimicrobial peptides (*e.g.* defensins), and generation of neutrophil extracellular traps (NETs) [5, 33, 45, 273]. Yet it is also well understood that host defence can come at the expense of considerable collateral damage.

Particularly in the context of excessive activation of PRRs by PAMPs, such as in systemic endotoxin exposure, products of neutrophil activation may be detrimental. NETs, which are released upon exposure to LPS [274], are thought to contribute to tissue and organ damage [45, 215, 275]. Mice deficient for neutrophil elastase and/or cathepsin G survive better than wild type mice after LPS injection [213]. Finally, MPO has been reported to contribute to both LPS-induced lung inflammation [276] and LPS-induced alterations in vasomotor function [277]. Thus it is generally considered that neutrophils exacerbate the inflammation and tissue damage associated with systemic exposure to LPS. On the other hand, systemic inflammation leads to a functionally heterogeneous neutrophil compartment [278], and moreover, low-dose LPS exposure in humans induces the appearance of a subset of neutrophils that can suppress T cell activation *ex vivo* [225], suggesting that neutrophils might possess some immunosuppressive functions in the context of endotoxemia.

Given the limitations of currently available genetic ablation or antibody-mediated depletion strategies, we developed a new approach for the specific, inducible and transient depletion of neutrophils. Mice expressing the Cre recombinase under the control of the human Mrp8 promoter, which restricts Cre activity to neutrophils (*MRP8-cre*) [279], were bred with mice carrying a loxP-flanked STOP cassette upstream of the simian diphtheria toxin receptor (DTR), inserted into the ubiquitous *ROSA26* locus (*iDTR^{fl}*) [280]. Mice are resistant to diphtheria toxin (DT), as they do not express the appropriate receptor for binding of the toxin to the cell surface. Thus, using Cre-driven expression of the simian DTR on mouse neutrophils, specific depletion of neutrophils can be achieved by systemic administration of DT. The detailed characterisation of DT-mediated neutrophil depletion in *MRP8-Cre⁺iDTR^{fl/+}* (*PMN^{DTR}*) mice is presented in Paper I. Briefly, 500ng DT administered i.p. is

sufficient to eliminate neutrophils in the blood, spleen and bone marrow 24 hours later. Though the depletion is transient, neutropenia could be maintained by daily DT exposure, even during systemic inflammation.

In Paper I we use a combination of antibody mediated depletion strategies and *MRP8-Cre⁺iDTR^{fl/+}* (*PMN^{DTR}*) mice to investigate the role of neutrophils in LPS-induced endotoxic shock, and capitalise on the crucial advantage of this new model; that neutrophil depleted *PMN^{DTR}* mice are permissive to neutrophil transfer. We found, surprisingly, that neutrophils serve to protect the host from LPS-induced lethal inflammation:

- We find that neutrophil depletion exacerbates the toxic effects and mortality associated with high-dose LPS exposure.
- We demonstrate that *Mpo^{-/-}* mice have considerably increased systemic inflammation and mortality in response to LPS challenge, and that pharmacological inhibition of MPO increases LPS-induced mortality.
- *Ex vivo* imaging indicates that neutrophils represent the major source of MPO during endotoxemia
- By adoptive transfer of MPO-sufficient or MPO-deficient neutrophils, we show that neutrophil-derived MPO mediates, at least in part, the protective functions of neutrophils during endotoxemia.

This study was completed in close collaboration with Dr L. Reber, the laboratory of Pr S. Galli at Stanford University, and Dr F. Jönsson. The manuscript in its current form (Paper I) has been submitted as a Brief Report to the *Journal of Experimental Medicine*.¹ C. Gillis 1st co-author (2nd position).

¹ *Authorship contribution of C. Gillis amounts to approximately 30% of the manuscript in its current state.*

3.1 PAPER I

Neutrophil myeloperoxidase diminishes the toxic effects and mortality induced by lipopolysaccharide

Authors

Laurent L. Reber^{1,2,3,4,*}, Caitlin M. Gillis^{3,4,*}, Philipp Starkl^{1,2,5}, Friederike Jönsson^{3,4}, Riccardo Sibilano^{1,2}, Thomas Marichal^{1,2,6}, Nicolas Gaudenzio^{1,2}, Marion Bérard⁷, Stephan Rogalla^{8,9}, Christopher H. Contag^{8,9,10}, Pierre Bruhns^{3,4,\$} and Stephen J. Galli^{1,2,10,\$}

Affiliations

¹Department of Pathology, Stanford University School of Medicine, Stanford, CA, USA. ²Sean N. Parker Center for Allergy and Asthma Research, Stanford University School of Medicine, Stanford, CA, USA. ³Department of Immunology, Unit of Antibodies in Therapy and Pathology, Institut Pasteur, Paris, France. ⁴Institut National de la Santé et de la Recherche Médicale, U1222, Paris, France. ⁵Current address: CeMM, Research Center for Molecular Medicine of the Austrian Academy of Sciences, and Department of Medicine I, Research Laboratory of Infection Biology, Medical University of Vienna, Vienna, Austria. ⁶Current address: GIGA-Research and Faculty of Veterinary Medicine, University of Liege, 4000 Liege, Belgium. ⁷Animalerie Centrale, Institut Pasteur, Paris, France. ⁸Department of Pediatrics and Neonatology, Stanford University School of Medicine, Stanford, CA, USA; ⁹Molecular Imaging Program at Stanford, Stanford, CA, USA. ¹⁰Department of Microbiology and Immunology, Stanford University School of Medicine, Stanford, CA, USA.

* and \$ These authors contributed equally to this work.

Corresponding authors

Stephen J. Galli, M.D.

Department of Pathology

Stanford University School of Medicine, L235

300 Pasteur Drive

Stanford, CA 94305-5324, USA

Phone: 650-723-7975

Fax: 650-725-6902

e-mail: sgalli@stanford.edu

Pierre Bruhns, Ph.D.

Unit of Antibodies in Therapy and Pathology

Department of Immunology

Institut Pasteur

25 rue du Docteur Roux

Paris, 75015, France

Phone: +33-1-4568-8629

Fax: +33-1-4061-3160

e-mail: bruhns@pasteur.fr

Abstract

Neutrophils have crucial antimicrobial functions, but are also thought to contribute to tissue injury upon exposure to bacterial products, such as lipopolysaccharide (LPS). To study the role of neutrophils in LPS-induced endotoxemia, we developed a new mouse model, *PMN^{DTR}* mice, in which injection of diphtheria toxin induces selective neutrophil ablation. Using this model, we found, surprisingly, that neutrophils serve to protect the host from LPS-induced lethal inflammation. This protective role was observed in conventional and germ-free animal facilities, indicating that it does not depend on a particular microbiological environment. Blockade or genetic deletion of myeloperoxidase (MPO), a key neutrophil enzyme, significantly increased mortality after LPS challenge, and adoptive transfer studies confirmed that neutrophil-derived MPO contributes importantly to protection from endotoxemia. Our findings imply that, in addition to their well-established antimicrobial properties, neutrophils can contribute to optimal host protection by limiting the extent of endotoxin-induced inflammation in an MPO-dependent manner.

Introduction

Innate immune recognition of invading pathogens by pattern-recognition receptors (PRRs) is important to initiate protective immune responses (Kawai and Akira, 2011; Medzhitov, 2007). Yet uncontrolled activation of PRRs by pathogen associated molecular patterns (PAMPs), such as lipopolysaccharide (LPS), can result in unbalanced cytokine production, and potentially fatal tissue injury. Neutrophils express multiple PRRs including the LPS receptor TLR4 (Hayashi *et al.*, 2003), and are typically the first immune cells to be recruited to sites of infection (Kolaczowska and Kubes, 2013; Mayadas *et al.*, 2014; Mocsai, 2013; Nauseef and Borregaard, 2014). Neutrophils can efficiently kill bacteria through different defense mechanisms (Borregaard, 2010; Kolaczowska and Kubes, 2013; Mayadas *et al.*, 2014; Mocsai, 2013), however some neutrophil products may be detrimental to the host, particularly in the context of excessive activation by PAMPs, such as during LPS-induced endotoxemia (Mayadas *et al.*, 2014; Mocsai, 2013; Nauseef and Borregaard, 2014). Indeed, it is generally considered that neutrophils exacerbate the inflammation and tissue damage associated with LPS exposure. Surprisingly, there is a lack of formal evidence to demonstrate this detrimental role for neutrophils. Moreover, systemic inflammation leads to a functionally heterogeneous neutrophil compartment (Pillay *et al.*, 2010) and, in humans, low-dose LPS exposure induces the appearance of a subset of CD62L^{dim}CD11b^{high} neutrophils that can suppress T cell activation *ex vivo* (Pillay *et al.*, 2012). The latter finding suggests that some neutrophils might possess immunosuppressive functions in the context of endotoxemia.

In the present study, we used mouse models to investigate further the role of neutrophils during LPS-induced endotoxemia. There is a paucity of suitable models available to study neutrophil functions *in vivo*: animals with constitutive neutropenia exhibit other immune abnormalities and are more susceptible to infections (Hock *et al.*, 2003), whereas antibodies used at high doses to deplete neutrophils have known or likely effects on other cell populations (Conlan and North, 1994; Daley *et al.*, 2008). Therefore, we have developed a new mouse model, which we call *PMN^{DTR}* mice, that allows selective and inducible ablation of neutrophils upon injection of diphtheria toxin (DT). Using this model, we discovered that, instead of exacerbating LPS-induced toxicity, neutrophils diminish the toxic effects and mortality induced by LPS in mice. We further demonstrated that this protective function is mediated by the major enzyme of neutrophils, myeloperoxidase (MPO).

Results and Discussion

Antibody-mediated neutrophil depletion increases LPS-induced mortality

To evaluate the contribution of neutrophils to LPS-induced endotoxemia in mice, we first assessed the phenotype of mouse neutrophil activation following intraperitoneal LPS administration. A marked dose-dependent decrease in expression of CD62L and increase in CD11b was observed in neutrophils from the blood (**Fig. 1, A-C**), peritoneal cavity and bone marrow (**Fig. S1, A-D**). This activated phenotype is consistent with the CD62L^{dim}CD11b^{high} subset of blood neutrophils observed after injection of low-dose LPS in humans, and which display immunosuppressive characteristics *ex vivo* (Pillay *et al.*, 2012). We then assessed the role of neutrophils in the LPS-induced endotoxemia model using neutrophil-depleting antibodies. Neutrophil depletion by treatment with anti-Gr-1 or anti-Ly6G antibodies greatly increased the hypothermia and mortality induced by LPS injection (**Fig. 1, D-G**). Despite the development of considerable neutrophilia in mice treated with isotype control antibodies, mice treated with neutrophil-depleting antibodies remained neutropenic after LPS injection (**Fig. S1, E and F**). We obtained very similar results at both Stanford University and Institut Pasteur (**Fig. 1, F-G vs. H-I**). However, WT mice maintained at Institut Pasteur were more susceptible to LPS toxicity than mice at Stanford University (data not shown). Such a difference in LPS reactivity could reflect differences in the microbiological environment. Given the known impact of commensal bacteria on neutrophil functions (Zhang *et al.*, 2015), we therefore compared responses to LPS, and the effect of neutrophil depletion, between mice housed in a conventional animal facility (specific pathogen-free, SPF) and those housed in a germ-free (GF) facility. We observed greatly reduced LPS-induced mortality in GF mice (**Fig. 1, H and I**), as described previously (Souza *et al.*, 2004). Yet depletion of neutrophils using an anti-Gr-1 antibody increased mortality in both SPF and GF mice, and responses of anti-Gr-1-treated SPF and GF mice were statistically indistinguishable (**Fig. 1, H and I**). Therefore, neutrophils appear to play a microorganism-independent role in limiting the extent of endotoxin-induced lethal shock.

A new mouse model for selective and inducible ablation of neutrophils confirms that neutrophil depletion enhances susceptibility to endotoxemia and sepsis

Since the efficiency and selectivity of neutrophil-depleting antibodies is still a matter of debate (Daley *et al.*, 2008; Nigrovic, 2013; Wang *et al.*, 2012; Yipp and Kubes, 2013), we generated a new transgenic mouse model allowing selective and inducible ablation of neutrophils. We used

MRP8-Cre mice expressing the Cre recombinase under the control of the neutrophil-associated human *MRP8* promoter, with an ires-GFP reporter (Abram *et al.*, 2013; Elliott *et al.*, 2011; Passegue *et al.*, 2004). First, we confirmed that GFP expression, as a marker of Cre activity, is restricted to neutrophils among major mature immune cell types in the blood, bone marrow, spleen and peritoneal lavage fluid (**Fig. 2 A** and **S2 A**). We then crossed these mice with *iDTR^{fl}* mice, which bear a Cre-inducible simian DT receptor (DTR) (Buch *et al.*, 2005), to generate mice with DTR expression highly restricted to neutrophils. A single injection of DT had no effect in control mice (*MRP8-Cre⁻; iDTR^{fl/+}* mice, named hereafter *PMN^{WT}* mice), but markedly reduced neutrophil numbers in the blood, spleen and bone marrow of *MRP8-Cre⁺; iDTR^{fl/+}* mice (named hereafter *PMN^{DTR}* mice) at 24 h (**Fig. 2, B-D** and **S2, B**). We found no significant effect of DT on any of the other major immune cell types we assessed, or on bone marrow granulocyte-macrophage progenitors (GMPs) (**Fig. 2, E-G** and **S2, D-G**). Consistent with a lack of effect of DT on GMPs, the neutrophil depletion in *PMN^{DTR}* mice was transient, and blood neutrophils started to reappear two days after DT injection (**Fig. S2, C**).

In accord with the results obtained with neutrophil-depleting antibodies (**Fig. 1**), we found that *PMN^{DTR}* mice were much more susceptible than *PMN^{WT}* mice to the development of hypothermia and death after LPS injection (**Fig. 2 H** and **I**). Despite considerable neutrophilia in *PMN^{WT}* mice, *PMN^{DTR}* mice remained deficient in neutrophils after LPS injection (**Fig. S3, A**). We found elevated levels of cytokines and chemokines in the blood 6 h after LPS injection in *PMN^{DTR}* mice as compared to *PMN^{WT}* mice (**Fig. S3, B-F**), supporting a protective role for neutrophils in LPS-induced endotoxemia.

To validate *PMN^{DTR}* mice as a model to study neutrophils *in vivo* in an inflammatory context, we also assessed responses in the cecal ligation and puncture (CLP) model of polymicrobial sepsis (**Fig. 2, J and K**). Although CLP induced a strong neutrophilia in *PMN^{WT}* mice, neutrophils remained barely detectable in the blood and peritoneal cavity of DT-treated *PMN^{DTR}* mice (**Fig. S3, G and H**). Confirming the critical role of neutrophils in defense against bacteria, we found that DT-treated *PMN^{DTR}* mice had diminished survival after CLP as compared to DT-treated *PMN^{WT}* mice (**Fig. 2 J**), with greater numbers of bacteria in the blood and peritoneal cavity (**Fig. 2 K** and **S3 I**), and elevated levels of cytokines and chemokines in the blood, 18 h after CLP (**Fig. S3, J-M**). Thus *PMN^{DTR}* mice represent a valuable model for studying neutrophils during *in vivo*

inflammation, and confirm a protective role for neutrophils in LPS-induced endotoxemia and CLP-mediated polymicrobial sepsis.

Myeloperoxidase (MPO) plays a beneficial role during sepsis and endotoxemia.

MPO is the major enzyme produced by neutrophils, and has an antibacterial function in sepsis (Klebanoff, 2005). A recent report indicates that diminished MPO expression might be a good predictor for identifying septic shock patients at high risk of death (Demaret *et al.*, 2015). We therefore hypothesized that, in addition to its antimicrobial properties, MPO might contribute to the beneficial function of neutrophils during LPS-induced endotoxemia. We first confirmed that MPO-deficient mice have increased mortality, elevated levels of blood cytokines and chemokines, and higher bacterial burden in the CLP model (Gaut *et al.*, 2001) (**Fig. S4**). We then assessed responses of *Mpo*^{-/-} mice in the LPS-induced endotoxemia model. Circulating neutrophils from MPO-deficient animals acquired a similar CD62L^{dim}CD11b^{high} phenotype to those of MPO-sufficient animals 6 h after injection of LPS (**Fig. 3 A and S5, A and B**). However, *Mpo*^{-/-} mice developed significantly increased hypothermia and mortality in response to LPS compared to WT mice (**Fig 3, B and C**), and elevated blood levels of cytokines and chemokines, despite similar levels of neutrophils in the blood (**Fig. S5, C-H**). Furthermore, treatment of WT mice with the MPO inhibitor 4-ABAH (4-aminobenzoic acid hydrazide (Gross *et al.*, 2009; Kettle *et al.*, 1995; Zhang *et al.*, 2013)) significantly increased mortality in response to LPS, supporting a protective role for MPO during endotoxemia (**Fig. 3 D**).

Although several myeloid cell types can produce MPO, including neutrophils, monocytes and macrophages, we found that MPO levels in the peritoneal cavity were reduced by 70% in neutrophil-depleted *PMN^{DTR}* mice compared to *PMN^{WT}* mice 6 h after LPS injection (**Fig. 3 E**). Employing *ex vivo* bioluminescent imaging of MPO activity following luminol administration (Gross *et al.*, 2009; Zhang *et al.*, 2013), we found that MPO activity was increased in the spleen and liver of both WT and *PMN^{WT}* mice after LPS, compared to PBS-treated controls (**Fig. 3, F-G and I**). The pronounced MPO activity detected in the lungs was comparable between PBS- and LPS-treated mice (**Fig. 3 H and I**). MPO activity was markedly reduced in both *Mpo*^{-/-} and *PMN^{DTR}* mice in all of the organs we examined, and statistically indistinguishable between MPO-deficient and neutrophil-deficient animals (**Fig. 3 F-I and S6**), suggesting that neutrophils are the major source of MPO after LPS injection *in vivo*.

Finally, we performed adoptive transfer experiments to assess directly the importance of neutrophil-derived MPO during LPS-endotoxemia. As a control, we first tested the efficiency of neutrophil engraftment in neutrophil-depleted PMN^{DTR} mice or PMN^{WT} controls using purified YFP⁺ neutrophils (isolated from the bone marrow of $MRP8-Cre^{+};iYFP^{fl/+}$ mice). We found significantly more circulating YFP⁺ neutrophils in the blood of PMN^{DTR} mice compared to PMN^{WT} mice 4 h after engraftment, indicating that PMN^{DTR} mice (in which endogenous neutrophils are depleted) represent an attractive model for adoptive transfer experiments (**Fig. S7**). We then engrafted PMN^{DTR} mice with neutrophils purified from either WT mice (WT PMNs \rightarrow PMN^{DTR}) or $Mpo^{-/-}$ mice ($Mpo^{-/-}$ PMNs \rightarrow PMN^{DTR}). LPS-induced hypothermia and survival in WT PMNs \rightarrow PMN^{DTR} mice were similar to those observed in neutrophil-sufficient PMN^{WT} mice (**Fig. 3, J and K**). By contrast, $Mpo^{-/-}$ PMNs \rightarrow PMN^{DTR} mice experienced significantly greater hypothermia and mortality compared to either WT PMNs \rightarrow PMN^{DTR} mice or PMN^{WT} mice, and the responses in $Mpo^{-/-}$ PMNs \rightarrow PMN^{DTR} mice were statistically indistinguishable from those of PMN^{DTR} mice not engrafted with neutrophils (**Fig. 3, J and K**). Thus, the adoptive transfer of MPO-sufficient, but not MPO-deficient neutrophils, ameliorated LPS-induced hypothermia and enhanced survival of neutrophil-depleted mice. Collectively, our data indicate that the protective function of neutrophils during endotoxemia is dependent, at least in part, on their major enzyme MPO.

Endotoxin challenge is a model of systemic inflammation relevant to our understanding of inflammatory pathways in multiple disease states: critically ill, post-trauma or septic patients are characterized by severe systemic inflammation. Moreover, immune suppression is a secondary component of these conditions, and associated with poor patient outcome (Hotchkiss *et al.*, 2013); ‘defective’ neutrophil function is observed in such settings, although the heterogeneity of neutrophil subsets is rarely addressed (Pillay *et al.*, 2010). Importantly, LPS exposure mimics the systemic immune activation that occurs during infection, yet decoupled from the presence of a pathogen. Here, we have identified an unexpected new role for neutrophils and neutrophil-derived MPO: enhancing innate host resistance to the toxic effects of LPS. Our results imply that, in addition to their direct antimicrobial functions, neutrophils and MPO can contribute to optimal host protection by modulating inflammation and limiting the toxic effects of endotoxins.

Materials and Methods

Mice. C57BL/6J specific pathogen free (SPF) (WT) mice were bred at the Stanford University Research Animal Facility or purchased from Jackson Laboratories or Charles River and used for experiments after maintaining the mice for at least one week in SPF conditions in either animal facility (Stanford or Pasteur). C57BL/6J germ-free (GF) mice were obtained from the Unit of Transgenesis, Archiving and Animal Models TAAM, UPS44, Orleans, France, or from Institut Pasteur, and were maintained in sterile isolators at Institut Pasteur. *iDTR^{fl/fl}* mice (C57BL/6-*Gt(ROSA)26Sor^{tm1(HBEGF)Awai}/J*) were purchased from Jackson Laboratories (Bar Harbor, Me). *MRP8-Cre/iresGFP* mice (B6.Cg-*Tg(S100A8-cre,-EGFP)11lw/J*) were obtained from Irving Weissman (Stanford University) and Clifford Lowell (UCSF). *MRP8-Cre/iresGFP* mice were crossed with *iDTR^{fl/fl}* mice to generate ‘*PMN^{DTR}*’ mice (*MRP8-Cre/iresGFP⁺; iDTR^{fl/+}*) and ‘*PMN^{WT}*’ littermate controls (*MRP8-Cre/iresGFP⁺; iDTR^{fl/+}*). ROSA-EYFP reporter mice (B6.129X1-*Gt(ROSA)26Sor^{tm1(EYFP)Cos}/J*) were obtained from Gerard Eberl (Institut Pasteur) and crossed with *MRP8-Cre/iresGFP* mice to generate mice with YFP-fluorescent neutrophils that were used as donors for the adoptive transfer experiments in Figure S6. *Mpo^{-/-}* mice (B6.129X1-*Mpotm1Lus/J*) were purchased from Jackson Laboratories and bred in the Institut Pasteur or Stanford University SPF Animal Facilities. We used age-and sex-matched mice for all experiments. All animal care and experimentation were conducted in compliance with the guidelines of the National Institutes of Health and with the specific approval of the Institutional Animal Care and Use Committees of Stanford University and of the Animal Ethics committee CETEA (Institut Pasteur, Paris, France) registered under #C2EA-89.

Diphtheria toxin- and antibody-mediated ablation of neutrophils. *PMN^{DTR}* mice and *PMN^{WT}* littermate control mice were injected i.p. with 500 ng diphtheria toxin (DT; Sigma). For antibody-mediated neutrophil depletion, WT mice were injected i.p. with anti-Ly6G (clone 1A8, 500 mg), anti-Gr-1 (clone RB6-8C5, 300 mg) or respective isotype control antibodies (Rat IgG2a clone 2A3 or Rat IgG2b clone LTF-2). Injections were performed in 200 μ L PBS daily commencing 1 day prior to LPS challenge. The RB6-8C5 antibodies used at the Institut Pasteur (Figure 1H-I) were produced from hybridomas kindly provided by Robert Coffman (Dynavax Technologies Corporation, Berkeley, California, USA), and purified by Protein G-affinity purification from hybridoma supernatants. All other antibodies were from BioXCell.

In vivo treatments. Mice were injected i.p. with LPS at 15 mg/kg (for the experiments performed at Institut Pasteur, **Fig. 1, H and I**) or 25 mg/kg, or at indicated doses, in 200 μ L PBS (**Fig. 1, A-C** and **S1, A-D**) (*E. coli*, serotype 055:B5, Sigma). Hypothermia was monitored and mice were observed for mortality at least twice daily. Mice that were clearly moribund were euthanized. For experiments involving germ-free mice, treatments were performed in parallel between GF and SPF facilities at Institut Pasteur, and all solutions were prepared sterile. For pharmacological inhibition of MPO activity, mice were injected i.p. with 80 mg/kg MPO inhibitor 4-Aminobenzoic hydrazide (4-ABAH; Sigma) (Zhang *et al.*, 2013) 3 h before, and 6, 24 and 36 h after challenge with LPS (Figure 4I).

Measurements of MPO and MPO activity. MPO was quantified from peritoneal lavage fluid by ELISA according to the manufacturer's instructions (R&D). Bioluminescent imaging of MPO activity was performed 6 h after LPS injection (Zhang *et al.*, 2013). Mice were anesthetized (isoflurane inhalation) and 10 min after injection of luminol-R (a mixture of luminol [Sigma; 200 mg/kg] and near-infrared quantum dots [QD800 from Life Sciences; 100 pmol]; 100 ml each i.p. + i.v.), animals were sacrificed and organs sampled for imaging (2 min; open filter). Imaging and analysis was performed using an IVIS Spectrum with LivingImage software (Xenogen Product from PerkinElmer).. We controlled for the *in vivo* distribution of luminol-R by fluorescent imaging of QD800 particles (Ex (nm) 745/ Em (nm) 800), and found no difference in fluorescence intensity between organs from LPS-treated neutrophil-sufficient and neutrophil-depleted mice or LPS-treated WT and *Mpo*^{-/-} mice (data not shown).

Adoptive transfer of neutrophils. Bone marrow neutrophils were purified from the tibia and femur by negative selection using the EasySep Mouse Neutrophil Enrichment Kit (StemCell Technologies; >90% Gr-1⁺ CD11b⁺ and Ly-6G⁺ CD11b⁺ on average). Neutrophils (10⁷ cells in **Fig. 3, J and K** and 2-10x10⁶ in **Fig. S6**) were transferred i.v. (20-30 min before LPS injection, **Fig. 3, J and K**).

Statistical analyses. Data are presented as mean \pm SEM or mean + SEM. Data were analyzed for statistical significance using a Mantel-Cox log-rank test, an unpaired Mann-Whitney *U* test or an unpaired Student *t* test, as indicated in figure legends. *P* values < 0.05 are considered statistically significant.

Further methods are detailed in Supplemental Information

Acknowledgments

We thank Irving Weissman (Stanford University) and Clifford Lowell (UCSF) for sharing *MRPP8-Cre* mice, and Gerard Eberl (Institut Pasteur) for ROSA-EYFP reporter mice. We thank members of the CGIP (Centre de Gnotobiologie de l'Institut Pasteur Murine, Institut Pasteur) for experiments with germ-free mice and animal husbandry. We also thank all members of the Galli and Bruhns laboratories for discussions and technical assistance. L.L.R. acknowledges support from National Institutes of Health grant K99AI110645, the European Commission (Marie Skłodowska-Curie Individual Fellowship H2020-MSCA-IF-2014 656086) and the Institut National de la Santé et de la Recherche Médicale (INSERM); C.M.G. was supported partly by a stipend from the Pasteur - Paris University (PPU) International PhD program and the Institut Carnot Pasteur Maladies Infectieuses, and partly by the Balsan company; P.S. was supported by a Max Kade Fellowship of the Max Kade Foundation and the Austrian Academy of Sciences and a Schroedinger Fellowship of the Austrian Science Fund (FWF): J3399-B21 and is supported by a Marie Skłodowska-Curie Individual Fellowship H2020-MSCA-IF-2014 (655153); F.J. is an employee of the Centre National de La Recherche Scientifique (CNRS); R.S. was supported by the Lucile Packard Foundation for Children's Health and the Stanford NIH/NCRR CTSA award number UL1 RR025744; T.M. was supported by Marie Curie International outgoing Fellowship for Career Development (299954), is supported by the Acteria Foundation and is a Research Associate of the F.R.S-FNRS; N.G. was the recipient of a fellowship from the French "Fondation pour la Recherche Médicale FRM"; S.R. was supported in part by the George Will Foundation; C.H.C. acknowledges support from the Child Health Research Institute at Stanford, and a generous gift from the Chambers Family Foundation for Excellence in Pediatric Research;; P.B acknowledges support from the Institut Pasteur and the Institut National de la Santé et de la Recherche Médicale (INSERM); S.J.G. acknowledges support from National Institutes of Health grants AI023990, CA072074, AI070813, AR067145, U19 AI104209, NS 080062, the Tobacco-Related Disease Research Program at University of California, and the Department of Pathology, Stanford University School of Medicine.

References

- Abram, C.L., G.L. Roberge, L.I. Pao, B.G. Neel, and C.A. Lowell. 2013. Distinct roles for neutrophils and dendritic cells in inflammation and autoimmunity in moth-eaten mice. *Immunity* 38:489-501.
- Borregaard, N. 2010. Neutrophils, from marrow to microbes. *Immunity* 33:657-670.
- Buch, T., F.L. Heppner, C. Tertilt, T.J. Heinen, M. Kremer, F.T. Wunderlich, S. Jung, and A. Waisman. 2005. A Cre-inducible diphtheria toxin receptor mediates cell lineage ablation after toxin administration. *Nature methods* 2:419-426.
- Conlan, J.W., and R.J. North. 1994. Neutrophils are essential for early anti-Listeria defense in the liver, but not in the spleen or peritoneal cavity, as revealed by a granulocyte-depleting monoclonal antibody. *The Journal of experimental medicine* 179:259-268.
- Daley, J.M., A.A. Thomay, M.D. Connolly, J.S. Reichner, and J.E. Albina. 2008. Use of Ly6G-specific monoclonal antibody to deplete neutrophils in mice. *J Leukoc Biol* 83:64-70.
- Demaret, J., F. Venet, A. Friggeri, M.A. Cazalis, J. Plassais, L. Jallades, C. Malcus, F. Poitevin-Later, J. Textoris, A. Lepape, and G. Monneret. 2015. Marked alterations of neutrophil functions during sepsis-induced immunosuppression. *J Leukoc Biol* 98:1081-1090.
- Elliott, E.R., J.A. Van Ziffle, P. Scapini, B.M. Sullivan, R.M. Locksley, and C.A. Lowell. 2011. Deletion of Syk in neutrophils prevents immune complex arthritis. *J Immunol* 187:4319-4330.
- Gaut, J.P., G.C. Yeh, H.D. Tran, J. Byun, J.P. Henderson, G.M. Richter, M.L. Brennan, A.J. Lulis, A. Belaouaj, R.S. Hotchkiss, and J.W. Heinecke. 2001. Neutrophils employ the myeloperoxidase system to generate antimicrobial brominating and chlorinating oxidants during sepsis. *Proc Natl Acad Sci U S A* 98:11961-11966.
- Gross, S., S.T. Gammon, B.L. Moss, D. Rauch, J. Harding, J.W. Heinecke, L. Ratner, and D. Piwnicka-Worms. 2009. Bioluminescence imaging of myeloperoxidase activity in vivo. *Nat Med* 15:455-461.
- Hayashi, F., T.K. Means, and A.D. Luster. 2003. Toll-like receptors stimulate human neutrophil function. *Blood* 102:2660-2669.
- Hock, H., M.J. Hamblen, H.M. Rooke, D. Traver, R.T. Bronson, S. Cameron, and S.H. Orkin. 2003. Intrinsic requirement for zinc finger transcription factor Gfi-1 in neutrophil differentiation. *Immunity* 18:109-120.
- Hotchkiss, R.S., G. Monneret, and D. Payen. 2013. Sepsis-induced immunosuppression: from cellular dysfunctions to immunotherapy. *Nat Rev Immunol* 13:862-874.

- Kawai, T., and S. Akira. 2011. Toll-like receptors and their crosstalk with other innate receptors in infection and immunity. *Immunity* 34:637-650.
- Kettle, A.J., C.A. Gedye, M.B. Hampton, and C.C. Winterbourn. 1995. Inhibition of myeloperoxidase by benzoic acid hydrazides. *Biochem J* 308 (Pt 2):559-563.
- Klebanoff, S.J. 2005. Myeloperoxidase: friend and foe. *J Leukoc Biol* 77:598-625.
- Kolaczowska, E., and P. Kubes. 2013. Neutrophil recruitment and function in health and inflammation. *Nat Rev Immunol* 13:159-175.
- Mayadas, T.N., X. Cullere, and C.A. Lowell. 2014. The multifaceted functions of neutrophils. *Annual review of pathology* 9:181-218.
- Medzhitov, R. 2007. Recognition of microorganisms and activation of the immune response. *Nature* 449:819-826.
- Mocsai, A. 2013. Diverse novel functions of neutrophils in immunity, inflammation, and beyond. *The Journal of experimental medicine* 210:1283-1299.
- Nauseef, W.M., and N. Borregaard. 2014. Neutrophils at work. *Nat Immunol* 15:602-611.
- Nigrovic, P.A. 2013. Ly6G: a work in progress--author's reply to Yipp. *Blood* 121:242-243.
- Passegue, E., E.F. Wagner, and I.L. Weissman. 2004. JunB deficiency leads to a myeloproliferative disorder arising from hematopoietic stem cells. *Cell* 119:431-443.
- Pillay, J., V.M. Kamp, E. van Hoffen, T. Visser, T. Tak, J.W. Lammers, L.H. Ulfman, L.P. Leenen, P. Pickkers, and L. Koenderman. 2012. A subset of neutrophils in human systemic inflammation inhibits T cell responses through Mac-1. *J Clin Invest* 122:327-336.
- Pillay, J., B.P. Ramakers, V.M. Kamp, A.L. Loi, S.W. Lam, F. Hietbrink, L.P. Leenen, A.T. Tool, P. Pickkers, and L. Koenderman. 2010. Functional heterogeneity and differential priming of circulating neutrophils in human experimental endotoxemia. *J Leukoc Biol* 88:211-220.
- Souza, D.G., A.T. Vieira, A.C. Soares, V. Pinho, J.R. Nicoli, L.Q. Vieira, and M.M. Teixeira. 2004. The essential role of the intestinal microbiota in facilitating acute inflammatory responses. *J Immunol* 173:4137-4146.
- Wang, J.X., A.M. Bair, S.L. King, R. Shnayder, Y.F. Huang, C.C. Shieh, R.J. Soberman, R.C. Fuhlbrigge, and P.A. Nigrovic. 2012. Ly6G ligation blocks recruitment of neutrophils via a beta2-integrin-dependent mechanism. *Blood* 120:1489-1498.
- Yipp, B.G., and P. Kubes. 2013. Antibodies against neutrophil LY6G do not inhibit leukocyte recruitment in mice in vivo. *Blood* 121:241-242.

Zhang, D., G. Chen, D. Manwani, A. Mortha, C. Xu, J.J. Faith, R.D. Burk, Y. Kunisaki, J.E. Jang, C. Scheiermann, M. Merad, and P.S. Frenette. 2015. Neutrophil ageing is regulated by the microbiome. *Nature* 525:528-532.

Zhang, N., K.P. Francis, A. Prakash, and D. Ansaldi. 2013. Enhanced detection of myeloperoxidase activity in deep tissues through luminescent excitation of near-infrared nanoparticles. *Nat Med* 19:500-505.

Figures

Figure 1. Antibody-mediated neutrophil depletion results in increased mortality after LPS injection. (A-C) Representative flow cytometry profile (A) and quantification of CD62L (B) and CD11b (C) (by geometric mean fluorescence intensity) on Ly6G⁺ CD11b⁺ blood neutrophils 6 h after LPS injection at indicated concentrations. Red areas outlined in A provide a visual indication of CD62L and CD11b on the neutrophil population from the control '0' group. B & C show values from individual mice, bars indicate means \pm SEM pooled from 2 independent experiments. ** or *** = $P < 0.01$ or 0.001 vs. control '0' group by two-tailed Mann-Whitney U test. (D-I) Changes in body temperature ($\Delta^{\circ}\text{C}$ [mean \pm SEM]) and survival (percentage of live animals) after LPS injection in C57BL/6J mice treated i.p. with anti-Ly6G (D & E) or anti-Gr-1 (F-I) neutrophil-depleting antibodies, or respective isotype control antibodies. Data in D-G are pooled from 3 independent experiments performed at Stanford University (total $n=10-12/\text{group}$). Data in H are pooled from 3 independent experiments performed in the Institut Pasteur conventional SPF animal facility (total $n=21-26/\text{group}$). Data in I are pooled from 2 independent experiments performed in the Institut Pasteur germ-free animal facility (total $n=18/\text{group}$). ** or *** = $P < 0.01$ or 0.001 vs. the corresponding isotype control group by Mantel-Cox log-rank test.

Figure 1

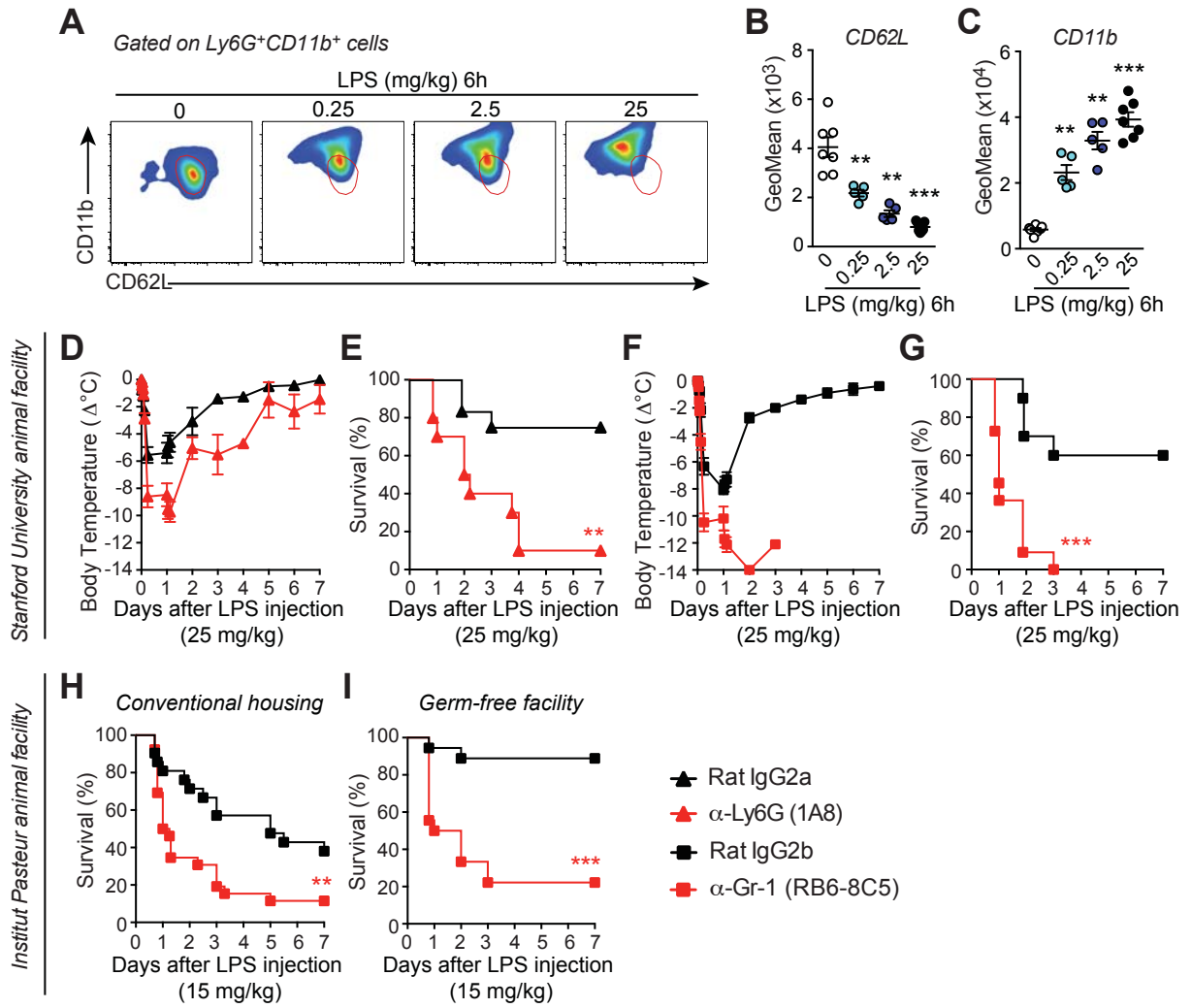


Figure 2. Injection of diphtheria toxin (DT) in PMN^{DTR} mice induces selective ablation of neutrophils and enhances susceptibility to LPS-induced endotoxemia and polymicrobial sepsis. (A) GFP expression (MFI) among leukocytes in the blood, bone marrow, spleen and peritoneal lavage fluid of $MRP8-Cre/iresGFP^+$ mice and $MRP8-Cre/iresGFP^-$ littermate controls. Results in A are pooled from 3 independent experiments, each column representing data from one mouse. Numbers of blood (B), spleen (C) and bone marrow (D) neutrophils, or blood monocytes (E), blood eosinophils (F) and blood basophils (G), 24 h after i.p. injection of 500 ng of DT into PMN^{DTR} mice and PMN^{WT} littermate control mice. Results in B-G show values from individual mice, bars indicate means \pm SEM pooled from 3 (C, D, E & G; total $n=7-8$ /group) or 4 (B & F; total $n=15-16$ /group) independent experiments. (H & I) Changes in body temperature ($\Delta^\circ\text{C}$ [mean \pm SEM]) (H) and survival (percentage of live animals) (I) after LPS injection in DT-treated PMN^{DTR} and PMN^{WT} mice. Data are pooled from 3 independent experiments (total $n=11$ /group). (J) Survival during the CLP model of sepsis in DT-treated PMN^{DTR} ($n=16$) and PMN^{WT} littermate control ($n=12$) mice. (K) Numbers of bacterial CFUs in the blood 18 h after CLP. Results in K show values from individual mice, with bars indicating means \pm SEM pooled from 3 independent experiments ($n=8-13$ /group). *, ** or *** = $P < 0.05$, 0.01 or 0.001 vs. PMN^{WT} littermate control mice by two-tailed Mann-Whitney U test (K) or Mantel-Cox log-rank test (I & J).

Figure 2

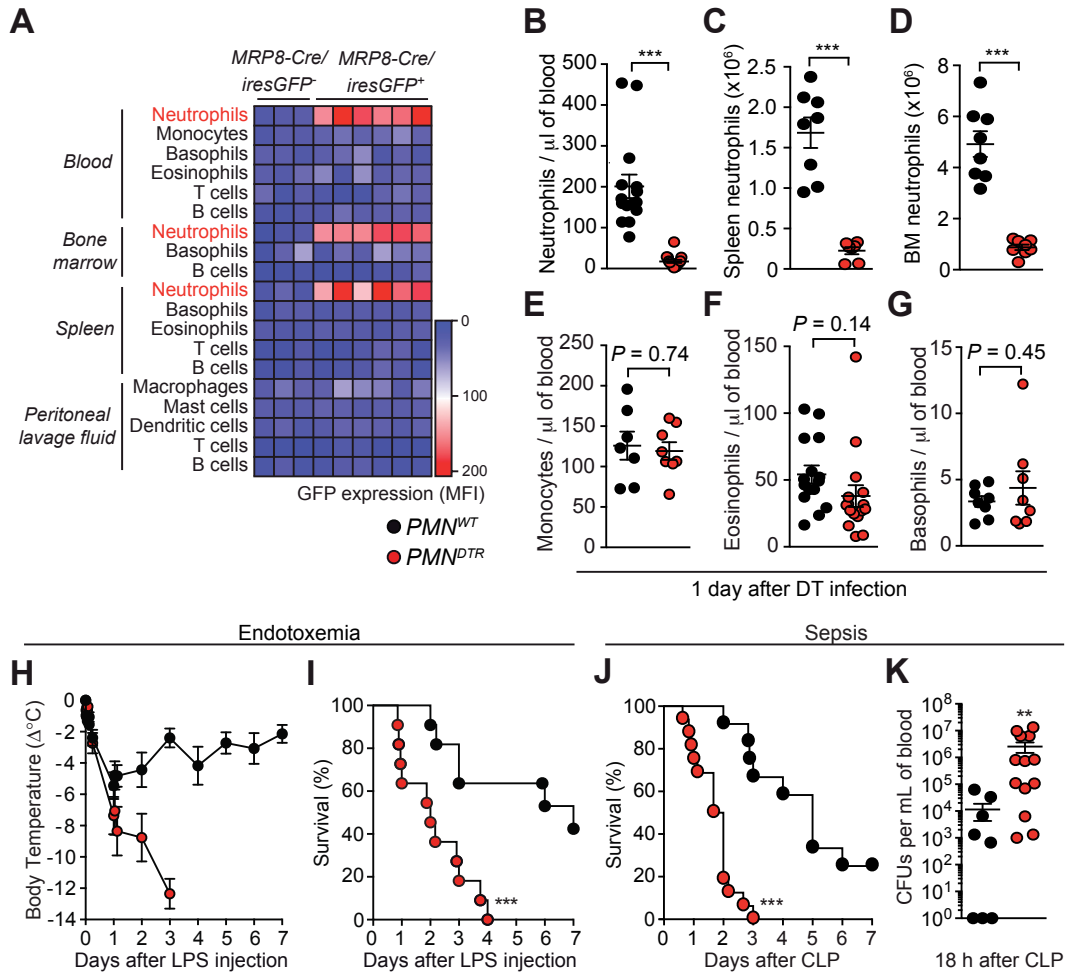
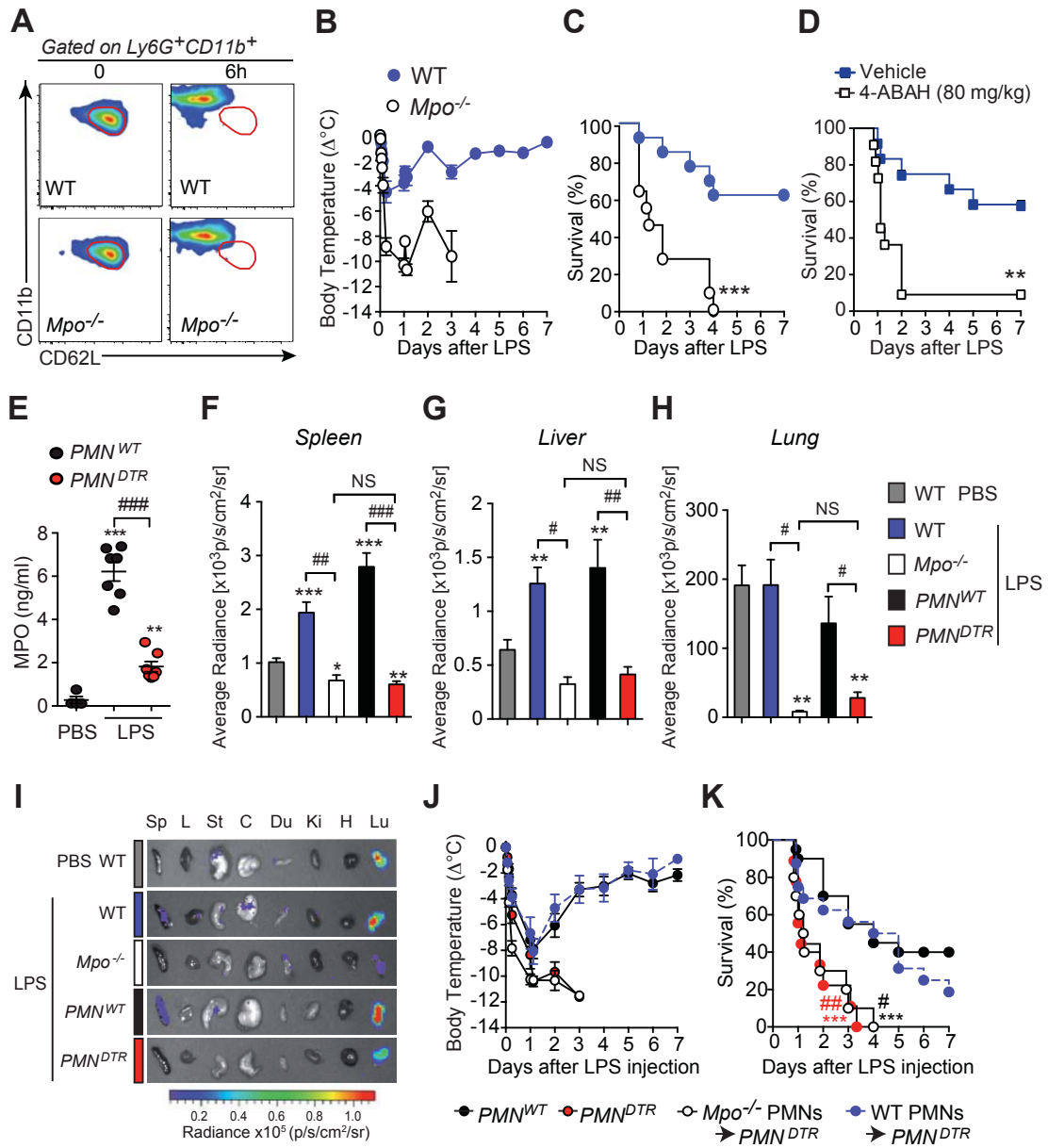


Figure 3. Neutrophil-derived MPO diminishes LPS-induced hypothermia and mortality. (A) Representative flow cytometry profile of Ly6G⁺ CD11b⁺ blood neutrophils 0 or 6 h after LPS injection in WT or *Mpo*^{-/-} mice. Areas outlined in red indicate values for neutrophils from the control (time 0) group; data are representative of results obtained in 2 independent experiments. (B & C) Changes in body temperature ($\Delta^{\circ}\text{C}$ [mean \pm SEM]) (B) and survival (percentage of live animals) (C) after LPS injection in WT and *Mpo*^{-/-} mice. (D) Survival after LPS injection in WT mice treated with the MPO inhibitor 4-ABAH or vehicle. Data in B-D are pooled from 3 independent experiments (total $n=11-13$ /group). ** or *** = $P < 0.01$ or 0.001 vs. respective WT group (C) or vehicle-treated group (D) by Mantel-Cox log-rank test. (E) MPO in the peritoneal lavage fluid 6 h after injection with PBS ($n=4$) or LPS ($n=7$ /group). Values from individual mice are shown, and bars indicate means \pm SEM pooled from 2 independent experiments. ** or *** = $P < 0.01$ or 0.001 vs. PBS group, and ### = $P < 0.001$ vs. LPS-treated control group by unpaired Student *t* test. (F-I) Bioluminescent visualization of MPO activity in various organs 6 h after injection of PBS or LPS in the indicated group. (F-H) Quantification of bioluminescence in spleen (F), liver (G) and lung (H). Data in F-H are means + SEM from three independent experiments (total $n=6-14$ /group) except for *Mpo*^{-/-} mice (2 independent experiments with a total of 3-4 mice). *, ** or *** = $P < 0.05$, 0.01 or 0.001 vs. PBS-treated WT group, and #, ## or ### = $P < 0.05$, 0.01 or 0.001 vs. corresponding LPS-treated control group by unpaired Student *t* test. NS: not significant ($P > 0.05$). (I) Representative images of different organs (Sp: spleen; L: liver; St: stomach; C: cecum; Du: duodenum; Ki: kidney; H: heart; L: lung). (J-K) Changes in body temperature (J) and survival (K) after LPS injection in DT-treated *PMN*^{DTR} mice ($n=9$), *PMN*^{WT} littermate controls ($n=24$), and *PMN*^{DTR} mice engrafted i.v. with 10^7 purified bone marrow neutrophils from WT mice (WT PMNs \rightarrow *PMN*^{DTR}; $n=16$) or from *Mpo*^{-/-} mice (*Mpo*^{-/-} PMNs \rightarrow *PMN*^{DTR}; $n=10$). Data are pooled from 2 (*Mpo*^{-/-} PMNs \rightarrow *PMN*^{DTR} group), 3 (*PMN*^{DTR} group) or 5 (*PMN*^{WT} and WT PMNs \rightarrow *PMN*^{DTR} groups) independent experiments. *** = $P < 0.001$ vs. *PMN*^{WT} group and # or ## = $P < 0.05$ or 0.01 vs. WT PMNs \rightarrow *PMN*^{DTR} group by Mantel-Cox log-rank test.

Figure 3



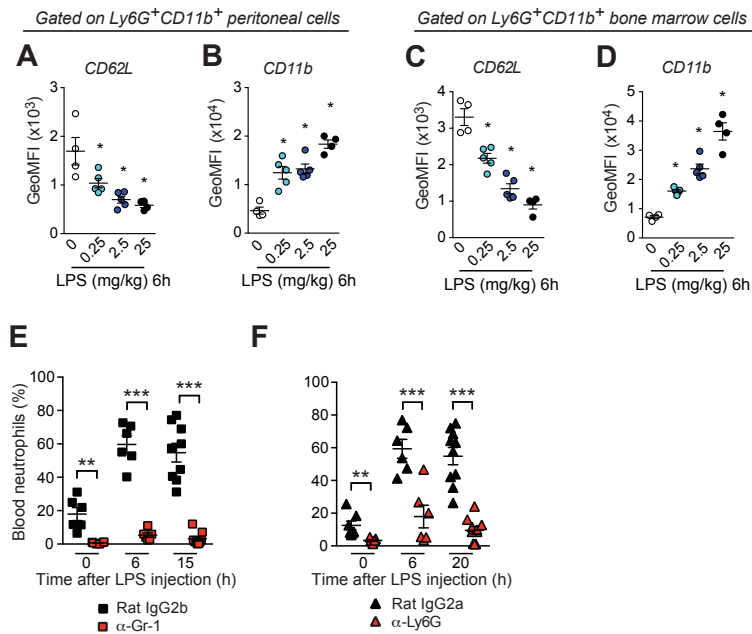
Supplementary Figures**Figure S1**

Figure S1. Phenotype of neutrophils in the peritoneum and bone marrow after LPS injection, and neutrophils in the blood of mice treated with neutrophil-depleting antibodies. (A-D) Levels of CD62L (A & C) and CD11b (B & D) (depicted as geometric mean fluorescence intensity) on Ly6G⁺ CD11b⁺ peritoneal (A & B) or bone marrow (C & D) neutrophils 6 h after injection of various concentrations of LPS (as indicated). Results in A-D show values from individual mice, with bars indicating means \pm SEM pooled from 2 independent experiments (total $n=4-5$ /group). * = $P < 0.05$ vs. control '0' group by two-tailed Mann-Whitney U test. (E & F) Percentage of Gr-1^{high} CD11b⁺ blood neutrophils at the indicated time point after injection of 25 mg/kg LPS (E) in C57BL/6J mice treated i.p. with an anti-Ly6G neutrophil-depleting antibody (clone 1A8; 500 μ g/injection) or an isotype control antibody (Rat IgG2a), and (F) in C57BL/6J mice treated i.p. with an anti-Gr-1 neutrophil-depleting antibody (clone RB6-8C5; 300 μ g/injection) or an isotype control antibody (Rat IgG2b). Data in E & F are pooled from 3 independent experiments (total $n=10-12$ /group). ** or *** = $P < 0.01$ or 0.001 vs. the corresponding isotype control group by two-tailed Mann-Whitney U test.

Figure S2

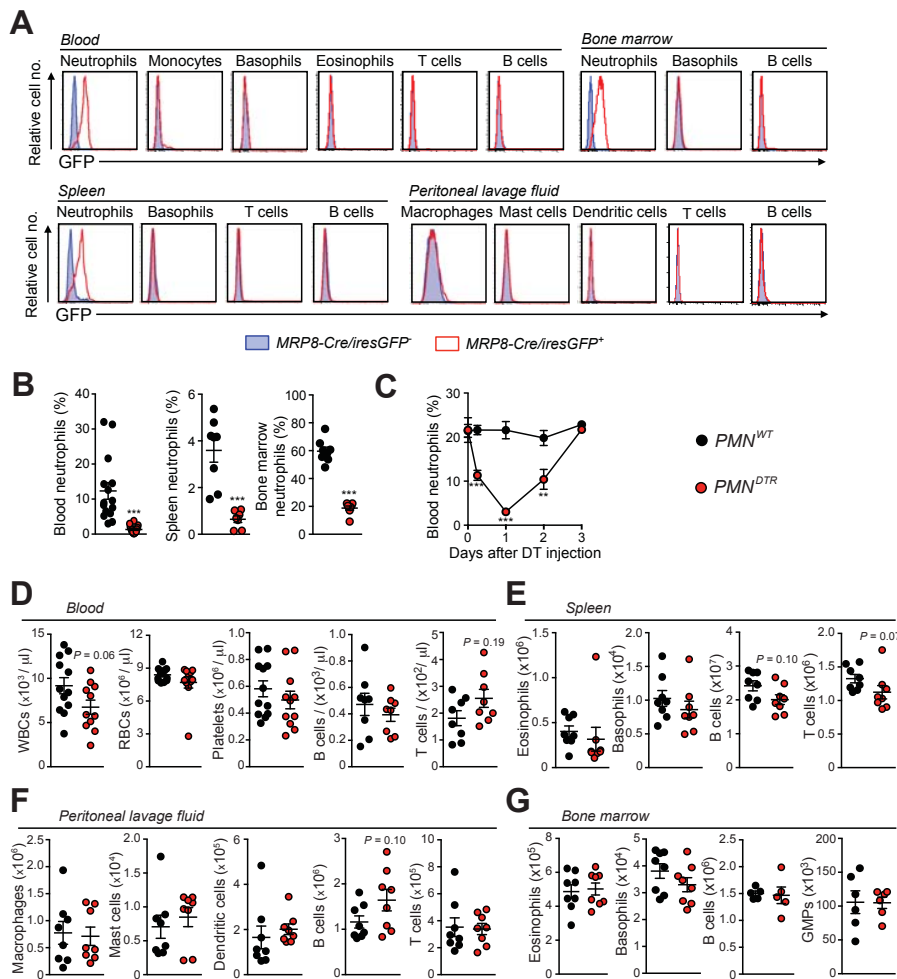


Figure S2. Analysis of GFP expression in various immune cell types from *MRP8-Cre/iresGFP* mice, and levels of various cell populations 24 h after DT injection into *PMN*^{DTR} mice. (A) Analysis of GFP expression (mean fluorescence intensity MFI) in the indicated cell populations in *MRP8-Cre/iresGFP* and *MRP8-Cre/iresGFP*⁺ mice. Results are representative of 3 independent experiments. (C) Percentage of blood, spleen and bone marrow neutrophils 24 h after i.p. injection of 500 ng of DT into *PMN*^{DTR} mice and *PMN*^{WT} littermate control mice. (D) Percentage of blood neutrophils at the indicated time points after i.p. injection of DT on day 0. Results in D are the means \pm SEM from $n=3-8$ mice per group pooled from 2 or 3 independent experiments. (E-H) Numbers of various cell populations in blood (E), spleen (F), peritoneal lavage fluid (G), and bone marrow (H) from *PMN*^{DTR} mice and *PMN*^{WT} littermate control mice 24 h after i.p. injection of 500 ng of DT. Results in C & E-H show values from individual mice, with bars indicating means \pm SEM pooled from 2 independent experiments for bone marrow B cells (total $n=5$ /group), 4 experiments for blood neutrophils (C; total $n=15-16$ /group) or 3 independent experiments for all other cell populations (total $n=7-12$ /group). P values < 0.3 are indicated (two-tailed Mann-Whitney U test). WBCs: white blood cells; RBCs: red blood cells.

Figure S3

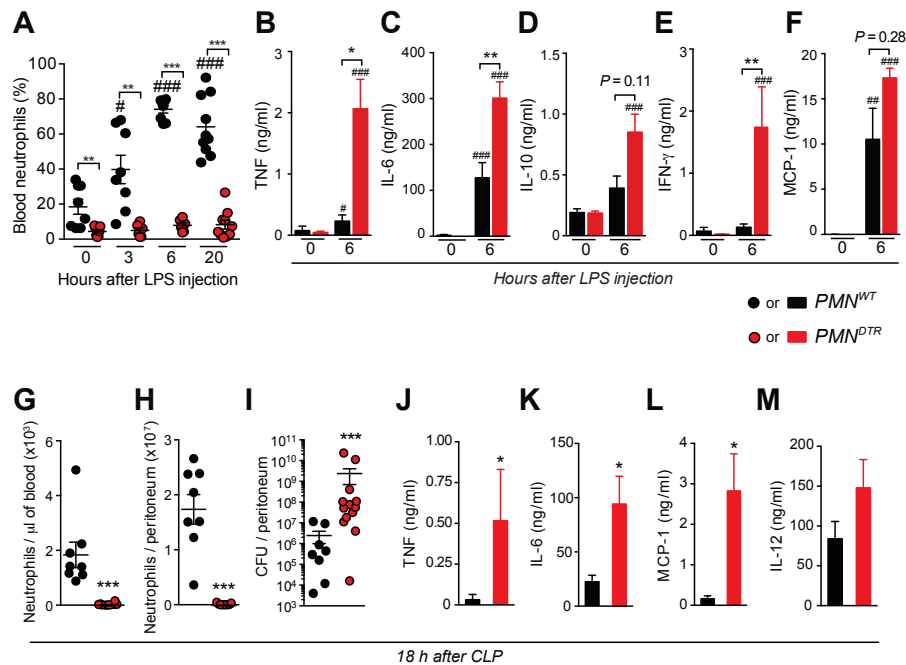


Figure S3. DT-mediated neutrophil depletion in PMN^{DTR} mice enhances susceptibility to polymicrobial sepsis and LPS-induced endotoxemia. (A-F) Responses of DT-treated PMN^{DTR} mice and PMN^{WT} littermate controls during LPS-induced endotoxemia. (A) Percentage of blood neutrophils before (time 0), 3, 6 and 20 h after LPS injection in DT-treated PMN^{DTR} mice and PMN^{WT} controls. Data show values from individual mice, with bars indicating means \pm SEM pooled from 3 independent experiments ($n=6-10$ /group). (B-F) Levels of TNF (B), IL-6 (C), IL-10 (D), IFN- γ (E) and MCP-1 (F) in the plasma of DT-treated PMN^{DTR} mice and PMN^{WT} littermate controls before (time 0) and 6 h after LPS injection ($n=6-16$ /group). Results in B-F are means + SEM pooled from 3 independent experiments. (G-M) Responses of DT-treated PMN^{DTR} mice and PMN^{WT} littermate controls in the cecal ligation and puncture (CLP) model of polymicrobial sepsis. Numbers of blood (G) and peritoneal (H) neutrophils, and numbers of bacterial CFUs recovered from the total peritoneal lavage fluid (I), 18 h after CLP ($n=8-13$ /group). Levels of TNF (J), IL-6 (K), MCP-1 (L) and IL-12 (M) in the plasma 18 h after CLP ($n=7-8$ /group). Results in G-I show values from individual mice, bars indicate means \pm SEM; results in J-M are means + SEM. *, ** or *** = $P < 0.05$, 0.01 or 0.001 vs. PMN^{WT} group, and #, ## or ### = $P < 0.05$, 0.01 or 0.001 vs. same group at time 0 by Mann-Whitney U test.

Figure S4

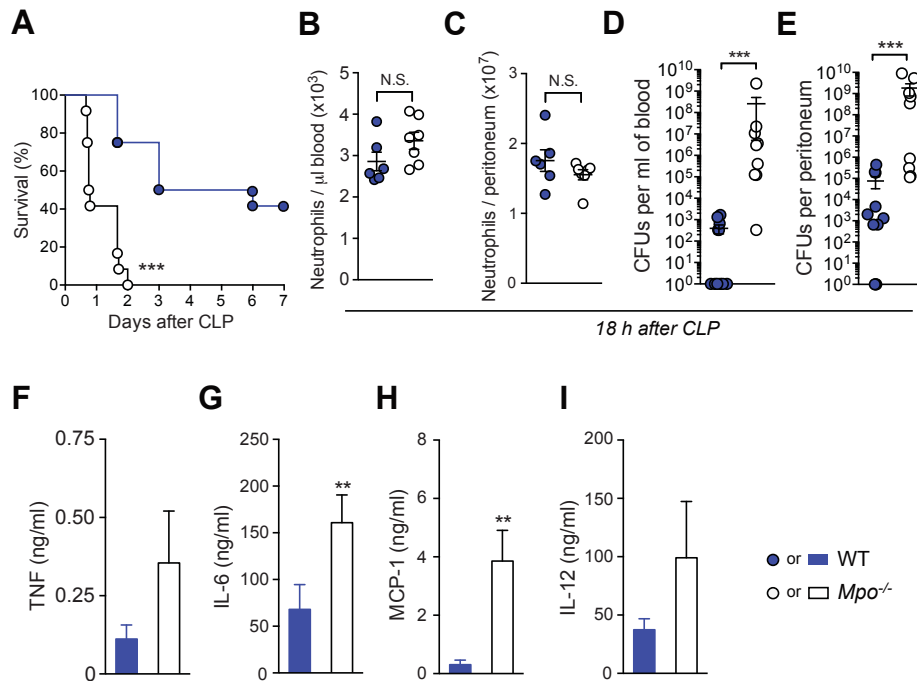


Figure S4. MPO deficiency enhances susceptibility to polymicrobial sepsis. (A-I) Responses of WT and *Mpo*^{-/-} mice in the cecal ligation and puncture (CLP) model of polymicrobial sepsis. (A) Survival (percentage of live animals) after CLP ($n=12/\text{group}$ pooled from 3 independent experiments). Numbers of blood (B) and peritoneal lavage fluid (C) neutrophils, and numbers of blood (D) and peritoneal lavage fluid (E) bacterial CFUs, 18 h after CLP. Results in B-D show values from individual mice, with bars indicating means \pm SEM pooled from 2 independent experiments (B & C, total $n=7-8/\text{group}$) or 3 independent experiments (D & E, total $n=9-11/\text{group}$). Levels of TNF (F), IL-6 (G), MCP-1 (H) and IL-12 (I) in the plasma of WT and *Mpo*^{-/-} mice 18 h after CLP. Data in F-I are means \pm SEM from three independent experiments (total $n=9-11/\text{group}$). ** or *** = $P < 0.01$ or 0.001 vs. WT group by Mantel-Cox log-rank test (A) or Mann-Whitney U test (B-I).

Figure S5

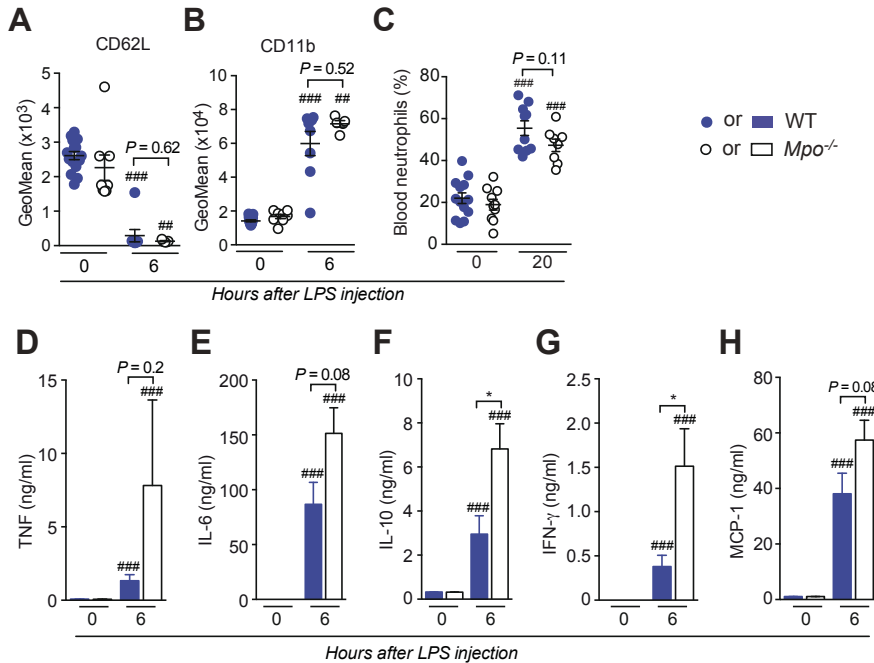


Figure S5. MPO deficiency enhances susceptibility to LPS-induced endotoxemia.

Quantification of CD62L (A) and CD11b (B) levels (geometric mean fluorescence intensity) on Ly6G⁺ CD11b⁺ blood neutrophils before (time 0) or 6 h after injection of LPS in WT (C57BL/6J) or *Mpo*^{-/-} mice. (C) Percentage of blood neutrophils before (time 0) and 20 h after LPS injection in WT and *Mpo*^{-/-} mice. A-C show values from individual mice; bars indicate means \pm SEM pooled from 2 (A-B) or 3 (C) independent experiments (total $n=5-15$ /group). Levels of TNF (D), IL-6 (E), IL-10 (F), IFN- γ (G) and MCP-1 (H) in the plasma of WT and *Mpo*^{-/-} mice before (time 0) and 6 h after LPS injection. Data in D-H are means + SEM from three independent experiments (total $n=8-12$ /group). * $P < 0.05$ vs. WT group by Mann-Whitney *U* test. #, ## or ### = $P < 0.05$, 0.01 or 0.001 vs. same group at time 0 by unpaired Student *t* test (C) or Mann-Whitney *U* test (A-B, D-H).

Figure S6

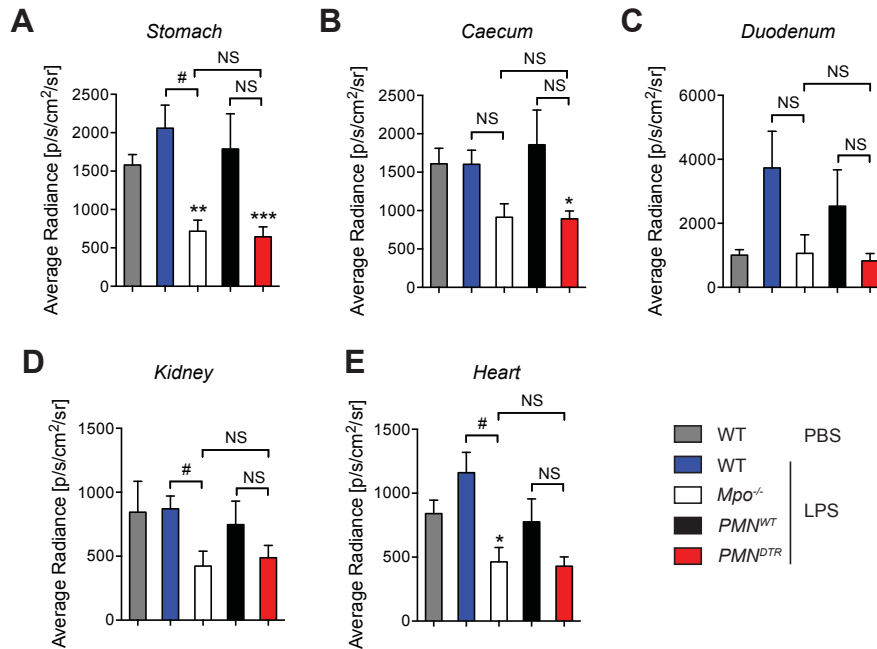


Figure S6. Neutrophils are the major source of MPO after LPS injection. Quantification of myeloperoxidase (MPO)-induced bioluminescence in the stomach (A), caecum (B), duodenum (C), kidney (D) and heart (E) 6 h after i.p. injection of PBS (in WT C57BL6/J mice) or LPS in WT (C57BL6/J), *Mpo*^{-/-} mice, DT-treated *PMN*^{DTR} mice and DT-treated *PMN*^{WT} littermate controls, and 5 min after luminol injection. Data are means + SEM from three independent experiments (total $n=6-14$ /group) except for *Mpo*^{-/-} mice (2 independent experiments with a total of 3-4 mice). *, ** or *** = $P < 0.05$, 0.01 or 0.001 vs. PBS-treated WT group, and # = $P < 0.05$ vs. corresponding LPS-treated control group by unpaired Student *t* test. NS: not significant ($P > 0.05$).

Figure S7

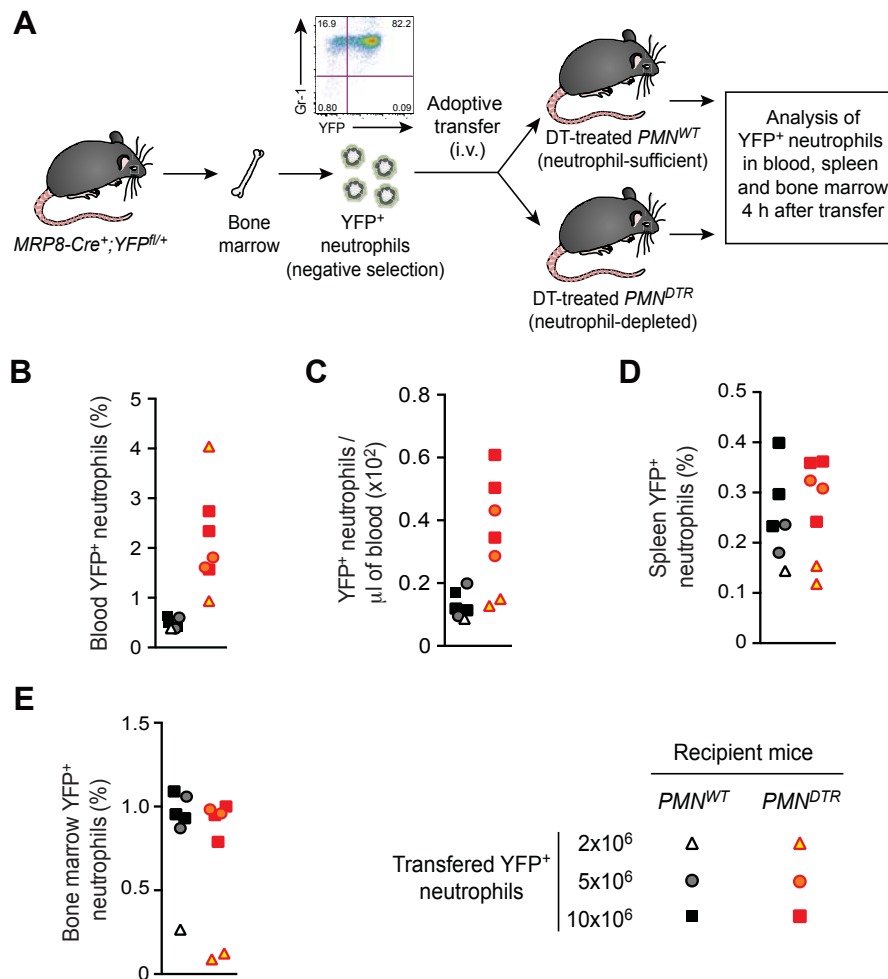


Figure S7. Neutrophils 4 h after adoptive transfer into DT-treated PMN^{DTR} or PMN^{WT} mice.

(A) Experimental outline. We purified bone marrow neutrophils by negative selection using a commercially-available kit. Purified cells were $>95\%$ Gr-1⁺ CD11b⁺ (as shown in A) and $>90\%$ Ly6G⁺ CD11b⁺ (not shown) on average for all adoptive transfer experiments (Figures 3 & S7). Cells were $>80\%$ YFP⁺ on average for all adoptive transfer experiments (Figure S7). Various numbers of purified neutrophils were transferred intravenously (i.v.) into DT-treated PMN^{DTR} mice (in which endogenous YFP⁻ neutrophils were depleted) or DT-treated PMN^{WT} mice (which contained endogenous YFP⁻ neutrophils). Four h after adoptive transfer, levels of YFP⁺ neutrophils (Ly6G⁺ CD11b⁺) were analyzed by flow cytometry in the blood (B & C), spleen (C) and bone marrow (D).

Supplementary Methods

Flow cytometry and blood cell analyses. We used flow cytometry to identify and enumerate immune cells in bone marrow, peripheral blood, peritoneal lavage fluid and spleen. Briefly, red blood cells were lysed by treatment with pH 7.3 ACK lysis buffer (0.15 M NH₄Cl, 1 mM KHCO₃, and 0.1 mM EDTA, pH 8.0) or RBC lysis buffer (BD Biosciences). Peritoneal lavages were performed with 2 ml of ice-cold PBS, and cells were washed and counted using a hemocytometer chamber. Cells were blocked with unconjugated anti-FcγRII/III (CD16/CD32) antibodies (BioXcell) on ice for 5 min and then stained with a combination of antibodies on ice for 30 min. Immune cell populations were identified as follows: neutrophils (CD11b⁺; Gr-1^{high} or CD11b⁺; Ly6G⁺ or CD45⁺; CD11b⁺; Ly6G⁺), monocytes (CD11b⁺; Gr-1^{low} or CD11b⁺; Ly6G⁻), macrophages in peritoneal lavage fluid (CD11b⁺; F4/80⁺), basophils (CD49b⁺; FcεRIa⁺), mast cells (c-KIT⁺; FcεRIa⁺), eosinophils (Siglec-F⁺; SSC^{high}), dendritic cells (CD11c⁺), T cells (CD3e⁺; B220⁻) and B cells (CD3e⁻; B220⁺). For analysis of bone marrow progenitor cells (Figure S1), bone marrow cells were stained with lineage markers (Gr-1, Ter119, CD4, CD8, CD3, B220, CD19), Sca-1, c-KIT, CD34, and FcγRII/III (CD16/32). Bone marrow progenitor cell populations were identified as follows (see Figure S1 for an example of the gating strategy): granulocyte-macrophage progenitors (GMPs) (Lineage⁻; c-KIT⁺; Sca-1⁻; CD34⁺, and FcγRII/III^{high}), common myeloid progenitors (CMPs) (Lineage⁻; c-KIT⁺; Sca-1⁻; CD34⁺, and FcγRII/III^{int}), megakaryocyte-erythrocyte progenitors (MEPs) (Lineage⁻; c-KIT⁺; Sca-1⁻; CD34⁻, and FcγRII/III⁻). Antibodies used were: Gr-1 (clone RB6-8C5), Ly6C (AL21), Ly6G (1A8), CD11b (M1/70), F4/80 (BM8), FcεRIa (MAR-1), c-KIT (2B8), CD49b (DX5), Siglec-F (E50-2440), CD11c (N418), CD3e (145-2C11), CD4 (RM4-5), CD8 (53-6.7), CD19 (6D5), CD34 (RAM34), CD45 (30F11), Sca-1 (D7), B220 (RA3-6B2) or CD62L (MEL-14). All antibodies were purchased from eBioscience, BD Pharmingen, Miltenyi or Biolegend. Data were acquired using FACSCalibur, LSRII, Accuri C6 (all from BD Biosciences) or MACSQuant (Miltenyi) flow cytometers. FITC channel was used for analysis of GFP or YFP expression (Figures 1, S1 and S6). Data were analyzed with FlowJo software (TreeStar). Dead cells (identified by staining with propidium iodide, or LIVE/DEAD Fixable Dead Cell Stains; Invitrogen) were not included in the analysis. For complete blood analysis (Supplementary Figure 3) total red blood cells (RBCs), white blood cells (WBCs), and platelets were counted using the Abbott Cell-Dyn 3500 automated hematology analyzer.

Cecal Ligation and Puncture. CLP was performed as described previously (Piliponsky et al., 2012). Briefly, mice were deeply anesthetized by an intramuscular injection of 100 mg/kg ketamine and 20 mg/kg xylazine, and the cecum was exposed by a 1- to 2-cm midline incision on the anterior abdomen and subjected to ligation of the distal half of the cecum and single puncture (with a 22-gauge needle) of the ligated segment. The cecum was then replaced into the abdomen, 1 ml of sterile saline (pyrogen-free 0.9% NaCl) was administered into the peritoneal cavity, and the incision was closed using 9-mm steel wound clips. Mice were observed for mortality at least four times daily. Mice that were clearly moribund were euthanized by CO₂ inhalation.

Quantification of Bacterial CFUs. Dilutions of peritoneal lavage fluids or blood were performed and samples were plated on LB agar for peritoneal fluids or tryptose blood agar (BD Biosciences), respectively. Colonies were counted after overnight incubation at 37°C.

Quantification of cytokines and chemokines in plasma. Levels of selected cytokines and chemokines in mouse plasma were analyzed by Cytometric Bead Array (mouse inflammation CBA kit, BD Bioscience) and quantified using an Accuri C6 flow cytometer (BD Biosciences).

Supplementary Reference

Piliponsky, A.M., C.C. Chen, E.J. Rios, P.M. Treuting, A. Lahiri, M. Abrink, G. Pejler, M. Tsai, and S.J. Galli. 2012. The chymase mouse mast cell protease 4 degrades TNF, limits inflammation, and promotes survival in a model of sepsis. *Am J Pathol* 181:875-886.

4 Neutrophils contribute to IgG-dependent anaphylaxis in FcγR-humanised mice

Systemic shock is also the most severe manifestation of an allergic hypersensitivity reaction, otherwise known as anaphylaxis. Although anaphylaxis is classically attributed to an IgE-mediated mast cell-dependent paradigm of allergic reactivity, mouse models have provided ample evidence of alternative pathways of anaphylaxis, dependant on IgG antibodies, FcγR, and other myeloid cells. IgG-dependent anaphylaxis in the mouse can proceed via the engagement of either mFcγRIII or mFcγRIV, with a dominant role for the former, resulting in the activation of one or more of several different myeloid cell populations. Neutrophils, monocytes, basophils, and mast cells all express activating FcγR, can release anaphylactogenic mediators such as histamine and PAF, and have demonstrable roles in anaphylaxis induction; however the relative contribution of each of these populations to IgG-dependent anaphylaxis depends on the model used [249-251, 281]. Indeed, we demonstrated that the different subclasses of IgG used in PSA models engage different pathways of anaphylaxis induction ([247]; paper accepted in JACI 2016, and included in this thesis as **Annex 7.1**; C. Gillis 2nd author).

Human IgG receptors (hFcγR) are highly distinct from mouse IgG receptors in structure, function and expression on immune cells (Figure 1.2). Human hFcγRs comprise hFcγRI (CD64), hFcγRIIA (CD32A), hFcγRIIB (CD32B), hFcγRIIC (CD32C), hFcγRIIIA (CD16A) and hFcγRIIIB (CD16B). All these receptors trigger cell activation and phagocytosis, except hFcγRIIB that inhibits cell activation and phagocytosis. Prior studies have demonstrated that hFcγRI and hFcγRIIA expressed in transgenic mice were each individually sufficient to mediate PSA, the symptoms of which were alleviated by pre-treatment with blocking antibodies [142, 161]. PSA mediated by hFcγRIIA was independent of mast cells and basophils, but rather dependent on neutrophils and monocytes/macrophages [161]. Furthermore, hFcγRI and hFcγRIIA were each individually sufficient to mediate ASA in transgenic mice, resulting in both hypothermia and death [142, 161]. hFcγRI-dependent ASA required neutrophils and the release of PAF [142]. These data demonstrate that hFcγR expressed on neutrophils and monocytes can mediate fatal anaphylactic reactions *in vivo*. On the other hand, these results were obtained in mice expressing only one human FcR as a transgene, in the absence of inhibitory hFcγRIIB, and in the absence of other hFcγRs that may regulate or contribute to anaphylaxis. A mouse model expressing the range of five common hFcγR as transgenes has been generated: that is, hFcγRI^{tg}IIA^{tg}IIB^{tg}IIIA^{tg}IIIB^{tg} mice, on an mFcγR^{null} background. In these

mice, which retain anomalous expression of some individual transgenes, administration of aggregated human IgG was sufficient to trigger anaphylaxis, indicating that human IgG immune complexes can trigger anaphylaxis in a context of multiple hFcγR, however the causal mechanisms were not addressed (Smith et al., 2012).

In collaboration with Regeneron Pharmaceuticals, we developed a novel knock-in mouse model, VG1543 mice, consisting of the targeted insertion of the entire low-affinity hFcγR locus into the corresponding mouse locus on chromosome 1. This approach preserves the human intergenic sequences and permits the study of low-affinity hFcγR in a native context of activating (CD32A, CD16A, CD16B) and inhibitory (CD32B) hFcγRs. The following manuscript describes, in human low-affinity IgG receptor locus knock-in mice (VG1543):

- The characterisation of hFcγR expression on immune cells, with comparison to human blood samples and published data.
- Fatal active anaphylaxis following immunisation and challenge with antigen
- Severe passive anaphylaxis induced by aggregated human IgG
- A central role for hFcγRIIA on neutrophils in anaphylaxis induction, and a minor contribution of basophils
- A contribution of the mediators PAF and histamine

Thus using a new mouse model, including robust expression of inhibitory hFcγRIIB, we demonstrate that activation of neutrophils via hFcγRIIA can cause systemic anaphylaxis in response to circulating aggregates of human IgG. This study (Paper II) was accepted in the *Journal of Allergy and Clinical Immunology* in 2016, and is currently in press². C. Gillis 1st author and co-corresponding author.

² *Authorship of C. Gillis amounts to approximately 65% of the manuscript*

4.1 PAPER II

1 **Mechanisms of anaphylaxis** 2 **in human low-affinity IgG receptor locus knock-in mice**

3

4

5 Caitlin M. Gillis, B.Sci.^{1,2,3}, Friederike Jönsson, PhD^{1,2}, David A. Mancardi, PhD^{1,2},
6 Naxin Tu, PhD⁵, Héloïse Beutier, PharmD^{1,2,3}, Nico Van Rooijen, PhD⁴, Lynn E.
7 Macdonald, PhD⁵, Andrew J. Murphy, PhD⁵ and Pierre Bruhns, PhD^{1,2}

8

9 **Authors' affiliations**

10 ¹Institut Pasteur, Department of Immunology, Unit of Antibodies in Therapy and
11 Pathology, Paris, France;

12 ²INSERM, U1222, Paris, France;

13 ³Université Pierre et Marie Curie, Paris, France;

14 ⁴Department of Molecular Cell Biology, VU Medical Center, Amsterdam, The
15 Netherlands;

16 ⁵Regeneron Pharmaceuticals, Inc., Tarrytown, NY, USA.

17

18 *Sources of funding: none of the sources of funding have an interest in the subject matter*
19 *or materials discussed in the submitted manuscript*

20

21 **Correspondence to:** Pierre Bruhns and Caitlin M. Gillis, Unit of Antibodies in Therapy
22 and Pathology, Department of Immunology, Institut Pasteur, 25 rue du Docteur Roux,
23 75015 Paris, France. Phone: +33144389146 or +33145688629. E-mail:
24 bruhns@pasteur.fr; caitlin.gillis@pasteur.fr

25

25

ABSTRACT

26 **Background:** Anaphylaxis can proceed through distinct IgE- or IgG-dependant
27 pathways, which have been investigated in various mouse models. We developed a
28 novel mouse strain in which the human low-affinity IgG receptor locus, comprising
29 both activating (hFcγRIIA, hFcγRIIIA, hFcγRIIIB) and inhibitory (hFcγRIIB) hFcγR
30 genes, has been inserted into the equivalent murine locus, corresponding to a locus
31 'swap'.

32 **Objective:** We sought to determine the capabilities of hFcγRs to induce systemic
33 anaphylaxis, and identify the cell types and mediators involved.

34 **Methods:** hFcγR expression on mouse and human cells was compared to validate the
35 model. Passive systemic anaphylaxis was induced by injection of heat-aggregated
36 human IVIG, and active systemic anaphylaxis following immunisation and challenge.
37 Anaphylaxis severity was evaluated by hypothermia and mortality. The contribution of
38 receptors, mediators or cell types was assessed by receptor blockade or depletion.

39 **Results:** The human to mouse low-affinity FcγR locus swap engendered
40 hFcγRIIA/IIB/IIIA/IIIB expression in mice comparable to that in humans. Knock-in
41 mice were susceptible to passive and active anaphylaxis, accompanied by
42 downregulation of both activating and inhibitory hFcγR expression on specific myeloid
43 cells. The contribution of hFcγRIIA was predominant. Depletion of neutrophils
44 protected against hypothermia and mortality. Basophils contributed to a lesser extent.
45 Anaphylaxis was inhibited by Platelet-Activating Factor receptor or Histamine receptor-
46 1 blockade.

47 **Conclusion :** Low-affinity FcγR locus-switched mice represent an unprecedented
48 model of cognate hFcγR expression. Importantly, IgG-anaphylaxis proceeds within a
49 native context of activating and inhibitory hFcγRs; indicating that, despite robust
50 hFcγRIIB expression, activating signals can dominate to initiate a severe anaphylactic
51 reaction.

52

53

54

54

CLINICAL IMPLICATIONS

55 In a mouse model of cognate human IgG receptors expression, hFcγR engagement with
56 IgG immune complexes induced severe anaphylaxis. These findings benefit the
57 understanding of human IgG-dependent anaphylaxis, whether non-classical (IgE-
58 independent) or following IgG-based therapies.

59

60

61

CAPSULE SUMMARY

62

63 Antibodies of the IgG class can contribute to anaphylaxis. This report reveals that
64 human IgG receptor knock-in mice are susceptible to systemic anaphylaxis,
65 demonstrating the predominance of activating over inhibitory IgG receptors and the
66 major contribution of human FcγRIIA, neutrophils and platelet-activating factor.

67

68

KEY WORDS

69

70 Anaphylaxis; IgG; knock-in mouse model; basophil; neutrophil; monocyte;
71 macrophage; human FcγR; Platelet-activating Factor; Histamine.

72

73

73

74

ABBREVIATIONS USED

75

76 FcγR: IgG Fc receptor

77 PAF: Platelet-Activating Factor

78 WT: Wild-Type

79 PSA: Passive Systemic Anaphylaxis

80 ASA: Active Systemic Anaphylaxis

81 BSA: Bovine Serum Albumin

82 HA: heat-aggregated

83 mAb: monoclonal Antibody

84 PBS: Phosphate Buffered Saline

85 BBS: Borate Buffered Saline

86 GeoMean: Geometric Mean

87 SEM: Standard Error of the Mean

88

88

89

INTRODUCTION

90

91 Anaphylaxis is a severe, systemic allergic reaction, the reported incidence of
92 which is increasing worldwide¹⁻³. Reactions are clinically heterogeneous, yet
93 characterised by rapid symptom progression and risk of death: intense vasodilation and
94 bronchoconstriction can lead to hypotension, hypothermia, tachycardia, and respiratory
95 distress, which may result in heart and lung failure. In children the most common
96 causative agent is food, whereas in adults drug-induced anaphylaxis accounts for the
97 majority of cases, and indeed the majority of fatal reactions. Anaphylaxis is classically
98 attributed to an IgE-mediated reaction driven by mast cell activation and release of
99 histamine and tryptase⁴.

100 Many cases of human anaphylaxis, in particular to drugs, are not accompanied
101 by elevated serum tryptase or detectable antigen-specific IgE⁵⁻⁸. Alternative, IgE-
102 independent pathways may actually underlie a significant fraction of these anaphylactic
103 events: indeed, non-IgE reactions have been reported to account for up to 30% of cases
104 of drug-induced anaphylaxis⁹. Furthermore, measures of histamine and mast cell
105 tryptase in patients' sera do not reflect the severity of reactions^{7, 10}, whereas serum
106 platelet-activating factor (PAF) levels were found to directly correlate with anaphylaxis
107 severity^{11, 12}. Supporting these notions, experimental animal models have demonstrated
108 that fatal systemic anaphylaxis following intravenous challenge proceeds via PAF
109 release triggered by non-IgE-dependant pathways, and in particular by IgG-dependant
110 pathways (reviewed in ^{13, 14}). The respective contribution of IgE- and IgG-mediated
111 pathways in human anaphylaxis remains however to be determined.

112

113 Passive systemic anaphylaxis (PSA) may be induced in mice by the transfer of
114 specific IgE or IgG antibodies prior to a challenge with a specific antigen, or by the
115 transfer of pre-formed IgG immune complexes. Active systemic anaphylaxis (ASA) is
116 elicited by immunisation with an antigen prior to challenge with the same antigen; a
117 polyclonal IgE and IgG antibody response is generated, and death can result from
118 antigen challenge. In both models, use of the intravenous route for allergen challenge
119 mimics drug-induced anaphylaxis in patients. ASA does not depend on IgE antibodies,
120 activating IgE receptors, or mast cells^{15, 16}, but rather requires activating IgG receptors

121 (Fc γ R), and the contribution of other myeloid cells: neutrophils, basophils or
122 monocyte/macrophages¹⁷⁻¹⁹. Platelet-activating factor (PAF) was identified as the
123 dominant downstream mediator of IgG-induced anaphylaxis, and PAF alone, like
124 histamine, can reproduce the signs and symptoms of anaphylaxis^{20, 21}. Thus mouse
125 models suggest a pathway of anaphylaxis driven by IgG-mediated activation of myeloid
126 cells and relying on PAF release.

127

128 Allergic patients that possess detectable allergen-specific IgE also possess
129 detectable allergen-specific IgG. These anti-allergen IgG antibodies are mainly of the
130 IgG1 isotype, whereas anti-allergen IgG4 antibodies increase following allergen
131 immunotherapy²²⁻²⁵. Allergen-specific IgG4 levels are considered a good correlate to
132 successful allergen immunotherapy, however it remains unknown if allergen-specific
133 IgG1 participate in, or are even responsible for, non-IgE mediated human anaphylaxis.
134 Humans express a family of IgG receptors (Fc γ R), comprised of activating IgG
135 receptors (hFc γ RI/CD64, hFc γ RIIA/CD32A, hFc γ RIIC/CD32C, hFc γ RIIIA/CD16A,
136 hFc γ RIIIB/CD16B) and a single inhibitory receptor (hFc γ RIIB/CD32B), that all bind
137 human IgG1 and that mediate most of the biological functions of IgG²⁶. Although mice
138 also express both activating and inhibitory Fc γ Rs, murine Fc γ Rs do not structurally or
139 functionally mirror those of humans: differential antibody binding affinities and
140 variable expression on immune cell subsets prevent extrapolation from one species to
141 another²⁶. We reported previously the induction of anaphylaxis (PSA and fatal ASA) in
142 mice transgenic either for hFc γ RI/CD64 or hFc γ RIIA/CD32A on a background
143 deficient in endogenous mFc γ R^{19, 27}. PSA mediated by hFc γ RIIA was independent of
144 mast cells and basophils, and relied on neutrophils and monocytes/ macrophages²⁸, and
145 hFc γ RI-dependent ASA required neutrophils and PAF release²⁷. An important caveat of
146 these results is that they were obtained in mice expressing only one hFc γ R, in the
147 absence of potential regulatory or cooperative effects of other hFc γ Rs. In a model
148 generated by intercrossing of five different hFc γ R-transgenic mice, incorporating
149 activating and inhibitory hFc γ Rs, administration of aggregated human IgG to [hFc γ RI^{tg}
150 hFc γ RIIA^{tg} hFc γ RIIB^{tg} hFc γ RIIIA^{tg} hFc γ RIIIB^{tg}] mice on a mFc γ R^{null} background was
151 sufficient to trigger anaphylaxis, although the mechanisms were not addressed²⁹. This
152 model reproduces, however, aberrant expressions seen in mice carrying the individual

153 transgenes, including extremely high expression of hFcγRIIB on mouse monocytes and
154 granulocytes²⁶.

155

156 Here, we present a novel mouse model in which we have employed highly
157 efficient knock-in technology to insert the entire low-affinity hFcγR locus into the
158 corresponding mouse locus on chromosome 1. This approach engendered expression of
159 activating hFcγRIIA/CD32A, hFcγRIIIA/CD16A and hFcγRIIIB/CD16B, and of
160 inhibitory hFcγRIIB/CD32B in mice, in a manner resembling expression patterns seen
161 in humans. This unprecedented model permits analyses of the role of hFcγRs and the
162 cell types that express them in IgG-mediated anaphylaxis, within a cognate context of
163 activating and inhibitory hFcγRs.

164

164

165

METHODS

166

Mice

168 VG1505 and VG1543 mice were designed and generated by Regeneron
169 Pharmaceuticals, Inc. on a mixed 62.5% C57BL/6N, 37.5% 129S6/SvEv genetic
170 background (refer to Supplemental Methods), and backcrossed one generation to
171 C57BL/6N. Mice were bred at Institut Pasteur and used for experiments at 7-11 weeks
172 of age. VG1505 and VG1543 mice demonstrate normal development and breeding
173 patterns. All mouse protocols were approved by the Animal Ethics committee CETEA
174 (Institut Pasteur, Paris, France) registered under #C2EA-89.

175

Active Systemic Anaphylaxis

177 Mice were injected intraperitoneally on day 0 with 200µg BSA in CFA, and boosted
178 intraperitoneally on day 14 with 200µg BSA in IFA. BSA-specific IgG1, IgG2a/b/c and
179 IgE antibodies in serum were titered by ELISA on day 21 as described¹⁹. Mice with
180 comparable antibody titers were challenged intravenously with 500µg BSA 10-14 days
181 after the last immunisation. Central temperature was monitored using a digital
182 thermometer (YSI) with rectal probe.

183

Passive Systemic Anaphylaxis

185 Human Intravenous Immunoglobulin (IVIG; Gamunex®, Grifols) was heat-aggregated
186 by incubation at 25mg/mL in BBS (0.17M H₃BO₃, 0.12M NaCl, pH8) for 1 hour at
187 63°C, then diluted in 0.9% NaCl for iv injection at 100µL per mouse. Central
188 temperature was monitored using a digital thermometer with rectal probe. Control non-
189 aggregated IVIG was similarly diluted without heating. For hFcγR expression analysis
190 following IVIG-PSA, heparinised blood was sampled 1hour after IVIG injection. IgE-
191 dependant PSA was induced by challenge with 500µg TNP-BSA 16 hours after passive
192 transfer of IgE anti-TNP (50µg clone C48.2). PSA was induced also by PAF injection at
193 0.3µg per mouse i.v., and hypothermia monitored immediately afterwards.

194

In vivo blocking and depletion

196 Anti-Fc γ RIIA mAbs (Clone IV.3, 60 μ g /mouse) were injected twice intravenously (24
197 hours and 4 hours) before challenge. Note that, unlike in Fc γ RIIA^{tg} mice³⁰, IV.3
198 administration did not induce hypothermia or symptoms of anaphylaxis, nor platelet
199 depletion. 300 μ g /mouse anti-Gr-1 (RB6-8C5), 300 μ g /mouse anti-Ly-6G (NIMP-R14),
200 30 μ g/mouse (Supplementary Figure 5A&D, Supplementary Figure 6B) or 60 μ g/mouse
201 anti-CD200R3 (Ba103) (Figure 4E), 300 μ g /mouse anti-Ly-6C (Monts 1, rat IgG2a)
202 mAbs, or corresponding rat IgG2b or IgG2a isotype control mAbs were injected
203 intravenously 24 hours before challenge. Note that the NIMP-R14 antibody clone is
204 specific to the Ly-6G antigen (Supplementary Figure 4A-C). 300 μ L /mouse PBS- or
205 clodronate-liposomes were injected intravenously either 24 hours before challenge, or
206 both 24 and 48 hours before challenge. Specificity of cell depletion was evaluated in the
207 blood, spleen and peritoneal lavage of naive 1543 mice 24 hours after NIMP-R14
208 (Supplementary Figure 4C-E) or Ba103 (Supplementary Figure 5). Please refer to
209 “*Specificity and efficiency of cell depletion strategies*” in the *Supplemental Methods for*
210 *more information*.

211 PAF-R antagonists ABT-491 (25 μ g/mouse) or CV-6209 (66 μ g/mouse) in 0.9% NaCl
212 were injected intravenously 15min or 10min prior to challenge, respectively. H1-
213 receptor antagonists cetirizine DiHCl, pyrilamine maleate , or triprolidine HCl at
214 300 μ g/mouse in 0.9% NaCl were injected intraperitoneally 30 minutes before challenge.
215

216 *Please refer to Supplemental Methods for details on: Generation of knock-in mice,*
217 *Antibodies and reagents, Flow cytometry, Specificity and efficiency of cell depletion*
218 *strategies, Statistics.*

219

219

220

RESULTS

221

222 Creation of VG1505 (mFcγRIIB^{-/-} mFcγRIII^{-/-} mFcγRIV^{-/-}) and VG1543
223 (mFcγRIIB^{-/-} mFcγRIII^{-/-} mFcγRIV^{-/-} hFcγRIIA^{KI} hFcγRIIB^{KI} hFcγRIIIA^{KI}
224 hFcγRIIIB^{KI}) mice

225 To delete the mouse low-affinity Fc receptors, a large targeting vector
226 (BACvec)^{31, 32} was constructed (as described in supplemental methods) to delete 106 kb
227 of mouse genomic sequence encompassing the mouse Fcgr2b, Fcgr3, and Fcgr4 genes,
228 and used to target VGF1 ES cells³³. The low-affinity FcγR deleted allele (deletion of
229 1:170,956,770-171,063,353 from Chr1_H3 based on the mouse GRCh38 assembly) was
230 given the designation VG1505 (Figure 1A).

231 To insert human FCGR3A and FCGR2A genes, a BACvec containing 69 kb of
232 the corresponding human sequence flanked by long mouse homology arms was
233 generated (refer to Supplemental Methods) and used to retarget VG1505 ES cells³¹. The
234 subsequent allele in which the three mouse low affinity Fc receptors were replaced with
235 hFCGR3A and hFCGR2A was given the designation VG1528 (Figure 1B). To insert
236 human FCGR2B, FCGR2C and FCGR3B genes next to the human FCGR3A and
237 FCGR2A genes, a BACvec was constructed containing an additional 142 kb of human
238 sequence between a human homology arm, homologous to the end of the human insert
239 in VG1528, and a mouse homology arm. This BACvec was used to retarget VG1528 ES
240 cells, and resulted in an allele designated VG1543^{31, 32} (insertion of human sequence
241 from 1:161,500,441-161,679,348 on Chr1_q23.3 based on the human GRCh38
242 assembly) in which all five human low-affinity FcγR receptor genes replace the three
243 mouse low-affinity FcγR genes (Figure 1C). The inserted human low-affinity FcγRs are
244 in the same order as in the human genome and the human intergenic sequences are
245 retained intact. The human BAC sequences used encode for the polymorphic variants
246 hFcγRIIA(H₁₃₁), hFcγRIIB(I₂₃₂), hFcγRIIC(Stop₁₃), hFcγRIIIA(V₁₅₈) and
247 hFcγRIIIB(NA2); therefore no expression of hFcγRIIC is expected in VG1543 mice.

248

249 VG1543 mice exhibit hFcγR expression patterns on immune cells comparable to
250 that of humans

251 First, we determined that VG1505 and VG1543 mice exhibit normal immune
252 cell composition (Supplementary Table 4). VG1505 mice demonstrate slightly elevated
253 frequencies of granulocytes and monocytes in the blood and spleen, and macrophages in
254 the peritoneum compared to VG1543 (Supplementary Figure 1A-C). Furthermore,
255 VG1505 and VG1543 mice exhibit comparable mFcεRI and mFcγRI expression
256 (Supplementary Figure 1D-F).

257 To compare the expression pattern of hFcγRs in VG1543 mice to that of humans,
258 specific antibody staining and flow cytometry analysis was performed on cells isolated
259 either from the blood of healthy human donors, or from the blood, spleen, lymph nodes,
260 bone marrow, peritoneum and broncho-alveolar lavage (BAL) of VG1543 mice. All
261 myeloid cells examined, including monocytes, macrophages, eosinophils, basophils and
262 mast cells, and among lymphocytes B and NK cells, but not T cells, expressed at least
263 one hFcγR (Figure 2A-B).

264 We detected hFcγRIIA (CD32A) staining on neutrophils, monocytes,
265 eosinophils and platelets from the blood of healthy human donors (Figure 2A) as
266 expected²⁶, and from the blood, spleen, lymph nodes, bone marrow, peritoneum and
267 broncho-alveolar lavage of VG1543 mice (Figure 2B). VG1543 peritoneal mast cells
268 also expressed hFcγRIIA. Like human blood basophils, VG1543 blood basophils
269 expressed variably hFcγRIIA (Figure 2A-B), but not basophils from the spleen or bone
270 marrow; the low level of expression of hFcγRIIA on VG1543 blood basophils is in the
271 range of expression found on basophils from human donors (Figure 2C). As expected,
272 lymphocytes, including B, T and NK cells, did not express hFcγRIIA in humans and
273 VG1543 mice (Figure 2A-B); notably we observed some background staining for
274 hFcγRIIA on human B cells, as published previously²⁸. Thus the hFcγRIIA expression
275 pattern and level is comparable between VG1543 mice and blood from normal human
276 donors.

277 In human blood hFcγRIIB was detected at high levels on all B cells and basophils,
278 at lower levels variably on a proportion of monocytes (2-38% positive; n=4 donors),
279 whereas other cells were mostly negative, *i.e.* neutrophils, eosinophils, NK cells, T cells,
280 platelets (Figure 2A and Supplemental Figure 1A), as expected^{34, 35}. Similarly, VG1543
281 mice expressed high levels of hFcγRIIB on B cells from blood, spleen, lymph node and
282 peritoneum (Figure 2B). Furthermore, we observed variation in hFcγRIIB staining
283 among B cell subpopulations isolated from the bone marrow and the peritoneum of

284 VG1543 mice (Supplementary Figure 1B-C). VG1543 mice demonstrated robust
285 hFcγRIIB expression on monocyte populations in the blood and lymphoid organs, yet
286 no staining was observed on Ly6C^{hi} monocytes from the bone marrow. Only a fraction
287 of donors we analysed demonstrated hFcγRIIB expression on blood monocytes
288 (Supplemental Figure 2A), consistent with its previously reported variable expression
289 on CD14^{lo} monocytes and absence of expression on CD14^{hi} monocytes³⁶. Thus VG1543
290 exhibit over-expression of hFcγRIIB on blood monocytes compared to human blood
291 monocytes. Interestingly, hFcγRIIB staining was higher on Ly6C^{low} “patrolling”
292 monocytes than on Ly6C^{hi} “classical” monocytes from VG1543 mice (Supplemental
293 Figure 2D), as it is on the analogous populations in human blood, CD14^{low}CD16^{hi}
294 “patrolling” monocytes and CD14^{hi} “classical” monocytes (Supplemental Figure 2E).
295 Furthermore, spleen monocytes in human³⁶ and VG1543 mice express significant levels
296 of hFcγRIIB, reconciling hFcγRIIB expression on monocytes in this compartment
297 between human donors and VG1543 mice. Macrophages from the peritoneum, but not
298 from BAL, of VG1543 mice were found positive for hFcγRIIB (Figure 2B). Although
299 human basophils express high levels of hFcγRIIB³⁷, basophils from VG1543 mice were
300 negative (Figure 2A-B). Overall, VG1543 mice appear to express hFcγRIIB at similar
301 levels on B cells, at the high end of the range on monocytes, but not on basophils,
302 compared to humans.

303 Human neutrophils, monocytes, eosinophils, NK cells and a small proportion of
304 basophils were labelled positive with an anti-CD16 antibody recognizing both
305 hFcγRIIIA and hFcγRIIB (Figure 2A), in accordance with known hFcγRIIIA (NK cells,
306 monocytes/macrophages and eosinophils) and hFcγRIIB expression (neutrophils and
307 some basophils)³⁵. Similarly, in the blood and organs from VG1543 mice, neutrophils
308 stained at high levels, and monocyte/macrophages, NK cells and basophils at variable
309 levels with anti-CD16 (Figure 2B and Supplemental Figure 1). Eosinophils from
310 VG1543 mice did not show detectable CD16 labelling, in accordance with 25% of
311 human donors (Supplemental Figure 1F). Interestingly, CD16 was apparent on only 30-
312 45% of NKp46⁺ NK cells from the spleen of VG1543 mice, compared to 85-98% of
313 CD56⁺ NK cells from human blood. Overall, VG1543 mice appear to express
314 hFcγRIIIA and hFcγRIIB at similar levels on neutrophils and NK cells, at higher levels
315 on blood monocytes, but not on eosinophils nor on blood basophils, respectively,
316 compared to humans.

317

318 Induction and mechanism of active systemic anaphylaxis in VG1543 mice

319 Among human low-affinity hFcγRs, the activating IgG receptors hFcγRIIA and
320 hFcγRIIIA, and the inhibitory IgG receptor hFcγRIIB, can bind mouse IgG isotypes^{26, 28,}
321 ³⁵ (Table 1): we therefore explored the capacity of these receptors to mediate active
322 systemic anaphylaxis (ASA) triggered by i.v. BSA challenge in VG1505 and VG1543
323 mice immunised with BSA (Supplemental Figure 3). Following challenge, VG1543
324 mice, but not in VG1505 mice, suffered from a severe drop in body temperature and 50-
325 100% mortality within 30 minutes (Figure 3A). Pre-treatment of VG1543 mice with
326 blocking antibodies against activating hFcγRIIA (mAb IV.3)²⁸ abolished hypothermia
327 and mortality (Figure 3B). hFcγRIIA is expressed by neutrophils,
328 monocyte/macrophages, eosinophils, basophils and mast cells in VG1543 mice. Of
329 these, neutrophils, monocyte/macrophages and basophils have been reported to
330 contribute to IgG-PSA in mice¹⁷⁻¹⁹. Neutrophil depletion using either anti-Ly6G or anti-
331 Gr1 mAbs protected VG1543 mice from ASA, but neither monocyte/macrophage nor
332 basophil depletion (Figure 3C; Supplemental Figure 5B-E). Finally, PAF-receptor
333 blockade protected from ASA-associated death and hypothermia, while H1-receptor
334 antagonist cetirizine had no effect (Figure 3D, Supplemental Figure 5F-G). Altogether
335 these data, obtained in this model of ASA contingent on hFcγR binding of mouse IgGs,
336 demonstrate that VG1543 mice present with anaphylactic symptoms and a fatal reaction
337 dependent on hFcγRIIA, neutrophils and PAF. They also demonstrate that mouse FcγRI,
338 which is still expressed in both VG1505 mice and VG1543 mice, cannot induce
339 anaphylaxis.

340

341 Aggregated human IVIG triggers passive systemic anaphylaxis in VG1543 mice

342 Although interactions between mouse IgG isotypes and some human FcγRs can
343 result in the induction of anaphylactic reactions (Figure 3, Table 1 and ^{19, 27, 28}), such
344 models are far from recapitulating the variety of human IgG interactions with both
345 activating and inhibitory hFcγRs³⁸. We therefore investigated whether anaphylaxis
346 could be initiated by triggering human FcγRs in VG1543 mice using aggregated human
347 intravenous immunoglobulin (IVIG) as a surrogate for human IgG-immune complexes.
348 Intravenous injection of 1mg heat-aggregated IVIG induced passive systemic
349 anaphylaxis (IVIG-PSA) in VG1543 mice, manifested by visual signs and severe

350 hypothermia, with a maximum temperature loss of 6-8°C 30-40 min after injection. This
351 reaction was dependant on the expression of hFcγR, since VG1505 mice were resistant
352 (Figure 4A). A dose response of heat-aggregated IVIG demonstrated that hypothermia
353 reaches a maximum at 1 mg, was lower at 500 or 300 μg, and was not observed at 30 μg
354 (Figure 4B & Supplemental Figure 4). A dose of 1mg was therefore chosen for all
355 subsequent IVIG-PSA, as it consistently induced in VG1543 mice a shock at sufficient
356 magnitude to assess the effect of receptor, cell and mediator blockade.

357

358 **hFcγRIIA and neutrophils contribute to IVIG-PSA in VG1543 mice**

359 hFcγRIIA blockade protected against both anaphylactic symptoms and
360 hypothermia during IVIG-PSA in VG1543 mice, (Figure 4C), even though VG1543
361 mice express also hFcγRIIA and hFcγRIIB that may induce cell activation^{26, 35, 39}.
362 Monocyte/macrophage depletion by toxic liposome administration had no effect (Figure
363 4D), whereas basophil depletion modestly reduced IVIG-PSA in VG1543 mice (Figure
364 4E). Neutrophil depletion, however, was protective (Figure 4F). Appropriate antibody-
365 mediated cell depletion was confirmed by flow cytometry analysis (Supplemental
366 Figure 4 and 5A), and we have previously demonstrated efficient monocyte/macrophage
367 depletion in the blood and spleen following liposome injection (Beutier et al 2016).
368 hFcγRIIB blockade, even using high doses of blocking mAb, did not modulate
369 anaphylactic symptoms in VG1543 mice induced by optimal (1mg; not shown) or
370 suboptimal (250μg; Figure 4G) doses of heat-aggregated IVIG. Thus VG1543 mice are
371 susceptible to PSA induced by human IgG, and the reaction proceeds primarily through
372 neutrophils and the activating receptor hFcγRIIA, with a minor contribution of
373 basophils, but does not require monocyte/macrophages, and is not negatively regulated
374 by inhibitory hFcγRIIB.

375

376 **Changes in hFcγR expression on myeloid cells following anaphylaxis**

377 It has been proposed that changes in Fc receptor expression may be used as a
378 biological marker for anaphylaxis, or an indicator of different pathways of activation⁴⁰.
379 We therefore investigated changes in hFcγR expression on circulating myeloid cell
380 populations following IVIG-PSA in VG1543 mice. One hour after anaphylaxis
381 induction, staining for activating hFcγR receptors was substantially reduced on
382 neutrophils (Figure 5A), Ly6C^{hi} (Figure 5B) and Ly6C^{low} monocytes (Figure 5C) in the

383 blood of VG1543 mice; entailing almost complete loss of hFcγRIIA on neutrophils and
384 monocytes, and significant downregulation of hFcγRIII on neutrophils and Ly6C^{low}
385 monocytes. The inhibitory receptor hFcγRIIB was also significantly reduced on Ly6C^{hi}
386 monocytes, yet unchanged on Ly6C^{low} monocytes and neutrophils. These changes in
387 receptor staining were not due merely to increased quantities of circulating IgG, as the
388 injection of non-aggregated IVIG did not affect receptor expression (Figure 5A-C).
389 Receptor detection by anti-hFcγR mAbs may be influenced by pre-bound human IgG-
390 immune complexes; however we confirmed that this was not the case using a panel of
391 different antibodies with different recognition sites, both within and outside of the
392 ligand-binding region. Furthermore, hIgG could be detected at low amounts on the
393 surface of VG1543 neutrophils and monocytes isolated after IVIG-PSA (Supplementary
394 Figure 7 and Supplementary Methods), yet the limited amount of bound hIgG that we
395 observe after PSA, particularly on neutrophils, certainly does not account for the several
396 logs of reduction in receptor staining intensity. These data indicate active engagement
397 of hFcγR on neutrophils and monocytes during IVIG-PSA, and suggest that these cells
398 are each involved in responding to IgG-immune complexes, even though, in the case of
399 monocytes, they may not be required for the induction of anaphylactic symptoms in
400 VG1543 mice.

401

402 **PAF and histamine contribute to IVIG-PSA in VG1543 mice**

403 We assessed the contribution of the mediators PAF and histamine to IVIG-PSA
404 in VG1543 mice, using receptor antagonists administered before PSA induction. PAF
405 receptor blockade using two different antagonists (ABT-491 and CV-6209)
406 significantly reduced the hypothermia associated with IVIG-PSA in VG1543 mice
407 (Figure 6A-B). Cetirizine, Pyrilamine and Tropolidine are different histamine-receptor 1
408 antagonists that inhibit IgE-induced PSA to various extents (Supplemental Figure 8A-
409 C). Cetirizine had no effect on IVIG PSA in VG1543 mice, unless combined with PAF-
410 R antagonist ABT-491 (Supplemental Figures 8D-E). Pyrilamine and Tropolidine,
411 however, significantly reduced the hypothermia associated with IVIG-PSA in VG1543
412 mice (Figure 6C-D). Of note, PAF-R antagonist ABT-491 injected at higher doses did
413 not confer greater protection (Supplemental Figure 8F). Therefore both PAF and
414 histamine contribute to IVIG-PSA, in agreement with the contribution of neutrophils
415 and basophils, in knock-in mice expressing human low-affinity IgG receptors.

416

416

DISCUSSION

417

418 We demonstrate here that VG1543 mice, which exhibit genuine expression of all
419 human low-affinity Fc γ Rs, are susceptible to IgG-dependant anaphylaxis. VG1543, but
420 not VG1505, mice experienced severe hypothermia following transfer of aggregated
421 human IgG or following immunisation and challenge with the same antigen. These data
422 show for the first time that, in a cognate context of activating and inhibitory human
423 Fc γ R signalling, immune complexes formed by either mouse or human IgG can trigger
424 cell activation, mediator release, and severe anaphylaxis.

425

426 Several transgenic mouse models have been developed previously to investigate
427 the *in vivo* functions of human Fc γ Rs (reviewed in ^{14, 35}). Transgenic approaches have
428 their inherent flaws, however, in terms of reproducibility of human Fc γ R expression,
429 heterogeneity of transgene expression between individuals of the same genotype, and
430 instability between generations, as a result of random transgene integration into the
431 genome. hFc γ RIIA(R₁₃₁)^{tg} mice⁴¹, hFc γ RIIB(I₂₃₂)^{tg} ⁴², hFc γ RIIIA(F₁₅₈)^{tg} and
432 hFc γ RIIB^{tg} (unknown polymorphic variant)⁴³ mice each employ their respective
433 genuine human promoter to drive transgene expression. Of these, it appears that only
434 hFc γ RIIA(R₁₃₁)^{tg} mice recapitulate the corresponding human expression patterns^{28, 41},
435 whereas hFc γ RIIB(I₂₃₂)^{tg} mice exhibit abnormally high expression on circulating
436 monocytes and granulocytes, and hFc γ RIIIA(F₁₅₈)^{tg} hFc γ RIIB^{tg} mice have aberrant
437 expression on DCs and eosinophils^{29, 42}. Furthermore, the study of hFc γ R-transgenic
438 strains necessitates genetic backgrounds lacking endogenous mFc γ Rs, because mouse
439 and human Fc γ Rs cross-bind human and mouse IgG, respectively (Table 1). hFc γ R-
440 transgenic mice have been studied on a background deficient in the FcR γ -chain
441 signalling subunit (FcR γ ^{KO}), that lacks functional expression of mFc γ RI, mFc γ RIII,
442 mFc γ RIV and mFc ϵ RI⁴⁴. Unfortunately FcR γ ^{KO} mice have deficiencies in signalling
443 through several non-FcR molecules, including integrin, cytokine and growth factor
444 receptors, affecting leukocyte recruitment and vascular haemostasis; and these mice
445 maintain inhibitory mFc γ RIIB expression that can modulate hFc γ R-induced signalling^{35,}
446 ⁴⁵⁻⁴⁷. A mFc γ R^{null} background, lacking all mouse IgG receptor expression but
447 maintaining FcR γ -chain expression, is a preferable approach, as exemplified in the

448 generation of hFcγRI^{tg}IIA^{tg}IIB^{tg}IIIA^{tg}IIIB^{tg} mFcγR^{null} mice by intercrossing of the five
449 single hFcγR-transgenic strains described above²⁹.

450

451 To circumvent the inherent issues of randomly integrated transgenics, we
452 employed gene knock-in technology to generate a mouse model deficient for the low-
453 affinity mouse IgG receptor locus (mFcγRIIB/III/IV^{KO}; VG1505), and to insert the
454 human low-affinity IgG receptor locus in its stead (hFcγRIIA(H₁₃₁)-hFcγRIIB(I₂₃₂)-
455 hFcγRIIC(Stop₁₃)-hFcγRIIA(V₁₅₈)-hFcγRIIB(NA2)^{KI}; VG1543). Consequently,
456 VG1543 mice demonstrate hFcγR expression consistent with that observed in humans²⁶,
457 ³⁵, with some minor differences: eosinophils lack hFcγRIIA expression and basophils
458 lack hFcγRIIB expression. In addition, hFcγRIIA and hFcγRIIB expression is higher
459 on blood monocytes compared to humans; nevertheless hFcγRIIB on these cells in
460 VG1543 remains very much closer to that observed in humans, when compared to the
461 expression reported in hFcγRI^{tg}IIA^{tg}IIB^{tg}IIIA^{tg}IIIB^{tg} mFcγR^{null} mice²⁹. Of note, VG1543
462 represent the first mouse model of hFcγRIIA(H₁₃₁) and hFcγRIIA(V₁₅₈) expression,
463 which is particularly advantageous for the study of human IgG2. Indeed hFcγRIIA(H₁₃₁)
464 binds significantly better human IgG2 than the polymorphic variant hFcγRIIA(R₁₃₁),
465 which is expressed in hFcγRIIA transgenic animals^{38, 48}; and hFcγRIIA(V₁₅₈) binds
466 human IgG2 whereas polymorphic variant hFcγRIIA(F₁₅₈), expressed in hFcγRIIA^{tg}
467 mice, does not^{38, 43, 48}.

468 Here we identify for the first time that, within the context of native co-
469 expression with other activating and inhibitory hFcγRs, hFcγRIIA drives IgG-
470 anaphylaxis induction. hFcγRIIA blockade indeed protected VG1543 mice against
471 systemic anaphylaxis induced by aggregated human IVIG. The transfer of IVIG
472 aggregated *ex vivo* mimics the formation of polyclonal hIgG immune complexes *in vivo*,
473 since the subclass composition reflects that of human serum: 63% IgG1, 29% IgG2, 5%
474 IgG3 and 3% IgG4. All human FcγRs expressed in VG1543 mice bind human IgG1 and
475 IgG3, only hFcγRIIA(H₁₃₁) and hFcγRIIA(V₁₅₈) bind human IgG2, and all except
476 hFcγRIIB(NA2) bind human IgG4. Yet hFcγRIIA(H₁₃₁) binds IgG2 with >7-fold
477 higher affinity than hFcγRIIA(V₁₅₈)³⁸, and therefore the IgG2 component of aggregated
478 IVIG may bias towards hFcγRIIA(H₁₃₁) engagement over the other hFcγRs expressed in
479 VG1543 mice. hFcγRIIA blockade also protected VG1543 mice from systemic

480 anaphylaxis and death following immunisation and challenge with the same antigen.
481 This is a less physiological model, as it relies on human hFcγRs cross-binding mouse
482 IgGs. Among the activating receptors expressed in VG1543 mice, only hFcγRIIA binds
483 mouse IgG1 (Table 1) - the predominant IgG isotype produced during ASA
484 immunisation - and logically therefore predominantly contributes to anaphylaxis
485 induction.

486 While the protective effect of hFcγRIIA blockade in IVIG-PSA suggests that
487 hFcγRIIIA and hFcγRIIIB are not individually capable of triggering systemic
488 anaphylaxis, we cannot formally exclude a cooperative role of these receptors in
489 anaphylaxis induction via hFcγRIIA in VG1543 mice. Indeed, we could not efficiently
490 block hFcγRIIIA and/or hFcγRIIIB *in vivo* using available anti-hFcγRIII antibodies
491 (data not shown). We did observe significant hFcγRIIIA/B down-regulation on
492 circulating neutrophils and monocytes after IVIG-PSA, but not after injection of non-
493 aggregated IVIG (Figure 6), supporting the notion that these receptors are actively
494 engaging with IgG immune complexes, despite not triggering a systemic reaction.
495 Indeed, in models of autoantibody-induced inflammation, hFcγRIIA and hFcγRIIIB
496 expressed on neutrophils were found to individually and cooperatively promote immune
497 complex-induced reactions; however hFcγRIIA alone promoted associated injury and
498 inflammation, whereas hFcγRIIIB rather mediated homeostatic clearance of immune
499 complexes^{39, 49}, suggesting that hFcγRIIA, but not hFcγRIIIB, is able to induce
500 detrimental reactions *in vivo*. Anaphylaxis induced by aggregated IVIG was also
501 demonstrated in the hFcγRI^{tg}IIA^{tg}IIB^{tg}IIIA^{tg}IIIB^{tg} mFcγR^{null} mouse model²⁹, but the
502 contributing hFcγRs were not identified.

503

504 Importantly, VG1505 and VG1543 mice still express the high-affinity mouse
505 receptor mFcγRI, which is expressed on monocytes, tissue resident monocyte-derived
506 cells and specific macrophage populations^{26, 50, 51} (Supplementary Figure 1). Even so,
507 VG1505 mice were resistant to IVIG-PSA (and active anaphylaxis) induction,
508 demonstrating that mFcγRI alone cannot trigger anaphylaxis, and that anaphylactic
509 reactions in VG1543 mice rely exclusively on hFcγR triggering. We previously reported
510 that the human counterpart of mFcγRI, hFcγRI (CD64) was sufficient to induce
511 systemic anaphylaxis in transgenic mice lacking mouse FcγRs²⁷. We used for this
512 former study the only reported hFcγRI-transgenic mouse: it expresses this receptor on

513 monocytes and macrophages as in humans, but also constitutively on neutrophils,
514 contrarily to humans^{35, 52}. Anaphylaxis in these mice relied on both neutrophils and
515 monocytes/macrophages²⁷. Human FcγRI is not expressed in the VG1543 background,
516 and the question remains open whether hFcγRI can participate in IgG-induced
517 anaphylaxis in a context of native hFcγR expression. We have developed a novel
518 hFcγRI knock-in mouse strain that does not present the discrepant expression of
519 existing hFcγRI-transgenic models^{29, 52}: hFcγRI is expressed on monocytes,
520 macrophages and dendritic cells, but not constitutively on neutrophils (data not shown).
521 We are currently crossing this mouse strain to VG1543 mice, to create a fully hFcγR-
522 humanized knock-in mouse model, which should enable us in the future to address the
523 relative contribution of hFcγRI in a model recapitulating all hFcγR expression.

524

525 Anaphylaxis is driven by the release of anaphylactogenic mediators from
526 myeloid cells^{4, 53}. The contribution of any given cell population is therefore determined
527 by the requisite expression of activating FcγR, the capacity of the cells to release active
528 mediators, and a cells' potential for negative inhibition of FcγR signalling by expression
529 of inhibitory FcγRIIB⁵⁴. In wild-type (wt) mice, pathways of active systemic
530 anaphylaxis and passive IgG anaphylaxis rely predominantly on monocyte and/or
531 neutrophil activation via mFcγRIII, with a minor contribution of mFcγRIV, and
532 subsequent PAF release^{18, 19, 55}. Considering genetic evolution, the functional homolog
533 of mFcγRIII is hFcγRIIA, and that of mFcγRIV is hFcγRIIIA (H. Watier, personal
534 communication)³⁵. It is therefore consistent that hFcγRIIA, which exhibits prominent
535 expression on all circulating myeloid cells, like mFcγRIII, may be the predominant IgG
536 receptor contributing to anaphylaxis in VG1543 mice. We previously demonstrated that
537 transgenic expression of hFcγRIIA(R₁₃₁) was sufficient to induce passive active
538 systemic anaphylaxis, and that IgG-induced PSA in hFcγRIIA(R₁₃₁)^{tg} mFcγRI/IIB/III^{KO}
539 mice required monocytes and neutrophils²⁸.

540 Here, we identify that neutrophils are mandatory for anaphylaxis in VG1543
541 mice, whereas we could not identify a contribution for monocytes/macrophages,
542 although they express hFcγRIIA. This discrepancy between mouse models may be due
543 to expression of inhibitory hFcγRIIB, absent in hFcγRIIA(R₁₃₁)^{tg} mFcγRI/IIB/III^{KO} mice,
544 but elevated on VG1543 blood monocytes compared to humans. Blood monocytes
545 express consistently hFcγRIIB in VG1543 mice but we and others have identified

546 variable hFcγRIIB on monocytes, particularly CD14^{lo} blood monocytes, and prominent
547 expression on only a fraction of human donors³⁶ (Supplementary Figure 2). Spleen
548 monocytes, however, significantly express hFcγRIIB in humans³⁶ and VG1543 mice.
549 Indeed, hFcγRIIB binds to all subclasses of human IgG³⁸ and therefore may inhibit
550 monocyte activation following engagement by IVIG aggregates in VG1543 mice. On
551 one hand, we observed down-regulation of inhibitory hFcγRIIB on circulating Ly6C^{hi}
552 and Ly6C^{low} monocytes following IVIG-PSA suggesting its engagement by IVIG-
553 immune complexes and potential inhibitory signalling by this receptor; on the other
554 hand blockade of hFcγRIIB did not modulate anaphylactic symptoms in VG1543 mice.
555 hFcγRIIB, and the inhibitory signals it can induce, do not appear to regulate this model
556 of anaphylaxis. These data do not favour a contribution of monocytes to anaphylaxis in
557 VG1543 mice. We cannot, however, exclude a potential contribution of blood
558 monocytes (mostly hFcγRIIB negative) to human anaphylaxis.

559

560 The contribution of basophils to anaphylaxis models in mice remains
561 controversial: mIgG1-induced PSA¹⁷ and mIgG2a-induced PSA⁵⁵ were inhibited
562 following antibody-mediated basophil depletion, but mIgG1-induced PSA was
563 unaffected in Mcpt8-cre mice that exhibit >90% basophil deficiency⁵⁶. In an active
564 model of peanut-induced anaphylaxis, involving both IgE and IgG, both antibody- or
565 diphtheria toxin-mediated basophil depletion significantly reduced hypothermia⁵⁷.
566 Human basophils express variable levels of hFcγRIIA and high levels of hFcγRIIB, yet
567 could not be activated by hIgG immune complexes *in vitro*, suggesting that hFcγRIIB-
568 dependent negative regulation is dominant over hFcγRIIA-dependent basophil
569 activation³⁷. VG1543 mice express hFcγRIIA at low levels on circulating basophils, but
570 within the range of that observed on peripheral blood cells from healthy donors (Figure
571 2A-B). Unlike human basophils, however, VG1543 basophils do not express hFcγRIIB:
572 that we do not identify a major contribution of basophils to anaphylaxis in VG1543
573 mice cannot be due to hFcγRIIB inhibition of hFcγRIIA-mediated signalling.

574 We reported previously that neutrophils predominantly contribute to ASA in wt
575 mice and that the transfer of human neutrophils can restore anaphylaxis in resistant
576 mice^{13, 19}. Neutrophils were mandatory for IVIG-PSA (and ASA) in VG1543 mice,
577 since neutrophil depletion abolished hypothermia and protected from death. Both of
578 these anaphylaxis models were dependent on hFcγRIIA, which is expressed at very high

579 levels on both human and VG1543 mouse neutrophils, whereas inhibitory hFcγRIIB
580 expression is found only on a small subset of neutrophils. This low or absent hFcγRIIB
581 expression implies that, unlike monocytes, neutrophil activation is not, or marginally,
582 regulated by inhibitory hFcγRIIB. Neutrophils also contributed to hFcγRIIA-dependent
583 PSA in hFcγRIIA(R₁₃₁)^{tg} mFcγRI/IIB/III^{KO} mice²⁸ in the absence of other hFcγR
584 expression. We demonstrate now that the contribution of neutrophils to IgG-induced
585 anaphylaxis is also predominant in the context of native hFcγR expression in VG1543
586 mice. Such an observation is of crucial consideration when we acknowledge that
587 neutrophils comprise >60% of circulating blood cells in humans.

588

589 Finally, we identified that the soluble mediator PAF was responsible for a
590 significant proportion of IVIG-PSA-induced hypothermia (and ASA-associated death),
591 a finding concurrent with a dominant pathway initiated by hFcγRIIA on neutrophils.
592 Neutrophils are indeed the major producers of PAF in humans⁵⁸. Among the three
593 Histamine receptor antagonists tested, two (Pyrilamine and Tripolidine) significantly
594 inhibited IVIG-induced anaphylaxis by themselves, and one (Cetirizine) only had an
595 effect when combined with PAF-R antagonists. These findings suggest that both PAF
596 and histamine contribute to hypothermia and mortality in the VG1543 model. These
597 results are in agreement with the inefficacy of H1-antihistamine treatment alone on
598 systemic anaphylactic symptoms in patients. Reports by Vadas and colleagues indicate
599 a correlation between levels of circulating PAF, rather than histamine, with anaphylaxis
600 severity¹², and identified PAF as a central mediator of human anaphylaxis
601 pathogenesis⁵⁹; which aligns with our findings reported herein using locus-swapped
602 human low-affinity hFcγR^{KI} mice.

603

604 Our data indicate that IgG-dependant anaphylaxis in VG1543 mice proceeds via
605 an activating pathway dependent on hFcγRIIA and neutrophils, with a contribution of
606 basophils, and driven by the mediators PAF and histamine. Although expressed in this
607 novel knock-in mouse model, hFcγRIIA and hFcγRIIB were not sufficient to trigger
608 anaphylaxis. That such drastic anaphylaxis induction is possible in the context of native
609 inhibitory and activating hFcγR expression suggests a similar pathway may occur in
610 humans. VG1543 mice represent an attractive knock-in model for the study of human
611 low-affinity IgG receptors, in which the encoding genes remain expressed in their

612 cognate genetic environment, including intergenic sequences; and consequently cell
613 surface expression largely reflects that of humans. Although the polymorphisms
614 expressed in the VG1543 mouse represent a section of individuals within the population,
615 other people express alternate and/or heterozygous polymorphisms, some of which have
616 been demonstrated to predispose to immunological susceptibility or resistance¹⁴. It
617 would be clinically relevant to extend studies in hFcγR-knock in mice to understand the
618 effect of hFcγR polymorphisms on cell activation and subsequent biological responses,
619 and therefore on sensitivity to anaphylaxis or other allergic diseases involving IgG
620 antibodies.
621

621

622

ACKNOWLEDGMENTS

623 We are thankful to O. Godon, B. Iannascoli and O. Richard-LeGoff for technical
624 help, P. Vieira and L. Reber for scientific advice and D. Sinnaya for administrative help
625 (Institut Pasteur, Paris). We are thankful to our colleagues for their generous gifts: R.
626 Coffman (DNAX, Palo Alto, CA, USA), R. Good (USFCM, Tampa, FL, USA), H.
627 Karasuyama (Tokyo Medical and Dental University Graduate School, Tokyo, Japan)
628 and D. Voehringer (Universitätsklinikum, Erlangen, Germany) for antibodies. CI2MDP
629 was a gift of Roche Diagnostics GmbH. This work was supported by the European
630 Research Council (ERC)–Seventh Frame-work Program (ERC-2013-CoG 616050);
631 additional support by the Institut Pasteur and the Institut National de la Santé et de la
632 Recherche Médicale (INSERM). C.G. was supported partly by a stipend from the
633 Pasteur - Paris University (PPU) International PhD program and by the Institut Carnot
634 Pasteur Maladies Infectieuses, and partly by the Balsan company. F.J. is an employee of
635 the Centre National de La Recherche Scientifique (CNRS). H.B. is supported by a
636 fellowship from the University Pierre et Marie Curie.

637

AUTHORSHIP AND CONFLICT OF INTEREST STATEMENTS

639 C.G. performed all experiments, with contributions from F.J., D.A.M. and H.B.;
640 A.M., L.E.M. and N.T. designed mouse targeting and generated mouse strains; N.v.R.
641 provided reagents; C.G., F.J., L.E.M. and P.B. analysed and discussed results; C.G. and
642 P.B. wrote the manuscript; P.B. supervised and designed the research.
643 LM, NT and AM are employees of Regeneron Pharmaceuticals, Inc. and hold stock in
644 the company. H.B., P.B, C.G., B.I., F.J. and D.A.M. declare no competing financial
645 interests.

646

646

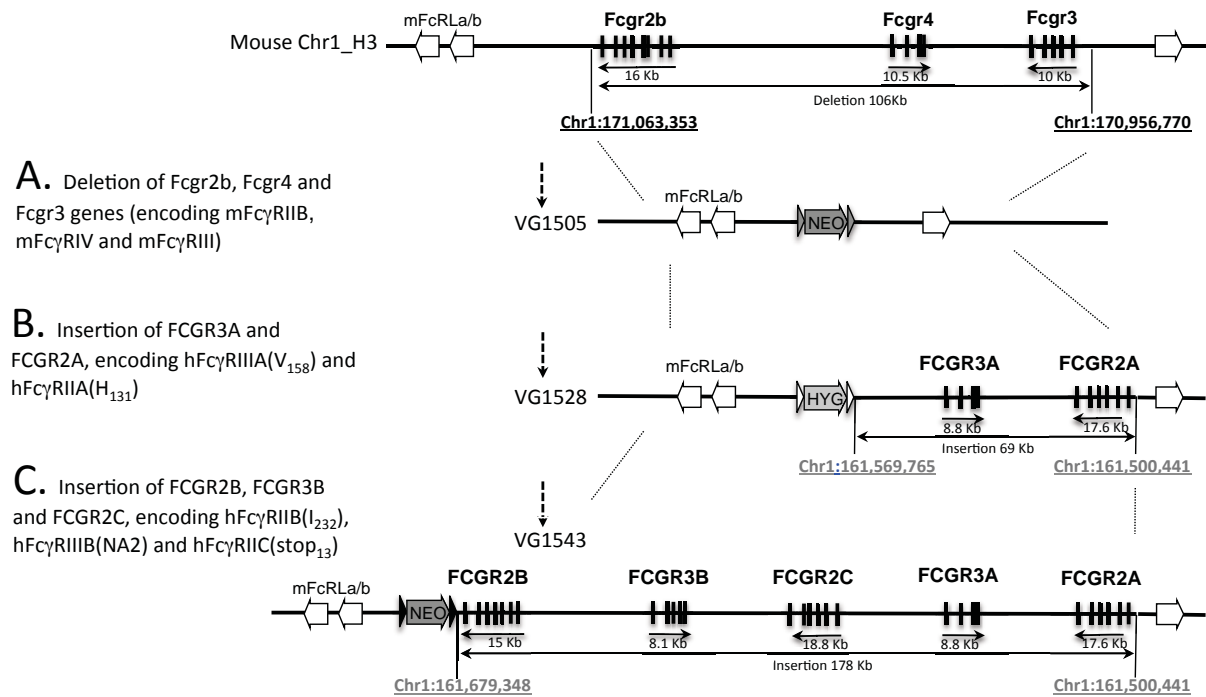
647

FIGURES and LEGENDS

648

649 **Figure 1: Humanization of the mouse low-affinity receptor locus.** Representations
650 are not drawn to scale. (A) Deletion of mouse *Fcgr2b*, *Fcgr4* and *Fcgr3* genes in a single
651 targeting step, deleting mouse sequences from 1:170,956,770 to 1:171,063,353 on
652 mouse Chr1_H3 (based on mouse GRCh38). (B) Insertion of human FCGR3A and
653 FCGR2A genes and (C) insertion of FCGR2B, FCGR3B and FCGR2C genes. The total
654 human sequence inserted in VG1543 ranges from 1:161,500,441 to 1:161,679,348 on
655 human Chr1_q23.3, based on human GRCh38. Mouse genomic coordinates are in black,
656 human genomic coordinates are in grey, light grey block arrow indicates Hygromycin
657 selection cassettes, dark grey block arrows indicate Neomycin selection cassettes, black
658 triangles represent *Loxp* sites, empty triangles represent *Frt* sites and grey triangles
659 represent *Lox2372* sites.

660

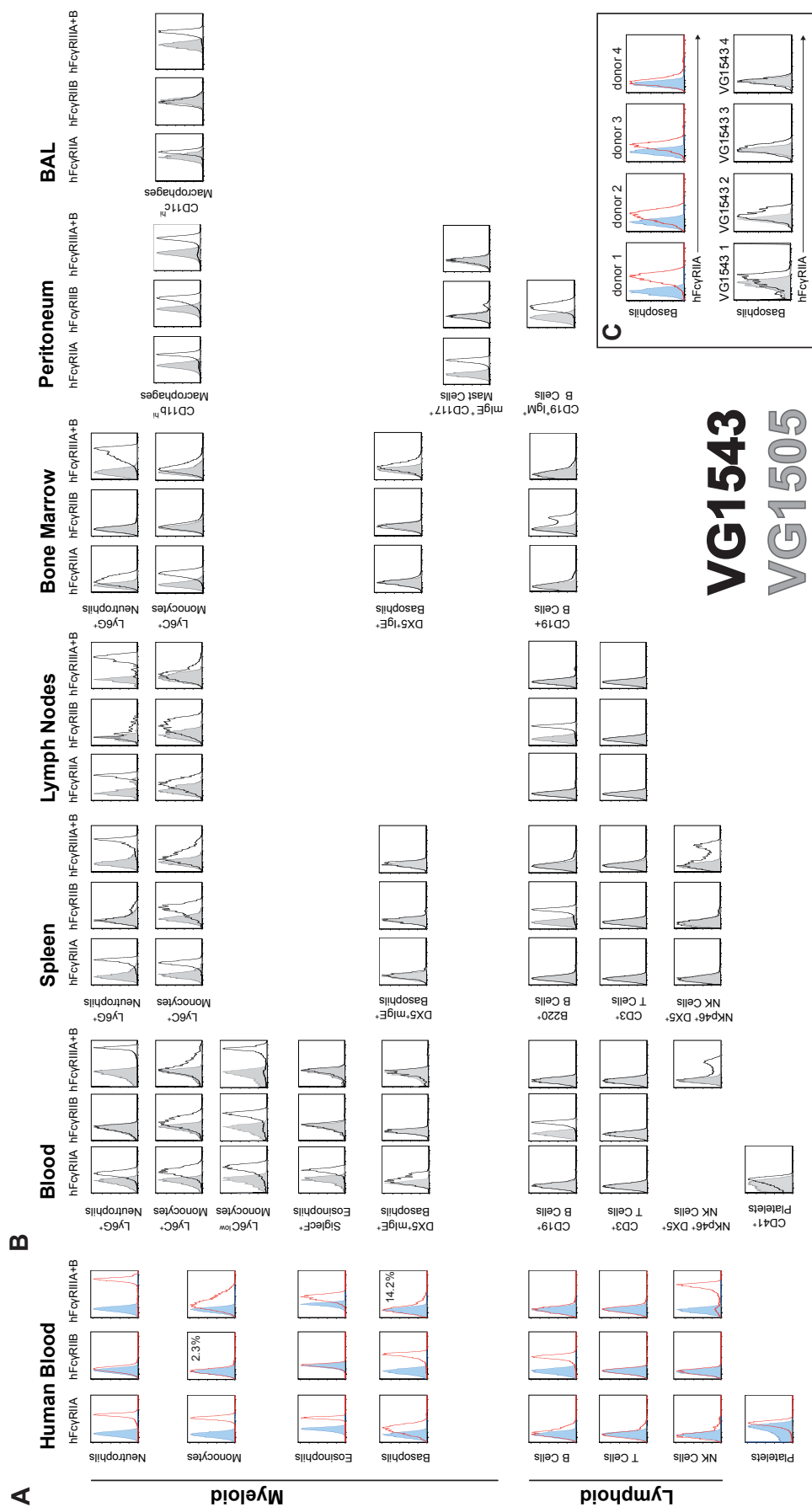
Figure 1

661

662 **Figure 2: Human FcγR expression on immune cell populations from VG1543 mice**
663 **recapitulates expression patterns in humans**

664 (A) hFcγRIIA, hFcγRIIB, hFcγRIIIA and hFcγRIIIB staining on immune cells from
665 human peripheral blood, assessed by fluorescent antibody labelling and flow cytometric
666 analysis. Shaded histograms indicate staining with an isotype control antibody,
667 excepting hFcγRIIB where shaded histograms indicate a fluorescence-minus-one
668 (FMO) control. (B) hFcγR staining on immune cells isolated from different tissues of
669 VG1543 mice, as indicated. Shaded histograms indicate background staining from
670 VG1505 mice. Data are representative of at least 2 independent experiments; total n>3.
671 BAL: bronchoalveolar lavage. Numbers indicate frequency of cells positive for FcγR
672 staining. (C) Individual variation in hFcγRIIA expression on basophils isolated from 4
673 different blood donors (upper panels) or from 4 different 1543 mice (lower panels).

Figure 2

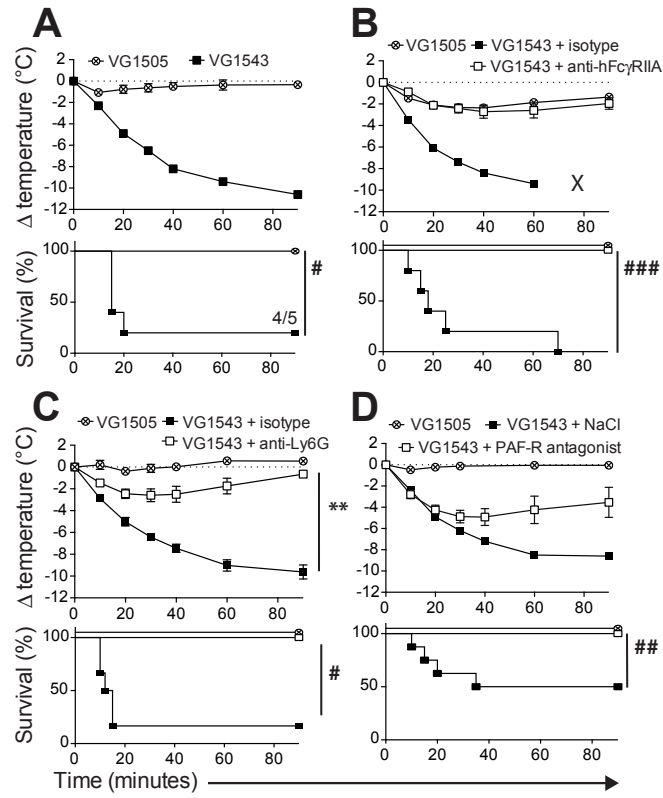


674

675 **Figure 3: VG1543 mice are susceptible to active systemic anaphylaxis, dominantly**
676 **mediated by hFcγRIIA, neutrophils and PAF.**

677 Indicated mice were immunised and challenged with BSA, and central temperatures and
678 survival rates were monitored. (A) Change in body temperature (upper panel) and
679 survival (lower panel) during BSA-ASA in VG1505 (crossed circles) and VG1543
680 (squares) mice. (B-D) BSA-ASA in VG1505 and VG1543 mice, and VG1543 mice
681 treated with (B) anti-hFcγRIIA blocking mAbs or isotype control, (C) anti-Ly6G mAbs
682 or isotype control, (D) vehicle (NaCl) or PAF-R antagonist ABT-491. Data are
683 represented as mean ± SEM and are representative of at least 2 independent experiments.
684 Numbers indicate mortality per experimental group; X represents 100% mortality. (#
685 p<0.05 ; ### p<0.001, Log-rank (Mantel-Cox) test for survival; * p<0.05, ** p<0.01,
686 Student's t-test of individual time points from 10 to 40min)

Figure 3

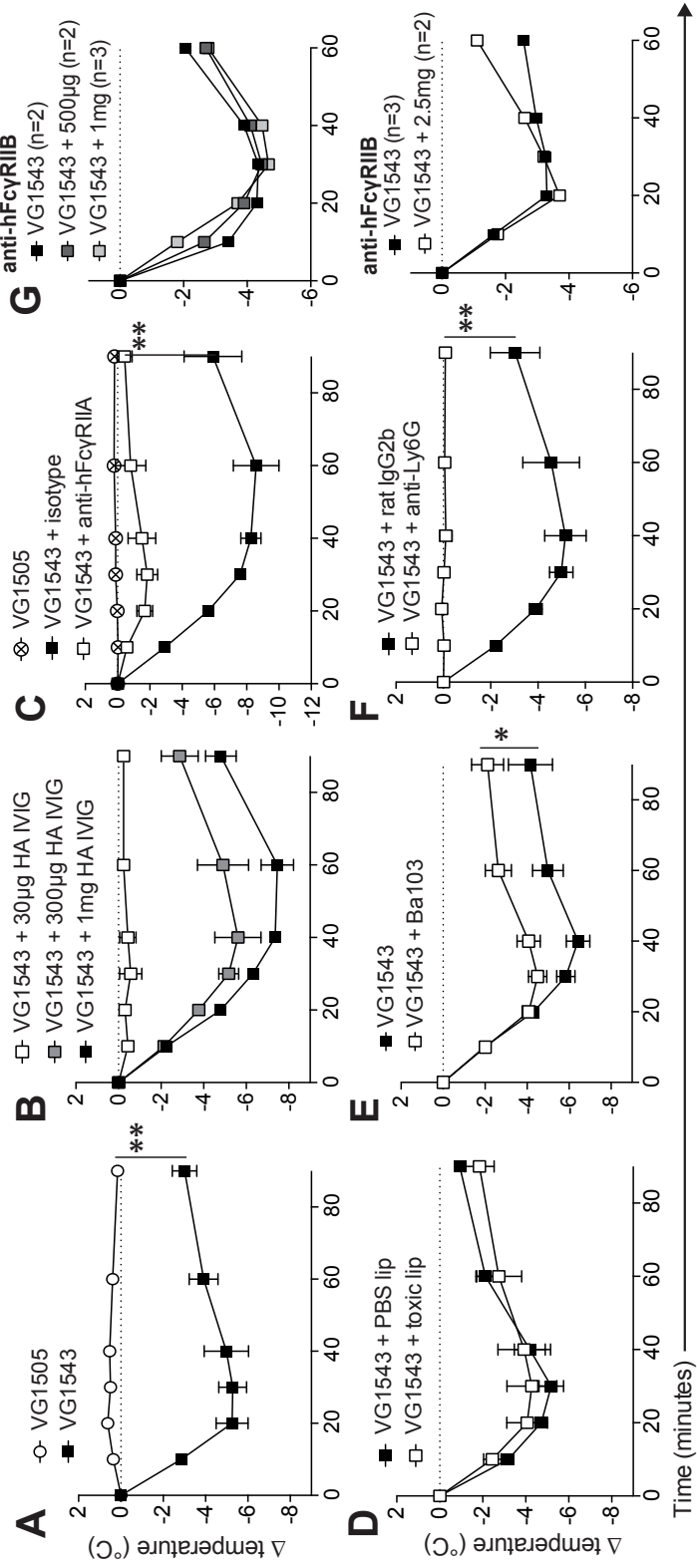


687

688 **Figure 4: Aggregated human IVIG triggers passive systemic anaphylaxis in**
689 **VG1543 mice, mediated by hFcγRIIA and neutrophils.**

690 VG1505 (circles) and VG1543 (squares) mice were injected with (A) 1mg or (B)
691 indicated amounts of heat-aggregated IVIG and central temperatures monitored. (C-F)
692 IVIG-PSA (1mg) in VG1543 mice injected with (C) anti-hFcγRIIA blocking mAbs, (D)
693 toxin-containing liposomes, (E) anti-CD200R3 mAbs, (F) anti-Ly6G mAbs, or
694 corresponding isotype or PBS controls, prior to anaphylaxis induction. (G) IVIG-PSA
695 (250μg) in VG1543 mice injected with indicated amounts of anti-hFcγRIIB blocking
696 mAbs. White or grey squares indicate treated mice; black squares indicate isotype or
697 vehicle controls. (A-F) Data are represented as mean ± SEM and are representative of at
698 least 2 independent experiments. (G) Data are represented as mean values of
699 independent experiments. (*p<0.05, **p<0.01; 2-way RM-ANOVA).

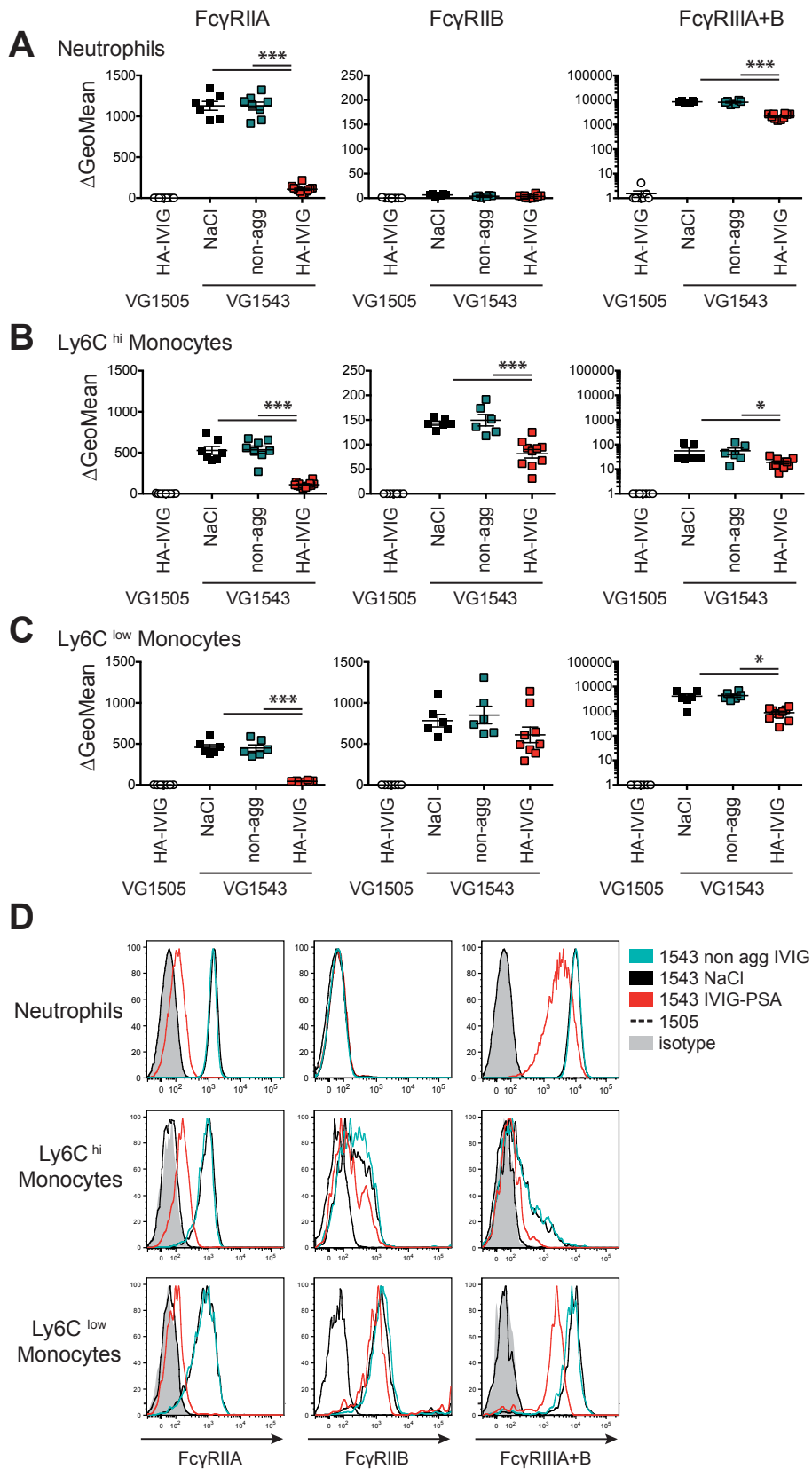
Figure 4



700

701 **Figure 5: Reduction in hFcγR expression on circulating myeloid cell populations**
702 **after IVIG-PSA.** hFcγRIIA, hFcγRIIB and hFcγRIII expression on (A) blood
703 neutrophils, (B) Ly6C^{hi} and (C) Ly6C^{low} monocytes from VG1543 mice; 1 hour after
704 injection of vehicle (NaCl), non-aggregated IVIG (non-agg) or heat aggregated-IVIG
705 and PSA induction (HA-IVIG). Background staining on cells from VG1505 mice is
706 shown 1 hour after injection of heat aggregated-IVIG. Values represent ΔGeoMean
707 between specific staining and corresponding isotype or FMO control, pooled from three
708 independent experiments. Representative histograms are shown in (D); background
709 staining of isotype control is indicated by shaded histograms; VG1505 mice by grey
710 histograms. (**p<0.001, *p<0.05, unpaired t test with Welch's correction)

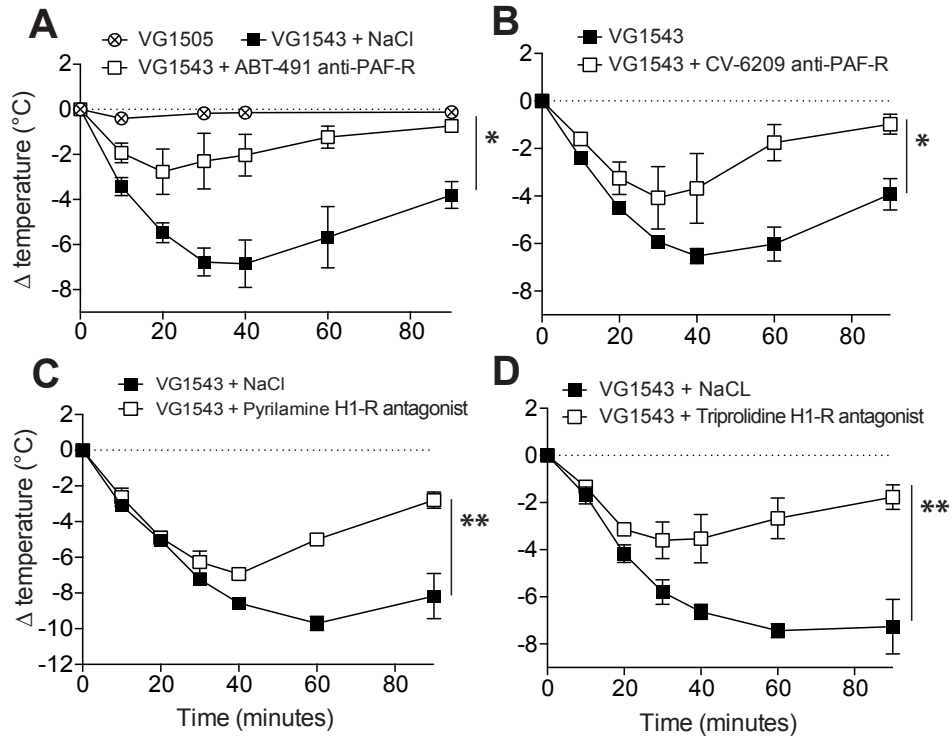
Figure 5



711

712 **Figure 6: The anaphylactic mediators PAF and histamine are responsible for**
713 **IVIG-PSA in VG1543 mice.** PSA was induced by 1mg heat-aggregated IVIG and
714 central temperatures monitored: indicated mice were pre-treated, with PAF-R
715 antagonists (A) ABT-491 or (B) CV-6209, H1-R antagonists (C) pyrilamine maleate or
716 (D) triprolidine hydrochloride, or with vehicle (NaCl). Data are represented as mean \pm
717 SEM and are representative of at least 2 independent experiments (* $p < 0.05$, ** $p < 0.01$,
718 VG1543 treated vs controls, 2-way RM-ANOVA)

Figure 6



719

TABLES

720

721 **Table 1:** Binding and crossbinding of human and mouse IgG subclasses to human and

722 mouse FcγRs

723 -, no binding; +/-, very-low binding; +, low-binding; ++, medium binding; +++, high

724 binding. Adapted from data reported in ^{19, 38, 60, 61} and unpublished data.

		HUMAN				MOUSE			
		IgG1	IgG2	IgG3	IgG4	IgG1	IgG2a/c	IgG2b	IgG3
HUMAN	hFcγRI	+++	-	+++	+++	-	+++	+++	+/-
	hFcγRIIA(H131)	++	+	+	+	+	+	+	-
	hFcγRIIA(R131)	++	+	+	+	++	+	+	-
	hFcγRIIB	+	+/-	+	+	-	-	+/-	-
	hFcγRIIC	+	+/-	+	+	-	-	+/-	-
	hFcγRIIIA(V158)	+	+/-	+++	+	-	+/-	-	-
	hFcγRIIIA(F158)	+	+/-	++	+	-	-	-	-
	hFcγRIIB(NA1)	+	-	++	-	-	-	-	-
	hFcγRIIB(NA2)	+	-	++	-	-	-	-	-
	hFcγRIIB(SH)	+	-	++	-	-	-	-	-
MOUSE	mFcγRI	+++	-	++	++	-	+++	+	+/-
	mFcγRIIB	-	+/-	-	-	++	+	++	-
	mFcγRIII	++	++	+/-	-	+	+	+	-
	mFcγRIV	++	+	++	+/-	-	+++	+++	-

725

726

726

REFERENCES

727

- 728 1. Mullins RJ, Dear KB, Tang ML. Time trends in Australian hospital anaphylaxis
729 admissions in 1998-1999 to 2011-2012. *J Allergy Clin Immunol* 2015; 136:367-
730 75.
- 731 2. Nocerino R, Leone L, Cosenza L, Berni Canani R. Increasing rate of
732 hospitalizations for food-induced anaphylaxis in Italian children: An analysis of
733 the Italian Ministry of Health database. *J Allergy Clin Immunol* 2015; 135:833-5
734 e3.
- 735 3. Turner PJ, Gowland MH, Sharma V, Ierodiakonou D, Harper N, Garcez T, et al.
736 Increase in anaphylaxis-related hospitalizations but no increase in fatalities: an
737 analysis of United Kingdom national anaphylaxis data, 1992-2012. *J Allergy
738 Clin Immunol* 2015; 135:956-63 e1.
- 739 4. Lee JK, Vadas P. Anaphylaxis: mechanisms and management. *Clin Exp Allergy*
740 2011; 41:923-38.
- 741 5. Fisher MM, Baldo BA. Mast cell tryptase in anaesthetic anaphylactoid reactions.
742 *Br J Anaesth* 1998; 80:26-9.
- 743 6. Cheifetz A, Smedley M, Martin S, Reiter M, Leone G, Mayer L, et al. The
744 incidence and management of infusion reactions to infliximab: a large center
745 experience. *Am J Gastroenterol* 2003; 98:1315-24.
- 746 7. Dybendal T, Guttormsen AB, Elsayed S, Askeland B, Harboe T, Florvaag E.
747 Screening for mast cell tryptase and serum IgE antibodies in 18 patients with
748 anaphylactic shock during general anaesthesia. *Acta Anaesthesiol Scand* 2003;
749 47:1211-8.
- 750 8. Golden DB. Patterns of anaphylaxis: acute and late phase features of allergic
751 reactions. *Novartis Found Symp* 2004; 257:101-10; discussion 10-5, 57-60, 276-
752 85.
- 753 9. Mertes PM, Alla F, Trechot P, Auroy Y, Jouglu E. Anaphylaxis during
754 anesthesia in France: an 8-year national survey. *J Allergy Clin Immunol* 2011;
755 128:366-73.
- 756 10. Laroche D, Gomis P, Gallimidi E, Malinovsky JM, Mertes PM. Diagnostic
757 value of histamine and tryptase concentrations in severe anaphylaxis with shock
758 or cardiac arrest during anesthesia. *Anesthesiology* 2014; 121:272-9.

- 759 11. Vadas P, Gold M, Perelman B, Liss GM, Lack G, Blyth T, et al. Platelet-
760 activating factor, PAF acetylhydrolase, and severe anaphylaxis. *N Engl J Med*
761 2008; 358:28-35.
- 762 12. Vadas P, Perelman B, Liss G. Platelet-activating factor, histamine, and tryptase
763 levels in human anaphylaxis. *J Allergy Clin Immunol* 2013; 131:144-9.
- 764 13. Jonsson F, Mancardi DA, Albanesi M, Bruhns P. Neutrophils in local and
765 systemic antibody-dependent inflammatory and anaphylactic reactions. *J Leukoc*
766 *Biol* 2013; 94:643-56.
- 767 14. Gillis C, Gouel-Cheron A, Jonsson F, Bruhns P. Contribution of Human
768 Fcγ3Rs to Disease with Evidence from Human Polymorphisms and
769 Transgenic Animal Studies. *Front Immunol* 2014; 5:254.
- 770 15. Oettgen HC, Martin TR, Wynshaw-Boris A, Deng C, Drazen JM, Leder P.
771 Active anaphylaxis in IgE-deficient mice. *Nature* 1994; 370:367-70.
- 772 16. Miyajima I, Dombrowicz D, Martin TR, Ravetch JV, Kinet JP, Galli SJ.
773 Systemic anaphylaxis in the mouse can be mediated largely through IgG1 and
774 Fc γ3R. Assessment of the cardiopulmonary changes, mast cell
775 degranulation, and death associated with active or IgE- or IgG1-dependent
776 passive anaphylaxis. *J Clin Invest* 1997; 99:901-14.
- 777 17. Tsujimura Y, Obata K, Mukai K, Shindou H, Yoshida M, Nishikado H, et al.
778 Basophils play a pivotal role in immunoglobulin-G-mediated but not
779 immunoglobulin-E-mediated systemic anaphylaxis. *Immunity* 2008; 28:581-9.
- 780 18. Strait RT, Morris SC, Yang M, Qu XW, Finkelman FD. Pathways of
781 anaphylaxis in the mouse. *J Allergy Clin Immunol* 2002; 109:658-68.
- 782 19. Jönsson F, Mancardi DA, Kita Y, Karasuyama H, Iannascoli B, Van Rooijen N,
783 et al. Mouse and human neutrophils induce anaphylaxis. *J Clin Invest* 2011;
784 121:1484-96.
- 785 20. Iff ET, Vaz NM. Mechanisms of anaphylaxis in the mouse. Similarity of shock
786 induced by anaphylaxis and by mixtures of histamine and serotonin. *Int Arch*
787 *Allergy Appl Immunol* 1966; 30:313-22.
- 788 21. Million M, Fioramonti J, Zajac JM, Bueno L. Effects of neuropeptide FF on
789 intestinal motility and temperature changes induced by endotoxin and platelet-
790 activating factor. *Eur J Pharmacol* 1997; 334:67-73.

- 791 22. van de Veen W, Stanic B, Yaman G, Wawrzyniak M, Sollner S, Akdis DG, et al.
792 IgG4 production is confined to human IL-10-producing regulatory B cells that
793 suppress antigen-specific immune responses. *J Allergy Clin Immunol* 2013;
794 131:1204-12.
- 795 23. Rispens T, Derksen NI, Commins SP, Platts-Mills TA, Aalberse RC. IgE
796 production to alpha-gal is accompanied by elevated levels of specific IgG1
797 antibodies and low amounts of IgE to blood group B. *PLoS One* 2013; 8:e55566.
- 798 24. Patil SU, Ogunniyi AO, Calatroni A, Tadigotla VR, Ruiter B, Ma A, et al.
799 Peanut oral immunotherapy transiently expands circulating Ara h 2-specific B
800 cells with a homologous repertoire in unrelated subjects. *J Allergy Clin*
801 *Immunol* 2015; 136:125-34 e12.
- 802 25. Hoh RA, Joshi SA, Liu Y, Wang C, Roskin KM, Lee JY, et al. Single B-cell
803 deconvolution of peanut-specific antibody responses in allergic patients. *J*
804 *Allergy Clin Immunol* 2015.
- 805 26. Bruhns P. Properties of mouse and human IgG receptors and their contribution
806 to disease models. *Blood* 2012; 119:5640-9.
- 807 27. Mancardi DA, Albanesi M, Jonsson F, Iannascoli B, Van Rooijen N, Kang X, et
808 al. The high-affinity human IgG receptor FcγRI (CD64) promotes IgG-
809 mediated inflammation, anaphylaxis, and antitumor immunotherapy. *Blood*
810 2013; 121:1563-73.
- 811 28. Jönsson F, Mancardi DA, Zhao W, Kita Y, Iannascoli B, Khun H, et al. Human
812 FcγRIIA induces anaphylactic and allergic reactions. *Blood* 2012;
813 119:2533-44.
- 814 29. Smith P, DiLillo DJ, Bournazos S, Li F, Ravetch JV. Mouse model
815 recapitulating human Fcγ receptor structural and functional diversity. *Proc*
816 *Natl Acad Sci U S A* 2012; 109:6181-6.
- 817 30. Meyer T, Robles-Carrillo L, Davila M, Brodie M, Desai H, Rivera-Amaya M, et
818 al. CD32a antibodies induce thrombocytopenia and type II hypersensitivity
819 reactions in FCGR2A mice. *Blood* 2015; 126:2230-8.
- 820 31. Valenzuela DM, Murphy AJ, Friendewey D, Gale NW, Economides AN,
821 Auerbach W, et al. High-throughput engineering of the mouse genome coupled
822 with high-resolution expression analysis. *Nat Biotechnol* 2003; 21:652-9.

- 823 32. Macdonald LE, Karow M, Stevens S, Auerbach W, Poueymirou WT, Yasenchak
824 J, et al. Precise and in situ genetic humanization of 6 Mb of mouse
825 immunoglobulin genes. *Proc Natl Acad Sci U S A* 2014; 111:5147-52.
- 826 33. Auerbach W, Dunmore JH, Fairchild-Huntress V, Fang Q, Auerbach AB,
827 Huszar D, et al. Establishment and chimera analysis of 129/SvEv- and
828 C57BL/6-derived mouse embryonic stem cell lines. *Biotechniques* 2000;
829 29:1024-8, 30, 32.
- 830 34. Veri MC, Gorlatov S, Li H, Burke S, Johnson S, Stavenhagen J, et al.
831 Monoclonal antibodies capable of discriminating the human inhibitory
832 Fc γ -receptor IIB (CD32B) from the activating Fc γ -receptor IIA
833 (CD32A): biochemical, biological and functional characterization. *Immunology*
834 2007; 121:392-404.
- 835 35. Bruhns P, Jonsson F. Mouse and human FcR effector functions. *Immunol Rev*
836 2015; 268:25-51.
- 837 36. Tutt AL, James S, Laversin SA, Tipton TR, Ashton-Key M, French RR, et al.
838 Development and Characterization of Monoclonal Antibodies Specific for
839 Mouse and Human Fc γ Receptors. *J Immunol* 2015; 195:5503-16.
- 840 37. Cassard L, Jonsson F, Arnaud S, Daeron M. Fc γ receptors inhibit mouse
841 and human basophil activation. *J Immunol* 2012; 189:2995-3006.
- 842 38. Bruhns P, Iannascoli B, England P, Mancardi DA, Fernandez N, Jorieux S, et al.
843 Specificity and affinity of human Fc γ receptors and their polymorphic
844 variants for human IgG subclasses. *Blood* 2009; 113:3716-25.
- 845 39. Tsuboi N, Asano K, Lauterbach M, Mayadas TN. Human neutrophil Fc γ
846 receptors initiate and play specialized nonredundant roles in antibody-mediated
847 inflammatory diseases. *Immunity* 2008; 28:833-46.
- 848 40. Khodoun MV, Strait R, Armstrong L, Yanase N, Finkelman FD. Identification
849 of markers that distinguish IgE- from IgG-mediated anaphylaxis. *Proc Natl*
850 *Acad Sci U S A* 2011; 108:12413-8.
- 851 41. McKenzie SE, Taylor SM, Malladi P, Yuhan H, Cassel DL, Chien P, et al. The
852 role of the human Fc receptor Fc γ RIIA in the immune clearance of
853 platelets: a transgenic mouse model. *J Immunol* 1999; 162:4311-8.
- 854 42. Li F, Ravetch JV. Inhibitory Fc γ receptor engagement drives adjuvant and
855 anti-tumor activities of agonistic CD40 antibodies. *Science* 2011; 333:1030-4.

- 856 43. Li M, Wirthmueller U, Ravetch JV. Reconstitution of human Fc gamma RIII
857 cell type specificity in transgenic mice. *J Exp Med* 1996; 183:1259-63.
- 858 44. Takai T, Li M, Sylvestre D, Clynes R, Ravetch JV. FcR gamma chain deletion
859 results in pleiotropic effector cell defects. *Cell* 1994; 76:519-29.
- 860 45. Borges L, Cosman D. LIRs/ILTs/MIRs, inhibitory and stimulatory Ig-
861 superfamily receptors expressed in myeloid and lymphoid cells. *Cytokine*
862 *Growth Factor Rev* 2000; 11:209-17.
- 863 46. Zarbock A, Abram CL, Hundt M, Altman A, Lowell CA, Ley K. PSGL-1
864 engagement by E-selectin signals through Src kinase Fgr and ITAM adapters
865 DAP12 and FcR gamma to induce slow leukocyte rolling. *J Exp Med* 2008;
866 205:2339-47.
- 867 47. Boulaftali Y, Hess PR, Kahn ML, Bergmeier W. Platelet immunoreceptor
868 tyrosine-based activation motif (ITAM) signaling and vascular integrity. *Circ*
869 *Res* 2014; 114:1174-84.
- 870 48. Warmerdam PA, van de Winkel JG, Gosselin EJ, Capel PJ. Molecular basis for
871 a polymorphism of human Fc gamma receptor II (CD32). *J Exp Med* 1990;
872 172:19-25.
- 873 49. Chen K, Nishi H, Travers R, Tsuboi N, Martinod K, Wagner DD, et al.
874 Endocytosis of soluble immune complexes leads to their clearance by
875 Fc gamma RIIIB but induces neutrophil extracellular traps via Fc gamma RIIA in
876 vivo. *Blood* 2012; 120:4421-31.
- 877 50. Mancardi DA, Jonsson F, Iannascoli B, Khun H, Van Rooijen N, Huerre M, et al.
878 The murine high-affinity IgG receptor Fc(gamma)RIV is sufficient for
879 autoantibody-induced arthritis. *J Immunol* 2011; 186:1899-903.
- 880 51. Langlet C, Tamoutounour S, Henri S, Luche H, Ardouin L, Gregoire C, et al.
881 CD64 Expression Distinguishes Monocyte-Derived and Conventional Dendritic
882 Cells and Reveals Their Distinct Role during Intramuscular Immunization. *J*
883 *Immunol* 2012; 188:1751-60.
- 884 52. Heijnen IA, van Vugt MJ, Fanger NA, Graziano RF, de Wit TP, Hofhuis FM, et
885 al. Antigen targeting to myeloid-specific human Fc gamma RI/CD64 triggers
886 enhanced antibody responses in transgenic mice. *J Clin Invest* 1996; 97:331-8.

- 887 53. Brown SG, Stone SF, Fatovich DM, Burrows SA, Holdgate A, Celenza A, et al.
888 Anaphylaxis: Clinical patterns, mediator release, and severity. *J Allergy Clin*
889 *Immunol* 2013.
- 890 54. Smith KG, Clatworthy MR. FcγRIIB in autoimmunity and infection:
891 evolutionary and therapeutic implications. *Nat Rev Immunol* 2010; 10:328-43.
- 892 55. Khodoun MV, Kucuk ZY, Strait RT, Krishnamurthy D, Janek K, Clay CD, et al.
893 Rapid desensitization of mice with anti-FcγRIIb/FcγRIII mAb
894 safely prevents IgG-mediated anaphylaxis. *J Allergy Clin Immunol* 2013;
895 132:1375-87.
- 896 56. Ohnmacht C, Schwartz C, Panzer M, Schiedewitz I, Naumann R, Voehringer D.
897 Basophils orchestrate chronic allergic dermatitis and protective immunity
898 against helminths. *Immunity* 2010; 33:364-74.
- 899 57. Reber LL, Marichal T, Mukai K, Kita Y, Tokuoka SM, Roers A, et al. Selective
900 ablation of mast cells or basophils reduces peanut-induced anaphylaxis in mice.
901 *J Allergy Clin Immunol* 2013; 132:881-8 e11.
- 902 58. Jouvin-Marche E, Ninio E, Beaurain G, Tence M, Niaudet P, Benveniste J.
903 Biosynthesis of Paf-acether (platelet-activating factor). VII. Precursors of Paf-
904 acether and acetyl-transferase activity in human leukocytes. *J Immunol* 1984; 133:892-8.
- 905 59. Gill P, Jindal NL, Jagdis A, Vadas P. Platelets in the immune response:
906 Revisiting platelet-activating factor in anaphylaxis. *J Allergy Clin Immunol*
907 2015; 135:1424-32.
- 908 60. Nimmerjahn F, Bruhns P, Horiuchi K, Ravetch JV. FcγRIV: a novel FcR
909 with distinct IgG subclass specificity. *Immunity* 2005; 23:41-51.
- 910 61. Mancardi DA, Iannascoli B, Hoos S, England P, Daeron M, Bruhns P.
911 FcγRIV is a mouse IgE receptor that resembles macrophage FcεRI
912 in humans and promotes IgE-induced lung inflammation. *J Clin Invest* 2008;
913 118:3738-50.
- 914

SUPPLEMENTAL METHODS

Generation of mFcγRIIB, mFcγRIII and mFcγRIV knock-out mice.

A targeting construct (Figure 1A) for deleting the mouse Fcgr2b, Fcgr3 and Fcgr4 genes (encoding mFcγRIIB, mFcγRIII, and mFcγRIV respectively) in a single targeting step was constructed by using *VELOCIGENE* technology¹. Mouse sequences were obtained from bacterial artificial chromosome (BAC) clone RP23-395F6. A donor fragment was constructed by cloning a lox'd neomycin cassette flanked by site-specific recombination sites. More specifically, 5' mouse homology arm, corresponding to 270bp of mouse sequence located 3796 bp downstream of Fcgr2b, was PCR'ed using oligos (Supplemental Tables 1 and 2) and cloned upstream of a mutant lox'd neomycin selection cassette followed by a mouse 3' homology arm corresponding to 342 bp of mouse sequence (PCR using oligos noted in Supplemental Tables 1 and 2) located 4001 bp upstream of the ATG of Fcgr3. This donor fragment was inserted into *Escherichia coli* strain DH10B containing the mouse BAC clone RP23-395F6 and a recombination enzyme vector. Cells were grown in drug selection medium. Upon homologous recombination (BHR) at the locus, a drug selection cassette replaces the Fcgr2b, Fcgr3 and Fcgr4 genes. Individual clones were grown, and the targeted BAC DNA that contains a lox'd drug cassette in place of the Fcgr2b, Fcgr3 and Fcgr4 genes was extracted. Targeted cells were identified by PCR using up detect primer set and down detect primer set (Supplemental Tables 1 and 2). Part of the vector was sequenced to confirm proper mouse-cassette junctions and pulsed field gel electrophoresis was used to establish insert size and expected restriction fragment length.

The targeting vector (LTVEC) VG1505 was linearized and used to electroporate VGF1 mouse embryonic stem (ES) cells. Upon homologous recombination at the locus 106kb of the endogenous Fcgr2b, Fcgr3 and Fcgr4 locus is thereby deleted & replaced by lox'd neomycin cassette resulting in an ES cell that does not express endogenous Fcgr2b, Fcgr3 and Fcgr4 genes. Correctly targeted ES cells were introduced into an eight cell stage mouse embryo by the *VELOCIMOUSE* method². *VELOCIMICE* (F0 mice fully derived from the donor ES cell) bearing the deleted Fcgr2b, Fcgr3 and Fcgr4 genes were identified by genotyping for loss of mouse allele using a modification of allele assay (Supplemental Table 3).

Generation of knock-in hFcγRIIA(H₁₃₁)-hFcγRIIB(I₂₃₂)-hFcγRIIC(Stop₁₃)-hFcγRIIIA(V₁₅₈)-hFcγRIIIB(NA2) mice

Targeting constructs (Figure 1B-C) for subsequent humanization of mouse mFcγRs by two sequential targeting steps, were constructed by using *VELOCIGENE* technology¹. For the first targeting construct, VG1528, human sequences were obtained from bacterial artificial chromosome (BAC) clone CTD-2514J12. BACvec VG1528 was constructed in four steps as described in Supplemental Tables 1 and 2. In step 1, a donor fragment was constructed by cloning a frt'd hygromycin cassette flanked by site-specific recombination sites. More specifically, 5' BAC backbone homology arm, corresponding to 384bp of pBeloBAC11, was PCR'ed using oligos (Supplemental Table 1) and cloned upstream of a frt'd hygromycin selection cassette followed by a human 3' homology arm corresponding to 342bp of human sequence (PCR'd using oligos in Supplemental Tables 1 and 2) located 19kb upstream of the human FCGR3A gene (encoding hFcγRIIIA). BHR with this donor fragment deleted 41kb from the 5' end of CTD-2514J12, replacing it with an I-CeuI site and the frt'd hygromycin cassette to make VI209. In step 2, VI209 was modified by BHR to insert a PI-SceI site and spec cassette at the 3' end to make VI212 (Supplemental Tables 1 and 2). In step 3, RP23-395F6 was modified by BHR to delete the entire 106kb mouse low-affinity mFcγR locus (Fcgr2b, Fcgr3 and Fcgr4 genes), replacing it with a lox'd neomycin cassette flanked by a 5' I-CeuI site and a 3' PI-SceI site. The extra PI-SceI site in the backbone was then deleted by AscI digestion and ligation to make VI208. In step 4, the 69kb human hFcγRs-encoding fragment from VI212 was ligated into the I-CeuI and PI-SceI sites of VI208, replacing the lox'd neomycin cassette to make the final LTVEC VG1528.

For the second targeting construct VG1543, human sequences were obtained from bacterial artificial chromosome (BAC) clone RP11-697E5. BACvec VG1543 was constructed in three steps as described in Supplemental Tables 1 and 2. In step 1, a donor fragment was constructed by cloning a spectinomycin cassette flanked by site-specific recombination sites. More specifically, 5' homology arm, corresponding to 59bp of human sequence and BAC backbone sequence that is 4558 bp downstream of FCGR3A, was ligated to a spectinomycin selection cassette followed by a 3' homology arm corresponding to 333bp of backbone sequence in pBACe3.6. BHR with this donor fragment trimmed the human hFcγR locus on the proximal end of RP11-697E5,

deleting the PI-SceI site, to make VI217. In step 2, VI217 was modified by BHR using a donor fragment consisting of 5' homology arm corresponding to 258bp of BAC backbone sequence in pBACe3.6, a frt'd hygromycin cassette flanked by a 5' NotI site and a 3' PI-SceI site, and 3' homology arm corresponding to 274bp of human sequence 1188bp upstream of FCGR2B to make VI222. In step 3, the 47kb mouse distal homology arm with lox'd neomycin cassette from VI208 was ligated into the NotI and PI-SceI sites of VI222, replacing the frt'd hygromycin cassette to make the final LTVEC VG1543.

The targeting vectors were linearized and used to electroporate mouse embryonic stem (ES) cells³. Upon homologous recombination at the locus 106kb of the endogenous mouse low-affinity FcγR locus (Fcgr2b, Fcgr3 and Fcgr4 genes) is thereby deleted & replaced by human FCGR2B, FCGR3B, FCGR2C, FCGR3A and FCGR2A genes (encoding hFcγRIIB variant I₂₃₂, hFcγRIIB variant NA2, hFcγRIIC variant stop₁₃, hFcγRIIIA variant V₁₅₈, and hFcγRIIA variant H₁₃₁) by sequential targeting of VG1528 and VG1543, resulting in an ES cell that expresses low-affinity human hFcγR genes instead of endogenous low-affinity mouse mFcγR genes. Correctly targeted ES cells were introduced into an eight cell stage mouse embryo by the *VELOCIMOUSE* method². *VELOCIMICE* (F0 mice fully derived from the donor ES cell) bearing the human FCGR2B, FCGR3B, FCGR2C, FCGR3A and FCGR2A genes were identified by genotyping for loss of mouse allele & gain of human allele using a modification of allele assay (Supplemental Table 3).

Antibodies and reagents

Bovine serum albumin (BSA), complete and incomplete Freund's adjuvant (CFA, IFA) and ABT-491 were from Sigma-Aldrich; Cetirizine DiHCl was from Selleck Chemicals; TNP-BSA was from Santa Cruz. Fluorescently labelled anti-mouse CD11b, CD43, CD49b, CD115, CD335 (NKp46), Ly6C, Ly6G, Gr-1, B220, IgD and SiglecF were from BD Biosciences; anti-mouse CD19 and IgM from Biolegend; and anti-mouse IgE from eBioscience. Fluorescently labelled anti-human CD3, CD11b, CD14, CD15, CD19, CD56 were from Miltenyi Biotec; anti-human CD61 and CD16 (3G8) from BD Biosciences; anti-hFcγRIIA (IV.3) from Stem Cell Technologies. Fluorescently labelled anti-hFcγRIIB (2B6) in a chimeric mouse-human IgG1 N_{297A} form was prepared in-house.

PBS-liposomes and Clodronate-liposomes were prepared as published⁴. The hybridoma producing mAbs anti-hFcγRIIA (IV.3) was provided by C.L. Anderson (Heart & Lung Research Institute, Columbus, OH, USA), anti-Gr1 (RB6-8C4) by R. Coffman (DNAX Research Institute, Palo Alto, California, USA), and anti-Ly-6G (NIMP-R14) by C. Leclerc (Institut Pasteur, Paris, France). mAbs were purified from hybridoma supernatants by Protein G-affinity purification. Purified mAbs anti-Ba103 were provided by H. Karasuyama (Tokyo Medical and Dental University Graduate School, Tokyo, Japan).

Tissue processing

Cells were isolated from the blood and organs of VG1505 and VG1543 mice as follows. Spleens were dissociated through a 70µm cell strainer into MACS buffer (PBS /0.5% BSA /2mM EDTA) and RBC lysis was performed using an ammonium chloride-based buffer. For isolation of skin cells, ears were split into dorsal and ventral halves and roughly chopped before digestion with 0.25mg/mL Liberase TL ResearchGrade (Roche) + 0.1mg/mL DNase (Sigma) for 1h at 37°C (800rpm; Eppendorf Thermomixer), washed with 10x volume of PBS/ 10%FBS /2mM EDTA and processed through a 100µm cell strainer. Livers were perfused with cold PBS before dissection, and processed using the GentleMACS liver dissociation kit and the Octo Dissociator (Miltenyi Biotec). Cells were isolated from the peritoneum by lavage with 6mL cold PBS; BALs were performed 3x with 1mL PBS. For blood leukocyte analysis, a precise volume of heparinised blood was subjected to RBC lysis and washed with MACS buffer.

Flow cytometry

Human EDTA-collected blood was obtained from the blood bank « Établissement Français du Sang ». After red blood cell lysis, leukocytes were stained with fluorescently labelled mAbs for 30min at 4°C. Human cell populations were distinguished as: CD15⁺CD193^{neg} neutrophils; CD193⁺CD15^{low} eosinophils; CD3⁺ T cells; CD19⁺ B cells; CD56⁺ NK cells; CD123⁺CD203c^{low}FcεRI^{hi} basophils; CD14⁺ monocytes; CD14^{hi}CD16^{low} classical monocytes and CD14^{low}CD16^{hi} patrolling monocytes; CD61⁺ platelets.

Isolated single cell suspensions from mouse blood and organs were stained with fluorescently labelled mAbs for 30-40min at 4°C. Mouse cell populations were distinguished by FSC/SSC characteristics and by surface markers as follows: neutrophils (CD11b⁺ Ly6C^{low} Ly6G⁺), monocytes (classical CD11b⁺ Ly6G^{neg} Ly6C^{hi} or patrolling CD11b⁺ Ly6G^{neg} CD115⁺ Ly6C^{low}), peritoneal macrophages (CD11b^{hi} Gr1^{low}), alveolar macrophages (CD11c^{hi}), liver and bone marrow macrophages (CD11b^{hi} Gr1^{low}F4/80⁺), eosinophils (CD11b⁺ SiglecF⁺ SSC^{hi}), basophils (CD45^{low} mIgE⁺ CD49b⁺), mast cells (mIgE⁺CD49b⁺CD117⁺), platelets (CD41⁺), T cells (CD3⁺; CD4⁺/CD8⁺), B cells (CD19⁺/B220⁺, subpopulations as in Supplemental Figure 1), and NK cells (NKp46⁺CD49b⁺).

hFc γ RIIA was identified by the specific mAb clone IV.3. hFc γ RIIIB was identified by the clone 2B6⁵, expressed as a chimeric mouse-human IgG1 N₂₉₇A variant to inhibit unspecific binding via the Fc portion of the antibody. We used an anti-CD16 antibody (clone 3G8) to characterise jointly hFc γ RIIIA and hFc γ RIIIB expression, because we could not identify, using a series of commercially available anti-CD16 antibodies, an antibody able to distinguish surface expression of hFc γ RIIIA(V₁₅₈) from hFc γ RIIIB(NA2). In supplemental figure 7: anti-CD32 clone FLI8.26 defines hFc γ RIIA+B expression; anti-CD32(R131) clone 3D3 defines hFc γ RIIB expression only, because VG1543 mice express the H131 variant of hFc γ RIIA; anti-CD16 clone MEM-154 defines hFc γ RIIA+B expression. mFc γ RI was identified using the specific clone X54-5/7.1 (BD Biosciences).

For *ex vivo* binding of cells with human IgG, blood cell suspensions were incubated first with aggregated IVIG (20 μ g/mL) for 1 hour on ice, and then stained with a fluorescently labelled antibody cocktail, including anti-human IgG Fab-specific goat F(ab')₂ fragment (Jackson Immunoresearch). Cells isolated from VG1543 mice after IVIG-PSA were stained with the secondary antibody alone. Samples were run on a MACSQuant flow cytometer (Miltenyi) and data analysed using FlowJo Software (Treestar Inc.).

Specificity and efficiency of cell depletion strategies:

Appropriate antibody-mediated cell depletion using anti-Ly6G (NIMP-R14) and anti-CD200R3 (Ba103) was examined by flow cytometry analysis. NIMP-R14 treatment (300 μ g) efficiently depleted neutrophils in the blood, spleen and peritoneum.

The percentage of total CD11b⁺CD115⁺ monocytes in the blood and CD11b⁺Gr1^{int} monocytes in the spleen were unaffected, while the percentage of CD11b⁺F4/80⁺ macrophages in the peritoneum increased slightly. The percentage of blood basophils was slightly increased, but total numbers were unaffected and spleen basophils and peritoneal mast cells were not affected. We did, however observe that the frequency of Ly6C^{hi} monocytes decreased while the frequency of Ly6C^{low} monocytes increased following NIMP-R14 treatment, a phenomenon which may reflect epitope masking by NIMP-R14 due to a low-level cross-recognition. NIMP-R14 therefore efficiently depletes neutrophils with some effects on other cell populations. Ba103 administration at 30µg per mouse induced basophil depletion in the blood and spleen, without affecting circulating neutrophils and monocytes (data not shown), or peritoneal mast cells. Yet the depletion of basophils was incomplete (up to 70%), and not uniformly efficient across individuals (Supplementary Figure 5A). We therefore administered Ba103 at a two-fold greater dose (60µg/mouse). Although we could not detect a significant increase in depletion compared to the 30µg dose (data not shown), this increased dose indicated a minor contribution of basophils to anaphylaxis severity (Figure 4E).

We have previously demonstrated efficient monocyte/macrophage depletion in the blood and spleen following intravenous liposome injection (Beutier et al 2016. *JACI in press*); whereas peritoneal macrophages remained intact. In efforts to achieve complete monocyte/macrophage depletion, we combined multiple injections of clodronate liposomes with different routes of administration, resulting in higher total liposome load: these approaches were inconclusive, however, and while we were efficiently able to deplete resident macrophages, we observed increases in numbers of circulating inflammatory monocytes, and wildly inconsistent responses during IVIG-PSA. Indeed, toxic liposomes can affect all phagocytic cell populations, and approaches to increase their efficacy also augment non-specific effects. For this study, we confirmed that the ability of macrophages to mediate thrombocytopenia (reflecting capacity to engage and engulf antibody-bound cells, and by logical extension, immune complexes) remains intact following antibody-mediated depletion strategies (*e.g.* NIMP-R14 or Ba103), but is blocked following intravenous clodronate liposome injection at the doses used herein.

Statistics

Statistical analyses were performed using Prism. Survival was analysed by a log-rank (Mantel-Cox) test to compare test subjects and controls. Temperature loss during ASA was compared using a Student's t-test of individual time points. Temperature loss during PSA was compared by 2-way repeated measures ANOVA (RM-ANOVA), except in Supplementary Figure 8E in which groups were compared using a Student's t-test at 30min. hFcγR expression in Figure 5 and Supplementary Figure 7 was compared using an unpaired t-test with Welch's correction for unequal variances.

Supplemental References

1. Valenzuela DM, Murphy AJ, Friendewey D, Gale NW, Economides AN, Auerbach W, et al. High-throughput engineering of the mouse genome coupled with high-resolution expression analysis. *Nat Biotechnol* 2003; 21:652-9.
2. Poueymirou WT, Auerbach W, Friendewey D, Hickey JF, Escaravage JM, Esau L, et al. F0 generation mice fully derived from gene-targeted embryonic stem cells allowing immediate phenotypic analyses. *Nat Biotechnol* 2007; 25:91-9.
3. Auerbach W, Dunmore JH, Fairchild-Huntress V, Fang Q, Auerbach AB, Huszar D, et al. Establishment and chimera analysis of 129/SvEv- and C57BL/6-derived mouse embryonic stem cell lines. *Biotechniques* 2000; 29:1024-8, 30, 32.
4. Van Rooijen N, Sanders A. Liposome mediated depletion of macrophages: mechanism of action, preparation of liposomes and applications. *J Immunol Methods* 1994; 174:83-93.
5. Veri MC, Gorlatov S, Li H, Burke S, Johnson S, Stavenhagen J, et al. Monoclonal antibodies capable of discriminating the human inhibitory Fcγ-receptor IIB (CD32B) from the activating Fcγ-receptor IIA (CD32A): biochemical, biological and functional characterization. *Immunology* 2007; 121:392-404.

SUPPLEMENTAL FIGURE LEGENDS

Supplemental Figure 1: VG1505 and VG1543 mice demonstrate normal immune cell composition of major compartments, and comparable expression of mFcεRI and mFcγRI. (A) Spleens taken from VG1505 mice and VG1543 mice were comparable in size. (B) Leukocyte counts in total blood were enumerated using an automatic blood cell analyser and (C; see also supplementary table 4) frequency of blood immune cell populations was determined by flow cytometry. (D) mFcεRI expression on peritoneal mast cells from VG1505 mice and VG1543 mice: representative histograms are shown and values represent ΔGeoMean between specific staining and isotype control. (E) Anti-IgE staining on basophils in the blood, spleen and bone marrow, as a surrogate measure of mFcεRI expression. (F) Representative histograms showing mFcγRI expression on various monocyte and macrophage populations isolated from VG1505 mice and VG1543 mice.

Supplemental Figure 2: Variability in hFcγR expression on monocytes and eosinophils from different human blood donors. B cells and monocytes exhibit subpopulation-distinct variation in hFcγR expression. Cells were isolated from the (A, E, F) blood of healthy human donors, or (B) bone marrow, (C) peritoneum, or (D) blood of VG1543 mice, for flow cytometry analysis. (A) Variable expression hFcγRIIB on monocytes from the blood of 4 different human donors; numbers indicate frequency of cells positive for FcγR staining. (B, C) Representative histograms showing hFcγRIIB expression on VG1543 B cell subpopulations: (B) mature B cells (B220^{hi} CD43^{neg} IgM⁺ IgD⁺) and (B220^{low} CD43^{neg}) immature (IgM⁺), pro (IgM^{neg}) and pre (IgM^{neg} IgD^{neg}) B cells from the bone marrow, and (C) peritoneal B1a cells (IgM⁺ CD11b⁺ IgD^{low}) and B2 cells (IgM⁺ CD11b^{neg} IgD^{hi}). Numbers indicate ΔGeoMean between specific staining and FMO controls. Data is representative of at least 2 independent experiments, n>3. (D, E) Discrimination of classical vs patrolling monocyte subsets in the blood of VG1543 mice (D) or human donors (E); differential hFcγRIIA, hFcγRIIB and hFcγRIII expression on monocyte subsets is shown by representative histograms. Shaded grey histograms indicate background staining from VG1505 mice; shaded blue histograms indicate background staining with an isotype control antibody (hFcγRIIA, hFcγRIII), or

an FMO control (hFcγRIIB). (F) Variable expression of hFcγRIII on eosinophils from the blood of 4 different human donors.

Supplemental Figure 3: Immunisation with BSA in CFA/IFA induces BSA-specific IgG1 and IgG2 in VG1505 and VG1543 mice. (A) Anti-IgG1 and (B) anti-IgG2a/b/c BSA-specific ELISA results from two independent experiments are represented as serial dilution curves of individual mouse sera, and as average curve (insets). VG1505 (dashed black line) and VG1543 (solid black line) mice exhibit comparable antibody titres; excl** (blue line) indicates mice that were excluded from challenge due to low antibody titres; positive (pos: red line) and negative (neg: dotted black line) ELISA controls are indicated.

Supplemental Figure 4: Antibody clone NIMP-R14 specifically targets Ly-6G antigen and efficiently depletes neutrophils *in vivo*. (A-C) Blood sampled from naive mice (pool of n=4) was stained with FITC-conjugated NIMP-R14 in combination with fluorescent antibody clones 1A8 (anti-Ly-6G; A), RB6-8C5 (anti-GR1: binds Ly-6C and Ly-6G; B), or anti-Ly-6C (Monts 1; C) with or without pre-blocking with an excess of unconjugated NIMP-R14 or 1A8. Staining was assessed by flow cytometry, and representative plots are shown pre-gated on single, live CD11b⁺ cells. (D-F) VG1543 mice were treated with 300µg NIMP-R14 or rat isotype control antibody (rIgG2b) and blood and tissues were sampled 24 hours later and frequencies of specific cell populations determined by flow cytometry: gating strategies are shown and frequencies of neutrophils and monocyte/macrophages in the (D) blood, (E) spleen and (F) peritoneum; and percentage of basophils in the (G) blood and (H) spleen, and (I) mast cells in the peritoneum. (D-F) Data is pooled from 2 independent experiments.

Supplemental Figure 5: Basophils, monocyte/macrophages and histamine were not found to contribute to BSA-ASA in VG1543 mice. (A) VG1543 mice were treated with 30µg anti-CD200R3 (Ba103) or rat isotype control antibody (rIgG2b) and blood and tissues sampled 24 hours later: representative gating strategy and percentage of basophils in the blood and spleen; and percentage of mast cells in the peritoneum. (B-G) Change in body temperature and survival during BSA-ASA in VG1505 and VG1543 mice, and VG1543 mice treated with (B) anti-GR1 mAbs, (C&E) toxic liposomes, (D) anti-CD200R3 mAbs, (F) H1-receptor antagonist Cetirizine, (G) PAF-R antagonist

ABT-491, or respective controls. Data are represented as mean \pm SEM and are representative of at least 2 independent experiments. (E) BSA-ASA with high mortality in VG1543 mice treated with PBS or toxin-containing liposomes before challenge: repeat of panel 5C. (G) BSA-ASA with no mortality in VG1543 mice treated or not with PAF-R antagonist before challenge: repeat of Figure 3D.

Supplemental Figure 6: PSA-induced hypothermia of VG1543 mice after injection of high-dose heat-aggregated IVIG, or basophil depletion

(A) VG1543 mice were injected with indicated amounts of heat-aggregated IVIG and central temperatures monitored. Data are represented as individual replicates of each dose. (B) VG1543 mice treated with 30 μ g anti-CD200R3 (Ba103) or isotype control 24 hours before injection of 1mg heat aggregated IVIG and PSA induction.

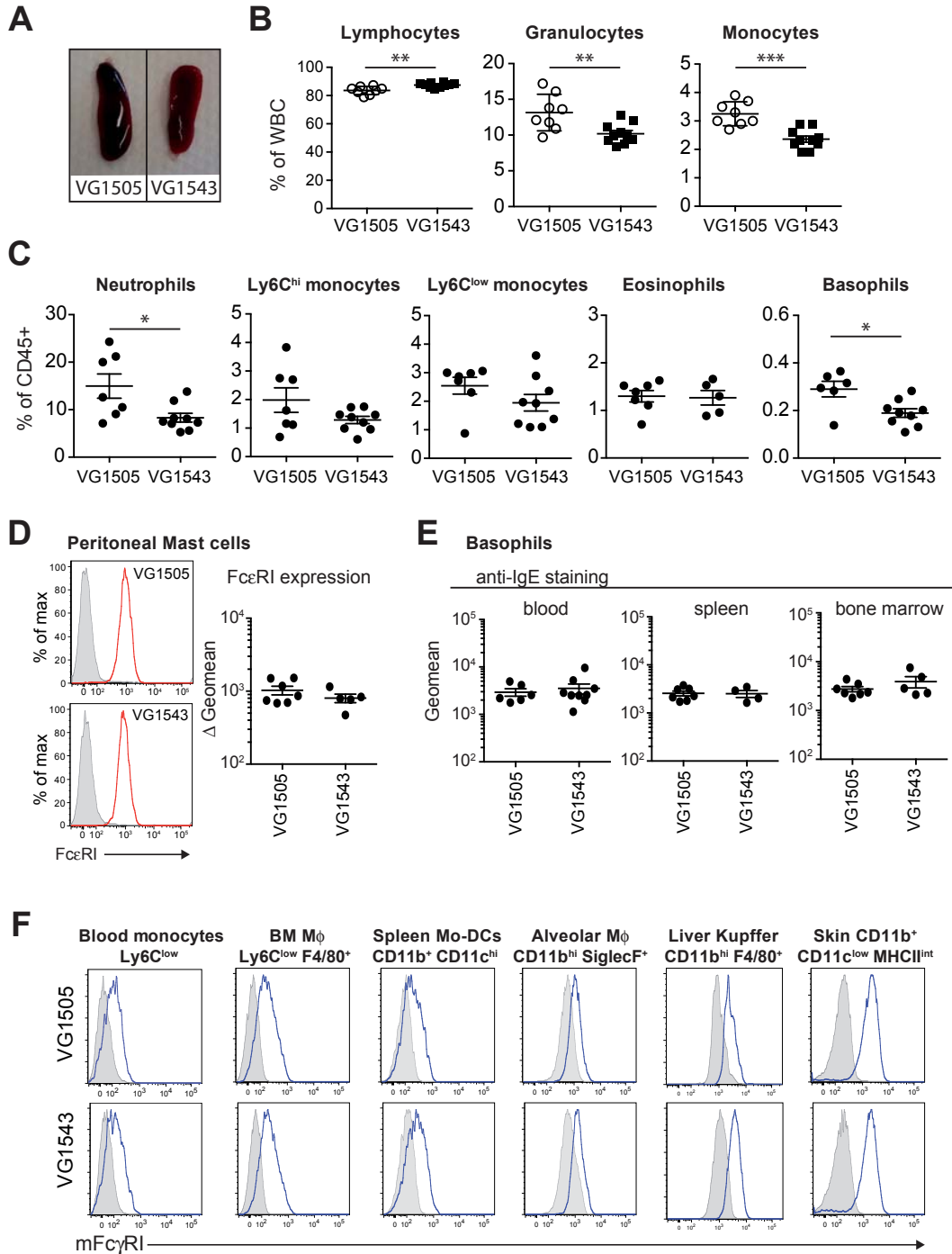
Supplemental Figure 7: Observed reduction in hFc γ R expression on circulating myeloid cell populations after IVIG-PSA is not due to binding inhibition by surface bound hIgG.

hFc γ R expression on blood (A) neutrophils, (B) Ly6C^{hi} and (C) Ly6C^{low} monocytes from VG1543 mice 1 hour after injection of non-aggregated IVIG (non-agg) or heat aggregated-IVIG (HA-IVIG, leading to PSA). Only non-blocking antibodies were used for detecting hFc γ R expression, to avoid competition with ligand (*i.e.* IVIG) binding: anti-CD32 clone FLI8.26 defines hFc γ RIIA+B expression, anti-CD32(R131) clone 3D3 defines hFc γ RIIB expression, and anti-CD16 clone MEM-154 defines hFc γ RIIIA+B expression. Background staining on cells from VG1505 mice is shown 1 hour after injection of heat aggregated-IVIG. Values represent GeoMean of specific staining, pooled from three independent experiments. (***) p <0.001, (**) p <0.01, Student's *t* test). (D) Staining of surface hIgG bound *ex vivo* by incubating blood neutrophils and monocytes isolated from (left histograms) naïve VG1543 mice or (central histograms) PAF-injected VG1543 mice (0.3 μ g PAF injected *i.v.* to induce PAF-dependent anaphylaxis) with HA-IVIG (20 μ g/mL). These histograms were compared to histograms (right) representing staining of surface hIgG bound *in vivo* to blood cell populations, isolated 1 hour after IVIG-PSA. Representative histograms are shown from 2-3 independent experiments, $n \geq 3$. Shaded histograms represent labelling with secondary antibody alone (left and central panels) or FMO control (right panels).

Supplemental Figure 8: Role of mediators in PSA. (A-C) Antihistamine treatment inhibits IgE-PSA: VG1505 mice were sensitised by transfer of anti-TNP specific IgE and challenged with TNP-BSA. Indicated mice were injected i.p. with H1 receptor antagonists (A) cetirizine 300µg or (B) pyrilamine 300µg 30min prior, or (C) triprolidine 200µg 20min prior to challenge. *NB* triprolidine was injected at 200µg/mouse in (C): this dose was increased to 300µg for IVIG-PSA pretreatment (Figure 6D). (D-E) VG1543 were treated (D) with cetirizine alone or (E) in combination with PAF-R antagonist ABT-491 prior to IVIG-PSA. Data is (D) representative or (E) collated from 6 independent experiments. *** $p < 0.001$, VG1543 controls vs VG1543 + PAF-R antagonist and VG1543 controls vs VG1543 + PAF-R antagonist + antihistamine, ** $p < 0.05$ VG1543 + PAF-R antagonist vs VG1543 + PAF-R antagonist + antihistamine, Student's t-test at 30min. (F) Administration of PAF-R antagonist ABT-491 at an increased dose does not confer increased protection from IVIG-PSA: VG1543 were injected i.v. with 25 or 100µg of PAF-R antagonist ABT-491 15 min before the induction of IVIG-PSA.

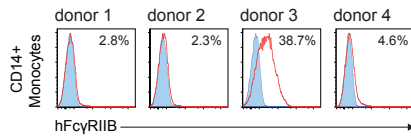
SUPPLEMENTAL FIGURES

Supplementary Figure 1

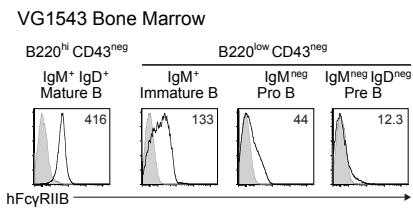


Supplementary Figure 2

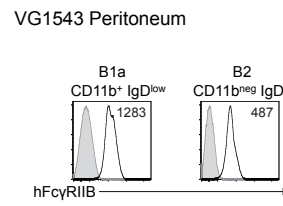
A



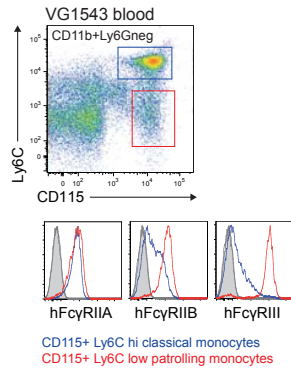
B



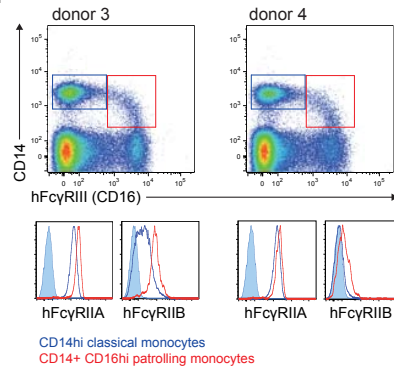
C



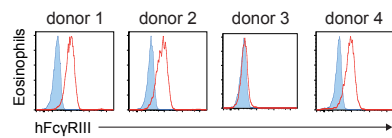
D



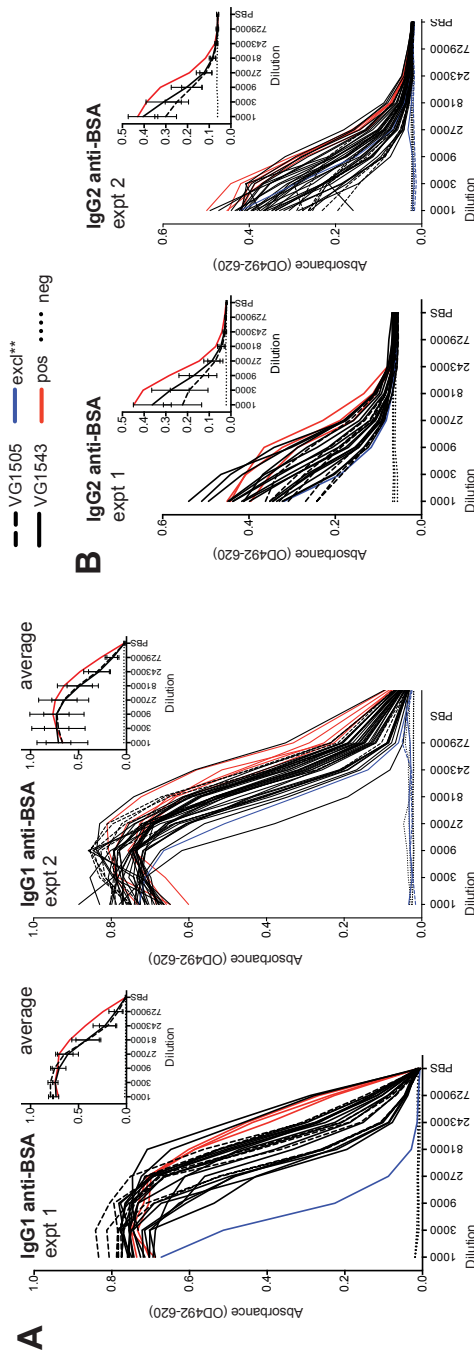
E



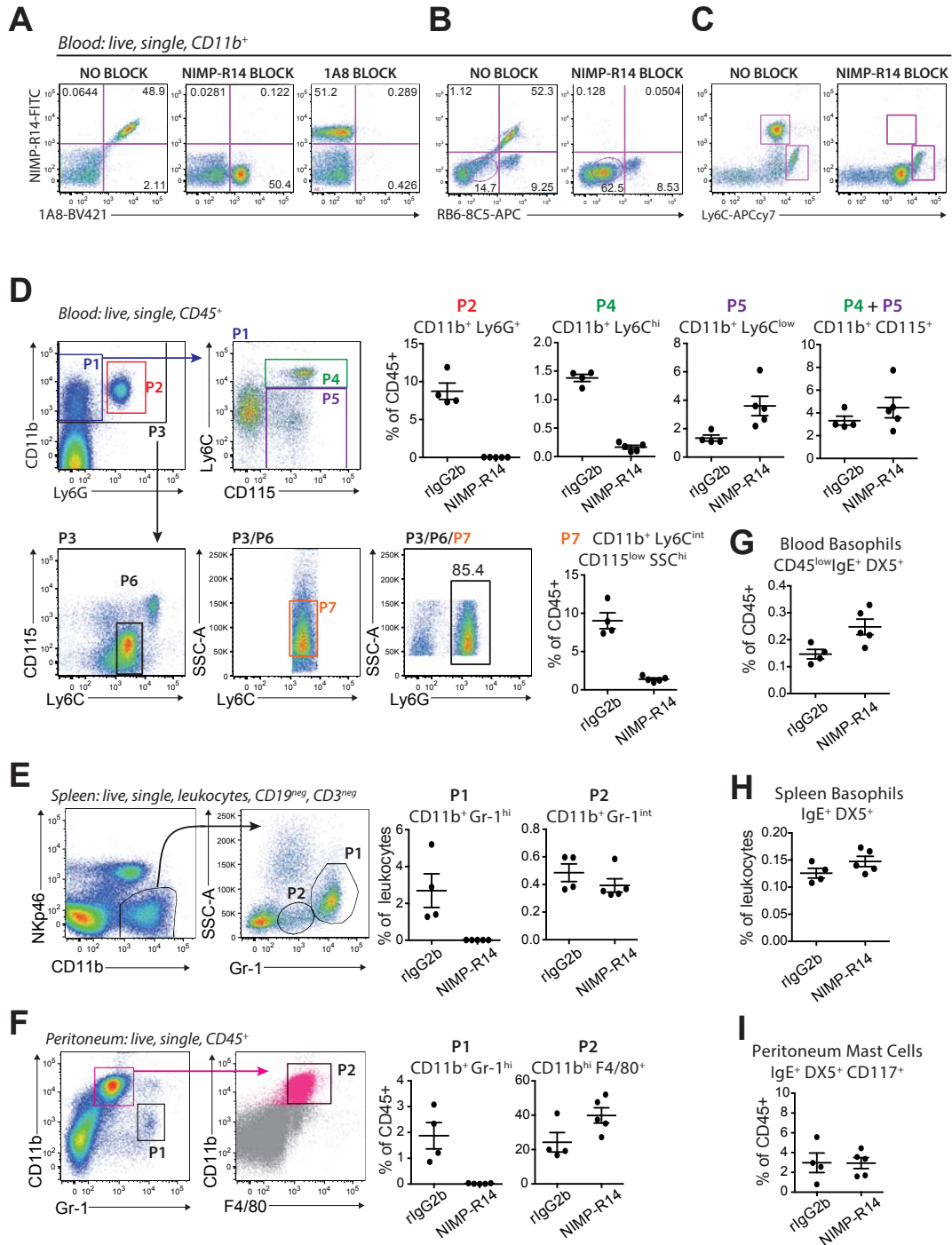
F



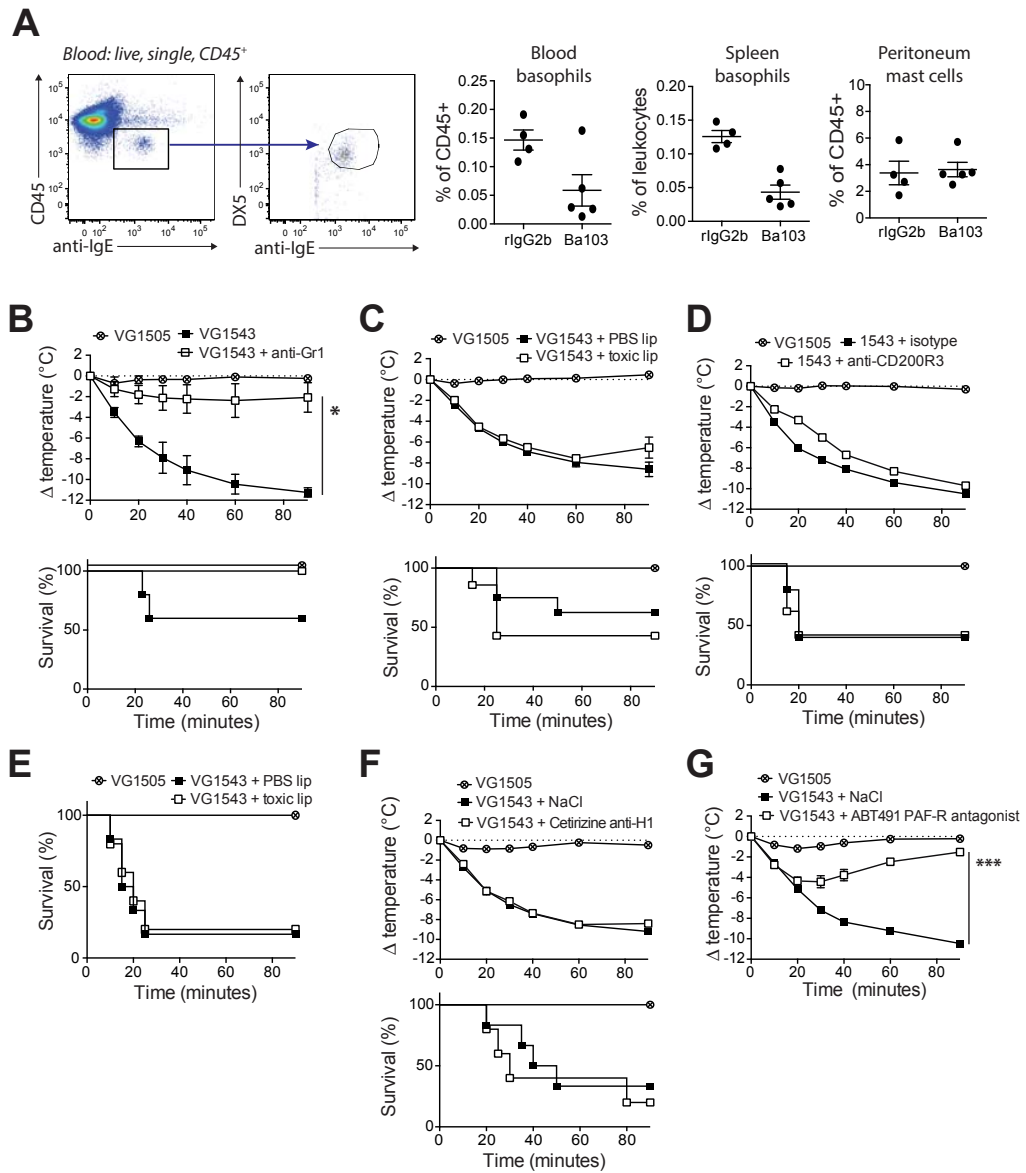
Supplementary Figure 3



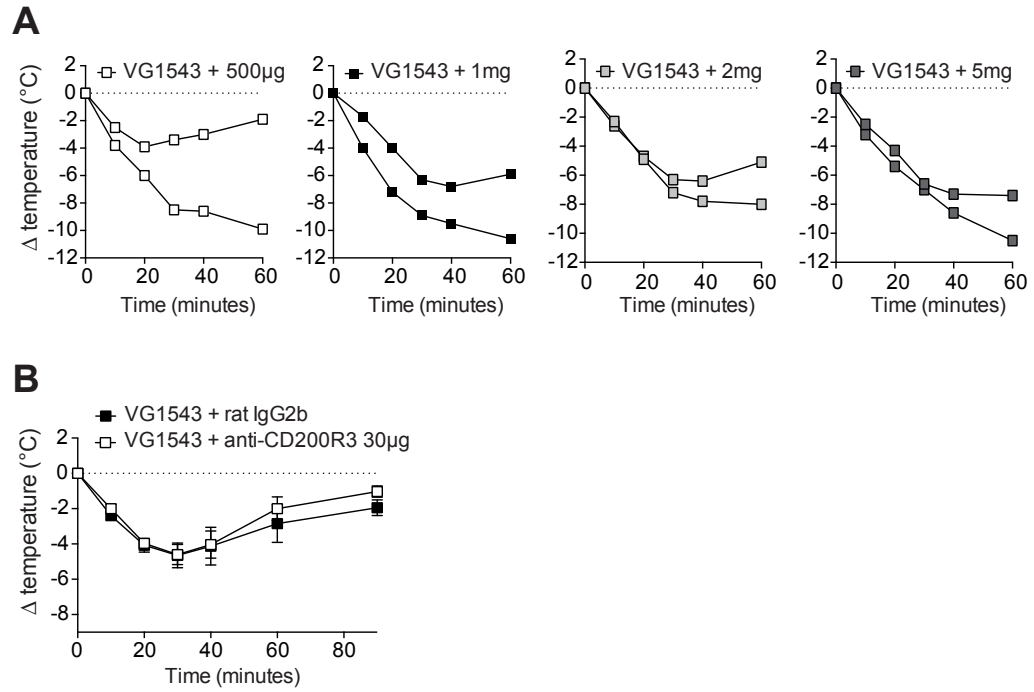
Supplementary Figure 4



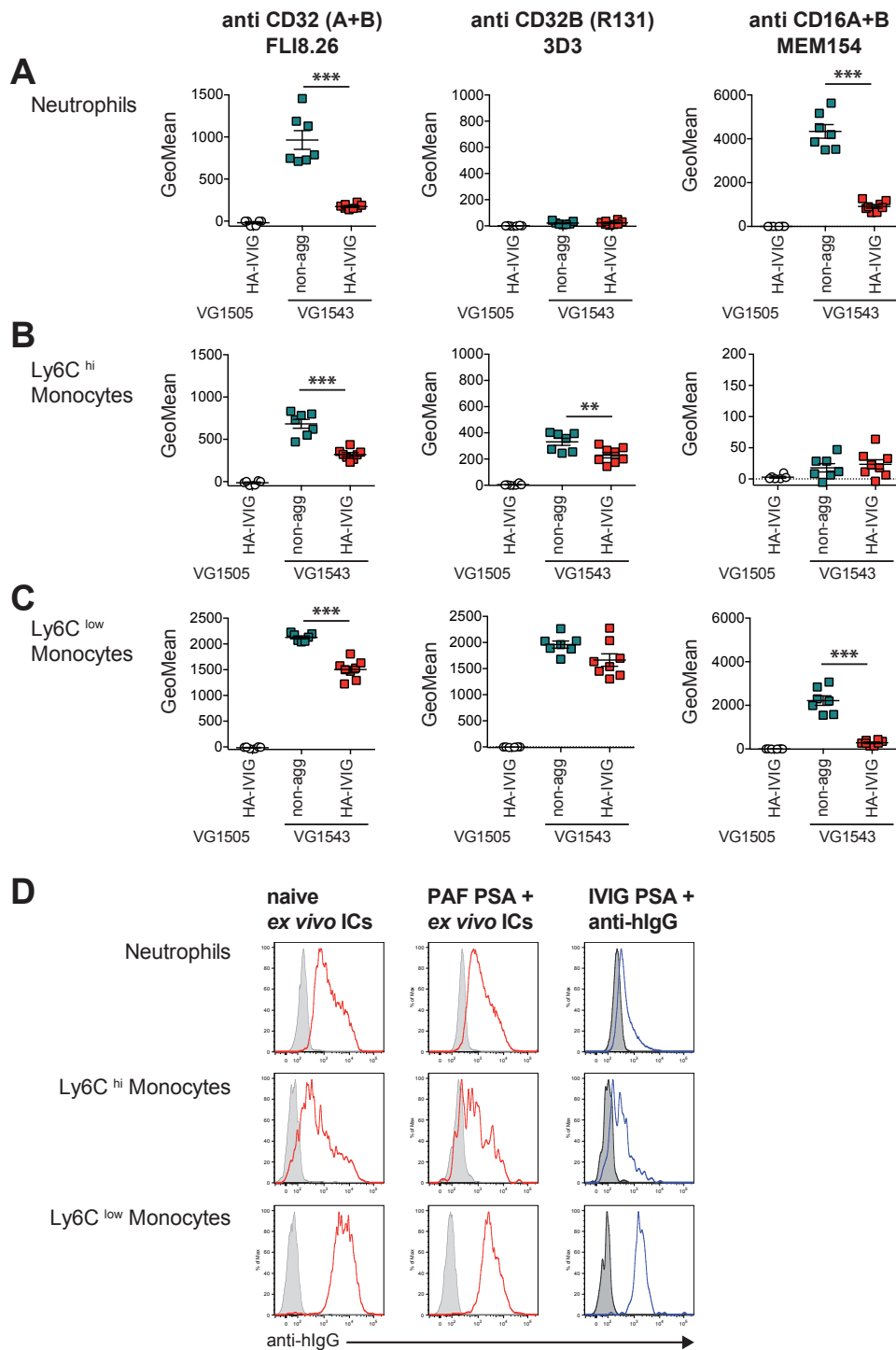
Supplementary Figure 5



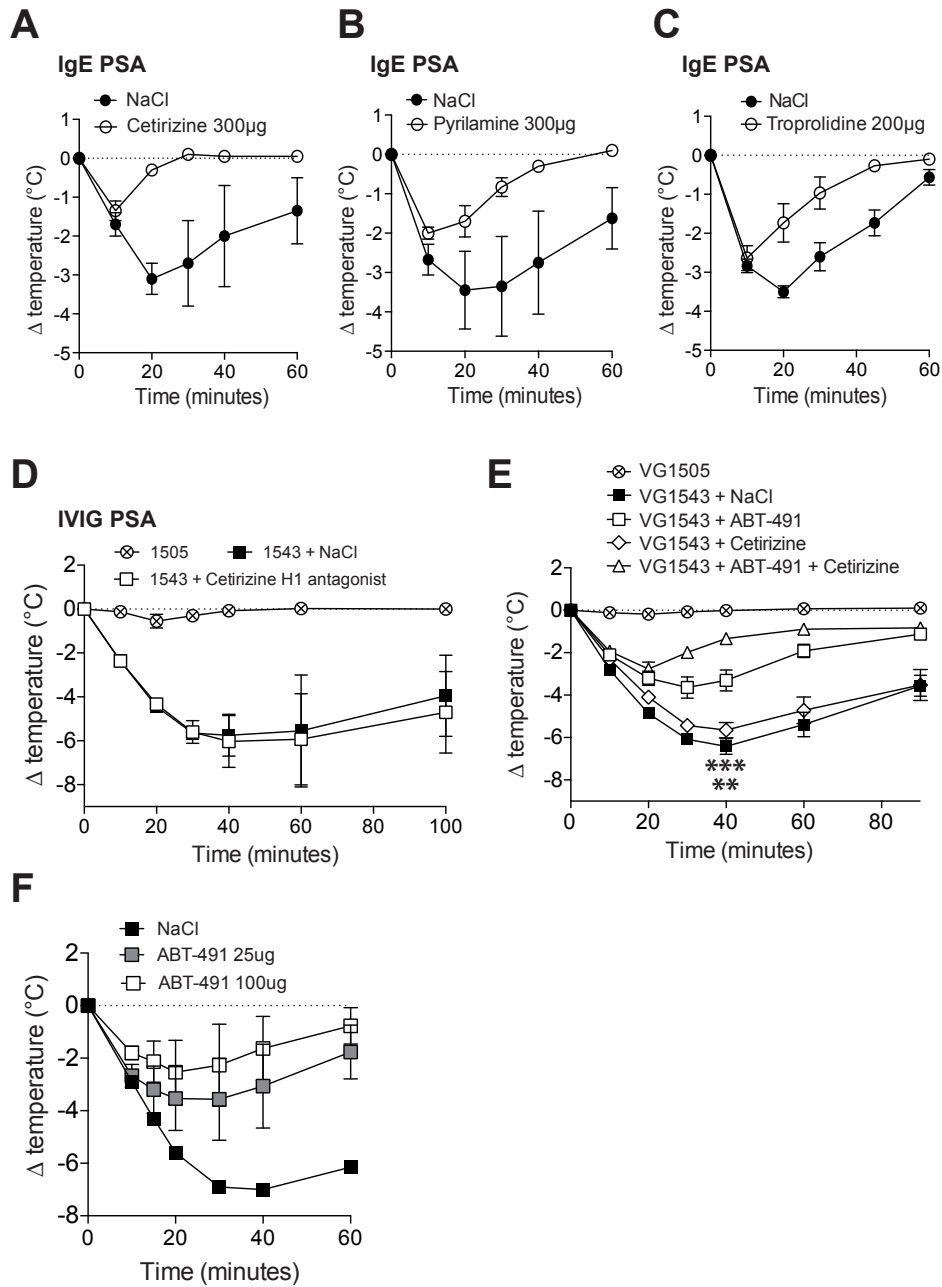
Supplementary Figure 6



Supplementary Figure 7



Supplemental Figure 8



SUPPLEMENTAL TABLES

Supplementary Table 1: Bacvec description

BAC vec	Step	Description	Cassette	Recipient BAC	Process	Product name	Drug selection	primers for detection
1505	1	Deletion of the mouse low FCGRs, deleting 106kb (fig 1).	[mFcr 5' up (1)/mFcr 3' up XbaI (1a)]-ICeu1-PGKp-em7-neoR-pA-lox2372-[5' down Sac1/mFcr 3' down]	RP23-395f6	BHR	1505	kan cm	mFcr 5'up detect(3), mFcr 3'down detect
1528	1	Trim human FCGR locus on the distal end of human BAC CTD2514j12, insert a ICeu1 site at the distal end, deleting 41kb.	[5' down loxp pbelo/3' del loxp (kpnI)]-ICeu1-frrt-UbCp-em7-hyg-pA-[5' down primer-Sac1 (h14)/3' down primer (h15)]	CTD2514j12	BHR	VI-209	hyg cm	5' pbelo loxp detect, 3' down detect (h16)
	2	Insert PI-Sce1 site into the proximal end human BAC construct VI-209.	[5' up primer (h4)/3' up primer XhoI (h5)]-PI-Sce1-Spec-[del cm (AvrII)/3' up homology CM pbelo]	VI-209	BHR	VI-212	hyg spec	5' up detect (h6), 3' pbelo-cm detect
	3	Deletion of the mouse low FCGRs (106kb) and inserted ICeu1 and PI-Sce1 sites flanking neoR (VI207), and then removed the extra PI-Sce1 site by Asc1, digestion and ligation to make VI208.	[mFcr 5' up (1)/3' up mFcr-2b NheI primer (2) [Rev]]-ICeu1-loxp-PGKp-em7-neoR-pA-loxp-PI Sce1 [mFcr 5' down ApaI (7) [Rev]/mFcr 3' down]	RP23-395f6 and VI207	BHR, Digestion /ligation	VI207 and VI208	kan cm	mFcr 5'up detect(3), mFcr 3'down detect
	4	Ligate human FCGR fragment 72.3kb from VI212 into VI208 replacing neoR.	VI212: ICeu1-hygr-72.3 kb of human FCGRs-PI-Sce1	VI208	ligation	1528	cm hyg	mFcr 5'up detect (3), mFcr 3' down detect(9)
1543	1	Trim human FCGR locus on the proximal end of human BAC RP11-697e5, deleting PI-Sce1 site (fig 3).	[5' up-(h40)/3' up-AvrII (h42)]-specR-[5' kpn del loxp bac3.6 (B10a)1 [Rev]/5' down loxp pbelo1 [Rev]]	RP11-697e5	BHR	VI-217	spec cm	5' up detect (h41), 5' del loxp detect (b14)1 [Rev]
	2	Insert Not1 and PI-Sce1 sites flanking hygR at the distal end of VI217.	[3' up homology CM pbelo1 [Rev]/5' pbelo del cm Nsi1 w/Not1 [Rev]]-Not1-Pgk-hygr-PI Sce1 [5' down SalI (h10)1 [Rev]/3' down (h11)1 [Rev]]	VI-217	BHR	VI-222	hyg spec	3' pbelo del cm detect1 [Rev], 3' down detect (h12)1 [Rev]
	3	Ligate mouse distal homology arm 47kb from VI-208 into VI222 replacing hygR.	Not1-PGKp-em7-neoR-pA-lox2372-47 kb of human FCGRs-PI Sce1	VI-222	ligation	1543	neo spec	3' pbelo del cm detect, 3' down detect (h12)

Supplementary Table 2: List of primers

Primer name	Sequence (5'-3')
mFcR 5' up (1)	ACCAGGATATGACCTGTAGAG
mFcR 3' up XbaI (1a)	TGTTTCTACTTACCCATGGAC
mFcR 5' up detect(3)	ATCCTGAGTATACTATGACAAGA
5' down Sac PI Sce	CATGCATCTATGTCGGGTGCGGAGAAAGAGGTAATGCATTCTTGCCCAATACTTAC
mFcR 3' down	CCCTCTAGCTAGGTTATTAGG
mFcR 3' down detect	GGAGCCTCAACAGGACTCCAT
5' down loxp pbelo	ATCCGATGCAAGTGTGTCGCT
3' del loxp (KpnI)	CTCGCTTTGACACCTGTGCT
5'pbelo loxp detect	CTGTAGAACGGAGTAACCTCG
3' down detect (h16)	CCCAGGTAAGTCGTGATGAAACAG
5' down primer-SacI (h14)	GCCAGCCCAAAGGAGATAATC
3' down primer (h15)	GCAACATTTAGGACAACCTGGG
5' up detect (h6)	CACACATCTCCTGGTGACTTG
3' pbelo-cm detect	ACAGCATGTGCATCGCATAGG
5' up primer (h4)	GATTTCTTAACCACTACCCC
3' up primer XhoI (h5)	CAACTGCCATTGAAAAAGA
5'up-(h40)	GAATGAATTCGCGGATCCTTCTATAGTGTACCTAAATGTCGACGCCAGGCAGCCGC
5'up detect (h41)	GAGCAGCCATCTATAGACCTAC
5' kpn del loxp bac3.6 (B10a)2[Rev]	CTTATCGATGATAAGCTGTCA
5' down loxp pbelo2[Rev]	ATCCGATGCAAGTGTGTCGCT
5' del loxp detect (b14)2[Rev]	TCGTGTTGTCGGTCTGATTAT
3' up homology CM pbelo2[Rev]	CAATCCAGGTCCTGACCGTTC
5' pbelo del cm nsi w/notii2[Rev]	GCCCCGTAGTGATCTTATTTTC
3' pbelo del cm detect2[Rev]	ACAGCATGTGCATCGCATAGG
5' down Sall (h10)2[Rev]	AAATACACACTGCCACAGACAG
3' down (h11)2[Rev]	CACAGGAAACTCACAAAAGAGG
3'down detect (h12)2[Rev]	CTTTTTATGGTCCCACAATCAG
mFcR 3' down detect(9)	ACTCATGGAGCCTCAACAGGA
mFcR 5' down ApaI(7) [Rev]	GCATTCTTGCCCAATACTTAC
3' up mFcR-2b NheI primer (2) [Rev]	GTTTCTACTACCCATGGAC

Supplementary Table 3: list of taqman probes

Taqman probe	Description	Forward primer (5'-3')	TaqMan probe (5'-3')	Reverse Promer (5'-3')	Probe copy numbers	
					Mod	WT
Fcgr4	Fcgr2b	CCAGGGTCTCCATCCATGTT	CCACCGTGGCATCA	TCCTATCAGCAGGCAGAATGTG	0	1
Fcgr2b-U	Fcgr2b	AGCAGTGCTGCCTCCTTCC	TGACCATCGTGGAGCCAGCCT	GGTTTGTTCCTTTGCCAGTATG	0	1
Neo	Neo gene	GGTGGAGAGGCTATTTCGGC	TGGGCACAACAGACAATCGGCTG	GAACACGGCGGCATCAG	0	1
1528 hT1	Fcgr2b	TCATCAGACTTACCTGGGTTC	CCCTCTGGTGTCCCTCTGATGAC	GGACAGGTGAAGCAGAGGAG	1	0
1528 hT1	Fcgr2b	TCCTTCTGGTCTGTCTATG	TCCCTTGCCAGACTTCAGACTGAGA	CTCTGTCACCCACCAATTTCC	0	0
Hyg	Hyg	TGCGGCCGATCTTAGCC	ACGAGCGGGTTCGGCCATTTC	TTGACCGATTCTTGCGG	0	0
1543hD	Fcgr2b	GTTCTGGTAATTGGGCTCTTTGTTTC	TCTGGAGCTTCCGACTGCATAAGCAG	ACTGCTGGTTCTGCCTTCTC	0	0
1543hU	Fcgr2b	GGGAGAATAGCAGAGCAGGAC	TCAGCAATCTCCACTCAGGGCTCA	ACACAAGTTCACGGGAAGTCAAAC	0	0
1543 AS 129	Fcgr2b	TTTCTTGCCCAAATTGAAGA	CTCCCAAATGAATG	TCAGGCAGTCGATCTCTGTTTTC	0	0
1543 AS B6	Fcgr2b	TTTCTTGCCCAAATTGAAGA	CTCCCAAATGAGTGGAG	TCAGGCAGTCGATCTCTGTTTTC	1	0
1543 AS2 129	Fcgr4	TTCTTGTGTCTCCTTTGCCTCTAA	ATCCACTTAGACTGCAC	TTGAAGCTCTGCACAGTGAGATC	1	0
1543 AS2 B6	Fcgr4	TTCTTGTGTCTCCTTTGCCTCTAA	TATCCACTAGACTGC	TTGAAGCTCTGCACAGTGAGATC	1	0
1543 AS3 129	Fcgr4	GGCAGGACAGTGATAAATCTGAGA	TGGCCCTTGCTGTGA	GGCCAAGAATGGAACATGACTT	1	0
1543 AS3 B6	Fcgr4	GGCAGGACAGTGATAAATCTGAGA	TGGCCCTTGCTGTGA	GGCCAAGAATGGAACATGACTT	1	0
					1	0

Supplementary Table 4: Immune cell composition in VG1505 and VG1543 mice, by flow cytometry analysis			
	VG1505	VG1543	
Blood			
CD19+	31,09 ± 2,012, n=7	36,48 ± 3,342, n=5	n.s.
CD4+	23,47 ± 2,489, n=7	28,24 ± 1,620, n=5	n.s.
CD8+	14,89 ± 0,9485, n=7	14,46 ± 1,006, n=5	n.s.
Neutrophils CD11b+ Ly6G+	14,97 ± 2,550, n=7	8,306 ± 0,9350, n=9	* p=0,0412
Monocytes CD11b+ (Ly6G neg) CD115+ Ly6C low-int	2,544 ± 0,2942, n=7	1,947 ± 0,2914, n=9	n.s.
Monocytes CD11b+ (Ly6G neg) CD115+ Ly6C hi	1,981 ± 0,4293, n=7	1,284 ± 0,1263, n=9	
Eosinophils CD11b+ SSC hi SiglecF+	1,299 ± 0,1207, n=7	1,266 ± 0,1527, n=5	n.s.
Basophils CD45 low IgE+ DX5+	0,2900 ± 0,03281, n=6	0,1894 ± 0,01816, n=9	* p=0,0123
Bone Marrow			
Neutrophils CD11b+ Ly6G int-hi	56,21 ± 3,956, n=7	45,80 ± 1,382, n=5	n.s.
Monocytes CD11b+ (Ly6G neg) Ly6C hi	8,803 ± 1,020, n=7	9,512 ± 0,6939, n=5	n.s.
Monocytes CD11b+ (Ly6G neg) Ly6C int	1,419 ± 0,2171, n=7	1,696 ± 0,1661, n=5	n.s.
Macrophages CD11b+ (Ly6G neg) Ly6C low F4/80+	1,494 ± 0,3950, n=7	1,706 ± 0,1856, n=5	n.s.
Basophils CD45 low IgE+ DX5+	0,5009 ± 0,03961, n=7	0,6222 ± 0,05160, n=5	n.s.
Spleen			
CD19+	37,57 ± 1,717, n=7	39,50 ± 3,019, n=5	n.s.
CD4+	15,60 ± 1,780, n=7	27,88 ± 1,423, n=5	*** p=0,0005
CD8+	9,691 ± 1,060, n=7	11,18 ± 0,6511, n=5	n.s.
Neutrophils CD11b+ Ly6G int-hi	7,900 ± 2,492, n=7	1,466 ± 0,1149, n=5	n.s.
Monocytes CD11b+ (Ly6G neg) CD115+ Ly6C low-int	1,028 ± 0,1689, n=7	0,7142 ± 0,07172, n=5	n.s.
Monocytes CD11b+ (Ly6G neg) CD115+ Ly6C hi	1,662 ± 0,5531, n=7	0,6308 ± 0,1815, n=5	n.s.
Eosinophils CD11b+ SSC hi SiglecF+	1,146 ± 0,1922, n=7	0,4212 ± 0,05560, n=5	* p=0,0116
Basophils CD45 low IgE+ DX5+	0,2484 ± 0,02648, n=7	0,1325 ± 0,005172, n=4	* p=0,0106
Peritoneum			
CD117+IgE+ Mast Cells	3,751 ± 0,3780, n=7	3,958 ± 1,133, n=5	n.s.
CD11b hi F480+ Macrophages	45,57 ± 3,675, n=7	20,18 ± 2,848, n=5	*** p=0,0005

4.2 Considering high affinity FcγRI: the Audrey mouse

Importantly, in paper II VG1505 and VG1543 mice still express the high-affinity mouse receptor mFcγRI. VG1505 mice were resistant to anaphylaxis induction, demonstrating that mFcγRI alone cannot trigger anaphylaxis, and that anaphylactic reactions in VG1543 mice rely exclusively on hFcγR triggering. As a supplement to this thesis work, we completed a study investigating the *in vivo* functionality of mouse FcγRI, making use of VG1505 or FcγRI^{only} mice. These findings will not be discussed herein, but the manuscript is attached as **Annex 7.2** (*C. Gillis 1st author*).

A former study from our laboratory identified that the human counterpart of mFcγRI, hFcγRI (CD64) was sufficient to induce systemic anaphylaxis in transgenic mice lacking mouse FcγRs [142]. This study used hFcγRI-transgenic mice, expressing hFcγRI prominently on monocytes and macrophages as in humans, but also constitutively on neutrophils [157], whereas human neutrophils generally exhibit low-absent hFcγRI, inducible in an inflammatory context. Anaphylaxis in hFcγRI^{tg} mice relied on both neutrophils and monocytes/macrophages [142]. Human FcγRI is not expressed in the VG1543 model (Paper I), and so the question becomes whether hFcγRI can participate in IgG-induced anaphylaxis in a context of native hFcγR expression.

We obtained a novel hFcγRI knock-in mouse strain that does not present the discrepant expression of existing hFcγRI-transgenic models [142, 157, 171]: hFcγRI is expressed on monocytes, macrophages and dendritic cells but, critically, not constitutively on neutrophils (see below). We therefore crossed this mouse strain to VG1543 mice, to create a fully hFcγR-humanised knock-in mouse model, which we refer to as *Audrey* mice. This section will describe the preliminary work: (i) to characterise hFcγR expression patterns in Audrey mice and (ii) to examine the hFcγR, cells and mediators contributing to the induction of IVIG-PSA in Audrey mice. For comparison, we derived a FcγR^{null} strain of mice (VG1505 x FcγRI KO).

4.2.1 Audrey mice exhibit hFcγRI expression patterns comparable to that of humans, and retain hFcγRIIA/IIB/III expression of VG1543 mice

To compare the expression pattern of hFcγRs in Audrey mice to that of humans, specific antibody staining and flow cytometry analysis was performed on cells isolated either from the blood of healthy human donors, or from the blood, spleen, lymph nodes, bone marrow, peritoneum and

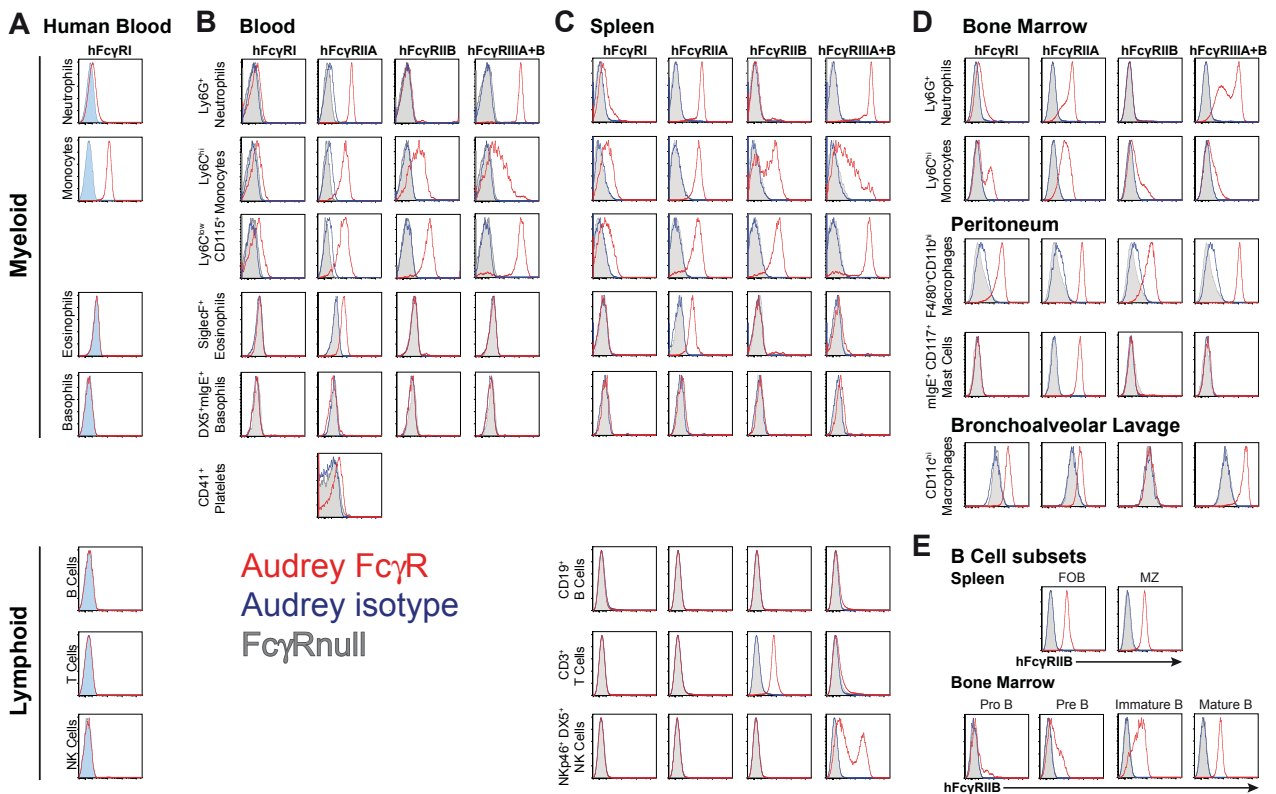


Figure 4.1: Human FcγR expression on immune cell populations from Audrey mice and human FcγRI on cells from human blood donors. (A) hFcγRI staining on immune cells from human peripheral blood, assessed by fluorescent antibody labelling and flow cytometric analysis (CD15⁺ Neutrophils, CD14⁺ Monocytes, CD193⁺CD15⁺ Eosinophils, CD123⁺CD203⁺ FcεRI⁺ Basophils, CD19⁺ B cells, CD3⁺CD56⁻ T cells, CD3⁻CD65⁺ NK cells or CD61⁺ Platelets). Shaded blue histograms indicate staining with an isotype control antibody, excepting hFcγRIIB where shaded histograms indicate a fluorescence-minus-one (FMO) control. (B-E) hFcγRI, hFcγRIIA, hFcγRIIB and hFcγRIII(A+B) staining on immune cells isolated from the blood and tissues of Audrey (red histograms) or FcγR^{null} mice (shaded grey histograms), as indicated. Blue unshaded histograms indicate background staining of isotype control antibodies on cells from Audrey mice. Data are representative of at least 2 independent experiments; total $n > 3$.

broncho-alveolar lavage (BAL) of Audrey mice. hFcγRIIA/IIB/III expression on human blood cells and in VG1543 mice was characterised and published in Paper I, Figure 2. hFcγRI expression was examined on the same blood donors. As previously described [173], we detected hFcγRI on circulating monocytes but not on basophils, eosinophils, B, T or NK cells, and barely on neutrophils isolated from human blood (Figure 4.1A). Similarly, Audrey mice exhibit hFcγRI expression on monocytes from the blood and spleen, barely detectable expression on neutrophils, and not on basophils, eosinophils, or B, T or NK cells (Figure 4.1B&C). Although hFcγRI expression on monocytes from Audrey mice is considerably lower than that of humans, this may reflect differential maturation or activation status according to the microbiological environment (SPF mice). Indeed, hFcγRI was higher on monocytes from the spleen than from the blood of Audrey mice, and expressed on a significant proportion of Ly6C^{hi} bone marrow monocytes (Figure 4.1B-D). Furthermore, when we examined macrophage populations in the bronchoalveolar lavage and peritoneal cavity of Audrey mice, we could detect prominent hFcγRI expression (Figure 4.1D), as has been reported for human dermal [282], pleural [283], peritoneal [284] and bone marrow derived macrophages [285]. Thus Audrey mice recapitulate hFcγRI expression patterns of human immune cells, excepting low expression on monocytes. As expected, FcγR^{null} mice did not stain for hFcγRI expression, nor any of the hFcγRs examined (Figure 4.1B-D).

hFcγRI expression is highly inducible following inflammatory stimulus. Audrey mice exhibit comparably low expression of hFcγRI on neutrophils and considerably lower expression on monocytes, compared to human blood cell populations, but we did not examine these cells in the context of inflammation. It would be informative to assess changes in hFcγRI expression on monocytes and neutrophils from Audrey mice, either during *in vivo* inflammation, following IFNγ injection, or following stimulation *in vitro*: such data would indicate whether the regulation of hFcγRI is preserved, when expressed in this knock-in model.

We confirmed that Audrey mice preserve hFcγRIIA/IIB/III expression patterns comparable to VG1543 mice (Figure 4.1 B-D and Paper I Figure 2), which is similar to that of humans. hFcγRIIA was detected on neutrophils, monocytes, eosinophils and platelets; hFcγRIIB on B cells and monocyte/macrophages, as well as variation in hFcγRIIB among B cell subpopulations from the spleen and bone marrow; hFcγRIII at high level on neutrophils and variably on monocyte/macrophages and NK cells (Figure 4.1B-E). Some caveats to the accurate reflection of hFcγR expression in Audrey mice compared to humans should be mentioned here. Firstly, blood basophils from human donors demonstrate varying expression of hFcγRIIA, prominent expression of hFcγRIIB, and some hFcγRIII

(Paper I). Whereas basophils from VG1543 mice express low levels of hFcγRIIA in the blood and hFcγRIII only in the bone marrow, but do not express hFcγRIIB (Paper II); limited to no hFcγR expression could be detected on basophils isolated from the blood of Audrey mice (Figure 4.1). Improvement of our techniques to examine basophils, a rare blood cell population, by flow cytometry may also account for the more consistent, albeit convincingly negative hFcγR staining in the Audrey mice. Secondly, like VG1543 mice, Audrey mice lack CD16 (hFcγRIII) expression on eosinophils, which is in accordance with 25% of the donors we examined. Nonetheless, with an awareness of these limitations, Audrey mice represent a novel model of a fully FcγR-humanised mouse: one that will be extremely valuable for the *in vivo* study of antibody-dependent pathologies, including anaphylaxis.

4.2.2 hFcγRI does not contribute to IVIG-PSA in Audrey mice, which proceeds via a dominant pathway involving hFcγRIIA, Neutrophils and PAF

As described for VG1543 mice (Paper I), intravenous injection of 1mg heat-aggregated IVIG induced passive systemic anaphylaxis (IVIG-PSA) in Audrey mice, manifested by visual signs and severe hypothermia, with a maximum temperature loss of 6-8°C 30-40 min after injection (Figure 4.2). FcγR^{null} mice were, as expected, resistant to anaphylaxis induction. Unexpectedly, pre-treatment with hFcγRI-blocking mAbs (clone 197) did not affect anaphylaxis induction (Figure 4.2A), whereas hFcγRIIA blockade (mAb clone IV.3) protected against both anaphylactic symptoms and hypothermia during IVIG-PSA in Audrey mice, compared to treatment with an isotype control (Figure 4.2B): in three out of four experiments of this type, IV.3-treated mice were completely resistant to anaphylaxis induction; in one experiment this group still experienced a mild hypothermia (2°C, Supplementary Figure 4S). These findings suggest that hFcγRIIA drives IVIG-PSA in Audrey mice, and hFcγRI does not contribute.

In a previous study, hFcγRI was found to be sufficient to mediate anaphylaxis induction in hFcγRI^{tg} mice, using agonistic anti-hFcγRI monoclonal antibodies, or polyclonal mouse IgG immune complexes [142]. We could consider that the dose or timing of administration of hFcγRI-blocking mAbs used herein was inefficient to completely block this receptor in Audrey mice. Yet we used same protocol as the earlier study (200µg 30min before challenge), and modification of the protocol did not affect the result (100µg each 24h and 4h before challenge; Supplementary Figure 4S), rendering such a hypothesis unlikely. As described above, hFcγRI^{tg} mice express this receptor at high levels on both neutrophils and monocytes, whereas Audrey mice exhibit considerably lower expression on both cells:

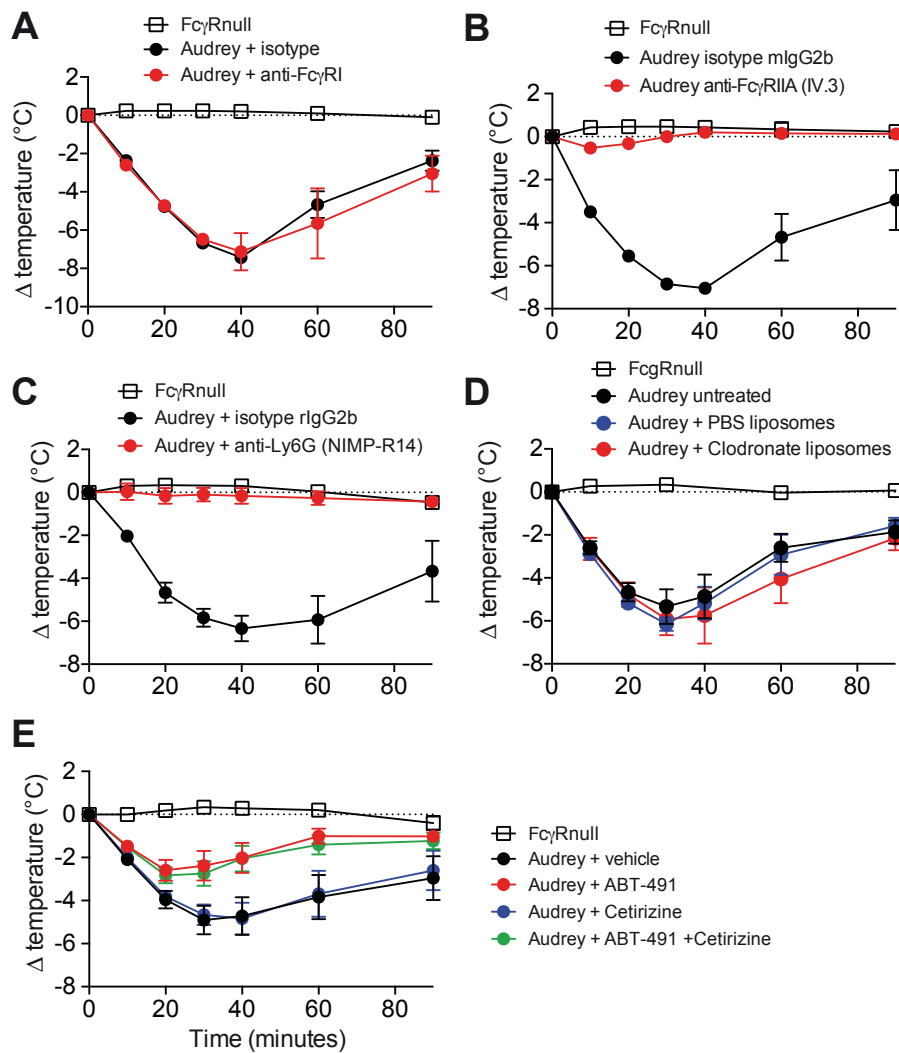


Figure 4.2 Aggregated human IVIG triggers passive systemic anaphylaxis in Audrey mice (IVIG-PSA), mediated by hFc γ RIIA and neutrophils with a contribution of the mediator PAF. (A-E) Fc γ R^{null} (open squares) and Audrey (filled circles) mice were injected with 1mg of heat-aggregated IVIG and central temperatures monitored. Prior to anaphylaxis induction Audrey mice were injected with (A) anti-hFc γ RI blocking mAbs, (B) anti-hFc γ RIIA blocking mAbs or (C) anti-Ly6G mAbs (Red circles), or corresponding isotype controls (Black circles); or (D) PBS-containing liposomes (Blue circles) or toxic clodronate-containing liposomes (Red circles), or left untreated (Black circles); or (E) PAF-R antagonist ABT-491 i.v. (Red circles) or H1-R antagonist cetirizine i.p. (Blue circles), or both (Green circles), or vehicle alone (NaCl, Black circles).

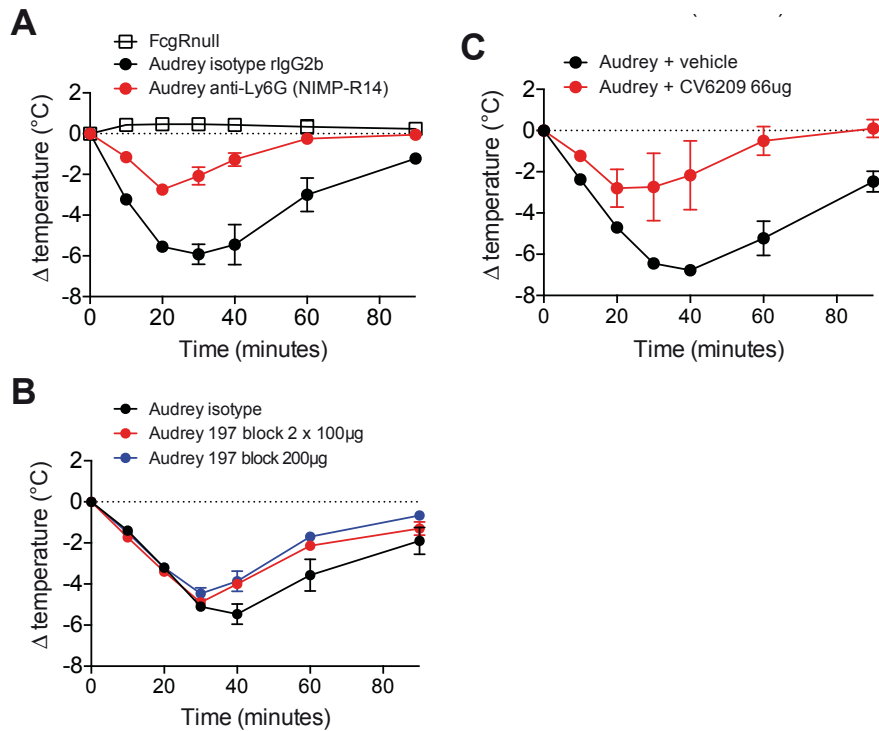
this level of expression may be insufficient to induce cell activation following immune complex engagement. Finally, in the previous study the hFcγRI transgene was expressed on a 5-KO mouse background: that is, lacking activating receptors mFcγRI, mFcγRIII, mFcεRI, mFcεRII and inhibitory mFcγRIIB, but retaining mFcγRIV [142]. mFcγRIV can trigger anaphylaxis [251]; therefore to examine hFcγRI-dependent anaphylaxis these authors used a mFcγRIV-blocking antibody in hFcγRI^{tg} 5-KO mice. Audrey mice express hFcγRIIB, particularly prominently on monocytes, which may effectively inhibit activating signals initiated by hFcγRI. It would be informative to assess the effect of hFcγRIIB blockade on anaphylaxis induction in Audrey mice: although administration of hFcγRIIB-blocking antibodies did not affect hFcγRIIA-dependent IVIG-PSA in VG1543 mice, this approach may reveal a contribution for hFcγRI in Audrey mice.

Neutrophil depletion using anti-Ly6G targeting antibodies (clone NIMP-R14) protected against IVIG-PSA in Audrey mice (Figure 4.2C), whereas monocyte/ macrophage depletion by intravenous toxic liposome administration had no effect (Figure 4.2D): an expected result, reflecting the hFcγR expression patterns of these cell populations. That monocyte/ macrophage depletion does not affect IVIG-PSA supports a non-contribution of hFcγRI to PSA induction, since hFcγRI is expressed predominantly on these cells. We then assessed the contribution of the mediators PAF and histamine to IVIG-PSA in Audrey mice, using the respective receptor antagonists ABT-491 and Cetirizine administered before PSA induction (Figure 4.2E). PAF receptor blockade using ABT-491 significantly ameliorated the hypothermia and symptoms associated with IVIG-PSA in Audrey mice, whereas the histamine receptor antagonist Cetirizine, either alone or in combination with ABT-491, did not affect anaphylaxis induction. In preliminary experiments, treatment with other histamine receptor antagonists that partially inhibited IVIG-PSA in VG1543 mice (Triprolidine and Pyrilamine) did not affect IVIG-PSA in Audrey mice (data not shown). A second PAF receptor antagonist, CV-6209, also inhibited hypothermia (Supplementary Figure 4S). These results imply that PAF, and not histamine, plays a dominant role in IVIG-PSA in Audrey mice, a finding consistent with a major contribution of neutrophils to this reaction. Furthermore, considering that PAF-R blockade alone did not protect from hypothermia, despite high doses of ABT-491, these data suggest the contribution of other(s) unidentified mediator(s) to PSA induction.

4.2.3 Supplemental Methodology and Data

Mice. VG6074 (mFcγRI^{-/-} hFcγRI^{KI}) mice were designed and generated by Regeneron Pharmaceuticals, Inc. Crossing of VG6074 strain with VG1543 strain (mFcγRIIB^{-/-} mFcγRIII^{-/-} mFcγRIV^{-/-} hFcγRIIA^{KI} hFcγRIIB^{KI} hFcγRIIIA^{KI} hFcγRIIIB^{KI}; described in Paper I) generated mFcγRI^{-/-} mFcγRIIB^{-/-} mFcγRIII^{-/-} mFcγRIV^{-/-} hFcγRI^{KI} hFcγRIIA^{KI} hFcγRIIB^{KI} hFcγRIIIA^{KI} hFcγRIIIB^{KI} mice, referred to as Audrey mice. FcγR^{null} mice (mFcγRI^{-/-} mFcγRIIB^{-/-} mFcγRIII^{-/-} mFcγRIV^{-/-}) were generated by the crossing of VG1505 mice (mFcγRI^{only} mFcγRIIB^{-/-} mFcγRIII^{-/-} mFcγRIV^{-/-}) with mFcγRI^{-/-} mice. Audrey and FcγR^{null} mice demonstrate normal development and breeding patterns. Mice were bred at Institut Pasteur and used for experiments at 8-12 weeks of age. All mouse protocols were approved by the Animal Ethics committee CETEA (Institut Pasteur, Paris, France) registered under #C2EA-89.

Antibodies for flow cytometry and in vivo blockade. hFcγRI was stained for flow cytometry analysis using FITC-conjugated anti-CD64 clone 10.1 (BD Biosciences). 200μg/mouse anti-hFcγRI blocking mAbs (clone 197) were injected i.v. 30min before PSA induction; controls were injected with vehicle (0.9% NaCl). In some experiments 100μg/mouse anti-hFcγRI blocking mAbs were injected i.v. 24 hours and 4 hours before anaphylaxis induction, and controls were injected with mIgG2a isotype control antibodies.



Supplementary Figure 4S: IVIG-PSA in Audrey mice. (A-C) $Fc\gamma R^{\text{null}}$ (open squares) and Audrey (filled circles) mice were injected with 1mg of heat-aggregated IVIG and central temperatures monitored. Audrey mice were injected with (A) 60 $\mu\text{g}/\text{mouse}$ anti-hFc γ RIIA blocking mAbs 24h and 4h before PSA (Red circles), or isotype control mAbs (Black circles); (B) 200 $\mu\text{g}/\text{mouse}$ anti-hFc γ RI blocking mAbs i.v. 30min before PSA (Blue circles), or 100 $\mu\text{g}/\text{mouse}$ anti-hFc γ RI blocking mAbs i.v. (Red circles) or mIgG2a isotype control antibodies (Black circles) 24h and 4h before PSA.

5 Discussion

This thesis examines the contribution of neutrophils to severe systemic inflammation, associated with the development of shock, in two distinct pathological models: LPS-induced endotoxemia, and IgG-dependent anaphylaxis. The discussion chapter is therefore composed of four parts: **(I)** the protective role of neutrophils in LPS-endotoxemia; **(II)** the value of novel mouse models to assess neutrophil function *in vivo*, with an emphasis on the pathogenic role of neutrophils in IgG-dependent anaphylaxis; **(III)** comparing the opposing protective or pathological neutrophil functions in these two models; and **(IV)** an extension of our mouse models to a putative role for neutrophils in human IgG-dependent anaphylaxis to neuromuscular blocking agents (NMBAs), including the outcomes of our ongoing work to develop a mouse model of NMBA-anaphylaxis, and the preliminary findings of a multicentric clinical investigation into human NMBA-anaphylaxis.

5.1 Part I: A protective role for neutrophils in LPS endotoxemia

Severe systemic inflammation is associated with infection in the context of sepsis, but can also arise in critically ill and post-trauma patients following sterile injury. The most severe outcomes are disseminated shock and multiple organ failure, which can be fatal. An understanding of the inflammatory insults that promote cellular and organ dysfunction, as well as the pathways that lead to pro-resolution physiology is critical to understanding the systemic inflammatory response, as it relates to multiple triggers. We used LPS-induced endotoxemia as a model of severe, systemic inflammation, associated with the development of shock, yet decoupled from the presence of a pathogen.

Neutrophils are central to inflammatory pathologies. As potent microbicidal effector cells of innate immunity, neutrophils were classically consigned to roles as unwitting perpetrators of both protective and pathological inflammation. Yet immune suppression, particularly pertaining to neutrophil dysfunction, is a secondary component of systemic inflammatory responses, which raises questions regarding the role of these cells in the balance of proinflammatory and regulatory pathways. In paper I, we demonstrate that in the absence of neutrophils mice are much more susceptible to toxic shock and mortality induced by endotoxin challenge. Furthermore, transfer of MPO-sufficient, but not MPO-deficient neutrophils prior to LPS exposure restored survival outcomes of neutrophil-deficient mice. These data suggest a protective role for neutrophils, and neutrophil-derived MPO, during systemic inflammation.

Several hypotheses can be drawn from these findings that may explain the phenomenon we observe: 1) Neutrophil depletion prior to LPS challenge exacerbates inflammation by virtue of excessive cell death or increased sensitivity to microbes in the environment; 2) Neutrophils release cytokines and mediators that suppress systemic inflammation, and this release is facilitated by MPO; 3) The recruitment and death of neutrophils in an appropriate context is necessary for the reprogramming of other phagocytes and initiation of pro-resolution pathways; 4) Neutrophil-derived MPO has a detoxifying effect, by effects on LPS itself, or by oxidative catabolism of mediators of inflammation; or 5) Neutrophil-derived MPO, or its products, have vasoprotective effects during systemic shock. It is important to consider also location-specific, compared to systemic, requirements for protection. These hypotheses will be elucidated and discussed hereforth.

Neutrophil affect the severity of endotoxic shock: “depletion enhances” versus “presence suppresses”

Firstly, to consider an explanation for our findings that doesn't entail a protective function of neutrophils: the depletion of neutrophils may itself be an inflammatory stimulus. In fact, depending on the specific conditions in which the cell death is occurring, apoptotic or necrotic cells can promote inflammation or tolerance [129]. We could suppose that following neutrophil depletion the threshold for systemic inflammation is lowered, thereby rendering mice more susceptible to LPS challenge. Inasmuch, it is pertinent that we replicate our findings using two different approaches to neutrophil depletion. Most convincingly, neutrophil transfer could restore the survival of neutrophil-depleted mice to be comparable to WT controls, demonstrating that neutrophil intrinsic elements truly play a protective role.

Systemic shock is associated with the loss of gut barrier function; thereby permitting bacterial translocation and endotoxin leakage that can exacerbate systemic inflammation, or event promote progression from non-infectious shock to sepsis [286-288]. Indeed, LPS-induced mortality is reduced in germ-free mice due to intestinal-biota driven inflammation [289]. It is therefore critical that we identified that neutrophil depletion increased the sensitivity of mice to endotoxin independently of the microbiological environment, and in a germ-free facility, indicating that the protective function of neutrophils is discrete from microbial exposure.

Neutrophils and neutrophil-derived products regulate immune responses

An anti-inflammatory role for neutrophils is not incongruent with recently emerging concepts of neutrophil regulatory functions [39, 64, 290]. In mouse models of chronic infection, the absence of neutrophils favoured *Brucella* or *Mycobacterium* clearance at later phases of infection, ostensibly because neutrophils suppress the early induction of effective Th1 responses [83, 291]. Human

neutrophils can regulate LPS-induced inflammatory responses: human neutrophil-derived NETs and ectosomes influence LPS-induced monocyte-derived dendritic cell maturation *in vitro* and the subsequent induction of T cell proliferation and polarization [292, 293], and diminished the inflammatory responses of macrophages [75]. Neutrophil-derived microparticles or ectosomes, although known to exacerbate coagulopathies [294], can exert anti-inflammatory effects on macrophages and other neutrophils [72-74]. Apoptosis associated neutrophil release of lactoferrin release inhibits ongoing granulocyte recruitment [81] and promotes dendritic cell recruitment [82]. Multiple mechanisms of neutrophil-mediated regulation have thus been proposed, and their relative significance likely depends on the model system and on the nature of the particular inflammatory, and oxidative, environment being studied.

We identified a requirement for neutrophil-derived MPO in the protective function of neutrophils during LPS-endotoxemia. MPO has well described antimicrobial properties [295] and evidently plays an antibacterial function in the context of infection and sepsis. A recent report indicates diminished MPO expression might be a good predictor to identify septic shock patients at high risk of death [296]. Yet MPO is also thought to be an important proinflammatory factor: elevated plasma MPO is associated with inflammation severity in critically ill patients [297], MPO has direct cytotoxic effects on endothelial cells [298], and animal models indicate that MPO and MPO-derived reactive oxidants can contribute to LPS-induced local inflammation and tissue damage in the lung [276]. As such, MPO has become a prime ‘read-out’ of inflammation and marker of neutrophil activation in many inflammatory disease models. It is therefore in striking contrast that here we demonstrate that mice have considerably increased systemic inflammation and mortality in response to LPS challenge in the absence of MPO, whether by genetic knockout or pharmacological inhibition.

We demonstrated that 1) neutrophils represent the major source of MPO, and 2) that neutrophil-derived MPO mediates, at least in part, the protective functions of neutrophils during endotoxemia. MPO is contained within neutrophil exosomes, and is a canonical component of NETs [39]. It is therefore tempting to speculate that MPO may account also for the suppressive effects of these neutrophil products on macrophage cytokine release and T cell polarisation [75, 292, 293]. Indeed, MPO was found to regulate dendritic cell activation and migration and subsequent T cell driven inflammation, an effect attributed to its catalytic action and also requiring CD11b on dendritic cells [299]. How MPO contributes to the regulation of inflammatory cytokines and the protective effect of neutrophils during endotoxemia remains, however, an open question.

The requirement for neutrophil MPO-sufficiency to exert a protective effect during endotoxemia may be independent of the MPO molecule *per se*, but arise rather as a result of phenotypic alterations in the neutrophil, or defective neutrophil recruitment and activation in the absence of MPO. Some neutrophil effector functions may require the expression of this enzyme; for example, MPO can be required for neutrophil NET formation, depending on the stimulus [61-63]. More subtly, MPO is a major component of neutrophil primary granules, and one could suppose that the orchestration and sequential degranulation of neutrophils could be impeded in the absence of this enzyme [14]. MPO can act in a cytokine-like fashion to bind and activate neutrophils, support cell adhesion, and prolong survival, mainly via interactions with CD11b/CD18 integrins [300-302], or via electrostatic interactions to support neutrophil recruitment and endothelial adhesion [303], and therefore MPO-KO neutrophils may exhibit a migration defect. The mechanisms by which neutrophil-derived MPO is protective during endotoxemia may therefore be either intrinsically MPO-dependent, or a product of the regulatory properties of neutrophils.

Regulation via macrophages // Dying for a cause

An immunosuppressive role for neutrophils during LPS-endotoxemia could involve the canonical regulatory cytokine IL-10. IL-10 does inhibit macrophage and monocyte inflammatory cytokine production. In a CLP model of sepsis, intraperitoneal transfer of IL-10-sufficient but not IL-10 deficient neutrophils suppressed TNF α production by peritoneal macrophages: although these authors did not identify a survival defect in neutrophil-depleted mice, they did observe greater inflammatory markers of macrophage activation after CLP [304]. Human LPS-stimulated Tregs were found to induce an autocrine loop of neutrophil IL-10 production associated with the induction of neutrophil apoptosis [86, 305]. Yet this phenomenon was reduced if the neutrophils had been pre-exposed to LPS, and as such may have greater application during chronic inflammatory pathologies in which infiltrating neutrophils may encounter Tregs prior to bacterial endotoxins [86]. After endotoxin challenge, we detected elevated levels of IL-10 in neutrophil-depleted *PMN^{dTR}* mice compared to *PMN^{WT}* controls. Without discounting a neutrophil intrinsic role for this cytokine, this finding indicates that there is not a systemic deficiency in IL-10 release in the absence of neutrophils, precluding such a hypothesis to account for the aggravated mortality we observe.

Neutrophil apoptosis, on the other hand, is an intriguing aspect of inflammation control and resolution. Macrophage uptake of aging or apoptotic neutrophils has long been regarded as a critical mechanism to limit inflammation and tissue injury [306]. This process is equally important to dampen the inflammatory responses of macrophages themselves: after ingestion, macrophages adopt

an anti-inflammatory phenotype [307]. Apoptotic granulocytes can influence phagocyte reprogramming through pleiotropic immune regulatory pathways [134]; modulating cytokine and eicosanoid release, and stimulating the production of specialised proresolving mediators [95].

Delayed apoptosis of neutrophils accompanies the systemic inflammatory response in critically ill or septic patients [308-311], and TNF α , a major cytokine driver of endotoxic shock, inhibits apoptotic cell uptake by macrophages [312]. The injection of spontaneously apoptotic neutrophils protected mice against LPS-induced shock [313]. These authors identified that, *in vitro*, the binding of LPS to apoptotic cells facilitated their uptake via CD14 on macrophages, and subsequently reduced macrophage TNF α production. While MPO itself can be taken up by macrophages via the mannose receptor [314], this association is thought to perpetuate inflammation, particularly during arthritis models [315]. We could predict that rather, in the absence of MPO, alterations in neutrophil apoptosis impair subsequent macrophage reprogramming and the induction of pro-resolution pathways. MPO-KO neutrophils have reportedly reduced cell death once recruited into the inflamed lung, thus prolonging acute inflammation [316]; although this study is at odds with findings that MPO-KO mice exhibit reduced inflammatory infiltrate after a higher dose of pulmonary LPS challenge [276]. Altogether, MPO-dependent alterations in neutrophil recruitment and apoptosis induction may account for the exacerbated mortality we observe during systemic endotoxin challenge in the absence of neutrophil MPO.

The detox hypothesis

Neutrophil products can bind and neutralise LPS, including the granule component lactoferrin [317], and histone proteins [318], contained in NETs. By its catalytic action MPO may have anti-inflammatory effects via the oxidative destruction or conversion of soluble mediators of inflammation, or the modification of regulatory molecules. Uric acid, for example, is produced by xanthine oxidase as the final product of purine metabolism, is eliminated predominantly via the kidneys, and in its crystalline form can act as a DAMP. Hyperuricemia, and the formation of urate crystals, promotes inflammation contributing to chronic illnesses such as gouty arthritis and kidney disease [319]. Elevated uric acid levels have been marginally associated with bad prognosis in septic patients [320], and uric acid promotes inflammatory responses to cell death in mice [321]. One study found that mice rendered granulopenic by cyclophosphamide treatment had elevated concentrations of uric acid in the blood, which these authors associated with reduced survival following LPS challenge [224]. Moreover, survival of cyclophosphamide-treated mice was restored by treatment with sodium bicarbonate to alkalis the urine, thereby increasing uric acid solubility and excretion. Importantly,

urate can be oxidised by neutrophil-derived MPO to yield allantoin [322]. We therefore postulated that neutrophil-derived MPO might protect from LPS-endotoxemia by the oxidation of uric acid, thereby limiting the development of hyperuricemia and associated inflammatory responses. Indeed, in the previous study, treatment with allopurinol to control hyperuricemia in cyclophosphamide-treated mice also diminished TNF α production after low-dose LPS challenge [224]. However, preliminary experiments that we performed did not support this hypothesis: six days of allopurinol pre-treatment did not affect survival outcomes of LPS-endotoxemia in either neutrophil-depleted or control mice (not shown). Hyperuricemia may exacerbate death after endotoxin challenge in cyclophosphamide-treated mice, as published previously [224]; yet this effect could be independent of neutrophils, given the known broad-spectrum toxicity of cyclophosphamide. Alternatively, the protective effect conferred by sodium bicarbonate gavage in the previous study may be independent of hyperuricemia.

The detox hypothesis remains viable, however: numerous other circulating mediators are subject to oxidative regulation. A notable target is HMGB1. This inflammatory mediator has been associated with lethality during models of systemic inflammation [207]; and the posttranslational modifications of the three cysteine residues of HMGB1 determine its capacity to promote leukocyte chemotaxis or cytokine release [323, 324]. Terminal oxidation of all three cysteine residues is inactivating, and thus abrogates the inflammatory effects of HMGB1 [325]. As yet, MPO-mediated oxidative regulation of HMGB1 has not been directly examined.

The lipid hypothesis

Lipoprotein oxidation by MPO is implicated in the development of atherosclerosis and cardiovascular disease [326]. Apropos, MPO can catalyse the peroxidation of lipid mediators such as leukotrienes and prostaglandins [327]. Lipid peroxidation is characteristic of acute inflammation associated with experimental endotoxemia, sepsis and critically ill patients [328, 329]. Following endotoxin challenge, MPO-KO mice were found to have elevated plasma levels of cysteinyl leukotrienes (LTC₄, LTD₄, LTE₄), and reduced oxidative metabolites of arachadonic acid and linoleic acid [330]. Thus MPO, by modulating the formation of pro- and anti-inflammatory lipid mediators, can systemically regulate the acute inflammatory response following endotoxin challenge. It is likely that such a mechanism contributes to our observations of a protective role for neutrophil-derived MPO during endotoxemia. The authors of this study [330] did not notice a difference in survival or physiological parameters between MPO-KO and WT mice following LPS challenge, however the dose of LPS was half that which we used, and mice were only monitored until 24 hours after LPS administration.

Interestingly, LPS itself is bound by plasma lipoproteins [331]. High-density lipoproteins (HDL) have the highest binding capacity for LPS [331], and a decrease in HDL is a risk factor for sepsis, suggesting that HDL may act as a humoral detoxifying factor in LPS-associated sepsis [332]. Indeed, HDL levels are reduced in patients with sepsis associated with gram-negative, but not gram-positive, infection [333]. It is feasible that MPO-catalysed oxidation of HDL could modulate its ability to bind and thereby detoxify LPS, although experimentally this remains to be tested.

MPO in the vasculature: hemodynamic regulation

Beyond the immunological effects of neutrophil-derived MPO, it is pertinent to consider the hemodynamic effects of its oxidative products, and the interplay with vascular regulation and dysfunction during endotoxic shock. As described above, MPO can modulate the systemic levels of lipid mediators of inflammation: leukotrienes and prostaglandins have potent vasodilatory effects, and the MPO-dependent catabolism of these may promote the restoration of hemodynamic function during shock [330].

Moreover, MPO can directly influence vascular function by regulating the bioavailability of nitric oxide (NO) [277, 334]. NO plays a prominent role in the pathogenesis of shock, driving vasodilation and vascular hyporeactivity, and therefore hypotension [335]. MPO, on the other hand, is a potent vasoconstrictor [336], and can exert systemic effects on vasomotor tone [337]. MPO binds to the surface of blood vessel endothelial cells and locates to the sub-endothelial space, where it remains catalytically active and anatomically positioned to regulate NO vascular signalling [277, 338]. Although NO was seen as an attractive therapeutic target, animal studies of septic shock and endotoxemia have demonstrated alternately beneficial or harmful effects of NO inhibition; and in patients with septic shock the inhibition of nitric oxide synthases can improve hemodynamic variables in the short term without significantly improving survival outcomes [339, 340]. Despite a reduction in systemic vascular resistance, during shock focal vasoconstriction occurs in the mesenteric, pulmonary, and renal circulations, and there NO appears critical to maintain organ perfusion [178]. Systemic NO inhibition may therefore increase venous return and vascular tone, but at the expense of increased pulmonary hypertension and risk of thrombotic events [339, 341]. Targeted inhibition of NOS isoforms is viewed as an improved strategy; indeed, endothelial NO is normally produced by eNOS, and evidence suggests that production of NO by iNOS contributes to the shock phenotype [203]. MPO can also regulate iNOS induction and function [334]. Together, these data suggest a hypothesis wherein MPO is important to regulate NO-dependent loss of vasomotor tone; and the

balance between MPO and NO synthases may contribute to the regulation of systemic vasculature during systemic inflammation.

A significant quantity of systemic MPO may be found bound to the vascular endothelium; this association can be blocked by heparin treatment, and thereby liberation of vessel-associated MPO was shown to improve NO bioavailability and vascular function [277, 342]. If MPO bound to the endothelium is critical to promote survival during endotoxemia, we might expect that heparin treatment would enhance the toxic effects and mortality following LPS. Heparin treatment of LPS-challenged mice, however, granted mild protection from the lethality of endotoxic shock, and somewhat improved LPS-induced lung pathology in mice pigs and rats [343-345], yet given the anti-thrombotic properties of heparin it would be implausible to attribute these findings to MPO-dependent effects. Bilvarudin, on the other hand, another anti-coagulant drug, which acts by directly inhibiting thrombin, was found to augment binding of MPO to endothelial cells [346]. Rats receiving bilvarudin experienced significantly reduced endotoxin-induced hypotension, and increased survival following LPS challenge [347]. In the context of critical illness and cardiogenic shock, cardiac surgery patients receiving bilvarudin rather than heparin exhibited reduced in-hospital mortality [348] [349]. Certainly we cannot dissociate the anti-thrombotic drug properties from the effects on MPO-NO-dependent vascular function, particularly in the complex context of cardiovascular illness, and considering that coagulation is a pathological component of systemic shock. Nonetheless these data open avenues of investigation in our endotoxin-challenge systemic shock model. It would be informative to test the effect of heparin and bilvarudin treatment on endotoxemia in both WT and MPO-KO mice.

From the cells to the vasculature to the tissues: location vs target

The specific location of MPO activity is likely to be critical, particularly given its diverse effects on inflammatory mediators, endothelial cells and the vascular bed. *Ex vivo* imaging revealed that MPO activity is elevated in the spleen and kidney of endotoxin challenged mice, whereas MPO activity in the lung was high in control mice and was not altered by LPS. Importantly, we could not restore survival of neutrophil-depleted mice by the intraperitoneal injection of recombinant MPO alone (**Figure 5.1**). It is likely that the dose and timing of MPO administration is critical, if a protective effect of systemic administration were to be established. Thus, although the protective function of MPO may be attributed to multiple mechanisms, as discussed above, presumably its targeted release by neutrophils satisfies spatial or temporal requirements for this role.

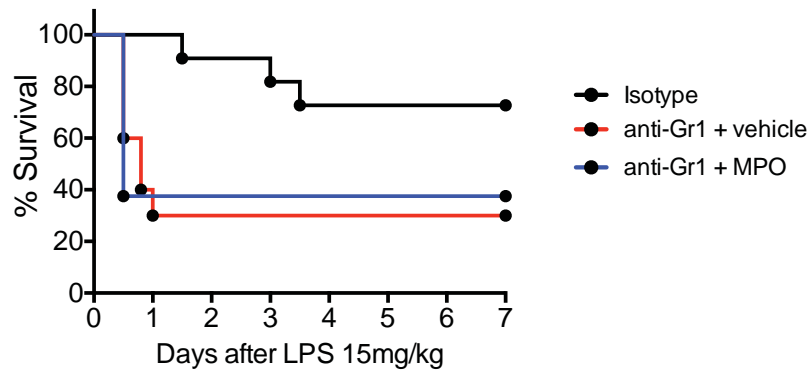


Figure 5.1: Injection of recombinant MPO does not affect survival in neutrophil-depleted mice. WT C57Bl/6 mice were injected daily i.p. with anti-Gr1 or isotype control depleting antibodies, beginning one day prior to LPS challenge (15mg/kg i.p.). Where indicated, mice were injected twice i.p. with 50µg of recombinant purified MPO (R&D systems) or vehicle (NaCl). Data is pooled from 2 independent experiments, $n = 8-11$ per group

Remarkably, the adoptive transfer of 10×10^6 neutrophils immediately prior to endotoxin administration was sufficient to restore survival of neutrophil-depleted mice, at least until five days after challenge. Neutrophils are a rich source of MPO; nonetheless, that such a relatively small number of cells within the system are sufficient supports a targeted effect. We did not examine the trafficking and localisation of transferred neutrophils after LPS challenge, although we did recover neutrophils from the blood, spleen and bone marrow of naïve recipients four hours after transfer. Identification of where the transferred neutrophils go may inform a more precise understanding of how they function to protect the host during endotoxin challenge. It was recently identified that MPO can bind and be transported systemically by red blood cells (RBCs) [350]. In that study, intravenous injection of MPO-loaded RBCs increased local MPO concentration in the liver, spleen, lung and heart tissue, and increased systemic vascular resistance. By employing such a strategy, we could envisage to deliver MPO in a targeted fashion within the vasculature following endotoxin challenge, thereby permitting an examination of neutrophil-independent MPO function during LPS-induced systemic shock.

While our data do not preclude a damaging role of neutrophils during endotoxemia, they emphasise that in the absence of neutrophils the systemic inflammatory response and associated lethality is greatly enhanced. Critically, the findings presented herein also encourage a re-evaluation of how we assess inflammation, particularly in animal models. A wealth of evidence indicates that neutrophil recruitment into the tissue is a damaging phenomenon. Yet although the mere presence of

neutrophils at the site, and indeed the activity of MPO, may be a marker of inflammatory processes; these are not inherently damaging to the host and can serve important protective functions.

5.2 Part II: The inflammatory effects of neutrophils: novel mouse models to study neutrophil function *in vivo*

5.2.1 A novel model of inducible neutropenia: PMN^{DTR} mice

The diverse effector functions of neutrophils are not specific to this cell population, and it remains difficult to discriminate between the role of neutrophils and that of other cell types. Owing partly to the technical challenges of isolating and studying these cells *in vitro*, and partly to the distinct roles of neutrophils in propagating and resolving both organ-specific and systemic inflammation, an important tool for immunologists lies in *in vivo* model systems, and various ablation approaches to investigate the contribution of neutrophils, or neutrophil specific proteins, by virtue of their absence. Antibody-mediated strategies to deplete neutrophils, or genetic approaches to render mice constitutively neutropenic, have been greatly improved upon by the recent development of more targeted strategies, including our novel PMN^{DTR} mouse model.

An improved neutropenic model

Antibody-mediated depletion strategies to target neutrophils have several disadvantages. The commonly used anti-Gr-1 antibody (clone RB6-8C5) is highly effective at eliminating neutrophils but also recognises Ly6C expressed on monocytes and monocyte-derived cells [351]. The more specific anti-Ly-6G antibodies, clones 1A8 [352] and NIMP-R14 [353], present other issues. 1A8 is less effective at depleting neutrophils than either anti-Gr1 or NIMP-R14, even when administered at higher doses, whereas NIMP-R14 seems to affect the monocyte population, even if it does not induce measurable depletion (Paper II, Fig.S2). Besides, the administration of antibodies at sufficiently large doses to eliminate neutrophils from the system entails the large-scale phagocytotic clearance of this cell population forcibly by FcγR-expressing cells, mainly macrophages [354] and therefore presumably has significant effects on these cells, which are difficult to evaluate. One could envision that the FcγR-dependant uptake of antibody-bound cells, as 'pseudo immune complexes', will modulate subsequent macrophage function. Moreover, as neutrophil production persists, the FcγR expressed on the surface of phagocytes are occupied with ongoing depletion. Lastly, the capacity to adoptively transfer exogenous neutrophils into mice after depleting antibody treatment, thereby reconstituting the neutrophil compartment, is thwarted by the continual presence of the depleting antibodies, which will equivalently target the adopted neutrophils for depletion.

Genetic approaches to render mice constitutively neutropenic generally target the zinc transcription factor Gfi-1, a transcriptional repressor responsible for the polarisation of hematopoietic precursors towards the neutrophil lineage by antagonising macrophage/monocyte development [355]. Gfi-1^{-/-} mice are deficient in neutrophils [8], yet exhibit reduced growth and viability along with defects in lymphoid cell development [356, 357]. *Genista* mice, harbouring a point mutation in Gfi-1, lack normal neutrophils and demonstrate normal growth and viability, and do not have prominent lymphopoietic defects [13]. Yet mice carrying this mutation do develop a CD11b⁺Ly6G^{int} intermediate neutrophil population, which although insufficient to protect against *S. typhi* infection, was capable of causing inflammation in models of immune-complex induced alveolitis and arthritis [13]. Thus constitutively neutropenic models have significant limitations with respect to both total immune homeostasis and the development of other leukocyte lineages, or intermediate development of myeloid precursor populations.

We have established herein a novel model of inducible neutropenia. We used the *Mrp8* promoter to drive Cre expression, and therefore conditional DTR expression on neutrophils [279, 280], generating *MRP8-Cre/iresGFP⁺iDTR^{f/+}* mice, referred to as *PMN^{DTR}*. In a similar fashion, the *MRP8-Cre* mouse strain has been used to examine the effect of neutrophil specific gene knockouts in arthritis [358], cancer immunotherapy [359] and acute lung injury [360]. Moreover, DT-mediated conditional cell ablation has already been used in a number of mouse models, targeting hepatocytes [361], CD19⁺ B cells, CD4⁺ T cells [280], Cd11b⁺ cells [362], CD11c⁺ cells [363], mast cells [364], eosinophils [365] and platelets [366]. Mouse cells are not inherently resistant to the effects of DT, rather they are 10,000 times less sensitive than human or primate cells: the absence of a DTR abolishes facilitated uptake of DT. DT is composed of an A and a B fragment: two separate polypeptides with, respectively, catalytic and receptor binding functions, linked by a peptide bond and a disulphide bridge. Receptor-bound DT is endocytosed and once trafficked to an acidic compartment, fragment B permits the translocation of fragment A to the cytosol [367]. In the cytosol, DT-A acts by ADP-ribosylation and inactivation of translation elongation factor 2, and thereby blocks protein synthesis in the cell with lethal effect [368]. One molecule of DT-A is sufficient to kill a cell [368], rendering such inducible models of cell death highly sensitive.

The DT approach to neutrophil ablation has its advantages to avoid the confounding effects of high dose antibody administration, and FcγR-mediated phagocytosis by macrophages. The induction of granulocyte cell death still, however, necessitates their clearance, the systemic effects of which are difficult to evaluate. Indeed, depending on the specific conditions in which the cell death is occurring,

apoptotic cells may promote inflammation or tolerance [129]. We did not observe an effect of DT administration on the frequency or number of any other cell populations in PMN^{DTR} mice, across all the organs examined. Yet in a model of DT-mediated dendritic cell depletion, neutrophilia was a common side effect, possibly via CXCL2 release and dendritic cell regulation of neutrophil mobilisation from the bone marrow [363]. We did observe some side effects of DT administration, arising only after 5 days of DT-treatment, whether as a result of non-specific DT sensitivity, or due to the significant systemic cell death – and persistent stimulation of granulopoiesis. Furthermore, inter-batch variability of commercially available DT creates difficulties in the balance between tolerability and effectiveness. Physiological clearance and turnover of neutrophils is known to regulate the hematopoietic niche [43]; therefore, the non-physiological clearance induced by exogenous depleting agents likely has significant systemic ramifications on immune cell function.

Despite this, the PMN^{DTR} is a valuable model of inducible neutropenia, particularly suitable to the study of acute disease models. In Paper I we demonstrate the crucial advantage of this approach: that neutrophil-depleted PMN^{DTR} mice are permissive to neutrophil reconstitution, and by reconstitution with neutrophils of different genotypes we can observe the outcome of neutrophil-specific gene deletion. Although still technically demanding and reagent costly, this technique improves upon time-consuming breeding strategies to generate neutrophil-specific gene knockouts – that is, by employing specific Cre expressing mouse strains – and can furthermore be generally applied to gene knockouts for which a floxed version of the allele is not available.

The challenges of neutrophil-targeting Cre

We found that Cre expression in the $MRP8-Cre$ mouse strain was substantially restricted to mature neutrophils, using the iresGFP reporter of the inserted construct ([279] and Paper I, Figure 2A and Supplemental Figure 2). Other publications have reported low-level GFP expression in 5-20% of other myeloid cells (monocytes, resident macrophages and basophils; Elliott et al. 2011), which we also observed, albeit at very low levels. Unlike prior publications we did not observe GFP expression on GMP precursors (not shown, L. Reber and P. Starkl). Along these lines, work by the group of C. Lowell has significantly characterised $MRP8-Cre/iresGFP^+$ mice [358, 369, 370]). Importantly, low levels of Cre expression may be insufficient to induce significant recombinase activity within a cell population. hMrp8-driven Cre expression induced deletion of a floxed gene in up to 90% of the peripheral circulating neutrophil compartment [369], and although other myeloid cells may express low levels of GFP in $MRP8-Cre/iresGFP^+$ mice, associated Cre expression was insufficient to induce measurable gene deletion [358].

Recently, neutrophil-specific Cre expression was achieved by a knock-in allele targeting the Ly-6G locus, encoding both Cre recombinase and a tdTomato fluorescent reporter protein [371]. In these so-called Catchup mice, tdTomato was, like GFP in *MRP8-Cre/iresGFP⁺* mice, sufficient to visualise neutrophils by flow cytometry. While Ly-6G expression was reduced in heterozygotes and absent from homozygote Catchup mice, notably these authors did not identify a resultant functional defect. For the complete characterisation of Cre expression, and for neutrophil visualisation by *in vivo* microscopy, these authors crossed Catchup mice to a tdTomato reporter mouse strain, generating a strain named Catchup^{IVM-red} [371].

In comparing the relative benefits of these neutrophil-targeting Cre strains, we should consider both the **penetrance** of the Cre, *ie* the proportion of neutrophils in which efficient recombinase activity has occurred, as well as the **specificity**. It is difficult to compare Cre expression between *MRP8-Cre* and Catchup strains by the fluorescent protein associated with the native Cre construct: homozygous Catchup mice do not express Ly6G, rendering the neutrophil population more difficult to identify by flow cytometry, and to this end, insufficient data is reported in the corresponding manuscript. The use of fluorescent reporter mice is an excellent monitor of gene deletion, however these strains have been thus far characterised using either Cre-inducible EYFP or tdTomato, and tdTomato exhibits considerably stronger fluorescence [372]. Nonetheless, in *MRP8-Cre-ROSA-EYFP* mice >90% of peripheral neutrophils in the blood and spleen and 80% of bone marrow neutrophils were YFP⁺ ([370] and our own data, not shown), while in Catchup^{IVM-red} mice approximately 85-90% of peripheral neutrophils and 60% of bone marrow neutrophils were positive for tdTomato [371]. We can cautiously deduce that Catchup mice have less penetrant Cre expression in the neutrophil compartment, especially accounting also for the increased relative brightness of tdTomato. Moreover, whereas 90% protein reduction was achieved by deletion of Syk in neutrophils using *MRP8-Cre* mice [369], only around 55% reduction in neutrophil FcγRIV was achieved using Catchup mice, and indeed, neutrophils remained responsive to stimulation by FcγRIV [371].

Catchup Cre may be less penetrant than *MRP8 Cre*, but it appears that it is more specific. Whereas 10-20% of blood monocytes and a small frequency of resident macrophage populations are YFP⁺ in *MRP8-Cre-ROSA-EYFP* mice, <5% of basophils and eosinophils are tdTomato⁺ in Catchup^{IVM-red} mice, and monocytes and macrophages are negative [370, 371]. Interestingly, the relative properties of these two Cre strains are surely attributable to the different promoters used, *ie* *hMrp8* versus *Ly-6G*, and thereby the induction of Cre recombinase expression at different times during neutrophil development.

The choice of appropriate neutrophil Cre strain is unquestionably dependent on its application. For imaging purposes, where you want to be sure that action being observed by the fluorescent cell is definitively attributable to a neutrophil, the specificity of the reporter gene is paramount (leaving aside the potential to distinguish cells by their morphology). For functional studies, wherein you want to be sure that the protein or gene of interest be completely eliminated in your population of interest, the penetration and efficiency of Cre recombinase may be paramount, albeit with an awareness of minor effects on other cell populations. The brightness of the tdTomato reporter in Catchup^{IVM-red} mice is extremely advantageous for *in vivo* microscopy, and although crossing *MRP8-Cre* mice to a tdTomato reporter strain may gain the same advantages, it is possible that the Cre leakiness into the monocyte population would also give greater background. Conversely, while breeding *iDTR^{fl}* mice with the newly developed Catchup strain may confer better specificity to the DTR gene, it is likely that such an approach will be compromised by a reduction in neutrophil DTR expression and therefore reduced efficacy of depletion by DT. Importantly, despite potential low non-specific expression of MRP8-Cre, DT administration in *PMN^{DTR}* mice did not affect monocyte, macrophage, or leukocyte populations other than neutrophils (Paper I). Ultimately the *PMN^{DTR}* mouse is but one approach in the toolkit of models to study neutrophil function *in vivo*. Yet as a model of inducible, specific and efficient neutrophil ablation, it is currently the best available.

5.2.2 *PMN^{DTR}* mice to study neutrophils in antibody-dependent pathologies: deciphering the contribution of neutrophils to systemic anaphylaxis

During endotoxemia (Paper I), we observed the same results by both antibody-mediated and DT-mediated neutrophil-depletion. That is, during a systemic inflammatory response arising from a strong, non-specific immunostimulant. In testing the functional application of the *PMN^{DTR}* mouse model, we used two mouse models of local antibody-dependent inflammatory reactions with a known neutrophil involvement: autoantibody-induced arthritis (**Figure 5.2**), and immune complex induced lung inflammation (**Figure 5.3**). In both models, DT-mediated neutrophil depletion in *PMN^{DTR}* mice protected against inflammation and associated tissue damage, indicating the value of this system to examine the contribution of neutrophils to antibody-driven pathological models associated with organ-specific inflammation (**Figure 5.2-5.3**).

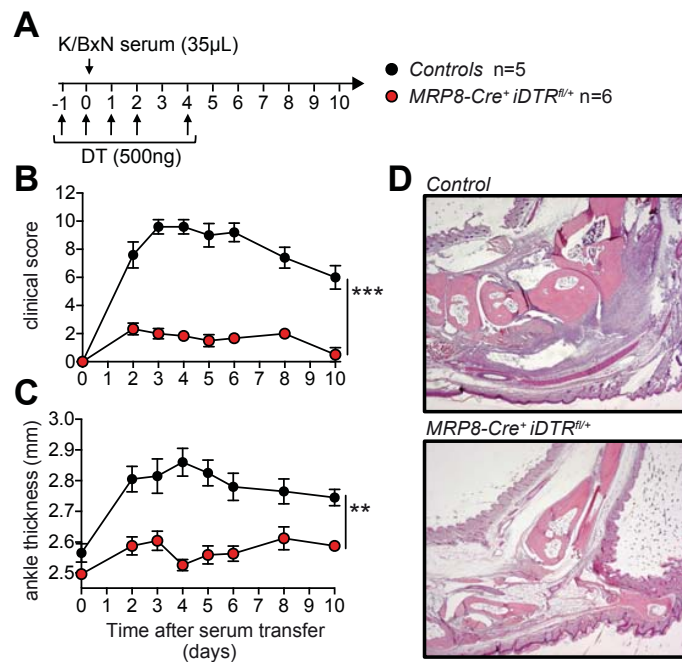


Figure 5.2: No K/BxN arthritis in neutrophil-depleted PMN^{DTR} mice. (A) *MRP8-Cre⁺iDTR^{fl/+}* mice (PMN^{DTR}; $n=6$), or littermate controls (PMN^{WT}; $n=5$: 2x *MRP8-Cre^{neg};iDTR^{fl/+}*, 2x *MRP8-Cre⁺iDTR^{neg}*, 1x *MRP8-Cre^{neg};iDTR^{neg}*) received a daily injection of 500ng DT beginning 1 day prior to the injection of 35 μ L K/BxN serum i.v. Clinical score (B) and ankle thickness (C) were monitored for 10 days following serum transfer. (D) H&E staining of sections of paraffin-embedded decalcified ankle joints on day 7 from 1 of 2 experiments. Results are means \pm SEM, representative of 2 independent experiments. N.B. 4/6 DT-injected *MRP8-Cre⁺iDTR^{fl/+}* mice were culled at day 6 for ethical reasons due to DT toxicity.

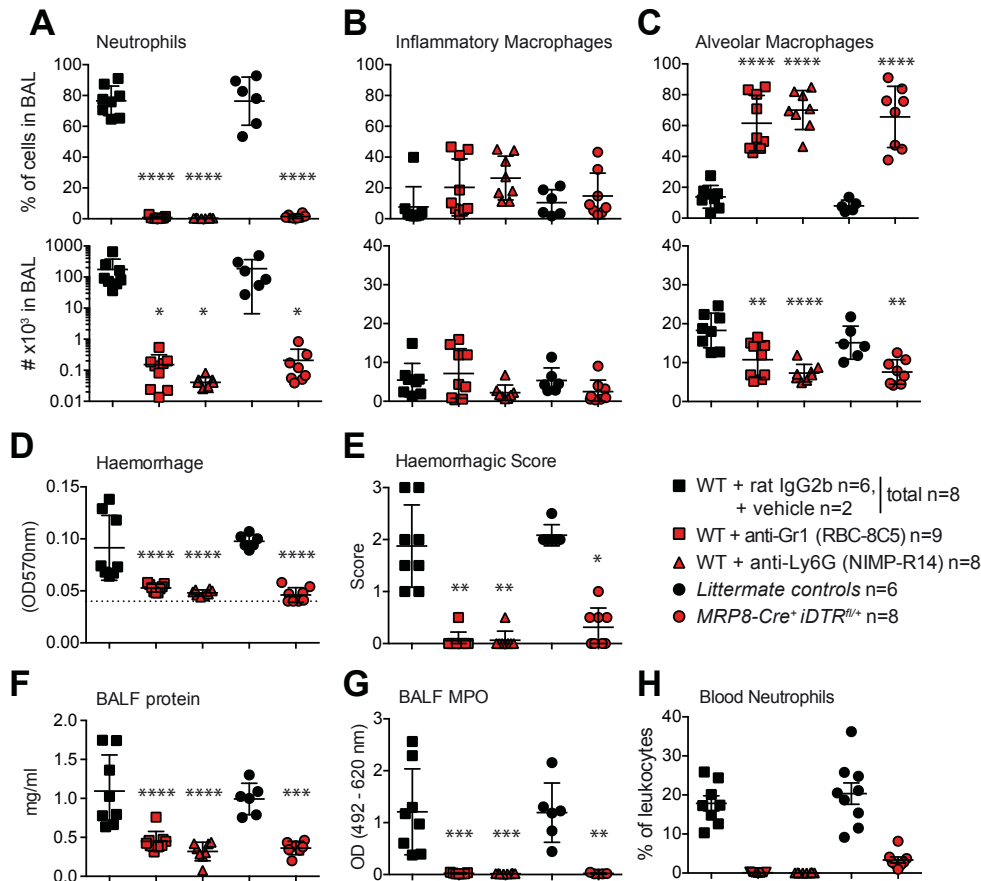


Figure 5.3: No immune complex-mediated airway inflammation in neutrophil-depleted PMN^{DTR} mice. *MRP8-Cre⁺;iDTR^{fl/+}* mice and littermate controls treated with 500 ng DT i.p. 34h and 10h before challenge, or *C57Bl/6* (WT) mice injected with 300 µg of isotype control antibodies or vehicle, or 300 µg of anti-Gr1 or anti-Ly6G antibodies 24 h before, were challenged by i.v. injection of OVA and intranasal instillation of rabbit anti-OVA serum. 18 hours after challenge blood was taken and 4 bronchoalveolar lavages (BAL) were performed. (A-C) Percentage (*upper panels*) and number (*lower panels*) of neutrophils (A), inflammatory monocytes (B) and alveolar macrophages (C) in the BAL were determined by flow cytometry. (D-E) Hemorrhage in BAL was determined by measuring hemoglobin concentration after treatment with hypotonic buffer (D) and by a visual score (E). (F) Concentration of total proteins in the supernatant of the first lavage (BALF) was determined using a Bradford assay and (G) MPO content was measured by its action on a peroxidase substrate. (H) Percentage of neutrophils in the blood was determined by flow cytometry. Values of individual mice are shown and black bars indicate means ± SEM; data is pooled from two independent experiments. Dotted lines indicate the detection limit. * $p \leq 0.05$, ** $p \leq 0.01$, and *** $p \leq 0.001$, significance is indicated compared to corresponding control group by one-way ANOVA with Tukey's multiple comparisons (A-D, F, G) or Kruskal-Wallis test with Dunn's multiple comparisons (E). **NB.** MPO content shown in (G) could not be determined in 2/9 of WT+anti-Gr1 group and 3/8 of *MRP8-Cre⁺;iDTR^{fl/+}* group due to insufficient BALF.

Another prototypical systemic inflammatory reaction is that which occurs during severe hypersensitivity reactions, or anaphylaxis. In this case, the inflammatory trigger is the recognition of antigen by specific antibodies, and the engagement of antibody receptors expressed on myeloid cells, leading to their activation, degranulation, and release of mediators. Systemic anaphylaxis following intravenous antigen exposure can proceed through pathways dependent on IgG and IgG receptors expressed on neutrophils, and neutrophil depletion can inhibit or protect from these reactions [247, 251]. We therefore studied the responses of PMN^{DTR} mice in IgG-dependent passive and active anaphylaxis models.

Passive systemic anaphylaxis (PSA) can be induced in mice by sensitisation with specific monoclonal IgG2a or IgG2b antibodies prior to intravenous challenge with the corresponding antigen: mice suffer from severe hypothermia immediately after challenge. Neutrophil depletion using anti-Ly6G (NIMP-R14) targeting antibodies, and constitutively neutropenic Gfi-KO mice protects against both IgG2a- and IgG2b-induced PSA (Beutier et al. 2016; paper included as **Annex 7.1**). Unexpectedly, however, DT-mediated neutrophil depletion was not protective against either IgG2a- or IgG2b-induced PSA (**Figure 5.4 A-B**): DT-treated PMN^{DTR} mice experienced comparable hypothermia to PMN^{WT} controls. Circulating neutrophils are not rendered absent in DT-treated PMN^{DTR} mice, and so we considered that perhaps DT treatment was insufficiently effective at eliminating the neutrophil compartment responsible for anaphylaxis induction. We therefore compared the responses of DT-treated $MRP8-Cre^{+}iDTR^{fl/+}$ mice (expressing a single $iDTR^{fl}$ allele) to that of $MRP8-Cre^{+}iDTR^{fl/fl}$ mice (expressing two $iDTR^{fl}$ alleles). Although DT-treated $MRP8-Cre^{+}iDTR^{fl/fl}$ mice demonstrated slightly more effective neutrophil elimination in the blood than $MRP8-Cre^{+}iDTR^{fl/+}$ mice (not shown), both groups were equivalently susceptible as littermate controls to IgG2b-PSA induction (**Figure 5.4 C**).

PSA induced by monoclonal IgG antibodies engages different activation pathways depending on the antibody isotype and dose used, and multiple myeloid cell populations can contribute [247, 250]. Although mice experience significant hypothermia during PSA, these models do not recapitulate the severe symptoms of active anaphylaxis models, and death rarely results. We therefore examined the responses of PMN^{DTR} mice in a model of fatal active systemic anaphylaxis (ASA), induced by BSA immunisation and challenge. A prior study from our lab found that neutrophils have a major contribution to shock induced in this model, particularly to anaphylaxis-associated death, whereas

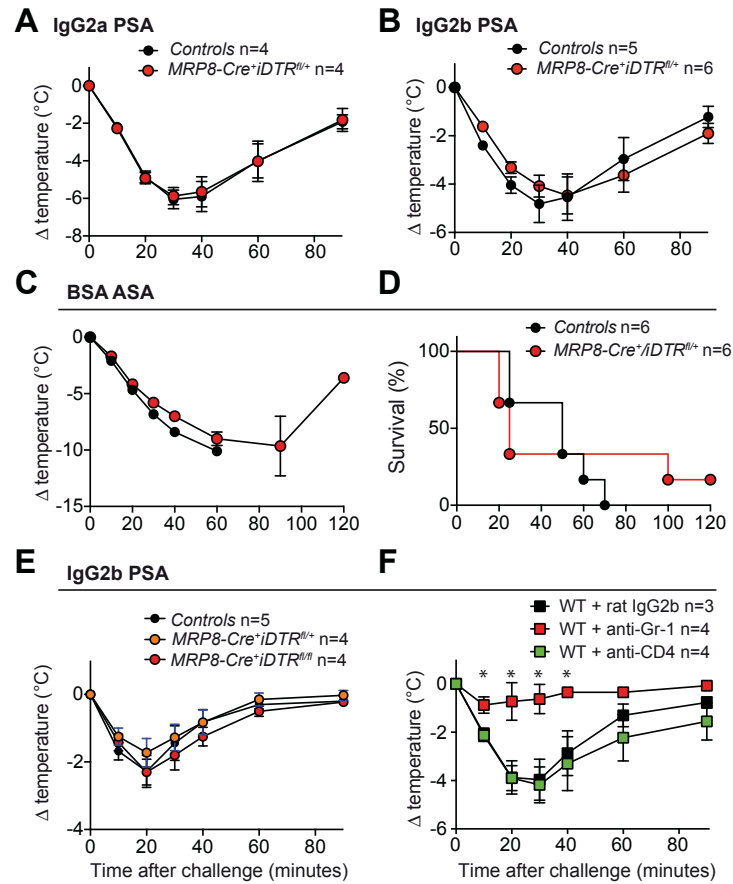


Figure 5.4: IgG2a- and IgG2b-induced PSA and BSA-dependent ASA in PMN^{DTR} mice. Changes in body temperature (Δ temperature) (A, B, C, E, F) and survival (%) (D) following challenge in mice sensitized by i.v. injection of 25 μ g/g anti-TNP IgG2a (A) or IgG2b (B, E, F) and 20 hours later challenged intravenously with TNP-BSA (10 μ g/g), or (C&D) mice immunized with 200 μ g BSA i.p. in adjuvant on day 0 (CFA), 14 (IFA), and 28 (IFA); and challenged intravenously on day 56 with 500 μ g BSA. Prior to challenge *MRP8-Cre⁺; iDTR^{fl/+}* mice, *MRP8-Cre⁺; iDTR^{fl/fl}* mice, or littermate controls received 500ng DT 24h and 4h (A, B, E) or 3 daily injections of 500ng DT (C-D) before challenge. (F) *C57Bl/6* (WT) mice received 300 μ g anti-Gr-1 (RB6-8C5), anti-CD4 (GK1.5) or isotype control (rat IgG2b) antibodies 24 hour before challenge. Cell depletion in the blood was confirmed by flow cytometry 90 min after challenge. Results are means \pm SEM and representative of at least 2 independent experiments. * $p < 0.05$ WT + anti-Gr1 vs WT + ratIgG2b, Student's t-test at individual timepoints.

basophils had a minor role, and monocyte/macrophages did not contribute [251]. Here, we found that DT-mediated neutrophil depletion in *PMN^{DTR}* mice did not affect ASA induction: these mice experienced comparable hypothermia and no significant difference in mortality following BSA challenge (**Figure 5.4 D-E**).

That DT-mediated neutrophil depletion in *PMN^{DTR}* mice does not imply a contribution of neutrophils to IgG2a or IgG2b PSA, or BSA-ASA is in striking contrast with our previous findings using neutrophil depleting antibodies: whether anti-Gr1, or anti-Ly6G mAb clones NIMP-R14 and 1A8. The perceived protective effect of neutrophil depletion on IgG–anaphylaxis may be a false phenomenon, attributable to antibody-mediated depletion of a large cell population (neutrophils, which constitute 10-20% of circulating blood cells in naïve mice of our animal facility) by other FcγR-expressing myeloid cells, particularly macrophages, either by FcγR occupancy or secondary effects on these cells. Monocyte/macrophages certainly can contribute to IgG anaphylaxis induction, as evidenced by toxic liposome-mediated depletion of these cells [247]. To investigate this hypothesis, we depleted CD4⁺ T cells (15-20% of peripheral blood cells) using a CD4-targeting antibody before IgG2b-PSA, to mimic the potential FcγR-mediated effects of antibody-dependent cell uptake on macrophages. Yet while antibody-mediated neutrophil depletion was protective, anti-CD4 treatment had no effect on hypothermia (**Figure 5.4F**), indicating that only the mAb-mediated depletion of Ly6G⁺ neutrophils protects, and not the depletion of any large cell population.

Constitutively neutropenic Gfi1-KO mice are protected from IgG2a and IgG2b PSA induction [247]. To further investigate the potential contribution of neutrophils to systemic anaphylaxis, we tested the responses of Gfi1-KO mice (*Gfi1-GFP^{KI/KI}*) and heterozygous littermate controls (*Gfi1-GFP^{KI/+}*) in the ASA model, which has not been examined previously. Although both Gfi1-KO and control mice developed IgG1, IgG2(a,b,c) and IgE antibodies against BSA, Gfi1-KO had reduced IgG1 and IgG2 titres (**Figure 5.5A**). This is not unsurprising, given the known role of Gfi1 in lymphoid cell development, as well as the suggested contribution of neutrophils to antigen uptake and presentation. Neutropenia was preserved in immunised Gfi1-KO mice, despite the prominent neutrophilia of immunised controls (**Figure 5.5B**). Following antigen challenge, Gfi1-KO mice experienced considerable hypothermia, but were protected from more severe symptoms and, critically, from ASA-associated death, whereas the mortality of littermate controls ranged from 55% (females) to 90% (males) (**Figure 5.5C-D**). The diminution of the anaphylactic response in Gfi1-KO mice compared to controls may be attributable to reduced titres of BSA-specific antibodies after immunisation (**Figure 5.5A**). We sought to address this issue by employing an alternate approach: the

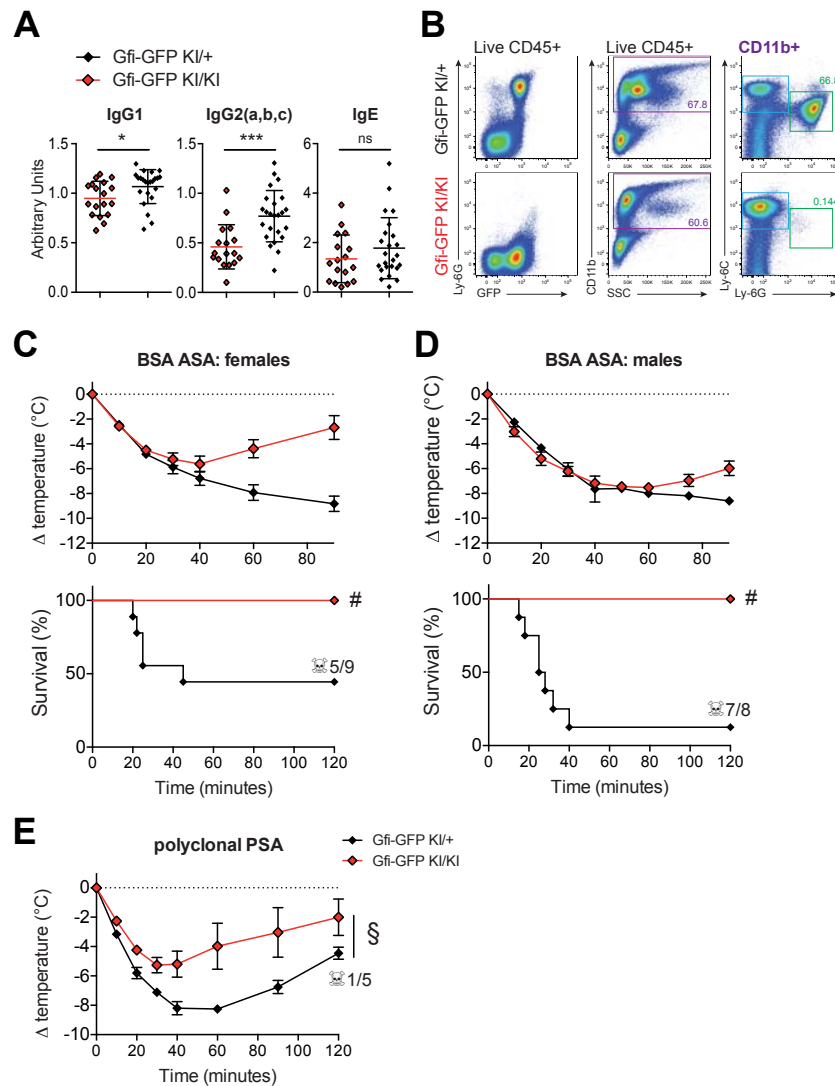


Figure 5.5: Genetically neutropenic Gfi-KO mice are resistant to BSA-dependent ASA and polyclonal PSA. (A-D) Neutrophil deficient Gfi-KO (*Gfi-GFP*^{KI/KI}, red) mice, or neutrophil sufficient heterozygous controls (*Gfi-GFP*^{KI/+}, black) were immunised with 200µg BSA i.p. in adjuvant on day 0 (CFA), 14 (IFA), and 28 (IFA). (A) BSA-specific IgG1, IgG2 and IgE serum antibody titres and (B) neutrophils in the blood of *Gfi-GFP*^{KI/+} but not *Gfi-GFP*^{KI/KI} mice on day 34-35. (C-D) Changes in body temperature (Δ temperature) and survival (%) of female (C) and male (D) BSA-immunised mice after i.v. challenge intravenously on day 41-43 with 500µg BSA. (E) Polyclonal PSA was induced in *Gfi-GFP*^{KI/+} and *Gfi-GFP*^{KI/KI} mice by transfer of 250µL serum of BSA-immunized WT mice 18 hours prior to i.v. challenge with 500µg BSA, and body temperature was monitored following challenge. Data in (A) show the values of individual mice with means ± SEM, (B) are representative figures, and (C-E) are represented as means ± SEM. (A and E) are pooled data and (B-D) are representative of 2 independent experiments. **p*<0.05, ****p*<0.001 by Mann-Whitney test; #*p*<0.05 by log-rank test; § *p*<0.05 from 10-60 min by unpaired t-tests at individual timepoints. ☠ fractions indicate mortality in heterozygous controls.

pooled serum of BSA-immunised WT mice was transferred into naive Gfi1-KO or control recipients and, thus sensitised, mice were challenged intravenously with BSA. This polyclonal PSA approach engendered a strong anaphylactic shock in control mice, comprising a marked hypothermia (-8°C at 40min), and a low mortality rate (**Figure 5.5E**). Gfi1-KO mice, on the other hand, experienced reduced hypothermia, improved symptoms, and no death. Together these data indicate that Gfi1-KO mice are resistant to anaphylaxis induction upon encountering polyclonal immune complexes consisting of IgG1, IgG2 and IgE antibodies; and are particularly protected from severe symptoms, including mortality. As such, these findings support a contribution of neutrophils to anaphylaxis in WT mice.

Collectively, these findings give an intriguing picture of the contribution of neutrophils to anaphylaxis in WT mice. Both antibody-depletion strategies and constitutive neutropenia protect from PSA and ASA, whereas DT-mediated neutrophil depletion in *PMN^{DTR}* mice does not. We can consider several explanations for these disparate findings.

1. DT-mediated neutrophil depletion may be insufficient. The small population of neutrophils remaining in the blood after DT treatment may be enough to trigger mediator release and systemic anaphylactic symptoms. Potentially there is a bodily compartment that is not targeted by DT but is reached by antibody-dependent elimination, or indeed a Ly-6G⁺ subpopulation that is not targeted by the hMrp8 promoter. A comprehensive analysis of the (sub)populations targeted or not by DT may serve to address this question.
2. Antibody-mediated neutrophil depletion could protect from IgG–anaphylaxis due to FcγR-mediated effects on macrophages: FcγR occupancy of these cells prohibits their engagement by immune complexes to trigger anaphylaxis. Our experiments using anti-CD4 treatment argue against this proposition, since CD4⁺ T cell depletion had no effect on PSA. Yet CD4⁺ T cells are rapidly depleted and slow to renew, unlike neutrophils that can be rapidly mobilised from the bone marrow. In addition, this finding does not negate a hypothesis whereby the protective effect of anti-Ly6G mAb administration on PSA induction is in fact a dual result of neutrophil-depletion and FcγR-mediated effects on macrophages.
3. Not only the complete elimination but also the manner in which the cells are eliminated may be critical. Antibody-mediated neutrophil depletion occurs via FcγR-dependent macrophage phagocytosis. Presumably, DT-mediated neutrophil death necessitates the large-scale and systemic clean up of dying cells, potentially altering the systemic inflammatory signature [129].

4. Depleting antibodies bind to Ly-6G on the surface of neutrophils: ‘blockade’ of Ly6G by low dose mAb administration can inhibit neutrophil recruitment to inflamed joints during arthritis [373], but did not affect neutrophil recruitment to other sites and stimulus [374]. Studies with the Catchup mice argue against a role for the Ly6G molecule itself in neutrophil recruitment and activation [371], however the binding of antibodies to Ly6G on the surface of the neutrophil could inhibit the neutrophil by binding to FcγR in *cis*, a likely hypothesis considering the requirement for the Fc portion of the anti-Ly6G antibody [373]. Under high-dose mAb administration as used in our studies, we can consider that neutrophils are mostly depleted; yet the surface Ly6G on any remaining neutrophils is bound and blocked by mAbs. Contrast this situation with *PMN^{DTR}* mice wherein neutrophils are mostly depleted but any remaining neutrophils are unaffected by antibody blockade.

Such speculations feed into more general questions of understanding when and how an IgG-dependent anaphylactic response is initiated and propagated; and how cellular activation drives systemic inflammatory symptoms. The activation of neutrophils, or other myeloid leukocytes, in the bloodstream alone may be enough to trigger mediator release. Yet it is more likely that the full and complete activation of these cells occurs at particular sites, or requires adhesion and potentially extravasation. On the one hand, the *PMN^{DTR}* model of inducible neutropenia potentially reveals outcomes that are not implicated by antibody-mediated depletion strategies. On the other hand, the neutropenia may be insufficient to model reactions that are initiated in the vasculature.

These data serve to emphasise that the study of the *in vivo* functions of neutrophils is best achieved by a combinatorial approach. Not merely depletion, but also confirmative reconstitution experiments are crucial to drawing appropriate conclusions. In this respect the *PMN^{DTR}* model is suited. *In vivo* cell tracking, followed up by *in vitro* studies to ascertain functional readouts, can identify the mechanisms whereby neutrophils affect systemic inflammatory outcomes. Accordingly, our lab has demonstrated in previous work that mouse neutrophils are systemically activated during IgG anaphylaxis; that they can release the anaphylactogenic mediator PAF *in vitro* following IgG stimulation; and that PAF is a crucial mediator of anaphylaxis [251]. Furthermore, purified human neutrophils can be activated *in vitro* by IgG immune complexes to release anaphylactogenic mediators, and the transfer of human neutrophils restores susceptibility to anaphylaxis in resistant mice [161, 251].

Mouse neutrophils express mFcγRIII and mFcγRIV and can be activated through either receptor by IgG immune complexes in the context of systemic anaphylaxis. Not only neutrophils, but

also basophils and monocytes play prominent roles in the IgG-dependent anaphylaxis mouse models used by us and others [141, 161, 249-251]. Human neutrophils, on the other hand, express the uniquely human IgG receptors hFcγRIIA and hFcγRIIIB. We therefore turned to humanised models of FcγR expression to elucidate the role of neutrophils in systemic inflammatory reactions triggered by IgG.

5.2.3 Audrey & humanised mouse models to study FcγR: limitations and potential³

Audrey mice were developed, using targeted knock-in technology, to circumvent the inherent flaws of transgenic approaches to engender human FcγR expression in the mouse; namely, the reproducibility of hFcγR expression, heterogeneity of transgene expression between individuals of the same genotype, and instability between generations [139, 154]. Upon critical consideration, however, the Audrey model has its own limitations. Indeed, although we saw considerable variation in hFcγRIIA expression on basophils in VG1543 mice, this expression appears to be lost in the Audrey mice. Other hFcγR seem to be fairly uniformly expressed across different individuals of the same genotype. The reproducibility of hFcγR expression compared to humans is certainly improved in Audrey mice compared to the other iteration of ‘FcγR-humanized mice’; that is, hFcγRI^{tg} IIA^{tg} IIB^{tg} IIIA^{tg} IIIB^{tg} mice, which exhibit exceptionally high hFcγRIIB on monocytes, and erroneously express hFcγRIIB and hFcγRIIIA on eosinophils, hFcγRIIIA and hFcγRIIIB on some DCs, hFcγRIIIB on monocytes, and constitutively express hFcγRI on neutrophils [171-173]. Overall Audrey mice exhibit more moderate hFcγR expression, without the exaggerated expression tendencies of the transgenic mice. Yet lack of both hFcγRIIA and hFcγRIIB on basophils and the lack of hFcγRIII on eosinophils render Audrey mice an incomplete model for studying all myeloid cell populations.

An unresolved issue of the Audrey model is the expression and function of hFcγRIII. Using available flow cytometry antibodies, we could not distinguish between surface expression of CD16A (hFcγRIIIA) and CD16B (hFcγRIIIB). CD16 expression on Audrey mice seems generally recapitulative of that on human cells: high on neutrophils, medium-high on monocyte/macrophages, and prominent on some but not all NK cells. Yet the difference between hFcγRIIIA and hFcγRIIIB is a critical determinant of the relevance of Audrey mice as model of hFcγR expression. Reassuringly, however, the targeting construct in VG1543 mice comprises the entire human low affinity hFcγR locus (Paper II), the elements conferring the cell type-specific expression of the two hFcγRIII genes are located within this genomic region, and have been previously shown to appropriately direct hFcγRIIIA on monocytes and NK cells and hFcγRIIIB on neutrophils, when expressed as transgenic constructs in

³ Note for ease of prose this discussion will refer mostly to *Audrey* mice, with the readers’ understanding that VG1543 and Audrey mice present a similar phenotype during IgG-induced anaphylaxis, as described in Chapter 4; and with the evident distinction of mFcγRI expression in VG1543 mice compared to hFcγRI expression in Audrey mice.

mice [375]. Careful assessment of transcript levels of CD16A and CD16B by qRT-PCR may be a solution, albeit one requiring the meticulous design of primers to distinguish the two.

One fundamental assumption of models that employ exogenous human receptor expression in mice is that the signalling capacity of the human receptors appropriately integrates with the mouse intracellular signalling systems. hFcγRIIA and hFcγRIIB contain their own intracellular ITAM and ITIM domains, respectively, which presumably couple to mouse kinases and phosphatases to correspondingly mediate intracellular signalling. While it is evident that this works for hFcγRIIA, it has not been demonstrated for hFcγRIIB: we did not detect a role for this receptor during anaphylaxis, using receptor-blocking antibodies (see discussion of Paper II for potential caveats). Still, hFcγRIIB engagement on B cells from hFcγRIIB^{tg} mice blocked calcium flux triggered by BCR stimulation [376], providing conceptual proof that it can function in the mouse system.

Signalling via hFcγRI and hFcγRIIIA, on the other hand, is contingent upon the appropriate association of the human receptor α -chains with the ITAM-containing mouse common FcR γ -chain. Like hFcγRIIB, hFcγRI has demonstrative functionality on mouse cells when expressed as a transgene [142, 155, 157, 377, 378], and transgenic hFcγRIIIA was implicated in antibody-mediated tumour clearance *in vivo* [168, 375, 379]. hFcγRIIB does not contain signalling motifs or associate with the common FcR γ -chain; however transgenic expression of this GPI-linked receptor on mouse neutrophils mediated interactions with intravascular immune complexes and neutrophil recruitment [164]. Thus data in transgenic mice indicate that the human FcγR receptors can integrate with mouse intracellular signalling pathways.

The careful design of experimental models to target particular receptors, and thereby demonstrate the functionality of the hFcγR constructs in Audrey mice, would comfort assumptions of appropriate downstream signalling. In the lab we have on-going projects to develop blocking antibodies against all hFcγR, for both preclinical studies and potential therapeutic approaches. The future application of such blocking, or even agonistic antibodies, will enable us to assess the relative contribution of each hFcγR to physiology and disease – including a potential role of hFcγRIIIA and hFcγRIIB during systemic anaphylaxis. Moreover, confirmation that ‘a function’, identified in Audrey mice, translates to ‘the correct function’, as it relates to humans, will require validation of future findings by comparison with *in vivo* patient data and *in vitro* studies of human cells (see **Section 5.4**).

As an alternative to transgenic approaches, humanised mice generated from the engraftment of human hematopoietic stem cells (HSCs) into immunodeficient NOD/SCID or Rag2^{-/-} γ c^{-/-} mice

represent valuable *in vivo* models of the human immune system. Yet these models are somewhat hampered by variability in the degree of reconstitution by human HSCs and, moreover, considerably defective in reconstitution of the human myeloid cell compartment, retaining high percentages of mouse monocyte/macrophages and neutrophils. Improved by crossing recipient Rag2^{-/-} γ c^{-/-} mice to a background also deficient in endogenous mouse Fc γ R, these mice were successfully employed to investigate hFc γ R-dependent mononuclear phagocyte function [380, 381]. However, appropriate development of the variety of human myeloid cell populations was not demonstrated in these studies, and remains difficult to achieve in humanised mouse models [382].

Anaphylaxis in Audrey mice depends on neutrophils: a biased model?

Of all the myeloid cells that have been proposed to contribute to IgG-dependent systemic anaphylaxis, Audrey mice most accurately model human Fc γ R expression on neutrophils. Audrey monocytes exhibit considerably high hFc γ RIIB expression, whereas basophils do not express hFc γ R. It is particularly apt, therefore, that we find a dominant role for neutrophils in mediating PSA induced by human IgG. Yet it would be overly presumptive to exclude a role of basophils and monocytes in human anaphylactic reactions. In this respect our model possesses some inherent bias. Mast cells of Audrey mice also express hFc γ RIIA. Although we did not directly assess the role of mast cells in IgG-induced systemic anaphylaxis in Audrey mice, it is unlikely that they contribute, considering that neutrophil depletion was wholly protective, and that mast cells were not found to contribute to IgG-induced systemic anaphylaxis in hFc γ RIIA^{tg} mice. That is not to discount, however, a role of mast cells at mucosal surfaces: in particular, hFc γ RIIA on mast cells can initiate cutaneous symptoms of anaphylaxis upon intradermal challenge [161]. Finally, both VG1543 and Audrey mice were susceptible to an active model of anaphylaxis consisting of BSA immunisation and challenge (Paper II and not shown), indicating that fatal anaphylaxis can result from engagement of hFc γ RIIA on neutrophils, albeit by a non-physiological ligand (mouse IgG), as also seen in hFc γ RIIA^{tg} mice.

We did not formally assess the potential contribution of hFc γ RIIB, highly expressed on neutrophils, to anaphylaxis induction. A dramatic reduction in CD16 staining on neutrophils was observed after IVIG-PSA in Audrey mice, which may signify down regulation of this receptor via uptake of immune complexes, or cleavage from the surface as the neutrophils are activated. In human neutrophils, cooperative engagement of hFc γ RIIB with hFc γ RIIA was found to promote maximal calcium flux in response to heat aggregated IgGs [383]. Evidence that hFc γ RIIA alone is sufficient for anaphylaxis is provided both from hFc γ RIIA^{tg} mice, but also by the active anaphylaxis model in Audrey mice, in which the mouse IgG immune complexes that form can bind to hFc γ RIIA but not

Fc γ RIIB. A potential contributory, or inhibitory, role for hFc γ RIIB during anaphylaxis in Audrey mice remains to be determined.

Audrey versus hFc γ RIIA^{tg} mice: anaphylaxis and thrombocytopenia

Together the data from VG1543, Audrey and hFc γ RIIA^{tg} mice provide evidence for a pathway of IgG-dependent systemic anaphylaxis mediated by hFc γ RIIA and neutrophils, and involving PAF, with some contributions for monocytes and basophils, and histamine. In fact, the findings presented herein mirror that of the previous study using hFc γ RIIA^{tg} mice, despite that the H₁₃₁ polymorphic variant is expressed in Audrey mice, compared to the R₁₃₁ in hFc γ RIIA^{tg} mice.

The one significant exception, however, is the agonistic effect of anti-hFc γ RIIA antibodies (clone IV.3): administration of hFc γ RIIA-targeting antibodies alone was enough to trigger hypothermia in hFc γ RIIA^{tg} mice but not in Audrey mice. Monocyte/macrophages played a dominant role in that reaction, since clodronate liposome pre-treatment was protective [161]. Importantly, both the R₁₃₁ and H₁₃₁ polymorphic variants of hFc γ RIIA bind to mouse IgG2b, the isotype of IV.3 antibodies. It has been recently demonstrated that the hypothermic symptoms elicited by treatment of hFc γ RIIA^{tg} mice with hFc γ RIIA-targeting antibodies are coincident with severe thrombocytopenia in mice also expressing all native mouse Fc γ R [384], a finding that is consistent with our own unpublished work. Furthermore, thrombocytopenic and hypothermic reactions required the Fc domain of these antibodies (IV.3, AT.10 and MDE-8): indicating that direct activation of hFc γ RIIA by F(ab')₂ antibody binding is not responsible. Rather, (i) engagement of hFc γ RIIA in *cis* or (ii) engagement of other Fc receptors in either *cis* or *trans* should be responsible for the thrombocytopenia and anaphylaxis seen in hFc γ RIIA^{tg} mice [384]. Reduced, but not absent, hypothermia was observed after IV.3 treatment of Fc γ R-KO hFc γ RIIA^{tg} mice, expressing no other activating Fc γ R [161], implying both (i) and (ii), although signifying greater importance for the latter.

Treatment of Audrey and VG1543 mice with IV.3 antibodies induced neither hypothermia nor thrombocytopenia, even at high doses (200 μ g). This may be accounted for by differences in the amount of hFc γ RIIA expressed on platelets, differences in the R₁₃₁/H₁₃₁ polymorphic variant expressed, or by differences in the expression of other Fc receptors. Monocyte/macrophages are the principal players in thrombocytopenia by platelet-targeting antibodies ([385] & **Annex 7.2**). As already mentioned, these cells appear not to be activated in Audrey mice following systemic IgG administration, at least in terms of mediator release and contribution to anaphylaxis induction. Yet Audrey mice are not resistant to thrombocytopenia induced by another platelet targeting antibody, clone 6A6 (data not shown). Human monocytes demonstrated greater release of anaphylactogenic

lipid mediators (LTB₄, LTC₄ and PAF) after stimulation with human IgG complexes than by direct IV.3 ligation [161], indicating that, considering monocytes alone, if we were to see an effect of IV.3 administration it would be more likely to be via immune complex formation than by direct hFcγRIIA ligation on these cells. Together these considerations endorse a hypothesis whereby the ligation of hFcγRIIA-R₁₃₁ on platelets, and the activating effects of these ‘pseudo’ platelet immune complexes binding hFcγRIIA on monocytes in the absence of inhibitory receptor expression, favours thrombocytopenia and hypothermia in hFcγRIIA^{tg} mice, whereas in Audrey mice the inhibitory hFcγRIIB stops these effects. Dissociating thrombocytopenic events from anaphylactic events is complex, considering the two may be intrinsically linked, not least by antibody-dependent and antibody-independent interactions between leukocytes and platelets. Notably, the role of platelets in anaphylaxis is the subject of ongoing projects in our laboratory.

Considering the high affinity receptor hFcγRI in inflammation

Mice and humans both express the high affinity receptor FcγRI, which is defined by its capacity to bind monomeric IgG, and thereby distinguished from other low-affinity FcγR. Although FcγRI still requires oligomeric ligation to initiate ITAM-dependent activation, the baseline occupancy of this receptor by monomeric ligands grants it several unique properties [386]. Human and mouse FcγRI share a highly homologous extracellular domain, yet structurally divergent cytoplasmic domains, and exhibit major discrepancies in their respective binding of IgG subclasses [387, 388]. Mouse FcγRI is expressed on monocytes, tissue macrophages, and monocyte-derived dendritic cells, but not on neutrophils or other myeloid cells [385, 389, 390]. Similarly, under homeostatic conditions, human FcγRI is normally expressed on monocyte-derived cells and macrophages but not other myeloid cells; however, unlike its murine counterpart, hFcγRI is rapidly and profoundly inducible [387]. During inflammation and with cytokine stimulation, hFcγRI expression on macrophages and monocytes can be enhanced by 5-20 fold, and induced *de novo* on myeloid cells [391], particularly neutrophils [392-394] and mast cells [395], as well as on non-hematopoietic cells [387, 396].

The *in vivo* functions of mouse FcγRI in VG1505 mice, also termed ‘mFcγRI^{only}’ mice, were the subject of a supplementary project to this thesis work (**Annex 7.2**, Gillis et al. *under revision*). mFcγRI was not sufficient to induce immune complex mediated inflammatory reactions in the form of K/BxN arthritis, airway inflammation or passive anaphylaxis; yet could potently induce cell clearance and phagocytosis in the context of immune thrombocytopenia, B cell depletion and anti-tumour immunotherapy. Meanwhile, replacement of mFcγRI with hFcγRI in the transition from

VG1543 mice to Audrey mice allows us to clarify the function of the human high-affinity receptor when expressed in a native context with diverse hFcγR expression.

Using hFcγRI-transgenic mice, our lab has previously demonstrated that the expression of this receptor alone was sufficient to mediate anaphylaxis, arthritis and inflammatory airway disease initiated by immune complex deposition, as well as the elimination of tumour metastases [142]. hFcγRI did not, however, appreciably contribute to anaphylaxis induction in Audrey mice: while blockade of hFcγRIIA protected against PSA induced by aggregated human IVIG, administration of hFcγRI-blocking antibodies had no effect (Figure 4.1). In the first study, the hFcγRI transgene was expressed on a 5-KO mouse background: that is, lacking activating receptors mFcγRI, mFcγRIII, mFcεRI, mFcεRII and inhibitory mFcγRIIB, but retaining mFcγRIV [142]. mFcγRIV can induce inflammatory pathologies including anaphylaxis [141, 251, 397] and therefore to specifically address the role of hFcγRI on the 5KO background, these authors used blocking antibodies against mFcγRIV [142]. This convoluted approach is an important caveat: investigation of hFcγRI^{tg} mice on the FcγR^{null} background would serve to confirm these findings. Nonetheless, to consider these data together with minimal scrutiny: neutrophils were responsible for hFcγRI-dependent anaphylaxis in transgenic mice, neutrophils do not express hFcγRI in Audrey mice, and therefore it is unsurprising that we do not find a contribution for this receptor to systemic anaphylaxis induction by human IgG in Audrey mice. More speculatively, however, these findings inform an understanding of the biology of this high affinity receptor.

In opposition to the previously held notion that hFcγRI is constantly saturated by circulating IgG (reviewed in [139]), the rapid dissociation of IgG from this receptor and enormous experimental evidence suggests that under steady state hFcγRI is exchanging bound monomeric IgG, thus favouring the capture of small immune complexes or sparsely bound antigens [172, 398]. While monomeric binding stimulates receptor endocytosis and recycling [399], IFNγ stimulation rapidly increases the affinity of hFcγRI for immune complexes over monomeric IgG and promotes efficient phagocytosis [143], and the valence of the ligand engagement influences cytokine responses [400]. Antigen uptake via FcγRI promotes both MHC-I and MHC-II associated presentation and strengthens T cell-dependent and independent responses [158, 378, 401-403]. Moreover, in cells of the monocytic lineage, hFcγRI-dependent uptake of immune complexes can promote either canonical pro-inflammatory outcomes, cytokine release and ROS production, or anti-inflammatory polarisation, IL-10 release and inhibition of IFNγ signalling [387, 404]. Critically, both IFNγ and IL-10 act to enhance hFcγRI expression on monocytes. We thus have a picture of hFcγRI as readily poised on

monocyte/macrophages and dendritic cells to take up antigens or small immune complexes from the plasma or extravascular space, or to efficiently phagocytose large opsonised particles, while being simultaneously endowed with the capacity to promote antigen presentation to lymphocytes, and to behave as a rheostat of immune complex-induced inflammation.

The highly inducible nature of hFcγRI on other granulocytes, expressed as it is in inflammatory contexts, indicates that it can contribute to the involvement of these cells in an ongoing inflammatory reaction. On *in vitro*-derived mast cells treated with IFNγ, hFcγRI can induce degranulation, histamine and eicosanoid release [395]; however physiological expression of hFcγRI on *ex vivo* human mast cells has never been reported. Expressed on neutrophils it can mediate their contribution to anaphylaxis, arthritis and airway inflammation, suggestive of both degranulation and release of inflammatory mediators [142]. On the other hand, potentially anti-inflammatory roles for this receptor on neutrophils have not been described, or investigated. mFcγRI is not inducible on granulocytes, and mFcγRI^{only} mice demonstrated that this receptor alone was insufficient to induce measurable immune cell recruitment and inflammation, yet was highly effective at clearing circulating immune complexes, and phagocytosis of antibody-bound cells, thus consigning its critical functions to antigen uptake, phagocytosis and antigen presentation (**Annex 7.2**, [401, 405]). Arthritis is a particularly useful example. K/BxN arthritis is a well-characterised pathology relying on both neutrophils and macrophages. FcγR expression on both these cell populations is necessary. It is unsurprisingly, therefore, that we do not observe arthritis induction in mFcγRI^{only} mice that do not express mFcγRI on neutrophils; while simultaneously evident that hFcγRI in transgenic mice is sufficient to cause pathology as both cell populations express hFcγRI. By comparison to its murine counterpart, we can thereby see how the inducible nature of hFcγRI informs its role in inflammatory processes.

hFcγRI^{tg} mice appropriately model hFcγRI *in vivo* under conditions of systemic inflammation, because hFcγRI is prominently upregulated on human neutrophils during infection and sepsis [406], sterile inflammation and GM-CSF therapy [407] [408], and in patients suffering from arthritis [392], melanoma [409] or lymphoma [410]. It will therefore be highly pertinent to experimentally assess changes in hFcγRI expression on Audrey mice in the context of inflammation, or after systemic GM-CSF or IFNγ administration to (i) confirm if this receptor construct is similarly regulated on the Audrey background and (ii) test how changes in this receptor expression affect the propagation or resolution of inflammation. Many inflammatory diseases have phasic bouts of severity, or are heightened following pathogen exposure, and up regulation of hFcγRI on granulocytes is likely a

contributing factor. Death following anaphylaxis in patients is highly associated with numerous comorbidities, including critical illness [411]; aside from the precariousness of these patients' cardiovascular and respiratory systems, we could speculate that an increased sensitivity of neutrophils to activation via IgG immune complexes may contribute.

Finally, the context of exposure to immune complexes via Fc γ RI, both how and where, is surely a major influence on monocyte/macrophage activation: macrophages in the liver may be responsible for the quiescent uptake of circulating immune complexes, whereas those in other organs (the lung, the peritoneum) may be poised for more rapid and inflammatory responses to Fc γ RI engagement – particularly as the presence of a pathogen in either of those spaces indicates a breach of barrier. Using again K/BxN arthritis as an example: while Fc γ RI expression on macrophages is not sufficient to promote inflammation, its expression on osteoclasts likely contributes to the severity of bone remodelling processes, once an inflammatory infiltrate is present [412].

5.3 Part III: Neutrophils as protective or pathological agents of systemic inflammation

In two distinct models of severe systemic inflammation associated with the development of shock, we herein describe neutrophils as alternatively protective or pathogenic agents. During LPS endotoxemia, neutrophil depletion exacerbates mortality (**Chapter 3, Paper I**), while during IgG-dependent anaphylaxis neutrophil depletion protected against the severe symptoms of shock and a fatal reaction (**Chapter 4, Paper II**). This is an intriguing outcome that likely results from multiple differences in the systemic inflammation associated with each model. This section will address some potential rationales for these divergent neutrophil roles.

In the first instance, endotoxin is a very potent and non-specific trigger of inflammatory responses of immune and non-immune cells, creating an environment conducive to bacterial clearance. Here we decouple endotoxin exposure from the presence of a pathogen, which allows us to demonstrate a protective role of neutrophils in limiting the toxicity and inflammation *per se*. Endotoxin challenge clearly entails the complex engagement of multiple inflammatory and anti-inflammatory pathways. We have only to consider the failures of all attempts to date to translate targeted inhibition of components of the immune system into treatment for inflammatory shock, in the context of either sepsis or trauma. In the end, it is perhaps unsurprising that neutrophils also are partners in the native checks and balances which are of course inherent to the maintenance of immunity, especially during the course of a potent innate reaction.

IgG-dependent anaphylaxis, on the other hand, is contingent on the presence of specific IgG and allergen at sufficiently high titers to form immune complexes: in our case modelled by the transfer of high doses of pre-formed immune complexes. This is a fundamentally different trigger, precisely because it requires a prior immune response mounted in an inflammatory context to promote B cell class switching and IgG production. Allergy and anaphylaxis are inherently a misfiring of the immune system against an otherwise innocuous agent. Yet the presence of high affinity and specific antibodies educates the system to see danger. While the sensitisation of allergic individuals is not the subject of this thesis work, some aspects are discussed in Part IV of the discussion.

Critically, the neutrophil response to TLR4 and Fc γ R ligation is different. LPS-mediated TLR4 ligation induces downstream NF- κ B activation, and modulates particularly cytokine production and neutrophil chemokine receptor expression, and prolongs neutrophil lifespan, as well as promoting ROS production [413]. It can promote neutrophil adhesion to vasculature and extravasation, notably by increasing CD11b and reducing CD62L (L-selection), which agrees with the neutrophil phenotype

we observed during endotoxemia (CD11b^{hi}CD62L^{low}). Moreover, prolonged TLR-4 engagement is associated with a neutrophil 'dysfunctional' phenotype: reduced inflammatory cytokine production, ROS production, and propensity for NET release. NET formation in response to LPS can have anti-inflammatory effects on other cells [75, 292, 293]. Conversely, FcγR ligation of neutrophils can induce prominent NET formation and vascular damage. Importantly, cooperation between the two main human neutrophil IgG receptors, hFcγRIIA and hFcγRIIB, promoted neutrophil recruitment and accumulation in the tissues, however hFcγRIIA alone was associated with injury and inflammation, as well as NET formation within the vasculature [162, 164]. These data align with our finding of a dominant role of hFcγRIIA on neutrophils in triggering IgG-dependent anaphylaxis. Altogether, the TLR4 agonist LPS modulates neutrophil migration and propensity to interact with the vasculature, whereas FcγR engagement can induce rapid degranulation and NET release.

Not only do endotoxic shock and IgG-dependent anaphylaxis represent fundamentally different immune triggers, the initial location of exposure, and the temporal engagements of immune pathways are very different. IgG-dependent anaphylaxis is an extremely rapid response to intravenous challenge, with hypothermia reaching a maximum 20-30min following challenge, and mortality outcomes occurring within the first 40min. These parameters clearly reflect an immediately severe reaction to intravascular neutrophil engagement, driven by the release of preformed mediators. The systemic shock response to endotoxin, on the other hand, requires several hours to reach maximal hypothermia, and death can occur within several days. Neutropenic mice experienced more severe inflammation and more rapid fatal outcomes, indicating an absence of critical factors to limit the course of inflammation. Endotoxin challenge is initiated in the peritoneum and rapidly spreads; the peritoneum, however, is a site populated with a large macrophage population and a minor neutrophil population. These temporal and location-specific factors highlight the potential for the timely engagement of anti-inflammatory and regulatory pathways, and the coordinated migration of neutrophils to promote protection from systemic shock during endotoxemia, as distinct from anaphylaxis.

In both models the outcome is systemic shock, a disseminated state of inflammation and hemodynamic distress. Elusive to our understanding of shock is what kills the host, which may differ from case to case: bronchospasm, cardiac failure or hypoxia as a result of dysregulated hemodynamics. In a simple comparison, we can reflect upon the vascular drivers of shock, and the potent mediator NO. iNOS-derived NO plays a major role in the cardiovascular symptoms of septic shock [339]. MPO can inhibit iNOS [334], and we found a critical requirement of neutrophil-derived MPO in

protecting from endotoxic shock. Conversely, PAF-induced shock is dependent entirely on NO produced not by inducible iNOS, but by constitutive eNOS [414], and PAF is a dominant mediator in IgG-dependent anaphylaxis, particularly in the fatal outcomes of neutrophil activation. One could deduce, therefore, that neutrophil-derived MPO is unlikely to protect from eNOS-driven anaphylactic shock. The temporally different and trigger-specific induction of NO release is thus relevant to understanding shock pathology [179], particularly as it pertains to therapeutic interventions and the use of specific inhibitors.

5.4 Part IV: Towards the clinic: systemic anaphylaxis to neuromuscular blocking drugs

The limitations of anaphylaxis models

Experiments that prove the existence of IgG-dependent anaphylaxis in mice, and evaluate the relative importance of different pathways, employ genetic knock-in and knock-out techniques, the administration of blocking antibodies to block FcR function, and antibodies or toxic products to deplete or block the function of different cells. Gene deletion approaches to study single mouse Fc γ R, or transgenic approaches to study single human Fc γ R generally address questions of ‘can the receptor alone induce anaphylaxis?’ and ‘does anaphylaxis proceed in the absence of this receptor?’ These tactics do not address either collaborative effects between different Fc γ R or compensatory mechanisms accorded by single Fc γ R expression; whether increased expression or enhanced signalling (reviewed in [139]). On the other hand, blocking antibodies to target particular receptors may induce off-target effects either by signalling directly through the Fc γ R, or by binding to non-targeted receptors by the Fc region [415]. FcR-humanised models, such as the Audrey mouse, necessitate also the use of blocking approaches to study individual receptor function. Improved antibody engineering to specifically target particular Fc γ R will be extremely valuable in the study of these mice, and indeed to translate these findings to human studies.

Most crucially, cell depletion or functional ablation approaches can have off-target effects, activate the cell population before elimination, or target only some bodily compartments, potentially leading to false conclusions being drawn. This was highlighted for neutrophils in section 5.2.2, but is equally applicable to other cell types. Antibodies used to deplete basophils are variably effective, and indeed antibody-mediated cell depletion approaches may activate and deplete complement, or affect Fc γ R expressed on other cell types. Monocyte/macrophage targeting by toxic liposomes can actually affect all phagocytic populations, and eliminates different compartments depending on the dose and route of administration. Not to mention the potential immunomodulatory effects of the death of many cells. The purification and transfer of cells, as was demonstrated for human neutrophils, while in one sense the gold standard to prove that these cells can trigger anaphylaxis induction [251], may be questioned by partial activation of these cells during purification and *in vitro* manipulation. Yet the transfer of neutrophils alone, into naïve mice, did not trigger anaphylaxis induction, indicating a requirement for *in vivo* neutrophil activation by specific antibody-allergen complex. In the end, although such experimental techniques cannot be directly applied to assess IgG-dependent anaphylaxis

in humans, the hypotheses drawn from these studies, and their inherent caveats, affects how we can evaluate human anaphylaxis (reviewed in [257]). On the other hand, human data is mostly correlative, with limited capacity for mechanistic insight, especially granted that the urgent and potentially fatal nature of the anaphylactic reaction leaves little room for trials.

Chapter 4 described that anaphylaxis can proceed via human IgG binding to human IgG receptors in hFcγR-knock-in mice. The stimulant we used for anaphylaxis induction was aggregated complexes of human IgG. Intravenous IgG (IVIG) is a blood product containing polyclonal immunoglobulin G (IgG) isolated and pooled from thousands of donors. This stimulus mimics the formation of polyclonal human IgG immune complexes, such as could be formed by specific antibody recognition of soluble antigen in the bloodstream. One could argue that the high doses we use in our IVIG-PSA model are non-physiological: we administer 1mg of aggregated IVIG per mouse, amounting to approximately 0.6-0.8 mg/mL of blood (600-800mg/L), assuming aggregate formation by all the IVIG in suspension. Human blood contains, as a normal average, 9-14 g/L of total IgG. So in effect we are looking at a phenomenon wherein around 5% of the IgG in the bloodstream rapidly forms immune complexes - an unlikely scenario in the case of an allergen-specific response. Indeed, even allergic patients with elevated allergen-specific IgG associated with severe reactions had antibody titres estimated to be in the range of 2-15mg/L (data from the NASA study, see below). Yet the high doses of IVIG used herein were chosen to consistently induce a maximally severe response across all mouse individuals. We nevertheless observed induction of hypothermia and symptoms of shock after administration of aggregated IVIG at 10-fold reduced doses.

As we attempt to move our mouse models closer to the human situation, by using FcγR-humanised mice and human antibodies as a trigger, there is a need to develop models that more accurately mimic human reactions also in terms of the eliciting antigen. It is intuitive that the type of immune complex formed by binding to a large protein antigen or hapten-coated protein, or even by the aggregation of IgG, will be different to that which is formed by binding a small molecule in the case of an intravenous drug. Hence the development of anaphylaxis models against clinically relevant antigens is important. Finally, routine practice of using hypothermia as a measure of anaphylaxis severity in mice, although practical, may ignore some of the subtleties of what drives reaction severity, and indeed what determines a fatal end.

Drug induced anaphylaxis: potentially human IgG-dependent reactions

The likely context in which IgG-dependent anaphylaxis can occur in humans is following intravenous administration of a relatively large quantity of antigen: whether a drug or IgG-containing

therapeutic agent. Drugs or medications are a leading cause of anaphylaxis, accounting for the majority of anaphylactic reactions in adults, and associated with greater severity [227, 230, 237, 411, 416]. Severe hypersensitivity reactions can occur in humans in the absence of detectable amounts of antigen-specific IgE and elevated mast cell tryptase levels [253] and, particularly in the case of drug hypersensitivity reactions, the presence of allergen-specific IgE is often difficult to ascertain [271, 272]. Still, there remains a paucity of direct evidence or proof that these atypical anaphylactic reactions are a result of an IgG-dependant pathway.

In seeking to understand the potential contribution of IgG-mediated pathways to human anaphylaxis, we focused on anaphylaxis to neuromuscular blocking agents (NMBA). Indeed, this curare-based class of compounds including Rocuronium, Suxamethonium and Atracurium account for up to 70% of anaphylactic reactions occurring in patients undergoing anaesthesia [266, 417] (Figure 5.6), and these reactions are fatal in 4-10% of cases [268-270]. With intent to address the role of human IgG antibodies and antibody receptors, myeloid cells and their mediators in NMBA-induced anaphylaxis, we took two complementary approaches. Firstly, we aimed to develop and characterise a mouse model of anaphylaxis in response to the NMBA Rocuronium. This model will enable the mechanistic investigation of pathways of anaphylaxis to a highly clinically relevant, non-protein allergen. In addition, by incorporating the transfer of specific human antibodies into FcR-humanised mice, such a model could permit the proof of antibodies as pathogenic agents, whether IgG or IgE. Secondly, in a large collaboration with a clinical consortium we investigated evidence of an IgG-dependant pathway of neutrophil activation in a multicentric prospective cohort of patients suspected of perioperative anaphylaxis to NMBA. The major advantage of analysing such a cohort to study human anaphylaxis is controlled allergen exposure with defined parameters, *ie* via the intravenous route, defined dose of drug, and timing of sampling.

5.4.1 Developing a mouse model of systemic anaphylaxis to a human drug allergen, Rocuronium Bromide

One of the primary goals of this thesis work was to create a model of NBMA-dependent anaphylaxis, to be developed in both FcγR-humanised and antibody-humanised mice. We chose the drug Rocuronium Bromide because it is a NMBA that occupies a large share of market use and has been identified a common causative agent of anaphylaxis reactions in patients [418, 419]. Furthermore, Rocuronium Bromide may be specifically ‘captured’ by the agent Sugammadex, which was developed for clinical use to reverse neuromuscular blockade [420, 421] (see also below,

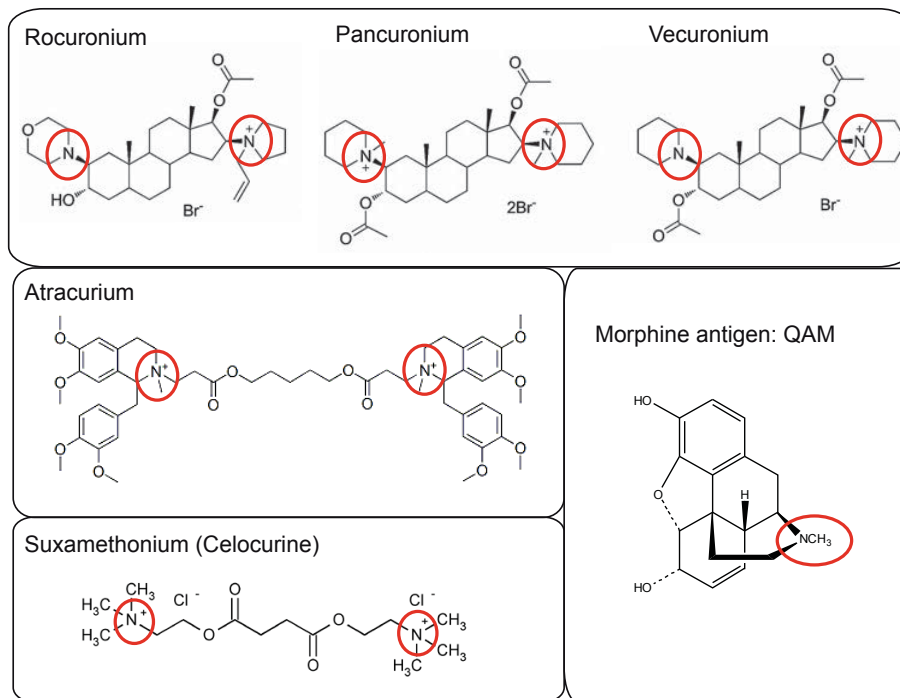


Figure 5.6: Structure of curare-based neuromuscular blocking agents (NMBAs). The aminosteroidal non-depolarising NMBAs Rocuronium, Pancuronium and Vecuronium; the benzylisoquinolinium agent Atracurium; and the depolarising agent suxamethonium (celocurine) are depicted. Red circles indicate the substituted tertiary or quaternary ammonium ions present within these structures. Adapted from structures provided in [422]. Also depicted is the quaternary ammonium morphine [QAM], used for ImmunoCAP® assays developed by Phadia AB, Uppsala, Sweden.

Therapeutic perspective). To develop allergic reactivity, two requisite phases are required. Firstly, sensitisation to the allergen, which in animal models is usually achieved by immunisation with an adjuvant, hapten-carrier approaches, or sustained exposure in the context of inflammation. Sensitisation is marked by an increase in circulating antibodies specific against the allergen. Secondly, in the challenge phase, exposure to the allergen must occur in an appropriate context to elicit an allergic response or a systemic anaphylactic reaction.

Sensitisation

Interestingly, most anaphylactic reactions to NMBA occur upon first exposure to the drug, indicating a potential role for environmental agents in sensitisation [423, 424]. Structure activity studies indicate that the common immunogenic epitopes of NMBA are the tertiary amines or quaternary ammonium ion structures (**Figure 5.6**) [425], which would account for the allergic cross reactivity between different drugs, although some reactivity to adjacent structures on the molecules is also assumed [426]. The ammonium/amine divalency of these small drug molecules is believed to account for their capacity to cross-link antibody receptors, and the space between the NH_x groups may thereby influence their capacity to trigger mediator release [427].

Moreover, the determination of these antigenic elements has had important implications for understanding how individuals may be sensitised to NMBAs, as well as the development of diagnostic tests. Indeed, substituted ammonium ions are present in many other compounds, including cosmetics, cleaning products and morphine and its derivatives [426]. Diagnostic immunoassays for NMBA allergy have been developed designed to mimic these ammonium ion determinants [428, 429]. In particular, an assay based on a modified form of the single tertiary ammonium group derived from morphine has been developed commercially and optimised to detect IgE of patients with NMBA sensitivity [272, 430, 431] (quaternary ammonium morphine [QAM] ImmunoCAP®; Phadia AB, Uppsala, Sweden). In applying these assays, evidence has been garnered for a hypothesis of NMBA allergy as a consequence of sensitivity acquired by environmental exposure to ammonium ion containing products, whether to pholcodine, cosmetics and hair products, or cleaning products [431-436].

We took a hapten-carrier approach to sensitisation of mice, using the antigenic protein carrier KLH (keyhole limpet hemocyanin). In collaboration with organic chemists (Dr S. Bay and C. Ganneau, *Chemistry of Biomolecules, Institut Pasteur*), we modified the Rocuronium molecule by the addition of a carboxyl group, permitting the subsequent coupling of this modified agent (Roc-COOH) with protein carriers: either KLH (keyhole limpet hemocyanin) or BSA (**Figure 5.7A**). Mice were then immunised with the KLH-Rocuronium construct, and the development of Rocuronium-specific antibodies was monitored by ELISA, optimised using the BSA-Rocuronium construct as a detection reagent (**Figure 5.7B-C**). Encouragingly, antibodies of mouse serum directed against BSA-Rocuronium were also observed to cross react with the quaternary ammonium morphine ([QAM], provided by Phadia) by ELISA (not shown). The development of an ELISA for the detection of Rocuronium-specific antibodies is an important tool, both for the mouse project and for the clinical

studies of NMBA-dependent anaphylaxis in which our lab is participating (see following section). Other projects in our laboratory are ongoing to refine the chemistry of agent coupling and testing of patient sera (thesis project of Dr A. Gouel).

Furthermore, we intend to use Rocuronium-immunised mice to generate B cell hybridomas secreting Rocuronium-specific monoclonal antibodies that have never been reported. Although our efforts in this regard have thus far been unsuccessful, the generation of monoclonal antibodies against Rocuronium would enable us to test models of passive anaphylaxis. Likewise, sequencing and cloning of these antibodies to generate chimeric mouse-human antibody variants possessing human Fc domains would enable their use in Fc γ R-humanised mice.

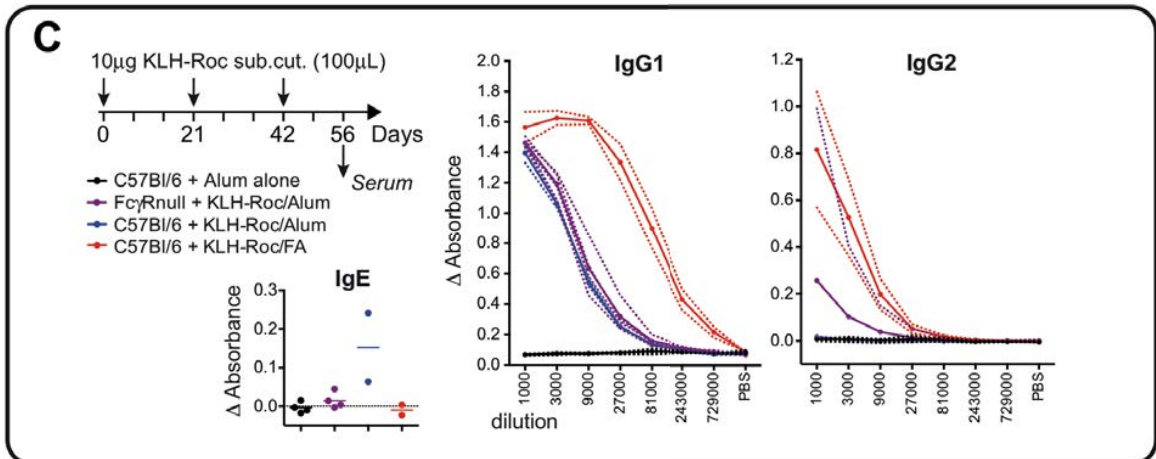
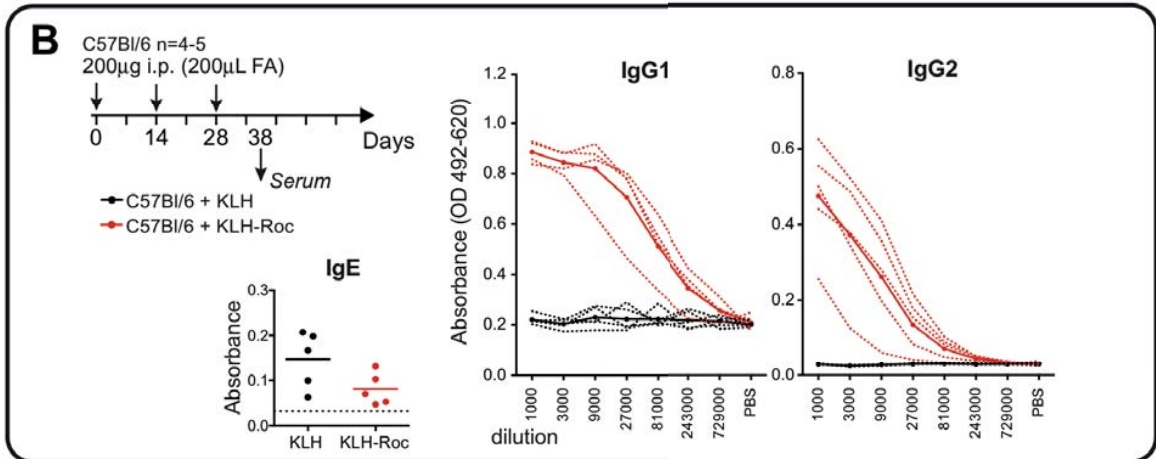
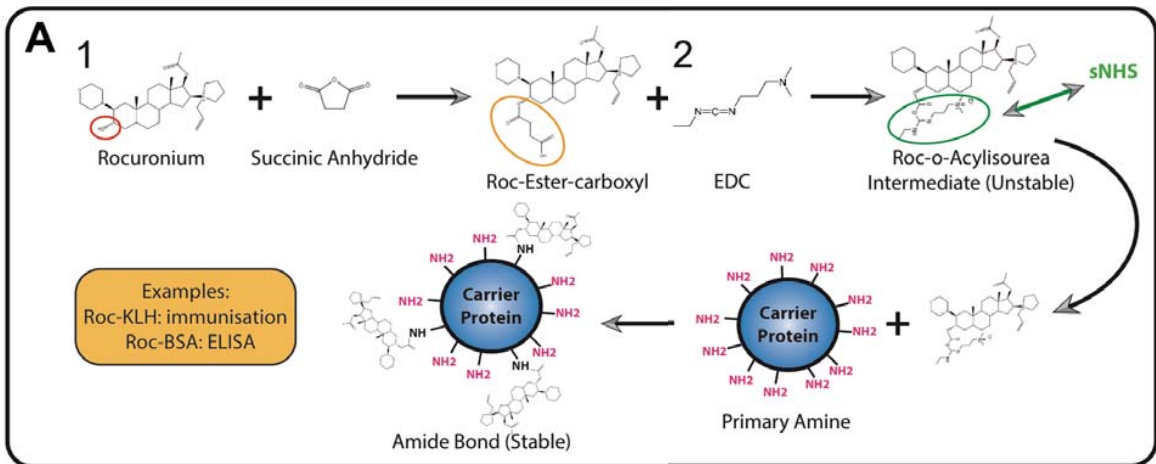
Challenge

To administer NMBA to mice we were obliged to employ a system of artificial ventilation to provide life support and critical respiratory function: mice were intubated or tracheotomised under anaesthesia and placed on an artificial ventilator, and anaesthesia maintained by isoflurane inhalation (2% isoflurane/ 98% O₂). Naïve animals could thereby survive intravenous administration of Rocuronium Bromide at a clinically relevant dose (1mg/kg). Thereafter, we were troubled by technical difficulties to ensure homoeothermia and to continually monitor the vitality and hemodynamic parameters of the animals, after they were anaesthetised and ventilated, and particularly following neuromuscular blockade. As a non-expert in animal surgery, the choice was made during the initial stages of project development to not take invasive approaches to animal monitoring: *ie* invasive heart and blood pressure monitoring, for example by arterial catheterisation [437]. Yet the project was hampered by a paucity of techniques for non-invasive vitality monitoring. Commercially developed strategies for rodents (eg the CODA™ system for non-invasive blood pressure monitoring, Emka Technologies) were not capable of accurate measures during anaesthesia or, particularly, anaphylaxis.

We chose to use the measurement of peripheral oxygen perfusion (PtiO₂, LiCox® apparatus, Integra®) in the skeletal muscle as a surrogate measure of cardiac and respiratory function. Skeletal muscle PtiO₂ has been studied in models of anaphylaxis in rats, and has been demonstrated to correlate well with cardiovascular signs of anaphylactic shock [433, 434]. Practically, this measure can be achieved by inserting an electrode probe into the peripheral muscle - in our case the gastrocnemius muscle was chosen - with minimal surgical intervention. Applied to mice for the first time, we found this detection method highly sensitive to changes in peripheral oxygen perfusion: in particular, and reassuringly, the PtiO₂ measures dropped dramatically during anaphylactic shock induced by

Figure 5.7: Chemical coupling of Rocuronium to carrier proteins KLH or BSA, immunisation of mice and detection of Rocuronium-specific antibodies by ELISA. (A) Coupling of Rocuronium to carrier proteins was achieved in a two-step reaction procedure. In the first reaction (1) the Rocuronium molecule was modified at the indicated hydroxyl group (red circle) by reaction with succinic anhydride (4.5 equivalent) in the presence of DMAP (0.25 equivalent) in pyridine (10mL/1mmol), stirred overnight at RT under argon, to create a stable ester derivative with a terminal carboxyl group (orange circle). The pyridine solvent was removed by vacuum evaporation and the modified Roc-Ester-carboxyl was purified by column chromatography and confirmed by mass spectrometry. In the second step (2) conjugation to carrier proteins was achieved using the carbodiimide crosslinker EDC (50mM), which mediates the formation of a stable amide bond between the carboxyl group and the amine groups on proteins, via a reactive o-Acylisourea intermediate (green circle), stabilised in the presence of sNHS (5mM). This protocol was used to generate KLH-Roc, for mouse immunisations, or BSA-Roc, for use as an ELISA detection reagent. (B-C) WT C57Bl/6J or Fc γ R^{null} mice were immunised with KLH alone or KLH-Roc in adjuvant as indicated: (B) 200 μ g/FA i.p.; complete FA for first immunisation and incomplete FA thereafter, (C) 10 μ g KLH-Roc/FA or Alum, or Alum alone s.c. (B-C) Rocuronium-specific antibodies were detected in the serum by ELISA using BSA-Roc as a detection reagent (coated on plates at 1 μ g/mL): after blocking, serum was added at indicated dilutions in PBS, incubated for >2h at RT, then plates were incubated with HRP-conjugated anti-mouse IgG1, IgG2 or IgE secondary antibodies for 1h at RT, and detection revealed using a peroxidase substrate. (B) Raw absorbance is shown (OD492-620). (C) Specific signal (Δ Absorbance) was determined by subtraction of the background binding to BSA alone. (B-C) Dotted lines (IgG1, IgG2) or symbols (IgE) represent values of individual mice and solid lines indicate the mean.

NB Chemical coupling was performed in collaboration with Dr S. Bay and C. Ganneau, *Chemistry of Biomolecules, Institut Pasteur*.



aggregated IgG antibody complexes. Beside this, stable and valid PtiO₂ measures were vulnerable to less-than-exact insertion of the probe, which is not adapted for rodent usage.

Unfortunately, thus far it has not been possible to reliably assess anaphylaxis induction in Rocuronium-sensitised mice, primarily due to engineering difficulties. (1) The optimisation of ventilation and anaesthesia parameters was hindered by reliable readouts of mouse vitality and sufficient oxygenation. (2) The variation of PiO₂ measures using a probe non-adapted for mouse usage makes it difficult to attain reliable data. Finally, (3) in preliminary experiments we did not see signs of anaphylaxis, in terms of loss of PtiO₂ or death, in mice that were positive for anti-Rocuronium serum IgG by ELISA and received a clinical dose of drug (~1mg/kg, *n*=2). Higher drug doses may be required to initiate anaphylaxis. Rocuronium is administered clinically at doses up to 1.2mg/kg, particularly to enable rapid intubation. We could not yet appropriately assess higher doses of Rocuronium administration in our mouse model, because sustained neuromuscular blockade and/or prolonged anaesthesia led to loss of PtiO₂ and death of naïve controls, presumably due to imperfect ventilation parameters (1). Greater reliability could be achieved by further optimisation of the experimental setup. Alternatively, it may be that finally the application of more sophisticated techniques of animal surgery and monitoring will be necessary to establish a system to test NMBA-dependent anaphylaxis in mice, or moreover, that mice are not the most appropriate model system.

It is likely that we will need to optimise our immunisation strategies to promote higher titres of Rocuronium-specific IgG and IgE antibody formation – or investigate alternate strategies to promote more IgE production. Indeed, while immunisation in Freund's adjuvant generates normally IgG1, IgG2 and IgE antibody titres [251], we could not detect Rocuronium-specific IgE in the sera of mice immunised in CFA/IFA (Figure 5.7B-C). Subcutaneous immunisation in Alum adjuvant, on the other hand, generated weaker IgG1 and no IgG2 responses, but detectable IgE specific to BSA-Rocuronium. Some authors have hypothesised that, in addition to the propensity of either IgG or IgE to initiate anaphylaxis depending on allergen dose, specific IgG may in fact bind to allergens and block the interaction with specific IgE on the surface of mast cells, thereby preventing IgE-induced anaphylaxis in the context of low amounts of allergen [440]. These studies were performed, however, in model systems using protein-conjugated haptens, ie. TNP-BSA.

Rocuronium and other NMBAs are small drug molecules, which presumably exhibit divalent antibody binding via their dual ammonium ion or amine determinants to crosslink adjacent antibody receptors (reviewed in [426]). Yet structural determinants besides from the substituted ammonia may also contribute to the immunogenicity of NMBAs, in particular in view of aminosteroidal NMBAs

such as Rocuronium, that are also more likely to demonstrate cross-reactivity [267] (Figure 5.6). Moreover, the potential for haptensisation of these agents is worth addressing. That is, curare-based neuromuscular blocking agents are known to bind to plasma proteins and lipids [441], and the degree to which this binding occurs affects their pharmacodynamics [442]. The perceived allergenicity of these agents could therefore be a result of their immunogenicity when bound to a particular plasma protein, or lipid, the identity of which remains to be elucidated. The type of immune complex formed, in terms of epitope proximity and number of bound antibodies has been shown to affect both IgE and IgG receptor-mediated cell activation [443], which is probably also the case for IgG: some IgG antibodies are capable of inducing anaphylaxis when bound to their cognate antigen, while others are not [444]. This is an important consideration for how anaphylaxis may occur in NMBA-sensitised individuals, who are in fact sensitised to agents other than the NMBA itself. It may be that the low degree of epitope-paratope matching renders some IgG antibodies sufficiently 'flexible' to bind multiple sites on the NMBA molecule and thereby form immune complexes more potent at activating cells via FcγR.

Finally, how and why anaphylactic reactions to NMBAs occur is still a matter of significant speculation and immunological presumption, especially considering that a significant proportion of the population can be sensitised to NMBAs without necessarily developing a reaction upon exposure. If successful, this unique model will ideally allow us to dissect the underlying mechanisms of NBMA-dependent anaphylaxis, permit the testing of patient-derived NMBA-specific antibodies and potentially provide direct confirmation that human antibodies can drive anaphylaxis in response to a clinical allergen. If it is not possible to demonstrate anaphylaxis after Rocuronium administration in Rocuronium-immunised mice, this finding has several implications for understanding human reactions. Of particular consideration should be how and in what contexts NMBAs are able to form immune complexes.

Therapeutic perspective

Sugammadex, a modified γ -cyclodextrin, rapidly binds Rocuronium with high affinity at a equivalent molar ratio, an encapsulation approach designed to reverse the neuromuscular blockade [420, 421] It has been speculated that the administration of Sugammadex during an anaphylactic reaction initiated by Rocuronium can rescue a patient from anaphylaxis [445, 446], a theoretical therapeutic approach based on allergen capture, and supported by several case reports [447-450]. From a conceptual standpoint, this is an intriguing proposition. Firstly, this theory is reliant on Sugammadex rapidly sequestering free Rocuronium and masking the allergenic epitopes, which is

effectively possible given the degree of encapsulation, although one ammonium group extends beyond the confines of the bound complex (reviewed in [451]). Secondly, the ability of Sugammadex to dissociate an already bound antibody-antigen complex, although less likely, depends on the affinity of antibody-antigen recognition [446].

We can reason that Sugammadex would not be able to reverse the mediator release of already activated and deregulated cells – especially given presumably after the anaphylactic reaction is apparent in the patient. Administered after the fact, Sugammadex could not prevent upregulation of CD63 expression on basophils *in vitro* stimulated by IgE immune complexes [452], or the reaction of a cutaneous skin test provoked by Rocuronium [453]. Yet if given systemically, during an ongoing reaction? The “reversal-rescue hypothesis” is crucially contingent on free drug encapsulation being sufficient to stop symptom propagation. If true, this outcome implies that initial cell activation and a cascade of mediator release is not sufficient to drive anaphylaxis; and rather that a severe reaction requires ongoing stimulation by antibody-allergen complexes. While some recent case reports disagree with this hypothesis [454], others emphasise that early administration of adequate doses of Sugammadex are a potent reversal agent for confirmed Rocuronium-induced anaphylaxis [450]. Certainly, an entirely valid alternative hypothesis for these observations is that the restoration of neuromuscular function, and therefore improvement in vascular resistance, is accountable for the improved hemodynamic parameters of patients after Sugammadex, and allows protective agents such as adrenaline to take effect. It is not a trivial question, considering the potentially fatal outcome of anaphylaxis, the difficulty of conducting controlled trials [455] and that Sugammadex itself can induce anaphylaxis [456, 457]. We therefore intend to test whether Sugammadex administration during Rocuronium-induced anaphylaxis in mice can arrest or even reverse the symptoms of shock. The results of this investigation may have application in a broader context, if indeed we are able to identify that allergen capture is a feasible goal to stop anaphylaxis progression.

5.4.2 Evidence from the clinical study NASA: Neutrophil activation in systemic anaphylaxis

Several lines of evidence using mouse models indicate that (1) anaphylactic reactions can proceed through a dominant pathway involving IgG antibodies and FcγR and (2) that neutrophils can contribute to IgG-induced systemic anaphylaxis. Although some mouse studies have reached divergent conclusions on the critical cell type involved in IgG-mediated anaphylaxis – whether neutrophils, monocytes or basophils [249-251], these studies universally agree in the identification of PAF as a dominant mediator of anaphylaxis. While IgG-dependent anaphylaxis has now been accepted in animal models, whether or not it exists in humans remains a matter of debate.

The project to establish a mouse model of Rocuronium-dependent anaphylaxis was conducted in parallel to a clinical investigation into NMBA-induced anaphylaxis. Conducted in collaboration with a large clinical consortium (NASA study group; for reference please visit <https://clinicaltrials.gov/ct2/show/NCT01637220>), the main objective of this investigation was to examine the possibility that an IgG-FcγR-neutrophil-PAF axis is activated during human anaphylaxis. Patients were recruited on the basis of suspected perioperative anaphylaxis to curare-based NMBAs ($n=86$), and were paired to control patients by age, type of surgery and NMBA received, age and infectious status. **Figure 5.8** outlines the study design and a description of the cohort. Blood samples were taken from patients and controls 30min after anaesthesia induction, and extensive allergological testing was performed on case patients 6-8 weeks after the reaction. Anaphylactic shocks were graded according to the severity of clinical symptoms (**Figure 5.8 C**). Circulating elastase, neutrophil extracellular traps (NETs), tryptase and histamine were measured in the blood by ELISA. Specific IgG and IgE anti-NMBA was measured in an ELISA assay by binding to QAM (quaternary ammonium morphine [QAM] ImmunoCAP®; Phadia AB, Uppsala, Sweden), hereafter referred to as ‘anti-NH4’. We assessed FcγR expression on the major cell populations in the blood by flow cytometry.⁴

⁴ Allergological testing, and measurements of elastase, neutrophil extracellular traps (NETs), tryptase, histamine, and IgG and IgE anti-NMBA were performed at Hôpital Bichat, Paris. Flow cytometry analysis of circulating leukocyte populations was performed at Institut Pasteur (F. Jönsson and C. Gillis).

Co-author list example (poster on the NASA study presented at EAACI 2016, Vienna): de Chaisemartin L.^{1,2} and Jönsson F.^{3,4}, Gouel-Chéron A.^{3,4,5}, Granger V.^{1,2}, Gillis C.^{3,4}, Neukirch C.^{6,7}, Nicaise-Roland P.¹, Dib F.^{8,9}, Tubach F.^{8,9}, Longrois D.^{5,10}, Bruhns P.^{3,4}, Chøllet-Martin S.^{1,2}, NASA Study Group
Institute(s): ¹APHP, Hôpital Bichat, Immunology, Paris, France, ²UMR996, INSERM, Univ Paris-Sud, Université Paris-Saclay, Chatenay-Malabry, France, ³Institut Pasteur, Département d'Immunologie, Anticorps en Thérapie et Pathologie, Paris,, ⁴INSERM, U 760, Paris, ⁵APHP, Hôpital Bichat, Département d'Anesthésie-Réanimation, Paris, ⁶APHP, Hôpital Bichat, Service Pneumologie A, Paris, ⁷UMR1152, INSERM, Université Paris Diderot Paris 7, Paris, ⁸APHP, Hôpital Bichat, Département d'épidémiologie et de recherche clinique, Paris, ⁹UMR1123, ECEVE, INSERM, Université Paris Diderot, Sorbonne Paris Cité, Paris, France, ¹⁰Université Paris Diderot, Sorbonne Paris Cité, Paris

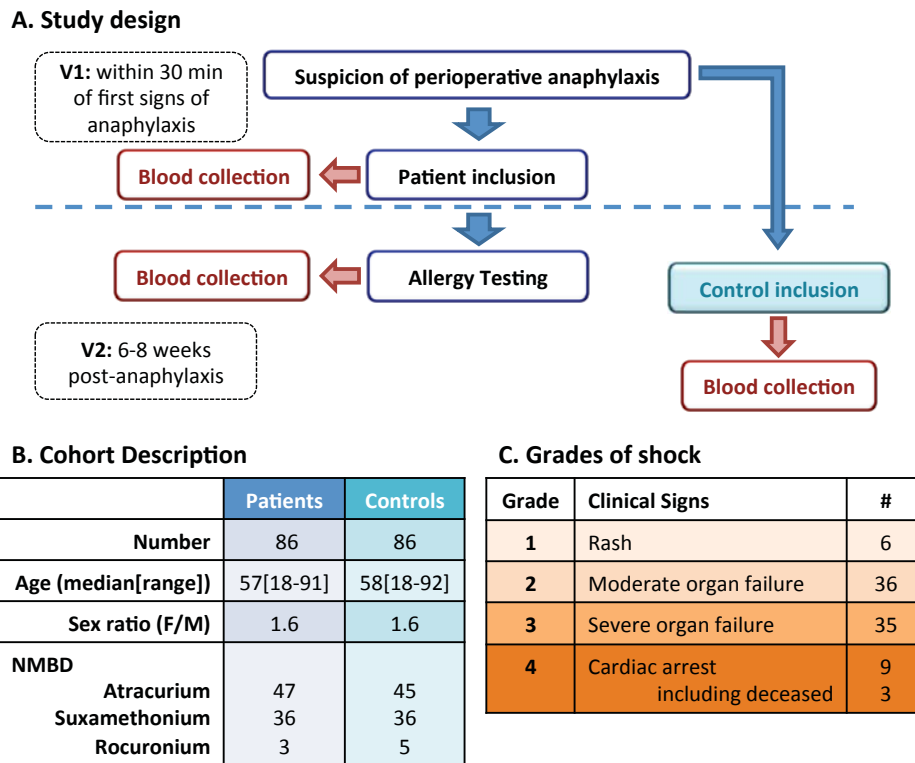


Figure 5.8 Neutrophils in active systemic anaphylaxis (NASA): study inclusion scheme
 (A) Patient cases were recruited after suspicion of perioperative anaphylaxis to curare-based NMBA ($n=86$). Blood samples were taken from cases and control patients 30min after anaesthesia induction (V1). Controls ($n=86$) were paired to cases by age, type of surgery and NMBA received, age and infectious status. Allergological testing was performed on case patients 6-8 weeks after the reaction, with a second blood sample (V2). A description of the cohort is provided (B), as well as the number of cases (#) falling into the respective grades of anaphylaxis shock severity (C). For further reference <https://clinicaltrials.gov/ct2/show/NCT01637220>

IgE anti-NH₄ detected in case patients was significantly elevated compared to controls, as previously reported [272]. Levels of IgE anti-NH₄ antibodies did correlate with the severity of the shock. The prior study found that a significant proportion (~10%) of NMBA-allergic patients do not have detectable NMBA-specific IgE [272]. Whereas in the NASA study it was identified that both cases and controls had IgG anti-NH₄, but elevated specific IgG titres correlated with the severity of the anaphylactic shock. Moreover, a subfraction of patients exhibited elevated titres of anti-NH₄ IgG antibodies in the absence of detectable IgE (data not shown).

We assessed the staining of surface receptors for IgE and IgG on blood leukocytes of case patients and controls. FcεRI was significantly down regulated on basophils, which correlated with the severity of the shock, suggesting that basophils are indeed activated by IgE-immune complexes, leading to receptor internalisation (**Figure 5.9A**). What is more, we observed a significant reduction in surface FcγRIIA on neutrophils from anaphylactic cases, in a manner which correlated with reaction severity, and which was specific to this cell population, because monocyte expression of FcγRIIA was not modulated in cases compared to controls (**Figure 5.9B-C**). We observed, in addition, a strong trend towards reduced FcγRIIIB on neutrophils (**Figure 5.9D**). Therefore, patients experiencing anaphylactic reactions to NMBAs demonstrate the presence of specific IgG and a reduction in staining for IgG receptors on neutrophils; both of which correlated with the severity of shock. In addition, markers of neutrophil activation, neutrophil elastase and DNA-MPO complexes, a marker of NET release, were elevated in case patients: these markers also correlated with reaction severity (not shown). Together these data strongly suggest that, during NMBA-induced anaphylaxis, neutrophils in the blood are directly engaging with IgG immune complexes via activating FcγR, and this is associated with their activation and degranulation. This study thereby provides the first evidence of IgG-dependent neutrophil activation during human anaphylaxis.

The putative activation of an IgG-dependent anaphylaxis pathway in humans is important for diagnosis and therapy, as well as ongoing risk management in allergic individuals. At a minimum, these data emphasise that specific IgG screening should be incorporated into the assessment of suspected anaphylactic reactions in the clinic, especially when specific IgE or positive skin test reactivity cannot be confirmed, and particularly in cases of suspected anaphylaxis to injectable drugs or therapeutic agents. Anaphylaxis has been previously described in patients who exhibit specific IgG but not IgE against therapeutic agents [252, 255, 256, 458]. IgG screening may help to elucidate the underlying causes of anaphylactic reactions where the eliciting agent remains unidentified,

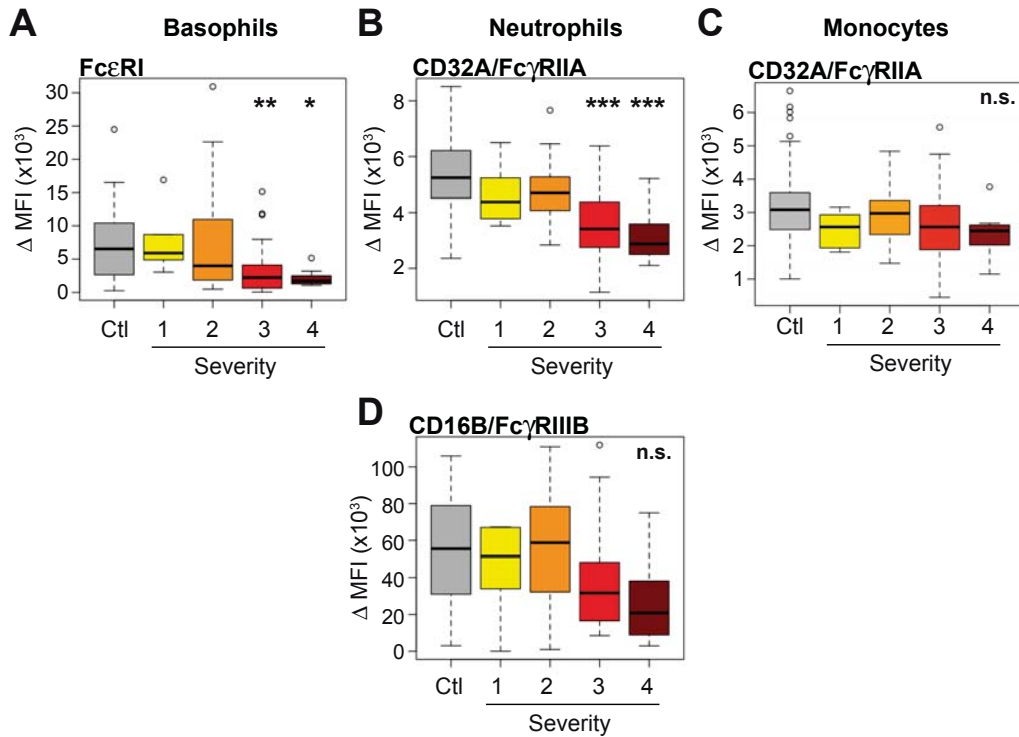


Figure 5.9 Reduction of FcεRI on basophils and FcγRIIA on neutrophils from NASA patients according to severity of anaphylactic shock. (A-D) Surface staining of receptors for IgE and IgG on leukocytes of NASA case patients and controls was determined by flow cytometry analysis of blood samples taken 30min after anaesthesia induction. Expression of FcεRI (A) FcγRIIA (B-C) and FcγRIIIB (D) was determined relative to staining with an isotype control antibody (ΔMFI) after gating on CD123⁺CD203c^{low} basophils (A), CD15⁺CD193^{neg} neutrophils (B & D) or CD14⁺ monocytes (C).

or so-called 'idiopathic' or 'anaphylactoid' reactions: these account for an extremely large proportion (25-60%) of anaphylaxis cases, and are unfortunately often disregarded [459].

The presence of IgG is one thing, and neutrophil activation is another. We can reasonably consider an alternative pathway: that neutrophil activation is in fact downstream of either mast cells or basophils engaging with IgE- or IgG- containing immune complexes, and the release of inflammatory mediators by these cells causes neutrophil activation. It is crucial, therefore, that we observe specifically the down-regulation of FcγRIIA on neutrophils. Whereas FcγRI is known to be upregulated on neutrophils during various inflammatory pathologies, such as sepsis [406], Kawasaki disease [407] and arthritis [392]; and FcγRIII down-regulation is a typical marker of neutrophil activation to different inflammatory stimuli, not specific to IgG engagement; FcγRIIA expression on neutrophils seems to remain stable in the general context of systemic inflammation [460]. Therefore a reduction in FcγRIIA during anaphylaxis would suggest that this receptor, on neutrophils, is actively binding and internalising IgG immune complexes.

Some authors have proposed a reduction in expression of activating IgG antibody receptors as a marker to distinguish IgG-mediated from IgE-mediated anaphylaxis [461]. We found that a significant reduction in both FcεRI on basophils and FcγRIIA on neutrophils were associated with anaphylaxis severity in patients from the NASA study. These data are coherent with our observations that both hFcγRIIA and hFcγRIII are down regulated on neutrophils during hIgG-mediated anaphylaxis in FcγR-humanised Audrey mice (Section 4), although in that model we also observed significant FcγR down regulation on monocytes, which may reflect the strength of the IgG stimulus. We have not yet addressed the differential regulation of receptor expression in NASA patient subsets: for example, to examine whether FcεRI modulation is uniquely observed in patients with detectable IgE anti-NH4, as compared to FcγRIIA modulation in patients with elevated IgG anti-NH4, or no detectable IgE anti-NH4. In a similar fashion, these data can be aligned with markers of neutrophil activation: for example, DNA-MPO complexes were considerably elevated in patients with no detectable IgE anti-NH4 (not shown). Analyses are ongoing. If indeed FcγRIIA down regulation on neutrophils, or the detection of DNA-MPO complexes in the plasma, can be validated as indicators of IgG-dependent anaphylaxis, this may have future diagnostic applications. Finally, a pathway of anaphylaxis induction via activation of FcγRIIA is supported by findings from patients in whom a novel splice variant of this receptor was identified [260]. This allelic variant comprises expression of a cryptic exon 6 of FcγRIIA (FcγRIIA^{exon6*}), which upon crosslinking generates a greater increase in calcium flux, and renders neutrophils from heterozygous patients hyper-responsive to stimulation with small IgG immune

complexes. Moreover, expression of this allele was strongly associated with anaphylaxis risk upon IVIG infusion in patients with common variable immunodeficiency [260].

Platelet activating factor (PAF) is associated with IgG-pathways of anaphylaxis [250, 251] and has been demonstrated to be a strong determinant of reaction severity in animal models, and particularly associated with fatal outcome [261, 262]. We did not yet have the opportunity to assess PAF levels in the sera of patients from the NASA study. Other studies of human patients, however, indicate that PAF levels strongly correlate with anaphylaxis severity, and indeed that PAF measures provide a more specific and sensitive diagnostic marker than either tryptase or histamine [264]. Not only do levels of PAF in the serum correlate with the severity of anaphylaxis, activity of its inactivating enzyme PAF acetylhydrolase was significantly lower in patients with severe and fatal reactions [230, 265], and low PAF-AH activity may be a risk factor for anaphylaxis independent of other inflammatory mediator networks, if the value of measures taken during anaphylaxis can be validated by measures at baseline [462, 463]. PAF has therefore been proposed as a central mediator in human anaphylaxis pathogenesis (reviewed in [263]). A broad range of cells can release PAF, including leukocytes, lymphocytes and endothelial cells, and it is secreted by mast cells and basophils following antibody-dependent activation. Neutrophils are a major source of PAF, but also express PAF-R on the surface, thus PAF can have an autocrine effect on these cells to enhance release of other lipid mediators, including arachadonic acid and its metabolites. PAF is implicated in both IgE and IgG pathways of anaphylaxis induction, and the measurement of PAF or PAF-AH activity in the serum of patients in our NASA study will be a valuable adjunct.

5.5 Final Considerations and Perspectives

This work may be summarised in five major outcomes:

- Neutrophils, and neutrophil-derived MPO, play a critical limiting role during the systemic inflammation of endotoxemia, and protect against toxic shock.
- Neutrophil activation via FcγRIIA is the dominant pathological pathway of systemic anaphylactic shock in response to human IgG immune complexes in ‘FcγR-humanised’ mice.
- We describe two novel mouse models to study neutrophil function *in vivo*: the first, a model of inducible neutropenia, the second a model of classical hFcγR expression recapitulated through knock-in transgenesis in the mouse (hFcγRI/IIA_{H131}/IIB_{I232}/ IIC_{stop13}/IIIA_{V158}/IIIB_{NA2}), particularly relevant to investigate antibody-dependent pathologies.
- Mouse immunisation using Rocuronium coupled to a protein carrier induces Rocuronium-specific antibody responses, for which we developed the first ELISA.
- *By way of a large collaborative study*: we find evidence for the activation of a neutrophil- and IgG-dependent axis during human anaphylaxis to neuromuscular blocking agents.

This thesis describes neutrophils in immunity as actors with several roles to play. A protective role for neutrophils, and neutrophil-derived MPO, in limiting the gravity of endotoxin-induced systemic inflammation implies a necessary reassessment of the way in which inflammation is assessed in animal models. The mere presence of neutrophils at the site, and the activity of MPO, although a marker of inflammatory processes, may not be inherently damaging to the host. These findings align with a wealth of recent studies of the regulatory and anti-inflammatory functions of neutrophils, particularly pertaining to switches in lipid mediator synthesis, reduced migration and changes in adhesion molecules, and a ‘dysfunctional’ phenotype during human sepsis and trauma. Importantly, this latter phenotype may be viewed as a protective outcome of severe systemic inflammation. Certainly our data indicate that neutrophil depletion, as advocated by some, is not a rational therapeutic venture in patients with severe inflammatory shock following sepsis or critical injury.

We did not identify how neutrophil-derived MPO could be protective, although several hypotheses are worth exploring. Is the presence of dead and dying neutrophils sufficient to regulate the extent of inflammation? Is the MPO molecule itself the critical component? Our data would tend to support the latter, although it is simultaneously apparent that the precise and localised delivery of MPO is important. In future investigations it would be worthwhile to concentrate on the vasoactive

effects of MPO, via regulation of iNOS and NO, as well as its effects on the synthesis and catabolism of lipid mediators.

Mouse models are a touchstone for the *in vivo* investigation of a wide range of pathologies, and preclinical studies inform clinical investigations and interventions. The PMN^{DTR} mouse is a new model of inducible, specific and efficient neutrophil ablation: an excellent tool to evaluate the contribution of neutrophils to *in vivo* pathological models, particularly owing to the facility for these mice to be reconstituted with a neutrophil compartment. Our findings using these mice emphasise the distinction between antibody-mediated and DT-mediated neutrophil ablation approaches to study antibody-dependent pathologies in the mouse. That we do not identify a role of neutrophils in IgG-dependent anaphylaxis pathways in the mouse, using PMN^{DTR} mice, is an enigma with several possible explanations. The most likely would be an additional blocking or Fc γ R-mediated effect of antibody-mediated depletion. Alternatively, the neutropenia of PMN^{DTR} mice may be insufficient to model reactions that are initiated in the vasculature. The additive administration of low-dose anti-Ly6G antibodies to DT-treated PMN^{DTR} mice, or increased DT administration to ensure the neutrophil compartment is eradicated, may resolve these questions.

Still, the mouse and human IgG receptor system are highly diverse. Herein we could recapitulate classical hFc γ R expression in the *Audrey* mouse, in a manner that has many advantages over existing transgenic models. We could demonstrate that human IgG binding to human IgG receptors can mediate systemic anaphylaxis in this context. Antibody-mediated neutrophil depletion abolished the shock: a finding that bears its own caveats considering the potential for non-specific antibody-mediated effects. However, that we did not identify a prominent contribution of other cell types, unlike in mouse IgG-dependent anaphylaxis models, emphasises the likelihood that neutrophils are the dominant players. Furthermore, human neutrophils alone have been found sufficient to mediate severe anaphylactic hypothermia upon transfer into the mouse. Together our findings support a pathological role of neutrophils in mediating IgG-dependent systemic inflammatory shock.

Audrey mice will be invaluable for future investigations of antibody-dependent pathologies, or indeed IgG effector mechanisms *in vivo*. In particular, these mice could act as recipients for the transfer of patient-derived or *in vitro* generated antigen-specific human IgG, allowing the investigation of allergen-specific and IgG subclass-specific effects on IgG-dependent anaphylaxis induction. These mice are but one representation of the panel of human polymorphic variants of Fc γ R. Importantly, they are the first mouse representation of human Fc γ RIIA-H131 and Fc γ RIIA-V158 expression, compared to the transgenic iterations of these hFc γ R in the mouse (Fc γ RIIA-R131 and

FcγRIIIA-F158, respectively). It would be clinically relevant to extend studies in hFcγR-knock in mice to understand the effect of hFcγR polymorphisms on cell activation and subsequent biological responses, and therefore on sensitivity to anaphylaxis or other diseases involving IgG antibodies.

IgG-dependent activation pathways in humans may contribute to anaphylaxis, particularly in response to injectable drugs, and to curare-based NMBAs. A mouse model of NMBA-dependent anaphylaxis (Rocuronium Bromide), although technically challenging, is under development, and will be further elucidated in the coming months, as I will stay as a post-doctorate for a short stint after my PhD completion. Potentially this model can be used to demonstrate anaphylaxis in response to a human drug allergen, the pathogenic role of human specific antibodies, as well as to test a novel therapeutic approach of allergen capture. Preliminary data from a clinical study provides the first evidence that neutrophils are activated in the presence of IgG during human NMBA-anaphylaxis, and that specific IgG and markers of neutrophil activation correlate with reaction severity.

The putative activation of an IgG-dependent anaphylaxis pathway in humans is of obvious relevance to adverse events following intravenous drug administration, the transfer of blood products, or therapeutic IgG. More broadly, however, the potential for IgG- dependent anaphylaxis induction is important for diagnosis and therapy. It is unfortunate that the screening of allergen-specific IgG is not recommended. Particularly pertaining to allergens such as injectable substances, to which anaphylaxis has been documented to proceed in the absence of specific IgE but in the presence of specific IgG. Moreover, IgG-dependent pathways, and therefore neutrophil activation, may underlie a fraction of reactions occurring in response to food and venom allergens: especially considering that the systemic absorption of antigen is necessary for severe systemic shock. Accurate diagnosis of apparent 'idiopathic' reactions could be achieved by IgG screening, along with other diagnostic markers of IgG-dependent anaphylaxis.

The theory of allergen immunotherapy appoints that different routes and doses of antigen administration, and the use of different adjuvant agents, can achieve a bias away from the production of IgE, or towards different subclasses of IgG. These techniques have demonstrable success, yet without a proper consideration of both the IgE and IgG pathological outcomes, we may be heading down an erroneous road for therapeutic applications. Although in some cases the allergic phenotype is highly evident, as is the pathophysiology – for example reducing IgE levels certainly protects against dermatitis or rhinitis – the potential side effects of guiding the response against any allergen towards a different type of immune reactivity remain incompletely determined. IgG may block the interaction of antigen with IgE- FcεR and mast cells, and therefore inhibit such a pathway of anaphylaxis. Some data

indicates that subclass specificity of IgG in allergen immunotherapy correlates with positive outcomes. Our data indicate that in the context of large amounts of immune complex formation, IgG can trigger anaphylaxis. An understanding of the relative importance of IgE and IgG pathways, as well as the anaphylactogenic potential of each of the four human IgG subclasses, will therefore inform such therapeutic approaches. Finally, we consider here primarily Fc receptor-dependent pathways of immune cell activation: IgG antibodies can also trigger complement pathway engagement and activate immune cells by co-engagement with other humoral components of innate immunity - feasibly contributing to either the perpetuation or dampening of inflammatory responses - yet these aspects remain to be addressed.

Herein we have identified a major contribution of PAF and histamine to IgG-dependent anaphylaxis induction. The contribution of PAF to human anaphylaxis is well established, and PAF antagonism seems a very promising avenue for therapeutic interventions during suspected anaphylaxis. It would be highly informative to furthermore investigate other potential mediators, particularly lipid-derived, during hIgG-dependent anaphylaxis in Audrey mice. Given the capacity for neutrophils to systemically influence lipid mediator production and release, such data may have potential therapeutic benefit. Many outstanding questions remain: where is the inflammatory response initiated during anaphylaxis, and how does the reaction propagate? Surely there are organ-specific effects that should be addressed? What are the determinants of reaction severity, and how do these relate to cause of death?

That neutrophils can be in one sense protective and in another pathological during systemic inflammation surely depends on the bodily compartment in which they are activated, and the combination of signals received. The data and models described herein provide some insight, and will have valuable future applications, to understand how the appropriate activation of neutrophils occurs in a regulated manner, so as to design interventions that promote host defence and homeostatic immunity, but minimize the detrimental effects of these innate effector cells.

6 References

1. Sampson, H.A., et al., *Second symposium on the definition and management of anaphylaxis: summary report--Second National Institute of Allergy and Infectious Disease/Food Allergy and Anaphylaxis Network symposium*. J Allergy Clin Immunol, 2006. **117**(2): p. 391-7.
2. Drissen, R., et al., *Distinct myeloid progenitor-differentiation pathways identified through single-cell RNA sequencing*. Nat Immunol, 2016. **17**(6): p. 666-76.
3. Sarrazin, S. and M.H. Sieweke, *Eosinophils and mast cells: a lineage apart*. Nat Immunol, 2016. **17**(6): p. 609-11.
4. Galli, S.J., N. Borregaard, and T.A. Wynn, *Phenotypic and functional plasticity of cells of innate immunity: macrophages, mast cells and neutrophils*. Nat Immunol, 2011. **12**(11): p. 1035-44.
5. Borregaard, N., *Neutrophils, from marrow to microbes*. Immunity, 2010. **33**(5): p. 657-70.
6. Dahl, R., et al., *Regulation of macrophage and neutrophil cell fates by the PU.1:C/EBPalpha ratio and granulocyte colony-stimulating factor*. Nat Immunol, 2003. **4**(10): p. 1029-36.
7. Reddy, V.A., et al., *Granulocyte inducer C/EBPalpha inactivates the myeloid master regulator PU.1: possible role in lineage commitment decisions*. Blood, 2002. **100**(2): p. 483-90.
8. Hock, H., et al., *Intrinsic requirement for zinc finger transcription factor Gfi-1 in neutrophil differentiation*. Immunity, 2003. **18**(1): p. 109-20.
9. Karsunky, H., et al., *Inflammatory reactions and severe neutropenia in mice lacking the transcriptional repressor Gfi1*. Nat Genet, 2002. **30**(3): p. 295-300.
10. Laslo, P., et al., *Multilineage transcriptional priming and determination of alternate hematopoietic cell fates*. Cell, 2006. **126**(4): p. 755-66.
11. Zarebski, A., et al., *Mutations in growth factor independent-1 associated with human neutropenia block murine granulopoiesis through colony stimulating factor-1*. Immunity, 2008. **28**(3): p. 370-80.
12. Person, R.E., et al., *Mutations in proto-oncogene GFII cause human neutropenia and target ELA2*. Nat Genet, 2003. **34**(3): p. 308-12.
13. Ordonez-Rueda, D., et al., *A hypomorphic mutation in the Gfi1 transcriptional repressor results in a novel form of neutropenia*. Eur J Immunol, 2012. **42**(9): p. 2395-408.
14. Faurschou, M. and N. Borregaard, *Neutrophil granules and secretory vesicles in inflammation*. Microbes Infect, 2003. **5**(14): p. 1317-27.
15. Sheshachalam, A., et al., *Granule protein processing and regulated secretion in neutrophils*. Front Immunol, 2014. **5**: p. 448.
16. Le Cabec, V., et al., *Targeting of proteins to granule subsets is determined by timing and not by sorting: The specific granule protein NGAL is localized to azurophil granules when expressed in HL-60 cells*. Proc Natl Acad Sci U S A, 1996. **93**(13): p. 6454-7.
17. Cowland, J.B. and N. Borregaard, *The individual regulation of granule protein mRNA levels during neutrophil maturation explains the heterogeneity of neutrophil granules*. J Leukoc Biol, 1999. **66**(6): p. 989-95.
18. Bjerregaard, M.D., et al., *The in vivo profile of transcription factors during neutrophil differentiation in human bone marrow*. Blood, 2003. **101**(11): p. 4322-32.
19. Arnljots, K., et al., *Timing, targeting and sorting of azurophil granule proteins in human myeloid cells*. Leukemia, 1998. **12**(11): p. 1789-95.
20. Rorvig, S., et al., *Proteome profiling of human neutrophil granule subsets, secretory vesicles, and cell membrane: correlation with transcriptome profiling of neutrophil precursors*. J Leukoc Biol, 2013. **94**(4): p. 711-21.

21. Owen, C.A. and E.J. Campbell, *The cell biology of leukocyte-mediated proteolysis*. J Leukoc Biol, 1999. **65**(2): p. 137-50.
22. Murphy, G., et al., *Collagenase is a component of the specific granules of human neutrophil leukocytes*. Biochem J, 1977. **162**(1): p. 195-7.
23. Kang, T., et al., *Subcellular distribution and cytokine- and chemokine-regulated secretion of leukolysin/MT6-MMP/MMP-25 in neutrophils*. J Biol Chem, 2001. **276**(24): p. 21960-8.
24. Sengelov, H., et al., *Mobilization of granules and secretory vesicles during in vivo exudation of human neutrophils*. J Immunol, 1995. **154**(8): p. 4157-65.
25. Borregaard, N., L.J. Miller, and T.A. Springer, *Chemoattractant-regulated mobilization of a novel intracellular compartment in human neutrophils*. Science, 1987. **237**(4819): p. 1204-6.
26. Borregaard, N., et al., *Stimulus-dependent secretion of plasma proteins from human neutrophils*. J Clin Invest, 1992. **90**(1): p. 86-96.
27. Sengelov, H., et al., *Subcellular localization and dynamics of Mac-1 (alpha m beta 2) in human neutrophils*. J Clin Invest, 1993. **92**(3): p. 1467-76.
28. Sengelov, H., et al., *Secretory vesicles are the intracellular reservoir of complement receptor 1 in human neutrophils*. J Immunol, 1994. **153**(2): p. 804-10.
29. Detmers, P.A., et al., *Endotoxin receptors (CD14) are found with CD16 (Fc gamma RIII) in an intracellular compartment of neutrophils that contains alkaline phosphatase*. J Immunol, 1995. **155**(4): p. 2085-95.
30. Borregaard, N., O.E. Sorensen, and K. Theilgaard-Monch, *Neutrophil granules: a library of innate immunity proteins*. Trends Immunol, 2007. **28**(8): p. 340-5.
31. Tak, T., et al., *What's your age again? Determination of human neutrophil half-lives revisited*. J Leukoc Biol, 2013. **94**(4): p. 595-601.
32. Geering, B., et al., *Living and dying for inflammation: neutrophils, eosinophils, basophils*. Trends Immunol, 2013. **34**(8): p. 398-409.
33. Kolaczkowska, E. and P. Kubes, *Neutrophil recruitment and function in health and inflammation*. Nat Rev Immunol, 2013. **13**(3): p. 159-75.
34. Stark, M.A., et al., *Phagocytosis of apoptotic neutrophils regulates granulopoiesis via IL-23 and IL-17*. Immunity, 2005. **22**(3): p. 285-94.
35. Eash, K.J., et al., *CXCR2 and CXCR4 antagonistically regulate neutrophil trafficking from murine bone marrow*. J Clin Invest, 2010. **120**(7): p. 2423-31.
36. Martin, C., et al., *Chemokines acting via CXCR2 and CXCR4 control the release of neutrophils from the bone marrow and their return following senescence*. Immunity, 2003. **19**(4): p. 583-93.
37. Scheiermann, C., P.S. Frenette, and A. Hidalgo, *Regulation of leucocyte homeostasis in the circulation*. Cardiovasc Res, 2015. **107**(3): p. 340-51.
38. Jiao, J., et al., *Central role of conventional dendritic cells in regulation of bone marrow release and survival of neutrophils*. J Immunol, 2014. **192**(7): p. 3374-82.
39. Nauseef, W.M. and N. Borregaard, *Neutrophils at work*. Nat Immunol, 2014. **15**(7): p. 602-11.
40. Bugl, S., et al., *Steady-state neutrophil homeostasis is dependent on TLR4/TRIF signaling*. Blood, 2013. **121**(5): p. 723-33.
41. Zhang, D., et al., *Neutrophil ageing is regulated by the microbiome*. Nature, 2015. **525**(7570): p. 528-32.
42. Devi, S., et al., *Neutrophil mobilization via plerixafor-mediated CXCR4 inhibition arises from lung demargination and blockade of neutrophil homing to the bone marrow*. J Exp Med, 2013. **210**(11): p. 2321-36.
43. Casanova-Acebes, M., et al., *Rhythmic modulation of the hematopoietic niche through neutrophil clearance*. Cell, 2013. **153**(5): p. 1025-35.

44. Wang, S., et al., *Venular basement membranes contain specific matrix protein low expression regions that act as exit points for emigrating neutrophils*. J Exp Med, 2006. **203**(6): p. 1519-32.
45. Mayadas, T.N., X. Cullere, and C.A. Lowell, *The Multifaceted Functions of Neutrophils*. Annu Rev Pathol, 2013.
46. Klesney-Tait, J., et al., *Trans epithelial migration of neutrophils into the lung requires TREM-1*. J Clin Invest, 2013. **123**(1): p. 138-49.
47. Buckley, C.D., et al., *Identification of a phenotypically and functionally distinct population of long-lived neutrophils in a model of reverse endothelial migration*. J Leukoc Biol, 2006. **79**(2): p. 303-11.
48. Colom, B., et al., *Leukotriene B4-Neutrophil Elastase Axis Drives Neutrophil Reverse Transendothelial Cell Migration In Vivo*. Immunity, 2015. **42**(6): p. 1075-86.
49. Woodfin, A., et al., *The junctional adhesion molecule JAM-C regulates polarized transendothelial migration of neutrophils in vivo*. Nat Immunol, 2011. **12**(8): p. 761-9.
50. Abadie, V., et al., *Neutrophils rapidly migrate via lymphatics after Mycobacterium bovis BCG intradermal vaccination and shuttle live bacilli to the draining lymph nodes*. Blood, 2005. **106**(5): p. 1843-50.
51. Duffy, D., et al., *Neutrophils transport antigen from the dermis to the bone marrow, initiating a source of memory CD8+ T cells*. Immunity, 2012. **37**(5): p. 917-29.
52. Hampton, H.R., et al., *Microbe-dependent lymphatic migration of neutrophils modulates lymphocyte proliferation in lymph nodes*. Nat Commun, 2015. **6**: p. 7139.
53. Yang, C.W. and E.R. Unanue, *Neutrophils control the magnitude and spread of the immune response in a thromboxane A2-mediated process*. J Exp Med, 2013.
54. Chtanova, T., et al., *Dynamics of neutrophil migration in lymph nodes during infection*. Immunity, 2008. **29**(3): p. 487-96.
55. Gorlino, C.V., et al., *Neutrophils exhibit differential requirements for homing molecules in their lymphatic and blood trafficking into draining lymph nodes*. J Immunol, 2014. **193**(4): p. 1966-74.
56. Aderem, A. and D.M. Underhill, *Mechanisms of phagocytosis in macrophages*. Annu Rev Immunol, 1999. **17**: p. 593-623.
57. Nauseef, W.M., *Biological roles for the NOX family NADPH oxidases*. J Biol Chem, 2008. **283**(25): p. 16961-5.
58. Brechard, S., S. Plancon, and E.J. Tschirhart, *New insights into the regulation of neutrophil NADPH oxidase activity in the phagosome: a focus on the role of lipid and Ca(2+) signaling*. Antioxid Redox Signal, 2013. **18**(6): p. 661-76.
59. Nauseef, W.M., *Myeloperoxidase in human neutrophil host defence*. Cell Microbiol, 2014. **16**(8): p. 1146-55.
60. Urban, C.F., et al., *Neutrophil extracellular traps contain calprotectin, a cytosolic protein complex involved in host defense against Candida albicans*. PLoS Pathog, 2009. **5**(10): p. e1000639.
61. Metzler, K.D., et al., *Myeloperoxidase is required for neutrophil extracellular trap formation: implications for innate immunity*. Blood, 2011. **117**(3): p. 953-9.
62. Akong-Moore, K., et al., *Influences of chloride and hypochlorite on neutrophil extracellular trap formation*. PLoS One, 2012. **7**(8): p. e42984.
63. Parker, H., et al., *Requirements for NADPH oxidase and myeloperoxidase in neutrophil extracellular trap formation differ depending on the stimulus*. J Leukoc Biol, 2012. **92**(4): p. 841-9.
64. Silvestre-Roig, C., A. Hidalgo, and O. Soehnlein, *Neutrophil heterogeneity: implications for homeostasis and pathogenesis*. Blood, 2016. **127**(18): p. 2173-81.

65. Scapini, P., F. Calzetti, and M.A. Cassatella, *On the detection of neutrophil-derived vascular endothelial growth factor (VEGF)*. J Immunol Methods, 1999. **232**(1-2): p. 121-9.
66. Tecchio, C., A. Micheletti, and M.A. Cassatella, *Neutrophil-derived cytokines: facts beyond expression*. Front Immunol, 2014. **5**: p. 508.
67. Naranbhai, V., et al., *Genomic modulators of gene expression in human neutrophils*. Nat Commun, 2015. **6**: p. 7545.
68. Zilbauer, M., et al., *Genome-wide methylation analyses of primary human leukocyte subsets identifies functionally important cell-type-specific hypomethylated regions*. Blood, 2013. **122**(25): p. e52-60.
69. Ostuni, R., et al., *Epigenetic regulation of neutrophil development and function*. Semin Immunol, 2016. **28**(2): p. 83-93.
70. Rivera, A., et al., *Innate cell communication kick-starts pathogen-specific immunity*. Nat Immunol, 2016. **17**(4): p. 356-63.
71. Novais, F.O., et al., *Neutrophils and macrophages cooperate in host resistance against Leishmania braziliensis infection*. J Immunol, 2009. **183**(12): p. 8088-98.
72. Dalli, J., et al., *Annexin 1 mediates the rapid anti-inflammatory effects of neutrophil-derived microparticles*. Blood, 2008. **112**(6): p. 2512-9.
73. Eken, C., et al., *Ectosomes released by polymorphonuclear neutrophils induce a MerTK-dependent anti-inflammatory pathway in macrophages*. J Biol Chem, 2010. **285**(51): p. 39914-21.
74. Eken, C., et al., *Ectosomes of polymorphonuclear neutrophils activate multiple signaling pathways in macrophages*. Immunobiology, 2013. **218**(3): p. 382-92.
75. Gasser, O. and J.A. Schifferli, *Activated polymorphonuclear neutrophils disseminate anti-inflammatory microparticles by ectocytosis*. Blood, 2004. **104**(8): p. 2543-8.
76. Yang, C.W., et al., *Neutrophils influence the level of antigen presentation during the immune response to protein antigens in adjuvants*. J Immunol, 2010. **185**(5): p. 2927-34.
77. Schwaller, J., et al., *Neutrophil-derived APRIL concentrated in tumor lesions by proteoglycans correlates with human B-cell lymphoma aggressiveness*. Blood, 2007. **109**(1): p. 331-8.
78. Scapini, P., F. Bazzoni, and M.A. Cassatella, *Regulation of B-cell-activating factor (BAFF)/B lymphocyte stimulator (BLyS) expression in human neutrophils*. Immunol Lett, 2008. **116**(1): p. 1-6.
79. Jones, H.R., et al., *The role of neutrophils in inflammation resolution*. Semin Immunol, 2016. **28**(2): p. 137-45.
80. Campbell, E.L., et al., *Transmigrating Neutrophils Shape the Mucosal Microenvironment through Localized Oxygen Depletion to Influence Resolution of Inflammation*. Immunity, 2014. **40**(1): p. 66-77.
81. Bournazou, I., et al., *Apoptotic human cells inhibit migration of granulocytes via release of lactoferrin*. J Clin Invest, 2009. **119**(1): p. 20-32.
82. Yang, D., et al., *Alarmins link neutrophils and dendritic cells*. Trends Immunol, 2009. **30**(11): p. 531-7.
83. Zhang, X., et al., *Coactivation of Syk kinase and MyD88 adaptor protein pathways by bacteria promotes regulatory properties of neutrophils*. Immunity, 2009. **31**(5): p. 761-71.
84. Bouabe, H., et al., *Novel highly sensitive IL-10-beta-lactamase reporter mouse reveals cells of the innate immune system as a substantial source of IL-10 in vivo*. J Immunol, 2011. **187**(6): p. 3165-76.
85. Davey, M.S., et al., *Failure to detect production of IL-10 by activated human neutrophils*. Nat Immunol, 2011. **12**(11): p. 1017-8; author reply 1018-20.
86. Lewkowicz, N., et al., *Induction of human IL-10-producing neutrophils by LPS-stimulated Treg cells and IL-10*. Mucosal Immunol, 2016. **9**(2): p. 364-78.

87. De Santo, C., et al., *Invariant NKT cells modulate the suppressive activity of IL-10-secreting neutrophils differentiated with serum amyloid A*. Nat Immunol, 2010. **11**(11): p. 1039-46.
88. Zhang, N., et al., *Serum amyloid A-luciferase transgenic mice: response to sepsis, acute arthritis, and contact hypersensitivity and the effects of proteasome inhibition*. J Immunol, 2005. **174**(12): p. 8125-34.
89. De Santo, C., et al., *Reply to "Failure to detect production of IL-10 by activated human neutrophils"*. Nat Immunol, 2011. **12**(11): p. 1018-1020.
90. Tamassia, N., et al., *Cutting edge: An inactive chromatin configuration at the IL-10 locus in human neutrophils*. J Immunol, 2013. **190**(5): p. 1921-5.
91. van Rees, D.J., et al., *Immunoreceptors on neutrophils*. Semin Immunol, 2016. **28**(2): p. 94-108.
92. Futosi, K., S. Fodor, and A. Mocsai, *Reprint of Neutrophil cell surface receptors and their intracellular signal transduction pathways*. Int Immunopharmacol, 2013. **17**(4): p. 1185-97.
93. Levy, B.D., et al., *Lipid mediator class switching during acute inflammation: signals in resolution*. Nat Immunol, 2001. **2**(7): p. 612-9.
94. Serhan, C.N., N. Chiang, and T.E. Van Dyke, *Resolving inflammation: dual anti-inflammatory and pro-resolution lipid mediators*. Nat Rev Immunol, 2008. **8**(5): p. 349-61.
95. Dalli, J. and C.N. Serhan, *Specific lipid mediator signatures of human phagocytes: microparticles stimulate macrophage efferocytosis and pro-resolving mediators*. Blood, 2012. **120**(15): p. e60-72.
96. Gordon, S. and P.R. Taylor, *Monocyte and macrophage heterogeneity*. Nat Rev Immunol, 2005. **5**(12): p. 953-64.
97. van Furth, R., et al., *The mononuclear phagocyte system: a new classification of macrophages, monocytes, and their precursor cells*. Bull World Health Organ, 1972. **46**(6): p. 845-52.
98. Yona, S., et al., *Fate mapping reveals origins and dynamics of monocytes and tissue macrophages under homeostasis*. Immunity, 2013. **38**(1): p. 79-91.
99. Hashimoto, D., et al., *Tissue-resident macrophages self-maintain locally throughout adult life with minimal contribution from circulating monocytes*. Immunity, 2013. **38**(4): p. 792-804.
100. Ginhoux, F. and M. Guilliams, *Tissue-Resident Macrophage Ontogeny and Homeostasis*. Immunity, 2016. **44**(3): p. 439-49.
101. Davies, L.C., et al., *Tissue-resident macrophages*. Nat Immunol, 2013. **14**(10): p. 986-95.
102. Gordon, S., A. Pluddemann, and F. Martinez Estrada, *Macrophage heterogeneity in tissues: phenotypic diversity and functions*. Immunol Rev, 2014. **262**(1): p. 36-55.
103. Dey, A., J. Allen, and P.A. Hankey-Giblin, *Ontogeny and polarization of macrophages in inflammation: blood monocytes versus tissue macrophages*. Front Immunol, 2014. **5**: p. 683.
104. Hanspal, M. and J.S. Hanspal, *The association of erythroblasts with macrophages promotes erythroid proliferation and maturation: a 30-kD heparin-binding protein is involved in this contact*. Blood, 1994. **84**(10): p. 3494-504.
105. Yoshida, H., et al., *Phosphatidylserine-dependent engulfment by macrophages of nuclei from erythroid precursor cells*. Nature, 2005. **437**(7059): p. 754-8.
106. Takayanagi, H., *Osteoimmunology: shared mechanisms and crosstalk between the immune and bone systems*. Nat Rev Immunol, 2007. **7**(4): p. 292-304.
107. Ganz, T., *Macrophages and systemic iron homeostasis*. J Innate Immun, 2012. **4**(5-6): p. 446-53.
108. Geijtenbeek, T.B., et al., *Marginal zone macrophages express a murine homologue of DC-SIGN that captures blood-borne antigens in vivo*. Blood, 2002. **100**(8): p. 2908-16.
109. Erwig, L.P. and P.M. Henson, *Clearance of apoptotic cells by phagocytes*. Cell Death Differ, 2008. **15**(2): p. 243-50.
110. Ziegler-Heitbrock, L., *Monocyte subsets in man and other species*. Cell Immunol, 2014. **289**(1-2): p. 135-9.

111. Ziegler-Heitbrock, L., et al., *Nomenclature of monocytes and dendritic cells in blood*. *Blood*, 2010. **116**(16): p. e74-80.
112. Swirski, F.K., et al., *Identification of splenic reservoir monocytes and their deployment to inflammatory sites*. *Science*, 2009. **325**(5940): p. 612-6.
113. Sica, A. and A. Mantovani, *Macrophage plasticity and polarization: in vivo veritas*. *J Clin Invest*, 2012. **122**(3): p. 787-95.
114. Mills, C.D., *M1 and M2 Macrophages: Oracles of Health and Disease*. *Crit Rev Immunol*, 2012. **32**(6): p. 463-88.
115. Martinez, F.O. and S. Gordon, *The M1 and M2 paradigm of macrophage activation: time for reassessment*. *F1000Prime Rep*, 2014. **6**: p. 13.
116. Mills, C.D., et al., *M-1/M-2 macrophages and the Th1/Th2 paradigm*. *J Immunol*, 2000. **164**(12): p. 6166-73.
117. Murray, P.J., et al., *Macrophage activation and polarization: nomenclature and experimental guidelines*. *Immunity*, 2014. **41**(1): p. 14-20.
118. Chen, C.C., et al., *Identification of mast cell progenitors in adult mice*. *Proc Natl Acad Sci U S A*, 2005. **102**(32): p. 11408-13.
119. Kitamura, Y., et al., *Differentiation and transdifferentiation of mast cells; a unique member of the hematopoietic cell family*. *Int J Cell Cloning*, 1987. **5**(2): p. 108-21.
120. Kitamura, Y., H. Matsuda, and K. Hatanaka, *Clonal nature of mast-cell clusters formed in W/W^v mice after bone marrow transplantation*. *Nature*, 1979. **281**(5727): p. 154-5.
121. Nakano, T., et al., *Fate of bone marrow-derived cultured mast cells after intracutaneous, intraperitoneal, and intravenous transfer into genetically mast cell-deficient W/W^v mice. Evidence that cultured mast cells can give rise to both connective tissue type and mucosal mast cells*. *J Exp Med*, 1985. **162**: p. 1025-43.
122. Galli, S.J., et al., *Mast cells as "tunable" effector and immunoregulatory cells: recent advances*. *Annu Rev Immunol*, 2005. **23**: p. 749-86.
123. Metcalfe, D.D., D. Baram, and Y.A. Mekori, *Mast cells*. *Physiol. Rev.*, 1997. **77**(4): p. 1033-1079.
124. Galli, S.J., K.M. Zsebo, and E.N. Geissler, *The kit ligand, stem cell factor*. *Adv Immunol*, 1994. **55**: p. 1-96.
125. Stone, K.D., C. Prussin, and D.D. Metcalfe, *IgE, mast cells, basophils, and eosinophils*. *J Allergy Clin Immunol*, 2010. **125**(2 Suppl 2): p. S73-80.
126. Kalesnikoff, J. and S.J. Galli, *New developments in mast cell biology*. *Nat Immunol*, 2008. **9**(11): p. 1215-23.
127. Enerback, L., *The differentiation and maturation of inflammatory cells involved in the allergic response: mast cells and basophils*. *Allergy*, 1997. **52**(1): p. 4-10.
128. Oetjen, L.K., M. Noti, and B.S. Kim, *New insights into basophil heterogeneity*. *Semin Immunopathol*, 2016.
129. Poon, I.K., et al., *Apoptotic cell clearance: basic biology and therapeutic potential*. *Nat Rev Immunol*, 2014. **14**(3): p. 166-80.
130. Koedel, U., et al., *Apoptosis is essential for neutrophil functional shutdown and determines tissue damage in experimental pneumococcal meningitis*. *PLoS Pathog*, 2009. **5**(5): p. e1000461.
131. Watson, R.W., et al., *Neutrophils undergo apoptosis following ingestion of Escherichia coli*. *J Immunol*, 1996. **156**(10): p. 3986-92.
132. Fadok, V.A., et al., *Regulation of macrophage cytokine production by phagocytosis of apoptotic and post-apoptotic cells*. *Biochem Soc Trans*, 1998. **26**(4): p. 653-6.
133. Filardy, A.A., et al., *Proinflammatory clearance of apoptotic neutrophils induces an IL-12(low)IL-10(high) regulatory phenotype in macrophages*. *J Immunol*, 2010. **185**(4): p. 2044-50.

134. Freire-de-Lima, C.G., et al., *Apoptotic cells, through transforming growth factor-beta, coordinately induce anti-inflammatory and suppress pro-inflammatory eicosanoid and NO synthesis in murine macrophages*. J Biol Chem, 2006. **281**(50): p. 38376-84.
135. Lai, A.Y. and M. Kondo, *T and B lymphocyte differentiation from hematopoietic stem cell*. Semin Immunol, 2008. **20**(4): p. 207-12.
136. Nutt, S.L., et al., *The generation of antibody-secreting plasma cells*. Nat Rev Immunol, 2015. **15**(3): p. 160-71.
137. Wienands, J. and N. Engels, *The Memory Function of the B Cell Antigen Receptor*. Curr Top Microbiol Immunol, 2016. **393**: p. 107-21.
138. Pone, E.J., et al., *B cell TLRs and induction of immunoglobulin class-switch DNA recombination*. Front Biosci (Landmark Ed), 2012. **17**: p. 2594-615.
139. Bruhns, P. and F. Jonsson, *Mouse and human FcR effector functions*. Immunol Rev, 2015. **268**(1): p. 25-51.
140. Foss, S., et al., *TRIM21: a cytosolic Fc receptor with broad antibody isotype specificity*. Immunol Rev, 2015. **268**(1): p. 328-39.
141. Mancardi, D.A., et al., *The murine high-affinity IgG receptor Fc(gamma)RIV is sufficient for autoantibody-induced arthritis*. J Immunol, 2011. **186**(4): p. 1899-903.
142. Mancardi, D.A., et al., *The high-affinity human IgG receptor FcgammaRI (CD64) promotes IgG-mediated inflammation, anaphylaxis, and antitumor immunotherapy*. Blood, 2013. **121**(9): p. 1563-73.
143. van der Poel, C.E., et al., *Cytokine-induced immune complex binding to the high-affinity IgG receptor, FcgammaRI, in the presence of monomeric IgG*. Blood, 2010. **116**(24): p. 5327-33.
144. Brandsma, A.M., et al., *Fc receptor inside-out signaling and possible impact on antibody therapy*. Immunol Rev, 2015. **268**(1): p. 74-87.
145. Blank, U., et al., *Inhibitory ITAMs as novel regulators of immunity*. Immunol Rev, 2009. **232**(1): p. 59-71.
146. Pfirsch-Maisonnas, S., et al., *Inhibitory ITAM signaling traps activating receptors with the phosphatase SHP-1 to form polarized "inhibisome" clusters*. Sci Signal, 2011. **4**(169): p. ra24.
147. Ben Mkaddem, S., et al., *Shifting FcgammaRIIA-ITAM from activation to inhibitory configuration ameliorates arthritis*. J Clin Invest, 2014. **124**(9): p. 3945-59.
148. Minard-Colin, V., et al., *Lymphoma depletion during CD20 immunotherapy in mice is mediated by macrophage FcgammaRI, FcgammaRIII, and FcgammaRIV*. Blood, 2008. **112**(4): p. 1205-13.
149. Clatworthy, M.R. and K.G. Smith, *FcgammaRIIb balances efficient pathogen clearance and the cytokine-mediated consequences of sepsis*. J Exp Med, 2004. **199**(5): p. 717-23.
150. Smith, K.G. and M.R. Clatworthy, *FcgammaRIIB in autoimmunity and infection: evolutionary and therapeutic implications*. Nat Rev Immunol, 2010. **10**(5): p. 328-43.
151. Bolland, S. and J.V. Ravetch, *Spontaneous autoimmune disease in Fc(gamma)RIIB-deficient mice results from strain-specific epistasis*. Immunity, 2000. **13**(2): p. 277-85.
152. Roopenian, D.C. and S. Akilesh, *FcRn: the neonatal Fc receptor comes of age*. Nat Rev Immunol, 2007. **7**(9): p. 715-25.
153. Metes, D., et al., *Expression of functional CD32 molecules on human NK cells is determined by an allelic polymorphism of the FcgammaRIIC gene*. Blood, 1998. **91**(7): p. 2369-80.
154. Gillis, C., et al., *Contribution of Human FcgammaRs to Disease with Evidence from Human Polymorphisms and Transgenic Animal Studies*. Front Immunol, 2014. **5**: p. 254.
155. Heijnen, I.A. and J.G. Van de Winkel, *A human Fc gamma RI/CD64 transgenic model for in vivo analysis of (bispecific) antibody therapeutics*. J Hematother, 1995. **4**(5): p. 351-6.

156. Van Vugt, M.J., I.E. Van den Herik-Oudijk, and J.G. Van de Winkel, *FcγRIa-gamma-chain complexes trigger antibody-dependent cell-mediated cytotoxicity (ADCC) in CD5+ B cell/macrophage IIA1.6 cells*. Clin Exp Immunol, 1998. **113**(3): p. 415-22.
157. Heijnen, I.A., et al., *Antigen targeting to myeloid-specific human Fc gamma RI/CD64 triggers enhanced antibody responses in transgenic mice*. J Clin Invest, 1996. **97**(2): p. 331-8.
158. Bevaart, L., et al., *CpG oligodeoxynucleotides enhance FcγRI-mediated cross presentation by dendritic cells*. Int Immunol, 2004. **16**(8): p. 1091-8.
159. McKenzie, S.E., et al., *The role of the human Fc receptor Fc gamma RIIA in the immune clearance of platelets: a transgenic mouse model*. J Immunol, 1999. **162**(7): p. 4311-8.
160. Pietersz, G.A., et al., *Inhibition of destructive autoimmune arthritis in FcγRIIA transgenic mice by small chemical entities*. Immunol Cell Biol, 2009. **87**(1): p. 3-12.
161. Jönsson, F., et al., *Human FcγRIIA induces anaphylactic and allergic reactions*. Blood, 2012. **119**(11): p. 2533-44.
162. Tsuboi, N., et al., *Human neutrophil Fcγ receptors initiate and play specialized nonredundant roles in antibody-mediated inflammatory diseases*. Immunity, 2008. **28**(6): p. 833-46.
163. Tsuboi, N., et al., *Regulation of human neutrophil Fcγ receptor IIa by C5a receptor promotes inflammatory arthritis in mice*. Arthritis Rheum, 2011. **63**(2): p. 467-78.
164. Chen, K., et al., *Endocytosis of soluble immune complexes leads to their clearance by FcγRIIIB but induces neutrophil extracellular traps via FcγRIIA in vivo*. Blood, 2012. **120**(22): p. 4421-31.
165. Taylor, S.M., et al., *Thrombosis and shock induced by activating antiplatelet antibodies in human Fc gamma RIIA transgenic mice: the interplay among antibody, spleen, and Fc receptor*. Blood, 2000. **96**(13): p. 4254-60.
166. Worth, R.G., et al., *Platelet FcγRIIA binds and internalizes IgG-containing complexes*. Exp Hematol, 2006. **34**(11): p. 1490-5.
167. Kim, J.M. and A. Ashkenazi, *Fcγ receptors enable anticancer action of proapoptotic and immune-modulatory antibodies*. J Exp Med, 2013. **210**(9): p. 1647-51.
168. Gerdes, C.A., et al., *GA201 (RG7160): a novel, humanized, glycoengineered anti-EGFR antibody with enhanced ADCC and superior in vivo efficacy compared with cetuximab*. Clin Cancer Res, 2013. **19**(5): p. 1126-38.
169. van der Heijden, J., et al., *Haplotypes of FcγRIIA and FcγRIIIB Polymorphic Variants Influence IgG-Mediated Responses in Neutrophils*. J Immunol, 2014.
170. Todd, R.F., 3rd and H.R. Petty, *Beta 2 (CD11/CD18) integrins can serve as signaling partners for other leukocyte receptors*. J Lab Clin Med, 1997. **129**(5): p. 492-8.
171. Smith, P., et al., *Mouse model recapitulating human Fcγ receptor structural and functional diversity*. Proc Natl Acad Sci U S A, 2012. **109**(16): p. 6181-6.
172. Bruhns, P., *Properties of mouse and human IgG receptors and their contribution to disease models*. Blood, 2012. **119**(24): p. 5640-9.
173. Tutt, A.L., et al., *Development and Characterization of Monoclonal Antibodies Specific for Mouse and Human Fcγ Receptors*. J Immunol, 2015. **195**(11): p. 5503-16.
174. Wedmore, C.V. and T.J. Williams, *Control of vascular permeability by polymorphonuclear leukocytes in inflammation*. Nature, 1981. **289**(5799): p. 646-50.
175. Finsterbusch, M., et al., *Neutrophils recruited by chemoattractants in vivo induce microvascular plasma protein leakage through secretion of TNF*. J Exp Med, 2014. **211**(7): p. 1307-14.
176. Di Gennaro, A., et al., *Leukotriene B₄-induced changes in vascular permeability are mediated by neutrophil release of heparin-binding protein (HBP/CAP37/azurocidin)*. FASEB J, 2009. **23**(6): p. 1750-7.

177. Gautam, N., et al., *Heparin-binding protein (HBP/CAP37): a missing link in neutrophil-evoked alteration of vascular permeability*. Nat Med, 2001. **7**(10): p. 1123-7.
178. Murray, P.T., M.E. Wylam, and J.G. Umans, *Nitric oxide and septic vascular dysfunction*. Anesth Analg, 2000. **90**(1): p. 89-101.
179. Cauwels, A., *Nitric oxide in shock*. Kidney Int, 2007. **72**(5): p. 557-65.
180. Vincent, J.L., et al., *Sepsis definitions: time for change*. Lancet, 2013. **381**(9868): p. 774-5.
181. Bermejo-Martin, J.F., et al., *Defining immunological dysfunction in sepsis: A requisite tool for precision medicine*. J Infect, 2016. **72**(5): p. 525-36.
182. Hotchkiss, R.S., G. Monneret, and D. Payen, *Sepsis-induced immunosuppression: from cellular dysfunctions to immunotherapy*. Nat Rev Immunol, 2013. **13**(12): p. 862-74.
183. Medzhitov, R., P. Preston-Hurlburt, and C.A. Janeway, Jr., *A human homologue of the Drosophila Toll protein signals activation of adaptive immunity*. Nature, 1997. **388**(6640): p. 394-7.
184. Park, B.S. and J.O. Lee, *Recognition of lipopolysaccharide pattern by TLR4 complexes*. Exp Mol Med, 2013. **45**: p. e66.
185. Schumann, R.R., et al., *Structure and function of lipopolysaccharide binding protein*. Science, 1990. **249**(4975): p. 1429-31.
186. Wright, S.D., et al., *CD14, a receptor for complexes of lipopolysaccharide (LPS) and LPS binding protein*. Science, 1990. **249**(4975): p. 1431-3.
187. Haziot, A., et al., *Resistance to endotoxin shock and reduced dissemination of gram-negative bacteria in CD14-deficient mice*. Immunity, 1996. **4**(4): p. 407-14.
188. Shimazu, R., et al., *MD-2, a molecule that confers lipopolysaccharide responsiveness on Toll-like receptor 4*. J Exp Med, 1999. **189**(11): p. 1777-82.
189. Gioannini, T.L., et al., *Isolation of an endotoxin-MD-2 complex that produces Toll-like receptor 4-dependent cell activation at picomolar concentrations*. Proc Natl Acad Sci U S A, 2004. **101**(12): p. 4186-91.
190. Poltorak, A., et al., *Defective LPS signaling in C3H/HeJ and C57BL/10ScCr mice: mutations in Tlr4 gene*. Science, 1998. **282**(5396): p. 2085-8.
191. Lu, Y.C., W.C. Yeh, and P.S. Ohashi, *LPS/TLR4 signal transduction pathway*. Cytokine, 2008. **42**(2): p. 145-51.
192. Munford, R.S., J.M. Andersen, and J.M. Dietschy, *Sites of tissue binding and uptake in vivo of bacterial lipopolysaccharide-high density lipoprotein complexes: studies in the rat and squirrel monkey*. J Clin Invest, 1981. **68**(6): p. 1503-13.
193. Shao, B., et al., *Hepatic uptake and deacylation of the LPS in bloodborne LPS-lipoprotein complexes*. Innate Immun, 2012. **18**(6): p. 825-33.
194. Munford, R.S., *Endotoxemia-menace, marker, or mistake?* J Leukoc Biol, 2016.
195. Peterson, A.A. and R.S. Munford, *Dephosphorylation of the lipid A moiety of Escherichia coli lipopolysaccharide by mouse macrophages*. Infect Immun, 1987. **55**(4): p. 974-8.
196. Hampton, R.Y. and C.R. Raetz, *Macrophage catabolism of lipid A is regulated by endotoxin stimulation*. J Biol Chem, 1991. **266**(29): p. 19499-509.
197. Shao, B., et al., *A host lipase detoxifies bacterial lipopolysaccharides in the liver and spleen*. J Biol Chem, 2007. **282**(18): p. 13726-35.
198. Kitchens, R.L. and R.S. Munford, *Enzymatically deacylated lipopolysaccharide (LPS) can antagonize LPS at multiple sites in the LPS recognition pathway*. J Biol Chem, 1995. **270**(17): p. 9904-10.
199. Shi, J., et al., *Inflammatory caspases are innate immune receptors for intracellular LPS*. Nature, 2014. **514**(7521): p. 187-92.

200. Kayagaki, N., et al., *Noncanonical inflammasome activation by intracellular LPS independent of TLR4*. Science, 2013. **341**(6151): p. 1246-9.
201. Hagar, J.A., et al., *Cytoplasmic LPS activates caspase-11: implications in TLR4-independent endotoxic shock*. Science, 2013. **341**(6151): p. 1250-3.
202. Deng, M., et al., *Lipopolysaccharide clearance, bacterial clearance, and systemic inflammatory responses are regulated by cell type-specific functions of TLR4 during sepsis*. J Immunol, 2013. **190**(10): p. 5152-60.
203. MacMicking, J.D., et al., *Altered responses to bacterial infection and endotoxic shock in mice lacking inducible nitric oxide synthase*. Cell, 1995. **81**(4): p. 641-50.
204. Laubach, V.E., et al., *Mice lacking inducible nitric oxide synthase are not resistant to lipopolysaccharide-induced death*. Proc Natl Acad Sci U S A, 1995. **92**(23): p. 10688-92.
205. Tracey, K.J., et al., *Anti-cachectin/TNF monoclonal antibodies prevent septic shock during lethal bacteraemia*. Nature, 1987. **330**(6149): p. 662-4.
206. Beutler, B., I.W. Milsark, and A.C. Cerami, *Passive immunization against cachectin/tumor necrosis factor protects mice from lethal effect of endotoxin*. Science, 1985. **229**(4716): p. 869-71.
207. Wang, H., et al., *HMG-1 as a late mediator of endotoxin lethality in mice*. Science, 1999. **285**(5425): p. 248-51.
208. Huebener, P., et al., *The HMGB1/RAGE axis triggers neutrophil-mediated injury amplification following necrosis*. J Clin Invest, 2015. **125**(2): p. 539-50.
209. Standiford, T.J., et al., *Neutralization of IL-10 increases lethality in endotoxemia. Cooperative effects of macrophage inflammatory protein-2 and tumor necrosis factor*. J Immunol, 1995. **155**(4): p. 2222-9.
210. Berg, D.J., et al., *Interleukin-10 is a central regulator of the response to LPS in murine models of endotoxic shock and the Shwartzman reaction but not endotoxin tolerance*. J Clin Invest, 1995. **96**(5): p. 2339-47.
211. Gerard, C., et al., *Interleukin 10 reduces the release of tumor necrosis factor and prevents lethality in experimental endotoxemia*. J Exp Med, 1993. **177**(2): p. 547-50.
212. Bohannon, J.K., et al., *The immunobiology of toll-like receptor 4 agonists: from endotoxin tolerance to immunoadjuvants*. Shock, 2013. **40**(6): p. 451-62.
213. Tkalcevic, J., et al., *Impaired immunity and enhanced resistance to endotoxin in the absence of neutrophil elastase and cathepsin G*. Immunity, 2000. **12**(2): p. 201-10.
214. Liu, F.C., et al., *Role of neutrophil extracellular traps following injury*. Shock, 2014. **41**(6): p. 491-8.
215. Czaikoski, P.G., et al., *Neutrophil Extracellular Traps Induce Organ Damage during Experimental and Clinical Sepsis*. PLoS One, 2016. **11**(2): p. e0148142.
216. Martinod, K., et al., *PAD4-deficiency does not affect bacteremia in polymicrobial sepsis and ameliorates endotoxemic shock*. Blood, 2015. **125**(12): p. 1948-56.
217. Asaduzzaman, M., et al., *LFA-1 and MAC-1 mediate pulmonary recruitment of neutrophils and tissue damage in abdominal sepsis*. Shock, 2008. **30**(3): p. 254-9.
218. Gao, X.P., et al., *Inactivation of CD11b in a mouse transgenic model protects against sepsis-induced lung PMN infiltration and vascular injury*. Physiol Genomics, 2005. **21**(2): p. 230-42.
219. Han, C., et al., *Integrin CD11b negatively regulates TLR-triggered inflammatory responses by activating Syk and promoting degradation of MyD88 and TRIF via Cbl-b*. Nat Immunol, 2010. **11**(8): p. 734-42.
220. Wu, X., et al., *The role of ICAM-1 in endotoxin-induced acute renal failure*. Am J Physiol Renal Physiol, 2007. **293**(4): p. F1262-71.
221. Xu, H., et al., *Leukocytosis and resistance to septic shock in intercellular adhesion molecule 1-deficient mice*. J Exp Med, 1994. **180**(1): p. 95-109.

222. Bouchon, A., J. Dietrich, and M. Colonna, *Cutting edge: inflammatory responses can be triggered by TREM-1, a novel receptor expressed on neutrophils and monocytes*. J Immunol, 2000. **164**(10): p. 4991-5.
223. Bouchon, A., et al., *TREM-1 amplifies inflammation and is a crucial mediator of septic shock*. Nature, 2001. **410**(6832): p. 1103-7.
224. Netea, M.G., et al., *The role of hyperuricemia in the increased cytokine production after lipopolysaccharide challenge in neutropenic mice*. Blood, 1997. **89**(2): p. 577-82.
225. Pillay, J., et al., *A subset of neutrophils in human systemic inflammation inhibits T cell responses through Mac-1*. J Clin Invest, 2012. **122**(1): p. 327-36.
226. Leliefeld, P.H., et al., *The role of neutrophils in immune dysfunction during severe inflammation*. Crit Care, 2016. **20**(1): p. 73.
227. Panesar, S.S., et al., *The epidemiology of anaphylaxis in Europe: a systematic review*. Allergy, 2013. **68**(11): p. 1353-61.
228. Gillis, C., A. Gouel-Cheron, and P. Bruhns, *Anaphylaxis (Immediate hypersensitivity): from old to new mechanisms*, in *Encyclopedia of Inflammatory Diseases*, M. Parnham, Editor. 2015.
229. Finkelman, F.D., et al., *Molecular mechanisms of anaphylaxis: lessons from studies with murine models*. J Allergy Clin Immunol, 2005. **115**(3): p. 449-57.
230. Brown, S.G., et al., *Anaphylaxis: Clinical patterns, mediator release, and severity*. J Allergy Clin Immunol, 2013.
231. Galli, S.J., *Pathogenesis and management of anaphylaxis: current status and future challenges*. J Allergy Clin Immunol, 2005. **115**(3): p. 571-4.
232. Dombrowicz, D., et al., *Abolition of anaphylaxis by targeted disruption of the high affinity immunoglobulin E receptor alpha chain gene*. Cell, 1993. **75**(5): p. 969-76.
233. Miyajima, I., et al., *Systemic anaphylaxis in the mouse can be mediated largely through IgG1 and Fc gammaRIII. Assessment of the cardiopulmonary changes, mast cell degranulation, and death associated with active or IgE- or IgG1-dependent passive anaphylaxis*. J Clin Invest, 1997. **99**(5): p. 901-14.
234. Dombrowicz, D., et al., *Anaphylaxis mediated through a humanized high affinity IgE receptor*. J Immunol, 1996. **157**(4): p. 1645-51.
235. Bryce, P.J., et al., *Humanized mouse model of mast cell-mediated passive cutaneous anaphylaxis and passive systemic anaphylaxis*. J Allergy Clin Immunol, 2016.
236. Strait, R.T., et al., *Ingested allergens must be absorbed systemically to induce systemic anaphylaxis*. J Allergy Clin Immunol, 2011. **127**(4): p. 982-989 e1.
237. Liew, W.K., E. Williamson, and M.L. Tang, *Anaphylaxis fatalities and admissions in Australia*. J Allergy Clin Immunol, 2009. **123**(2): p. 434-42.
238. Jerschow, E., et al., *Fatal anaphylaxis in the United States, 1999-2010: temporal patterns and demographic associations*. J Allergy Clin Immunol, 2014. **134**(6): p. 1318-1328 e7.
239. Brown, S.G., *The pathophysiology of shock in anaphylaxis*. Immunol Allergy Clin North Am, 2007. **27**(2): p. 165-75, v.
240. Sheikh, A., et al., *H1-antihistamines for the treatment of anaphylaxis: Cochrane systematic review*. Allergy, 2007. **62**(8): p. 830-7.
241. Nowak, R., et al., *Customizing anaphylaxis guidelines for emergency medicine*. J Emerg Med, 2013. **45**(2): p. 299-306.
242. Lo, J.C., M.A. Darracq, and R.F. Clark, *A review of methylene blue treatment for cardiovascular collapse*. J Emerg Med, 2014. **46**(5): p. 670-9.
243. Zheng, F., et al., *Methylene blue and epinephrine: a synergetic association for anaphylactic shock treatment*. Crit Care Med, 2013. **41**(1): p. 195-204.

244. Zilberstein, J., M.T. McCurdy, and M.E. Winters, *Anaphylaxis*. J Emerg Med, 2014. **47**(2): p. 182-7.
245. Pumphrey, R.S., *Lessons for management of anaphylaxis from a study of fatal reactions*. Clin Exp Allergy, 2000. **30**(8): p. 1144-50.
246. Ohnmacht, C., et al., *Basophils orchestrate chronic allergic dermatitis and protective immunity against helminths*. Immunity, 2010. **33**(3): p. 364-74.
247. Beutier, H., et al., *IgG subclasses determine pathways of anaphylaxis in mice*. J Allergy Clin Immunol, 2016. **in press**.
248. Oettgen, H.C., et al., *Active anaphylaxis in IgE-deficient mice*. Nature, 1994. **370**(6488): p. 367-70.
249. Tsujimura, Y., et al., *Basophils play a pivotal role in immunoglobulin-G-mediated but not immunoglobulin-E-mediated systemic anaphylaxis*. Immunity, 2008. **28**(4): p. 581-9.
250. Strait, R.T., et al., *Pathways of anaphylaxis in the mouse*. J Allergy Clin Immunol, 2002. **109**(4): p. 658-68.
251. Jönsson, F., et al., *Mouse and human neutrophils induce anaphylaxis*. J Clin Invest, 2011. **121**(4): p. 1484-96.
252. Steenholdt, C., et al., *Acute and delayed hypersensitivity reactions to infliximab and adalimumab in a patient with Crohn's disease*. J Crohns Colitis, 2012. **6**(1): p. 108-11.
253. Cheifetz, A., et al., *The incidence and management of infusion reactions to infliximab: a large center experience*. Am J Gastroenterol, 2003. **98**(6): p. 1315-24.
254. Umeda, Y., et al., *[Anaphylactic shock related to aprotinin induced by anti-aprotinin immunoglobulin G antibody alone; report of a case]*. Kyobu Geka, 2007. **60**(1): p. 69-71.
255. Hedin, H., et al., *Incidence, pathomechanism and prevention of dextran-induced anaphylactoid / anaphylactic reactions in man*. Dev Biol Stand, 1980. **48**: p. 179-89.
256. Schmidt, A.P., H.F. Taswell, and G.J. Gleich, *Anaphylactic transfusion reactions associated with anti-IgA antibody*. N Engl J Med, 1969. **280**(4): p. 188-93.
257. Finkelman, F.D., M.V. Khodoun, and R. Strait, *Human IgE-independent systemic anaphylaxis*. J Allergy Clin Immunol, 2016. **137**(6): p. 1674-80.
258. Kraft, D., et al., *Immunoglobulin class and subclass distribution of dextran-reactive antibodies in human reactors and non reactors to clinical dextran*. Allergy, 1982. **37**(7): p. 481-9.
259. Williams, S.J. and S. Gupta, *Anaphylaxis to IVIG*. Arch Immunol Ther Exp (Warsz), 2016.
260. van der Heijden, J., et al., *A novel splice variant of FcγRIIa: A risk factor for anaphylaxis in patients with hypogammaglobulinemia*. J Allergy Clin Immunol, 2013. **131**(5): p. 1408-1416 e5.
261. Arias, K., et al., *Concurrent blockade of platelet-activating factor and histamine prevents life-threatening peanut-induced anaphylactic reactions*. J Allergy Clin Immunol, 2009. **124**(2): p. 307-14, 314 e1-2.
262. Ishii, S., et al., *Impaired anaphylactic responses with intact sensitivity to endotoxin in mice lacking a platelet-activating factor receptor*. J Exp Med, 1998. **187**(11): p. 1779-88.
263. Gill, P., et al., *Platelets in the immune response: Revisiting platelet-activating factor in anaphylaxis*. J Allergy Clin Immunol, 2015. **135**(6): p. 1424-32.
264. Vadas, P., B. Perelman, and G. Liss, *Platelet-activating factor, histamine, and tryptase levels in human anaphylaxis*. J Allergy Clin Immunol, 2013. **131**(1): p. 144-9.
265. Vadas, P., et al., *Platelet-activating factor, PAF acetylhydrolase, and severe anaphylaxis*. N Engl J Med, 2008. **358**(1): p. 28-35.
266. Mertes, P.M., et al., *Anaphylaxis during anesthesia in France: an 8-year national survey*. J Allergy Clin Immunol, 2011. **128**(2): p. 366-73.
267. Mertes, P.M., et al., *Epidemiology of perioperative anaphylaxis*. Presse Med, 2016.

268. Harper, N.J., et al., *Suspected anaphylactic reactions associated with anaesthesia*. *Anaesthesia*, 2009. **64**(2): p. 199-211.
269. Light, K.P., et al., *Adverse effects of neuromuscular blocking agents based on yellow card reporting in the U.K.: are there differences between males and females?* *Pharmacoepidemiol Drug Saf*, 2006. **15**(3): p. 151-60.
270. Reitter, M., et al., *Fatal anaphylaxis with neuromuscular blocking agents: a risk factor and management analysis*. *Allergy*, 2014. **69**(7): p. 954-9.
271. Decuyper, II, et al., *Quantification of specific IgE antibodies in immediate drug hypersensitivity: More shortcomings than potentials?* *Clin Chim Acta*, 2016. **460**: p. 184-9.
272. Laroche, D., et al., *Evaluation of a new routine diagnostic test for immunoglobulin E sensitization to neuromuscular blocking agents*. *Anesthesiology*, 2011. **114**(1): p. 91-7.
273. Mocsai, A., *Diverse novel functions of neutrophils in immunity, inflammation, and beyond*. *J Exp Med*, 2013. **210**(7): p. 1283-99.
274. McDonald, B., et al., *Intravascular neutrophil extracellular traps capture bacteria from the bloodstream during sepsis*. *Cell Host Microbe*, 2012. **12**(3): p. 324-33.
275. Kruger, P., et al., *Neutrophils: Between host defence, immune modulation, and tissue injury*. *PLoS Pathog*, 2015. **11**(3): p. e1004651.
276. Haegens, A., et al., *Myeloperoxidase deficiency attenuates lipopolysaccharide-induced acute lung inflammation and subsequent cytokine and chemokine production*. *J Immunol*, 2009. **182**(12): p. 7990-6.
277. Eiserich, J.P., et al., *Myeloperoxidase, a leukocyte-derived vascular NO oxidase*. *Science*, 2002. **296**(5577): p. 2391-4.
278. Pillay, J., et al., *Functional heterogeneity and differential priming of circulating neutrophils in human experimental endotoxemia*. *J Leukoc Biol*, 2010. **88**(1): p. 211-20.
279. Passegue, E., E.F. Wagner, and I.L. Weissman, *JunB deficiency leads to a myeloproliferative disorder arising from hematopoietic stem cells (Mrp8cre)*. *Cell*, 2004. **119**(3): p. 431-43.
280. Buch, T., et al., *A Cre-inducible diphtheria toxin receptor mediates cell lineage ablation after toxin administration*. *Nat Methods*, 2005. **2**(6): p. 419-26.
281. Balbino, B., et al., *Pathways of immediate hypothermia and leukocyte infiltration in an adjuvant-free mouse model of anaphylaxis*. *J Allergy Clin Immunol*, 2016. **in press**.
282. McGovern, N., et al., *Human dermal CD14(+) cells are a transient population of monocyte-derived macrophages*. *Immunity*, 2014. **41**(3): p. 465-77.
283. Frankenberger, M., et al., *Immunologic characterization of normal human pleural macrophages*. *Am J Respir Cell Mol Biol*, 2000. **23**(3): p. 419-26.
284. Burger, M., et al., *In vitro differentiation and characterization of human peritoneal macrophages from CAPD-peritonitis patients*. *Immunobiology*, 1999. **200**(1): p. 62-76.
285. Koller, M., et al., *Immunophenotyping of human bone marrow-derived macrophages*. *Scand J Immunol*, 1996. **43**(6): p. 626-32.
286. Baker, J.W., et al., *Hemorrhagic shock induces bacterial translocation from the gut*. *J Trauma*, 1988. **28**(7): p. 896-906.
287. Magnotti, L.J., et al., *Gut-derived mesenteric lymph but not portal blood increases endothelial cell permeability and promotes lung injury after hemorrhagic shock*. *Ann Surg*, 1998. **228**(4): p. 518-27.
288. O'Boyle, C.J., et al., *Microbiology of bacterial translocation in humans*. *Gut*, 1998. **42**(1): p. 29-35.
289. Souza, D.G., et al., *The essential role of the intestinal microbiota in facilitating acute inflammatory responses*. *J Immunol*, 2004. **173**(6): p. 4137-46.

290. Mayadas, T.N., X. Cullere, and C.A. Lowell, *The multifaceted functions of neutrophils*. Annu Rev Pathol, 2014. **9**: p. 181-218.
291. Barquero-Calvo, E., et al., *Neutrophils exert a suppressive effect on Th1 responses to intracellular pathogen Brucella abortus*. PLoS Pathog, 2013. **9**(2): p. e1003167.
292. Barrientos, L., et al., *Neutrophil extracellular traps downregulate lipopolysaccharide-induced activation of monocyte-derived dendritic cells*. J Immunol, 2014. **193**(11): p. 5689-98.
293. Eken, C., et al., *Polymorphonuclear neutrophil-derived ectosomes interfere with the maturation of monocyte-derived dendritic cells*. J Immunol, 2008. **180**(2): p. 817-24.
294. Chou, J., et al., *Hematopoietic cell-derived microparticle tissue factor contributes to fibrin formation during thrombus propagation*. Blood, 2004. **104**(10): p. 3190-7.
295. Klebanoff, S.J., *Myeloperoxidase: friend and foe*. J Leukoc Biol, 2005. **77**(5): p. 598-625.
296. Demaret, J., et al., *Marked alterations of neutrophil functions during sepsis-induced immunosuppression*. J Leukoc Biol, 2015. **98**(6): p. 1081-90.
297. Kothari, N., et al., *Increased myeloperoxidase enzyme activity in plasma is an indicator of inflammation and onset of sepsis*. J Crit Care, 2011. **26**(4): p. 435 e1-7.
298. Lentsch, A.B. and P.A. Ward, *Regulation of inflammatory vascular damage*. J Pathol, 2000. **190**(3): p. 343-8.
299. Odobasic, D., et al., *Neutrophil myeloperoxidase regulates T-cell-driven tissue inflammation in mice by inhibiting dendritic cell function*. Blood, 2013. **121**(20): p. 4195-204.
300. Johansson, M.W., et al., *Myeloperoxidase mediates cell adhesion via the alpha M beta 2 integrin (Mac-1, CD11b/CD18)*. J Cell Sci, 1997. **110 (Pt 9)**: p. 1133-9.
301. Lau, D., et al., *Myeloperoxidase mediates neutrophil activation by association with CD11b/CD18 integrins*. Proc Natl Acad Sci U S A, 2005. **102**(2): p. 431-6.
302. El Kebir, D., et al., *Myeloperoxidase delays neutrophil apoptosis through CD11b/CD18 integrins and prolongs inflammation*. Circ Res, 2008. **103**(4): p. 352-9.
303. Klinke, A., et al., *Myeloperoxidase attracts neutrophils by physical forces*. Blood, 2011. **117**(4): p. 1350-8.
304. Ocuin, L.M., et al., *Neutrophil IL-10 suppresses peritoneal inflammatory monocytes during polymicrobial sepsis*. J Leukoc Biol, 2011. **89**(3): p. 423-32.
305. Lewkowicz, P., et al., *Lipopolysaccharide-activated CD4+CD25+ T regulatory cells inhibit neutrophil function and promote their apoptosis and death*. J Immunol, 2006. **177**(10): p. 7155-63.
306. Savill, J.S., et al., *Macrophage phagocytosis of aging neutrophils in inflammation. Programmed cell death in the neutrophil leads to its recognition by macrophages*. J Clin Invest, 1989. **83**(3): p. 865-75.
307. Fadok, V.A., et al., *Macrophages that have ingested apoptotic cells in vitro inhibit proinflammatory cytokine production through autocrine/paracrine mechanisms involving TGF-beta, PGE2, and PAF*. J Clin Invest, 1998. **101**(4): p. 890-8.
308. Fialkow, L., et al., *Neutrophil apoptosis: a marker of disease severity in sepsis and sepsis-induced acute respiratory distress syndrome*. Crit Care, 2006. **10**(6): p. R155.
309. Chitnis, D., et al., *Inhibition of apoptosis in polymorphonuclear neutrophils from burn patients*. J Leukoc Biol, 1996. **59**(6): p. 835-9.
310. Garlichs, C.D., et al., *Delay of neutrophil apoptosis in acute coronary syndromes*. J Leukoc Biol, 2004. **75**(5): p. 828-35.
311. Ertel, W., et al., *Circulating mediators in serum of injured patients with septic complications inhibit neutrophil apoptosis through up-regulation of protein-tyrosine phosphorylation*. J Trauma, 1998. **44**(5): p. 767-75; discussion 775-6.

312. McPhillips, K., et al., *TNF-alpha inhibits macrophage clearance of apoptotic cells via cytosolic phospholipase A2 and oxidant-dependent mechanisms*. J Immunol, 2007. **178**(12): p. 8117-26.
313. Ren, Y., et al., *Apoptotic cells protect mice against lipopolysaccharide-induced shock*. J Immunol, 2008. **180**(7): p. 4978-85.
314. Shepherd, V.L. and J.R. Hoidal, *Clearance of neutrophil-derived myeloperoxidase by the macrophage mannose receptor*. Am J Respir Cell Mol Biol, 1990. **2**(4): p. 335-40.
315. Lefkowitz, D.L. and S.S. Lefkowitz, *Macrophage-neutrophil interaction: a paradigm for chronic inflammation revisited*. Immunol Cell Biol, 2001. **79**(5): p. 502-6.
316. Kremserova, S., et al., *Lung Neutrophilia in Myeloperoxidase Deficient Mice during the Course of Acute Pulmonary Inflammation*. Oxid Med Cell Longev, 2016. **2016**: p. 5219056.
317. Drago-Serrano, M.E., et al., *Lactoferrin-lipopolysaccharide (LPS) binding as key to antibacterial and antiendotoxic effects*. Int Immunopharmacol, 2012. **12**(1): p. 1-9.
318. Augusto, L.A., et al., *Histones: a novel class of lipopolysaccharide-binding molecules*. Biochemistry, 2003. **42**(13): p. 3929-38.
319. Martinon, F., *Mechanisms of uric acid crystal-mediated autoinflammation*. Immunol Rev, 2010. **233**(1): p. 218-32.
320. Akbar, S.R., et al., *Hyperuricemia: An Early Marker for Severity of Illness in Sepsis*. Int J Nephrol, 2015. **2015**: p. 301021.
321. Kono, H., et al., *Uric acid promotes an acute inflammatory response to sterile cell death in mice*. J Clin Invest, 2010. **120**(6): p. 1939-49.
322. Meotti, F.C., et al., *Urate as a physiological substrate for myeloperoxidase: implications for hyperuricemia and inflammation*. J Biol Chem, 2011. **286**(15): p. 12901-11.
323. Yang, H., et al., *Redox modification of cysteine residues regulates the cytokine activity of high mobility group box-1 (HMGB1)*. Mol Med, 2012. **18**: p. 250-9.
324. Venereau, E., et al., *Mutually exclusive redox forms of HMGB1 promote cell recruitment or proinflammatory cytokine release*. J Exp Med, 2012. **209**(9): p. 1519-28.
325. Yang, H., et al., *The many faces of HMGB1: molecular structure-functional activity in inflammation, apoptosis, and chemotaxis*. J Leukoc Biol, 2013. **93**(6): p. 865-73.
326. Shao, B., et al., *Myeloperoxidase: an inflammatory enzyme for generating dysfunctional high density lipoprotein*. Curr Opin Cardiol, 2006. **21**(4): p. 322-8.
327. Zhang, R., et al., *Myeloperoxidase functions as a major enzymatic catalyst for initiation of lipid peroxidation at sites of inflammation*. J Biol Chem, 2002. **277**(48): p. 46116-22.
328. Cook, J.A., *Eicosanoids*. Crit Care Med, 2005. **33**(12 Suppl): p. S488-91.
329. Willenberg, I., et al., *Characterization of changes in plasma and tissue oxylipin levels in LPS and CLP induced murine sepsis*. Inflamm Res, 2016. **65**(2): p. 133-42.
330. Kubala, L., et al., *Modulation of arachidonic and linoleic acid metabolites in myeloperoxidase-deficient mice during acute inflammation*. Free Radic Biol Med, 2010. **48**(10): p. 1311-20.
331. Levels, J.H., et al., *Distribution and kinetics of lipoprotein-bound endotoxin*. Infect Immun, 2001. **69**(5): p. 2821-8.
332. Morin, E.E., et al., *HDL in sepsis - risk factor and therapeutic approach*. Front Pharmacol, 2015. **6**: p. 244.
333. Zou, G., et al., *The delta high-density lipoprotein cholesterol ratio: a novel parameter for gram-negative sepsis*. Springerplus, 2016. **5**(1): p. 1044.
334. Kumar, A.P., et al., *Inducible nitric oxide synthase expression is inhibited by myeloperoxidase*. Nitric Oxide, 2005. **13**(1): p. 42-53.
335. Fernandes, D. and J. Assreuy, *Nitric oxide and vascular reactivity in sepsis*. Shock, 2008. **30** **Suppl 1**: p. 10-3.

336. Csato, V., et al., *Myeloperoxidase evokes substantial vasomotor responses in isolated skeletal muscle arterioles of the rat*. Acta Physiol (Oxf), 2015. **214**(1): p. 109-23.
337. Rudolph, T.K., et al., *Myeloperoxidase deficiency preserves vasomotor function in humans*. Eur Heart J, 2012. **33**(13): p. 1625-34.
338. Baldus, S., et al., *Endothelial transcytosis of myeloperoxidase confers specificity to vascular ECM proteins as targets of tyrosine nitration*. J Clin Invest, 2001. **108**(12): p. 1759-70.
339. Kirkeboen, K.A. and O.A. Strand, *The role of nitric oxide in sepsis--an overview*. Acta Anaesthesiol Scand, 1999. **43**(3): p. 275-88.
340. Avontuur, J.A., et al., *Prolonged inhibition of nitric oxide synthesis in severe septic shock: a clinical study*. Crit Care Med, 1998. **26**(4): p. 660-7.
341. Avontuur, J.A., et al., *Pulmonary hypertension and reduced cardiac output during inhibition of nitric oxide synthesis in human septic shock*. Shock, 1998. **9**(6): p. 451-4.
342. Baldus, S., et al., *Heparins increase endothelial nitric oxide bioavailability by liberating vessel-immobilized myeloperoxidase*. Circulation, 2006. **113**(15): p. 1871-8.
343. Darien, B.J., et al., *Low molecular weight heparin prevents the pulmonary hemodynamic and pathomorphologic effects of endotoxin in a porcine acute lung injury model*. Shock, 1998. **9**(4): p. 274-81.
344. Luan, Z.G., M. Naranpurev, and X.C. Ma, *Treatment of low molecular weight heparin inhibits systemic inflammation and prevents endotoxin-induced acute lung injury in rats*. Inflammation, 2014. **37**(3): p. 924-32.
345. Zhao, D., et al., *Heparin rescues sepsis-associated acute lung injury and lethality through the suppression of inflammatory responses*. Inflammation, 2012. **35**(6): p. 1825-32.
346. Rudolph, V., et al., *Bivalirudin decreases NO bioavailability by vascular immobilization of myeloperoxidase*. J Pharmacol Exp Ther, 2008. **327**(2): p. 324-31.
347. Cicala, C., et al., *Hirulog effect in rat endotoxin shock*. Life Sci, 1995. **57**(20): p. PL307-13.
348. Bonello, L., et al., *Bivalirudin with provisional glycoprotein IIb/IIIa inhibitors in patients undergoing primary angioplasty in the setting of cardiogenic shock*. Am J Cardiol, 2008. **102**(3): p. 287-91.
349. Pappalardo, F., et al., *Anticoagulation for critically ill cardiac surgery patients: is primary bivalirudin the next step?* J Cardiothorac Vasc Anesth, 2014. **28**(4): p. 1013-17.
350. Adam, M., et al., *Red blood cells serve as intravascular carriers of myeloperoxidase*. J Mol Cell Cardiol, 2014. **74**: p. 353-63.
351. Conlan, J.W. and R.J. North, *Neutrophils are essential for early anti-Listeria defense in the liver, but not in the spleen or peritoneal cavity, as revealed by a granulocyte-depleting monoclonal antibody*. J Exp Med, 1994. **179**(1): p. 259-68.
352. Daley, J.M., et al., *Use of Ly6G-specific monoclonal antibody to deplete neutrophils in mice*. J Leukoc Biol, 2008. **83**(1): p. 64-70.
353. Charmoy, M., G. Milon, and F. Tacchini-Cottier, *Role of Neutrophils in the Early Shaping of the Leishmania Major Specific Immune Response in Experimental Murine Cutaneous Leishmaniasis*, in *Neutrophils in Infectious Diseases*, F. Tacchini-Cottier and G. van Zandbergen, Editors. 2011, Bentham Books. p. 49-58.
354. Bruhn, K.W., et al., *Ly6G-mediated depletion of neutrophils is dependent on macrophages*. Results Immunol, 2016. **6**: p. 5-7.
355. Vassen, L., et al., *Growth factor independence 1 (Gfi1) regulates cell-fate decision of a bipotential granulocytic-monocytic precursor defined by expression of Gfi1 and CD48*. Am J Blood Res, 2012. **2**(4): p. 228-42.
356. Li, H., et al., *Repression of Id2 expression by Gfi-1 is required for B-cell and myeloid development*. Blood, 2010. **116**(7): p. 1060-9.

357. Yucel, R., et al., *The transcriptional repressor Gfi1 affects development of early, uncommitted c-Kit+ T cell progenitors and CD4/CD8 lineage decision in the thymus*. J Exp Med, 2003. **197**(7): p. 831-44.
358. Elliott, E.R., et al., *Deletion of Syk in neutrophils prevents immune complex arthritis*. J Immunol, 2011. **187**(8): p. 4319-30.
359. Albanesi, M., et al., *Neutrophils mediate antibody-induced antitumor effects in mice*. Blood, 2013. **122**(18): p. 3160-4.
360. Hu, R., et al., *Endoplasmic Reticulum Stress of Neutrophils Is Required for Ischemia/Reperfusion-Induced Acute Lung Injury*. J Immunol, 2015. **195**(10): p. 4802-9.
361. Saito, M., et al., *Diphtheria toxin receptor-mediated conditional and targeted cell ablation in transgenic mice*. Nat Biotechnol, 2001. **19**(8): p. 746-50.
362. Cailhier, J.F., et al., *Conditional macrophage ablation demonstrates that resident macrophages initiate acute peritoneal inflammation*. J Immunol, 2005. **174**(4): p. 2336-42.
363. Tittel, A.P., et al., *Functionally relevant neutrophilia in CD11c diphtheria toxin receptor transgenic mice*. Nat Methods, 2012. **9**(4): p. 385-90.
364. Heger, K., et al., *CreER(T2) expression from within the c-Kit gene locus allows efficient inducible gene targeting in and ablation of mast cells*. Eur J Immunol, 2014. **44**(1): p. 296-306.
365. Jacobsen, E.A., et al., *Eosinophil activities modulate the immunel/inflammatory character of allergic respiratory responses in mice*. Allergy, 2014. **69**(3): p. 315-27.
366. Wuescher, L.M., A. Takashima, and R.G. Worth, *A novel conditional platelet depletion mouse model reveals the importance of platelets in protection against Staphylococcus aureus bacteremia*. J Thromb Haemost, 2015. **13**(2): p. 303-13.
367. Collier, R.J., *Understanding the mode of action of diphtheria toxin: a perspective on progress during the 20th century*. Toxicol, 2001. **39**(11): p. 1793-803.
368. Yamaizumi, M., et al., *One molecule of diphtheria toxin fragment A introduced into a cell can kill the cell*. Cell, 1978. **15**(1): p. 245-50.
369. Van Ziffle, J.A. and C.A. Lowell, *Neutrophil-specific deletion of Syk kinase results in reduced host defense to bacterial infection*. Blood, 2009. **114**(23): p. 4871-82.
370. Abram, C.L., et al., *Comparative analysis of the efficiency and specificity of myeloid-Cre deleting strains using ROSA-EYFP reporter mice*. J Immunol Methods, 2014. **408**: p. 89-100.
371. Hasenberg, A., et al., *Catchup: a mouse model for imaging-based tracking and modulation of neutrophil granulocytes*. Nat Methods, 2015. **12**(5): p. 445-52.
372. Madisen, L., et al., *A robust and high-throughput Cre reporting and characterization system for the whole mouse brain*. Nat Neurosci, 2010. **13**(1): p. 133-40.
373. Wang, J.X., et al., *Ly6G ligation blocks recruitment of neutrophils via a beta2-integrin-dependent mechanism*. Blood, 2012. **120**(7): p. 1489-98.
374. Yipp, B.G. and P. Kubes, *Antibodies against neutrophil LY6G do not inhibit leukocyte recruitment in mice in vivo*. Blood, 2013. **121**(1): p. 241-2.
375. Li, M., U. Wirthmueller, and J.V. Ravetch, *Reconstitution of human Fc gamma RIII cell type specificity in transgenic mice*. J Exp Med, 1996. **183**(3): p. 1259-63.
376. Horton, H.M., et al., *Antibody-mediated coengagement of Fc gamma RIIb and B cell receptor complex suppresses humoral immunity in systemic lupus erythematosus*. J Immunol, 2011. **186**(7): p. 4223-33.
377. van Vugt, M.J., et al., *FcR gamma-chain is essential for both surface expression and function of human Fc gamma RI (CD64) in vivo*. Blood, 1996. **87**(9): p. 3593-9.
378. Keler, T., et al., *Targeting weak antigens to CD64 elicits potent humoral responses in human CD64 transgenic mice*. J Immunol, 2000. **165**(12): p. 6738-42.

379. DiLillo, D.J. and J.V. Ravetch, *Differential Fc-Receptor Engagement Drives an Anti-tumor Vaccinal Effect*. *Cell*, 2015. **161**(5): p. 1035-45.
380. Lux, A., et al., *A humanized mouse identifies the bone marrow as a niche with low therapeutic IgG activity*. *Cell Rep*, 2014. **7**(1): p. 236-48.
381. Schwab, I., A. Lux, and F. Nimmerjahn, *Pathways Responsible for Human Autoantibody and Therapeutic Intravenous IgG Activity in Humanized Mice*. *Cell Rep*, 2015. **13**(3): p. 610-20.
382. Shultz, L.D., et al., *Humanized mice for immune system investigation: progress, promise and challenges*. *Nat Rev Immunol*, 2012. **12**(11): p. 786-98.
383. Marois, L., et al., *Fc gammaRIIIb triggers raft-dependent calcium influx in IgG-mediated responses in human neutrophils*. *J Biol Chem*, 2011. **286**(5): p. 3509-19.
384. Meyer, T., et al., *CD32a antibodies induce thrombocytopenia and type II hypersensitivity reactions in FCGR2A mice*. *Blood*, 2015. **126**(19): p. 2230-8.
385. Biburger, M., et al., *Monocyte subsets responsible for immunoglobulin G-dependent effector functions in vivo*. *Immunity*, 2011. **35**(6): p. 932-44.
386. Chenoweth, A.M., et al., *The high-affinity receptor for IgG, FcgammaRI, of humans and non-human primates*. *Immunol Rev*, 2015. **268**(1): p. 175-91.
387. Swisher, J.F. and G.M. Feldman, *The many faces of FcgammaRI: implications for therapeutic antibody function*. *Immunol Rev*, 2015. **268**(1): p. 160-74.
388. Bruhns, P., et al., *Specificity and affinity of human Fc{gamma} receptors and their polymorphic variants for human IgG subclasses*. *Blood*, 2009. **113**: p. 3716-3725.
389. Tan, P.S., et al., *Unique monoclonal antibodies define expression of Fc gamma RI on macrophages and mast cell lines and demonstrate heterogeneity among subcutaneous and other dendritic cells*. *J Immunol*, 2003. **170**(5): p. 2549-56.
390. Langlet, C., et al., *CD64 Expression Distinguishes Monocyte-Derived and Conventional Dendritic Cells and Reveals Their Distinct Role during Intramuscular Immunization*. *J Immunol*, 2012. **188**(4): p. 1751-60.
391. Perussia, B., et al., *Immune interferon induces the receptor for monomeric IgG1 on human monocytic and myeloid cells*. *J Exp Med*, 1983. **158**(4): p. 1092-113.
392. Quayle, J.A., et al., *Neutrophils from the synovial fluid of patients with rheumatoid arthritis express the high affinity immunoglobulin G receptor, Fc gamma RI (CD64): role of immune complexes and cytokines in induction of receptor expression*. *Immunology*, 1997. **91**(2): p. 266-73.
393. Schiff, D.E., et al., *Increased phagocyte Fc gammaRI expression and improved Fc gamma-receptor-mediated phagocytosis after in vivo recombinant human interferon-gamma treatment of normal human subjects*. *Blood*, 1997. **90**(8): p. 3187-94.
394. Pan, L.Y., et al., *Regulation of the steady state level of Fc gamma RI mRNA by IFN-gamma and dexamethasone in human monocytes, neutrophils, and U-937 cells*. *J Immunol*, 1990. **145**(1): p. 267-75.
395. Okayama, Y., A.S. Kirshenbaum, and D.D. Metcalfe, *Expression of a functional high-affinity IgG receptor, Fc gamma RI, on human mast cells: Up-regulation by IFN-gamma*. *J Immunol*, 2000. **164**(8): p. 4332-9.
396. Uciechowski, P., et al., *IFN-gamma induces the high-affinity Fc receptor I for IgG (CD64) on human glomerular mesangial cells*. *Eur J Immunol*, 1998. **28**(9): p. 2928-35.
397. Mancardi, D.A., et al., *FcgammaRIV is a mouse IgE receptor that resembles macrophage FcepsilonRI in humans and promotes IgE-induced lung inflammation*. *J Clin Invest*, 2008. **118**(11): p. 3738-3750.
398. van der Poel, C.E., et al., *Functional characteristics of the high affinity IgG receptor, FcgammaRI*. *J Immunol*, 2011. **186**(5): p. 2699-704.

399. Harrison, P.T., et al., *Binding of monomeric immunoglobulin G triggers Fc gamma RI-mediated endocytosis*. J Biol Chem, 1994. **269**(39): p. 24396-402.
400. Gallo, P., R. Goncalves, and D.M. Mosser, *The influence of IgG density and macrophage Fc (gamma) receptor cross-linking on phagocytosis and IL-10 production*. Immunol Lett, 2010. **133**(2): p. 70-7.
401. Barnes, N., et al., *Fc gamma RI-deficient mice show multiple alterations to inflammatory and immune responses*. Immunity, 2002. **16**(3): p. 379-89.
402. van Vugt, M.J., et al., *The Fc gamma RIa (CD64) ligand binding chain triggers major histocompatibility complex class II antigen presentation independently of its associated FcR gamma-chain*. Blood, 1999. **94**(2): p. 808-17.
403. Wallace, P.K., et al., *Exogenous antigen targeted to Fc gamma RI on myeloid cells is presented in association with MHC class I*. J Immunol Methods, 2001. **248**(1-2): p. 183-94.
404. Boekhoudt, G.H., M.R. Frazier-Jessen, and G.M. Feldman, *Immune complexes suppress IFN-gamma signaling by activation of the Fc gamma RI pathway*. J Leukoc Biol, 2007. **81**(4): p. 1086-92.
405. Albanesi, M., et al., *Cutting Edge: Fc gamma RIII (CD16) and Fc gamma RI (CD64) Are Responsible for Anti-Glycoprotein 75 Monoclonal Antibody TA99 Therapy for Experimental Metastatic B16 Melanoma*. J Immunol, 2012. **189**(12): p. 5513-5517.
406. Wang, X., et al., *Neutrophil CD64 expression as a diagnostic marker for sepsis in adult patients: a meta-analysis*. Crit Care, 2015. **19**: p. 245.
407. Hokibara, S., et al., *Markedly elevated CD64 expression on neutrophils and monocytes as a biomarker for diagnosis and therapy assessment in Kawasaki disease*. Inflamm Res, 2016. **65**(7): p. 579-85.
408. Repp, R., et al., *Neutrophils express the high affinity receptor for IgG (Fc gamma RI, CD64) after in vivo application of recombinant human granulocyte colony-stimulating factor*. Blood, 1991. **78**(4): p. 885-9.
409. Ohsaka, A., et al., *Increased expression of the high-affinity receptor for IgG (FcRI, CD64) on neutrophils in multiple myeloma*. Hematopathol Mol Hematol, 1996. **10**(3): p. 151-60.
410. Komiya, A., et al., *Neutrophil CD64 is upregulated in RA patients with lymphoma but not in other solid cancers*. Mod Rheumatol, 2016. **26**(2): p. 216-23.
411. Mullins, R.J., et al., *Increases in anaphylaxis fatalities in Australia from 1997 to 2013*. Clin Exp Allergy, 2016. **46**(8): p. 1099-110.
412. Ioan-Facsinay, A., et al., *Fc gamma RI (CD64) contributes substantially to severity of arthritis, hypersensitivity responses, and protection from bacterial infection*. Immunity, 2002. **16**(3): p. 391-402.
413. Sabroe, I., et al., *Selective roles for Toll-like receptor (TLR)2 and TLR4 in the regulation of neutrophil activation and life span*. J Immunol, 2003. **170**(10): p. 5268-75.
414. Cauwels, A., et al., *Anaphylactic shock depends on PI3K and eNOS-derived NO*. J Clin Invest, 2006. **116**(8): p. 2244-51.
415. Tipton, T.R., et al., *Anti-mouse Fc gamma RIV antibody 9E9 also blocks Fc gamma RIII in vivo*. Blood, 2015. **126**(24): p. 2643-5.
416. Bonamichi-Santos, R. and M. Castells, *Diagnoses and Management of Drug Hypersensitivity and Anaphylaxis in Cancer and Chronic Inflammatory Diseases: Reactions to Taxanes and Monoclonal Antibodies*. Clin Rev Allergy Immunol, 2016.
417. Dong, S.W., et al., *Hypersensitivity reactions during anesthesia. Results from the ninth French survey (2005-2007)*. Minerva Anestesiol, 2012. **78**(8): p. 868-78.
418. Reddy, J.I., et al., *Anaphylaxis is more common with rocuronium and succinylcholine than with atracurium*. Anesthesiology, 2015. **122**(1): p. 39-45.

419. Mertes, P.M. and G.W. Volcheck, *Anaphylaxis to neuromuscular-blocking drugs: all neuromuscular-blocking drugs are not the same*. *Anesthesiology*, 2015. **122**(1): p. 5-7.
420. Bom, A., et al., *A novel concept of reversing neuromuscular block: chemical encapsulation of rocuronium bromide by a cyclodextrin-based synthetic host*. *Angew Chem Int Ed Engl*, 2002. **41**(2): p. 266-70.
421. Makri, I., et al., *Sugammadex, a promising reversal drug. A review of clinical trials*. *Rev Recent Clin Trials*, 2011. **6**(3): p. 250-5.
422. Hu, H., et al., *16-morpholino quaternary ammonium steroidal derivatives as neuromuscular blocking agents: synthesis, biological evaluation and in silico probe of ligand-receptor interaction*. *Eur J Med Chem*, 2012. **56**: p. 332-47.
423. Mertes, P.M., et al., *Hypersensitivity reactions to neuromuscular blocking agents*. *Curr Pharm Des*, 2008. **14**(27): p. 2809-25.
424. Gueant, J.L., C. Masson, and M.C. Laxenaire, *Biological tests for diagnosing the IgE-mediated allergy to anesthetic drugs*. *Monogr Allergy*, 1992. **30**: p. 94-107.
425. Baldo, B.A. and M.M. Fisher, *Substituted ammonium ions as allergenic determinants in drug allergy*. *Nature*, 1983. **306**(5940): p. 262-4.
426. Baldo, B.A., M.M. Fisher, and N.H. Pham, *On the origin and specificity of antibodies to neuromuscular blocking (muscle relaxant) drugs: an immunochemical perspective*. *Clin Exp Allergy*, 2009. **39**(3): p. 325-44.
427. Didier, A., et al., *Role of the quaternary ammonium ion determinants in allergy to muscle relaxants*. *J Allergy Clin Immunol*, 1987. **79**(4): p. 578-84.
428. Gueant, J.L., et al., *Evaluation of a new reactive solid phase for radioimmunoassay of serum specific IgE against muscle relaxant drugs*. *Allergy*, 1991. **46**(6): p. 452-8.
429. Guilloux, L., et al., *A new radioimmunoassay using a commercially available solid support for the detection of IgE antibodies against muscle relaxants*. *J Allergy Clin Immunol*, 1992. **90**(2): p. 153-9.
430. Ebo, D.G., et al., *Immunoglobulin E antibodies to rocuronium: a new diagnostic tool*. *Anesthesiology*, 2007. **107**(2): p. 253-9.
431. Florvaag, E., et al., *Prevalence of IgE antibodies to morphine. Relation to the high and low incidences of NMBA anaphylaxis in Norway and Sweden, respectively*. *Acta Anaesthesiol Scand*, 2005. **49**(4): p. 437-44.
432. Florvaag, E., et al., *IgE-sensitization to the cough suppressant pholcodine and the effects of its withdrawal from the Norwegian market*. *Allergy*, 2011. **66**(7): p. 955-60.
433. Johansson, S.G., et al., *National pholcodine consumption and prevalence of IgE-sensitization: a multicentre study*. *Allergy*, 2010. **65**(4): p. 498-502.
434. Katelaris, C.H., et al., *Pholcodine consumption and immunoglobulin E-sensitization in atopics from Australia, Korea, and Japan*. *Asia Pac Allergy*, 2014. **4**(2): p. 86-90.
435. Dong, S., et al., *Prevalence of IgE against neuromuscular blocking agents in hairdressers and bakers*. *Clin Exp Allergy*, 2013. **43**(11): p. 1256-62.
436. Gonzalez, M., et al., *Asthma among workers in healthcare settings: role of disinfection with quaternary ammonium compounds*. *Clin Exp Allergy*, 2014. **44**(3): p. 393-406.
437. Zhao, X., et al., *Arterial Pressure Monitoring in Mice*. *Curr Protoc Mouse Biol*, 2011. **1**: p. 105-122.
438. Dewachter, P., et al., *Comparison of arginine vasopressin, terlipressin, or epinephrine to correct hypotension in a model of anaphylactic shock in anesthetized brown Norway rats*. *Anesthesiology*, 2006. **104**(4): p. 734-41.

439. Dewachter, P., et al., *A comparison of epinephrine only, arginine vasopressin only, and epinephrine followed by arginine vasopressin on the survival rate in a rat model of anaphylactic shock*. *Anesthesiology*, 2007. **106**(5): p. 977-83.
440. Strait, R.T., S.C. Morris, and F.D. Finkelman, *IgG-blocking antibodies inhibit IgE-mediated anaphylaxis in vivo through both antigen interception and Fc gamma RIIb cross-linking*. *J Clin Invest*, 2006. **116**(3): p. 833-41.
441. Skivington, M.A., *Protein binding of three tritiated muscle relaxants*. *Br J Anaesth*, 1972. **44**(10): p. 1030-4.
442. Roy, J.J. and F. Varin, *Physicochemical properties of neuromuscular blocking agents and their impact on the pharmacokinetic-pharmacodynamic relationship*. *Br J Anaesth*, 2004. **93**(2): p. 241-8.
443. Gieras, A., et al., *IgE epitope proximity determines immune complex shape and effector cell activation capacity*. *J Allergy Clin Immunol*, 2016. **137**(5): p. 1557-65.
444. Jiao, D., et al., *Characteristics of anaphylaxis-inducing IgG immune complexes triggering murine passive systemic anaphylaxis*. *Allergy*, 2013. **68**(2): p. 236-45.
445. Jones, P.M. and T.P. Turkstra, *Mitigation of rocuronium-induced anaphylaxis by sugammadex: the great unknown*. *Anaesthesia*, 2010. **65**(1): p. 89-90; author reply 90.
446. Baldo, B.A. and N.J. McDonnell, *Sugammadex and anaphylaxis in the operating theater*. *Rev Esp Anesthesiol Reanim*, 2014. **61**(5): p. 239-45.
447. McDonnell, N.J., et al., *Sugammadex in the management of rocuronium-induced anaphylaxis*. *Br J Anaesth*, 2010. **106**(2): p. 199-201.
448. McDonnell, N.J., et al., *Sugammadex in the management of rocuronium-induced anaphylaxis*. *Br J Anaesth*, 2011. **106**(2): p. 199-201.
449. Barthel, F., et al., *Sugammadex in rocuronium anaphylaxis: dose matters*. *Br J Anaesth*, 2012. **109**(4): p. 646-7.
450. Conte, B., et al., *Reversal of a rocuronium-induced grade IV anaphylaxis via early injection of a large dose of sugammadex*. *Can J Anaesth*, 2014. **61**(6): p. 558-62.
451. Baldo, B.A., N.J. McDonnell, and N.H. Pham, *Drug-specific cyclodextrins with emphasis on sugammadex, the neuromuscular blocker rocuronium and perioperative anaphylaxis: implications for drug allergy*. *Clin Exp Allergy*, 2011. **41**(12): p. 1663-78.
452. Clarke, R.C., P.H. Sadleir, and P.R. Platt, *The role of sugammadex in the development and modification of an allergic response to rocuronium: evidence from a cutaneous model*. *Anaesthesia*, 2012. **67**(3): p. 266-73.
453. Leysen, J., et al., *Rocuronium-induced anaphylaxis is probably not mitigated by sugammadex: evidence from an in vitro experiment*. *Anaesthesia*, 2011. **66**(6): p. 526-7.
454. Platt, P.R., et al., *Efficacy of sugammadex in rocuronium-induced or antibiotic-induced anaphylaxis. A case-control study*. *Anaesthesia*, 2015. **70**(11): p. 1264-7.
455. Plaud, B., *A new option for the treatment of anaphylaxis linked to steroidal neuromuscular blockers: How much value should we grant to case reports?* *Can J Anaesth*, 2014. **61**(6): p. 511-8.
456. Tsur, A. and A. Kalansky, *Hypersensitivity associated with sugammadex administration: a systematic review*. *Anaesthesia*, 2014. **69**(11): p. 1251-7.
457. Nakanishi, T., et al., *Anaphylaxis to sugammadex diagnosed by skin prick testing using both sugammadex and a sugammadex-rocuronium mixture*. *Anaesth Intensive Care*, 2016. **44**(1): p. 122-4.
458. Bergamaschini, L., et al., *Posttransfusion anaphylactic reactions in a patient with severe von Willebrand disease: role of complement and alloantibodies to von Willebrand factor*. *J Lab Clin Med*, 1995. **125**(3): p. 348-55.

459. Fenny, N. and L.C. Grammer, *Idiopathic anaphylaxis*. Immunol Allergy Clin North Am, 2015. **35**(2): p. 349-62.
460. Hsu, K.H., et al., *Comparison of Fcγ receptor expression on neutrophils with procalcitonin for the diagnosis of sepsis in critically ill patients*. Respirology, 2011. **16**(1): p. 152-60.
461. Khodoun, M.V., et al., *Identification of markers that distinguish IgE- from IgG-mediated anaphylaxis*. Proc Natl Acad Sci U S A, 2011. **108**(30): p. 12413-8.
462. Brown, S.G., et al., *Reply: To PMID 23915715*. J Allergy Clin Immunol, 2013. **132**(6): p. 1457.
463. Vadas, P. and G. Liss, *Anaphylaxis: Clinical features and mediator release patterns*. J Allergy Clin Immunol, 2013. **132**(6): p. 1456-7.

7 Annex

7.1 IgG subclasses determine pathways of anaphylaxis in mice

Héloïse Beutier^{1,2,3}, Caitlin Gillis^{1,2,3}, Bruno Iannascoli^{1,2}, Ophélie Godon^{1,2}, Nico Van Rooijen⁴, David A. Mancardi^{1,2,5}, Pierre Bruhns^{1,2,*} and Friederike Jönsson^{1,2,*}

Authors' affiliations

¹ Institut Pasteur, Département d'Immunologie, Unité des Anticorps en Thérapie et Pathologie, Paris, France;

² INSERM, U1222, Paris, France;

³ Université Pierre et Marie Curie, Paris, France;

⁴ Department of Molecular Cell Biology, VU Medical Center, Amsterdam, The Netherlands;

⁵ Present address: Institut National de Police Scientifique, Laboratoire de Police Scientifique de Paris, Paris, France.

*co-senior authorship.

Journal of Allergy and Clinical Immunology 2016 Apr 26.

doi: 10.1016/j.jaci.2016.03.028.

7.2 In vivo effector functions of high-affinity mouse IgG receptor FcγRI in disease and therapy models

Caitlin M. Gillis^{1,2,3}, Priscila P. Zenatti^{1,2}, David A. Mancardi^{1,2}, Héloïse Beutier^{1,2,3}, Laurence Fiette⁴, Lynn E. Macdonald⁵, Andrew J. Murphy⁵, Susanna Celli⁶, Philippe Bousso⁶, Friederike Jönsson^{1,2} and Pierre Bruhns^{1,2}

Authors' affiliations

¹ Institut Pasteur, Department of Immunology, Unit of Antibodies in Therapy and Pathology, Paris, France;

² INSERM, U1222, Paris, France;

³ Université Pierre et Marie Curie, Paris, France;

⁴ Département Infection et Epidémiologie, Unité d'Histopathologie Humaine et Modèles Animaux, Institut Pasteur, Paris, France;

⁵ Regeneron Pharmaceuticals, Inc., Tarrytown, NY, USA;

⁶ Institut Pasteur, Department of Immunology, Unit of Dynamics of Immune Responses, Paris, France.

Under revision as a brief communication in the Journal of Autoimmunity

7.3 Review – Contribution of human FcγRs to disease with evidence from human polymorphisms and transgenic animal studies

Caitlin Gillis^{1,2,*}, Aurélie Gouel^{1,2,3,*}, Friederike Jönsson^{1,2,§} and Pierre Bruhns^{1,2,§}

Authors' affiliations

¹Institut Pasteur, Département d'Immunologie, Laboratoire Anticorps en Thérapie et Pathologie, Paris, France;

²INSERM, U760, Paris, France;

³Department of Anesthesia and Intensive Care, Hospital of Bichat-Claude Bernard, Public Assistance-Hospitals of Paris, Paris, France.

*Equal contributors and §Co-senior authors

Frontiers in Immunology, 2014

DOI 10.3389/fimmu.2014.00254

7.4 Book chapter - Anaphylaxis (Immediate hypersensitivity): from old to new mechanisms

Caitlin Gillis^{1,2,3}, Aurélie Gouel^{1,2,3} and Pierre Bruhns^{1,2}

Authors' affiliations

¹Institut Pasteur, Département d'Immunologie, Laboratoire Anticorps en Thérapie et Pathologie, Paris, France;

²INSERM, U760, Paris, France;

³Université Pierre et Marie Curie, Paris, France.

M. Parnham (ed.), *Encyclopedia of Inflammatory Diseases*, 2015

DOI 10.1007/978-3-0348-0620-6_115-2

IgG subclasses determine pathways of anaphylaxis in mice

Héloïse Beutier, PharmD,^{a,b,c} Caitlin M. Gillis, BSc,^{a,b,c} Bruno Iannascoli, BTS,^{a,b} Ophélie Godon, MSc,^{a,b} Patrick England, PhD,^d Riccardo Sibilano, PhD,^{e,f} Laurent L. Reber, PhD,^{a,b} Stephen J. Galli, MD,^{e,f} Mark S. Cragg, PhD,^g Nico Van Rooijen, PhD,^h David A. Mancardi, PhD,^{a,b} Pierre Bruhns, PhD,^{a,b*} and Friederike Jönsson, PhD^{a,b*} *Paris, France, Stanford, Calif, Southampton, United Kingdom, and Amsterdam, The Netherlands*

Background: Animal models have demonstrated that allergen-specific IgG confers sensitivity to systemic anaphylaxis that relies on IgG Fc receptors (FcγRs). Mouse IgG_{2a} and IgG_{2b} bind activating FcγRI, FcγRIII, and FcγRIV and inhibitory FcγRIIB; mouse IgG₁ binds only FcγRIII and FcγRIIB. Although these interactions are of strikingly different affinities, these 3 IgG subclasses have been shown to enable induction of systemic anaphylaxis.

Objective: We sought to determine which pathways control the induction of IgG₁-, IgG_{2a}-, and IgG_{2b}-dependent passive systemic anaphylaxis.

Methods: Mice were sensitized with IgG₁, IgG_{2a}, or IgG_{2b} anti-trinitrophenyl mAbs and challenged with trinitrophenyl-BSA intravenously to induce systemic anaphylaxis that was monitored by using rectal temperature. Anaphylaxis was evaluated in mice deficient for FcγRs injected with mediator antagonists or in which basophils, monocytes/macrophages, or neutrophils had been depleted. FcγR expression was evaluated on these cells before and after anaphylaxis.

Results: Activating FcγRIII is the receptor primarily responsible for all 3 models of anaphylaxis, and subsequent downregulation of this receptor was observed. These models differentially relied on histamine release and the contribution of mast cells, basophils, macrophages, and neutrophils. Strikingly, basophil contribution and histamine predominance in mice with IgG₁- and IgG_{2b}-induced anaphylaxis correlated with the ability of inhibitory FcγRIIB to negatively regulate these models of anaphylaxis.

Conclusion: We propose that the differential expression of inhibitory FcγRIIB on myeloid cells and its differential binding of IgG subclasses controls the contributions of mast cells, basophils, neutrophils, and macrophages to IgG subclass-dependent anaphylaxis. Collectively, our results unravel novel complexities in the involvement and regulation of cell populations in IgG-dependent reactions *in vivo*. (J Allergy Clin Immunol 2016;■■■■:■■■■-■■■■.)

Key words: Anaphylaxis, IgG, mouse model, basophil, neutrophil, monocyte, macrophage, IgG Fc receptor, platelet-activating factor, histamine

From ^athe Department of Immunology, Unit of Antibodies in Therapy and Pathology, Institut Pasteur, Paris; ^bINSERM, U1222, Paris; ^cUniversité Pierre et Marie Curie, Paris; ^dInstitut Pasteur, Plate-Forme de Biophysique Moléculaire, Centre d'Innovation et Recherche Technologique (CiTech), CNRS-UMR3528, Paris; ^ethe Department of Pathology and ^fthe Sean N. Parker Center for Allergy and Asthma Research, Stanford University School of Medicine; ^gthe Antibody and Vaccine Group, Cancer Sciences Unit, University of Southampton Faculty of Medicine, Southampton General Hospital; and ^hthe Department of Molecular Cell Biology, VU Medical Center, Amsterdam.

*These authors contributed equally to this work.

Supported by Institut Pasteur, Institut National de la Santé et de la Recherche Médicale (INSERM), the European Research Council (ERC)–Seventh Frame-work Program (ERC-2013-CoG 616050), Société Française d'Allergologie (SFA; Soutien de la Recherche en Allergologie), and the Balsan company. H.B. is supported by a fellowship from the University Pierre et Marie Curie. C.M.G. is a scholar of the Pasteur Paris University International Doctoral Program and supported by a stipend from the Institut Carnot Pasteur Maladies Infectieuses. F.J. is an employee of the Centre National de La Recherche Scientifique (CNRS). R.S. and S.J.G. are supported by NIH/NIAMS grant R01 AR067145 and the Department of Pathology at Stanford University.

Disclosure of potential conflict of interest: C. M. Gillis declares a grant from Institut Carnot Pasteur Maladies Infectieuses and travel assistance from Societe Francaise d'Immunologie. R. Sibilano declares a grant from Stanford Lucile Packard Fellowship. S. J. Galli declares a grant from the National Institutes of Health. M. S. Cragg declares providing consultancy to Bioinvent International. P. Bruhns declares grants from ERC and Balsan Company. F. Jönsson declares a grant from Société Française d'Allergologie. The rest of the authors declare that they have no relevant conflicts of interest.

Received for publication June 19, 2015; revised January 29, 2016; accepted for publication March 3, 2016.

Corresponding author: Friederike Jönsson, PhD, and Pierre Bruhns, PhD, Unit of Antibodies in Therapy and Pathology, Department of Immunology, Institut Pasteur, 25 rue du Docteur Roux, 75015 Paris, France. E-mail: joensson@pasteur.fr. Or: bruhs@pasteur.fr.

0091-6749/\$36.00

© 2016 American Academy of Allergy, Asthma & Immunology

<http://dx.doi.org/10.1016/j.jaci.2016.03.028>

Anaphylaxis is a hyperacute allergic reaction that occurs with increasing incidence in the population and can be of fatal consequence. Symptoms include skin rash, hypotension, hypothermia, abdominal pain, bronchospasm, and heart and lung failure, which can lead to asphyxia and sometimes death.¹ The main treatment remains epinephrine (adrenaline) injection to restore heart and lung function. Because anaphylaxis represents an emergency situation, few clinical studies have been possible to address the mechanisms leading to anaphylaxis in patients. Experimental models of anaphylaxis identified mechanisms involving allergen-specific antibodies that trigger activating antibody receptors on myeloid cells, leading to mediator release. These mediators can, by themselves, recapitulate the symptoms of anaphylaxis observed in human subjects.^{2,3}

The “classical” mechanism of anaphylaxis states that allergen-specific IgE binds the activating IgE receptor FcεRI on mast cells, which, on allergen encounter, become activated and release histamine, among other mediators. Notably, histamine injection suffices to induce signs of anaphylaxis in animal models.⁴ In many cases detectable allergen-specific IgE and increased histamine levels do not accompany anaphylaxis in human subjects (discussed in Khodoun et al⁵), leading to the notion that “atypical” or “alternate” mechanisms of induction could explain these cases. One of these atypical/alternate models proposes a similar cascade of events but instead based on allergen-specific IgG binding to allergen, forming IgG-allergen immune complexes that trigger activating IgG Fc receptors (FcγRs) expressed on myeloid cells (ie, macrophages,

Abbreviations used

FcγR:	IgG Fc receptor
FcRn:	Neonatal IgG receptor
FITC:	Fluorescein isothiocyanate
Gfi1:	Growth factor independence 1
K _A :	Affinity constant
K _D :	Dissociation equilibrium constant
K _{off} :	Dissociation rate
K _{on} :	Association rate
mMCP-1:	Mast cell protease 1
PAF:	Platelet-activating factor
PSA:	Passive systemic anaphylaxis
RU:	Resonance units
TNP:	Trinitrophenyl
TRIM21:	Tripartite motif-containing protein 21
WT:	C57Bl/6 wild-type

basophils, and/or neutrophils), which in turn release platelet-activating factor (PAF).^{2,3} Importantly, PAF injection suffices to induce signs of anaphylaxis in animal models.⁶ IgG-induced anaphylaxis can be elicited by intravenous injection of allergen-specific IgG followed by allergen administration and is termed IgG-induced passive systemic anaphylaxis (PSA).

IgG receptors in the mouse comprise 4 “classical” IgG receptors termed FcγRs but also the neonatal IgG receptor (FcRn) and the intracellular FcR tripartite motif-containing protein 21 (TRIM21).^{7,8} Although FcRn and TRIM21 both participate in the intracellular routing of IgG and FcRn in protection from catabolism and distribution to tissues,⁹ FcγRs control cell activation in the presence of immune complexes. FcγRs in mice are subdivided into (1) activating FcγRs (ie, FcγRI, FcγRIII, and FcγRIV), which lead to cell activation on immune complex binding, and (2) an inhibitory FcγR (ie, FcγRIIB), which inhibits cell activation when coengaged by an immune complex with an activating FcγR coexpressed on the same cell.¹⁰ Thus inhibition of cell activation by FcγRIIB requires that the immune complex contains IgG bound by both the activating and inhibitory FcγR.

Four IgG subclasses exist in mice: IgG₁, IgG_{2a}, IgG_{2b}, and IgG₃. Among those, only IgG_{2a} and IgG_{2b} bind to all FcγRs, whereas IgG₁ binds only to FcγRIIB and FcγRIII. It remains under debate whether IgG₃ binds to FcγRs, particularly FcγRI.^{11,12} The affinities of these FcγRs toward IgG subclasses are strikingly different (Table I),¹¹⁻¹⁴ leading to the notion of high-affinity receptors that retain monomeric IgG and low-affinity receptors that do not.⁸ However, the avidity of IgG-immune complexes enables both types of receptors to retain IgG-immune complexes, leading to receptor clustering, intracellular signaling events, and, eventually, cell activation. FcγRI is a high-affinity receptor for IgG_{2a},¹⁵ and FcγRIV is a high-affinity receptor for IgG_{2a} and IgG_{2b}.¹⁶ All other FcγR-IgG interactions are of low affinity (reviewed in Bruhns⁷).

Three of the 4 IgG subclasses in the mouse, IgG₁, IgG_{2a}, and IgG_{2b}, have been reported to enable the induction of systemic anaphylaxis, inducing mild-to-severe hypothermia.^{5,17,18} This is rather surprising for IgG₁, considering that inhibitory FcγRIIB binds IgG₁ with a 10-fold higher affinity (affinity constant [K_A], $3.3 \times 10^6 \text{ M}^{-1}$) than activating FcγRIII (K_A, $3.1 \times 10^5 \text{ M}^{-1}$; Table I),¹³ implying that inhibition should dominate over activation. C57Bl/6 wild-type (WT) mice experience a very mild anaphylactic reaction during IgG₁-induced PSA compared to FcγRIIB^{-/-} mice,¹⁹ indicating that inhibition

TABLE I. Affinities of mouse FcγR-IgG subclass interactions (K_A values in M⁻¹)

	IgG ₁	IgG _{2a}	IgG _{2b}	IgG ₃
FcγRI	–	1×10^8	1×10^5	(+)
FcγRIIB	3.3×10^6	4.2×10^5	2.2×10^6	–
FcγRIII	3.1×10^5	6.8×10^5	6.4×10^5	–
FcγRIV	–	2.9×10^7	1.7×10^7	–

Data were compiled from Nimmerjahn and Ravetch¹³ and Nimmerjahn et al.¹⁴
–, No detectable affinity; (+), under debate.^{11,12}

by FcγRIIB occurs in WT mice during IgG₁-induced PSA, reducing but not protecting against anaphylaxis. IgG₁-dependent PSA has been reported to rely on basophils²⁰ that coexpress FcγRIIB and FcγRIII.²¹ In this apparently simple situation, only 1 activating receptor and 1 inhibitory receptor are engaged on a single cell type that, once activated, produces an anaphylactogenic mediator, such as PAF.²⁰

However, IgG_{2a} and IgG_{2b} bind 3 activating FcγRs and inhibitory FcγRIIB with different affinities, ranging over 2 logs. In particular, the affinity of FcγRIIB for IgG_{2a} is significantly lower than that for IgG_{2b}, whereas the activating IgG receptors FcγRIII and FcγRIV bind IgG_{2a} and IgG_{2b} with similar affinities, respectively (Table I). Notably, FcγRIV is not expressed on basophils but on monocytes/macrophages and neutrophils,¹⁴ which have both been reported to contribute to experimental anaphylaxis.^{18,22-24} In addition, mice expressing only FcγRIV can develop IgG-dependent PSA.¹⁶ Therefore, together with expression and binding data, one would hypothesize that FcγRIV contributes predominantly to IgG_{2a}- and IgG_{2b}-induced PSA.

In this work we present evidence contrary to this hypothesis and reveal which activating FcγR on which cell types releasing which mediators are responsible for IgG_{2a}-dependent PSA and IgG_{2b}-dependent PSA and the differential regulation of these models of anaphylaxis by FcγRIIB. Our results unravel a complex balance determined by FcγR expression patterns, inhibition potential by FcγRIIB, and respective affinities of activating and inhibitory FcγRs for IgG subclasses that, together, regulate the contribution of cells and anaphylactogenic mediators to a given model of IgG-induced anaphylaxis.

METHODS

Mice

Female C57Bl/6J mice (herein referred to as WT mice) were purchased from Charles River (Wilmington, Mass), female BALB/cJrj mice were from Janvier Labs (Le Genest-Saint-Isle, France), and FcγRIIB^{-/-} (MGI:1857166), FcγRIII^{-/-} (MGI:3620982) and Rosa26-YFP mice were from Jackson Laboratories (Bar Harbor, Me). FcγRI^{-/-} mice (MGI:3664782) were provided by J. Leusen (University Medical Center, Utrecht, The Netherlands), FcγRIV^{-/-} mice (MGI:5428684) were provided by J. V. Ravetch (Rockefeller University, New York, NY), growth factor independence 1 (Gfi1)^{-/-} mice were provided by T. Moroy (Montreal University, Montreal, Quebec, Canada), and MRP8-cre mice were provided by Clifford Lowell (University of California at San Francisco, San Francisco, Calif). MRP8-cre and Rosa26-YFP mice were intercrossed to generate MRP8-cre; Rosa26-YFP mice. Cpa3-Cre; Mcl-1^{fl/fl} mice²⁵ (backcrossed for at least 9 generations on a C57Bl/6J background) were kept in the Stanford University animal facility. All mouse protocols were approved by the Animal Ethics committee CETEA (Institut Pasteur, Paris, France) registered under #C2EA-89 and/or the Institutional Animal Care and Use Committee of Stanford University.

Antibodies and reagents

PBS and clodronate liposomes were prepared as previously described.²⁶ Trinitrophenyl (TNP_[21-31])-BSA was obtained from Santa Cruz Biotechnology (Dallas, Tex), ABT-491 was obtained from Sigma-Aldrich (St Louis, Mo), cetirizine DiHCl was obtained from Selleck Chemicals (Houston, Tex), anti-mouse FcγRIII (275003) was obtained from R&D Systems (Minneapolis, Minn), and rat IgG_{2b} isotype control (LTF-2) was obtained from Bio X Cell (West Lebanon, NH). Purified anti-CD200R3 (Ba103) was provided by H. Karasuyama (Tokyo Medical and Dental University Graduate School, Tokyo, Japan). The hybridoma producing mAb anti-mouse FcγRIV (9E9) was provided by J. V. Ravetch (Rockefeller University), anti-Ly6G (NIMP-R14) was provided by C. Leclerc (Institut Pasteur), IgG₁ anti-TNP (TIB-191) was provided by D. Voehringer (Universitätsklinikum, Erlangen, Germany), IgG_{2a} anti-TNP (Hy1.2) was provided by Shozo Izui (University of Geneva, Geneva, Switzerland), and IgG_{2b} anti-TNP (GORK) was provided by B. Heyman (Uppsala Universitet, Uppsala, Sweden); corresponding antibodies were purified, as previously described.¹⁸ Purified mouse IgE anti-TNP was purchased from BD PharMingen (San Jose, Calif). The mAb 9E9 was coupled to fluorescein isothiocyanate (FITC) by using the Pierce FITC Antibody labeling kit (Life Technologies, Grand Island, NY). Antibodies used for flow cytometry staining of c-Kit (clone 2B8), CD49b (clone DX5), IgE (clone R35-72), CD11b (clone M1/70), F4/80 (clone 6F12), CD115 (clone T38-320), Ly6G (clone 1A8), and Ly6C (clone AL-21) were purchased from BD PharMingen; CD45 (clone 30F11) and Gr1 (clone RB6-8C5) were purchased from Miltenyi Biotec (Bergisch Gladbach, Germany). FcγRIIB was detected by using the FITC-coupled mAb AT130-2 mIgG1 N297A.²⁷

PSA

IgG-induced PSA. IgG₁, IgG_{2a}, or IgG_{2b} anti-TNP antibodies were administered intravenously at a dose of 500 μg, if not otherwise indicated, in 200 μL of physiologic saline, followed by an intravenous challenge with 200 μg of the antigen (TNP-BSA) in physiologic saline 16 hours later.

IgE-induced PSA. IgE anti-TNP antibodies were administered intravenously at a dose of 50 μg in 200 μL of physiologic saline, followed by an intravenous challenge with 500 μg of TNP-BSA in physiologic saline 24 hours later. The body temperature of mice was monitored with a digital thermometer with a rectal probe (YSI, Yellow Springs, Ohio).

In vivo blocking and cellular depletion

Three hundred microlitres per mouse of PBS or clodronate liposomes, 300 μg/mouse of rat IgG_{2b} isotype control or anti-Ly6G, and 30 μg/mouse of anti-CD200R3 mAbs were injected intravenously 24 hours before challenge. The specificity of cell depletion was evaluated by using flow cytometry on blood, bone marrow, and splenic and peritoneal cells taken from naive WT mice 24 hours after injection of the depleting antibody or clodronate-liposomes (examples are shown in Figs E1 and E2 in this article's Online Repository at www.jacionline.org). Twenty-five micrograms per mouse of ABT-491 or 300 μg/mouse of cetirizine was injected intravenously 20 minutes or intraperitoneally 30 minutes before challenge, respectively. Two hundred micrograms per mouse of anti-FcγRIV mAb was injected intravenously 30 minutes before challenge.

Flow cytometric analysis

Freshly isolated cells were stained with indicated fluorescently labeled mAbs for 30 minutes at 4°C. Cell populations were defined as follows: neutrophils (CD45⁺/CD11b⁺/Ly6G^{hi}/Ly6C^{int}), monocytes (CD45⁺/CD11b⁺/Ly6G^{lo}/Ly6C^{lo/hi}), basophils (CD45^{int}/CD49b⁺/IgE⁺), spleen macrophages (CD45⁺/CD11b⁺/Gr-1^{lo}/CD115⁺/F4/80^{hi}), peritoneal macrophages (CD45⁺/CD11b⁺/F4/80⁺), and peritoneal mast cells (CD45⁺/c-Kit⁺/IgE⁺). FcγR expression on the indicated cell population is represented as Δ geometric mean between specific and isotype control staining.

Surface plasmon resonance analysis

Experiments were performed at 25°C with a ProteOn XPR36 real-time SPR biosensor (Bio-Rad Laboratories, Hercules, Calif). Anti-TNP antibodies were immobilized covalently through amine coupling on the surface of a GLC chip. TNP-BSA was then injected on the chip at a flow rate of 25 μL · min⁻¹, with contact and dissociation times of 8 minutes each. Binding responses were recorded in real time as resonance units (RU; 1 RU ≈ 1 pg/mm²). Background signals were subtracted, and binding rates (k_{on} [association rate] and k_{off} [dissociation rate]) and equilibrium constants (Kd [dissociation equilibrium constant]) were determined with BIAevaluation software (GE Healthcare, Fairfield, Conn).

ELISAs

After induction of IgG₁-, IgG_{2a}-, IgG_{2b}-, or IgE-induced PSA, plasma and sera were collected at 5 minutes and 3 hours later to determine the histamine and mast cell protease 1 (mMCP-1) content, respectively. Histamine and mMCP-1 concentrations were determined with commercially available ELISA kits (Beckman Coulter, Fullerton, Calif, and eBioscience, San Diego, Calif), according to the manufacturer's instructions. The relative binding affinity of IgG₁, IgG_{2a}, and IgG_{2b} anti-TNP antibodies to TNP-BSA was determined by using ELISA. Briefly, TNP-BSA-coated plates were incubated with dilutions of IgG₁, IgG_{2a}, or IgG_{2b} anti-TNP antibodies. After washing, bound anti-TNP IgG was revealed by using the same horseradish peroxidase-coupled anti-mouse IgG and SIGMAFAST OPD Sigma-Aldrich (St Louis, Mo) solution.

Mast cell histology

Mouse back skin biopsy specimens were collected 24 hours after induction of specific cell depletion, and mouse ear skin biopsy specimens were collected 30 minutes after IgE-, IgG₁-, IgG_{2a}-, or IgG_{2b}-induced PSA and embedded in paraffin before sectioning. Mast cells in toluidine blue-stained biopsy specimens were counted visually in at least 15 fields of view per mouse and more than 6 mice per treatment (see Fig E1, I).

Statistics

Data were analyzed by using 1-way or 2-way ANOVA with the Tukey posttest. A *P* value of less than .05 was considered significant. If not stated otherwise, data are represented as means ± SEMs.

RESULTS

FcγRIII dominates anaphylaxis induced by IgG subclasses

PSA was induced by means of an intravenous injection of one of the different anti-TNP IgG isotypes (IgG₁, IgG_{2a}, and IgG_{2b}), followed by an intravenous challenge with TNP-BSA 16 hours later. This protocol induces a transient decrease in body temperature that is most pronounced between 30 and 40 minutes. As reported previously,^{3,18,20,22,28} all 3 IgG isotypes were capable of inducing anaphylaxis in WT mice (Fig 1). In these experimental conditions IgG₁-induced PSA triggered a maximum temperature loss of approximately 2°C, IgG_{2a}-induced PSA triggered a maximum temperature loss of approximately 4°C, and IgG_{2b}-induced PSA triggered a maximum temperature loss of approximately 3°C in WT mice. Using single FcγR knockout mice we evaluated the contribution of each of the 4 mouse FcγRs to these anaphylaxis models. The absence of either FcγRIV (with the exception of a single time point in IgG_{2b}-induced PSA) or FcγRI had no significant effect on IgG- PSA-induced hypothermia, regardless of the subclass of IgG antibodies used to induce anaphylaxis (Fig 1). However, the lack of FcγRIII protected mice from anaphylaxis in all models.

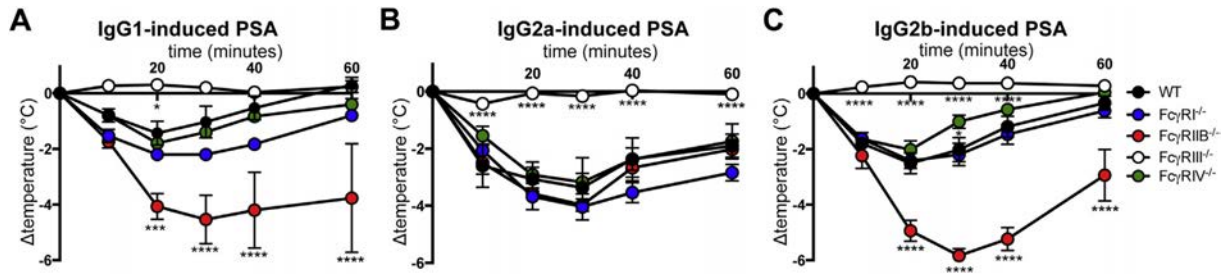


FIG 1. Fc γ RIII dominates in IgG-induced PSA models. Mice injected with anti-TNP mAbs were challenged with TNP-BSA, and body temperatures were monitored: IgG₁-induced PSA (A), IgG_{2a}-induced PSA (B), or IgG_{2b}-induced PSA (C) in indicated mice (n \geq 3 per group). Data are representative of at least 2 independent experiments (Fig 1, A: n = 2; Fig 1, B: n = 3; Fig 1, C: n = 2). Significant differences compared with the WT group are indicated. *P < .05, ***P < .001, and ****P < .0001.

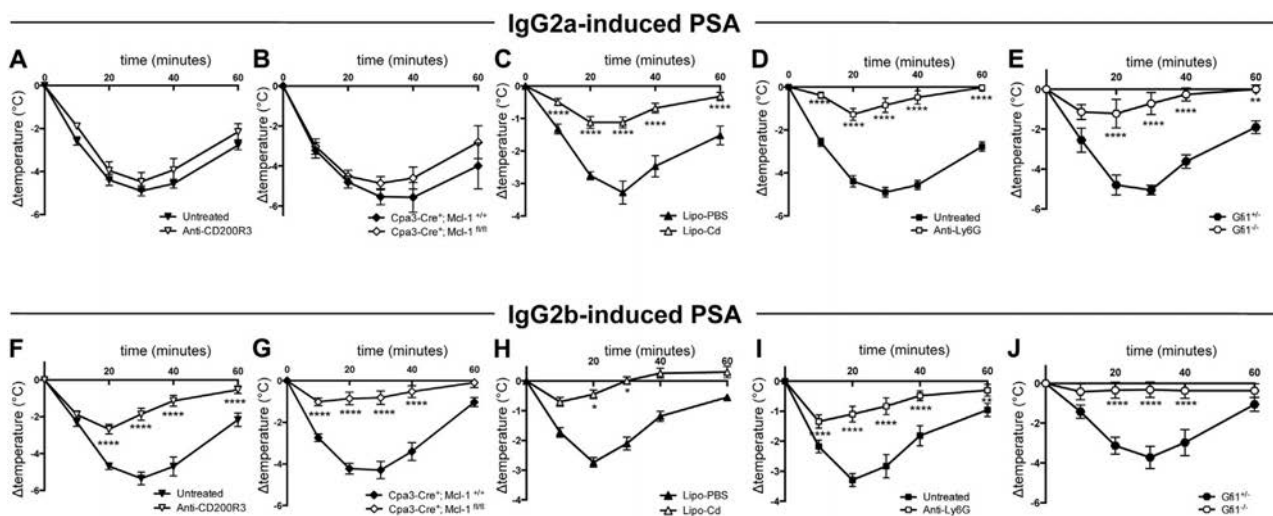


FIG 2. Basophils, mast cells, monocytes/macrophages, and neutrophils contribute differentially to IgG-induced PSA models. Indicated mice (n \geq 8 per group) were injected with IgG_{2a} (A-E) or IgG_{2b} (F-J) anti-TNP mAbs and challenged with TNP-BSA, and body temperatures were monitored. WT mice (n = 8 per group) were pretreated, as indicated (Fig 2, A, C, D, F, H, and I). *Lipo-PBS*, PBS liposomes; *Lipo-Cd*, clodronate liposomes. Data are pooled from at least 2 independent experiments. *P < .05, **P < .01, and ****P < .0001.

Mice lacking the inhibitory receptor Fc γ RIIB had a significantly more severe temperature decrease than seen in WT mice with IgG₁- or IgG_{2b}-induced PSA but showed no significant difference in the severity of IgG_{2a}-induced PSA (Fig 1). Even though the 3 anti-TNP IgG mAbs used are not switch variants of a unique anti-TNP antibody, they show comparable binding to TNP-BSA, as determined by using ELISA, and similar affinity (nanomolar range) and dissociation rates (k_{off}), as determined by using surface plasmon resonance analysis, particularly the IgG_{2a} and IgG_{2b} anti-TNP antibodies (see Fig E3, A-C, in this article's Online Repository at www.jacionline.org).

Of note, untreated Fc γ R-deficient mice presented modest variations in Fc γ R expression levels (see Fig E4 in this article's Online Repository at www.jacionline.org) and leukocyte representation among blood cells compared with WT mice (see Fig E5 in this article's Online Repository at www.jacionline.org). In particular, a mild lymphopenia in Fc γ RIV^{-/-} and Fc γ RIIB^{-/-} mice (the latter also have a tendency to express higher levels of Fc γ RIII and Fc γ RIV) and a mild eosinophilia in Fc γ RIII^{-/-} mice, which also express significantly more

Fc γ RIIB on neutrophils and Ly6C^{hi} monocytes, were seen. Together, we think that these variations do not explain the drastic phenotypes observed for PSA in Fc γ RIIB^{-/-} and Fc γ RIII^{-/-} mice compared with WT mice. Thus these data indicate that Fc γ RIII predominates in the induction of IgG₁-, IgG_{2a}-, and IgG_{2b}-induced PSA and that Fc γ RIIB specifically dampens anaphylaxis severity in mice with IgG₁- and IgG_{2b}-induced PSA.

Basophils, mast cells, monocytes/macrophages and neutrophils contribute differentially to IgG isotype-dependent anaphylaxis models

Fc γ RIII is expressed by all myeloid cells^{7,21} and, to a lesser extent, by natural killer (NK) cells.²⁹ Therefore one might anticipate that IgG immune complexes formed *in vivo* as a consequence of TNP-BSA injection in anti-TNP-sensitized mice would engage Fc γ RIII on these cells, leading to cell activation and possibly contributing to anaphylaxis. Basophils, mast cells, neutrophils, and monocyte/macrophages have indeed been reported to contribute to IgG-induced PSA,^{17,18,20,22} however, the

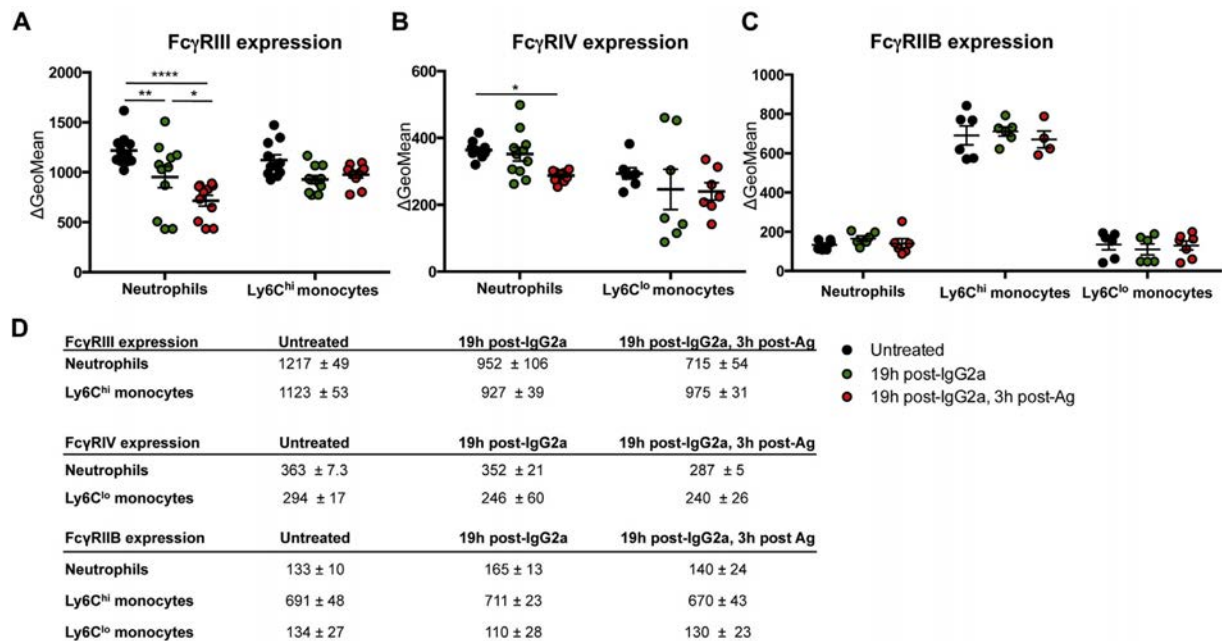


FIG 3. Reduced expression of Fc γ RIII and Fc γ RIV, but not Fc γ RIIB, on neutrophils after IgG_{2a}-induced PSA. **A-C**, Fc γ RIII (Fig 3, A), Fc γ RIV (Fig 3, B), and Fc γ RIIB (Fig 3, C) expression on blood cells from WT mice (Fig 3, A and B: n = 11 per group; Fig 3, C: n \geq 6 per group) left untreated, injected with IgG_{2a} anti-TNP mAbs, or injected with IgG_{2a} anti-TNP mAbs and challenged with TNP-BSA is shown. **D**, Compilation of Δ geometric mean (*GeoMean*) \pm SEM data from Fig 3, A-C. Ag, Antigen. **P* < .05, ***P* < .01, and *****P* < .0001.

respective contribution of each of these different cell types remains debated.^{2,28} To investigate which cell types contribute to PSA induced by different IgG subclasses, we depleted basophils (anti-CD200R3 mAb), monocytes/macrophages (clodronate-filled liposomes), or neutrophils (anti-Ly6G) before anaphylaxis induction or evaluated anaphylaxis induction in transgenic mice deficient in certain cell populations.

Of note, the relatively mild temperature loss in WT mice with IgG₁-induced PSA (see Fig E6, A, in this article's Online Repository at www.jacionline.org) did not allow us to address reliably the contribution of either basophils or neutrophils to this model of anaphylaxis. Therefore we restricted our analysis of the contribution of myeloid cell populations to IgG_{2a}- and IgG_{2b}-induced PSA. Antibody-induced basophil depletion or genetically induced mast cell and basophil deficiency (see Fig E2, H: Cpa3-Cre; Mcl-1^{fl/fl} mice²⁵) did not affect IgG_{2a}-induced PSA (Fig 2, A and B) but significantly inhibited IgG_{2b}-induced PSA (Fig 2, F and G). Monocyte/macrophage depletion (Fig 2, C and H) significantly inhibited both IgG_{2a}- and IgG_{2b}-induced PSA. The absence of neutrophils, either after antibody-mediated depletion (Fig 2, D and I) or with neutropenic Gfi1^{-/-} mice (Fig 2, E and J),³⁰ significantly inhibited both IgG_{2a}- and IgG_{2b}-induced PSA. Although monocytes/macrophages and neutrophils appear to contribute to both models of anaphylaxis, basophils and possibly mast cells contribute specifically to IgG_{2b}- but not IgG_{2a}-induced PSA.

Fc γ RIII is downregulated specifically on neutrophils after IgG_{2a}-induced PSA

Khodoun et al³¹ proposed to use the reduced expression of Fc γ RIII on mouse neutrophils as a marker to distinguish

IgE- from IgG₁-induced PSA, both of which required priming with an antigen-specific antibody and challenge with the recognized antigen. Therefore we wondered whether Fc γ RIII expression on neutrophils might also be a marker for IgG_{2a}- and IgG_{2b}-induced PSA. In addition, reduced expression of Fc γ R after IgG-induced PSA might document that a particular cell population is activated after engagement of its Fc γ R by IgG-immune complexes during anaphylaxis. Thus this parameter can be used to discriminate cell populations contributing to anaphylaxis after direct activation by IgG-immune complexes from those contributing after activation by mediators liberated by IgG-immune complex-activated cells (eg, histamine, PAF, leukotrienes, and prostaglandins).

Among mouse IgG receptors, only Fc γ RIIB, Fc γ RIII, and Fc γ RIV are significantly expressed on circulating myeloid cells but not Fc γ RI.^{7,32,33} Of circulating monocyte populations, "classical" Ly6C^{hi} monocytes are Fc γ RIIB^{med}Fc γ RIII^{med}Fc γ RIV⁻, whereas "nonclassical" Ly6C^{lo} monocytes are Fc γ RIIB^{lo}Fc γ RIII^{lo}Fc γ RIV^{hi}.³⁴ Therefore we determined the expression of Fc γ RIIB, Fc γ RIII, and Fc γ RIV before and after IgG_{2a}-induced PSA induction on neutrophils and monocyte subsets. Expression of Fc γ RIII was downregulated on neutrophils, but not on Ly6C^{hi} monocytes, during IgG_{2a}-induced PSA (Fig 3, A and D). Expression of Fc γ RIV was also downregulated on neutrophils, but not on Ly6C^{lo} monocytes, during IgG_{2a}-induced PSA (Fig 3, B and D). This was unexpected considering that Fc γ RIV does not significantly contribute to this PSA model (Fig 1, B). However, Fc γ RIIB expression remained unchanged on Ly6C^{hi} and Ly6C^{lo} monocytes and neutrophils (Fig 3, C and D), which is in agreement with the lack of contribution of this receptor to IgG_{2a}-induced PSA (Fig 1, B).

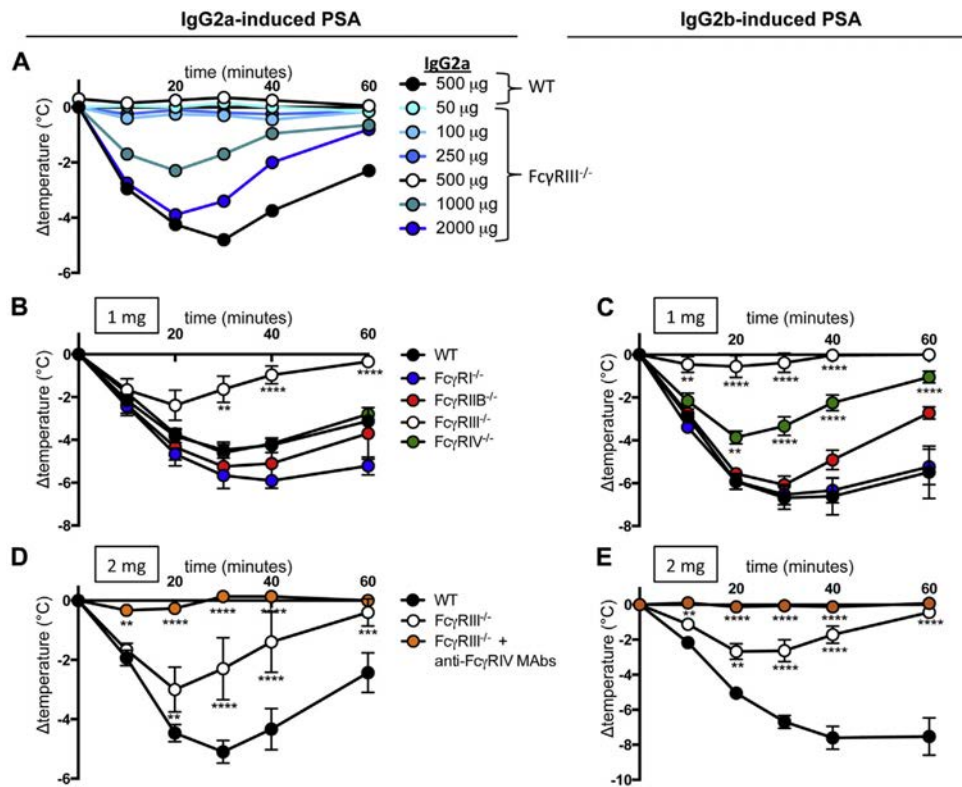


FIG 4. High doses of IgG₂ antibodies reveal Fc γ RIV contribution to IgG₂-induced PSA. **A**, PSA in indicated mice injected with various doses of IgG_{2a} anti-TNP mAbs ($n = 2$ per group). **B-E**, PSA in indicated mice (Fig 4, **B** and **C**: $n = 8$ per group; Fig 4, **D** and **E**: $n \geq 3$ per group) injected with indicated doses of anti-TNP mAbs. Data are pooled from 2 independent experiments. Significant differences compared with the untreated WT group are indicated. ** $P < .01$, *** $P < .001$, and **** $P < .0001$.

Together, these data suggest that neutrophils might be activated directly through Fc γ RIII by immune complexes formed during IgG_{2a}-induced PSA. They also suggest that neutrophils, but not Ly6C^{lo} monocytes, can be similarly activated through Fc γ RIV, even if no contribution of this receptor was identified in this model using Fc γ RIV^{-/-} mice (Fig 1, **B**).

Increased IgG₂ antibody doses reveal the contribution of Fc γ RIV to IgG_{2a} and IgG_{2b}-induced PSA

In mice Fc γ RIV binds monomeric IgG_{2a} and IgG_{2b}. Therefore at physiologic concentrations of IgG_{2a} (approximately 2.5 mg/mL) and IgG_{2b} (approximately 1.5 mg/mL) in serum, Fc γ RIV might be occupied *in vivo*, particularly on circulating neutrophils and monocytes. Nevertheless, the short binding half-lives of monomeric IgG_{2a} (half-life, approximately 3 minutes) and monomeric IgG_{2b} (half-life, approximately 10 minutes) by Fc γ RIV and their ability to be displaced from this receptor by immune complexes¹⁶ might enable IgG₂-immune complexes to interact with Fc γ RIV during anaphylaxis and therefore contribute to its induction, severity, or both.

To explore this possibility, we primed Fc γ RIII^{-/-} mice with various doses of anti-TNP IgG_{2a} before challenge with TNP-BSA to induce a range of *in vivo* concentrations of immune complexes. As expected, the low doses did not trigger Fc γ RIII^{-/-}

mice to have anaphylaxis after challenge. However, increased doses (1 or 2 mg) enabled significant temperature decreases in Fc γ RIII^{-/-} mice comparable with those observed in WT mice primed with 500 μ g of IgG₂, particularly at the highest dose of IgG_{2a} (2 mg; Fig 4, **A**). Already at a dose of 1 mg of IgG₂, Fc γ RIII^{-/-} mice had mild hypothermia with IgG_{2a}- but not IgG_{2b}-induced PSA (Fig 4, **B** and **C**). Unexpectedly, in the same conditions Fc γ RIV contributed to IgG_{2b}-induced PSA, which was no longer dampened by inhibitory Fc γ RIIB (Fig 4, **C**). At a dose of 2 mg of IgG, Fc γ RIII^{-/-} mice had hypothermia with both IgG_{2a}- and IgG_{2b}-induced PSA, which was abolished when Fc γ RIII^{-/-} mice were pretreated with a blocking antibody against Fc γ RIV (Fig 4, **D** and **E**). Fc γ RI did not contribute to either model of IgG₂-induced PSA at an increased dose (Fig 4, **B** and **C**). Furthermore, Fc γ RIII expression was downregulated on neutrophils and basophils, but not on Ly6C^{hi} monocytes, after IgG_{2b}-induced PSA (Fig 5, **A** and **D**). Fc γ RIV expression was also downregulated on neutrophils, but not on Ly6C^{lo} monocytes (Fig 5, **B** and **D**). However, Fc γ RIIB expression did not change on either neutrophils or Ly6C^{hi} and Ly6C^{lo} monocytes, even though this inhibitory receptor regulates IgG_{2b}-induced PSA (Figs 1, **C**, and 5, **C** and **D**). This observation is in agreement with the study by Khodoun et al,³¹ which reported that Fc γ RIIB expression did not change on neutrophils after IgG₁-induced PSA. Altogether, high doses of antigen-specific IgG₂ reveal the contribution of Fc γ RIV to IgG_{2a}-induced PSA and IgG_{2b}-induced PSA and

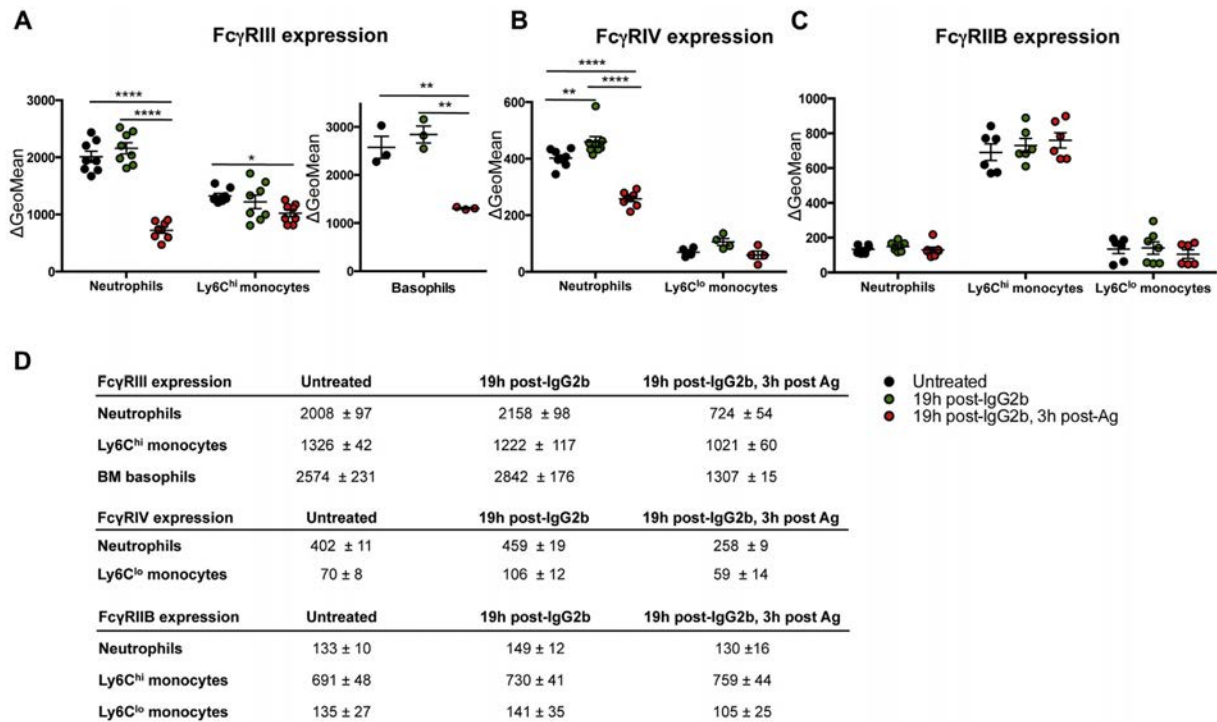


FIG 5. Expression of FcγRs on myeloid cells after IgG_{2b}-induced PSA. **A-C**, FcγRIII (left: n = 8 per group, right: n = 3 per group; Fig 5, A), FcγRIV (n = 8 per group; Fig 5, B), and FcγRIIB expression (n ≥ 6 per group; Fig 5, C) on cells from WT mice (n = 8 per group) left untreated, injected with IgG_{2b} anti-TNP mAbs, or injected with IgG_{2b} anti-TNP mAbs and challenged with TNP-BSA. **D**, Compilation of Δ geometric mean (GeoMean) ± SEM data from Fig 5, A-C. Ag, Antigen. In this figure 1 or 0.5 mg of IgG_{2b} was injected to assess expression on neutrophils/monocytes or basophils, respectively. *P < .05, **P < .01, and ****P < .0001.

suggest the direct activation of neutrophils and basophils by IgG_{2b}-immune complexes.

IgG₁-induced PSA in the absence of inhibitory FcγRIIB

The unexpected differences observed between IgG_{2a}- and IgG_{2b}-induced PSA induction pathways prompted us to find a mouse model more sensitive to IgG₁-induced PSA than WT mice to be able to evaluate the contribution of cell types and mediators in this model. Indeed, as mentioned earlier, WT mice respond poorly in a model of IgG₁-induced PSA (Fig 1, A, and see Fig E6, A).¹⁹ However, FcγRIIB^{-/-} mice experience a temperature decrease of approximately 4°C during IgG₁-induced PSA, which is comparable with temperature losses observed in WT mice during IgG_{2a}- or IgG_{2b}-induced PSA (Fig 1, B and C). Therefore we analyzed the contribution of cell types to IgG₁-induced PSA in FcγRIIB^{-/-} mice. Basophil depletion mildly but significantly inhibited IgG₁-induced PSA (Fig 6, A), which is in agreement with previous data.²⁰ The depletion of neutrophils had the same effect, although not consistently as strongly as basophil depletion (Fig 6, B, and data not shown). Monocyte/macrophage depletion had a tendency to ameliorate anaphylaxis that was reproducible but not significant (Fig 6, C). These results suggest that IgG₁-induced PSA relies on basophils and neutrophils and possibly also monocytes.

PAF and histamine contribute differentially to IgG_{2a}- and IgG_{2b}-induced PSA

Because cell types contribute differently to IgG₂-induced PSA models (ie, IgG_{2a}-induced PSA for neutrophils and monocytes and IgG_{2b}-induced PSA for basophils, neutrophils, and monocytes), one can expect that the mediators responsible for clinical signs also might differ between them. PAF has been shown to be responsible for anaphylactic reactions that required basophil,²⁰ neutrophil,^{18,24} and/or monocyte/macrophage²² activation, whereas histamine has been shown to be responsible for mast cell- and basophil-dependent anaphylaxis.^{35,36} Neutrophils are the main producers of PAF,³⁷ whereas mast cells and basophils are the main producers of histamine.^{38,39} Therefore we analyzed the relative contribution of these 2 mediators to the 3 models of PSA by using the histamine receptor 1 antagonist cetirizine and the PAF receptor antagonist ABT-491. Surprisingly, the histamine receptor 1 antagonist cetirizine significantly inhibited IgG₁-induced PSA, whereas the PAF receptor antagonist ABT-491 had no significant effect, which is in opposition to previous data.²⁰ The combination of both antagonists had an additive effect and almost abolished IgG₁-induced PSA (Fig 7, A). The results obtained in FcγRIIB^{-/-} mice were confirmed in WT mice (Fig 7, A). Whereas cetirizine mildly reduced hypothermia in IgG_{2a}-induced PSA, it significantly inhibited IgG_{2b}-induced PSA. ABT-491 mildly reduced hypothermia in mice with IgG_{2a}-induced PSA but had no significant effect on mice with IgG_{2b}-induced PSA (Fig 7, B and C). However, the combination

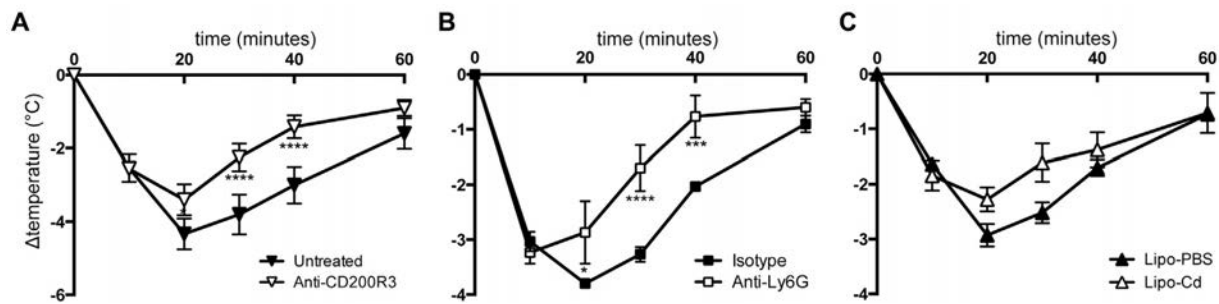


FIG 6. Cell contributions to IgG₁-induced PSA in the absence of inhibitory FcγRIIB. FcγRIIB^{-/-} mice were pretreated as indicated, injected with IgG₁ anti-TNP mAbs, and challenged with TNP-BSA, and central temperatures were monitored (A: n = 8 per group; B: n = 7 per group; C: n = 10 per group). Data are represented as means ± SEMs. Data are pooled from 2 independent experiments. *P < .05, ***P < .001, and ****P < .0001.

of cetirizine and ABT-491 almost abolished both IgG_{2a}- and IgG_{2b}-induced PSA. Increased plasma histamine levels were detected 5 minutes after challenge in all 3 IgG-induced PSA models, and particularly high levels were observed in mice undergoing IgE-induced PSA (as a positive control) or IgG_{2a}-induced PSA (Fig 7, D and E). This latter finding is surprising because IgG_{2a}-induced PSA is unaffected by the absence of both mast cells and basophils, which are considered major sources of histamine. mMCP-1, which is released on activation of mucosal mast cells, could be detected in the sera of mice undergoing IgE-induced PSA but not in those undergoing any one of the 3 models of IgG-induced PSA 3 hours after PSA induction (Fig 7, F). Collectively, these results suggest that histamine predominantly contributes to IgG₁- and IgG_{2b}-induced PSA, whereas histamine and PAF together are necessary for IgG_{2a}-induced PSA.

DISCUSSION

Our work suggests that the activating IgG receptor FcγRIII predominantly contributes to IgG-dependent PSA, irrespective of whether induced by IgG₁, IgG_{2a}, or IgG_{2b} antibodies. A contribution of the activating IgG receptor FcγRIV was only identified when using very high amounts of IgG₂ antibodies, whereas the activating IgG receptor FcγRI played no detectable role. Remarkably, the inhibitory IgG receptor FcγRIIB controlled the severity of IgG₁- and IgG_{2b}- but not IgG_{2a}-induced anaphylaxis. The ability of FcγRIIB to inhibit a given model of IgG-induced anaphylaxis correlated with the contribution of basophils and histamine to that model. Indeed, basophils, and possibly mast cells, contributed with neutrophils to IgG₁-induced PSA and with neutrophils and monocytes to IgG_{2b}-induced PSA but not to IgG_{2a}-induced PSA, which appeared to depend entirely on neutrophils and monocytes/macrophages. Altogether, our data propose that the 3 IgG subclasses, IgG₁, IgG_{2a}, and IgG_{2b}, induce 3 qualitatively different pathways of anaphylaxis that are nevertheless triggered primarily by a single IgG receptor, FcγRIII.

FcγRIII is a low-affinity receptor for IgG₁, IgG_{2a}, and IgG_{2b}, whereas FcγRI is a high-affinity receptor for IgG_{2a}, and FcγRIV is a high-affinity receptor for IgG_{2a} and IgG_{2b}. Therefore one would assume that FcγRIII predominates in IgG₁-induced PSA, FcγRI and FcγRIV predominate in IgG_{2a}-induced PSA, and FcγRIV predominates in IgG_{2b}-induced PSA. However, our data from FcγRIII^{-/-} mice indicate that this receptor

predominates in all 3 models. Notably, we found increased expression of FcγRIIB on neutrophils and Ly6C^{hi} monocytes in FcγRIII^{-/-} mice, which could mask a potential contribution of FcγRIV in these conditions.

In support of the notion that FcγRIII predominates in IgG-induced PSA induction, an alternative model of PSA induced by sensitization and challenge with goat antibodies was found to be driven by FcγRIII,²² and blocking antibodies against FcγRIII were protective in a model of PSA induced by IgG immune complexes.¹⁸ In addition, IgG_{2a}-induced PSA in FcγRIIB^{-/-} mice was abolished after injection of anti-FcγRIIB/III blocking mAbs.⁵ FcγRIII is the only activating IgG receptor in the mouse that does not bind an IgG subclass with high affinity, and thus it remains unoccupied by monomeric IgG and accessible for binding of immune complexes. This is theoretically not the case for FcγRI and FcγRIV, which at physiologic serum concentrations of IgG_{2a} (approximately 2.5 mg/mL) and IgG_{2b} (approximately 1.5 mg/mL), are likely occupied *in vivo*, particularly on circulating cells. Of note, C57Bl/6 mice produce IgG_{2c} but not IgG_{2a} antibodies, the amino acid sequence of which varies by about 15%. Experiments performed in BALB/c mice that express endogenous IgG_{2a} (but no IgG_{2c}) produced similar results regarding the contribution of basophils, neutrophils, and monocytes to IgG_{2a} (see Fig E6, B), indicating that IgG_{2a} and IgG_{2c} sequence variations probably do not affect the mechanisms of anaphylaxis induction that we describe herein.

Adult female mice of 20 g, as used in this study, possess a circulating blood volume of 1.4 to 1.5 mL. Injection of 500 μg of antibody thus corresponds to approximately 330 μg/mL of circulating antibody, injection of 1 mg corresponds to approximately 660 μg/mL, and injection of 2 mg corresponds to approximately 1.3 mg/mL. In cases of anaphylaxis, the circulating concentration of allergen-specific IgG has not been evaluated because of a lack of testing and appropriate controls (ie, anti-allergen mAbs), although we have reported high circulating antigen-specific IgG levels in an autoimmune model of arthritis.³⁵ It seems rather unlikely that patients with anaphylaxis possess such increased circulating levels of IgG anti-allergen as mice receiving the high doses we used in this study. Nevertheless, our results in high-dose IgG_{2a}- and IgG_{2b}-induced PSA demonstrate that FcγRIV can trigger anaphylaxis by itself (ie, in the absence of FcγRIII). Similar results have been obtained in mice expressing only FcγRIV: “FcγRIV-only” mice had IgG_{2b}-induced PSA after injection of preformed IgG_{2b} immune complexes and also on

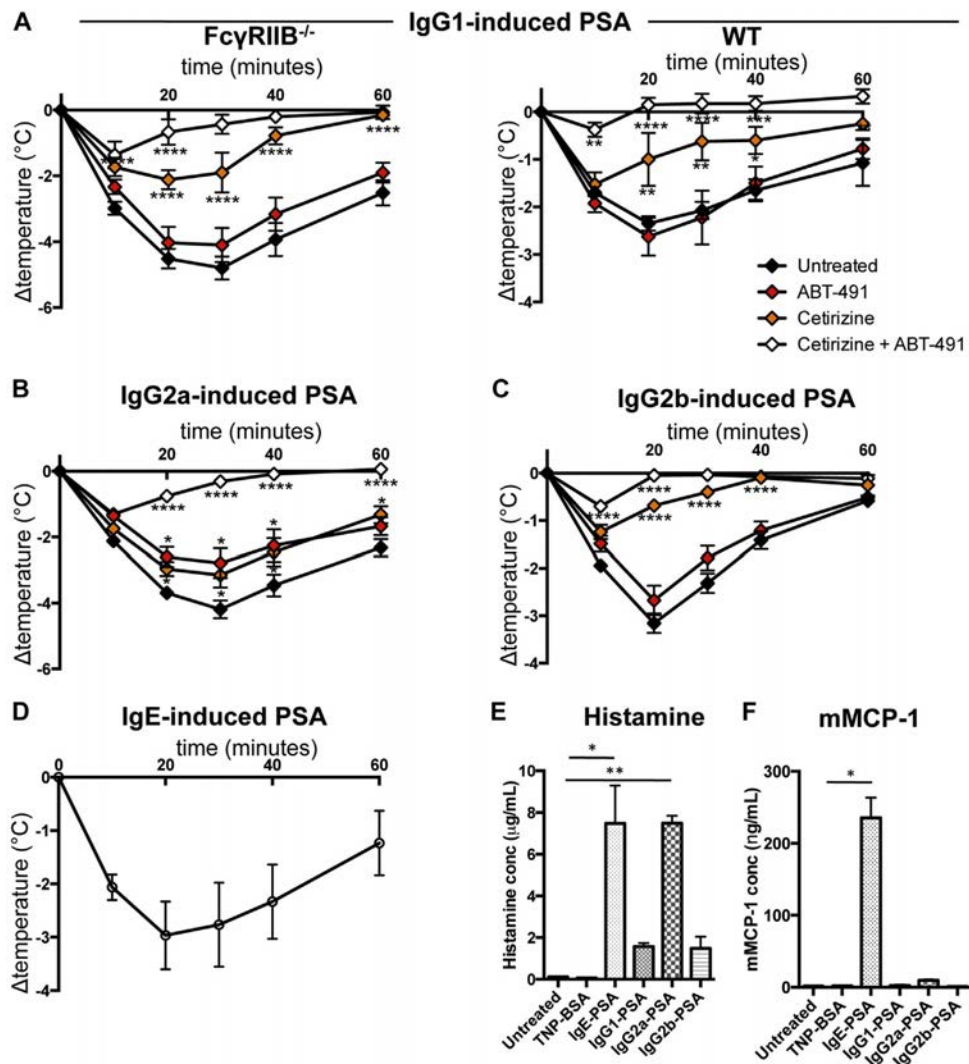


FIG 7. Contributions of histamine and PAF to IgG-induced PSA. **A-D**, Body temperatures of pretreated mice during IgG₁-induced PSA in FcγRIIB^{-/-} (n = 6 per group) or WT (n = 4 per group) mice (Fig 7, A), IgG_{2a}-induced PSA (Fig 7, B), IgG_{2b}-induced PSA (Fig 7, C) or IgE-induced PSA (Fig 7, D) in WT mice (n ≥ 7 per group). **E** and **F**, Histamine (Fig 7, E) and mMCP-1 (Fig 7, F) concentrations after PSA (n = 3 per group). Data are representative of at least 2 independent experiments, except for Fig 7, A and C (pooled from 2 independent experiments). *P < .05, **P < .01, ***P < .001, and ****P < .0001.

injection of polyclonal anti-sera, followed by antigen challenge.¹⁸ We reported previously that IgG_{2b}-induced PSA triggered by injection of preformed IgG_{2b}-immune complexes in WT mice was abolished after injection of anti-FcγRIV blocking mAb 9E9.¹⁸

This contrasts with the findings of the current study, in which we show that FcγRIII is the major activating receptor in all models of IgG-induced PSA and FcγRIV contributes only at high antibody concentrations. Two hypotheses might explain these discrepant results: (1) the injection of preformed IgG_{2b}-immune complexes leads to an immediate circulating bolus of immune complexes, which are similarly formed only after injection of high amounts of IgG_{2b} and antigen, thus triggering FcγRIV, and (2) as recently reported,⁴⁰ mAb 9E9 might not only block FcγRIV through its Fab portions but also FcγRIII through its Fc portion once 9E9 is bound to FcγRIV. In our view it is likely that a

combination of these mechanisms reconciles our previous and herein described results and suggest that IgG_{2b} PSA induced after injection of preformed IgG_{2b}-immune complexes relies on both FcγRIII and FcγRIV rather than on FcγRIV alone, as we reported previously.¹⁸ Together, this body of evidence supports the notion that FcγRIV is capable of triggering cell activation leading to anaphylaxis, although in restricted conditions (ie, in the absence/blockade of FcγRIII or presence of large amounts of IgG_{2a} and/or IgG_{2b} antibodies).

The differential contribution of FcγRs to IgG-induced PSA might rely on their respective expression patterns on myeloid cells. Indeed, FcγRI is not^{32,33} or is only barely³⁴ expressed on circulating monocytes, and its expression is largely restricted to tissue-resident macrophages. Therefore the level of its expression on cells reported to contribute to anaphylaxis (ie, monocytes in

this case) might not suffice to induce their activation. This notion is supported by the absence of any detectable effect of Fc γ RI deficiency in the mice with IgG₂-induced PSA on which we report in this study, even at high doses of IgG₂ antibodies. However, Fc γ RIII is expressed on all myeloid cells⁷ and, moreover, at comparably high levels on all those cell types that have been reported to contribute to anaphylaxis: basophils, monocytes, and neutrophils.²¹ This pattern of cellular expression might explain its predominant contribution to all models of IgG-induced anaphylaxis. Fc γ RIV is expressed on neutrophils and Ly6C^{lo} monocytes. However, it remains unclear whether Ly6C^{lo}, Ly6C^{hi}, or both monocyte subsets contribute to anaphylaxis. Fc γ RIV could contribute to PSA induction in exceptional conditions (Fc γ RIII deficiency or high IgG₂ antibody doses). The lack of Fc γ RIV contribution in classical conditions of PSA might suggest that its expression level is not sufficient in WT mice. Notably, it has been reported previously that particular Fc γ R deficiencies modify the expression levels of other Fc γ Rs. In particular, Fc γ RIII^{-/-} mice, but not Fc γ RI^{-/-} mice, presented a significant increase in Fc γ RIV expression levels on neutrophils^{18,41,42} and a tendency for increased expression on Ly6C^{lo} monocytes (see Fig E4, B). This could explain why the contribution of Fc γ RIV to IgG₂-induced PSA becomes apparent in Fc γ RIII^{-/-} mice. Conversely, Fc γ RIV^{-/-} mice did not present alterations of Fc γ RIII expression on neutrophils or Ly6C^{hi} monocytes compared with WT littermates (see Fig E4, A). Fc γ RIIB^{-/-} mice expressed significantly higher levels of Fc γ RIII and Fc γ RIV on neutrophils and increased Fc γ RIII levels on Ly6C^{hi} monocytes that might, altogether, contribute to their higher susceptibility to anaphylaxis induction (see Fig E4, A and B).

The contribution of a rather restricted subset of myeloid cells to these (and other) models of anaphylaxis^{2,3} appears to be determined by at least 2 factors: their capacity to release anaphylactogenic mediators (eg, histamine or PAF) and their expression of sufficient levels of activating IgG receptors. Mast cells and basophils release histamine, and neutrophils monocytes/macrophages, and basophils release PAF on Fc γ R triggering. Other mediators might induce anaphylaxis or contribute to its severity, among them lipid mediators, such as prostaglandins, thromboxanes, and leukotrienes. Indeed, some of these have been reported to trigger bronchoconstriction and an increase in vascular permeability.⁴³ The release of such mediators is sufficiently rapid to coincide with the celerity of hypothermia, which is detectable within minutes after allergen challenge. Therefore it is surprising that eosinophils do not contribute to IgG-induced PSA because they express high levels of activating Fc γ RIII and Fc γ RIIB²¹ (but no Fc γ RI or Fc γ RIV) and are capable of releasing leukotriene C₄, prostaglandin E₂, thromboxane, and PAF on activation.⁴³ Although eosinophils appear in relatively low numbers among blood cells (approximately 2×10^5 /mL), this is an unlikely explanation because basophils are significantly less numerous (approximately 5×10^4 /mL) but do contribute to anaphylaxis models. Most revealingly, it has been reported that eosinophils do not release PAF after IgG-dependent activation.⁴⁴ Whether eosinophils produce other potentially anaphylactogenic mediators after IgG-immune complex activation has not been investigated, but the lack of such an effect appears the most reasonable hypothesis to explain why eosinophils have not been found to contribute to IgG-induced anaphylaxis.

We investigated the contribution of neutrophils and monocytes to IgG-induced PSA models by using depletion approaches.

Ly6G⁺ cell depletion with NIMP-R14 resulted in an efficient depletion of neutrophils in the blood and spleen (see Figs E1, B, and E2, B). The same treatment resulted only in partial depletion in the bone marrow, in which a proportion of Ly6G⁺ cells are masked from fluorescent anti-Ly6G staining but not depleted by NIMP-R14 treatment (refer to bone marrow panels in Figs E1, C and D, and E2, C, D, and I). Importantly, we found that NIMP-R14 depletion has a significant effect on monocyte populations in the blood and, to some extent, in the spleen. This should be taken into consideration when interpreting the results of NIMP-R14 depletion experiments. All IgG-induced PSA models were ameliorated after NIMP-R14 depletion but also when monocytes/macrophages were targeted by using clodronate liposomes. Intravenous injection of clodronate liposomes resulted in a significant depletion of monocytes from the blood and monocytes/macrophages from the spleen and bone marrow but not from the skin (data not shown) and peritoneum (see Figs E1 and E2, as previously reported²⁶) and to a significant increase in blood leukocyte counts, particularly neutrophils (see Figs E1 and E2). Thus the anti-Ly6G and clodronate liposome treatments alter also monocytes and the neutrophil compartment, respectively, but reduce hypothermia in the 3 models of IgG-induced PSA studied. Constitutive deficiency in neutrophils, as studied with Gfi1^{-/-} mice, confirmed the role of neutrophils in IgG_{2a}- and IgG_{2b}-induced PSA models. Therefore both neutrophils and monocytes can be considered to contribute to IgG-induced anaphylaxis in mice, whether dependent on IgG₁, IgG_{2a}, or IgG_{2b}. The role of macrophages in the different IgG-induced PSA models remains to be investigated more deeply because clodronate liposomes injected intravenously efficiently targeted macrophages in the spleen but not in other tissues, such as the peritoneum or skin, and this does not allow conclusions on their contribution.

The contribution of basophils to models of anaphylaxis has been a recent matter of debate. Tsujimura et al²⁰ reported that depletion of basophils with anti-CD200R3 (clone Ba103) mAbs strongly inhibited IgG₁-induced PSA and rescued mast cell-deficient mice from active anaphylaxis. However, Ohnmacht et al⁴⁵ found that basophil-deficient Mcpt8^{cre} mice demonstrated slightly decreased but significant hypothermia in response to IgG₁-induced PSA (induced with the same antibody clone) when compared with WT mice. More recently, Reber et al³⁶ reported that peanut-induced anaphylaxis was reduced after diphtheria toxin injection in Mcpt8^{DTR} mice, which selectively depletes basophils, and confirmed that basophil depletion with anti-CD200R3 mAbs inhibited anaphylaxis. Moreover, Khodoun et al⁵ found a contribution of basophils to anaphylaxis-related mortality but not to hypothermia in a model of IgG_{2a}-induced PSA after anti-CD200R3 mAb injection. Therefore it appears that differences between inducible basophil depletion with specific antibodies or toxin administration and a constitutive lack of basophils, possibly leading to compensatory mechanisms during development of these mice, might account for the divergent results observed. However, intriguingly, basophils have been reported to be resistant to IgG-immune complex triggering *ex vivo* because of dominant inhibition by Fc γ RIIB over activation by Fc γ RIII.²¹

In this study we report that both basophil depletion after anti-CD200R3 mAb (Ba103) injection or constitutive deficiency of basophils and mast cells in Cpa3-Cre; Mcl-1^{fl/fl} mice inhibits IgG_{2b}-induced PSA but not IgG_{2a}-induced PSA, confirming a role for basophils (and potentially mast cells) to specific IgG-induced PSA models. Of note, Ba103 efficiently depleted

basophils from the blood and partially from the spleen and the bone marrow but had no significant effect on mast cells in the peritoneum or skin (see Figs E1, A and E, and E2, A and E). The difference in the ability of basophils to respond to IgG-immune complex triggering *in vitro* and the various *in vivo* models might be explained by functional alterations during basophil purification or a requirement for costimulation by other cells or their products that are present *in vivo*, but not *ex vivo*, for basophils to respond to IgG-immune complexes.

Our results with Cpa3-Cre; Mcl-1^{fl/fl} mice indicate that mast cells were not necessary for IgG_{2a}-induced PSA. We could not formally define their role in IgG_{2b}-induced PSA because basophil depletion and deficiency in basophils and mast cells lead to similar reduction in IgG_{2b}-induced PSA. Notably, increased plasma histamine levels, but no increase in mMCP-1 levels, could be detected, suggesting that mucosal mast cells were not activated during IgG-induced PSA. Intriguingly, however, some dermal mast cells displayed a degranulated morphology 30 minutes after challenge in all IgG-induced PSA models tested (for examples see Fig E7 in this article's Online Repository at www.jacionline.org). However, whether their degranulation is a cause or a consequence of anaphylaxis remains elusive.¹⁷

The ability of cells expressing activating FcγRs to respond to IgG-immune complexes has been proposed to be regulated by coexpression of FcγRIIB.⁴⁶ FcγRIIB^{-/-} mice experience increased hypersensitivity and anaphylactic reactions to IgG₁-induced PSA (as seen in this report).^{18,19} Our results further demonstrate that FcγRIIB inhibits IgG_{2b}-induced PSA but not IgG_{2a}-induced PSA. This latter finding is supported by results from Khodoun et al,⁵ who proposed that the lack of this inhibitory receptor can lead to increased spontaneous formation of immune complexes in FcγRIIB^{-/-} mice, which could compete with IgG_{2a}-immune complexes. In light of our results comparing IgG₁-, IgG_{2a}-, and IgG_{2b}-induced PSA, we propose that the significantly lower affinity of inhibitory FcγRIIB for IgG_{2a} (K_A , $4.2 \times 10^5 \text{ M}^{-1}$) than for IgG₁ (K_A , $3.3 \times 10^6 \text{ M}^{-1}$) and IgG_{2b} (K_A , $2.2 \times 10^6 \text{ M}^{-1}$) is the determining factor (Table 1). Another factor might be the variance in expression of FcγRIIB on circulating myeloid cells as follows: basophils > monocytes > eosinophils >> neutrophils.²¹ Although the exact numbers of expressed activating FcγRIII and inhibitory FcγRIIB per cell remain unknown, flow cytometric analysis allowed the estimation of their relative expression: indeed, the FcγRIII/FcγRIIB ratio is higher on neutrophils than on monocytes and basophils. Thus these differential expression levels might explain why neutrophils contribute to anaphylaxis because the receptor balance is in favor of the activating receptor. Strikingly, FcγRIIB is coexpressed only with FcγRIII on basophils and Ly6C^{hi} monocytes, whereas it is coexpressed with FcγRIII and FcγRIV on neutrophils and Ly6C^{lo} monocytes.³⁴ Therefore contribution of a given cell type to anaphylaxis might be favored when inhibitory FcγRIIB is required to dampen the stimulatory potential of 2 activating IgG receptors instead of 1. This concept extends to IgG₁-immune complexes that only engage one activating receptor, FcγRIII.

Our results on the contribution of mouse IgG receptors, cells, and mediators in the setting of IgG-induced anaphylaxis can potentially be translated to human IgG-dependent anaphylaxis (eg, after intravenous IgG or therapeutic IgG antibody administration). Indeed, even though IgG receptors are different in the 2 species, we have already reported that human FcγRI and human

FcγRIIA can induce anaphylaxis when expressed under the control of their own promoter in transgenic mice.^{23,24} Human FcγRI (CD64) is the equivalent of mouse FcγRI, whereas human FcγRIIA (CD32A) can be regarded as the equivalent of mouse FcγRIII, and human FcγRIIA (CD16A) is the equivalent of mouse FcγRIV.⁷ Human FcγRIIA, like mouse FcγRIII, is expressed on all myeloid cells and could therefore act as the principal IgG receptor responsible for anaphylaxis in human subjects. Human FcγRIIB, the equivalent of mouse FcγRIIB, is scarcely expressed on most circulating myeloid cells,⁴⁷ except for its high expression on basophils,²¹ suggesting that among myeloid cells, only human basophils are highly sensitive to human FcγRIIB-mediated inhibition. In contrast to mouse FcγRI, human FcγRI is constitutively expressed on circulating monocytes and inducibly on neutrophils, allowing this receptor to induce anaphylaxis.²⁴ The binding of human IgG subclasses to human FcγRs differs strikingly from the binding of mouse IgG subclasses to mouse FcγRs. Noticeably, the affinity of human FcγRIIB for any human IgG subclass is the lowest among human IgG-human FcγR interactions. For example, human IgG₁, the equivalent of mouse IgG_{2a}, is bound by all activating human FcγRs (K_A , $>10^6 \text{ M}^{-1}$) with at least a 10-fold higher affinity than by inhibitory human FcγRIIB (K_A , 10^5 M^{-1}).⁴⁸ If we consider the translation of our results obtained in the mouse to human IgG-induced anaphylaxis, one could anticipate that human FcγRIIB-mediated inhibition of IgG-induced anaphylaxis is inefficient in human neutrophils and monocytes and efficient only in human basophils for which increased human FcγRIIB expression might compensate for the low-affinity version of this receptor for human IgG subclasses. Certainly, FcγR engagement by IgG immune complexes on human basophils could not trigger any detectable basophil activation *in vitro*,²¹ which is similar to the results we reported for mouse basophil activation. Altogether, our data propose that the differential expression of inhibitory FcγRIIB on myeloid cells and its differential binding of IgG subclasses control the contribution of basophils, neutrophils, and monocytes to IgG-dependent anaphylaxis, thus revealing novel complexities in the mechanism of regulation of cell populations and therefore their contribution to IgG-induced reactions *in vivo*.

We thank our colleagues at Institut Pasteur, Paris: D. Sinnaya for administrative help, Stéphane Petres for help with antibody purifications, and Laurence Fiette for help with histological analyses. We thank our colleagues for their generous gifts: T. Moroy (Montreal University, Montreal, Quebec, Canada), C. Lowell (University of California at San Francisco, San Francisco, Calif), J. V. Ravetch (Rockefeller University, New York, NY, USA), and J. Leusen (University Medical Center, Utrecht, The Netherlands) for mice and R. Coffman (DNAX, Palo Alto, Calif), R. Good (USFCM, Tampa, Fla), B. Heyman (Uppsala Universitet, Uppsala, Sweden), H. Karasuyama (Tokyo Medical and Dental University Graduate School, Tokyo, Japan), and D. Voehringer (Universitätsklinikum, Erlangen, Germany) for antibodies. Cl₂MDP was a gift of Roche Diagnostics GmbH.

Clinical implications: Anaphylactic pathways induced by different IgG subclasses in mice vary in terms of contributions by different cell types, mediators, and antibody receptors. These results might help in the design of efforts to understand and treat IgG-induced anaphylaxis in human subjects, such as those seen after intravenous IgG or administration of therapeutic IgG antibodies.

REFERENCES

- Brown SG, Stone SF, Fatovich DM, Burrows SA, Holdgate A, Celenza A, et al. Anaphylaxis: clinical patterns, mediator release, and severity. *J Allergy Clin Immunol* 2013;132:1141-9.e5.
- Finkelman FD, Rothenberg ME, Brandt EB, Morris SC, Strait RT. Molecular mechanisms of anaphylaxis: lessons from studies with murine models. *J Allergy Clin Immunol* 2005;115:449-58.
- Jonsson F, Mancardi DA, Albanesi M, Bruhns P. Neutrophils in local and systemic antibody-dependent inflammatory and anaphylactic reactions. *J Leukoc Biol* 2013;94:643-56.
- Iff ET, Vaz NM. Mechanisms of anaphylaxis in the mouse. Similarity of shock induced by anaphylaxis and by mixtures of histamine and serotonin. *Int Arch Allergy Appl Immunol* 1966;30:313-22.
- Khodoun MV, Kucuk ZY, Strait RT, Krishnamurthy D, Janek K, Clay CD, et al. Rapid desensitization of mice with anti-FcγRIIb/FcγRIII mAb safely prevents IgG-mediated anaphylaxis. *J Allergy Clin Immunol* 2013;132:1375-87.
- Million M, Fioramonti J, Zajac JM, Bueno L. Effects of neuropeptide FF on intestinal motility and temperature changes induced by endotoxin and platelet-activating factor. *Eur J Pharmacol* 1997;334:67-73.
- Bruhns P. Properties of mouse and human IgG receptors and their contribution to disease models. *Blood* 2012;119:5640-9.
- Guilliams M, Bruhns P, Saeyns Y, Hammad H, Lambrecht BN. The function of Fcγ receptors in dendritic cells and macrophages. *Nat Rev Immunol* 2014;14:94-108.
- Roopenian DC, Akilesh S. FcRn: the neonatal Fc receptor comes of age. *Nat Rev Immunol* 2007;7:715-25.
- Bruhns P, Fremont S, Daëron M. Regulation of allergy by Fc receptors. *Curr Opin Immunol* 2005;17:662-9.
- Gavin AL, Barnes N, Dijkstra-Hoogstraaten HM, Hogarth PM. Identification of the mouse IgG3 receptor: implications for antibody effector function at the interface between innate and adaptive immunity. *J Immunol* 1998;160:20-3.
- Saylor CA, Dadachova E, Casadevall A. Murine IgG1 and IgG3 isotype switch variants promote phagocytosis of *Cryptococcus neoformans* through different receptors. *J Immunol* 2010;184:336-43.
- Nimmerjahn F, Ravetch JV. Divergent immunoglobulin g subclass activity through selective Fc receptor binding. *Science* 2005;310:1510-2.
- Nimmerjahn F, Bruhns P, Horiuchi K, Ravetch JV. FcγRIV: a novel FcR with distinct IgG subclass specificity. *Immunity* 2005;23:41-51.
- Unkeless JC, Eisen HN. Binding of monomeric immunoglobulins to Fc receptors of mouse macrophages. *J Exp Med* 1975;142:1520-33.
- Mancardi DA, Iannascoli B, Hoos S, England P, Daeron M, Bruhns P. FcγRIV is a mouse IgE receptor that resembles macrophage FcεRI in humans and promotes IgE-induced lung inflammation. *J Clin Invest* 2008;118:3738-50.
- Miyajima I, Dombrowicz D, Martin TR, Ravetch JV, Kinet JP, Galli SJ. Systemic anaphylaxis in the mouse can be mediated largely through IgG1 and FcγRIII. Assessment of the cardiopulmonary changes, mast cell degranulation, and death associated with active or IgE- or IgG1-dependent passive anaphylaxis. *J Clin Invest* 1997;99:901-14.
- Jönsson F, Mancardi DA, Kita Y, Karasuyama H, Iannascoli B, Van Rooijen N, et al. Mouse and human neutrophils induce anaphylaxis. *J Clin Invest* 2011;121:1484-96.
- Ujike A, Ishikawa Y, Ono M, Yuasa T, Yoshino T, Fukumoto M, et al. Modulation of immunoglobulin (Ig)E-mediated systemic anaphylaxis by low-affinity Fc receptors for IgG. *J Exp Med* 1999;189:1573-9.
- Tsujimura Y, Obata K, Mukai K, Shindou H, Yoshida M, Nishikado H, et al. Basophils play a pivotal role in immunoglobulin-G-mediated but not immunoglobulin-E-mediated systemic anaphylaxis. *Immunity* 2008;28:581-9.
- Cassard L, Jonsson F, Arnaud S, Daeron M. Fcγ receptors inhibit mouse and human basophil activation. *J Immunol* 2012;189:2995-3006.
- Strait RT, Morris SC, Yang M, Qu XW, Finkelman FD. Pathways of anaphylaxis in the mouse. *J Allergy Clin Immunol* 2002;109:658-68.
- Jonsson F, Mancardi DA, Zhao W, Kita Y, Iannascoli B, Khun H, et al. Human FcγRIIIA induces anaphylactic and allergic reactions. *Blood* 2012;119:2533-44.
- Mancardi DA, Albanesi M, Jonsson F, Iannascoli B, Van Rooijen N, Kang X, et al. The high-affinity human IgG receptor FcγRIIb (CD64) promotes IgG-mediated inflammation, anaphylaxis, and antitumor immunotherapy. *Blood* 2013;121:1563-73.
- Lilla JN, Chen CC, Mukai K, BenBarak MJ, Franco CB, Kalesnikoff J, et al. Reduced mast cell and basophil numbers and function in Cpa3-Cre; Mcl-1fl/fl mice. *Blood* 2011;118:6930-8.
- Van Rooijen N, Sanders A. Liposome mediated depletion of macrophages: mechanism of action, preparation of liposomes and applications. *J Immunol Methods* 1994;174:83-93.
- Williams EL, Tutt AL, French RR, Chan HT, Lau B, Penfold CA, et al. Development and characterization of monoclonal antibodies specific for the murine inhibitory FcγRIIb (CD32B). *Eur J Immunol* 2012;42:2109-20.
- Jiao D, Liu Y, Lu X, Liu B, Pan Q, Liu Y, et al. Macrophages are the dominant effector cells responsible for IgG-mediated passive systemic anaphylaxis challenged by natural protein antigen in BALB/c and C57BL/6 mice. *Cell Immunol* 2014;289:97-105.
- Biburger M, Nimmerjahn F. Low level of FcγRIII expression on murine natural killer cells. *Immunol Lett* 2012;143:53-9.
- Yucel R, Kosan C, Heyd F, Moroy T. Gfi1:green fluorescent protein knock-in mutant reveals differential expression and autoregulation of the growth factor independence 1 (Gfi1) gene during lymphocyte development. *J Biol Chem* 2004;279:40906-17.
- Khodoun MV, Strait R, Armstrong L, Yanase N, Finkelman FD. Identification of markers that distinguish IgE- from IgG-mediated anaphylaxis. *Proc Natl Acad Sci U S A* 2011;108:12413-8.
- Tan PS, Gavin AL, Barnes N, Sears DW, Vremec D, Shortman K, et al. Unique monoclonal antibodies define expression of FcγRI on macrophages and mast cell lines and demonstrate heterogeneity among subcutaneous and other dendritic cells. *J Immunol* 2003;170:2549-56.
- Mancardi DA, Jonsson F, Iannascoli B, Khun H, Van Rooijen N, Huerre M, et al. The murine high-affinity IgG receptor Fc(γ)RIV is sufficient for autoantibody-induced arthritis. *J Immunol* 2011;186:1899-903.
- Biburger M, Aschermann S, Schwab I, Lux A, Albert H, Danzer H, et al. Monocyte subsets responsible for immunoglobulin G-dependent effector functions in vivo. *Immunity* 2011;35:932-44.
- Makabe-Kobayashi Y, Hori Y, Adachi T, Ishigaki-Suzuki S, Kikuchi Y, Kagaya Y, et al. The control effect of histamine on body temperature and respiratory function in IgE-dependent systemic anaphylaxis. *J Allergy Clin Immunol* 2002;110:298-303.
- Reber LL, Marichal T, Mukai K, Kita Y, Tokuoka SM, Roers A, et al. Selective ablation of mast cells or basophils reduces peanut-induced anaphylaxis in mice. *J Allergy Clin Immunol* 2013;132:881-8.e11.
- Camussi G, Aglietta M, Coda R, Bussolino F, Piacibello W, Tetta C. Release of platelet-activating factor (PAF) and histamine. II. The cellular origin of human PAF: monocytes, polymorphonuclear neutrophils and basophils. *Immunology* 1981;42:191-9.
- Wedemeyer J, Tsai M, Galli SJ. Roles of mast cells and basophils in innate and acquired immunity. *Curr Opin Immunol* 2000;12:624-31.
- Jonsson F, Daeron M. Mast cells and company. *Front Immunol* 2012;3:16.
- Tipton TR, Mockridge CI, French RR, Tutt AL, Cragg MS, Beers SA. Anti-mouse FcγRIV antibody 9E9 also blocks FcγRIII in vivo. *Blood* 2015;126:2643-5.
- Syed SN, Konrad S, Wiege K, Nieswandt B, Nimmerjahn F, Schmidt RE, et al. Both FcγRIIb and FcγRIII are essential receptors mediating type II and type III autoimmune responses via FcγRIII-LAT-dependent generation of C5a. *Eur J Immunol* 2009;39:3343-56.
- Nimmerjahn F, Lux A, Albert H, Woigk M, Lehmann C, Dudziak D, et al. FcγRIIb deletion reveals its central role for IgG2a and IgG2b activity in vivo. *Proc Natl Acad Sci U S A* 2010;107:19396-401.
- Stone KD, Prussin C, Metcalfe DD. IgE, mast cells, basophils, and eosinophils. *J Allergy Clin Immunol* 2010;125:S73-80.
- Capron M. Eosinophils: receptors and mediators in hypersensitivity. *Clin Exp Allergy* 1989;19(suppl 1):3-8.
- Ohnmacht C, Schwartz C, Panzer M, Schiedewitz I, Naumann R, Voehringer D. Basophils orchestrate chronic allergic dermatitis and protective immunity against helminths. *Immunity* 2010;33:364-74.
- Smith KG, Clatworthy MR. FcγRIIb in autoimmunity and infection: evolutionary and therapeutic implications. *Nat Rev Immunol* 2010;10:328-43.
- Veri MC, Gorlatov S, Li H, Burke S, Johnson S, Stavenhagen J, et al. Monoclonal antibodies capable of discriminating the human inhibitory FcγRIIb (CD32B) from the activating FcγRIIa (CD32A): biochemical, biological and functional characterization. *Immunology* 2007;121:392-404.
- Bruhns P, Iannascoli B, England P, Mancardi DA, Fernandez N, Jorieux S, et al. Specificity and affinity of human Fc(γ) receptors and their polymorphic variants for human IgG subclasses. *Blood* 2009;113:3716-25.

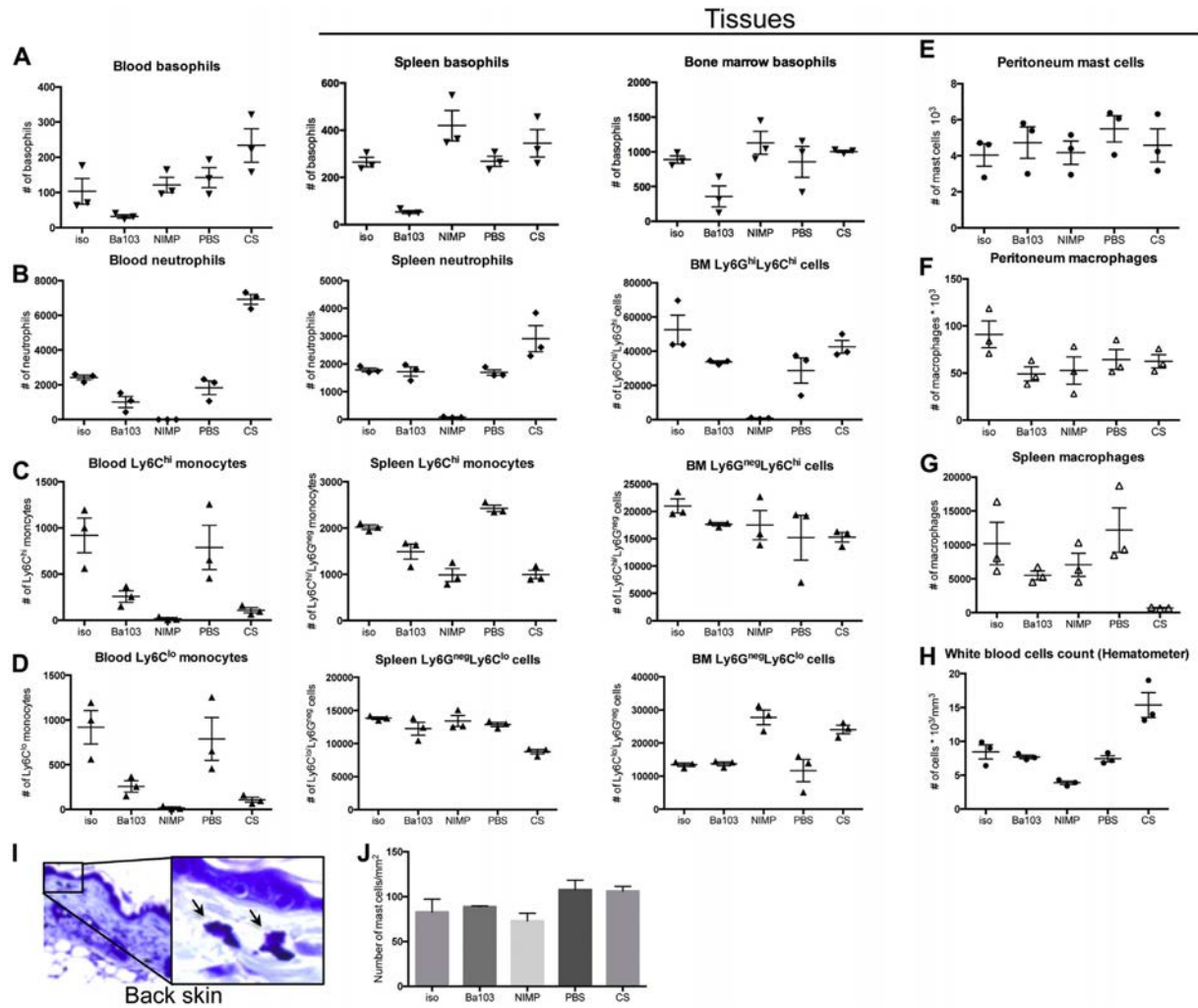


FIG E1. Effects of depletion strategies on myeloid cell populations: cell counts. WT mice were treated with indicated reagents. Twenty-four hours after injection, counts of specific cell populations were determined by means of flow cytometry (**A-G**) or histology (**I** and **J**), and leukocyte counts in total blood were measured with an automatic blood analyzer (**H**): counts of basophils (Fig E1, **A**), neutrophils (Fig E1, **B**), Ly6C^{hi} monocytes (Fig E1, **C**), and Ly6C^{lo} monocytes (Fig E1, **D**) in blood, spleen, and bone marrow; peritoneal mast cells (Fig E1, **E**); peritoneal macrophages (Fig E1, **F**); and splenic macrophages (Fig E1, **G**). **I**, Representation of a toluidine blue-stained back skin section with 2 mast cells (*arrows*). **J**, Counts of mast cells per square millimeter in the dermis of WT mice. Fig E1, **A-H**, show 1 of 3 independent experiments. Individual measurements and means \pm SEMs are represented. *Ba103*, Anti-CD200R3 mAb; *CS*, clodronate liposomes; *Iso*, isotype rat IgG_{2b}; *NIMP*, anti-Ly6G mAb; *PBS*, PBS liposomes.

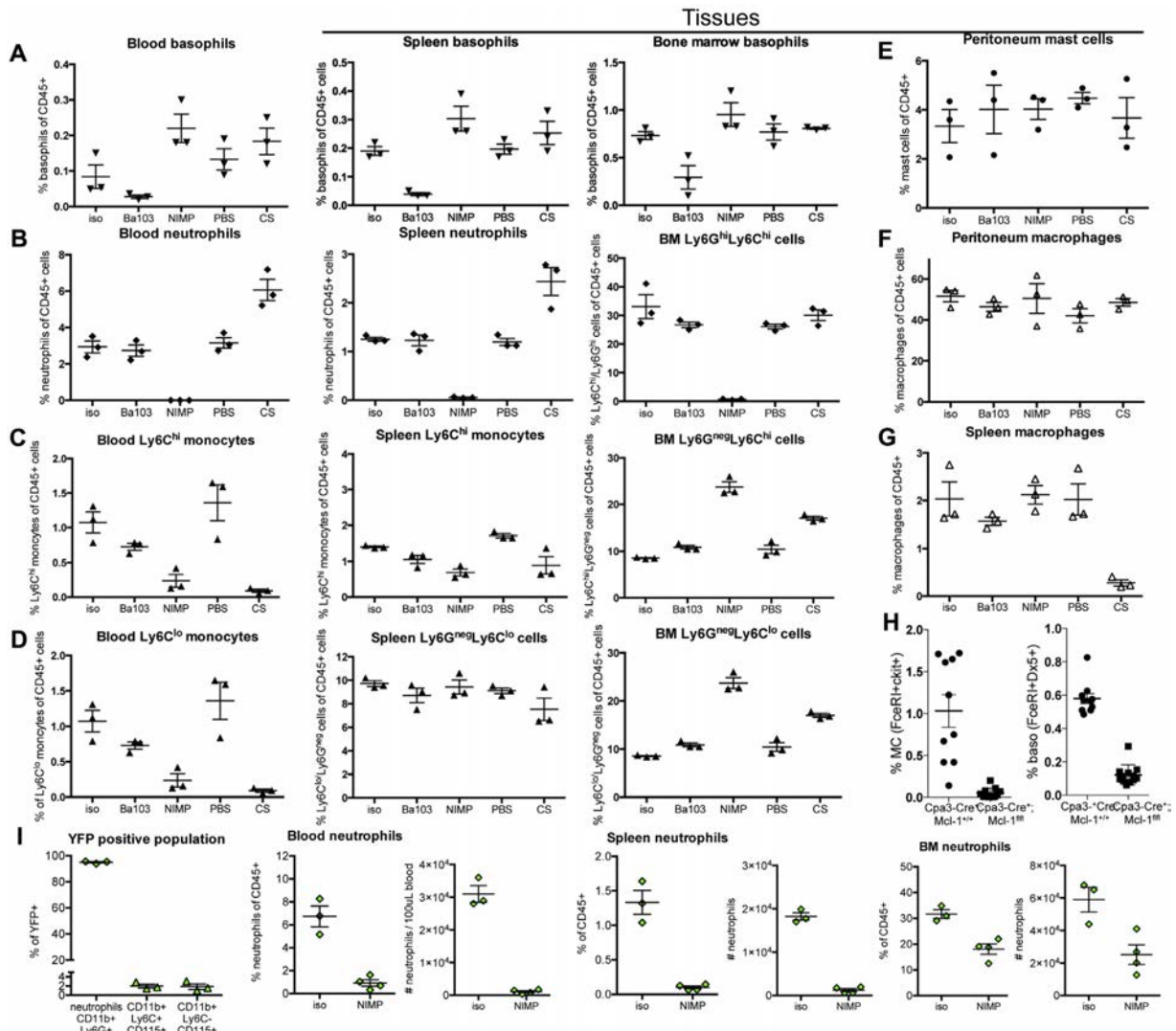


FIG E2. Effects of depletion strategies on myeloid cell populations: frequencies. WT mice were treated with indicated reagents. **A-G**, Twenty-four hours after injection, percentages of specific cell populations among CD45⁺ cells were determined by means of flow cytometry: basophils (Fig E2, A), neutrophils (Fig E2, B), Ly6C^{hi} monocytes (Fig E2, C), and Ly6C^{lo} monocytes (Fig E2, D) in blood, spleen, and bone marrow; peritoneal mast cells (Fig E2, E); peritoneal macrophages (Fig E2, F); and splenic macrophages (Fig E2, G). Fig E2, H, Percentages of peritoneal mast cells (pMC FceRI⁺/c-Kit⁺) and blood basophils (FceRI⁺/CD49b⁺) in Cpa3-Cre; Mcl-1^{fl/fl} and Cpa3-Cre; Mcl-1^{+/+} mice. **I**, *Left*, Percentages of YFP-positive cells in MRP8-Cre; Rosa26-YFP mice. *Right*, Effect of NIMP-R14 injection on neutrophils (percentages and counts of CD45⁺/YFP⁺/Ly6C^{neg}/CD115^{neg} cells) in blood, spleen, and bone marrow of MRP8-Cre; Rosa26-YFP mice. Fig E2, A-H, show corresponding percentages to cell counts shown in Fig E1 and display values for individually measured mice with means and SEMs. Ba103, Anti-CD200R3 mAb; CS, Clodronate liposomes; Iso, isotype rat IgG_{2b}, NIMP, anti-Ly6G mAb; PBS, PBS liposomes.

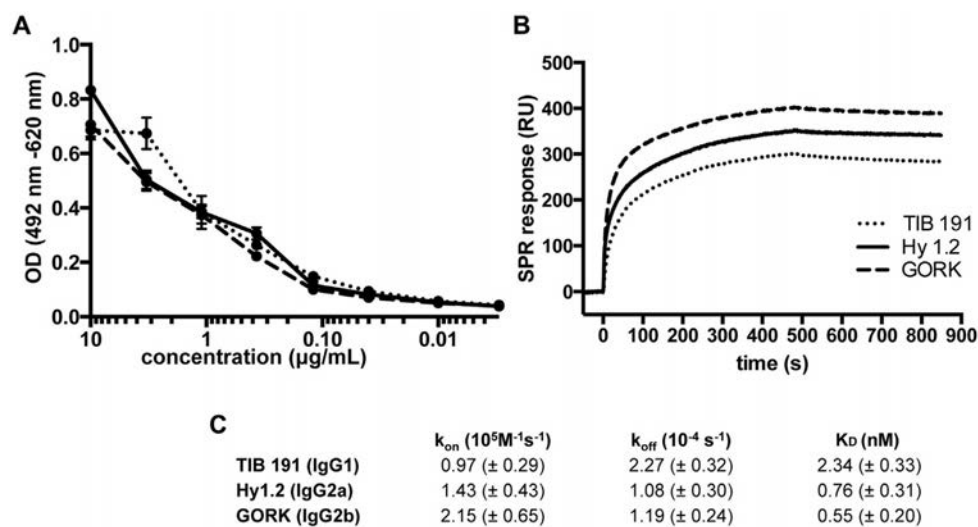


FIG E3. Relative affinity of IgG₁ (TIB191), IgG_{2a} (Hy1.2), and IgG_{2b} (GORK) anti-TNP to TNP-BSA. **A**, ELISA anti-TNP. Comparison of binding capacity of TIB191, Hy1.2, or GORK to immobilized TNP-BSA. Data are presented as means \pm SEMs and representative of results from 5 independent experiments. **B**, Surface plasmon resonance analysis. Comparison of binding affinity TNP-BSA to immobilized TIB191, Hy1.2 or GORK clones. **C**, The table shows the k_{on} , k_{off} , and K_D values for each condition.

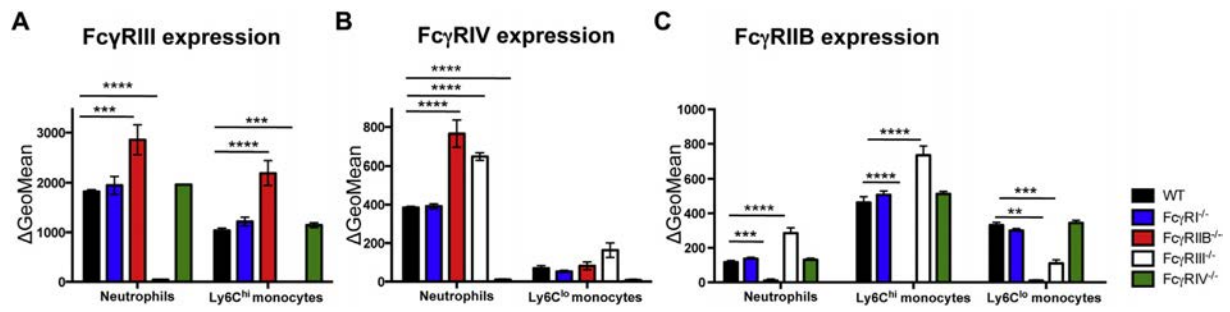


FIG E4. Fc γ R expression in Fc γ R-deficient mice. Expression of Fc γ RIII (A), Fc γ RIV (B), and Fc γ RIIB (C) is represented as the Δ geometric mean (*GeoMean*) of Fc γ R-specific staining compared with isotype control staining from blood leukocytes collected from untreated WT, Fc γ RI^{-/-}, Fc γ RIIB^{-/-}, Fc γ RIII^{-/-}, and Fc γ RIV^{-/-} mice ($n = 4$ per group). Data are represented as means \pm SEMs. ** $P < .01$, *** $P < .001$, and **** $P < .0001$.

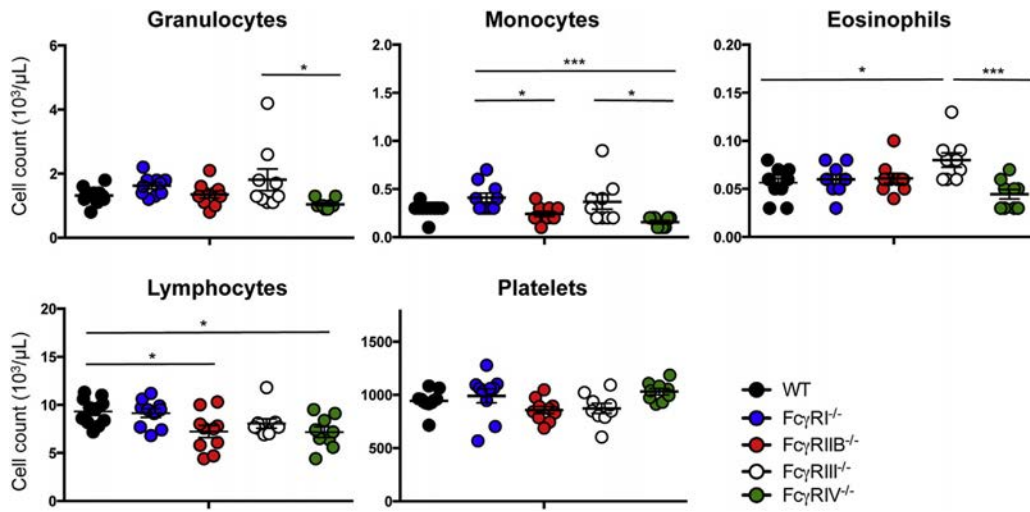


FIG E5. Blood leukocyte numbers in Fc γ R-deficient mice. Leukocyte populations were assessed by using an ABC Vet automatic blood analyzer (Horiba ABX, Irvine, Calif) from blood collected from untreated WT, Fc γ RI $^{-/-}$, Fc γ RIIB $^{-/-}$, Fc γ RIII $^{-/-}$, and Fc γ RIV $^{-/-}$ mice ($n = 4$ per group). Granulocytes represent mainly neutrophils (as judged by their size and granularity). Data are represented as means \pm SEMs, and each point represents 1 mouse. *GeoMean*, Geometric mean. * $P < .05$ and *** $P < .001$.

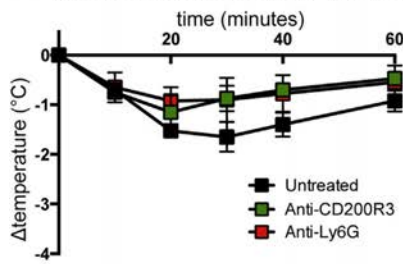
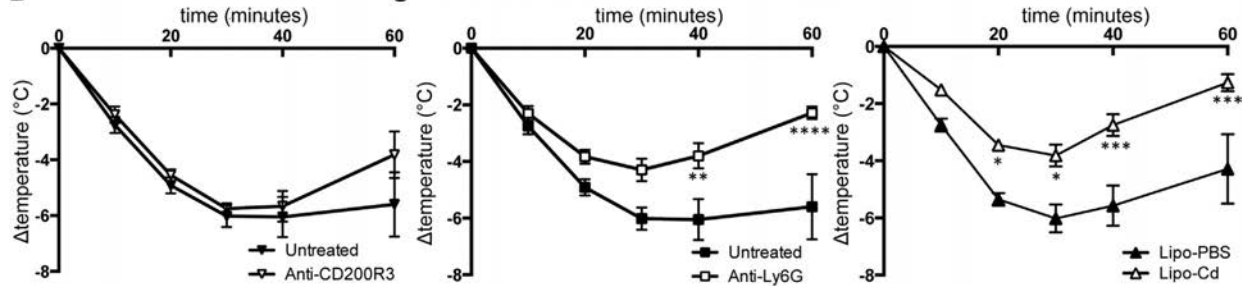
A IgG1-induced PSA in wt mice**B IgG2a-induced PSA in wt Balb/c mice**

FIG E6. IgG₁-induced PSA induces mild hypothermia in WT mice, and monocytes/macrophages and neutrophils contribute to IgG_{2a}-induced PSA in BALB/c mice. **A**, WT mice were injected with IgG₁ anti-TNP mAbs and challenged with TNP-BSA, and body temperatures were monitored. PSA in mice left untreated or injected with anti-Ly6G or anti-CD200R3 ($n = 4$ per group) is shown. **B**, BALB/c mice were left untreated or injected with anti-Ly6G, anti-CD200R3 ($n = 6$ per group), lipo-PBS ($n = 6$ per group), or lipo-Cd ($n = 6$ per group) before IgG_{2a}-induced PSA induction. Body temperatures were monitored. Data are represented as means \pm SEMs. Data are pooled from 2 independent experiments. Significant differences compared with the untreated group are indicated. * $P < .05$, ** $P < .01$, *** $P < .001$, and **** $P < .0001$.

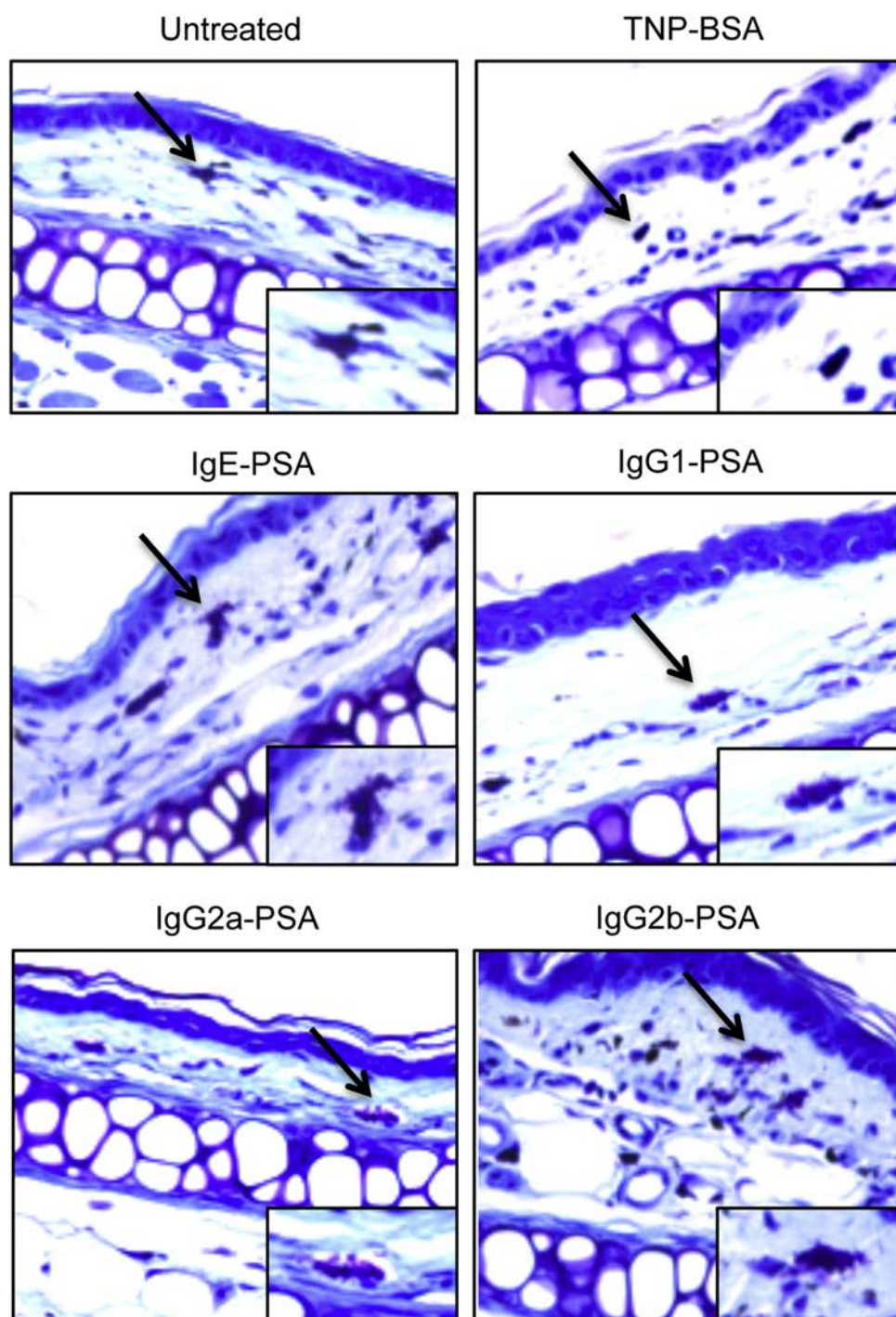


FIG E7. Examples of mast cell degranulation after IgG₁-, IgG_{2a}-, and IgG_{2b}-induced PSA. WT mice were injected with IgE, IgG₁, IgG_{2a}, and IgG_{2b} anti-TNP mAbs or left untreated (n = 3 for all groups) and challenged with TNP-BSA. Mouse ear skin biopsy specimens were collected 30 minutes after TNP-BSA injection. A representation of a toluidine blue-stained ear skin section with 1 mast cell (indicated by an arrow) for 1 mouse of each group of mice is shown.

In vivo effector functions of high-affinity mouse IgG receptor

FcγRI in disease and therapy models

Caitlin M. Gillis^{1,2,3}, Priscila P. Zenatti^{1,2}, David A. Mancardi^{1,2}, Héloïse Beutier^{1,2,3}, Laurence Fiette⁴, Lynn E. Macdonald⁵, Andrew J. Murphy⁵, Susanna Celli⁶, Philippe Bousso⁶, Friederike Jönsson^{1,2} and Pierre Bruhns^{1,2}

Authors' affiliations

¹Institut Pasteur, Department of Immunology, Unit of Antibodies in Therapy and Pathology, Paris, France;

²INSERM, U1222, Paris, France;

³Université Pierre et Marie Curie, Paris, France;

⁴Département Infection et Epidémiologie, Unité d'Histopathologie Humaine et Modèles Animaux, Institut Pasteur, Paris, France;

⁵Regeneron Pharmaceuticals, Inc., Tarrytown, NY, USA;

⁶Institut Pasteur, Department of Immunology, Unit of Dynamics of Immune Responses, Paris, France.

Sources of funding: none of the sources of funding have an interest in the subject matter or materials discussed in the submitted manuscript

Correspondence to: Pierre Bruhns, Unit of Antibodies in Therapy and Pathology, INSERM U1222, Department of Immunology, Institut Pasteur, 25 rue du Docteur Roux, 75015 Paris, France. Phone: +33145688629. E-mail: bruhns@pasteur.fr

ABSTRACT

Two activating mouse IgG receptors (FcγRs) have the ability to bind monomeric IgG, the high-affinity mouse FcγRI and FcγRIV. Despite high circulating levels of IgG, reports using FcγRI^{-/-} or FcγRIV^{-/-} mice or FcγRIV-blocking antibodies implicate these receptors in IgG-induced disease severity or therapeutic Ab efficacy. From these studies, however, one cannot conclude on the effector capabilities of a given receptor, because different activating FcγRs possess redundant properties *in vivo*, and cooperation between FcγRs may occur, or priming phenomena. To help resolve these uncertainties, we used mice expressing only FcγRI to determine its intrinsic properties *in vivo*. FcγRI^{only} mice were sensitive to IgG-induced autoimmune thrombocytopenia, anti-CD20 and anti-tumour immunotherapy, but resistant to IgG-induced autoimmune arthritis, anaphylaxis and airway inflammation. Our results show that the *in vivo* roles of FcγRI are more restricted than initially reported using FcγRI^{-/-} mice, but confirm effector capabilities for this high-affinity IgG receptor *in vivo*.

1. INTRODUCTION

IgG receptors (Fc γ R) in both humans and mice are divided into high-affinity IgG receptors that are able to retain monomeric IgG, and low-affinity IgG receptors that do not. Both high- and low-affinity Fc γ Rs are, however, able to bind to IgG-immune complexes or IgG-opsonised cells and surfaces. In humans only hFc γ RI is a high-affinity IgG receptor, for human IgG1, IgG3 and IgG4; and in mice both mFc γ RI (for mouse IgG2a) and mFc γ RIV (for mouse IgG2a and IgG2b) are high-affinity receptors [1]. Although it was proposed that high-affinity Fc γ Rs are occupied by circulating IgG *in vivo* (discussed in [2]), multiple effector roles for hFc γ RI, mFc γ RI and mFc γ RIV have been reported using mouse models of disease and therapy [3-6].

hFc γ RI has been studied by exogenous expression in hFc γ RI^{tg} mice, demonstrating its role on dendritic cells in the enhancement of antigen presentation and cross-presentation [7], and on neutrophils and monocyte/macrophages in inflammation, autoimmunity and systemic anaphylaxis [8]. These studies indicate that hFc γ RI can, by itself, induce clinical signs of autoimmune diseases, by triggering local inflammation (*e.g.* autoimmune rheumatoid arthritis) or phagocytosis (*e.g.* autoimmune thrombocytopenia and anaemia [9]). Additionally, hFc γ RI was reported to induce allergic shock (anaphylaxis) triggered by IgG-immune complexes [8]. Finally, hFc γ RI may also be a therapeutic target as it can mediate antibody-based therapies such as anti-malaria [10], anti-metastatic melanoma [8] and angiogenesis prevention [6]. The mouse counterpart of hFc γ RI, mFc γ RI, has been so far studied only by the effect of its absence. Compared to wild-type, mFc γ RI^{-/-} mice demonstrate reduced reaction severity in models of autoimmune diseases such as experimental haemolytic anaemia and arthritis [11, 12]. In addition

mFcγRI^{-/-} mice are less susceptible to IgG-mediated systemic anaphylaxis, Arthus reactions [13, 14], and show reduced efficacy of anti-melanoma [15-17], anti-lymphoma [18] and anti-angiogenic therapies [6]. mFcγRIV was also initially studied by its absence in mFcγRIV^{-/-} mice or by using blocking anti-mFcγRIV mAbs. These studies reported reduced IgG-mediated autoimmune anaemia, thrombocytopenia, rheumatoid arthritis, experimental nephrotoxic nephritis, but also reduced anaphylaxis and less efficient subcutaneous melanoma therapy in the absence or after blockade of mFcγRIV [19, 20]; some of the latter results should be taken with caution since mFcγRIV-blocking antibody 9E9 may also block mFcγRIII *in vivo* [21]. Effector functions could nevertheless be definitively attributed to mFcγRIV through the generation of mice expressing mFcγRIV without other FcγR. Indeed, using mFcγRIV^{only} mice we could demonstrate that mFcγRIV can individually induce autoimmune thrombocytopenia and rheumatoid arthritis, as well as IgG-mediated airway inflammation and anaphylaxis, but not anti-metastatic melanoma therapy [8, 22-24]. Altogether these data propose multiple effector functions for high-affinity receptors hFcγRI, mFcγRI and mFcγRIV in autoimmune and inflammatory disease models, and therapy, with direct evidence provided by studies using hFcγRI^{tg} mice and mFcγRIV^{only} mice, but only indirect evidence provided by mFcγRI^{-/-} mice.

The *in vivo* effector functions proposed for mFcγRI in IgG-mediated autoimmune disease and therapy models are surprising, considering its expression is restricted to monocytes, monocyte-derived dendritic cells and some tissue-resident macrophages, and is absent on neutrophils. As several reports suggest redundant functions among mFcγRs (reviewed in [1, 2]), it is uncertain if mFcγRI can induce IgG-mediated autoimmune diseases and therapeutic efficacy by itself, or if this receptor is indirectly involved: either for optimal activation via other mFcγRs or priming of effector cells. Therefore we analysed the *in vivo* effector functions of mFcγRI in

mFcγRI^{only} mice, *i.e.* in the absence of mFcγRIIB, mFcγRIII and mFcγRIV, in comparison with mFcγR^{null} mice that express no mFcγR. Our results identify the effector functions of mFcγRI as more restricted than initially reported, but confirm that mFcγRI does function independently *in vivo*, in particular for depletion of IgG-opsonised cells.

2. MATERIALS & METHODS

2.1 Mice

C57BL/6J mice (WT) were purchased from Charles River. VG1505 (Fc γ RI^{only}) mice were reported previously [17] and generated by Regeneron Pharmaceuticals, Inc. Fc γ R^{null} mice were generated by crossing Fc γ RI^{only} mice to Fc γ RI^{-/-} mice. Fc γ RI^{only} and Fc γ R^{null} mice were bred at Institut Pasteur, used for experiments at 8-11 weeks of age and all protocols were approved by the Animal Ethics committee CETEA (Institut Pasteur, Paris, France) registered under #C2EA-89.

2.2 K/BxN serum-induced passive arthritis

K/BxN serum was generated from a pooled collection of >40 animals. Arthritis was induced by i.v. transfer of indicated volumes of K/BxN serum, and scored as described [25]. In some experiments mice were sacrificed on day 8 for blinded histological assessment.

2.3 Airway Inflammation

As previously described [26], mice were injected with 50 μ L of rabbit anti-OVA serum i.n. and 500 μ g of OVA i.v. 16-18h later 4 bronchoalveolar lavages (BALs) were performed with cold PBS (1x 0.5ml, then 3x 1mL) under lethal anaesthetic. Cells were pooled and stained for flow cytometry after RBC lysis; and haemorrhage was determined by OD570nm in the supernatant. We confirmed that mFc γ RI, like all mouse Fc γ R, can indeed bind rabbit IgG immune complexes (Supplementary Fig.2).

2.4 Passive Systemic Anaphylaxis (PSA)

Mice were sensitised by i.v. injection of 500µg anti-DNP IgG2a (clone Hy1.2) and challenged 16h later with 200µg TNP(21-31)-BSA i.v. Alternatively, mice were injected with 1mg of heat-aggregated (1 hour at 63°C in BBS pH8) human IVIG; considering that mouse FcγRI cross-binds human IgG subclasses 1, 3 and 4 [27]. Central temperature was monitored using a digital thermometer with rectal probe (YSI).

2.5 Experimental Thrombocytopenia

Blood samples were taken in EDTA before and at indicated time points after i.v. injection of 3 or 10µg anti-platelet mAb 6A6. Some mice were treated 32h before 6A6 injection with PBS- or clodronate- liposomes. Platelet counts were determined using an ABC Vet automatic blood analyser (Horiba ABX).

2.6 Tumour Immunotherapy

Mice were depilated and received 5×10^5 B16-Luc2+ cells s.c. on d0. Where indicated, mice were injected i.v. with 200µg mAb TA99 on d1, d2 and d3 (Figure 4A, closed symbols), and control groups were untreated (Figure 4A, open symbols). Bioluminescence was acquired from anaesthetised mice on d1, d7 and d13, 10 min after injection of 75µg luciferin s.c. (IVIS Spectrum CT, Caliper Life Sciences), and images were analysed with Living Image software.

2.7 Anti-mouse CD20 treatment

Mice received a single i.v. injection of 50µg anti-mouse CD20 (clone 5D2, rat IgG2a, Genentech) to deplete endogenous B cells, or saline control, and CD19⁺B220⁺ B cells in the blood, spleen

and inguinal lymph nodes were assessed 16 hours later by flow cytometry. Remaining B cells were calculated as a percentage of the average of vehicle-treated controls (Fig. 4B).

2.7 Statistics

Data was analysed using one-way ANOVA with Bonferroni post-test (Fig.2C) or a Tukey's multiple comparisons test (Fig.1 B&C) to compare individual timepoints (Fig.2 B, D & E, and Fig.3 A, B & E), or a Kruskal-Wallis test with Dunn's multiple comparisons (Fig. 2A & 2C, bottom panel); a Student's t-test (Fig.3 C&D, Fig.4B) or a Mann-Whitney test (Fig.4A). Statistical significance is indicated (ns: $p>0.05$; * $p<0.05$; ** $p<0.01$, *** $p<0.001$, **** $p<0.0001$).

Please refer to supplemental Methods for information on reagents, flow cytometry, histology, surgical procedures and Active Systemic Anaphylaxis (ASA).

3. RESULTS & DISCUSSION

To evaluate the *in vivo* effector functions of mouse FcγRI, we investigated mice expressing this receptor in the absence of other endogenous classical FcγR (FcγRIIB, FcγRIII and FcγRIV-deficient), termed FcγRI^{only} mice [17] or VG1505 mice (Gillis *et al*, J Allergy Clin Imm, *in press*), in comparison with mice deficient for all four endogenous classical FcγRs (FcγRI, FcγRIIB, FcγRIII and FcγRIV-deficient), termed FcγR^{null} mice (Fig.1A). Both strains retain FcRn and non-classical IgG receptor expression. FcγRI^{only} and FcγR^{null} mice display normal breeding patterns and development, and no overt pathological signs up until 1 year of age. We assessed the circulating immune cell populations in these novel strains, compared to WT mice, using an automated blood cell analyser (Fig.1B-C). Across a large sample size, WT, FcγRI^{only} and FcγR^{null} mice display comparable total leukocyte counts in the blood (Fig.1B), and similar frequencies of leukocytes, granulocytes and eosinophils (Fig.1C). Notably, FcγRI^{only} and FcγR^{null} mice have a slightly higher frequency of circulating monocytes. The pattern of expression of FcγRI in FcγRI^{only} mice was comparable to wt mice: FcγRI was detected on circulating Ly6C^{hi} and Ly6C^{low} monocytes (Fig.1D), with greater expression on the latter, and on CD11b⁺CD11c⁺ spleen cells, liver kupffer cells and liver macrophages, alveolar macrophages and bone marrow monocytes (not shown) and prominently on CD11b⁺ skin resident cells (Fig.1E), but barely detected on F4/80⁺ peritoneal macrophages, in agreement with previous reports [24, 28, 29].

An understanding of the participation of FcγRI in autoimmune and inflammatory pathologies remains elusive [4]. FcγRI^{-/-} mice seem to experience reduced inflammation associated with immune complex tissue deposition [13] and severity of antigen-induced arthritis [11, 12]. Yet redundancy between FcγRI and FcγRIII certainly exists [12] and many of these

earlier studies did not consider the potential contribution of Fc γ RIV [14, 24]. To address whether Fc γ RI can play an effector role in inflammatory autoimmunity, we subjected Fc γ RI^{only} and Fc γ R^{null} mice to the K/BxN passive serum transfer model of autoimmune rheumatoid arthritis (K/BxN PA) [30], and to a model of airway inflammation induced by immune complex deposition. Transfer of K/BxN serum into wt mice induced inflammatory signs of arthritis, and an arthritic score which peaked at day 4-6 and remained elevated until day 10 following serum transfer (Fig.2A&B), yet the same volume transferred into Fc γ RI^{only} or Fc γ R^{null} mice did not induce arthritis. Histological assessment of ankle joints confirmed marked to severe arthritis in wt mice, and no microscopic signs of arthritis observed in either Fc γ RI^{only} or Fc γ R^{null} mice (Supplementary Fig.1A-F). Moreover, K/BxN serum transfer at a dose higher than which was sufficient to induce arthritis in Fc γ RIV^{only} mice [24] did not result in arthritis induction in Fc γ RI^{only} mice (Supplementary Fig.1G), indicating that Fc γ RI alone cannot induce significant cellular infiltration and inflammation associated with this model of autoimmune rheumatoid arthritis. Indeed, during experimental antigen-induced arthritis (EAIA), Fc γ RI^{-/-} mice were reported to experience comparable joint swelling but a reduction in severe cartilage destruction compared to wt mice [11, 12]. Importantly, EAIA relies on antigen uptake and presentation, a known functionality of Fc γ RI [13] on monocyte-derived dendritic cells. Therefore in this latter model Fc γ RI^{-/-} mice may highlight the contribution of Fc γ RI to the induction phase of arthritis rather than its effector function. Furthermore, the cardinal marker of cartilage destruction used in EAIA studies relies on the release of matrix metalloproteinases (MMPs) and the creation of neo-epitopes [11, 31]. Therefore although Fc γ RI does not mediate cell recruitment and joint inflammation in either of these arthritis models (Fig.2A and [11, 12]), it may contribute to reaction severity via local events in the tissue, *i.e.* MMP release and cartilage destruction.

The K/BxN model of autoimmune rheumatoid arthritis relies on local generation of IgG-immune complexes on the cartilage surface, that trigger the activation of Fc γ R-expressing cells. To determine if Fc γ RI can induce local inflammation in another context, we induced IgG-immune complexes at another anatomical site, the airways, and examined the resulting alveolitis. The inflammatory response in wt mice is characterised in the bronchoalveolar lavage (BAL) by massive neutrophil infiltration, significant infiltration of Ly-6C⁺ monocytes, and damage to the airways with haemorrhage into the BAL 16h after challenge (Fig.2C) [26]. Neither Fc γ R^{null} mice nor Fc γ RI^{only} mice experienced significant local inflammation: only a mild neutrophil infiltration was observed in the absence of inflammatory monocytes and haemorrhage. Together, our data support the notion that Fc γ RI does not mediate significant immune cell recruitment and inflammation associated with IgG-immune complex deposition, but may contribute to reaction severity via local events in the tissue, as suggested by studies using Fc γ RI^{-/-} mice [13, 14].

Local inflammatory reactions, such as that which drive autoimmune arthritis, require the activation of several cell populations including monocytes/macrophages and neutrophils. Systemic inflammatory reactions like severe hypersensitivity reactions, or anaphylaxis, can also proceed through pathways dependent on IgG and IgG receptors, yet symptoms may arise following the activation of only one cell population, among monocyte/macrophages, neutrophils and basophils (reviewed in [5, 32]). Fc γ RI may participate in such reactions by its expression on monocyte/macrophages. Although Fc γ RI^{-/-} mice were reported to experience mouse IgG2a-induced passive systemic anaphylaxis (PSA) with reduced severity [11], we could not reproduce these findings [33]. Here we demonstrate that Fc γ RI^{only}, as Fc γ R^{null} mice, were resistant to mouse IgG2a-mediated anaphylaxis (Fig.2D), heat-aggregated human IVIG-mediated anaphylaxis (Fig.2E) and even to an active model of anaphylaxis induced by BSA immunization and

challenge (Supplementary Fig.3). Two possibilities emerge from these findings: firstly, that Fc γ RI alone is incapable of triggering sufficient inflammatory mediator release to cause systemic symptoms; secondly, that Fc γ RI expression is insufficient on monocyte/macrophages to mediate anaphylaxis induction.

Since we found that Fc γ RI is not sufficient to mediate IgG-induced local or systemic inflammation that require cell recruitment and activation, and release of mediators, we wondered if Fc γ RI was able to induce IgG-mediated cell depletion through phagocytosis and/or ADCC mechanisms that contribute to several autoimmune diseases (*e.g.* autoimmune thrombocytopenia and anaemia) and to immunotherapies. Earlier studies using Fc γ RI^{-/-} mice indicated that Fc γ RI contributes to experimental autoimmune haemolytic anaemia induced by RBC-targeting mIgG2a antibodies [11], particularly to more severe manifestations at high Ab doses [34]. To determine if Fc γ RI has autoimmune destructive properties in Fc γ RI^{only} mice, we examined another model of autoimmunity characterised by circulating immune complexes, immune thrombocytopenic purpura (ITP) induced by injecting anti-platelet antibodies intravenously. ITP could be induced in wt and Fc γ RI^{only} mice, but not Fc γ R^{null} mice (Fig.3A). Within 4 hours of mAb injection, circulating platelet levels were reduced to <20% of their initial concentration in both wt and Fc γ RI^{only} mice (Fig.3B), and platelet counts remained low even 24 hours later. Administration of platelet-targeting mAb at a threefold-reduced dose was also sufficient to induce platelet clearance in Fc γ RI^{only} mice, comparable to that of WT mice (Supplementary Fig.4A&B). Toxic clodronate-containing liposomes, administered i.v. to deplete monocyte/macrophages mainly in the blood, spleen, and liver, protected against ITP induction in both WT and Fc γ RI^{only} mice (Fig.3C), indicating that macrophages are responsible for platelet clearance.

To investigate the organ-specific macrophage population responsible for Fc γ RI-dependent autoimmune platelet clearance, we subjected Fc γ RI^{only} mice to either removal of the spleen (splenectomy), or partial removal of the liver (hemi-hepatectomy), prior to ITP induction (Figure 3D&E). ITP induction in Fc γ RI^{only} mice was mildly inhibited by splenectomy (Figure 3D): comprising an average reduction in platelet clearance from 88% (\pm 4.2%) to 77% (\pm 9%) 3.5 hours after mAb injection. Splenectomised Fc γ RI^{only} and WT mice had somewhat elevated platelet counts at baseline, whether sampled 1 week or 3 weeks post-surgery, yet notably spleen removal did not inhibit ITP induction in WT mice (Supplementary Fig 4C, and data not shown). These data suggest that splenic macrophages contribute partially to Fc γ RI-dependent ITP. Conversely, partial removal of the liver, which amounted to about 50% reduction in liver mass [35], did not affect ITP induction in Fc γ RI^{only} mice (Figure 3E and Supplementary Fig 4F), suggesting that liver macrophages may not be mandatory for Fc γ RI-dependent ITP. We performed ITP experiments starting 4-5 days after hepatectomies or sham surgeries, due to the rapid regenerative potential of the liver. Importantly, despite the inflammatory effect of the surgical procedures, we did not see differences in Fc γ RI expression on circulating cells between sham operated and hemi-hepatectomised mice (data not shown). It is difficult to completely exclude a role for the liver in this model, as the part of the organ remaining after hemi-hepatectomy may be sufficient to efficiently mediate ITP. Moreover, considerable platelet clearance was still observed in splenectomised mice, which implies the involvement of another physiological site. Collectively, our data indicate a contribution of splenic macrophages to Fc γ RI-dependent ITP, but do not provide evidence of a role for liver macrophages.

Antibody-mediated therapies are now a frontline treatment for many malignancies, and a number of autoimmune diseases. Reports using Fc γ RI^{-/-} mice suggest that Fc γ RI contributes to IgG-induced tumour cell depletion in the lung [15] and liver [16] but not the skin [20]. As the

latter finding may be due to redundant functions among mouse FcγRs in the skin, we followed TYRP-1⁺ Luc2⁺ B16 melanoma cells tumour growth by bioluminescent imaging *in vivo* [17] in mice treated or not with anti-TYRP-1 mouse IgG2a TA99 mAb. Identical growth kinetics were detected in FcγRI^{only} and FcγR^{null} mice (Fig.2F; WT mice in Supplementary Fig.5A), and repeated TA99 injections dramatically reduced tumour load in FcγRI^{only} mice, but not in FcγR^{null} mice, to that of background levels (Fig.4A and Supplementary Fig.5). Thus FcγRI^{only} mice reveal FcγRI-mediated functions that can remain masked in FcγRI^{-/-} mice. Furthermore, these data reinforce the previously reported anti-tumour effector function of FcγRI in lung and liver tissues [15-18] and extends it to the skin tissue.

Anti-CD20 therapy to deplete B cells has been highly successful in the treatment of B cell malignancies and autoimmune disorders. B cell depletion is known to depend on FcR-dependent mechanisms [36], primarily phagocytosis by Kupffer cells in the liver [35]. A role for FcγRI in the clearance of both malignant and endogenous B cells, in cooperation with FcγRIII and FcγRIV, has been suggested by several studies [18, 37], but has not been formally demonstrated. Since FcγRI was sufficient to mediate destructive platelet clearance (Fig.3), and is expressed on liver Kupffer cells, we tested the capacity of FcγRI to deplete endogenous B cells in a model of anti-CD20 therapy. Administration of mouse CD20-targeting mAb 5D2 (IgG2a) induced B cell depletion in the blood, spleen and lymph nodes of FcγRI^{only}, but not FcγR^{null} mice: 16 hours after treatment 85% of B cells were cleared from the blood and 25-30% of B cells from the secondary lymphoid organs of anti-CD20 treated FcγRI^{only} mice. These data demonstrate that FcγRI, in the absence of FcγRIII and FcγRIV, is sufficient to mediate endogenous B cell clearance, and support a contribution for FcγRI to the efficacy of anti-CD20 therapy in models of lymphoma and autoimmunity.

In conclusion, genetically modified Fc γ RI^{only} mice enabled us to demonstrate that the mouse high-affinity IgG receptor Fc γ RI is sufficient to mediate IgG-induced autoimmune thrombocytopenia and IgG-based immunotherapy targeting either B cells (anti-CD20) or subcutaneous melanoma, in the absence of Fc γ RIIB, Fc γ RIII and Fc γ RIV. Fc γ RI alone is, however, insufficient to induce IgG-induced autoimmune rheumatoid arthritis, airway inflammation and systemic anaphylaxis, probably due to its inability to efficiently mediate Ab-induced cell recruitment or release of inflammatory mediators. Rather we identify that Fc γ RI mediates Ab-induced cell depletion/destruction, in both pathogenic autoimmune and therapeutic anti-tumour contexts; which agrees with the important contributions of this receptor to pathogen elimination [11, 38, 39] and antigen uptake and presentation [13]. Furthermore, our data attribute Fc γ RI-dependent phagocytic function to macrophages in the skin and the spleen. Finally, the effector capabilities of mouse Fc γ RI appear aligned with its restricted expression profile: low to moderate expression on monocytes, tissue macrophages and monocyte-derived DCs, who are indeed responsible for clearance of foreign bodies and antigen uptake, whereas that of its human homolog hFc γ RI extend to pro-inflammatory and pro-anaphylactic functions attributable to more promiscuous expression, particularly high on circulating monocytes and neutrophils. In conclusion, mice models expressing only one particular IgG receptor, *e.g.* Fc γ RI^{only} or Fc γ RIV^{only} mice [17, 22-24], are particularly useful to ascribe independent functions to Fc γ Rs, as distinct from potential cooperative roles with other Fc γ R, the latter of which may be implied from studies using specific Fc γ R^{-/-} mice.

4. ACKNOWLEDGMENTS

We are thankful to O. Godon, B. Iannascoli, B. Todorova and O. Richard-LeGoff for technical help; the members of the Unit of Dynamics of Immune Responses for discussion; the Service Communication Institutionnelle et Image, Institut Pasteur, Paris, for photography work (Supplementary Figure 3D); A-M. Nicola (Plate-Forme d'Imagerie Dynamique, Institut Pasteur, Paris) for help with bioluminescence experiments; and D. Sinnaya for administrative help (Institut Pasteur, Paris). We are thankful to our colleagues for their generous gifts: D. Mathis and C. Benoist (HMS, Boston, MA, USA) and IGBMC (Illkirch, France) for K/BxN mice, R. Good (USFCM, Tampa, FL, USA) for IgG2a mAb 6A6, S. Izui (University of Geneva, Geneva, Switzerland) for IgG2a mAb Hy1.2, and N. Van Rooijen (VU Medical Center, The Netherlands) and Roche Diagnostics GmbH for liposomes and Cl2MDP, respectively. This work was mainly supported by the Institut Pasteur and the Institut National de la Santé et de la Recherche Médicale (INSERM); anaphylaxis studies were specifically supported by funding from the European Research Council (ERC)–Seventh Frame-work Program (ERC-2013-CoG 616050). C.G. was supported partly by a stipend from the Pasteur - Paris University (PPU) International PhD program and by the Institut Carnot Pasteur *Maladies Infectieuses*, and partly by the Balsan company. P.Z. was supported by FAPESP, process number 2014/233533-9. F.J. is an employee of the Centre National de La Recherche Scientifique (CNRS). H.B. is supported by a fellowship from the University Pierre et Marie Curie.

5. CONFLICT OF INTEREST STATEMENT

L.E.M and A.M. are employees of Regeneron Pharmaceuticals, Inc. and hold stock in the company. C.G., H.B., F.J., L.F., S.C., D.A.M., P.P.Z., P.Bousso and P.Bruhns declare no competing financial interests.

6. REFERENCES

- [1] Bruhns P. Properties of mouse and human IgG receptors and their contribution to disease models. *Blood*, 2012;119:5640-9.
- [2] Bruhns P, Jonsson F. Mouse and human FcR effector functions. *Immunol Rev*, 2015;268:25-51.
- [3] Nimmerjahn F, Ravetch JV. Fcgamma receptors: old friends and new family members. *Immunity*, 2006;24:19-28.
- [4] van der Poel CE, Spaapen RM, van de Winkel JG, Leusen JH. Functional characteristics of the high affinity IgG receptor, FcgammaRI. *J Immunol*, 2011;186:2699-704.
- [5] Gillis C, Gouel-Cheron A, Jonsson F, Bruhns P. Contribution of Human FcgammaRs to Disease with Evidence from Human Polymorphisms and Transgenic Animal Studies. *Frontiers in immunology*, 2014;5:254.
- [6] Bogdanovich S, Kim Y, Mizutani T, Yasuma R, Tudisco L, Cicatiello V *et al*. Human IgG1 antibodies suppress angiogenesis in a target-independent manner. *Signal Transduct Target Ther*, 2016;1.
- [7] Bevaart L, Van Ojik HH, Sun AW, Sulahian TH, Leusen JH, Weiner GJ *et al*. CpG oligodeoxynucleotides enhance FcgammaRI-mediated cross presentation by dendritic cells. *Int Immunol*, 2004;16:1091-8.
- [8] Mancardi DA, Albanesi M, Jonsson F, Iannascoli B, Van Rooijen N, Kang X *et al*. The high-affinity human IgG receptor FcgammaRI (CD64) promotes IgG-mediated inflammation, anaphylaxis, and antitumor immunotherapy. *Blood*, 2013;121:1563-73.
- [9] van Vugt MJ, Heijnen AF, Capel PJ, Park SY, Ra C, Saito T *et al*. FcR gamma-chain is essential for both surface expression and function of human Fc gamma RI (CD64) in vivo. *Blood*, 1996;87:3593-9.
- [10] McIntosh RS, Shi J, Jennings RM, Chappel JC, de Koning-Ward TF, Smith T *et al*. The importance of human FcgammaRI in mediating protection to malaria. *PLoS Pathog*, 2007;3:e72.
- [11] Ioan-Facsinay A, de Kimpe SJ, Hellwig SM, van Lent PL, Hofhuis FM, van Ojik HH *et al*. Fc gamma RI (CD64) contributes substantially to severity of arthritis, hypersensitivity responses, and protection from bacterial infection. *Immunity*, 2002;16:391-402.
- [12] van Lent PL, Nabbe K, Blom AB, Holthuysen AE, Sloetjes A, van de Putte LB *et al*. Role of activatory Fc gamma RI and Fc gamma RIII and inhibitory Fc gamma RII in inflammation and cartilage destruction during experimental antigen-induced arthritis. *Am J Pathol*, 2001;159:2309-20.
- [13] Barnes N, Gavin AL, Tan PS, Mottram P, Koentgen F, Hogarth PM. FcgammaRI-deficient mice show multiple alterations to inflammatory and immune responses. *Immunity*, 2002;16:379-89.
- [14] Baumann U, Kohl J, Tschernig T, Schwerter-Strumpf K, Verbeek JS, Schmidt RE *et al*. A codominant role of Fc gamma RI/III and C5aR in the reverse Arthus reaction. *J Immunol*, 2000;164:1065-70.
- [15] Bevaart L, Jansen MJ, van Vugt MJ, Verbeek JS, van de Winkel JG, Leusen JH. The high-affinity IgG receptor, FcgammaRI, plays a central role in antibody therapy of experimental melanoma. *Cancer Res*, 2006;66:1261-4.

- [16] Otten MA, van der Bij GJ, Verbeek SJ, Nimmerjahn F, Ravetch JV, Beelen RH *et al.* Experimental antibody therapy of liver metastases reveals functional redundancy between Fc gammaRI and Fc gammaRIV. *J Immunol*, 2008;181:6829-36.
- [17] Albanesi M, Mancardi DA, Macdonald LE, Iannascoli B, Zitvogel L, Murphy AJ *et al.* Cutting Edge: FcgammaRIII (CD16) and FcgammaRI (CD64) Are Responsible for Anti-Glycoprotein 75 Monoclonal Antibody TA99 Therapy for Experimental Metastatic B16 Melanoma. *J Immunol*, 2012;189:5513-7.
- [18] Minard-Colin V, Xiu Y, Poe JC, Horikawa M, Magro CM, Hamaguchi Y *et al.* Lymphoma depletion during CD20 immunotherapy in mice is mediated by macrophage FcgammaRI, FcgammaRIII, and FcgammaRIV. *Blood*, 2008;112:1205-13.
- [19] Nimmerjahn F, Bruhns P, Horiuchi K, Ravetch JV. Fc gamma RIV: a novel FcR with distinct IgG subclass specificity. *Immunity*, 2005;23:41-51.
- [20] Nimmerjahn F, Lux A, Albert H, Woigk M, Lehmann C, Dudziak D *et al.* FcgammaRIV deletion reveals its central role for IgG2a and IgG2b activity in vivo. *Proc Natl Acad Sci U S A*, 2010;107:19396-401.
- [21] Tipton TR, Mockridge CI, French RR, Tutt AL, Cragg MS, Beers SA. Anti-mouse FcgammaRIV antibody 9E9 also blocks FcgammaRIII in vivo. *Blood*, 2015;126:2643-5.
- [22] Mancardi DA, Iannascoli B, Hoos S, England P, Daeron M, Bruhns P. FcgammaRIV is a mouse IgE receptor that resembles macrophage FcepsilonRI in humans and promotes IgE-induced lung inflammation. *J Clin Invest*, 2008;118:3738-50.
- [23] Jönsson F, Mancardi DA, Kita Y, Karasuyama H, Iannascoli B, Van Rooijen N *et al.* Mouse and human neutrophils induce anaphylaxis. *J Clin Invest*, 2011;121:1484-96.
- [24] Mancardi DA, Jonsson F, Iannascoli B, Khun H, Van Rooijen N, Huerre M *et al.* The murine high-affinity IgG receptor Fc(gamma)RIV is sufficient for autoantibody-induced arthritis. *J Immunol*, 2011;186:1899-903.
- [25] Bruhns P, Samuelsson A, Pollard JW, Ravetch JV. Colony-stimulating factor-1-dependent macrophages are responsible for IVIG protection in antibody-induced autoimmune disease. *Immunity*, 2003;18:573-81.
- [26] Jönsson F, Mancardi DA, Zhao W, Kita Y, Iannascoli B, Khun H *et al.* Human FcgammaRIIA induces anaphylactic and allergic reactions. *Blood*, 2012;119:2533-44.
- [27] Overdijk MB, Verploegen S, Ortiz Buijsse A, Vink T, Leusen JH, Bleeker WK *et al.* Crosstalk between Human IgG Isotypes and Murine Effector Cells. *J Immunol*, 2012;189:3430-8.
- [28] Tan PS, Gavin AL, Barnes N, Sears DW, Vremec D, Shortman K *et al.* Unique monoclonal antibodies define expression of Fc gamma RI on macrophages and mast cell lines and demonstrate heterogeneity among subcutaneous and other dendritic cells. *J Immunol*, 2003;170:2549-56.
- [29] Langlet C, Tamoutounour S, Henri S, Luche H, Ardouin L, Gregoire C *et al.* CD64 Expression Distinguishes Monocyte-Derived and Conventional Dendritic Cells and Reveals Their Distinct Role during Intramuscular Immunization. *J Immunol*, 2012;188:1751-60.
- [30] Monach PA, Mathis D, Benoist C. The K/BxN arthritis model. *Curr Protoc Immunol*, 2008;Chapter 15:Unit 15 22.
- [31] Singer, II, Kawka DW, Bayne EK, Donatelli SA, Weidner JR, Williams HR *et al.* VDIPEN, a metalloproteinase-generated neopeptide, is induced and immunolocalized in articular cartilage during inflammatory arthritis. *J Clin Invest*, 1995;95:2178-86.

- [32] Jonsson F, Mancardi DA, Albanesi M, Bruhns P. Neutrophils in local and systemic antibody-dependent inflammatory and anaphylactic reactions. *J Leukoc Biol*, 2013;94:643-56.
- [33] Beutier H, Gillis CM, Iannascoli B, Godon M, England P, Sibilano R *et al.* IgG subclasses determine pathways of anaphylaxis in mice. *J Allergy Clin Immunol*, 2016;in press.
- [34] Baudino L, Nimmerjahn F, Azeredo da Silveira S, Martinez-Soria E, Saito T, Carroll M *et al.* Differential contribution of three activating IgG Fc receptors (FcγRI, FcγRIII, and FcγRIV) to IgG2a- and IgG2b-induced autoimmune hemolytic anemia in mice. *J Immunol*, 2008;180:1948-53.
- [35] Montalvao F, Garcia Z, Celli S, Breart B, Deguine J, Van Rooijen N *et al.* The mechanism of anti-CD20-mediated B cell depletion revealed by intravital imaging. *J Clin Invest*, 2013;123:5098-103.
- [36] Uchida J, Hamaguchi Y, Oliver JA, Ravetch JV, Poe JC, Haas KM *et al.* The innate mononuclear phagocyte network depletes B lymphocytes through Fc receptor-dependent mechanisms during anti-CD20 antibody immunotherapy. *J Exp Med*, 2004;199:1659-69.
- [37] Hamaguchi Y, Xiu Y, Komura K, Nimmerjahn F, Tedder TF. Antibody isotype-specific engagement of Fcγ receptors regulates B lymphocyte depletion during CD20 immunotherapy. *J Exp Med*, 2006;203:743-53.
- [38] Mittal R, Sukumaran SK, Selvaraj SK, Wooster DG, Babu MM, Schreiber AD *et al.* Fcγ receptor I alpha chain (CD64) expression in macrophages is critical for the onset of meningitis by *Escherichia coli* K1. *PLoS Pathog*, 2010;6:e1001203.
- [39] Esser-von Bieren J, Volpe B, Kulagin M, Sutherland DB, Guiet R, Seitz A *et al.* Antibody-mediated trapping of helminth larvae requires CD11b and Fcγ receptor I. *J Immunol*, 2015;194:1154-63.

FIGURE LEGENDS

Figure 1: Fc γ RI only mice have normal blood leukocyte composition and show comparable Fc γ RI expression to that of WT mice. (A) Schematic representation of WT, Fc γ RI^{only} and Fc γ R^{null} mice. Leukocyte counts (B) and relative percentages of immune cell populations (C) in the blood of WT (n=20), Fc γ RI^{only} (n=35) and Fc γ R^{null} (n=24) mice were enumerated using an automatic blood cell analyser. (D-E) Representative flow cytometry profiles of Fc γ RI expression on indicated cell populations from the blood (D) and organs (E) of WT, Fc γ RI^{only} and Fc γ R^{null} mice (M Φ ; macrophages). Shaded histograms indicate background staining of a mIgG1 isotype control. Staining is representative of at least 2 independent experiments, n \geq 2.

Figure 2: Fc γ RI alone is insufficient to mediate IgG-induced arthritis, airway inflammation or systemic anaphylaxis, (A-B) Arthritis was evaluated by clinical score (A) and ankle thickness (B) measured following transfer of K/BxN serum (5 μ L/g body weight) into WT (triangles), Fc γ RI^{only} (circles) or Fc γ R^{null} (squares) mice. (A) *p<0.05 on d3-6, WT compared to Fc γ R^{null} mice; (B) *p<0.05 on d2, **p<0.01 on d3, ***p<0.001 on d4-6, WT compared to Fc γ R^{null} and Fc γ RI^{only} mice. Data is representative of >2 independent experiments, n \geq 3 per group. (C) Bronchoalveolar lavage (BAL) was performed on naive (open symbols, n=3 per group) WT (triangles), Fc γ RI^{only} (circles) and Fc γ R^{null} (squares) mice, or mice 16-18h after challenge with antiserum i.n. and OVA antigen i.v. (closed symbols). Neutrophils and Ly6C⁺ macrophages (M Φ) in the BAL were determined by flow cytometry. Haemorrhage was determined by measuring haemoglobin concentration in the BAL supernatant. **p<0.01, *** p<0.001, **** p<0.0001; challenge data is pooled from 2 independent experiments, n=8-10 mice per group. (D-E) Temperature monitoring during passive systemic anaphylaxis (PSA) in WT, Fc γ R^{null} or

Fc γ RI^{only} mice, induced by (D) mIgG2a anti-TNP sensitization and TNP-BSA i.v. challenge or (E) i.v. injection of aggregated human IVIG. $n=3-5$ per group; data is representative of 2 independent experiments. * $p<0.05$, ** $p<0.01$, **** $p<0.0001$ at all time points from 30min; WT compared to Fc γ R^{null} and Fc γ RI^{only} mice.

Figure 3: Fc γ RI-mediated thrombocytopenia is dependent on macrophages, and partially

inhibited by splenectomy. (A-B) Circulating platelets in the blood of WT ($n=3$), Fc γ RI^{only} ($n=7$)

and Fc γ R^{null} ($n=7$) mice were quantified at baseline and following i.v. injection of 10 μ g anti-platelet mAb (clone 6A6) and are represented as (A) percentage over time and (B) number of platelets 4 hours after mAb injection; **** $p<0.0001$ at 4h, 9h and 24h, WT vs Fc γ R^{null} and

Fc γ RI^{only} vs Fc γ R^{null}. (C) Platelet counts at baseline and 4 hours after mAb injection in mice pre-

treated with PBS- (open symbols) or toxic- (closed symbols) liposomes; $n=4-5$ per group; * $p<0.05$, **** $p<0.0001$, significance values indicated at 4 hours for each group compared to

baseline. (D-E) ITP induction and percentage of circulating platelets in (D) Fc γ RI^{only} mice following splenectomy (closed symbols, $n=11$) compared to controls (open symbols, $n=10$); and

(E) Fc γ R^{null} mice ($n=4$) or Fc γ RI^{only} mice following hemi-hepatectomy ($n=5$), compared to sham operated ($n=4$), or controls ($n=3$); ** $p<0.01$ and *** $p<0.001$, splenectomised mice compared to controls; **** $p<0.0001$ at 3.5h, 8h and 24h, all groups compared to Fc γ R^{null}; ns not significant.

Data in (D&E) is pooled from two independent experiments.

Figure 4 Fc γ RI is sufficient for anti-melanoma and B cell depletion therapies.

(A) Fc γ RI^{only} (circles) or Fc γ R^{null} (squares) mice were injected with B16-Luc2+ cells s.c. on d0 and received no treatment (open symbols) or mAb TA99 i.v. on day 1, 2 and 3 (closed symbols); tumour growth was monitored by bioluminescent signal after s.c. injection of luciferin.

(B) FcγRI^{only} (circles) or FcγR^{null} (squares) mice were injected with anti-CD20 mAb 5D2 (closed symbols) or vehicle (open symbols). The percentage of remaining CD19⁺B220⁺ B cells (compared to the average of vehicle-treated controls) was determined in the blood, spleen and inguinal lymph nodes after 16h later. Data in **(A)** is representative of 2 independent experiments, $n=4-5$ per group. Data in **(B)** is pooled from 2 independent experiments, $n=3-5$ per group. * $p<0.05$ on day 7 and day 13, *** $p<0.001$, **** $p<0.0001$, FcγRI^{only} controls compared to mAb-treated; ns not significant, FcγR^{null} controls compared to mAb-treated.

Figure 2

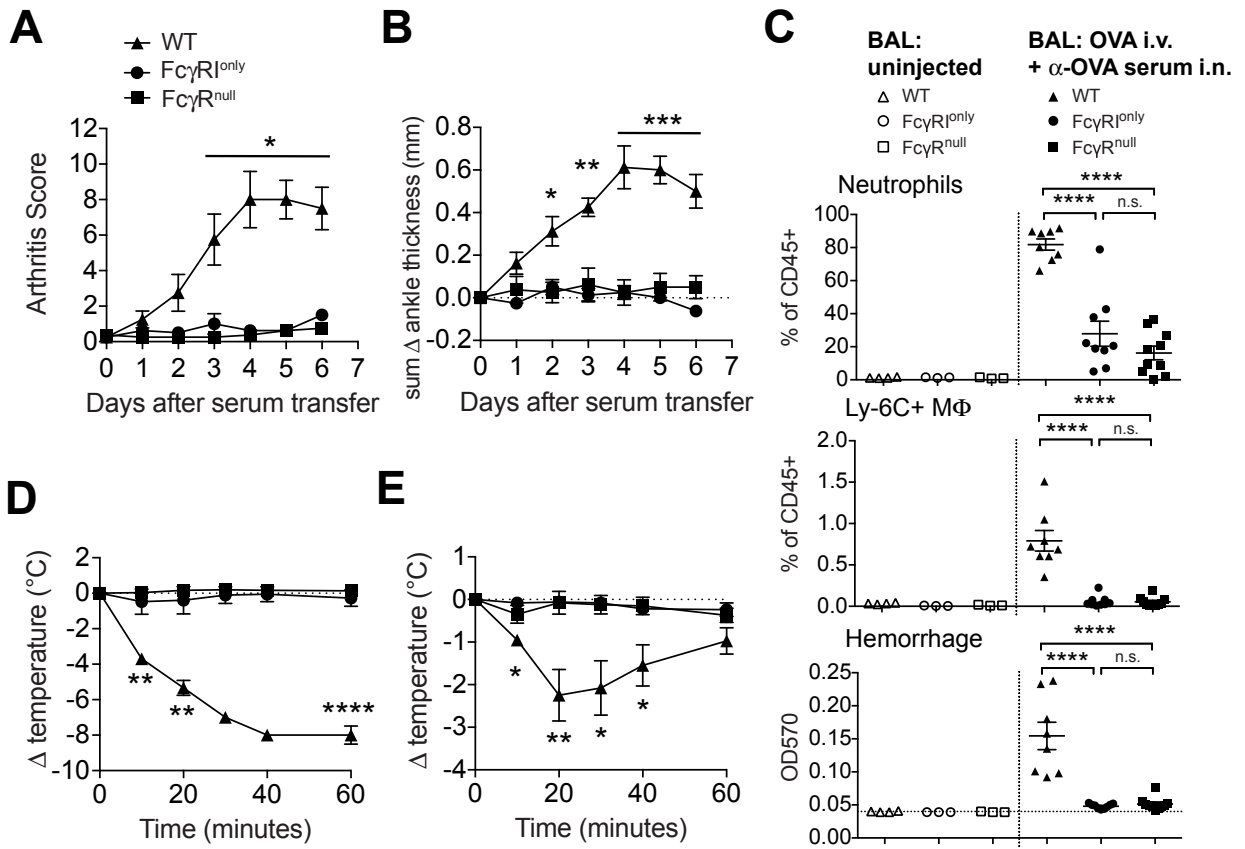


Figure 3

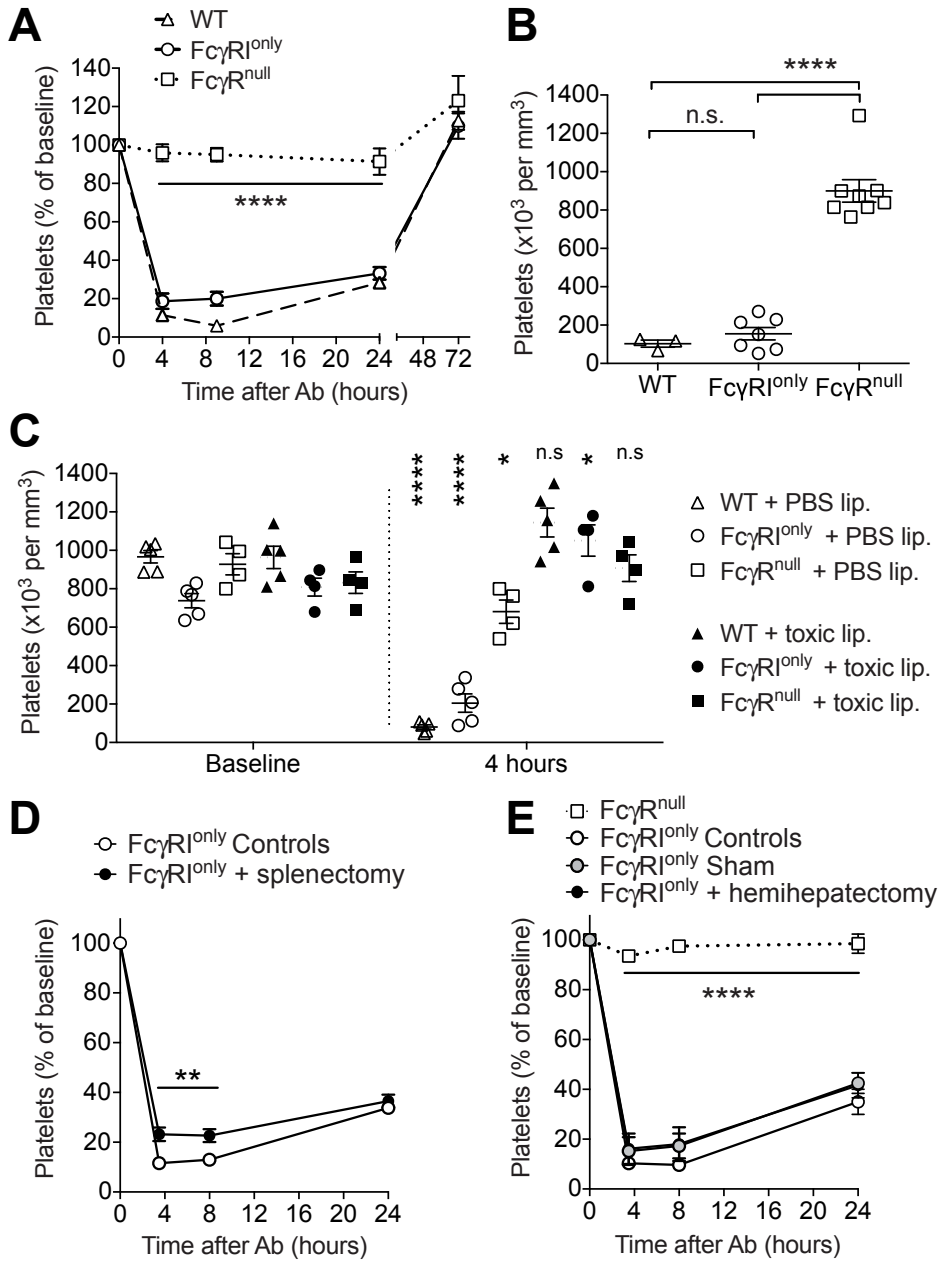
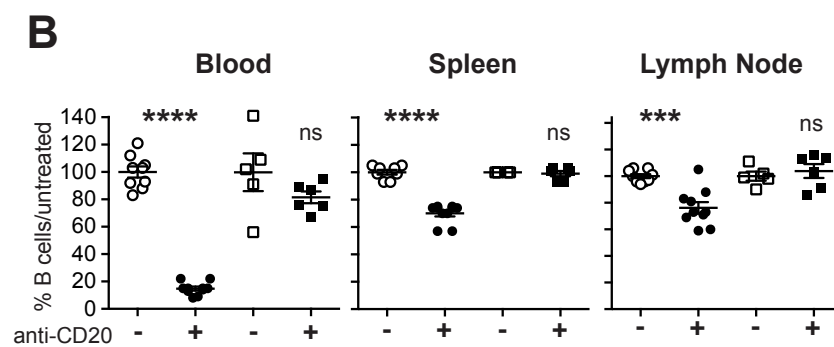
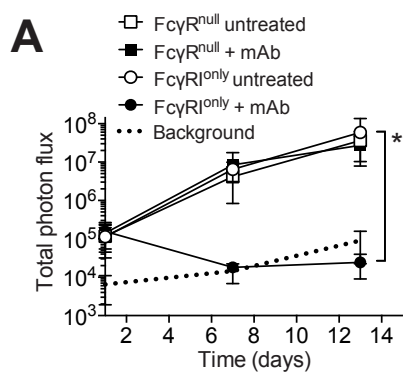
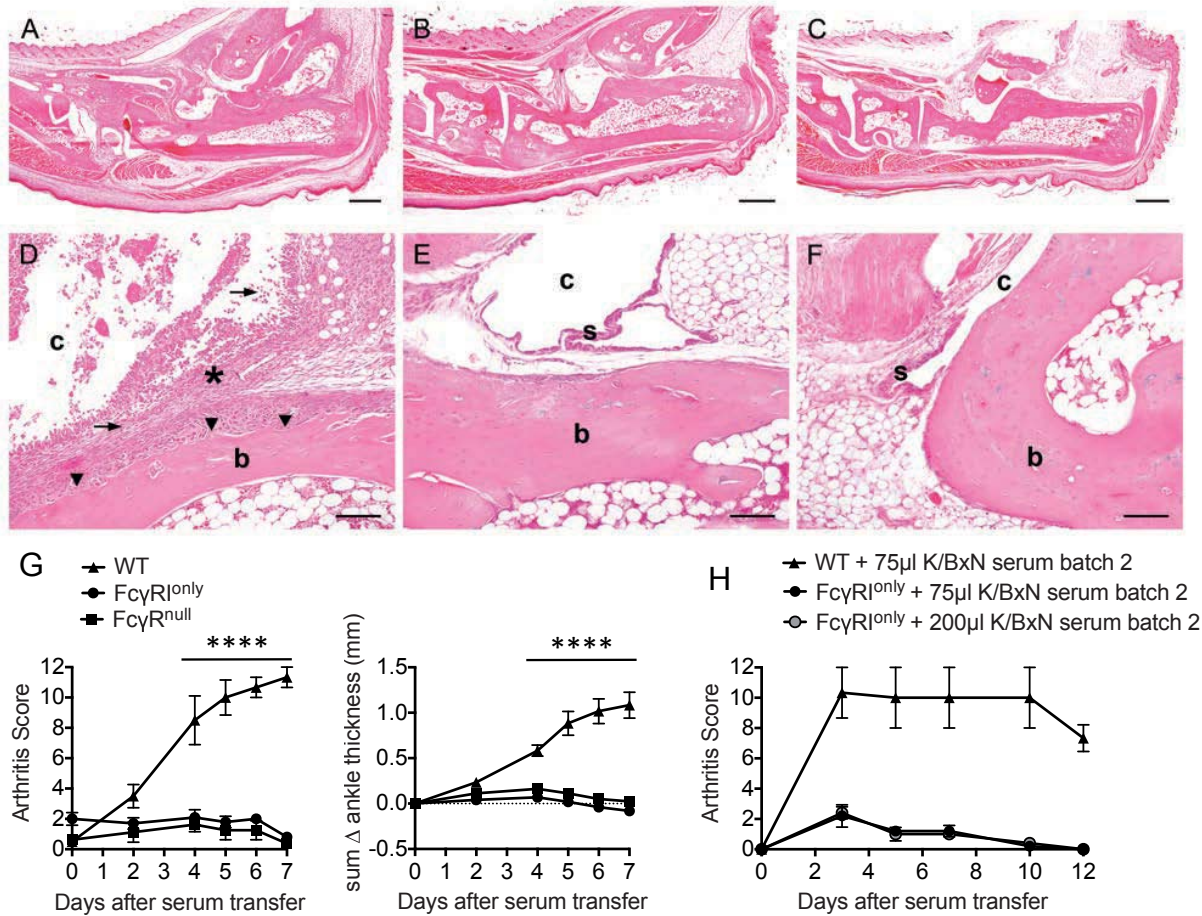


Figure 4

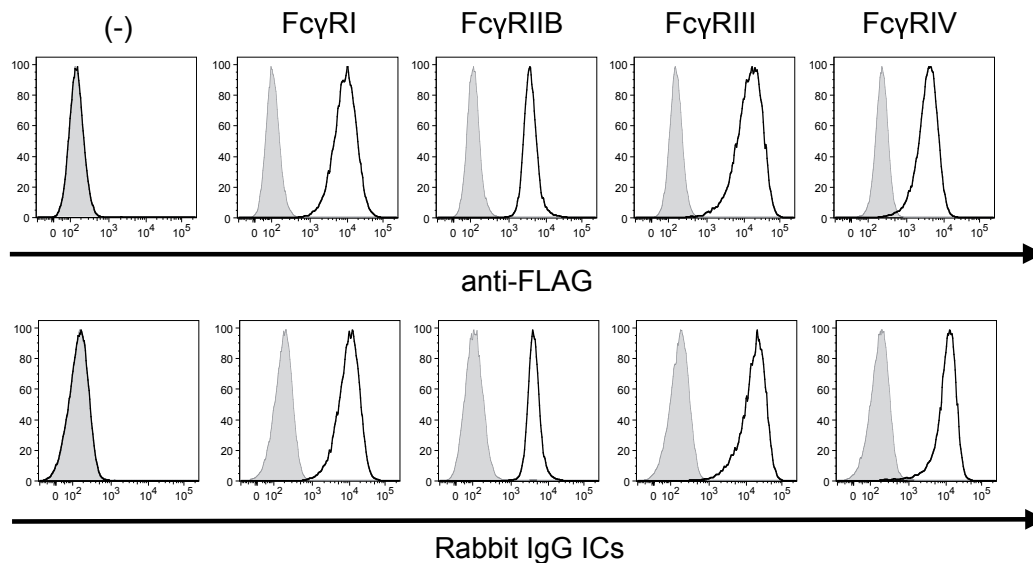


Supplementary Figure 1



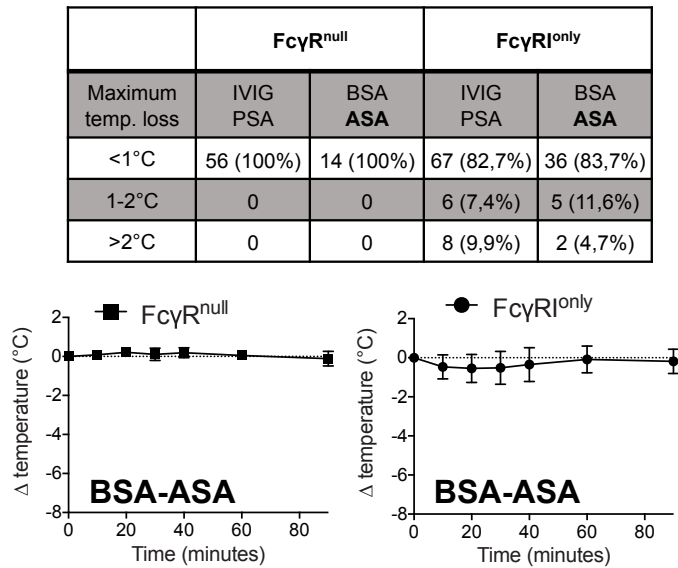
Supplementary Figure 1: mFcγRI alone is insufficient to induce arthritis, even with increased dose of administration, or a different batch of K/BxN serum. (A-F) H&E stained paraffin-embedded sections of decalcified ankle joints on day 8 after K/BxN serum transfer (batch #1, 5mL/kg). Histological signs of marked to severe arthritis were noted in WT mice (A, D), and were characterised by neutrophil and mononuclear cell infiltrates (arrow), pannus formation (asterisk), cartilage damage and bone resorption (arrowhead). No microscopic signs of arthritis were observed in FcγR^{null} (B, E) or FcγRI^{only} (C, F) mice. (b: bone; c: synovial cavity, s: synovial membrane). Scale bar: (A, B, C) 500 μm, (D, E, F) 100 μm (G) Arthritic score and ankle thickness following transfer of high-dose K/BxN serum (batch #1, 10mL/kg) into WT (triangles), FcγR^{null} (squares) or FcγRI^{only} (circles) mice, or (H) arthritic score following transfer of K/BxN serum (batch #2, indicated volumes) into WT or FcγRI^{only} mice.

Supplementary Figure 2



Supplemental Figure 2: FcγRI binds OVA immune complexes. CHO cells stably transfected to express FLAG-tagged mFcγRI, mFcγRIIB, mFcγRIII, or mFcγRIV, as indicated, or control cells (-) were stained with an anti-FLAG antibody (upper panel) to confirm receptor expression; shaded histograms represent isotype control staining. CHO transfectants were incubated with immune complexes (ICs) formed by rabbit anti-OVA serum and fluorescently (vivotag680)-tagged OVA (lower panel). Shaded histograms represent background fluorescence (OVA-vivotag680 alone); open histograms IC binding.

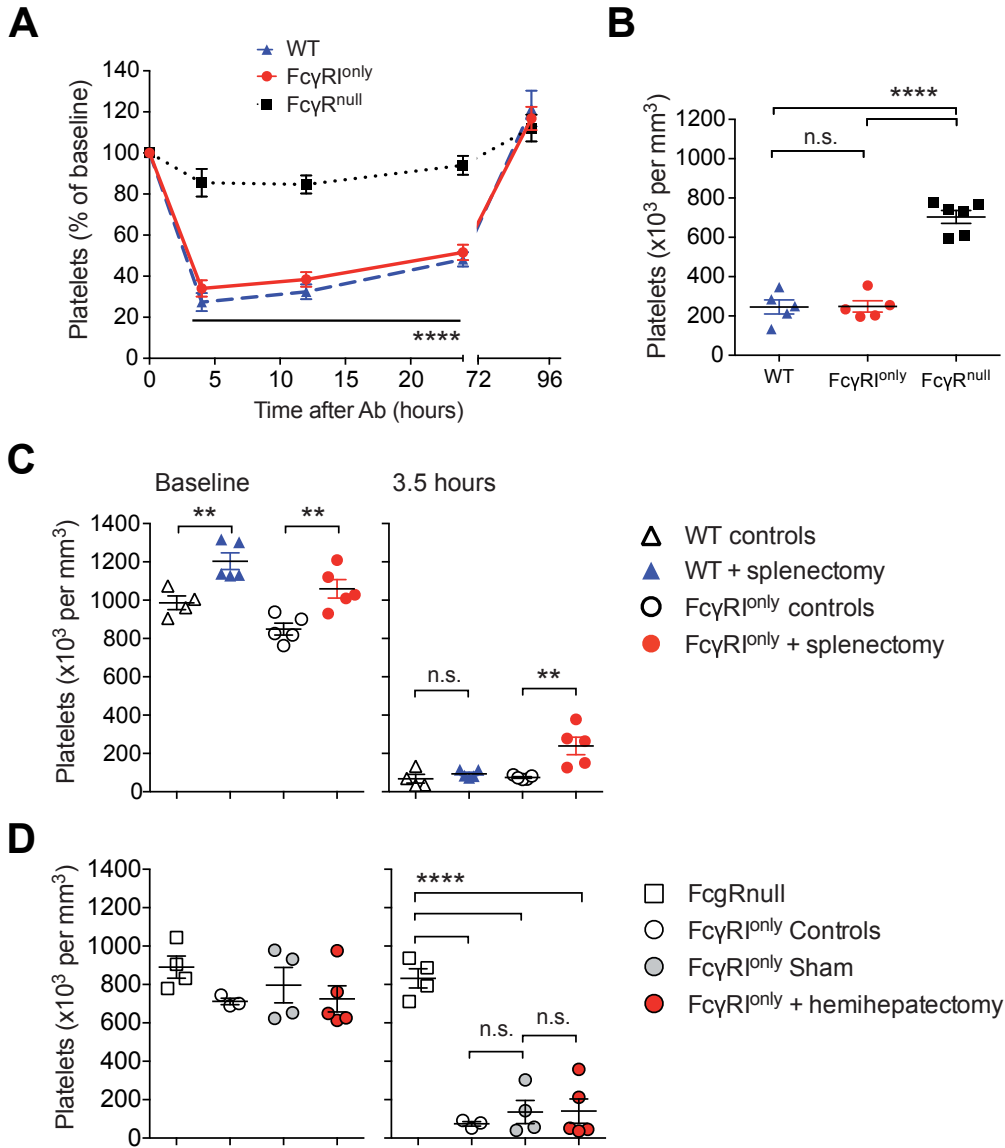
Supplementary Figure 3



Supplementary Figure 3: FcyRI^{only} mice are resistant to BSA-ASA and IVIG-PSA.

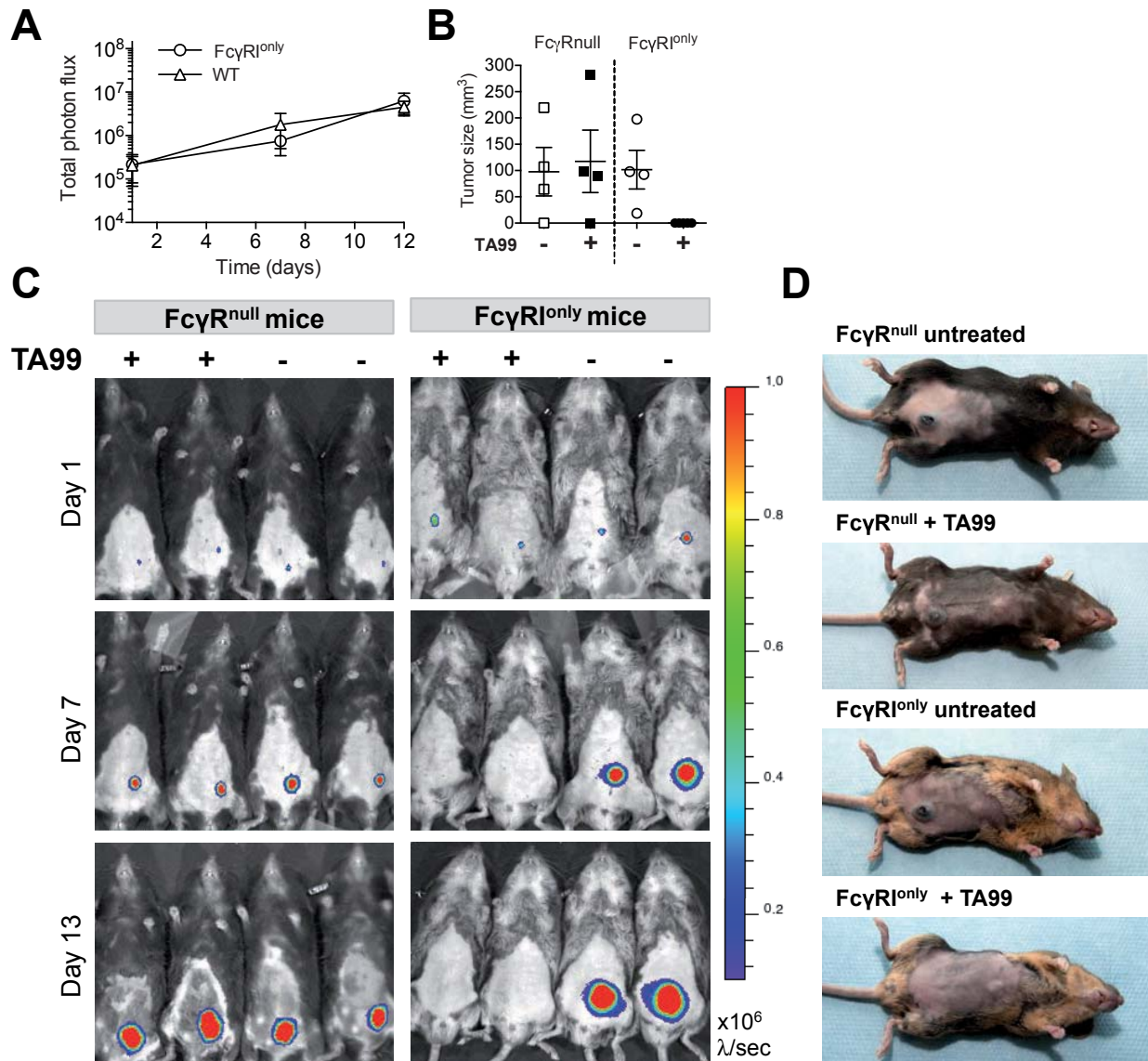
(A) FcyR^{null} (left) and FcyRI^{only} (right) mice were injected with 1mg heat-aggregated IVIG (IVIG-PSA) or immunized and challenged with BSA antigen (BSA-ASA) and central temperatures were monitored. Only a small percentage of FcyRI^{only} animals across all experiments demonstrated a mild hypothermia. Table summarises individual values and graphs represent mean \pm SEM. Data is pooled from >4 individual experiments.

Supplementary Figure 4



Supplementary Figure 4: FcγRI^{only} and WT mice are susceptible to thrombocytopenia at a low-dose of platelet-targeting Ab; platelet clearance is partially inhibited by splenectomy but not affected by hemihepatectomy. Circulating platelets were quantified in the blood of (A-B) WT, FcγRI^{only} and FcγR^{null} mice at baseline and after injection of 3μg anti-platelet mAb 6A6, and are represented as (A) percentage over time and (B) number of platelets 4 hours after mAb injection. n=5-6 per group; **** p<0.0001 at 4, 12 and 24 hours. (C-D) Number of platelets in the blood of WT or FcγRI^{only} controls, sham operated, or mice with splenectomy (C) or hemihepatectomy (D), at baseline (1 week after splenectomy or 2 days after hemihepatectomy or sham) and 3,5 hours after 10μg mAb 6A6. (C) n=4-5 per group, data shown from one of two experiments; ** p<0.01. (D) n=3-5 per group, data pooled from two independent experiments; **** p<0.0001.

Supplementary Figure 5



Supplemental Figure 5: mFcγRI alone is sufficient to mediate mAb therapy of subcutaneous melanoma.

Mice were injected subcutaneously with B16-Luc2+ melanomas cells with or without therapeutic mAb TA99 treatment and (A,C) tumour growth was monitored by bioluminescent signal 10min after s.c. luciferin injection at indicated timepoints or (B) tumour size measured on day 12.

(A) Tumour growth is comparable between untreated WT (triangles, n=5) and FcγRI^{only} (circles, n=5 until d7, n=3 at d12) mice. (B-D) FcγRI^{only} mice eliminate tumours with TA99 treatment, and FcγR^{null} mice do not. (D) Representative photographs taken at day 16. (B-D) correspond to the experiment shown in Figure 2F and are representative of 2 individual experiments.

Supplemental Materials and Methods

Reagents

Human IVIG (Gamunex®) was from Grifols, containing 63% hIgG1, 29% hIgG2, 5% hIgG3 and 3% hIgG4. B16-Luc2+ cells were from Caliper-Life Sciences. IgG were purified by Protein G-affinity purification from supernatants of hybridomas producing anti-gp75 mAb (TA99) from American Type Culture Collection, mIgG2a anti-platelet mAb (clone 6A6) provided by Dr R. Good (USFCM, Tampa, FL, USA), and mIgG2a anti-TNP mAb (Hy1.2) provided by Shozo Izui (University of Geneva, Geneva, Switzerland). Luciferin was from Invitrogen, rabbit anti-OVA antiserum, OVA, BSA, and Freund's adjuvant (CFA/IFA) were from Sigma-Aldrich, TNP₍₂₁₋₃₁₎-BSA was from Santa Cruz and PBS- and clodronate-liposomes were prepared as previously described ¹. Vivotag-680 was from Perkin Elmer and OVA-vivotag-680 was prepared as recommended by the manufacturer.

Tissue processing and flow cytometry

Spleens were dissociated through a 70µm cell strainer into MACS buffer (PBS /0.5%BSA /2mM EDTA) and RBC lysis was performed using an ammonium chloride-based buffer. For isolation of skin cells, ears were split into dorsal and ventral halves and roughly chopped before digestion with 0.25mg/mL Liberase TL ResearchGrade (Roche) + 0.1mg/mL DNase (Sigma) for 1h at 37°C (800rpm; Eppendorf Thermomixer), washed with 10x volume of PBS/ 10%FBS /2mM EDTA and processed through a 100µm cell strainer. Livers were perfused with cold PBS before dissection, and liver leukocytes were isolated using the Liver Dissociation Kit and gentleMACS Octo Dissociator from Miltenyi, according to the manufacturer's

instructions. Cells were isolated from the peritoneum by lavage with 6mL cold PBS; BALs were performed 3x with 1mL PBS. For blood leukocyte analysis, heparinised blood was subjected to RBC lysis with either Red Blood Cell Lysis Solution (Miltenyi) or BD Pharm Lyse Lysing Buffer (BD Biosciences) and washed with MACS buffer. Single cell suspensions were washed with MACS buffer, incubated with 2.4G2 (Fab')₂ fragments (anti-CD16/32, 40µg/mL; 15min on ice) and stained with fluorochrome-conjugated antibodies in MACS buffer for 30min on ice. Data was collected on a MACSQuant flow cytometer (Miltenyi), and analysed using FlowJo Software (TreeStar, Inc.).

Cell populations were defined by FSC/SSC properties and surface markers as indicated (Fig.1B), or in the BAL (Fig.2B): alveolar macrophages (CD11c⁺/ SiglecF⁺), eosinophils (CD11c^{neg}/ SiglecF⁺), neutrophils (CD11c^{neg}/ SiglecF^{neg}/ CD11b⁺/ Ly-6G⁺), Ly-6C⁺ macrophages (CD11c^{neg}/ SiglecF^{neg}/ CD11b⁺/ Ly-6G^{neg}/ Ly-6C⁺).

Active Systemic Anaphylaxis (ASA)

Mice were immunised i.p. on d0 with 200µg BSA in Complete Freund's Adjuvant, and boosted on d14 with 200µg BSA in Incomplete Freund's Adjuvant. BSA-specific IgG1, IgG2a/b/c and IgE serum antibodies were titered by ELISA on d21 as described². Mice with comparable antibody titers were challenged 13-14 days after the last immunisation i.v. with 500µg BSA. Central temperature and mortality was monitored.

Partial hepatectomy and splenectomy

Partial hepatectomy was performed as described³. Mice were anaesthetised and a transverse abdominal incision was made. The superior lobes of the liver were laid on the diaphragm and the ligaments of the caudate lobe dissected. The caudate lobe was

then pulled in front of the stomach and resected after in-bloc ligation of its hilum (6/0 silk). The lateral left lobe was resected using the same technique. The abdomen was closed using 4/0 silk running sutures. The procedure removed approximately half of the initial liver mass. Mice were rested for 2 days before experimental procedure. For splenectomy, a small vertical incision was made on the left flank, the spleen was gently pulled outside the abdomen, and the splenic ligaments and vessels were cut. The abdomen was closed with a 4/0 silk suture, and the skin with a surgical staple. Mice were rested for 1-3 weeks before experimental procedure.

Histology

Ankle joints and surrounding tissues (from the extremity of the femur/tibia to the digits) were sampled on day 8 after K/BxN serum transfer (batch #1, 5mL/kg), then fixed and simultaneously decalcified using Formical-4[®] (StatLab Medical Products) for 2 weeks. Samples were routinely embedded in paraffin, and 4 mm sections were stained with haematoxylin and eosin (H&E). Sections were evaluated microscopically and histological changes (*i.e.* inflammation, pannus formation, bone erosion and cartilage damage) were scored from 0 (no change) to 5 (severe).

Supplemental references

- 1 Van Rooijen, N. & Sanders, A. Liposome mediated depletion of macrophages: mechanism of action, preparation of liposomes and applications. *J Immunol Methods* **174**, 83-93 (1994).
- 2 Jönsson, F. *et al.* Mouse and human neutrophils induce anaphylaxis. *J Clin Invest* **121**, 1484-1496 (2011).
- 3 Montalvao, F. *et al.* The mechanism of anti-CD20-mediated B cell depletion revealed by intravital imaging. *J Clin Invest* **123**, 5098-5103, doi:10.1172/JCI70972 (2013).



Contribution of human FcγRs to disease with evidence from human polymorphisms and transgenic animal studies

Caitlin Gillis^{1,2†}, Aurélie Gouel-Chéron^{1,2,3†}, Friederike Jönsson^{1,2*‡} and Pierre Bruhns^{1,2*‡}

¹ Laboratoire Anticorps en Thérapie et Pathologie, Département d'Immunologie, Institut Pasteur, Paris, France

² U760, INSERM, Paris, France

³ Department of Anesthesia and Intensive Care, Hospital of Bichat-Claude Bernard, Public Assistance-Hospitals of Paris, Paris, France

Edited by:

Jan Terje Andersen, Oslo University Hospital, Norway

Reviewed by:

Beatrice Jahn-Schmid, Medical University of Vienna, Austria
Sylvie Fournel, Strasbourg University, France

*Correspondence:

Friederike Jönsson and Pierre Bruhns, Laboratoire Anticorps en Thérapie et Pathologie, Département d'Immunologie, Institut Pasteur, 25 rue du Docteur Roux, Paris 75015, France

e-mail: joensson@pasteur.fr;
bruhns@pasteur.fr

[†] Caitlin Gillis and Aurélie Gouel-Chéron have contributed equally to this work.

[‡] Friederike Jönsson and Pierre Bruhns are Co-senior authors.

The biological activities of human IgG antibodies predominantly rely on a family of receptors for the Fc portion of IgG, FcγRs: FcγRI, FcγRIIA, FcγRIIB, FcγRIIC, FcγRIIIA, FcγRIIIB, FcRL5, FcRn, and TRIM21. All FcγRs bind IgG at the cell surface, except FcRn and TRIM21 that bind IgG once internalized. The affinity of FcγRs for IgG is determined by polymorphisms of human FcγRs and ranges from 2×10^4 to 8×10^7 M⁻¹. The biological functions of FcγRs extend from cellular activation or inhibition, IgG-internalization/endocytosis/phagocytosis to IgG transport and recycling. This review focuses on human FcγRs and intends to present an overview of the current understanding of how these receptors may contribute to various pathologies. It will define FcγRs and their polymorphic variants, their affinity for human IgG subclasses, and review the associations found between FcγR polymorphisms and human pathologies. It will also describe the human FcγR-transgenic mice that have been used to study the role of these receptors in autoimmune, inflammatory, and allergic disease models.

Keywords: IgG receptors, transgenic mice, anaphylaxis, autoimmune diseases, genetic polymorphisms and disease association, human IgG receptors

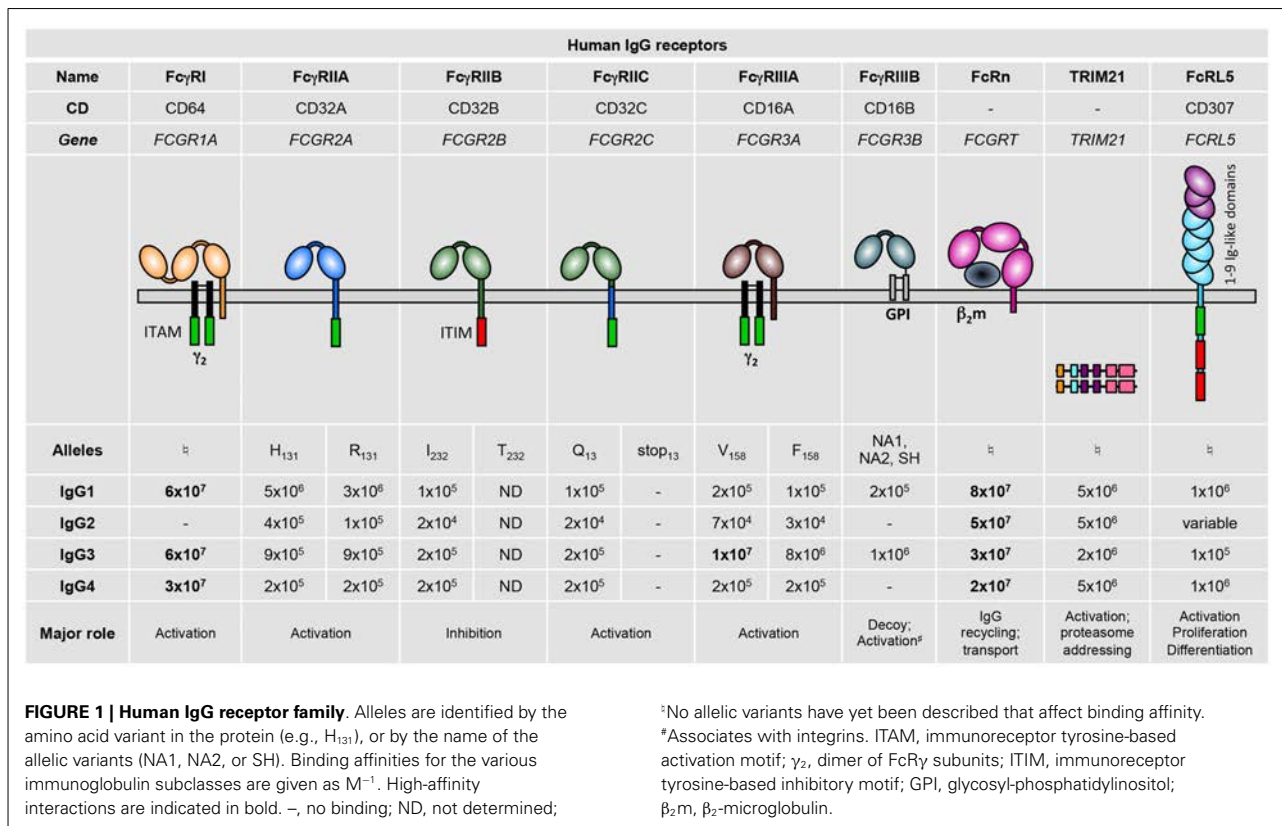
INTRODUCTION ON HUMAN FcγRS: DEFINITION AND BASIC FUNCTIONS

Human myeloid cells, NK cells, and B cells are equipped with a variety of receptors that enable their interaction with monomeric or aggregated immunoglobulins, antigen-antibody immune complexes, and opsonized (antibody-coated) particles, cells, or surfaces. Most of these receptors bind the Fc portion of immunoglobulins (receptors for the Fc portion of immunoglobulins, FcR) and endow these cells with the capacity to interact with IgM, IgA, IgG, and/or IgE. This review will focus on IgG-binding human FcRs, FcγRs.

Humans express nine FcγRs: the six classical FcγRs, FcγRI, FcγRIIA, FcγRIIB, FcγRIIC, FcγRIIIA, and FcγRIIIB; as well as FcRn, FcRL5 (1, 2), and TRIM21 (3) (Figure 1). These FcγRs all bind IgG on the surface of the cells expressing them, except FcRn (4, 5) and TRIM21 (6, 7) that bind IgG once internalized. Notably, all IgG receptors bind at least two human IgG subclasses, albeit with varying binding affinity: the association constants (K_A) of IgG-FcγR interactions range from 8×10^7 down to 2×10^4 M⁻¹ (8) (Figure 1). Historically, FcγRs were categorized as either *low-affinity* receptors that can only bind IgG when present in an immune complex, aggregated, or opsonized; or *high-affinity* receptors that can also bind free or monomeric IgG. This terminology has become rather obsolete considering reports of high- and low-affinity interactions for a single receptor toward

different Ig subclasses. Furthermore, although the prevailing belief was that occupancy of high-affinity receptors with pre-bound monomeric IgG prevents their participation in immediate IgG-dependent reactions; this has recently been refuted *in vivo* (9). Adding to this complexity, human FcγR polymorphisms that modulate affinity for some human IgG subclasses have been described (8) (refer to part 2; Figure 1).

Human FcγR expression on different cell types has been fairly comprehensively described, mostly by the use of FcγR-specific monoclonal antibodies (mAb) but also from data using mRNA profiling (Figure 2). Generally, the following observations can be made: hFcγRI (CD64) is restricted to monocytes/macrophages and dendritic cells and is inducibly expressed on neutrophils (10) and mast cells (11); hFcγRIIA (CD32A) is expressed on all myeloid cells but not on lymphocytes; hFcγRIIB (CD32B) is expressed at high levels only on B cells (12) and basophils (13). It is also expressed on tissue macrophages and dendritic cells (12), but only at low levels on 20% of circulating monocytes and 4% of circulating neutrophils (12, 14), and is not expressed on primary skin mast cells (15); hFcγRIIC (CD32C; refer to Section "Human FcγR Polymorphisms" for its "stop₁₃" polymorphism) is expressed on NK cells (16), monocytes, and neutrophils (17); hFcγRIIIA (CD16A) is expressed on NK cells and monocytes/macrophages; hFcγRIIIB (CD16B) is highly expressed on neutrophils and at low levels on some basophils (18). TRIM21 (aka Ro52) was described



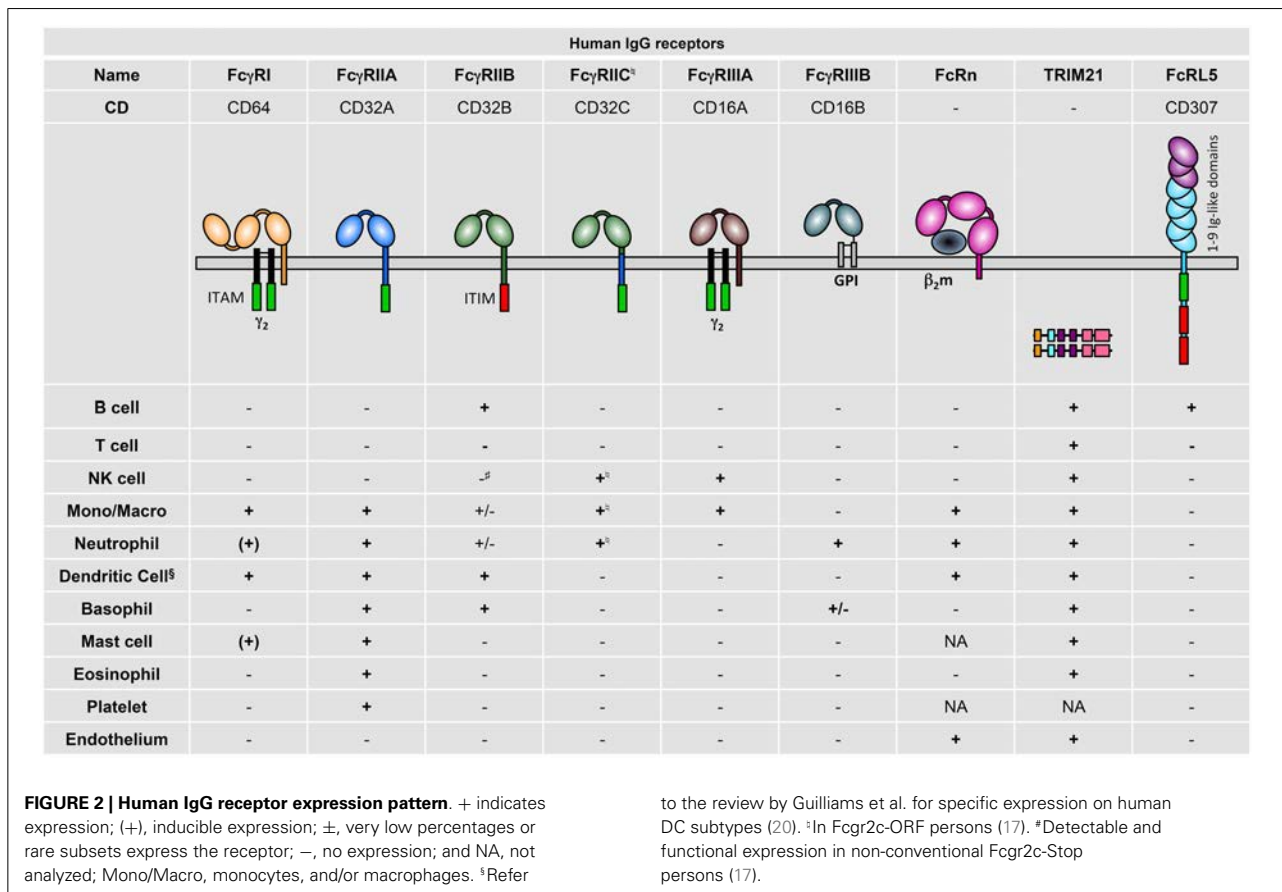
to be widely expressed among lymphoid and myeloid populations, but also on endothelial cells (19). FcRL5 has been reported to be restricted to B cells (2).

These expression patterns highlight that hFcγRIIA is the only activating IgG receptor constitutively expressed by mast cells, basophils, neutrophils, and eosinophils, and that FCRL5 is the only activating IgG receptor constitutively expressed by B cells. Importantly, signal transduction events induced by human activating IgG receptors may be negatively regulated by hFcγRIIB only in B cells, dendritic cells, and basophils, and rare fractions of monocytes and neutrophils. Indeed, mast cells, NK cells, and most neutrophils and monocytes do not express this inhibitory receptor. hFcRn has been reported in dendritic cells, monocytes/macrophages (21), neutrophils (22), and endothelial cells (23), but expression on platelets and mast cells has not been examined so far.

These patterns correspond to the expression of FcγRs in healthy individuals. These may be modified during pathological conditions or following therapeutic treatments. Certain cytokines for example have been reported to up-regulate or down-regulate some hFcγRs; e.g., B cells express higher levels of hFcγRIIB following IFN-γ but lower levels following IL-4 stimulation, whereas opposite effects have been reported for monocytes [reviewed in Ref. (24)]. On the latter cells, expression of hFcγRIIA is increased following IFN-γ and decreased following IL-4 stimulation (25). IL-3 stimulation, however, induces higher expression of both receptors (activating hFcγRIIA and inhibitory hFcγRIIB) on basophils

(13). Mucosal mast cells express hFcγRI upon IFN-γ stimulation (11). Surprisingly, IL-3 stimulation of primary monocytes did not modify hFcγRI expression, but increased its ability to bind IgG-immune complexes and to induce intracellular activation signals (26).

Activating FcγRs signal through an immunoreceptor tyrosine-based activation motif (ITAM) that is either present in their intracytoplasmic domain or in associated signaling subunits, such as the Fcγ chain (Figure 1), the FcRβ chain (exclusively in mast cells and basophils), or the CD3ζ chain (exclusively in NK cells). These ITAM-containing structures allow FcγRs, once aggregated by multimeric ligands, to activate signaling cascades via SRC family kinases and spleen tyrosine kinase (SYK) leading to cell activation, cytokine/chemokine production, and cell migration (27–29). The inhibitory receptor FcγRIIB possesses instead an immunoreceptor tyrosine-based inhibition motif (ITIM) in its intracytoplasmic domain (30), which allows this receptor, once co-engaged with an activating FcγR, to recruit the inositol polyphosphate-5-phosphatase SHIP1 (31) that counteracts the signaling cascades initiated by activating FcγRs (24). FcRL5 possesses both an ITAM and two ITIMs; however, it has been reported to exert mainly negative regulatory functions (32). IgG receptors devoid of both ITAM and ITIM may induce cell activation by associating with other receptors at the cell membrane, for example the glycosylphosphatidylinositol-anchored FcγRIIIB (33, 34) associates with integrins (35); or by activating transcription pathways or proteasome-related mechanisms as does TRIM21 (7, 36).



Internalization of antibodies, and of the antigens they are bound to, represents the only shared function of IgG receptors expressed at the cell surface (that is, all except FcRn and TRIM21), whether ITAM-bearing, ITIM-bearing, or neither. FcγRs thereby enable antigen capture and internalization by all FcγR-expressing nucleated cells, as well as phagocytosis of opsonized bacteria, viruses, or cells by phagocytes. FcRn is the only receptor enabling transcytosis of IgG or IgG-IC by polarized cells (23). Enhanced uptake of antibody-bound antigen enables antigen-presenting cells to activate antigen-specific T cells considerably more efficiently than free antigen (37), signifying the pivotal role of FcγRs in the initial phase of humoral and cellular immune responses. Receptors that bind IgG only when it has already been internalized, FcRn (the topic of this review series) and the ubiquitously expressed intracellular receptor TRIM21, may possibly contribute to this phenomenon [reviewed in Ref. (20)].

HUMAN FcγR POLYMORPHISMS

DEFINITIONS

The multiplicity of human FcγRs (Figure 1) is increased by a series of genetic polymorphisms, for which we will describe herein only those leading to known functional modifications. These are summarized in Table 1.

FcγRIIA

A polymorphism resulting in the presence of a histidine or an arginine residue at position 131 may also be referred to

as low-responder (H₁₃₁) or high-responder (R₁₃₁) (38). The FcγRIIA-H₁₃₁ allotype was originally reported to allow binding to IgG2 (53), subject to ethnic variation (54, 55), and was later described to also have increased binding for IgG3 (39). More recently, we have identified that only the binding to IgG1 and IgG2 are increased for H₁₃₁ compared to R₁₃₁ (8).

A novel splice variant of *FCGR2A*, FcγRIIA-exon 6*, containing an expressed cryptic exon 6* was identified in 2013 (41), and is associated with increased neutrophil sensitivity to IgG stimulation (56).

FcγRIIB

Single-nucleotide polymorphisms (SNPs) at positions 386 [IIB-386 (G/c)] and 120 [IIB-120 (T/a)], collectively constitute the 2B.4 promoter haplotype, which displays increased binding capacity for transcription factors GATA4 and Yin-Yang1, resulting in increased promoter activity and higher expression of FcγRIIB on monocytes, B lymphocytes, neutrophils, and myeloid DCs (24, 42).

A polymorphism encoding an isoleucine to threonine substitution at position 232 in the transmembrane domain of FcγRIIB (T₂₃₂) may disable receptor function via exclusion from lipid rafts (43, 57).

FcγRIIC

In 20% of individuals *FCGR2C* encodes for a glutamine at position 13 (Q₁₃ or ORF) and FcγRIIC is expressed; but in 80% of

Table 1 | Summary of human FcγR polymorphisms.

Receptor	Variant	Effect	Reference
FcγRIIA	H/R ₁₃₁	H ₁₃₁ : ↗ binding of IgG2 and IgG1 ↗ Immune complex-opsonization	(8, 38–40)
	FcγRIIA-exon 6*	↗ Activation following IgG stimulation	(41)
FcγRIIB	–386G/c –120T/a	↗ promoter activity: thus, ↗ FcγRIIB expression	(24, 42)
	I/T ₂₃₂	T ₂₃₂ : ↘ inhibitory function	(43)
FcγRIIC	Q/stop ₁₃	Q ₁₃ : expression on NK cells, monocytes, neutrophils ↗ IgG-induced cell activation	(17)
	CNV	Correlation with protein expression levels	(44)
FcγRIIIA	V/F ₁₅₈	V ₁₅₈ : ↗ binding to IgG1, IgG2, IgG3 ↗ Cell activation	(8, 45, 46)
	CNV	Correlation with protein expression levels; impaired NK cell cytotoxic function	(47)
FcγRIIIB	NA1/NA2/SH	NA1: ↗ phagocytosis of IgG-immune complexes SH: ↗ FcγRIIIB expression levels	(48–51)
	CNV	Correlation with protein expression levels	(52)

individuals a SNP generates a stop codon (stop₁₃), in which case *FCGR2C* represents a pseudogene (16).

A subset of individuals carrying *FCGR2C-ORF* do not express FcγRIIC due to splice-site mutations and loss of exon 7. Inversely, this polymorphism leads to the expression of inhibitory hFcγRIIB expression on NK cells that has been shown to negatively regulate IgG-induced NK cell activation (17).

FcγRIIIA

A SNP determines the presence of a valine or phenylalanine at position 158 (45). The FcγRIIIA-V₁₅₈ variant demonstrates increased affinity for IgG1, IgG2, and IgG3, and increased IgG-induced cell activation and elimination of immune complexes (8, 46, 58).

FcγRIIIB

FcγRIIIB bears the neutrophil antigen (NA) in its membrane-distal Ig-like domain, generating three variants termed NA1 (R₃₆ N₆₅ A₇₈ D₈₂ V₁₀₆), NA2 (S₃₆ S₆₅ A₇₈ N₈₂ I₁₀₆) (48, 59), and SH (S₃₆ S₆₅ D₇₈ N₈₂ I₁₀₆) (50) that do not demonstrate detectable differences in affinity for hIgG subclasses (8). The NA1 allotype was, however, reported to increase phagocytosis of IgG-opsonized particles (49). The SH allotype has been associated with higher FcγRIIIB expression levels (51).

Gene copy number variation (CNV)

Recognized as an important indicator for inter-individual differences, can alter the expression of activating IgG receptors. The balance between activating and inhibitory FcγRs can therefore be perturbed, altering cellular responses toward IgG-immune complexes. CNV of *FCGR2C*, *FCGR3A*, and *FCGR3B* (Table 1) have been shown to correlate with protein expression levels. Duplications of the gene encoding *FCGR3B* can lead to the expression of the three different FcγRIIIB variants (NA1, NA2, and SH) in a single individual (51). CNV in *FCGR3A* (deletion of one allele) correlated with a reduced expression of FcγRIIIA on NK cells and

impaired cytotoxic function (47). Deletion of a large portion of the *FCGR* locus, including *FCGR2C* and *FCGR3B*, also resulted in abnormal expression of FcγRIIB on NK cells, presumably due to deletion of upstream regulatory elements. Expression of this inhibitory receptor enabled negative regulation of IgG-induced NK cell activation (17). To the extent of our knowledge, CNV of the *FCGR2A* and *FCGR2B* genes have not been reported (47).

ASSOCIATION WITH DISEASE SUSCEPTIBILITY AND/OR SUCCESS OF ANTIBODY-BASED THERAPIES

Several *FCGR* polymorphisms modify the affinity between FcγRs and human IgG, and therefore the efficacy of immune complex clearance can be affected. Reduced immune complex clearance is indeed a risk factor for diseases like Systemic Lupus Erythematosus and Wegener's granulomatosis (60, 61). Other polymorphisms may favor detrimental inflammatory responses and thus predispose to autoimmunity. Diseases that have been associated with FcγR polymorphisms are presented in Table 1.

FcγR polymorphisms may also influence patients' response to treatment with intravenous immunoglobulin and therapeutic mAb. Almost all mAb used in therapy are based on human IgG1 antibodies, either chimeric mouse/human or fully human, allowing their interaction with all human FcγRs (8, 62). The first report to assess the predictive value of FcγR polymorphisms in responses to antibody therapies associated homozygous *FCGR3A-V/V*₁₅₈ individuals with better clinical responses to anti-CD20 therapy (Rituximab) in the treatment of non-Hodgkin lymphomas (63). Homozygous *FCGR3A-V/V*₁₅₈ individuals have since been found to have improved biological responses to anti-CD20 therapy in immune thrombocytopenia (64) and rheumatoid arthritis (RA) (65); and anti-TNF-α therapy (Infliximab) to treat Crohn's disease (66, 67); compared to carriers of one or two *FCGR3A-F*₁₅₈ alleles. In arthritis patients, however, findings are controversial regarding the association of *FCGR3A* polymorphisms with clinical response to TNF-α inhibitors (infliximab, adalimumab,

etanercept): although one study describes a better clinical response in *FCGR3A*-F/F₁₅₈ patients (68); another, larger study with a more homogenous patient cohort found no association (69). Homozygous *FCGR3A*-V/V₁₅₈ individuals were more likely to experience complete remission from immune thrombocytopenia following medication, but conversely remission rates after splenectomy were higher in homozygous *FCGR3A*-F/F₁₅₈ or heterozygous individuals (70). The *FCGR2A*-H131 variant associates with susceptibility to Kawasaki Disease (Table 1), whereas responsiveness to IVIG therapy in Kawasaki Disease patients is strongly associated with the *FCGR3B* genotype: the NA1 variant significantly decreases the odds of an appropriate clinical outcome (71). Similarly, CNV of both *FCGR3B* and *FCGR2C* were associated with Kawasaki Disease susceptibility and influenced IVIG treatment response (72). Furthermore, the *FCGR2B* minor alleles (IIB-386c and IIB-120a) conferring increased promoter activity were positively correlated to IVIG therapeutic response, although with limited statistical power over a small sample size (73). Each of these genetic associations is also constrained by unequal polymorphic variation between the different ethnic groups studied.

Altogether, particular FcγR polymorphisms have been described to be associated with the induction or severity of antibody-related disease, or patient responsiveness to antibody-based therapies. Nonetheless one should keep in mind that most FcγR-encoding genes are located within the 1q23 locus (*FCGR2A*, *FCGR3A*, *FCGR2B*, *FCGR2C*, *FCGR3B*) and may display a high degree of linkage disequilibrium, as reported for *FCGR2A* and *FCGR3A* (74) and for *FCGR2C* and *FCGR3B* (44). Association studies of FcγR-encoding genes should therefore include analyses of all FcγR-encoding genes from the 1q23 locus, and not focus on one particular gene.

IN VIVO ROLES OF HUMAN FcγRS: LESSONS FROM MOUSE MODELS¹

TRANSGENIC MOUSE MODELS EXPRESSING hFcγR(s)

Transgenic mouse studies have greatly enhanced our understanding of the *in vivo* function of hFcγRs. In particular, these studies have highlighted the respective contributions of hFcγRs to antibody-mediated inflammatory and allergic diseases (refer to Section “Understanding the Role of hFcγRs *In vivo* Using Transgenic Mouse Models: Illustrated in Autoimmune, Inflammatory, and Allergic Diseases”). Over the last two decades, various transgenic mouse strains have been generated that carry single or multiple hFcγR-encoding genes (Table 2). Transgenic strains were initially generated on a wild-type mouse background; however, later studies have examined transgene expression in mice deficient for multiple endogenous mFcγRs, to specifically study the function of the transgenic human receptor.

The common approach to reproduce hFcγR expression patterns in mice is to use the genuine human promoter to drive transgene expression (Table 2). Whereas this strategy was successful for hFcγRIIA^{tg} and hFcγRIIIB^{tg} mice, both hFcγRI^{tg} mice and hFcγRIIB^{tg} mice exhibit somewhat abnormal expression [discussed in Ref. (62)]. hFcγRI^{tg} mice, for example, constitutively

express substantial amounts of this receptor on neutrophils (37), while in humans hFcγRI is only inducibly expressed on neutrophils in contexts of inflammation, infection and during particular therapies [reviewed in Ref. (62)]. An alternative strategy consists of using a cell-specific promoter to drive hFcγR expression. hFcγRIIA^{tg}, hFcγRIIIB^{tg}, or double-transgenic mice were generated using the human MRP8 promoter to express these receptors on neutrophils and, abnormally for hFcγRIIIB, on a proportion of monocytes (34). Finally, efforts made to cross the five single hFcγR-transgenic mouse strains with mFcγR^{null} mice – lacking mFcγRI, IIB, III, and IV – yielded a mouse model expressing most human IgG receptors – hFcγRI, IIA, IIB, IIIA, and IIIB – that preserves most human expression patterns (119) (Table 2).

UNDERSTANDING THE ROLE OF hFcγRS *IN VIVO* USING TRANSGENIC MOUSE MODELS: ILLUSTRATED IN AUTOIMMUNE, INFLAMMATORY, AND ALLERGIC DISEASES

FcR-mediated uptake of immune complexes and subsequent antigen presentation is a critical aspect of the immune response to foreign pathogens. Targeting of antigen to hFcγRI in hFcγRI^{tg} mice induced a strong antibody response, suggesting that hFcγRI on myeloid cells is capable of mediating antigen uptake and presentation *in vivo* (37, 120, 121). Various studies have demonstrated the capacity for hFcγRI and hFcγRIIIA to mediate cytotoxicity in the form of anti-tumor activity when engaged by bi-specific antibodies or antibodies with enhanced FcR binding, highlighting the effectiveness of such engineered antibody therapeutics *in vivo* (122–125). The role of FcγR in mediating anti-tumor therapies has recently been well-reviewed elsewhere (126, 127) and will not be discussed further in this review. hFcγR-transgenic mice have been useful both in understanding the *in vivo* function of these receptors and dissecting pathological mechanisms of disease; for illustration this section will describe results obtained in models of autoimmune thrombocytopenia, anaphylaxis, inflammation, and RA. Clearly, the biological responses to immobilized IgG are a function of their location, structure, and deposition, determining the subsequent recruitment and FcγR-mediated activation of immune cells: hFcγR-transgenic mice can assist us also in understanding the cell-specific role of FcγR in recruitment and immune complex clearance.

Autoimmune thrombocytopenia

Mice deficient for the FcRγ-subunit that is necessary for the expression of all mouse activating FcγRs are resistant to antibody-mediated platelet destruction, demonstrating the importance of activating FcγRs in this model of autoimmune thrombocytopenia (128). Using transgenic mice, both hFcγRI and hFcγRIIA were found to be independently sufficient for platelet clearance (9, 129). In hFcγRI^{tg} mice, thrombocytopenia was mediated by monocyte/macrophages outside of the spleen (9), whereas in hFcγRIIA^{tg} mice, splenectomy was found to provoke a more severe phenotype of thrombosis and systemic shock when thrombocytopenia was induced by activating anti-platelet antibodies (130). Importantly, hFcγRIIA is the only FcγR expressed on platelets, in humans and hFcγRIIA^{tg} mice. It is likely, therefore, that the presence of this FcγR on the platelets themselves contributes to antibody-induced intravascular platelet activation that is most efficiently resolved

¹Note: for the sake of clarity, this section will use the terminology “hFcγR” for human IgG receptors, and “mFcγR” for mouse IgG receptors.

Table 2 | Association of FcγRs receptor variants with chronic inflammatory or immunological diseases.

Gene	SNP	Disease	Reference
FCGR2A	H ₁₃₁	GBS, Kawasaki disease, idiopathic pulmonary fibrosis, and, for homozygous genotypes, MG, and children chronic ITP	(75–79)
	R ₁₃₁	Bronchial asthma and allergic rhinitis, Still disease, Behçet's disease, refractory ITP, WG, MS, SLE, lupus nephritis, antiphospholipid syndrome, giant cell arteritis, rheumatic fever, ITP, and IgA nephropathy	(55, 60, 80–94)
	FcγRIIIa-exon 6*	Anaphylaxis in patients with hypogammaglobulinemia, common variable immunodeficiency	(41)
FCGR2B	T ₂₃₂	SLE, anti-GBM disease	(57, 95–99).
	–386C/–120A	SLE, chronic inflammatory demyelinating polyneuropathy	(42, 100, 101)
FCGR2C	CNV	ITP, Kawasaki disease	(44, 72)
FCGR3A	F ₁₅₈	SLE, Crohn's disease, Behçet's disease, severe GBS, bullous pemphigoid, WG relapses, RA, and for homozygotes, chronic ITP, and nephritis	(45, 60, 67, 70, 77, 93, 102–105)
	V ₁₅₈	For homozygotes: RA susceptibility and severity, idiopathic inflammatory myopathies, and IgA nephropathy	(90, 106–108)
	CNV	Anti-GBM disease, RA	(109, 110)
FCGR3B	NA1	For homozygotes: anti-neutrophil cytoplasmic antigen systemic vasculitis, chronic ITP in children, and severe course of MG	(75, 77, 111, 112)
	NA2	SLE, severe GBS, Behçet's disease, IgA nephropathy, and MS	(85, 93, 105, 111, 113)
	SH	Alloimmune neonatal neutropenia, transfusion reactions	(50)
	CNV	Glomerulonephritis, SLE, systemic autoimmunity, RA, idiopathic pulmonary fibrosis, systemic sclerosis, and Kawasaki disease	(52, 72, 114–118)

GBM, glomerular basement membrane; GBS, Guillain-Barré syndrome; ITP, idiopathic thrombocytopenic purpura; MG, myasthenia gravis; MS, multiple sclerosis; RA, rheumatoid arthritis; SLE, systemic lupus erythematosus; SNP, single nuclear polymorphism; WG, Wegener's granulomatosis.

by phagocytes in the spleen. These findings have implications for understanding human immune-mediated thrombocytopenic disorders, such as heparin-induced thrombocytopenia/thrombosis (HIT/T), a serious complication arising from the clinical use of heparin. Using hFcγRIIA^{tg} mice it was identified that antibodies against heparin–platelet factor 4 complexes are responsible for hFcγRIIA-mediated platelet activation, thrombocytopenia, and thrombi formation in the lung vasculature (131, 132). Similarly, thromboembolic complications from the use of monoclonal antibody therapies may be a result of hFcγRIIA-dependent platelet activation due to circulating immune complexes (133, 134). Another important outcome of these mouse studies is that the density of hFcγRIIA expression in the transgenic animal affects the severity of antibody-induced disease (130), which has critical ramifications for understanding differences in immune reactions between individuals. Finally, a therapeutic intervention targeting the hFcγRIIA-signaling pathway proved successful for the prevention of thrombocytopenia in hFcγRIIA^{tg} mice (135).

Anaphylactic reactions

Individuals who have developed antibodies against a given allergen can, upon re-exposure, develop a severe systemic allergic reaction (anaphylaxis). Allergen re-exposure induces the rapid formation of immune complexes that leads to cellular activation and release of vasoactive mediators, which drives the phenotype of systemic shock, including symptoms of hypotension and respiratory distress. Although anaphylaxis is classically attributed to an IgE-mediated mast cell-dependent paradigm of allergic reactivity, the same systemic symptoms can be reproduced experimentally

in mice by the transfer of specific IgG antibodies and allergen, of preformed immune complexes (passive systemic anaphylaxis, PSA), or by repeated immunization with an antigen prior to challenge (active systemic anaphylaxis, ASA). hFcγRI and hFcγRIIA expressed in transgenic mice were each individually sufficient to mediate PSA, the symptoms of which may be alleviated by pre-treatment with blocking antibodies (9, 136). PSA mediated by hFcγRIIA was found to be independent of mast cells and basophils, but rather dependent on neutrophils and monocytes/macrophages (136). Furthermore, hFcγRI and hFcγRIIA were identified as each individually sufficient to mediate ASA in transgenic mice, resulting in both hypothermia and death (9, 136). hFcγRI-dependent ASA required neutrophils and the release of platelet activating factor (9). These data demonstrate that hFcγR expressed on neutrophils and monocytes can mediate fatal anaphylactic reactions *in vivo*. Furthermore, in hFcγRI^{tg}RIIA^{tg}IIB^{tg}IIIA^{tg}IIIB^{tg} mice (on the mFcγR^{null} background), administration of aggregated IgG was sufficient to trigger anaphylaxis (119). In addition, directly targeting either hFcγRI or hFcγRIIA by injection of agonistic mAb could induce anaphylaxis in transgenic mice (9, 136). Altogether, these data support the notion that anaphylaxis may also occur in humans in an hFcγR-dependent manner when allergen-specific IgGs are produced by an individual.

Immune complex induced inflammation

The formation of immune complexes is a hallmark of many human diseases, and their accumulation is an important trigger of inflammation-induced tissue damage. Pathogenic antibodies may bind directly to host cells, or immune complexes may deposit

within tissues and trigger activation of local or circulating hFcγR-expressing cells. Using hFcγRIIA^{tg} mice, it was demonstrated that hFcγRIIA expressed on skin mast cells could trigger their activation following intradermal injection of immune complexes resulting in an inflammatory reaction in the skin (136). Inflammation of the airways due to local formation of immune complexes is characterized by granulocyte infiltration, elevated levels of myeloperoxidase, and subsequent damage to the lung epithelium, mimicking symptoms of asthmatic disease in humans. Whereas Fcγ-subunit^{-/-} mice are resistant to IC-induced airway inflammation, transgenic expression of either hFcγRI or hFcγRIIA was sufficient to restore this antibody-mediated pathology (9, 136).

Rheumatoid arthritis

Rheumatoid arthritis is an autoimmune disease in which the formation of immune complexes within the joints drives an inflammatory pathology. Autoantibodies directed against joint proteins such as collagen type II or glucose-6-phosphate isomerase (GPI) are found in RA patients, and the arthritis pathology may be modeled in mice by either active immunization with joint-associated components or by passive antibody transfer. hFcRn^{tg} mice provided direct evidence for the role of this receptor in serum persistence and transport of antibodies into tissues (23). Indeed, mFcRn^{-/-} mice are resistant to passive arthritis induction, and transgenic expression of hFcRn could restore arthritis susceptibility (137, 138); suggesting that greater IgG serum persistence may have implications for many autoimmune and inflammatory conditions (139). Surprisingly, transgenic expression of hFcγRIIA-R131 on a wild-type mouse background was associated with the spontaneous development of an RA-like joint pathology (140). Expression of hFcγRIIA indeed renders mice highly susceptible to various models of arthritis (140, 141), even if its expression is purposely restricted to neutrophils (142). Small inhibitors designed to bind antagonistically to hFcγRIIA were found to be protective (143), proposing a hFcγR-targeted therapy for RA. Besides hFcγRIIA^{tg} mice, other hFcγR-transgenic mice do not exhibit spontaneous joint inflammation. Nevertheless, hFcγRI^{tg} mice demonstrated that this receptor is sufficient to mediate arthritis induction in transgenic mice, dependent on the presence of both neutrophils and monocytes/macrophages (9). Therapeutic elimination of inflammatory macrophages by an hFcγRI-targeting immunotoxin inhibited the progression of experimental arthritis in hFcγRI^{tg} rats (144), and resolved cutaneous inflammation (145).

Cell-specific function of FcγR

Studies using hFcγR^{tg} mice have enabled the description of specific *in vivo* functions not only for these IgG receptors, but also the cells that express them. Neutrophils are a particularly relevant example: the two main human neutrophil IgG receptors, hFcγRIIA and hFcγRIIIB, were found to individually and cooperatively promote IC-induced neutrophil recruitment and accumulation in the tissues. hFcγRIIA alone, however, promoted associated injury and inflammation in multiple models of antibody-dependent autoimmunity. Importantly, neutrophil recruitment occurred despite the absence of FcγR expression on other cell types such as mast cells and macrophages, indicating a prominent role for hFcγRs on neutrophils in IC-induced recruitment (34). Furthermore,

specialized functions may be attributed to these two neutrophil FcγR: hFcγRIIIB seems to play an important role in homeostatic clearance of immune complexes deposited within the vasculature, whereas in a complex environment of immune complex deposition within the tissue and the vasculature, hFcγRIIA was required for the formation of neutrophil extracellular traps (NETs) (146). Collectively, these data in hFcγR^{tg} mice demonstrate the value of a transgenic approach to appreciate the role of human FcγR and the cells expressing them.

FINAL CONSIDERATIONS

Although, it is tempting to draw conclusions from genetic association studies performed in humans, it would be overreaching to delineate causal relationships between particular FcγR variants and antibody-mediated human disease. Importantly, all the human FcγR-transgenic mouse strains that have been reported express a single polymorphic variant of each FcγR (Table 3). Thus, no comprehensive study can compare today the properties of a given polymorphism in mouse models of disease. Novel mouse models based on the exchange of the entire FCGR locus with that of humans may allow these comparison studies, or transgenic/knock-in mice expressing different polymorphic variants than the transgenic mice already reported, but remain to be generated. Still, when taking into account published data from both humans and animal models (referenced in Tables 2 and 3) several parallel observations have been described:

- Expression of hFcγRIIA (R131) renders mice susceptible to arthritis and autoimmune pathologies including thrombocytopenia (Table 3); and expression of hFcγRIIA-R131 allotype is similarly associated with inflammatory diseases, thrombocytopenia, and autoimmunity in humans (Table 2). The FcγRIIA-exon 6* polymorphic variant, which confers increased neutrophil sensitivity to IgG stimulation (Table 1) was also associated with anaphylactic responses in patients upon IVIG therapy (Table 2); consistent with data obtained in hFcγRIIA^{tg} mice indicating that neutrophils can contribute to IgG-dependant anaphylaxis mediated by FcγRIIA.
- The NA1 allotypic variant of FcγRIIIB confers increased phagocytosis of IgG-immune complexes, and is associated with thrombocytopenia in humans; whereas FcγRIIIB-NA2 and CNV are associated with inflammatory and autoimmune conditions characterized by immune complex deposition. These data are congruent with findings in NA2-hFcγRIIIB^{tg} mice (Table 2), demonstrating an important role for this receptor in mediating neutrophil recruitment as well as homeostatic clearance of immune complexes.

While genetic association studies identify important risk factors and inform on the involvement of FcγR in human disease; hFcγR^{tg} mice allow us to more precisely dissect pathological mechanisms, and describe the role of human FcγR and the cells expressing them in various clinically relevant pathologies. Together, these data in humans and transgenic models highlight the contribution of hFcγR to antibody-mediated diseases, and open avenues for understanding pathogenic mechanisms. Such data will continue

Table 3 | hFcγR-transgenic mouse models: description and main results obtained.

Promoter	Expression	Variant	Strain	<i>In vivo</i> findings	Reference
CD64 (hFcγRI)					
<i>FCGR1</i>	Monocytes, macrophages, DCs, neutrophils		FVB/N	Bi-specific mAb-dependent hFcγRI-triggered killing (<i>in vitro</i>)	(122)
			FVB/N	Anti-hFcγRI mAb immunization elicits higher Ab responses	(37)
			FVB/N	hFcγRI-mediated binding and phagocytosis of opsonized RBCs	(147)
			?	Antigen targeting to hFcγRI increased vaccination potency	(120)
			FVB/N	Weak antigen targeting to hFcγRI enhances immunogenicity	(121)
			FVB/N	Immunotoxin targeting of hFcγRI reduces inflammation	(145)
			5KO (B6 F6)	hFcγRI-dependent arthritis, thrombocytopenia, airway inflammation, and anaphylaxis (PSA and ASA)	(9)
CD32A (hFcγRIIA)					
<i>FCGR2A</i>	Monocytes, macrophages, neutrophils, eosinophils, basophils, mast cells, DCs, megakaryocyte, platelets	R ₁₃₁	FcRγ ^{-/-} (B6xSJL)	Immune thrombocytopenia can be induced via hFcγRIIA	(129)
			FcRγ ^{-/-} (B6)	hFcγRIIA-dependent thrombosis and shock	(130)
			hPF4 ^{tg} (B6)	hFcγRIIA-dependent Heparin-induced thrombocytopenia	(131)
			C57BL/6	Increased active and passive collagen-induced arthritis	(140)
			FcRγ ^{-/-} (B6xSJL)	hFcγRIIA mediates experimental immune hemolytic anemia	(148)
			hPF4 ^{tg} lo/hi (B6)	PF4-hFcγRIIA-dependent Heparin-induced thrombocytopenia	(132)
			C57BL/6 × SJL F ₁	hFcγRIIA-dependent platelet activation by Bevacizumab IC	(133)
			C57BL/6 × SJL F ₁	Small chemical entities inhibit collagen-induced arthritis	(143)
			C57BL/6 × SJL F ₁	hFcγRIIA-dependent platelet activation by CD40L IC	(134)
			C57BL/6 × SJL F ₁	Increased sensitivity to autoimmune arthritis	(141)
			C57BL/6	Inhibition of hFcγRIIA-signaling pathway to inhibit thrombosis and thrombocytopenia	(135)
					FcRγ ^{-/-} , 5KO
		C57BL/6J	hFcγRIIA cooperates with integrin signaling in platelets	(149)	
<i>MRP8</i>	Neutrophils, some monocytes	R ₁₃₁	FcγR ^{-/-}	hFcγRIIA-dependent nephritis, Arthus reaction, neutrophil recruitment and tissue injury	(34)
			FcγR ^{-/-}	Neutrophil hFcγRIIA is sufficient for arthritis induction	(142)
			FcγR ^{-/-}	hFcγRIIA-dependent NETosis in Arthus reaction	(146)
CD32B (hFcγRIIB)					
<i>FCGR2B</i>	B cells, splenic CD11c DCs, monocytes, neutrophils, eosinophils	I ₂₃₂	C57Bl/6	Crosslinking hFcγRIIB and CD19 suppresses humoral immunity in systemic lupus erythematosus	(150)
			FcRγ ^{-/-} or FcγRIIB ^{-/-}	hFcγRIIB-enhanced immunostimulatory and anti-tumor activity of chimeric mouse-human agonistic anti-CD40 Abs	(151)
			CD40 ^{-/-}	Anti-tumor activity of agonistic anti-TNFR Abs requires differential hFcγRIIB coengagement	(152)
CD16A (hFcγRIIIA)					
<i>FCGR3A</i>	NK cells, macrophages	F ₁₅₈	B6xCBAFI	Promoter/expression analysis	(153)
?	NK cells and ?	?	SCID	Glycoengineering of a humanized anti-EGFR Ab leads to enhanced ADCC through hFcγRIIIA	(125)
CD16B (hFcγRIIIB)					
<i>FCGR3B</i>	Neutrophils	?	B6xCBAFI	Promoter/expression analysis	(153)
<i>MRP8</i>	Neutrophils, some monocytes	NA2	FcRγ ^{-/-}	hFcγRIIIB is sufficient for NTS nephritis, cutaneous RPA reaction and promotes neutrophil recruitment	(34)
			FcRγ ^{-/-}	hFcγRIIIB mediates neutrophil tethering to intravascular immune complexes and their uptake	(146)
CD32A (hFcγRIIA) + CD16B (hFcγRIIIB)					
<i>MRP8</i>	Neutrophils, some monocytes	IIA: R ₁₃₁ IIIB:NA2	FcRγ ^{-/-}	hFcγRIIA and hFcγRIIIB cooperate to induce nephritis and cutaneous Arthus reaction	(34)

(Continued)

Table 3 | Continued

Promoter	Expression	Variant	Strain	<i>In vivo</i> findings	Reference
FcγR-HUMANIZED MICE (INTERCROSS OF hFcγRI^{tg}, IIA^{tg}, IIB^{tg}, IIIA^{tg} AND IIIB^{tg} MICE)					
<i>FCGR1</i>	Please refer to single transgenic mice	I	mFcγRI ^{-/-}	Antibody-mediated FcγR-dependent cell depletion (B cells, T cells, platelets), and B16-F10 lung metastasis clearance	(119)
<i>FCGR2A</i>		IIA-R ₁₃₁	mFcγRIIB ^{-/-}	FcγR-mediated IC-induced systemic anaphylaxis	
<i>FCGR2B</i>		IIB-I ₂₃₂	mFcγRIII ^{-/-}		
<i>FCGR3A</i>		IIIA-F ₁₅₈	mFcγRIV ^{-/-}		
<i>FCGR3B</i>		IIIB-?			
hFcRn					
<i>FCGRT</i>	Intestine and ?		mFcRn ^{-/-}	hFcRn expression restores serum half life of hIgG in mFcRn ^{-/-} mice	(154)
			mFcRn ^{-/-} ; mFcRn ^{-/-} FcγRIIB ^{-/-}	hIgG with engineered high FcRn binding affinity has enhanced half life <i>in vivo</i> ; inhibition of the binding of pathogenic Abs to hFcRn ameliorates arthritis	(137)
			mFcRn ^{-/-} mβ2m ^{-/-}	Blocking hFcRn using a peptide antagonist increases hIgG catabolism	(155)
			hFcRn ^{tg} hβ2m ^{tg} 6KO (B6 F6)	hFcRn restores arthritis susceptibility in 6KO mice	(138)

?, information unavailable in the original publication.

to impact on therapeutic choices and potentially identify new interventional targets.

ACKNOWLEDGMENTS

Works of our laboratory discussed in this review were supported by the Institut Pasteur, the Institut National de la Santé et de la Recherche Médicale (INSERM), the Agence Nationale pour la Recherche (grant GENOPAT-09-GENO-014-01), the Société Française d'Allergologie (SFA), and the company Balsan. Caitlin Gillis is a scholar of the Pasteur Paris University International Doctoral Program (PPUIDP) and received a stipend from the Institut Carnot Pasteur Maladies Infectieuses. Friederike Jönsson is a *chargé de recherche* (Investigator) at the Centre National de la Recherche Scientifique (CNRS).

REFERENCES

- Wilson TJ, Fuchs A, Colonna M. Cutting edge: human FcRL4 and FcRL5 are receptors for IgA and IgG. *J Immunol* (2012) **188**:4741–5. doi:10.4049/jimmunol.1102651
- Franco A, Damdinsuren B, Ise T, Dement-Brown J, Li H, Nagata S, et al. Human Fc receptor-like 5 binds intact IgG via mechanisms distinct from those of Fc receptors. *J Immunol* (2013) **190**:5739–46. doi:10.4049/jimmunol.1202860
- Yang Y, Eversole T, Lee DJ, Sontheimer RD, Capra JD. Protein-protein interactions between native Ro52 and immunoglobulin G heavy chain. *Scand J Immunol* (1999) **49**:620–8. doi:10.1046/j.1365-3083.1999.00547.x
- Simister NE, Mostov KE. An Fc receptor structurally related to MHC class I antigens. *Nature* (1989) **337**:184–7. doi:10.1038/337184a0
- Ober RJ, Martinez C, Vaccaro C, Zhou J, Ward ES. Visualizing the site and dynamics of IgG salvage by the MHC class I-related receptor, FcRn. *J Immunol* (2004) **172**:2021–9. doi:10.4049/jimmunol.172.4.2021
- James LC, Keeble AH, Khan Z, Rhodes DA, Trowsdale J. Structural basis for PRYSPRY-mediated tripartite motif (TRIM) protein function. *Proc Natl Acad Sci U S A* (2007) **104**:6200–5. doi:10.1073/pnas.0609174104
- Mallery DL, McEwan WA, Bidgood SR, Towers GJ, Johnson CM, James LC. Antibodies mediate intracellular immunity through tripartite motif-containing 21 (TRIM21). *Proc Natl Acad Sci U S A* (2010) **107**:19985–90. doi:10.1073/pnas.1014074107
- Bruhns P, Iannascoli B, England P, Mancardi DA, Fernandez N, Jorieux S, et al. Specificity and affinity of human Fc[gamma] receptors and their

polymorphic variants for human IgG subclasses. *Blood* (2009) **113**:3716–25. doi:10.1182/blood-2008-09-179754

- Mancardi DA, Albanesi M, Jonsson F, Iannascoli B, van Rooijen N, Kang X, et al. The high-affinity human IgG receptor FcγRI (CD64) promotes IgG-mediated inflammation, anaphylaxis, and antitumor immunotherapy. *Blood* (2013) **121**:1563–73. doi:10.1182/blood-2012-07-442541
- Ravetch JV, Kinet JP. Fc receptors. *Annu Rev Immunol* (1991) **9**:457–92. doi:10.1146/annurev.iy.09.040191.002325
- Okayama Y, Kirshenbaum AS, Metcalfe DD. Expression of a functional high-affinity IgG receptor, Fc gamma RI, on human mast cells: up-regulation by IFN-gamma. *J Immunol* (2000) **164**:4332–9. doi:10.4049/jimmunol.164.8.4332
- Veri MC, Gorlatov S, Li H, Burke S, Johnson S, Stavenhagen J, et al. Monoclonal antibodies capable of discriminating the human inhibitory FcγRIIB (CD32B) from the activating FcγRI (CD64): biochemical, biological and functional characterization. *Immunology* (2007) **121**:392–404. doi:10.1111/j.1365-2567.2007.02588.x
- Cassard L, Jonsson F, Arnaud S, Daeron M. FcγRIIB receptors inhibit mouse and human basophil activation. *J Immunol* (2012) **189**:2995–3006. doi:10.4049/jimmunol.1200968
- Magnusson SE, Engstrom M, Jacob U, Ulfgren AK, Kleinau S. High synovial expression of the inhibitory FcγRIIB in rheumatoid arthritis. *Arthritis Res Ther* (2007) **9**:R51. doi:10.1186/ar2206
- Zhao W, Kepley CL, Morel PA, Okumoto LM, Fukuoka Y, Schwartz LB. Fc gamma RIIB, not Fc gamma RIIB, is constitutively and functionally expressed on skin-derived human mast cells. *J Immunol* (2006) **177**:694–701. doi:10.4049/jimmunol.177.1.694
- Metes D, Ernst LK, Chambers WH, Sulica A, Herberman RB, Morel PA. Expression of functional CD32 molecules on human NK cells is determined by an allelic polymorphism of the FcγRIIB gene. *Blood* (1998) **91**:2369–80.
- van der Heijden J, Breunis WB, Geissler J, De Boer M, van den Berg TK, Kuijpers TW. Phenotypic variation in IgG receptors by nonclassical FCGR2C alleles. *J Immunol* (2012) **188**:1318–24. doi:10.4049/jimmunol.1003945
- Meknache N, Jönsson F, Laurent J, Guinépain MT, Daeron M. Human basophils express the glycosylphosphatidylinositol-anchored low-affinity IgG receptor Fc[gamma]RIIB (CD16B). *J Immunol* (2009) **182**:2542–50. doi:10.4049/jimmunol.0801665
- Espinosa A, Dardalhon V, Brauner S, Ambrosi A, Higgs R, Quintana FJ, et al. Loss of the lupus autoantigen Ro52/Trim21 induces tissue inflammation and systemic autoimmunity by dysregulating the IL-23-Th17 pathway. *J Exp Med* (2009) **206**:1661–71. doi:10.1084/jem.20090585

20. Williams M, Bruhns P, Saey Y, Hammad H, Lambrecht BN. The function of Fcγ receptors in dendritic cells and macrophages. *Nat Rev Immunol* (2014) **14**:94–108. doi:10.1038/nri3582
21. Zhu X, Meng G, Dickinson BL, Li X, Mizoguchi E, Miao L, et al. MHC class I-related neonatal Fc receptor for IgG is functionally expressed in monocytes, intestinal macrophages, and dendritic cells. *J Immunol* (2001) **166**:3266–76. doi:10.4049/jimmunol.166.5.3266
22. Vidarsson G, Stemerding AM, Stapleton NM, Spliethoff SE, Janssen H, Rebers FE, et al. FcRn: an IgG receptor on phagocytes with a novel role in phagocytosis. *Blood* (2006) **108**:3573–9. doi:10.1182/blood-2006-05-024539
23. Roopenian DC, Akilesh S. FcRn: the neonatal Fc receptor comes of age. *Nat Rev Immunol* (2007) **7**:715–25. doi:10.1038/nri2155
24. Smith KG, Clatworthy MR. FcγRIIB in autoimmunity and infection: evolutionary and therapeutic implications. *Nat Rev Immunol* (2010) **10**:328–43. doi:10.1038/nri2762
25. Pricop L, Redecha P, Teillaud JL, Frey J, Fridman WH, Sautes-Fridman C, et al. Differential modulation of stimulatory and inhibitory Fc gamma receptors on human monocytes by Th1 and Th2 cytokines. *J Immunol* (2001) **166**:531–7. doi:10.4049/jimmunol.166.1.531
26. van der Poel CE, Karssemeijer RA, Boross P, van der Linden JA, Blokland M, van de Winkel JG, et al. Cytokine-induced immune complex binding to the high-affinity IgG receptor, FcγRI, in the presence of monomeric IgG. *Blood* (2010) **116**:5327–33. doi:10.1182/blood-2010-04-280214
27. Daëron M. Fc receptor biology. *Annu Rev Immunol* (1997) **15**:203–34. doi:10.1146/annurev.immunol.15.1.203
28. Nimmerjahn F, Ravetch JV. Fcγ receptors as regulators of immune responses. *Nat Rev Immunol* (2008) **8**:34–47. doi:10.1038/nri2206
29. Blank U, Launay P, Benhamou M, Monteiro RC. Inhibitory ITAMs as novel regulators of immunity. *Immunol Rev* (2009) **232**:59–71. doi:10.1111/j.1600-065X.2009.00832.x
30. Amigorena S, Bonnerot C, Drake JR, Choquet D, Hunziker W, Guillet JG, et al. Cytoplasmic domain heterogeneity and functions of IgG Fc receptors in B lymphocytes. *Science* (1992) **256**:1808–12. doi:10.1126/science.1535455
31. Ono M, Bolland S, Tempst P, Ravetch JV. Role of the inositol phosphatase SHIP in negative regulation of the immune system by the receptor Fc(γ)RIIB. *Nature* (1996) **383**:263–6. doi:10.1038/383263a0
32. Zhu Z, Li R, Li H, Zhou T, Davis RS. FCRL5 exerts binary and compartment-specific influence on innate-like B-cell receptor signaling. *Proc Natl Acad Sci U S A* (2013) **110**:E1282–90. doi:10.1073/pnas.1215156110
33. Kimberly RP, Ahlstrom JW, Click ME, Edberg JC. The glycosyl phosphatidylinositol-linked Fc gamma RIIPMN mediates transmembrane signaling events distinct from Fc gamma RII. *J Exp Med* (1990) **171**:1239–55. doi:10.1084/jem.171.4.1239
34. Tsuboi N, Asano K, Lauterbach M, Mayadas TN. Human neutrophil Fcγ receptors initiate and play specialized nonredundant roles in antibody-mediated inflammatory diseases. *Immunity* (2008) **28**:833–46. doi:10.1016/j.immuni.2008.04.013
35. Todd RF III, Petty HR. Beta 2 (CD11/CD18) integrins can serve as signaling partners for other leukocyte receptors. *J Lab Clin Med* (1997) **129**:492–8. doi:10.1016/S0022-2143(97)90003-2
36. McEwan WA, Tam JC, Watkinson RE, Bidgood SR, Mallery DL, James LC. Intracellular antibody-bound pathogens stimulate immune signaling via the Fc receptor TRIM21. *Nat Immunol* (2013) **14**:327–36. doi:10.1038/ni.2548
37. Heijnen IA, van Vugt MJ, Fanger NA, Graziano RF, De Wit TP, Hofhuis FM, et al. Antigen targeting to myeloid-specific human Fc gamma RI/CD64 triggers enhanced antibody responses in transgenic mice. *J Clin Invest* (1996) **97**:331–8. doi:10.1172/JCI118420
38. Warmerdam PA, van de Winkel JG, Gosselin EJ, Capel PJ. Molecular basis for a polymorphism of human Fc gamma receptor II (CD32). *J Exp Med* (1990) **172**:19–25. doi:10.1084/jem.172.1.19
39. Parren PW, Warmerdam PA, Boeije LC, Arts J, Westerdaal NA, Vlug A, et al. On the interaction of IgG subclasses with the low affinity Fc gamma RIIa (CD32) on human monocytes, neutrophils, and platelets. Analysis of a functional polymorphism to human IgG2. *J Clin Invest* (1992) **90**:1537–46. doi:10.1172/JCI116022
40. Salmon JE, Edberg JC, Brogle NL, Kimberly RP. Allelic polymorphisms of human Fc gamma receptor IIA and Fc gamma receptor IIIB. Independent mechanisms for differences in human phagocyte function. *J Clin Invest* (1992) **89**:1274–81. doi:10.1172/JCI115712
41. van der Heijden J, Geissler J, van Mirre E, van Deuren M, van der Meer JW, Salama A, et al. A novel splice variant of FcγRIIIa: a risk factor for anaphylaxis in patients with hypogammaglobulinemia. *J Allergy Clin Immunol* (2013) **131**(1408–1416):e1405. doi:10.1016/j.jaci.2013.02.009
42. Su K, Wu J, Edberg JC, Li X, Ferguson P, Cooper GS, et al. A promoter haplotype of the immunoreceptor tyrosine-based inhibitory motif-bearing FcγRIIB alters receptor expression and associates with autoimmunity. I. Regulatory FCGR2B polymorphisms and their association with systemic lupus erythematosus. *J Immunol* (2004) **172**:7186–91. doi:10.4049/jimmunol.172.11.7186
43. Li X, Wu J, Carter RH, Edberg JC, Su K, Cooper GS, et al. A novel polymorphism in the Fcγ receptor IIB (CD32B) transmembrane region alters receptor signaling. *Arthritis Rheum* (2003) **48**:3242–52. doi:10.1002/art.11313
44. Breunis WB, van Mirre E, Bruin M, Geissler J, De Boer M, Peters M, et al. Copy number variation of the activating FCGR2C gene predisposes to idiopathic thrombocytopenic purpura. *Blood* (2008) **111**:1029–38. doi:10.1182/blood-2007-03-079913
45. Wu J, Edberg JC, Redecha PB, Bansal V, Guyre PM, Coleman K, et al. A novel polymorphism of FcγRIIIa (CD16) alters receptor function and predisposes to autoimmune disease. *J Clin Invest* (1997) **100**:1059–70. doi:10.1172/JCI119616
46. Ferrara C, Stuart F, Sondermann P, Brunner P, Umansky P. The carbohydrate at FcγRIIIa Asn-162. An element required for high affinity binding to non-fucosylated IgG glycoforms. *J Biol Chem* (2006) **281**:5032–6. doi:10.1074/jbc.M510171200
47. Breunis WB, van Mirre E, Geissler J, Laddach N, Wolbink G, van der Schoot E, et al. Copy number variation at the FCGR locus includes FCGR3A, FCGR2C and FCGR3B but not FCGR2A and FCGR2B. *Hum Mutat* (2009) **30**:E640–50. doi:10.1002/humu.20997
48. Ory PA, Clark MR, Kwok EE, Clarkson SB, Goldstein IM. Sequences of complementary DNAs that encode the NA1 and NA2 forms of Fc receptor III on human neutrophils. *J Clin Invest* (1989) **84**:1688–91. doi:10.1172/JCI114350
49. Salmon JE, Edberg JC, Kimberly RP. Fc gamma receptor III on human neutrophils. Allelic variants have functionally distinct capacities. *J Clin Invest* (1990) **85**:1287–95. doi:10.1172/JCI114566
50. Bux J, Stein EL, Bierling P, Fromont P, Clay M, Stroncek D, et al. Characterization of a new alloantigen (SH) on the human neutrophil Fc gamma receptor IIIb. *Blood* (1997) **89**:1027–34.
51. Koene HR, Kleijer M, Roos D, De Haas M, Von Dem Borne AEGK. FcγRIIIB gene duplication: evidence for presence and expression of three distinct FcγRIIIB genes in NA(1+,2+)SH(+) individuals. *Blood* (1998) **91**:673–9.
52. Willcocks LC, Lyons PA, Clatworthy MR, Robinson JI, Yang W, Newland SA, et al. Copy number of FCGR3B, which is associated with systemic lupus erythematosus, correlates with protein expression and immune complex uptake. *J Exp Med* (2008) **205**:1573–82. doi:10.1084/jem.20072413
53. Warmerdam PA, van de Winkel JG, Vlug A, Westerdaal NA, Capel PJ. A single amino acid in the second Ig-like domain of the human Fc gamma receptor II is critical for human IgG2 binding. *J Immunol* (1991) **147**:1338–43.
54. Osborne JM, Chacko GW, Brandt JT, Anderson CL. Ethnic variation in frequency of an allelic polymorphism of human Fc gamma RIIA determined with allele specific oligonucleotide probes. *J Immunol Methods* (1994) **173**:207–17. doi:10.1016/0022-1759(94)90299-2
55. Lehnbecher T, Foster CB, Zhu S, Leitman SF, Goldin LR, Huppi K, et al. Variant genotypes of the low-affinity Fcγ receptors in two control populations and a review of low-affinity Fcγ receptor polymorphisms in control and disease populations. *Blood* (1999) **94**:4220–32.
56. van der Heijden J, Nagelkerke S, Zhao X, Geissler J, Rispen T, van den Berg TK, et al. Haplotypes of FcγRIIIa and FcγRIIIB polymorphic variants influence IgG-mediated responses in neutrophils. *J Immunol* (2014) **192**(6):2715–21. doi:10.4049/jimmunol.1203570
57. Floto RA, Clatworthy MR, Heilbronn KR, Rosner DR, Macary PA, Rankin A, et al. Loss of function of a lupus-associated Fc[γ]RIIB polymorphism through exclusion from lipid rafts. *Nat Med* (2005) **11**:1056–8. doi:10.1038/nm1288
58. Takai T. Fc receptors and their role in immune regulation and autoimmunity. *J Clin Immunol* (2005) **25**:1–18. doi:10.1007/s10875-005-0353-8
59. Huizinga T, Kleijer M, Tetteroo P, Roos D, Von Dem Borne A. Biallelic neutrophil Na-antigen system is associated with a polymorphism on the phosphoinositol-linked Fc gamma receptor III (CD16). *Blood* (1990) **75**:213–7.

60. Dijkstra D, Scheepers RHM, Oost WW, Stegeman CA, van der Pol WL, Sluiter WJ, et al. Fcγ receptor polymorphisms in Wegener's granulomatosis: risk factors for disease relapse. *Arthritis Rheum* (1999) **42**:1823–7. doi:10.1002/1529-0131(199909)42:9<1823::AID-ANR5>3.0.CO;2-X
61. Dijkstra D, Bijl M, Fijnheer R, Scheepers RHM, Oost WW, Jansen MD, et al. Fcγ receptor polymorphisms in systemic lupus erythematosus: association with disease and in vivo clearance of immune complexes. *Arthritis Rheum* (2000) **43**:2793–800. doi:10.1002/1529-0131(200012)43:12<2793::AID-ANR20>3.0.CO;2-6
62. Bruhns P. Properties of mouse and human IgG receptors and their contribution to disease models. *Blood* (2012) **119**:5640–9. doi:10.1182/blood-2012-01-380121
63. Cartron G, Dacheux L, Salles G, Solal-Celigny P, Bardos P, Colombat P, et al. Therapeutic activity of humanized anti-CD20 monoclonal antibody and polymorphism in IgG Fc receptor Fcγ3 gene. *Blood* (2002) **99**:754–8. doi:10.1182/blood.V99.3.754
64. Cooper N, Stasi R, Cunningham-Rundles S, Cesarman E, McFarland JG, Busnel JB. Platelet-associated antibodies, cellular immunity and FCGR3a genotype influence the response to rituximab in immune thrombocytopenia. *Br J Haematol* (2012) **158**:539–47. doi:10.1111/j.1365-2141.2012.09184.x
65. Ruysen-Witrand A, Rouanet S, Combe B, Dougados M, Le Loët X, Sibilia J, et al. Fcγ receptor type IIIa polymorphism influences treatment outcomes in patients with rheumatoid arthritis treated with rituximab. *Ann Rheum Dis* (2012) **71**:875–7. doi:10.1136/annrheumdis-2011-200337
66. Louis E, El Ghoul Z, Vermeire S, Dall'ozzo S, Rutgeerts P, Paintaud G, et al. Association between polymorphism in IgG Fc receptor IIIa coding gene and biological response to infliximab in Crohn's disease. *Aliment Pharmacol Ther* (2004) **19**:511–9. doi:10.1111/j.1365-2036.2004.01871.x
67. Moroi R, Endo K, Kinouchi Y, Shiga H, Kakuta Y, Kuroha M, et al. FCGR3A-158 polymorphism influences the biological response to infliximab in Crohn's disease through affecting the ADCC activity. *Immunogenetics* (2013) **65**:265–71. doi:10.1007/s00251-013-0679-8
68. Tutuncu Z, Kavanaugh A, Zvaifler N, Corr M, Deutsch R, Boyle D. Fcγ receptor type IIIa polymorphisms influence treatment outcomes in patients with inflammatory arthritis treated with tumor necrosis factor α-blocking agents. *Arthritis Rheum* (2005) **52**:2693–6. doi:10.1002/art.21266
69. Kastbom A, Bratt J, Ernestam S, Lampa J, Padyukov L, Söderkvist P, et al. Fcγ receptor type IIIa genotype and response to tumor necrosis factor α-blocking agents in patients with rheumatoid arthritis. *Arthritis Rheum* (2007) **56**:448–52. doi:10.1002/art.22390
70. Fujimoto T-T, Inoue M, Shimomura T, Fujimura K. Involvement of Fcγ receptor polymorphism in the therapeutic response of idiopathic thrombocytopenic purpura. *Br J Haematol* (2001) **115**:125–30. doi:10.1046/j.1365-2141.2001.03109.x
71. Shrestha S, Wiener H, Shendre A, Kaslow RA, Wu J, Olson A, et al. Role of activating FcγR gene polymorphisms in Kawasaki disease susceptibility and intravenous immunoglobulin response. *Circ Cardiovasc Genet* (2012) **5**:309–16. doi:10.1161/CIRCGENETICS.111.962464
72. Makowsky R, Wiener HW, Ptacek TS, Silva M, Shendre A, Edberg JC, et al. Fcγ3 gene copy number in Kawasaki disease and intravenous immunoglobulin treatment response. *Pharmacogenet Genomics* (2013) **23**:455–62. doi:10.1097/FPC.0b013e328363686e
73. Shrestha S, Wiener HW, Olson AK, Edberg JC, Bowles NE, Patel H, et al. Functional FCGR2B gene variants influence intravenous immunoglobulin response in patients with Kawasaki disease. *J Allergy Clin Immunol* (2011) **128**:677–80. doi:10.1016/j.jaci.2011.04.027
74. Lejeune J, Thibault G, Ternant D, Cartron G, Watier H, Ohresser M. Evidence for linkage disequilibrium between Fcγ3A-R131H and Fcγ3A-R131I polymorphisms in white patients, and for an Fcγ3A-R131I-restricted influence on the response to therapeutic antibodies. *J Clin Oncol* (2008) **26**:5489–91. doi:10.1200/JCO.2008.19.4118
75. Raknes G, Skeie GO, Gilhus NE, Aadland S, Vedeler C. FcγRIIA and FcγRIIIB polymorphisms in myasthenia gravis. *J Neuroimmunol* (1998) **81**:173–6. doi:10.1016/S0165-5728(97)00174-4
76. van der Pol W-L, van den Berg LH, Scheepers RHM, van der Bom JG, van Doorn PA, van Koningsveld R, et al. IgG receptor IIa alleles determine susceptibility and severity of Guillain-Barré syndrome. *Neurology* (2000) **54**:1661–5. doi:10.1212/WNL.54.8.1661
77. Foster CB, Zhu S, Erichsen HC, Lehrnbecher T, Hart ES, Choi E, et al. Polymorphisms in inflammatory cytokines and Fcγ receptors in childhood chronic immune thrombocytopenic purpura: a pilot study. *Br J Haematol* (2001) **113**:596–9. doi:10.1046/j.1365-2141.2001.02807.x
78. Bournazos S, Grinfeld J, Alexander K, Murchison J, Wallace W, McFarlane P, et al. Association of Fcγ3A-R131H polymorphism with idiopathic pulmonary fibrosis severity and progression. *BMC Pulm Med* (2010) **10**:51. doi:10.1186/1471-2466-10-51
79. Khor CC, Davila S, Breunis WB, Lee Y-C, Shimizu C, Wright VJ, et al. Genome-wide association study identifies FCGR2A as a susceptibility locus for Kawasaki disease. *Nat Genet* (2011) **43**:1241–6. doi:10.1038/ng.981
80. Sanders LAM, van de Winkel JGJ, Rijkers GT, Voorhorst-Ogink MM, De Haas M, Capel PJA, et al. Fcγ receptor IIa (CD32) heterogeneity in patients with recurrent bacterial respiratory tract infections. *J Infect Dis* (1994) **170**:854–61. doi:10.1093/infdis/170.4.854
81. Duits AJ, Bootsma H, Derksen RH, Spronk PE, Kater L, Kallenberg CG, et al. Skewed distribution of IgG Fc receptor IIa (CD32) polymorphism is associated with renal disease in systemic lupus erythematosus patients. *Arthritis Rheum* (1995) **38**:1832–6. doi:10.1002/art.1780381217
82. Edberg JC, Wainstein E, Wu J, Csernok E, Sneller MC, Hoffman GS, et al. Analysis of Fcγ3 gene polymorphisms in Wegener's granulomatosis. *Exp Clin Immunogenet* (1997) **14**:183–95.
83. Haseley LA, Wisniewski JJ, Denburg MR, Michael-Grossman AR, Ginzler EM, Gourley MF, et al. Antibodies to C1q in systemic lupus erythematosus: characteristics and relation to Fcγ3 alleles. *Kidney Int* (1997) **52**:1375–80. doi:10.1038/ki.1997.464
84. Williams Y, Lynch S, McCann S, Smith O, Feighery C, Whelan A. Correlation of platelet FcγRIIA polymorphism in refractory idiopathic (immune) thrombocytopenic purpura. *Br J Haematol* (1998) **101**:779–82. doi:10.1046/j.1365-2141.1998.00802.x
85. Myhr K-M, Raknes G, Nyland H, Vedeler C. Immunoglobulin G Fc-receptor (FcγR) IIA and IIIB polymorphisms related to disability in MS. *Neurology* (1999) **52**:1771. doi:10.1212/WNL.52.9.1771
86. Norsworthy P, Theodoridis E, Botto M, Athanassiou P, Beynon H, Gordon C, et al. Overrepresentation of the Fcγ receptor type IIA R131I/R131I genotype in Caucasoid systemic lupus erythematosus patients with autoantibodies to C1q and glomerulonephritis. *Arthritis Rheum* (1999) **42**:1828–32. doi:10.1002/1529-0131(199909)42:9<1828::AID-ANR6>3.0.CO;2-F
87. Yuh HR, Koh HK, Kim SS, Chung WT, Kim DW, Hong KP, et al. Fcγ3A-R131I polymorphism and its association with clinical manifestations in Korean lupus patients. *Lupus* (2001) **10**:466–72. doi:10.1191/096120301678416015
88. Karassa FB, Trikalinos TA, Ioannidis JPA. Role of the Fcγ receptor IIa polymorphism in susceptibility to systemic lupus erythematosus and lupus nephritis: a meta-analysis. *Arthritis Rheum* (2002) **46**:1563–71. doi:10.1002/art.10306
89. Karassa FB, Bijl M, Davies KA, Kallenberg CGM, Khamashta MA, Manger K, et al. Role of the Fcγ receptor IIa polymorphism in the antiphospholipid syndrome: an international meta-analysis. *Arthritis Rheum* (2003) **48**:1930–8. doi:10.1002/art.11059
90. Tanaka Y, Suzuki Y, Tsuge T, Kanamaru Y, Horikoshi S, Monteiro RC, et al. Fcγ3A-R131I allele and Fcγ3A-R131I-V genotype are risk factors for progression of IgA nephropathy. *Nephrol Dial Transplant* (2005) **20**:2439–45. doi:10.1093/ndt/gfi043
91. Morgan AW, Robinson JI, Barrett JH, Martin J, Walker A, Babbage SJ, et al. Association of FCGR2A and FCGR2A-FCGR3A haplotypes with susceptibility to giant cell arteritis. *Arthritis Res Ther* (2006) **8**:R109. doi:10.1186/ar1996
92. Gulen F, Tanac R, Altinoz S, Berdeli A, Zeyrek D, Koksoy H, et al. The FcγRIIA polymorphism in Turkish children with asthma bronchial and allergic rhinitis. *Clin Biochem* (2007) **40**:392–6. doi:10.1016/j.clinbiochem.2006.11.014
93. Aksu K, Kitapcioglu G, Keser G, Berdeli A, Karabulut G, Kobak S, et al. Fcγ3A-R131I, IIIa and IIIb gene polymorphisms in Behçet's disease: do they have any clinical implications? *Clin Exp Rheumatol* (2008) **26**:S77–83.
94. Woo J-H, Sung Y-K, Lee J-S, Chung WT, Choe J-Y, Song GG, et al. Association of Fcγ receptor polymorphisms with adult onset still's disease in Korea. *J Rheumatol* (2009) **36**:347–50. doi:10.3899/jrheum.071254
95. Kyogoku C, Dijkstra D, Scheepers RHM, Tsuchiya N, Hattori Y, Yamaguchi A, et al. Fcγ receptor gene polymorphisms in Japanese patients with systemic

- lupus erythematosus: contribution of FCGR2B to genetic susceptibility. *Arthritis Rheum* (2002) **46**:1242–54. doi:10.1002/art.10257
96. Siriboonrit U, Tsuchiya N, Sirikong M, Kyogoku C, Bejrachandra S, Suthipinittharm P, et al. Association of Fcγ receptor IIb and IIb polymorphisms with susceptibility to systemic lupus erythematosus in Thais. *Tissue Antigens* (2003) **61**:374–83. doi:10.1034/j.1399-0039.2003.00047.x
 97. Kono H, Kyogoku C, Suzuki T, Tsuchiya N, Honda H, Yamamoto K, et al. FcγRIIB Ile232Thr transmembrane polymorphism associated with human systemic lupus erythematosus decreases affinity to lipid rafts and attenuates inhibitory effects on B cell receptor signaling. *Hum Mol Genet* (2005) **14**:2881–92. doi:10.1093/hmg/ddi320
 98. Willcocks LC, Carr EJ, Niederer HA, Rayner TF, Williams TN, Yang W, et al. A defuncting polymorphism in FCGR2B is associated with protection against malaria but susceptibility to systemic lupus erythematosus. *Proc Natl Acad Sci U S A* (2010) **107**:7881–5. doi:10.1073/pnas.0915133107
 99. Zhou X-J, Lv J-C, Yu L, Cui Z, Zhao J, Yang R, et al. FCGR2B gene polymorphism rather than FCGR2A, FCGR3A and FCGR3B is associated with anti-GBM disease in Chinese. *Nephrol Dial Transplant* (2010) **25**:97–101. doi:10.1093/ndt/gfp374
 100. Blank M, Stefanescu R, Masuda E, Marti F, King P, Redecha P, et al. Decreased transcription of the human FCGR2B gene mediated by the -343 G/C promoter polymorphism and association with systemic lupus erythematosus. *Hum Genet* (2005) **117**:220–7. doi:10.1007/s00439-005-1302-3
 101. Tackenberg B, Jelcic I, Baerenwaldt A, Oertel WH, Sommer N, Nimmerjahn F, et al. Impaired inhibitory Fcγ receptor IIB expression on B cells in chronic inflammatory demyelinating polyneuropathy. *Proc Natl Acad Sci U S A* (2009) **106**:4788–92. doi:10.1073/pnas.0807319106
 102. Koene HR, Kleijer M, Swaak AJ, Sullivan KE, Bijl M, Petri MA, et al. The Fc gammaRIIA-158F allele is a risk factor for systemic lupus erythematosus. *Arthritis Rheum* (1998) **41**:1813–8. doi:10.1002/1529-0131(199810)41:10<1813::AID-ART13>3.3.CO;2-Y
 103. Nieto A, Cáliz R, Pascual M, Matarán L, García S, Martín J. Involvement of Fcγ receptor IIIA genotypes in susceptibility to rheumatoid arthritis. *Arthritis Rheum* (2000) **43**:735–9. doi:10.1002/1529-0131(200004)43:4<735::AID-ANR3>3.0.CO;2-Q
 104. Edberg JC, Langefeld CD, Wu J, Moser KL, Kaufman KM, Kelly J, et al. Genetic linkage and association of Fcγ receptor IIIA (CD16A) on chromosome 1q23 with human systemic lupus erythematosus. *Arthritis Rheum* (2002) **46**:2132–40. doi:10.1002/art.10438
 105. van Sorge NM, van der Pol WL, Jansen MD, Geleijns KPW, Kalmijn S, Hughes RAC, et al. Severity of Guillain-Barré syndrome is associated with Fcγ receptor III polymorphisms. *J Neuroimmunol* (2005) **162**:157–64. doi:10.1016/j.jneuroim.2005.01.016
 106. Morgan AW, Griffiths B, Ponchel F, Montague BMN, Ali M, Gardner PP, et al. Fcγ receptor type IIIA is associated with rheumatoid arthritis in two distinct ethnic groups. *Arthritis Rheum* (2000) **43**:2328–34. doi:10.1002/1529-0131(200010)43:10<2328::AID-ANR21>3.0.CO;2-Z
 107. Lee YH, Ji JD, Song GG. Associations between FCGR3A polymorphisms and susceptibility to rheumatoid arthritis: a meta analysis. *J Rheumatol* (2008) **35**:2129–35. doi:10.3899/jrheum.080186
 108. Bronner IM, Hoogendijk JE, De Visser M, van de Vlekkert J, Badrising UA, Wintzen AR, et al. Association of the leukocyte immunoglobulin G (Fcγ) receptor IIIa-158V/F polymorphism with inflammatory myopathies in Dutch patients. *Tissue Antigens* (2009) **73**:586–9. doi:10.1111/j.1399-0039.2009.01236.x
 109. Thabet MM, Huizinga TWJ, Marques RB, Stoeken-Rijsbergen G, Bakker AM, Kurreeman FA, et al. Contribution of Fcγ receptor IIIA gene 158V/F polymorphism and copy number variation to the risk of ACPA-positive rheumatoid arthritis. *Ann Rheum Dis* (2009) **68**:1775–80. doi:10.1136/ard.2008.099309
 110. Zhou X-J, Lv J-C, Bu D-F, Yu L, Yang Y-R, Zhao J, et al. Copy number variation of FCGR3A rather than FCGR3B and FCGR2B is associated with susceptibility to anti-GBM disease. *Int Immunol* (2010) **22**:45–51. doi:10.1093/intimm/dxp113
 111. Hatta Y, Tsuchiya N, Ohashi J, Matsushita M, Fujiwara K, Hagiwara K, et al. Association of Fc gamma receptor IIIB, but not of Fc gamma receptor IIA and IIIA polymorphisms with systemic lupus erythematosus in Japanese. *Genes Immun* (1999) **1**:53–60. doi:10.1038/sj.gene.6363639
 112. Tse WY, Abadeh S, Jefferis R, Savage CO, Adu D. Neutrophil Fcγgamma-RIIB allelic polymorphism in anti-neutrophil cytoplasmic antibody (ANCA)-positive systemic vasculitis. *Clin Exp Immunol* (2000) **119**:574–7. doi:10.1046/j.1365-2249.2000.01182.x
 113. Xu G, He Q, Shou Z, Wang H, Zhang X, Wang Y, et al. NA1/NA2 heterozygote of Fcγr3b is a risk factor for progression of IgA nephropathy in Chinese. *J Clin Lab Anal* (2007) **21**:298–302. doi:10.1002/jcla.20189
 114. Aitman TJ, Dong R, Vyse TJ, Norsworthy PJ, Johnson MD, Smith J, et al. Copy number polymorphism in Fcγr3 predisposes to glomerulonephritis in rats and humans. *Nature* (2006) **439**:851–5. doi:10.1038/nature04489
 115. Fanciulli M, Norsworthy PJ, Petretto E, Dong R, Harper L, Kamesh L, et al. FCGR3B copy number variation is associated with susceptibility to systemic, but not organ-specific, autoimmunity. *Nat Genet* (2007) **39**:721–3. doi:10.1038/ng2046
 116. Bournazos S, Bournazou I, Murchison JT, Wallace WA, McFarlane P, Hirani N, et al. Copy number variation of <i>FCGR3B</i> is associated with susceptibility to idiopathic pulmonary fibrosis. *Respiration* (2011) **81**:142–9. doi:10.1159/000321997
 117. Graf SW, Lester S, Nossent JC, Hill CL, Proudman SM, Lee A, et al. Low copy number of the FCGR3B gene and rheumatoid arthritis: a case-control study and meta-analysis. *Arthritis Res Ther* (2012) **14**:R28. doi:10.1186/ar3731
 118. McKinney C, Broen JCA, Vonk MC, Beretta L, Hesselstrand R, Hunzelmann N, et al. Evidence that deletion at FCGR3B is a risk factor for systemic sclerosis. *Genes Immun* (2012) **13**:458–60. doi:10.1038/gene.2012.15
 119. Smith P, Dillillo DJ, Bournazos S, Li F, Ravetch JV. Mouse model recapitulating human Fcγamma receptor structural and functional diversity. *Proc Natl Acad Sci U S A* (2012) **109**(16):6181–6. doi:10.1073/pnas.1203954109
 120. Guyre PM, Graziano RF, Goldstein J, Wallace PK, Morganeli PM, Wardwell K, et al. Increased potency of Fc-receptor-targeted antigens. *Cancer Immunol Immunother* (1997) **45**:146–8. doi:10.1007/s002620050418
 121. Keler T, Guyre PM, Vitale LA, Sundarapandiyam K, van de Winkel JG, Deo YM, et al. Targeting weak antigens to CD64 elicits potent humoral responses in human CD64 transgenic mice. *J Immunol* (2000) **165**:6738–42. doi:10.4049/jimmunol.165.12.6738
 122. Heijnen IA, van de Winkel JG. A human Fc gamma RI/CD64 transgenic model for in vivo analysis of (bispecific) antibody therapeutics. *J Hematother* (1995) **4**:351–6. doi:10.1089/scd.1.1995.4.351
 123. Stavenhagen JB, Gorlatov S, Tuailon N, Rankin CT, Li H, Burke S, et al. Fc optimization of therapeutic antibodies enhances their ability to kill tumor cells in vitro and controls tumor expansion in vivo via low-affinity activating Fcγamma receptors. *Cancer Res* (2007) **67**:8882–90. doi:10.1158/0008-5472.CAN-07-0696
 124. Junttila TT, Parsons K, Olsson C, Lu Y, Xin Y, Theriault J, et al. Superior in vivo efficacy of afucosylated trastuzumab in the treatment of HER2-amplified breast cancer. *Cancer Res* (2010) **70**:4481–9. doi:10.1158/0008-5472.CAN-09-3704
 125. Gerdes CA, Nicolini VG, Herter S, van Puijenbroek E, Lang S, Roemmele M, et al. GA201 (RG7160): a novel, humanized, glycoengineered anti-EGFR antibody with enhanced ADCC and superior in vivo efficacy compared with cetuximab. *Clin Cancer Res* (2013) **19**:1126–38. doi:10.1158/1078-0432.CCR-12-0989
 126. Kim JM, Ashkenazi A. Fcγamma receptors enable anticancer action of proapoptotic and immune-modulatory antibodies. *J Exp Med* (2013) **210**:1647–51. doi:10.1084/jem.20131625
 127. Mellor JD, Brown MP, Irving HR, Zalberg JR, Dobrovic A. A critical review of the role of Fc gamma receptor polymorphisms in the response to monoclonal antibodies in cancer. *J Hematol Oncol* (2013) **6**:1. doi:10.1186/1756-8722-6-1
 128. Clynes R, Ravetch JV. Cytotoxic antibodies trigger inflammation through Fc receptors. *Immunity* (1995) **3**:21–6. doi:10.1016/1074-7613(95)90155-8
 129. McKenzie SE, Taylor SM, Malladi P, Yuhan H, Cassel DL, Chien P, et al. The role of the human Fc receptor Fc gamma RIIA in the immune clearance of platelets: a transgenic mouse model. *J Immunol* (1999) **162**:4311–8.
 130. Taylor SM, Reilly MP, Schreiber AD, Chien P, Tuckosh JR, McKenzie SE. Thrombosis and shock induced by activating antiplatelet antibodies in human Fc gamma RIIA transgenic mice: the interplay among antibody, spleen, and Fc receptor. *Blood* (2000) **96**:4254–60.
 131. Reilly MP, Taylor SM, Hartman NK, Arepally GM, Sachais BS, Cines DB, et al. Heparin-induced thrombocytopenia/thrombosis in a transgenic mouse model requires human platelet factor 4 and platelet activation through FcγgammaRIIA. *Blood* (2001) **98**:2442–7. doi:10.1182/blood.V98.8.2442

132. Rauova L, Zhai L, Kowalska MA, Arepally GM, Cines DB, Poncz M. Role of platelet surface PF4 antigenic complexes in heparin-induced thrombocytopenia pathogenesis: diagnostic and therapeutic implications. *Blood* (2006) **107**:2346–53. doi:10.1182/blood-2005-08-3122
133. Meyer T, Robles-Carrillo L, Robson T, Langer F, Desai H, Davila M, et al. Bevacizumab immune complexes activate platelets and induce thrombosis in FCGR2A transgenic mice. *J Thromb Haemost* (2009) **7**:171–81. doi:10.1111/j.1538-7836.2008.03212.x
134. Robles-Carrillo L, Meyer T, Hatfield M, Desai H, Davila M, Langer F, et al. Anti-CD40L immune complexes potently activate platelets in vitro and cause thrombosis in FCGR2A transgenic mice. *J Immunol* (2010) **185**:1577–83. doi:10.4049/jimmunol.0903888
135. Stolla M, Stefanini L, Andre P, Ouellette TD, Reilly MP, McKenzie SE, et al. CalDAG-GEFI deficiency protects mice in a novel model of FcγRIIA-mediated thrombosis and thrombocytopenia. *Blood* (2011) **118**:1113–20. doi:10.1182/blood-2011-03-342352
136. Jönsson F, Mancardi DA, Zhao W, Kita Y, Iannascoli B, Khun H, et al. Human FcγRIIA induces anaphylactic and allergic reactions. *Blood* (2012) **119**:2533–44. doi:10.1182/blood-2011-07-367334
137. Petkova SB, Akilesh S, Sproule TJ, Christianson GJ, Al Khabbaz H, Brown AC, et al. Enhanced half-life of genetically engineered human IgG1 antibodies in a humanized FcRn mouse model: potential application in humoral mediated autoimmune disease. *Int Immunol* (2006) **18**:1759–69. doi:10.1093/intimm/dx110
138. Mancardi DA, Jonsson F, Iannascoli B, Khun H, van Rooijen N, Huerre M, et al. The murine high-affinity IgG receptor Fc(γ)RIV is sufficient for autoantibody-induced arthritis. *J Immunol* (2011) **186**:1899–903. doi:10.4049/jimmunol.1003642
139. Christianson GJ, Blankenburg RL, Duffy TM, Panka D, Roths JB, Marshak-Rothstein A, et al. beta2-microglobulin dependence of the lupus-like autoimmune syndrome of MRL-lpr mice. *J Immunol* (1996) **156**:4932–9.
140. Tan Sardjono C, Mottram PL, van de Velde NC, Powell MS, Power D, Slocombe RF, et al. Development of spontaneous multisystem autoimmune disease and hypersensitivity to antibody-induced inflammation in FcγRIIa receptor IIa-transgenic mice. *Arthritis Rheum* (2005) **52**:3220–9. doi:10.1002/art.21344
141. van de Velde NC, Mottram PL, Powell MS, Lim B, Holmdahl R, Hogarth PM. Transgenic mice expressing human FcγRIIa have enhanced sensitivity to induced autoimmune arthritis as well as elevated Th17 cells. *Immunol Lett* (2010) **130**:82–8. doi:10.1016/j.imlet.2009.12.005
142. Tsuboi N, Hernandez T, Li X, Nishi H, Cullere X, Mekala D, et al. Regulation of human neutrophil FcγRIIa by C5a receptor promotes inflammatory arthritis in mice. *Arthritis Rheum* (2011) **63**:467–78. doi:10.1002/art.30141
143. Pietersz GA, Mottram PL, van de Velde NC, Sardjono CT, Esparon S, Ramsland PA, et al. Inhibition of destructive autoimmune arthritis in FcγRIIa transgenic mice by small chemical entities. *Immunol Cell Biol* (2009) **87**:3–12. doi:10.1038/icb.2008.82
144. van Vuuren AJ, van Roon JA, Walraven V, Stuij I, Harmsen MC, McLaughlin PM, et al. CD64-directed immunotoxin inhibits arthritis in a novel CD64 transgenic rat model. *J Immunol* (2006) **176**:5833–8. doi:10.4049/jimmunol.176.10.5833
145. Thepen T, van Vuuren AJ, Kiekens RC, Damen CA, Vooijs WC, van de Winkel JG. Resolution of cutaneous inflammation after local elimination of macrophages. *Nat Biotechnol* (2000) **18**:48–51. doi:10.1038/71908
146. Chen K, Nishi H, Travers R, Tsuboi N, Martinod K, Wagner DD, et al. Endocytosis of soluble immune complexes leads to their clearance by FcγRIIIB but induces neutrophil extracellular traps via FcγRIIA in vivo. *Blood* (2012) **120**:4421–31. doi:10.1182/blood-2011-12-401133
147. van Vugt MJ, Heijnen AF, Capel PJ, Park SY, Ra C, Saito T, et al. FcR gamma-chain is essential for both surface expression and function of human Fc gamma RI (CD64) in vivo. *Blood* (1996) **87**:3593–9.
148. van Royen-Kerkhof A, Sanders EA, Walraven V, Voorhorst-Ogink M, Saeland E, Teeling JL, et al. A novel human CD32 mAb blocks experimental immune haemolytic anaemia in FcγRIIA transgenic mice. *Br J Haematol* (2005) **130**:130–7. doi:10.1111/j.1365-2141.2005.05571.x
149. Zhi H, Rauova L, Hayes V, Gao C, Boylan B, Newman DK, et al. Cooperative integrin/ITAM signaling in platelets enhances thrombus formation in vitro and in vivo. *Blood* (2013) **121**:1858–67. doi:10.1182/blood-2012-07-443325
150. Horton HM, Chu SY, Ortiz EC, Pong E, Cemerski S, Leung IW, et al. Antibody-mediated coengagement of FcγRIIb and B cell receptor complex suppresses humoral immunity in systemic lupus erythematosus. *J Immunol* (2011) **186**:4223–33. doi:10.4049/jimmunol.1003412
151. Li F, Ravetch JV. Inhibitory FcγRIIb receptor engagement drives adjuvant and anti-tumor activities of agonistic CD40 antibodies. *Science* (2011) **333**:1030–4. doi:10.1126/science.1206954
152. Li F, Ravetch JV. Antitumor activities of agonistic anti-TNFR antibodies require differential FcγRIIb coengagement in vivo. *Proc Natl Acad Sci U S A* (2013) **110**:19501–6. doi:10.1073/pnas.1319502110
153. Li M, Wirthmueller U, Ravetch JV. Reconstitution of human Fc gamma RIII cell type specificity in transgenic mice. *J Exp Med* (1996) **183**:1259–63. doi:10.1084/jem.183.3.1259
154. Roopenian DC, Christianson GJ, Sproule TJ, Brown AC, Akilesh S, Jung N, et al. The MHC class I-like IgG receptor controls perinatal IgG transport, IgG homeostasis, and fate of IgG-Fc-coupled drugs. *J Immunol* (2003) **170**:3528–33. doi:10.4049/jimmunol.170.7.3528
155. Mezo AR, McDonnell KA, Hehir CA, Low SC, Palombella VJ, Stattel JM, et al. Reduction of IgG in nonhuman primates by a peptide antagonist of the neonatal Fc receptor FcRn. *Proc Natl Acad Sci U S A* (2008) **105**:2337–42. doi:10.1073/pnas.0708960105

Conflict of Interest Statement: The authors declare that the research was conducted in the absence of any commercial or financial relationships that could be construed as a potential conflict of interest.

Received: 11 March 2014; paper pending published: 29 March 2014; accepted: 14 May 2014; published online: 30 May 2014.

Citation: Gillis C, Gouel-Chéron A, Jönsson F and Bruhns P (2014) Contribution of human FcγRs to disease with evidence from human polymorphisms and transgenic animal studies. *Front. Immunol.* 5:254. doi: 10.3389/fimmu.2014.00254

This article was submitted to *Immunotherapies and Vaccines*, a section of the journal *Frontiers in Immunology*.

Copyright © 2014 Gillis, Gouel-Chéron, Jönsson and Bruhns. This is an open-access article distributed under the terms of the Creative Commons Attribution License (CC BY). The use, distribution or reproduction in other forums is permitted, provided the original author(s) or licensor are credited and that the original publication in this journal is cited, in accordance with accepted academic practice. No use, distribution or reproduction is permitted which does not comply with these terms.

A

Anaphylaxis (Immediate Hypersensitivity): From Old to New Mechanisms

Caitlin M. Gillis^{1,2,3}, Aurélie Gouel-Chéron^{1,2,3} and Pierre Bruhns^{1,2}

¹Institut Pasteur, Department of Immunology, Unit of Antibodies in Therapy and Pathology, Paris, France

²INSERM, U1222, Paris, France

³Université Pierre et Marie Curie, Paris, France

Synonyms

[Allergic shock; Systemic type I immediate hypersensitivity reaction](#)

Anaphylaxis: Definition and Historical Perspectives

Anaphylaxis is a severe and potentially fatal systemic allergic reaction that occurs immediately after contact with the provocative substance (allergen). The most common causative agents are food and drugs; however, an equivalently large proportion of cases (20 %) are idiopathic. Although there continues to be a dramatic increase in prevalence of anaphylaxis worldwide (Koplin et al. 2011), our understanding of the responsible immune mechanisms remains incomplete. As a clinical condition, variable

presentation and heterogeneity in terminology, criteria, and definitions have led to inconsistent diagnoses of anaphylaxis, and further confound attempts to understand the underlying pathogenesis. Recent efforts to define the diagnostic criteria for an anaphylactic reaction consider the involvement of multiple organ systems: primarily the skin or mucosal tissue, since 80 % of cases experience cutaneous symptoms such as hives, itch, or flush, with simultaneous respiratory or cardiovascular compromise, or persistent gastrointestinal symptoms.

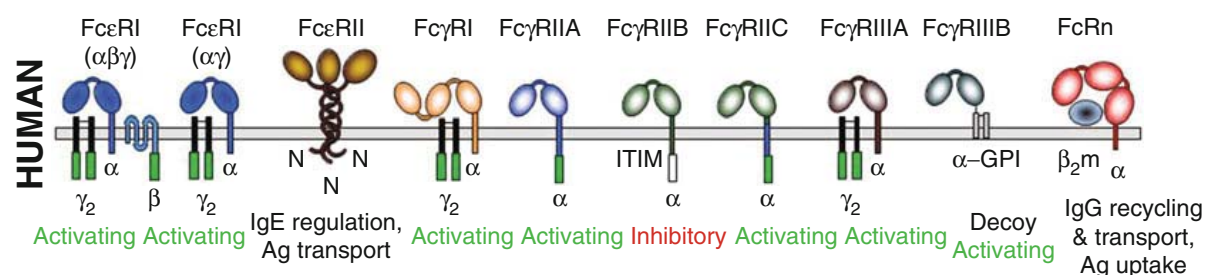
The classical paradigm considers anaphylaxis to be an immediate hypersensitivity reaction to an allergen mediated by IgE antibodies, in a patient previously sensitized to that particular antigen, resulting in the release of granular mediators by mast cells and basophils. These mediators induce vasodilatation, increased vascular permeability, and bronchoconstriction, leading to a state of “shock”: a drop in arterial pressure, tachycardia, bronchospasm, and digestive troubles. Death can result from subsequent cardiac failure, asphyxia, or pulmonary edema following major bronchospasm with respiratory distress. Altogether, current treatments for allergic anaphylaxis remain primarily limited to prophylactic allergen avoidance and medications to reverse the physiological effects of mediator release, such as adrenaline. It is therefore necessary to understand the underlying immune mechanisms, to target these pathways to alleviate shock or even ameliorate the allergic state of the individual.

Our understanding of the phenomenon of anaphylaxis began with the findings of Nobel prize-winner Charles Richet and Paul Portier in 1902, working with toxins isolated from the sea anemone *Actinia sulcata* (reviewed by Cohen and Zelaya-Quesada (2002)). They found that dogs which had recovered from receiving an injection of the toxin experienced sudden and fatal reactions after subsequent injection, even at a weaker dose. Others had previously observed that injection of a foreign protein into laboratory animals, although initially well tolerated, upon repeat injection may give rise to unanticipated adverse effects, systemic shock, and death. Indeed, 63 years earlier Magendie had noted that rabbits developed sudden and fatal collapse upon repeated injection of egg albumen. Portier and Richet identified these reactions that they observed in dogs to be a result of a pathological phenomenon behaving in a similar yet opposite manner to immunity. The initial inoculation, rather than inducing antigen tolerance as expected, specifically sensitized the animals to subsequent exposure. Richet coined the term “aphylaxis,” to indicate a lack of protection, a term subsequently modified to anaphylaxis for the sake of euphony. In 1907 Richet went on to observe that the serum of inoculated dogs contained anaphylactogenic properties, and that transferring blood from an affected animal to a healthy one could elicit hypersensitivity in the recipient.

The passive transmission of hypersensitivity was recapitulated in humans in 1921: conceived as a test for patient allergy, Prausnitz and Küstner demonstrated that a serum factor or “reagin” from an allergic patient could transfer antigen sensitivity when injected intradermally into a healthy recipient, manifesting as a skin reaction after challenge with the antigen in question (Prausnitz and Küstner 1921). Indeed, the Prausnitz-Küstner reaction (P-K test) was thereafter used not only as an assay for patients’ allergic status but also as a test to determine the component of serum responsible for sensitization. New analytical methods for serum protein fractionation facilitated the identification of the “reaginic” portion of allergic serum as a new

immunoglobulin class, subsequently designated to be IgE (Ishizaka et al. 1966). At the same time, an IgE-producing myeloma was identified, and this myeloma-derived IgE protein was demonstrated to block the induction of a Prausnitz-Küstner reaction if injected prior to sensitization with allergic serum, providing the experimental proof that this was an IgE-mediated phenomenon. Furthermore, the Fc fragment of the myeloma protein was sufficient to inhibit the P-K test, indicating that the reaction proceeds through binding to Fc receptors. Indeed the high-affinity FcεRI is expressed on mast cells in the skin, and receptor-mediated mast cell activation leading to degranulation and histamine release can induce local inflammation. The current consensus of anaphylaxis induction is that upon antigen sensitization, specific IgE antibodies are produced and bind to FcεRI expressed on mast cells and basophils. When an individual is reexposed to the allergen, the binding of antigen to these specific IgE-prebound receptors leads to rapid cellular activation and the release of preformed mediators, such as histamine and mast cell-specific proteases, chemokines, and cytokines, which mediate anaphylactic symptoms and shock. The mechanisms controlling antigen sensitization, or the induction of an allergic state, remain incompletely defined.

The discovery of IgE was critical to advances in the field of allergy: antigen-dependent activation of tissue mast cells that have specific IgE bound to their surface is the central event in many acute allergic reactions (Galli 2005). Importantly, however, the P-K test exemplifies a passive cutaneous model of anaphylaxis, with a specific sensitization protocol and route of allergen exposure. Anaphylaxis may result from exposure at cutaneous surfaces (insect stings), at mucosal linings (gut epithelium) and on a systemic level (injectable drugs). Considering that food and drug exposure accounts for the majority of anaphylactic reactions, and studies have indicated that drug-induced anaphylaxis is the most common cause of anaphylaxis fatalities, it is necessary to understand the immunological mechanisms underlying these systemic reactions. Indeed IgE represents only a very minor proportion of the total systemic



Anaphylaxis (Immediate Hypersensitivity): From Old to New Mechanisms, Fig. 1 Human IgE and IgG receptors. Schematic representation of human FcRs at the

cell membrane (gray bar) and their association or not to the FcR γ -chain dimer (black). ITAMs are represented by green boxes and ITIMs by a white box

immunoglobulin, present in the serum at concentrations less than 0.002 mg/mL, and with a very short half-life of several hours in circulation. IgG on the other hand is the most dominant antibody subclass and exhibits the highest synthetic rate and longest biological half-life: IgG antibodies are present at serum concentrations of 5–12 mg/mL with a half-life of 14–21 days. Both IgE and IgG have been implicated as mediators of anaphylactic events. Mast cells and basophils express IgG receptors as well as IgE receptors, and furthermore other antibody receptor-expressing cell types have the capacity to produce vasoactive mediators.

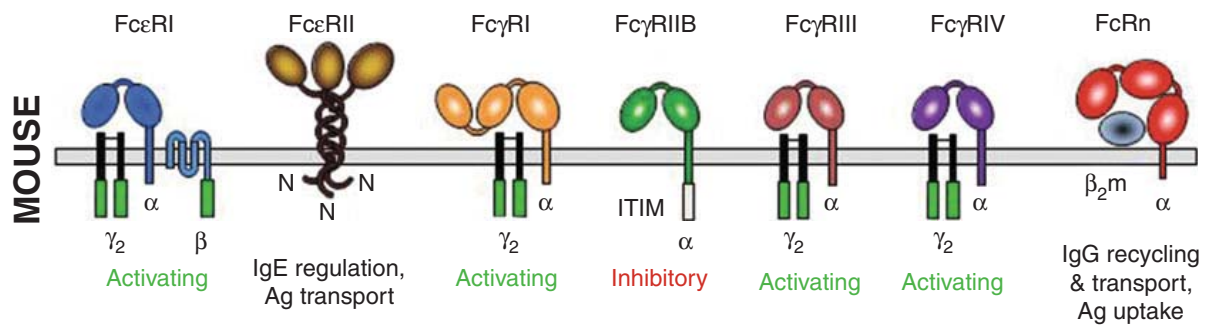
Structure and Functions

Antibodies and their receptors: The immunoglobulin protein backbone consists of two identical heavy and two identical light chains. The amino-terminal regions of the heavy and light chains exhibit highly variable amino acid composition, and these variable regions are involved in antigen binding and determine the specificity of the antibody. Five classes of immunoglobulins (IgG, IgA, IgM, IgD, and IgE) have been distinguished on the basis of antigenic determinants in regions of highly conserved amino acid sequences in the constant regions of their heavy chains. Four distinct heavy chain subgroups of human IgG are defined as IgG subclasses 1, 2, 3, and 4 based on their relative concentration in normal serum. The “constant” regions of the antibody heavy chain determine their effector functions: complement fixation and ability to cross

membranes and to bind to antibody receptors (FcR).

FcR induce biological responses within the cell via activating or inhibitory signaling motifs contained within the cytoplasmic portion of the receptor molecule, or associated signaling chains. Upon binding of antigen-antibody complexes, receptor aggregation triggers intracellular signaling pathways in a process referred to as receptor cross-linking. Humans express a single high-affinity activating receptor for IgE (hFcεRI), several activating receptors for IgG (hFcγRI, hFcγRIIA, hFcγRIIC, and hFcγRIIIA), a single inhibitory IgG receptor (hFcγRIIB), and a glycoposphatidylinositol-linked receptor hFcγRIIIB (Fig. 1). Mice express both IgE and IgG immunoglobulins; however, the murine antibody receptor family is not a replicate of the human (Fig. 2). In both species, each of these receptors exhibits differential affinity for their respective antibody binding (Table 1) and variable expression on different cellular subsets (Table 2; Bruhns 2012). Interestingly, inhibitory mFcγRIIB and activating mFcγRIII and mFcγRIV in the mouse also have low affinity for binding IgE (Mancardi et al. 2008).

Studies of anaphylaxis in human patients are extremely difficult due to the rapid rate of onset and lethal potential of the reaction, as well as large variability in the type and amount of allergen and route of exposure. Early treatment of shock is essential, and agents such as adrenaline can mask subsequent signs and symptoms. The investigation of anaphylaxis in the clinic has also been severely impeded by the difficulties in diagnosis and absence of reliable laboratory



Anaphylaxis (Immediate Hypersensitivity): From Old to New Mechanisms, Fig. 2 Mouse IgE and IgG receptors. Schematic representation of mouse FcRs at the

cell membrane (gray bar) and their association or not to the Fcγ-chain dimer (black). ITAMs are represented by green boxes and ITIMs by a white box

biomarkers to confirm the clinical impression. Therefore, to elucidate the underlying cellular and molecular mechanisms of the anaphylactic reaction, while avoiding the complications of clinical studies, several animal models of anaphylaxis have been developed. Genetically modified mice, including gene-deficient or knockout (KO) strains, have enabled the identification of different ligands, receptors, and cells necessary for the induction of anaphylaxis in specific experimental protocols. While results obtained in animal models are not necessarily applicable to humans, they provide a framework for understanding the mechanisms at work.

IgE-induced passive systemic anaphylaxis (PSA) is elicited by injecting mice systemically with IgE antibodies 24–48 h before an intravenous (i.v.) challenge with specific antigen. The anaphylactic shock which develops within minutes can be easily assessed by monitoring the decrease in body temperature. IgE-induced PSA observed in wild-type (wt) mice was abrogated in mice deficient for mFcεRI, the high-affinity IgE receptor expressed by mast cells and basophils (Dombrowicz et al. 1993) and in mast cell-deficient W/W^v mice (Miyajima et al. 1997). It was also abrogated in histidine decarboxylase-deficient mice, which lack histamine, and in mice injected with histamine receptor antagonists. Furthermore, an i.v. injection of histamine alone can induce anaphylactic symptoms in mice. These findings altogether demonstrate the mandatory role of mFcεRI and mast cells in IgE-induced PSA and emphasize the contribution of

histamine, contained within mast cell granules, which are rapidly released upon the cross-linking of IgE molecules bound to the mast cell surface via mFcεRI. This IgE-dependent mechanism mediated by mast cells and the release of histamine has been widely accepted as the paradigm of the anaphylactic reaction (reviewed by Galli (2005)).

IgG-induced PSA is elicited by injecting mice systemically with IgG antibodies 2–24 h before an i.v. challenge with specific antigen. Alternatively, preformed IgG-immune complexes (IC), consisting of antibody bound to soluble antigen, can be injected i.v. Both IgE- and IgG-induced PSA develop with similar symptoms and comparable kinetics.

IgG1 is the dominant antibody subclass raised during humoral responses to protein antigens in mice, and passively administered IgG1-IC are sufficient to induce anaphylaxis. The low-affinity IgG receptor mFcγRIII is the only activating FcγR in mice that can bind mouse IgG1 (Table 1), and since mFcγRIII can mediate mast cell activation in vitro and passive cutaneous anaphylaxis in vivo, these receptors are considered to mediate IgG1-induced PSA. Indeed, IgG1-induced PSA was abrogated in mFcγRIII-deficient mice. Inhibitory mFcγRIIB that binds mouse IgG1 negatively regulates mFcγRIII-dependent IgG1-induced PSA (reviewed by Bruhns (2012)).

Surprisingly, IgG1-induced PSA was not abrogated in mast cell-deficient mice (Miyajima et al. 1997) and although reportedly absent in

Anaphylaxis (Immediate Hypersensitivity): From Old to New Mechanisms, Table 1 *Affinity of binding of human and murine Fc receptors to IgG and IgE subclasses*

Ig subclass	hFcγRI (CD64)	hFcγRIIA (CD32A)	hFcγRIIB (CD32B)	hFcγRIIC (CD32C)	hFcγRIIIA (CD16A)	hFcγRIIIB (CD16B)	hFceRI
hIgG1	++	+	+	+	+	+	–
hIgG2	–	+	+/-	+/-	+	–	–
hIgG3	++	+	+	+	++	+	–
hIgG4	++	+	+	+	+	–	–
hIgE	–	–	–	–	–		++
mIgG1	–	+	–	–	–	–	–
mIgG2a	+	+	+/-	+/-	+	–	–
mIgG2b	+	+	+	+	?	–	–
mIgG3	+	–	–	–	–	–	–
mIgE	–	–	–	–	–	–	++
Ig subclass	mFcγRI	mFcγRIIB	mFcγRIII	mFcγRIV			mFceRI
hIgG1	++	+	+	+			–
hIgG2	–	+	+	+			–
hIgG3	++	+	+	+			–
hIgG4	++	+	+	+			–
hIgE	–	–	–	–			–
mIgG1	–	+	+	–			–
mIgG2a	++	+	+	++			–
mIgG2b	+	+	+	++			–
mIgG3	+	–	–	–			–
mIgE	–	+/-	+/-	+			++

++ : High-affinity binding
+ : low-affinity binding
+/- : weak/barely detectable binding
– : no binding

wild-type mice after basophil depletion (Tsujiura et al. 2008), IgG1-induced PSA was normal in genetically basophil-deficient mice (Ohnmacht et al. 2010). These data suggest that mFcγRIII-expressing cells other than mast cells and basophils can contribute to IgG1-induced PSA.

Neutrophils can contribute to IgG-induced PSA: in a model of polyclonal IgG-induced PSA, neutrophil depletion was sufficient to

abrogate the reaction (Jönsson et al. 2011). Whereas mouse mast cells and basophils express mFcγRIII as their only activating FcγR, mouse neutrophils express both mFcγRIII and mFcγRI-V. Neutrophils are also necessary for IgG2-induced PSA mediated via mFcγRIV. Upon activation, mouse neutrophils and basophils rapidly release granular mediators, including histamine, but also lipid-derived mediators such as platelet-activating factor (PAF). Like histamine,

Anaphylaxis (Immediate Hypersensitivity): From Old to New Mechanisms, Table 2 *Human and mouse FcR expression pattern*

HUMAN	FcγRI	FcγRIIA	FcγRIIB	FcγRIIC*	FcγRIIIA	FcγRIIIB	FcRn	FcεRI
B cell	–	–	+	–	–	–	–	–
T cell	–	–	–	–	–	–	–	–
NK cell	–	–	**	+	+	–	–	–
Monocyte/Macro.	+	+	+/-	+	+	–	+	+ [‡]
Neutrophil	(+)	+	+/-	+	–	+	+	+ [‡]
Dendritic cell	+	+	+	–	–	–	+	–
Basophil	–	+	+	–	–	+/-	–	+
Mast cell	(+)	+	–	–	–	–	–	+
Eosinophil	–	+	–	–	–	–	–	+
Endothelium	–	–	–	–	–	–	+	–
Platelet	–	+	–	–	–	–	?	–
Intestine epithelium	–	–	–	–	–	–	–	–
Syncytiotrophoblast	–	–	–	–	–	–	+	–

MOUSE	FcγRI	FcγRIIB	FcγRIII	FcγRIV	FcRn	FcεRI
B cell	–	+	–	–	+ [†]	–
T cell	–	–	–	–	–	–
NK cell	–	–	+	–	–	–
Monocyte/Macro.	–	+	+	+	+	–
Neutrophil	–	+	+	+	+	–
Dendritic cell	+ [§]	+	+	–	+	–
Basophil	–	+	+	–	–	+
Mast cell	–	+	+	–	?	+
Eosinophil	–	+	+	–	–	–
Endothelium	–	–	–	–	+	–
Intestine epithelium	–	–	–	–	+	–

(+) : Inducible expression

+/- : Some subsets express the receptor

* : In *Fcgr2c*-ORF individuals

** : Detectable and functional expression in non-conventional *Fcgr2c*-Stop individuals

‡ : In atopic/allergic individuals

§ : Monocyte-derived dendritic cells, but not conventional dendritic cells

† : On splenic B cells only

PAF can reproduce the clinical signs of anaphylactic shock when injected into naive animals, and PAF, but not histamine, was shown to be responsible for IgG1-induced PSA and IgG2-induced PSA. Altogether these findings indicate that IgG1-IC and IgG2-IC induce anaphylaxis mediated by the release of PAF, probably by aggregating mFcγRIII on basophils and mFcγRIII and mFcγRIV on neutrophils (reviewed by Bruhns (2012) and summarized in Table 3).

Active systemic anaphylaxis (ASA) is elicited by injection of allergen/antigen into mice immunized with the same allergen/antigen and is therefore a better model of anaphylaxis that arises in humans who have been previously sensitized to a specific allergen. Different routes of exposure will mimic different human pathologies: in particular, intravenous antigen challenge resembles drug-induced anaphylaxis. Although similar symptoms develop during ASA and PSA, a greater proportion of animals die during

Anaphylaxis (Immediate Hypersensitivity): From Old to New Mechanisms, Table 3 *Contribution of specific pathways to experimental anaphylaxis models.* A pathway is represented by a cell type, the antibody class, and the mediator released. ASA models describe BSA-immunized mice challenged with BSA (BSA-ASA) and goat IgG anti-mouse IgD-immunized mice challenged with goat IgG. If identified, the responsible FcRs are indicated

	PSA			ASA	
	IgE	IgG1	IgG2b	BSA	Goat IgG anti-IgD
Mast cell / IgE / Histamine	YES (FcεRI)	NO	<i>n.a.</i>	NO	NO
Basophil / IgG / PAF	NO	<i>disputed</i>	<i>n.a.</i>	YES (FcγRIII)	<i>n.a.</i>
Macrophage / IgG / PAF	NO	NO	<i>n.a.</i>	NO	YES
Neutrophil / IgG / PAF	?	NO	YES (FcγRIV)	YES (FcγRIII+IV)	NO

n.a. : not analyzed.

ASA. Perhaps unsurprisingly, however, results obtained from active models of anaphylaxis do not correlate with most results from passive models. Neither IgE nor mFcεRI, mast cells, basophils, nor both cells are mandatory for the induction of ASA (reviewed by Bruhns (2012)).

Antibody-dependent ASA develops in mice that have been immunized with protein antigen (bovine serum albumin, BSA) in Freund's adjuvant prior to intravenous challenge: BSA-ASA is lethal in wt mice but does not affect mice that lack expression of activating FcRs. Studies using this model have demonstrated important roles for IgG, neutrophils, and PAF in the induction of ASA. Even though antigen-specific IgG and IgE are both present in immunized mice at the time of challenge, the IgG receptors mFcγRIII and mFcγRIV are responsible for ASA induction, demonstrated by the abolition of the reaction in mice treated with mFcγRIII- and mFcγRIV-specific blocking antibodies. Neutrophils were the dominant cell type responsible for the induction of shock, since neutrophil depletion prevented ASA-associated death, while basophils played a minor role: the contribution of basophils was observable only in the absence of

neutrophils. Importantly, the transfer of human neutrophils restored ASA in resistant mice (Jönsson et al. 2011). In an alternate model of ASA induced by i.v. injection of goat IgG in mice immunized with goat IgG anti-mouse IgD (GaMD-ASA), the reaction was determined to proceed via mFcγRIII, monocyte/macrophage activation, and the release of PAF (Strait et al. 2002). Although a role for monocytes/macrophages was not detectable in BSA-ASA, PAF receptor antagonists also strongly inhibited BSA-ASA, while a histamine receptor antagonist had little effect. Altogether, data from these animal models support a mandatory role for IgG and IgG receptors in ASA and the downstream production of PAF that mediates the physiological symptoms (summarized in Table 3).

Intestinal models of anaphylaxis to food have been difficult to develop with the elicitation of systemic symptoms. Studies in the mouse intestine examining local allergic manifestations in response to food allergens have highlighted the contribution of classical mast cell- and IgE-mediated mechanisms. A recent study of a murine model of oral antigen-induced anaphylaxis with intestinal and systemic symptoms

found that some symptoms, namely, diarrhea and hypothermia, were attenuated in mFcεRI-deficient mice compared to controls. The severity of these symptoms was also found to correlate with levels of intestinal mast cells. Airway hyperresponsiveness, however, occurred independently of the IgE/mFcεRI/mast cell pathway (Ahrens et al. 2012). Most animal models of food allergy involve the generation of both antigen-specific IgE and IgG; however, the specific role of IgG in these models has not been well addressed.

Deleterious Effects of Activated Neutrophils: A Role for Extracellular Traps in Anaphylaxis?

If neutrophils are activated during anaphylactic shock in patients, they may also contribute to the deleterious pulmonary and cardiovascular symptoms of the shock. Indeed, while neutrophils play an essential role in fighting infection and in the resolution of inflammation, neutrophil-derived products such as reactive oxygen species, proteases, lipid mediators, and pro-inflammatory cytokines can induce tissue damage and toxicity in the local environment (Borregaard 2010). Tissue pathology induced by these mediators has been associated with the clinical manifestation of other acute inflammatory reactions, including acute respiratory distress syndrome of the adult, acute alcoholic hepatitis, and heat shock. Neutrophils, as well as mast cells and eosinophils, may contribute to tissue pathology under conditions of inflammation by the formation of extracellular traps. These filamentous structures consist of a backbone of DNA, and histones presenting numerous granular mediators are extruded following cell activation and constitute a novel death mechanism called NETosis. Whereas the role of NETs (Neutrophil Extracellular Traps) in the anti-infectious response is well documented, the interactions of NETs with the cellular environment of the host are little understood. Some reports, however, describe a deleterious effect of NETs constituents for tissues, in particular of histones on endothelial cells during sepsis, of proteases on bronchial epithelia in asthma, or of procoagulation molecules that induce thrombosis. It can be hypothesized that during a severe

systemic anaphylactic reaction, NETs may be released by neutrophils following their activation by IgG receptors in the presence of allergen and specific IgG; these NETs cause damage to tissues, endothelial surfaces, and vasculature and may contribute to respiratory distress.

Pathological Relevance

Clinical Aspects

Anaphylactic reactions are unpredictable and life-threatening and therefore represent an emergency situation for medical staff. As discussed above, there are a great variety of eliciting compounds to which allergic individuals can be exposed via different routes of contact and at varying distances from hospital and treatment, rendering clinical studies difficult to conduct. In cases of anaphylaxis arising in a clinical setting, however, more homogenous groups of patients may facilitate clinical studies. Immediate hypersensitivity reactions during the perioperative period have been reported with increasing frequency in most developed countries and may be attributable to anesthetic drugs, antibiotics, latex, antiseptics, radiocontrast agents, colloids for intravascular volume expansion, blood products, or disinfectants. The most common causes of anaphylaxis in this setting are neuromuscular blocking agents (60–70 %) followed by latex (12–18 %) and antibiotics (8–15 %) (Mertes et al. 2011).

Any suspected anaphylactic reaction must be investigated to provide precise recommendations for future procedures. The severity of anaphylaxis can vary from a simple cutaneous rash to cardiac failure and eventually death. Reactions are therefore classified as a function of their severity: grade 1, generalized cutaneous signs; grade 2, moderate cardiovascular or bronchial dysfunction that does not require a specific treatment; grade 3, dysfunction with vital threat that would not have receded in the absence of symptomatic treatment; grade 4, cardiorespiratory arrest; and grade 5, corresponding to death. Cutaneous signs may be absent in more severe grades

of anaphylaxis or appear only when an adequate perfusion pressure has been reestablished.

Since the classical immunological mechanism of anaphylaxis implies the immediate release of mediators by mast cells and basophils sensitized by specific IgE (Galli 2005), when anaphylactic shock is suspected in the clinic, levels of circulating histamine and of tryptase (a mast cell-specific protease) are measured to confirm the diagnosis. If the patient survives the shock, immunological tests are performed during a physician's appointment 6–8 weeks later. To identify the allergenic compound the patient reacted against, these tests include skin tests (prick test and/or intradermal test), measurement of allergen-specific IgE in the patient's serum, and ex vivo basophil degranulation in the presence of the "suspected allergen." In view of the patient's medical history and the results of the immunological tests, recommendations to avoid the "suspected allergen" may be given to the patient to prevent future occurrences of anaphylaxis. Clinical reactions observed can, however, also be a result of nonimmune-mediated events, such as the nonspecific release of histamine, a phenomenon referred to as an "anaphylactoid" reaction, and reportedly accounting for 30–40 % of hypersensitivity reactions. The use of the term "anaphylactoid," however, is discouraged by the European Academy of Allergy and Clinical Immunology. Clinically, these two terms are indistinguishable in presentation, and rather such a distinction disregards the potential contribution of as yet unrecognized immunological mechanisms to the anaphylactic response, or processes for which reliable laboratory biomarkers are not yet established.

None of the cutaneous or immunological tests performed reach a sensitivity or specificity of 100 %. The situation is particularly difficult with drugs in the neuromuscular blocking drug family because anaphylactic shocks to neuromuscular blocking drugs have been reported in patients that have never received them before, and cross-reactions to various neuromuscular blocking drugs exist (Mertes et al. 2008). To comfort a diagnosis of neuromuscular blocking drug-induced anaphylaxis, the following set of

immunological tests have to be positive: skin test, presence of specific IgE, and ex vivo basophil activation in the presence of neuromuscular blocking drugs. Specific neuromuscular blocking drug-reactive IgE can be quantified using a chemical structure, a quaternary ammonium, which represents a common antigenic determinant of the family of neuromuscular blocking agents (e.g., suxamethonium, rocuronium). Yet in around 10 % of cases of anaphylaxis to neuromuscular blocking drugs, the clinical reaction does not correlate with the levels of mediators in the serum (histamine and tryptase) and the immunological tests performed, suggesting another mechanism leading to anaphylactic shocks (Laroche et al. 2011). In agreement with this, animal models suggest that antibodies other than IgE and, probably, cell populations other than mast cells and basophils can mediate anaphylaxis.

Data published by different groups on different animal models of anaphylaxis (refer to Structure and Function) compile a rather complicated picture on the different cell types, antibody receptors, and mediators involved in systemic anaphylaxis. That neither mast cells nor IgE, but rather neutrophils and/or macrophages and IgG, contribute to some of these models is unexpected and opens novel areas of research in human anaphylaxis. That PAF is a major responsible mediator for active systemic anaphylaxis in murine models should prompt a reevaluation of the contribution of PAF to human anaphylaxis. In two human studies, serum PAF concentrations were shown to correlate with the severity of anaphylactic shocks (Vadas et al. 2008; 2013). Certainly, clinical application of the findings of animal models requires close consideration of the appropriateness of the model used; in particular, human anaphylactic reactions are essentially always "active." In order to be better able to extrapolate to the human conditions, efforts have been made to develop humanized models of anaphylaxis, by using mice expressing human IgE or IgG receptors.

“Humanized” Models of Anaphylaxis

The role of the human high-affinity receptor for IgE, hFcεRI, was first investigated in IgE-PSA in the mouse. Mice deficient for mFcεRI and transgenic for hFcεRI developed IgE-PSA, but not mice that did not carry the human transgene (Dombrowicz et al. 1996). This pioneering work demonstrated that anaphylaxis could be reconstituted in an “FcR-humanized” mouse. Notably, however, this reaction was dependent on the injection of antigen-specific mouse IgE that bound to hFcεRI *in vivo*.

Recently, the transfer of human neutrophils has been reported to restore anaphylaxis in anaphylaxis-resistant mice, that is, mice deficient for activating FcRs (Jönsson et al. 2011). Human neutrophils from normal donors constitutively express the low-affinity activating IgG receptor hFcγRIIA: hFcγRIIA is the most widely expressed FcR in humans (Tan Sardjono et al. 2005), possesses its own activating motif in its intracytoplasmic domain, and is not associated to the FcRγ subunit that enables the other activating IgG (and IgE) receptors to signal (Fig. 1). hFcγRIIA binds all four human IgG subclasses (Bruhns et al. 2009), as well as mouse IgG1, IgG2a, and IgG2b subclasses (Jönsson et al. 2012). Mice transgenic for the *Fcgr2a* gene have been generated that recapitulate the expression of hFcγRIIA in humans (McKenzie et al. 1999). hFcγRIIA was found to be sufficient to induce fatal ASA when expressed on a transgenic mouse background deficient in endogenous murine FcR. hFcγRIIA-dependent IgG-induced PSA relied on neutrophils and monocyte/macrophages, but not on mast cells and basophils. Human mast cells, monocytes, and neutrophils can produce anaphylactogenic mediators following hFcγRIIA engagement. hFcγRIIA may therefore contribute to allergic reactions and anaphylaxis in humans (Jönsson et al. 2012).

Human neutrophils from atopic and allergic patients also express hFcεRI (Gounni et al. 2001). Neutrophils may therefore contribute with mast cells and basophils to IgE-dependent allergic reactions in these individuals. In addition, neutrophils can express the activating high-affinity IgG receptor hFcγRI under several

pathological (e.g., multiple myeloma, rheumatoid arthritis, bacterial infection, sepsis, and inflammatory bowel disease) and therapeutic conditions (e.g., treatment with recombinant G-CSF or chemotherapy). Mice transgenic for the *Fcgr1a* gene have been generated that recapitulate the expression of hFcγRI in humans (Heijnen et al. 1996). hFcγRI was found to be sufficient to induce IgG-induced PSA and fatal ASA when expressed on a transgenic mouse background deficient in several endogenous murine FcRs. hFcγRI-dependent ASA relied on neutrophils, but not on monocyte/macrophages. Human neutrophils can produce anaphylactogenic mediators following hFcγRI engagement, and hFcγRI-dependent ASA was strongly inhibited following treatment with PAF receptor antagonists. hFcγRI may therefore contribute to allergic reactions and anaphylaxis in humans that express this high-affinity IgG receptor on their neutrophils (Mancardi et al. 2013).

Thus, like mouse IgE receptor mFcεRI and mouse IgG receptors mFcγRIII and mFcγRIV, human IgE receptor hFcεRI and human IgG receptors hFcγRIIA and hFcγRI are sufficient to trigger IgE- and IgG-induced systemic anaphylaxis, respectively, when expressed in mice. Yet these results have been obtained in mice expressing only one human hFcR, in the absence of inhibitory hFcγRIIB, and in the absence of other hFcγRs, that may regulate or contribute to anaphylaxis, respectively. If other hFcγRs play a role in anaphylaxis in humans, other cell types than those identified so far may contribute to, or even be responsible for, the induction of anaphylaxis. The use of mouse models expressing multiple or, preferably, all hFcγRs (Smith et al. 2012) may be necessary to fully understand their relative contribution to anaphylaxis and the role of the cells expressing them.

In addition, cross-species binding of mouse IgE or mouse IgG to hFcεRI and hFcγRI and hFcγRIIA enabled the use of mouse monoclonal antibodies to induce anaphylaxis in mice transgenic for these receptors (Dombrowicz et al. 1996; Jönsson et al. 2012; Mancardi et al. 2013). Several hFcγRs, however, do not bind (or very poorly) mouse IgG (Table 1). In particular, only hFcγRIIA cross-binds the

predominant mouse IgG subclass, mIgG1, whereas all human Fc γ Rs bind the predominant human IgG subclass, hIgG1 (Bruhns 2012). Of note, hFc γ RIIB that is very highly expressed on human neutrophils does not detectably cross-bind mouse IgG. hFc γ RIIB has nevertheless been reported to play specialized roles in these cells using murine models transgenic for this human receptor, demonstrating expression on neutrophils, as well as on monocytes (Chen et al. 2012; Tsuboi et al. 2008). Investigating the role of most human hFc γ Rs in anaphylaxis in mouse models using mouse IgG may therefore lead to conclusions irrelevant to human physiopathology of hFc γ Rs and of human IgG. Models integrating mice expressing hFc γ R and producing human/chimeric IgG would be more physiologically relevant, but no report of this kind has been made so far.

Interactions with Other Processes and Drugs

Atopic individuals, such as those with asthma or other allergies, are identified to be at high risk of anaphylactic episodes. Overall, anaphylaxis is more common in females than in males, yet for unknown reasons 95 % of deaths from insect sting anaphylaxis occur in males. Patterns of exposure influence relative anaphylaxis risk: seasonal changes in insect populations relate to risk of insect sting anaphylaxis, multiple surgery procedures increase risk factors for allergic perioperative reactions, and professional exposure to latex increases predisposition to latex allergies. Other medications can predispose to anaphylaxis or interfere with treatment, for example, β -blockers can interfere with the action of adrenaline and increase severity of symptoms or duration of the reaction. Delayed access to adrenaline is a consistent risk factor for fatalities following anaphylaxis. Deficiencies in PAF acetylhydrolase, the enzyme that degrades PAF, were found to inversely correlate with anaphylaxis severity (Vadas et al. 2008), which emphasises a contribution of this mediator to human anaphylactic reactions.

Cross-References

- ▶ [Allergic Disorders](#)
- ▶ [Anti-histamines](#)
- ▶ [Basophils](#)
- ▶ [Cell Signaling in Neutrophils](#)
- ▶ [Immunoglobulin Receptors and Inflammation](#)
- ▶ [ITAM Regulatory Receptors](#)
- ▶ [Mast Cells](#)
- ▶ [Monoclonal Antibody Technology](#)
- ▶ [Neutrophil Netosis](#)

References

- Ahrens, R., Osterfeld, H., Wu, D., Chen, C. Y., Arumugam, M., Groschwitz, K., Strait, R., Wang, Y. H., Finkelman, F. D., & Hogan, S. P. (2012). Intestinal mast cell levels control severity of oral antigen-induced anaphylaxis in mice. *The American Journal of Pathology*, *180*(4), 1535–1546.
- Borregaard, N. (2010). Neutrophils, from marrow to microbes. *Immunity*, *33*(5), 657–670.
- Bruhns, P. (2012). Properties of mouse and human IgG receptors and their contribution to disease models. *Blood*, *119*(24), 5640–5649.
- Bruhns, P., Iannascoli, B., England, P., Mancardi, D. A., Fernandez, N., Jorieux, S., & Daeron, M. (2009). Specificity and affinity of human Fc{gamma} receptors and their polymorphic variants for human IgG subclasses. *Blood*, *113*, 3716–3725.
- Chen, K., Nishi, H., Travers, R., Tsuboi, N., Martinod, K., Wagner, D. D., Stan, R., Croce, K., & Mayadas, T. N. (2012). Endocytosis of soluble immune complexes leads to their clearance by FcgammaRIIB but induces neutrophil extracellular traps via FcgammaRIIA in vivo. *Blood*, *120*(22), 4421–4431.
- Cohen, S. G., & Zelaya-Quesada, M. (2002). Portier, Richet, and the discovery of anaphylaxis: A centennial. *The Journal of Allergy and Clinical Immunology*, *110*(2), 331–336.
- Dombrowicz, D., Flamand, V., Brigman, K. K., Koller, B. H., & Kinet, J. P. (1993). Abolition of anaphylaxis by targeted disruption of the high affinity immunoglobulin E receptor alpha chain gene. *Cell*, *75*(5), 969–976.
- Dombrowicz, D., Brini, A. T., Flamand, V., Hicks, E., Snouwaert, J. N., Kinet, J. P., & Koller, B. H. (1996). Anaphylaxis mediated through a humanized high affinity IgE receptor. *Journal of Immunology*, *157*(4), 1645–1651.
- Galli, S. J. (2005). Pathogenesis and management of anaphylaxis: Current status and future challenges. *The Journal of Allergy and Clinical Immunology*, *115*(3), 571–574.

- Gounni, A. S., Lamkhioed, B., Koussih, L., Ra, C., Renzi, P. M., & Hamid, Q. (2001). Human neutrophils express the high-affinity receptor for immunoglobulin E (Fc epsilon RI): Role in asthma. *FASEB Journal*, 15(6), 940–949.
- Heijnen, I. A., van Vugt, M. J., Fanger, N. A., Graziano, R. F., de Wit, T. P., Hofhuis, F. M., Guyre, P. M., Capel, P. J., Verbeek, J. S., & van de Winkel, J. G. (1996). Antigen targeting to myeloid-specific human Fc gamma RI/CD64 triggers enhanced antibody responses in transgenic mice. *Journal of Clinical Investigation*, 97(2), 331–338.
- Ishizaka, K., Ishizaka, T., & Hornbrook, M. M. (1966). Physicochemical properties of reaginic antibody. V. Correlation of reaginic activity with gamma-E-globulin antibody. *Journal of Immunology*, 97(6), 840–853.
- Jönsson, F., Mancardi, D. A., Kita, Y., Karasuyama, H., Iannascoli, B., Van Rooijen, N., Shimizu, T., Daëron, M., & Bruhns, P. (2011). Mouse and human neutrophils induce anaphylaxis. *Journal of Clinical Investigation*, 121(4), 1484–1496.
- Jönsson, F., Mancardi, D. A., Zhao, W., Kita, Y., Iannascoli, B., Khun, H., van Rooijen, N., Shimizu, T., Schwartz, L. B., Daëron, M., & Bruhns, P. (2012). Human Fc gamma RIIA induces anaphylactic and allergic reactions. *Blood*, 119(11), 2533–2544.
- Koplin, J. J., Martin, P. E., & Allen, K. J. (2011). An update on epidemiology of anaphylaxis in children and adults. [Review]. *Current Opinion in Allergy and Clinical Immunology*, 11(5), 492–496.
- Laroche, D., Chollet-Martin, S., Leturgie, P., Malzac, L., Vergnaud, M. C., Neukirch, C., Venemalm, L., Gueant, J. L., & Roland, P. N. (2011). Evaluation of a new routine diagnostic test for immunoglobulin e sensitization to neuromuscular blocking agents. *Anesthesiology*, 114(1), 91–97.
- Mancardi, D. A., Iannascoli, B., Hoos, S., England, P., Daëron, M., & Bruhns, P. (2008). Fc gamma RIV is a mouse IgE receptor that resembles macrophage Fc epsilon RI in humans and promotes IgE-induced lung inflammation. *Journal of Clinical Investigation*, 118(11), 3738–3750.
- Mancardi, D. A., M. Albanesi, F. Jonsson, B. Iannascoli, N. Van Rooijen, X. Kang, P. England, M. Daëron and P. Bruhns (2013). The high-affinity human IgG receptor Fc gamma RI (CD64) promotes IgG-mediated inflammation, anaphylaxis, and antitumor immunotherapy. *Blood* 121(9): 1563–1573.
- McKenzie, S. E., Taylor, S. M., Malladi, P., Yuhan, H., Cassel, D. L., Chien, P., Schwartz, E., Schreiber, A. D., Surrey, S., & Reilly, M. P. (1999). The role of the human Fc receptor Fc gamma RIIA in the immune clearance of platelets: A transgenic mouse model. *Journal of Immunology*, 162(7), 4311–4318.
- Mertes, P. M., Aimone-Gastin, I., Gueant-Rodriguez, R. M., Mouton-Faivre, C., Audibert, G., O'Brien, J., Frendt, D., Brezeanu, M., Bouaziz, H., & Gueant, J. L. (2008). Hypersensitivity reactions to neuromuscular blocking agents. *Current Pharmaceutical Design*, 14(27), 2809–2825.
- Mertes, P. M., Alla, F., Trechot, P., Auroy, Y., & Jouglia, E. (2011). Anaphylaxis during anesthesia in France: An 8-year national survey. *The Journal of Allergy and Clinical Immunology*, 128(2), 366–373.
- Miyajima, I., Dombrowicz, D., Martin, T. R., Ravetch, J. V., Kinet, J. P., & Galli, S. J. (1997). Systemic anaphylaxis in the mouse can be mediated largely through IgG1 and Fc gamma RIII. Assessment of the cardiopulmonary changes, mast cell degranulation, and death associated with active or IgE- or IgG1-dependent passive anaphylaxis. *Journal of Clinical Investigation*, 99(5), 901–914.
- Ohnmacht, C., Schwartz, C., Panzer, M., Schiedewitz, I., Naumann, R., & Voehringer, D. (2010). Basophils orchestrate chronic allergic dermatitis and protective immunity against helminths. *Immunity*, 33(3), 364–374.
- Prausnitz, C., & Küstner, H. (1921). Studien über die Ueberempfindlichkeit. *Zentralblatt für Bakteriologie*, 86, 160–169.
- Smith, P., D. J. DiLillo, S. Bournazos, F. Li and J. V. Ravetch (2012). Mouse model recapitulating human Fc gamma receptor structural and functional diversity. *Proc Natl Acad Sci U S A* 109(16): 6181–6186.
- Strait, R. T., Morris, S. C., Yang, M., Qu, X. W., & Finkelman, F. D. (2002). Pathways of anaphylaxis in the mouse. *The Journal of Allergy and Clinical Immunology*, 109(4), 658–668.
- Tan Sardjono, C., Mottram, P. L., van de Velde, N. C., Powell, M. S., Power, D., Slocombe, R. F., Wicks, I. P., Campbell, I. K., McKenzie, S. E., Brooks, M., Stevenson, A. W., & Hogarth, P. M. (2005). Development of spontaneous multisystem autoimmune disease and hypersensitivity to antibody-induced inflammation in Fc gamma receptor IIa-transgenic mice. *Arthritis and Rheumatism*, 52(10), 3220–3229.
- Tsuboi, N., Asano, K., Lauterbach, M., & Mayadas, T. N. (2008). Human neutrophil Fc gamma receptors initiate and play specialized nonredundant roles in antibody-mediated inflammatory diseases. *Immunity*, 28(6), 833–846.
- Tsujimura, Y., Obata, K., Mukai, K., Shindou, H., Yoshida, M., Nishikado, H., Kawano, Y., Minegishi, Y., Shimizu, T., & Karasuyama, H. (2008). Basophils play a pivotal role in immunoglobulin-G-mediated but not immunoglobulin-E-mediated systemic anaphylaxis. *Immunity*, 28(4), 581–589.
- Vadas, P., Gold, M., Perelman, B., Liss, G. M., Lack, G., Blyth, T., Simons, F. E., Simons, K. J., Cass, D., & Yeung, J. (2008). Platelet-activating factor, PAF acetylhydrolase, and severe anaphylaxis. *New England Journal of Medicine*, 358(1), 28–35.
- Vadas P, Perelman B, Liss G. Platelet-activating factor, histamine, and tryptase levels in human anaphylaxis. *J Allergy Clin Immunol* 2013; 131:144–9.

Abstract

Neutrophils are agents of protective and pathological inflammation. My thesis work aimed to determine the role of neutrophils during severe, potentially fatal models of systemic inflammation induced by lipopolysaccharide (LPS, endotoxemia) or by IgG immune complexes (anaphylaxis). Anaphylaxis is a severe allergic reaction that may proceed via IgE- or IgG-dependant pathways. Endotoxemia is a model relevant to inflammation during critical illness. To study neutrophils *in vivo*, we employed a new mouse model of inducible neutropenia. We found, surprisingly, that neutrophils and neutrophil-derived MPO protected against the severity of endotoxic shock, independently of the microbiological environment, suggesting that neutrophils contribute to host immunity by limiting inflammation during endotoxemia. Conversely, neutrophils can contribute to IgG-induced anaphylaxis in mice. As mice and human IgG receptors (Fc γ R) are very different, our laboratory developed a novel mouse strain in which targeted insertion of human Fc γ R into the murine loci recapitulated hFc γ R expression patterns. In these mice I show that anaphylaxis induced by hIgG proceeds within a native context of activating and inhibitory hFc γ Rs, and that neutrophil activation via Fc γ RIIA is a dominant pathological pathway, involving the mediators PAF and histamine. Finally, I describe ongoing work to develop a mouse model of anaphylaxis in response to Rocuronium, a curare-based neuromuscular blocking agent (NMBA). In collaboration with a clinical consortium, I contributed to the analysis of blood samples from patients suspected of NMBA-induced anaphylaxis, identifying evidence also for the activation of a neutrophil- and IgG-dependent axis during human anaphylaxis.