



HAL
open science

Engagement au travail, addiction au travail & orientation culturelle : le cas d'entreprises enThaïlande

Vajiraporn Sriput

► **To cite this version:**

Vajiraporn Sriput. Engagement au travail, addiction au travail & orientation culturelle : le cas d'entreprises enThaïlande. Gestion et management. Université Paul Valéry - Montpellier III, 2016. Français. NNT : 2016MON30021 . tel-01469792

HAL Id: tel-01469792

<https://theses.hal.science/tel-01469792>

Submitted on 16 Feb 2017

HAL is a multi-disciplinary open access archive for the deposit and dissemination of scientific research documents, whether they are published or not. The documents may come from teaching and research institutions in France or abroad, or from public or private research centers.

L'archive ouverte pluridisciplinaire **HAL**, est destinée au dépôt et à la diffusion de documents scientifiques de niveau recherche, publiés ou non, émanant des établissements d'enseignement et de recherche français ou étrangers, des laboratoires publics ou privés.

THÈSE

Pour obtenir le grade de
Docteur

Délivré par l'université PAUL-VALÉRY MONTPELLIER 3

Préparée au sein de l'école doctorale **Territoires, Temps,
Sociétés et Développement - n° 60**

Et de l'unité de recherche **CORHIS**
Spécialité : **Sciences de Gestion**

Présentée par **Vajiraporn SRIPUT**

**ENGAGEMENT AU TRAVAIL, ADDICTION AU TRAVAIL
& ORIENTATION CULTURELLE :
LE CAS D'ENTREPRISE EN THAÏLANDE**

Soutenue le 25 Novembre 2016

Devant le jury composé de :

Monsieur Marc BONNET,
Professeur, Université Jean-Moulin
Lyon 3

Rapporteur

Monsieur Alain BRIOLE,
Professeur émérite, Université Paul Va-
léry Montpellier 3

Directeur de la thèse

Monsieur Jacques JAUSSAUD,
Professeur, Université de Pau et des pays
de l'Adour

Rapporteur

Monsieur Jean-Michel PLANE,
Professeur, Université Paul Valéry
Montpellier 3

Suffragant

Acknowledgements

I would not have completed this dissertation without the support, encouragement, and assistance from many people. First, I would like to express my appreciation to my adviser, Professor Alain Briole. I have learned so many things from him both in terms of academic knowledge professional development, and give the opportunities to fulfil in life when stay in France, including I really appreciate his effort to motivate me finish this dissertation.

In addition, I owe my special thanks to the Faculty of Science and Arts , Burapha University, Chantaburi campus, Thailand for the financial support throughout my studies.

Finally, all my achievements have been realized because of my wonderful family: my parents, my brothers, my sisters, my aunt, and all other extended family members.

Dedication

This dissertation is dedicated to my family, and all my past and present teachers, especially, my advisor. Without their support and belief in my potential, I would have never achieved this accomplishment.

Abstract

This present study aims at the influence of culture by applying five cultural dimensions: power distance, individualism versus collectivism, masculinity versus femininity, uncertainty avoidance, and long-term orientation, to study their relationships with work engagement in order to create the work engagement model driven by culture and orientation to workaholism. The study had been done in 48 companies in automobile, electronic and electronic, and hotel sectors in Thailand, with 403 participants. The result shows the score of three cultural dimensions include power distance, masculinity, and long-term orientation are moderate to high, individualism is moderate to low, and uncertain voidance score is low. In addition to the power distance and individualism levels are varied according to educational levels. Furthermore, the work engagement level among participants is moderate to high, while workaholism level is moderate to low, and the work engagement levels are difference between single and married group. The influence of masculinity had been found in work engagement and workaholism, thus masculinity culture can drive work engagement and workaholism. In addition to, there is no relationship between work engagement and workaholism.

Résumé

Cette recherche s'inscrit dans le domaine du management interculturel et du comportement organisationnel. Plus précisément, elle examine la relation et les interactions entre culture et engagement au travail, voire le sur-engagement ou addiction au travail. Dans cette perspective, nous tentons d'analyser l'influence de la culture sur l'engagement au travail et d'identifier, à partir du modèle de G. Hofstede, les dimensions qui prédisposent à l'addiction au travail. Nous essayons également, pour les diverses variables culturelles (démographiques et autres), de déterminer également le niveau de leur impact en situation de travail. Nous étudierons par exemple les variables du genre, statut familial, générationnelle, le niveau d'éducation, d'expérience et l'ancienneté (dans l'entreprise et dans le poste actuel), la position hiérarchique, le degré d'autonomie.

Par conséquent, cette étude va s'attacher à :

- 1) Examiner les dimensions culturelles, l'engagement et l'addiction au travail, et leur interaction.
- 2) Démontrer le poids de la culture sur ces derniers ; comparé aux variables évoquées supra (genre, statut familial, génération, etc.).
- 3) Modéliser le type de relations existantes entre les dimensions culturelles de Hofstede, avec l'engagement au travail et de l'addiction au travail.
- 4) Démontrer l'influence de l'engagement au travail sur l'addiction au travail.

L'étude a été réalisée dans 48 entreprises dans les secteurs de l'automobile, de l'électronique et de l'électricité, et du secteur hôtelier en Thaïlande, avec 403 participants.

Les résultats montrent que trois des dimensions culturelles d'Hofstede, à savoir la distance hiérarchique, la dimension masculinité/féminité, et l'orientation sur le long-terme obtiennent un score plutôt élevé, l'individualisme et le collectivisme ont un score modéré à bas, et le contrôle de l'incertitude obtient un score bas

L'influence de la dimension masculine a été observée pour l'engagement au travail. Par ailleurs, l'engagement au travail parmi les participants va de modéré à haut, alors que le niveau d'addiction au travail va de modéré à bas, et les niveaux d'engagements au travail sont différents entre les groupes de gens célibataires et le groupe de gens mariés. Il semblerait qu'il n'y ait pas de lien entre l'engagement au travail et l'addiction au travail. Pour de futures études, ces résultats donnent un modèle pour l'engagement au travail motivé par la culture, en s'orientant sur l'addiction au travail.

Comment la culture incite-t-elle à l'engagement et oriente –t-elle vers l'addiction au travail ?

Etude de cas des entreprises en Thaïlande

Cette recherche s'inscrit dans le domaine du management interculturel et du comportement organisationnel. Plus précisément, cette étude évalue les dimensions culturelles telles qu'elles sont définies par Hofstede¹ ; elle examine la relation entre l'engagement au travail² (*work engagement*) et l'addiction au travail³ ou *workaholism* qui caractérise les personnes dont le besoin de travailler est devenu si excessif qu'il peut constituer un danger pour leur santé, leur épanouissement personnel ainsi que leur fonctionnement social.

La culture et le développement organisationnel peuvent déterminer les différentes formes d'engagement liées au travail et plus particulièrement à l'addiction au travail. Aussi cette étude permet-elle d'évaluer la face sombre de l'engagement au travail au regard des exigences du travail (demande psychologique, effort, surinvestissement...etc.) et ses résultats clarifient le type de relation existant entre l'engagement et l'addiction au travail.

Par ailleurs, l'importance des variables démographiques et de la situation au travail (le statut conjugal, le sexe, la génération, l'éducation, la position et l'ancienneté dans l'entreprise) ont été étudiées en relation avec la culture et des situations

¹ Hofstede (1990, 2001)

² Schaufeli et al. (2002)

³ Schaufeli, Taris et Bakker (2008)

organisationnelles. Cette étude vise à fournir une vue d'ensemble de la dimension humaine des organisations et cherche à interpréter des situations organisationnelles. Ainsi les principaux objectifs de cette étude sont :

- Examiner les dimensions culturelles, l'engagement et l'addiction au travail.
- Observer les résultats des dimensions culturelles selon les données démographiques : sexe, la génération, le statut conjugal, l'éducation, et les caractéristiques des situations professionnelles : la position, la division, l'ancienneté dans entreprise, et au poste actuel.
- Examiner le type de relations existant entre les dimensions culturelles et l'engagement et l'addiction au travail.
- Démontrer l'influence de l'engagement au travail sur l'addiction au travail.

Engagement, addiction et culture organisationnelle

Comment les entreprises gagnent-elles en compétitivité ? Cette simple question représente toujours un défi pour les équipes de management, qui font de grands efforts afin de trouver les moyens à mettre en œuvre pour accomplir leurs objectifs organisationnels, et essayer de devancer leurs concurrents. Par ailleurs, assurer la réussite des employés au sein de l'entreprise est un autre défi des équipes organisationnelles. Par conséquent, concevoir un type de gestion capable de favoriser à la fois l'organisation et la réussite des employés représente à un enjeu majeur pour la performance de l'entreprise.

En termes de ressources humaines, on considère souvent que l'engagement des employés est primordial pour aider les entreprises à maintenir leurs atouts concurrentiels, mais aussi comme un facteur de réussite organisationnelle⁴.

⁴ SHRM & DDI (2007)

Bakker ⁵soutient également l'idée que l'engagement peut faire une réelle différence qui mène à des avantages concurrentiels durables. Par ailleurs, George⁶ décrit d'une manière générale l'engagement et l'addiction au travail des employés comme étant un facteur contribuant à une situation avantageuse pour tout le monde.

Le terme d'engagement (engagement) a été étudié pour la première fois par Kahn⁷ qui définit l'engagement de l'employé comme étant l'exploitation des membres même de l'entreprise pour leur fonction. En s'impliquant, les gens s'emploient et s'expriment physiquement, cognitivement, et émotionnellement pendant l'exercice de leur fonction.

Depuis, l'engagement des employés a été conceptualisée de plusieurs manières différentes. Par exemple, Harter, Schmidt et Hayes⁸définissaient l'engagement au travail comme la contribution de l'individu, sa satisfaction et son enthousiasme pour le travail. Wellins et Concelman ⁹définissaient quant à eux l'engagement comme la force illusoire qui motive les employés à atteindre des niveaux supérieurs de performance.

Cependant Robinson, Perryman et Hayday ¹⁰conçoivent l'engagement comme une attitude positive adoptée par l'employé envers l'entreprise. L'engagement est aussi défini comme étant l'opposé positif de l'épuisement professionnel¹¹. Robinson, Perryman et Hayday ¹²ont fait des recherches sur l'engagement des employés en se

⁵ Bakker (2009)

⁶ George (2011)

⁷ Kahn (1990)

⁸ Harter, Schmidt et Hayes (2002)

⁹ Wellins et Concelman (2004)

¹⁰ Robinson, Perryman et Hayday (2004)

¹¹ Schaufeli et Bakker (2004).

¹² Robinson et Perryman & Hayday (2004)

focalisant sur l'entreprise, alors que Kahn ¹³, Harter, Schmidt et Hayes¹⁴, Wellins et Concelman ¹⁵ se sont concentrés sur le travail des employés.

Conscientes que l'engagement est crucial pour le fonctionnement des entreprises, de nombreuses sociétés spécialisées ont également travaillé sur l'engagement comme The Gallup, Hewitt Associates, Burke, Development Dimensions International Inc. The International Survey Research : ISR, The Institute for Employment Studies, Dr.Ed Gubman, et Alpha Measure... etc. The Gallup définit les employés impliqués comme ceux qui travaillent avec enthousiasme, avec passion, en tirant l'entreprise vers le haut, avec de l'intérêt pour leur travail. Avec un tel engagement, ces employés vont augmenter la productivité, le profit et la sécurité de l'entreprise.

Par ailleurs, l'International Survey Research (ISR) définit l'engagement des employés comme un processus qui permet à une entreprise d'améliorer le dévouement du personnel et de s'assurer une pérennité. De même, la DDI (Development Dimensions International Inc.) définit les termes de cet engagement comme le niveau auquel les gens estiment, apprécient et croient en ce qu'ils font.

Blesswhite¹⁶ affirme aussi que la compagnie devrait maximiser la satisfaction des employés afin de recevoir en retour une contribution maximale pour l'entreprise. Aussi Burke définit-il l'engagement comme quelque chose de supérieur à une simple satisfaction professionnelle ; cela inclut également le dévouement à l'entreprise, l'évolution de la carrière, et les relations professionnelles avec les dirigeants, les équipes, et les clients.

¹³ Kahn (1990),

¹⁴ Harter, Schmidt et Hayes (2002),

¹⁵ Wellins et Concelman (2004)

¹⁶ Blesswhite (2009)

Dans le milieu des affaires, l'engagement se focalise principalement à la fois sur l'entreprise, et sur les engagements de l'employé. Les deux ont des points communs: le dévouement organisationnel, la notion de comportement de citoyen organisationnel (Organizational Citizenship Behavior ou OCB), la contribution et l'intensité du travail, l'attitude ou le comportement de l'individu ou du groupe, et la satisfaction professionnelle ; Kumar & Swetha¹⁷. Cependant, les bénéfices de l'engagement sont aussi intéressants.

Les bénéfices de l'engagement ont été étudiés par les secteurs des affaires académiques depuis 1990, et les exemples présentés dans les schémas 1 ,2 et 3 montrent pourquoi cette engagement est important. The Development Dimension International : DDI ¹⁸ considère le fait que les employés impliqués augmentent leurs efforts au profit du succès organisationnel. Cela va entraîner la satisfaction du client et sa fidélisation, ainsi que le profit et la croissance des recettes de l'entreprise.



Schéma 1 : Proposition de la valeur de l'engagement selon DDI

Source : adapté de DDI, 2005.

¹⁷ Kumar et Swetha (2011)

¹⁸ DDI (2005)

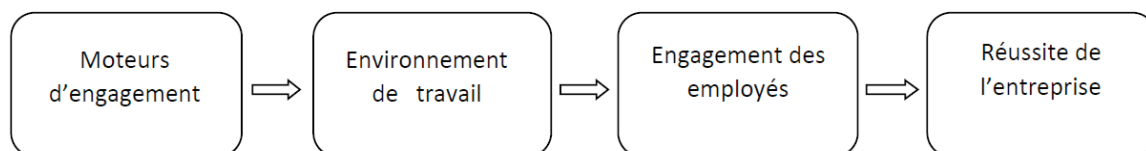
Sak¹⁹ montre que la satisfaction professionnelle et l'engagement vis-à-vis de l'entreprise réduisent le taux de roulement du personnel. Toutefois l'augmentation du comportement de citoyen organisationnel est la conséquence de l'engagement des employés.



Schéma 2 : Antécédences et conséquences de l'engagement de l'employé Source : Sak (2006).

Par conséquent, les employés impliqués peuvent aider les entreprises à accroître leurs avantages concurrentiels. Quand ils sont impliqués dans le travail, ils mènent à la croissance des affaires, et les entreprises ont de bons résultats. Les employés deviennent ainsi plus enclins à travailler plus longtemps pour la même entreprise. Les employés impliqués apprécient de travailler chaque jour ; Engage group²⁰.

¹⁹ Sak (2006)

²⁰ Engage group (2009)

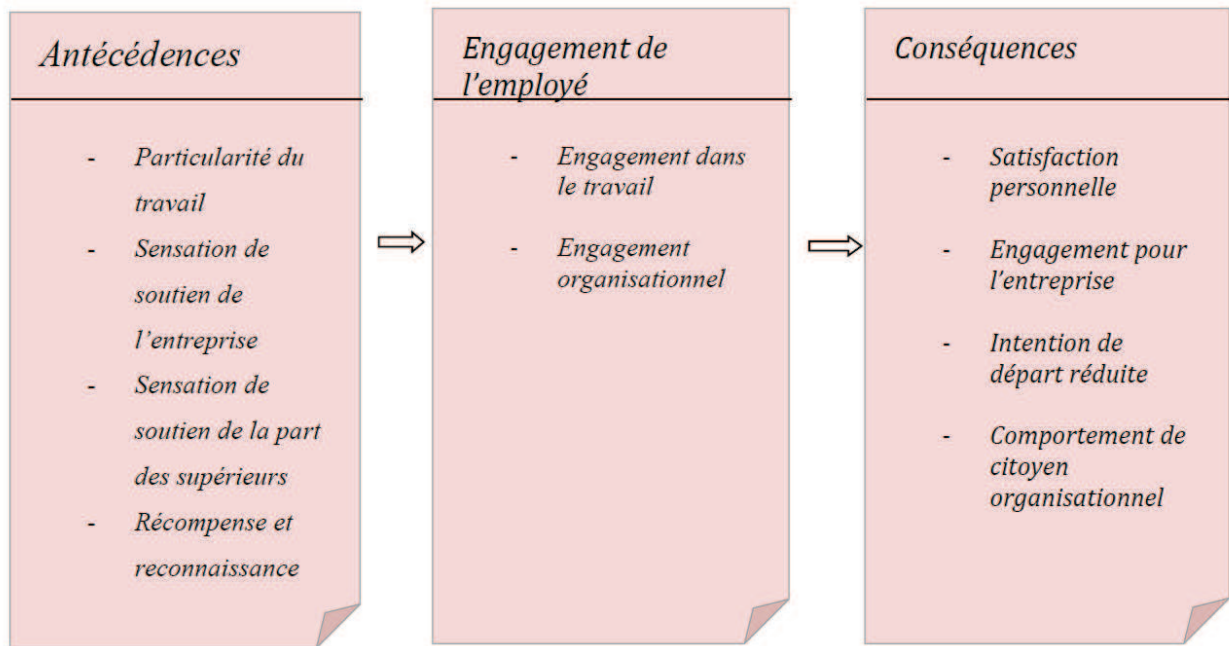
L'engagement est bénéfique tant pour l'entreprise que pour l'employé. D'ailleurs les études montrent également qu'il y a des corrélations positives entre l'engagement et le bien-être des salariés.

On distingue différentes formes d'engagement :

- L'engagement dans l'emploi occupé (son poste et ses tâches)
- L'engagement dans les valeurs du travail (vis-à-vis de l'entreprise et des équipes)
- L'engagement dans l'organisation
- L'engagement dans la carrière (son travail)

Ainsi, comme l'indique le schéma 3, la présente étude considère l'engagement d'un employé comme son engagement à la fois dans ses tâches, dans son travail pour son équipe et pour l'entreprise. Le travail est le point de contact primaire entre l'entreprise et l'employé. L'unité de travail est une pièce du puzzle, chaque unité est impliquée dans la performance de l'entreprise.

L'engagement au travail est considéré comme l'opposé du burn-out, Maslach & Leiter²¹. Par définition, le burn-out est un état dépressif lié au milieu professionnel, et se caractérise par un épuisement général. Après l'avoir étudié pendant plus de 25 ans, Schaufeli et al²² défendent l'idée selon laquelle l'engagement est un état d'esprit positif lié au travail qui se caractérise par la vigueur, l'absorption et le dévouement.

La vigueur représente un niveau élevé d'énergie et de résilience mentale afin de fournir des efforts dans le travail pour faire face aux difficultés. Le dévouement qu'elle permet représente un fort engagement dans son travail. Cette qualité est caractérisée par des

²¹ Maslach et Leiter (1997).

²² Schaufeli et al (2002)

sentiments comme l'importance, l'enthousiasme, la fierté, l'inspiration et le challenge. Enfin, l'absorption correspond au sentiment d'être pleinement occupé, c'est un niveau élevé de concentration et un plaisir ressenti dans l'exercice de son travail et, avec le temps, les employés peuvent avoir des difficultés à se détacher de leur travail. Les caractéristiques des employés qui sont hautement impliqués dans leur travail sont décrites par Schaufeli et Bakker, qui ont démontré que ces personnes auront un niveau d'énergie élevé allant avec leur enthousiasme.



Schéma 3 Types d'implication de l'employé.

De plus, ils sont souvent pleinement immergés dans leur travail sans tomber dans l'addiction, ils apprécient aussi d'autres choses dans la vie en dehors de leur travail. Cependant, cela diffère des addictions au travail ou workaholism qui caractérisent ceux qui travaillent durement à cause d'une pulsion intérieure irrésistible, et non pas parce qu'ils pensent que le travail est amusant ²³.

Selon le modèle Job Demands-Ressources (JD-R / Exigences et ressources du travail), il est désormais admis que l'engagement au travail constitue un avantage comparatif et contribue à la performance des employés dans leur rôle au travail, au développement de leur créativité et à la hausse du chiffre d'affaire financier²⁴ comme décrit dans le

²³ Bakker et Demerouti (2008)

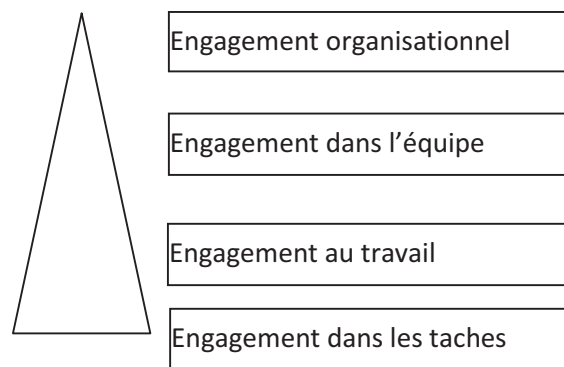
²⁴ Bakker et Demerouti (2008)

schéma 4. L'engagement au travail participe ainsi à la performance économique et sociale des organisations, c'est l'une des attitudes les plus positives en entreprise qui contribue au résultat final qui est la performance et la satisfaction du client²⁵

En outre, l'engagement au travail est positivement lié à la satisfaction professionnelle. Les concepts de satisfaction, motivation, engagement et engagement sont systématiquement corrélés les uns aux autres. L'engagement et la motivation au travail des collaborateurs sont plus évidents dès lors que les individus ressentent un niveau élevé de satisfaction personnelle et professionnelle.

L'engagement envers la profession, qui est parfois confondu avec l'engagement dans le métier ou dans la carrière, ainsi que le comportement du citoyen organisationnel peuvent aussi influencer la décision d'un travailleur de maintenir son poste ou de mettre fin à son appartenance (l'envie d'abandon ou de partir)²⁶

L'engagement au travail est également lié à l'attitude positive des employés. Un niveau élevé de bien-être et un comportement proactif d'un employé s'avèrent essentiels à la croissance du travail individuel et à la performance de l'entreprise²⁷. Par conséquent, les travailleurs impliqués semblent avoir une meilleure santé mentale et psychosomatique²⁸. En outre, les employés dont le niveau d'engagement est élevé ont tendance à augmenter leur vigueur, leur dévouement et leur absorption pour atteindre des performances plus élevées. Cela peut engendrer un 'engagement excessif' et perturber l'équilibre Travail/Vie.

²⁵ Bakker et Schaufeli (2008)

²⁶ Saks (2006).

²⁷ Bakker et al (2008).

²⁸ Shimazu et Schaufeli (2009).



Schéma 4 Modèle JD-R Source : Bakker & Demerouti, 2007

L'engagement au travail est à la fois opposé et similaire à l'addiction; cette relation est expliquée dans le schéma 4 par Bakker. Les employés impliqués ou engagés présentent un niveau d'activité élevé et un plaisir intense pour le travail. De même pour l'addiction qui est caractérisée par un niveau élevé d'activité mais avec une forte déplaisance pour le travail.

Cependant, les employés souffrant de burn-out (Fatigue Professionnelle), qui est un pôle opposé à l'engagement, présentent un faible niveau d'activité et un sentiment de déplaisance pour le travail. Au contraire, les employés dits satisfaits ne sont ni impliqués ni addicts au travail ; ils sont heureux de travailler bien qu'ils aient un niveau d'activité bas.

Les employés impliqués ou engagés peuvent tomber dans l'addiction tout en perdant la joie et le plaisir du travail, alors que les personnes qui sont dans l'addiction pourraient s'impliquer en découvrant une nouvelle source de joie dans leur environnement. Par conséquent, la gestion de l'entreprise devrait insister sur le bien-être des employés pour éviter l'addiction au travail.

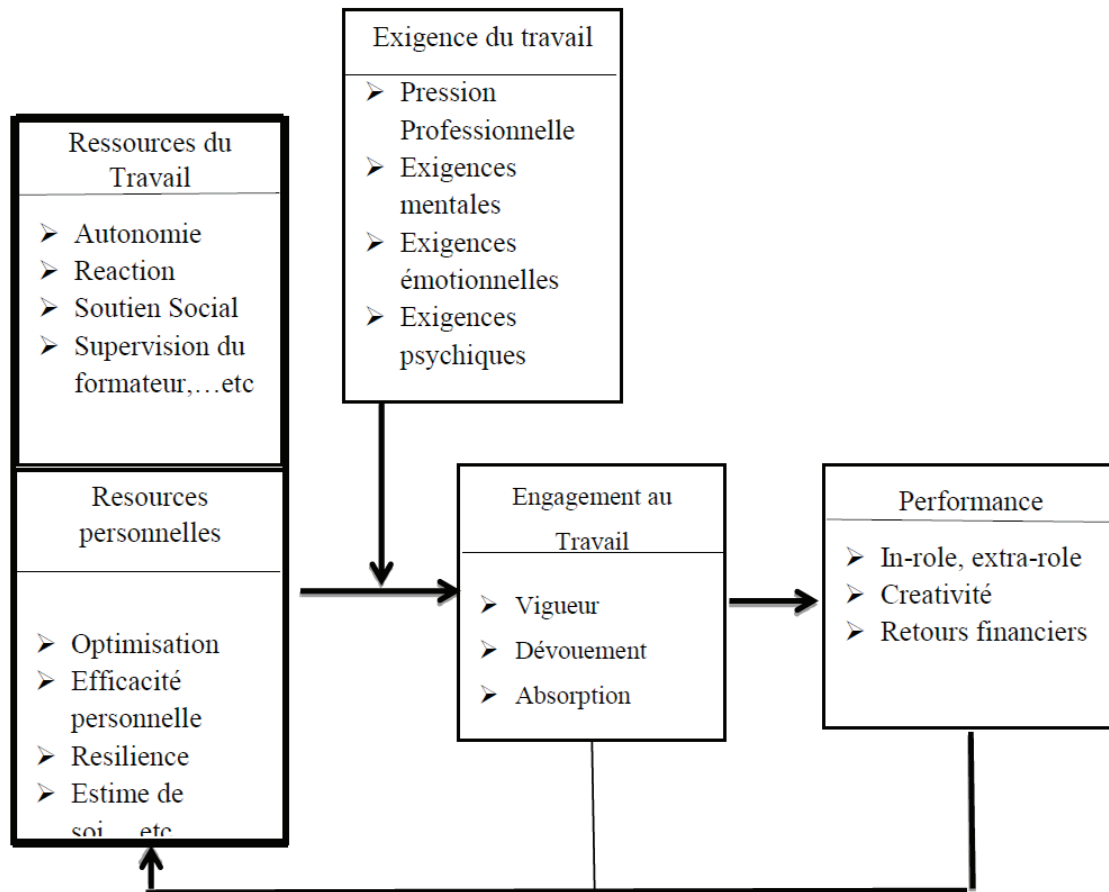
Par ailleurs, l'absorption pourrait être liée à l'addiction : les employés absorbés par le travail ressentent un plaisir dans l'exercice de leurs tâches, et se caractérisent par le sentiment d'être pleinement occupés et, avec le temps, ces employés peuvent avoir des difficultés à se détacher de leur travail, cela peut entraîner une perte progressive d'intérêt pour le travail et ces individus peuvent facilement tomber dans l'addiction, comme expliqué dans le schéma 5.

Cependant, Schaufeli, Taris et Van Rhenen²⁹ pensent que l'engagement et l'addiction au travail sont liés à différentes variables : le travail acharné et la loyauté à l'entreprise. Les employés qui tombent dans l'addiction auront du mal à maintenir une santé mentale stable, ainsi que leurs relations sociales, alors que les travailleurs impliqués réussissent à maintenir leur bien-être et à garder une excellente qualité de vie. Peu de recherches ont été réalisées sur l'influence de l'engagement sur les travailleurs addicts au travail.

Shimazu et al³⁰ affirment que l'addiction et l'engagement sont deux concepts différents, qui sont reliés de manières opposées au bien-être et aux performances des travailleurs. De ce fait, il est recommandé d'enquêter sur la relation entre les travailleurs qui s'impliquent et ceux qui s'acharnent au travail pour vérifier si les addictions peuvent avoir un effet bénéfique sur les personnes engagées dans le travail.

²⁹ Taris et Van Rhenen (2003)

³⁰ Shimazu & all (2012)



Schéma 5 Rapport du bien-être subjectif au travail

Source : (Bakker, 2011)

Vu l'importance de l'engagement au travail, il est facile de comprendre l'évolution des pratiques de gestion qui vont davantage dans le sens d'une recherche de stratégies organisationnelles et de méthodes afin d'augmenter le niveau d'implication des collaborateurs. Cependant, il y a de nombreux facteurs qui déterminent le niveau d'implication ou d'engagement d'un employé : des facteurs qui peuvent être liés à la personnalité et les ressources personnelles, d'autres à l'entreprise (les ressources du travail, la culture de l'entreprise), mais aussi des facteurs externes ou sociaux-culturels qui contribuent à cette dynamique.

L'impact des facteurs sociaux-culturels sur l'engagement et l'addiction au travail ne sont pas négligeables. Le schéma ci-dessous montre l'influence de la culture et des valeurs propres sur le comportement humain.

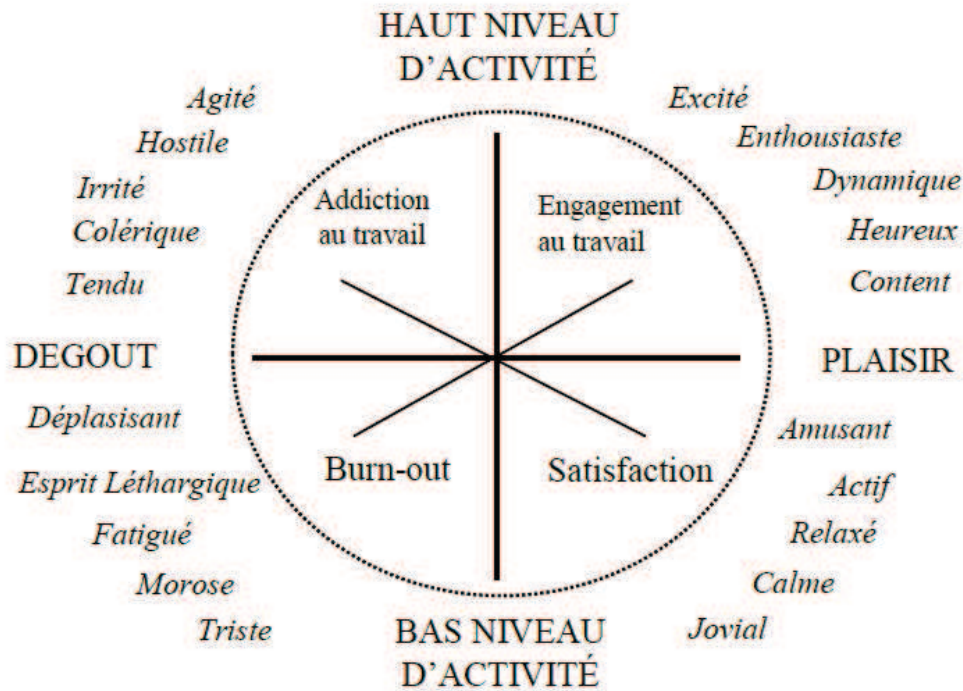

Schéma 6 : Processus du comportement

Ces différentes variables dans les équipes de travail et dans la société elle-même, amèneront les employés à développer des stratégies et un comportement approprié qui affectera l'expérience et la performance de l'entreprise et sa clientèle.

L'engagement et l'addiction au travail est la combinaison de différentes valeurs culturelles propres à chaque individu, ils sont liés à l'appartenance religieuse, sociale, professionnelle et aux valeurs qui définissent les façons d'agir et de penser. Le comportement individuel est influencé par les croyances et les valeurs qui guident les individus³¹.

³¹ Hofstede (2010).

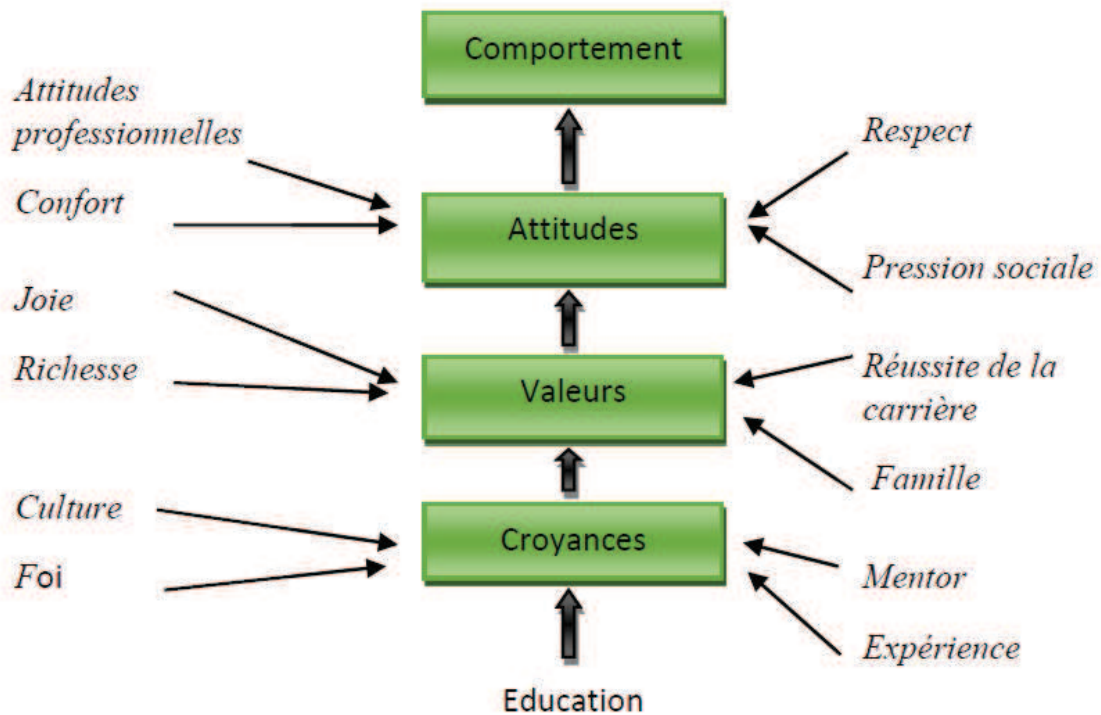

Schéma 7 : Influence de la culture sur l'engagement au travail

Source : Adapté de Right managements organizational effectiveness framework (Right managements, 2011)

L'engagement ou l'engagement au travail, ainsi que l'addiction sont considérés comme étant des comportements individuels. De ce fait, la culture peut être utilisée sous forme de pression sociale afin d'imposer ou de modifier les attitudes et les comportements des individus ou des groupes au sein des sociétés.

Par ailleurs, la culture crée un climat qui permet aux membres d'un groupe de partager des perceptions organisationnelles vis-à-vis de leur environnement de travail. Robbin³² précise également que « si vous travaillez avec quelqu'un ou avec une équipe interne dont l'attitude est positive, qui influence votre motivation et vous incite à faire de votre mieux, vous avez vécu les effets du climat. »

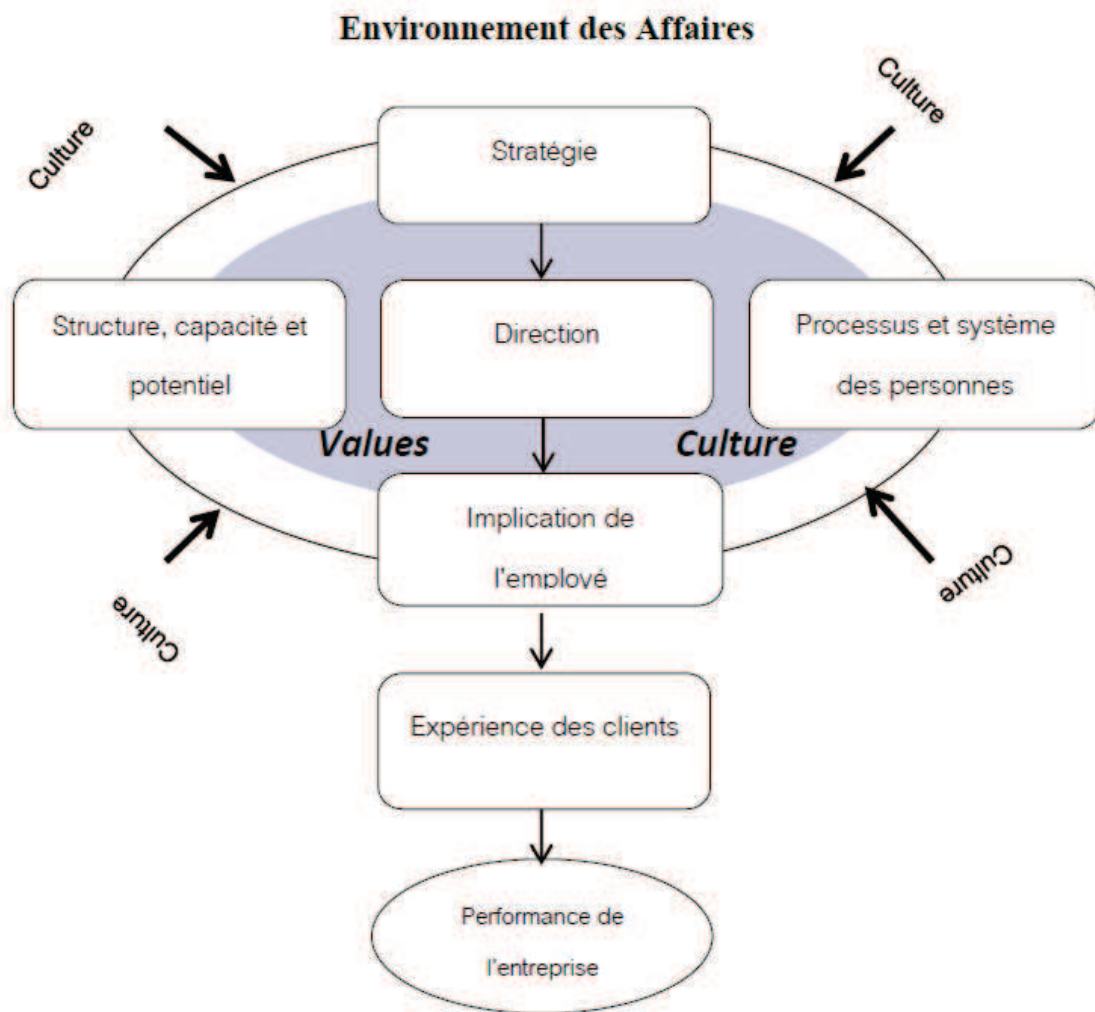
Bakker³³ admet l'idée qu'avec la mise en disposition de hautes ressources liées au travail et moins d'exigences on peut conduire à l'augmentation de la motivation et de l'engagement des employés. Il y a de multiples consultants en affaires qui suggèrent la création d'une culture d'implication pour favoriser l'engagement et la motivation des employés. Robbin³⁴ présentait une approche qui montre comment la culture d'une entreprise peut être établie et soutenue (schéma 8).

La culture originale et la philosophie du fondateur de la société influence fortement les critères d'embauche au fur et à mesure que la firme s'agrandit. Les actions de l'administration peuvent mettre en place un climat général en incluant un comportement acceptable.

³² Robbin (2005)

³³ Bakker (2009)

³⁴ Robbin (2012)



Schéma 8 : Modalité de formation du concept de culture de l'entreprise

Source : Robbin, 2009

Pour conclure, on peut dire que la culture peut avoir une influence sur la motivation et l'engagement des employés, dans la mesure où elle a un effet non négligeable sur le comportement individuel et sur le climat général au sein d'une entreprise. Les valeurs culturelles déterminent également en partie les ressources personnelles ou la personnalité des individus, et procurent ainsi des ressources liées au travail comme une sorte de soutien social et de coaching. La culture influence aussi le style de gestion et crée un climat organisationnel qui agit en retour sur l'engagement et l'addiction au travail. Les valeurs culturelles peuvent avoir un effet négatif sur la motivation et l'engagement d'un employé en le conduisant à l'addiction comme le montre le schéma 9.

Geert Hofstede³⁵ admet que l'étude de la culture serait l'approche la plus pertinente pour l'étude des différences interculturelles en tant que variable indépendante dans le comportement humain. Dans cette recherche, les cinq facteurs de différenciation culturelle (la distance hiérarchique, l'individualisme contre le collectivisme, la dimension masculin/féminin, le contrôle de l'incertitude et l'orientation à long terme) sont combinés pour étudier les relations entre l'engagement au travail et l'addiction au travail.

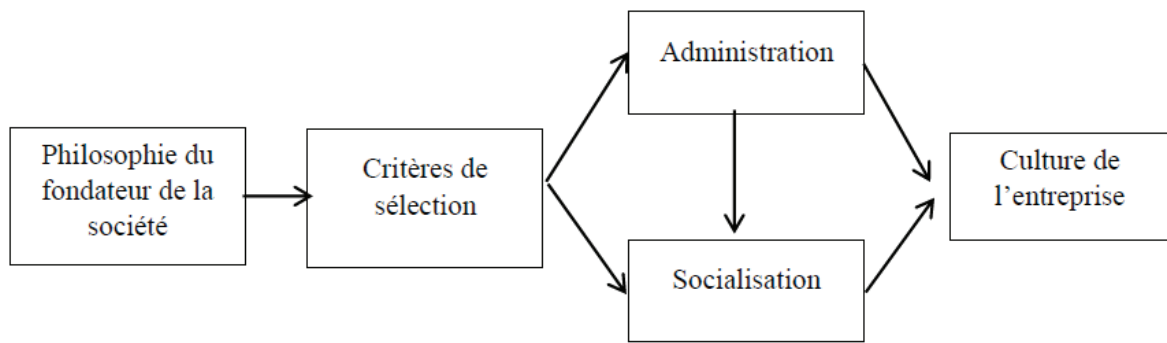
³⁵ Hofstede (1980, 2001)



Schéma 9 Influence de la culture sur l'engagement au travail

La manière dont la culture motive les employés impliqués et dont elle oriente ceux qui développent une addiction au travail doit être étudiée. Etant donné que la culture agit sur le comportement individuel, comme le précise Hofstede³⁶, les dimensions du système psychologique et les comportements organisationnels sont liées à la manière dont les personnes elles-mêmes fonctionnent dans les sociétés industrielles. Ces dimensions ont fait l'objet de très nombreuses recherches, et ont eu une grande influence sur toutes les sciences sociales³⁷.

³⁶ Hofstede (2010),

³⁷ Triadis (2004).

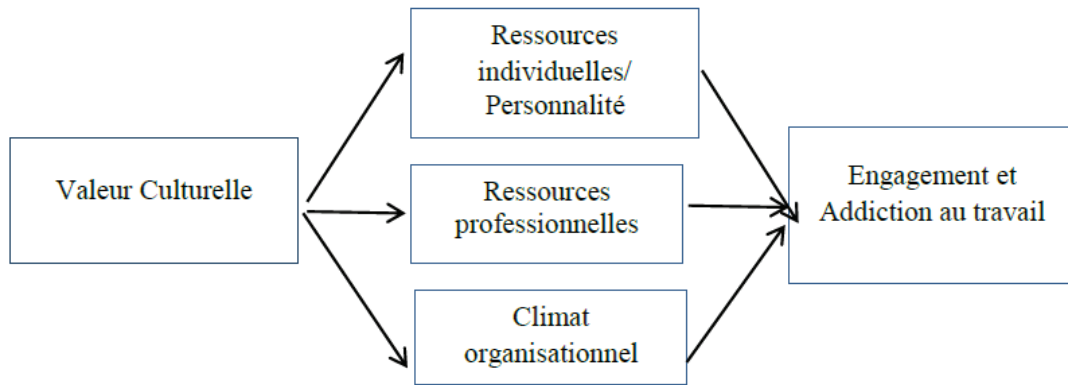
En examinant le modèle de recherche sur la culture de Hofstede³⁸, le modèle d'implication de Fleck et Inceoglu³⁹, le cadre de l'efficacité organisationnelle selon Right Managements⁴⁰ et le modèle d'implication des interactions personnes/environnements de Neufeld et al⁴¹ conjointement avec l'étude de Wu⁴², on constate que les valeurs culturelles des individus liées au travail dans une culture spécifique ne sont pas statiques, elles peuvent varier à tout moment quand l'environnement politique, social et économique change.

L'étude menée par Hofstede⁴³ portant sur l'influence des différences culturelles sur l'addiction au travail peut être comparée à celle de Baruch⁴⁴. Les deux études admettent que l'addiction au travail peut devenir positive dans les cultures qui sont caractérisées par une grande distance hiérarchique et un haut contrôle de l'incertitude, principalement masculines et orientées sur le long terme ; et moins dans les cultures accordant une grande place à la féminité.

Business insider nomma le Japon comme le pays ayant le plus d'addiction au travail alors que le Japon présente une distance hiérarchique modérée dans l'individualisme, une forte présence masculine dans le contrôle face à l'incertitude et l'orientation à long-terme ;

³⁸ Hofstede (2010)

³⁹ Fleck & Inceoglu (2010)

⁴⁰ Right Managements (2011)

⁴¹ Neufeld et al (2006)

⁴² Wu (2006),

⁴³ Hofstede (2010)

⁴⁴ Baruch (2011).

Hofstede ⁴⁵. Par ailleurs, les Français sont désignés comme les travailleurs les plus relaxés alors que l'on trouve une forte distance hiérarchique, de l'individualisme, du contrôle de l'incertitude, et de l'orientation à long terme, mais avec une masculinité modérée. De ce fait, on peut conclure que les valeurs culturelles peuvent avoir un effet non négligeable sur l'addiction au travail.

Dans les études menées par Shimazu, Miyanaka et schaufeli⁴⁶ sur l'engagement des employés, on admet que c'est en France et en Finlande que se trouvent les plus fortes implications au travail, contrairement au Japon qui présente un faible niveau d'implication de la part des employés.

Comme les études sur l'influence des différences culturelles sur l'engagement au travail sont rares, la deuxième et la troisième partie de ce travail seront consacrées à l'étude de la manière dont les différences culturelles amènent les individus vers une implication ou une addiction au travail. L'analyse de l'impact de la culture constituera la quatrième partie de cette étude afin d'actualiser la théorie des dimensions culturelles de Hofstede en utilisant des informations venant de différents secteurs d'activité. Les paramètres démographiques tels que le genre, la génération, l'éducation et le statut conjugal sont présentés conjointement avec les caractéristiques de chaque situation professionnelle (l'ancienneté dans l'entreprise, le poste occupé et la branche). Il est important d'étudier la culture, l'engagement et l'addiction au travail parmi des groupes spécifiques pour comprendre leurs influences sur les employés et la performance des entreprises.

⁴⁵ Hofstede (2010).

⁴⁶ Shimazu, Miyanaka et schaufeli (2010)



Schéma 10 Modèle de recherche

Pour résumer, le cadre de la recherche de cette étude, représenté dans le schéma 10, a été choisi afin de trouver les réponses aux questions suivantes :

- 1) Est-ce que les dimensions culturelles définies par Hofstede, l'engagement au travail et l'addiction au travail diffèrent selon les données démographiques et les caractéristiques de situation professionnelle ?
- 2) Les dimensions culturelles définies par Hofstede ont-elles un lien avec l'engagement au travail ?
- 3) Les dimensions culturelles définies par Hofstede ont-elles un lien avec l'addiction au travail ?
- 4) L'addiction au travail agit-elle négativement sur l'engagement au travail ?

Le cadre de la recherche est composé des quatre parties suivantes :

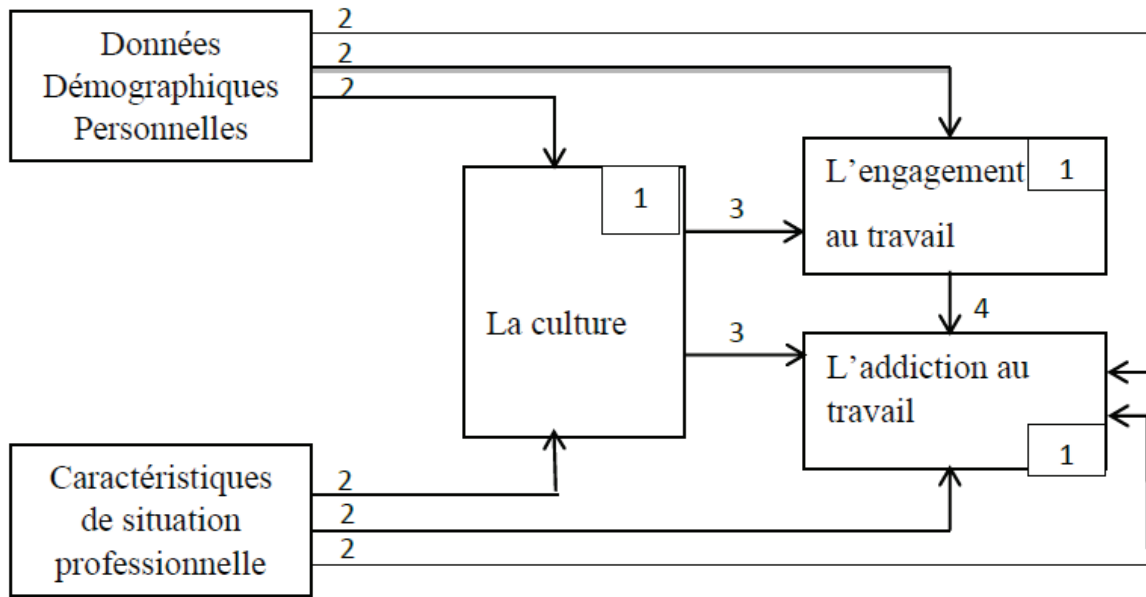
- (1) L'étude des différenciations culturelles définies par Hofstede, du niveau d'engagement au travail et du niveau d'addiction au travail.
- (2) La comparaison des différenciations culturelles, du niveau d'engagement au travail et du niveau d'addiction au travail, en lien avec les données démographiques personnelles et les caractéristiques de la situation professionnelle.
- (3) Identification des liens entre les différenciations culturelles, l'engagement et l'addiction au travail.
- (4). Identification de l'influence de l'engagement au travail sur l'addiction au travail.

**les numéros 1,2,3,4 du schéma 10 soulignent la pertinence de ces objectifs.

Les données démographiques personnelles prennent en compte le sexe, la génération, le statut conjugal et le niveau d'éducation.

Les caractéristiques de la situation professionnelle comprennent l'ancienneté dans l'entreprise, la position, la division et l'ancienneté au poste actuel.

Les dimensions culturelles de Hofstede tiennent compte de la distance hiérarchique, de l'individualisme contre le collectivisme, de la masculinité contre la féminité, du contrôle de l'incertitude et de l'orientation à long terme.

Un engagement au travail se caractérise par la vigueur, le dévouement et l'absorption.

Une addiction au travail se manifeste par un travail compulsif et un travail excessif.



Schéma 10 Modèle de la recherche (version complète)

Le modèle de recherche (version complète), illustré par le schéma 11, peut être considéré comme un guide de la recherche présentée ici:

- 1.1 Les dimensions culturelles de Hofstede: HOFS, se composent des scores de la distance hiérarchique: PDI, de l'individualisme: IDV, de la masculinité: MAS, du contrôle de l'incertitude: UAI et de l'orientation à long-terme: LTO.
- 1.2 Le niveau de l'engagement au travail : UWES, est constitué des niveaux de vigueur : VI, de dévouement : DE et d'absorption : AB.
- 1.3 Le niveau de l'addiction au travail : DUWAS, comprend les niveaux de travail excessif : WKE et de travail compulsif.
- 2.1 Les dimensions culturelles de Hofstede établissent des comparaisons entre le sexe, la génération, le statut conjugal et l'éducation.
- 2.2 L'engagement au travail compare le sexe, la génération, le statut conjugal et l'éducation.
- 2.3 L'addiction au travail compare le sexe, la génération, le statut conjugal et l'éducation.
- 2.4 Les dimensions culturelles de Hofstede comparent l'ancienneté dans l'entreprise, la position, la division et l'ancienneté au poste actuel.
- 2.5 L'engagement au travail compare l'ancienneté dans l'entreprise, la position, la division et l'ancienneté au poste actuel.
- 2.6 L'addiction au travail compare l'ancienneté dans l'entreprise, la position, la division et l'ancienneté au poste actuel.
- 3.1 La relation entre les dimensions culturelles de Hofstede et un engagement au travail.
- 3.2 La relation entre les dimensions culturelles de Hofstede et une addiction au travail.
- 4.0 Une influence d'un engagement au travail sur une addiction au travail.

Les dimensions culturelles de Hofstede sont impliquées dans cette étude comme une variable indépendante. Cette étude s'attend à ce que les dimensions de la culture de Hofstede aient une relation avec l'engagement au travail et l'addiction au travail. On peut en effet remarquer qu'il existe peu d'études traitant des relations entre les dimensions culturelles de Hofstede et l'engagement au travail. Une relation avec l'addiction au travail a été mise en évidence par l'étude de Baruch (2011). Ce dernier explique que l'addiction au travail est perçue plus positivement dans les cultures caractérisées par une distance hiérarchique élevée, un évitement de l'incertitude important, un individualisme élevé, une forte masculinité et une orientation à long terme, que dans les cultures à forte féminité. Ainsi, on peut, pour confirmer l'étude de Baruch⁴⁷, formuler l'hypothèse que la distance hiérarchique, l'évitement de l'incertitude, l'orientation à long terme, la masculinité et l'individualisme favorisent l'addiction au travail.

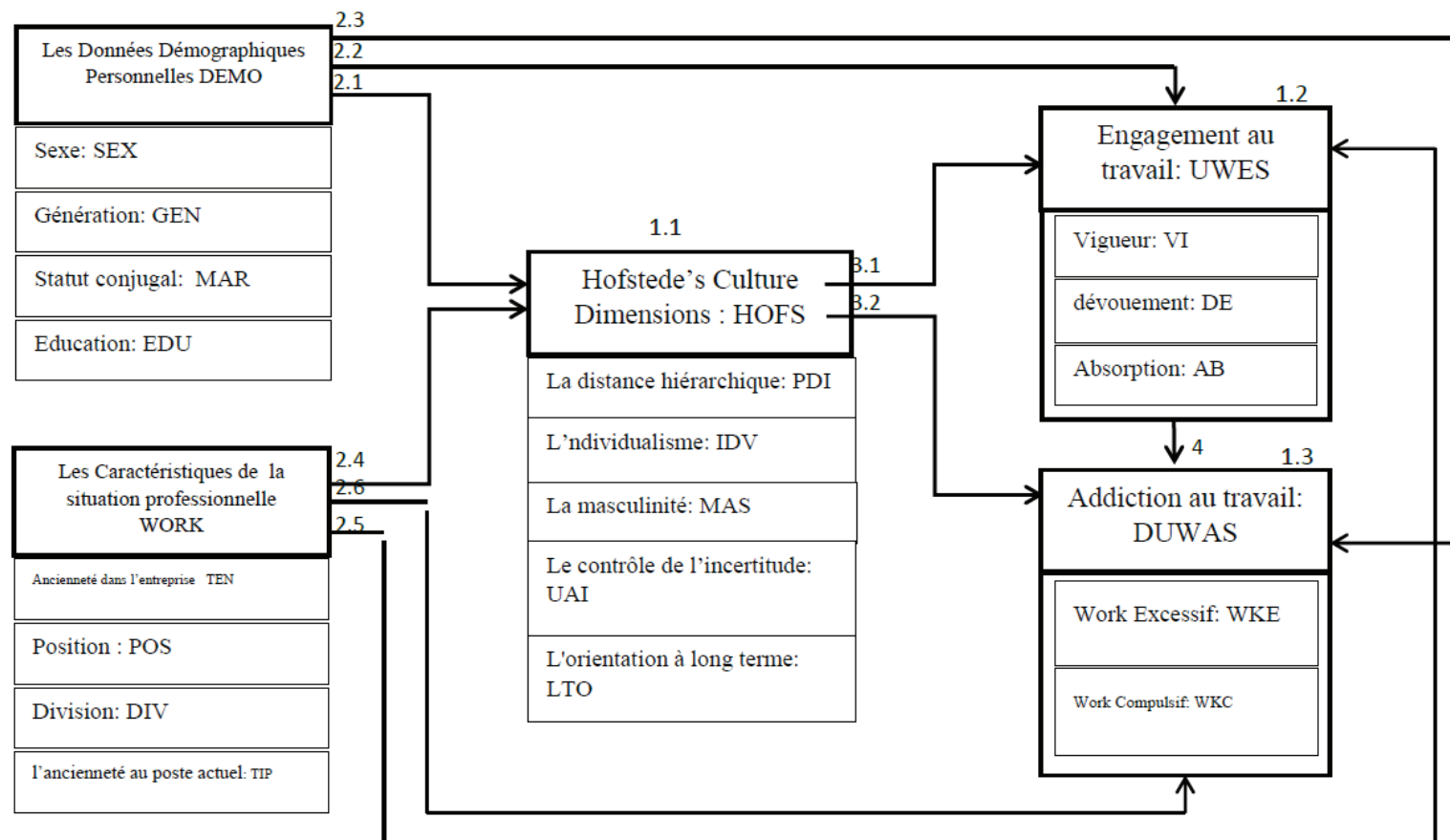
Hofstede⁴⁸ définit les caractéristiques des dimensions culturelles. *La distance hiérarchique* est le fait qu'une personne ayant peu de pouvoir attende et accepte que le pouvoir soit inégalement distribué. Les caractéristiques d'une grande distance hiérarchique sont une autorité centralisée, un leadership autocratique, un mode de gestion paternaliste, un grand nombre de niveaux hiérarchiques, beaucoup de personnel de surveillance, l'acceptation que ce pouvoir induise des privilèges, une attente d'inégalité et une différence de pouvoir. A l'inverse, une autorité décentralisée, un mode de gestion

⁴⁷ Baruch (2011)

⁴⁸ Hofstede (2010)

consultatif ou participatif et donc une responsabilité dans la décision, une structure organisationnelle, une faible proportion de personnels d'encadrement, un refus d'acceptation et une contestation de l'autorité, une conscience de l'individu et une tendance à l'égalitarisme sont des caractéristiques que l'on retrouve dans une culture présentant une faible distance hiérarchique.

Par conséquent, la distance hiérarchique peut avoir un impact négatif sur l'engagement au travail. L'existence d'un leadership autocratique dans une organisation où la distance hiérarchique est élevée peut générer une ambiance négative notamment par le manque de ressources d'emploi comme l'autonomie, ce qui entraînera une baisse de l'engagement au travail.

La dimension de l'individualisme contre le collectivisme renvoie à la manière dont les sexes se définissent eux-mêmes et dans leurs relations avec les autres. Les caractéristiques de l'individualisme sont les suivantes : des relations contractuelles d'accueil basées sur des principes d'échange, un calcul des profits et des pertes avant de adopter un comportement et l'acceptation de la confrontation. L'individualiste se concentre sur lui-même, ou sur des proches en mesure de décider de son comportement, de servir son besoin propre, son intérêt et son objectif. Sont mises en avant les valeurs d'indépendance et d'autosuffisance, ainsi que la primauté des intérêts propres sur les intérêts collectifs. L'accent est mis davantage sur les notions d'amusement et de plaisir personnel que sur les normes sociales et les droits des autres membres du groupe car ces derniers ont peu d'influence sur l'existence de l'individu. Les individualistes pensent que leurs croyances sont l'inverse, et donnent une priorité aux relations horizontales (par exemple : conjoint- conjoint) sur les relations verticales (par exemple : parent -enfant).

A l'inverse, les personnes issues d'une culture collectiviste se comportent selon les normes sociales élaborées pour maintenir une harmonie sociale entre les membres d'un groupe, considèrent les enjeux de leurs actions pour le plus grand nombre, partagent des ressources et sont prêts à sacrifier leur intérêt personnel pour des intérêts collectifs. Ils favorisent certains individus dans le groupe (famille, amis), mettent en évidence une hiérarchie et une harmonie au sein du groupe, et régulent les comportements par les normes du groupe.

Dès lors, les employés qui relèvent de l'individualisme peuvent augmenter leur engagement au travail s'ils savent qu'ils feront plus de profit. Ils seront plus autonomes car leurs comportements sont influencés par leurs attitudes, ils se comportent davantage comme ils le veulent que comme ils le doivent. A l'inverse, les employés relevant d'une culture de type collectiviste s'engageront seulement si leur groupe est engagé car leurs comportements sont influencés par les normes du groupe. Par conséquent, l'orientation individualiste a un impact positif sur l'engagement au travail, tandis qu'un engagement au travail dans une culture collectiviste dépend de la norme du groupe.

L'opposition de la masculinité contre la féminité est relative aux comportements qui dépendent à la fois de la différenciation sexuelle et des caractéristiques de chaque sexe.

Les cultures masculines font une distinction claire entre les rôles de chacun des sexes. Les hommes sont définis comme autoritaires, solides et axés sur la réussite matérielle. Ils accordent peu d'importance à la bienveillance, et sont en recherche de maîtrise (un emploi, des gens, etc), de défis et de réussite dans leur carrière. Les femmes doivent être modestes, tendres, attentives à la santé, à la richesse et à la qualité de vie.

Les cultures féminines, quant à elles, ne font pas de distinction des rôles sociaux en fonction du sexe. Les hommes et les femmes sont supposés être modestes et soucieux de la qualité de vie. Les femmes souhaitent être traitées de manière égale par leurs maris ou conjoints, et mettent l'accent sur les aspects non-matérialistes du succès.

Par conséquent, la valeur de la masculinité est liée positivement à l'engagement au travail puisqu'elle valorise le succès de carrière, comme le suggère Blesswhile⁴⁹. Selon lui, l'engagement est plus élevé quand une organisation ou un employé arrive à atteindre ses objectifs.

Le contrôle de l'incertitude renvoie à la capacité des membres d'une société à gérer l'incertitude de l'avenir, sans éprouver un stress excessif. Un faible contrôle de l'incertitude se caractérise par une prise de risque, une tolérance aux comportements et opinions différents, une flexibilité, des organisations peu structurées, régies par quelques règles, et des promotions fondées sur le mérite. Alors que la culture à fort contrôle de l'incertitude préfère l'évitement du risque, possède des structures clairement délimitées, de nombreuses règles écrites, des procédures normalisées, des promotions fondées sur l'ancienneté ou l'âge, un manque de tolérance pour les pervertis, une nécessité de consensus, un besoin de prévisibilité, un planning important, et un respect de l'autorité. Par conséquent, une culture au fort contrôle de l'incertitude peut limiter l'engagement au travail.

⁴⁹ Blesswhile (2009).

Le critère d'orientation à long terme, comme une réflexion dynamique, une mentalité tournée vers l'avenir, met l'accent sur la persistance (persévérance), sur l'ordre des relations fondées, sur le statut et les observations de cet ordre, sur l'économie et l'épargne, le sens de la honte, une sensibilité aux contacts sociaux. Elle est corrélée positivement à la croissance économique⁵⁰.

A l'inverse, l'orientation à court terme est tournée vers le présent et le passé. Elle est relativement statique et liée à une mentalité traditionnelle. Cette orientation met l'accent sur une constance personnelle, une stabilité, une face protégée, un respect de la tradition, un échange de salutations, de faveurs et de cadeaux. Elle est corrélée négativement à la croissance économique⁵¹.

L'orientation à long terme a une influence positive sur l'engagement au travail puisqu'elle prévoit des objectifs pour l'avenir, pour un individu ou une organisation, qui motivent au travail, bien plus qu'une orientation à court terme.

Pour apporter une réponse à l'ensemble des hypothèses : l'individualisme, l'évitement de l'incertitude, une forte masculinité, et une orientation à long terme favorisent l'engagement au travail, alors que la distance hiérarchique peut, quant à elle, avoir un impact négatif sur l'engagement au travail.

De plus, cette étude intègre également des variables de démographie personnelle (le sexe, la génération, l'éducation, et le statut conjugal) afin d'étudier l'influence des facteurs interpersonnels sur la distance hiérarchique, l'individualisme, la masculinité, l'évitement de l'incertitude, l'orientation à long terme, l'engagement au travail et l'addiction au travail.

⁵⁰ Hofstede et Bond (1988-1992).

⁵¹ Hofstede et Bond (1988-1992).

La distance hiérarchique diminue avec le niveau d'éducation, les variations culturelles, les phénomènes d'engagement et d'addiction au travail, la valeur accordée au travail en fonction du sexe et de la génération. Un travail excessif a également des repercussions sur le fonctionnement familial. Ces informations contribuent à répondre aux hypothèses formulées.

H1 (a). Les résultats des dimensions culturelles de Hofstede diffèrent selon les données démographiques personnelles et les caractéristiques de la situation professionnelle : le sexe, la génération, le statut conjugal et l'éducation, l'ancienneté dans l'entreprise, la position, la division et l'ancienneté au poste actuel.

H1 (b). Les niveaux d'engagement au travail diffèrent selon les données démographiques personnelles et les caractéristiques de la situation professionnelle.

H1 (c). Les niveaux d'addiction au travail diffèrent selon les données démographiques personnelles et les caractéristiques de la situation professionnelle.

H2 Il existe des relations entre les dimensions culturelles de Hofstede et l'engagement au travail.

H3 Il existe des relations entre les dimensions culturelles de Hofstede et l'addiction au travail.

H4 Il y a des relations entre engagement et addiction au travail.

Les résultats

Les questionnaires d'enquête ont été distribués au sein de trois entreprises ; 403 questionnaires exploitables ont été obtenus en retour. Les secteurs d'activité représentés dans notre étude sont l'hôtellerie, l'automobile et l'électronique. Parmi les 403 questionnaires, 78 proviennent du secteur hôtelier, ce qui représente 15% du nombre total de questionnaires, 60 questionnaires proviennent de l'automobile (19%) et 265 de l'électronique (76%).

Les données Démographiques personnelles	Les Catégories	Nombre	Pourcentage	les Caractéristiques de la situation professionnelle	Les catégories	Nombre	Pourcentage
Le sexe	Mâle	194	48 %	L'ancienneté dans l'entreprise	<5	108	27%
	Femelle	209	52 %		6-10	120	30%
La génération	Baby-Boomer	49	12%		11-15	64	16%
	Gen-X	258	64%		15-20	48	12%
	Gen-Y	96	24%		>20	63	16%
L'éducation	< Licence	112	28%	Division	Support	235	58%
	= Licence	239	59%		Non-support	168	42%
	> Licence	52	13%	Position	Staff	188	47%
Le statut conjugal	Célibataire	194	48%		Supervisor	120	30%
	Marié	185	46%		Middle manager	33	8%
	Autre	24	6%		Over middle manager	62	15%
				L'ancienneté au poste actuel	<5	171	43%
					5-10	157	39%
					11-15	37	9%
					15-20	26	6%
					>20	12	3%

Tableau 1 Distribution des caractéristiques démographiques et des situations de travail des répondants.

Culture			L'engagement au travail			L'addiction au travail		
<i>Dimensions</i>	<i>moyenne</i>	<i>S.D.</i>	<i>Types</i>	<i>moyenne</i>	<i>S.D.</i>	<i>Types</i>	<i>moyenne</i>	<i>S.D.</i>
PDI	3.43	.499	L'engagement au travail	4.68	.725	L'addiction au travail	2.42	.451
IDV	2.82	.769	VI	4.47	.813	WKE	2.38	.469
MAS	3.66	.527	DE	5.15	.803	WKC	2.45	.470
UAI	4.03	.451	AB	4.43	.857			
LTO	3.75	.455						

Tableau 2 Résultats de l'analyse pour l'échelle des dimensions culturelles, de l'engagement au travail et de l'addiction au travail.

Moyenne des Variables	Hotel N = 78		automobile n= 60		électrique & électronique n = 265	
	Moyenne	S.D.	Moyenne	S.D.	Moyenne	S.D.
PDI	3.44	.517	3.45	.537	3.42	.487
IDV	2.83	.760	2.84	.827	2.81	.760
MAS	3.69	.594	3.64	.508	3.66	.511
UAI	3.93	.478	3.97	.371	4.07	.455
LTO	3.72	.483	3.67	.445	3.77	.447
UWES	4,78	.607	4,63	.651	4.66	.770
VI	4.50	.718	4.42	.780	4.47	.848
DE	5.27	.727	5.11	.716	5.11	.842
AB	4.78	.761	4.37	.780	4.39	.897
DUWAS	2.32	.437	2.37	.471	2.45	.447
WKE	2.30	.453	2.34	.498	2.41	.465
WKC	2.34	.494	2.40	.495	2.48	.452

Tableau 3 : Mesure des dimensions culturelles, de l'engagement au travail et de l'addiction au travail dans les trois secteurs d'activité.

Les dimensions culturelles

Les dimensions culturelles ont été évaluées en utilisant 28 points adaptés à la théorie de Hofstede (1984). Cette étude propose cinq (05) dimensions :

- La distance hiérarchique par rapport au pouvoir : PDI – 6 items ;
- L'évitement de l'incertitude : UAI – 7 items ;
- L'individualisme contre le collectivisme : IDV – 4 items ;
- La masculinité par opposition à la féminité : MAS – 5 items ;
- L'orientation à long terme contre l'orientation à court terme : LTO-6 items.

Les mesures des dimensions culturelles sont comparées à celles de Hofstede (1977) et de Budsakorn (2005) et les résultats de cette comparaison sont décrits dans le tableau 4.

Les dimensions culturelles	comparaison des études		
	Notre étude	Budsakorn, 2005	Hofstede 1977
La distance hiérarchique : PDI	66	44	64
Le contrôle de l'incertitude: UAI	81	83	64
L'individualisme et le collectivisme: IDV	56	55	20
La masculinité et la féminité : MAS	73	19	34
L'orientation à court terme/long terme : LTO	75	40	32

Tableau 4. Comparaison des données relatives aux dimensions culturelles entre notre étude et celles de Budsakorn et Hofstede

L'engagement au travail

La mesure de l'engagement utilisée dans cette étude est adaptée à l'échelle d'engagement au travail d'Utrecht, elle prend la forme d'une échelle composée de 17 items étalonnés sur trois bases : la vigueur (VI – 6 items), le dévouement (DE – 5 items), et l'absorption (AB- 7 items). La moyenne des scores de chaque composante (vigueur, dévouement et absorption) permet d'apprécier le niveau global d'engagement au travail. L'analyse fait ressortir trois (03) sous-échelles allant de 0 à 6 :

- « *Engagement au travail faible* » ; il varie de 0 à 2,99 ;
- « *Engagement modéré* », il varie de 3 à 4,99 ;
- « *Engagement élevé* », il varie de 5 à 6.

L'analyse du niveau d'engagement est présentée dans le tableau 5 :

Les variables	Total n =403		Hotel n = 78		Automobile n= 60		Electrique & Electronique n = 265	
	Moyenne	S.D.	Moyenne	S.D.	Moyenne	S.D.	Moyenne	S.D.
UWES	4.68	.725	4,78	.607	4,63	.651	4.66	.770
VI	4.47	.813	4.50	.718	4.42	.780	4.47	.848
DE	5.15	.803	5.27	.727	5.11	.716	5.11	.842
AB	4.43	.857	4.78	.761	4.37	.780	4.39	.897

Tableau 5 : Analyse du niveau d'engagement

On peut conclure que l'engagement au travail dans cette étude va de modéré à élevé (4,68), avec un score VI (4,47) inférieur au score DE (5,15) et supérieur au score AB (4,43).

Les types d'engagement sont regroupés en 08 catégories, et sont présentés dans le tableau 6 :

Types de travailleurs	Nombre	%	Vigueur	Dévouement	Absorption
Travailleur engagé	68	16.90	Elevée	Elevé	Elevée
Travailleur Non motivé	45	11.20	Elevée	Faible	Faible
Travailleur Non Dévoué	3	0.70	Elevée	Faible	Elevée
Travailleur Non vigoureux	55	13.60	Faible	Elevé	Faible
Travailleur Vigoureux	4	1.00	Elevée	Faible	Faible
Travailleur Dévoué	118	29.3	Faible	Elevé	Faible
Travailleur Motivé	2	0.50	Faible	Faible	Elevée
Travailleur Désengagé	108	26.80	Faible	Faible	Faible
Total	403	100,0			

Tableau 6. Types d'engagement au travail

Le résultat du tableau 6 fait apparaître que les travailleurs désengagés sont plus nombreux que les travailleurs engagés, et que 103 travailleurs tendant vers l'engagement (non-motivé, non-dévoué, non-vigoureux) alors que 124 tendent vers un désengagement (vigoureux, dévoué, vigoureux).

L'addiction au travail

La mesure de l'addiction est adaptée à l'échelle d'addiction au travail ou DUWAS, Schaufeli et al (2006). Elle prend la forme d'une échelle composée de 17 items étalonnés sur deux composantes :

- Travail excessif : WkE, 10 items ;
- Travail compulsif : WkC, 7 items.

Le score global présente le niveau d'addiction. L'analyse fait ressortir trois sous échelles allant de 1 à 4 comme suit :

- Score de 1 à 1,99 : addiction faible
- Score de 2 à 2,99 : addiction modérée
- Score de 3 à 4 : addiction élevée

L'analyse pour l'échelle de l'addiction au travail est présentée dans le tableau 7 :

les variables	Total n =403		Hotel n = 78		Automobile n= 60		Electrique & Electronique n = 265	
	moyenne	S.D.	moyenne	S.D.	moyenne	S.D.	moyenne	S.D
DUWAS	2.42	.451	2.32	.437	2.37	.471	2.45	.447
WKE	2.38	.469	2.30	.453	2.34	.498	2.41	.465
WKC	2.45	.470	2.34	.494	2.40	.495	2.48	.452

Tableau 7 : Analyse du niveau d'addiction.

Le résultat de cette analyse présente une addiction modérée dans chacun des trois secteurs d'activité. La moyenne de l'excessivité dans le travail (2,42) est inférieure à celle de la compulsivité (2,45). L'écart entre les différents secteurs (l'hôtellerie, l'automobile et l'électronique) n'est pas significatif, il sera étudié avec plus de précision dans la seconde partie. Dans cette étude, l'addiction au travail est divisée en 4 types. La politique de classification propose une distinction entre l'addiction élevée, qui a un score entre 3 (souvent) et 4 (toujours), et l'addiction faible qui a un score entre 1 (jamais) et 2,99 (parfois). Voir tableau 8.

Types	Nombre	%	Travail Ex- cessif	Travail Com- pulsif
Travailleur détendu	320	79,4	Faible	Faible
Travailleur compulsif	33	8,2	Faible	Elevé
Travailleur excessif	20	5,0	Elevé	Faible
Addiction au travail	30	7,4	Elevé	Elevé
Total	403	100,0		

Tableau 8 : types d'addiction au travail.

On peut conclure qu'il y a un petit groupe de travailleurs manifestant une addiction au travail (7,4%) et que les 4/5ème des répondants ne présentent aucune addiction, sont peu sujets au stress, au travail excessif ou compulsif. Quelques répondants seulement se montrent excessif (5%) ou compulsifs (8,2%) dans leur travail.

Analyse comparée des moyennes

Le programme SPSS, le t-test (pour deux groupes), et le test ANOVA (pour plus de deux groupes) permettent de comparer la moyenne de trois variables dépendantes (variables quantitatives) et de deux variables dites indépendantes (paramètres démographiques et des situations professionnelles). Il s'agit de savoir si les groupes ont une distribution significativement différente.

En premier lieu, la moyenne des variables dépendantes : PDI, IDV, MAS, LTO, VI, DE, AB, DE, UWES, WKE, WKC et DUWAS ne diffère pas significativement dans les trois secteurs d'activités ; seul le score UAI du secteur hôtelier est significativement inférieur (0,05) à celui du secteur électrique et électronique (P-value=0,23). Les divergences liées aux situations professionnelles (le statut : titulaire ou non) ne sont pas significatives. Les moyennes obtenues en fonction des groupes démographiques sont présentées dans le tableau 9.

Données démographiques personnelles	Les dimensions culturelles					L'engagement au travail	L'addiction au travail
	PDI	IDV	MAS	UAI	LTO		
Sexe	-	-	-	-	-	-	-
Generations	-	-	-	-	-	-	-
Le statut conjugal	-	-	-	-	-	liée	-
L'éducation	liée	liée	-	-	-	-	-

Tableau 9 : La moyenne en fonction des paramètres démographiques

Analyse de corrélation

1) Analyse des corrélations entre les dimensions culturelles et l'engagement au travail:

Afin de tester les hypothèses, le programme SPSS permet l'étude des coefficients de corrélation entre les variables, et de comprendre ainsi l'intensité de la liaison qui peut exister entre elles. Les variables concernées par cette analyse sont les dimensions culturelles de Hofstede, et l'engagement au travail.

Les dimensions culturelles	Coefficient de corrélation	L'engagement au travail et ses composantes			
		UWES	VI	DE	AB
PDI	Sig, (2-tailed)	-0.68	-115*	-.045	-.021
	P-value	.173	.021	.371	.669
UAI	Sig, (2-tailed)	.132**	.092	.180**	.079
	P-value	.008	.066	.000	.113
IDV	Sig, (2-tailed)	0.44	-0.17	.008	.121*
	P-value	.375	.037	.877	.015
MAS	Sig, (2-tailed)	.153**	.129**	.139**	.135**
	P-value	.002	.009	.005	.007
LTO	Sig, (2-tailed)	.107*	.094	.126*	.065
	P-value	.031	.059	.012	.195

*La corrélation est significative au niveau 0,05 (2-tailed)

**La corrélation est significative au niveau 0,01(2-tailed)

Tableau 10 : Corrélation entre les dimensions culturelles et l'engagement au travail

L'analyse des corrélations dans le tableau 10 montre une corrélation positive entre les variables MAS * et VI, DE, AB, EE. La même relation est observée entre les variables UAI et LTO et DE et EE. IDV est seulement corrélé positivement à AB. Par ailleurs, PI et IDV sont corrélés négativement à AB. Cependant le coefficient de corrélation entre les variables est faible (entre 0,10 et 0,30), selon McMillan (2000).

2) *Analyse des corrélations entre les dimensions culturelles et l'addiction au travail*

L'étude des coefficients de corrélation dans le tableau 11 permet d'apprécier l'intensité du lien entre les dimensions culturelles de Hofstede et l'addiction au travail. On observe que l'IDV n'est pas corrélé à l'addiction au travail et ses composantes. PDI, MAS et LTO sont corrélés à l'addiction, WKE et WKC à un niveau significatif de 0,01. UAI en a une avec l'addiction, WKE et WKC à un niveau significatif de 0,05.

Les dimensions culturelles	Coefficient de corrélation	L'addiction au travail		
		DUWAS	WkE	WkC
PDI	Sig, (2-tailed)	.171**	.167**	.148*
	P-value	.001	.001	.003
UAI	Sig, (2-tailed)	.115*	.108*	.124*
	P-value	.021	.030	.012
MAS	Sig, (2-tailed)	.211**	.189**	.221*
	P-value	.000	.000	.000
LTO	Sig, (2-tailed)	.163**	.138**	.176**
	P-value	.001	.006	.000

*La corrélation est significative au niveau 0,05 (2-tailed)

**La corrélation est significative au niveau 0,01 (2 tailed)

Tableau 11 : Corrélations entre les dimensions culturelles et l'addiction au travail

La mesure des corrélations dans cette analyse montre l'absence de rapport entre la variable IDV et l'addiction au travail contrairement aux autres variables (PDI, MAS et LTO) qui ont des corrélations moins significatives, comme le montre le tableau 11.

Cependant, ces corrélations sont toutes inférieures au seuil de 0,08, valeur en dessous de laquelle la colinéarité est considérée comme problématique ⁵².

3) *Analyse des corrélations entre l'engagement et l'addiction au travail* Concernant l'influence de l'engagement au travail, les résultats de l'analyse montrent qu'il existe un impact moins significatif de l'engagement sur l'addiction au travail, le calcul des coefficients de corrélation entre les différentes variables donne un résultat faible (entre 0,10 et 0,30). (McMillan.2000). Les détails sont présentés dans le tableau 12 suivant :

L'engagement au travail	Coefficient de corrélation	L'addiction au travail		
		DUWAS	WKE	WKC
UWES	Sig, (2-tailed)	0.40	.006	.074
	P-value	.426	.911	.074
VI	Sig, (2-tailed)	-.071	-.099*	-.030
	P-value	.158	.047	.555
DE	Sig, (2-tailed)	.023	-.026	.080
	P-value	.647	.600	.108
AB	Sig, (2-tailed)	.146**	.133**	.141**
	P-value	.003	.008	.004

*La corrélation est significative au niveau 0,05 (2-tailed) (-) la corrélation négative

**La corrélation est significative au niveau 0,01(2-tailed) (+) la corrélation positive

Tableau 12 corrélation entre engagement et addiction

⁵² Lewis-Beck (1991)

Tests d'hypothèses

H1(a). Les mesures des dimensions culturelles de Hofstede varient à un niveau significatif de 0,05 selon le sexe, la génération, l'éducation, le statut conjugal, l'ancienneté dans entreprise, la position, la division et l'ancienneté au poste actuel.

Les résultats confirment H1(a). Si les scores des dimensions culturelles de Hofstede ne varient pas selon le sexe, la génération, l'éducation, le statut conjugal, l'ancienneté dans entreprise, la position, la division et l'ancienneté au poste actuel à un niveau significatif de 0,05, le PDI et l'IDV varient bien en fonction de l'éducation, à un niveau significatif de 0,05.

H1 (b). Le niveau d'engagement au travail diffère en fonction des paramètres démographiques et des facteurs liés à la situation professionnelle : le sexe, la génération, le statut conjugal, l'éducation, l'ancienneté dans entreprise, la position, la division et l'ancienneté au poste actuel.

Les résultats valident H1(b). L'engagement au travail (UWES) inclut VI et DE. Les résultats montrent que l'engagement au travail varie à un niveau significatif de 0,05 en fonction de la situation familiale. Cependant, on ne retrouve pas cette différence pour le sexe, le groupe organisationnel, la position et la fonction de l'individu au sein du groupe et les scores de la vigueur seulement semblent dépendre de la génération.

H1(c) Le niveau d'addiction au travail varie selon les données démographiques personnelles et les caractéristiques de la situation professionnelle : le sexe, la génération, le statut conjugal, l'éducation, l'ancienneté dans entreprise, la position, la division et l'ancienneté au poste actuel.

Les résultats permettent de rejeter H1(c) : l'addiction au travail ne dépend pas des variables telles que le sexe, le statut conjugal, le groupe organisationnel, la position et la fonction de l'individu au sein du groupe (il n'y a pas de corrélation à un niveau significatif de 0,05).

H2 Il y a une relation entre les dimensions culturelles et l'engagement au travail.

Les résultats permettent de valider H2. En effet, MAS est corrélé positivement à UWES, VI, DE, et AB à un niveau significatif de 0,01 ; UAI l'est à UWES et DE à un niveau significatif de 0,01 ; LTO l'est à EE et DE à un niveau significatif de 0,05. Cela contraste avec PDI et IDV qui ne sont pas corrélés à UWES, mais PDI est corrélé négativement à VI à un niveau significatif de 0,05, alors que IDV est corrélé positivement à DE à un niveau significatif de 0,05.

H3 Il y a une relation entre les dimensions culturelles et l'addiction au travail.

Les résultats confirment H3. En effet, IDV n'a pas de corrélation avec DUWAS, WKE et WKC alors que trois dimensions PDI, MAS et LTO sont corrélées positivement à DUWAS, WKE, et WKC à un niveau significatif de 0,01 et UAI est corrélé positivement à DUWAS, WKE, et WKC à un niveau significatif de 0,05.

H4 Il y a une relation entre l'addiction au travail et l'engagement au travail.

Les résultats permettent d'infirmer H4 : il n'y a pas de corrélation à un niveau significatif entre l'engagement au travail et l'addiction au travail, mais il y a une corrélation positive entre AB et DUWAS, WKE, et WKC à un niveau significatif de 0,05. VI a une corrélation négative avec WKE, mais n'est pas relié de manière significative avec DUWAS.

Conclusion

Cette section présente un résumé des objectifs de la recherche :

Objectif (1) Evaluer le niveau des dimensions culturelles d'Hofstede, de l'engagement et l'addiction au travail :

Le tableau ci-dessous présente le niveau de ces trois dimensions dans les différentes entreprises :

Dimensions culturelles d'Hofstede (Meilleur score =100)					Engagement au travail (Meilleur score = 6)	Addiction au travail (Meilleur score = 4)
PDI	IDV	MAS	UAI	LTO	UWES	DUWAS
66	56	73	81	75	4.68	2.42

Tableau 13 : Résultats des mesures des dimensions culturelles, de l'engagement et de l'addiction au travail.

Objectif (2) Vérifier l'homogénéité entre les dimensions culturelles d' Hofstede, l'addiction et l'engagement au travail :

Les résultats de l'analyse montrent une homogénéité entre les résultats des dimensions culturelles et celles de l'engagement au travail en fonction des données démographiques personnelles et les caractéristiques de la situation professionnelle. Seuls les résultats de l'IDV et PDI varient en fonction de l'éducation, l'engagement au travail et le statut conjugal.

Objectif (3) Etudier les relations entre les dimensions culturelles d'Hofstede,

l'engagement au travail et l'addiction au travail :

- Seul le niveau d'éducation est corrélé positivement à la distance hiérarchique (la distance hiérarchique augmente avec le niveau d'éducation) et négativement à l'individualisme (l'individualisme tend à diminuer avec le niveau d'éducation).
Le statut conjugal (marié) est positivement lié à l'engagement au travail.
- L'engagement et l'addiction au travail ne présentent pas de corrélations entre eux, mais l'absorption, qui est l'une des composantes de l'engagement, favorise l'addiction et ses composantes, alors que la vigueur est corrélée négativement au travail excessif (une des composantes de l'addiction au travail).

Objectif (4) Etudier l'influence des dimensions culturelles d'Hofstede sur l'engagement

et l'addiction au travail :

- La dimension de masculinité, la distance hiérarchique et l'individualisme sont liés à l'engagement au travail et ses composantes. L'individualisme est en effet favorable à l'absorption.

Le Schéma 12 montre la manière dont les quatre dimensions culturelles pourraient influencer l'engagement d'un employé au travail. Etre de genre masculin favorise les trois composantes de l'engagement ; le contrôle de l'incertitude et l'orientation à long terme conduisent à l'engagement au travail via le dévouement. L'individualisme conduit à l'absorption mais pas à l'engagement au travail. Par ailleurs, l'évitement de l'incertitude et la dimension de l'orientation à long terme sont considérés pour le genre masculin comme étant des dimensions culturelles conduisant à l'engagement au travail.



Schéma 12 : Relations entre masculinité, évitement de l'incertitude et orientation à long terme et l'engagement au travail

Le Schéma 13 montre comment les différentes composantes de la culture peuvent conduire les travailleurs à s'engager dans leur travail, voire à développer une addiction au travail :

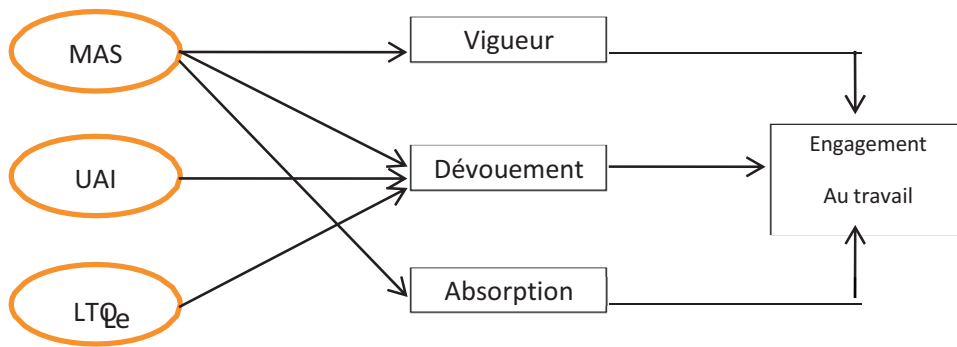

Schéma 13 les dimensions culturelles incitent à l'engagement et orientent vers l'addiction au travail.

Discussion

Les Dimensions Culturelles du modèle de Hofstede (2001)

Les résultats de l'étude des cinq dimensions culturelles mesurées avec les indices : PDI (la distance hiérarchique), UAI (le contrôle de l'incertitude), IDV (l'individualisme et le collectivisme), MAS (La dimension de masculinité/féminité) et LTO (l'orientation sur le long-terme) – révèlent une différence par rapport aux indices obtenus dans les études précédentes. Le score de la PDI est élevé (il mesure le niveau d'acceptation des inégalités) tout comme dans l'étude d'Hofstede. Le score de l'UAI, qui reflète le contrôle de l'incertitude est similaire à celui de l'étude de « Watcharasriroj and collègues⁵³ » mais plus élevé que celui de l'étude d'Hofstede. Le score de l'IDV reste modéré mais supérieur à ceux observés dans les deux études précédentes ; le résultat de l'indice MAS est nettement plus haut que dans les études citées ci-dessus, tout comme le résultat de l'indice LTO. Il faut souligner que ces trois études ne diffèrent pas seulement par la période où elles ont été menées, mais aussi par leurs échantillons.

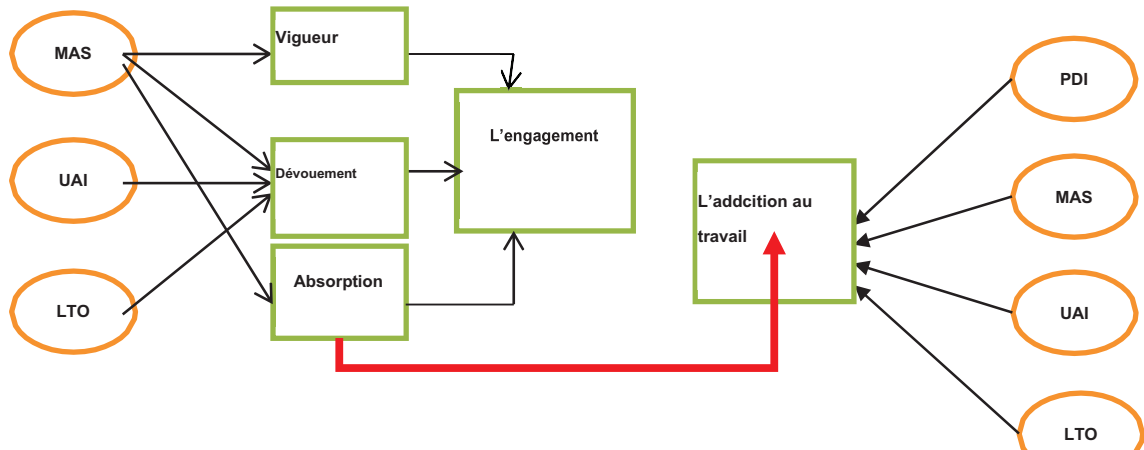
Par ailleurs, l'enquête qualitative de Petison⁵⁴ sur la culture en Thaïlande a mis l'accent sur la place considérable de la distance hiérarchique et sur une présence forte du collectivisme et du féminisme. A l'inverse, elle révèle une tendance moins marquée pour le contrôle de l'incertitude et l'orientation sur le court terme. Les différences observées entre les quatre études sur la culture, chacune conduites sur des périodes et des échantillons différents, et avec des méthodes distinctes, sont détaillées ci-dessous.

⁵³ Watcharasriroj et ses collègues (2005)

⁵⁴ Petison (2010)

Ces quatre études mettent en lumière les résultats des différentes dimensions culturelles, tout comme l'a fait celle de Purohit et Simmers⁵⁵. Dans cette enquête, l'indice du contrôle de l'incertitude du Nigeria était de 46.8, il était de 24.5 en Inde et de 7.9 aux Etats-Unis. Dans l'étude d'Hofstede, ces indices étaient respectivement de 55, 40 et 46. Chez Purohit et Simmers⁵⁶, ces indices étaient de 56.85, 25.8 et 38.15 alors que chez Hofstede, ils étaient de 80 pour le Nigeria, 77 pour l'Inde et 40 pour les USA. Les autres études culturelles menées en Russie et conduites par Bollinger⁵⁷, Naumoy⁵⁸ et Eelevnkov⁵⁹ ont mesurées des scores différents pour la distance hiérarchique, l'individualisme, la dimension masculine et le contrôle de l'incertitude. Fey et Denison⁶⁰ ont cependant trouvé que l'indice du contrôle de l'incertitude en Russie n'était pas en accord avec ce qui pouvait être observé dans les études précédentes.

⁵⁵ Purohit et Simmers (2006)

⁵⁶ Purohit et Simmers (2006)

⁵⁷ Bollinger (1994),

⁵⁸ Naumoy (1996)

⁵⁹ Eelevnkov (1998)

⁶⁰ Fey et Denison (2000)

Par conséquent, la variation observée dans l'étude d'Hofstede concernant les dimensions culturelles en Thaïlande n'est pas surprenante au regard des différences dans l'époque des enquêtes, des échantillons, des lieux et des méthodes de réalisation de celles-ci. Cependant mon but est d'étendre les résultats de l'étude menée par d'Hofstede. L'analyse de l'évolution des dimensions culturelles décrites dans la prochaine partie est de ce fait basée sur la comparaison avec l'enquête culturelle d'Hofstede⁶¹.

La distance hiérarchique

Le niveau d'acceptation de l'inégalité hiérarchique est toujours important selon l'étude d'Hofstede⁶² et selon celle de Petison⁶³ bien qu'il soit plutôt faible en Thaïlande selon l'étude de Watcharasriroj⁶⁴,

L'évolution de la distance hiérarchique est liée à l'âge, l'éducation, la richesse, et le statut, mais elle peut aussi varier selon la hiérarchie de l'entreprise⁶⁵. La Thaïlande est considérée comme un pays avec un fort développement⁶⁶ humain, principalement grâce au système éducatif qui ne cesse de se développer depuis 1980 (National Statistical Office/ Office National des Statistiques). Les résultats concernant la distance hiérarchique devraient être plus faibles que ceux trouvés dans l'étude d'Hofstede.

⁶¹ Hofstede (2001)

⁶² Hofstede (2001)

⁶³ Petison (2010)

⁶⁴ Watcharasriroj (2005)

⁶⁵ Hofstede (2001)

⁶⁶ UNDP (2015)

Il y a par conséquent d'autres facteurs induisant l'évolution de la distance hiérarchique et l'un d'entre eux peut être le système de grades qui reste profondément ancré dans le pays.

Le contrôle de l'incertitude

Cette dimension a un score élevé à la fois dans l'étude d'Hofstede⁶⁷ et dans celle de Watcharasriroj⁶⁸, mais l'étude de Muenjohn⁶⁹ a mesuré un niveau faible de contrôle de l'incertitude. L'étude qualitative de Petison⁷⁰ démontra aussi un niveau acceptable de la tendance au contrôle de l'incertitude en Thaïlande.

La Thaïlande évite clairement l'incertitude ou toute forme de culture fermée qui serait à la base de règles, normes, et standards de bonne conduite contraignante. Cette société n'accepte pas facilement les changements et n'est pas sujette à la prise de risque. L'évolution est cependant considérée comme meilleure pour le groupe de personnes que pour l'individu, chaque personne appartenant à un groupe et étant dirigée par lui.

L'indice UAI est lié au niveau d'anxiété national : quand le niveau d'anxiété augmente, le niveau de contrôle de l'incertitude augmente aussi⁷¹. L'innovation est un autre facteur important. Les cultures favorisant le contrôle de l'incertitude innoveraient moins.

⁶⁷ Hofstede (2001)

⁶⁸ Watcharasriroj (2005)

⁶⁹ Muenjohn (2004)

⁷⁰ Petison (2010)

⁷¹ Hofstede (2001).

Les données supplémentaires fournies par le « Global Innovation Index » (GII) placent la Thaïlande au 48^{ème} rang au monde avec un score de 37.63 sur 100 en 2011. L'innovation en Thaïlande est cependant plutôt rare, et cette tendance s'accroît avec l'aggravation des problèmes politiques depuis 2010 qui renforcent d'autant plus le contrôle de l'incertitude dans la société Thaïlandaise. Cependant « Rujirawanich et ses collègues ⁷² » ont suggéré en 2011 qu'il pourrait y avoir d'autres facteurs culturels en plus de ceux décrits dans l'enquête d'Hofstede ⁷³ qui pourraient influencer le niveau d'innovation en Thaïlande.

D'autres études, comme celle de Petison ⁷⁴, de Muenjohn ⁷⁵ et de Triandis ⁷⁶, indiquent qu'un faible contrôle de l'incertitude peut être symbolisé par l'expression « Mai Ben Rai » (ça ne fait rien/Ce n'est pas important). « Mai Ben Rai » est toujours utilisé en cas de déception, dans des situations inattendues, ou quand des personnes thaïlandaises ne font pas ce qu'elles s'attendaient à faire. Dans ces situations, elles peuvent aussi simplement sourire et laisser aller ⁷⁷.

⁷² Rujirawanich et ses collègues (2011)

⁷³ Hofstede (2001).

⁷⁴ Petison (2010),

⁷⁵ Muenjohn (2004)

⁷⁶ Triandis (2004),

⁷⁷ Komin (1990)

L'individualisme et le collectivisme

L'indice IDV est en augmentation si on le compare à celui présent dans l'étude d'Hofstede et il est égal à celui observé dans l'étude de Watcharasriroj. Cela semble montrer que les Thaïlandais sont de plus en plus favorables aux valeurs individuelles.

L'évolution de cette dimension est expliquée par Triandis ⁷⁸ comme suit : dans toutes les cultures, il y a un certain nombre de personnes « égocentriques » (elles pensent, se sentent, et agissent comme les gens le font dans les cultures « individualistes ») et également des individus « allocentriques » (similaires aux personnes issues de cultures collectivistes). Une culture collectiviste compte entre 30 et 100 pourcent de personnes « allocentriques » et entre 0 et 35 pourcent de personnes « égocentriques ». En plus de cela, le niveau d'« égocentrisme » augmente quand les personnes sont fortement exposées aux médias de masse occidentaux, qu'elles ont été acculturées pendant des années par n'importe quelle culture occidentale ou qu'elles ont travaillé dans des entreprises dotée d'une organisation de type occidental.

Il va de soi que l'évolution de la dimension IDV du collectivisme à un niveau entre l'individualisme et le collectivisme est influencée par l'éducation, le développement, la culture occidentale via les médias ou tout ce qui est amené en Thaïlande, y compris les jeunes qui étudient à l'étranger.

⁷⁸ Triandis (2004)

La dimension masculine/féminine

De même que pour la distribution entre « individualistes » et « collectivistes », cette enquête démontre une augmentation de la dimension masculine face à la dimension féminine, ce qui contraste avec les études d'Hofstede ⁷⁹ de Watcharasriroj ⁸⁰ et de Petison ⁸¹.

Hofstede et Watcharasriroj ont indiqué que la Thaïlande est un pays à dominante féministe : « La Thaïlande est de fait le pays asiatique le plus féministe, les Thaïs apprennent comment éviter l'agression plutôt que comment s'en défendre ; si les enfants se battent même pour se défendre, ils sont généralement punis. L'indicateur qui classifie » les sociétés selon leur orientation masculine ou féminine est le ratio masculin/féminin ⁸². Le ratio masculin/féminin dans la population est plus haut dans les cultures féminines comme la Thaïlande et l'Indonésie qu'il ne l'est dans les cultures masculines comme l'Inde et la Chine.

Cependant dans la présente étude, le résultat augmente de 34 à 73 par rapport à la période de l'étude d' Hofstede ⁸³.

⁷⁹ Hofstede (2001)

⁸⁰ Watcharasriroj (2005)

⁸¹ Petison (2010).

⁸² Hofstede (2001).

⁸³ Hofstede (2001)

Cela pourrait être expliqué par l'évolution de la dimension individualiste qui est, comme on l'a vu dans la partie précédente, due à l'influence de la culture occidentale, surtout celle des États-Unis, définie comme une culture de type masculine par Hofstede⁸⁴.

La Thaïlande a absorbé la dimension Masculine des pays occidentaux via les médias, les étrangers qui font du business en Thaïlande et les étudiants qui ont étudié à l'étranger et ont ramené certains aspects de la culture occidentale à leur retour au pays. La culture occidentale favorise donc la dimension masculine, mais la culture du travail japonaise la favorise tout autant. La théorie de la convergence culturelle (Axelord, 1997), pose que lorsque différentes cultures interagissent de manière fréquente, chaque culture absorbe progressivement des caractéristiques de l'autre.

Les cinq nations étrangères qui comptaient le plus de travailleurs en Thaïlande en décembre 2012 (Bureau du travail des étrangers Thaïlandais, 2012) étaient le Japon, l'Angleterre, la Chine, les Philippines et les États-Unis : toutes des sociétés dites masculines. La plupart de ces travailleurs avaient un emploi de gestionnaire, de directeur où occupaient d'autres postes haut-placés comme professeur ou enseignant. En raison de leur statut social, ils peuvent jouer d'une grande influence sur les travailleurs ayant un statut inférieur⁸⁵.

⁸⁴ Hofstede (2001)

⁸⁵ Hofstede (2001)

En plus de cela, les résultats de l'étude ont montré que tant la dimension masculine que l'individualisme ont des indices plus élevés que dans l'étude d'Hofstede⁸⁶, pour qui la dimension masculine a une influence positive sur l'individualisme.

L'orientation court terme/long terme

Le score de l'orientation sur le long terme dans la présente étude est de 75 sur 100 ce qui est bien plus élevé que dans les études précédentes. Hofstede⁸⁷ indiquait que la Thaïlande était assez partagée entre les orientations à long et à court terme, avec un score de 32. Dans une étude de Watcharasriroj et ses collègues⁸⁸, ce score est à 40, et si l'on inclut les résultats observés par Paterson en 2010, tout cela donne à la Thaïlande une orientation à court terme. Cependant le score LTO obtenu dans cette étude est différent des études précédentes.

On peut penser que l'explosion de cette dimension est liée à la croissance de la population ; le PIB de la Thaïlande n'a cessé d'augmenter de 1980 à nos jours, ce qui classe désormais le pays 30^{ème} sur 192. Cela pourrait expliquer la tendance à l'orientation à long terme observée dans cette recherche.

⁸⁶ Hofstede (2001)

⁸⁷ Hofstede (1977,2001)

⁸⁸ Watcharasriroj et ses collègues (2005)

Le niveau d'engagement au travail

L'engagement au travail affiche un score de 4.68 sur 6, ce qui constitue un score modéré à haut. Le résultat de ses composantes est de 4.47 pour la vigueur (VI), 5.15 pour le dévouement (DE), et de 4.43 pour l'Absorption (AB). L'engagement au travail observé en Australie, en Belgique, en Finlande, en France, en Allemagne, en Italie, et en Afrique du Sud est comparable puisque ces résultats sont tous compris entre 4 et 5.

De plus, cette étude ne montre aucune différence significative entre le secteur automobile, le secteur de l'électricité et de l'électronique et le secteur hôtelier, alors que dans l'étude de l'engagement au travail conduite par Taipale, Selander, et Anttila⁸⁹ dans huit pays européens, les résultats varient non seulement entre les pays, mais aussi selon les secteurs (comme les industries textiles, la télécommunication, les hôpitaux, les banques ...).

Cette étude catégorise huit types d'engagement au travail. Les travailleurs désengagés (26,80%) obtiennent le plus bas résultat pour les indices VI, DE, et AB ; ils sont plus nombreux que les travailleurs qui s'engagent (16,90%) et qui ont un score élevé de VI, DE et AB ; mais la plupart des travailleurs (29,3%) sont des travailleurs enthousiastes avec un haut niveau de DE, mais un bas niveau de VI et d'AB. Ces conclusions sont aussi tirées par Gallop⁹⁰, qui dirigea une enquête sur l'engagement au travail en Thaïlande, et montra également que seulement 12% des employés thaïlandais sont engagés dans leur travail, 82% sont activement désengagés et 6 % simplement désengagés.

⁸⁹ Taipale, Selander, et Anttila (2010)

⁹⁰ Gallop (2004)

Catégories de travailleurs	Nombre	Pourcentage	Vigueur	Dévouement	Absorption
Travailleur engagé	68	16.90	Haut	Haut	Haut
Travailleur Non-motivé	45	11.20	Haut	Haut	Bas
Travailleur Non-Dévoué	3	0.70	Haut	Bas	Haut
Travailleur Non-vigoureux	55	13.60	Bas	Haut	Haut
Travailleur Vigoureux	4	1.00	Haut	Bas	Bas
Travailleur Dévoué	118	29.3	Bas	Haut	Bas
Travailleur Motivé	2	0.50	Bas	Bas	Haut
Travailleur Désengagé	108	26.80	Bas	Bas	Bas
Total	403	100,0			

Tableau 14 Types d'engagement au travail.

Le niveau d'addiction au travail

Les résultats pour le niveau d'addiction au travail sont modérés (2.42 sur 4.00) ; le score du travail dur et excessif (WkE) est de 2.38, ce qui est inférieur à celui du travail compulsif (WkC, 2.45). Les résultats ne montrent aucune différence significative entre les trois secteurs : automobile, électronique/électrique et hôtelier.

Cependant, le terme anglais « workaholism » que l'on pourrait traduire par « alcoolisme du travail » n'est pas bien connu en Thaïlande. Les termes « office- syndrome » (syndrome du bureau) ou « work addiction » qui se rapprochent de la traduction française utilisée ici sont plus communs. De ce fait, aucune réelle étude concernant les « workaholisms » n'a été menée en Thaïlande que ce soit dans le secteur académique ou professionnel. Ce sujet n'a été abordé que dans des recherches sur la santé et le mental.

Pour les « workaholisms » Les travailleurs détendus ont un score élevé de 79% et l'addiction au travail est 7.4% . C'est-à-dire que les participants ont représenté leur même sont fable d'addiction de travail.

Types	Nombre	Pourcentage	Travailleur excessif	Travailleur compulsif
Travailleur détendu	320	79,4	Bas	Bas
Travailleur compulsif	33	8,2	Bas	Haut
Travailleur excessif	20	5.0	Haut	Bas
Addiction au travail	30	7.4	haut	Haut
Total	403	100,0		

Tableau 15 Types d'addiction au travail

L'influence des données démographiques personnelles.

Selon les objectifs de la recherche, cette partie montre que les caractéristiques de chacun peuvent influencer les perceptions et l'attitude. Cela aidera les entreprises à comprendre les impacts des différents facteurs individuels – sexe, âge, niveau d'éducation, situation familiale – sur les dimensions culturelles, l'engagement et l'addiction au travail.

Bien que seuls les niveaux d'éducatons puissent influencer sur la distance hiérarchique et la dimension de l'individualisme et du collectivisme, et bien que l'âge et la situation familiale puissent être liés à l'engagement au travail, aucune des variables des données personnelles ne sont liées à l'addiction au travail. Donc, les différences personnelles devraient être inévitablement impliquées dans l'engagement au travail.

Les données démographiques personnelles et la culture

Les résultats présentent un lien entre le niveau d'éducation, la distance hiérarchique et l'individualisme. Les participants du groupe ayant une licence avaient un indice PDI faible, et un indice IDV plus bas que ceux ayant un diplôme technique ou supérieur. De la même manière, l'étude d'Hofstede⁹¹ a montré qu'il y a une diminution de la distance hiérarchique quand les participants ont un haut niveau d'éducation car ils montrent une plus grande confiance en eux et une plus grande volonté de participer que ceux ayant des niveaux plus bas. Ainsi si la distance hiérarchique est faible et si les travailleurs ont confiance en eux, ils auront tendance à devenir plus individualistes⁹². Par conséquent, si l'on se concentre sur le niveau d'éducation, il ne pourrait y avoir des fossés dans le problème de l'inégalité en entreprise.

⁹¹ Hofstede (2010)

⁹² Stedham et Yamamura (2004).

Les différences liées au sexe des personnes dans les dimensions culturelles sont aussi présentées dans une étude de Stedham et Yamamura⁹³ selon laquelle le sexe a une influence sur la distance hiérarchique au Japon et le sexe a une influence sur l'individualisme au Japon et aux USA. Cette recherche affirme également que, dans ces deux pays, il y a des différences importantes dans la main-d'œuvre féminine, comme l'éducation, l'importance de la position, le succès dans la carrière, et une augmentation de la confiance en soi. Cela peut engendrer des changements culturels.

Les résultats de cette étude montrent qu'il n'y a pas de différences culturelles entre les différentes générations. Cependant, les différences liées à l'âge sont clairement catégorisées dans plusieurs domaines : les valeurs fondamentales, l'attitude de travail, la manière de travailler et l'évolution. On aurait pu s'attendre à des différences culturelles dans ces domaines, selon la théorie des changements culturels.

La situation familiale n'influence pas les dimensions culturelles. Il y a eu très peu de recherches à propos de la situation familiale et de ses répercussions sur les dimensions culturelles. Ainsi, il est difficile de statuer si la situation familiale a un effet ou non sur les dernières.

Pour conclure, les perceptions de la culture ne varient pas selon le sexe, la tranche d'âge, le niveau d'éducation ou la situation familiale ; seul le niveau d'éducation a un impact sur la perception de la distance hiérarchique. Ainsi, il est important pour les entreprises d'être attentives aux fossés d'équité. Des outils de développement individuel, tels que des sessions d'entraînement, seront utiles afin de réduire ces fossés.

⁹³ Stedham & Yamamura (2004)

Les données démographiques personnelles et l'engagement au travail.

Cette étude montre que l'engagement au travail est homogène entre les sexes. En revanche, une étude de Wajid et ses collègues ⁹⁴ rapporte que les hommes sont plus dévoués que les femmes. Un résultat équivoque sur la relation entre l'engagement au travail et le sexe fut présenté dans une étude inter-nations par Schaufeli, Bakker et Salanova ⁹⁵, attribuant aux hommes un score légèrement supérieur aux femmes dans les échantillons belge, allemand finlandais, et norvégien.

De plus, la vigueur chez les hommes apparaît plus forte en Afrique du sud. Il en va de même pour le dévouement et l'absorption qui sont plus importants chez les hommes espagnols et néerlandais. Cependant, Smulders ⁹⁶, enquêtant sur l'engagement au travail parmi 4000 participants aux Pays-Bas, a conclu qu'il n'y avait pas de différence systématique entre les sexes.

Par conséquent, les sexes ne devraient pas être différenciés dans l'étude du niveau d'engagement. Cela pourrait signifier qu'il y a d'autres facteurs ayant une plus grande influence sur l'engagement au travail.

⁹⁴ Wajid et ses collègues (2011)

⁹⁵ Schaufeli, Bakker et Salanova (2006)

⁹⁶ Smulders (2006)

En ce qui concerne l'âge et l'engagement travail, l'indice de vigueur dans Gen-X est plus fort que les autres. Il se pourrait que les personnes issues de la Gen-X soient plus jeunes que celles du baby-boom. En plus de cela, la Gen-X, dans laquelle les couples mariés sont plus nombreux que chez la Gen-Y, a un niveau de vigueur plus élevé que la Gen-Y et que les autres générations. Cependant, dans les études précédentes, les résultats concernant l'âge sont mitigés.

Par exemple, Schaufeli, Bakker, et Salanova⁹⁷ et Smulders⁹⁸ trouvent que l'engagement au travail croît légèrement avec l'âge. Cela implique que des employés un peu plus âgés se sentiraient légèrement plus engagés que de jeunes employés. En revanche Wajid et ses collègues⁹⁹ argumentent qu'il n'y a aucune différence significative par rapport à l'âge pour quelque dimension de l'engagement au travail que ce soit.

Les différents groupes de situation familiale présentent des résultats différents relatifs à l'engagement au travail. Ces résultats indiquent que les participants mariés sont plus engagés que les participants célibataires. C'est également la conclusion tirée par Wajid et ses collègues¹⁰⁰.

Par conséquent, il semble intéressant de réaliser une prochaine enquête destinée à déterminer les raisons pour lesquelles les participants mariés manifestent davantage d'engagement dans leur travail.

⁹⁷ Schaufeli, Bakker, et Salanova (2006)

⁹⁸ Smulders (2006)

⁹⁹ Wajid and colleagues (2011)

¹⁰⁰ Wajid et ses collègues (2011)

L'engagement au travail ne varie pas selon le niveau d'éducation. Wajid et ses collègues¹⁰¹

affirment qu'il n'existe une influence significative du niveau d'éducation sur aucune des dimensions de l'engagement au travail. Néanmoins il n'y a à ce jour qu'un petit nombre de recherches concernant l'impact du niveau d'éducation sur l'engagement au travail.

On pourrait alors recommander d'analyser les facteurs de la situation familiale et toutes les motivations susceptibles d'affecter l'engagement au travail afin de développer un modèle de l'engagement. alors que l'âge aurait une influence sur l'engagement au travail à cause de la vigueur.

Les données personnelles et l'addiction au travail

Les résultats ne valident pas l'hypothèse de la recherche selon laquelle le sexe, l'âge, l'éducation et la situation familiale ne sont pas liés à l'addiction au travail. Et ce du fait que dans la présente étude il y a de nombreuses variantes de données personnelles, telles que la différence de sexe parmi les caractéristiques personnelles : on note ainsi une forte proportion de femmes mariées et d'hommes célibataires, de femme de la Gen-Y et d'hommes du baby-boom, et des niveaux de diplôme différents (les hommes ayant en général un diplôme supérieur à celui des femmes alors qu'il y a pourtant plus de femmes que d'hommes en possession d'une licence). Par conséquent l'étude de la relation entre les données personnelles et l'addiction au travail devrait être particulièrement centrée sur un groupe en particulier.

¹⁰¹ Wajid et ses collègues (2011)

L'INFLUENCE DES CARACTERISTIQUES DE LA SITUATION PROFESSIONNELLE

En ce qui concerne les objectifs de la recherche, on observe que les différentes variables de la situation professionnelle – l'ancienneté dans l'entreprise, la branche, le poste, et l'ancienneté au poste en question – ne sont pas associées à toutes les dimensions culturelles d'Hofstede, à l'engagement au travail ou à l'addiction au travail.

Les caractéristiques de la situation professionnelle et les dimensions culturelles

Nous nous attendions à observer des variations des dimensions culturelles en fonction de la situation professionnelle. En effet, on pourrait imaginer que l'ancienneté dans l'entreprise par exemple pousse les employés à se socialiser avec des personnes ayant des perceptions culturelles différentes. Néanmoins les résultats ne donnent aucune information permettant de soutenir cette hypothèse. Cela est peut-être dû au fait que la culture de l'entreprise est trop homogène.

Les caractéristiques de la situation professionnelle et l'engagement au travail.

Les employés, n'ayant pas tous la même ancienneté et occupant différentes positions, sont engagés au travail pour de multiples raisons. Par exemple, les nouveaux venus le sont car ils ont besoin de montrer leurs capacités et leur sérieux pendant la période d'essai, et leurs nouveaux rôles professionnels constituent pour eux un challenge.

Bien que la plupart des employés ayant une certaine ancienneté soient engagés, ils peuvent s'en-
nuyer à cause de la longue période qu'ils ont passé dans l'entreprise. Smulders ¹⁰²
montre qu'il existe différentes sortes d'engagement au travail parmi les professionnels : les
managers se montrent plus engagés que les ouvriers. Néanmoins, les résultats de la recherche
ne valident pas cette dernière hypothèse. Par conséquent, une nouvelle analyse des situations
professionnelles devrait être menée dans de prochaines études.

En conclusion, l'étude relative à l'engagement au travail devrait mettre en évidence l'influence
de la situation professionnelle. Pour les prochaines recherches, l'étude de l'engagement au tra-
vail en fonction des différentes situations professionnelles devrait s'intéresser tout spécialement
au niveau d'engagement au travail respectif des managers et des employés.

Les caractéristiques de la situation professionnelle et l'addiction au travail.

*Puisqu'il n'y a pas de relation entre ces deux variables et que très peu d'études précédentes ont
soutenu cette thèse, l'étude de ces variables pourrait être importante lors de prochaines re-
cherches.*

¹⁰² Smulders (2006)

L'engagement au travail et l'addiction au travail

La relation entre l'engagement au travail et l'addiction au travail sera, selon les recommandations de Grogievski et Bakker¹⁰³, illustrée de manière à déterminer si l'addiction au travail est une dimension négative de l'engagement au travail ou pas.

Au vu des résultats, il ne semble pas y avoir de relation directe entre l'engagement et l'addiction au travail, mais des relations ont pu être trouvées parmi leurs composantes. L'absorption est faiblement corrélée à l'addiction au travail ($r=.146$, $p<0.01$), au travail excessif ($r=.133$, $p<0.01$), et au travail compulsif ($r=.141$, $p<0.01$). Ces observations sont conformes à celles de Schaufeli et ses collègues¹⁰⁴ selon lesquels l'addiction et l'engagement au travail semblent partager certains éléments de l'absorption. Néanmoins, Taris et ses collègues¹⁰⁵ affirment que l'engagement au travail, le travail excessif et compulsif peuvent être considérés comme trois facteurs distincts, ce que corrobore cette étude, puisqu'on observe également une corrélation négative minimale entre la vigueur et le travail excessif ($r=-.099$, $p<0.05$).

L'addiction et l'engagement au travail sont tous deux bénéfiques pour l'entreprise, étant donné que les travailleurs engagés, tout comme les travailleurs ayant développé une addiction, travaillent dur, réalisant de bonnes performances avec une bonne productivité.

¹⁰³ Grogievski et Bakker (2000)

¹⁰⁴ Schaufeli et ses collègues (2001)

¹⁰⁵ Taris et ses collègues (2009)

Cependant les employés engagés ne semblent pas avoir développé d'addiction au travail. Ils savent prendre du plaisir dans d'autres domaines et non seulement dans le travail. Contrairement aux employés ayant développé une addiction, ils n'ont pas la volonté de travailler dur à cause d'une pulsion intérieure trop forte et irrésistible, mais parce qu'ils trouvent de la joie dans le fait de travailler.

Les travailleurs dépendants et les travailleurs engagés ont différentes passions et motivations. L'employé ayant développé une addiction est mû par une passion obsessionnelle et déséquilibrée¹⁰⁶. La personne engagée a davantage de contrôle sur elle-même pour travailler alors que l'employé dépendant se retrouve contrôlé par le travail et se sent moins heureux au travail que l'individu engagé. Ainsi l'addiction au travail est liée au mal-être alors que l'engagement au travail est lié au bien-être.

Toutefois, dans cette étude, certains résultats de l'addiction et de l'engagement au travail s'entremêlent. Parmi ceux-ci, on trouve une corrélation entre l'absorption et certaines composantes de l'engagement et de l'addiction au travail. Cela pourrait montrer que l'engagement au travail peut se transformer en addiction via l'absorption (lorsque le travail est trop prenant, avec la sensation que le temps passe trop vite).

Enfin, il est peut-être réducteur de poser que l'addiction au travail est une évolution négative de l'engagement, mais il semble que des employés engagés ayant une forte absorption puissent développer une addiction. En parallèle, afin d'élever le niveau d'engagement au travail au sein de l'entreprise, certaines conditions, comme l'absorption, devraient être étudiées de manière plus approfondie car elles risquent d'augmenter le niveau d'addiction.

¹⁰⁶ Vallerand (2008).

Comment la culture peut-elle inciter à l'engagement au travail et à l'addiction au travail ?

On peut résumer dans un tableau les différentes relations entre les dimensions culturelles (distance hiérarchique, contrôle de l'incertitude, dimension masculine et féminine, individualisme contre collectivisme, orientation à long terme) l'engagement au travail et l'addiction. Le tableau montre également la manière dont la culture pousse à l'engagement ou à l'addiction (où positif/négatif correspond à la nature de la corrélation).

	Engagement au travail	Vigueur	Dévouement	Absorption	Addiction au travail	Travail excessif	Travail compulsif
PDI	-	négatif	-	-	Positif	Positif	Positif
IDV			-	Positif	-	-	-
MAS	Positif	positif	positif	Positif	Positif	Positif	Positif
UAI	-	-	positif	-	Positif	Positif	Positif
LTO	-	-	positif	-	Positif	Positif	Positif

Tableau 16 Les relations entre les dimensions culturelles d'Hofstede, l'engagement et l'addiction au travail

Comment la distance hiérarchique incite-t-elle à l'engagement au travail et à l'addiction au travail ?

Les résultats montrent que la distance hiérarchique n'est pas directement associée à l'engagement au travail mais qu'elle tend à inhiber une de ses composantes : la vigueur, validant ainsi l'hypothèse de l'étude à propos de la distance hiérarchique.

Par conséquent, l'engagement au travail est sensible à la vigueur, qui est la volonté de concentrer ses efforts dans son travail. Cependant, la vigueur peut être réduite par une grande distance hiérarchique et par une gestion autocratique. Par exemple, c'est le cas pour les employés subordonnés qui se doivent d'obéir aux autorités supérieures, et ce sans volonté¹⁰⁷.

La dimension culturelle qu'est la distance hiérarchique peut être positivement corrélée à et l'addiction au travail, tout comme au travail excessif et au travail compulsif (voir tableau 14.). Cette idée est mise en avant par Baruch¹⁰⁸ qui dit que, dans une culture ayant une forte distance hiérarchique, les facteurs susceptibles de permettre à l'employé d'accroître son pouvoir individuel (un investissement fort et visible pendant de longues heures de travail) sont plus recherchés que dans une culture ayant une faible distance hiérarchique.

¹⁰⁷ Hofstede (2010)

¹⁰⁸ Baruch (2011)



Schéma 14 Relations entre la vigueur, l'addiction au travail et la distance hiérarchique

On peut alors conclure que la distance hiérarchique n'influe pas sur l'engagement au travail et participe à la baisse du niveau de vigueur, ce qui peut au final favoriser une addiction chez les employés. En plus de cela, le principe d'une direction autocratique, c'est-à-dire d'une relation où les employés ne sont que les simples exécutants du directeur, est toujours présent dans les cultures ayant une forte distance hiérarchique, comme le Japon. Une telle relation peut inciter les employés à travailler plus dur et à ne plus se détacher du travail.

Comment l'individualisme / collectivisme incite-t-il à l'engagement au travail et à l'addiction au travail ?

On ne trouve dans l'étude présentée ici aucune influence de la dimension de l'individualisme sur l'engagement ou l'addiction au travail. Seules de faibles corrélations positives ont été démontrées entre l'individualisme et l'absorption. Par conséquent, la culture de l'individualisme ne s'associe pas avec l'engagement au travail, mais un léger impact sur l'absorption peut être révélé.

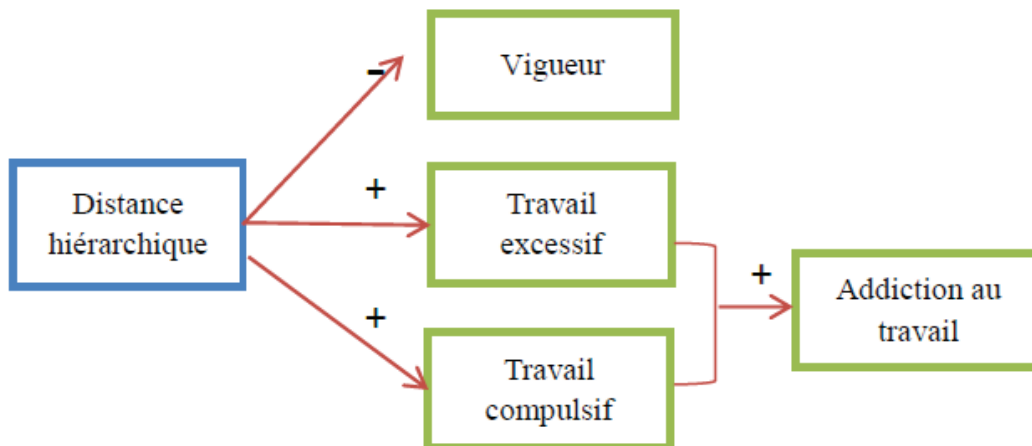
Ces résultats montrent que les employés ne sont pas engagés en équipe, mais mettent l'accent sur leur autonomie et leur accomplissement personnel ¹⁰⁹. Ce faisant, ces personnes individualistes peuvent se concentrer pleinement sur leur travail, de manière positive, le cœur en joie. A l'inverse, les personnes ayant un comportement collectiviste ont plus tendance à dépendre d'un groupe, ce qui pourrait créer chez eux un manque de liberté et les rendre malheureux. Enfin, l'individualisme n'a aucun impact sur l'addiction au travail. Ce résultat va à l'encontre de l'hypothèse qui soutenait que l'individualisme pourrait avoir un certain degré d'influence sur l'addiction.

L'addiction au travail peut se manifester dans une culture collectiviste si cette attitude fait partie des valeurs et de la norme du groupe. Si la majorité des employés du groupe a développé une addiction, on peut supposer que le reste du groupe développera également une addiction. De la même manière, si certaines personnes appartiennent à un groupe d'employés hautement engagés, elles deviendront elles-mêmes plus engagées avec le temps. L'absorption étant une composante liée à l'addiction au travail et ses composantes, on observe une relation entre la dimension de l'individualisme, l'engagement au travail et l'addiction au travail, comme montré dans le schéma 15.

¹⁰⁹ Hofstede (1980).



Schéma 15 : la relation entre l'individualisme, l'engagement et l'addiction au travail

Les résultats de cette étude ne valident que partiellement le fait qu'une culture individualiste amène à l'engagement au travail. Le collectivisme pourrait aussi augmenter l'engagement au travail, via les valeurs d'un groupe, dans le cas où l'engagement se développe dans des conditions de comportements raisonnables, de sécurité et de disponibilité. La sécurité est créée par des systèmes sociaux comme la dynamique entre les groupes ou les relations interpersonnelles¹¹⁰ comme lorsque l'on mélange des équipes par exemple.

En plus de cela, les personnes « collectivistes » dépendent de la norme, de la cohésion et des caractéristiques véhiculées par le groupe. Ainsi, le collectivisme devrait être étudié avec plus de détails et dans des situations plus diverses.

¹¹⁰ Kahn (1990),

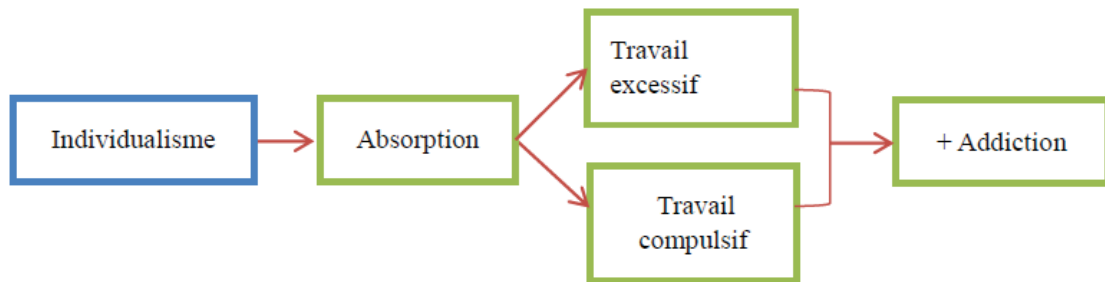
Comment la dimension masculine/féminine incite-t-elle à l'engagement et à l'addiction au travail ?

La dimension masculine favorise l'engagement de travail et à ces trois composantes : la vigueur le dévouement et l'absorption. Cela pourrait être dû au fait que les personnes évoluant dans une culture masculine sont plus agressives, ambitieuses, décisives et compétitives que celles évoluant dans une culture féminine. Ainsi, travailler au sein d'une culture masculine implique des employés plus vigoureux, dévoué et absorbés que dans une culture féminine.

Par ailleurs, on trouve également dans cette étude une corrélation positive entre la culture masculine, le travail excessif, le travail compulsif et l'addiction au travail. Cela confirme ce que disait Baruch¹¹¹, à savoir que l'addiction au travail est perçue plus positivement dans les sociétés caractérisées par une haute présence masculine, et plus négativement dans une culture plutôt féminine.

¹¹¹ Baruch (2011),



Schéma 16 La dimension masculine/féminine incite à l'engagement et à l'addiction au travail

Comment le contrôle de l'incertitude incite-t-il l'engagement au travail et l'addiction au travail ?

Les résultats de cette étude montrent que l'indice du contrôle de l'incertitude semble se renforcer (80 sur 100), tandis que l'indice de l'engagement au travail reste modéré (4.68 sur 6.00), tout comme celui de l'addiction au travail (2.42 sur 4.00). Le lien entre le contrôle de l'incertitude et l'engagement au travail est significativement positif ($r=132, p<0.01$), et seulement peu positif avec le dévouement ($r=180, p <0.01$) ; cependant ce lien n'existe ni avec la vigueur, ni avec l'absorption. Cela contraste avec ce que l'on attendait de l'étude : on pensait que le contrôle de l'incertitude inhiberait l'engagement au travail, et tout spécialement la vigueur et l'absorption.

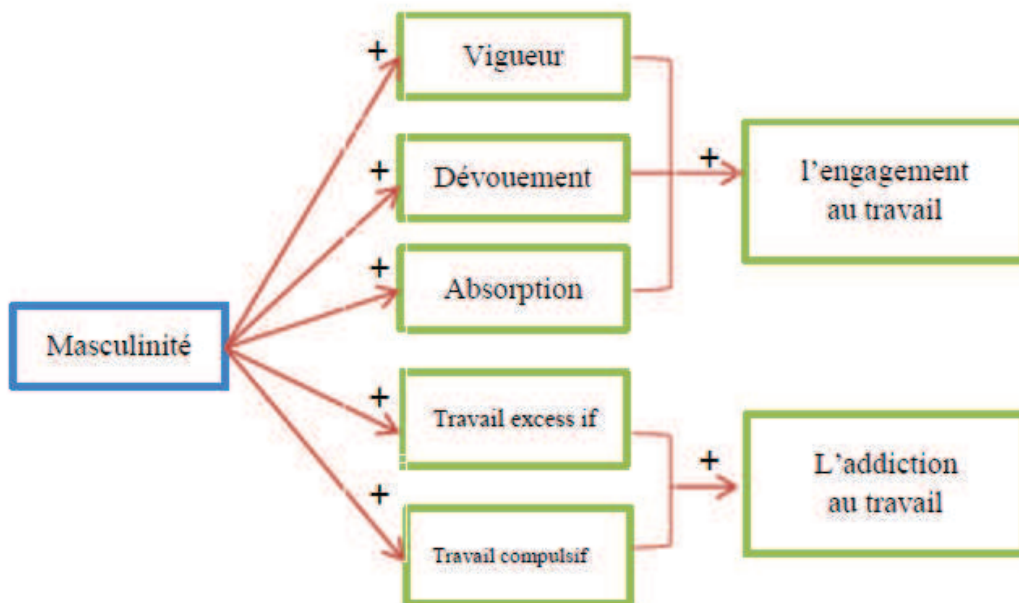

Schéma 16 Le contrôle de l'incertitude favorise le dévouement et l'addiction au travail.

Sans surprise, le contrôle de l'incertitude est corrélé positivement à l'addiction au travail et à ses composantes : le travail excessif et le travail compulsif. Baruch¹¹² explique cela en soutenant que les employés ayant développé une addiction au travail travaillent si dur que leurs incertitudes se réduisent face au fort climat de contrôle de l'incertitude qui les entoure, alors qu'à l'inverse, dans un environnement ayant un faible contrôle de l'incertitude, les employés doivent travailler dur si nécessaire mais n'y sont poussés par aucune pulsion comme c'est le cas chez les employés dépendants.

On pourrait résumer en concluant qu'une culture du contrôle de l'incertitude peut aussi bien encourager que freiner l'engagement : l'encourager via le dévouement des employés qui donnent beaucoup d'eux-mêmes dans leur travail, car ils cherchent à éviter tous les imprévus possibles. Le freiner à cause de la vigueur et du dévouement car les travailleurs, en voulant éviter des situations chaotiques, développent une grande anxiété, ce qui peut affecter négativement leur travail.

¹¹² Baruch (2011)

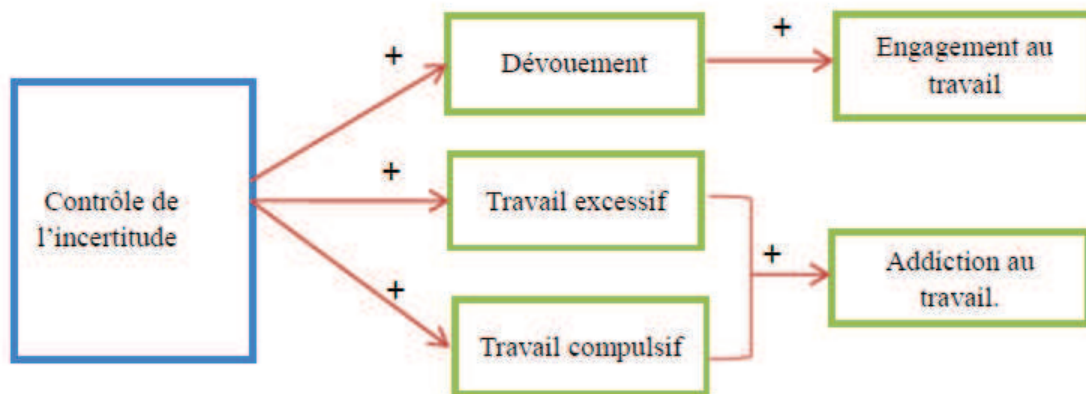
On trouve donc un haut niveau d'addiction au travail dans les cultures au fort contrôle de l'incertitude, car les employés veulent travailler plus dur afin d'éviter d'être confrontés à des risques dans l'avenir. Il semble que leur forte volonté incitera à travailler dur dans ces sociétés du contrôle de l'incertitude.

Comment l'orientation à court terme/long terme incite-t-elle à l'engagement au travail et à l'addiction au travail ?

L'influence des indices UAI et LTO ne se ressent que sur le dévouement car ces deux dimensions ne sont pas liées aux personnes mais à ce qui les entoure : la nature et le temps.

Le dévouement pour le travail est très marqué lorsque ce dernier apporte aux employés, de l'enthousiasme, de l'inspiration, de la fierté et du challenge, tout en ayant un sens. Ces éléments de dévotion peuvent être influencés par les ressources du travail, et non par les ressources personnelles¹¹³. Les ressources du travail impliquent des pratiques organisationnelles comme les opportunités de carrière, la supervision, la clarté du rôle de l'employé et l'autonomie¹¹⁴. Pour conclure, une culture valorisant l'orientation sur le long terme peut conduire l'employé à l'engagement via le dévouement, et à l'addiction via le travail excessif et compulsif.

¹¹³ Xanthopoulou, Bakker, Demerouti et Schaufeli (2007)

¹¹⁴ Bakker et Demerouti, (2007).



Schéma 17 L'orientation sur le long terme favorise le dévouement et l'addiction au travail

Résumé

La culture masculine favorise l'engagement au travail et ses trois composantes : la vigueur, le dévouement et l'absorption. Ainsi, une culture masculine ou compétitive augmentera la productivité et les performances des employés. Une culture privilégiant le contrôle de l'incertitude et les objectifs d'orientation sur le long terme peut également permettre l'élévation du niveau de dévouement et d'engagement au travail. Cependant, une grande distance hiérarchique peut faire baisser le niveau de vigueur, causant ainsi des relations faibles difficilement qualifiables d'importantes.

La distance hiérarchique, le contrôle de l'incertitude, la dimension masculine et l'orientation à long-terme peuvent amener les employés à développer une addiction et améliorer leurs performances en les laissant travailler plus dur selon leur volonté. Cela risque d'avoir des répercussions négatives sur le bien-être des employés. Ainsi les entreprises devraient introduire des programmes de prévention sur l'équilibre vie professionnelle / vie privée afin de limiter le niveau d'addiction au travail des employés.

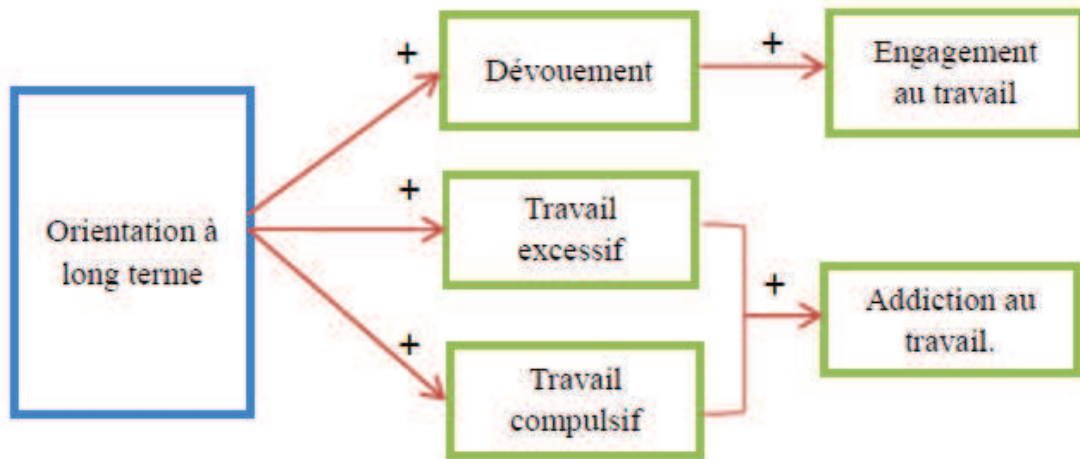
Pour finir, les trois modèles synthétisant les résultats de cette recherche ont été représentés dans les schémas 19, 20 et 21 afin de suggérer des pistes d'étude pour de futures enquêtes sur l'engagement au travail.



Schéma 19 Les cultures de la dimension masculine, du contrôle de l'incertitude et de l'orientation sur le long terme amènent à l'engagement au travail

Le modèle d'engagement au travail, présenté dans le schéma 19, montre qu'une culture masculine incite à l'engagement via ses trois composantes : la vigueur, le dévouement et l'absorption. Au vu du résultat (34) attribué à la Thaïlande pour la dimension masculine chez Hofstede (2010), on comprend que la Thaïlande est une société féminine ; mais le résultat de cette étude suggère que la culture masculine est en train de progresser (73).

Les pays ayant les taux d'engagement au travail les plus élevés, la France, le Portugal, et la Finlande¹¹⁵, ont un score pour la dimension masculine de respectivement 43, 31 et 26

¹¹⁶. Au contraire, les pays ayant un engagement au travail plus bas, tels que le Japon et la Chine, ont des indices de culture masculine de respectivement 96 et 66. Ce paradoxe peut être expliqué par le fait que les moteurs de l'engagement ne sont pas universels¹¹⁷. Ces moteurs sont variés dans les sociétés multiculturelles. Cependant, des rapports montrent que le salaire est l'un des moteurs principaux de l'engagement au travail, ce qui va de pair avec le fait que la culture masculine concerne principalement les sociétés matérialistes. Cela peut expliquer pourquoi les cultures masculines incitent aujourd'hui à l'engagement au travail.

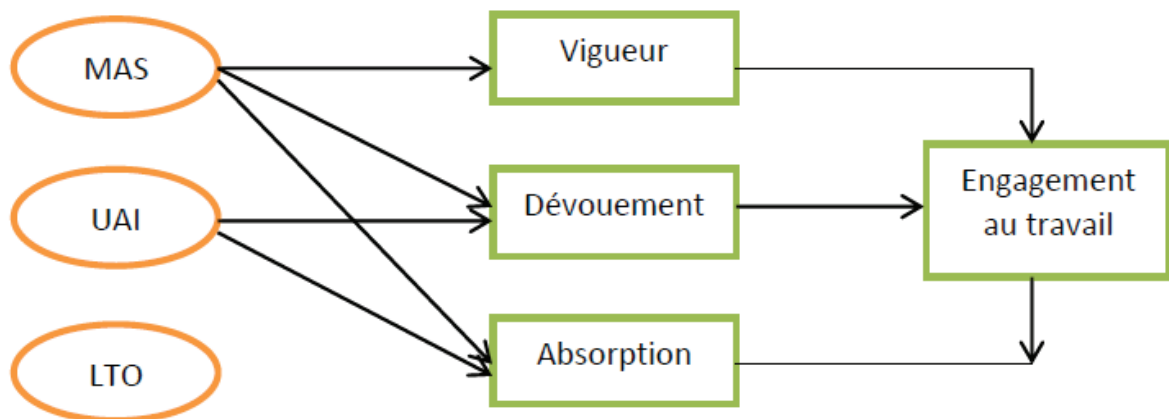
Puisqu'il n'y a aucun lien entre l'engagement au travail et l'addiction au travail, ces deux notions devraient être étudiées séparément. Néanmoins, les résultats prouvent l'existence d'une relation entre les dimensions culturelles et l'addiction au travail. Ainsi, on peut créer le modèle de l'addiction au travail. (Schéma 20).

¹¹⁵ Shimazu, Miyataka et Schaufeli (2010),

¹¹⁶ Hofstede (2010)

¹¹⁷ AON-Hewitt (2012).

Le modèle d'addiction au travail (Schéma 20) montre quatre dimensions culturelles qui sont propices au développement de l'addiction : PDI, MAS, UAI, et LTO. Cela corrobore la proposition de Baruch¹¹⁸ selon laquelle, dans une culture caractérisée par une forte distance hiérarchique, les facteurs qui peuvent améliorer de possibles pouvoirs individuels (force) et les investissements visibles dans son travail (de longues heures de travail), seront plus recherchés que dans une culture ayant une faible distance hiérarchique. L'addiction au travail est perçue comme une chose plutôt positive dans les cultures ayant un grand contrôle de l'incertitude, une dominante masculine, et des objectifs d'orientation sur le long terme. Mais L'addiction au travail est bien moins positivement connotée dans les cultures présentant un faible contrôle de l'incertitude, une dominante féminine et des objectifs d'orientation à court-terme.



Schéma 20 les cultures centrées sur la distance hiérarchique, une dimension masculine, le contrôle de l'incertitude et une orientation à long terme amènent à l'addiction au travail

¹¹⁸ Baruch (2011)



Schéma 21 : la culture incite à l'engagement et oriente vers l'addiction au travail

Limites et suggestions pour de futures recherches

L'étude présentée ici est limitée par sa méthodologie. Premièrement, l'utilisation d'auto-questionnaires peut donner des résultats biaisés. Deuxièmement, cette étude n'a utilisé qu'une seule méthode afin de mesurer toutes les variables, ce qui pourrait, une nouvelle fois, produire des résultats biaisés (mono-method bias)¹¹⁹. On pourrait suggérer alors que les méthodologies utilisées dans de futures études soient plus variées, afin de confirmer les résultats et d'éviter les biais possibles. Par exemple, une méthode qualitative ou une base de données secondaire spécialisée dans les enquêtes culturelles peuvent être utilisées. Troisièmement, les échantillons choisis parmi les secteurs électronique et électrique, de l'automobile et de l'hôtellerie ne peuvent pas représenter l'ensemble des activités industrielles et de service existant à l'échelle nationale. Ainsi, des études dans d'autres secteurs peuvent être réalisées afin de confirmer ou d'améliorer les résultats de l'étude présentée ici.

¹¹⁹ Cook & Campbell (1979).

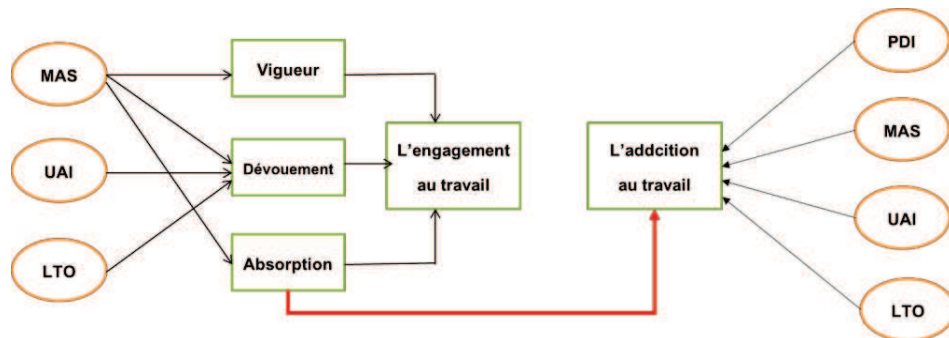
Quatrièmement, une étude transversale se concentrant sur une période spécifique peut ne pas donner les résultats les plus récents. Par conséquent, une méthode d'analyse par période temporelle pourra être utilisée afin de contourner cette limite. Enfin, étant donné que le résultat de cette étude n'établit que des relations minimales entre les variables, on peut estimer que d'autres facteurs mériteraient d'être étudiés à l'avenir.

On pourrait suggérer qu'une étude future se penche sur la comparaison de chaque dimension culturelle afin de confirmer ou d'approfondir l'étude d'Hofstede, tout en utilisant d'autres dimensions culturelles que celles de son étude afin d'analyser leur influence sur l'engagement et l'addiction au travail. L'étude devrait aussi s'attacher à identifier d'autres facteurs impactant ces deux notions, tels que les contextes organisationnels. Toutefois, les études sur l'engagement travail et l'addiction au travail devraient être menées indépendamment.

Table of Contents

LIST OF TABLES.....	viii
LIST OF FIGURES.....	xI
CHAPTER ONE:.....	1
1.1 Statement of problem.....	3
1.2 Background of sample.....	19
1.3 Research's objectives.....	22
1.4 The importance's of research.....	24
1.5 The scope of research.....	23
1.6 Research hypotheses.....	27
1.7 Definitions.....	28
1.8 Research model.....	31
1.9 The thesis structure.....	34
CHAPTER TWO: REVIEW OF THE LITERATURE.....	35
2.1 Work engagement.....	36
2.1.1 The concept of work engagement.....	37
2.1.2 Work engagement model, level, and distribution.....	41
2.1.3 Engagement level and individual condition.....	48
2.1.4 The importance of work engagement.....	52
2.1.5 The drivers of work engagement.....	55
2.2 Workaholism.....	62
2.2.1 Workaholism concept.....	63
2.2.2 Workaholism model, level, and distribution.....	65
2.2.3 Workaholism types.....	68
2.2.4 The importance of workaholism.....	72
2.2.5 Workaholism's studies.....	74
2.3 Work engagement and workaholism.....	78
2.4 Hofstede's culture dimensions.....	86
2.4.1 Overview of culture.....	86
2.4.2 The characteristics of Hofstede's culture dimensions.....	89

2.4.3	The changing of culture	100
2.4.4	Hofstede’s cultural dimensions in Thailand	102
2.4.5	The culture difference among personal demographic and work experience characteristics	106
2.4.6	The influence of culture	109
2.4.7	Summary	115
CHAPTER THREE: METHODOLOGY		116
3.1	Population and sample	116
3.2	Research questions and hypotheses	120
3.3	Research model	123
3.4	Data collection procedures	125
3.5	Variables and measurement	125
3.6	Validity and reliability of measures	134
3.7	Data analysis procedures	134
3.8	Summary	137
CHAPTER FOUR: FINDING		138
4.1	General analysis	138
4.1.1	Descriptive analysis	138
4.1.2	Hofstede’s culture score	142
4.1.3	Work engagement level	148
4.1.4	Workaholism level	151
4.2	The Mean comparing analysis	154
4.3	The correlation analysis	158
4.4	The Hypotheses testing	163
4.5	Summary	165
CHAPTER FIVE: DISCUSION AND CONCLUSION		169
5.1	The results of survey	169
5.1.1	Hofstede’s culture survey	169
5.1.2	Work engagement survey	178
5.1.3	Workaholism survey	182
5.2	The influence of personal demographics	184
5.3	The influence of work situation characteristics	189
5.4	Work engagement and workaholism	191

5.5	How does culture drives work engagement and workaholism.....	193
5.5.1	How does power distance drives work engagement and workaholism?.....	194
5.5.2	How does individualist versus collectivist culture drives work engagement and workaholism?.....	196
5.5.3	How does masculine versus feminine culture drives work engagement and workaholism?.....	198
5.5.4	How does uncertainty avoidance culture drives work engagement and workaholism?.....	201
5.5.5	How does long-term orientation culture drives work engagement and workaholism?.....	204
5.6	Summary.....	207
5.7	Limitation and Suggestion for Further research.....	210
5.8	The managerial Benefits.....	211

REFERENCE.....	216
----------------	-----

APPENDICES

Appendix A: Reliability.....	228
Appendix B: Mean and Standard deviation.....	229
Appendix C: Person correlation of work engagement and workaholism.....	230
Appendix D: Person correlation of work engagement and culture.....	231
Appendix E: Person correlation of workaholism and culture.....	232
Appendix F: Questionnaires.....	233

List of Tables

Table	Page
Table 1.1: Yamane ‘s table.....	25
Table 2.1: Engagement’s approaches comparing.....	39
Table 2.2: Work Engagement Types	47
Table 2.3: Comparing between work engagement level and culture	60
Table 2.4: Workaholism’s types.....	70
Table 2.5: The differences between large and small power distance.....	90
Table 2.6: The differences between Collectivism and Individualism.....	93
Table 2.7: The differences between Masculine and Feminine.....	95
Table 2.8: The differences between high and low uncertainty-avoidance culture.....	97
Table 2.9: The differences between short-term and long-term orientation.....	98
Table 2.10: Hofstede’s culture score by countries.....	102
Table 2.11: A comparison scores of cultural dimensions between the study of Hofstede, Muenjohn, and Watcharasriroj et al.....	105
Table 3.1: Sample Profiles.....	118
Table 3.2: Sample Profiles by electronic and electric sector.....	119
Table 3.3: Sample Profiles by Automotive sector.....	119
Table 3.4: Sample Profiles by hotel sector.....	119
Table 3.5: Summary of hypotheses (1a) (1b) (1c).....	121
Table 3.6: Summary of hypotheses (2) (3)	121
Table 3.7 : Summary of hypotheses (4).....	122
Table 3.8: Specific meaning of Hofstede’s culture dimensions.....	136
Table 4.1: The frequencies of personal demographics and work situation Characteristics variables	139
Table 4.2: The Hofstede’s culture dimensions, work engagement, and workaholism Level	140
Table 4.3: The culture dimensions’ scores, work engagement, and workaholism level among three sectors.....	141
Table 4.4: Power Distance: PDI score among respondents.....	142
Table 4.5: Uncertainty avoidance: UAI score among respondents.....	143
Table 4.6: Individualism versus Collectivism: IDV score among respondents.....	144
Table 4.7: Masculinity versus Femininity: MAS score among respondents	145
Table 4.8: Long-term orientation: LTO score among respondents.....	145
Table 4.9: Comparing of Hofstede’s culture dimensions scores between three Studies.....	147
Table 4.10: Work engagement among respondents.....	148

Table 4.11: work engagement score.....	149
Table 4.12: Types of work engagement.....	150
Table 4.13: Workaholism among respondents.....	151
Table 4.14: Workaholism mean and standard deviation.....	152
Table 4.15: Types of workaholism.....	153
Table 4.16: VI mean compare among generations.....	155
Table 4.17: Mean difference of VI, DE, and EE scores among marital status.....	155
Table 4.18: Mean PDI and IDV scores among education levels.....	156
Table 4.19: The results of hypotheses (1a) (1b) (1c).....	157
Table 4.20: The correlation between culture dimensions and work engagement	158
Table 4.21: The correlation between culture dimensions and workaholism	160
Table 4.22: The correlation between work engagement and workaholism.....	162
Table 4.23: Hofstede’s culture dimensions, work engagement, and workaholism score.....	165
Table 5.1: Comparing of PDI, UAI, IDV, MAS, LTO index of four studies.....	171
Table 5.2: Personal demographic and culture dimensions, work engagement, and Workaholism.....	184
Table 5.3: The relationship between Hofstede’s culture dimensions with work engagement and workaholism.....	193

List of Figures

Figure	Page
Figure 1.1: DDI’s Engagement Value Proposition.....	5
Figure 1.2: Antecedences and consequences of employee engagement.....	6
Figure 1.3: Types of employee engagement.....	7
Figure 1.4: Job demands – resources Model.....	9
Figure 1.5: Work-related subjective well-being.....	10
Figure 1.6: Behavior process.....	12
Figure 1.7: Influence process of culture on work engagement.....	13
Figure 1.8: How an organization’s culture forms.....	14
Figure 1.9: How culture creates work engagement and workaholism.....	15
Figure 1.10: Research Model.....	18
Figure 1.11: Research Model (Full vision).....	33
Figure 2.1: Work engagement components.....	40
Figure 2.2: Engagement Model.....	41
Figure 2.3: Engagement level of organization.....	42
Figure 2.4: Engagement distributions.....	44
Figure 2.5: The engagement-profit chain.....	52
Figure 2.6: Job-Demand resource model.....	57
Figure 2.7: Aon Hewitt’s Engagement Model.....	58
Figure 2.8: IES Engagement Model.....	59
Figure 2.9: Workaholism model.....	65
Figure 2.10: Workaholism Types.....	71
Figure 2.11: The different between work engagement and workaholism.....	79
Figure 2.12: Work-related subjective well-being.....	82
Figure 2.13: Transforming of engagement to workaholism.....	85
Figure 3.1: Research Model.....	124
Figure 4.1: Correlation coefficient values and correlation direction between PDI,UAI,MAS, and LTO with work engagement.....	159
Figure 4.2: Correlation coefficient values and correlation direction between PDI,UAI, MAS, and LTO with workaholism.....	161
Figure 4.3: Masculine, uncertainty avoidance , and long-term orientation culture drive work engagement.....	168
Figure 4.4: Power distance, Masculine, uncertain avoidance and long-term orientation culture that drive workaholism.....	168
Figure 4.5: Culture drives work engagement, orientation to workaholism.....	168
Figure 5.1: Comparing of PDI, UAI, IDV, MAS, LTO index of three studies.....	170

Figure 5.2: Work engagement survey.....	179
Figure 5.3: Work engagement types.....	179
Figure 5.4: Work engagement development plan.....	181
Figure 5.5: Workaholism survey.....	182
Figure 5.6: Workaholism types.....	183
Figure 5.7: Power distance related with workaholism and vigor.....	195
Figure 5.8: Individualism related to absorption and workaholism.....	198
Figure 5.9: Masculinity dimension drive work engagement and workaholism.....	200
Figure 5.10: Uncertainty avoidance drives the dedication and workaholism.....	202
Figure 5.11: Long-term orientation dimension drives the dedication and Workaholism.....	206
Figure 5.12: Masculine, uncertainty avoidance and long-term orientation culture drive work engagement.....	207
Figure 5.13: Power distance, Masculine, Uncertainty avoidance, and long-term orientation culture drive workaholism.....	209
Figure 5.14: Culture drives work engagement and orients to workaholism model...	209

CHAPTER I

This present study applies the study of culture by Geer Hofstede (1980, 2010) by selecting the five cultural dimensions: power distance, individualism versus collectivism, masculinity versus femininity, uncertainty avoidance, and long-term orientation to study those cultural influences on work engagement and workaholism in order to explain how culture drives work engagement and workaholism. Furthermore, this present study focuses on the relationship and the influence of work engagement and workaholism in order to find out whether workaholism is the negative side of work engagement (Halbesleben, Harvey, and Bolino, 2009).

This present study includes the impact of personal demographics (gender, generation, marital status, and education, on culture, work engagement, and workaholism). The impact of work situation characteristics (organization tenure, position, department, and tenure in current position, on culture, work engagement, and workaholism) in order to study the differences of personal demographics and work situation characteristics that will distribute level of culture, work engagement, and workaholism in the same way or difference way.

The methodology in this present study is questionnaire distribution to survey a situation of work engagement from the employees in the automobile's company, electronic and electronics' company, and the hotels located in Thailand. The data was analyzed by SPSS program version 20.0 by using descriptive statistics, and person correlation statistics.

The results of the study present (1) the level of culture in dimensions: power distance, individualism versus collectivism, masculinity versus femininity, un-certainty avoidance, and long-term orientation. This data will present level of work engagement and level of workaholism, compare with the previous studies, and explain the reason of differences results from this present study than the previous studies. (2) The level of cultural dimensions (power distance, individualism versus collectivism, masculinity versus femininity, un-certainty avoidance, and long-term orientation, the level of work engagement) will present along with the level of workaholism by gender, generation, education level, marital status, organization tenure, position, division, and tenure in current position. This includes the comparative study with the previous ones. (3) The relationship among the cultural dimensions (power distance, individualism versus collectivism, masculinity versus femininity, un-certainty avoidance, and long-term orientation), work engagement and workaholism will be examined. (4) This study will look into the relationship between work engagement and workaholism together with the explanation about kinds of relationship between them. (5) Finally, work engagement model will be created as the output by this study.

This chapter focused on statement of problem, together with background of the sample. This research also includes objectives of the study and its importance. Scope and hypothesis have also been illustrated as well as definitions and model of the research. Finally, the structure of the thesis presents in the last section of this chapter.

1.1 Statement of Problem

How organizations gain a competitive advantage? The simple question is always challenging organization managerial teams who have made great effort to implement various ways to achieve organizational goals and try to outstand among their competitors. As well as this, to retain the employees' success is another job of managerial team. Therefore, style of management to serve of both organization and employees' success needs to be sorted out.

Marketing approaches: product differentiation or low cost management can maintain business competitive condition (Porter, 1990). Moreover, proper human resources managements, employee and organization developments, can be partial of business success (DCU, 1996).

In terms of human resource, it is believed that employee engagement is a primary key to help companies maintain their competitive advantages and one of drivers for organizational success (SHRM, 2007), (DDI, 2011.), and Bakker (2009) also supported this claim that engagement can make a true difference and lead to organizational advantages. Furthermore, George (2011) stated that work engagement usually engaged employees as a win-win situation for everyone.

Engagements, relationship between employees and organization, are famed in many facets: employee engagement, organization engagement, team engagement, work engagement, job engagement, task engagement, and work engagement. These could be similar or different depending on organization's context. Therefore, engagement should be focused on particular point.

Kahn (1990) who defined employee engagement as the harnessing of organization members 'selves to their work roles firstly studied the term of engagement. Through engagement, people employ and express themselves physically, cognitively, and emotionally during their role performances.

Furthermore, employee engagement was conceptualized in many different ways. For example, Harter, Schmidt and Hayes (2002) defined employee engagement as the individual's involvement, satisfaction and enthusiasm for work. Wellins & Concelman (2004) also defined employee engagement as the illusive force that motivates employees to higher levels of performance, while Robinson, Perryman and Hayday (2004) defined engagement as a positive attitude held by the employee towards the organization and its values. Engagement is also defined as the positive opponent of burnout (Schaufeli & Bakker, 2004). However, Kahn (1990), Harter Schmidt and Hayes (2002), and Wellins & Concelman (2004) had studied employee engagement that focused on work. While the studies of employee engagement by Robinson, Perryman and Hayday (2004) focus on engaging with organization.

Since engagement is crucial in running businesses, there are many consultant organizations working about engagement such as The Gallup, Hewitt Associates, Employee engagement index: EEI, Development Dimensions International: DDI , The International Survey Research: ISR, The Institute for Employment Studies, Alpha Measure, etc.

The Gallop (2006) defined engaged employees as those who work enthusiastically with a passion and drive the organization forward including feel involved with their work. By such engagement, these employees will increase business profitability,

productivity, and safety. Moreover, ISR (2004) defined employee engagement as a process which enables an organization to increase employees' commitments and continuations to achieve superior results. As well as this, DDI (2011) defined terms of this engagement as the extent to which people value, enjoy and believe in what they do. Blesswhite (2011) also asserted that the company should maximize employees' satisfaction in order to meet maximum contribution for organization. While, EEI (2005) defined engagement is more than simply job satisfaction. It also encompasses company commitment, career development, and work relationships, manager, teamwork and customer.

In business, engagement mostly is focused on both organization and employee engagements. Both of them shared some common concepts: organizational commitment, organizational citizenship behavior (OCB), job involvement and flow, attitude or behavior, individual or group, and job satisfaction (Kumar & Swetha, 2011). However, the benefits of engagement are also interesting.

The benefits of engagement have been researched by business and academic sectors since 1990. The models of engagement in figure 1.1, 1.2 and 1.3 present why engagement is matter. DDI (n.d.) proposed engaged employees are greater royalty and increased their efforts to their organizational success that will cause customers' satisfaction, increase retention, profitability, and revenue growth.

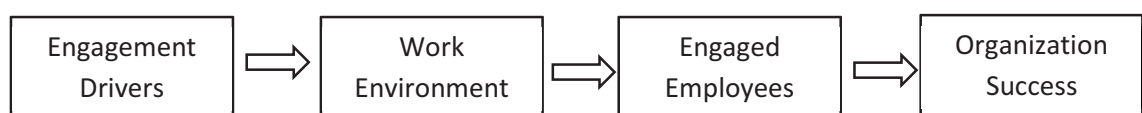

Figure 1.1 DDI's Engagement Value Proposition

Source: adapt from DDI, n.d.

Sak (2005) indicated that job satisfaction, organizational commitment, lower employees' turnover rate and increase proper organizational citizenship behavior are consequences of employee engagement.

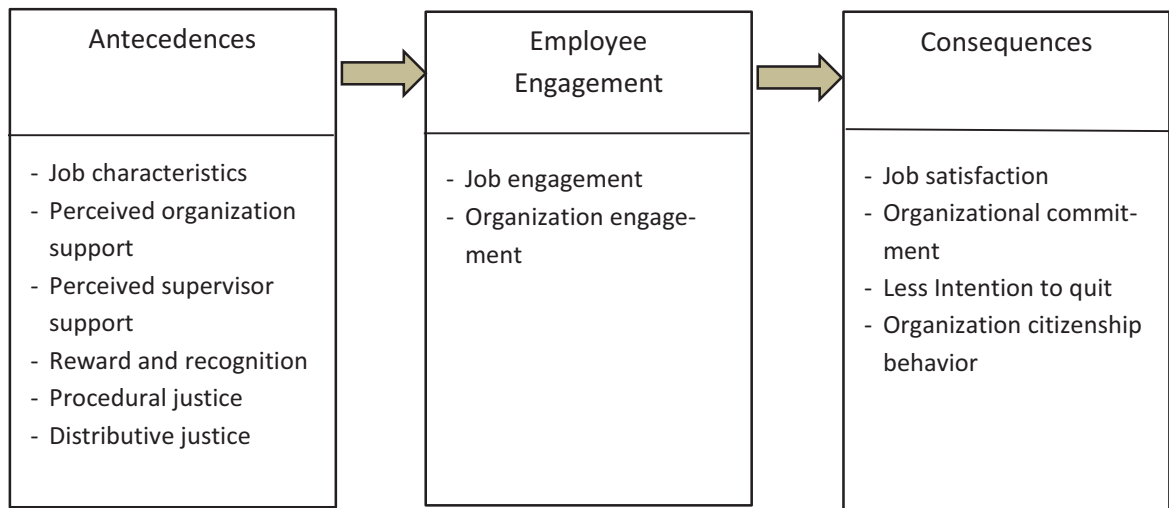

Figure 1.2 Antecedences and consequences of employee engagement

Source : Sak, 2005

Wherefore, engaged employees can optimize organizations to gain more competitive advantage. When employees are engaged, they will have better performance that leads the business growth.

They, then, are likely to work harder in order to get better result and work with the organization for years. Engaged employees enjoy working every day (Sak, 2005). Engagement also is beneficial to both the organization and the employees.

The studies show that there have been positive relations between engagement and well-being (Hayter, Smeed & Robertson, 2011). Furthermore, Fairhurst and O'connor (2010) explained the connections between engagement and well-being are engagement in the absence of well-being can lead to a burned-out and unstable engagement.

While Engagement with well-being enables sustained employee performance or sustainable engagement.

As the reasons, there are many facets of engagements: job, work, team, employee, and organization. Thus, according to figure 1.3, this present study viewed employee engagement as an employee who engages with task, work or job, team, and organization. Work is a primary contact point between the organization and employee. Work unit is a piece of the whole organization's jigsaw. Every work unit is involved in organizational performing. Work engagement is mainly focused on each organization level as the figure 1.3 below.

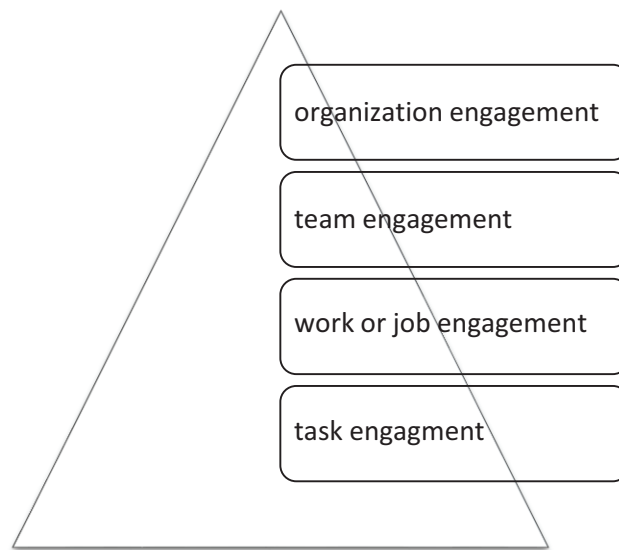

Figure 1.3 Types of employee engagement

Work engagement is assumed as the opponent of burnout (Maslach & Leiter, 1997). After investigating burnout for more than 25 years, Schaufeli et al (2002) found that work engagement was a positive fulfilling in the state of mind that is characterized by vigor, absorption, and dedication.

Vigor is explained to the extent that employees feel stimulated and energized at work, and how willing they are to invest their energy and effort in their work.

Dedication, which can be depicted as significant and meaningful work to the employees, is characterized by feelings such as significance, enthusiasm, pride, inspiration and challenge.

Absorption is characterized by feelings of being fully occupied and gripped with one's work, so, by the time being, it is found that the employees will have difficulties to detach themselves from their work.

The characteristics of employees, who are highly work engaged, is described by Schaufeli, Bakker, and Salanova (2006) who illustrated that the engaged employees will have high level of energy with their enthusiasm. Moreover, they are often fully immersed but are not addicted to their work. They also enjoy other things apart from their work. However, this is different than workaholism who do not work hard because of a strong and irresistible inner drive but they believe that working is fun (Bakker & Demerouti, 2009).

However, job-demand resource model has influenced work engagement and employee performance, such as in-role, extra role, creativity, and financial turnover (Bakkerand & Demerouti, 2009) as depicted in figure 1.4.

Work engagement is important to an organization since work engagement is one of positive organizational behaviors which is contributed to the bottom line – performance and client satisfaction (Bakker & Schaufeli, 2008).

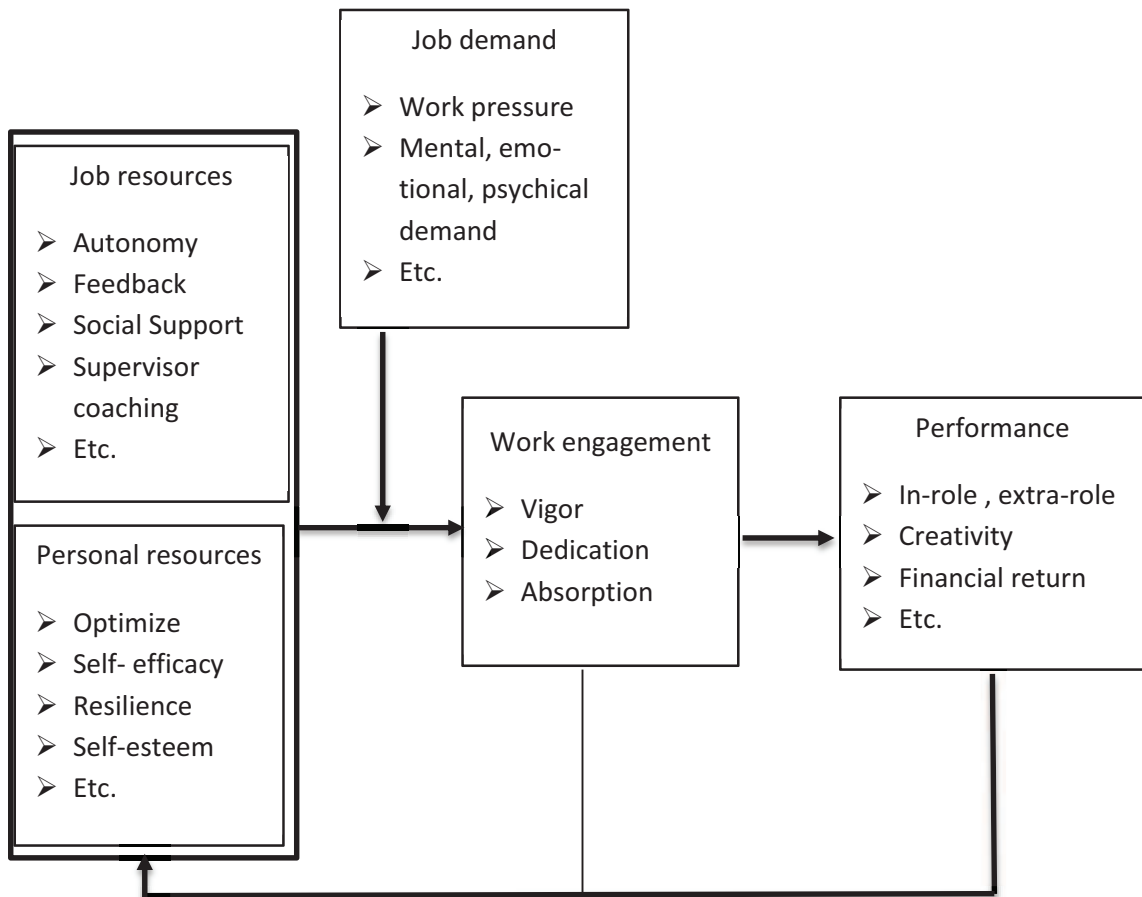

Figure 1.4 Job demands – resources Model

Source: Bakker & Demerouti, 2009

Furthermore, Work engagement is positively associated with job satisfaction, organization commitment and citizenship behavior while it is negatively related to intention to quit (Saks, 2005). Work engagement is also associated with positive employees' attitudes, proactive behavior, high level of employees' well-being, increasing individual job and organizational performance (Bakker & Demerouti, 2009). As well as this, engaged workers seem to have better mental and psychosomatic health (Shimazu & Schaufeli, 2009).

On the other hand, employees with higher of work engagement will elevate their vigor, dedication, and absorption to meet higher performance. This will cause ‘over-engaged’ and can distort the work-life balance when employees take work home. They will heavily concentrate on work and become workaholism.

Work engagement can be different and similar to workaholism. Bakker (2011) explains this relationship in figure 1.4. Engaged employees are characterized by high levels of activation and pleasure whereas workaholism are characterized by high levels of activation and unpleased. Moreover, burnout employees, an opposite pole of work engagement, have low levels of activation and unpleasant whilst satisfied employees are not placed in both engaged and workaholism because of their low levels of activation, but they are still happy to work in the organizations.

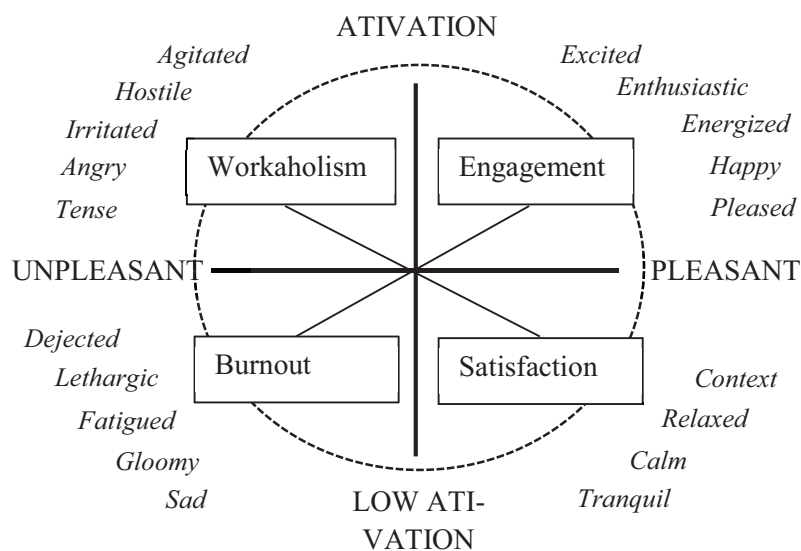

Figure 1.5 work-related subjective well-being

Source: (Bakker, 2011)

Therefore, engaged employees may become workaholic when they lose their happiness in work while workaholism may engage if they perceive happiness at work. From model of work-related subjective well-being, workaholism is related to work engagement with pleasant working, but on the opposite pole. Thus, organizational management should emphasize on employee well-being in order to prevent working addiction or workaholism.

It can be suggested that an absorption, one of three components of work engagement, could be related to workaholism because an absorption is defined as feelings of being fully occupied and gripped with one's work that will make such employees unable to detach themselves from work. That will result in putting more effort and working unpleasantly. Finally, they will be workaholism as explained in figure 1.4.

However, Schaufeli, Taris and Rhenen (2008) suggested that work engagement and workaholism were related to different variables: hard working and organizational loyalty. Workaholism will find it difficult to maintain mental health and social contacts outside work whereas engaged workers have better mental health and social contact. It is hardly to find some research about influence of work engagement on workaholism. Moreover, Shimazu et al (2012) asserted that workaholism and work engagement are two different kinds of concepts that are oppositely related to well-being and performance. Hence, it is recommended to investigate the relationship between work engagement and workaholism to support previous claim that workaholism could be beneficial to work engagement.

Since work engagement is important, the level to enhance work engagement became an organizational strategy, and the method to create an engagement has been implemented. However, there are many impacts on work engagement, such as, personal factors (personality or personal resources), organizational factors (job resources and organization culture), and external factors (socio-cultural) (Bakker ,2009 ;Bakker & Demerouti,2009 ; Ferguson, 2007).

This present study aims to study an influence of culture on work engagement and workaholism because both work engagement and workaholism are types of behavior which employees behave in their work; meanwhile, culture also gives an impact on behavior (figure 1.6).

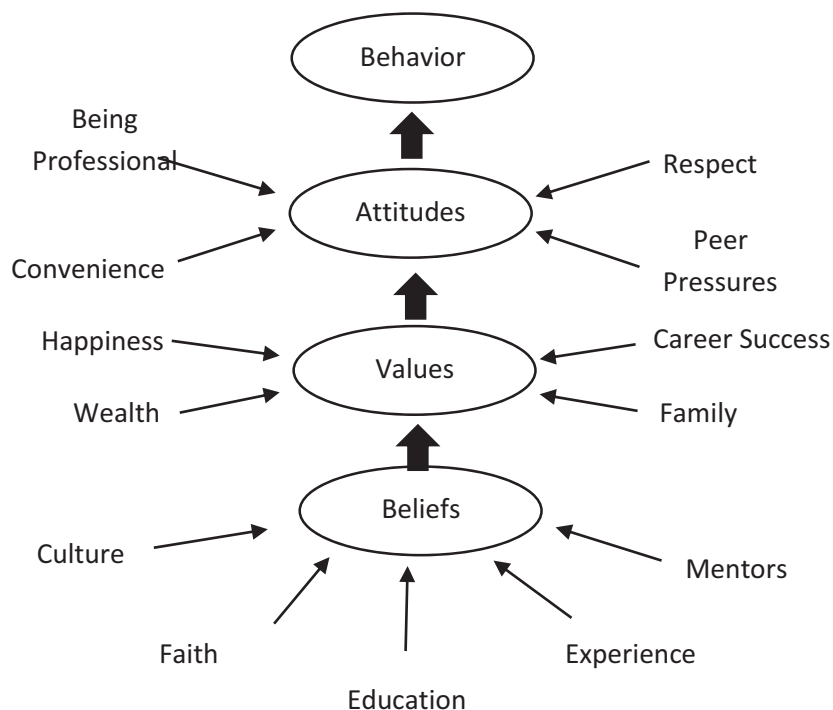

Figure 1.6 Behavior process

Culture drives work engagement that is attracted by the social context, presented in figure 1.7. This figure explained that the organization is influenced by many cultural contributions: strategy, person's system and process, structure capacity and capability. Leadership, including organization's value and culture, influenced push - pull employee engagement. These contributions in work, team and organization will drive appropriate employee behavior that affects customer experience and organization performance.

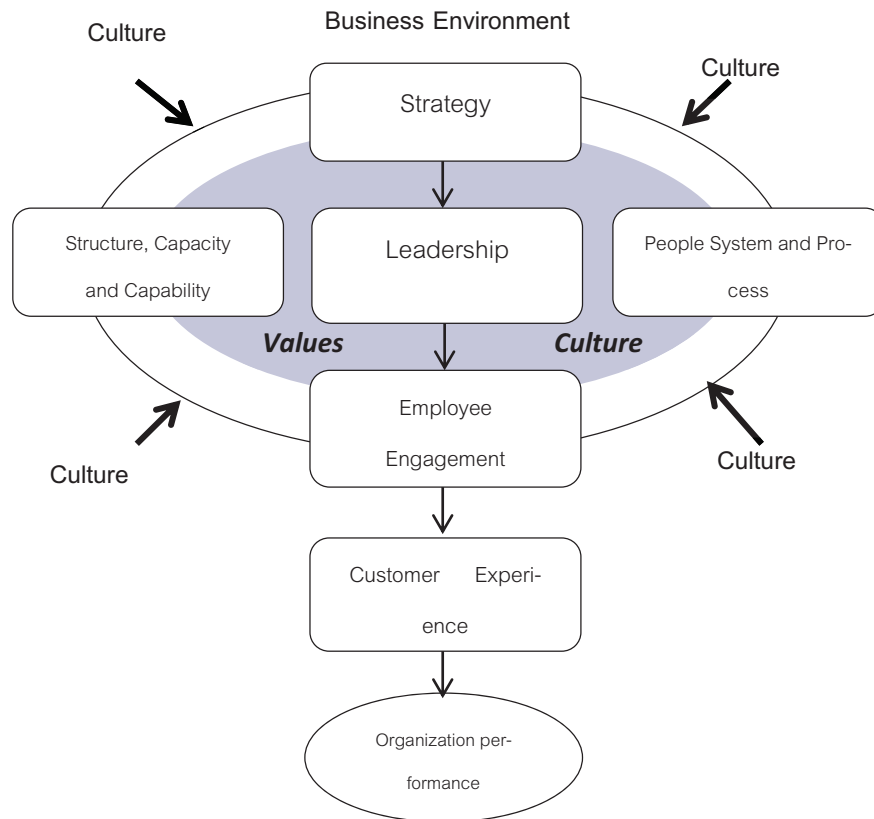

Figure 1.7 Influence process of culture on work engagement

Source: Adapted from Right managements organizational effectiveness framework (Right managements, 2011)

Culture values impact work engagement and workaholism because these values influence on individual behavior through belief, values and attitude (Hofstede, 1990). Both work engagement and workaholism are individual behavior, so culture values can influence on individuals to behave as engaged or workaholism ones.

Furthermore, culture creates climate that allows member to share organizational perceptions towards their working environment. Robbins (2005) also stated that “if you work with someone whose positive attitude inspired you to do your best, or with the lackluster team that drain your motivation, you’ve experienced the effect of climate.” Swidler (1986) also states that culture can influence action, by shaping a repertoire of habits, skill, and styles. Bakker (2009) also supported this claim that work engagement will be increased with high job resources and low job demand.

There are several business consultants suggested that enhancing engagement in organization can create an engaged culture. Robbins (2005) presented the approach that an organization’s culture established and sustained (figure 1. 8). The original culture derives from the founder’s philosophy which strongly influences the hiring criteria as the firm grows. Top managers’ actions can set a general climate including an acceptable behavior.

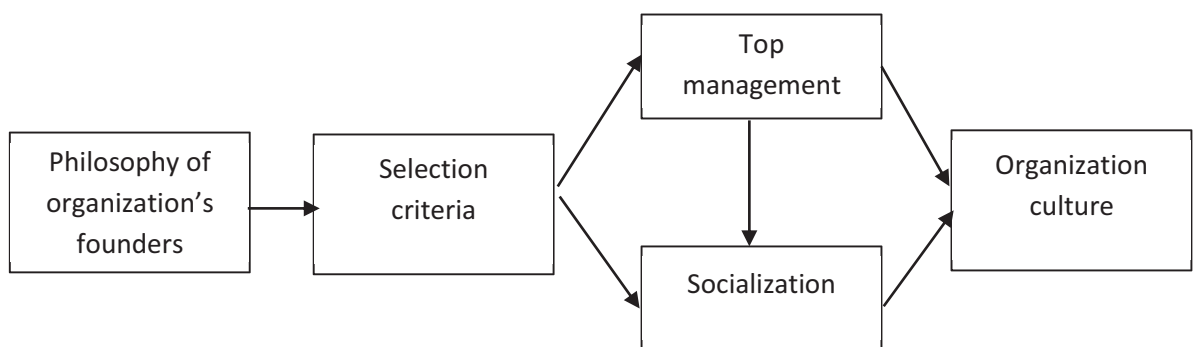

Figure 1.8 How an organization’s culture forms
Source: Robbins, 2005

To conclude that culture can influence on work engagement, and workaholism since culture gives an impact on individual behavior and organizational climate. Culture values also shape personal resource or personality and provide job resources such as a style of social support and coaching. Culture also influences leadership style and creates organizational climate which influences work engagement and workaholism. Therefore, culture values driving work engagement and workaholism can take place as figure 1.9,

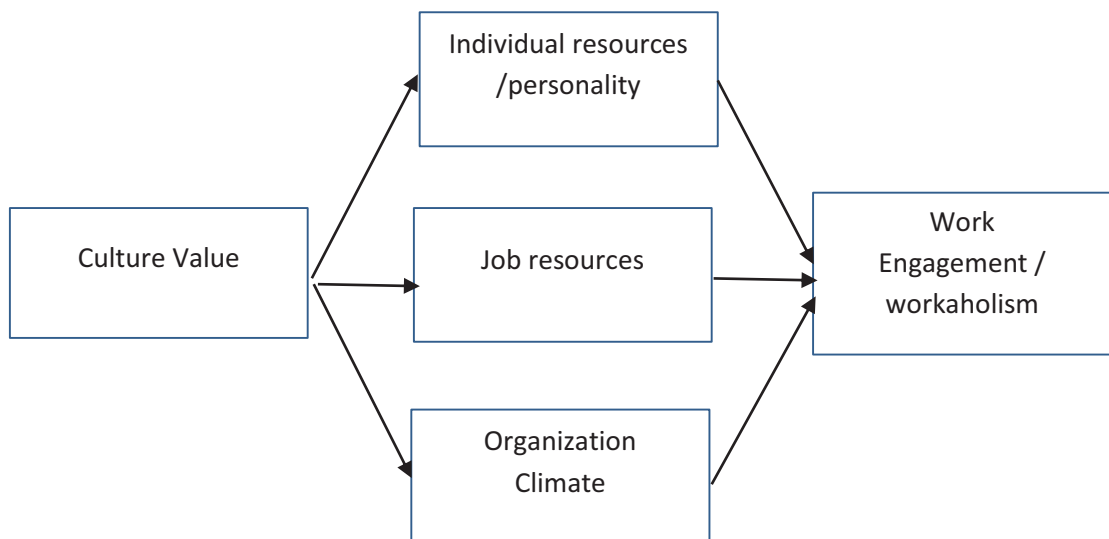

Figure 1.9 How culture creates work engagement and workaholism

The study of culture by Geert Hofstede (1990, 2010) has been widely acknowledged as the most significant approach to the study of cross-cultural differences in human behavior as an independent variable. The five dimensions of culture; power distance, individualism versus collectivism, masculinity versus femininity, uncertainty avoidance, and long-term orientation are taken for studying their relationship with work engagement and workaholism

The way that cultures drive work engagement and orientation to workaholism can be questioned. Since cultures drive individual behavior (Hofstede, 1990), the dimensions of psychological process and organizational behaviors are relevant to the way people function themselves in industrial societies. These dimensions have generated a tremendous amount of research and have been influential in all the social science.

Through reviewing Hofstede's culture framework, Fleck and Inceoglu's engagement model (2010), Right managements' organizational effectiveness framework (2011) and engagement model of person-environment interaction by Neufeld and colleagues (2006) together with Wu's study (Wu, Taylor & Chen, 2001). It found that work-related cultural values in a specific culture are not static and can be changed over time including people's cultural values when the political, societal, and economic environments change. Therefore, Hofstede had been collected data 30 years ago (2010) and to update Hofstede's culture dimensions is one of the objectives in this present study.

A study about Hofstede's culture dimensions influencing on workaholism is also found in Baruch's study (2011). Both of them proposed that workaholism became more positive in cultures which were characterized by high power distance, high uncertainty avoidance high individualism, high masculinity and long-term orientation less positive in cultures high on femininity.

Business insider named Japan as the first workaholism country while Japan presented moderate power distance and individualism, high masculinity, uncertainty avoidance, and long-term orientation (Hofstede, Hofstede & Minkov, 2010).

On the other hand, French are named as the best relaxing worker while France presents high power distance, individualism, uncertainty avoidance, and long-term orientation, but moderate masculinity. Those can be concluded that culture values create workaholism.

In a study of work engagement by Shimazu, Miyanaka, and schaufeli (2010) stated that high work engagement had found in France and Finland while Japan had low work engagement environment. However, a study about Hofstede's culture dimensions influence on work engagement is rare. Thus, the way that culture drives work engagement and workaholism, are the second and third investigations in this present study.

Furthermore, culture survey is focused as the fourth investigation in order to update Hofstede's and previous culture surveys including presenting workaholism and work engagement surveys for future studies, and utilizing information in business sectors.

The information of personal demographics: gender, generation, education, marital status is presented aligned with working situation characteristics: organization tenure, position, and division. This is vital information to study culture, work engagement, and workaholism among specific groups for better understanding of culture, work engagement and workaholism.

Therefore, the research framework of this present study was concluded as in figure 1.10 in order to find the answers of research's questions as follow;

- 1) Do the scores of Hofstede's cultural dimensions; power distance, masculinity, individualism, uncertainty avoidance, and uncertainty avoidance, work engagement and workaholism differ among personal demographics and work situation characteristics.
- 2) Do the Hofstede's culture dimensions relate to work engagement?
- 3) Do the Hofstede's culture dimensions relate to workaholism?
- 4) Does workaholism perform as a negative side of work engagement?

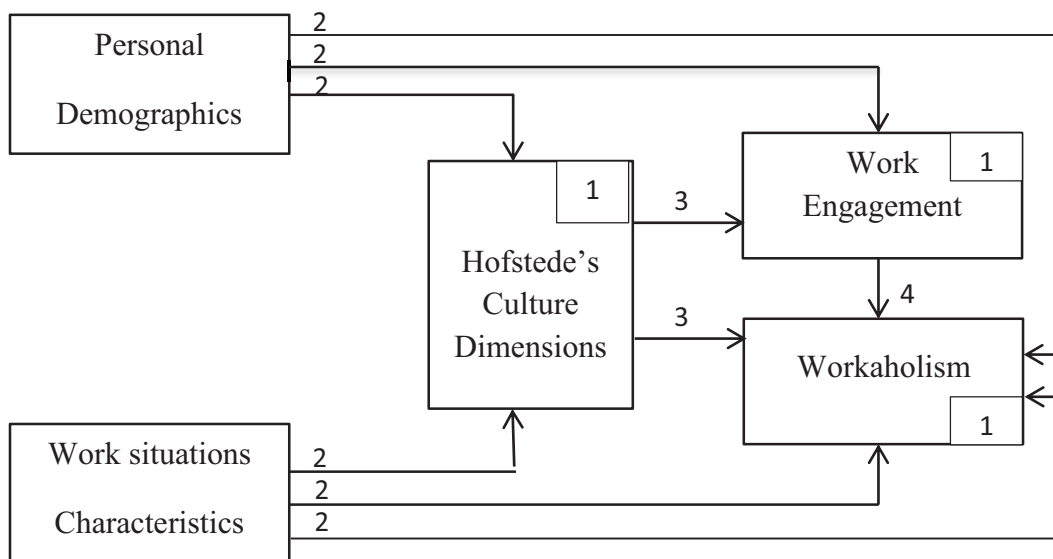

Figure 1.10 Research Model

The research framework consists of four parts as followed:

- (1) To study Hofstede's culture dimensions, work engagement, and workaholism.
- (2) To compare the score of Hofstede's culture dimensions, work engagement level, and workaholism level among personal demographics and work situation characteristics.
- (3) To find the relationships between culture dimensions with work engagement and workaholism.
- (4) To find the influence of work engagement on workaholism.

1.2 Background of sample

This present research has been tried out among business sectors Thailand, such as, hotel, automobile, and electrical and electronic sector. Questionnaires and SPSS program had been used to analyzed culture, work engagement and workaholism survey in order to explain their relationship: how culture drives work engagement, workaholism orientation, and to confirm prior work engagement model. The results of research can help organizations understand how to enhance work engagement in a middle way. Organizations can perceive high performance from employees without deteriorate the health of employees.

Thailand, officially the Kingdom of Thailand, is situated in the south eastern part of Asia between 15° 00' North latitude and 100° 00' East longitude with an area of approximately 513,000 km² (198,000 square mile) and around 66 million people. This makes it the 20th most populous country in the world (world population review 2010),

female are occupied around 33.6 million, and male are around 32.4 (2010, www.nso.go.th). The largest capital city is Bangkok.

In the past, Thailand was agricultural economy. However, nowadays, Thailand has been transferred from agriculture to industrial economy. The GDP (gross domestic product of Thailand) in 2012 by World Bank presented in the 21st world was 365,564 million dollar, and ranked in the place of 87th of the world with 9.820 million dollars of GPP (gross domestic product at purchasing power parity per capita). The GDP growth from 2003 to 2008 is average 5.6% per year.

UNPD explored Human development indicators of Thailand: HDI, in 2000, was a medium human development country presented as the 103rd world ranking with the score 0.690, while the highest development country is Norway, a score is 0.905. The GII (gender Inequality Index composed of measure reflecting inequality in achievements between women and men in three dimensions: reproductive health, empowerment and the labor market) presented a score with 0.0360 decreed from 2000 with the score 0.458. The ratio of seats, held by a respective gender in a lower or single house or an upper house or senate where relevant, was 0.186 and was higher than the score at 2000 (0.073), and than the house in Japan (0.155), but lower than the house in the United States (0.203).

Industry clusters in Thailand are divided into three clusters: niche, supporting, and basic industries. Niche industry, such as automobile and spare parts sector, gained high profit with high export revenue, high employment rate and was highly competitive. Similarly, hotel sector was ranked as the 1st popular investment in ASIA with high revenue, and heavily supported from Thailand government while electrical and electronic sector was the highest export value industry (TID, 2555-2574).

Generally, Thai people have unique cultural values, which can reflect their social interactions and behaviors. Therefore, cultural values can influence characteristic of most Thai people. There are six influential values in Thai society: flexibility and adaptable, believe in spirit and luck, education and competence, unpunctuality, forgive each other easily, and don't like to disagree with anyone (Komin, 1990).

In 1980, Hofstede explored Thai culture through four cultural dimensions: power distance, masculinity and femininity, individualism and collectivism, and uncertainty-avoidance. The fifth dimension was presented in 1991 was a long-term orientation.

However, power distance score could be decreased with increased education level. The gap between individualism and collectivism relates to equivalent levels of per capita income. Female/male ratio is higher in feminine culture. Masculine cultures meant large families in poor country and smaller families in wealthy countries. Uncertainty avoidance seemed related to national anxiety, religious, political, and economic. This would affect to people's long-term thinking (Hofstede, Hofstede, & Minkov, 2010).

Utrecht Work Engagement Scale: UWES-9 and UWES-17, can be utilized in rating work engagement in multicultural context, is widely acceptable in most countries in Europe. Additionally, the results of work engagement level in eight European countries showed that the level of work engagement varied not only between countries but also among those four economic sectors within each country (Aipale et al, 2011). Nonetheless, Sarkisian et al. (2011) presented the different outcome of work engagement scores among the United States and the two country clusters (young and old developing countries) were not statistically significant.

Work engagement study in Thailand have applied UWES-9 measurement by Rurkkhun(2010), workaholism measurement, Dutch Work Addiction Scale (DUWAS). However, work engagement level in Thailand may tend to achieve high work engagement level, since some Thais value as gratefulness which means employees will get compensations by the organization and they will have an awareness in return. Therefore, such value could drive work engagement among Thais employees.

1.3 Research's Objectives

The researches of objectives are:

1. To study Hofstede's culture dimensions, work engagement, and workaholism.
2. To prove Hofstede's culture dimensions' scores, work engagement score, and workaholism which will be different among variables: gender, generation, education, marital status, organizational tenure, position, division, and tenure in current position.
3. To study the relationships between Hofstede's cultural dimensions with work engagement, and workaholism
4. To find the influence work engagement on workaholism.
5. To explain how Hofstede's cultural dimensions drive work engagement, and workaholism.

1.4 The importance's of research

This present research will be beneficial to academic, business, and human resources as followed: By studying about work engagement and workaholism level, this research will be of help to human resource to maintain number of employees in the organization. By studying work engagement and workaholism level, this research can help human resource management to understand an organizational situation. By studying a homogenous of culture, work engagement and workaholism, this research will give benefit to organization to keep focused on necessary points. Impact factors on work engagement and workaholism should be concerned to enhance work engagement level and reduce workaholism level. This will guild human resource management about the idea to create work engagement culture in organizations.

The benefits of research for applying in academic are extending the study of work engagement and workaholism, confirming the study of culture is changing, and extending the study of culture impact. Especially, the influence of culture on work engagement and workaholism that there are very few studies on this topic. The benefits of research for applying in business as follow:

1. The organizations understand their status about engagement level, workaholism level, types of work engagement, and types of workaholism, these direct them develop in right group and appropriate way.
2. The organizations can develop culture that can increase work engagement and decrease workaholism.

:

1.5 The scope of research

The scope of research focuses on business groups: hotel, automobile, and electrical and electronic sector located in Thailand. Since the levels of engagement in each group are different, to get reliable results from various groups is vital for this study.

A hotel sector is a representative of a service sector; an automotive sector is a representative of a production sector; and electrical and electronic sector is a representative of support production sector.

1.5.1 Population

The population in this present research is targeted on employees who work in the hotel sector, automobile sector, and electrical and electronic sector. Its estimated number could be around more than 100,000 units.

1.5.2 Sample

Non-probability, random is used in this present research by convenience sampling method; the random simple units will be done by convenience sampling.

According to Yamane table (Yamane, 1973), the numbers of samples are totally 625 units because the number of population is more than 100,000 with confidence of level, 4%.

Population (N)	Sample (n) with confidence level (e)					
	+,- 1%	+,- 2%	+,- 3%	+,- 4%	+,- 5%	+,- 10%
50,000	8,333	2,381	1,087	617	397	100
100,000	9,091	2,439	1,099	621	398	100
∞	10,000	2,500	1,111	625	400	100

Table 1.1 Yamane table

Source: (Yamane, 1973)

1.5.3 Variables

The variable categories of five groups are as followed:

1. Individual demographic variable: INDEM, independent variable, is consisted of four variables;

1.1. Gender: SEX

(1) male (2) female

1.2. Generation: GEN

(1) Gen-Y (2) Gen-X (3) Baby Boomer

1.3. Marital status: MAR

(1) Single (2) Married (3) Divorced, separated, and others

1.4. Education level: EDU

(1) Technical certificate

(2) Bachelor's Degree

(3) Master's Degree, or Doctoral Degree

2. Work situation characteristics: WORKSIT, independent variable, are consisted of four variables:

2.1. Organizational tenure: TEN,

- (1) Less than 5 years
- (2) 5 -10 years
- (3) 11-15 years
- (4) 16 -20years
- (5) More than 20 years

2.2. Division: DIV,

- (1) Support
- (2) Non-support

2.3. Position: POS,

- (1) Staff
- (2) Supervisor
- (3) Middle manager
- (4) High manager

2.4. Tenure in current position: TIC

- (1) Less than 5 years
- (2) 5 -10 years
- (3) 11-15 years
- (4) 16 -20years
- (5) More than 20 years

3. Hofstede's culture: HOFS, dependent and independent variables are consisted of five dimensions with five scales of measurement from 1-5 (mostly disagree to mostly agree):

3.1. Power Distance: PDI

3.2. Individualism and Collectivism: IDV

3.3. Masculine and Feminine: MAS

3.4. Uncertainty Avoidance: UAI

3.5. Long-term Orientation: LTO

4. Work engagement: UWES, dependent variables, is consisted of three components with seven scales of measurement from 0-6 (never to everyday):

4.1. Vigor: VI 4.2 Dedication : DE 4.3 Absorption: AB

5. Workaholism: DUWAS, dependent variables, is consisted of two components with four scales of measurement from 1-4 (never to always):

5.1. Work excessively: WkE 5.2 Work compulsively: WkC

1.6 Research hypotheses

Three mains items of hypothesis are:

1. Testing of the different between variables

H1 (a). The scores of Hofstede's culture dimensions are differences among personal demographics and work situation characteristics.

H1 (b). The levels of work engagement are different among personal demographics and work situation characteristics.

H1 (c) The levels of workaholism are difference among personal demographics and work situation characteristics.

2. Testing of relationship

H2 Hofstede's culture dimensions have a relationship with work engagement.

H3 Hofstede's culture dimensions have a relationship with workaholism.

H4 Work engagement has a relationship with workaholism.

1.7 Definitions

Variables definitions in this present research as follow:

Gen-Y: Employee who was born between 1980 to 1999.

Gen-X: Employee who was born between 1965 to 1979.

Baby Boomer: Employee who was born between 1946 to 1964.

Been married: Employee who had ever been married, and does not have spouse living together now, such as divorced, widowed, or separated.

Organizational tenure: The period of work in the current company.

Non-support division: Employee who works in departments which contact directly with customers or products, such as front office and marketing in hotel sector, production department in automobile and electrical and electronic sector.

Support division: Employee who works in department which is not contact directly with customers or products, such as accounting, administration, human resource, and purchasing.

Power Distance: Level of accepting in inequity, power, and authority of higher position.

Individualism and Collectivism: Level of individuals is perceived to be self-reliant and independent or concerning of the benefits of group more than oneself .

- Masculine and Feminine:*** Level of expectations concerning behavior and acting social roles connected with maleness, assertive and oriented towards success, or femaleness, harmony and cooperation.
- Uncertainty Avoidance:*** Level of thinking about difference, danger, and acceptance the unpredictability of social and the future.
- Long-term Orientation:*** Level of standing for the fostering of virtues oriented toward future rewards in particular perseverance and thrift.
- Work engagement:*** Level of positive fulfilling work related state of mind that is characterized by vigor, dedication, and absorption
- Vigor:*** Level of energy and mental resilience while working; the willingness to invest effort in one's work, and persistence even in the face of difficulties.
- Dedication:*** Level of a being strongly involved in one's work, and experiencing a sense of significance, enthusiasm, inspiration, pride, and challenge.
- Absorption:*** Level of a being fully concentrated and happily engrossed in one's work. By the time being, one has difficulties in detaching oneself from work.

Workaholism: Level of work addiction and difficult to detach oneself from one's work characterized by work excessively and work compulsively.

Work Excessively: Level of behavior which tends to allocate an exceptional amount of their time and energy to work and that they work beyond what is reasonably expected to meet organizational or economic requirements

Work compulsively: Level of behavior which is obsessed with their work and persistently and frequently think about work even when not being at work.

1.8 Research model

The expected results (four parts of research model results, work engagement model under culture context) together with the numbers of sub-variables are presented by full model in figure 1.10.

This present study explored work engagement model within culture contexts (power distance, individualisms versus collectivisms, masculinity versus femininity, uncertainty avoidance, and long-term orientation) by studying effects of culture on work engagement and workaholism, differences of culture, work engagement, workaholism among genders, generations, marital status, education, organizational tenure, position, division, and tenure in current position. Studying influence of work engagement on workaholism has been illustrated as well. Thus, results of finding summarized from research model are:

- 1.1 Hofstede's culture dimensions: HOFS, consisted of scores of power distance: PDI, individualism: IDV, masculinity: MAS, uncertainty avoidance: UAI, and long-term orientation: LTO.
- 1.2 Work engagement level: UWES, including vigor score: VI, dedication: DE, and absorption: AB.
- 1.3 Workaholism level: DUWAS, including work excessively: WKE, and work compulsively.
- 2.1 Hofstede's culture dimensions compared among gender, generations, marital status, and education.

- 2.2 Work engagement compared among gender, generations, marital status, and education
- 2.3 Workaholism compared among gender, generations, marital status, and education
- 2.4 Hofstede's culture dimensions compared among organization tenure, position, division, and current position tenure.
- 2.5 Work engagement compared among organization tenure, position, division, and current position tenure.
- 2.6 Workaholism compared among organization tenure, position, division, and current position tenure.
- 3.1 The relationships between Hofstede's culture dimensions and work engagement.
- 3.2 The relationships between Hofstede's culture dimensions and workaholism.
- 4.0 An influence of work engagement on workaholism.

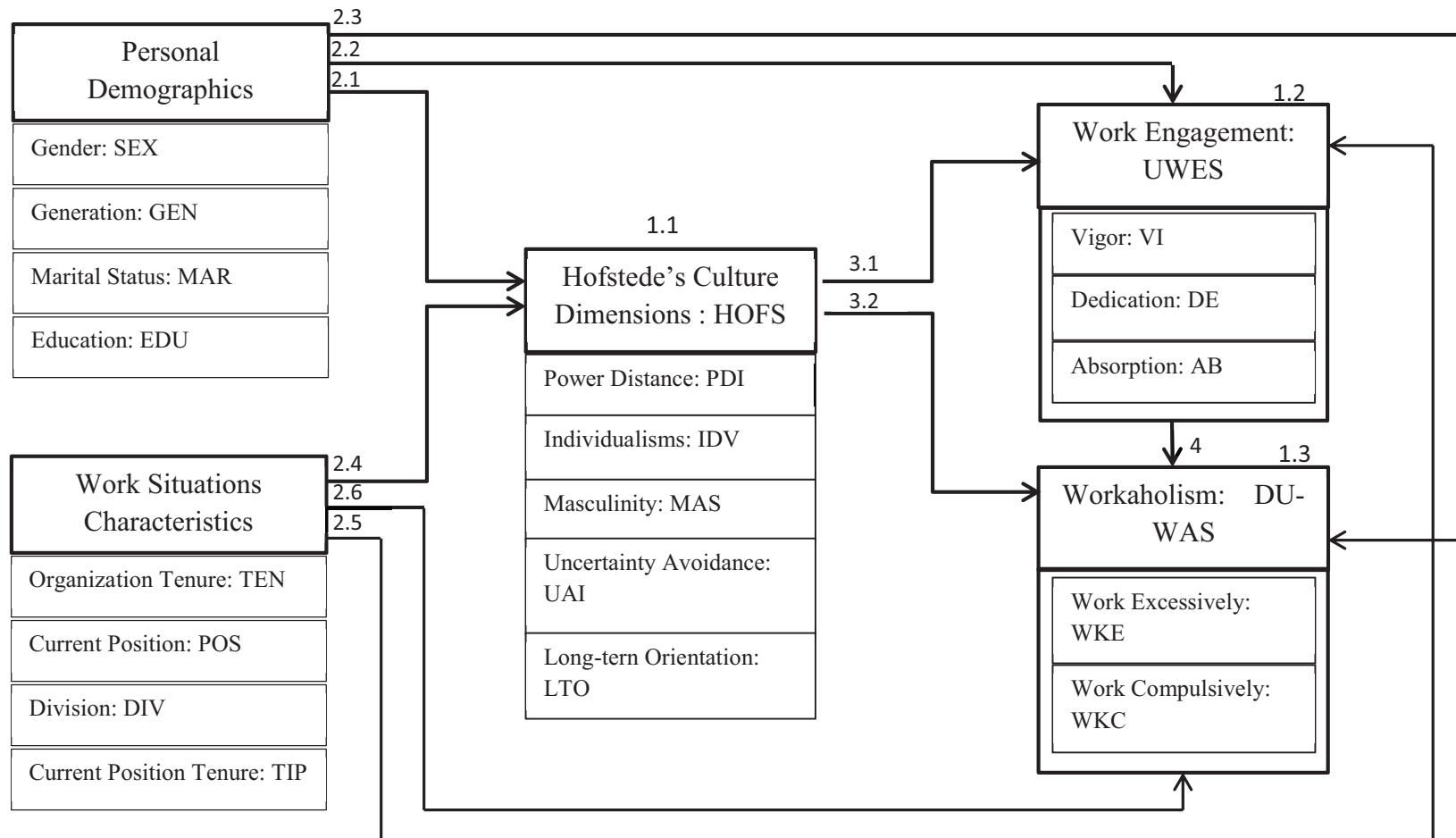

Figure 1.10 Research Model (Full vision)

1.9 The thesis structure

The thesis is consisted of five chapters: the chapter I is about introduction, overview, the research's question, and the objective of the research, the research hypotheses, the research model, and the scope of research, and the sample background presentation. Chapter II is included literature review; work engagement, workaholism, and Hofstede's culture dimensions. This chapter explains the importance of work engagement, the drivers of work engagement, the relationship between work engagement and workaholism, Hofstede's culture dimensions and its influences (power distance, individualism versus collectivism, masculinity versus femininity, uncertainty avoidance, and long-term orientation). Chapter III describes the methodology. Chapter IV presents a finding of the research, (1) Hofstede's culture survey, work engagement survey, workaholism survey, (2) the variable's relationships: the relationship between the personal demographic and the work situation characteristics with culture dimensions, work engagement, and workaholism and the relationship between work engagement and workaholism. Finally, Chapter V is a suggestion and a conclusion; this chapter explains why the scores of Hofstede's culture dimensions are different than previous studies, the types of work engagement, and the type of workaholism. Chapter V also presents the relationship between work engagement and workaholism, and explains power distance, individualism versus collectivism, masculinity, uncertainty avoidance, and long-term orientation, drive work engagement and workaholism.

CHAPTER TWO

REVIEW OF THE LITERATURE

This study emphasizes on the importance of culture which has been impacted on individual behaviors and major business activities from capital structure to group performance (Hofstede, 2001 and Leung et al, 2005) although culture has many complex dimensions. Thus, this study applies five cultural dimensions of Hofstede's cultural model (1991, 1997) (power distance, masculinity versus femininity, individualism versus collectivism, uncertainty avoidance, and long-term orientation) to investigate their relationship between work engagement and workaholism.

Work engagement is important for organization development as it can improve the well-being of employees, optimize staffs' performances in order to reduce staff turnover, and increase organizational performance and success (Taris et al., 2003; Harter et al., 2002; Salanova et al. 2003). Workaholism is also beneficial to organization's success because workaholism is hardworking beyond the organizational expectation (Douglas and Morris, 2009). However, both work engagement and workaholism involve work immersion and are likely to involve attempting to achieve appetitive effects through an entrenchment in work activity (Andreassen et al, 2011). Furthermore, there have been negative studies about workaholism fields (Pines, 1993) where over-engaged employees may become workaholism (Halbesleben et al., 2009). Therefore, this study focuses on work engagement and workaholism as work behavior which are influenced by culture.

This chapter provides a review of literature on the three main constructs: Hofstede's culture framework and work engagement, Hofstede's culture framework and workaholism, and work engagement and workaholism, in order to explain how culture drives work engagement and workaholism and to create work engagement model.

2.1 Work engagement

The term engagements: work engagement, employee engagement, and organizational engagement, have gained popularity over the past twenty years. Harter et al.(2002) and Salanova et al. (2003) stated that organizations which develop culture of work engagement as their priority will maximize organizational performance and success.

Khan (1990), who firstly studied about engagement, referred personal engagement to one's psychological presence focusing on role activities which may be an important ingredient for effective role performance composed of two critical components: attention and absorption in a role. Employees can be engaged in a physical, emotional and cognitive level which are significantly affected by three psychological domains: meaningfulness, safety and availability.

Schaufeli and Bakker (2004) have developed MBI model to measure burnout components: exhaustion, cynicism and (lack of) professional efficacy. However, measuring burnout and engagement should be done independently with different instruments.

Subsequently, Schaufeli and colleagues (2002) continued the study of engagement which was more persistently, pervasively and affectively cognitive state on ordinary object, event, individual, or behavior. Seventeen item Utrecht Work Engagement Scale (UWES) was used to measure engagement in the field of psychological presence and found that engagement had provided a positive, fulfilling, work-related state of mind characterized by vigor, dedication, and absorption.

Interestingly, studies done by Schaufeli and colleagues (2002) has been repeated for decades in many countries and has been translated into twenty languages, such as English, French, Germany, and Japan by Shimazu et al. (2008). Nonetheless, this study has never been existed in Thai. Therefore, this study applies work engagement modal by Schaufeli to study work engagement in organizations in Thailand in order to continue his study and to be a pilot study for further study.

2.1.1 The concept of work engagement

This study focuses on engagement at work level or job engagement. Work engagement has been studied by a number of academics and businesses for decades. There are four approaches of work engagement by academic concept as followed:

Firstly, Kahn (1990) described job engagement as a multidimensional investment of individual three states: *physically, cognitively, and emotionally engagements* in work performance. These three states were affected significantly by three psychological domains: *meaningfulness, safety, and availability*.

Secondly, Maslach and team (2011) asserted that employee engagement was the positive antithesis to burnout and explored the engagement measurement which was operationalized as the reverse of the score on the Maslach Burnout Inventory (MBI-GS). Afterward, the MBI-GS was tested by Schaufeli, Salanova, Gonzalez-Roma, and Bakker (2002) who replaced “the state of engagement” with “work engagement” which was a persistent, positive and affective motivational state of fulfillment characterized by vigor, dedication, and absorption.

Next, Harter and colleagues (2002) created satisfaction-engagement approach. They defined employee engagement as an individual’s involvement and satisfaction with as well as enthusiasm in work, and utilized the Gallup Work Audit: Q12 (GWD) to assess employee engagement.

Finally, Saks (2006) was the first academic researcher studied multidimensional approach and suggested separate states of engagements: job and organization engagements. He also defined employee engagement as a unique construct consisting of cognitive, emotional, and behavioral components associated with individual role performance.

The differences of work engagement characteristics among four approaches are presented in the table 2.1 presents. Most of them focus on individual behavior related to work with the exception of a multinational approach which focused on individual behavior related to work and organization. However, the construct of engagement in each approach are different. The studies by Kahn (1990), and Schaufeli and colleagues (2003) shared some similarities: vigor involved with physical, dedication involved with cognitive, and absorption involved with emotional.

Approach	need-satisfying	burnout and antithesis	satisfaction-engagement	Multidimensional
Researcher	Kahn, 1990	Schaufeli et al.,2002	Harter et al., 2002	Saks, 2006
Focus on	Individual	Individual	Individual	Individual
Construct	Physical Cognitive Emotional	Vigor Dedication Absorption	Involvement Satisfaction Enthusiasm	Cognitive Emotional Behavioral
Related to	Work	Work	Work	Work and Organizational

Table 2.1 Engagement's approaches comparing

These four approaches, which focused on work engagement, have named employee engagement in different definitions: work engagement, and employee engagement, with the exception of Saks (2006) who focused both work and organization engagement.

In terms of business, Blessing White (2011) engagement model focussed on individuals' contribution to the company's success and personal satisfaction in their role. It was found that full engagement occurred in the alignment of maximum satisfaction and contribution. Right Management (2011) presented employee engagement model by two construct models, describing both job and organization, consisted of commitment, advocacy, satisfaction, and pride.

The difference between academic and business is a scope of studies. In terms of academic, there was a study related engagement with work while business sectors have emphasized the study of engagement in work and organization.

This present study has applied work engagement concepts by Schaufeli et al. (2002) who have focused obviously on work engagement and defined work engagement as a positive fulfilling work related state of mind characterized by vigor, dedication, and absorption.

Vigor (VI) is characterized by high energy level and mental resilience together with the willingness to invest effort and persistence even being in difficult situation while working.

Dedication (DI) refers to be strongly involved in one's work and to experience a sense of significance, enthusiasm, inspiration, pride, and challenge.

Absorption (AB) is characterized by being fully concentrated and happily engrossed in one's work. By the time being, it is difficult for him or her to detach him/herself from work. The characteristics of work engagement and its components are summarized in figure 2.1

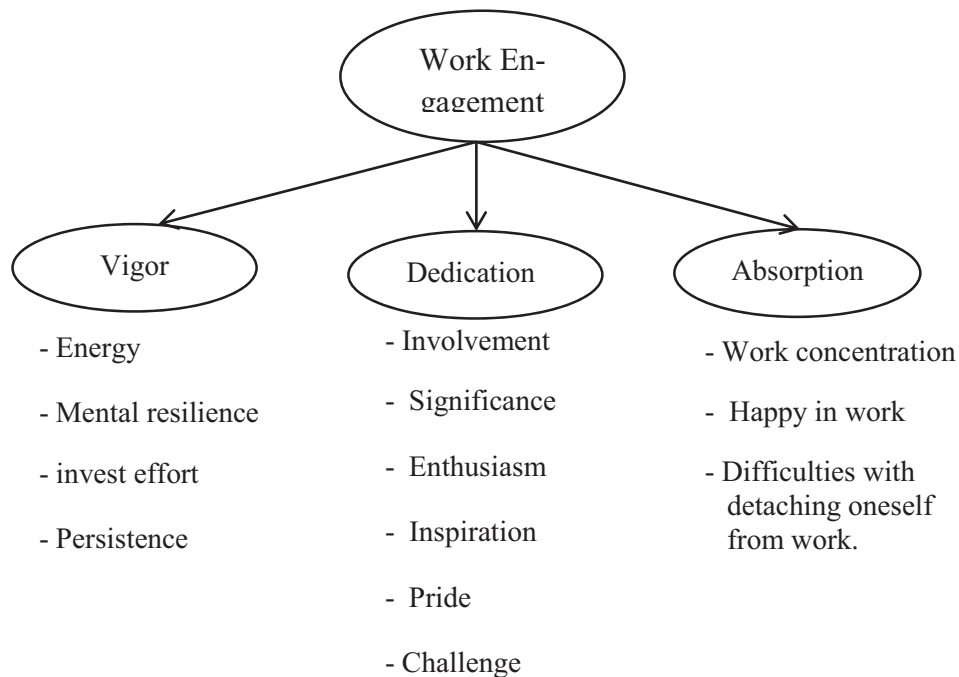

Figure 2.1 work engagement components

2.1.2 Engagement model, levels, and distribution

The reasons that employees become engaged can be described by the model of engagement by Fleck and Inceoglu (2010), figure 2.3. The employees, starting to work at organization with individual differences, are influenced by engagement drivers. They, then, put their great effort and advocacy to work over expectation. The meaningful outcome will meet the organization's and employees' goals. Thus, Working engaged improvement and culture creation in an organization should be based on individual, job, and organizational factors.

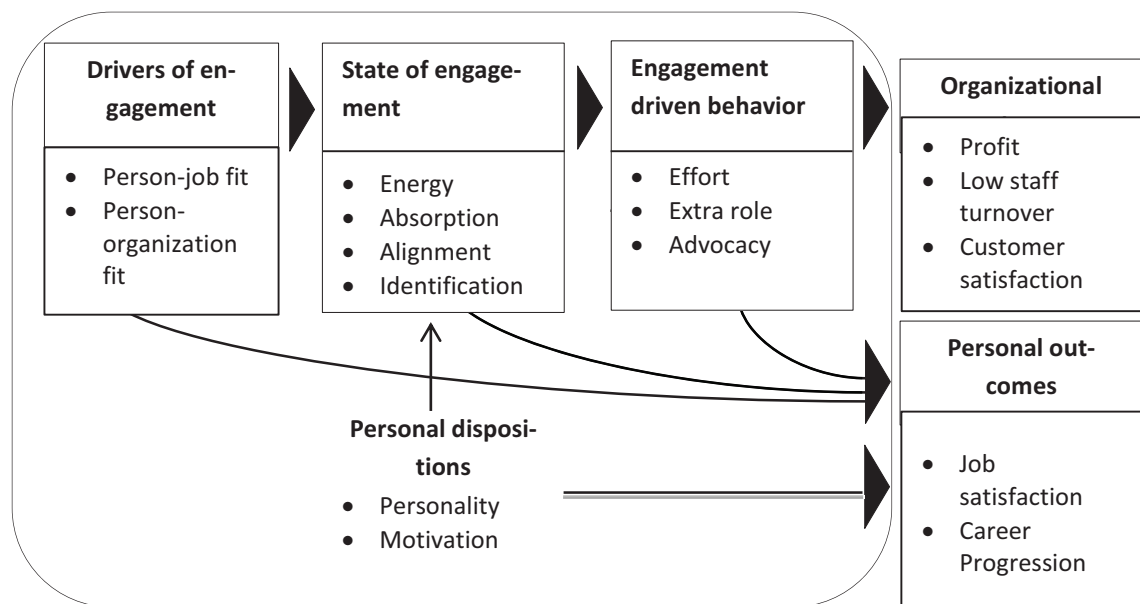

Figure 2.2 Engagement Model
 Source: Fleck, S. and Inceoglu, I, 2010

According to an engagement model (figure 2.1), besides personal factor, job and organization are other factors that can drive employees become engaged.

Therefore, this study expands the engagement model by focusing on organizational factor and examining culture's model by Hofstede (1991, 1997) as the drivers of engagement.

The engagement levels (organization, employee, team, work, job and task) can be varied by levels of management and what they are engaged with (figure 2.2). Hence, it should be clear that which engagement is focused.

In this study, engagement depends on what the employees engage. The employee engagement refers to overall of engagement in organizations. Organizational engagement refers to engagement within organization. Team engagement refers to engage within team. Work engagement refers to engage with work. Task engagement refers to engage with task.

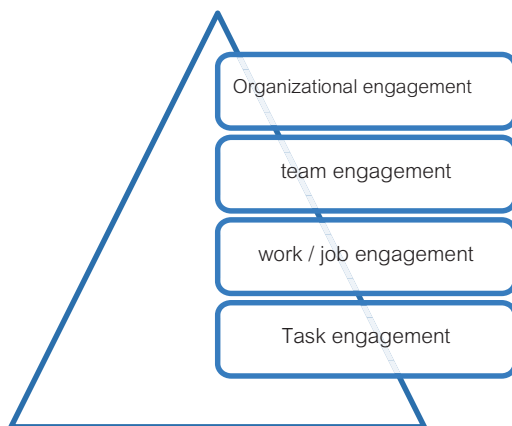

Figure 2.3 Engagement level of organization

However, all of levels of engagements: organizational, team, work, and task, are important in organizational development. This study focuses on work level because it is the first relationship between organization and employees. The organization can

gain benefit from employees through their working. If they are highly engaged in work, it is inevitable that there will be high productivity to the organization.

Therefore, this study focuses on engagement at working level including cultural factors and the relationship between work engagement and workaholism.

Several researchers have categorized levels of employee engagement as followed. Gallop (1993) differentiated employees into three groups: engaged, non-engaged and actively disengaged. Federman (2009) presented typical of employee engagement in five levels, highly disengaged, learning toward disengaged, skeptic, learning toward engaged and highly engaged. Tower Watson(2012) displayed four segments of sustainable engagement; highly engaged, unsupported, detached, and disengaged. Dale Carnegie Training (2012) promoted employees to a higher level of engagement. Figure 2.4 is presented as four types of engagement distribution.

It could be concluded that engagement distributions are generally presented in four types defining according to levels of engagement and kind of behavioral engagements.



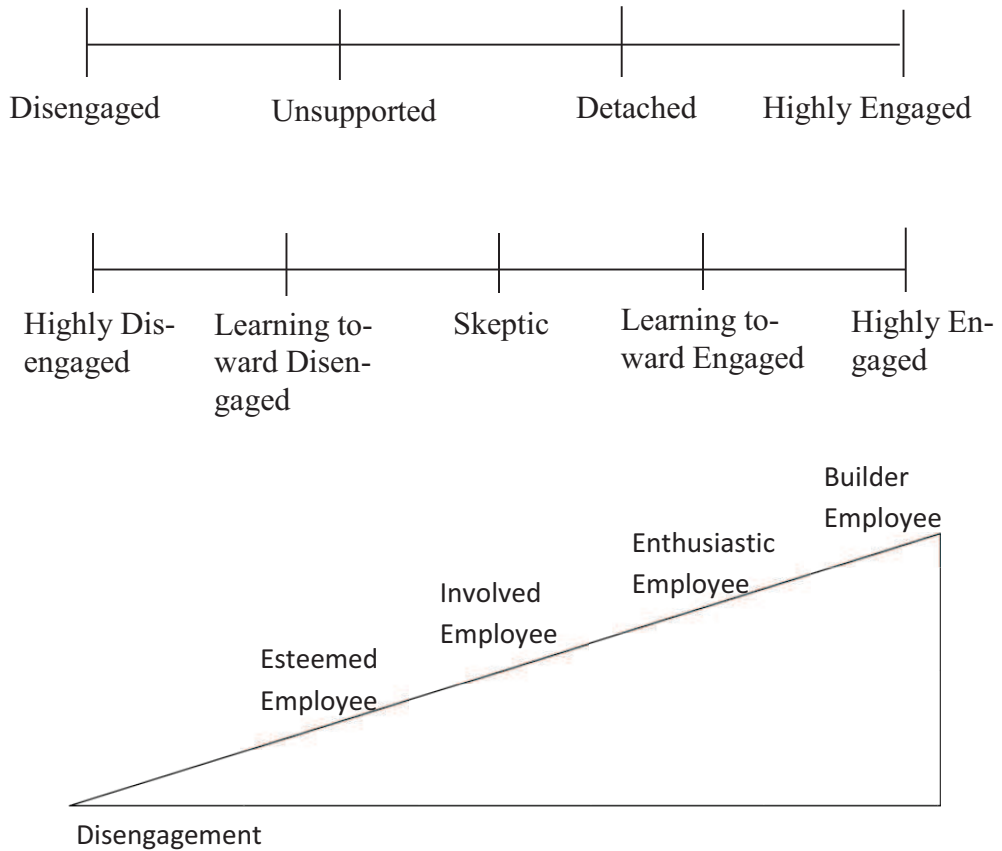

Figure 2.4 Engagement distributions.

The engagement distribution by Aon Hewitt (2012) reported that engagement in Latin America is higher than North America, Asia, and Europe respectively. In Asia, the report showed that fifty-five percent of participants distributed engagement; twenty-five percent of them distributed near-engagement; fourteen percent of them did not show engagement; and three percent of them showed disengagement

Shimazu and colleagues (2004) report that French work engagement is higher than in Finland, South Africa, Germany, Belgium, Italy, Australia, Czech republic, Norway, Sweden, Netherlands, Canada, China, Greece, Spain, and Japan respectively.

Furthermore, Taipale and colleagues (2010) studied work engagement in eight European countries. They found that work engagement in the United Kingdom and Germany were ranked as the lowest while work engagement in the Netherlands and Portugal were the highest. Work engagement was placed on different levels in retail, hospital, telecom, and banking sectors.

In retail companies, work engagement in Portugal, the Netherlands, and Hungary scored higher than in Sweden, Germany, Finland, Bulgaria, and the United Kingdom. In telecom companies, work engagement level in Portugal was higher than in Sweden, the Netherlands, Hungary, Bulgaria, Germany, Finland, and The United Kingdom. In hospital companies, work engagement level in the Netherlands was higher than in Bulgaria, Sweden, Finland, Hungary, The United Kingdom, and Germany. In banking companies, work engagement level in the Netherlands was higher than Finland, Germany, Sweden, Portugal, Bulgaria, Hungary, and The United Kingdom.

The differences of engagement levels across industries were also presented in the study of Towers Perrin's (2003). The engagement of employees of non-profit organizations was higher than engagement in the sectors of insurance, financial and banking, pharmaceutical, high-tech, hospital and heavy manufacturing, but such engagement was lower than others' moderate engagement. In contrast, disengagement level of employees from the heavy manufacturing sector was higher than the employees in insurance, financial and banking, hospital, high-tech, pharmaceutical, and nonprofit organizations.

To summarize, the levels of engagement are varied in the business sectors. Meanwhile, the levels of engagement in the same business were different among countries. Hence, factors, that gave impact to engagement, may depend on countries and businesses according to different environments: social, economic, and technology.

This study focuses on three business units in Thailand: electric and electronic, automobile, and hotel, compare work engagement in three sectors among countries. As well as this, this study will include the reasons of different work engagement in business units and countries. It is believed that the finding will be beneficial to working engaged development in the organization and to better understand work engagement differences among countries.

Moreover, this study continues work engagement study by studying work engaged types among employees so as to group employees in and develop work engagement with the right strategies. Since this study has related Schaufeli and colleagues' work engagement's concept (2002), engagement distributions will be presented according to types of work engagement which is the combination of three components: vigor, dedication, and absorption. Hard working engaged individuals (vigor) were involved (dedicated) and felt happily engrossed (absorbed) in their work (Bakker, Schaufeli, Leiter, and Taris, 2008).

Through three work engagement characters (vigor, dedication, and absorption), this present study classified employees in eight different combinations of three components of work engagement as can be seen in table 2.2,

Level of Work engagement			Types of work engagement
VI	DE	AB	
High	High	High	Engaged worker
High	High	Low	Non-absorption worker
High	Low	High	Non-dedication worker
High	Low	Low	Energy worker
Low	High	High	Non-vigor worker
Low	High	Low	Enthusiasm worker
Low	Low	High	Enjoyment worker
Low	Low	Low	Disengaged worker

Table 2.2 Work Engagement Types

Similarly, the distribution of engagement and work engaged types are focused as one out of the fifth of the objectives of this study in order to understand an organizational situation, kinds of employees and types of engagement.

The advantages of this table show not only levels of engagement, but also employees' behavior because the distribution combines both quantitative and quality information. Consequently, this will help organizations better understand and analyze their employees whom will be enhanced by working engaged program to meet the organizations' requirement.

2.1.3 Engagement level and individual condition

Not only are work engagement levels different among countries and business units, but also among the levels of individuals, personal demographics and working characteristics. Engagement levels can vary according to different biographical and personality. Robertson-Smith and Markwick (2009) suggest that engagement levels can vary according to different biographical, personality, seniority, occupation and length of service in an organization, but not by sector

Aon Hewitt (2011) presented the global different engagement levels among generations, job level, job functions, and genders in Asia, Europe, Latin America, and North America. For examples, executive manager distributed higher engagement than middle manager, front line manager, and professional manager.

Engagement levels can be arranged by job functions. HR department distributed higher engagement than customer service, RandD, marketing, production, IT, operation, and administration (Aon Hewitt, 2011). In contrast, support function and IT in Asia presented lower engagement than the others.

In terms of position or level in organizations, job position demonstrated significant association with work engagement. Kim et al. (2009) established a project survey in Subway stores in the Northwestern United. It was found that there was a high level engagement in the organization. Managers, manager assistants, and supervisors displayed significant higher rate of vigor, dedication, and absorption than non-supervisor. As well as this, Burke and Koyuncu et al (2009) asserted that hotel managers indicated higher levels of vigor, dedication and absorption than the others.

As far as engagement by gender was concerned, it was found that male's engagement level was lower than female's in Latin America and North America, but, in Asia, male's engagement level was higher than female's (Aon Hewitt, 2011).

There was no difference between male and female engagement levels in Europe. Blessing White (2011) reported that gender differentiation took place in some regions. For instances, in India and China, man's engagement level was substantially higher than woman's. However, there was no difference in gender engagement in North America and Europe.

Gender differences on engagement were also found in two studies: Firsi, Johnson (2004) and Taipale et al (2010). Firsi, Johnson (2004) found that women tended to feel more job fulfillment and more engaged than men did, but there was no substantial difference of engagement levels between Thai men and women.

Taipale et al (2010) studied work engagement in eight European countries: Bulgaria, Finland, Germany, Hungary, The Netherlands, Portugal, Sweden and The United Kingdom. They found that women seemed to be more engaged than men did. On the contrary, Bakker and Xanthopoulou (2009), studied in the Netherlands, did not find any relationship between gender and work. They also applied UWES-9 to a cross-national study (n = 14,521): Australia, Belgium, Canada, Finland, France, Germany, the Netherlands, Norway, South Africa, and Spain and found that there was indifferent in the relationship between work engagement and gender (Schaufeli, Bakker and Salanova 2006).

In terms of generation, baby boomed generations occupied higher engagement than generation-X and Millennial in Asia, Europe, Latin America, and North America (Aon Hewitt, 2011).

Comparably, aged employees are more engaged than younger colleagues in Finland, Hungary and the UK (Taipale et al , 2010). Bakker and Xanthopoulou (2009) also supported this claim by studying 80 employees in different organizations in the Netherlands and found that participant's' age are positively related to their work engagement.

Park and Gursoy (2012) found that levels of work engagement in American hotel employees are varied based on the generation membership of employees and asserted that older employees tend to be more engaged, or dedicated to, engrossed in, and even vigorous at work than employees of younger generations particularly Millennial or Gen-Y employees. This was also supported by BlessingWhite (2011) that the elders were more engaged and employee engagement distributions display differently among generations cohorts. In a study of the relationship between age of female academics and level of work engagement by Bezuidenhout and Cilliers(2011), it was found that the older female academics maintained higher scores on vigor and absorption than the others.

However, a cross-national study by Schaufeli, Bakker and Salanova (2006) found that engagement was insignificantly related with age. A study in China by Pitt-Catsouphes et al. (2011) found that work engagement in China was not affected by age. This is supported by the study of work engagement among hotel managers in China (Burke and Koyuncu et al., 2009) indicated that demographics, age, marital status,

number of children, and education level did not have any impacts on level of work engagement.

As far as marital status is concerned, Gallop found that married employees tended to have a higher level of engagement than those who were single whereas the Taipale et al (2010) showed that marital status did not have any effect on work engagement.

Nevertheless, Bakker and Shimazu et al. (2011) surveyed 462 Japanese couples working in different occupational sectors and found that engagement crossover was strongest when both men and women were high in perspective taking*.

In terms of organizational tenure, employees with longer tenure had lower feeling of vigor in the workplace as presented in a study of hotel employees' work engagement in Abuja, Nigeria by Karatepe and Olugbade (2009), and in China (Burke and Koyuncu et al., 2009). Those results showed that hotel managers, who had longer hotel tenure, were indicated as lower work engagement of all.

To conclude, there are no clear cut to assume that which factors: personal demographic and work situation experience, has the most impact in work engagement. Therefore, there will be room for this study to find out engagement levels that are affected by personal demographic, gender, generations, educational levels, marital status and work situation characteristics (position, division, organization tenure, and tenure). These results will be beneficial to better understand the differences of demographics and the influence of work situation of work engagement.

2.1.4 The importance of work engagement

Work engagement has played an important role in various organizations around the world because it provides positive experience that results in positive outcomes from building employee engagement (Schaufeli and colleagues,2002), and Harter et al.(2002) also found that employee engagement had a positive influence on organizational performance indicators.

In the business practice, positive consequences on employee engagement are also associated with outcomes which are directly relevant to customer satisfaction, productivity, profit, employee turnover and safety at work (Harter et al., 2002).

The Forbes reported that the engagement-profit chain (figure 2.4), show a correlation, between employee engagement and service, sales, quality, retention, profit, and total shareholder returns.



Figure 2.5 the engagement-profit chain

Source: www.forbes.com

Aon Hewitt (2012) indicated that employee engagement has a positive influence on customer satisfaction, financial performance, and shareholder return. Right management (2013) presented that higher employee engagement levels lead to higher customer satisfaction, higher productivity, and higher return on assets.

The Gallup Organization (2004) also found critical links between employee engagement, customer loyalty, business growth and profitability.

Engagement also involved employee turnover rate. Towers Perrin (2003) showed the relationship between engagement and employees' intention to leave the company. He found that Sixty-six percent of employees, who were highly engaged, do not have plans to leave while fifty-two percent of disengaged employees were looking for another job (but would consider the right opportunity). Six percent of disengaged employees, and three percent of moderately engaged have made plans to leave their current job while only one percent of engaged employees had made plans to leave their current job. Engaged employees perform better than disengaged because of positive emotion, good health, ability to mobilize resources, and transfer of engagement (Bakker and Demerouti, 2008). Other than that, Robinson and colleagues (2004) summarized the eight reasons which engaged employees behave as followed;

1. They are positive about the job and the organization.
2. They believe in the organization.
3. They work actively to make thing better.
4. They treat others with respect, and help colleagues to perform more effectively
5. They can be relied upon, and go beyond the requirements of the job.
6. They can see the big picture, even at personal cost.
7. They identify with the organization.
8. They keep up to date with development in their fields

In academic researches, work engagement was a mediator to the organization's success. Sonnentag (2003) studied and explored that work engagement was a mediator in the relationship between recovery and proactive behavior traits: personal initiative and pursuit of learning, in the employees of six public service organizations in Germany. Moreover, engagement has a mediate relationship among value congruence, organizational support perceiving, core self-evaluations and two job performance dimensions: task dimension and organizational citizenship behavior (Rich et al., 2010). Contrary to Alarcon and Edwards (2011), who studied 227 part-time employees in The United States, found that dedication and absorption were significant predictors of job satisfaction and had negative related to turnover intention,

Work engagement is a positive experience and related to positive work attitudes, individual health, extra-role behaviors and performance (Schaufeli et al., 2002 and Schaufeli and Salanova, 2007). It is found that work engagement fully mediated the impact of job resources on proactive behaviors (Salanova and Schaufel, 2008). Moreover, Bakker and Leiter (2010) found that productivity, sales, customer satisfaction and employee retention increased when employee engagement was increased.

Work engagement is not only related to organizational success, but also related to employee well-beings: physical, social and psychological health, as engaged employees had more activation and pleasure in work. Work engagement is also related to social health or workplace well-being (work relationships, balance in work and personal life, equity, fairness, respect, social connectedness) since work engagement is positively related to job resources supporting from supervisors (Schaufeli, 2011).

Furthermore, the connection between engagement and well-being are engaged in the absence of well-being can lead to a burn-out workforce, while engagement with well-being enables sustained employee performance, and low engagement and low well-being lead a chronic disengaged workforce, including to low engagement with well-being lead to a complacent disengagement as well (Fairhurst and O'connor, 2010).

Bakker and Demerouti (2007) found work engagement can be defined as states including vigor, dedication, and absorption. Job and personal resources are the main predictors of engagement. These resources gain their salience in the context of high job demands. Engaged workers are more creative and productive than the others.

It can be concluded that engaged employees have positive belief towards job and organization, perform more effectively and make thing better. These will retain those employees to work with the organization as they can be relied upon, go beyond job requirements, and willing to develop themselves. Thus, engaged employees are healthy and will be useful to an organization at work level (task performance) and at organization level (organization citizenship behavior). Furthermore, work engagement has positive relationship with employee well-being.

2.1.5 The drivers work engagement

Develop work engagement is vital for organizations as this will help them better understand factors (demographic and work situation) that affect engagement levels.

Many researchers agreed that engagement can be formed from both personal and environmental sources (Macey and Schneider, 2008). Fleck and Inceoglu (2010) indicated personal -job-fit and personal–organization-fit can drive engagement in the organizations. By this, it means employees will be engaged if their work is suitable for them and they feel satisfied with organization environments: policy, leadership, managing styles, physical environment, and culture. Likewise, Bowditch and Buono (2001) stated that engagement has been shaped by internal factors: individuals, personality, demographic attributes, leadership, co-worker, work environment, organization system and climate and external factors

Personalities have been found as a driver of engagement in the study of Inceoglu and Warr (2012), who found that emotional stability and conscientiousness can predict job engagement. The study by Xanthopoulou and colleagues (2009) also found that the personality types combined optimism, self-efficacy and organization-based self-esteem are related to work engagement. The study of Macey and Schneider (2008) described traits (initiative seeking, positive affectivity, and conscientiousness traits) are represented as engagement trait.

Additionally, Kim and colleagues (2009) found that some of the Big Five traits were significant independent contributions to engagement in certain environmental features (job position, skill variety and customer aggression). Furthermore, the job demand together with job resources and personal resources can be the drivers leading to work engagement (figure 2.6).

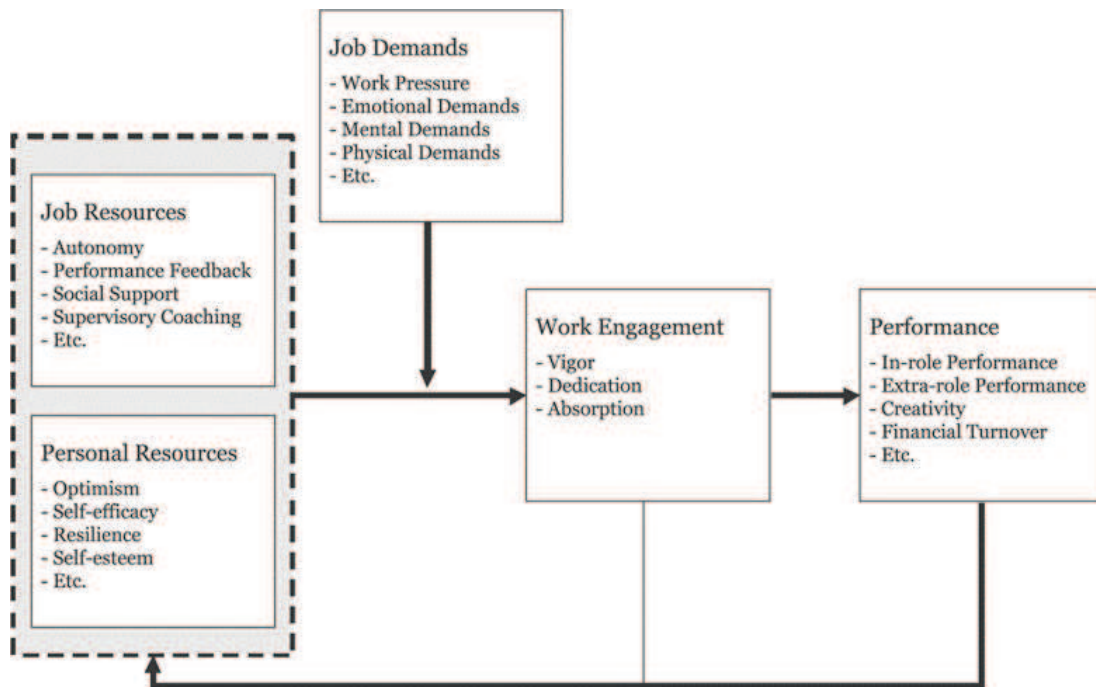

Figure 2.6 Job-Demand resource model

Source: Bakker and Demerouti (2007)

The JD-R model explains that organizations can get better employees' performance through work engagement (vigor, dedication, and absorption) by increasing job resource. As well as this, physical, psychological, social, or organizational aspects of the job are key-functions to help employees to achieve working goals. Reducing job demands, physiological and psychological cost can stimulate personal growth, learning, and development. If increasing of job demand decreases work engagement, the organization should reduce job demand so as to enhance work engagement. In addition, personal resources or personalities (optimism, self-esteem, self-efficacy, and resilience) related to work engagement.

Aon Hewitt's Engagement Model indicated nineteen work engagement drivers that have influenced on work engagement (Aon Hewitt, 2011).



Figure 2.7 Aon Hewitt's Engagement Model

Source: Aon Hewitt (2011)

The Thirst model, IES's diagnostic tool (IES, 2003), explains employee will engage when they have feeling of value and involvement with work or organization. The model show ten factors influenced on employee's value and involvement. Most of them involve organization factor and leadership.



Figure 2.8 IES Engagement Model

Source: IES (2003)

By the studying engagement drivers and engagement distribution, it can be concluded that engagement drivers can be categorized that personal resource, function and experience at work, leadership, organization system and practices, and external factors drive engagement.

Aon Hewitt (2012), studying employee engagement and economic condition, indicated that engagement patterns were closely aligned with GDP and unemployment trends. The report presented that employees felt thankful of having a job and were truly more committed. It can be implied that lower engagement can be affected by regressive economic conditions: higher rate of unemployment and lower rate of GDP. Nevertheless, there are few studies about culture or technology conditions effected engagement.

Therefore, to continue the study of work engagement drivers, this study will include culture condition related to work engagement and will apply Hofstede's culture studies: power distance, individualism versus collectivism, masculinity versus femininity, uncertainty avoidance, and long-term orientation.

The work engagement levels, which have been researched by Taipale et al. (2010) and Shimazu et al. (2004), have been compared among the Netherlands, the United Kingdom, China, and Japan. The result showed that the culture conditions are varied in comparable with engagement levels (table 2.3).

Countries	Work engagement	Power distance	Individualism	Masculinity	Uncertainty avoidance	Long-term orientation
The Netherland	High	38	80	14	53	67
France	High	68	71	43	86	63
China	Moderate	80	20	66	30	87
The United Kingdom	Low	35	89	66	35	51
Japan	Low	54	46	95	92	88

Table 2.3 Comparing between work engagement level and culture

Furthermore, Hofstede (1990, 1997) suggested that culture has an impact on individual behavior, general normand family, gender, education, customer behavior, the workplace, organization system, leadership, political, and religious. Moreover, Hofstede's culture model has been studied in nation and organization cultures. Thus, it is undeniable that culture has played an interesting role in work engagement.

This study emphasizes on the importance of culture, because of culture has been impacted on individual behavior (Hofstede. 2001), and culture impacts on major business activities from capital structure to group performance (Leung et al, 2005). However, culture is complex and has many dimensions, thus this study implies Hofstede's culture model (1991, 1997), and focus on five culture dimensions; power distance, masculinity versus femininity, individualism versus collectivism, uncertainty avoidance, and long-term orientation, to investigate their relationship with work engagement and workaholism.

Work engagement is important for organization development; to improve the well-being of employee (Taris et al., 2003), to lead to staff performance, to reduce staff turnover, and to support organizational performance and success (Harter et al., 2002; Salanova et al. 2003). Workaholism also gains the benefit to organize, because workaholism is work hard, and work beyond the organization's expectation (Douglas and Morris, 2009). However, both work engagement and workaholism involve immersion in work, and likely involve attempting to achieve appetitive effects through entrenchment in work activity (Andreassen et al, 2011). Furthermore, workaholism has been studied as the negative side of work engagement (Pines, 1993), wherewith employees who are over-engagement may also become to workaholism (Halbesleben et al., 2009). Therefore, this study focuses on work engagement and workaholism as work behavior which are influenced or driven by culture.

2.2 Workaholism

Since, developing of work engagement level has been interested in organizations' practices, they try to enhance work engagement in order to achieve organizational success, thus employees who have high of work engagement level are welcome. However, Halbesleben, Harvey, and Bolino (2009) suggested that there is also a possibility of becoming over-engaged among employees, it can distort the work-life balance when employees take work home, and an over-engagement may also lead to workaholism.

Workaholism has been studied as the negative side of engagement (Bakker and Leiter, 2010), their literatures reviews displayed that (1) the absorption component of work engagement seems likely candidate for evoking unhealthy behavior, (2) Employees, they may become so engaged on their work that they take work home, (3) work engagement are positively related to work overtime, and (4) may create workaholisms, employees who have an inner drive to work hard, even when they no longer like working overtime. Indeed, some scholars have noted that "In order to burn out, a person needs to have been on fire at one time" (Pines, Aronson, and Kafry, 1981, cite in Bakker and Leiter, 2010).

Therefore, this study is not only focus on work engagement and how culture drives work engagement, but also focus on how culture drives workaholism. Moreover this study focus on the relationship between workaholism and work engagement in order to confirm the previous study by Bakker and Leiter (2010) that high work engagement did not relate with workaholism. This study also focus on personal conditions and work experience influence on workaholism.

2.2.1 Workaholisms concept

Workaholism was firstly coined by Wayne E. Oates , the definition of workaholism is closely to work addiction, he defined workaholism, is the compulsion or the uncontrollable need to work incessantly because It is an addiction akin to alcoholics (Oates, 1971). While workaholism, by dictionary, is a person who work most of the time and find it difficult to stop working in order to do other thing, as one who has a compulsive and unrelenting need to work, such as they behave as workaholism behavior.

Workaholism refers to work behavior, refers to someone who works very long hours and finds it difficult not to be working (Cambridge, 2000), workaholism also refers a person who feels compelled to work excessively. Workaholism therefor refers to someone who work hard, to work long hours, and difficult to detach themselves from their work. While, workaholism is defined as “the compulsion or the uncontrollable need to work incessantly” (Oates, 1971), likely to someone who addicts in work and cannot take themselves out of work, like people who have been alcoholic, or shopaholics refers to someone who shops very frequently. Since the definitions of workaholism and workaholism are closed, therefor both workaholism and workaholism are used as the same meaning in this study

Spence and Robbins (1992) defined workaholism as a person who is highly work involvement, feel compelled or driven to work because of inner pressures, and low in enjoyment at work and suggested that workaholisms are more perfectionistic, have greater difficulty in delegating job responsibilities and rely on others and experience more job stress.

While, Mosier (1983, cited in Burke et al., 2004) defined workaholism involve to terms of worked, and workaholism is synonymous with working long hours (Shimazu et al.,2011).

Schaufel et al (2009), defines workaholism as the tendency to work excessively hard in a compulsive way, working excessively hard represents its behavioral component that indicates that workaholisms tend to allocate an exceptional amount of their time and energy to work and that they work more than organization's expectation.

Working compulsively represents the cognitive component of workaholism and indicates that workaholisms are obsessed with their work persistently and frequently think about work, even when not being at work. The compulsive element of workaholism are think about work more frequently which is compare to non-workaholisms, and focus their conversation on work even in social situations. Seemly that, working compulsively is difficult in distancing themselves from job.

Whereas, working excessively are work with a passion that is obvious to the outside observer, strive for tangible achievement in the work workplace and work slightly more hour than hour (McMillan and O'Driscoll, 2006).

In sum, this present study defines the workaholisms is the working's characteristics of employee which pulling of work excessively and work compulsively, and workaholism refers to employee whose has working characteristics as workaholisms.

The three characteristics of workaholism are (1) workaholisms spend a great deal of time on work activities when given the discretion to do, (2) workaholisms are reluctant to disengage from work and they persistently and they are frequently think

about work when they are not work, and (3) workaholisms work beyond what is reasonably expected from them to meet organizational or economic requirement (Scott et al, 1997).

2.2.2 Workaholisms model, level, and distribution

Taris, Beek, and Schaufeli (2010) presented the Heuristic model for the relations among background variables, perfectionism, workaholism and burnout. The model explains the workaholism has been influence by personal condition; age, gender, and personality, and organizational conditions; salary, job demands and control. For extending this model the others individual and work experience factors such as education level, marital status, organizational tenure, position should be study their influence too.

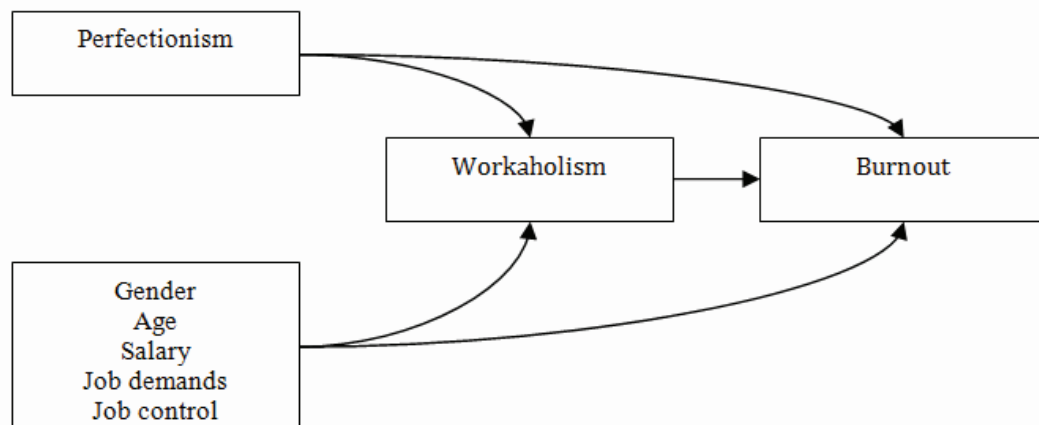

Figure 2.9 Workaholism model
Source : Taris, Beek, and Schaufeli (2010)

Shimazu et al. (2011) explain why people become to workaholism, these because of, (1) they possess certain personality traits. (2) their social or cultural experiences facilitate workaholism, and (3) their workaholism's behavior are reinforced repeatedly. They mention about culture promotes workaholism behavior, but there is rarely research support their mention, therefore this study inline on the influence of culture on workaholism.

Scott et al. (1997) distinguish three constituting features of workaholism. First, workaholisms put a lot of hours in their work when they get the opportunity to do so. Second, workaholisms are unwilling to disengage from work and they persistently think about work when they are not working. Third, workaholisms work beyond what is reasonably expected from them to meet organizational or economic requirements.

It seems that the pressures of the global economy and the concomitant increased competition prompt organizations to reward employees who are willing to work hard for a career (Blair-Loy and Jacobs, 2003; Schabracq and Cooper, 2000) and workaholism has been influence by organization culture (Scott et al., 1997)

Concerning workaholism results are likely both good and poor. In accordance with some studies, workaholisms are both satisfied, productive, and unassociated with salary increases (Machlowitz, 1980),(Burke, 2001). Nevertheless, other researchers have suggested that workaholisms' performance may be poor.

Moreover, workaholism refers to one of six dimensions of individual perceptions of organization cultures; alienation, workaholism, ambition, machismo, orderliness, and authoritarianism. Workaholism was stronger among employees who was younger, more educated, male and managerial. (Hofstade et al., 2010)

The Work Addiction Risk Test: WART was developed by Robinson (1989), to measure workaholism tendencies and addictive working patterns. Scoring for the WART is typically obtained by adding the responses for each the 25 items to calculate an overall score.

Workaholism Battery: WorkBAT was designed to measure three dimensions of workaholism, work involvement, drive, and enjoyment at work (Spence and Robbins, 1992).

Dutch Work Addiction Scales: DUWAS, consist of two core-components: Working Excessively (WE or WkE - 9 items) and Working Compulsively (WC or WkC – 7 items). The WE-scale originates from the Work Addiction Risk Test (WART – Robinson, 1998), the co-scale (WC) originates from the WorkBat (Spence and Robbins, 1992) and was originally called ‘Drive’.

The significantly positive correlations were found between workaholism, measured by WART, and work-life imbalance in a study of Aziz et al. (2010), and the result indicated that cultural origin, race, did not moderate the relationship between workaholism and work-life imbalance.

Although, there are many definitions of workaholism, and many workaholism’s measures, but the study of Bakker and Leiter (2010) implied Dutch Work Addiction Scales: DUWAS to study the relation of workaholism with work engagement. Thus, this study utilizes this measurement in order to confirm the study of Bakker and Leiter.

2.2.3 Workaholism types

Oates (1971) delineated five types of workaholisms as (1) Die-in-the-wool workaholisms or perfectionist employees who work beyond work standard, and over-committed in work, (2) Converted workaholisms refers to employees who have limit on their working hour, and avoiding additional work assignments, (3) Situational workaholisms work for job security achievement, (4) Pseudo workaholisms, who pretend to be serious workaholisms to advance into organizational power, not productivity, and (5) Escapists posing as workaholisms as a person who want to stay to work rather than stay home, they escape from unhappy home-life.

Naughton (1987) presented four workaholisms types are (1) job-involved workaholism refers to employees who are high work commitment, job satisfaction ,including perform well in work, but low obsession compulsion (2) compulsive workaholism as employees who are poor in performance, work conflict, but work commitment and obsession compulsion are high, (3) non-workaholisms refers to employees who are low work commitment and obsession –compulsion., and (4) compulsive non-workaholism as employees whose work commitment are low, but obsession –compulsion are high.

Fassel (1990) conducted four types of workaholisms are (1) compulsive worker which was claimed as a stereotype workaholism, (2) binge worker refers to person who wants to work in short-time, but does not want to work hard continuously , (3) closet worker as worker who works secretly, and (4) work anorexic refers to employee who avoid to work

Spence and Robbins (1992) divided workaholism types into six types, on the basis of either high or low scores on three scales; work involvement, feeling drive to work, and work enjoyment, and workaholism were categorized to two types as workaholism type are (1) work addict as who is high in work involvement and drivenness, but low work enjoyment, (2) enthusiastic workaholism refers to who are high in three scales. While non-workaholisms types are (1) work enthusiast as who is high work involvement and enjoyment, but low drivenness, (2) disenchanted worker refers to who is high only in drivenness, (3) relaxed worker as who is high only in work enjoyment, and (4) unengaged worker refers to employee who is low in three scales.

Scott and colleagues (1997) suggested three types of workaholism; (1) compulsive – dependent workaholisms refers to employees excessively work and longer hour, (2) perfectionist workaholisms as employees who are inflexible work behavior, more rigid, rely on rules, focus on productivities than social activities, and (3) achievement orientated workaholisms refers to employees who strive for achievement, success, and focus on distant goal.

Concluded that workaholism is not completely negative, these depend on types of workaholisms. Workaholism types took form four studies are re-categorized into two-side of workaholisms; negative and positive sides with organizations, are presented in table 2.4

Workaholism types		
Positive effects	Negative effects	Both positive and negative effects
- Die-in-the-wool workaholism	- Pseudo workaholism	- Converted workaholism - Situational workaholism - Escapist pose as workaholism
- Job- involvement	<ul style="list-style-type: none"> • Compulsive workaholism • Non-Compulsive workaholism • non-workaholism 	

Table 2.4 Workaholism's types

There have been numbers of researchers: Shimazu et al. (2011), Oates (1971), Naughton (1987), Spence and Robbins (1992), and Scott and colleagues (1997) who tried to categorize workaholism types which have been distinguished into four different combinations based upon workaholism components: excessive work and compulsive work as followed:

- (1) Relax workers, who obtained low score on both excessive work and compulsive work, are not hard workers, so they are willing to detach themselves from work at any time.
- (2) Hard workers, who obtained high score only in excessive work, will work beyond the organizational expectation and will be likely to detach themselves from work.
- (3) Compulsive workers, who obtained high score only in compulsive work, cannot detach themselves from work, but their working performance does not meet an exceptional level.
- (4) Workaholism workers, who obtained high score on both excessive work and compulsive work, are hard workers and will not be able to detach themselves from work.

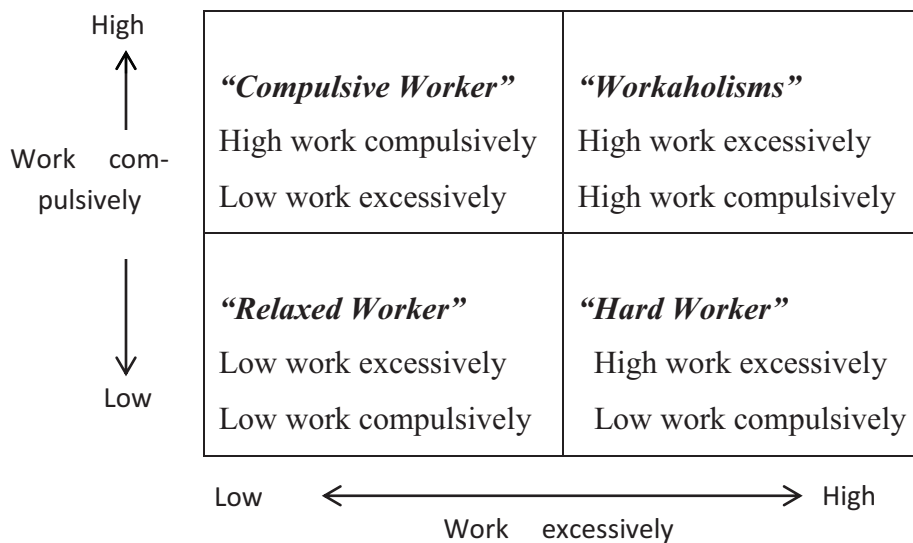

Figure 2.10 Types of workaholism

Therefore, categorizing the types of workaholism can see the differences of workaholism level among workers, can suggest how to decrease workaholism level by decreasing work excessively or work compulsively or both of them. However, workers who are relaxed worker or low in work excessively or work compulsively are claimed they are not workaholism, they might not reach the organizational performance because they are not hard worker which lack of work excessively. They also can detach themselves from work or they have low level in work compulsively. Thus developing of this group could be focus on work excessively and maintain their work compulsively for protecting them to become workaholism and keep going their performances.

The types of workaholism can help the organizations to protect employees become to workaholism, and decrease workaholism in the right personness. These can reduce cost of employee development, and increase employee well-being.

2.2.4 The importance of workaholism

The influence of workaholism has been reflected in both positive and negative ways to employees and organizations. Although workaholism is described as an attitude towards only work, excluding the number of working hours (Machlowitz, 1980), it has been found that workaholism is correlated with long working hours (Mosier, 1982). Those people often devote themselves beyond the demand of job, and engage themselves in busy work and continuously re-evaluate their performances. However, workaholism made an independent contribution to the satisfaction and well-being to organizational members (Burke, 2004).

Obviously, some researchers have studied and contributed the several advantages of workaholism. For example, Douglas and Morris (2006) have referred workaholism as people who are not only hard workers, but they also work far beyond their job descriptions. Machlowitz (1980) also added that workaholism is a state of satisfaction and productivity, but this is unassociated with the salary increase. Workaholism could positively impact on the workers' performance, such as, maintaining their long working hours (Ng et al., 2005). Nevertheless, Burke (2001) has found that workaholism was positively related to salary increase and self-reported career prospects.

On the other hand, there have been several drawbacks of workaholism. Haraguchi, Tsuda, and Ozeki (1991) found that workaholism was associated with high working stress, absenteeism, social withdrawal, low productivity, highly mistake committing, and numbers of accidents occurring on the job. Moreover, many researchers (Maslach, Schaufeli, and Leiter, 2001; Burke, 2004; Taris, et al., 2005; Bakker, Demerouti, and Burke, 2009; Chamberlin and Zhang, 2009) have found that

workaholism could cause negative impacts on work and family conflict, unhealthy effect, burnout, risk of strain related to some working issues, and decrease in well-being.

Workaholism impacts on family, workaholism behavior not only impact to workaholism, but impact to their families also. A study of Robinson (1998) show that workaholisms' wives and children report feeling lonely, unloved, isolated, emotionally and physically abandon.

Although, workaholism seemly refers to people who not just hard worker (Douglas and Morris, 2006) but they work far beyond their job description and unwilling to separate or disengaged themselves from job. Pragmatically, organizational should be satisfied with workaholisms' staffs, but the characteristics and behavior of workaholism or work addicted should be concerned.

For examples, workaholism would have a tendency to make projects larger and more complex than necessary; they may suffer from perfectionism, rigidity and inflexibility, and as a consequence would not delegate and potentially create conflicts and difficulties for their co-worker (Gorgievski and Bakker, 2008)

Halbesleben et al. (2009) talk about too-engaged that engagement might contribute to work interference; time based, strain based, and behavior based, with family, and the results of their study, by surveying 513 working adults in The United Stated, presented that state engagement is significantly associated with all three types of work interference with family, and organization citizenship behavior: OCB, and OCB is also significantly related to three types of work interference with family.

Likely with a coin, two sides of coin. One side is clearly, the benefits from engagement are usually discussed both academics and business. Another side, too

engaged or limit of engagement or the negative side of engagement, is not rarely to present.

2.2.5 Workaholism Studies

The famous example in workaholism is Japan, this country is claimed as a workaholism country. The word of mount as *karōshi* or death by overwork is refers to workaholism or a person who works compulsively, support by the world workaholism ranking (Ipsos Global and Reuters,2010). The survey found that Japanese workers are least likely to use their vacation days and were therefore dubbed the most workaholism, followed by Austrlia and South Africa.

Workaholism, in same as more work hours longer, are found in cross culture perspective (Snir and Harpaz, 2006) explains the Japanese worked more hours per week than all other nationalities, such as Belgium, Israel, The Netherlands, and the USA, respondents with a high level of work centrality worked more hours per week than did those with a low level of work centrality. Men worked more hours per week than women. Married women worked fewer hours per week than unmarried women, while married men worked more hours per week than unmarried men. Private-sector employees worked more hours per week than public-sector employee.

Workaholism among age, gender and marital status, Gender has been considered in workaholism studied, Schaufeli and colleagues (2008) presents that men score significantly higher than women on both workaholism scales; work excessively and work compulsively. while Aziz and Cunningham (2008) found that workaholism and gender are independent.

Furthermore, a study about gender related with working hours, Snir and Harpaz (2011), studied in Belgium, Israel, Japan, The Netherlands, and the USA, found that men work more hour per week than women, moreover married women work fewer hour per week than unmarried women, while married work more hour per week than unmarried men.

Workaholism among gender and marital status , gender has been consider in workaholism studied, as men might be more likely to work more hours and engaged in workaholism, while some studies found workaholism and gender are independent (Aziz and Cunningham, 2008)

A study about gender related with working hours, Snir and Harpaz (2011), studied in Belgium, Israel, Japan, The Netherlands, and the USA, found that men work more hour per week than women, moreover married women work fewer hour per week than unmarried women, while married work more hour per week than unmarried men.

Workaholism related to age was found in Schaufeli and colleagues (2008), they found a correlation of work compulsively with age is statistically significant, while work excessively was not related to age.

Furthermore, The related studies of workaholisms by samples country, as:

Dutch, a study of position related with workaholisms presented manager and high level professional, on average, the score higher than blue collar, pink collar, blue collar and executive and low level professional (Taris et al., 2012) . While, level of workaholism in industry sector higher than service sector (Taris et al., 2012).

Italy, workaholism relates to individual behavior, workplace aggressive, was found that increasing level of workaholisms were related with higher frequency of aggressive behavior and job related emotion fully mediated the association between workaholism and aggressive behavior (Balducci,2009). Thus, studying about workaholisms must be understood as individuals with psychological and behavioral problems,

The United States, the association between workaholism and marital status was studied in US, by Robinson and colleagues, both wife and husband's perspective, suggested that that women who identified their husbands as workaholisms also reported greater marital disaffection and less positive feeling toward their spouse (Robinson et al.,2001), and stated that workaholism is positively related to marital disaffection, and workaholism domains for predicting marital disaffection were over controlling behavior and impaired. communication (Robinson et al., 2009).

Japan, the association between workaholism and sleep problem hospital nurses in japan (Kubota et al, 2010). The research indicated that workaholism nurses who have the tendency to work excessively hard in a compulsive fashion have higher risks for impaired awakening, insufficient sleep, and workplace sleepiness. In addition to, a spillover-crossover perspective had been studied workaholism and well-being among Japanese dual-earner couples, Results showed that workaholisms workers were more likely to experience work-to-family-conflict and psychological distress compared to relaxed workers both gender, and husbands of workaholisms women workers were more likely to experience family-to-work conflict, whereas wives of workaholisms men workers were not (Shimazu et al., 2011).

Although, there are many studies about the relation between workaholism and individual factors and others factors. Some studies presented some factors have relation with workaholism, but others studied presented these factors do not have relation with workaholism. These could be say that workaholism level is different in individual, work experience factors or others factors, as same as the level of workaholism vary by countries. However, the workaholism study among individual, work experience and external factors are interesting because workaholism gains both advantage and disadvantage to organizations. Maintaining employees in appreciate level of workaholism is get more benefits.

Thus, this study focus on workaholism level for knowing the status of workaholism in the sample of this study. This study focus on the types of workaholism in order to know status of each participant, these will give benefits in individual development program. This study also focuses on individual factors and work experience factors such as: gender, generations, education, marital status, organizational tenure, tenure in current position, division, and position, relate with workaholism in order to extent and to confirm the previous study.

Furthermore, the relationship between workaholism and work engagement is inline in this study, because both workaholisms and engaged employees are hard worker. They are employees who are gain benefits to organization, but work engagement relates with employee's well-being while workaholism relates with employee's unwell- being.

2.3 Work engagement and workaholism

Workaholism and work engagement are both as predictors of employee performance as working hard, but apparently represent different psychological states as exemplified by their associations with different types of outcomes as work engagement is usually linked with positive outcomes, whereas workaholism is primarily associated with negative outcomes (Beek et al , 2011), however some study found both are positively relations with work outcomes as work satisfaction and work commitment (Schaufeli et al, 2008).

Both workaholisms and engaged employees are work so hard, especially workaholisms work harder than jobs than expected by people with whom or for whom they work, therefore they neglect their life outside their job which differences from engaged employees, do not neglect their social life outside work; rather they spend time on socializing, hobbies, and work as volunteers. Furthermore, workaholisms employees work so hard out of an inner compulsion need, or drive, and not because of external factor such as financial rewards, career perspectives, organizational culture, or poor marriage, unlike workaholisms, engaged employees are enjoy doing thing outside work, they do not feel guilty when not working (Schaufeli et al., 2008).

In ten context of work, the motivation concept which studied the relationship between workaholism and work engagement, Almost of all found that there were differences motivations drive workaholisms and work engagement.

A summary of the different between work engagement and workaholisms by characteristics, motivation, passion(Schaufeli and Salanova, 2011), (Gorgievski and Bakker,), and (Beek et al, 2001) see figure 2.11

Furthermore, high levels of workaholism were associated with high levels of interjected and identified regulations. This could be described that high levels of work engagement were mainly associated with high levels of intrinsic regulations (Beek et al , 2012).

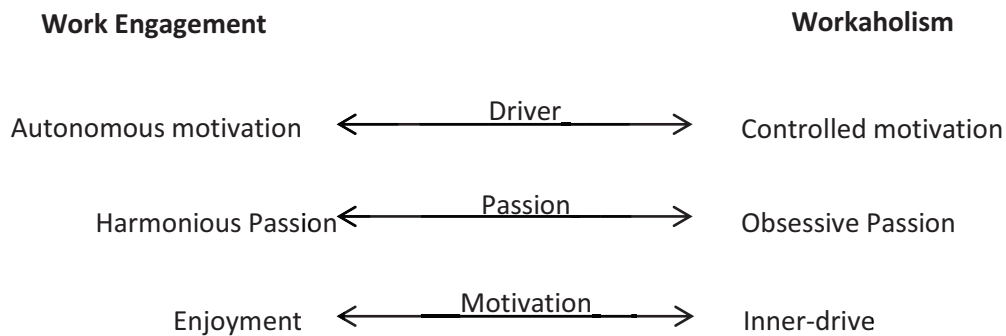

Figure 2.11 The differences between work engagement and workaholism

Wijhe et al (2011) studied the differences between workaholism and work engagement by applying the Mood As Input model (MAI) and found that workaholism has been reported as a negative effect whereas work-engaged employees could have more positive working experience than the workaholism.

Moreover, workaholism, correlated to negative mood, need an enough stop rule for them to stop working. On the other hand, there are no an evidence of applicable stop rule between work engagement and enjoyment.

The relationships of workaholism and work engagement with other variables explained that workaholism and work engagement were regarded as positive relationship with excessive work and working outcome. This might be because workaholism involved negative relationship with social interaction and caused health problems while work engagement has been declared as positive relationships with the

others. Workaholism was positively correlated with job demand, but there was no evidence of significant relationship with job resources. In contrast, work engagement was regarded as a positive relationship with job resources, but there was no significant relationship with job demand (Schaufeli et al, 2008).

The consequences different between workaholism and work engagement. Shimuzu et al (2012) studied the relationship to well-being and performance, that is workaholism was related to a increase in ill-health and a decrease in life satisfaction, in contrast work engagement was related to a decrease in ill-health and a increase in both life satisfaction and job performance. However, both workaholism and work engagement were weakly and positively related to each other.

Moreover, Shimuzu and Schaufeli et al., 2012 suggested that workaholism and work engagement are two different kind of concept that are oppositely related to well-being and performance, including to the results of study show that workaholism and work engagement were weakly and positively related to each other, as workaholism were related to an increase in ill-health and to a decrease in life satisfaction. Contrary to work engagement were related to decrease in ill-health and to decrease on life satisfaction.

Workaholism may not the negative side of work engagement (Schaufeli and Salanova, 2011). Beek et al. (2011) studied workaholism and work engaged employees to find out that can high level of work engagement compensate the adverse consequences of workaholism? The study implied four types of workers: (1) workaholism employees, employees who are workaholism and disengaged, (2) engaged employees, employee who are non-workaholisms and engaged, (3) engaged workaholism , employees who are both workaholisms and engaged, and (4) non-

workaholisms and disengaged employees, found that, engaged workaholisms spent most time on working including to work hard than others, but experience less burnout than workaholism employees. They suggested that high engagement may buffer the adverse consequences of workaholism. Furthermore, noted that engaged workaholism employees were driven by both controlled and autonomous motivation.

The negative side of engagement was exhibited by Bakker and Leiter (2010), their literatures reviews displayed that (1) the absorption component of work engagement seems likely candidate for evoking unhealthy behavior, (2) Employees, they may become so engaged on their work that they take work home, (3) work engagement are positively related to work overtime, and (4) may create workaholisms, employees who have an inner drive to work hard, even when they no longer like working overtime. Indeed, some scholars have noted that “In order to burn out, a person needs to have been on fire at one time” (Pines, Aronson, and Kafry, 1981, cite in Bakker and Leiter, 2010).

Overlapping between work engagement and workaholisms first is found in the study of Xanthopoulou et al. (2009). An items measure day-level work engagement, Absorption, “Today, I was completely immersed in my work”, is closely to work compulsively, a dimensions of workaholisms. Second, both workaholisms and work engagement are likely that they are work hard. While, the perfect engagement should be somewhat does not harmful to employees, while they put extra role in their work, pull their work direct to organizations’ success, they should be meet their goal and must not negatively to well-being and family.

Finally, to concern about the negative side of work engagement, too engaged or more engagement, is highlighted in this present study as a variable which to find a

relationship between work engagement and workaholisms. An overview of workaholism, workaholism's studies, and which areas are overlap between work engagement and workaholism, are presented in next sector, follow.

Work engagement is both difference and similar as workaholism, these are explained in figure 2.12 by Bakker (2011) , that engaged employees are characterized by high levels of activation and pleasure, while workaholism are characterized by high levels of activation and unpleased. Moreover, burnout employees are in opposite pole of work engagement, low levels of activation and unpleasent, while satisfaction employees are not both engaged worker and workaholism because they are low levels of activation, but they are happy to work in organizations.

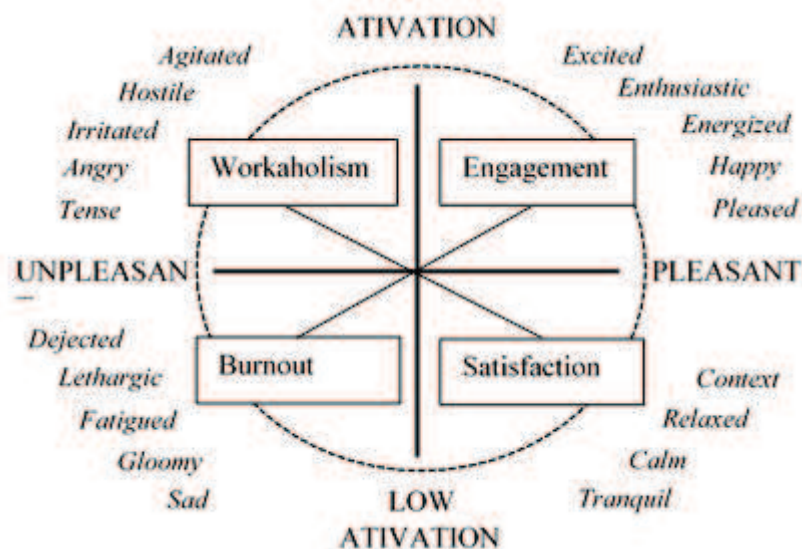

Figure 2.12 work-related subjective well-being (Bakker, 2011)

Therefore, engaged employees may become to workaholism when they lost their happiness in work, while workaholism may engage if they perceive happiness in work. From model of work-related subjective well-being, workaholism is related to work engagement in pleasant working, but in opposite pole.

Thus, organizational management should emphasize on employees well-being in order to prevent employees become more addiction in work or workaholism.

However, workaholism works in active way with excitement, enthusiasm, and plain of energy. If organization can fulfill employees who are workaholism with happiness in work, these benefits to both employees and organizations.

Comparing with work engagement studied by Schafeli (2009) , three components of work engagement; vigor, dedication, and absorption. The third component, absorption, is seemly involved with workaholism in opposite way, which is increasing of workaholism when employee's absorption is low.

Concluded that both of workaholism and engaged employees work hard with high energy and enthusiasm, while workaholism could be a negative side of work engagement when employees work more hard and lost their happiness in work. Specially, workaholism in managerial position, they could use their power to establish and enforce work schedules and performance criteria, these can make interpersonal conflict, resentment, and low employee motivation (Vodanovich and Piotrowski, 2006).

Does workaholism matter? Although workaholism studies indicated that workaholism is tendency to threats than benefits, especially it impact not only with employees themselves such as well-being and their collogues such as interpersonal relationship, but it also impact to their families such as family conflict too, because they not only carry their perception and compulsive work habits into their families, but also into workplace (Robison, 1999).

Notwithstanding the threats from workaholisms, but workaholism behavior still have been seen in organizations. These not only because of personalities can drive workaholism behavior (2009) , but factors influence on organizational management also.

Internal factors provide workaholisms are not fade off, such as organizations often reward workaholism behaviors; employees who work long hour are better to complete with peers for recognitions, rewards, and career development opportunities (Burke, 2001), seeking out employees who possess workaholisms tendencies (Vodanovich and Piotrowski, 2006),including a long hour work culture has been developed in organizations as well.

External factors such as communication technology in organization such as mobile phone, e-mail, including face time, these make employees cannot detach themselves from work. While organizational downsizing policy has created more work for a few staff, these can conduct workaholism too (Burke, 2001).

Concluded that, (1) work value always influences on organizational management, if they reward on work hard value or seven-eleven employees, these may create workaholism culture in organization and it is likewise work value in Japan. They work hard and prefer to come home after their manager leave from office. (2) Technologies and management trends are impact on organizational management, these can shape employees became twenty-four hour workers. They can work all the time because technologies support, until one day they found that working is the one part of breading, and cannot remove it out, thus workaholism will come.

Why does workaholism matter? Because workaholism behavior could easily percolate through ourselves by work habits or/and socialization process. Exactly, employees cannot become workaholic in short time, but workaholism disappearing seems difficult to eliminate. Thus, organizations should concern about organizational management, maybe they would create more workaholics in organizations by themselves.

Engaged employee could become workaholic because both of them have same components, such as work hard, enjoyment and /or absorption, including factors impact on employee behavior become workaholic behavior, the figure 2.13 explain transforming engagement to workaholism. As follow;

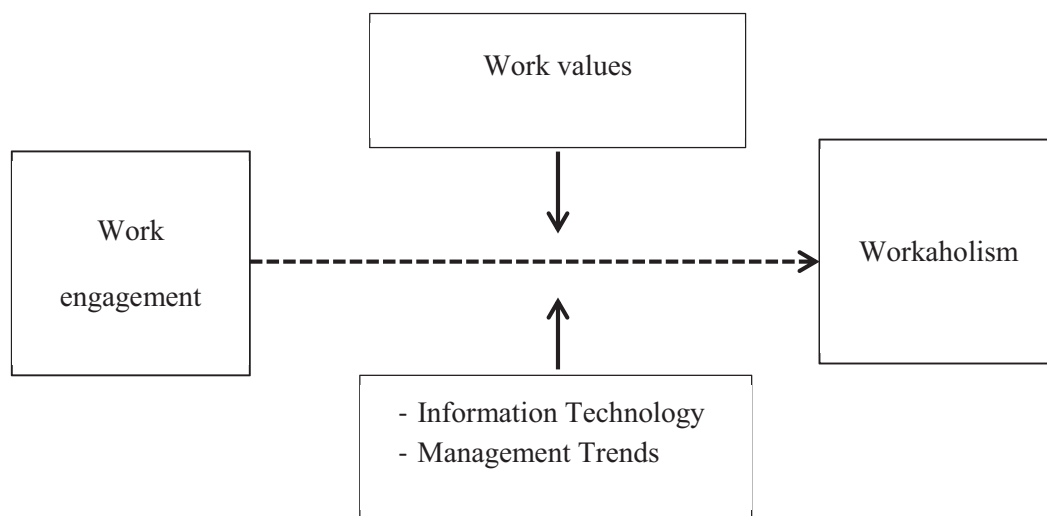

Figure 2.13 transforming of engagement to workaholism.

2.4 Hofstede's culture dimensions

There are many studies focus on internal factors such as personality, individual demographic, and work experience factor impact level of work engagement and workaholism. There is rarely study about influence of internal factor on them. Although, social factor can increase level work engagement and workaholism, but culture is complex. Therefore, this study implies the culture dimensions by Hofstede to study their relationship with work engagement and workaholism in order to study how culture drive work engagement and workaholism.

2.4.1 Overview of Culture

Culture, in anthropology, refers to the sum total of ways of living built up by a group of human beings and transmitted from one generation to another, in sociology, culture refers to the total of the inherited ideas, beliefs, values, and knowledge, which constitute the shared basis of social action. Culture is seemly as all of human creating, such as language, traditions, religions, laws, arts, ethics, including science and technology. Concluding that culture is human's tools to assist humanity to live sustainable.

The nested layers of culture starts from inside are individual, classroom, community, local, national, and human. Some study names layers of culture as individual, micro, meso, macro, meta, and global culture, and some study categories culture as family, professional, divisional, corporate, regional. Industry, and national culture.

Culture, is a collective concept that can be used to differentiate between groups. Culture consist of the knowledge, philosophy, morals, languages, motivation, attitudes, value and norms shared and transmitted in a society. Culture directly frames individuals' values, attitudes, beliefs, and norms, including culture shares values among people. Culture exists everywhere and everyone belongs to at least one. Culture has a hierarchy which provides from higher level to lower level, the layers of culture are:

- A supranational level, such as Western or Eastern culture
- A national level according to one's country (or countries, for people who migrated during their lifetimes), French, Thais, or Chinese culture.
- A regional level and/or ethnic and/or religious and/or linguistic affiliation level, Hispanics culture or Buddhist culture.
- A gender level, according to one was born as a girl or as a boy
- A generation level, separating grandparents from parents and children
- A social class level, associated with educational opportunities and with a person's occupation or profession, lawyers, hotel or accounting culture.
- Corporate level according to the way employees have been socialized by their work organization.

Since culture is huge and complex, the studies of culture in social science, mostly focus on dimension of culture, start from a study of parson and shils (1951) exhibited four cultural dimensions are affectivity, specificity, universalism, and quality versus performance,

Hall (1959, 1976) studied culture in contact versus non-contact culture, low and high context culture, monochronic versus polychronic culture, and high versus low territory.

Hofstede (1980, 2011) categorized culture to five dimensions are power distance, individualism versus collectivism, masculinity versus femininity, uncertainty avoidance, and long-term orientation.

Trompenaars and Hampden (1997) developed seven dimensions of culture are (1) universalism vs particularism, (2) Individualism vs communitarianism, (3) specific vs diffuse, (4) neutral vs emotional, (5) achievement vs ascription, (6) sequential time vs synchronous time, and (7) internal direction vs outer direction.

Schwartz and collages (1994), started the project Schwartz Value Survey (SVS) in 63 countries. has a identified seven culture-level dimensions, namely (I) egalitarianism, (II) harmony ,(IV) embeddedness, (IV) hierarchy, (V) mastery ,(VI) affective autonomy, and (VII) intellectual autonomy.

Lastly, Lewis (2000) explored linear-active, multi-active, reactive culture's dimension, including data based and dialog based culture.

Since culture is very comprehensives, thusly a study of culture could focal point on levels of culture or dimensions of culture. Some dimensions are not completely differences, long-term orientation and future orientation, hierarchy and power distance, collectivism by Hofstede is divided to institutional and in – Group, by House, and masculinity is divided to assertiveness and gender egalitarianism.

This present study builds on the conceptualization of culture given by Hofstede (1980, 2011), who defined culture as *the collective programming of the mind distinguishing the members of one group or category of people from others*".

2.4.2 The characteristics of Hofstede's culture dimensions

Geert Hofstede's culture study was based on a study of IBM employees in over fifty countries., he identified five dimensions or 'problem areas' which represent differences among national cultures (Hofstede, 1997) as,

1. Power distance, related to the different solutions to the basic problem of human inequality.

2. Uncertainty avoidance, related to the level of stress in a society in the face of an unknown future.

3. Individualism versus collectivism, related to the integration of individuals into primary groups;

4. Masculinity versus femininity, related to the division of emotional roles between women and men.

5. Long term versus short term Orientation, related to the choice of focus for People's efforts: the future or the present and past.

6. Indulgence versus restraint, related to the gratification versus control of basic human desires related to enjoying life.

This present study provides five dimensions; power distance, uncertainty avoidance, individualism versus collectivism, masculinity versus femininity and long-term orientation, not indulgence versus restraint, to study level of these culture values , to find the culture values in different groups, to study relationship with work engagement and workaholism, and to explain how culture drive work engagement and workaholisms.

Power Distance: PDI refers to inequality in society and the distribution of influence within a culture, defined as the extent to which the less powerful members of the institution, such as family, school and community, and organization within a country expect and accept that power is distributed unequally, the key differences comparing between large and small power distance are presented in the table 2.5

	Small Power Distance	Large Power Distance
Norm	Less powerful people and more powerful people should be interdependent.	Less powerful people should be dependent.
Family	Parents treat children as equals.	Parents teach children obedience.
Community	Less educated persons hold more authoritarian values than more educated persons.	More and less educated persons show equality authoritarian values.
Workplace	Decentralization is popular. The idea boss is a resourceful democrat.	Centralization is popular. The idea boss is a benevolent autocrat or a good father.
	Manual work has the same status as office work.	White-collar jobs are valued more than blue-collar jobs.
	There are fewer supervisory personal and a narrow salary range between the top and the bottom of the organization.	There are more supervisory personal and a wide salary range between the top and the bottom of the organization.

Table 2.5 The differences between large and small power distance

Source: Adapted from Hofstede, G., Hofstede, G.J., and Minkov, M. (2010).

Furthermore, The characteristics of large power distance are centralized authority, autocratic leadership, paternalistic management style, many, hierarchical levels, large number of supervisory staff, acceptance that power has its privileges, an expectation of inequality and power differences. Large power distance values was found in India, Mexico, Philippines, Turkey, Singapore, and Thailand (Hofstede, 1977).

While the characteristics of small power distance as decentralized authority and decision making responsibility, consultative or participative management style, flat organizational structure, the small proportion of supervisory staff, lack of acceptance and questioning of authority, rights consciousness, and tendency toward egalitarianism, countries as Austral, New Zealand, Israel and Denmark were found as small power distance societies .

The level of PDI is correlated with geographic latitude, population size, wealth, and education, including PDI scores within countries decreased with increased education level (Hofstede, Hofstede, & Minkov, 2010).

Education is one of the most powerful instruments for reducing poverty and inequality and lays a foundation for sustained economic growth (www.worldbank.org), thus education level impact on power distance level is focus in this present study.

Individualism versus Collectivism: IDV, refers to how people define themselves and their relationships with others. The key differences between people in individualism and collectivism societies are described in the table 2.2

In an individualist culture, the interest of the individual prevails over the interests of the group, ties between individuals are loose, and people look after themselves and their immediate families, in short, individualism was spilt into several

facets, such as distance from in-groups, hedonism, and competition. This contrast with collectivist (Triandis, 2004), they behaved much more under the influence of norm (what should I do?) than of attitudes (What would I like to do?), or claim that collectivism was spilt into such factors as family integrity and sociability.

The characteristics of individualism are foster contractual relationships that are based on the principles of exchange, they calculate profit and loss before engaging in a behavior, focus on self or at most on close loved ones are concerned with the relationship between their behaviors and their own needs, interests and goals, value independence and self-sufficiency place self-interests above collective interests accept confrontation as an attribute, emphasize pleasure, fun and personal enjoyment more than social norms and duties belong to many in groups that exert little influence on their lives, believe that their beliefs are unique, and give precedence to horizontal relationships (e.g. spouse-spouse) over vertical relationships (e.g. parent, child).

While, people in collectivism culture behave according to social norms that are designed to maintain social harmony among members of an ingroup, consider the implications of their actions for wider collective, share resources and are prepared to sacrifice personal interest for collective interests, favor certain in-groups (e.g. Family, friends), emphasize hierarchy and harmony within the group, and regulate behavior through group norms.

IDV also refers to the power of groups, family, school, and community and organizational, which influence on person in each society, and how they define themselves and their relationships with others.

IDV dimension, link to the country's wealth, geographic latitude, but not related to the size of the population of a country, for example, countries having achieved fast

economic development have experienced a shift toward individualism. Furthermore, Hofstede found the relationship between PDI and IDV, the two dimensions tend to be negatively correlated: large power distance countries are also likely to be more collectivist such as Malaysia, Thailand, Japan, except Costa Rica, and small power distance countries to be more individualist such as The United State, Sweden, Australia, except France, Poland, and Spain.

	Collectivism	Individualism
Norm	Resources should be shared with relatives	Individual ownership of resources even for children.
	High-context communication prevails.	Low-context communication prevails
	On personality tests, people score more introverts.	On personality tests, people score more extroverts.
School	Students speak up in class only when sanctioned by the groups.	Students are expected to individually speak up in class.
	Diplomas provide entry to higher-status group.	Diplomas increase the economic worth and/or self-respect.
Workplace	Hiring and promotion decisions take employee's in-group into account.	Hiring and promotion decisions are supposed to be based on skills and rules only.
	Occupational mobility is lower.	Occupational mobility is higher.
	Companies are owned by families and collectives.	Joint-stock companies are owned by individual inventors.

Table 2.6 The differences between Collectivism and Individualism

Source: Adapted from Hofstede, G., Hofstede, G.J., and Minkov, M. (2010).

Masculinity versus Femininity: MAS This dimension extends to which behaviors belong either gender differs, both not only about gender, male and female, but involves with gender's characteristics. The key differences between people in feminine and masculine societies are shown in table 2.3

The masculinity represents a preference in society for achievement, heroism, assertiveness and material reward for success. Society at large is more competitive and tends to resolve conflict by fighting.

Masculinity culture values career success, their characteristics are gender roles are clearly distinct, men are supposed to be assertive, tough and focused on material success, do not place great importance on benevolence, places importance on the value of mastery (of job, nature, people, etc), the women considered health, wealth and understanding as desirable characteristics of a husband, the women considered personality, affection, intelligence and sense of humor as desirable characteristics of a boyfriend.

The feminine side focuses on stands for a preference for cooperation, modesty, caring for the weak and quality of life. Society at large is more consensus-oriented and more compromises and negotiation in conflict management.

Femininity culture or quality of life value are characteristics as social gender roles overlap, both men and women are supposed to be modest, tender and concerned with the quality of life, desired traits in husbands were the same as desired traits in boyfriends, and emphasize non-materialistic aspects of success.

A society is called masculine when emotional gender roles are clearly distinct: men are supposed to be assertive, tough, and focused on material success, whereas women are supposed to be more modest, tender, and concerned with quality of life.

While a society called feminine when emotional gender roles overlap: both men and women are supposed to be modest, tender, and concerned with the quality of life. In short, in masculine cultures: men are from Mars, but women are from Venus, whereas in feminine cultures both sexes are from Venus.

Age, gender and education effects on masculinity values, elders tend to become more social and lower MAS, the female/male ratio in the population is higher in feminine culture, such as Thailand and Indonesia than in masculine culture such as India and China, and gender equality has a lot to do with women's education level.

	Femininity	Masculinity
Norm and Family	Both men and women should be modest, be tender, and focus on relationship.	Men should be assertive, ambitious, and tough. Women are supported to be tender and to take care or relationships.
Education	Job choice is based on intrinsic interest.	Job choice is based on career opportunities.
Workplace	Rewards are based on equality.	Rewards are based on equity.
	There is a higher share of working women in professional jobs.	There are lower share of working women in professional jobs.
Politics and Religion	Many women are in elected political positions.	Few women are in elected political positions.

Table 2.7 The differences between Masculine versus Feminine

Source: Adapted from Hofstede, G., Hofstede, G.J., and Minkov, M. (2010).

Uncertainty Avoidance: UAI, Uncertainty avoidance index: UAI, is about how people think about what is different is dangerous, as the extent to which the member of a culture feel threatened by ambiguous or unknown situations. This feeling is expressed through nervous stress and in a need for predictability. The uncertainty avoidance index score or UAI is from strong (uncertainty-avoiding culture) to weak (uncertainty-accepting culture). The key differences between people in strong and weak uncertainty avoidance are shown in table 2.3

The character of weak uncertainty avoidance is risk taking, tolerance of differing behaviors and opinions, flexibility, and organizations with a relatively low degree of structure and few rules, promotions based on merit.

While, strong uncertainty avoidance culture, organization avoidance of risk, have clearly delineated structures, many written rules, standardized procedures, promotions based on seniority or age, lack of tolerance for deviants, strong need for consensus, need for predictability hence, planning is important, and respect for authority.

The anxiety level is related to UAI, in strong uncertainty avoidance countries, anxiety levels are relatively high and tend to have high average alcohol consumption because drinking help for anxiety release, including to more unhappy people existed especially in uncertainty avoidance culture too. They showed a negative tendency in describing their work and life situation.

These could be concluded that UAI level is influenced by national anxiety levels (Hofstede, Hofstede & Minkov, 2010) such as war, politic with in the country and anti-anxiety: technology, help to avoid the uncertainties of nature, laws and rule, try to prevent uncertainties in the behavior of other people, and religions help individual to accept the uncertainties.

	Weak Uncertainty Avoidance	Strong Uncertainty Avoidance
General norm and family	Low stress and low anxiety.	High stress and high anxiety.
	Personality tests, higher scores on agreeableness.	Personality tests, higher scores on neuroticism.
	What is different is curious	What is different is dangerous
	Comfortable in ambiguous situations and with unfamiliar risks.	Acceptance of familiar risks; fear of ambiguous situation and of unfamiliar risks.
Health and education	Few people feel unhappy	People feel more unhappy
	People have fewer worries about health and money.	People have more worries about health and money.
Work, Organization and Motivation	Work hard only when need.	This is an emotional need to be busy and an inner urge to work hard.
	Belief in generalists and common sense.	Belief in experts and technical solution.
	Motivation of achievement and esteem or belonging	Motivation by security and esteem or belonging.
The State	Few and general laws or unwritten rules.	Many and precise laws or unwritten rules.
	Fast result in case of appeal to justice.	Slow result in case of appeal to justice.
	Liberalism	Conservatism, law and order.

Table 2.8 The differences between uncertainty-accepting and uncertainty-avoiding culture.

Source: Adapted from Hofstede, G., Hofstede, G.J., and Minkov, M. (2010)

Long-term Orientation (LTO), this dimension has two side long-term and short-term orientation, and the key differences between short and long term are described in the table 2.5

	Short-term Orientation	Long-term Orientation
Norm and family	Social pressure toward spending.	Thrift, being sparing with resources.
	Children get gifts for fun and love.	Children get gifts for education and development.
Business and ways of thinking.	Main work values include freedom, rights, achievement, and thinking for oneself.	Main work values include learning, honesty, adapts, accountability, and self- discipline.
	Personal loyalties vary with business needs.	Investment in lifelong personal networks. Guanxi.
	Managers and workers are psychological in two camps.	Owner-manager and workers share the same aspirations.
Societies	Slow or no economic growth of poor countries.	Fast economic growth of poor countries.
	Investment in mutual funds.	Investment in real estate.

Table 2.9 The differences between short-term and long-term orientation dimension

Source: Adapted from Hofstede, G., Hofstede, G.J., and Minkov, M. (2010).

Long-term orientation stand for the fostering of virtues oriented toward future rewards in particular, perseverance and thrift, its opposite pole. The characteristics of LTO as reflected a dynamic, future-oriented mentality, emphasizes persistence (perseverance), emphasizes ordering of relationships based upon status and observing this order, emphasizes thrift, emphasizes having a sense of shame, supports

interrelatedness through sensitivity to social contacts, and positively associated with economic growth (Hofstede and Bond, 1988 - 22 countries). The countries present long-term orientation value such as Hong Kong, Japan, Taiwan, and Thailand.

While, Australia, Belgium, Great Britain, Philippines, New Zealand, Sweden, and U.S.A present their value in opposite pole, short-term orientation, these stand for the fostering of virtues related to the past and present in particular, respect for tradition, preservation of “face” and fulfilling social obligations, toward present and past, reflects a relatively static, tradition-oriented mentality, emphasizes personal steadiness, emphasizes stability, emphasizes protecting face, emphasizes respect for tradition, emphasizes reciprocation of greetings, favors and gifts, and negatively associated with economic growth (Hofstede and Bond, 1988 - 22 countries)

However, Long-term orientation was suggested that is positive associated with economic growth. The data from UN. (www.worldbank.org) shows the GDP in 1990-1994 of Hong Kong, Japan, and Thailand were continue growth, including U.S.A., Philippines and Belgium. While, Australia, New Zealand, Great Britain and Sweden, their GDP. were both increase and decrease. These points is contrast with Hofstede’s suggestion that short-term orientation is negatively associated with economic growth. The reason is U.S.A and Belgium which are presents their value in short-term orientation, but there were economic growth in their countries.

Summary that the economic growth could be related with long-term orientation, but might not have relationship with short-term orientation with completely. Therefore, consider with economic growth associate with long and short term orientation should be careful, these may have other influencing.

2.4.3 The changing of culture

The changing of culture, Hofstede (2001) explained that culture change would be extremely slow and should be measured in term of generations and centuries, not decades. Furthermore he predicted that relative national culture scores would not change substantially until at least 2100. Furthermore, Triandis (2004) indicated that countries become more affluent, their populations become more individualist. However, this change requires several generations. Those, support by Swidler (1986) that culture in current period.

Fernandez et al. (1997) explored research project in nine countries between 1989-1990, Chile, China, Germany, Japan, Mexico, Russia, The United State, Venezuela, and Yugoslavia, with the respondents were employed business professional and advanced business students. Some propositions about culture shifting are:

- (1) There are large PDI, strong UAI, and collectivist in communist work ethic
- (2) The shift from weak UAI to strong UAI may generated by the increased uncertainty about the economic power in The United State, meanwhile an economic strength leaded Japan willingness to take risk are acceptable than in the past.
- (3) IDV score has change in Mexico, from collectivist to individualist caused by the trend toward more economic development supports the greater emphasis placed on individual rewards, while IDV in Japan is also ranked as collectivist, in agreement with Hofstede's study.

(4) MAS score in Germany and The United State are decreased, they become feminist that could be changing in the work force, in which women have increasingly gained more positions of power.

Supporting by Wu (2006), studied in Taiwan and The United State, suggested that wok-related cultural values in a specific culture are not static and can be change over time. Furthermore the finding presented the shift from large PDI to small PDI in Taiwan since Taiwan has moved dramatically toward democratization. The shift from weak to strong UAI in The United State is about the economic power. The MAS score in Taiwan and The United State decrease, in contradicts Hofstede's study, and the U.S. participants have a high score on collectivist , and LTO score is highly in Taiwan and medium score in The United State.

Migliore (2011), presented the results which are large difference in all five cultural dimension as compared to Hofstede's 1980 data. The results display changes in Hofstede's scores in India and The United State; the scores of PDI and MAS decrease in both. IDV and UAI scores decrease in The United State, while increase in India. The LTO score in The United State increase, while decrease in India. Furthermore, the study also suggests that: The rapid change in information and communication technologies may account for the large decreases in PDI. The increasing of LTO may be attributed by changing in global economy, perhaps the large US employment number and continued threats of job loss, meanwhile there is the explosive economic growth in India.

Regarding to the studies of culture, these could be say that culture may be changed by influences of economy, technology, political, societal, and work force.

When environments change, people values also change, thus many cultural theories should be updated and re-evaluated periodically. However cultural changing may differences by difference sample (Fernandez et al., 1997)

2.4.4 Hofstede's cultural dimensions in Thailand

Hofstede studied culture by analyzing a database of employee value scores collected within IBM between 1967 and 1973, the data covered more than 70 countries, the examples countries as follow,

Country	Power distance	Uncertainty avoidance	Individual Collectivism	Masculinity Femininity	Long-term orientation
Australia	36	51	90	61	31
France	68	86	71	43	-
Hong Kong	68	29	25	57	96
India	77	40	48	56	-
Japan	54	92	46	95	80
Philippines	94	44	32	64	19
Singapore	74	8	20	48	38
Taiwan	58	69	17	45	87
Thailand	64	64	20	34	56
USA	40	46	91	62	29

Table 2.10 Hofstede's culture score by countries

Sources: Hofstede,G.,Hofstede, G.J., and Minkov, M. (2010).

The power distance score in Thailand tends to high, same as France, India, Hong Kong, Philippines, Singapore, and Taiwan which can say that there are more hierarchy in social, and people respect person who have more powerful, and the countries in Asia are seemly high power distance country.

Uncertainty avoidance score is 64 in Thailand that means there are more rules and regulations, including anxiety for change, difference from Singapore which weak uncertainty avoidance country. While, France, Japan, and Tai wan are strong uncertainty avoidance country.

Individualism in Thailand presents their score in 20, as claimed that Thailand is a collectivism country as same as Hong Kong, Singapore, Taiwan, and Philippines, seemly that mostly of Asia are collectivism culture.

Masculine score in Thailand is lowest compare with nine countries, while japan is higher in masculine score, thus Thailand is Feminine culture which is focus on human relationship and quality of life than achievement and competition.

The moderate score in long-term orientation, claim that they are focus on future, but not far compare with japan, Hong Kong, and Taiwan, while Philippines, Australia, Singapore and USA present short-term orientation.

This present study expects that the score of Hofstede's culture dimensions which will be found in this survey will be difference from Hofstede's study, as follow:

- 1) Power distance is lower than Hofstede's study, since impact of increasing of education level and increasing of wealth reduce level of power distance.
- 2) Individualism value increases because decreasing of power distance, and the achievement of fast economic development in Thailand.
- 3) Femininity value is still install in Thailand as same as Hofstede's study, because the ratio of female is higher than male, including there are increase of older people will decrease masculine value.
- 4) Turning to acceptance avoidance societies because of the teachings of Buddhism will shape people decrease level of anxiety, and turn from uncertainty avoidance to accepting.
- 5) There is not clearly for long-term and short-term orientation because seemly, there have more economic growth in Thailand supports long-term orientation, but face saving culture and low saving rate are support short-term orientation value. Thus, this dimension will be present moderate score.

Furthermore, Muenjohn (2004), investigated the work-related values of Thai subordinates who worked under expatriate managers in Thailand, presents the four cultural dimensions scores which are power distance is 93, Individualism is 19, masculinity is 17, and uncertainty avoidance is 47. Those are different from Hofstede's survey, except Individualism dimensions.

Including Watcharasriroj and associates (2005) analyzed culture of Thailand by collecting in three sectors; public organizations, state enterprises and private organizations. The results presented, difference score with the Hofstede's finding, moderate power distance (44), individualism (55) and long-term orientation (40) with

low Masculinity (19) and high Uncertainty Avoidance(83), comparing result between three studies is presented in table 2.6.

Those studies infer to the differences scores of Hofstede’s culture dimensions in Thailand, with suggestion by Fernandez et al., (1997) that there are changes in the scores of cultural dimensions when study in differences group or difference time.

Cultural dimensions	Hofstade, 1977	Muenjohn ,2004	Watcharasriroj and associates ,2005			
			Average	Public	State Enterprise	Private
PDI	64	93	44	46.12	44.86	41.30
IDV	20	19	55	55.69	59.68	58.10
MAS	34	17	19	22.26	25.95	13.27
UAI	64	47	83	84.19	67.88	88.94
LTO	32	-	40	39.95	45.40	38.55

Tables 2.11 A comparison scores of cultural dimensions between the study of Hofstede, Muenjohn, and Watcharasriroj.

For updating Hofstede’s culture dimensions in Thailand, and the importance of the layers of culture, thus this present study focus on three sector; automotive, electronics and electric, and hotel sector, in order to supporting Hofstede’s suggestion that culture can be changed and in difference group have difference culture (Hofstede,2001).

2.4.5 The culture difference among personal demographic and work experience characteristics

Does culture homogenous between genders, generation cohorts and class, education and occupation or else? Hofstede's study assumes the domestic population is homogeneous whole, and suggested that gender, generation, and class cultures can only partly be classified by the dimensions found for national culture. This is because they are categories of people within social systems, not integrated social systems, and should be described in their own-terms base on special studies of such culture.

Homogeneous of culture is presented by Hofstede's study, He identified that culture dimensions were statistically independent and did not differ by age, gender, education, except masculinity dimension was differ by gender (Hofstede.2001). Furthermore, culture change may occur in response to change in external factor, economic, education, legislation, or female workforce participation.

Heterogeneous of culture is presented in Stedhan and Yamamura's study (2004), the results show significant gender differences in PDI and IDV in Japan, and IDV in The United State. PDI score differ among gender in Japan since more educated women than before, that confirmed by Hofstede's suggestion, increasing level of education could be decrease level of power. while IDV difference among gender in Japan and The United State could be influenced by more female in work place.

Possibility that culture is not homogeneous, these could be differing among differences groups (gender and generation) and class (education level), including differences organizations, these may socialized by organizational culture. Thusly these

present study focuses on a heterogeneous of culture since influence of external environment in nowadays, they are rapid change, huge and vary impact to social.

In addition to a study of Watcharasriroj and associates (2004), related the studies by Muenjohn (2004) and Pimpa (2012), present the differences cultural scores among group,

The results by Watcharasriroj(2005), levels of Power Distance, Individualism, Uncertainty Avoidance, and Long Term Orientation are found different among public organizations, state enterprises and private organizations, while no significant difference among three types of organizations is shown for Masculinity. Moreover, the scores of culture dimensions differ among gender, are found in masculinity dimension which male are higher score than female, while female are higher score in uncertainty avoidance dimensions than male.

Pimpa (2012), studied Hofstede's culture dimensions in Thailand public sector, found high scores in power distance, uncertainty avoidance and long-term orientation, while the scores are moderate in masculinity and individualism dimensions. Furthermore, the study indicated that culture is not homogenies since the results showed differences in culture dimensions between gender, level of education and organizational tenure in Thailand public sector, summary that,

(1) The score of PDI, IDV and MAS between Thai males and Females are differences , Thai female public servants tend to accept the power from the leaders within the organization, and Thai female are more collectivistic in the organization than Thai male public servants, including to Thai male public servants are more aggressive and assertive than female public servants.

(2) There was significant difference among public servants with undergraduate and postgraduate qualifications on masculinity dimension, explained that public servant with postgraduate qualifications are more aggressive, task-oriented and try to achieve goals than those with undergraduate qualification.

(3) In masculinity dimension, the mean scores for public servant who work in the public system for 5 to 9 years differ significantly from those who stay in the system for 10 years or longer, and the mean scores of individualism for public servants who work in the range of 5-9 years differ significantly from those who work longer than 10 years.

Since the cultural change may occur in respond to change in external environment and culture could not be homogenies, certainly culture must be changed in order to fit with environment and could be differ between gender and groups . This present study surveys five Hofstede's culture dimensions in Thailand to compare with previous studies in order to observe the significant of culture's dimensions in differences sample.

Summary that, culture dimensions could be changed and differences among groups and class, including culture should be specific identified by layer of culture, concluding to *the hypothesis, H1 (a)* the scores of Hofstede's culture dimensions are differences among gender, generation, level of education and organizational tenure group.

2.4.6 Influence of culture

This sector presents the studies of Hofstede's culture dimension on individual, group's behaviors and organizational practices, as follow,

Culture influences on behavior, could be explain trough Social learning theory by Bandura (1963) , learning is a cognitive process that takes place in a social context and can occur purely through observation or direct instruction, even in the absence of motor reproduction or direct reinforcement, in short in social context people can learn each other's by direct and indirect ways, involves observation, extraction of information from those observations, and making decisions about the performance of the behavior (observational learning or modeling).

A cross- culture study of Irani and Oswald (2006) explained people from difference culture preformed their aggressive in differences ways because culture values define appropriate or inappropriate behavior, such as workplace aggression in India will be lower and more covert than in the US, Indians will tend to display more overt forms of peer-directed and downward aggression, and vice versa, workplace aggression will occur more often and more overtly in the US than in India (based on higher individualism and lower power distance).

Including to theory of reasoned action (TRA) is support impact of culture on behavior that individual behavioral intentions are influenced by personal attitudes and perceptions of how referent others view that behavior (Eves and Cheng, 2007) , thus when individuals perceive that referent others (e.g., society, co-workers, family,

friends) view a behavior in a positive light, they are more likely to have resulting behavioral intentions. These intentions, in turn, could translate into actual behavior.

Furthermore, Subjective norms (Chang, 1988) refers to an individual's perceptions of how referent others (e.g., society, co-workers, family, friends) will respond to a given behavior. When individuals perceive stronger subjective norms from their cultural in-group, they are more likely to behave as the group expects. Thus, culture may have a significant effect on subjective norms.

Culture effects on behavior, individual and group, starting from the relation with personality traits, big five model, by Migliore (2011) reported an extraversion trait has a positive relation with IDV, but has a negative relation with UAI are presented in the a study of Magnini (2009), a study with sale manager in 392 hotel in 28 countries, found that nation cultures has an influence on the price empowerment decision. Specially, there are more likely to be granted pricing authority in individualistic, low uncertainty avoidance and low power distance countries,

Culture influence on asset managers' views and behavior, in the United State, Germany, Japan, and Thailand, found that more IDV predicts less herding behavior, more PDI leads to older and comparatively less experienced manager to the upper hierarchy, MAS brings men in to top positions, and UAI is related to higher safety margins (Beckmann et al., 2008). Luthar and Luthar (2002), applied hofstede's cultural dimensions to explain sexually harassing behaviors, suggested that varying difference in dimensions as: power distance, Individualism, Masculinity, and uncertainty avoidance, across countries may predict the likelihood of managers sexually harassing in an international and a cross culture context.

PDI was found to impact on proactive behavior (Aycan et al., 2000) , large PDI predicted less endorsement of proactivity assumption in , Canada, USA, Germany, Israel, Romania, Pakistan and India except Russia, China and Turkey.

The IDV dimension is seemly effect on diversity perceptions (Guidroz et al,2005) , Countries high in collectivism, such as Brazil, Chile, Hong Kong, Malaysia or Thailand, should see stronger effect on involvement on diversity perceptions than individualistic countries because of the emphasis on team work and inclusion, further more collectivist orientation with respect to “blowing the whistle” than individualist (Brody et al., 1999)

IDV influences on commitment, Felfe and colleagues (2008), surveyed through service-orientated companies in Germany, Romania, and China, found that collectivism as a cultural value orientation is related to commitment, and exert a stronger influence on commitment in collectivistic countries, furthermore collectivistic orientation elevated (attenuated) the effect of self-determination (impact) on job satisfaction in hotel employees in Canada (Fock, et al., (2011), but no significant results were found with respect to meaning and competence.

Collectivism also effect on consumer behavior is found in the study of Hossein and Hamed (2012), the result is Thai and Iran customers, which are collectivist countries, are influenced by group opinion, Family and friend discussion, in purchasing mobile phone

Furthermore, Caramelli and Briole (2007) discusses about how cultural values may moderate the attitudinal effects of employee stock ownership, they proposed that the employees' perception of employee ownership-related information and participation

in decision-making are more strongly (positively) associated to work satisfaction and organizational commitment for low power distance employees, the financial value of employee ownership is more strongly (positively) associated with work satisfaction for less individualistic employees, the strength of the positive relation between the individual level of employee stock ownership and affective organizational commitment and job satisfaction is higher for masculine employees compared to feminine employees, and the preference for employee stock ownership over other investments is higher for low uncertainty avoidance employees

Culture influences on group level, an impact of culture on group level, starting by Hope (2004), lanced project in hotels in St. Lucia, indicated that culture factors related to power distance and risk avoidance seem to create barriers to empowerment and team working

PDI impacts conflict management model, Purohit and Simmers (2006) found that students from three countries; America which is 38.50 scores in PDI, Nigeria which is 98 scores in PDI , and India which is 28,5 scores in PDI, were differences significantly on their preference for two conflict management models as compromising and avoiding.

The study about culture impact on communication of construction industry managers in Singapore by Tran and Skitmore (2002). Suggested that low uncertainty avoidance relative with communication process based on trust. In contrast high uncertainty avoidance culture has a more formal and standard communication.

More Collectivist cultures perceive effective communication and messages are often highly coded and implicit. Masculinity culture, unexpectedly power distance was

not significant correlated with any of communication variables. However, a positive correlation was found between Masculinity versus Femininity and communication barrier as “Limited resources”. And Impact of Power distance was found as positively associated with the choice of face to face communication and negatively associated with choice of e-mail communication (Richardson and Smith, 2007)

Culture influences on organizational level, the studies of culture are presented both impact and not impact in organizational level, the studies relate with impact areas are,

A study among 192 hotel managers in Hong Kong, Japan, and Korea by Pizam et al. (1997) indicated that PDI, IDV, MAS and UAI have a stronger effect on managerial behavior, had a greater impact on 22 of 29 managerial practices than the hotel industry culture.

Pagell, Katz and Sheu (2005) explained that national culture significantly important international operations management behavior among similar manufacturing plants in the same industry located in different cultures

Madlock (2012) explored a case study in Mexico, found that PDI in positive relationship with communication satisfaction, through communication apprehension and using avoidance messages, and satisfaction of communication is positively related with job satisfaction and organizational commitment

Khatri (2009) , suggested that it could be lower employees participation, a greater communication gaps between superiors and subordinates, more centralized in decision making, greater control over employees behavior, more unethical behavior than small.

PDI and MAS are found to have significant negative effect on corporate social and environment performance, whereas IDV and UAI have no significant effect (Ringov and Zollo, 2007)

Some studies suggest that decreasing power distance for close the gap between superior and subordinate, changing perception of power distance should concentrate on changing organization climate, particularly towards “employee-entered management” and flatter hierarchies(Tan and Chong ,2003).

While Nahs (2005) found that no significant differences in affective responses of the manager in difference level of power distance on responding in 360 feedback.

In hotel sector, there are researches about influence of national culture on many areas, but UAI does not significant impact on business development are found in the study of 207 hotel managers in American , Malaysia, Thailand and Turkish (Ayoun and Moreo ,2008). Moreover, the influence on business-units, management control and incentive design, from parent company effect in much greater than the influence from nation culture at the local business-unit level (Ver der Stede, W.A.,2003)

Concluding that culture influences behavior by socialization process, observation, norms’ expectation, social’s expectation, people in difference culture performs differences of their behaviors, moreover impact of culture are on individual, group, and organizational level, in short culture could influence both vertical and lateral area. However, since culture is huge and there are many dimensions of culture and more than ten culture’s frameworks, thus studying of culture impact could not study on whole of cultures or all of dimensions, focusing on each dimension could understand culture more.

2.4.7 Summary

By reviewing the literatures, found that culture can influence both negative and positive on work engagement and workaholism. Power distance could decrease work engagement because the autocratic leadership style in large power distance may be pull work engagement down. Collectivism culture may both pull work engagement up or down because slip-over phenomenal between supervisor and workers, while individual culture could pull work engagement up if employees can achieve their goals. Masculinity culture also pull work engagement because they are more focus on achievement Uncertainty-avoidance culture may pull work engagement down because they are more anxiety level than uncertainty-acceptance, these might lead them not happy in work. But there is rely evidence to support the long-term orientation or short-term orientation cultue can pull up or pull down work engagement.

Baruch's study (2011) explained the dimensions of culture drive workaholism that under a culture of high power distance can improve possible power of individuals like strong and visible investment such as long working hour. Workaholism is perceived as more positive in cultures characterized by high uncertainty avoidance, high individualism, high masculinity long-term orientation.

Therefore, how culture drives work engagement and workaholism is the one the main area in this study, including the relationship between work engagement and workaholism, studying level of work engagement, workaholism, the changing of culture: power distance, masculinity, collectivism, uncertainty avoidance, and long-term orientation, the influence of individual and work experience factors on work engagement, workaholism, and culture dimensions. All are underlined in this study

Chapter III

Methodology

This chapter includes the following sections: population and sample, research questions and hypotheses, research model, data collection, variables and measurement, the validity and reliability of measures, data analysis, and summary.

3.1 Population and sample

In this study, 403 participants in Thailand were chosen. The data collection was done during September 2012 – February 2013. This could be explained that 78 participants were from 14 hotels. 60 participants were from 6 companies in the automotive industry, and 265 participants were from 28 companies in the electronic and electric industry. The target companies are located in Bangkok and the surrounding area.

Regarding the participants, 209 (51.90%) was female and males were 194 (48.10%). The majority of the participants were born in 1964-1987. The range of age is 36 - 46 years. Also, they were Gen-X (64.00%). For the age of 18-35 years, there were 23.80% (Gen-Y). Regarding to the age of 47-66 years old, there were (12.30%), and they were Baby Boomer. Based on the respondents' education, 59.30% hold the bachelor degree, 27.80 % received technical certificate. Also, 12.90% of respondents got master or doctoral degrees. In terms of the marital status, 51.90 % of respondents were married, divorced, and separated. 48.10 % of respondents were single. According to this, the information is presented in Table 3.1.

The sample by sector, first, twenty-eight companies both electrical and electronic industries, where are located in Bangkok and nearby area, this sample included 265 participants or 65.80%. It consisted of male participants of 45.30%, and females were 54.70%. Based on the participants' generation, 182 participants (68.70%) were Gen X. Gen Y was 18.90%, and Baby Boomer was 12.50%. In terms of education, 54.70% of the participants got a bachelor degree. 29.80% of them hold technical certificate. Meanwhile, 15.50% of respondents had the master and doctoral degrees. Regarding the marital status, 54.30% of respondents were married, divorced, and separated. Single status was 45.70%. The details are presented in Table 3.2.

Second, a group of sample was the automotive industry. There were six companies. They also are located in Bangkok and surrounding area. The participants in this industry were 10 females (16.70%). The male participants were 50 or 83.30%. The majority of the participants were born in 1964-1987. They were a group of Gen X (63.30%), and the range of age was 36-46 years old. The age of 18-35 years old was Gen Y (16.70%). Meanwhile, 20.00% of participants were the baby Boomer or the age of 47-66 years old. Based on the education of participants, 51.70% of them hold a bachelor degree. 33.30% got technical certificates, and 15% has the master and doctoral degree. Regarding their marital status, respondents (70%) were married, divorced, or separated. 18% of them was single. The information is presented in Table 3.3.

Third, the participants from 14 hotels, there were 54 females (69.20%), and 24 males (30.80%). They were born in 1964 to 1987. Their age was 36-46 years old, and they are Gen X. Thus, it was 48.70%. For the age of 18-35 years old or Gen Y, They were 46.20%. However, there was 5.10% of the age 47-66 years old or Baby Boomer. Regarding the educational level of respondents, 80.80% of respondents got a bachelor degree. 16.70% hold a technical certificate. Meanwhile, 2.60% of those respondents completed the master and doctoral degrees. Based on the marital status, 70% of the respondents were single. Conversely, 25.50% of them were married, divorced, or separated. The information shown in Table 3.3

The sample profiles		Frequency	Percentage
Industry	Automotive	60	14.90
	Electric and Electronic	265	65.80
	Hotel	76	19.40
Gender	Male	194	48.10
	Female	209	51.90
Generation	Gen Y	96	23.80
	Gen X	258	64.00
	Baby boomer	49	12.30
Education	Technical certificate	112	27.80
	Bachelor's degree	239	59.30
	Master or Doctoral degrees	52	12.90
Marital status	Single	194	48.10
	Married, separated, divorced	209	51.90

Table 3.1: Sample Profiles

The sample profiles of electronic and electric industries		Frequency	Percentage
Gender	Males	120	45.30
	Females	145	54.70
Generation	Gen Y	50	18.90
	Gen X	182	68.70
	Baby boomer	33	12.50
Education	Technical certificate	79	29.80
	Bachelor's degree	145	54.70
	Master or Doctoral degrees	41	15.50
Marital status	Single	121	45.70
	Married, separated, divorced	144	54.30

Table 3.2: Sample profiles by electronic and electric sector

The sample profiles of automotive sector		Frequency	Percentage
Gender	Males	50	83.30
	Females	10	16.70
Generation	Gen Y	10	16.70
	Gen X	38	63.30
	Baby boomer	12	12.00
Education	Technical certificate	20	33.30
	Bachelor's degree	31	51.70
	Master or Doctoral degrees	9	15.00
Marital status	Single	12	30.00
	Married, separated, divorced	42	70.00

Table 3.3 Sample profiles by Automotive sector

The sample profiles of hotel sector		Frequency	Percentage
Gender	Males	24	30.80
	Females	54	69.20
Generation	Gen Y	36	46.20
	Gen X	38	48.70
	Baby boomer	4	5.10
Education	Technical certificate	13	16.70
	Bachelor's degree	63	80.80
	Master or Doctoral degrees	2	2.60
Marital status	Single	55	70.50
	Married, separated, divorced	23	29.50

Table 3.4 Sample profiles by Hotel sector

3.2 Research questions and hypotheses

In this study, research's question (1) 'what is the homogenous culture?' Hofstede (1990) indicated that culture is a homogeneous feeling. It could be implied that people's perception in culture is indifferent. However, Stedham and Yamamura (2004) found that the perception of culture was different between genders. Thus, the perceptions of culture could be varied. In addition, generations, personal demographics and working situational characteristic could have influential effects in work engagement and workaholism. Therefore, this study aims for the answers of the hypothesized statement (1):

H1(a) The scores of Hofstede's cultural dimensions are different among personal demographics and working situational characteristic.

H1 (b). The levels of work engagement are different among personal demographics and working situational characteristic.

H1(c) The levels of workaholism are different among personal demographics and working situational characteristic.

Hofstede's cultural dimensions include power distance, masculinity, individualism, uncertainty avoidance, and long-term orientation. *Work engagement* consists of vigor, dedication, and absorption. *Workaholism* consists of excessive work and compulsive work. The variables of *personal demographic* include genders, generation, levels of education, and marital status. The variables of *work situation characteristic* include organizational tenure, positions, divisions, and current position tenure.

	Power distance	Masculinity	Individualism	Uncertainty avoidance	Long term orientation	Work engagement	Workaholism
Sex	Differ	Differ	Differ	Differ	Differ	Differ	Differ
Generation	Differ	Differ	Differ	Differ	Differ	Differ	Differ
Education	Differ	Differ	Differ	Differ	Differ	Differ	Differ
Marital status	Differ	Differ	Differ	Differ	Differ	Differ	Differ
Organizational Tenure	Differ	Differ	Differ	Differ	Differ	Differ	Differ
Position	Differ	Differ	Differ	Differ	Differ	Differ	Differ
Division	Differ	Differ	Differ	Differ	Differ	Differ	Differ
Tenure in current position	Differ	Differ	Differ	Differ	Differ	Differ	Differ

Table 3.5 Summary of hypotheses (1a) (1b) (1c)

Research question (2), Does the culture influence on work engagement and workaholism. To find which dimension impacts on the level of work engagement and workaholism, thus the hypotheses 2 and 3 are:

H2 Hofstede’s cultural dimensions influence on work engagement.

H3 Hofstede’s cultural dimensions influence on workaholism.

	Work engagement	Vigor	dedication	absorption	Workaholism	Work excessively	Work compulsively
Power distance	relate	relate	relate	relate	relate	relate	relate
Masculinity	relate	relate	relate	relate	relate	relate	relate
Individualism	relate	relate	relate	relate	relate	relate	relate
Uncertainty avoidance	relate	relate	relate	relate	relate	relate	relate
Long term orientation	relate	relate	relate	relate	relate	relate	relate

Table 3.6 Summary of hypotheses (2) (3)

Research question (3), Does workaholism is a dark side of work engagement?
 Hallbesleben and Bolino (2009) explains the downside of work engagement. When engaged employees become too engaged or over-engagement, they may also lead to workaholism. Based on this, the hypothesis 4 is,

H4 Work engagement is related with workaholism.

	Workaholism	Work excessively	Work compulsively
Work engagement	relate	relate	relate
Vigor	relate	relate	relate
Dedication	relate	relate	relate
Absorption	relate	relate	relate

Table 3.7 Summary of hypotheses (4)

3.3 Research model

There are four parts in the research model:

1) to survey whether Hofstede's cultural dimensions is related to power distance, individualism versus collectivism, masculine versus feminine, uncertainty avoidance, and long-term orientation, the level of work engagement, and the level of workaholism.

2) to compare cultural dimensions, work engagement, workaholism level

among personal demographics, together with work situation characteristics

3) to find the relationships between cultural dimensions and work engagement, together with workaholism

4) to find the influence of work engagement on workaholism.

Moreover, how culture drives work engagement, and workaholism will discuss, in order to create the model of work engagement driven by culture, orientation to workaholism. The model presents which cultural dimensions have a relationship with work engagement and workaholism, and the relationship between work engagement and workaholism

The expected results from this study are from the result of the four parts of research model. In addition, the work engagement model is under the culture context. These will be helpful in work engagement development, and decreasing workaholism in organization, in addition to understand the influence of culture on work engagement and workaholism. Furthermore, the numbers of sub-variables, which combine in each variable, are presented by a full model. This is explained in the figure 4.1 as follows:

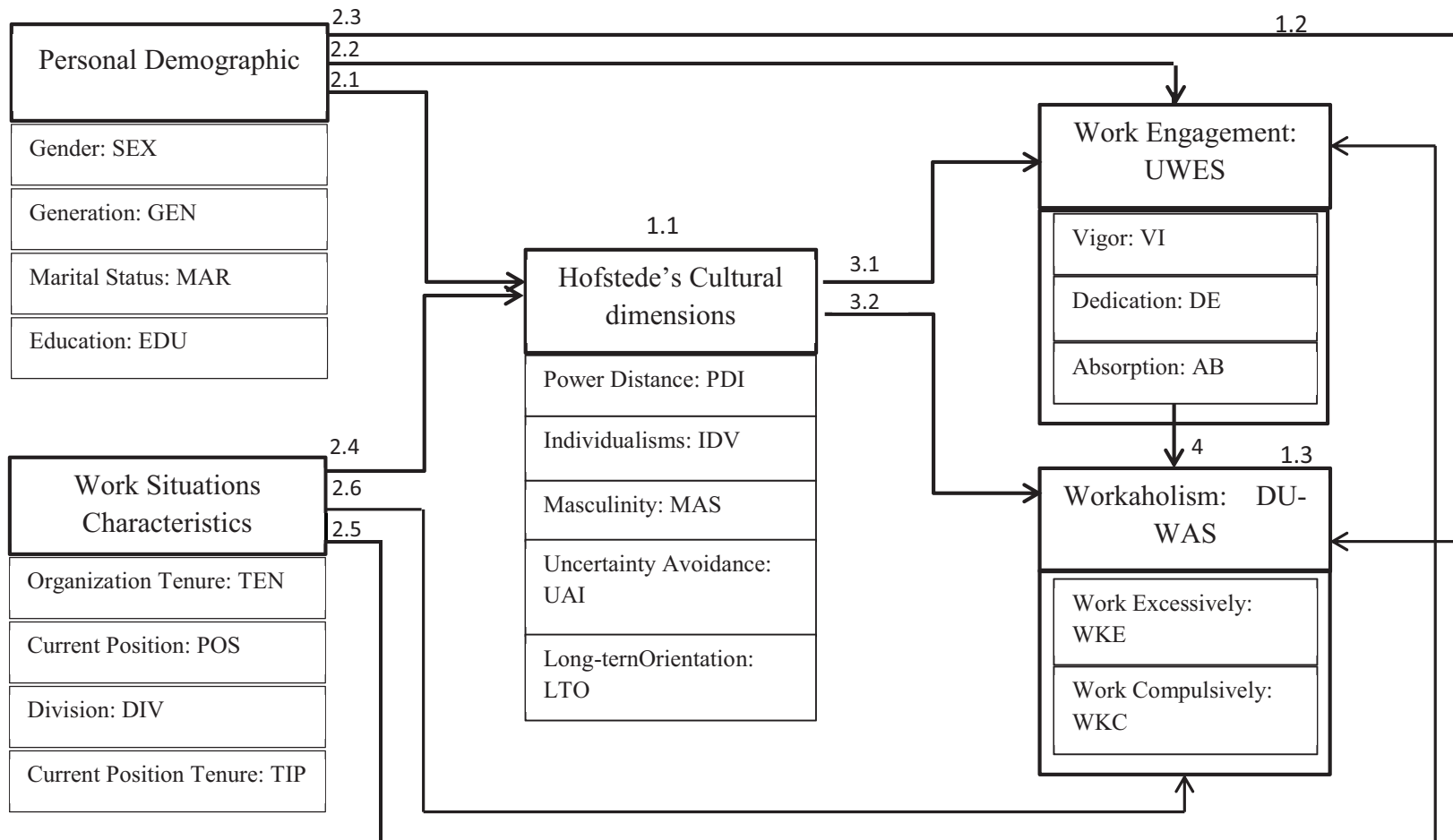

Figure 3.1 Research Model

3.4 Data collection procedures

The questionnaire was divided into five sections. Also, it contained six pages. The section 1 consisted of the introduction and the objectives of questionnaire. The section 2 contained the personal demographics. These were gender, generations, education, and marital status. The section 3 consisted of the work situation characteristics, division, organizational tenure, together with position and tenure in current position. Regarding to section 4, it contained Hofstede's cultural dimensions with questions related to the aspect of national culture. This was developed from Hofstede's questionnaire. The section 5 concerned the questions of workaholism level, and section 6 contained the questions of work engagement. This related to the engaged level to work.

Based on designed questionnaires, 620 questionnaires were distributed to participants. They worked for the organizations of automobile, hotel, and electric and electronics industry. These questionnaires were sent to the participants by mail. This was a postal survey. As a result, 403 questionnaires were returned to the sender by mail.

3.5 Variables and measurement

Personal demographics consists of four variables, they are measured by single items,

1. Gender (GEN): male and female
2. Generation (GENR): Baby Boomer, Gen X , and Gen Y
3. Educational level (EDU): technical certificate, bachelor degree, and master and doctoral degree.

4. Marital status (MAR): single and married (including divorced and separated).

Work situation characteristics compose of four variables. They are measured by single items.

1. Division (DIV): support units and others.
2. Position (POS): staff, supervisor, middle manager, and higher manager
3. Organisational tenure (TEN): less than 5 years, 6-10 years, 11-15 years, 16-20 years, and more than 20 years
4. Tenure in current position (TIC): less than 5 years, 6-10 years, 11-15 years, 16-20 years, and more than 20 years

In terms of Hofstede's cultural dimensions, they were assessed by a culture survey. This was developed by Dorfman and Howell (1989). Based on this part, a set of questionnaire consisted of five culture value, 28 items. These composed of 6 items of a power distance, 7 items of the uncertainty avoidance, the individualism versus collectivism for 4 items. In addition, the masculinity versus femininity had 5 items, uncertainty avoidance 7 items, together with 5 items of the long-term orientation.

Regarding the scoring, Likert scale ranging was used, from 1 to five. This explained that 1 means strongly disagree, 2 means disagree, 3 means neutrals, 4 means agree, and 5 means strongly agree. Based on the measurement, a high score indicated a high level of culture value in each dimension. Meanwhile, a questionnaire in Thai version (28 items) regarding to Hofstede's cultural dimensions were applied to a study of Watcharasriroj et al (2005), Prasongsukarn (2009). It also was approved by a specialist. The questions of Hofstede's culture survey were presented as follows.

Power distance: PDI, expresses the degree is less powerful members of a society. Also, a society accepts and expects that the power is distributed unequally. Meanwhile, people in a large power distance society accept a hierarchy. However, people in societies with a low power distance demand the equality of power (Hofstede, 1990). Thus, this dimension was assessed by six items. These are:

- PDI_1 Managers should make the decisions without consulting subordinates
- PDI_2 It is frequently necessary for a manager to use the authority and power when dealing with subordinates.
- PDI_3 Managers should seldom ask employees for their opinions.
- PDI_4 Employees should not disagree with the management team's decisions.
- PDI_5 From your working experience, the employees always are afraid of the disagreement from the higher positions.
- PDI_6 Managers should not delegate the important tasks to an employee.

Individualism versus collectivism: IDV refers to people's self image. Thus, it is defined as 'I' or 'we'. The high side of this dimension is called individualism. They are expected to take care of only themselves and their intermediate families.

In opposition, collectivism represents an individual can expect their relatives or members of a particular in-group to look after them in exchange for unquestioning loyalty (Hofstede, 1990). This dimension was measured by four items as follow:

- IDV_1 Group welfare is more important than individual reward.
- IDV_2 Group success is more important than individual success.
- IDV_3 Being accepted by the members in your workgroup is very important.
- IDV_4 Employees should pursue their goals after considering group welfare.

Masculinity versus femininity dimension (MAS), masculinity expresses a preference in society to the achievement, heroism, assertiveness, material rewards for success, and competitiveness. In terms of femininity, this is the preference for cooperation, modesty, and caring for the weak and quality of life (Hofstede, 1990). This dimension was assessed by five items below:

MAS_1 Meetings are usually run effective when they are chaired by a man

MAS_2 It is preferable to have a man in a high level position rather than a woman.

MAS_3 It is more important for men to have a professional career than women.

MAS_4 Men usually solve the problems by logical analysis. Meanwhile, women use the intuition to solve the problems.

MAS_5 Solving organisational problems usually require an active, together with the forcible approach that is typical for men.

Uncertainty avoidance: UAI, presents the degree that the members of a society feel uncomfortable between uncertainty and ambiguity. Strong uncertainty avoidance societies maintain the rigid codes of belief and behavior. They are intolerant of unorthodox behavior and ideas. In contrast, weak uncertainty avoidance societies maintain a more relaxed attitude which practise counts more than principles (Hofstede, 1990). This dimension was assessed by seven items. These are:

UAI_1 It is important to have job requirements and instructions in details. Thus, those employees always know what they are expected to do.

UAI_2 Managers expect workers to closely follow the instructions and the procedures.

- UAI_3 Rules and regulations are significant because they inform workers what the organisation expects from them.
- UAI_4 Standard operating procedures are beneficial for the employees on the job.
- UAI_5 Instructions for the operations are important for the employees on the job.
- UAI_6 Competitions among employees cause the adverse effects more than the goodness.
- UAI_7 Employees should not break the rule, even if that rule would be beneficial for the company.

Long-term orientation: LTO, the high score of this dimension indicated that long-term orientation societies take more pragmatic approach. They encourage thrift and efforts in modern education. This is a way to prepare for the future. Meanwhile, a short-term orientation prefers the maintaining time-honored traditions and norms while social change with suspicion (Hofstede, 1990) This dimension was measured by five items as follow:

- LTO_1 Thrift is significant in the workplace.
- LTO_2 Persistence is important in the workplace.
- LTO_3 Employees' ethics are important.
- LTO_4 Employees should follow the same practice in the past.

Work Engagement was assessed by 17-items Utrecht Work Engagement Scales (UWES-17; Schaufeli and Bakker, 2004). the UWES-17 consists of three subscales; vigor, dedication, and absorption. These reflect the underlining dimensions of work engagement. Each item was scored on a 7-point Likert scale ranging from never. This could be explained that 0= never, almost never (1= a few times a year or less), rarely (2= once a month or less), sometime (3 = a few time a month), often (4= once a week), very often (5= a few times a week), and always (6= every day). A high score shows a high level of work engagement. A Thai version of UWES-17 was translated by researcher. Also, UWES-17 was approved and translated back by specialists.

Vigor: VI, is characterised by the high levels of energy and mental resilience while working, the willingness to invest effort in one's work, and the persistence in the face of difficulties (Schaufeli and Bakker, 2004). These are measured by six items as follow.

- Item_1 At my work, I feel bursting with energy.
- Item 4 At my job, I feel strong and vigorous.
- Item_8 When I get up in the morning, I feel like going to work.
- Item_12 I can continue working for very long periods at a time.
- Item_15 At my job, I am very resilient mentally.
- Item_17 At my work, I always persevere, even when things do not go well.

Dedication: DE, is identified by a sense of significance, enthusiasm, inspiration, pride, and challenge (Schaufeli and Bakker, 2004). These are measured by five items as below.

- Item_2 I find a work that it is full-fill meaning and purpose.
- Item_5 I am enthusiastic with my job.
- Item_7 My job inspires me.
- Item_10 I am proud of my work.
- Item_13 To me, my job is challenging.

Absorption: AB, is characterized by being fully concentrated and happily that engrossed in one's work, whereby time passes quickly. Also, one has difficulties with detaching oneself from work (Schaufeli and Bakker, 2004), These are measured by six items as follow,

- Item_3 Time flies when I am working.
- Item_6 I forget everything else around me while I am working.
- Item_9 I feel happy while I am working intensely.
- Item_11 I am immersed in my work.
- Item_14 I get carried away while I am working (คืออะไร)
- Item-16 It is difficult to detach myself from job.

Workaholism was measured by the Dutch Workaholism Scale: DUWAS (Schaufeli et al., 2009). The DUWAS composes of two subscales. These are working excessively and working compulsively. For working excessively, it consists of 10 items, item_1, 3, 4, 6, 8, 10, 12, 13, 15, 17. Meantime, working compulsively composes of 7 items, item_2, 5, 7, 9, 11, 14, 16. The two subscales are supported by Beek et al. (2011). This distinguishes workaholism employees from other hard-working employees. Workaholism should be measured both work excessively and work compulsively. All items are scored on a four-point rating scale, ranging from 1 = never to 4= always. A high score shows a high level of workaholism. A Thai version of DUWAS was translated by researcher. Also, DUWAS was approved and translated back by specialists.

Work excessively: WKE, refers to work hard, this tends to allocated the exceptional much time to work and work beyond what is reasonably expected to meet oragnisational or economic requirement (Schaufeli et al, 2008). Work excessively is measured by 10 items as follow.

- WKE_1 I dislike overwork.
- WKE_2 I seem to be in a hurry and race against the clock.
- WKE_3 I find myself continuing work after my co-workers have called it quits
- WKE_4 I am busy and keep my irons in the fire.
- WKE_5 I overly commit myself by biting more off than I can chew.
- WKE_6 I put myself under pressure with self-imposed deadlines when I work.

- WKE_7 I spend more time working than socializing with friends, on hobbies, or on leisure activities.
- WKE_8 I feel guilty while I am not working on something.
- WKE_9 I find myself doing two or three things at one time such as eating lunch and writing a memo, while talking on the phone.
- WKE_10 It is hard for me to relax when I do not work.

Work compulsively: WKC is recognized that the workaholism are obsessed with work. Also, it is persistently and frequently thinks regarding work, even not working (Schaufeli et al, 2008). Work compulsively is measured by 7 items:

- WKC_1 I often wish I do not commit to my work.
- WKC_2 It is important for me to work hard even when I do not enjoy what I am doing.
- WKC_3 I often find myself thinking about work even when I want to get away from it for a while.
- WKC_4 I seem to have an inner compulsion to work hard, a feeling that It is something I have to do whether I want to or not.
- WKC_5 I often feel that there is something inside me that it drives me to work hard.
- WKC_6 I feel obliged to work hard, even when it is not enjoyable.
- WKC_7 I feel guilty when I take time off work.

3.6 Validity and reliability of measures

According to the Thai version of Hofstede cultural dimensions, work engagement, together with workaholism scale were translated from English to Thai version by researchers. In addition, they were translated back into English by a specialist. Based on this, the translation back policy (Brislin's, 1970) and questionnaires' tryout for reliability testing, 30 samples, were done.

The Cronbach's alpha values of PDI, IDV, MAS, UAI and LTO are .60, .64, .80, .48, and .54 respectively. Otherwise, the Cronbach's alpha value of UWES, VI, DE, and AB are .87, .80, .78, and .56 respectively. Lastly, the Cronbach's alpha value of DUWAS, WKE, and WKC are .84, .72, and .72 respectively.

3.7 Data analysis procedures

This present study used SPSS program (22.0) for data analysis. The analysis was divided into three parts:

- (1) Pearson relation was used for analyzing relationships between culture dimension and work engagement and workaholism, including work engagement and workaholism, to test hypotheses H2, H3, and H4
- (2) T-test and ANOVA were used in the comparison of meaning and to test hypothesis H1(a), H1 (b), and H1(c)
- (3) Mean average and standard deviation were used in the measuring of

Hofstede's culture score, work engagement level and workaholism level, the detail as follows,

Hofstede's cultural dimensions, the score of dimension would be between 0 to 100 that are categorized as follow.

Average score 0.00-20.00 = very low cultural characteristics

Average score 20.01-40.00 = low cultural characteristics

Average score 40.01- 60.00 = medium cultural characteristics

Average score 60.01 – 80.00 = high cultural characteristics

Average score 80.01 – 100.00= very high cultural characteristics

$$PDI = 3.33(\text{mean of PDI}_1) + 3.33(\text{mean of PDI}_2) + 3.33(\text{mean of PDI}_3) + 3.33(\text{mean of PDI}_4) + 3.33(\text{mean of PDI}_5) + 3.33(\text{mean of PDI}_6).$$

The result would be between 0 (small / low power distance) to 100 (large/high power distance).

$$UAI = 2.86(\text{mean of UAI}_1) + 2.86(\text{mean of UAI}_2) + 2.86(\text{mean of UAI}_3) + 2.86(\text{mean of UAI}_4) + 2.86(\text{mean of UAI}_5) + 2.86(\text{mean of UAI}_6) + 2.86(\text{mean of UAI}_7).$$

The result would be between 0 (low uncertainty avoidance) to 100 (high uncertainty avoidance).

$$IDV = 5.00(\text{mean of IDV}_1) + 5.00(\text{mean of IDV}_2) + 5.00(\text{mean of IDV}_3) + 5.00(\text{mean of IDV}_4).$$

The result would be between 0 (low individualist or tendency to collectivist) to 100 (high individualist or tendency to individualist)

$MAS = 4.00(\text{mean of MAS}_1) + 4.00(\text{mean of MAS}_1) + 4.00(\text{mean of MAS}_2) + 4.00(\text{mean of MAS}_3) + 4.00(\text{mean of MAS}_4)$.

The result would be between 0 (low masculinity or tendency to feminist) to 100 (high masculinity or tendency to masculinity).

$LTO = 3.33(\text{mean of LTO}_1) + 3.33(\text{mean of LTO}_2) + 3.33(\text{mean of LTO}_3) + 3.33(\text{mean of LTO}_4) + 3.33(\text{mean of LTO}_5) + 3.33(\text{mean of LTO}_6)$.

The result would be between 0 (short-term orientation) to 100 (long-term orientation)

Thus, the specific meanings of the scores of Hofstede's cultural dimensions are present in table 3.8.

Cultural dimensions	Low score	High score
Power distance	Small power distance	Large power distance
Collectivism versus Individualisms	Collectivism	Individualism
Masculinity versus Femininity	Femininity	Masculinity
Uncertainty avoidance	Low uncertainty avoidance	High uncertainty avoidance
Long-term orientation	Short-term orientation	Long-term orientation

Table 3.8 Specific meaning of Hofstede's cultural dimensions

Work engagement level is considered scores as follow:

- Scores ranging from 0.01-2.00 = low work engagement
- Scores ranging from 2.01-4.00 = moderate work engagement
- Scores ranging from 4.01-6.00 = high work engagement

Workaholism level, is considered scores as follow:

- Scores ranging from 1.00-2.00 = low workaholism
- Scores ranging from 2.01-3.00 = moderate workaholism
- Scores ranging from 3.01-4.00 = high work workaholism

3.8 Summary

Data was collected by a questionnaire that contained 60 items. It consists of four parts. There are personal demographics (4-items), work situation characteristics (4-items), culture survey (26 items), work engagement survey (17 items), and workaholism survey (17 items). The questionnaires were distributed by post to employees. They worked in the different organizations: hotel, automobile, and electric and electronic sectors. The questionnaires were returned to sender by post. After that, data was analyzed by SPSS program version 22.0, mean, standard deviation t-test, ANOVA, and Pearson correlation. Then the results of data analysis are presented next chapter.

Chapter IV

Findings

This chapter consists of five parts. The first part presents general analysis: descriptive analysis, the score of five dimensional cultures, the levels of work engagement, and the levels of workaholism. The second part presents the comparison of mean scores of culture, work engagement, and workaholism among personal demographics, and working situation characteristics. The third part presents the correlation between culture and work engagement, culture and workaholism, and work engagement and workaholism. The fourth part presents hypothesis testing, and the final part is summary.

4.1 General analysis

This general analysis composes of descriptive analysis, means comparative study and correlated analysis among variables.

4.1.1 Descriptive analysis

The details of all variables will be presented in the forms of descriptive statistics: frequency, percentile, mean, and standard deviation. The table 4.1 describes the number of dependent variables, personal demographic and working situational characteristics based on 403 questionnaires from three sectors: 78 from the hotels (15%), 60 from automobile (19%), and 265 from electrical and electronic (76%). The result shows that

- 1) There is a substantial different number among generations and education levels. The numbers of Gen-X (64%) is higher than the other two generations: baby-boomers and Gen-Y (36%). The number of bachelor's degree (59%) is higher than the rest (41%).
- 2) There is marginally distinction between Genders (male 48%, female, 52%), marital status (single 48%, married and others 52%), divisions (support 58%, non-support 42%), positions (staff 47%, leader 53%), organization tenures (less than 10 years, 57%, more than 10 years 43%), and tenure in current position (less than 5 years 43%, 5 years and more 57%).

Personal Demographics	Categories	Number	Per.	Work Situation Characteristics	Categories	Number	Per.
Gender	Male	194	48 %	Organization tenure	<5	108	27%
	Female	209	52 %		6-10	120	30%
Generation	Baby-Boomer	49	12%		11-15	64	16%
	Gen-X	258	64%		15-20	48	12%
	Gen-Y	96	24%		>20	63	16%
Education	< Bachelor	112	28%	Division	Support	235	58%
	= Bachelor	239	59%		Non-support	168	42%
	> Bachelor	52	13%	Position	Staff	188	47%
Marital Status	Single	194	48%		Supervisor	120	30%
	Married	185	46%		Middle manager	33	8%
	Others	24	6%		Higher manager	62	15%
					Year in current Position	<5	171
				5-10		157	39%
				11-15		37	9%
				15-20		26	6%
				>20		12	3%

Table 4.1 Frequencies of personal demographics and work situation characteristics variables

The result in table 4.2 provides the overall scores of Hofstede’s cultural dimensions, work engagement, and workaholism.

Culture Survey			Work Engagement Survey			Workaholism Survey		
<i>Dimensions</i>	<i>Mean</i>	<i>S.D.</i>	<i>Types</i>	<i>Mean</i>	<i>S.D.</i>	<i>Types</i>	<i>Mean</i>	<i>S.D.</i>
PDI	3.43	.499	Work Engagement	4.68	.725	Workaholism	2.42	.451
IDV	2.82	.769	VI	4.47	.813	WE	2.38	.469
MAS	3.66	.527	DE	5.15	.803	WC	2.45	.470
UAI	4.03	.451	AB	4.43	.857			
LTO	3.75	.455						

Table 4.2 Hofstede’s cultural dimensions, work engagement, and workaholism level

The means and standard deviations of Hofstede’s cultural dimensions, work engagement, and workaholism in various business sectors: hotel, automobile, and electric and electronic, are presented in table 4.3.

Furthermore, the values of variables among groups are equally by a test of homogeneous variances, and a test of equal means by Welch statistic. It is found that the mean scores from UAI among the groups of hotel, automobile, and electric and electronic are significantly different with level 0.05, p-value =0.49. In contrast, when using Scheffe’s in multiple comparisons, the results of means are not significantly different. However, it is found that there is constitutional difference among the means of hotel

and electric and electronic group by using LSD in multiple comparisons. UAI score of the hotel is lower than an electric and electronic group with significant level 0.05, P value = 0.23 (appendix A).

Mean scores of Variables	Hotel N = 78		Automobile n= 60		Electric and Electronic n = 265	
	Mean	S.D.	Mean	S.D.	Mean	S.D.
PDI	3.44	.517.	3.45	.537	3.42	.487
IDV	2.83	.760	2.84	.827	2.81	.760
MAS	3.69	.594	3.64	.508	3.66	.511
UAI	3.93	.478	3.97	.371	4.07	.455
LTO	3.72	.483	3.67	.445	3.77	.447
EE	4,78	.607	4,63	.651	4.66	.770
VI	4.50	.718	4.42	.780	4.47	.848
DE	5.27	.727	5.11	.716	5.11	.842
AB	4.78	.761	4.37	.780	4.39	.897
AHO	2.32	.437	2.37	.471	2.45	.447
WkE	2.30	.453	2.34	.498	2.41	.465
WkC	2.34	.494	2.40	.495	2.48	.452

Table 4.3, Cultural dimensional scores of work engagement and workaholism level among three sectors.

4.1.2 Hofstede's cultural scores

Hofstede's cultural dimensions were assessed by adapting 28 items from Hofstede's cultural survey (Hofstede, 1984) consisting of five dimensions: power distance (PDI- 6 items), uncertain avoidance (UAI-7 items), individualism versus collectivism (IDV-4 items), masculinity versus femininity (MAS-5), and long-term orientation (LTO-6). The frequencies of responses to Hofstede's cultural dimensions are illustrated in table 4.4 – 4.8. The respondents are as followed:

As far as PDI is concerned, three-quarters of samples have strongly agreed that managers should not delegate important tasks to employees as can be seen from PDI_6 (78.2%). On the contrary, only one-fourth has strongly agreed that managers should make most decisions without consulting subordinates as can be seen from PDI_1 (27.8%).

Question	Mean	S.D	Percent of respondents				
			Strongly Disagree	Disagree	Neutral	Agree	Strongly Agree
PDI_1	2.94	1.07	9,2%	24,1%	39,0%	18,9%	8,9%
PDI_2	3.60	0.81	1,5%	6,2%	33,3%	48,9%	10,2%
PDI_3	3.64	0.99	2,7%	11,4%	23,6%	43,7%	18,6%
PDI_4	2.67	0.95	7,7%	40,2%	33,7%	14,6%	3,7%
PDI_5	3.67	0.93	2,7%	6,0%	23,1%	48,6%	19,6%
PDI_6	4.00	0.88	2,0%	3,5%	16,4%	48,9%	29,3%

Table 4.4 Power Distance: PDI score among respondents

In terms of UAI, more than four-fifths of respondents have strongly agreed that it is important to specify details in job requirements and instructions so that employees always know what they are expected to do (UAI_1: 90.3%). They also need the management to inform rules and regularities as they will know what the organizations expect from them (UAI_3:91.5%). Moreover, it is seemed that it could be helpful if the company notifies standard operating procedures in the job to the employees (UAI_4: 93.1%).

Question	Mean	S.D	Percent of respondents				
			Strongly Disagree	Disagree	Neutral	Agree	Strongly Agree
UAI_1	4.37	0.68	0,0%	1,0%	8,7%	42,9%	47,4%
UAI_2	4.11	0.78	0,7%	1,0%	18,4%	46,7%	33,3%
UAI_3	4.33	0.66	0,0%	1,0%	7,4%	49,1%	42,4%
UAI_4	4.39	0.63	0,0%	0,5%	6,5%	46,9%	46,2%
UAI_5	4.31	0.72	0,2%	0,2%	12,7%	42,2%	44,7%
UAI_6	3.30	1.08	5%	16,1%	40,2%	21,6%	17,1%
UAI_7	3.42	0.95	2,5%	11,7%	40,2%	32,3%	13,5%

Table 4.5 Uncertain avoidance: UAI scores among respondents

According to IDV, more than two-third of respondents feels strongly disagree to neutral in all of IDV items (IDV_1: 81.7%). It is found that group welfare is more important than individual rewards (IDV_2 :66.9%). As well as this, group success is more important than individual success (IDV_3:79.1%). Feeling of being accepted is very important (IDV_4:74.1%). It seems that employees will pursue their goals after the management considers the group welfare.

Question	Mean	S.D	Percent of respondents				
			Strongly Disagree	Disagree	Neutral	Agree	Strongly Agree
IDV_1	2.63	0.00	13,9%	30,3%	37,5%	15,9%	2,5%
IDV_2	3.01	0.97	7,4%	20,3%	39,2%	29,3%	3,7%
IDV_3	2.77	0.94	10,4%	24,8%	43,9%	18,9%	2,0%
IDV_4	2.87	0.96	8,4%	24,8%	40,9%	22,8%	3,0%

Table 4.6 Individualism versus Collectivism: IDV score among respondents

Regarding to MAS score, one- third of respondents regarded themselves from disagreeing to strongly disagreeing to have men in higher level positions than women (MAS_2:34%). In contrast, three-fourths of them have strongly agreed that solving organizational problems usually requires an active and forceful approach which is mostly found in typical men (MAS_5:81.6%).

Question	Mean	S.D	Percent of respondents				
			Strongly Disagree	Disagree	Neutral	Agree	Strongly Agree
MAS_1	3.41	0.93	3,0%	9,2%	41,7%	35,7%	10,4%
MAS_2	3.07	1.14	7,7%	26,3%	28,8%	25,3%	11,9%
MAS_3	4.02	0.90	1,5%	4,0%	17,9%	44,2%	32,5%
MAS_4	3.76	0.89	1,7%	6,2%	24,8%	48,4%	18,9%
MAS_5	4.06	0.74	0,5%	1,7%	16,1%	54,8%	26,8%

Table 4.7 Masculinity versus Femininity: MAS score among respondents

In terms of LTO score, three-fourths of respondents strongly agree that thrift is important in a workplace (LTO_2:83.9%). They also found that employees' ethic is important (LTO_5:78.6%). Moreover, people always do whatever they have to in order to keep their social status (LTO_6:78.9%).

Question	Mean	S.D	Percent of respondents				
			Strongly Disagree	Disagree	Neutral	Agree	Strongly Agree
LTO_1	3.17	0.92	3,5%	18,4%	41,9%	30,0%	6,2%
LTO_2	4.12	0.71	0,2%	1,5%	14,4%	54,1%	29,8%
LTO_3	3.88	0.86	2,0%	4,2%	19,1%	53,6%	21,1%
LTO_4	3.46	0.92	2,7%	10,2%	36,7%	39,2%	11,2%
LTO_5	3.89	0.72	0,5%	4,0%	16,9%	63,0%	15,6%
LTO_6	4.00	0.79	1,0%	2,7%	17,4%	53,1%	25,8%

Table 4.8 Long-term orientation: LTO score among respondents

The overall score of each dimension illustrates the level of culture. Those scores could range from 1 to 5 calculated by means and percentages for some answers to specific items. The scores will be calculated scores ranging from 1 (low) to 100 (high).

The results of Hofstede's cultural dimensions after weighting the means are presented as followed,

$$\begin{aligned}
 \text{PDI} &= 3.33 (\text{mean of PDI}_1) + 3.33 (\text{mean of PDI}_2) + 3.33 (\text{mean of PDI}_3) + \\
 &\quad 3.33 (\text{mean of PDI}_4) + 3.33 (\text{mean of PDI}_5) + 3.33 (\text{mean of PDI}_6) \\
 &= .33(2.64) + 3.33(3.60) + 3.33(3.64) + 3.33(2.67) + 3.33(3.67) + 3.33(4.00) \\
 &= 68.63, \text{ the PDI score of power distance is ranged from moderate to high levels.}
 \end{aligned}$$

$$\begin{aligned}
 \text{UAI} &= 2.86 (\text{mean of UAI}_1) + 2.86 (\text{mean of UAI}_2) + 2.86 (\text{mean of UAI}_3) + \\
 &\quad 2.86 (\text{mean of UAI}_4) + 2.86 (\text{mean of UAI}_5) + 2.86 (\text{mean of UAI}_6) + \\
 &\quad 2.86 (\text{mean of UAI}_7) \\
 &= 2.86(4.37) + 2.86(4.11) + 2.86(4.33) + 2.86(4.39) + 2.86(4.31) + \\
 &\quad 2.86(4.30) + 2.86(3.42) \\
 &= 80.71, \text{ the UAI score of uncertain avoidance tends to be high level.}
 \end{aligned}$$

$$\begin{aligned}
 \text{IDV} &= 5.00 (\text{mean of IDV}_1) + 5.00 (\text{mean of IDV}_2) + 5.00 (\text{mean of IDV}_3) + \\
 &\quad 5.00 (\text{mean of IDV}_4) \\
 &= 5.00(2.63) + 5.00(3.01) + 5.00(2.77) + 5.00(2.87) \\
 &= 56.43, \text{ the IDV score between individualism and collectivism is moderate level.}
 \end{aligned}$$

$$\begin{aligned}
\text{MAS} &= 4.00 (\text{mean of MAS}_1) + 4.00 (\text{mean of MAS}_2) + 4.00 (\text{mean of MAS}_3) \\
&\quad + 4.00 (\text{mean of MAS}_4) + 4.00 (\text{mean of MAS}_5) \\
&= 4.00(3.41) + 4.00(3.07) + 4.00(4.02) + 4.00(3.76) + 4.00(4.06) \\
&= 73.33, \text{ the MAS score of masculine is ranged from moderate to high levels.}
\end{aligned}$$

$$\begin{aligned}
\text{LTO} &= 3.33 (\text{mean of LTO}_1) + 3.33 (\text{mean of LTO}_2) + 3.33 (\text{mean of LTO}_3) + \\
&\quad 3.33 (\text{mean of LTO}_4) + 3.33 (\text{mean of LTO}_5) + 3.33 (\text{mean of LTO}_6) \\
&= 3.33(3.17) + 3.33(3.12) + 3.33(3.88) + 3.33(3.46) + 3.33(3.89) + 3.33(4.00) \\
&= 74.98, \text{ the LTO score of long term orientation is considered moderated.}
\end{aligned}$$

The scores of Hofstede's cultural dimensions in this study comparing with Hofstede's survey and the previous cultural surveys are presented in table 4.9.

Hofstede's Culture Score	Culture study comparing		
	This study	Budsakorn, 2005	Hofstede 1977
Power Distance: PDI	66	44	64
Uncertainty Avoidance: UAI	81	83	64
Individualism and Collectivism	56	55	20
Masculine and Feminine	73	19	34
Long-term Orientation: LTO	75	40	32

Table 4.9 Comparing of Hofstede's cultural dimension scores among three studies.

4.1.3 Work engagement level

Work engagement was assessed by utilizing 17 items of questionnaire adapted from the Utrecht Work engagement Scale (UWES) (Schaufeli and Bakker, 2003). This consists of three core-components: Vigor (VI- 6 items), Dedication (DE-5 items), and Absorption (AB-7 items). The frequencies of responses to these work engagement items are indicated in table 4.10.

UWES-17	Never	2-3 times per year	Once a month	2-3 times Per month	Once a week	2-3 times per week	Everyday
VI_1	0.7%	0.2%	1.2%	3.2%	13.9%	36.7%	43.9%
VI_2	0.2%	0.0%	1.2%	5.0%	14.4%	43.4%	35.7%
VI_3	8.9%	17.4%	17.6%	15.9%	17.1%	10.7%	12.4%
VI_4	6.0%	2.0%	3.7%	15.4%	18.6%	37.5%	16.9%
VI_5	3.2%	1.0%	2.5%	10.7%	19.9%	39.5%	23.3%
VI_6	0.5%	1.0%	2.2%	8.2%	17.6%	31.5%	39.0%
DE_1	0.5%	0.2%	0.2%	5.5%	7.7%	21.1%	64.8%
DE_2	0.0%	0.0%	0.5%	3.7%	7.7%	34.0%	54.1%
DE_3	0.7%	0.5%	2.5%	4.5%	12.4%	36.0%	43.0%
DE_4	0.2%	0.5%	1.2%	3.7%	8.7%	27.0%	58.6%
DE_5	3.5%	1.5%	5.0%	11.9%	14.9%	36.2%	27.0%
AB_1	2.2%	0.0%	1.0%	3.5%	9.2%	32.3%	51.9%
AB_2	1.7%	0.5%	1.7%	4.2%	16.4%	42.2%	33.3%
AB_3	1.7%	0.2%	2.7%	7.9%	15.9%	38.5%	33.0%
AB_4	10.9%	2.2%	4.5%	13.9%	21.8%	33.5%	13.2%
AB_5	0.2%	0.5%	0.5%	4.7%	10.7%	37.7%	45.7%
AB_6	34.0%	5.2%	7.7%	13.6%	12.9%	19.9%	6.7%

Table 4.10 Work engagement among respondents

According to table 4.10, there are more than three-fourths (80.6%) reported that they feel energetic when they go working with the frequency of two or three days a week to everyday (VI_1). Furthermore, more than half of respondents feel that their jobs are meaningful and purposeful (DE_1). Moreover, they feel enthusiastic about their jobs (DE_2). As well as this, they are proud of their jobs (DE_4). They also feel that

their working time speeds so fast while they are working (AB_1). Finally, one-fourth (26.6%) report that they feel difficult to detach themselves from their work with the frequency of two or three times a week to everyday (AB_6).

The overall score of work engagement presents level of work engagement ranging from 0 to 6. It can be implied the meaning of the scores as followed:

- A score ranging from 0 to 2.99 = low level of work engagement
- A score ranging from 3 to 4.99 = moderate level of work engagement
- A score ranging from 5 to 6.00 = high level of work engagement

The average (mean) scores of work engagement are presented in table 4.11.

Mean scores of Variables	Overall n =403		Hotel n = 78		Automobile n= 60		Electric and Electronic n = 265	
	Mean	S.D.	Mean	S.D.	Mean	S.D.	Mean	S.D.
EE	4.68	.725	4,78	.607	4,63	.651	4.66	.770
VI	4.47	.813	4.50	.718	4.42	.780	4.47	.848
DE	5.15	.803	5.27	.727	5.11	.716	5.11	.842
AB	4.43	.857	4.78	.761	4.37	.780	4.39	.897

Table 4.11 work engagement score

Overall work engagement score ranged from moderate to high (4.68). VI score (4.47) is lower than DE score (5.15) but higher than the AB score (4.43). The scores are slightly different by sectors and they will be tested in the second part.

This table (4.12) shows eight types of workers generated by work engagement components: vigor (high, low), dedication (high, low), and absorption (high, low). The frequencies have been classified into 7 levels: always, very often, often, sometimes, rarely, almost never, and never. However, these can be grouped in to two levels, which are high level scoring in each component between 5 (very often) to 6 (always), and low level scoring between 0 (never) to 4.99 (often).

Type of worker	Number	Percentage	Vigor	Dedication	Absorption
Engaged worker	68	16.90	High	High	High
Non-Absorption worker	45	11.20	High	High	Low
Non-Dedication worker	3	0.70	High	Low	High
Non-vigor worker	55	13.60	Low	High	High
Energy worker	4	1.00	High	Low	Low
Enthusiasm worker	118	29.3	Low	High	Low
Enjoyment worker	2	0.50	Low	Low	High
Disengaged worker	108	26.80	Low	Low	Low
Total	403	100.0			

Table 4.12 Types of work engagement

Regarding to table 4.12, it is found that the number of disengaged workers is higher than engaged workers. Moreover, the number of workers who tend to be disengaged (Enthusiasm: 118, Enjoyment:2, and Energy worker:4) is 124 while 103 workers tend to be engaged (Non-absorption:45, Non-dedication:3, and Non-vigor:55) because they missed only one component of work engagement.

4.1.4 Workaholism score

Workaholism levels were assessed by applying 17 item questionnaire adapted from Dutch Work Addiction Scale (DUWAS) (Schaufeli et al, 2006). In the questionnaire, there are two core-components: excessive working (WE –10 items) and compulsive working (WC – 7 items). The frequencies of responses to the workaholism items will be presented in table 4.13.

DUWAS	Never	Sometime	Often	Always
WE_1	8.7%	66.3%	19.6%	5.5%
WE_2	3.0%	36.5%	39.7%	20.8%
WE_3	14.1%	45.4%	27.0%	13.4%
WE_4	6.5%	52.4%	30.8%	10.4%
WE_5	16.1%	51.4%	25.8%	6.7%
WE_6	13.6%	48.6%	25.8%	11.9%
WE_7	9.2%	46.2%	31.5%	13.2%
WE_8	23.3%	44.9%	23.6%	8.2%
WE_9	23.6%	51.1%	18.1%	7.2%
WE_10	10.4%	34.0%	40.7%	14.9%
WC_1	10.2%	53.8%	29.8%	6.2%
WC_2	6.7%	44.4%	35.2%	13.6%
WC_3	17.4%	50.9%	24.6%	7.2%
WC_4	10.9%	45.4%	33.3%	10.4%
WC_5	10.2%	45.9%	34.7%	9.2%
WC_6	4.5%	25.8%	51.6%	18.1%
WC_7	14.9%	44.2%	33.0%	7.9%

Table 4.13 Workaholism among respondents

As can be seen from table 4.13, more than two-thirds in WE_8 (68.2%) reported that, when they were not working, the frequencies of feeling guilty was ranged from sometimes to never feel guilty. Three – fourths of respondents (74.7%) admitted that they can sometimes manage two to three activities at the same time including those who never do multitasking (WE_9). More than half of them (56.3%) report that they sometimes or never have an inner compulsion to work hard or even the feeling that they have to work whether they want to or not (WC_4). The respondents (56.1%) feel that there are some inner drives causing them to work hard (WC_5). Finally, the respondents (59.1%) feel guilty when they take time off work (WC_7).

The score of workaholism from DUWAS ranges from 1 to 4 which can be implied as followed:

- A score ranging from 1 to 1.99 = low level of workaholism
- A score ranging from 2 to 2.99 = moderate level of workaholism
- A score ranging from 3 to 4.00 = high level of workaholism

The average (mean) scores of workaholism levels are presented in table 4.14.

Mean scores of Variables	Overall n =403		Hotel n = 78		Automobile n= 60		Electric and Electronic n = 265	
	Mean	S.D.	Mean	S.D.	Mean	S.D.	Mean	S.D.
DUWAS	2.42	.451	2.32	.437	2.37	.471	2.45	.447
WE	2.38	.469	2.30	.453	2.34	.498	2.41	.465
WC	2.45	.470	2.34	.494	2.40	.495	2.48	.452

Table 4.14 mean and standard deviation of workaholism score

According to overall mean score, DUWAS (2.42) and WE (2.38) scores are slightly lower than WC (2.45) scores. There are no substantial gaps among scores of three sectors which will be tested later.

Similarly to work engagement, workaholism types can be classified by level of excessive work and compulsive work. In this present study, workaholism level has been divided into four types. High workaholism level will be scored between 3 (often) to 4 (always), and low workaholism level will be scored between 1 (never) to 2.99 (sometime) as followed:

Types	Number	Percent	Work Excessively	Work Compulsively
Relaxed worker	320	79,4	Low	Low
Compulsive worker	33	8,2	Low	High
Excessive worker	20	5.0	High	Low
Workaholism	30	7.4	High	High
Total	403	100,0		

Table 4.15 Types of workaholism

To conclude, there are far fewer people who were categorized as workaholism (7.4%) than non-workaholism or relaxed workers (79.4%) which are four-fifths of respondents. Moreover, the minority of respondents scored high in excessive work (5.0%) and compulsive work (8.2%).

4.2 The mean of comparative analysis

The SPSS program, t-test (for 2 groups) and one-way ANOVA (for more than two groups) will be applied to analyze the mean scores of three dependent variables among two independent variables: personal demographics and work situation characteristics.

Firstly, mean scores of dependent variables (PDI, IDV, MAS, LTO, VI, DE, AB, DE, EE, WE, WC and AHO) among industries are not significantly different with the only exception that UAI score of hotel sector is lower than electric and electronic sector with significant level 0.05 (P-value =0.23).

Personal demographics group

T-test and one-way ANOVA will be utilized to analyze gender, generation, marital status, and education level. Since the number of samples in some groups is markedly fewer than others, generation, marital, and education level will be categorized in the new group.

1. Gender (SEX): From T-test, the results show there is no different between man and woman in Hofstede's cultural dimensions, work engagement and workaholism with significant level 0.05.
2. Generation cohorts (GEN): Since the Gen-X (258) group is far larger than Gen-Y (45) and Baby Boomer (96) combined, generations will be generated into two groups: Gen-Y and Baby Boomer compared with Gen-X. It is found that mean scores of Vigor (VI) is marginally different between those two groups with significant level 0.05 (table 4.16).

Dependent variables	Independent variables	N	Mean	S.D.	T	Sig,
VI Score	Gen-Y and Baby Boomer	145	4.36	.811	-2,091	0.37
	Gen-X	258	4.53	.809		

Table 4.16 VI means compared between two groups of generations

3. Marital status (MAR): Since there are a very few people who were divorced, separated and widowed (24), marital status will be grouped into two groups: married and used to be married (185+24 = 209) and single (194). The result shows that the mean scores from the group of married and used to be married in all independent variables are higher than single's mean score with the significant different with levels of (0.05) in VI, DE, and EE (table 4.17).

Dependent variables	Independent variables	N	Mean	S.D.	T	Sig,
VI Score	Single	194	4.29	.799	-4.22	0.000
	Married and Others	209	4.63	.795		
DE Score	Single	194	5.05	.804	-2.37	0,018
	Married and Others	209	5.23	.894		
EE Score	Single	194	4.57	.725	-2.97	0.003
	Married and Others	209	4.78	.711		

Table 4.17 difference of mean scores in VI, DE, and EE between marital statuses

4. Education Level (EDU): Education levels will be divided into two groups, which are Bachelor's degree group (n=239) and not Bachelor's degree group (n=163) consisting of lower than Bachelor's degree (n=112) and higher Bachelor's degree (n=52). The results are illustrated that mean scores of PDI and IDV are different with significant level of 0.05 (table 4.18).

Dependent variables	Independent variables	N	Mean	S.D.	T	Sig,
PDI	Not Bachelor's degree	164	3.50	.523	2.22	0.027
	Bachelor's degree	239	3.39	.478		
IDV	Not Bachelor's degree	164	2.93	.771	2.521	0.012
	Bachelor's degree	239	2.74	.758		

Table 4.18 Mean PDI and IDV scores between education levels.

Working situation characteristic variables: organizational tenure, division, position, and tenure in current position

1. Organizational tenure (TEN): Since the number of some groups is markedly lower than others, TEN will be re-categorized from 5 groups to 3 groups: less than 5 years, 5-10 years, and more than 10 years. These groups were analyzed by one-way ANOVA. It is found that there are no different in mean scores of Hofstede's cultural dimensions: work engagement and workaholism among organization tenure with significant level 0.05.
2. Division (DIV): This was analyzed by T-test. According to Hofstede's cultural dimensions (work engagement and workaholism), there are no different in mean scores between support and non-support divisions with significant level of 0.05.

3. Position (POS): It is found that are no different in mean scores between staff level and higher level with significant level 0.05.
4. Tenures in current position (TIC): These tenures were re-categorized from 5 groups into 3 groups: lower 5 years, 5-10 years, and more than 10 years. According to Hofstede’s cultural dimensions (work engagement and workaholism), there are no different in mean scores among tenures in current position with significant level 0.05.

The table 4.19 presents the result of the research question (1) what is the culture homogenous? Do the scores of Hofstede’s culture dimensions, work engagement level, and workaholism level differ among personal demographics, and work situation characteristics. The result indicates that the hypotheses 1(a) and H1(b) is particularly accepted, while H1(c) is rejected.

	Power distance	Masculinity	Individualism	Uncertainty avoidance	Long term orientation	Work engagement	Workaholism
Sex	X	X	X	X	X	X	X
Generation	X	X	X	X	X	X	X
Education	Differ	X	Differ	X	X	X	X
Marital status	X	X	X	X	X	Differ	X
Organizational Tenure	X	X	X	X	X	X	X
Position	X	X	X	X	X	X	X
Division	X	X	X	X	X	X	X
Tenure in current position	X	X	X	X	X	X	X

Table 4.19 The results of hypotheses (1a) (1b) (1c)

4.3 Correlation analysis

SPSS Program has been used to analyze the influence of variables effecting to others. The results are sequenced by groups of dependent variables, Hofstede's culture, work engagement, and workaholism as followed:

Q, (2) Do Hofstede's cultural dimensions have a relationship with work engagement?

The correlation analysis by SPSS V 20.0 together with Pearson's statistic, MAS has correlated with work engagement and its components. UAI and LTO have correlated with DE and EE while PDI has correlated only with VI, and IDV has correlated only with AB. These details are presented in table 4.20 and the figure 4.1.

Hofstede's Culture	Correlated Coefficient	Work engagement and components			
		UWES	VI	DE	AB
PDI	Sig, (2-tailed)	-0.68	-115*	-.045	-.021
	P-value	.173	.021	.371	.669
UAI	Sig, (2-tailed)	.132**	.092	.180**	.079
	P-value	.008	.066	.000	.113
IDV	Sig, (2-tailed)	0.44	-0.17	.008	.121*
	P-value	.375	.037	.877	.015
MAS	Sig, (2-tailed)	.153**	.129**	.139**	.135**
	P-value	.002	.009	.005	.007
LTO	Sig, (2-tailed)	.107*	.094	.126*	.065
	P-value	.031	.059	.012	.195

*. Correlation with significant level at 0.05 (2-tailed).

** . Correlation with significant level at 0.01 (2-tailed).

Table 4.20 The correlation between cultural dimensions and work engagement

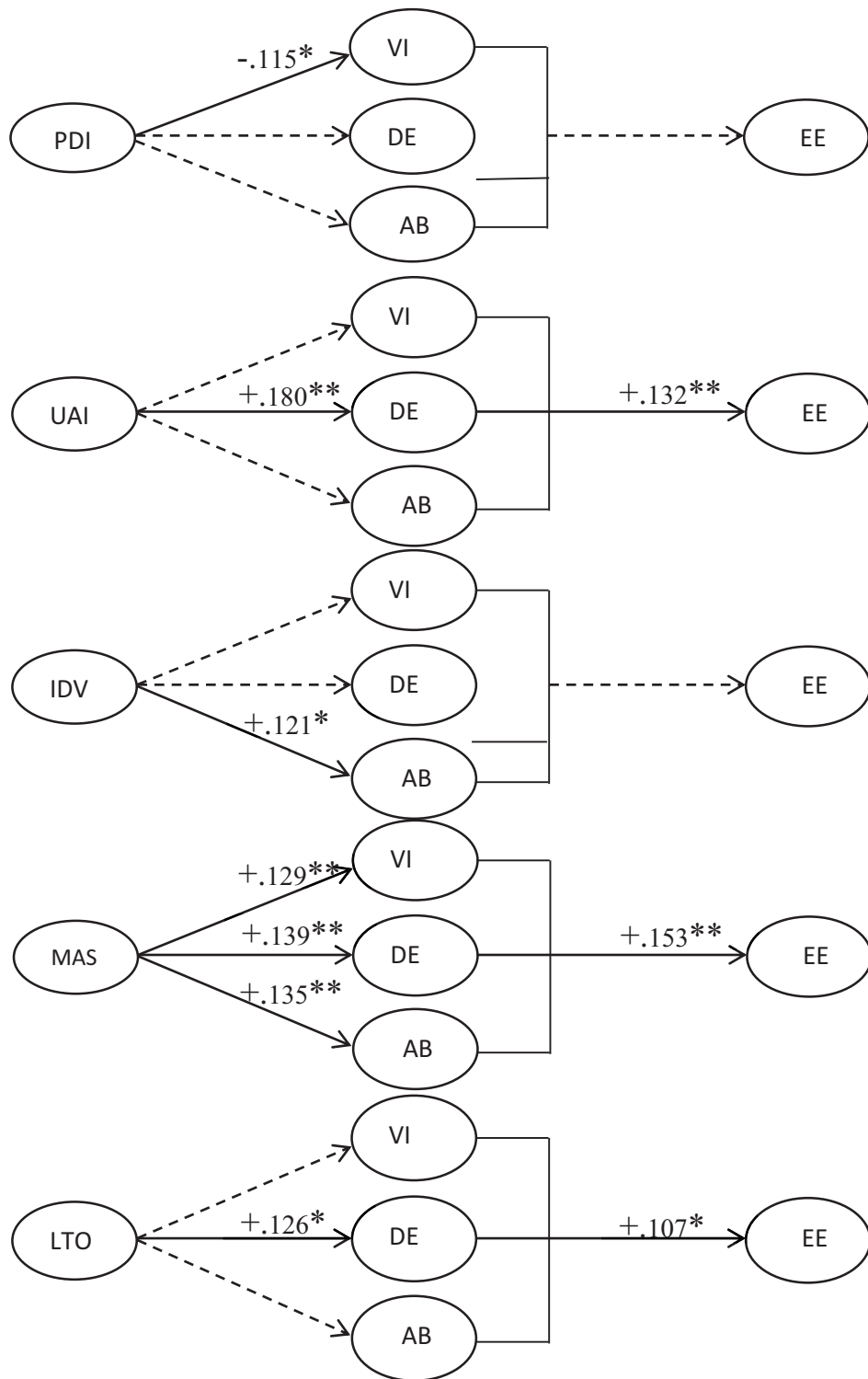

*. Correlation with significant level at 0.05 (1-tailed) (-) negative correlation

**, Correlation with significant level at 0.01 (1-tailed) (+) positive correlation

Figure 4.1 Correlated coefficient values and correlated directions among PDI,UAI,MAS, and LTO with work engagement

The directions of correlations in figure 4.1 present the positive relationship of MAS among VI, DE, AB, and EE while UAI and LTO have a positive relationship with DE and EE. Furthermore, IDV has a positive relationship with only AB, but PDI and IDV have a negative relationship with AB. However, the co-efficiencies of correlated values among variables maintain in low level: from 0.10 to 0.30 (McMillan.2000).

Q (2) Do Hofstede's cultural dimensions have a relationship with workaholism?

It is found that IDV score has not correlated with workaholism and its components while PDI, MAS, and LTO have correlated with workaholism -WE and WC- with significant level of 0.01. UAI score has correlated with workaholism -WC and WE- with significant level of 0.05. The detail is presented in table 4.21 and figure 4.2.

Hofstede's Culture	Correlated Coefficient	Workaholism		
		DUWAS	WkE	WkC
PDI	Sig, (2-tailed)	.171**	.167**	.148*
	P-value	.001	.001	.003
UAI	Sig, (2-tailed)	.115*	.108*	.124*
	P-value	.021	.030	.012
MAS	Sig, (2-tailed)	.211**	.189**	.221*
	P-value	.000	.000	.000
LTO	Sig, (2-tailed)	.163**	.138**	.176**
	P-value	.001	.006	.000

*. Correlation with significant level at 0.05 (2-tailed).

**. Correlation with significant level at 0.01 (2-tailed).

Table 4.21 Correlation between cultural dimensions and workaholism

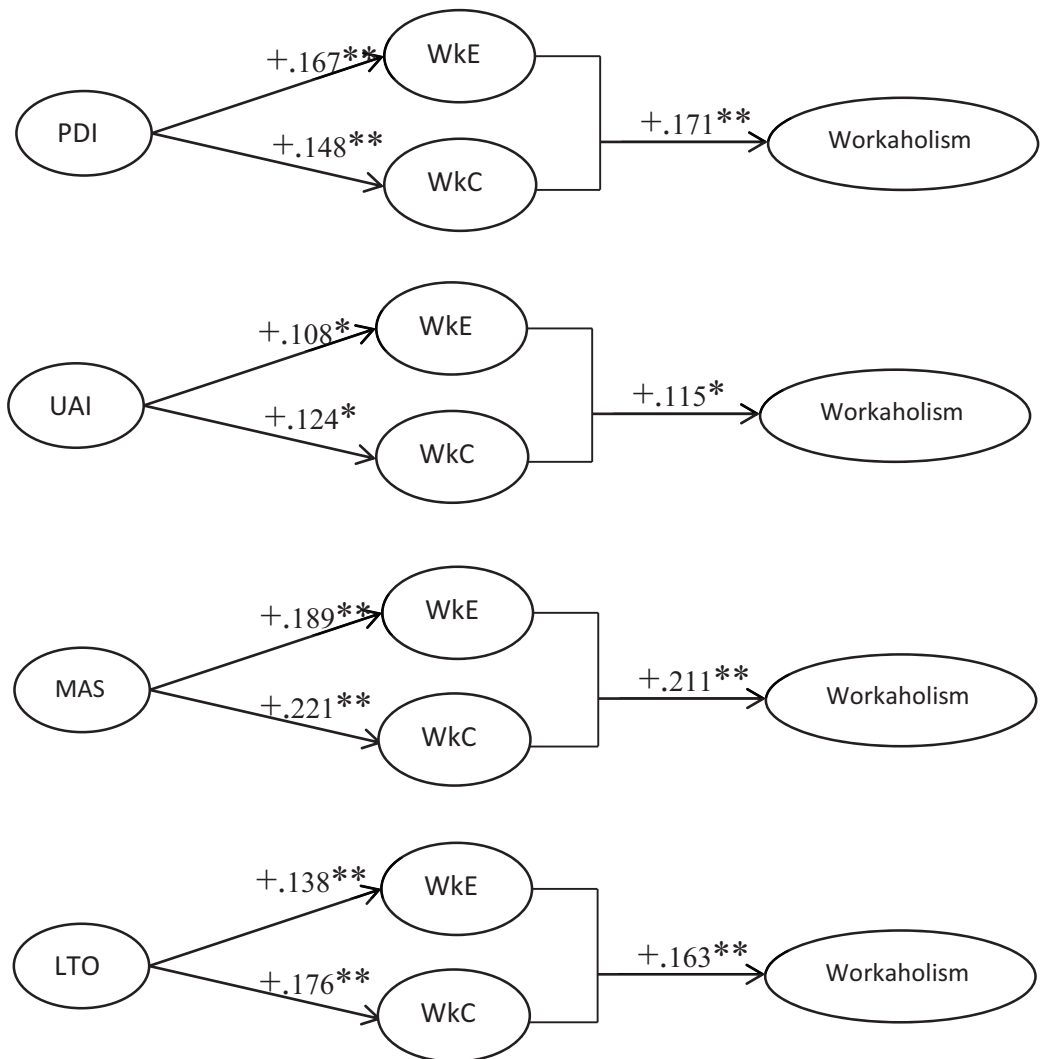

*. Correlation with significant level at 0.05 (1-tailed), (-) negative correlation

** . Correlation with significant level at 0.01 (1-tailed). (+) positive correlation

Figure 4.2 Correlated coefficient values and correlated directions among PDI, UAI, MAS, and LTO with workaholism.

The correlated directions of variables in figure 4.2 show a positive relationship between the scores of PDI, UAI, MAS, and LTO and Workaholism and its components. However, the correlations among variables are low (between 0, 10-0.30) (McMillan.2000).

Q (3) Does work engagement have a relationship with workaholism?

The results show that there is no relationship between work engagement and workaholism, but AB score has a positive correlation with WE, WC, and workaholism with significant level 0.01. However, VI score has a negative correlation with WE score. DE score does not have any correlation with workaholism and its components. However, the correlations among variables are low (between 0, 10-0.30) (McMillan.2000). The details are presented in table 4.22.

Work Engagement	Correlation Coefficient	Workaholism		
		DUWAS	WE	WC
UWES	Sig, (2-tailed)	0.40	.006	.074
	P-value	.426	.911	.074
VI	Sig, (2-tailed)	-.071	-.099*	-.030
	P-value	.158	.047	.555
DE	Sig, (2-tailed)	.023	-.026	.080
	P-value	.647	.600	.108
AB	Sig, (2-tailed)	.146**	.133**	.141**
	P-value	.003	.008	.004

*. Correlation with significant level at 0.05 (1-tailed), (-) negative correlation

**. Correlation with significant level at 0.01 (1-tailed). (+) positive correlation

Table 4.22 Correlation between work engagement and workaholism

4.4 Hypotheses Testing

This section presents the hypothesis, homogenous, correlation, and model tests. The homogenous and correlation tests are analyzed by SPSS program V.20.0. The details of the analysis are presented in title 4.1 and 4.3. The conclusion of hypothesis is as followed:

Homogenous testing

H1 (a). The scores of Hofstede's cultural dimensions are varied among personal demographics and work situation characteristics.

The results are not associated with H1(a). There are no differences in the scores of five Hofstede's cultural dimensions (genders, generations, and organizational tenure groups) with significant level of 0.05.

H1(b). The levels of work engagement are varied among personal demographics and work situation characteristics.

The results particularly agree with H1(b). Work engagement scores (EE, VI and DE) of marital status are different with significant level of 0.05 while there is no different among genders, organization tenures, positions, and tenure in current positions with significant level 0.05 with the exception of VI score that presents different mean scores among generations cohorts.

H1 (c) The levels of workaholism are varied among among personal demographics and work situation characteristics.

The results do not agree with H1(c). There is no difference of workaholism level among genders, marital status, organizational tenures, positions and tenure in current position groups with significantly level 0.05.

Correlation testing

H2 (a) There is a relationship between Hofstede's cultural dimensions and work engagement.

The results particularly agree with H2(a) that MAS is positively correlated with EE, VI, DE, and AB by significant level of 0.01. As well as this, UAI is positively correlated with EE and DE with significant level of 0.01. LTO is positively correlated with EE and DE with significance level of 0.05. In Contrast, PDI and IDV are not correlated with EE. PDI is negatively correlated with VI with significant level of 0.05 while IDV is a positively correlated with DE with significance level of 0.05.

H2 (b) There is a relationship between Hofstede's cultural dimensions and workaholism.

The results do particularly support H2 (b) that IDV has not correlated with AHO, WE, and WC whereas three dimensions (PDI, MAS, and LTO) are positively correlated with AHO, WE, and WC with significant level of 0.01. UAI is positively correlated with AHO, WE, and WC with significance level of 0.05, as well.

H2 (c) There is a relationship between workaholism and work engagement.

The results does not agree with H2 (c). There is no correlation with significant level between work engagement and workaholism, but there is a positive correlation between AB with AHO, WE, and WC with significance level of 0.05. VI has a negative correlation with WE with significant level of 0.05, yet it is not related with DUWAS with any significant level.

4, 5 Summary

According to cultural scores in table 4.3, it shows different scores from three studies because those scores are evaluated from samples with different factors: Hofstede's and different periods of time. However, culture can be changed from time to time and takes more time than generation's shift (Hofstede, 1990)

Summary of finding generated by research's objectives and hypothesis testing can be found as followed

Objective (1) To study Hofstede's culture dimensions, work engagement, and workaholism. The result is displayed in table 4.23.

Hofstede's culture dimensions (highest score =100)					Work engagement (highest score = 6)	Workaholism (highest score = 4)
PDI	IDV	MAS	UAI	LTO	UWES	DUWAS
66	56	73	81	75	4.68	2.42

Table 4.23 Hofstede's cultural dimensions, work engagement, and workaholism scores

Objective (2), To prove Hofstede's culture dimensions' scores, work engagement score, and workaholism which will be different among variables: personal demographics and work situation characteristics.

It is found that only educational level has a positive relationship with power distance but a negative correlation with individualism. Meanwhile, marital status is positively related to work engagement score.

The finding does not agree with H1 (a). It was expected that the scores of Hofstede's cultural dimensions could be different among genders, generations, and organizational tenure groups. After conducting this study, it is found that the finding has been contrasted with H1(c). The levels of workaholism are not different among genders, marital status, organizational tenures, positions and tenure in the current position groups. However, H1 (b) is particularly supported the claim that the levels of work engagement can be varied among marital status, but look similar among genders, generations, organizational tenures, positions, and tenure with current position groups

Objective (3), To study the relationships between Hofstede's cultural dimensions with work engagement, and workaholism

The results were divided into three groups: (1) Masculine culture is related to work engagement and its components, (2) Uncertain avoidance and long-term orientation culture are correlated with work engagement via dedication, and (3) Power distance and individualism are related with work engagement's components. Power distance is negative related with vigor while individualism is positive related with absorption.

Hence, the results particularly support H2 that there is a relationship between Hofstede's cultural dimensions and work engagement: masculine, uncertain avoidance, and long-term orientation. H3 is particularly agreed that four cultural dimensions with the exception of individualism are related with workaholism.

Objective (4), To find the influence work engagement on workaholism

Work engagement and workaholism are correlated, but a component of work engagement (absorption) is positively related with workaholism and its components. However, vigor (work engagement component) presents a negative correlation with excessive work (workaholism component). The finding also disagrees with H4 that there is no correlation with significant level between work engagement and workaholism, but there are some relationships among their components. Absorption has a positive correlation with workaholism and its components.

Objective (5), to explain how Hofstede's cultural dimensions drive work engagement, orientation to workaholism. Regarding to figure 4.1, there are four dimensions that can drive work engagement. Furthermore, masculine culture can drive three components and work engagement. As well as this, uncertain avoidance and long-term orientation can drive work engagement through dedication. Additionally, individualism can drive absorption but not work engagement. Hence, masculine culture, uncertain avoidance, and long-term orientation dimension which are cultural dimensions can drive work engagement (figure 4.3). Power distance, masculine, uncertain avoidance, and long-term orientation which are cultural dimensions can drive workaholism (figure 4.4). and the figure 4.5 presents culture drives work engagement, orientation to workaholism.

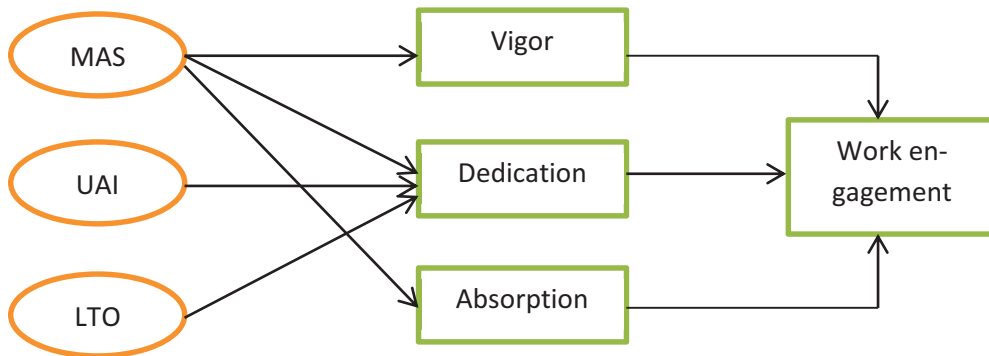

Figure 4.3: Masculine, uncertain avoidance, and long-term orientation culture that drive work engagement

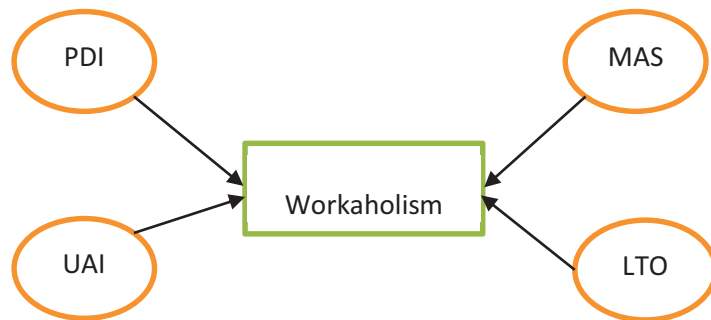

Figure 4.4: Power distance, Masculine, uncertain avoidance and long-term orientation culture that drive workaholism.

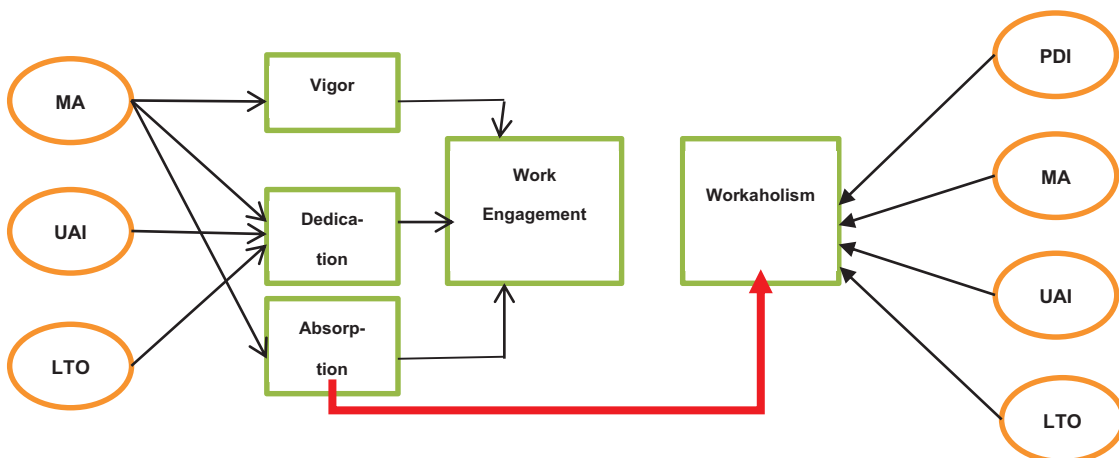

Figure 4.5: Culture drives work engagement, orientation to workaholism..

Chapter V

Discussions and Conclusions

In this chapter, the Analysis and the conclusions will follow the definition of the research objects and the results obtained from different studies including the Hofstede's culture survey, a work engagement survey and a study on workaholism. The analysis of the impact of personal demographic details on Hofstede's cultural dimensions, work engagement, and workaholism will form the second part. The work situation characteristics on the Hofstede's culture dimensions, on work engagement and on workaholism will appear in part 4. How much the Hofstede's culture dimensions influence work engagement and Workaholism, what links Workaholism and work engagement will also be questions to be answered at the end of the document.

5.1 The survey results

In this part, the object and the results of the survey will be first commented and compared with the results of other studies.

5.1.1 The Hofstede's culture survey

This Culture survey has been carried out on 403 participants working in three distinctive sectors: the automotive industry, the electronic and electric sector and the hotel industry. The scores of five cultural dimensions that were measured - PDI, UAI,

IDV, MAS, and LTO - appear in chart 5.1. Those figures are also compared with those of 2 previous studies (Hofstede, 1990) & (Watcharasriroj, Khangshanun & Chodcheai, 2005); there are both similarities and differences between them all.

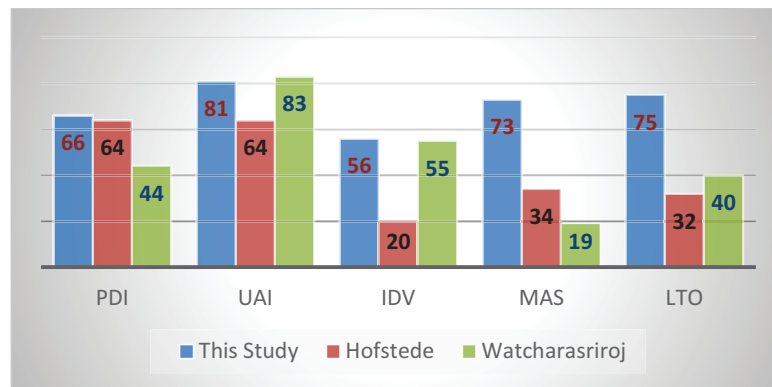

Figure 5.1 Comparison of the PDI, UAI, IDV, MAS, LTO indexes of three different studies

This survey shows that the indices of the cultural dimensions are different from those obtained in the previous studies. The PDI score is high (it measures the level of acceptance of inequity) and is similar to the one in the Hofstede's study. The UAI score that shows the uncertainty avoidance culture is similar to the one of the Watcharasriroj and colleagues' study (2005) but is higher than it is in the Hofstede's study. The score of the individualism dimension is moderate but higher than in the two previous studies; the MAS score is high and also higher than in the previous studies as is the LTO score. The three studies are not only different in the period they were conducted but also in terms of sampling.

Furthermore, the qualitative survey of Petison (2010) on the culture in Thailand stressed a considerable distance to Power, a strong culture of both collectivism and feminism, a rather small tendency of avoiding uncertainty and an orientation towards short term. The differences found in the four studies on culture that have been conducted at different periods of time, on different samples and with distinct methods are shown hereunder:

Method	Study	PDI	UAI	IDV	MAS	LTO
Quantitative	This study	High	High	Moderate	High	High
	Hofstede	High	High	Low	Low	Low
	Watcharasriroj	Low	High	Moderate	Low	Low
Qualitative	Petison	High	Low	Low	Low	Low

Table 5.1 Comparison of the PDI, UAI, IDV, MAS, LTO indexes of four different studies

These four cultural studies highlighted different dimension scores as did the Purohit and Simmers' one in 2006. In this survey, the uncertainty avoidance index of Nigeria was 46.8 , it was 24.5 in India and 7.9 in the United States. In the Hofstede' study, those indexes were 55, 40, and 46 respectively. They also found that the power distance score in Nigeria, India and in the united states were 56.85, 25.8 and 38.15 respectively but with Hofsted, it was 80 for Nigeria, 77 for India, and 40 for the United states of America. Other cultural surveys in Russia conducted by Bollinger (1994), Naumov and Petrovskaia (2010) , Elenkov (1998) measured different scores for Power distance, Individualism, Masculinity and Uncertainty Avoidance. Fey and Denison in

2003 nonetheless found that the score of uncertainty avoidance was in Russia not in keeping with what was reported in the previous studies. Therefore, the variation observed with the Hofstede's study concerning the cultural dimensions in Thailand is not surprising due to the differences in the investigation periods, samples, locations and methods. However, my purpose is to extend the Hofstede's study results. The analysis of the change of culture's dimensions describe in the next section is therefore based on the comparison with the Hofstede culture survey.

Power distance

The level of Acceptance of power inequity is still important according to the Hofstede's study (1990) and to the Peterson one (2010) whereas it is rather small in Thailand in the Watcharasriroj's study (2005).

The Change of power distance is affected by age, education, wealth and status but it can also vary according to the organization's hierarchy (Hofstede, 1990). Thailand is categorized as a high human development country (UNDP, 2015) mainly because the education system in Thailand has been continuously developing since 1980 (National Statistical Office). The results concerning power distance should show a lower score than what is found in the Hofstede's study.

There are therefore other factors impacting the change of power distance and one of them may be the deeply-rooted senior system that keeps being strong in the country.

Uncertainty Avoidance

This dimension proves high in score in both Hofstede's study (1990) and in Watcharasriroj's study (2005) but the Muenjohn (2004) measured a weak level of uncertainty avoidance. The qualitative study of Petison (2010) also reported an accepting uncertainty culture level in Thailand.

Thailand is obviously avoiding Uncertainty or any form of narrow culture that stems from overwhelming rules, norms and standards for correct behavior. This society does not readily accept changes as it is not prone to taking risks. Evolution has therefore to be considered for the best of the group as opposed to individual improvement, each person belonging and being directed by a group.

The UAI score was found to follow the national anxiety level: when the anxiety level increases, the level uncertainty avoidance rises. Innovation is another contributing factor: uncertainty-avoidance cultures are slower for innovation. The supporting data released by Global Innovation Index (GII) ranked Thailand 48 with a score of 37.63 out of 100 in 2011 and 57 with a score of 36.9, Innovation in Thailand is therefore rather slow and this has worsened with the increasing political problems since 2010 that made uncertainty avoidance even more stronger in the Thai society. However, Rujirawanich and colleagues suggested in 2011 that there may be other cultural factors besides those described in the Hofstede's survey that could influence the level of innovation in Thailand.

Other studies such as Petison (2010), Muenjohn (2004) and Triandis (2004) indicated a weak level of uncertainty avoidance that could be symbolized by the expression "Mai Ben Rai" (it does not matter). "Mai Ben Rai" is always used in case

of disappointment, in unexpected situation, or when Thai people did not do what they were expected to do. In those situations, they may also just smile and let it go (Komin, 1990)

Individualism versus Collectivism

The IDV score is increasing if compared to the one in the Hofstede's study and equal to the one in the Watcharasriroj's study. That could show that Thai people get more and more in favour of individual values.

The evolution of this dimension is explained by Triandis (2004) as follows: within any culture, there IS a certain number of "idiocentric" individuals (they think, feel and behave as people in individualistic cultures do) as well as "allocentric" individuals (similar to people from collectivist cultures). A collectivist culture counts somewhere between 30 and 100 percent of allocentric people and between zero and 35 percent of "idiocentric" people. Furthermore, the level of "Idiocentrism" increases when the person has been greatly exposed to the Western mass media or has been acculturated for years in any Western culture.

Undoubtedly, the evolution of the IDV dimension from collectivism to a level between individualism and collectivism is influenced by education, development, Western culture via the media or whatever that is brought to Thailand, including via the people studying overseas.

Masculinity versus Femininity

As same as individualists versus collectivists, this investigation found an increase of the masculinity dimension over the femininity one which contrasts with the Hofstede's study (2001), the Watcharasriroj's study (2005), and the Petison's study (2010),

Hofstede (1990) and Watcharasriroj (2005) indicated that Thailand is a feminist country; "Thailand is to be the most feminine Asian country, the Thai learns how to avoid aggression rather than how to defend himself against it; if the children fight, even in defense, they are usually punished. The indicator which classifies societies as masculinity or femininity oriented ones is the female and male ratio (Hofstede, 1990). The female and male ratio in the population is higher in feminine cultures such as Thailand and Indonesia than it is in masculine cultures such as India and China.

However, in this present study, the score increases from 34 to 73 compared to when Hofstede carried out his own survey. It could be explained as the evolution of the individualistic dimension in the previous section is: the influence of western culture, especially the united stated, which was claimed as a Masculinity kind of culture by Hofstede (1990) may be a major contributing factor.

Thailand has absorbed Masculinity from western countries through the media, the foreigners who do business or work in Thailand and the students who have studied abroad and transmit some parts of western culture when they come back in the country. The western culture carries some Masculinity, but the Japan work culture does even more . The culture convergence theory (Axelrod, 1997), argued that when different cultures interact frequently, the culture of origin will get similar over time.

The top five foreign nations in terms of people working in Thailand in December 2012 (Thailand foreign labor office, 2012) were Japan, England, China, the Philippines, and the United states, which are all masculine societies. Most of these people were working as managers, directors or were holding other high level positions such as teachers or professors. Due to their social status, they can highly influence lower-status workers (Hofstede, 1990).

Furthermore, the study's result showed that both masculinity and individualism scores were higher than they were in the Hofstede's study. According to Hofstede (1980), masculinity is also positively correlated with individualism.

Long-term and short-term orientations

The long-term orientation score in this present study is 75 out of 100 which is higher than in previous studies. Hofstede (1990) indicated that Thailand was rather moderate between long-term and short-term orientations with a score of 32. LTO score is 40 in a Watcharasriroj and colleagues' study (2005) and including the results observed by Paterson in 2010, it indicated a short-term orientation for Thailand. Thus, the LTO score found in this present study is discordant from previous studies.

However, the growth of this dimension is linked with nation's growth: Thailand's GDP has been continuously increasing from 1980 until now, and is now ranked 30th from 192 countries. These could explain the increasing long-term orientation score observed in this present study.

Conclusion of the culture survey

This culture survey shows high scores in power distance, uncertainty avoidance, long-term orientation, masculinity, and rather moderated in individualism. These results are not similar to what was found by Hofstede and others, certainly because Culture is not static and can change with time (Hofstede, 1980). Furthermore Hofstede also suggested that the economic changes and technological development have an impact on culture. Thus, the influence of globalization has altered the cultural dimensions in Thailand.

Since nations are subsystems of a global system, the culture changing phenomenon can be explained by the cultural convergence theory (Axelrod, 1997), that make the foreign media, the students that study overseas and the foreigner workers contributing factors. When different cultures often interact, they become closer .In such cases, the economy, the technology and other factors can trigger cultural changes.

Although, it is not clear about what kind of factors can make culture change, some as Hofstede (1980), and Trompennars (1993) noticed in the vast national culture literatures that three main factors can be categorized as follows: (1) relationship to people: power distance, masculinity vs. Femininity, individualism vs. Collectivism; (2) relationship with nature: uncertainty avoidance; and (3) relationship with time: time orientation (past, present and future).

This could lead to the idea that the evolution of PDI might be influenced by traditional culture; seniority culture, the fact that MAS and IDV are affected by western cultures, the politics that can change the UAI and the LTO that depends more on the future than it does on the past.

Since there are numerous factors impacting cultural evolutions, the scores observed in the present survey may differ from what was found in other studies for time difference reasons because culture can change with time passing. The Sample taken and the method used are other potential explanations for these variations. A survey on culture should consequently be periodically updated and use both qualitative and quantitative methods in order to confirm the results.

5.1.2 The Work engagement survey

The Work engagement reports a 4.68 score out of 6 which is moderate to high. The scores of its components are 4.47 of VI, 5.15 of DE, and 4.43 of AB. The work engagement observed in Australia, Belgium, Finland, France, Germany, Italy, and South Africa is comparable since the scores reported are all between 4 to 5.

Canada, china, the Chek republic, Greece, the Netherland, Norway, Spain, and Sweden carry work engagement scores between 3 to 4 (out of 6). Japan has the lowest score which is between 2 to 3 (Shimazu, Miyanaka, & Schaufeli, 2010).

Furthermore, the findings show no significant difference between the automobile sector, electronic andelectric sector and hotel Industry whereas in study of work engagement in eight European countries conducted by Taipale, Selander, and Anttila (2010), the results vary not only between countries, but also between sectors (economic sectors such as retail, telecommunication , hospital, and bank)..

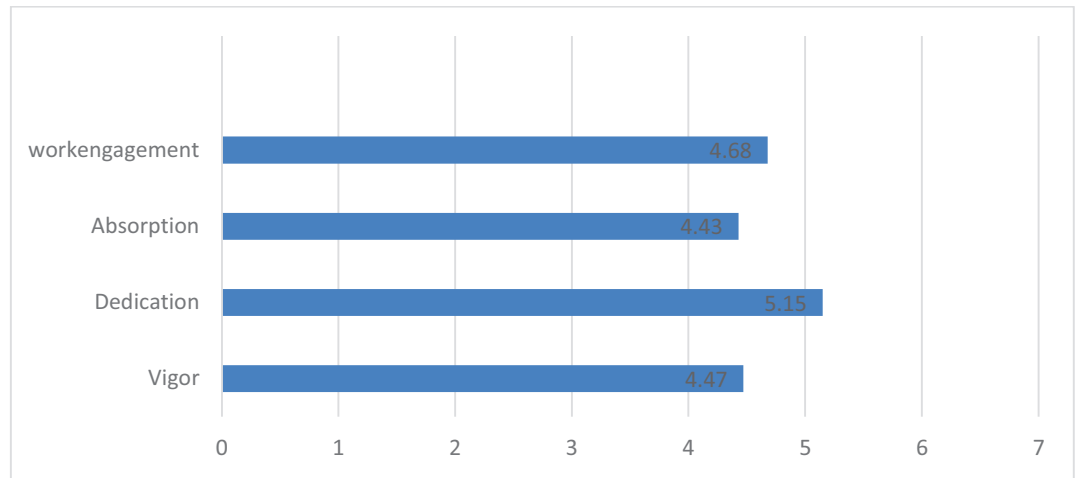

Figure 5.2 work engagement survey

Furthermore, this study categories eight work engagement types: the disengagement type of workers (26.80%), which get the lowest score in VI, DE, and AB are more numerous than that the engagement type of workers (16.90%) which get a high score in VI, DE, and AB. while most of the worker (29.3%) are enthusiastic workers with a high score of DE, but a low level of VI and AB. These findings supported by Gallop (2004), conducted work engagement in Thailand, also showed that only 12% of Thailand's employee population are engaged, 82% are actively disengaged and 6% are disengaged.

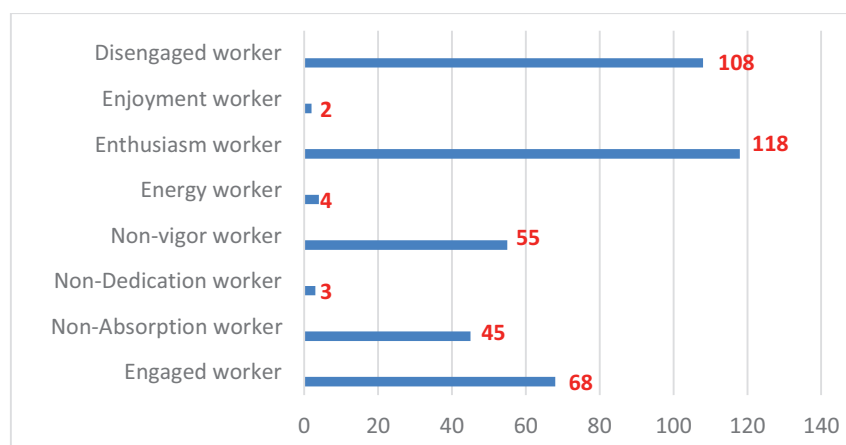

Chart 5.3 Work engagement types

An improvement in Work engagement should be observed in each component since the results of this study indicate moderate to high worker engagement. A thorough analysis of the data show that the number of engaged workers is lower than that of disengaged workers. The results reports 11.2% of low absorption type of workers and 13.6% of those who are low in VI. Workers who belong to a low DE group amount to 0.70%. This indicate that focusing on the triggering factors for absorption and vigor could be helpful in the aim to enhance the work engagement level in the organization.

Conclusions of the work engagement survey

Although the results presented in this study show a moderate to high level of worker engagement, it mostly came from a higher dedication than for the other components (118 participants). Fifty-five participants indicated that they had low energy at work and forty-five participants were unhappy with their job. Therefore, the development of work engagement should target all of the components

The study on the work engagement types is important because it helps to understand what factors have an impact on work-engagement. The three components of work engagement which are vigor, dedication, and absorption, are driven by different factors: dedication is about being strongly involved in one's work and experiencing a sense of significance, enthusiasm, inspiration, pride and challenge. Those factors influence the job resources, while vigor and absorption affect personal resources (Xanthopoulou, Bakker, Demerouti, and Schaufeli, 2009).

However, catering a type of work engagement is useful for work any development plan because it helps define and choose the types of workers who are high or low for each component. It can help any organization to find an approximate way for an individual development plan. Hence, any work engagement development plan should follow the model in figure 5.4

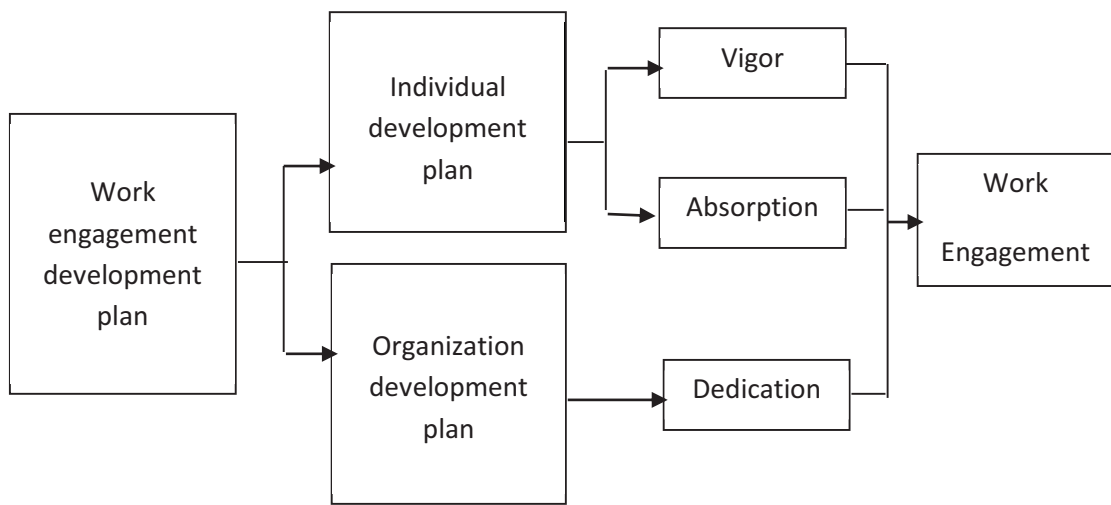

Figure 5.4 work engagement development plan

The next questions to go further in the research concerns the way to make any individual to increase their level of vigor and absorption, and the means for an organization to rise the dedication score. The contributing factors for vigor, dedication, and absorption should be identified because the three components react differently to these factors. Therefore, an in-depth study of work engagement is necessary to find the best way to improve the level of work engagement in the organization”.

5.1.3 The Workaholism survey

Scores for Workaholism are moderate (2.42 out of 4.00), the one of excessively-hard working (WkE) is 2.38 which is lower than for it is for work compulsive work (WkC, 2.45), the Chart 5.5 shows no significant difference between the three sectors: automobile, electronic and electric, and hotels.

However, workaholism is not well-known in Thailand. The terms “office-syndrome” or “work addiction” to refer to someone who cannot detach themselves from work are most common. No real study about workaholism in both the academic and business sectors have been carried out in Thailand. This subject has only been studied in mental and Heath’s researches.

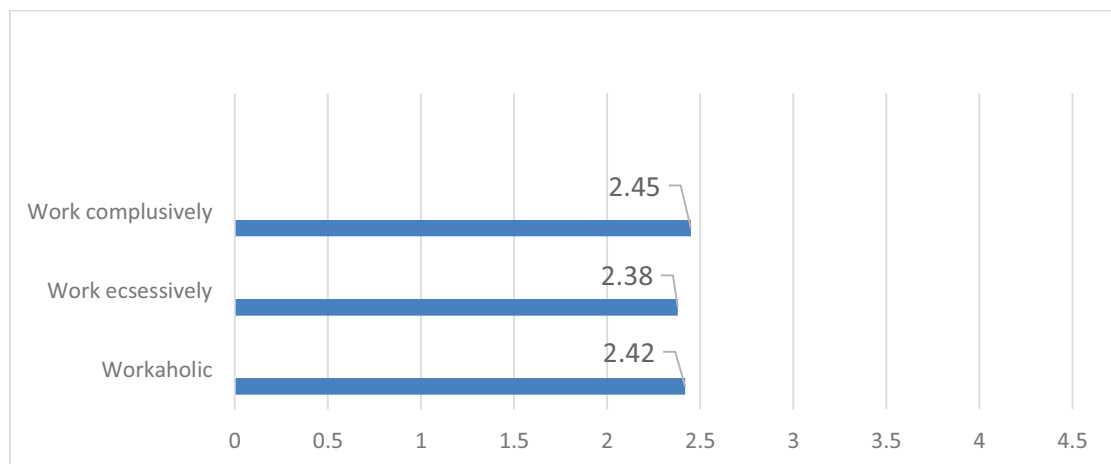

Figure 5.5 workaholism survey

Japan has been suffering from the Karoshi syndrome striking people who are perfectionists, over-serious at work, work-lovers or just thinking about it all the time. The consequence that has usually been described for this Japanese phenomenon is an

early-age sudden death of the Japanese hard-working white-collar workers. Furthermore, Japan is claimed to be the most workaholic country worldwide (www.businessinsider.com), with only 33% of the workers taking all their allotted vacation.

As well as workaholism, WkE is high. On the contrary, WkC is only 7.4%, Relaxing workers get high score of WkE and WkC is 79%.

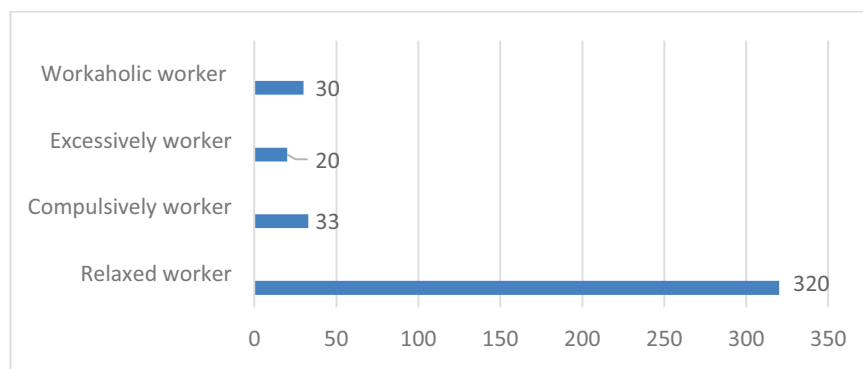

Figure 5.6 workaholism types

Conclusion of the workaholism survey

Although the researches on workaholism in the business and academic sectors in Thailand have been much less than in the mental and health sector, this study explores workaholism in an organizational point of view. It may ease valuing the employees well-being in the organization they depend on.

Workaholism is generally associated to hard-working or excessively hard-working. Subjects allocate much time to their work, even more than compulsively - working people who frequently think about work even during leisure time.

The study findings reports a low score excessive working and compulsive working. There are few workaholism workers within the participants. Workaholism people work hard, but there is a negative impact to their well-being, and to the organization performance. Maintaining a low score for this criterion should be considered as important in all organizational practices.

5.2 The influence of personal demographics.

According to research objective, this section presents an individual’s difference that might be influenced on perceptions and behavior. This will help the organizations understand impacts of individual factors -gender, generation, education levels, and marital status- on cultural dimensions, work engagement, and workaholism.

	PDI	UAI	IDV	MAS	LTO	UWES	DUWAS
Gender	-	-	-	-	-	-	-
Generation	-	-	-	-	-	differ	-
Education	Differ	-	-	-	-	-	-
Marital	-	-	-	-	-	differ	-

Table 5.2 Personal demographic and cultural dimensions, work engagement, and workaholism

Although only educational levels influence on power distance and individualism versus collectivism dimension, and generations and marital status related to work engagement, none of personal demographic variables is related with a workaholism. It is inevitable that personal differences should be involved (table 5.2).

Personal demographics and culture, the results present educational level was associated with power distance and individualism. Bachelor's degree participant group was indicated to have smaller PDI and lower IDV than technical degree and higher degree group. Similarly to Hofstede's study (1990) noted that there will be a decrease in power distance when participants educated from high educational level because knowledgeable workers are more self-confident and volunteering to participate than the lower ones. Thus, a power distant gap is small and self-confidence could turn people become more individual (Stedham and Yamamura, 2004). Therefore, if educational level is focused, there could be some gaps in the inequity problem in the organization.

Gender differences in cultural dimensions were also found in a study of Stedham and Yamamura (2004) who found that the gender differences exist in the power distant dimension in Japan and in the individualism versus collectivism for Japan and The USA. This research also asserted that, in Japan and the USA, there were substantial changes in female workforce, such as, education, higher position, career success, and an increase in self-confidence. This might influence on cultural change.

The result of this study explored the differences in terms of culture. It has been declared that there was no cultural difference among generations. However, the cultural differences among generations can be clearly categorized in several areas: core values, work attitude, work behavior and development. It could be assumed that

the perceptions in cultural dimensions could be different by utilizing the cultural changing theory.

Although there is no impact from marital status to cultural dimensions, a very few research studies have been indicated the impact from marital status to cultural dimension. Thus, it is difficult to identify whether marital status has an effect on cultural dimensions.

To conclude, the perceptions of culture among genders, generations, educational levels and marital status are indifferent although only educational level has an impact on perception of power distance. Therefore, it is crucial for the organizations to be careful of the gaps of equity. Individual development tools, such as training sessions, will be useful to reduce the gaps.

Personal demographics and work engagement. This study found that work engagement is homogenous state between genders. In contrast, a study by Wajid and colleges (2011) found that males are more dedicated to work than females. An equivocal relationship between work engagement and gender was presented in a cross national study by Schaufeli, Bakker, and Salanova (2006) that men scored slightly higher than women in Belgian, German, Finish, and Norwegian samples. Additionally, in South African samples, vigor level in men is higher than women. As well as this, in Spanish and Dutch samples, males' dedicated and absorption levels are higher than females'. However, Smulders (2006), compiling work engagement from 4,000 participates in Netherlands, illustrated that there was no systematic difference between genders. Therefore, genders' factors might not affect to engaging levels. This could mean that there could be other factors with greater impact than genders' factors on work engagement.

As far as Age and work engagement are concerned, the result of vigor in Gen-x is higher than others. This could be because Gen-X is younger than Baby-Boomer. Moreover, Gen-X, whose married couples outnumbered than Gen-Y's, has higher level of vigor than Gen-Y and the other generations. However, in the previous literatures, there have been mixed results associated with age. For examples, Schaufeli, Bakker, and Salanova(2006) and Smulders(2006) found that work engagement was slightly positively related with age. This could be implied that older employees feel slightly more engaged than younger employees. In contrast, Wajid and colleges (2011) argued that there was no significant difference with respect to age for any dimensions of work engagement.

Marital status group presents a different score in work engagement. The result indicates that married participants are higher engaged than the singles. Similarly, Wajid and colleagues (2011) also found that married people are more engaged in work than single people. Therefore, it is recommended to do further study about the reasons of highly working engaged in married participants.

Work engagement doesn't vary by education level. According to Wajid and colleges (2011), they indicated that there was no significant difference between education levels for any dimension of work engagement as there are small numbers of research about the impact of education level on work engagement.

It can be recommended that marital status factors affecting work engagement and kinds of motivation should be analyzed in order to develop engagement plan while work engagement will be differed by age because of vigor.

Personal demographics and workaholism. The results do not support the research expectation that gender, generation, education, and marital status were not related with workaholism. This is because, in this present study, there were numbers of personal demographic variances, such as gender difference among personal characteristics, more single women and more married men, more Gen-Y women and more Baby-Boomed men, different educational degrees: more men graduated higher degree than women while there are more Bachelors' degree women than men. Therefore, studying of the relationship between personal demographics and workaholism should be specifically focused on particular group.

It can be summarized that culture is not stable, but the cultural dimension acknowledgement is indifferent between genders, various generations, and different marital statuses. By this, it means culture can be altered when the time has been passed, but levels of cultural dimensions could be the same. However, those levels have been elevated by the time being. Similarly to "Power distance" in cultural dimensions, it is found that acknowledgement of power distant between genders is relatively the same.

Changing of cultural dimension by educating employees could close the gap of power distance while education level is not related to hard working in engaged and workaholism people. Work engagement and workaholism are defined as an individual cognitive, attitude, and behavior. Only work engagement is influenced by age and marital status with an exception of gender. Not only dose employees' education can close the gap in power distance, to restructure the managing levels and increasing leadership training can be another way to reduce the gap. Then, the self-confidence in each employee will be increasing.

Thus, in order to increase work engagement, the company should be aware of marital status and should create some training sessions to elevate the engagement in Gen-Y. This is because the singles have less work engagement level than the married ones. Moreover, the new comings (Gen-Y) are young fresh graduated and unmarried. According to the results, Gen-X is the highest working engaged levels compared with the other generations. It is recommended the further workaholism and work engagement research should focus more specifically on genders, aged intervals, generations, and marital status.

5.3 The influence of work situation characteristics

Regarding to the research's objective, it is found that work situation characteristics variables-organization tenure, division, position, and tenure in current position- are not associated to all dimensions of Hofstede's culture, work engagement, and workaholism.

Work situation characteristics and culture dimensions

According to the research's expectation, cultural dimensions could be varied by work situational characteristics, organizational tenure because organizational culture could be socialized people with cultural different perceptions. Nonetheless, there is no supporting information from the result. This might be because the organizational culture is similar.

Work situation characteristics and work engagement

Employees with different organizational tenure and current position are engaged with work with various reasons. For examples, newcomers are engaged with work because they need to show their promise during their probationary period and the new work-roles are challenging for them.

Although most organizational tenure employees are engaged, they might get bored because of long period of organizational tenure. Smulders (2006) found there were different work engagements among professionals-managers were found more engaged than blue collar workers. Nonetheless, the results of research do not support research's expectation. Therefore, re-studying of work situation characteristics should be done in further research.

It is important to enhance work engagement in supervisor or managerial levels because this could drive subordinates' work engagement. This shows common results of work engagement in both of them. This could be implied that higher level participants have similar work engagement score as their priorities. However, it is crucial to compare work engagement between organizational levels because if higher level in organizational is not engaged, the subordinates might be unengaged too.

Likewise, a comparison study between divisions- especially operational divisions which have direct contact with customers- should be done since high positive work engagement will rise the customers' satisfaction. However, the results did not depict the relationship between divisions, but it is essential to diagnose work engagement in organizations.

In conclusion, work engagement study should be related work situational characteristics since this presents different work engagement scores. For further research, work engagement among working situational characteristic study should be conducted especially work engagement levels between manager and staff.

Work situation characteristics and workaholism,

Since there is no relationship between two variables and there are very few previous studies supporting this claim, to study these variables might be important to further studies.

5.4 Work engagement and workaholism

The relationship between work engagement and workaholism according to Grogievski and Bakker's recommendation (2000) will be illustrated as well as to prove whether workaholism is a negative side of work engagement or not.

From the results, there was no relationship between work engagement and workaholism, but those relationships were found among their components. Absorption has a minimal positively relationship with workaholism ($r = .146, p < 0.01$), excessive working ($r = .133, p < 0.01$), and compulsive working ($r = .141, p < 0.01$). These findings are correlated with Schaufeli and colleagues (2001) that work engagement and workaholism seem to share some element of absorption. Nonetheless, Taris and colleagues (2009) indicated that work engagement, excessive working and compulsive

working can be distinguished as three separate factors. It is also found that Vigor has a minimal negative relationship to excessive working ($r = -.099$, $p < 0.05$).

Since both workaholism and work engagements are beneficial to organizations, both engaged worker and workaholism work hard with high performance and productivity. However, engaged employees do not seem to be work addicted. They enjoy other matters apart from work too. Unlike workaholism, they do not work hard because of a strong and irresistible inner drive, but because they think that working is fun (Schauleli, Bakker, & Salanova, 2007).

Both workaholism and work engagement have different drives and passions. Workaholism is driven by obsessive passion with harmonious passion (Vallerand, 2008). Engaged person has more controlled himself to work while workaholism has let himself in controlled by work and felt more unhappy at work when compared with working engaged. Thus, workaholism is related with unwell-being while work engagement is related to well-being.

Nevertheless, there are some results overlapping between workaholism and work engagement in this study. A correlation among absorption, work engagement components and workaholism has been found upon. This could be pointed that work engagement could generate workaholism through absorption, work engrossing and feeling that time flies too fast.

Finally, it could be stated that workaholism is not completely negative side of work engagement, but engaged employees with high absorption might become workaholism. Meanwhile, to enhance work engagement in the organization, some

condition, such as absorption, should be concerned because it may increase workaholism level.

5.5 How do Hofstede’s cultural dimensions drive work engagement and workaholism?

The result explains the relationships among Hofstede’s cultural dimensions, work engagement and workaholism and describes the way that cultural dimensions drive work engagement and workaholism so as to create a work engagement model.

This sector presents the relationships among cultural dimensions(power distance, uncertainty avoidance, masculinity, individualism, and long-term orientation) work engagement and workaholism. It also includes the way that culture drives work engagement and workaholism. The table 5.3 shows the relationship of cultural dimensions, work engagement and workaholism

	Work engagement	Vigor	Dedication	Absorption	Workaholism	Work Excessively	Work Compulsively
PDI	-	negative	-	-	positive	positive	positive
IDV	-	-	-	positive	-	-	-
MA S	positive	positive	positive	positive	positive	positive	positive
UAI	-	-	positive	-	positive	positive	positive
LTO	-	-	positive	-	positive	positive	positive

Table 5.3 the relationship between Hofstede’s culture dimension with work engagement and workaholism

5.5.1 How does power distance drive work engagement and workaholism?

Power distance reflects cultural attitudes towards human-inequalities which define itself through a managing subordinated relationship inside organization. Thus, the influence of power distance is revolved around a followed leader relationship between boss and subordinate. In large power distant cultures, it is hardly found personal relationship between the boss and subordinate and there are large gaps between levels of management. On the other hands, in small power distant culture, the gaps between the boss and subordinate might be relatively small. The superior ones treat the subordinate with respect.

The result shows that power distance is not associated to work engagement but has a small negative relationship with vigor component particularly supporting the study's hypothesis about power distance.

Therefore, work engagement could be pulled down by vigor: the willingness to invest effort in one's work. However, vigor could be reduced by large amount of power distance and autocratic management. For examples, the subordinates need to oblige to superiors' authorities without willingness (Hofstede, 1990).

Vigor is characterized by high levels of energy, mental resilience during working, the willingness to invest effort in one's work and persistence in the difficult situation (Schauli, Salaniva, & Bakker, 2006). In large power distance, the managers always make the decisions about everything and give the command to the subordinate (Hofstede, 1990). Perhaps, employees, in large power distance, are familiar with working under the command causing them feel less self-confident and unwilling to invest effort without command.

Power distant culture and workaholism present their positive associations, as well as excessive working and compulsive working (see figure 5.7). This can be supported by a claim from Baruch (2011) that, under a culture of high power distance, factors, that can improve possible individual powers - strong and visible investment in long working hour, will be more desired than working under a culture of small power distance.

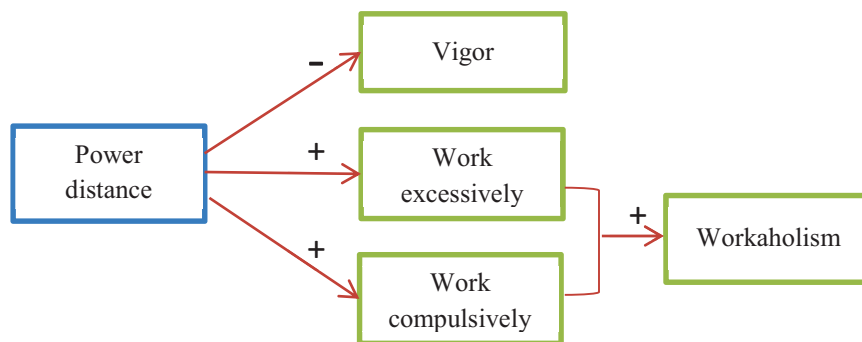

Figure 5.7: Power distance related with workaholism and vigor

It can be concluded that power distant culture does not associated to work engagement but can decrease vigor level, so it can make employees became workaholism. Moreover, followed-leader relationship (autocratic leadership) is always found in a large power distant culture, such as Japan. Such relationship might activate their followers (employees) to work harder and cannot detach them from work.

Therefore, power distance does not drive work engagement, but the large power distance culture can drop vigor level. Why employees unwilling invest their effort to work under control or high hierarchy environment, because they work by leader's commanding. They do not solve the problem by themselves, and their superiors control

them closely. These means they are influenced by leader not themselves, thus they are lower persistence in their work.

Large power distance drives people become workaholism through work excessively and work compulsively, these support the study by Baruch (2011) that “under a culture of high power distance, can improve possible power of individuals like strong and visible investment in work engagement like long working hours will be more desired than under a culture of low power distance” Thus, this present study will propose for the future study that *there are more workaholism in high power distance society than low power distance society.*

5.5.2 How does individualist versus collectivist drive work engagement and workaholism?

Individualism versus collectivism culture refers to the degree of interdependence which socially maintains its members. It has to do with whether people’s self-image is defined themselves as “I” or “We”. If those people work in individualism culture, they will define themselves as “I”. In contrast, if they work in collectivism, they will call themselves as “we”. In high Individualism culture, an identity is based on the individual - task prevails over relationship, people are viewed as independent from the group, and emphasize on personal autonomy and self-fulfillment, while high collectivism emphasizes people's interdependence within the group, an identity is based on one's social grouping - relationships prevail over task (Hofstede, 1980).

This study assumes that individualism might raise work engagement level as well as workaholism because individualism has a greater need for freedom of choice and for being seen as unique. Moreover, they tend to be more motivated with the attainment of success (Vogt and Laher, 2009). Thus, people, who work for themselves, could maintain their work engagement and work harder than the others.

An influence of individualism dimension on work engagement and workaholism are not found in this present study, but only small positive correlation between individualism with absorption was presented. Hence, individualism culture does not associate with work engagement, but the impact on absorption can be revealed. This is because individuals are not engaged in group, but they emphasize on personal autonomy and self-fulfillment (Hofstede, 1980). By personal autonomy emphasis, those individualists could fully concentrate and be happily engrossed in their work. On the other hand, collectivists depend on a group which could make them lack of freedom and unhappy.

Lastly, individualism does not have any impacts to workaholism. This finding is not correlated to the study's hypothesis which expects that individualism could have some degree of influence.

Workaholism could take place in collectivism culture because such behavior is belonged to group's value and norm. If the majority is workaholism, it can be assumed that the rest will become workaholism as well. Likewise, if some people belong in the group of highly work engagement, they will soon become higher working engaged.

Since absorption component is related with workaholism and its component, a relationship between individualism dimension with work engagement and workaholism is presented in figure 5.8

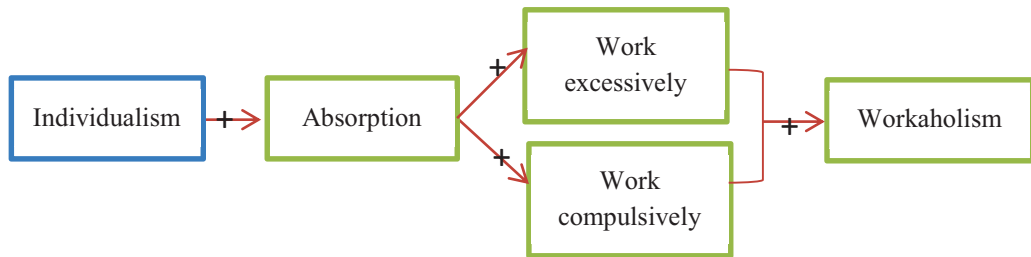

Figure 5.8 Individualism related to absorption and workaholism.

Although the study’s finding partially supported this claim that individualism cultural drives work engagement, “collectivisms” could increase work engagement through group’s value since engagement will take place in the situations where meaningfulness, safety and availability are involved. Safety are created by the social systems: group/inter-group dynamics and interpersonal relationships (Kahn, 1990), including crossover phenomena among teams. Furthermore, collectivists depend on group characteristics, cohesiveness and norm. Thus, studying collectivism should be concerned with more details or situations such as sympathy scrip or simpatico.

Therefore, individual culture does not drive work engagement and workaholism. The country is individual countries and high work engagement level, such as the Netherlands and France, while the United Kingdom is claimed as individual country (Hofstede,1990) but level of work engagement is low (Taipale et al, 2010). This dimension should study in narrow scope when study relate with work engagement. Furthermore,

the result of this study reject Baruch's proposition (2011) that workaholism is perceived as more positive in cultures characterized by high individualism and less positive in cultures high on collectivism.

5.5.3 How does masculine versus feminine drive work engagement and workaholism?

Masculinity culture is lined upon values of achievement and material advancement over social goals. Similarly, engaged employees also value rewards for what they have done; for examples, social recognition, financial rewards, expressed interest from the company, goal achievement, and self-confirmation (Schaufeli & Salanova, 2007).

Thus, there is no surprise that masculine culture is positively related to work engagement and its three components: vigor, dedication, and absorption. This might be because people in masculine culture are more decisive, aggressive, ambitious, and competitive than feminine culture. Thus, working in masculine culture needs the employees to invest more vigor, dedication, and absorption than in feminine culture.

Furthermore, a positive relationship among masculine culture and workaholism, work excessively, and work compulsively is also found in this study. This support the claim from Baruch (2011) that workaholism is perceived more positive in cultures characterizing by high masculinity but less positive in cultures high on femininity.

It is inevitably to state that masculine culture elevates work engagement level and workaholism. Therefore, enhancing work engagement level should create a masculine cultural climate in the workplace. For instances, this will create competitive

environment, goal oriented, or assertive. However, it needs to be careful as masculine culture has highly affected to the level of workaholism.

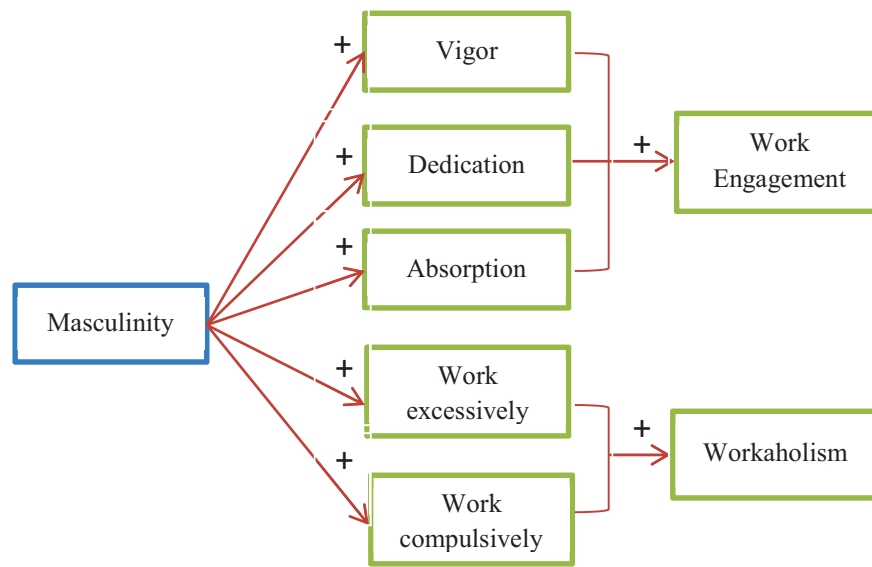

Figure 5.9 Masculinity dimension drive work engagement and workaholism.

Concluding that the competition culture can drive employees more work engagement and more workaholism, according with Baruch's study (2011). Employees want to achieve their goals. These motivate them work hard, invest more effort, more involvement, including they do not want to leave their work if they do not yet achieve their goals. Concentration with work can turn employees more absorption in work and more work compulsively when work does not complete. These are the reason why masculine culture drive work engagement and workaholism. However, there are femininity countries, such as France and the Netherlands, have high work engagement level. Thus, the proposition for the future research, when implies culture dimension as masculinity should more concern with others factor, or more focus in specific point or area, or study work engagement in femininity culture.

5.5.4 How does uncertainty avoidance drive work engagement and workaholism?

In an uncertain avoidant culture, people try to avoid some malpractices or mistakes which will create hard-pressed situation causing high level of anxiety. From time to time, people try to reduce unexpected events by controlling the factors that could lead to deterioration in the future. In contrast, people in an uncertain accepting culture response something different or some ambiguity with more flexible reaction.

In strong uncertainty avoidance societies, people respond an uncontrollable situation with high level of neuroticism and without any compromise. Moreover, Kim and colleagues (2009) found that high level of neuroticism was significantly correlated with low level of vigor and lack of vigor (energy) can contributes employees' disengagement.

Similar to the study of Langelaan and colleagues (2006) indicated that high neuroticism is the core characteristic of burnout whereas work engagement is characterized by low neuroticism in combination with high extraversion and high level of mobility.

Moreover, there was a negative correlation with organizational citizenship behavior in neuroticism while there was positive work engagement related to organizational citizenship behavior. This could be said that a strong uncertain avoidance will give a negative impact on work engagement.

People in countries where stronger uncertain avoidance takes place are unhappy. They always show negative opinions in describing their work and their life

situations while stronger uncertain avoidant environment could decrease work engagement in engaged employees.

In another word, work engagement might be lower within the stronger uncertain avoidant environment. However, the study of Chew and Putti (1995) indicated that individuals with higher score on uncertain avoidance tend to have a long tenure in organization because they need to avoid risks.

The result of this study displays an uncertainty avoidant score tend to be stronger (80 of 100), moderate work engagement score (4,68 from 6.00), and moderate workaholism (2.42 from 4.00). The relationship between uncertainty avoidant score and work engagement is significantly positive ($r = .132, p < 0.01$), and just only positive related with dedication ($r = .180, p < 0.01$), but unrelated to vigor and absorption. This contrasts the expectation of this study that uncertain avoidant dimension will become a negative relationship with work engagement especially with vigor and absorption.

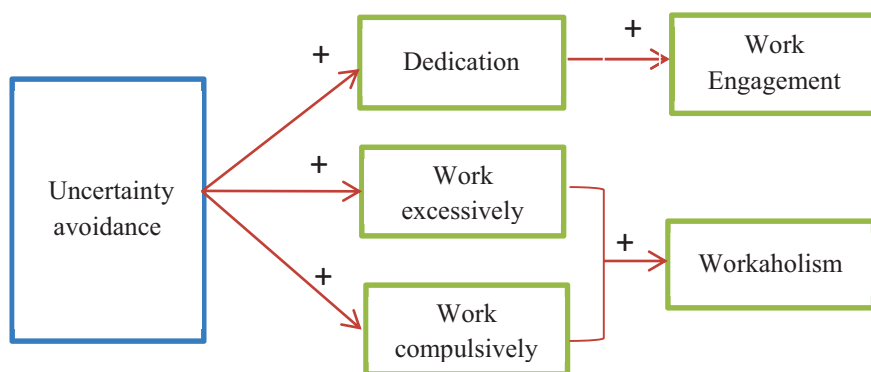

Figure 5.10 Uncertain avoidance drives the dedication and workaholism

Unsurprisingly, uncertainty avoidance is positively related to workaholism and its components: excessive work and compulsive work. Baruch (2011) has reasoned this

claim that those employees work so hard that an uncertainty becomes reduced in strong uncertain avoidant atmosphere while, in weak uncertain avoidant atmosphere, people need to work hard if necessary. However, they are not driven by an inner workaholism.

It could be summarized that uncertain avoidant culture could either drive or reduce work engagement. Uncertain avoidance can raise work engagement through dedication from people who are strongly involved themselves in their work because they want to avoid an unexpected circumstance. On the other hand, an uncertain avoidance might degrade engagement by vigor and absorption because those workers are willing to avoid the chaos situations and high anxiety which might negatively affect to their work.

High level of workaholism is strong in uncertain avoidant culture because those people are willing to work harder in order to avoid facing risks in the future. It seems that their strong willingness will drive a sense of hard working in strong uncertain avoidant societies.

Therefore, uncertainty avoidance cannot drive work engagement, but this culture has positive relation with dedication. The strong uncertainty avoidance involves the employees' emotional need to be busy and inner urge to work hard, the employees' belief in expert and technical solution, and employees are motivated by security, esteem, or belonging. (Hofstede,2010). these can enhance dedication level because when employees have a sense of belonging or esteem with organization, and high levels of work involvement and input generally result in a reduction of uncertainty (Baruch, 2011), these can drive dedication level.

As uncertainty avoidance culture involves employees' emotional need to be busy and inner urge to work hard, these will increase work excessively, work compulsively, also workaholic level, according the proposition by Baruch (2011) that workaholism is perceived as more positive in cultures characterized by high uncertainty avoidance and less positive in cultures with low uncertainty avoidance.

5.5.5 How does long-term orientation drive work engagement and workaholism?

Long-term orientation refers to the fostering of virtue orientation towards future rewards particularly perseverance and thrift while short-term orientation stands for the fostering of virtue orientation to present and past, in particular respect for tradition, face saving behavior, and fulfilling social obligations (Hofstede, 1990).

Long-term orientation is correlated to the divorced rates (Hofstede, Hofstede & Minkov, 2010): the low divorcing rate in long-term orientation and culture. Nonetheless, the divorced rate in Thailand has been increasing for two decades (National Statistical Office), meanwhile face saving behavior still remains in Thai society (Komin, 1990).

Work engagement shows little positive relation to dedication, but work engagement does not have a relationship with vigor and absorption. Dedication refers to being strongly involved in one's work, and experiencing a sense of significance, enthusiasm, inspiration, pride, and challenge.

Ng and Ng (2003) found that working ethic is negatively correlated with short-term views on welfare assistance and consumption. Employees with lower levels of working ethic have been found to have higher absenteeism and give little contribution to the company.

Workaholism, excessive work, and compulsive work are minimal positive correlated with long-term orientation. Regarding to the uncertain avoidance, dedication is related to excessive work. Thus, to increase workaholism level can be suggested by illustrating future outcome and profit.

Unsurprisingly, UAI and LTO influence only on dedication because both dimensions are not related with people but relate with environments: nature and time (Trompenars ,1993). Dedication is regarded to being strongly involved in one's work, and experiencing a sense of significance, enthusiasm, inspiration, pride, and challenge. Those dedication elements might be influenced by job resources not personal resources (Xanthopoulou, Bakker, Demerouti, and Schaufeli, 2007). Job resource involves organizational practices which are career opportunities, supervisor coaching, role-clarity, and autonomy (Bakker and Demerouti, , 2007).

To conclude, culture can drive work engagement via dedication and workaholism via excessive and compulsive work in long-term orientation as can be seen in figure 5.11.

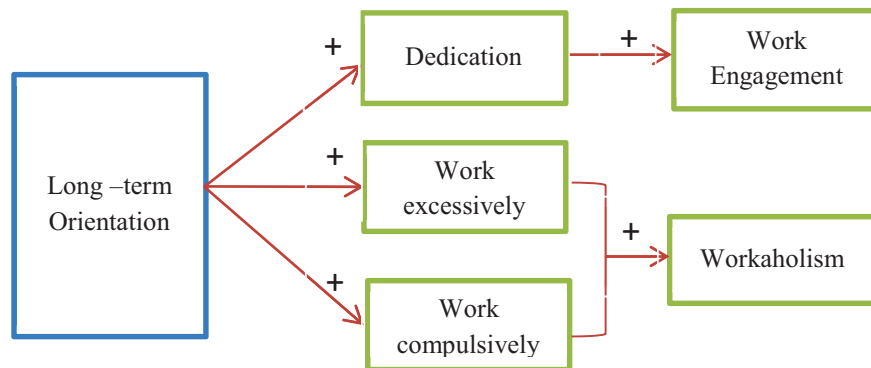

Figure 5.11 Long-term orientation dimension drives the dedication and workaholism.

The relation between long-term orientation culture with work engagement and workaholism is similarly uncertainty avoidance culture. They do not drive work engagement, but can increase dedication level, also drive workaholism, work excessively, and work compulsively.

The model in figure 5.11 supported the proposition by Baruch (2011) that workaholism is perceived as more positive in cultures characterized by long-term orientation and less positive in cultures of short-term orientation. In this case, because of employees have perceived as important for achieving long term individual career goals, and the manager and employees share the same inspiration (Hofstede,2010) make employees work harder than short-term orientation value.

Because of manager and employees share the same inspiration, they will have more work involvement and work inspiration, therefor the dedication level is higher.

5.6 Summary

This summary of analysis divided into two parts: culture influence work engagement and culture influence workaholism. Masculine culture has been impacting on work engagement and its three components: vigor, dedication, and absorption. Thus, masculine or competitive culture will increase employees' productivity and performance. Uncertain avoidant culture and long-term goal orientation could increase the level of dedication and work engagement as well. However, large amount of power distance could decrease vigor level causing weak relationship that can hardly be considered as a meaningful.

Power distance, uncertain avoidance, masculine and long-term goal orientation could influence employees to be more workaholism and might increase employees' performance by letting them work harder with their strong willingness. These could give a negative impact to employee well-being. Thus, the company should introduce work-life balance program to prevent employees' high level of workaholism.

Lastly, the three models as the result of this present study created in figure 5.12 to suggest further study in work engagement.

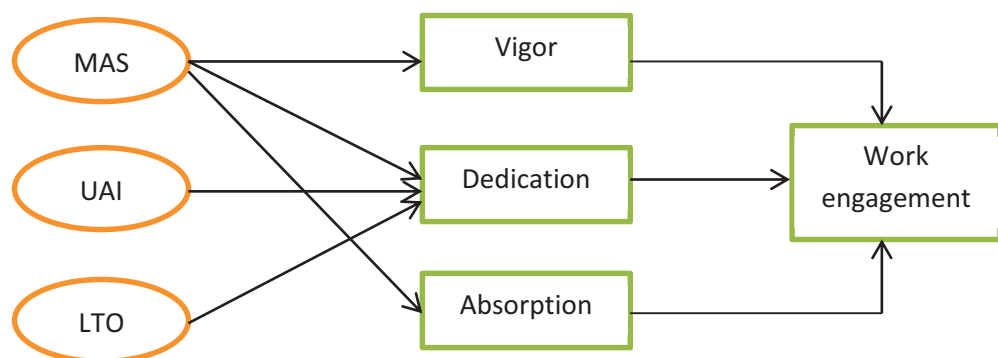

Figure 5.12 Masculine, uncertainty avoidance and long-term orientation culture drive work engagement

The work engagement model, in figure 5.9, shows masculine culture drives work engagement through its three components: vigor, dedication, and absorption. According to the score of masculine dimension by Hofstede (2010), it is found that 34 indicated that Thailand is a femininity society while the result of this study indicates that masculinity culture is increasing (73).

The countries with high work engagement, such as France, Portugal, and Finland (Shimazu, Miyanaka and Schaufeli, 2010), had their masculine scores 43, 31, and 26 respectively (Hofstede.2010). On the contrary, lower work engagement countries, namely, Japan and China, acquired their masculine scores 96 and 66 respectively. This contrast can be explained that engagement drivers are not universal (AON-Hewitt, 2012). The drivers are different in multicultural societies. However, the report indicates that the payment is one of the top drivers of work engagement similarly to masculine culture which focuses on materialism. This can be the result of why masculine culture drives work engagement.

Since there is no relationship between work engagement and workaholism, this should be studied separately. Nonetheless, the result presents the relationship between cultural dimensions and workaholism. Then, the workaholism model is created (figure 5.10).

The workaholism model (figure 5.13) shows four culture dimensions: PDI, MAS, UAI, and LTO, which drive workaholism level. This supports the proposition of Baruch (2011) that, under a culture of high power distance, factors, that can improve possible individual powers (strength) and visible investment in work engagement (long working hours), will be more desired than factors under a culture of low power distance.

Workaholism is perceived to be more positive in the cultures with high uncertain avoidant, high masculinity and long-term goal orientation, but workaholism is considered to be less positive in the cultures with low uncertain avoidant, high level of femininity and short-term goal orientation.

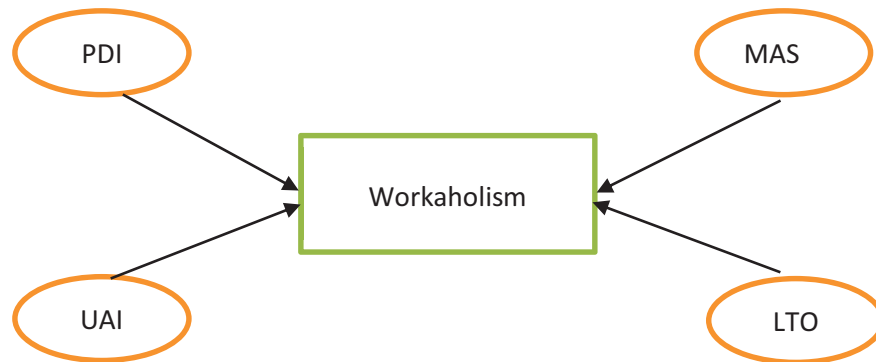

Figure 5.13 Power distance, Masculine, Uncertain avoidance, and long-term goal orientation cultures drive workaholism.

Conclude to the model of culture drives work engagement and orients to workaholism is presented in figure 5.14

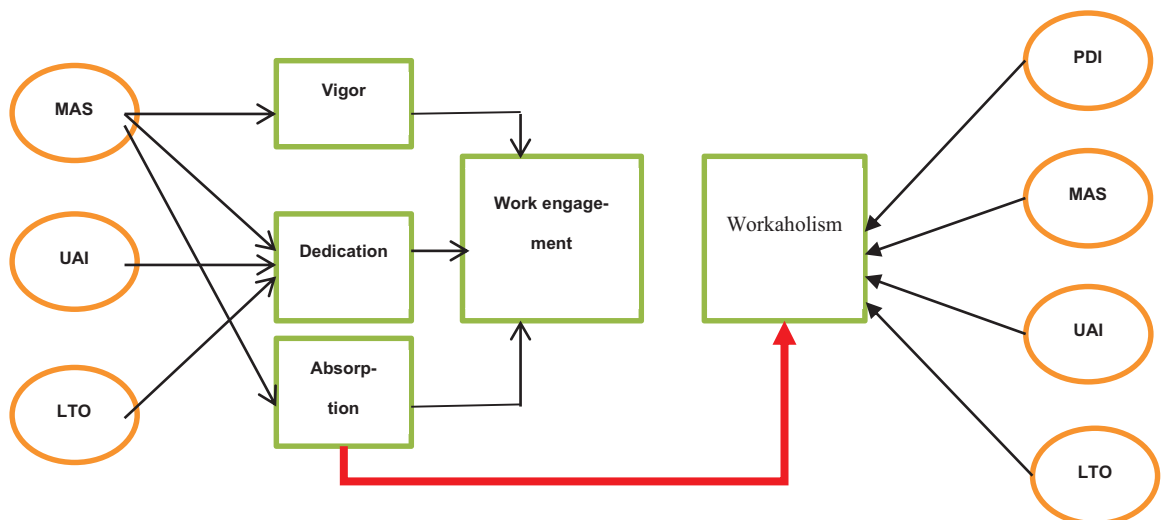

Figure 5.14 Model of culture drives work engagement and orients to workaholism

5.7 Limitations and Suggestions for Further research

This present study has some limitations from methodologies. First, the self-report questionnaire may create bias from the results. Second, this study had applied only one method to measure all variables. This could also mono-method bias (Cook and Campbell, 1979). It can be suggested that methodologies for further research should be utilized more than one to confirm the results and to reduce the bias. For examples, qualitative method or secondary data collection especially culture survey can be used. Third, the samples in electronics and electronic, automotive, and hotel sectors cannot represent as industry level or national level as a whole. Thus, study in other sectors can be done to confirm or extend the results from this study. Forth, cross-sectional study, focusing on specific time interval, may not give the updated results. Hence, time-series analysis method can be used to reduce the gap of this limitation. Lastly, the study's results present the minimal relationship among variables, so there could be other impact factors to be further studied.

The suggestion of the further research, should present the comparisons of each cultural dimension in order to confirm or extend the Hofstede's study, including to apply others cultural dimensions apart from Hofstede's study to analyst the influence on work engagement and workaholism, next study others factors impact on work engagement and workaholism, such as organization contexts, lastly studying of a workaholism and work engagement should be in a separate study of one of them.

5.8 The managerial benefits

The managerial benefits from this study is about to increase work engagement level and to decrease workaholic level in the right way and in the right person.

Enhancing work engagement individually will provide better effective outcome than applying one typical pattern of work engagement to the whole organization. This study recommends that the organization should group their employees not only according to their work engagement or workaholic levels, but it should group or categories their employee also according to the work engagement or workaholism components. This study has established eight types of work engagements and four types of workaholism for enhancing work engagement and monitoring workaholism in organizations. Furthermore, this study has focused on the cultural factors related to work engagement, workaholism and their components. These can provide right approaches for organizations to enhance work engagement and to decrease workaholism.

Therefore, the discussion from this study could be benefic for the organization who would like to apply the right approaches to optimize their work engagement and to monitor workers' workaholism, by observing three questions.

- (1) How to enhance work engagement?
- (2) How to monitor workaholism in organization?
- (3) *Which individual and work situation factors should be concerned in work engagement and workaholism?*

(1) How to enhance work engagement? This study has generated work engagement into eight groups regarding to their components: vigor, dedication, and absorption. Through careful observation, the organization will be able to apply the right approach to the particular employees. For example, if those employees lack vigor or willingness for investing their effort in work, it can be assumed that they may not have an appropriate level of their competency. In this case, employee developing program should be applied. If their dedication level does not achieve at the certain level, the organization can implement the employee's involvement scheme or assign more challenging job to improve their dedicational level.

If their absorption level is not enough, this means such employees cannot concentrate on their jobs or they may not enjoy working. In this case, the organization can implement the happy workplace model to fix the problem, or make an appointment to the employee's consultant to help them solve their personal or work problems.

The organization should be aware of a cultural impact on work engagement as the organization value could cause the decrease or increase work engagement. The results of this study showed that power distance is negatively related to vigor, so enhancing work engagement among non-vigor workers may not be successful when work engagement scheme has been deployed in high power distance environment.

While individual culture is positively related to absorption, this will help create suitable work environment through task-oriented or result-oriented approach, such as, mental expressing activities, self-respect encouragement or individual rewards. By employing these individual cultural activities, this could raise the level of work engagement among employees, especially non-absorption workers.

To achieve the maximum level of work engagement among disengaged workers, the positive relationships between masculinity culture and work engagements: vigor, dedication, and absorption, can create competitive culture to increase work engagement in an organization.

The uncertainty avoidance and long-term orientated culture are positively related to work engagement and dedication. These have provided the guideline to organization to create work environment related to the uncertainty avoidant culture, such as, calling the workers by their official and academic titles or task-orientated positions. This will put an importance of being academic experts or specialists on these workers. Sometimes, the workers are allowed to express their feelings when they are in an ambiguous state in some situations.

To set up a suitable work environment related to the long-term orientation can include focusing heavier on pragmatic culture than normative culture. Noticeably, the establishment of uncertainty avoidance and long-term oriented culture to enhance work engagement will give maximum result on non-absorption group.

To set up a suitable work environment related to the long-term orientation can include focusing heavier on pragmatic culture than normative culture. Noticeably, the establishment of uncertainty avoidance and long-term oriented culture to enhance work engagement will give maximum result on non-dedicated group

(2) How to monitor workaholism in organization? Similarly, to work engagement, this study has classified workaholism into four groups by considering these components: work excessively and work compulsively. The employees, who work excessively and compulsively, tend to become workaholism. Workaholism situation in the workplace can change employees' work value from work hard to work smart, or detach

themselves to work sharing. Creating the pleasant working environment can turn unhappy employees to be highly- motivated and engaged.

Organization should monitor the workaholism who are maintain high level in absorption and attached themselves closely with their work. According to ‘Work-Related Subjective Well-Being Model’ by Bakker (2011), the engagement is closely related to workaholism in active employees. These active employees will become more workaholic when they are placed in unpleasant situations, such as, tense, angry, irritated, hostile, and agitated. The results about positive relationship between absorption and workaholism from this study have correlated to Bakker and Lieter’s (2010) that the absorption component of work engagement is likely to evoke candidates’ unhealthy behaviors. Therefore, enhancing work engagement should implement carefully intertwined with absorption factor.

The cultural impact on workaholism could drive the level of organizational value in positive or negative directions. The results of this study showed that the positive relationship has been appeared between workaholism and the other elements: power distance, uncertainty avoidance, masculinity, and long-term orientation.

Thus, to decrease workaholism, the organization should flatten managerial levels, so the gaps between leader and employees will be closed. To increase job mobility, to decrease numbers of rules, and to improve interpersonally orientated management would help eliminate the level of workaholism, as well.

Importantly, masculine culture can enhance work engagement and workaholism. Thus, creating competitive environment through enhancing work engagement can raise the level of workaholism in highly competitive employees.

(3) Which individual and work situation factors should be concerned in work engagement and workaholism?

After exploring the individual and work situational factors related to work engagement and workaholism, the results of this study can be a solution for organization to better understand the difference between work engagement and workaholism. It is advisable that organization should analyze work engagement or workaholism level by concerning individual and work situation factors in order to enhance work engagement to the right person. By applying these suggested frameworks from this study, it is undeniable that there will be a productive dynamic momentum in working situation. This movement will help modernize the organization to be able to keep up on the current of global change by work engagement employees.

REFERENCES

- Alarcon, G. M., & Edwards, J. M. (2011). The relationship of engagement, job satisfaction and turnover intentions. *Stress and Health, 27*, 294-298.
[doi:10.1002/smi.1365](https://doi.org/10.1002/smi.1365)
- AON-Hewitt. (2012). Trends in Global Employee Engagement 2012. Retrieved from <http://www.aon.com>.
- Avery, D.R., McKay, P.F., & Wilson, D.C. (2007). Engaging the aging: the relationship between perceived age similarity, satisfaction with co-worker, and employee employment. *Journal of Applied Psychology, 92*(6), 1542-1556.
- Axelrod, R. (1997) The dissemination of culture - A model with local convergence and global polarization. *Journal of Conflict Resolution. 41*(2), 203-226.
- Aycan, Z., Kanungo, R.N., Mendonca, M., Yu, K., Deller, J., Stahl, G., & Kurshid, A. (2000). Impact of culture on human resource management practices: A 10-country comparison. *Applied Psychology: An International Review, 49*(1), 192-221.
- Ayoun, B.M., & Moreo, J.M. (2008). The influence of the cultural dimension of uncertainty avoidance on business strategy development: A cross-national study of hotel managers. *International journal of Hospitality Management, 27*, 65-75
- Bandura, Albert. (1963). Social learning and personality development. NY: Holt, Rinehart & Winston.
- Bakker, A.B. (2009). Building engagement in the workplace. In R. J. Burke and C.L. Cooper (Eds.). *The peak performing organization* (pp. 50-72). Oxon, UK: Routledge.
- Bakker, A.B. (2011). An evidence-based model of work engagement. *Current Directions in Psychological Science, 20* (4), 265-269.
- Bakker, A.B., & Demerouti, E. (2009). The crossover of work engagement between working couples: A close look at the role of empathy. *Journal of Managerial Psychology, 24* (3), 220-239.
- Bakker, A.B., & Schaufeli, W.B. (2008) .Positive organizational behavior: engaged employees in flourishing organizations. *Journal of Organizational Behavior, Vol. 29* (2), 147-154.
- Bakker, A.B., & Xanthopoulou, D. (2009). The crossover of daily work engagement: test of an actor-partner interdependence model. *Journal of Applied Psychology, 94*(6), 1562-1571.
- Bakker, A.B., Demerouti, E., & Brummelhuis, L.L.T. (2012). Work engagement, performance, and active learning: The role of conscientiousness. *Journal of Vocational behavior, 80* (2), 555-564.
- Bakker, A.B., Demerouti, E., & Schaufeli, W.B. (2005). The crossover of burnout and work engagement among working couples. *Human Relations, 58*(5), 661-689.

- Bakker, A.B., Emmerik, H. van., & Euwema, M.C. (2006). Crossover of burnout and engagement in work teams. *Work and occupations*, 32 (4), 464-489.
- Bakker, A.B., Shimazu, A., Demerouti, E., Shimada, K., & Kawakami, N. (2011). Crossover of work engagement among Japanese couples: Perspective taking by both partners. *Journal of Occupational Health Psychology*, 16 (1), 112-125.
- Baruch, Y. (2011). The positive wellbeing aspects of workaholism in cross cultural perspective: The chocoholism metaphor. *Career Development International*, 16 (6), 572 – 591.
- Beckmann, D., Menkhpf, L., & Suto, M. (2008). Does culture influence asset managers' views and behavior? *Journal of Economic Behavior and Organization*, 67(3-4), 624-643. doi:10.1016/j.jebo.2007.12.001
- Beek, I.V., Taris, T.W., & Schaufeli, W.B. (2011). Workaholism and work engaged employees: Dead ringers or worlds apart? *Journal of Occupational Health Psychology*, 16(4), 468–482.
- Beek, I.V., Hu, Q., Schaufeli, W.B., & Schreurs, B.H.J. (2012). For fun, love, or money: What drives workaholism, engaged, and burned-out employees at work?. *Applied Psychology: An international review*, 61(1), 30-55.
- Bezuidenhout, A., & Cilliers, F. (2011). Age, burnout, work engagement and sense of coherence in female academics at two South African universities. *South African Journal of Labour Relations*, 25(1), 61- 80
- Birkman Internation. (2009). How do generational differences impact organizations and teams? Retrieved from <http://www.Birkman.com/>
- BlessingWhite. (2011). Employee engagement report 2011, Beyond the number: A practical approach for individual, managers, and executives. Retrieved from <http://www.blessingwhite.com/>
- Bollinger, D. (1994): The Four Cornerstones and Three Pillars in the “House of Russia” Management System. *Journal of Management Development*, 13(2), 49-54.
- Bond, M. H., Al Au, K.L., Tong, K., Reimel de Carrasquel, S., Murakami, F., Yamaguchi, S.,...Lewis, J.R. (2004). Culture-level dimensions of social axioms and their correlates across 41 cultures. *Journal of Cross- Cultural Psychology*, 35(5), 548-570.
- Brody, R.G., Coulter, J.M., & Lin, S. (1999). The effect of national culture on whistle-blowing perception. *Teaching Business Ethics*, 3 (4), 383-398.
- Brown, M.A. (1976). Values- a necessary but neglected ingredient of motivation on the job. *Academy of Management Review*, 1(4), 15-21.
- Burke., R.J. (2000). Workaholism and extra-work satisfactions. *The International Journal of Organizational Analysis*, 7(4), 352-364.
- Burke., R.J., Oberklaid, F., & Burgess, Z. (2004). Workaholism among Australian women psychologist: Antecedents and consequences. *Women in Management Review*, 19(5), 252-259.

- Burke, R. J., Koyuncu, M., Jing, W., & Fiksenbaum, L. (2009). Work engagement among hotel managers in Beijing, China: Potential antecedents and consequences. *Tourism Review*, 64(3), 4-18.
- Caramelli, M., & Briole, A. (2007). Employee stock ownership and job attitudes: Does culture matter? *Human Resource Management Review*, 17 (3) ,290–304
- Chang, M. K. (1998). Predicting unethical behavior: A comparison of the theory of reasoned action and the theory of planned behavior. *Journal of Business Ethics* ,17 (6) ,1825-1834.
- Chen, P.J., & Choi, Y. (2007). Generation differences in work values: A study of hospitality management. *International Journal of Contemporary Hospitality Management*, 20(6), 595-615.
- Chew, I.K.H., & Putti, J. (1995). Relationship on work-related values of Singaporean and Japanese managers in Singapore. *Human Relations*, 48 (10), 1149-1170.
- Cook, T.D., & Campbell, D.T. (1979). *Quasi-Experimentation: Design and Analysis for Field Settings*. Rand McNally, Chicago, Illinois.
- Crampton, S.M., & Hodge, J.W. (2009). Generation Y: Uncharted territory. *Journal of Business and Economics Research*, 7(4), 1-6.
- David, J.B., Pawlowski, S.D., & Houston, A. (2006). Work commitment of baby boomers and Gen-Xers in the IT profession: Generational differences or Myth. *Journal of Computer Information System*, 46 (3), 43-49.
- DDI. (n.d.) Employee Engagement: the key of realizing competitive advantage. Retrieved from <http://www.ddiworld.com/>
- DDI. (2011) Global Leadership Forecast 2011. Retrieved from <http://www.ddiworld.com/>
- Douglas, R.J. & Morris, R.L. (2006). Workaholism, or just hard worker? *Career Development International*, 11(5), 394-417.
- EEL. (2005). Building and Enhancing Employee Engagement and Retention. Retrieved from <http://www.brake.com/>
- Elenkov, D. (1998). Can American management concepts work in Russia? A cross-cultural comparative study. *California Management Review*, 40(4), 133–56.
- Eves, A., & Cheng, L. (2007). Cross cultural evaluations of factors driving intention to purchase new food products—Beijing China and south-east England. *International Journal of Consumer Studies*, 31(4), 410-417.
- Fairhurst, S. & O'connor, J. (2010) Employee Well-Being: Taking Engagement and Performance to the Next Level. Retrieve from <http://www.towerswatson.com/>
- Fairlie, P. (2011). Meaningful work, employee engagement, and other key employee outcomes: Implications for human resource development. *Advances in Developing Human Resource*, 13 (4), 508-525.
- Federman, B. (2009). Employee engagement: A roadmap for creating profits, optimizing performance, and increasing loyalty. Jossey-Bass, USA.

- Felke, J., Yan, W., & Six, B. (2008). The impact of individual collectivism on commitment and its influence on organizational citizenship behavior and turn over in three countries. *International Journal of Cross Cultural Management*, 8(2), 211-237.
- Ferguson, A. (2007). Employee engagement: Does it exist, and if so, how does it relate to performance, other constructs and individual differences? Retrieved from <http://www.lifethatworks.com/>
- Fernandez, D.R., Carlson, D.S., Stepina, L.P., & Nicholson, J.D. (1997). Hofstede's country classification 25 years later. *The Journal of Social Psychology*, 137(1), 43-54.
- Fey, C., & Denison, D.R. (2003). Organizational culture and effectiveness: Can an American theory be applied in Russia?. *Organization Science* 14(6), 686-706.
- Fleck, S., & Inceoglu, I. (2010). Handbook of Employee Engagement: Perspective, Issues, Research and Practice. Edited by Simon L. Albrecht. Edward Elgar Publishing Limited. UK.
- Fock, H., Chiang, F., Au, K.Y., & Hui, M. K. (2011). The moderating effect of collectivistic orientation in psychological empowerment and job satisfaction relationship. *International Journal of Hospitality Management*, 30 (2), 319-328.
- Geurts, S.A.E., & Demerouti, E. (2003). Work/Non-work interface: A review of theories and findings. in M. Schabraq, J. Winnubst and C.L. Cooper (Eds.), *The handbook of work and health psychology* (2nd ed.; pp. 279-312). Chichester: Wiley.
- Gallup (2006). Gallup study: engaged employees inspire company innovation: national survey finds that passionate workers are most likely to drive organisations forward', *The Gallup Management Journal*, Retrieved from <http://gmj.gallup.com/content/24880/Gallup-Study-Engaged-Employees-Inspire-Company.aspx/>
- Gibson, J.W., & Greenwood, R.A. (2009). Generation differences in the workplace: personal values, behaviors, and popular beliefs. *Journal of Diversity Management. Third Quarter* 4(3). 1-7.
- George, J. M. (2011). The wider context, costs, and benefits of work engagement. *European Journal of Work and Organizational Psychology*, 20(1), 53–59.
- Guidroz, A.M., Kotrba, L.M., & Denison, D.R. (2005). Workplace diversity: Is national or organizational culture predominant. Retrieved from <http://www.Linkageinc.com/>
- Halbesleben, J.R.B., Harvey, J., & Bolino, M.C. (2009). Too engaged? A conservation of resources view of the relationship between work engagement and work interference with family. *Journal of Applied Psychology*, 94 (6), 1452-1465.
- Harter, J. K., Schmidt, F. L., & Hayes, T. L. (2002). Business-unit-level relationship between employee satisfaction, employee engagement, and business outcomes: A meta-analysis. *Journal of Applied Psychology*, 87(2), 268-279.

- Hayter, N., Smeed, M., & Robertson, I. (2011). Improving performance through wellbeing and engagement: wellbeing and performance mapping exercise Summary report. Retrieved from <http://www.ucea.ac.uk/>
- Hemmingsem, M. (2008). Generational differences at work. *Canadian HR reporter*, May 19 2008, 21, 9-10.
- Hirschman, A. (1970). Exit, voice and loyalty: to decline in firms, organizations, and states. Cambridge, MA: Harvard University.
- Hofstede, G. (1980). Culture's consequences: International differences in work-related values. Beverly Hills, CA: sage
- Hofstede, G. (1990). Cultures and organizations: Software of the mind. New York: McGraw-Hill.
- Hofstede, G., Hofstede, G.J., & Minkov, M. (2010). Cultures and organizations: software of the mind: Intercultural cooperation and its importance for survival. 3rd. McGrawHill.
- Hope, C.A. (2004). The impact of national culture on the transfer of "best practice operation management" in hotels in St. Lucia. *Tourism Management*, 25 (1), 45-49.
- Hosseini, R. D., & Hamed, D. (2012). Comparative study effect of culture from Hofstede perspective on purchasing mobile phone in Iran and society. *International Journal of Business and Social Science*, (Special Issue – March 2012), 3(6).
- Irani, F., S., & Oswald, S.,L. (2001). Workplace Aggression: Is National Culture a Factor?. *The Business Renaissance Quarterly: Enhancing the Quality of Life at Work*, 4 (1), 63-89.
- ISR. (2004). International Survey Research. Retrieved from <http://www.isrsurveys.com/>
- Johnson, J.A., & Lopes, J. (2008). The intergenerational workforce revisited, *Organizational Development Journal*, 26(1), 31-37.
- Jones, M.L. (2007). Hofstede – culturally questionable? . Oxford Business and Economics Conference, Oxford, UK, 24-26 June 2007.
- Kahn, W. A. (1990). Psychological conditions of personal engagement and disengagement at work. *Academy of Management Journal*, 33(4), 692–724.
- Karetepe, O.M., & Olusegun, O.A. (2009). The effect of job and personal resource on hotel employees' work engagement. *International Journal of Hospitality Management*, 28 (4) , 504-512.
- Khatri, N. (2009). Consequences of power distance orientation in organizations. *The journal of Business Management Perspective*, 3(1), 1-9.
- Kim, H.J., Shin, K.H., & Swanger, N. (2009). Burnout and engagement: A comparative analysis using the big five personality dimensions. *International Journal of Hospitality Management*, 28 (1), 96-104.

- Kowske, B.J., Rasch, R., & Wiley, J. (2010). Millennials' (lack of) attitude problem: An empirical examination of generational effect on work attitudes. *Journal of Business Psychology, 25*(2), 265-279.
- Kubota, K., Shimazu, A., Kawakami, N., Takanahahi, M., Nakata, A., & Schaufeli, W.B. (2010). Association between workaholism and sleep problems among hospital nurses. *Industrial Health, 48* (6), 864–871.
- Komin, S. (1990) Culture and work-related values in Thai organizations. *International Journal of psychology. 25*(3), 681-704. DOI: 10.1080/00207599008247921
- Langelaan, S., Bakker A.B., Doornen, L.J.P. V., & Schaufeli, W.B. (2006). Burnout and work engagement: Do individual differences make difference? Personality and individual differences? 40(3), 521-532, Retrieved from <http://dx.doi.org/10.1016/j.paid.2005.07.009>
- Lathar, V.K., & Luthar, H.K. (2002). Using Hofstede's cultural dimensions to explain sexually harassing behaviors in an international context. *The international of Human Resource Management, 13* (2), 268-284.
- Li, C., Zinn, H.C., Chick, G.E., Graefe, A.R., & Absher, J.D. (2004). Hofstede's measure of cultural values in a national forest recreation context. Retrieved from <http://www.metla.fi/>
- Liao, F.Y., Yang L.Q., & Wang, M. (2013). Team-member exchange and work engagement: Does personality make a difference. *Journal of Business Psychology, 28* (1), 63-77.
- Macey, W., & Schneider, B. (2008). Engaged in Engagement: We are delighted we did it. *Industrial and Organizational psychology, 1* (1), 76-83.
- Mackym K., Gardner, D., & Forsyth, S. (2008). Generational differences at work : Introduction and overview. *Journal of Managerial Psychology, 23*(8), 857-861.
- Madlock, P.E. (2012). The influence of power distance and communication on Mexican Workers. *Journal of Business Communication, 49*(2), 169-184.
- Magnini, V.P. (2009). The influence of national culture on the strategic use of salesperson pricing authority: A cross-country study within the hotel industry. *International Journal of Hospitality Management, 28* (1), 173-176.
- Mannhien, K. (1953) *Essays on sociology and social psychology*. New York: Oxford University Press.
- Maslach, C. & Leiter, M.P. (1997). *The truth about burnout*. San Francisco: Jossey Bass.
- Mauno, S., Kinnunen, U., Ma"rikangas, A., & Na"tti, J. (2005). Psychological consequences of fixed-term employment and perceived job insecurity among health care staff. *European Journal of Work and Organizational Psychology, 14* (3), 209–237.
- Mayer, J.P., & N.J. Allen. (1997). *Commitment in the workplace: Theory, research, and application*. Sage Thousand Oaks, CA: Sage.es.

- Meriac, J.P., Woehr, D.J., & Banister, C. (2010). Generational differences in work ethic: An examination of measurement equivalence across three cohorts. *Journal of Business Psychology, 25* (2) ,315-324.
- Migliore, L.A. (2011). Relation between big five personality traits and Hofstede's cultural dimensions. *Cross Culture Management: An International Journal .18*(1), 38-54.
- Muenjohn, N. (2004). Expatriate Management: Getting a perspective on host-nation subordinates' cultural values, *4 th Asian Academy of Management conference 2004*, December 16-18, 2004, Shanghai, China.
- Muenjohn, N. (2011). Dimensions of Culture: Understanding Thai working and management styles in Wenchang Fang (ed.) *International Conference on Business and Information 2011*, Taiwan.
- Naumov A., Petrovskaia I. (2010): Evolution of National Culture Impact on Managing Business in Russia in 1996-2006. *Eurasian Review, 3*, 76-87.
- Neufeld, J.E., Rasmussen, H.N., & Lopez, S.J. (2006). The engagement model of person-environment interaction. *The Counseling Psychologist, 34*(2), 245-259.
- Ng, Y.K., & Ng, S. (2003). Do the economies of specialization justify the work ethics: An examination of Buchanan's hypothesis. *Journal of Economic Behavior & Organization, 50*(3), 339-353.
- Pagell, M., Hatz, J.P., & Sheu, S. (2005). The importance of national culture in operations management research. *International Journal of Operation management and Production Management, 25*(4), 371-394,
- Park, J., & Gursoy, D. (2012). Generation effects on work engagement among U.S. hotel employees. *International Journal of Hospitality Management, 3*(4), 1195-1202.
- Paul, T. (2012). The impact of age and education on the level of satisfaction and motivation among employees. *The IUP Journal of Management Research, 11*(1), 29-37.
- Pavett, C. (2011). U.S. cross-generational variations in culturally- oriented value systems. *American Journal of Management, 12*(1), 57-68.
- Petison, P. (2010). Cross Cultural Relationship Marketing in the Thai Context: The Japanese Buyer's Perspective. *International Journal of Trade, Economics and Finance, 1* (1), 17-23.
- Pimpa, N. (2012). Amazing Thailand: Organizational Culture in the Thai Public Sector. *International Business Research, 5*(11), 35-42.
- Pizam, A., Pine, R., Mok, C., & Shin, J.Y. (1997). Nationality vs industry cultures: which has a greater effect on managerial behavior?. *Journal of Hospitality Management, 16*(2), 127-145.
- Pizam, A. (1993) *Managing Cross Culture Hospitality enterprise*. In Jones, P. and Pizam, A. (Eds) *the international Hospitality industry*, London: Pitman.
- Porter, M. E. (1987), *From Competitive Advantage to Corporate Strategy*, Harvard Business Review, May/June 1987. 43-59.
- Porter, M.E. (1990) "The Competitive Advantage of Nations". Retrieved from <http://www.economist.com>

- Purohit, Y. S., & Simmers, C. A. (2006) Power Distance and Uncertainty Avoidance: A Cross-National Examination of Their Impact on Conflict Management Modes. *Journal of International Business Research*, 5(1), 1-19.
- Rich, B.L., Lepine, J.A., & Crawford, E.R. (2010) . Job engagement: antecedents and effects on job performance. *Academy of Management Journal*. 53(3), 617-653.
- Richardson, R.M. and Smith S.W. (2007). The influence of high/low –context culture and power distance on choice of communication media: students’ media choice to communicate with professors in Japan and America. *International Journal of Intercultural Relations*, 31 (4), 479-501.
- Right management. (2011). Organizational Effectiveness: Discovering How to Make It Happen. Retrieved from [http:// www.rightmanagement.com/](http://www.rightmanagement.com/)
- Ringov, D. and Zollo, M. (2007). Corporate responsibility from a socio-institutional perspective: The impact of national culture on corporate social performance. *Corporate Governance*, 7(4), 476-485.
- Robertson-Smith, G., & Markwick, C. (2009) Employee Engagement: A review of current thinking, The institute for employment studies, Brighton: University of Sussex.
- Robbins, Stephen P. (2005), Organizational Behavior, Upper Saddle River, New Jersey, Pearson, Prentice Hall
- Robinson, D., Perryman, S., & Heyday, S. (2004) The divers of employee engagement, The institute for employment studies, Brighton: University of Sussex.
- Robinson., B.E., Carroll, J.J., & Flower, C. (2001). Marital estrangement, positive affect, and locus of control among spouses of workaholism and spouses of nonworkaholism: A national study, *The American Journal of family*, 29 (5), 397-410.
- Rojjanaprayon, W. (1997). Communication patterns of Thai people in a non-Thai context. Unpublished doctoral dissertation, Purdue University.
- Robinson., B.E., Flowers, C., & Ng, K. (2006). The relationship between workaholism and Marital Disaffection: Husband’ perspective. *The Family Journal: Counseling and Therapy for Couples and Families*, 14(3), 213-220.
- Rusbult, C.E., Farrell, D., Rogers, G., & Mainous III R.G. (1988). Impact of Exchange Variables on Exit, Voice, Loyalty, and Neglect: An Integrative Model of Responses to Declining Job Satisfaction, *The Academy of Management Journal*, 31(3), 599-627.
- Sak, A. M. (2005). Antecedents and consequences of employee engagement, *Journal of Managerial Psychology*, 21(7), 600-619.
- Sarkisian, N., Pitt-Catsouphes, M., Bhate, R., Carapinha, R., Lee, J.,& Minnich, C. (2011). Effects of Country & Age on Work Engagement, Job Satisfaction & Organizational Commitment Among Employees in India. Retrieves from <http://www. /www.bc.edu/>
- Schaufeli W.B., Bakker, A.B., & Salanova, M., (2006) The measurement of work engagement with a short questionnaire: A cross-national study, *Educational and Psychological Measurement*, 66(4) , 701-716.

- Schaufeli, W., & Salanova, M. (2007). Work Engagement: An emerging psychological concept and its implications for organizations. In S.W. Gilliland, D.D. Steiner, & D.P. Skarlicki (Eds.), *Research in Social Issues in Management (Volume 5): Managing Social and Ethical Issues in Organizations*. Greenwich, CT: Information Age Publishers.
- Schaufeli, W.B., Salanova, M., Gonzalez-Roma, V., & Bakker, A.A. (2002). The measurement of engagement and burnout: A two sample confirmatory factor analytic approach. *Journal of Happiness Studies*, 3 (1), 71-92.
- Schaufeli, W.B., Taris T.W., & Bakker, A.B. (2008). It take two to tango: is workaholism is working excessively and working compulsively in “ the long work hours culture” Emerald Group Publishing Limited. DOI: 10.1016/B978-1-84855-038-4.00009-9.
- Schaufeli W.B., Trais, T.W., & Rhenen, W.V. (2008). Workaholism, burnout, and work Engagement: Three of kind or three different kinds of employee well-being. *Applied Psychology : an international review*, 57(2) , 173-203.
- Schaufeli W.B., Bakker, A.B., Van der Heijden, M.M.A., & Prins, J.T. (2009). Workaholism, burnout and well-being among junior doctors: The mediating role of role conflict. *Work and Stress*, 23(2), 155-172.
- Schaufeli, W.B., & Bakker, A.B. (2004). Job demands, job resources, and their relationship with burnout and engagement: A multi-sample study. *Journal of Organizational Behavior*, 25(3), 293–315.
- Scott, K.S., Moore, K.S., & Miceli, M.P. (1977). An exploration of the meaning and consequences of workaholism. *Human Relations*, 50 (3), 287-314.
- Shimazu, A., Demerouti, E., Bakke, A.B., Shimada, K., & Kawakami, N. (2011). Workaholism and well-being among Japanese dual-earner couples: A spillover-crossover perspective. *Social Science and Medicine*, 73 (3), 399-409.
- Shimazu, A., Miyanaka, D., & Schaufeli, W. B. (2010). Work engagement from a cultural perspective. In S. L. Albrecht (Ed.), *Handbook of employee engagement: Perspectives, issues, research and practice*. Northampton, MA: Edward-Elgar.
- Shimazu, A., & Schaufeli, W.B. (2009). Is workaholism good or bad for employee well-being? The distinctiveness of workaholism and work engagement among Japanese employees. *Industrial Health*, 47(5), 495-502. Doi:10.2486/indhealth.47.495.
- Shimazu, A., Schaufeli, W.B., Kubota, K., & Kawakami, N. (2012). Do workaholism and work-engagement predict employee well-being and performance in opposite directions? *Industrial health*, 50 (4), 316-321.
- Shragay, D., & Tziner, A., (2011). The generational effect on the relationship between job involvement , job satisfaction, and organizational citizenship behavior. *Revista de Psicología del Trabajo y de las organizaciones. Journal of Applied Psychology and organizations*, 27 (2), 143-157
- Shuck, B. (2011) Four emerging perspectives of employee engagement: An integrative literature review, *Human resource development review*, 10(3) , 304-328

- Smola, K.W., & Sutton, C.D. (2002). Generation Differences: revisiting generational work values for the new millennium. *Journal of Organization Behavior*, 22(1), 363-382.
- Smulders, P.G.W. (2006). The measurement of employee engagement. *TNO Special. September*, 8-12.
- Snir, R., & Harpaz, I. (2006). The workaholism phenomenon: a cross-national perspective. *Career Development International*, 11(5), 374-393
- Sonnetag, S. (2003) Recovery engagement, and proactive behavior; A new look at the interface between nonwork and work. *Journal of applied psychology*, 88 (3), 518-528.
- Spence, J.T., & Robbins, A.S. (1992). Workaholism: definition, measurement and preliminary results. *Journal of Personality Assessment*, 58 (1), 160-178.
- Stedham, Y.E. , & Yamamura, J.H. (2004). Measuring National Culture: Does gender matter?. *Women in Management Review*, 19 (5), 223-243.
- Swidler, A. (1986). Culture in action: Symbols and strategies. *American Sociological Review*, 51(2) , 273-286.
- Taipale, S., Selander, K., Anttila, T.,& Nätti, T. (2011). Work engagement in eight European countries: The role of job demands, autonomy, and social support. *International Journal of Sociology and Social Policy*, 31 (7), 486 – 504.
- Tan, W., & Chong, E. (2003). Power distance in Singapore construction organizations: Implications for project manager. *International Journal of Project Management*, 21(7), 523-536.
- Taris, T.W., Schaufeli, W.B., & Verhoeven, L.C. (2005). Internal and external validation of the Dutch Work Addiction Risk Test: Implications for jobs and non-work conflict. *Journal of Applied Psychology: An international Review*, 54 (1), 37-60.
- Thailand foreign labor office. (2012). *Thailand Migrants Report 2012*. Retrieves from: <http://wp.doe.go.th>.
- Thanasankit, T., & Corbitt, B. (2002). Understanding Thai culture and its impact on requirement engineering process management during information systems development. *Asian Academy of Management Journal*, 7(1), 103-126.
- Trandis, H. (2004). The many dimensions of culture. *The Academy of Management Executive*, 19(1), 88-95.
- Tridis, H. C. (2004). The many dimensions of culture. *Academy of Management Executive*, 18(1) ,88-93
- Trompenaars, F. (1993) *Riding the Waves of Culture: Understanding Cultural Diversity in Business*. Nicholas Brealey Publ., London.
- SHRM. (2007). Change Management Survey Report. Retrieved from <https://www.shrm.org/>
- Swidler, A. (1986). Culture in action: Symbols and strategies. *American Sociological Review*, 51 (2), 273-286.

- Petison, P. (2010). Cross Cultural Relationship Marketing in the Thai Context: The Japanese Buyer's Perspective. *International Journal of Trade, Economics and Finance*, 1 (1), 17-23.
- Pitt-Catsouphes, A., Sarkisian, N., Carapinha, R., Bahte., R., Lee, Jungui., & Minnich, C. (2011). Effect of country and age on work engagement, job satisfaction, and organizational commitment among employees in China, Finding from the generations of talent study. The Sloan Center on Aging and Work. Retrieved from [http:// bc.edu/](http://bc.edu/)
- Tower Watson. (2012). Global workforce study 2012: Engagement at rich: Driving strong performance in a volatile global environment. Retrieved from [https:// towerswatson.com/](https://towerswatson.com/)
- Trais, T.E., Beek, I.V.. & Schaufeli, W.B. (2012). Demographic and occupational, correlated of workaholism. *Psychological*, 110(2), 547-554.
- Tran, D., & Skitmore, M. (2002). The impact of culture on international management: A study of project communications in Singapore. *The Australian Journal of Construction Economics and Building*, 2(2), 36-47.
- Twenge, J.M. (2010). A Review of the empirical evidence on generational differences in work attitudes. *Journal of Business Psychology*, 25 (2), 201-210.
- Twenge, J.M., & Campbell, S.M. (2008). Generational differences in psychological traits and their impact on the workplace. *Journal of Management Psychology*, 23(8), 862-877.
- Van der Stede, W., A. (2003). The effect of national culture on management control and incentive system design in multi-business firms: evidence of intracorporate isomorphism. *European Accounting Review*, 12(2), 263-285.
- Vitell, Scott J., Nwachukwu, Saviour L., & Barnes, James H.(1993). The effect of culture on ethical decision-making: An application of Hofstede's typology. *Journal of Business Ethics*, 12 (10), 753-760.
- Vogt, L., & Laher, S. (2009). The Five Factor Model of Personality and Individualism/Collectivism in South Africa: An exploratory study. *Psychology in Society*, 3, 39-54.
- Wajid, R.B., Zaidi, N.R., Zaidi, M.T., & Zaidi, F.B. (2011). The relationship between demographic characteristic and work engagement among public sector university teacher of Lahore. *Journal of Contemporary Research in Business*, 3, 110-122.
- Watcharasriroj, B., Khangshanun, K., & Chodcheai, B. (2005). *Research report: Analysis of the culture of Thailand*. The National Institute of Development and Administration.
- Wellins, R. & J. Concelman. (2005). Creating a culture for engagement. Workforce Performance Solutions. Retrieved from <http://www.wpsmag.com/>
- Whitney, J.G., Greenwood, R.A., & Murphy, E.F., (2009). Generation differences in the workplace: Personal values, behaviors, and popular beliefs, *Journal of Diversity Management*, 4(3), 1-8.

- Wildermuth, C. de Mello e Souza. (2010). The personal side of engagement: the influence of personality factors in handbook of employee engagement: Perspective, issues, research and practice. Edited by Simon L. A., Edward Elgar Publishing Limited. UK.
- Wong, M., Gardiner, E., Lang, W., & Coulon, L., (2008). Generational differences in personality and motivation: Do they exist and what are the implications for the workplace? *Journal of Managerial Psychology*, 23(8), 878-890.
- Wu, M. Y., Taylor, M., & Chen, M. J. (2001). Exploring societal and cultural influences on Taiwanese public relations. *Public Relations Review*, 27(3), 317-336.
- Xanthopoulou, D., Bakker, A.B., Demerouti., & Schaufeli, W.B. (2009), Work engagement and financial returns: A diary study on the role of job and personal resources. *Journal of Occupational and Organizational Psychology*, 82(1), 183-200.
- Yener, M., Yaldiran, M., & Ergun, S. (2012) . The effect of ethical climate on work engagement. *Social and Behavior Sciences*. Retrieved from [http:// sciencedirect.com/doi:10.1016/j.sbspro.2012.09.1050](http://sciencedirect.com/doi:10.1016/j.sbspro.2012.09.1050).

Appendix A - Cronbach's Alpha / reliability

Cronbach's Alpha		Cronbach's Alpha Based on Standardized Items	N of Items
PDI	.604	.600	5
UAI	.642	.713	7
IDV	.808	.809	4
MAS	.487	.516	5
LTO	.543	.563	6
VI	.709	.733	5
DE	.788	.815	5
AB	.567	.653	5
UWES	.873	.900	15
WkC	.721	.722	6
WkE	.729	.728	8
DUWAS	.841	.841	14

Appendix B

Mean and standard deviation of variables

Descriptive Statistics

	N	Mean	Std. Deviation	Variance	Skewness		Kurtosis	
	Statistic	Statistic	Statistic	Statistic	Statistic	Std. Error	Statistic	Std. Error
PDI_index	403	3,3226	,59397	,353	-,031	,122	,672	,243
UAI_index	403	4,0315	,45127	,204	-,202	,122	,445	,243
IDV_index	403	2,8213	,76906	,591	-,417	,122	,068	,243
MAS_index	403	3,6665	,52703	,278	,037	,122	,270	,243
LTO_index	403	3,7527	,45504	,207	-,287	,122	,714	,243
Vigor	403	4,7732	,83653	,700	-,771	,122	,447	,243
Dedication	403	5,1475	,80396	,646	-1,314	,122	1,840	,243
Aborption	403	4,5413	,85164	,725	-,648	,122	,871	,243
UWES_index	403	4,8207	,74957	,562	-,974	,122	1,189	,243
WkE	403	2,4698	,52374	,274	,158	,122	,220	,243
WkC	403	2,4698	,52374	,274	,158	,122	,220	,243
DUWAS_index	403	2,4698	,52374	,274	,158	,122	,220	,243
Valid N (listwise)	403							

Appendix C
Pearson Correlation between work engagement and workaholism

Correlations

		VI	DE	AB	UWES	WkC	WkE	DUWAS
VI	Pearson Correlation	1	,719**	,642**	,893**	-,030	-,099*	-,071
	Sig. (2-tailed)		,000	,000	,000	,555	,047	,158
	N	403	403	403	403	403	403	403
DE	Pearson Correlation	,719**	1	,617**	,882**	,080	-,026	,023
	Sig. (2-tailed)	,000		,000	,000	,108	,600	,647
	N	403	403	403	403	403	403	403
AB	Pearson Correlation	,642**	,617**	1	,862**	,141**	,133**	,146**
	Sig. (2-tailed)	,000	,000		,000	,004	,008	,003
	N	403	403	403	403	403	403	403
UWES	Pearson Correlation	,893**	,882**	,862**	1	,074	,006	,040
	Sig. (2-tailed)	,000	,000	,000		,136	,911	,426
	N	403	403	403	403	403	403	403
WkC	Pearson Correlation	-,030	,080	,141**	,074	1	,740**	,918**
	Sig. (2-tailed)	,555	,108	,004	,136		,000	,000
	N	403	403	403	403	403	403	403
WkE	Pearson Correlation	-,099*	-,026	,133**	,006	,740**	1	,922**
	Sig. (2-tailed)	,047	,600	,008	,911	,000		,000
	N	403	403	403	403	403	403	403
DUWAS	Pearson Correlation	-,071	,023	,146**	,040	,918**	,922**	1
	Sig. (2-tailed)	,158	,647	,003	,426	,000	,000	
	N	403	403	403	403	403	403	403

** . Correlation is significant at the 0.01 level (2-tailed).

* . Correlation is significant at the 0.05 level (2-tailed).

Appendix D
Pearson Correlation between work engagement and culture

		PDI	UAI	IDV	MAS	LTO	VI	DE	AB	UWES
PDI	Pearson Correlation	1	,144**	,249**	,154**	,150**	-,115*	-,045	-,021	-,068
	Sig. (2-tailed)		,004	,000	,002	,003	,021	,371	,669	,173
	N	403	403	403	403	403	403	403	403	403
UAI	Pearson Correlation	,144**	1	-,049	,256**	,312**	,092	,180**	,079	,132**
	Sig. (2-tailed)	,004		,324	,000	,000	,066	,000	,113	,008
	N	403	403	403	403	403	403	403	403	403
IDV	Pearson Correlation	,249**	-,049	1	,181**	,156**	-,017	,008	,121*	,044
	Sig. (2-tailed)	,000	,324		,000	,002	,737	,877	,015	,375
	N	403	403	403	403	403	403	403	403	403
MAS	Pearson Correlation	,154**	,256**	,181**	1	,361**	,129**	,139**	,135**	,153**
	Sig. (2-tailed)	,002	,000	,000		,000	,009	,005	,007	,002
	N	403	403	403	403	403	403	403	403	403
LTO	Pearson Correlation	,150**	,312**	,156**	,361**	1	,094	,126*	,065	,107*
	Sig. (2-tailed)	,003	,000	,002	,000		,059	,012	,195	,031
	N	403	403	403	403	403	403	403	403	403
VI	Pearson Correlation	-,115*	,092	-,017	,129**	,094	1	,719**	,642**	,893**
	Sig. (2-tailed)	,021	,066	,737	,009	,059		,000	,000	,000
	N	403	403	403	403	403	403	403	403	403
DE	Pearson Correlation	-,045	,180**	,008	,139**	,126*	,719**	1	,617**	,882**
	Sig. (2-tailed)	,371	,000	,877	,005	,012	,000		,000	,000
	N	403	403	403	403	403	403	403	403	403
AB	Pearson Correlation	-,021	,079	,121*	,135**	,065	,642**	,617**	1	,862**
	Sig. (2-tailed)	,669	,113	,015	,007	,195	,000	,000		,000
	N	403	403	403	403	403	403	403	403	403
UWES	Pearson Correlation	-,068	,132**	,044	,153**	,107*	,893**	,882**	,862**	1
	Sig. (2-tailed)	,173	,008	,375	,002	,031	,000	,000	,000	
	N	403	403	403	403	403	403	403	403	403

** . Correlation is significant at the 0.01 level (2-tailed). * . Correlation is significant at the 0.05 level (2-tailed).

Appendix E
Pearson Correlation between workaholism and culture

		PDI	UAI	IDV	MAS	LTO	WkC	WkE	DUWAS
PDI	Pearson Correlation	1	,144**	,249**	,154**	,150**	,148**	,167**	,171**
	Sig. (2-tailed)		,004	,000	,002	,003	,003	,001	,001
	N	403	403	403	403	403	403	403	403
UAI	Pearson Correlation	,144**	1	-,049	,256**	,312**	,124*	,108*	,115*
	Sig. (2-tailed)	,004		,324	,000	,000	,012	,030	,021
	N	403	403	403	403	403	403	403	403
IDV	Pearson Correlation	,249**	-,049	1	,181**	,156**	,091	,065	,091
	Sig. (2-tailed)	,000	,324		,000	,002	,067	,195	,069
	N	403	403	403	403	403	403	403	403
MAS	Pearson Correlation	,154**	,256**	,181**	1	,361**	,221**	,189**	,211**
	Sig. (2-tailed)	,002	,000	,000		,000	,000	,000	,000
	N	403	403	403	403	403	403	403	403
LTO	Pearson Correlation	,150**	,312**	,156**	,361**	1	,176**	,138**	,163**
	Sig. (2-tailed)	,003	,000	,002	,000		,000	,006	,001
	N	403	403	403	403	403	403	403	403
WkC	Pearson Correlation	,148**	,124*	,091	,221**	,176**	1	,740**	,918**
	Sig. (2-tailed)	,003	,012	,067	,000	,000		,000	,000
	N	403	403	403	403	403	403	403	403
WkE	Pearson Correlation	,167**	,108*	,065	,189**	,138**	,740**	1	,922**
	Sig. (2-tailed)	,001	,030	,195	,000	,006	,000		,000
	N	403	403	403	403	403	403	403	403
DUWAS	Pearson Correlation	,171**	,115*	,091	,211**	,163**	,918**	,922**	1
	Sig. (2-tailed)	,001	,021	,069	,000	,001	,000	,000	
	N	403	403	403	403	403	403	403	403

** . Correlation is significant at the 0.01 level (2-tailed).

* . Correlation is significant at the 0.05 level (2-tailed).

Appendix F
Questionnaires

ส่วนที่ 1 มิติวัฒนธรรม / Part 1 National Culture Dimensions

คำชี้แจง (Instructions)

กรุณาใส่เครื่องหมาย (X) หรือ (/) ในช่องที่ตรงกับความคิดเห็นของท่านมากที่สุด
Please indicate your responses to each items by marking (X) or (/).

5	4	3	2	1
เห็นด้วยมากที่สุด	เห็นด้วย	เห็นด้วยและไม่เห็นด้วยพอพอกัน	ไม่เห็นด้วย	ไม่เห็นด้วยอย่างยิ่ง
Strongly Agree	Agree	Neutral	Disagree	Strongly Disagree

คำถามด้านมิติของวัฒนธรรม
<p>Power Distance : PDI</p> <p>1. หัวหน้าควรทำการตัดสินใจโดยไม่ต้องปรึกษากับพนักงาน Managers should make most decisions without consulting subordinates.</p> <p>2. เป็นเรื่องปกติที่หัวหน้ามีการใช้อำนาจในการเป็นหัวหน้าสั่งงานผู้ใต้บังคับบัญชาให้ปฏิบัติตาม It is frequently necessary for a manager to use authority and power when dealing with subordinates.</p> <p>3. หัวหน้าไม่จำเป็นต้องสอบถามความคิดเห็นจากผู้ใต้บังคับบัญชาในการแก้ไขปัญหาต่างๆ Managers should seldom ask for the opinions of employees.</p> <p>4. ผู้ใต้บังคับบัญชาไม่ควรแสดงการไม่เห็นด้วยกับการตัดสินใจของหัวหน้า Employees should not disagree with management decisions.</p> <p>5. จากประสบการณ์ของท่าน บ่อยครั้งที่ท่านเห็นผู้ใต้บังคับบัญชากลัวที่จะแสดงความไม่เห็นด้วยกับผู้ที่มีตำแหน่งสูงกว่า By your experience, The employees always afraid to disagree with higher positions.</p> <p>6. หัวหน้าไม่ควรมอบหมายงานที่สำคัญให้ผู้ใต้บังคับบัญชารับผิดชอบ Managers should not delegate important tasks to employees</p>
<p>Uncertainly Avoidance :UAI</p> <p>7. องค์กรควรมีการระบุความต้องการขององค์กรจากการทำงานของพนักงานเพื่อเป็นคู่มือการทำงานให้กับพนักงาน It is important to have job requirements and instructions spelled out in detail so that employees always know what they are expected to do</p> <p>8. หัวหน้างานคาดหวังว่าพนักงานจะปฏิบัติตามวิธีการปฏิบัติงานที่ระบุไว้ในคู่มือการทำงานอย่างเคร่งครัด Managers expect workers to closely follow instructions and procedures.</p> <p>9. การใช้กฎระเบียบมีความสำคัญในการแจ้งพนักงานว่าพนักงานควรปฏิบัติอย่างไร Rules and regularities are important because they inform workers what the organization expects of them.</p>

10. การมีมาตรฐานการปฏิบัติงานมีประโยชน์สำหรับการใช้เป็นแนวทางการปฏิบัติให้กับพนักงาน Standard operating procedures are helpful to employees on the job
11. คู่มือการแนะนำในการปฏิบัติงานมีความสำคัญต่อพนักงาน Instructions for operations are important for employees on the job.
12. การแข่งขันระหว่างพนักงานมักทำให้เกิดผลเสียมากกว่าผลดี Competitions among employees likely to cause adverse effects than good
13. พนักงานไม่ควรมีการทำผิดกฎระเบียบของงานแม้ว่าในกรณีที่พนักงานคิดว่าเป็นผลดีต่อองค์กร Employees should not break the rule even if that would be beneficial to beneficial to company.
Masculine : MAS
14. การประชุมจะมีประสิทธิภาพมากกว่าหากมีประธานการประชุมเป็นเพศชาย Meetings are usually run more effectively when they are chaired by a man.
15. เพศชายควรมีตำแหน่งหน้าที่การงานสูงกว่าเพศหญิง It is preferable to have a man in a high level position rather than a woman
16. เพศชายมีได้รับโอกาสความก้าวหน้าในสายงานอาชีพมากกว่าเพศหญิง It is more important for men to have a professional career than it is for women to have a professional career.
17. เพศชายจะแก้ไขปัญหาด้วยการวิเคราะห์เหตุผลขณะที่เพศหญิงใช้สัญชาตญาณ ในการแก้ไขปัญหา Men usually solve problems with logical analysis; women usually solve problems with intuition
18. องค์กรควรใช้การตัดสินใจที่เด็ดขาดอันเป็นลักษณะของเพศชายในการแก้ไขปัญหาที่เกิดขึ้นในองค์กร Solving organizational problems usually requires an active, forcible approach which is typical of men
Individual : IDV
19. การที่องค์กรให้ผลประโยชน์แบบเท่ากันทุกคนมีความสำคัญมากกว่าการให้ผลประโยชน์ตามความสามารถของแต่ละบุคคล Group welfare is more important than individual rewards
20. ความสำเร็จของกลุ่มมีความสำคัญมากกว่าความสำเร็จของปัจเจกบุคคล Group success is more important than individual success
21. การได้รับการยอมรับจากสมาชิกที่อยู่ในกลุ่มมีความสำคัญเป็นอย่างยิ่ง Being accepted by the members of your workgroup is very important
22. สมาชิกกลุ่มควรยึดมั่นตามเป้าหมายที่ทางกลุ่มพิจารณาแล้วว่าเป็นผลประโยชน์ของกลุ่ม Employees should pursue their goals after considering the welfare of the group
Long-term Orientation : LTO
23. ควรมีการติดตามสถานการณ์ต่างๆที่เกิดขึ้นในองค์กร Ordering relationships by status and observing this order important in the workplace
24. องค์กรควรให้ความสำคัญกับการประหยัด Thrift is important in the workplace
25. ความสามารถในการดำเนินงานอย่างยั่งยืนมีความสำคัญต่อองค์กร Persistence is important in the workplace
26. องค์กรควรให้ความสำคัญต่อจริยธรรมของพนักงานในองค์กร Employees' ethics are important.
27. พนักงานควรเลือกปฏิบัติตามธรรมเนียมที่มีการปฏิบัติกันมา Employees should follow the same practice in the past..

ส่วนที่ 2 ภาวะเสพติดติตงาน (Workaholism)

4	3	2	1
Almost (Always)	Often	Sometimes	(Almost) Never
เป็นประจำ	บ่อยๆ	บางครั้ง	ไม่เคย

คำถามภาวะการเสพติดติตงาน	
1.	ข้าพเจ้าไม่ชอบการทำงานที่หนักมากเกินไป I dislike overwork (WkE)
2.	ข้าพเจ้าไม่ต้องการให้ตนเองผูกติดอยู่กับงาน I often wish I weren't so committed to my work. (WkC)
3.	ข้าพเจ้ารู้สึกเร่งรีบและแข่งขันกับเวลา I seem to be in a hurry and racing against the clock. (WkE)
4.	ข้าพเจ้าพบว่าตนเองยังทำงานอยู่ขณะที่เพื่อนร่วมงานเลิกงานแล้ว I find myself continuing work after my co-workers have called it quits.(WkE)
5.	ข้าพเจ้าเห็นว่าเป็นเรื่องสำคัญที่ข้าพเจ้าต้องทำงานหนักถึงแม้ว่าข้าพเจ้าจะไม่สนุกไปกับงานที่ข้าพเจ้าทำอยู่ก็ตาม It's important for me to work hard even when I don't enjoy what I'm doing(WkC) .
6.	ข้าพเจ้าพบว่าตนเองมักจะยุ่งอยู่กับงานตลอดเวลา I stay busy and keep my irons in the fire. (WkE)
7.	ข้าพเจ้าพบว่าตนเองคิดถึงงานอยู่ตลอดเวลาถึงแม้ว่าข้าพเจ้าต้องการหลุดจากงานเป็นการชั่วคราว I often find myself thinking about work even when I want to get away from it for a while.(WkC)
8.	ข้าพเจ้าทุ่มเทในการทำงานเป็นอย่างมากจนเกินกำลังของตัวเอง I overly commit myself by biting more off than I can chew.(WkE)
9.	ข้าพเจ้ามีแรงผลักดันภายในในการทำงานหนัก แม้ว่าบางครั้งงานที่ข้าพเจ้าทำอยู่ไม่ใช่สิ่งที่ข้าพเจ้าต้องการ I seem to have an inner compulsion to work hard , a feeling that it's sometime I have to do whether I want to or not. (WkC)
10.	ข้าพเจ้าอยู่ภายใต้แรงกดดันเนื่องมาจากถึงครบกําหนดการส่งงาน I put myself under pressure with self-imposed deadlines when I work. (WkE)
11.	ข้าพเจ้ารู้สึกว่าภายในตัวข้าพเจ้ามีบางสิ่งบางอย่างที่ผลักดันให้ข้าพเจ้าทำงานหนักเข้าไว้ I often feel that there are something inside me that drive me to work hard. (WkC)
12.	ข้าพเจ้าใช้เวลาในการทำงานมากกว่าที่จะไปสังสรรค์กับเพื่อนฝูงหรือทำกิจกรรมสันทนาการ อื่นๆ I spend more time working than socializing with friends, on hobbies , or on leisure activities. (WkE)
13.	บางครั้งข้าพเจ้ารู้สึกผิดที่ข้าพเจ้าไม่ทำงาน I feel guilty when I'm not working on sometime.
14.	ข้าพเจ้าทุ่มเทอย่างเต็มที่ในการทำงานหนักแม้ว่างานนั้นจะไม่สนุกก็ตาม I feel obliged to work hard , even when it's not enjoyable. (WkC)

15. ข้าพเจ้าพบว่าตัวเองทำสองหรือสามสิ่งในเวลาเดียวกัน เช่น ทานข้าวไปด้วยทำงานไปด้วย หรือ ทานข้าวไปด้วยคุยโทรศัพท์ที่เรื่องงานไปด้วย I find myself doing two or three things at one time such as eating lunch and writing menu , while talking on the phone. (WkE)
16. ข้าพเจ้ารู้สึกไม่ดีถ้าข้าพเจ้าใช้เวลาทำงานไปทำงานอย่างอื่น I feel guilty when I take time off work. (WkC)
17. ข้าพเจ้ารู้สึกไม่สบายใจเมื่อข้าพเจ้าไม่ได้ทำงาน It's hard for me to relax when I'm not working. (WkE)

ส่วนที่ 3 ความผูกพันของพนักงาน The Utrecht Work Engagement Scale: UWES-17

6	5	4	3	2	1	0
ทุกวัน	สองถึงสามครั้งต่อสัปดาห์	หนึ่งครั้งต่อสัปดาห์	สองสามครั้งต่อเดือน	หนึ่งครั้งต่อเดือนหรือน้อยกว่า	สองหรือสามครั้งต่อปี	ไม่เคย
Every day	A few times a week	Once a week	A few times a month	Once a month or less	A few time a year or less	Never

1. ข้าพเจ้ารู้สึกว่ระหว่างการทำงานนั้นข้าพเจ้าเต็มเปี่ยมไปด้วยพลังในการทำงาน At my work , I feel bursting with energy. (VI)
2. ข้าพเจ้าเห็นว่างานที่ข้าพเจ้าทำอยู่มีคุณค่า I find the work that I do full of meaning and purpose. (DE)
3. ข้าพเจ้ารู้สึกว่าเวลาผ่านไปอย่างรวดเร็ว ในระหว่างการทำงาน Time flies when I am working.(AB)
4. ข้าพเจ้ารู้สึกว่ตนเอง กระฉับกระเฉง กระปรี้กระเปร่า ในระหว่างการทำงาน At my job, I feel strong and vigorous.. (VI)
5. ข้าพเจ้ามีความกระตือรือร้นต่อหน้าที่ของตนเอง I am enthusiastic about my job(DE)
6. ข้าพเจ้ามักจะไม่สนใจสิ่งอื่น และตั้งใจ จดจ่อ กับงานในระหว่างการทำงาน When I am working. I forget everything else around me(VI)
7. ข้าพเจ้ามีแรงบันดาลใจจากงานที่ข้าพเจ้าทำอยู่ My job inspires me.(DE)
8. ข้าพเจ้ารู้สึกไม่อยากจะตื่นไปทำงานเลยในตอนเช้า When I get up in the morning. I feel like going to work.. (VI)
9. ข้าพเจ้ารู้สึกมีความสุขกับการทำงานแม้ว่าปริมาณงานที่ทำมีมาก I feel happy when I am working intensely.(VI)
10. ข้าพเจ้ามีความภาคภูมิใจในงานที่ข้าพเจ้าทำอยู่ I am proud of my work that I do.(DE)

11. ข้าพเจ้ามักจะจมปลักอยู่ในงาน I am immersed in my work.(VI)
12. ข้าพเจ้าสามารถทำงานอย่างต่อเนื่อง โดยไม่รู้สึกรเหน็ดเหนื่อย I can continue working. (VI)
13. ข้าพเจ้าทำงานด้วยความท้าทาย To me, my job is challenging(DE)
14. ข้าพเจ้ามีความกระตือรือร้นในขณะที่ทำงาน I get carried away when I am working.(VI)
15. ข้าพเจ้ารู้สึกว่าจิตใจของตนเองมีความผ่อนคลายในขณะที่ทำงานอยู่ (สบายใจ ไม่เครียด) At my job, I am very resilient, mentally.. (VI)
16. ข้าพเจ้าสนุกกับการทำงานมากจนไม่อยากหยุดการทำงาน) It is difficult to detach myself from my job.(AB) ข้าพเจ้าสนุกกับการทำงานมากจนไม่อยากให้มีวันหยุด
17. ข้าพเจ้ามักจะทำงานด้วยความมุมานะพยายาม แม้ว่าจะมีอุปสรรคมากมายในการทำงาน At my work, I always persevere, even when thing do not go well.. (VI)

ส่วนที่ 4 ข้อมูลทั่วไปและข้อมูลด้านประสบการณ์การทำงาน Part 4 , Individual and Work experience

1. เพศ Gender

- () ชาย Male
() หญิง Female

2. อายุ Age

- () น้อยกว่า 30 ปี Less than 30 years
() 31 – 47 ปี 31 – 47 years
() 48 – 66 ปี 48 – 66 years
() มากกว่า 66 ปี More than 66 years

3. ระดับการศึกษา Education

- () ต่ำกว่าปริญญาตรี Vocational
() ปริญญาตรี Bachelor Degree
() ปริญญาโท Master Degree
() ปริญญาเอก Doctoral Degree

4. สถานะทางครอบครัว Marital Status
- () โสด Single
- () หย่า , หม้าย , แยกกันอยู่ Divorced, Widow, Separated
- () แต่งงาน Married
5. ประสบการณ์การทำงานในบริษัทปัจจุบัน Year of services in current company
- () น้อยกว่า 5 ปี Less than 5 years
- () 5 - 10 ปี 5 – 10 years
- () 11 - 15 ปี 11 – 15 years
- () 16 - 20 ปี 16 – 20 years
- () มากกว่า 20 ปี More than 20 years
6. ส่วนงานที่สังกัด (Division)
- () แผนกต้อนรับส่วนหน้า (Front office or core-business office)
- () แผนกสนับสนุน (Support office or backoffice)
7. ตำแหน่งปัจจุบันของท่าน Position
- () พนักงาน (Staff)
- () หัวหน้างานระดับต้น (Supervisor)
- () ผู้ช่วยหัวหน้าแผนก หรือ รองหัวหน้าแผนก หรือ หัวหน้าแผนก (Assistant / deputy /Division Manager)
- () ผู้ช่วยผู้จัดการฝ่าย หรือ รองผู้จัดการฝ่าย หรือ ผู้จัดการฝ่าย (Assistant / deputy /Department Manager)
- () ตำแหน่งอื่นๆ โปรดระบุ.....
8. จำนวนปีหรือประสบการณ์การทำงานในตำแหน่งปัจจุบันของท่าน
Year of services in present company in current position .
- () น้อยกว่า 5 ปี Less than 5 years
- () 5 - 10 ปี 5 – 10 years
- () 11 - 15 ปี 11 – 15 years
- () 16 - 20 ปี 16 – 20 years
- () มากกว่า 20 ปี More than 20 years

9. ท่านเคยมีการทำงานล่วงเวลาหรือไม่

How many days per month, which is you work overtime?

() ไม่เคย No

() เคย ประมาณโดยเฉลี่ย เดือนละ.....ชั่วโมง yes, By approximately.....hrs. / month

10. ท่านเคยมีการทำงานในวันทีวันนั้นเป็นวันหยุดของท่านหรือไม่

How many days per month, which is you work on your holiday ?

() ไม่เคย No

() เคย ประมาณโดยเฉลี่ย เดือนละ.....วัน Yes , By approximately.....days / month

11. ท่านมีการนำงานที่ท่านรับผิดชอบไปทำต่อที่บ้าน

How many days per month, which is you work home?

() ไม่เคย No

() เคย ประมาณโดยเฉลี่ย เดือนละ.....วัน Yes, By approximately.....days / month

ข้อเสนอแนะ suggestion

.....
.....
.....
..... ขอขอบพระคุณท่านอย่างสูงในการตอบแบบสอบถาม

Thank you for taking time to complete this survey