



**HAL**  
open science

## Energy-efficiency in wireless sensor networks

Tifenn Rault

► **To cite this version:**

Tifenn Rault. Energy-efficiency in wireless sensor networks. Other [cs.OH]. Université de Technologie de Compiègne, 2015. English. NNT : 2015COMP2228 . tel-01470489

**HAL Id: tel-01470489**

**<https://theses.hal.science/tel-01470489>**

Submitted on 17 Feb 2017

**HAL** is a multi-disciplinary open access archive for the deposit and dissemination of scientific research documents, whether they are published or not. The documents may come from teaching and research institutions in France or abroad, or from public or private research centers.

L'archive ouverte pluridisciplinaire **HAL**, est destinée au dépôt et à la diffusion de documents scientifiques de niveau recherche, publiés ou non, émanant des établissements d'enseignement et de recherche français ou étrangers, des laboratoires publics ou privés.

Par Tifenn RAULT

*Energy-efficiency in wireless sensor networks*

Thèse présentée  
pour l'obtention du grade  
de Docteur de l'UTC

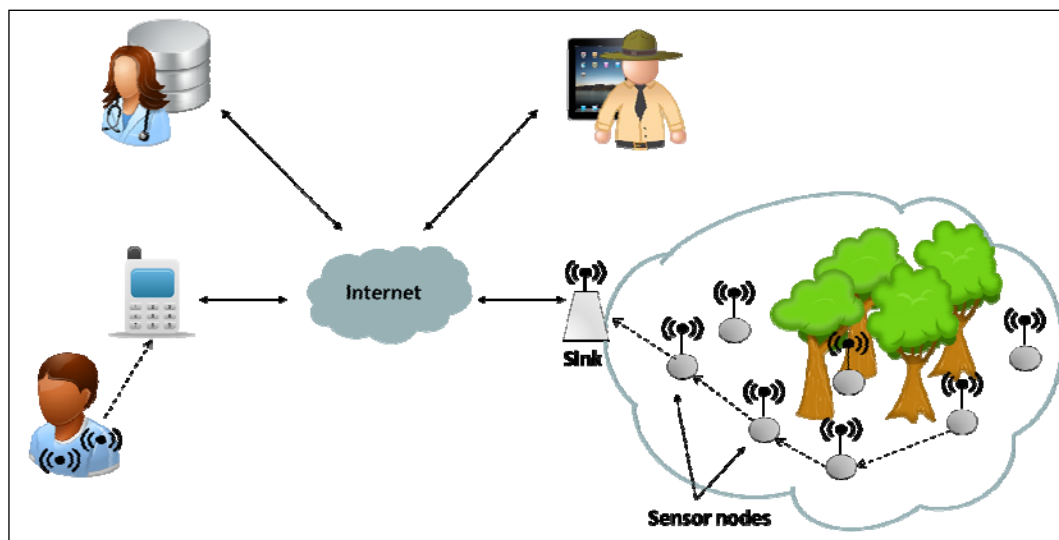

Soutenue le 2 octobre 2015

**Spécialité** : Technologies de l'Information et des Systèmes

D2228

# Energy-efficiency in wireless sensor networks

**Tifenn Rault**

Sorbonne Universités, Université de Technologie de Compiègne,  
CNRS, Heudiasyc UMR 7253

**Spécialité : Technologies de l'Information et des Systèmes**

Thèse soutenue le 2 octobre 2015

## **Jury**

Marcelo Dia De Amorim	Directeur de Recherche	Président
Francine Krief	Professeur des Universités	Rapporteur
Ken Chen	Professeur des Universités	Rapporteur
Yacine Challal	Maître de Conférences HDR	Examineur
Abdelmadjid Bouabdallah	Professeur des Universités	Directeur
Frédéric Marin	Professeur des Universités	Directeur





*A mes parents, pour leur soutien.  
A Sam, car Frodon ne serait pas allé bien loin sans Sam.*

## Acknowledgments

This thesis was carried out during the period October 2012 - September 2015 at the Heudiasyc laboratory at the Université de Technologie de Compiègne, and was funded in the framework of the Labex MS2T. The Labex MS2T is a multi-disciplinary scientific program supported by the French Government, through the program 'Investments for the future' managed by the National Agency for Research (ANR-11-IDEX-0004-02). This thesis was supervised by Professor Abdelmadjid Bouabdallah from Heudiasyc laboratory and Professor Frédéric Marin from the BioMechanics and BioEngineering laboratory.

I am using this opportunity to acknowledge everyone who supported me throughout the course of this thesis project. Foremost, I would like to express my sincere gratitude to my advisor Abdelmadjid Bouabdallah for the continuous support and guidance of my PhD study. He has shared with me many metaphors and lessons on how to do research. I used to go to his office looking for insightful comments, encouragements and positivism. I express my warm thanks to Yacine Challal for reading my reports, commenting on my views and helping me enrich my ideas. His valuable advice helped us improve the quality of our contributions. I am grateful to Frédéric Marin for sharing his time and knowledge in our cooperative work.

I would also like to convey thanks to the Labex MS2T for funding my thesis. Many thanks are, as well, due to the Université de Technologie de Compiègne (UTC), and in particular to the members of the computer science department, the Heudiasyc laboratory, and the doctoral school, for providing me the best conditions to complete this project. I also would like to acknowledge my colleagues Walid Bechkit, Abdelkrim Hadjidj, Ahmed Lounis, Marion Souil and Lotfi Zaouche.

Finally, I do not forget my brother, my friends, and my family. Particularly, I must thank my parents for supporting me throughout all my studies at the UTC. I thank Ronan for providing me continuous moral support and love during the course of my thesis.



## Abstract

Wireless sensor networks (WSN) are key components of systems of systems (SoS) since they can be integrated in complex assemblies in order to respond to current societal issues such as the aging of the population, the optimization of natural resources and the reduction of carbon footprint. Typically, kinematic sensors can be used to remotely supervise elderly patient, humidity sensors can be deployed to control field irrigation for a more sustainable agriculture, and connected vehicles will help to optimize the management of urban traffic while limiting pollution.

In these contexts, sensor nodes are expected to operate autonomously in unattended area for long periods of time since it is not always possible to manually replenish the nodes because of their number, the maintenance costs or the inaccessibility of monitored regions. Indeed, sensors are battery-powered devices with stringent resource limitation, especially in terms of energy. The depletion of one component may compromise the operation of the whole network. Therefore, there is a need to develop energy-efficient solutions to increase the network lifetime.

In this thesis, we propose new strategies for energy conservation in wireless sensor networks, so that the operational time of these networks can be extended. The work can be divided into two main focus areas, namely general wireless sensor networks, and healthcare-oriented wearable sensor networks. In the first part of this thesis we provide a comprehensive survey of the existing energy-efficient mechanisms. Then, we propose two new solutions: the first one optimizes the displacement of a mobile base station as well as buffer usage and data routing at sensor nodes; the second one optimizes the deployment of wireless chargers in the network to satisfy the energy demand of the sensors. The second part of this thesis is dedicated to healthcare application where wearable sensors are used to remotely supervise a patient. We begin with a state-of-the-art of the energy-efficient techniques existing in the literature. We then introduce a new energy-efficient architecture that allows to optimize the lifetime of both the sensor and the base station. This is a context-aware solution that takes into consideration heterogeneous devices.



---

Our results show that the lifetime of the sensor networks can be extended using the proposed strategies. All the results obtained are supported by numerical experiments and extensive simulations. For one of them, a testbed is under development.

## Résumé

Les Réseaux de capteurs sans fil (RCSF) sont des éléments importants des Systèmes de systèmes (SoS) car ils peuvent être intégrés à des ensembles complexes pour répondre aux problématiques sociétales d'aujourd'hui, telles que le vieillissement de la population, l'optimisation des ressources naturelles ou la réduction de l'empreinte carbone. Typiquement, des capteurs cinématiques peuvent être utilisés pour la supervision à distance des personnes âgées, des capteurs d'humidité peuvent servir à contrôler l'irrigation des champs pour une agriculture raisonnée et les véhicules connectés aideront à optimiser la gestion du trafic urbain tout en limitant la pollution.

Dans ces contextes, les capteurs sont supposés fonctionner de manière autonome pendant de longues périodes, puisqu'il n'est pas toujours possible de remplacer les batteries manuellement (nombre, coût de maintenance, inaccessibilité). En effet, ces appareils sont alimentés par des batteries, ce qui limite grandement leur durée de vie. L'épuisement d'un ou plusieurs nœuds peut compromettre le bon fonctionnement du réseau, particulièrement dans le cas d'applications critiques telles que la supervision de patient à risque ou le control de processus industriels. Dans cette thèse, nous avons proposé des solutions originales et performantes pour l'économie d'énergie dans les RCSF. Ces contributions s'organisent autour de deux grands axes: les réseaux de capteurs génériques et les réseaux de capteurs sans fils dédiés aux applications santé.

Dans la première partie, nous avons tout d'abord réalisé un état-de-l'art des mécanismes d'économie d'énergie pour les RCSF. Pour cela, nous avons identifié les grandes familles d'application des RCSF et leurs exigences respectives. Ensuite, nous avons proposé une nouvelle classification des techniques d'économie d'énergie et nous avons étudié les compromis qui apparaissent lors du développement de réseaux de capteurs sans fils entre ces exigences et la nécessité de prolonger la durée de vie du réseau. Nous avons ensuite proposé deux solutions originales. L'une repose sur une station de base mobile qui se déplace dans le réseau afin de collecter les données générées par les capteurs. Nous optimisons le déplacement de cette station de base, ainsi que la façon dont les données sont stockées dans les capteurs et routées vers le puit mobile. Comparée aux solutions existantes, cette approche offre un bon compromis entre l'économie d'énergie et la latence. L'autre solution optimise

---

le déploiement de chargeurs mobiles, qui une fois dans le réseau permettent de satisfaire la demande en énergie des nœuds via la transmission d'énergie sans fil sur plusieurs sauts. Nous montrons ici qu'il existe un compromis entre la demande en énergie des nœuds, la capacité des chargeurs, et le nombre maximum de sauts à travers lesquels l'énergie peut être transmise.

Dans la deuxième partie de la thèse, nous nous sommes intéressés plus particulièrement aux applications des RCSF pour la supervision de patients à distance. Nous avons proposé une nouvelle classification des architectures économes en énergie qui utilisent des capteurs sans fils pour superviser l'état d'un patient. Nous avons réalisé un état de l'art des différentes stratégies mises en œuvre pour prolonger la durée de vie de ces réseaux, et proposer une comparaison qualitative de ces solutions en termes de consommation d'énergie, de latence et de précision. Nous avons constaté un manque de prise en compte des architectures hétérogènes, où des appareils de types et rôles différents présentent des contraintes d'énergie. C'est pourquoi, dans un second temps, nous avons proposé une nouvelle architecture pour la supervision de patient à distance à l'aide de capteurs sans fils qui permet de prolonger la durée de vie des capteurs et de la station de base. En effet, cette solution prend en compte l'environnement du patient pour favoriser l'utilisation d'une technologie de communication plus économe en énergie pour les capteurs lorsque cela est possible, tout en permettant au téléphone mobile du patient qui agit comme la station de base d'éteindre son interface réseau.

## List of publications

### International journals

1. T. Rault, A. Bouabdallah, Y. Challal. Energy efficiency in wireless sensor networks : A top-down survey. *Computer Networks*, pp 104-122, (67), 2014.

### International conferences

1. T. Rault, A. Bouabdallah, Y. Challal. WSN Lifetime Optimization through Controlled Sink Mobility and Packet Buffering. *The 5th Global Information Infrastructure and Networking Symposium, Trento, Italy*, pp. 1-6, 2013.
2. T. Rault, A. Bouabdallah, Y. Challal. Multi-hop wireless charging optimization in Low-Power Networks. *IEEE Global Communications Conference (GLOBECOM), Atlanta, USA*, pp. 462-467, 2013.
3. T. Rault, A. Bouabdallah, Y. Challal, F. Marin. Context-aware energy-efficient wireless sensor architecture for activity recognition. *IEEE International Conference on Pervasive Computing and Communications Workshops (PERCOM Workshops), Budapest, Hungary*. pp. 1-4, 2014.
4. T. Rault, A. Bouabdallah, Y. Challal, F. Marin. Energy efficient architecture for wearable sensor networks. *Wireless days, Rio de Janeiro, Brazil*, pp. 1-8 2014.

### Under preparation

1. T. Rault, A. Bouabdallah, Y. Challal, F. Marin. A survey of energy-efficient architectures using wearable sensors for activity recognition. *Submitted to Pervasive and Mobile Computing*.
2. T. Rault, A. Bouabdallah, Y. Challal, F. Marin. Energy-efficient gateway selection strategies for a wearable sensor architecture. *Submitted to Journal of Biomedical and Health Informatics*.



# Table of contents

<b>Acknowledgments</b>	<b>ii</b>
<b>Abstract</b>	<b>v</b>
<b>Résumé</b>	<b>vii</b>
<b>List of publications</b>	<b>viii</b>
<b>Chapter 1 - Introduction</b>	<b>1</b>
1.1 Problem definition . . . . .	1
1.2 Contributions . . . . .	2
1.3 Organization of the manuscript . . . . .	3
<b>Chapter 2 - Energy efficiency in wireless sensor networks: A top-down survey</b>	<b>5</b>
2.1 Introduction . . . . .	5
2.2 Background . . . . .	6
2.3 WSN applications and their requirements . . . . .	10
2.4 Low-power WSN standards . . . . .	17
2.5 Energy-saving mechanisms . . . . .	21
2.6 Energy efficiency and requirements trade-offs . . . . .	34
2.7 Conclusion . . . . .	38
<b>Chapter 3 - WSN lifetime optimization through controlled sink mobility and packet buffering</b>	<b>39</b>
3.1 Introduction . . . . .	39
3.2 Related works . . . . .	41
3.3 Introduction to linear programming . . . . .	43
3.4 Our solution: system model . . . . .	44
3.5 Numerical results . . . . .	47

## Table of contents

---

3.6	Distributed algorithm . . . . .	50
3.7	Simulation results . . . . .	51
3.8	Conclusion . . . . .	54
<b>Chapter 4 - Multi-hop wireless charging optimization in wireless sensor networks</b>		<b>55</b>
4.1	Introduction . . . . .	55
4.2	Related works . . . . .	57
4.3	Overview of our solution . . . . .	59
4.4	The multihop wireless charging scheme . . . . .	60
4.5	The optimization model . . . . .	62
4.6	Performance evaluation . . . . .	64
4.7	Conclusion . . . . .	67
<b>Chapter 5 - Energy-efficiency of human context recognition systems using wearable sensors for healthcare applications: state-of-the-art</b>		<b>69</b>
5.1	Introduction . . . . .	70
5.2	Human context recognition using wearable sensors . . . . .	71
5.3	General framework and requirements . . . . .	74
5.4	Classification of energy-efficient mechanisms . . . . .	79
5.5	Power-on time reduction . . . . .	81
5.6	Communication reduction . . . . .	85
5.7	Computation reduction . . . . .	89
5.8	Battery charging . . . . .	93
5.9	Summary and discussion . . . . .	96
5.10	Conclusion and open research issues . . . . .	100
<b>Chapter 6 - Energy-efficient gateway selection strategies for a wearable sensor architecture</b>		<b>105</b>
6.1	Introduction . . . . .	105
6.2	Related works . . . . .	107
6.3	Motivations and general idea of our solution . . . . .	108
6.4	Adaptive approach . . . . .	111
6.5	SMS-based approach . . . . .	118
6.6	Delay modeling and analysis . . . . .	120
6.7	Simulation . . . . .	124
6.8	Conclusion . . . . .	133

<b>Chapter 7 - Implementation of an energy-efficient wearable sensor network proto- type</b>	<b>135</b>
7.1 Introduction . . . . .	135
7.2 General architecture of our prototype . . . . .	136
7.3 Sensor node . . . . .	137
7.4 ZigBee access point . . . . .	138
7.5 Mobile phone . . . . .	139
7.6 Server . . . . .	140
7.7 Conclusion . . . . .	141
<b>Chapter 8 - Conclusion</b>	<b>143</b>
8.1 Summary . . . . .	143
8.2 Future work . . . . .	144
<b>References</b>	<b>145</b>





# Chapter 1

## Introduction

### 1.1 Problem definition

Recent advances in wireless communications and Micro-Electro-Mechanical systems have enabled the development of wireless sensor networks (WSN) which are expected to be one of the most promising technologies in the near future. Wireless sensors are small, low-cost and battery-operated devices whose sensing capabilities enable them to retrieve information from their environment. They can be deployed in a large number to detect events of interest or send periodic reports about their surroundings. This makes them attractive for a plethora of applications where remote monitoring abilities are required. For example, kinematic sensors can be used to remotely supervise elderly patient. In agriculture, untethered motes can be deployed to sense relevant parameters influencing the crop, like temperature, humidity and luminosity. In these contexts, energy-constrained sensor nodes are expected to operate autonomously in unattended area for long period of time. Nevertheless, it may be cost-prohibitive to replace exhausted batteries or even impossible in hostile environment. It is therefore necessary to develop energy-aware solutions to increase the lifetime of sensor networks.

The design of energy-efficient wireless sensor networks is, however, a very challenging issue. On one hand, energy-constrained sensors are resource-limited in terms of memory and computational capacities, which prevent the use of complex algorithms and makes traditional protocols of the TCP/IP stack not well suited. On the other hand, unlike other networks, WSN are designed for specific applications. These applications range from small size healthcare supervision systems to large scale environment monitoring. Thus, any WSN deployment has

to satisfy a set of requirements that differs from one application to another. As a consequence, energy saving techniques usually trade-off lifetime maximization with other optimization objectives.

## 1.2 Contributions

In this thesis, we propose new solutions to improve the energy-efficiency of wireless sensor networks while taking into consideration applications requirements. Our work can be divided into two main focus area, namely *general wireless sensor networks*, and *healthcare-oriented wearable sensor networks*.

In the first part of this thesis, we start with a comprehensive review of existing energy-efficient mechanisms designed for wireless sensor networks. This top-down study surveys the different WSN application families and their specific requirements, and analyses the trade-offs between application requirements and lifetime extension that arise when designing wireless sensor networks. This is a thorough introduction to the energy challenge of WSN. Then, we present two contributions which can be applied in multi-hop wireless sensor networks. The first one exploits the fact that one of the possible solutions to save energy in WSN is to balance the load between nodes using a mobile base station that moves in the network to collect the data. In this context, we propose a new energy-efficient data collection scheme, that optimizes the sojourn times of a mobile base station at different locations, as well as the buffer usage and data routing at sensor nodes. Compared to existing approaches, our model achieves better lifetime while guaranteeing no data is lost due to buffer overflow. We also introduce a new distributed algorithm at sensor nodes in order to determine whether sensors have to send their data or not based on their distance to the base station, and their buffer occupancy. This technique achieves a desired trade-off between data delivery delays and energy performance. We also explored another approach which allows to extend network lifetime, which consists in charging sensor nodes. To this end, in our second contribution, we propose a new solution for multi-hop wireless charging that optimizes the deployment of wireless chargers in the network. Once deployed, the chargers can satisfy the energy-demand of every sensor through multi-hop wireless energy transfer. Our solution effectively reduces the number of required chargers, and we highlight that there exists a trade-off between the capacity of the chargers, the energy demand of the network, and the maximum number of hops along which energy can be sent.

The second part of this thesis is dedicated to energy-efficiency of wearable sensor networks for healthcare-oriented applications. We first propose a new classification of energy-efficient approaches designed for human context recognition based on wearable

sensors for healthcare and wellbeing applications. After a description of the specificities of human context recognition applications, we review related energy-efficient mechanisms in details. Several systems and energy saving strategies are qualitatively evaluated in terms of energy consumption, latency and classification accuracy. Then, motivated by the lack of solutions that conserve the energy of heterogeneous devices, we develop a new architecture that allows to save energy at both the sensors and the base station, by privileging a less consuming communication technology when available. This context-aware solution takes into account the effective opportunities that arise in the user environment to relieve the user's mobile phone from receiving all the data. Our simulation results show that the proposed approach effectively improves the energy efficiency of the system compared to traditional architectures where wearable sensors can only communicate with the user mobile phone. Finally, in order to assess the efficiency of our architecture through a real-world prototype, we describe the design and implementation of a light-weight wearable sensor network for remote patient supervision. The proposed testbed is still under development, but early results demonstrate the feasibility of our approach.

Thus, throughout this thesis we develop new architectures, models and distributed algorithms, and we evaluate their performances through extensive numerical experiments and simulations. Our results show that the lifetime of the sensor networks can be extended using the presented strategies. These contributions and their results, summarized in Figure 1.1, are further developed in the following chapters.

### **1.3 Organization of the manuscript**

The rest of this thesis is organized as follows. In Chapter 2, we provide a thorough survey on energy-efficient wireless sensor networks with a focus on application-specific design. Then, in Chapter 3, we describe our energy-efficient data collection scheme with a mobile base station, and we compare its performance against existing approaches. In Chapter 4, we present and evaluate our multi-hop wireless charging optimization solution. Afterwards, in Chapter 5, we review energy-efficient mechanisms for health-related human context recognition applications making use of wearable sensors. In Chapter 6, we detail our energy-efficient architecture for wearable sensor networks and we analyze different gateway selection strategies. In order to assess the efficiency of our approach, in Chapter 7, we give the details of hardware and software implementation of a wearable sensor architecture prototype. Finally, in Chapter 8, we conclude this thesis by providing a summary of our contributions, and discussing prospects and opportunities for the future.



Fig. 1.1 Overview of our contributions.

# Chapter 2

## Energy efficiency in wireless sensor networks : A top-down survey

Wireless sensor networks (WSN) has emerged as a promising technology for a large number of applications with different needs. However, there are still a few obstacles to overcome before it finally becomes a mature technology. One of the key obstacles is the energy constraint suffered by sensor nodes, where batteries are the main source of power supply. In this context, a host of research work has been conducted in order to propose a wide range of solutions to the energy-saving problem. This research covers several areas going from physical layer optimization to network layer solutions. Therefore, it is not easy for the WSN designer to select the efficient solutions that should be considered in the design of application-specific WSN architecture. In this chapter, we present a top-down survey of the trade-offs between application requirements and lifetime extension that arise when designing wireless sensor networks.

### 2.1 Introduction

There is abundant literature relating to energy-saving in WSNs as numerous methods have been proposed in the last few years, and there is still much ongoing research on how to optimize power usage in battery-limited sensor networks. However, none of the proposed solutions is universally applicable. For example, if safety applications require fast and timely responsiveness, this is not the case for other applications, such as in agriculture where the delay property is not as important. We believe that WSN energy-saving problems should be tackled by taking into consideration application requirements in a more systematic manner.

In [1], Yick et al. provide a general survey of wireless sensor networks. This study reviews sensor platforms and operating systems, network services issues and communication protocol challenges, but it does not address the energy issues. In [2], Anastasi et al. present a valuable taxonomy of energy-conservation schemes. However, the authors mainly focus on duty cycling and data-reduction approaches. There also exist several technique-specific surveys that concentrate on only one energy-efficient mechanism (like energy-efficient routing protocols, data aggregation techniques, energy harvesting approaches [3–5]) since every category of solution often represents a whole research area in itself.

Our aim is to provide WSN designers with a top-down survey that offers a holistic view of energy-saving solutions while taking into consideration the specific requirements of the applications. In this chapter, we propose a new classification of energy-efficient mechanisms which integrates the most recent techniques and up-to-date references. Moreover, we give particular attention to the design of energy-efficient sensor networks that satisfy application requirements. Our study is original in that we focus on the trade-offs between meeting specifications and sustainability that necessarily arise when designing a WSN. We thus discuss mechanisms that enable a satisfactory trade-off between multiple requirements to be achieved.

The rest of this chapter is organised as follows. In the next section, we provide some background on wireless sensor networks. Then, in Section 2.3, we present the main categories of applications we have identified and their respective requirements. Afterwards, in Section 2.4, we discuss existing standards for low-power wireless sensor networks and show that current standards cannot respond to all application needs. In Section 2.5, we give an overview of the major energy-saving mechanisms developed so far and discuss their advantages and shortcomings regarding the set of identified requirements. In Section 2.6, we review techniques proposed in the literature to achieve a trade-off between multiple requirements, including network lifetime maximization. Finally, Section 2.7 concludes this chapter.

## 2.2 Background

### Overview of wireless sensor networks

Wireless sensor networks consist of individual sensor nodes, also called motes, deployed in a given area that cooperatively collect and carry data to a main entity in order to monitor physical or environmental conditions. The main entity, also denoted as base station or sink, can be connected to an infrastructure or to the Internet through a gateway, which allows remote users to access the collected data. The main advantage of wireless sensor networks

lies in the ability to deploy a lot of tiny autonomous motes without any pre-established infrastructure (see Figure 2.1). After the deployment, motes gather information from the physical world, and according to a defined communication protocol, they cooperate to deliver data towards the sink through single-hop or multi-hop communications.

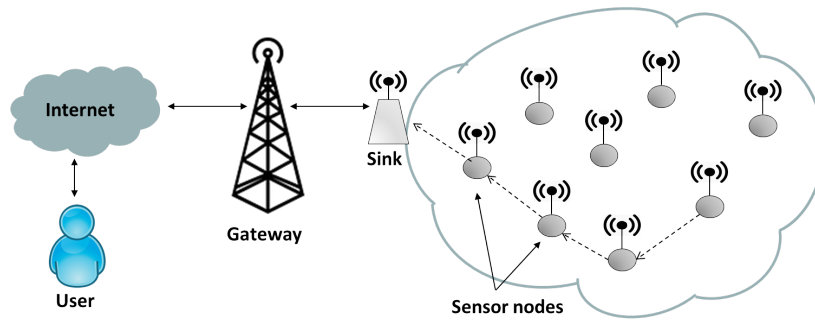

Fig. 2.1 Architecture of a simple WSN.

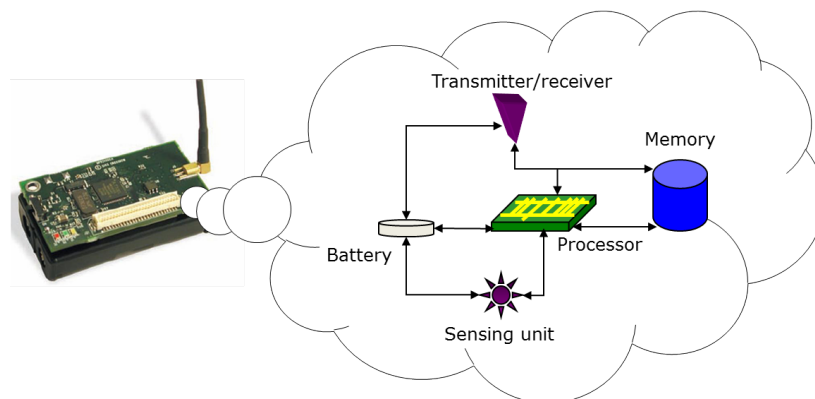

Fig. 2.2 Architecture of a sensor node.

In Figure 2.2, we present a generic sensor node architecture. A sensor is basically composed of sensing, data storage, data processing, and communicating components powered with batteries. More particularly, the radio is used to communicate through wireless links with other sensors and the base station, while the sensing unit measures external parameters (e.g temperature, acceleration, noise level). Sensors may be equipped with additional elements such as a localization system (GPS), power harvesting components, or actuators. The cost of nodes has to be kept low to minimize the overall cost of the network, and a good trade-off must be found between the amount of features provided by the sensor and its cost.



Module	Mode	Measured current
Radio	Receive	22.8 mA
Radio	Transmit (0 dB)	21.7 mA
Radio	Transmit (-25 dB)	12.1 mA
Radio	Idle (-25 dB)	2.4 mA
Microcontroller	CPU active	2.33 mA
Microcontroller	CPU idle	2.25 mA
Internal flash	Erase	1.35 mA
Internal flash	Write	0.9 - 1.34 mA
Internal flash	Read	0.68 mA
Microcontroller	CPU disable	1.80 $\mu$ A

Table 2.1 Energy consumption profile of a TelosB sensor platform [7].

## Sensor energy consumption

The main sources of power consumption at sensor nodes are the **communication** tasks, followed by **computation** and **sensing** operations. Although different sensing platforms will have different energy consumption profile, the following remarks generally hold [2]:

- The communication subsystem has an energy consumption much higher than the computation subsystem. Therefore, communication should be traded for computation.
- The radio energy consumption is of the same order of magnitude in the reception, transmission, and idle states, while the power consumption drops of at least one order of magnitude in the sleep state. Therefore, the radio should be turned off whenever possible.
- Depending on the specific application, the sensing subsystem might be another significant source of energy consumption, so its power consumption has to be reduced as well.

The energy consumption profile of a TelosB sensor platform, represented in Table 2.1, verifies these observations. Indeed, the radio module is the most energy-consuming component, and the energy consumption of the radio when idle is about ten time lower than when the radio is receiving data. In accordance to this result, Nguyen et al. [6] measured that a TelosB can last 95 hours with 100% duty cycle (no sleep, radio always on, no communication), and 200 hours with a 25% duty cycle.

## Lifetime and energy-efficiency definitions

At that point, we provide definitions of the *lifetime* and the *energy-efficiency* of a wireless sensor network, since these two notions are employed throughout the manuscript

As detailed by Dietrich and Dressler [8], there exist several definitions of the lifetime of a wireless sensor network, depending on whether we consider the number of nodes that are alive, the coverage of the region of interest, the connectivity between nodes or the quality of service of the application. As a consequence, we give a general definition of the lifetime of a WSN as **the time elapsed until a certain condition in the network is verified**. Examples of such conditions are: "the first/last sensor dies", "a given percentage of the sensors cannot reach the sink", "the data delivery ratio / coverage drops below a predefined threshold". Therefore, the lifetime of a sensor network is related to a time measure, but sometimes fails to characterize other dimensions of the network, such as latency or fault tolerance properties.

Energy-efficiency was first defined as the ratio between total amount of data delivered and total energy consumed [9]. Therefore, as more data is successfully transmitted for a given amount of energy consumption, the energy efficiency of the solution increases. A broader definition that covers the previous one has then been proposed: energy-efficiency can be defined as "using less energy to provide the same service" [10]. In this context, a system that provides a higher event detection accuracy for the same amount of energy consumption may be considered energy-efficient. As a consequence, energy-efficiency is usually understood to mean a satisfactory trade-off between multiple optimization criteria (e.g energy-consumption, latency and data delivery ratio), where the evaluation of the notion of 'satisfaction' is left to the discretion of the designer. As we will see in the following sections, maximizing the network lifetime only makes sense if done in an energy-efficient manner, that is if the application requirements are taken into account.

WSN have the potential to revolutionize traditional monitoring tasks. Indeed, the availability of such low-cost sensor nodes enables ubiquitous unattended monitoring, even in areas difficult to access. However, realizing such wireless sensor networks is a challenging research and engineering problem because of the diversity of envisioned applications and the limited resources of the sensor nodes.

## 2.3 WSN applications and their requirements

In this section, we propose a taxonomy of WSN applications, given in Figure 2.3, and we summarise in Table 2.2 the specific requirements of each described application.

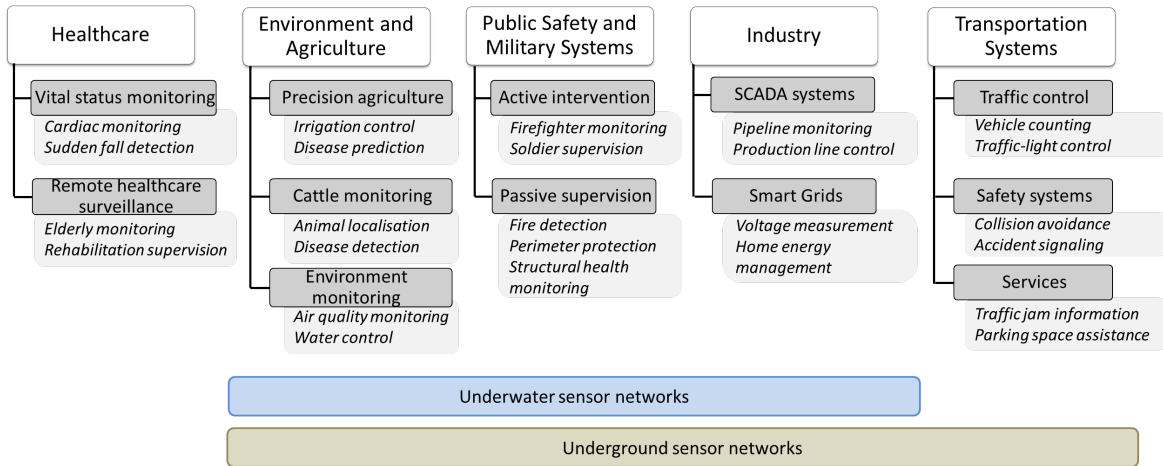

Fig. 2.3 Taxonomy of WSN applications.

### 2.3.1 Healthcare

Wireless sensor networks used in healthcare systems have received significant attention from the research community, and the corresponding applications are surveyed in [11–13]. We identify two types of healthcare-oriented systems, namely, *vital status monitoring* and *remote healthcare surveillance*.

In *vital status monitoring* applications, patients wear sensors that supervise their vital parameters in order to identify emergency situations and allow caregivers to respond effectively. Applications include mass-casualty disaster monitoring [14], vital sign monitoring in hospitals [15], and sudden fall or epilepsy seizure detection [16].

*Remote healthcare surveillance* concerns care services that are not vital and for which the constant presence of a healthcare professional is not necessary. For example, as illustrated in Figure 2.4, body sensors can be used to gather clinically relevant information for rehabilitation supervision [17], elderly monitoring [18] or to provide support to a physically impaired person [19].

WSNs used in healthcare must meet several requirements. In particular, they have to guarantee **hard real-time data delivery delays**, **confidentiality** and **access control**. They must also support **mobility** and provide **Quality of Service**. Indeed, in the context of early

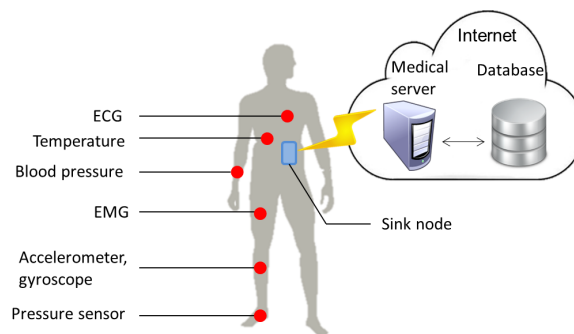

Fig. 2.4 Illustration of a Body Sensor Network

and life-critical detection of emergencies such as heart attacks and sudden falls, the real-time aspect is decisive. In this case, situation identification and decision-making must occur as quickly as possible to save precious minutes and the person's life. Therefore, the data delivery delay between the nodes and the end-user must be short in order to meet hard real-time requirements. It is also necessary that healthcare networks support node mobility to ensure the continuity of service when both patients and caregivers move. Additionally, exchanged healthcare data are sensitive and medical information must be kept private by restricting access to authorized persons. Thus, achieving confidentiality and access control through a communication network requires the establishment of mechanisms for data protection and user authentication. Furthermore, when WSNs are integrated into a global hospital information system, critical data such as alarms share the bandwidth with less sensitive data such as room temperature. Therefore, traffic prioritisation is essential to satisfy strict delay requirements through QoS provisioning.

### 2.3.2 Industry: manufacturing and Smart Grids

The automation of monitoring and control systems is an important aim for many utility companies in manufacturing, water treatment, electrical power distribution, and oil and gas refining. We consider the integration of WSNs in *Supervisory Control and Data Acquisition (SCADA) systems* and *Smart Grids*.

*SCADA systems* refer to computer systems that monitor and control industrial processes. Wireless sensors, together with actuators, can be used for factory automation, inventory management, and detection of liquid/gas leakages. These applications require accurate supervision of shock, noise and temperature parameters in remote or inaccessible locations such as tanks, turbine engines or pipelines [20, 21].

The aim of *Smart Grids* is to monitor the energy supply and consumption process thanks to an automated and intelligent power-system management. The potential applications of

sensor networks in smart grids are: sensing the relevant parameters affecting power output (pressure, humidity, wind orientation, radiation, etc.); remote detection of faulty components; control of turbines, motors and underground cables; and home energy management [22, 23].

The main requirements of industrial applications are **bounded delay**, **robustness** and **security**. Indeed, the products handled in industry can be very dangerous and require special care in storage and handling. For example, in an oil refinery, due to their high volatility and flammability, products with low boiling points evaporate easily, forming flammable vapors. Thus, the pressure in a tank or the temperature of a furnace can quickly become critical. This is why strict delays must be ensured so that the time that elapses between the detection of an anomaly and the intervention of the operator enables the incident to be resolved. Furthermore, in many industries, networks are subject to diverse disturbances such as faulty components, node failure, disconnections and congestion. This is because sensors operate under harsh conditions, as motes placed in pipelines or tanks experience high pressure and temperatures, or continuous vibrations. So, industry implementations must ensure data reliability at all times. Moreover, given the sensitivity of the data, availability, integrity, authenticity and confidentiality are all security problems that must be taken into consideration when designing an industrial communication network.

### 2.3.3 Transportation systems

Various studies related to the integration of WSNs and transportation systems have already been conducted: they include *traffic monitoring* and real-time *safety systems* sharing bandwidth with commercial *services*.

In *traffic-monitoring* systems, wireless sensors are embedded on roadways and intersections in order to collect traffic data. For example, they can count vehicles in queues to adjust traffic signals or the number of toll booths and lanes opened [24, 25].

In *safety systems*, wireless sensors are employed to cope with situations such as emergency braking, collision avoidance, lane insertion assistance and hazardous driving conditions warnings (stop-and-go waves, ice on the road, crossing animals) [26, 27].

In addition to passenger-safety applications, commercial on-board applications are being devised by service providers. They include route guidance to avoid rush-hour jams [28], smart high-speed tolling, assistance in finding a parking space [29] and automobile journey statistics collection [30].

Due to the life-critical characteristics of transport applications, the WSNs designed in this domain must guarantee **hard real-time delays**, **security** and **QoS** while supporting

**mobility.** For instance, systems related to driving safety must ensure tight bounded end-to-end delays in order to guarantee response times. This constitutes the main challenge of such applications since people's lives are at stake. For traffic monitoring applications, timely information is also required in order to ensure efficient real-time management of vehicle flow. In future Intelligent Transportation Systems (ITSs), safety systems and service applications will share the same wireless channel which requires tools to integrate service differentiation. Indeed, critical information and traffic-control should have higher priority than other service packets. Furthermore, vehicle-to-vehicle and vehicle-to-infrastructure communications are constrained by car speed. So, mobility is inherent to the automotive domain as nodes evolve in an extremely dynamic environment. Finally, the life-critical characteristic of some applications raises security issues in the transport network, which may be the target of a cyber-attack. Thus, the network must be protected against data corruption that could give false information about traffic or conditions on the road. By relaxing the power factor, nodes can support sophisticated encryption algorithms to provide a higher level of security.

### 2.3.4 Public safety and Military systems

Wireless sensor networks can help to anticipate and manage unpredictable events, such as natural disasters or man-made threats. We categorise public safety and military applications into *active intervention* and *passive supervision*.

*Active intervention* refers to systems with nodes attached to agents for temporary deployment and is dedicated to the safety of team-oriented activities. While working, each member carries a sensor so that a remote leader will be able to monitor both the holder's status and the environmental parameters. This applies to emergency rescue teams [31], miners [32] and soldiers [33].

With *passive supervision*, static sensors are deployed in a large area such as a civil infrastructure or nuclear site for long-term monitoring. Relevant examples of passive supervision applications are surveillance and target tracking [34], emergency navigation [35], fire detection in a building, structural health monitoring [36, 37] and natural disaster prevention such as in the case of tsunamis, eruptions or flooding [38].

Due to their critical nature, public safety and military applications are characterised by the need for **short delays**, **service differentiation** and **data integrity** provisioning. In addition, active intervention applications must support **mobility** and passive supervision should ensure **coverage**. First, a decisive parameter to take into account when designing a public safety system is the delivery delay, as in emergency applications, timely alarm reporting is necessary

for the system to be reactive. Furthermore, public safety and military systems deal with both everyday monitoring data and warning data. Thus, anomaly detection alarms should be sent in packets having high priority over regular reports through an efficient service differentiation mechanism. Finally, both kinds of public safety applications should guarantee data integrity: in active intervention, corrupt data could endanger agents by giving false information to headquarters; in passive supervision, an ill-intentioned person could circumvent a surveillance system by sending false data. In the case of active intervention, mobility is inherent to the architecture as wearable sensors are carried by working people. Moreover, from drilling tunnels to the fire field, active intervention applications are often characterised by their use in harsh environmental conditions. In these conditions, the network should be resistant to node failure and poor link quality by means of a fault-tolerant routing scheme. Long-term infrastructure monitoring requires the deployment of untethered static sensors in order to supervise the region of interest. Therefore, passive supervision applications may run into coverage problems when required to entirely supervise a building or a tunnel.

### 2.3.5 Environment and agriculture

WSNs are particularly well suited to agricultural and open-space monitoring applications since wired deployment would be expensive and inefficient. A variety of applications have been developed in *precision agriculture*, *cattle monitoring* and *environmental monitoring*.

In *precision agriculture*, sensor nodes are scattered throughout a field to monitor relevant parameters, such as atmospheric temperature, soil moisture, hours of sunshine and the humidity of the leaves, creating a decision support system. Another purpose of precision agriculture is resource (water, fertiliser, pesticides) optimization [39], frost protection, disease development prediction [40].

In *cattle monitoring* applications, general surveillance of livestock is convenient to keep watch on cattle health status, to detect disease breakouts, to localise them and to control end-product quality (meat, milk) [41, 42].

The use of WSNs for diverse *environmental monitoring* applications has been studied for coastline erosion [43], air quality monitoring [44], safe drinking water and contamination control [45].

The main requirements of environmental and agricultural applications are **scalability**, **coverage** and **lifetime prolongation**. Agricultural fields, grazing land and monitored sites can reach several tens of hectares, so the number of nodes deployed varies from dozens to thousands. This is why scalability is an important issue when developing protocols to support a high quantity of nodes and ensure full coverage of the controlled area. Corke et

al. [46] have conducted several real experiments in natural environments and have shown that outdoor conditions could be very harsh and impact the feasibility of communication. Typically, foliage, rain or humidity can lead to the breakdown of inter-node links, resulting in highly variable and unpredictable communications. Fault tolerant routing schemes must therefore be set up to ensure area coverage and cope with failure or temporary disconnection. In most environmental monitoring applications, nodes are static as they are deployed on the ground in fields, in forests or along the banks of rivers. Nevertheless, mobility must be taken into account, whether this is desired or not. Unwished-for mote displacement can be caused by heavy rains, wind, animals or engines. When mobility is intentional, nodes and sinks are embedded in vehicles [47] or a natural moving bearer such as animals.

### 2.3.6 Underground and underwater sensor networks

Underground and underwater sensor networks are emerging types of WSNs, which are used in different categories of applications including environmental monitoring, public safety and industry. They differ from traditional terrestrial networks in that the sensors are deployed in special environments that make communications difficult and impact their ease of deployment. *Underground sensor networks* consist of sensors that are buried in and communicate through dense materials like soil or concrete. Such networks can be used for soil moisture reporting in agriculture [48], infrastructure supervision, intrusion detection [49] and transport systems [50]. *Underwater sensor networks* rely on immersed sensors and are used in a variety of applications such as ocean supervision [51], water quality monitoring [52], disaster prevention, surveillance [53] and pipeline monitoring.

Underground and underwater sensor networks share common requirements such as **robustness** and **coverage**. The main characteristic of these networks is their lossy channel due to extreme environmental conditions. Indeed, acoustic communications for underwater sensors and electromagnetic waves for underground sensors suffer from lower propagation speed, noise and path loss, which lead to the degradation of the signal [50, 53]. Therefore, they require the development of specific communication protocols to ensure the application's reliability. Coverage is also an issue since it may not be possible to optimally deploy the nodes due to the ground profile, the costs and the efforts required for excavation. Moreover, these networks are inherently three-dimensional (which raises additional issues) since the devices can be deployed at varying depths depending on the phenomenon to supervise. Besides these requirements, energy is of great importance due to the difficulty of unearthing a device to replace it or recharge its battery.



		Scalability	Coverage	RT Delay	QoS	Security	Mobility	Robustness
<b>Healthcare</b>	Vital status monitoring	--	--	++	+	++	++	+
	Remote surveillance	--	--	+	+	++	++	-
<b>Agriculture and Environment</b>	Precision agriculture	++	++	--	--	--	--	+
	Cattle monitoring	++	-	-	--	--	+	-
	Environment monitoring	--	--	+	+	++	++	-
<b>Public Safety &amp; Military systems</b>	Active intervention	--	--	++	+	++	++	++
	Passive supervision	--	+	++	+	++	--	-
<b>Transportation systems</b>	Traffic control	--	-	++	++	++	++	-
	Safety system	--	-	++	++	++	+	+
	Services	--	--	-	+	+	+	-
<b>Industry</b>	SCADA systems	--	-	++	+	++	--	++
	Smart grids	+	-	++	+	++	--	++
--								Very low
-								Low
+								High
++								Very high

Table 2.2 WSN applications requirements.

### 2.3.7 Discussion

The main WSN requirements that we identified in the different applications are *scalability*, *coverage*, *latency*, *QoS*, *security*, *mobility* and *robustness*. In Table 2.2, we summarise the importance of these requirements for every class of application considered in this section. In these applications, sensors are expected to operate autonomously for a long period of time, ranging from weeks to months. However, every application is constrained in terms of energy due to the scarce battery resources of the sensors, which limits the network lifetime. Indeed, it may not always be possible to manually replenish the motes because of their number, the maintenance cost or the inaccessibility of monitored regions. This is the case of structural health monitoring applications, precision agriculture and environment monitoring, transportation systems. Furthermore, some applications such as healthcare applications can tolerate battery replacement, but we believe that the rapid depletion of the battery prevent their wide adoption. Indeed, efforts are still made to propose energy-efficient solutions for body area networks to foster the acceptance of these technologies by the patients. This is why the design of WSNs requires, in both cases, the development of energy-efficient solutions that meet a specific set of requirements.

In order to achieve energy efficiency, we first present in the next section existing standards developed for low-power wireless sensor networks.

## 2.4 Low-power WSN standards

Wireless sensor network standards have been specifically designed to take into account the scarce resources of nodes. In what follows we give a brief description of low-power standards including IEEE 802.15.4, ZigBee, WirelessHART, ISA100.11a, Bluetooth low energy, IEEE 802.15.6, 6LoWPAN, RPL and MQTT.

*IEEE 802.15.4* [54] specifies the physical and MAC layers for low data rate wireless personal area networks (LR-WPANs). In the beacon-enabled mode, the standard allows energy to be saved by implementing duty cycling, so that all nodes can periodically go to sleep. In practice, a coordinator sends beacon packets to synchronise the nodes, and the superframe structure presented in Figure 2.5 is subdivided into three parts: 1) a contention access period during which nodes use a slotted CSMA/CA 2) a contention-free period containing a number of guaranteed time slots (GTS) that can be allocated by the coordinator to specific nodes and 3) an inactive period during which the end-devices and coordinator can go to sleep.

*ZigBee* [55] is a wireless technology developed as an open standard to address the requirements of low-cost, low-power devices. ZigBee defines the upper layer communication protocols based on the IEEE 802.15.4 standard. It supports several network topologies connecting hundreds to thousands of devices.

*WirelessHART* [56] operates on the IEEE 802.15.4 specification and targets field devices such as sensors and actuators that are used to monitor plant equipment or processes. The standard characteristics are integrated security, high reliability and power efficiency. WirelessHART relies on a fixed length TDMA scheme so nodes can go to sleep when it is not their slot time. Moreover, it specifies a central mesh network where routing is exclusively determined by the network manager that collects information about every neighbouring node. It uses this information to create an overall graph of the network and defines the graph routing protocol. In practice, the standard does not specify how to implement such a graph routing so some research work already proposes multipath routing protocols for industrial processes [57, 58]. While these studies take link quality into consideration for the routing decisions, it may be possible to use the node battery-level information in order to further improve energy savings.

The *ISA100.11a* [59] standard relies on the IEEE 802.15.4 specification and is dedicated to reliable wireless communications for monitoring and control applications in the industry. ISA100.11a uses deterministic MAC scheduling with variable slot length, allowing nodes to go into sleep mode when it is not their time slot. Moreover, the standard defines non-router nodes that do not act as forwarders and experience very low energy depletion. Finally,

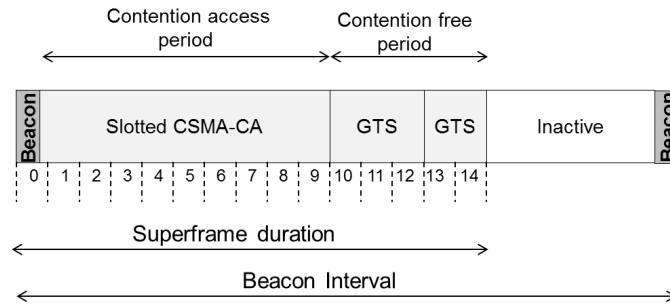

Fig. 2.5 The superframe structure of the IEEE 802.15.4 beacon-enabled mode.

the standard requires each device to report its estimated battery life and associated energy capacity to the System Manager which allocates communication links based on the reported energy capabilities. In addition to low power consumption, ISA100.11a also focuses on scalable security; robustness in the presence of interference; and interoperability with other wireless devices such as cell phones or devices based on other standards.

*Bluetooth Low Energy (BLE)* [60] addresses low-cost devices with very low battery capacity and short-range requirements. It is an extension of the Bluetooth technology that allows communication between small battery-powered devices (watches, wireless keyboards, sport sensors) and Bluetooth devices (laptops, cellular phones). In terms of energy efficiency, Bluetooth low energy is designed so that devices can operate for over a year thanks to an ultra low-power idle mode. BLE is suitable for a variety of applications in the fields of healthcare, sports and security.

*IEEE 802.15.6* [61] is a recent standard that defines the PHY and MAC layers for low-power devices operating in the vicinity of, or inside a human body for medical and non-medical applications. A BAN (Body Area Network) is composed of one hub and up to 64 nodes, organised into one-hop or two-hops star topologies. At the MAC level, the channel is divided into super-frame structures, which are further divided into different access phases to support different traffic and channel access modes (contention based and contention free). There are eight user priorities, ranging from best-effort to emergency event reports. These are differentiated based on the minimum and maximum contention windows. The standard also supports 3 levels of security: level 0 - unsecured communications, level 1 - authentication only, level 2 - authentication and encryption.

*6LoWPAN* (RFC 4919) [62] stands for IPv6 over Low power Wireless Personal Area Networks. 6LoWPAN is designed for low-power devices that require Internet communication. It enables IEEE 802.15.4-based networks to send and receive IPv6 packets so that small devices are able to communicate directly with other IP devices, locally or via IP networks (e.g. Ethernet).

## 2.4 Low-power WSN standards

Name	Wi-Fi	WiMAX	WiMedia	Bluetooth	ZigBee	Bluetooth low energy
Standard	IEEE 802.11b	IEEE 802.16	IEEE 802.15.3	IEEE 802.15.1	IEEE 802.15.4	
Applications	internet access web, email, video	broadband connections	real-time multimedia streaming	cable replacement	low-power devices communication	Bluetooth ↔ low-power device communication
Devices	laptop, tablet console	PC peripheral	wireless speaker, printer television	mobile phone, mouse keyboard, console	embedded systems, sensors	watch, sport sensor, wireless keyboard
Target lifetime [63]	hours	-	-	days - months	6 months - 2 years	1-2 years
Data rates	11 Mbps	30-40 Mbps	11-55 Mbps	1-3 Mbps	20-250 Kbps	1 Mbps
Transmission range	100 m	50 km	10 m	10-50 m	100 m	10 m
Network size	32	-	245	7	65000	-
Success metric	Flexibility Speed	Long range	High data rates	Cost Convenience	Reliability, Cost, Low-power	Low-power

Table 2.3 Wireless standards characteristics.

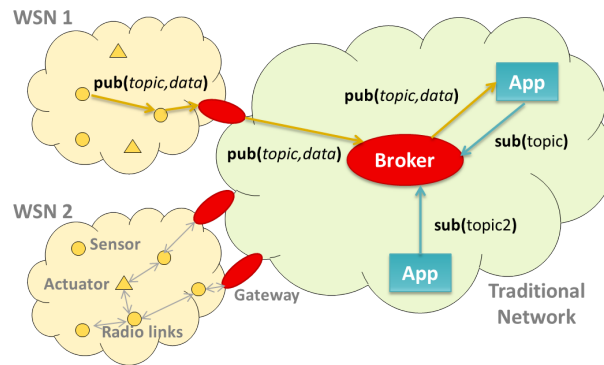

Fig. 2.6 MQTT-S architecture for WSN with Pub/Sub communications.

*RPL* (RFC 6550) [64] is a distance vector Routing Protocol for Low Power and lossy networks compliant with IPv6, specifically designed to meet the requirements of resource-constrained nodes. RPL is optimized for many-to-one communications for data collection, but it also supports one-to-many and one-to-one communications. RPL creates a Directed Acyclic Graph (DAG) anchored at a border router of a WSN. A node maintains several parents to construct different routes towards the sink and selects its preferred parent based on an Objective Function that uses routing metrics. For example, a draft [65] proposes to select the path that minimizes the sum of Expected Number of Transmissions (ETX) over traversed links but the design of the Objective Function is still an open research issue. Thus, it is possible to create a DAG focusing on energy efficiency, as in Kamgueu et al. [66] who use the node's remaining energy as an RPL routing metric. RPL offers other features like fault-tolerance, self-repair mechanisms, and security [67].

*MQTT* [68] (Message Queuing Telemetry Transport) is a lightweight publish/subscribe protocol for one-to-many message distribution. Currently undergoing standardisation, MQTT is envisioned to be the future protocol for the Internet-of-Things to connect devices with low

bandwidth and power budget over TCP/IP infrastructures. MQTT-S [69] extends MQTT for Wireless Sensors and Actuators Networks on non-TCP/IP networks. As illustrated in Figure 2.6, *publishers* produce information and send their data to the *broker* via a *pub* message. *Subscribers* interested in receiving certain data send a *sub* message to the broker. If there is a match between a subscriber's and a publisher's topics, the broker transfers the message to the subscriber. MQTT-S saves energy by supporting multiple gateways to balance the load in the network. It also supports sleeping clients (subscribers/publishers) and size-limited packets to be compliant with ZigBee. Moreover, most of the protocol logic is handled in the broker and the gateway, which makes the device's implementation lightweight [70]. Although MQTT is already implemented in various projects [71], there is a lack of evaluation regarding the energy-efficiency of the protocol.

### 2.4.1 Discussion

Bluetooth low energy and IEEE 802.15.4-based standards have been specifically developed for battery-operated devices. They enable energy-saving through duty cycling and include optional modes that can be disabled for further network lifetime optimization. In Table 2.3 we compare these two WSN-specific standards with other well-known wireless standards (Wi-Fi, WiMax, WiMedia, Bluetooth) regarding data rate, transmission range, scalability and applications.

In terms of applications, existing healthcare platforms often interface with Bluetooth due to the suitability of this technology for body area networks that demand short communication ranges and high data rates. However, Bluetooth technology may quickly deplete a nodes' energy. In this case, BLE or IEEE 802.15.6 may be considered as alternatives. ZigBee technology is suitable for a large number of applications thanks to its scalability and energy-efficiency. For example, in smart home automation, ZigBee data rate and radio range are sufficient for room supervision. Nevertheless, in a more complex monitoring system, both ambient sensor networks and body sensor networks may be integrated together and further connected to the Internet via 6LowPan. In large-scale outdoor deployment, the Zigbee 100-meter achievable radio range may quickly become limiting. In this case, we envision that WiMax-enabled gateways will be able to mesh the topology to connect the network to the Internet. Thus, the integration of different technologies and standards is necessary to respond to the needs of emerging and challenging applications such as Smart grids, Intelligent Transportation Systems and Healthcare Information Systems.

Standardisation is a key issue for the success of WSN markets. Although application-specific standards are emerging, such as WirelessHART and ISA100.11a for industry, and IEEE 802.15.6 for body sensor networks, they can still be improved in regard to application

requirements. For instance, some research studies propose to optimize standard parameters such as packet size, slot length, contention window length or even introduce alternative protocols. Moreover, the performance of recent standards (e.g., MQTT, IEEE 802.15.6) need further investigation, because there is a lack of evaluation concerning these solutions and a lack of comparisons with well-established protocols. It also appears that current standards cannot respond to all application needs, notably regarding hard real-time requirements and security issues. In parallel to ongoing standardisation efforts, many solutions have been developed which strongly consider energy-saving.

## 2.5 Energy-saving mechanisms

In this section, we review the major existing approaches proposed to tackle the energy consumption problem of battery-powered nodes. The proposed taxonomy of energy-efficient mechanisms is summarised in Figure 2.7.

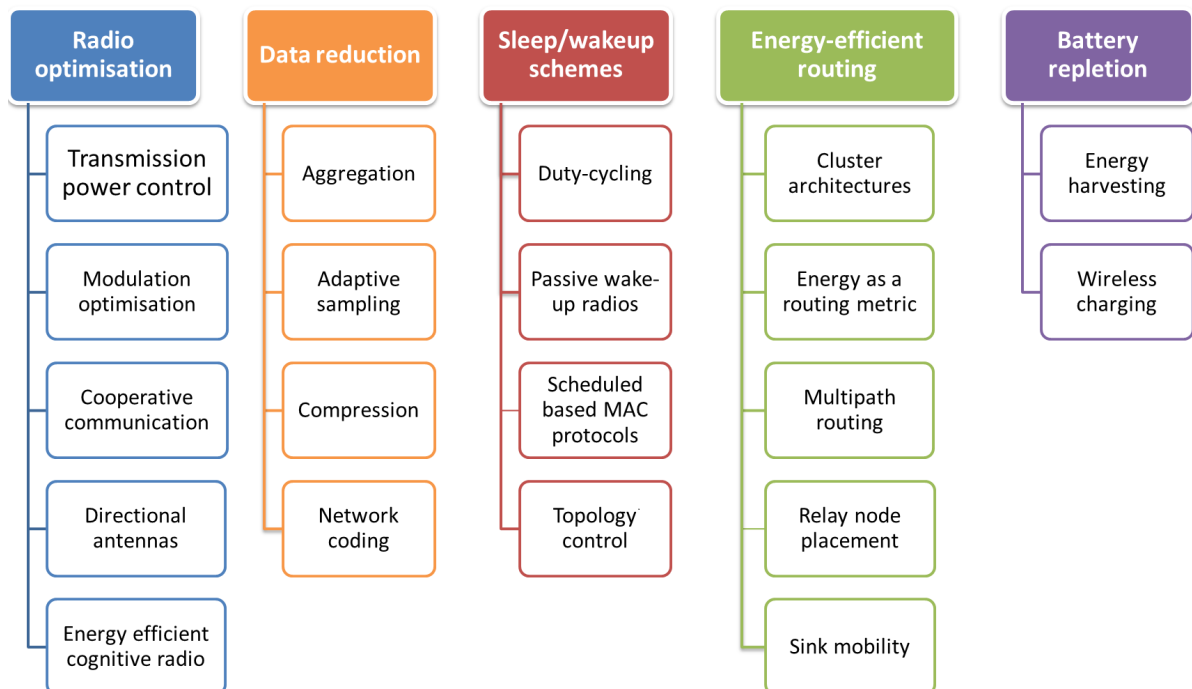

Fig. 2.7 Classification of energy-efficient mechanisms.

### 2.5.1 Radio optimization

The radio module is the main component that causes battery depletion of sensor nodes. To reduce energy dissipation due to wireless communications, researchers have tried to optimize radio parameters such as coding and modulation schemes, power transmission and antenna direction.

**Modulation optimization** aims to find the optimal modulation parameters that result in the minimum energy consumption of the radio. For instance, energy depletion is caused by the circuit power consumption and the power consumption of the transmitted signal. For short distances, circuit consumption is greater than the transmission power while for longer ranges the signal power becomes dominant. Existing research tries to find a good trade-off between the constellation size (number of symbols used), the information rate (number of information bits per symbol), the transmission time, the distance between the nodes and the noise. Cui et al. [72] showed that the energy consumption required to meet a given Bit Error Rate (BER) and delay requirement can be minimized by optimizing the transmission time. Costa and Ochiai [73] studied the energy efficiency of three modulation schemes and derived from this the modulation type and its optimal parameters that achieve minimum energy consumption for different distances between nodes.

**Cooperative communications schemes** have been proposed to improve the quality of the received signal by exploiting several single-antenna devices which collaborate to create a virtual multiple-antenna transmitter. The idea is to exploit the fact that data are usually overheard by neighbouring nodes due to the broadcast nature of the channel. Therefore, by involving these nodes in the retransmission of data it is possible to create spatial diversity and combat multi-path fading and shadowing [74]. Jung et al. [75] investigated how cooperative transmission can be used to extend the communication range and thus balance the duty cycling of nodes as normal relay sensors can be replaced by other cooperative nodes. Cui et al. [76] and Jayaweera [77] compared the energy consumption of both SISO (Single Input Single Output) and virtual MIMO (Multiple Input and Multiple Output) systems and show that MIMO systems can provide better energy savings and smaller end-to-end delays over certain transmission range distances, even with the extra overhead energy required for MIMO training.

**Transmission Power Control (TPC)** has been investigated to enhance energy efficiency at the physical layer by adjusting the radio transmission power [78, 79]. In CTCA (Cooperative Topology Control with Adaptation) [80] the authors propose to regularly adjust

the transmission power of every node in order to take into consideration the uneven energy consumption profile of the sensors. Therefore, a node with higher remaining energy may increase its transmission power, which will potentially enable other nodes to decrease their transmission power, thus saving energy. However, TPC strategy has an effect not only on energy but also on delays, link quality, interference and connectivity. Indeed, when transmission power decreases, the risk of interference also decreases. Moreover, fewer nodes in the neighbourhood are subjected to overhearing. On the contrary, delay is potentially increased, because more hops will be needed to forward a packet. Finally, transmission power influences the network topology because the potential connectivity between sensors will vary, and it also favours the spatial reuse of bandwidth if two communications can occur without interference.

**Directional antennas** allow signals to be sent and received in one direction at a time, which improves transmission range and throughput. Directional antennas may require localisation techniques to be oriented, but multiple communications can occur in close proximity, resulting in the spatial reuse of bandwidth. In contrast to omnidirectional nodes which transmit in unwanted directions, directional antennas limit overhearing and, for a given range, require less power. Thus, they can improve network capacity and lifetime while influencing delay and connectivity [81, 82]. To take advantage of the properties of directional antennas, new MAC protocols have been designed [83, 84]. However, some problems that are specific to directional antennas have to be considered: signal interference, antenna adjustments and deafness problems [85].

**Energy-efficient cognitive radio:** A cognitive radio (CR) is an intelligent radio that can dynamically select a communication channel in the wireless spectrum and can adapt its transmission and reception parameters accordingly. The underlying Software-Defined Radio (SDR) technology is expected to create fully reconfigurable wireless transceivers which automatically adapt their communication parameters to network demands, which improves context-awareness. However, CR requires significant energy consumption compared with conventional devices due to the increased complexity involved for new and sophisticated functionalities [86]. In this context, designing energy-efficient cognitive radio sensor networks is a key challenge in the intelligent use of battery energy. Recent cognitive radio studies are interested in the power control of transmitters [87], residual energy-based channel assignment, and combining network coding and CR. Open research issues include the development of cross-layer approaches for MAC, routing or clustering protocols that take advantage of cognitive radio opportunities.



## 2.5.2 Data reduction

Another category of solutions aims to reduce the amount of data to be delivered to the sink. Two methods can be adopted jointly: the limitation of unneeded samples and the limitation of sensing tasks because both data transmission and acquisition are costly in terms of energy.

**Aggregation:** In data aggregation schemes, nodes along a path towards the sink perform data fusion to reduce the amount of data forwarded towards it. For example, a node can retransmit only the average or the minimum of the received data. Moreover, data aggregation may reduce the latency since it reduces traffic, thus improving delays. However, data aggregation techniques may reduce the accuracy of the collected data. Indeed, depending on the aggregation function, original data may not be recovered by the sink, thus information precision can be lost. Data aggregation techniques dedicated to wireless sensor networks are surveyed in detail by Rajagopalan and Varshney in [3] and by Fasolo et al. in [88].

**Adaptive sampling:** The sensing task can be energy-consuming and may generate unneeded samples which affects communication resources and processing costs. Adaptive sampling techniques adjust the sampling rate at each sensor while ensuring that application needs are met in terms of coverage or information precision. For example, in a supervision application, low-power acoustic detectors can be used to detect an intrusion. Then, when an event is reported, power-hungry cameras can be switched on to obtain finer grained information [2]. Spatial correlation can be used to decrease the sampling rate in regions where the variations in the data sensed is low. In human activity recognition applications, Yan et al. [89] propose to adjust the acquisition frequency to the user activity because it may not be necessary to sample at the same rate when the user is sitting or running.

**Network coding (NC)** is used to reduce the traffic in broadcast scenarios by sending a linear combination of several packets instead of a copy of each packet. To illustrate network coding, Figure 2.8 shows a five-node topology in which node 1 must broadcast two items of data,  $a$  and  $b$ . If nodes simply store and forward the packets they receive, this will generate six packet transmissions (2 for each node 1, 2 and 3 respectively). With the NC approach, nodes 2 and 3 can transmit a linear combination of data items  $a$  and  $b$ , so they will have to send only one packet. Nodes 4 and 5 can decode the packet by solving linear equations. Therefore, two packets are saved in total in the example. Network coding exploits the trade-off between computation and communication since communications are slow compared to computations and more power-hungry. Wang et al. [90] combine network

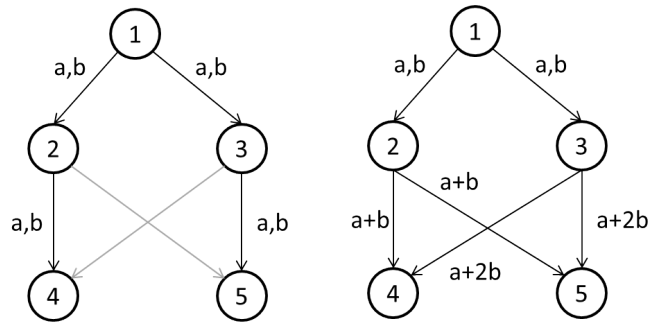

Fig. 2.8 An example of network coding.

coding and Connected Dominating Sets to further reduce energy consumption in broadcast scenarios. AdapCode [91] is a data dissemination protocol where a node sends one message for every  $N$  messages received, saving a fraction of the bandwidth up to  $(N-1)/N$  compared to naive flooding. The receiver node can recover the original packets by Gaussian elimination after receiving  $N$  coded packets successfully. Moreover, AdapCode improves reliability by adapting  $N$  to the node density, because when  $N$  increases and the density decreases, it becomes harder to recover enough packets to decode the data. Reliability is further enhanced by allowing nodes receiving less than  $N$  packets to send a negative acknowledgement to retrieve missing data.

**Data compression** encodes information in such a way that the number of bits needed to represent the initial message is reduced. It is energy-efficient because it reduces transmission times as the packet size is smaller. However, existing compression algorithms are not applicable to sensor nodes because of their resource limitations. Therefore, specific techniques have been developed to adapt to the computational and power capabilities of wireless motes. Kimura et al. [92] have surveyed compression algorithms specifically designed for WSNs.

### 2.5.3 Sleep/wakeup schemes

Idle states are major sources of energy consumption at the radio component. Sleep/wakeup schemes aim to adapt node activity to save energy by putting the radio in sleep mode.

**Duty cycling schemes** schedule the node radio state depending on network activity in order to minimize idle listening and favour the sleep mode. These schemes are usually divided into three categories: *on-demand*, *asynchronous* and *scheduled rendezvous* [2]. A summary of the properties of each category is given in Table 2.4. Duty cycle based protocols are certainly the most energy-efficient but they suffer from sleep latency because a node must wait for the receiver to be awake. Moreover, in some cases it is not possible for a node to broadcast information to all of its neighbours because they are not active simultaneously. Finally, fixing parameters like listen and sleep periods, preamble length and slot time is a tricky issue because it influences network performance. For example, a low duty cycle saves a large amount of energy but can drastically increase communication delays. Thus, protocol parameters can be specified prior to deployment for simplicity, although this leads to a lack of flexibility, or they can be set up dynamically for improved adaptation to traffic conditions. Concerning duty cycling, some work has been done to adapt the active period of nodes online in order to optimize power consumption in function of the traffic load, buffer overflows, delay requirements or harvested energy [93, 94]. For more details about duty cycling, information can be found in [2] and [95].

Type	On-demand	Schedule rendez-vous	Asynchronous
<b>Principle</b>	Wake up a node only when another wants to communicate with it.	Nodes wakeup at the same time as its neighbours according to a wakeup schedule. Then they go to sleep until their next rendez-vous.	Each node wakes up independently but its active period must overlap with its neighbours.
<b>Broadcast</b>	No	Yes	No
<b>Synchronisation</b>	No	Yes	No
<b>Energy-efficiency</b>	Nodes remain active only for the minimum time required.	More collisions because nodes wakeup at the same time after an inactive period.	Nodes need to wake up more frequently. Either the sender sends long preamble or the receiver remains awake longer.
<b>Examples of applications</b>	Event-driven application with low duty cycle.	Data-gathering application with possibility of aggregation.	Mobile applications when the neighbourhood is unpredictable.
<b>Illustration</b>			

Table 2.4 Duty cycle properties.

**Passive wake-up radios:** While duty cycling wastes energy due to unnecessary wake-ups, low-power radios are used to awake a node only when it needs to receive or transmit packets while a power-hungry radio is used for data transmission. Ba et al. [96] consider a network composed of passive RFID wake-up radios called WISP-Motes and RFID readers. A passive RFID wake-up radio uses the energy spread by the reader transmitter to trigger an interruption that wakes up the node. In practice all sensors cannot be equipped with RFID readers since they have a high power consumption. This is a major shortcoming because, coupled with the short operational range of RFID passive devices, it restricts their use to single-hop scenarios. Simulations have shown that WISP-Motes can save a significant amount of energy at the expense of extra hardware and increased latency in data delivery. The authors demonstrated their benefits in the case of a sparse delay-tolerant network with mobile elements equipped with RFID readers.

**Topology control:** When sensors are redundantly deployed in order to ensure good space coverage, it is possible to deactivate some nodes while maintaining network operations and connectivity. Topology control protocols exploit redundancy to dynamically adapt the network topology based on the application's needs in order to minimize the number of active nodes. Indeed, nodes that are not necessary for ensuring connectivity or coverage can be turned off in order to prolong the network lifetime, as in Figure 2.9. Misra et al. [97] propose a solution capable of maintaining network coverage while minimizing the energy consumption of the network by activating only a subset of nodes, with the minimum overlap area. In a recent work, Karasabun et al. [98] consider the problem of selecting a subset of active connected sensors for correlated data gathering. This is very useful in some applications like environmental monitoring, when the sensed data are location-dependent, since the data of inactive nodes can be inferred from those of active nodes due to the spatial correlation. Bachir et al. [99] propose a distributed temperature-aware algorithm that dynamically allows some nodes to go to sleep mode when the temperature is low (because links quality improve) while guaranteeing the coverage and connectivity.

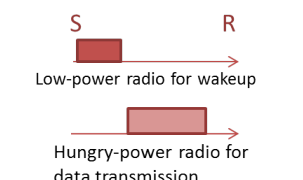
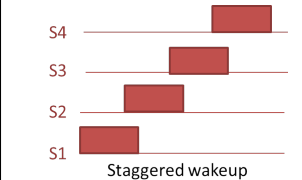
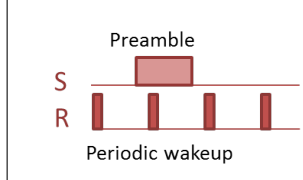
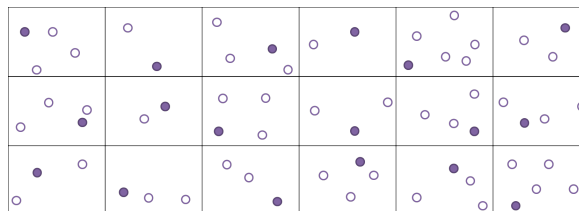

Fig. 2.9 Example of a topology control method applied to a network. To ensure the field coverage, a sensor must remain activated in each square area. The other nodes are deactivated.

## 2.5.4 Energy-efficient routing

Routing is an additional burden that can seriously drain energy reserves. In particular, in multi-hop schemes, nodes closer to the sink are stressed because they have to route more packets. Therefore, their battery depletes faster. In what follows, we discuss the general energy-saving mechanisms of different routing paradigms. For an extensive review of energy-aware routing protocols, survey articles can be found in [4, 100, 101].

**Cluster architectures** organise the network into clusters, where each cluster is managed by a selected node known as the cluster head (CH). The cluster head is responsible for coordinating the members' activities and communicating with other CHs or the base station. Cluster techniques have been proposed to enhance energy efficiency because they help to limit energy consumption via different means: i) they reduce the communication range inside the cluster which requires less transmission power, ii) they limit the number of transmissions thanks to fusion performed by the CH, iii) they reduce energy-intensive operations such as coordination and aggregation to the cluster head, iv) they enable to power-off some nodes inside the cluster while the CH takes forwarding responsibilities and v) they balance energy consumption among nodes via CH rotation. In addition to energy-efficiency, cluster architectures also improve network scalability by maintaining a hierarchy in the network [102, 103].

**Energy as a routing metric:** Another solution to extend the lifetime of sensor networks is to consider energy as a metric in the setup path phase. By doing so, routing algorithms do not only focus on the shortest paths but can select the next hop based on its residual energy. Recently, Liu et al. [104] introduced two new energy-aware cost functions. The Exponential and Sine Cost Function based Route (ESCFR) function can map a small change in remaining nodal energy to a large change in the cost function value. By giving preference to sensors with higher remaining energy during route selection, the function enforces energy balance. The Double Cost Function based Route (DCFR) protocol considers the energy consumption rate of nodes in addition to their remaining energy. The rationale behind this is that nodes in hotspots have high energy consumption rates. Thus, the use of this function further improves the energy-balancing performance of the routing protocol, even in networks with obstacles.

**Multipath routing:** While single-path routing protocols are generally simpler than multipath routing protocols, they can rapidly drain the energy of nodes on the selected path. In contrast, multipath routing enables energy to be balanced among nodes by alternating forwarding nodes. As an example, the EEMRP (Energy-Efficient Multipath Routing Protocol) [105] discovers multiple node-disjoint paths using a cost function depending on the energy

levels and hop distances of the nodes and allocates the traffic rate to each selected path. The EECA (Energy-Efficient and Collision Aware) protocol [106] constructs two node-disjoint and collision-free routes between a source and a sink. Multipath routing protocols also enhance network reliability by providing multiple routes, which enables the network to recover faster from a failure, whereas in single path schemes, when a node runs out of power, a new route must be recomputed. The interested reader can consult [107] for a recent survey of multipath routing protocols for WSNs.

**Relay node placement:** The premature depletion of nodes in a given region can partition the network or create energy holes. Sometimes, this situation can be avoided thanks to the optimal placement of nodes through even distribution or by adding a few relay nodes with enhanced capabilities. This helps to improve energy balance between nodes, avoid sensor hot-spots and ensure coverage and k-connectivity [108]. Several works have focused on finding the minimum number of relay nodes or placing them optimally to prolong the network lifetime [109, 110]. For example, Dandekar and Deshmukh [111] optimize the placement of static sinks to shorten the average hop distance of every node to its nearest sink.

**Sink mobility:** In WSN architectures that use a static base station, sensors located close to the base station deplete their battery faster than other sensor nodes, leading to premature disconnection of the network. This is due to the fact that all traffic is forwarded towards the sink which increases the workload of the nodes closer to the sink. To increase network lifetime, it is possible to balance the load between nodes using a mobile base station which moves around the network to collect node information. Sink mobility also improves connectivity in sparse architectures and enhances reliability because communication occurs in a single-hop fashion. Thus, it reduces contention, collisions and message loss [2, 112]. When controllable, this mobile displacement can be studied to prevent high latency, buffer overflow and energy depletion [113, 114].

### 2.5.5 Charging

Several recent research studies address energy harvesting and wireless charging techniques. Both are promising solutions which aim to recharge sensor batteries without human intervention.

**Energy harvesting:** New technologies have been developed to enable sensors to harvest energy from their surrounding environment such as solar, wind and kinetic energy [5]. Compared to traditional sensors, rechargeable motes can operate continuously and, theoretically,

for an unlimited length of time. They convert ambient energy to electrical energy and then either consume it directly or store it for later use. Energy harvesting architectures often require energy prediction schemes in order to efficiently manage the available power. Indeed, sensors require an estimation of energy evolution to adjust their behaviour dynamically and last until the next recharge cycle. Hence, they can optimize decisive parameters such as sampling rate, transmit power and duty cycling to adapt their power consumption according to the periodicity and magnitude of the harvestable source. It is important to note that nodes remain energy-limited between two harvesting opportunities, so they still need to implement energy-saving mechanisms. For example, motes using solar panels to replenish their batteries can operate intensively during daytime. At night, nodes may enter a conservative mode to use the stored energy. Furthermore, nodes may have an uneven residual energy distribution due to the difference in the quantity of energy collected, and this has to be taken into account when designing protocols [115]. For example, nodes with low residual energy may be assigned higher sleep periods and lower transmission ranges, while those with high residual energy may be preferred when selecting a routing path. Another open perspective is the development of protocols that consider the degradation of the battery over time (leakage, storage loss) [116] which will influence network performance.

**Wireless charging:** Recent breakthroughs in wireless power transfer are expected to increase the sustainability of WSNs and make them perpetually operational, since these techniques can be used to transmit power between devices without the need of any contact between the transmitter and the receiver. Wireless charging in WSNs can be achieved in two ways: electromagnetic (EM) radiation and magnetic resonant coupling. Xie et al. [117] show that omni-directional EM radiation technology is applicable to a WSN with ultra-low power requirement and low sensing activities (like temperature, light, moisture). This is because EM waves suffer from rapid drop of power efficiency over distance, and active radiation technology may pose safety concerns to humans. In contrast, magnetic resonant coupling appears to be the most promising technique to address energy needs of WSNs thanks to an higher efficiency within several-meter range.

The applications of wireless energy transfer in WSNs are numerous. It has already been applied to power medical sensors and implantable devices [118], to replenish sensors embedded in concrete in a wireless manner [119] and to power a ground sensor from a UAV [120]. The emergence of wireless power charging technology should allow the energy constraint to be overcome, as it is now possible to replenish the network elements in a more controllable manner. In this way, some researchers have already investigated the use of mobile chargers that directly deliver power to deployed nodes [121–124]. A new challenge

raised by wireless charging technologies is *energy cooperation*, since nodes may now be able to share energy between neighbors. So, in future wireless networks, nodes are envisioned to be capable of harvesting energy from the environment and transferring energy to other nodes, rendering the network self-sustaining [125]. In order to do this, recent studies demonstrate the feasibility of multi-hop energy transfer [126, 127], which open new perspectives for the design of wireless charging protocols and energy cooperative systems.

### 2.5.6 Discussion

It is clear that many efforts have been made to enhance the lifetime of WSNs through a variety of energy-efficient mechanisms. It also appears that energy efficiency and other applications requirements are strongly dependent, so that various performance metrics have to be optimized jointly. Indeed, energy-efficient routing protocols and sleep/wakeup schemes directly influence network latency. Similarly, radio optimization trades off signal quality for battery conservation, and data reduction approaches can affect the accuracy of the collected information. Additionally, if sensor recharging techniques are promising, energy-saving mechanisms remain essential. In Table 2.5, we summarise the different energy-saving mechanisms and the WSN requirements they directly influence. For example, we can see that energy-efficient routing solutions can improve the robustness by using multipath routing protocols that provide alternative paths in case of a node failure.

Furthermore, in Table 2.6, we link Tables 2.2 (which represents the applications requirements) and Table 2.5 (which represents the interdependence between energy-efficient mechanisms and other requirements) in order to show how some energy-efficient techniques can be used in specific applications to jointly optimize multiple criteria. Here is an example to explain how to read Table 2.6: in agricultural applications, sleep/wakeup schemes can influence the coverage by using topology control mechanisms. The justification of these statements can be found in Table 2.5, and more generally in the discussions in Section 2.5.

Given the interdependence between the different design goals, it is thus necessary to develop solutions that can achieve a satisfactory trade-off between multiple requirements. For this reason, in the next section we will review how research attempts to satisfy multiple objectives including network lifetime maximization.



Energy-efficient mechanisms		Impacted requirements	Justification
<b>Data reduction</b>	aggregation, compression adaptive sampling	delay, QoS, scalability	<ul style="list-style-type: none"> <li>Data reduction approaches can improve the latency by reducing the amount of packets to be transmitted, decreasing the waiting time in queues.</li> <li>These methods can improve the QoS by assigning higher priority to certain class of data when performing the aggregation function or when sampling the parameters.</li> <li>The techniques exhibit good scalability properties by reducing the traffic load.</li> </ul>
<b>Sleep/wakeup schemes</b>	adaptive duty-cycling	robustness	<ul style="list-style-type: none"> <li>Adaptive duty-cycling schemes can adapt the sleep period to the network conditions to improve context-awareness.</li> </ul>
	topology control	coverage	<ul style="list-style-type: none"> <li>Topology control can be used to enhance the network coverage by characterising how the sensing field is monitored.</li> </ul>
	TDMA based MAC protocol	delay	<ul style="list-style-type: none"> <li>TDMA based MAC protocols can achieve good delay under high traffic.</li> </ul>
	hybrid TDMA/CSMA MAC protocol	QoS	<ul style="list-style-type: none"> <li>TDMA/CSMA MAC protocols can enhance the QoS by providing guaranteed time slots for high rate periodic data and contention based periods for aperiodic low rate traffic.</li> </ul>
<b>Radio optimization</b>	transmission power control	coverage	<ul style="list-style-type: none"> <li>Transmission power control and directional antennas techniques affect the coverage by adjusting the communication range (and direction), and thus the node connectivity.</li> </ul>
	directional antenna	coverage, robustness	<ul style="list-style-type: none"> <li>Cognitive radio and cooperative communications impact the quality of the signal through smart channel selection and collaborative re-transmission.</li> </ul>
	cooperative communications energy-efficient cognitive radio	robustness	
<b>Energy-efficient routing</b>	cluster architecture	scalability	<ul style="list-style-type: none"> <li>Cluster architectures improve scalability by maintaining a hierarchy in the network.</li> </ul>
	multipath routing	robustness	<ul style="list-style-type: none"> <li>Multipath routing protocols enhance robustness by providing alternative routing paths in case of node failure.</li> </ul>
	relay node placement	coverage	<ul style="list-style-type: none"> <li>Relay node placement strategies can control the connectivity between nodes and the network coverage.</li> </ul>
	sink mobility	mobility, scalability	<ul style="list-style-type: none"> <li>Sink mobility can improve the scalability by connecting sparse networks.</li> </ul>

Table 2.5 Interdependence between energy-efficient mechanisms and applications requirements.

	<b>Healthcare</b>	<b>Agriculture and Environment</b>	<b>Industry</b>	<b>Public Safety Military systems</b>	<b>Transportation systems</b>
<b>Data reduction</b>	<b>QoS</b> with compression, adaptive sampling	<b>scalability</b> with aggregation	<b>QoS, scalability</b> with aggregation, compression, adaptive sampling		
<b>Sleep/wakeup schemes</b>	<b>delay</b> with TDMA	<b>coverage</b> with topology control	<b>QoS, delay</b> with hybrid TDMA/CSMA	<b>robustness</b> with adaptive duty-cycling	<b>delay</b> with TDMA
<b>Energy-efficient routing</b>	<b>QoS</b> with star topology 1-hop communications	<b>coverage</b> with relay node  <b>placement scalability</b> with sink mobility	<b>robustness</b>  with multipath routing <b>scalability</b>  with cluster architecture		<b>coverage</b> with relay node  <b>placement scalability</b> with cluster architecture
<b>Radio optimization</b>	<b>robustness</b> with cognitive radio	<b>coverage</b> with transmission  power control	<b>robustness</b> with cognitive radio, cooperative communications	<b>coverage, robustness</b> with directionnal antennas	
<b>Sources of energy harvesting</b>	body motion body heat	seismic vibration solar energy	mechanical vibration acoustic noise		solar energy acoustic noise

Table 2.6 Applications and energy-efficient mechanisms.

## 2.6 Energy efficiency and requirements trade-offs

In this section, we present the different techniques explored in the literature to achieve trade-offs between multiple objectives in wireless sensor networks, including energy saving. We have classified these solutions into three categories: *Multi-metric protocols*, *Cross-layer approaches* and *Multi-objective optimization*.

### 2.6.1 Multimetric protocols

As discussed in Section 2.3, several applications require the optimization of multiple parameters, like delay and security, while reducing energy consumption. Multi-metric protocols use various network measurements to satisfy multiple application needs. For example, recent application-specific routing protocols have proposed to combine energy efficiency with QoS requirements [128–130] or security concerns [131]. These research works consider the energy reserves of nodes along with video distortion, packet error rate or node reputation. However, this kind of multi-metric protocols raises new challenges. The protocols usually rely on a weight function of various metrics and the weight adjustments are often made following a trial-and-error methodology. Moreover, multimetric protocols require the definition of comprehensive metrics and their maintenance in each node which induces supplementary control message exchange. For instance, the quality of a link can only be estimated statically through RSSI (Received Signal Strength Indication), LQI (Link Quality Indicator) or Packet Rate Reception indicators and varies over time. Thus, these techniques suffer from extra overheads, but on the other hand they enable adaptability to network condition changes to be improved because node decisions are based on metrics whose evolution reflects the network status. Below we present some multi-metric protocols with energy-efficient considerations.

In ATSR (Ambient Trust Sensor Routing) [132] the routing decisions are made locally based on a weight function which takes into account the residual energy of neighbouring nodes, location and trust. The trust evaluation of a neighbour uses seven security metrics such as node reputation, authentication and message integrity in order to detect malicious nodes. The protocol requires additional control messages to evaluate the energy of the neighbouring nodes, and trust levels and weights have to be adjusted to trade off security and energy. The enhanced real-time routing protocol with load distribution (ERTLD) [133] is a real-time routing protocol for mobile wireless sensor networks which makes optimal forwarding decisions based on RSSI, remaining power, and packet delay over one hop. ERTLD can deliver packets within their end-to-end deadlines while improving the flexibility as it can avoid the problem of routing holes. Moreover, it has a higher delivery ratio and

consumes less energy than state-of-the-art solutions. Kandris et al. [128] have proposed a hierarchical routing protocol called PEMuR (Power Efficient Multimedia Routing) which is devoted to video routing over a stationary WMSN while satisfying both energy efficiency and QoS requirements. In this solution, the CH selects the path to the base station (BS) whose remaining energy after transmission will be the highest among all of the possible paths. If there is not enough available bandwidth, a CH can choose to drop less significant packets according to their impact on the overall video distortion. PEMuR is well-suited to surveillance applications, traffic control and battlefield monitoring. However, cluster formation is a centralised procedure thus it creates additional overheads: each node sends information about its remaining energy and location to the BS. InRout [130] addresses route selection for industrial wireless sensor networks to provide high reliability while considering the limited resources of sensor nodes. The solution uses Q-learning to select the best possible route online, based on current network conditions and application settings. A node will choose the route that maximizes its reward with regard to Packet Error Rate (PER) and energy.

### 2.6.2 Cross Layer approaches

Much research has been conducted to tackle energy consumption at all layers, especially at the network, MAC and physical layers. It is expected that an integrated cross-layer design can significantly improve energy efficiency as well as adaptability to dynamic environments. Indeed, cross-layer solutions exploit interactions between different layers to optimize network performances, as surveyed in [134] and [135]. Sensor requirements (QoS, routing, lifetime, security, etc.) are closely linked and require a comprehensive study of existing trade-offs. Cross-layer solutions enable the problem's interdependence to be tackled. As a concrete example, it is possible to monitor the battery level at the physical layer and use this information at the MAC layer to fairly assign communication slots to the nodes. Similarly, it is possible to consider the graph of interference when routing data to optimize the transmission delay. Topology changes are likely to occur in WSNs and may benefit from a cross-layer approach. For instance, after node addition or removal, the neighbourhood is modified which influences network density and interference at the physical layer. Thus, it may be necessary to reallocate the slots or to change the contention window accordingly at the MAC layer while creating different opportunities for path selection at the routing layer.

Regarding energy efficiency, practices that are generally adopted at each layer to save energy such as cluster formation, sleep/active scheduling and power control, are jointly exploited in cross-layer solutions. For example, Gao et al. [136] took advantage of cooperative communication, hierarchical architectures and data aggregation to enhance energy

balance among nodes. Chang et al. [137] combined node placement, topology control and MAC scheduling to better balance energy consumption. Transmission power control and sleep/wakeup scheduling are exploited jointly by Liu et al. [138].

Regarding the optimization of competing metrics, [139] address joint routing, MAC and physical layer protocols for power allocation in cooperative communication sensor networks under a specified packet-error-rate (PER). Cuomo et al. [140] propose an energy efficient algorithm for PAN coordinator election in IEEE 802.15.4-based sensor networks. They combine the network formation procedure defined at the MAC layer by the standard with a topology reconfiguration algorithm operating at the network layer. By minimizing the height of the cluster-tree, their algorithm can reduce the delay and extend the network lifetime. Almalkawi et al. [141] propose a cross-layer design between the routing and MAC layers. Their cluster-based routing protocol balances the load between nodes by constructing several paths based on signal strength and hop counts. In the TDMA-based MAC protocol, the cluster head adaptively assigns slots to active nodes based on the traffic type. Their solution reduces energy consumption and delay, and achieves high throughput and packet delivery ratios by selecting paths with better link quality and by avoiding collisions and interference.

### 2.6.3 Multi-objective optimization

Multi-objective optimization aims at optimizing multiple objective functions simultaneously. Nevertheless, for non-trivial multi-objective optimization problems (MOPs), no single solution exists that simultaneously optimizes each objective function. In this case, the objective functions are said to be conflicting, and there are a (possibly infinite) number of Pareto-optimal solutions. In MOPs it is preferable to obtain a diverse set of candidate solutions that correspond to different trade-off points between the extreme solutions. To achieve multi-objective optimization in wireless sensor networks, several solutions exploit evolutionary algorithm (EA) principles or game theoretic approaches.

The *Evolutionary algorithm* approach uses mechanisms inspired by biological evolution, such as survival of the fittest, reproduction, mutation, selection, competition and symbiosis. Candidate solutions represent individuals in a population. Each individual possesses a set of distinct characteristics and the fitness function determines the fitness of each individual. Generation after generation, the best-fit individuals are selected for reproduction to give new ones (called offspring). Offspring can be mutated and are then evaluated. The fittest individuals are selected to go into the next generation, and the rest are eliminated. Xue et al. [142] propose a multi-objective differential evolution (MODE) algorithm that produces multiple candidate routes that represent different possible trade-offs between energy consumption and communication latency. In [143], Konstandinidis et al. develop a multi-

objective decomposition-based algorithm called DPAP that gives the location and transmit power of each node so that the coverage and the lifetime are simultaneously optimized. In [144], the author applies an evolutionary Multi-Objective Crowding Algorithm (EMOCA) to solve the sensor placement problem in a WSN target detection application. The aim is to maximize the probability of target detection, while minimizing the total energy dissipated in the network and minimizing the total number of sensors deployed.

*Game theoretic* approaches have been successfully applied for a variety of applications in WSNs, as surveyed in [145] and [146]. Game theory provides the designer with a useful tool to model the competitive and distributed nature of sensor networks. The solutions exploit rational interactions between nodes or entities, where incentives (such as token or reputation) are used to motivate the players to cooperate instead of acting selfishly (e.g. not relaying data to conserve energy). Felegyhazi et al. [147] foster packet forwarding cooperation between sensors that belong to different authorities. The authority gains a payoff that corresponds to the difference between the benefit of data successfully received by the sink and the energy costs experimented by its sensors for relaying both its own and opponents' packets. Their results show that cooperation through mutual service provisioning is beneficial, particularly for sparse networks or hostile environments where the sinks are shared between authorities. In [148], Zeydan et al. introduce the CAR (Correlation-aware routing) solution to construct data gathering routes aimed at minimizing the energy per symbol by exploiting aggregation in correlated data. Every route is associated with a cost that reflects its energy consumption, interference, and aggregation rate. At each iteration, every node investigates the utility associated with all possible paths and then selects the best response that maximizes the utility.

There are many studies that deal with multi-objective optimization, but their practical implementation could consume a lot of resources, which may not be suitable for sensor networks. Indeed, solutions that require heavy computational or storage capabilities are suitable for centralised computations carried out by a base station. On the other hand, solutions that require less computations and storage are convenient for distributed computations carried out at each node [149]. Thus, when considering MOO solutions, it should be investigated whether or not they are applicable to real WSNs since these approaches may be hard to compute on sensor nodes. Typically, the major weakness of the evolutionary approach is that the optimization process is performed in a central server and requires global knowledge of the network at each node or at the base station. It can lead to scalability issues as the network size increases.

### **2.6.4 Discussion**

In this section, we provide a classification of solutions proposed in the literature to satisfy multiple objectives. We can distinguish the aforementioned techniques based on the flexibility of the obtained trade-off over time. By flexibility we mean that the trade-off may change over the time depending on the network conditions. For instance, multi-metric protocols usually specify a desired trade-off between the requirements at the conception phase when setting the parameters. Preference is given to a requirement by the designer. For this reason, even if the requirements are highly dependent, the trade-off is decided once and for all. In contrast, MOO solutions explore a variety of candidate solutions at run-time that represent different trade-off points of the design space. Generation after generation, behaviour policy evolves and is adjusted to the network dynamics. In-between, cross-layer approaches are expected to improve network performances by exploiting the interactions between layers. The downside is the complexity of the method that necessitates a good understanding of the interplay of various variables.

## **2.7 Conclusion**

In the last decade, we have witnessed a proliferation of potential application domains of wireless sensor networks. These applications include, but are not limited to, life-critical healthcare supervision, large-scale precision agriculture, security-oriented industrial process monitoring and nation-wide smart grid systems. In this chapter, we surveyed the recent advances in the development of energy-efficient solutions for WSNs while taking into consideration the application requirements. We first categorized the different WSN applications and we identified their specific requirements. Then we introduced a new taxonomy of energy conservation schemes and we provided the reader with a comprehensive analysis of how these techniques can affect performance of applications. We finally reviewed some existing methods that allow trade-offs between multiple requirements to be achieved for efficient and sustainable sensor networks.

# Chapter 3

## WSN lifetime optimization through controlled sink mobility and packet buffering

It has been demonstrated that the use of a mobile sink can significantly increase the network lifetime by balancing the communication load among nodes. However, in existing solutions that use a mobile sink to reduce energy consumption of WSN, nodes either forward their data through multihop towards the sink which induces energy consumption due to relaying process, or the nodes store the data until the sink comes at their vicinity, which usually requires an infinite buffer capacity or induces buffer overflow if the buffer is of fixed size. In this chapter, we propose a new approach in which nodes send their data through multihop path of reduced length by offering nodes the possibility to buffer data while waiting the sink coming closer (not necessarily *at* node range), which exempts more sensors from relaying these data. Based on this strategy, we first propose a model that optimizes the base station displacement, the routing and the memory use, which allows to save energy while ensuring no data is lost due to buffer overflow. We then introduce a distributed algorithm for data collection that achieves a good trade-off between energy consumption and latency.

### 3.1 Introduction

In wireless sensor networks using a unique static base station, sensor nodes located close to the base station deplete their battery faster than other sensor nodes, leading to an early disconnection of the network. This is due to the fact that all traffic is forwarded towards the base station (or sink) which induces a workload of few nodes closer to the sink. To increase the network lifetime, one of the efficient solutions is to balance the load among nodes using



a mobile base station which moves in the network to collect nodes information. This kind of operation can be envisioned in many effective applications, such as collecting data from WSN deployed in an agricultural field using a mobile sink embedded in an aerial drone or a motorized agricultural engine [47].

The sink mobility can be *controlled* or *uncontrolled* [150]. For the uncontrolled solution, the mobile sink moves randomly in the monitored region, while the controlled mobile sink can only move along a predefined trajectory. Finding the optimal trajectory that maximizes the network lifetime is very challenging. Indeed, the maximum lifetime can only be achieved by solving optimally two joint problems: a *scheduling* problem that determines the sojourn times of the sink at different locations, and a *routing* problem which defines the path that will be used by the collected data to reach the mobile sink in an energy-efficient way [151, 152]. In other words, routing and mobility are strongly interrelated because the routing strategy greatly influences energy consumption and as the sink moves, paths will change. However, in existing joint scheduling and routing problem solutions, the considered routing paradigm is a *pure multihop forwarding*, as nodes continuously send data towards the mobile sink [114, 151, 153–157]. It results in higher energy expenditure compared to a *pure direct communication* approach where the mobile sink visits each sensor and collects data through single-hop [158–160]. Indeed, direct communications enable a minimum energy consumption at each node, but only at the expense of an increased data delivery delay and data storage. One solution to trade-off energy and latency is to consider hybrid routing schemes which combine single-hop and multi-hop communication strategies [161, 162]. Nevertheless, in hybrid solutions data are buffered at selected nodes while waiting the sink passage. But in real scenario, those nodes may experiment data loss due to buffer overflow while waiting the sink coming into their vicinity. In order to avoid this situation, we propose to offer nodes the possibility to delay their transmissions, but not necessarily to wait until the sink is at a one-hop proximity. The idea is to allow nodes to buffer data while waiting the sink to come closer to the node (not necessarily at the node), which would relieve more nodes from relaying these data. We also ensure that there is no data loss due to buffer overflow.

In this chapter, our contributions are manifolds :

- We develop a new linear programming model for the joint scheduling and routing problem with limited buffer capacity. For arbitrary topologies, the LP resolution determines the sink sojourn times at visited location, the data transfer rates between nodes and the buffered packets quantities.
- Our solution achieves better lifetime compared to previous works and assesses the efficiency of the delayed communication paradigm.

- We propose a practical distributed algorithm using delayed communications for data collection in WSN and compare its performance against single-hop and multihop forwarding approaches. The results show that our protocol achieves the desired trade-off between data delivery delay and energy performance.

The chapter is organized as follows. In the next section we review existing solutions regarding joint sink mobility and routing problem for lifetime prolongation via controlled mobile sink. Then, in Section 3.3, we briefly introduce linear programming methods. Afterwards, in section 3.4 we present the network model and our optimization problem formulation. In Section 3.5 we report numerical results and show how far our approach outperforms existing schemes in terms of lifetime. In section 3.6 we introduce a new distributed algorithm for data collection in WSN with limited buffer capacity. Further, in section 3.7 we compare through simulation the performance of our delayed approach with direct communications and multihop forwarding schemes. Finally, Section 3.8 concludes the chapter.

## 3.2 Related works

In this section we review existing works related to the use of a controlled mobile sink for lifetime prolongation in WSN. We classify the solutions as follows.

### 3.2.1 Pure multihop forwarding

In multihop forwarding schemes, nodes continuously send their data towards the sink, which minimizes the latency but can rapidly deplete the devices battery. Papadimitriou and Georgiadis [151] formulate a linear programming model that determines the sink sojourn times and the transfer rates between neighboring nodes that maximize the network lifetime. Basagni et al. [153] and Liang et al. [114] introduce new constraints like the maximum distance between two consecutive movements, the minimum sojourn time at each location and the energy cost for building new routes when the sink moves. However, in both solutions the routing protocol is predefined and does not appear as a variable in the optimization formulation. Further, Luo et al. [154] propose a distributed protocol to control sink mobility. In an initialization phase, the sink visits all possible locations to collect the power consumption records from all nodes and runs a LP. In the operation phase, the sink goes through each location given by the LP and still continues to collect information in order to obtain a better estimation and regularly resolve the LP. Luo et al. [155] prove the NP-hardness of the joint sink mobility and routing problem for lifetime maximization with multiple mobile sinks. They also present an algorithm to solve the problem involving a single sink and then

generalized it to approximate the problem with multiple sinks. Basagni et al. [156] define a LP model that gives an upper bound on the maximum lifetime that can be achieved through controlled mobility of multiple sinks in a WSN, for a given routing protocol. Then they propose a distributed heuristic where every sink periodically decides whether to move or not based on estimates of the nodes residual energy, other sinks location and current traffic.

### 3.2.2 Single-hop data collection

In single-hop data collection scenario, the routing strategy is limited to direct communication with the mobile base station, which maximizes the network lifetime at the expense of an increased latency. Gu et al. [158] are interested in networks of sensors operating at different sampling rates and propose a solution to schedule the sink movement so that each node is visited - possibly several times – before it experiences data loss due to buffer overflow. Rao et al. [159] develop distributed algorithms to compute the sink trajectory for single-hop data collection in order to reduce the average collection delay. Turgut et al. [160] consider a static sensor network with multiple mobile sinks, where every node has to take the decision whether to transmit or not its collected data when a sink is in its vicinity, based on its buffer occupancy, its euclidean distance to the sink or an history of previous occasions.

### 3.2.3 Hybrid routing schemes

Some hybrid routing schemes that combine direct and multihop communication strategies with a mobile sink have been proposed. Somasundara et al. [161] propose that sensors that are never within the sink radio range send their data through multihop towards their closest cluster head, where a cluster head is a node that can reach the sink directly. To reduce latency, data are stored in the cluster heads which suppose that these nodes have a higher buffer capacity than the other nodes. Rao and Biswas solution [162] computes the minimum-distance trajectory so that while the sink moves along this path, it comes within up to  $k$  hop reach of all nodes. They define some Designated Gateways (DG) that can reach the sink in 1-hop when it passes close to them. A DG buffers data from other nodes that are at most  $k-1$  hop away from it, and uploads these collected data to the mobile sink. Even if the solution offers a trade-off between energy and latency, it results in a uneven distribution of the energy consumption among nodes. Indeed, the energy consumption of a node depends on the number of hops that separates it from its assigned DG. Moreover, DGs are supposed to have an infinite buffer capacity. In these hybrid routing schemes, data are buffered at some selected nodes while waiting the sink passage, but in real scenario, those nodes may

experiment data loss due to buffer overflow while waiting the sink coming into their vicinity.

To overcome this limitation, we address the joint scheduling and routing problem by considering a delayed communication scheme. Nodes can forward their data through multihop towards the mobile sink, and they can also buffer a certain amount of data while it does not exceed their buffer capacity. So, our solution improves the network lifetime while it avoids data loss due to buffer overflow.

### 3.3 Introduction to linear programming

In this section, we provide a brief introduction to linear programming and mixed-integer linear programming methods because we use them in this thesis. Readers who are already familiar with constrained optimization may skip this section.

#### Linear programming

A *linear programming* (LP) problem is the problem of maximizing or minimizing a linear function subject to linear constraints. The constraints may be equalities or inequalities, and the objective is to find the "best" value obtainable under those conditions:

$$\left\{ \begin{array}{ll} \max f(x_1, \dots, x_n) & \text{(objective function)} \\ g_1(x_1, x_2, \dots, x_n) & \leq b_1 \text{ (constraints)} \\ \vdots & \vdots \\ g_p(x_1, x_2, \dots, x_n) & \leq b_p \\ h_1(x_1, x_2, \dots, x_n) & = c_1 \\ \vdots & \vdots \\ h_q(x_1, x_2, \dots, x_n) & = c_q \end{array} \right.$$

where  $x \in \mathbb{R}^n$  defines the decision variables,  $b_{i \in [1..p]} \in \mathbb{R}$  and  $c_{i \in [1..q]} \in \mathbb{R}$  are given parameters,  $f$ ,  $g_{i \in [1..p]}$  and  $h_{i \in [1..q]}$  are linear functions, and  $f$  is the benefit function to be maximized.

A *solution* to a linear program is a setting of the variables. If a solution satisfies all the constraints, then the solution is *feasible*. A linear program is feasible if there exists a feasible solution, otherwise it is said to be *infeasible*. Thus, a LP may not have solutions, which can be the case when the constraints cannot be satisfied jointly (e.g.  $x \geq 2$  and  $x \leq 1$ ). An *optimal solution* is a feasible solution with the largest objective function value (for a maximization problem). The value of the objective function for the optimal solution is said to be the *value*

of the linear program. A linear program may have multiple optimal solutions, but only one optimal solution value.

If decision variables are all defined on a continuous domain such as  $\mathbb{R}$  or any interval  $[a, b]$  of  $\mathbb{R}$ , the linear-programming model is said *continuous*. In this case, the optimization problem may be solved in polynomial time with Khachiyan's *ellipsoid algorithm* [163] or Karmarkar's *projective algorithm* [164]. This being said, most of the solver implements Dantzig's *simplex algorithm* [165] whose complexity in the worst case is exponential. The latter is indeed cubic in average and seems to offer nowadays the best computational results.

## Integer programming

Fractional solutions are not always realistic, and in a variety of optimization problems variables are required to be integer. This problem is called an integer programming problem (ILP). It is said to be a mixed integer program (MILP) when some, but not all, decision variables are restricted to be integer. Integer programs are NP-hard, and are a lot harder to solve than linear programs. Their resolution can be based on branching algorithms such as Branch and Bound techniques.

Lots of problems are now known to be equivalent to the solving of a linear program, like for example the allocation of production facilities, the selection of shipping patterns, and agricultural planning. In networking, routing, tasks and resources allocation, network design, channel assignments are examples of problems that can be modeled using linear programs. The literature regarding constrained optimization is rich and extensive (algorithms and results about existence or uniqueness are indeed numerous). All of this is nowadays materialized into a plenty of powerful callable libraries and black box softwares (IBM ILOG CPLEX, GLPK, LPSolve, Matlab, R, etc...) that it is legitimate to use. In this way, the users only have to formulate their problem as a linear program, while solvers take in charge the resolution.

## 3.4 Our solution: system model

In this section, we propose a model for the lifetime prolongation of a WSN with a controlled mobile base station. We define a linear programming model that determines for a given topology: the sink sojourn times at different locations, the data flows between neighboring nodes, and packets buffering. Thus, we obtain both the optimal sink mobility displacement and the optimal data routing scheme that maximize the lifetime of a specified network.

For the formulation, we use the same notation as in [151] and we introduce new ones when needed. We consider that the wireless sensor network is composed of a set  $N$  of static sensor nodes and one mobile sink  $s$  collecting the information. The sensors are randomly deployed to monitor their physical surroundings and generate a constant data rate  $Q_i > 0, i \in N$ . We denote by  $L$  the set of possible locations of the sink, not necessarily collocated with the sensors. We also assume that  $K = (l_1, l_2, l_3, \dots, l_{|L|-1}, l_{|L|})$  is an ordered list of sink visiting locations, i.e. the sink will first visit  $l_1$  and then  $l_2$  and so on. The sink sojourns at the location  $l_k$  for a time duration  $t_{l_k} \geq 0$  and changes its position from one location to another with a negligible traveling time as considered in [151, 155].

The set  $S_i^{l_k} \subseteq N \cup \{s\}$  represents the nodes (either sensors or the sink) that are in the transmission range of sensor  $i \in N$  for a given location  $l_k \in K$  of the sink. Note that the only possible difference between two sets  $S_i^{l_{k_1}}, S_i^{l_{k_2}}$  is the sink  $s$ . Every sensor sends its data either through multihop towards the sink or via direct communication if the sink is in the node vicinity. We consider that  $q_{ij}^{l_k} \geq 0$  represents the data rate transmission from node  $i$  to its neighboring node  $j \in S_i^{l_k}$  when the sink is at the location  $l_k \in K$ . Additionally, each sensor has the possibility to buffer a certain amount of data while this quantity does not exceed its buffer capacity  $W_i \geq 0$ .  $w_i^{l_k} \geq 0$  corresponds to the amount of data contained in the buffer of the sensor  $i \in N$  at the end of the sink sojourn time at location  $l_k \in K$ . Additionally, we denote by  $R_{ij}(i \in N, j \in S_i^{l_k})$ , the capacity of the link  $(i, j)$ . It is a constant quantity that upper bounds the transmission rates  $q_{ij}^{l_k}$ .

We consider that each sensor has an initial energy  $E_i$  and we suppose that the main factors of energy consumption are data reception and transmission. We denote by  $e_{ij}^T$  the energy consumption of sensor  $i$  to transmit a data unit to its neighboring node  $j$  and by  $e_{ji}^R$ , the energy consumption of sensor  $i$  when receiving a data unit from its neighboring node  $j$ .

We suppose that the sink has an unlimited energy and keeps moving until the end of the network lifetime, which is defined as the time until the first node dies due to energy depletion. The objective of our optimization problem is to find the optimal routing strategy and the optimal sojourn times at each sink location so that the network lifetime is maximized for a given order of visited locations. In the following, we give the formulation of the problem of maximizing the network lifetime and then derive a linear programming model.

$$\max \sum_{l_k \in K} t_{l_k} \text{ subject to} \quad (3.1)$$

$$\sum_{l_k \in K} \sum_{j \in S_i^{l_k}} e_{ij}^T q_{ij}^{l_k} t_{l_k} + \sum_{l_k \in K} \sum_{j: i \in S_j^{l_k}} e_{ji}^R q_{ji}^{l_k} t_{l_k} \leq E_i, \quad i \in N \quad (3.2)$$

$$w_i^{l_k} = \sum_{j:i \in S_j^{l_k}} t_{l_k} q_{ji}^{l_k} + t_{l_k} Q_i - \sum_{j \in S_i^{l_k}} t_{l_k} q_{ij}^{l_k} + w_i^{l_{k-1}}, \quad i \in N, k \in \{0, 1, \dots, |L|\} \quad (3.3)$$

$$\sum_{i \in N} Q_i t_{l_k} + \sum_{i \in N} w_i^{l_{k-1}} - \sum_{i \in N} w_i^{l_k} = \sum_{j:s \in S_j^{l_k}} t_{l_k} q_{js}^{l_k}, \quad l_k \in K \quad (3.4)$$

$$w_i^{l_0} = 0, \quad i \in N \quad (3.5)$$

$$t_{l_k} \geq 0, \quad l_k \in K \quad (3.6)$$

$$q_{ij}^{l_k} \geq 0, \quad i \in N, j \in S_i^{l_k}, l_k \in K \quad (3.7)$$

$$w_i^{l_k} \geq 0, \quad i \in N, l_k \in K \quad (3.8)$$

$$q_{ij}^{l_k} \leq R_{ij}, \quad i \in N, j \in S_i^{l_k}, l_k \in K \quad (3.9)$$

$$w_i^{l_k} \leq W_i, \quad i \in N, l_k \in K \quad (3.10)$$

The objective function (4.4) maximizes the network lifetime, i.e. the sum of the sojourn times of the mobile sink at all locations. Constraint (3.2) states that the energy consumed in sensor  $i$  for transmission and reception must not exceed its initial energy  $E_i$ . Constraints (3.3) and (3.4) correspond to flow constraints with buffer capacity. The left part of the inequality in constraint (3.3) represents the amount of data buffered by node  $i$  when the sink sojourns at the location  $l_k$  for a duration  $t_{l_k}$ . It is equal to the difference between the amount of data the node has to transmit (i.e. the data received from its neighboring nodes, its own generated data and the data previously buffered) and the amount of data it effectively transmits. Constraint (3.4) assures that at any time  $t_{l_k}$ , the sink is the final destination of all the data transmitted by nodes, which consist in the data generated by all nodes and their previously buffered data minus the data buffered at  $t_{l_k}$ . Note that we have introduced an artificial state  $l_0$  and we impose in constraint (3.5)  $w_i^{l_0} = 0$  to represent the fact that at the beginning of the network operation buffers are empty. Similarly, we can set  $w_i^{l_L} = 0$  to impose that buffers are empty at the end of the network lifetime. Constraints (3.6), (3.7) and (3.8) assure the non-negativity of sojourn times  $t_{l_k}$ , the rates  $q_{ij}^{l_k}$  and the quantities  $w_i^{l_k}$ . Constraint (3.9) ensures that at any time the flow information rates going through a link  $(i, j)$  do not exceed the capacity of the link.

Constraint (3.10) states that at any time, the amount of data buffered at node  $i$  should not exceed its buffer capacity  $W_i$ . By defining  $\hat{q}_{ij}^{l_k} = t_{l_k} q_{ji}^{l_k}$  as the amount of data transmitted from sensor  $i$  to its neighboring node  $j$  during time  $t_{l_k}$ , the optimization problem can be expressed as a LP model.

## 3.5 Numerical results

### 3.5.1 Scenario and parameters settings

To assess the efficiency of our approach, we compare our solution (denoted OPT) with the approach of Papadimitriou and Georgiadis [151] (denoted REF). REF provides the optimal solution of the joint routing and scheduling problem without packet buffering. We compare the performances of these two models for various network sizes with respect to lifetime, which is defined as the time until the first sensor dies. We solved the LP models with CPLEX. We consider arbitrary topologies where nodes are randomly and uniformly distributed within a square area of size  $L = 350$  m. The network sizes vary from 300 to 700 nodes, and for each size we generate 12 different connected topologies. The transmission range varies from 35 m to 22 m depending on the number of nodes deployed in the area so that the average degree of nodes is roughly comprise between 8 and 10 for every topology. The possible locations of the sink  $s$  are restricted to a  $6 \times 6$  grid as in [153]. Figure 3.1 illustrates the random deployment of a 400-nodes network (blue circle) with the sink possible locations (red square). In every scenario, parameters  $W_i$  and  $R_{ij}$  are set identical for all nodes and all links, and we use realistic values for the WSN parameters. The channel data rate is  $R_{ij} = 20$  Kpbs, which is consistent with IEEE 802.15.4 [54]. The data generation rate is set to  $\lambda = 34$  bps, which corresponds to one 128-Byte packet every 30 seconds. The default buffer capacity is 16 KB which is conform to sensor scarce resources. The initial energy is set to  $E = 50$  Joules and the energy cost of one transmission/reception is  $e = 0.62e^{-6}$  Joules/bit.

### 3.5.2 Results

We first investigate the improvement of our solution OPT over the one of Papadimitriou and Georgiadis in terms of network lifetime and nodes residual energy. We then study the impact of the buffer capacity on the network lifetime. Finally we highlight how buffers are used by nodes in OPT.

Table 3.1 compares the maximum average lifetime achieved for four different network sizes (300, 400, 500, 700) of arbitrary topologies. For each network size, it represents the average of the results obtained from 12 randomly generated instances. We can observe that

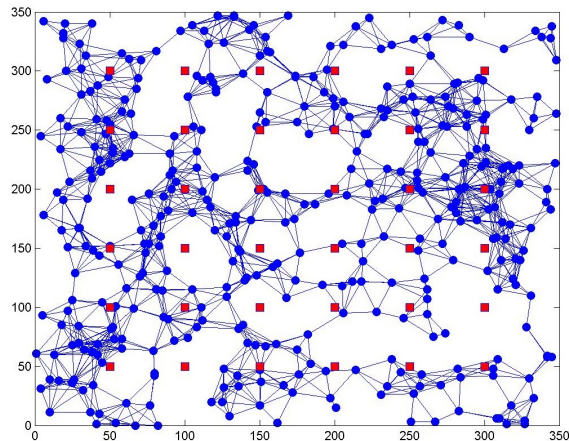

 Fig. 3.1 A 400-nodes network with a  $6 \times 6$  grid for the sink possible locations.

$ N $	REF [151]	OPT	Improvement
300	91 553	114 177	24.71%
400	71 335	88 294	23.70%
500	43 093	62 204	44.34%
700	28 080	41 035	46.13%

Table 3.1 Average lifetime of the two models in arbitrary topology.

$ N $	$E_i^r = 0$		$E_i^r \leq 0.25E_i$		$E_i^r \leq 0.50E_i$	
	REF	OPT	REF	OPT	REF	OPT
300	80.00%	87.19%	84.58%	90.64%	90.05%	93.67%
400	77.27%	85.38%	83.25%	88.88%	89.29%	92.31%
500	73.41%	84.08%	79.60%	88.56%	86.55%	92.53%
700	72.40%	81.08%	78.27%	85.86%	85.65%	90.74%

Table 3.2 Comparison of the residual energy of the sensors.

as the network size increases, the improvement in lifetime of OPT over REF also increases. Indeed, for a 400-nodes network the improvement is in the order of 23.70% while it goes to 46.13% for a 700-nodes network with a buffer capacity  $W_i$  set to 16 KB in both cases. As expected, our delayed communication paradigm enables to achieve better lifetime than solutions where data are continuously forwarded towards the base station.

In Table 3.2 we compare the balancing of energy depletion among sensor nodes. We recall that  $E_i$  denotes the initial energy of sensor  $i \in N$ . Let  $E_i^r$  be the residual energy of  $i$  at the end of the network lifetime. For every instance, we compute the percentages of

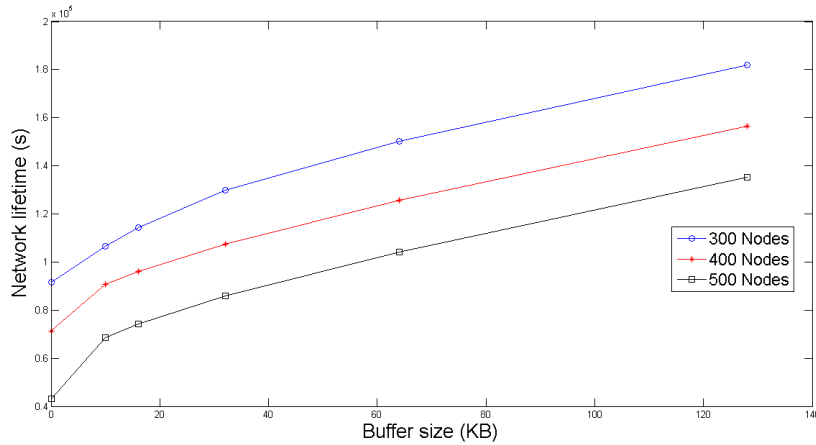

Fig. 3.2 Average lifetime depending on the buffer size. When the buffer size is equal to zero, it corresponds to the REF model.

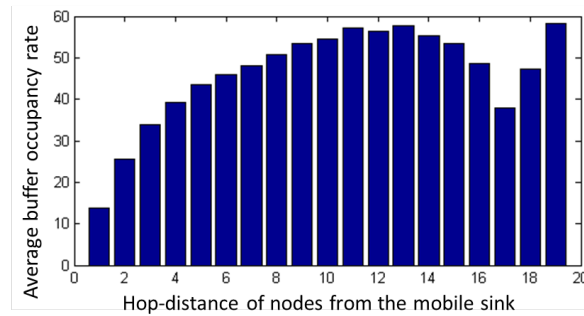

Fig. 3.3 Average buffer occupancy rates depending on the hop-distance of the nodes from the base station in 300-nodes networks

sensors whose residual energy is equal to zero ( $E_i^r = 0$ ), below 25% of the node's initial energy ( $E_i^r \leq 0.25E_i$ ) and below 50% of its initial energy ( $E_i^r \leq 0.50E_i$ ). We then average the corresponding percentages over the 12 instances of each network size. We observe that in our solution nodes exhibit lower residual energy than in REF. For example, at the end of 300-nodes networks lifetime, 80% of the sensors have depleted their battery in REF while in OPT they are 87%. This means that our solution better balance the load among nodes. Moreover, as in OPT the network lasts longer than in REF, much more data are generated and routed towards the sink (constant and periodic data generation rate assumption). So, it is clear that the energy spent in sending more data in OPT is compensated by the energy saved for not relaying some of others packets.

In Figure 3.2 we study the impact of the buffer capacity  $W_i$  on the network operation time for our model OPT. As expected, the introduction of a buffer capacity enables to increase the network lifetime and greater is the buffer capacity, higher is the improvement. Indeed, for a

300-nodes topology when the buffer capacity is small, e.g. equal to 10 KB the improvement in lifetime over REF is equal to 17%. But with a buffer equal to 128 KB, the improvement goes to 64% over REF. This is because sensors can wait longer before their buffer are full, which gives them more opportunities to wait until the sink comes closer to them, thus decreasing the number of hops along which data are transmitted.

The average buffer utilization depending on the hop-distance of the nodes from the mobile base station location is plotted in Figure 3.3. It appears that the more distant is the base station, the more the node will buffer data. Indeed, buffers are used to store data while waiting the base station to come closer to the node. Then nodes take advantage of the base station proximity to empty their buffer. This strategy relieves more sensors from relaying others data and results in an overall energy saving.

Although our results assess the energy-efficiency of our solution, the outputs of our LP are not easy to exploit. Indeed, it is a centralized process that will require to program each node individually. Particularly, the routing information  $q_{ij}^k$  - in the form of a data rate per node, per neighbor for each time slot - is not easy to implement, and offers no flexibility. Still, it is an interesting tool that provides a reference about the lifetime that can be achieved for data collection with a controlled mobile sink and limited buffer capacity. For all these reasons, we propose a practical algorithm in the following section.

### 3.6 Distributed algorithm

In this section, we propose a distributed algorithm for data collection in WSN with a mobile base station. This algorithm is based on the information derived from the numerical results. The idea is that sensors have to decide whether to send their data or not based on their distance to the base station and their buffer occupancy. Indeed, in the previous section, we have observed that nodes tend to buffer their data when the sink is far and inversely, they tend to send their data when the sink is close to them. As we will see through simulation, our algorithm enables us to control the trade-off between energy expenditure and latency by tuning parameters.

Our solution runs on top of a shortest path routing protocol which is updated each time the sink moves. In our approach, the decision rule is triggered when a node receives a new data to send from its *own* application layer. When a node receives a packet from another node, it directly forwards the packet. Indeed, if the decision were made at each node for a given data, the induced latency may dramatically increase as the data will be held in the buffer of every intermediary node. Moreover, it is possible that the data never reach the base station if

it is forwarded back-and-forth between the nodes because the base station will move several times while the data will be successively buffered at sensors.

The DIS K-Hops decision rule is given in Algorithm 1. A node sends its data if its distance  $d_i$  (in hops) to the sink is less than a value  $k$ , or if its distance is greater than  $k$  but the buffer occupancy  $BO_i$  is above a given threshold  $Thres_i$ . In this way, we favor the transmission of data over few hops, while the parameter  $Thres_i$  allows us to reduce the risk of buffer overflow as nodes can send their data when it is almost full. When the condition is satisfied, a node does not completely empty its buffer but rather a part of its data to prevent congestion. Similarly, while the parameter  $k$  is identical for all sensors, we set different buffer occupancy threshold at nodes. The rationale behind that is to prevent situations where the condition becomes true at the same time for every node, which may happen since we have considered periodic data generation rate. Such a situation would congest the network because all nodes will try to empty their buffer simultaneously. In the simulation, we have chosen to express  $Thres_i$  as a linear function of the node distance, i.e.  $Thres_i = ad_i + b$ . In this way, the more distant is the node from the sink, the longer it will wait to transmit, hoping that in the meantime the sink will get closer. Note that when  $k$  is set to the maximum number of hop that can separate a node from the base station, our algorithm is equivalent to a pure forwarding protocol as for any node the condition is always satisfied.

---

**Algorithm 1** DIS K-Hops
 

---

```

function NODE_TRANSMISSION_DECISION( $BO_i, d_i$ )
  if ( $BO_i \geq Thres_i \parallel d_i \leq k$ ) then
    Send 25% of the buffer
  end if
end function

```

---

## 3.7 Simulation results

### 3.7.1 Scenario and parameter settings

To evaluate the performance of our distributed approach, we implement it in the OM-NeT++ simulator. We use the IEEE 802.15.4 non-beacon enabled CSMA protocol with exponential backoff [166] and a shortest path routing protocol (in hops). Every time the sink changes its location, it broadcasts a route message to advertise its new position. Then, thanks to successive broadcasts, every node is aware of its distance to the base station. Our scheme is implemented at the routing layer. We compare our solution with:

- A pure multihop forwarding scheme (FWD) where nodes continuously forward their data towards the base station following the shortest path routing protocol.
- A single-hop data communication scheme (SIN) where nodes send their data if and only if they are within the vicinity of the mobile base station.

We consider the same 300-nodes network used for the numerical experiments with one mobile base station whose possible locations are restricted to a  $6 \times 6$  grid. Every  $t_{min}$  seconds, the sink chooses randomly its next location among its one-hop grid location. We run every scenario for 4000s and the simulation parameters are summarized in table 3.3.

Parameter	Value
data generation rate	1 data every 30s
data/route/MAC-ack packet size	128/4/4 Byte
buffer capacity	16 KB
link capacity	250 Kbps
$t_{min}$	10-100 s
DIS K-Hops ( $a, b$ )	(3,40)

Table 3.3 Simulation parameters.

### 3.7.2 Results

We study the performances of our algorithm in terms of energy, latency and delivery ratio. Figure 3.4 shows the energy spent by all nodes for sending and receiving data and the control messages, which include the broadcasts needed for the shortest tree construction and the RTS/CTS exchanges. As expected, the FWD solution is the one that consumes the most of energy, as nodes continuously send their data towards the base station, independently of their distance or buffer state. Inversely, the SIN solution consumes the less energy as nodes only spend energy for their own data transmission when the sink is within their communication range. Regarding our distributed algorithm DIS K-Hops, the higher the parameter  $k$ , the more energy is consumed. This is because more nodes are allowed to transmit their data without considering their buffer occupancy, so packets are routed over more hops. As we will see, this additional energy expenditure is compensated by a lower latency. Finally, we can observe that our solution stays between FWD and SIN, the two extreme solutions trading off energy for latency. Regarding the impact of the mobility on the energy consumption, we can see that when the sink changes its location faster (i.e. every 10s), it results in a slightly

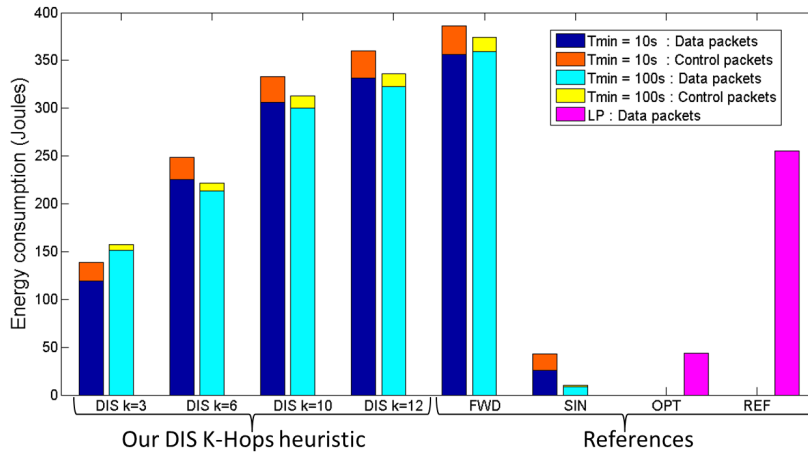

Fig. 3.4 Energy consumption in a 300-nodes network for different solutions.

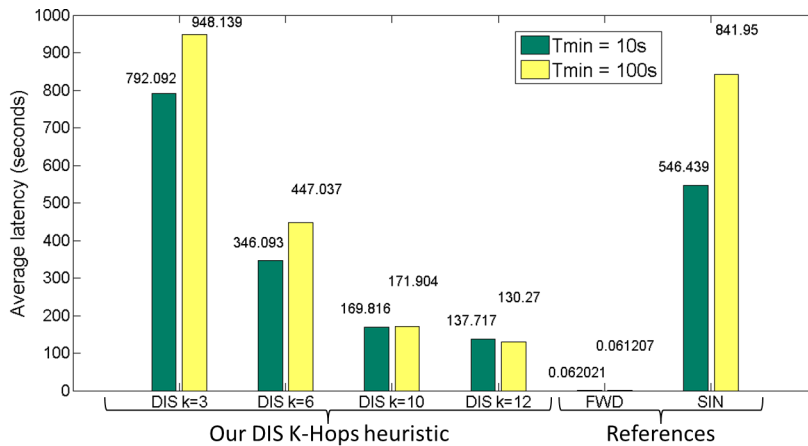

Fig. 3.5 Average latency in a 300-nodes network for different solutions.

higher energy consumption. This is mostly due to the fact that the routing overhead is more important when  $t_{min} = 10s$  as the tree is reconstructed after each sink's move.

In Figure 3.5, we represent the average latency of the data, from their generation by the sensor application to their reception at the base station. As we can see, the FWD solution exhibits the lowest latency, as nodes do not buffer data. Contrarily, the highest latency is due to the SIN approach because only direct communication occurs between the sink and sensors, so they have to wait until the sink comes in their vicinity. In between, with our algorithm, the latency increases as the parameter  $k$  decreases. This is because nodes have to wait longer that the sink comes within their  $k$ -hop reach. Furthermore, for a given approach, when the sink changes its location more frequently (i.e. every 10s), the latency decreases as it visits more

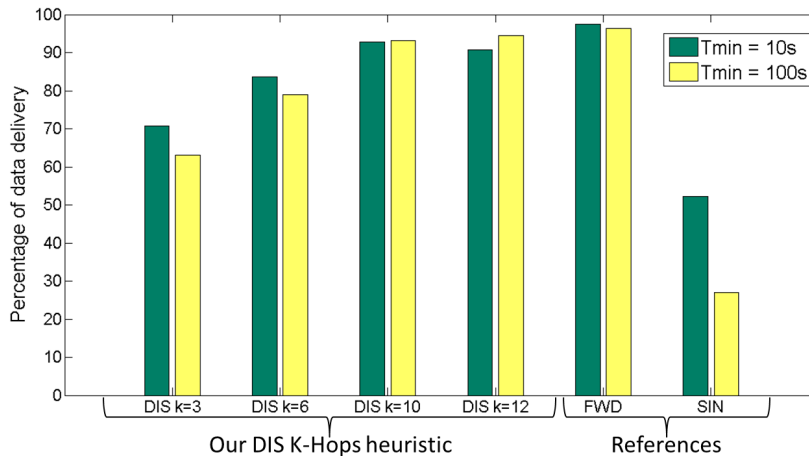

Fig. 3.6 Delivery ratio in a 300-nodes network for different solutions.

nodes and the conditions on the maximum distance is satisfied more regularly by different nodes.

In Figure 3.6 we plot the packet delivery ratio for every considered solution. Our first observation is that when the sink changes its location more frequently, more packets are successfully delivered. This is because the base station comes within the vicinity of more nodes, giving them the opportunity to empty their buffer. Furthermore, once again the SIN approach performs worst as it experiments no less than 50% packet loss due to buffer overflow. For  $k \geq 6$  the DIS K-Hops heuristic delivers from 80% up to 96% of the packets, as FWD performances. This minor packet loss ratio may be affordable in several non-critical applications. As we can see, our solution enables us to achieve the desired trade-off between data delivery, delay and energy performance by tuning the parameters accordingly.

### 3.8 Conclusion

The design of sustainable wireless sensor networks is a very challenging issue as it may be cost-prohibitive to replace exhausted batteries or even impossible in hostile environment. In this chapter, we proposed a novel linear programming model for the lifetime optimization of wireless sensor networks with limited buffer capacity and a controlled mobile base station. Our solution outperforms existing solutions and assesses the efficiency of the delayed paradigm, in which nodes buffer their data while waiting the sink coming closer to them. Further, we proposed a distributed algorithm to control the trade-off between energy expenditure and latency for data collection in WSN with a mobile element.

# Chapter 4

## Multi-hop wireless charging optimization in wireless sensor networks

Recent advancements in wireless charging technology offer promising alternative to address the challenging problem of energy need in low-power networks, as WSN for example. Based on these breakthroughs, existing solutions have investigated wireless charging strategies of low-power networks through the use of mobile chargers, where a charger has to come at the nodes' vicinity to recharge their battery. However, none of these works have considered the multihop energy transmission, whose feasibility have been demonstrated recently and which may improve efficiency and waiting delay for battery charging, in particular for high scalable WSN. In such a system, a node can transmit energy wirelessly to its neighbors. In this chapter, we propose a new approach in which several chargers are introduced in the WSN and these chargers may transfer energy to some node via a multihop path. The remaining question is: what is the minimum number of chargers we have to deploy to cover the WSN. To answer this question, we develop an optimization model to determine the minimum number of chargers needed to recharge the elements of a network in a multihop scenario. Our model takes into account the energy demand of the nodes, the energy loss that occurs during a transfer and the capacity of the chargers.

### 4.1 Introduction

In the literature, many energy-efficient protocols have been proposed to tackle energy consumption of wireless sensor networks at all layer of the protocol stack [4, 167]. Despite these efforts, WSN lifetime remains a performance bottleneck as these solutions can only



extend the network lifetime for a limited period of time. Similarly, energy harvesting techniques [5] have been developed to enable devices to harvest energy from their surrounding environment like sun, wind or movement. The nodes convert ambient energy to electrical energy to replenish their battery. However, energy scavenging techniques remain highly dependent on the environment as the ambient energy is not always available. Thus, the next harvesting opportunity is not easily predictable nor controllable.

In this context, recent breakthroughs in wireless energy transfer (WET) are expected to increase the sustainability of WSN and make them operational forever. For instance, a new wireless power transfer technique, called Witricity, was reported in *Sciences* by Kurs et al. [168]. Using Witricity, the authors were able to power a 60-W light bulb over 2 meters with an efficiency of 40 %. The technique uses strongly coupled magnetic resonance to transmit power between devices without the need of any contact between the transmitter and the receiver. The applications of wireless energy transfer in low-power networks are numerous. It has already been applied to power medical sensors and implantable devices [118], to replenish wirelessly sensors embedded in concrete [119] and to power a ground sensor from a UAV [120]. So, it is expected that wireless energy transfer will revolutionize the principles of low-power networks design. Indeed, the emergence of wireless power charging technology should allow overcoming the energy constraint of WSN, as it is now possible to replenish the network elements in a more controllable manner. For the moment, most of the existing works that aim to take advantage of WET consider mobile chargers that directly deliver power to deployed nodes.

A step further, Watfa et al. [169] demonstrate that it is possible to transfer wireless energy over multihop. In such a system, a device can both transmit and receive energy. This new paradigm offers unexplored perspectives regarding lifetime enhancement of WSN. Now, we can imagine that nodes are several hops away from the charger and that neighboring nodes are able to exchange energy. Using the paradigm of multihop wireless charging, we develop a model which minimizes the number of chargers required to recharge all the elements of the network and we determine their location. Our model takes into consideration the energy demand of the nodes, the energy loss that occurs during a transfer and the energy capacity of the chargers. As a result, we obtain different disjoint charging trees, so that a charger located at a root can recharge all the nodes of the charging tree.

The rest of this chapter is organized as follows. In section 4.2, we first survey studies that use wireless charging technology in low-power networks. We introduce the general idea of our solution in section 4.3. Then, in section 4.4, we detail the proposed multihop wireless charging scheme. In section 4.5, we present our optimization model for multihop wireless

energy transfer. We report the simulation results and discuss the advantage of our solution over single-hop energy transfer in section 4.6. Finally, section 4.7 concludes the chapter.

## 4.2 Related works

In this section, we review existing works that use wireless charging technology for lifetime prolongation in low-power networks. Most existing solutions consider only one-hop energy transfer through the use of mobile chargers that visit each node to recharge its battery.

### 4.2.1 Single-hop energy transfer

In [170], Yao et al. propose three simple charging schemes. In two schemes, a charger is assigned to a region and computes a shortest round path which links all sensor nodes in the area. The charger patrols along this path and charges a node when it is short of energy. In the last scheme, the network is not divided into regions and sensors send requests to mobile chargers when their energy falls under a given threshold. Then, the closest charger have to send a repeat packet. When a charger have to charge more than one sensor, it decides its charging sequence based on a function that takes into account the nodes residual energy and their distance to the charger.

Peng et al. [171] propose a three-tier architecture composed of i) *stationary sensor nodes*, ii) *a mobile charger (MC)* and iii) *an energy station* that monitors the energy status of sensors and directs the mobile charger. Sensors periodically send information about their battery state, then the energy station computes a charging sequence and sends commands to the MC. The authors formulate the charging problem and prove that it is NP-complete. They then present two greedy algorithms that prolong the network lifetime.

Li et al. [123] consider a mobile charger called Qi-Ferry (QiF), that must start from a charging station, visit tour stops to wirelessly charge sensors and then go back to the charging station. A tour stop is not necessarily collocated to a sensor because the QiF can charge a sensor while its distance from the sensor is less than a given threshold. The authors define the Qi-Ferry problem which aim to maximize the number of sensors charged during a tour, while the energy spent by the mobile during the tour to move and to power sensors does not exceed its initial energy. They prove the NP-hardness of the problem and propose a PSO-based heuristic to compute a tour that covers all the sensors. Then, if the energy consumption of the QiF is not respected, the algorithm iteratively removes one tour stop that incurs the minimum reduction in coverage at a time, until the energy constraint is satisfied.

Li et al. [172] formulate the joint routing and charging problem for lifetime maximization (ML-JRC) and prove its NP-hardness. They give a linear programming model that determines an upper bound of the maximum network lifetime that can be achieved in the ML-JRC problem and propose three heuristic solutions. In these approaches, the time is divided into slots and at the beginning of each slot, a node selects the least-cost route to the sink by exchanging information with its neighbors. Meanwhile, the mobile charger plans its activity for this slot. Then, depending on the solution, the mobile charger chooses to charge either i) nodes with the minimum residual energy, ii) nodes with the minimum estimated lifetime taking into account the energy consumption rate and assuming fixed routes, and iii) nodes that bottleneck the network taking into consideration routes dynamic by solving at the beginning of each slot a modified version of the LP. In this work the MC is assumed to have a full knowledge of the network, including nodes locations and nodes energy level.

Doost et al. [122] highlight that the charging rate may be different for the nodes depending on their location-specific channel behavior. In order to enhance the network lifetime, they propose a new routing metric that favors the formation of routes including nodes that have the best energy charging characteristics. In this way, the base station selects a path with the lowest maximum charging time. The authors also consider that the wireless charging waves operates in the same frequency band as the ones used for communications. So, a node either receives energy or transmits packets. After selecting the optimal path, the base station runs an optimization model that determines the charging time and the transmission time of the sensors, that maximizes the throughput under energy and latency constraints.

Shi et al [121] consider a mobile charger that periodically visits each network node to replenish their battery. They formulate an optimization model to maximize the ratio of the time spent by the charger at its home station over the time spent in charging the sensors. The authors prove that the optimal path for the charger is the shortest Hamiltonian cycle. Then, given an optimal traveling path, they formulate the joint problem for routing and charging time under the constraint that a sensor never runs out of its energy. With their approach, the network can remain operational forever, but the charger is supposed to have enough energy to recharge all sensors during a cycle.

Erol-Kantarci and Mouftah [124] propose SuReSense, a two phase algorithm for wireless rechargeable sensor networks in smart grid. The authors consider mobile chargers that can wirelessly power multiple sensors simultaneously, if the charger is located at a landmark which is in the sensors energy transfer range. The solution first runs a linear programming model that gives the minimum number of landmarks based on sensor energy-demand and constrained by the initial energy of the charger. Then the landmarks are grouped based on

their proximity to form clusters. A mobile charger is assigned to each cluster and visits each landmark following the shortest Hamiltonian cycle.

### 4.2.2 Multi-hop energy transfer

Watfa et al. [169] demonstrate the feasibility of transferring energy through multihop. They achieve an efficiency of 20% over 8 hops. The authors also propose a charging strategy for a flat and a clustered topology. In the flat topology, a sensor whose energy goes below a given threshold flood a request packet in the network. If a node is able to charge the requesting sensor, it sends back a message and transmits energy (possibly along a multihop path). In a clustered architecture, the sensor first sends its request to the cluster head (CH). If the CH cannot charge the sensor, it broadcasts the request to the members of the cluster. If there are no node able to charge the sensor, the CH charges itself by sending requests to the other CH, and then charges the requesting sensor.

In most of the existing solutions, authors consider only one-hop wireless charging systems by using a mobile charger that must visit each node to recharge its battery. Instead, we propose to consider a multihop wireless charging scheme where a node can transmit energy to its neighbors. Particularly, we are interested in minimizing the number of chargers required to recharge the nodes of a network. This problem have not already been considered in the litterature. In the next section, we expose the general idea of our solution. We later detail the envisioned multihop wireless charging strategy and the optimization model.

## 4.3 Overview of our solution

We consider a static wireless low-power network and a set of chargers of fixed capacity. The aim of our solution is to determine the minimum number of chargers - and their location - required to recharge nodes in a multihop scenario, taking into account the energy-demand of the nodes, the energy loss that occurs during a transfer and the capacity of the chargers. We suppose that the chargers locations are restricted to the nodes locations. As explained below, our approach works in two steps.

At the first step, for each possible location of the chargers, we construct a shortest path tree rooted at this location that covers all the nodes (using Dijkstra's algorithm). In order to take into consideration the energy losses, we consider a multiplicative cost of the edge's weight instead of an additive one. At the second step, we propose a Mixed Integer Linear Programming (MILP) model that determines the minimum number of chargers required to recharge all nodes given: the energy demand of the nodes, the energy loss that occurs during

a transfer and the energy capacity of the chargers. The MILP uses the trees constructed at the first step to return the minimum number of disjoint shortest-path trees, so that if a charger is located at the root, it can satisfy the energy-demand of all the nodes present in the tree.

From this optimization problem, it is easy to see that if the chargers' capacity is unlimited, and because our objective is to minimize the number of chargers, our MILP will return only one tree. The drawback of this solution is the charging time and the total energy required to charge all the nodes. On the contrary, if we suppose that the chargers have a very low energy capacity, the MILP will construct one-hop trees, so that each node will be in the vicinity of a charger. In this case, an important number of chargers will be required. Note that the recharging schedule is beyond the scope of this chapter. We further detail our solution in section 4.5, after presenting our multihop wireless charging scheme in the next section.

## 4.4 The multihop wireless charging scheme

In this section, we model our multihop wireless charging scheme for low-power networks. We successively describe the network model, a one-hop energy transfer and a multihop energy transfer.

### 4.4.1 Network model

We consider that the wireless low-power network is composed of a set of  $N$  static nodes randomly deployed in a region of interest. We consider a set of  $S$  chargers with identical energy capacity  $C$ . In our scenario, the only sources of energy in the network are the chargers. Nodes may act as intermediary transmitter to transfer the energy over multihop. So, a transmitter of energy can be either a charger or a node. A receiver necessarily refers to a node. We assume that a node can receive energy from only one transmitter and that a transmitter can transmit energy to multiple neighbors, but only to one at a time<sup>1</sup>. This corresponds to a tree structure, where a node can transmit energy to its sons, and a node receives energy from its unique parent. Further, the energy-demand of a node  $i$  is denoted  $E_i > 0$ .

### 4.4.2 Direct energy transfer

We now explain the one-hop energy transmission between two neighboring nodes. A transmitter  $i$  can wirelessly charge one of its neighbors  $j$  with a loss coefficient  $\kappa_{ij} \geq 1$ . This means that if the receiver needs  $E_j$  units of energy, the transmitter must transmit  $E_j \kappa_{ij}$  units

---

<sup>1</sup>This assumption is justified by the fact that a receiver can switch on or off its circuit used for energy reception.

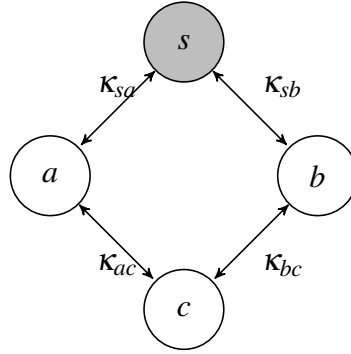

Fig. 4.1 A four-nodes network and their one-hop loss coefficients

of energy because of loss phenomenon. Technically, the energy losses of a transmission depend on the receiver and transmitter specific circuitry and on the distance between the two devices [169]. For the sake of simplicity, we consider that the energy transmission loss depends only on the distance between the two devices, and that the loss coefficient is an increasing function with respect to the distance. We also assume that the loss coefficient is symmetric, i.e.  $\kappa_{ij} = \kappa_{ji}$ . We now model the network as a non-oriented graph  $G = (V, E)$  where  $V$  is the set of static nodes. There is an edge between two nodes  $i$  and  $j$  if and only if they can directly send energy to each other. Each edge is associated a weight  $\kappa_{ij}$  that corresponds to the loss coefficient of the direct transmission between  $i$  and  $j$ . In Figure 4.1, we give an example for a four-nodes topology.

### 4.4.3 Multihop energy transfer

When the energy is transmitted from a charger to a given node through multihop path, energy is lost at each intermediate transmission along this path. We denote by  $P_{ij}$  the set of different paths that exist between nodes  $i$  and  $j$ . We assume that the final loss coefficient  $K_{ij}^p$  of a multihop transmission between a charger  $j$  and a node  $i$  along the path  $p \in P_{ij}$ , is equal to the product of the loss coefficients of the intermediate one-hop transmissions.

$$K_{ij}^p = \prod_{(x,y) \in p} \kappa_{xy} \quad (4.1)$$

Note that if there exists multiple paths from a charger to a node, the loss coefficient may be different for each path. Hence, we define  $\pi_{ij}$  the minimum energy loss coefficient of a multihop transmission between a charger  $j$  and a node  $i$ . We denote by  $p_{ij}^*$  the path which

minimizes  $\pi_{ij}$ .

$$\pi_{ij} = \min_{p \in P_{ij}} K_{ij}^p = K_{ij}^{p_{ij}^*} \quad (4.2)$$

Figure 4.1 illustrates a two-hops energy transmission between the charger  $s$  and node  $c$ . Either node  $a$  or  $b$  can be used as an intermediate transmitter. If  $a$  is used as the intermediate transmitter, to satisfy the energy-demand  $E_c$ , the charger must provide  $E_c \kappa_{sa} \kappa_{ac}$  because of the energy loss along the path. If  $b$  is selected as the intermediate transmitter, the charger will have to provide  $E_c \kappa_{sb} \kappa_{bc}$  units of energy. Here,  $\pi_{sc} = \min(\kappa_{sa} \kappa_{ac}, \kappa_{sb} \kappa_{bc})$ .

#### 4.4.4 Charging tree

In the graph  $G = (V, E)$  that we consider, we define a charging tree  $T_j(U, A)$  as a tree rooted at  $j$ , so that a charger located at  $j$  must supply energy to all the node  $i \in U$ . Moreover, the path from any node  $i \in U$  to the root  $j$ , is the path  $p_{ij}^*$  that minimizes the final loss coefficient  $K_{ij}^{p_{ij}^*}$ . More formally,  $T_j(U, A)$  can be defined as follows.

$$T_j(U, A) : \begin{cases} U \subseteq V \\ (x, y) \in A \text{ iff } (x, y) \in E \wedge x \in U \wedge y \in U \wedge (x, y) \in p_{xj}^* \end{cases} \quad (4.3)$$

Clearly, there is a trade off between the height of a charging tree, the time required to charge all the nodes of the tree and the total amount of energy needed to cover the nodes' energy-demand. Indeed, due to the cumulative energy loss that happens during a multihop energy transfer, the longer the transmission path between the charger and the receiver is, the higher energy the charger has to provide. That's why it could be interesting to limit the maximum height  $h$  of the charging trees. In order to do this, we denote by  $Z_i^h$  the set of nodes that are at most  $h$ -hops away from  $i$ .

### 4.5 The optimization model

In this section, we present our optimization model for multihop wireless charging in WSN. We suppose that we have a set  $S$  of chargers of identical capacity  $C$ . Our goal is to determine the minimum number of chargers of fixed capacity (and their locations) required to charge every element in the network through multi-hop energy transfer. Moreover, our solution ensures that the energy needed to recharge all the nodes assigned to a charger does not exceed the capacity of the charger. In what follows, we suppose that the possible locations of the chargers are restricted to the nodes locations. At the end, our solution constructs

different disjoint charging trees, so that a charger located on a root can recharge all the nodes of the charging tree.

### Step 1: Shortest-path trees construction

On the graph  $G = (V, E)$  that models the network, we first run a modified Dijkstra's algorithm, considering a multiplicative cost instead of an additive one. In this way, we obtain for any pair of nodes  $i$  and  $j$  the minimum loss coefficient  $\pi_{ij}$  and the path  $p_{ij}^*$  that minimizes this coefficient. We also compute the length of each path  $p_{ij}^*$ , and we denote by  $l(p_{ij}^*)$  the number of intermediate nodes of the path between  $i$  and  $j$ . So, if  $i$  and  $j$  are two neighboring nodes,  $l(p_{ij}^*) = 0$ . The two quantities  $\pi_{ij}$  and  $l(p_{ij}^*)$  are then used as parameters of the MILP in the second step.

### Step 2: Optimization of the number of chargers

In the second step, we run a Mixed Integer Linear Programming (MILP) model that minimizes the number of chargers under several energy constraints. Indeed, our solution takes into account the energy-demand of the nodes, the energy capacity of the chargers and the cumulative energy loss that occurs during multihop energy transfer. Moreover, we can bound the maximum height of the charging trees by  $h$ , i.e. energy is not transmitted over more than  $h$  hops. We recall that  $Z_i^h$  denotes the set of nodes that are at most  $h$ -hops away from  $i$ . Our MILP uses a binary variable  $B_{ij}$  ( $i \in N, j \in Z_i^h$ ), that is equal to 1 if the node  $i$  belongs to the charging tree  $T_j$ , and 0 otherwise. More specifically,  $B_{jj}$  is equal to 1 if and only if the charging tree rooted at  $j$  exists. We can now formulate the MILP that minimizes the number of chargers as below:

$$\min \sum_{j \in N} B_{jj} \text{ subject to} \quad (4.4)$$

$$B_{ij} \leq B_{jj}, \quad i \in N, j \in Z_i^h \quad (4.5)$$

$$\sum_{j \in Z_i^h} B_{ij} = 1, \quad i \in N \quad (4.6)$$

$$\sum_{i \in Z_j^h} E_i \pi_{ij} B_{ij} \leq C, \quad j \in N \quad (4.7)$$



$$\sum_{x \in P_{ij}} B_{xj} \geq l(p_{ij}^*) B_{ij}, \quad i \in N, j \in Z_i^h, i \neq j \quad (4.8)$$

$$B_{ij} \in \{0, 1\}, \quad i \in N, j \in Z_i^h \quad (4.9)$$

The objective function (4.4) minimizes the number of chargers, i.e. the sum of nodes that are selected as roots. Constraint (4.5) ensures that a node  $i$  cannot belong to a tree rooted at  $j$  if the node  $j$  is not selected as a root. In other words, the tree rooted at  $j$  does not exist. Constraint (4.6) guarantees that a node has only one charger. It also assures that a node belongs to only one tree. Constraint (4.7) refers to the chargers' limited energy capacity. The left part of the inequality in the constraint represents the amount of energy a charger located at node  $j$  must provide to satisfy the energy demand of all the nodes belonging to the tree rooted in  $j$ . The right part of the inequality specifies that the amount of energy a charger will have to provide must not exceed its capacity. Constraint (4.8) ensures that we obtain disjoint charging tree. Indeed, (4.8) states that a node  $i$  cannot belong to a tree rooted at  $j$  if the intermediate nodes involved in the transmission of the energy from  $j$  to  $i$  (i.e. the nodes that belong to the optimal path  $p_{ij}^*$ ) are not in the tree  $j$ . Finally, constraint (4.9) states that  $B_{ij}$  are binary variables.

## 4.6 Performance evaluation

The network that we consider for performance evaluation is composed of 100 nodes randomly deployed in a rectangular field of 25m X 25m. The energy-demand  $E_i$  of every node is set to 1KJ. We vary the battery capacity of the chargers between 20KJ as in [124] and 2000KJ as in [171]. We also vary the maximum height of the charging trees from 1 to 6 hops. Two neighboring nodes can exchange energy if there are at most 3 meters away from each other. The loss coefficient between every pair of neighboring nodes is set equal to 20%. We solved the MILP models with CPLEX<sup>2</sup> and the constraints are generated in C++. In what follows, we study for different values of parameters, the optimal number of chargers and the total energy necessary to satisfy the energy-demand of the nodes. Note that the maximum height of the charging trees corresponds to the parameter  $h$  of the MILP, which means that the energy is transmitted *at most* over  $h$ -hops (the height of the charging trees is *at most*  $h$ ). This does not mean that the obtained charging trees have a height equal to  $h$ . Indeed, even if the solver will tend to construct charging trees with high height in order to minimize the

---

<sup>2</sup><http://www-01.ibm.com/software/integration/optimization/cplex-optimizer/>

number of chargers, if the battery capacity of the chargers is too low, the chargers will only be able to supply energy to smaller trees.

Figure 4.2 shows the minimum number of chargers required to satisfy the energy-demand of the nodes depending on the maximum height of the charging trees and the battery capacity of the chargers. We can make several observations. First, as expected, higher is the chargers battery capacity, smaller is the number of chargers. This is because a charger will be able to serve more nodes. Second, we can see that the maximum height of the charging trees and the chargers' capacity highly constrain the problem. Indeed, for every battery capacity, after 4 hops, the minimum number of chargers does not change. This is because the energy capacity of the charger is not sufficient to build charging trees with more hops. Thus, for every capacity, after 4 hops, the solution does not change any more and the resulting networks are similar. Third, our results bring useful information regarding the network dimensioning. When the battery capacity of the chargers increases from 20KJ to 100KJ, we cut the number of chargers by two. But when it passes from 500KJ to 2000KJ, we only save two chargers. So, we may prefer to use 8 chargers of 500KJ instead of 6 chargers of 2000KJ, even if it is not the optimal solution.

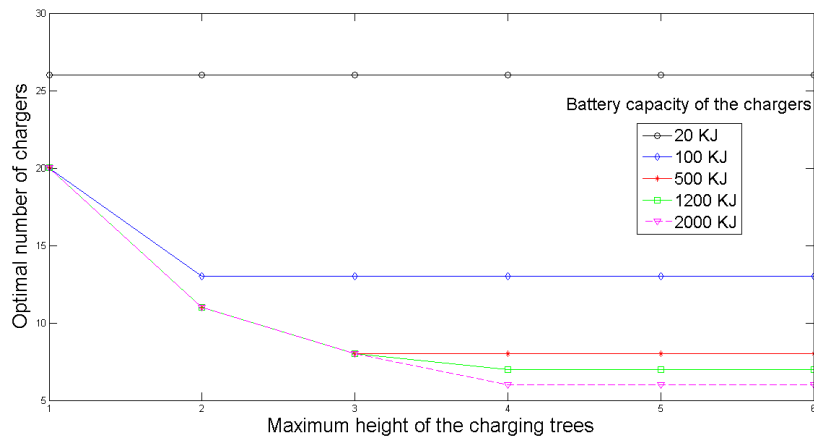

Fig. 4.2 The minimum number of chargers depending on the maximum height of the charging trees and the battery capacity of the chargers.

From another point of view, Figure 4.3 compares the simulation results of our multihop energy transfer scheme to a naive single-hop energy transfer approach, which is similar to [124], where the parameter  $h$  is set to 1. As expected, our solution enables to decrease the total number of chargers required to satisfy the energy-demand of every node. This is because a higher tree can cover more nodes. The only exception is when the chargers capacity is very low (20KJ), as the minimum number of chargers is 26, whatever is the considered approach. In this case, the energy is so low that chargers can only supply energy to the nodes that are

one-hop away from them. So, even though we increase the maximum authorized height, it is not possible to decrease the number of chargers by building higher trees. Regarding the network dimensioning, we can observe that if one of the requirement is to construct 1-hop charging trees, the minimum number of chargers is 20. In this special case, it is not necessary to use chargers with more than 100KJ as it will not improve the solution.

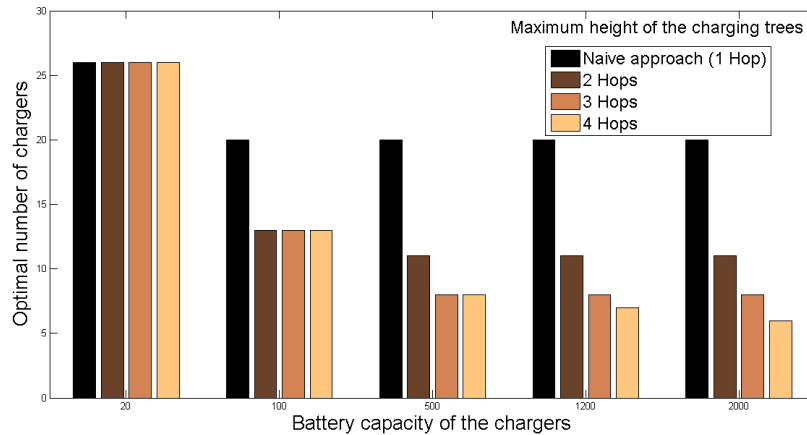

Fig. 4.3 The minimum number of chargers for our multihop energy transfer scheme compared to a naive single hop energy transfer approach.

The amount of energy a charger located at node  $j$  must provide to satisfy the energy demand of all the nodes belonging to the tree rooted at  $j$  is equal to  $\sum_{i \in Z_j^h} E_i \pi_{ij} B_{ij}$  as explained for the constraint (4.7). We call this quantity the energy-supply of a charger. We define the *total energy supply* as the sum of the energy-supply of each charger. The minimum total energy supply we can obtain is 100KJ when a mobile charger is assigned to every node. In this case, a charger has to supply 1KJ to its single node and we have hundred charging trees of height equal to 0. This gives a total energy of 100KJ. Even if this solution minimizes the total energy supply, it is not conceivable as it requires one charger per node.

Figure 4.4 represents the total energy supply required to satisfy the energy-demand of the nodes depending on the maximum height of the charging trees and the battery capacity of the chargers. When the height of the charging trees increases, the total energy supply also increases. This is expected as the cumulative loss coefficient increases when the number of hops that separates the node from the charger increases. From Figure 4.4, we see that for every battery capacity, after 4 hops, the total energy supply does not change. This can be explained by the fact that the optimal number of chargers does not change after 4 hops as we have seen in Figure 4.2.

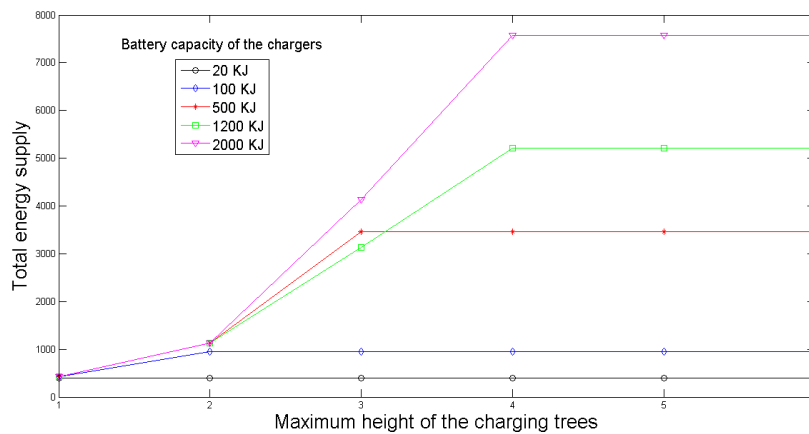

Fig. 4.4 The total energy supply, depending on the maximum height of the charging trees and the battery capacity of the chargers.

## 4.7 Conclusion

In this chapter, we have explored how multihop wireless energy transfer paradigm can be used to enhance the lifetime of low-power networks, by charging nodes in a more controllable manner. In particular, we have developed an optimization model to minimize the number of required chargers while taking into account the energy-demand of the nodes, the cumulative energy loss that occurs during a transfer and the capacity of the chargers. As expected, multihop energy transfer enables us to reduce the number of chargers necessary to satisfy the energy-demand of every node. Furthermore, we showed that our solution offers a good trade-off between the number of chargers, the height of the charging trees and the total amount of energy needed to cover the nodes' energy-demand over multihop.



# Chapter 5

## **Energy-efficiency of human context recognition systems using wearable sensors for healthcare applications: state-of-the-art**

Human context recognition (HCR) from on-body sensor networks is an important and challenging task for many healthcare applications because it offers continuous monitoring capability of both personal and environmental parameters. However, these systems still face a major energy issue that prevent their wide adoption. Indeed, in healthcare applications, sensors are used to capture data during daily life or extended stays in hospital. Thus, continuous sampling and communication tasks quickly deplete sensors' battery reserves, and frequent battery replacement are not convenient. Therefore, there is a need to develop energy-efficient solutions for long-term monitoring applications in order to foster the acceptance of these technologies by the patients. In this chapter, we survey existing energy-efficient approaches designed for HCR based on wearable sensor networks. We propose a new classification of the energy-efficient mechanisms for health-related human context recognition applications and we review the related works in details. Moreover, we provide a qualitative comparison of these solutions in terms of energy-consumption, recognition accuracy and latency. Finally, we discuss open research issue and give directions for future works.

## 5.1 Introduction

The aging of the population is a chief concern of many countries since longer life expectancy and declining fertility rates are increasing the proportion of the elderly worldwide. It is expected that approximately 20% of the world population will be age 60 or older by 2050 [173]. This situation poses new challenges to existing healthcare systems, such as an increase in age-related diseases, dependency, and shortage of caregivers. It is hoped that technology will be helped in addressing these challenges, for instance by helping elderly people to live more independent lives and thus reducing the burden of caregivers.

It is against this background that the recognition of human context has received a significant attention in the medical field, because it is a task of interest for many applications, including assisted living of elderly, physical assessment, and supervision of patient with chronic diseases such as diabetes, obesity, cognitive disorder or arrhythmia [174]. In a typical scenario, wearable sensors like accelerometers or ECG are attached to the patient to measure biomechanical, physiological and environmental data [175]. These data are further analyzed to provide a feedback to caregivers who can assess the efficiency of a new treatment, adjust medication, better study a disease or supervise a patient behavior [176]. In practice, such systems face a major challenge that limit their widespread adoption: the significant energy consumption of battery-operated devices for continuous sensing and communications. Indeed, radio transmissions, data processing and sensing tasks actively stress the nodes reserves, whereas they are expected to operate during the course of the day without maintenance.

To tackle this problem, many solutions have been proposed to save energy in context recognition applications. Among them, we can cite sensor set selection [177], deactivation of power-hungry sensors [178], adaptive sampling rate [89], communications reduction [179]. All these solutions leverage energy consumption for latency and recognition accuracy. This is because health-related HCR applications have specific requirements, and energy-efficiency is usually understood to mean a satisfactory trade-off between three optimization criteria: low energy consumption, high recognition accuracy and low latency. Although numerous methods have been proposed to address the energy problem of HCR based on body sensors, there does not exist a comprehensive survey on the techniques available in the literature. In this chapter, we survey the state-of-the-art of energy-efficient HCR solutions making use of wearable sensors. Our aim is to provide designers of HCR systems with a survey that offers a holistic view of energy-saving solutions while taking into consideration the specific requirements of healthcare applications.

This survey is organized as follows. In the next section, we introduce health-related human context recognition applications using wearable sensors. Then, in Section 5.3, we

discuss the general components of context recognition systems and their main requirements. Afterwards, in section 5.4, we introduce our classification of the existing energy-efficient mechanisms developed for HCR applications. From Section 5.5 to 5.8, we present solutions related to respectively power-on time reduction, communication reduction, computation reduction, and battery charging. Subsequently, in Section 5.9, we provide a qualitative comparison of the reviewed solutions, and in Section 5.10 we identify open research issues.

## 5.2 Human context recognition using wearable sensors

In this section, we briefly introduce human context recognition (HCR) applications making use of wearable sensor networks.

### 5.2.1 Applications

A human context recognition system using wearable sensors exploits sensors signals that allow monitoring a user and its environment in order to infer ongoing tasks and living conditions. Human context recognition encompasses both personal context recognition (e.g. activity, health status, emotion) and environmental context recognition (e.g. location, dust-level, social interaction), as described in Table 5.1. The comprehension of the personal and environmental contexts is of great importance to improve the patient follow up for medical and wellbeing applications.

Human context	Context type	Sensor type
Personal context	activity, emotion, health status	accelerometers, gyroscope, blood pressure, ECG, EMG, temperature
Environmental context	location, place, noise-level, pollution, social interaction	GPS, WiFi traces, $CO_2$ sensor, luminosity, microphone, Bluetooth scans

Table 5.1 Human context recognition.

In a typical scenario, patients wear sensors that supervise their vital parameters in order to identify emergency situations and allow caregivers to respond effectively. This kind of application includes remote vital sign monitoring [15], and sudden fall or epilepsy seizure detection [16]. Moreover, body sensors can be used to gather clinically relevant information for rehabilitation supervision, elderly monitoring [180] or to provide support to a person with cognitive disorder [181]. For example, in [181], Lin et al. use a GPS-enabled wearable



device to detect potential disorientation behaviors of cognitively-impaired elders. Zhan et al. [180] infer activities of daily living using accelerometer and video data embedded in conventional reading glasses in order to remotely supervise elder and disabled patients. Another type of health-related system aims to use human context information to promote a more active and healthy lifestyle. For example, the BeWell+ application monitors user everyday activities using the accelerometer and microphone sensors on phone [182]. It computes and displays wellbeing scores (sleep score, physical activity score and social interaction score) in order to encourage healthy behaviors. In [175], the authors designed a system to promote physical activity among elderlies: the platform uses wearable sensors to provide a real-time feedback to the user regarding his movement. It is worth mentioning that human context recognition can be of great interest in other domains of application such as gaming or in industry. However, health-related applications have specific requirements in terms of energy-consumption, latency and recognition accuracy. These specifications justify the fact that dedicated energy-efficient solutions have been developed in the literature, although they may be transferable to other applications.

### 5.2.2 History

Early researches in context recognition were conducted using vision-based systems [183], but these systems were found expensive, intrusive and limited to well-equipped laboratories because of their cost and complexity. With the development of hardware technologies, sensing devices - lightweight enough to be worn - were developed. They provided a low-cost and effective alternative for human context recognition [184]. As a consequence, the first studies on human context recognition using wearable sensors emerged around the 1990s. They mostly relied on inertial sensors such as accelerometers and gyroscopes, and focused on recognizing a special subset of everyday activities (e.g. ambulation, walking, sitting, typing) [185]. At that time, a portable data logger was used to gather the data from body mounted sensors. Although these research prototypes were still bulky and did not propose real time feedback, they offered promising perspectives for ubiquitous and personal applications.

In early 2000s, medical sensors have incorporated wireless connections, such as Bluetooth and ZigBee, to communicate wirelessly to nearby computers, personal digital assistants, or mobile phones. Meanwhile, advances in miniaturization permitted sensors to be embedded within wrist band, belts, bracelets, rings [186]. Since then, mobile and real-time systems incorporating multi-modal sensors that could be used to recognize physical activities, social interactions or location have emerged [187]. Still, these applications were constrained by the sensors resources limitations. On the one hand, low memory and computation capabilities of sensors required the development of new algorithms for signal processing and context

classification. On the other hand, the sensors' energy consumption became a key challenge for the successful development of pervasive systems which necessitate to be worn during an extended period of time for in-wild experiments and long-term monitoring applications.

### 5.2.3 Sensors

One of the most commonly type of sensors used for personal context recognition is accelerometers, because they are small, cheap and unobtrusive. Other types of sensors used for health-related data collection include pressure sensors, body temperature sensors, electromyography, oximetry sensors, and electrocardiographs. More kinds of sensors have been employed to improve the context-awareness of the application. For example, GPS or WiFi traces are used to determine the user localization [188], microphone records and Bluetooth traces are analyzed to detect ongoing interaction [189],  $CO_2$  and dust sensors are employed to estimate the pollution level [190]. With the advances in miniaturization, increasingly pervasive sensing devices have been developed: sensors are now integrated into clothes, smart glasses and wearable rings [180, 186, 191]. A step further, some applications now instrument objects in the user's environment with RFID tags, and use data from a wearable RFID reader to infer household activities (such as making coffee, doing laundry, washing dishes) [179]. However, the use of RFID tags restricts these approaches to closed instrumented environments.

Depending on the application objective, a recognition system can use the same type of sensors at multiple body locations or combine complementary sensors that can help in recognizing personal and environmental contexts, e.g motion and audio, motion and location [188, 192]. Traditionally, information sources were deployed for a specific goal, but new applications try to dynamically adapt to available sensor data [193]. Indeed, the available source of information now varies depending on the user co-location with other body area networks [194], and on the user location when there exist space-embedded sensors [195].

### 5.2.4 Context information

Having the viewpoint of human context sensing provides a great deal of advantages. First, the recognition of human environment helps to efficiently monitor the current human activity, and vice versa. For instance, in [179], Wang et al. employ location information to infer household activities. Nath propose ACE [196], a system that can learn associative rules between contexts such as 'if the user is not walking and is not driving, he/she is indoor'. In CenceMe [197], Miluzzo et al. show that activity classification accuracy varies when the phone is carried in the pocket or in the hand. This is why the system uses phone sensing context to drive the classification model by switching in the right technique to enhance the application performances. Moreover, the result of a context recognition application can be

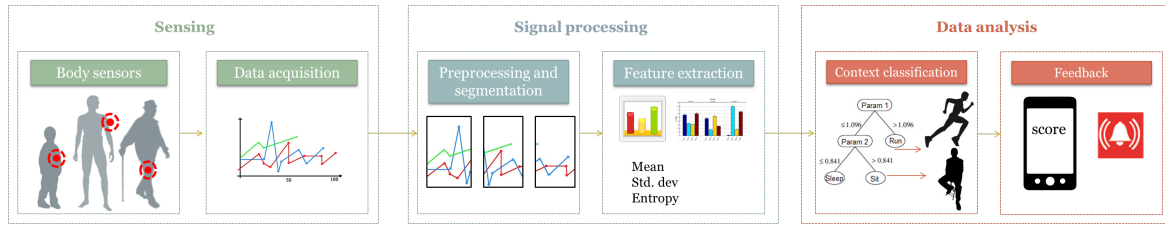

Fig. 5.1 The main stages of human context recognition systems.

used a clue to reduce the energy consumption of the recognition system itself. For example, a human activity recognition system can reduce its energy consumption when the user is not moving or performs activities with low intensity [89, 198]. A place detection application can monitor the user mobility and location in order to take advantage of the existence of external devices in the environment to save energy [192, 195]. Finally, personal context recognition can improve the energy efficiency of an ambient context recognition system, while the environment recognition can certainly enhance the energy-efficiency of personal context recognition application. For example, in SensLoc [188], when the movement detector detects that the user is stationary, it switches off the path recognition application. Inversely, one can imagine that if a location recognition system detects that the user is at home, a vision-based system in charge of monitoring the user's personal context may be activated, thus relieving the wearable sensors.

### 5.3 General framework and requirements

In this section, we first describe the general structure of any human context recognition system, and we propose a generic architecture able to support such applications. Then, we present the main requirements of HCR applications.

#### 5.3.1 General framework

General models for context recognition systems are given by Bulling et al. [199], Hoseini-Tabatabaei et al. [187], and Lara and Labrador [174]. The main stages for human context recognition include *sensing*, *signal processing* and *data analysis*, as illustrated in Figure 5.1. More specifically, sensing corresponds to the data acquisition at sensor nodes which produces raw data. Then, the data stream can be preprocessed to filter out signal variability. At the segmentation stage, the processed data are split into time windows that are likely to contain an information. Afterwards, features extraction is applied to each segment in order to obtain relevant characteristics of the signal, e.g. standard deviation, average, discrete Fast Fourier Transform (FFT) coefficients. During the training phase, the extracted features and

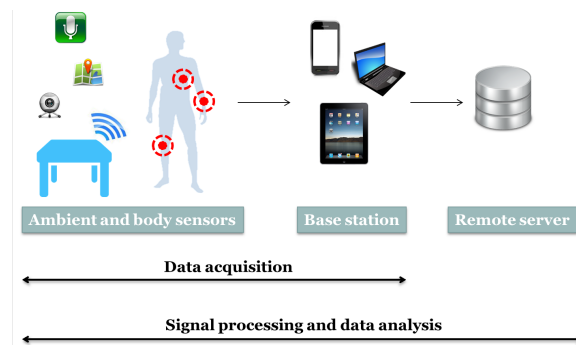

Fig. 5.2 A generic human context recognition architecture.

corresponding ground truth labels are used as input to train a classifier model. During the testing phase, the extracted features and the trained model are used to identify the ongoing activity or current environment. Finally, depending on the recognized context, the application can provide the user with a feedback (e.g. display a wellbeing score, raise an alarm).

To support this context recognition chain, a typical HCR architecture relies on the following devices: body sensors and possibly ambient sensors, a base station and possibly a remote server. This generic architecture for HCR is shown in Figure 5.2. In the first place, wearable sensors worn on the body measure attributes of interest such as ECG, motion or temperature. Ambient sensors (e.g. microphone and tagged objects) may also be used to improve the context-awareness of the application. The sensors communicate with a base station, which can be a laptop or a mobile phone, and whose main role is to run the healthcare monitoring application. In order to do that, the base station can communicate with a remote server on which the collected data are stored. Data acquisition is performed at the sensors, and at the base station when it has integrated sensors as is often the case of today's mobile phone. The other tasks (signal processing and data analysis) can be conducted on any devices depending on the architecture. The different devices (sensors / base station / server) have various computing, memory and energy capabilities.

From the generic architecture presented in Figure 5.2, we identify different scenarios in Table 5.2. Indeed, depending on where the context recognition tasks are executed, the energy/performance profile of the body sensor network varies. For example, in *scenario 1*, the sensors have the possibility to directly store the raw data, leaving all the processing for later. The drawbacks of this method is that it prevents real-time feedback to the patient and it requires a lot of memory, even if to save space, the sensor can store extracted features. Another solution, represented in *scenario 2*, consists in sending the raw data to the base station, but it results in a huge amount of energy consumption due to transmissions. In the meantime, using

a more powerful base station allows to have access to more complex algorithms and models. Furthermore, in *scenario 3*, the sensor can send only the extracted features or the compressed signal, which decreases communication cost but increases the computation load. Indeed, computations that run on a mobile device can also consume a considerable amount of energy: Milluzzo et al. [197] noticed that sampling the phone's microphone and running a discrete Fourier transform on the sound sample uses more power than sampling the accelerometer and classifying the accelerometer data. In *scenario 4*, the entire context recognition process is performed on the sensor. From the energy point of view it may be optimal, but sensor scarce resources limit the implementation to lightweight algorithms. Actually, some classification algorithms are very expensive in terms of memory and computation requirements, which makes them not suitable for sensor platforms [174]. Therefore, there exist a trade-off between the accuracy that can be achieved through local computation and the additional power required for transferring the data. Besides energy consideration, when the context recognition is conducted on sensors, it could prevent designers from using these sensors as sources of information in opportunistic applications since the results will be application- or user-centric. In *scenario 5*, we present a more complex hierarchical architecture, where the sensor calculates extracted features and sends them towards the user's mobile phone. Using these samples, the phone performs personal context recognition (e.g activity recognition), and sends the recognized activity, as well as its own raw data obtained from an integrated microphone, to a remote server, which performs the social context recognition.

Inferring the context locally has been emphasized to provide a number of advantages [197]. It presents resilience to cellular or WiFi dropouts and minimizes the data transmitted to the backend server, which in turn improves the system communication load efficiency. It also protects user privacy and the data integrity by keeping the raw data on the mobile device. However, the complexity of the applications is limited by the available local computing and storage resources. Uploading data to a mobile phone or a backend server provides better opportunities for the exploitation of aggregate data from a large number of users, while allowing for the realization of more complex applications. However, it demands more serious considerations of privacy, and requires a careful study of the additional delay and power consumption needed for the remote context delivery. As we can see, context recognition architectures often leverage energy consumption for accuracy and latency performances, and vice versa.

Finally, when considering multiple sensors communicating with a mobile phone, two alternative approaches are generally envisioned: *pull* and *push* models. In push approaches, the sensors transmit continuously their samples (or extracted features) to the smartphone [200]. On the one hand, this technique increases the accuracy by maximizing the amount

### 5.3 General framework and requirements

Scenario	Architecture	Advantages	Disadvantages
1	 <ul style="list-style-type: none"> <li>Data storage</li> </ul>	<ul style="list-style-type: none"> <li>no energy consumption for transmission and processing</li> </ul>	<ul style="list-style-type: none"> <li>memory needs</li> <li>no real-time feedback</li> </ul>
2	 <ul style="list-style-type: none"> <li>Data acquisition</li> <li>Raw data transmission</li> </ul> <p>PDA, laptop, smartphone</p> <ul style="list-style-type: none"> <li>Feature extraction</li> <li>Context classification</li> <li>Data relay</li> </ul> <p>Database</p> <ul style="list-style-type: none"> <li>Data storage</li> <li>Data analysis</li> </ul>	<ul style="list-style-type: none"> <li>no computation at sensor</li> <li>access to more complex algorithms</li> </ul>	<ul style="list-style-type: none"> <li>increase energy consumption for transmission</li> <li>increase energy consumption at the mobile phone</li> </ul>
3	 <ul style="list-style-type: none"> <li>Data acquisition</li> <li>Feature extraction</li> <li>Feature transmission</li> </ul> <p>PDA, laptop, smartphone</p> <ul style="list-style-type: none"> <li>Context classification</li> <li>Data relay</li> </ul> <p>Database</p> <ul style="list-style-type: none"> <li>Data storage</li> <li>Data analysis</li> </ul>	<ul style="list-style-type: none"> <li>reduce energy for transmission at sensor</li> </ul>	<ul style="list-style-type: none"> <li>lightweight pre-processing algorithms at sensor</li> </ul>
4	 <ul style="list-style-type: none"> <li>Data acquisition</li> <li>Feature extraction</li> <li>Feature transmission</li> <li>Context classification</li> </ul> <p>PDA, laptop, smartphone</p> <ul style="list-style-type: none"> <li>Data relay</li> </ul> <p>Database</p> <ul style="list-style-type: none"> <li>Data storage</li> <li>Data analysis</li> </ul>	<ul style="list-style-type: none"> <li>reduce energy for transmissions</li> <li>increase privacy</li> <li>increase resilience to wireless dropouts</li> </ul>	<ul style="list-style-type: none"> <li>increase energy for computation at sensor</li> <li>not for opportunistic applications since results are application- or user-centric</li> </ul>
5	 <ul style="list-style-type: none"> <li>Data acquisition</li> <li>Feature extraction</li> <li>Feature transmission</li> </ul> <p>PDA, laptop, smartphone</p> <ul style="list-style-type: none"> <li>Activity classification from wearable sensors' data</li> <li>Raw data transmission of integrated sensors</li> </ul> <p>Personal context</p> <p>Raw data</p> <p>Server</p> <ul style="list-style-type: none"> <li>Social context classification</li> <li>Data storage</li> <li>Data analysis</li> </ul>	<ul style="list-style-type: none"> <li>possibility to merge different sources of information</li> <li>opportunities for resources sharing</li> <li>allow complex processing</li> </ul>	<ul style="list-style-type: none"> <li>need for security</li> <li>trade-off between local and remote computing must be carefully studied</li> <li>dependent on network access</li> </ul>

Table 5.2 Possible architectures for context recognition.

of acquired data. On the the other hand, continuous transmission of high data rate streams can often impose impractical traffic loads on existing wireless technologies likely to be used between the sensors and the mobile gateway (e.g. ZigBee, Bluetooth). Although sensors can take decision on whether to transmit or not the data based on internal processing, such as accelerometer classification, the data acquisition process is generally decoupled from the actual context recognition. Inversely, in pull services, the mobile phone acts as a coordinator, and carefully chooses the order and the numbers of data items to request from each individual sensor [176, 201]. These solutions spare bandwidth and allow implementing more fine-grained optimization since the device retrieve information from sensors depending on the application needs. In the same time, the latency will certainly be increased.

### 5.3.2 Requirements

Health-related application making use of wearable sensors have specific requirements, and designers of energy-efficient user context recognition systems face challenges associated with the trade-off between high recognition accuracy, low latency and low power consumption.

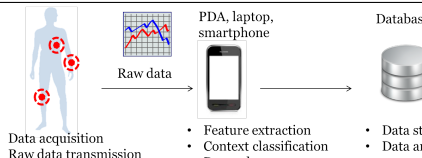
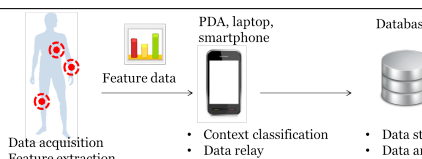
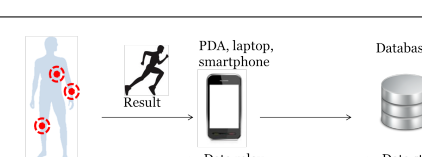
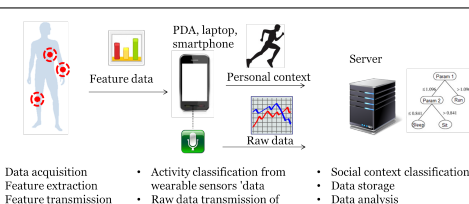
**The energy consumption** is decisive in order to ensure long term monitoring of the patients and to foster the acceptance of these technologies by the patients. Generally, most of the energy drainage is due to the radio communications, followed by the sensing and computation tasks. When considering the general architecture depicted in Figure 5.2, it is important to notice that both the sensors and the base station may be energy constrained which currently dramatically limit the use of context monitoring applications. Traditionally, powerful laptop were used as base station, but for mobility consideration most of the works now consider mobile phone as base station. Although phones are more powerful devices compared to wearable sensors, the truth is that they also face energy consumption problems [202]. Thus, we will consider studies that are interested in either the energy consumption of the sensors or the base station (e.g. mobile phone). Note that few approaches aim to tackle the energy problem of both devices [178, 194].

**The latency** corresponds to the system reactivity, that is the time that elapsed between the beginning of an activity and its detection by the system. It includes the time required to acquire, process and analyze the data. The latency is crucial for some critical applications such as epilepsy seizure detection and sudden fall detection. In this case, low detection latency is the chief concern so that less attention may be paid to the node battery charge.

**The recognition accuracy** characterizes how well the system detects and identifies current contexts from sensor data. This usually requires that the recognized context be compared to ground truth labels representing the actual environment and activity being performed. Besides correct classification, context recognition systems can miss, confuse or

falsely detect events that did not occur [199]. Therefore, the *recognition accuracy* is defined as the number of correct predictions over the total number of predictions [178, 179]. There exist several other metrics to evaluate the performances of a recognition system, such as precision, recall or F-Measure [203] but most of the reviewed architectures consider the accuracy.

We used the data of SociableSense [192] to represent in Figure 5.3 the latency and accuracy achieved by this architecture in function of the energy consumption. This behavior illustrates the traditional energy-latency-accuracy trade-off faced by context recognition applications. As we can see, when the energy decreases, the latency increases and the classification accuracy degrades. This is because energy-efficient mechanisms spare resources to increase the devices lifetime.

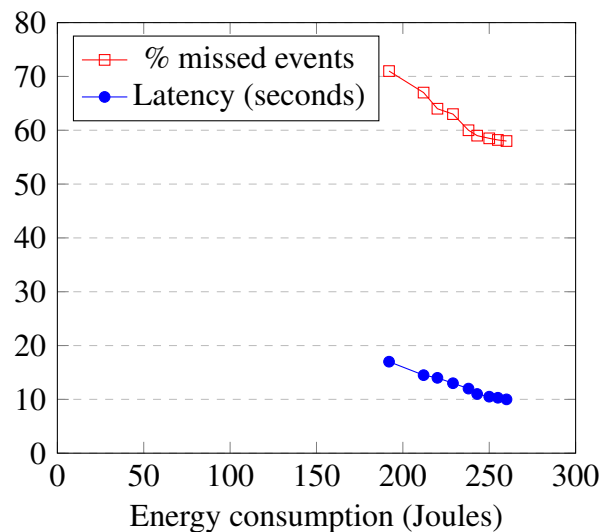

Fig. 5.3 The energy-latency-accuracy trade-off of an activity recognition application [192].

## 5.4 Classification of energy-efficient mechanisms

Energy conservation in wireless sensor networks (WSN) in general, and in wearable computing in particular has attracted many research works that have already been surveyed. For WSN, in [2], Anastasi et al. present a valuable taxonomy of energy-conservation schemes focusing on duty cycling and data-reduction approaches. There also exist surveys that concentrate on only one energy-efficient mechanism (like energy-efficient routing protocols or data aggregation techniques [3, 4]) since every category of solution often represents a whole research area in itself. Regarding wearable computing, Lane et al. [204] review many challenges related to mobile phone sensing, and Hoseini-Tabatabaei et al. [187] study



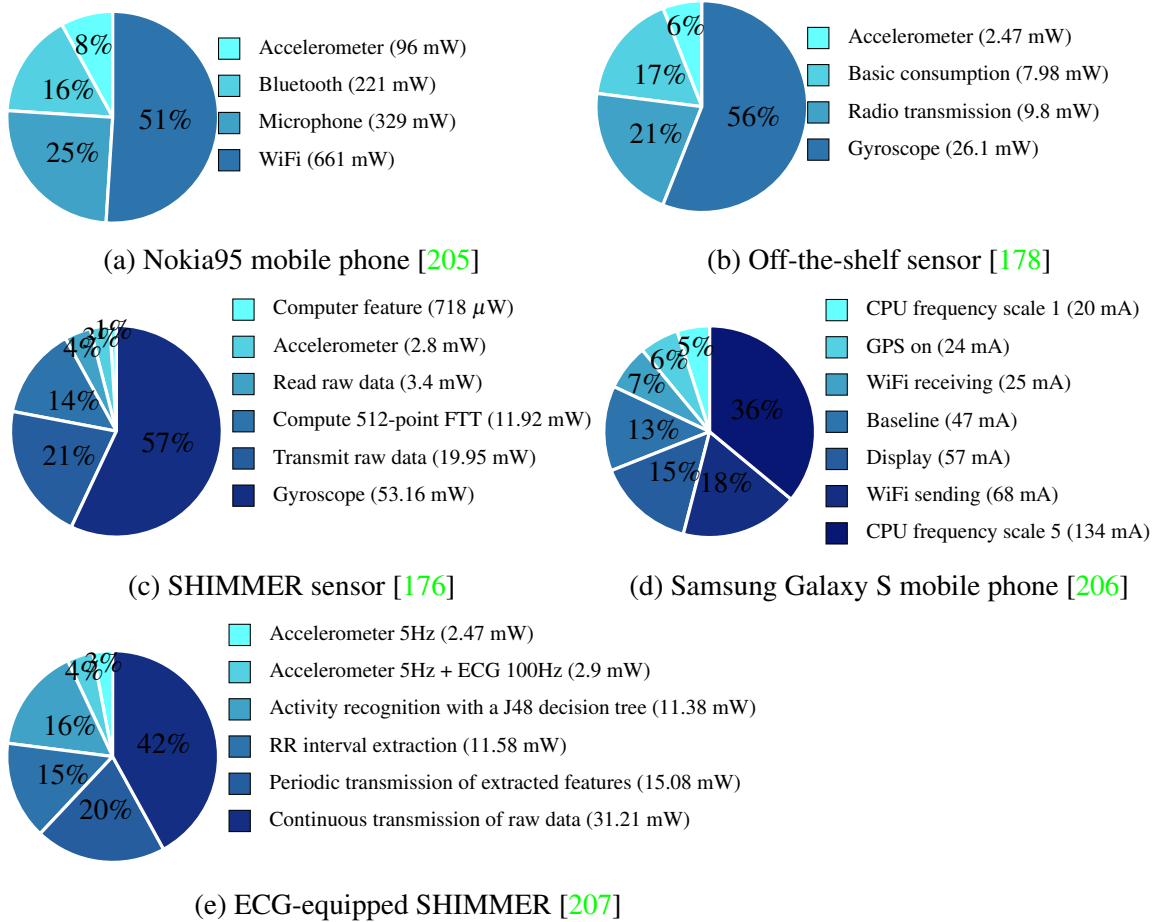

Fig. 5.4 Energy consumption profile of different devices.

smartphone-based user context recognition, but they do not focus on energy-efficiency. Our survey is different since we focus on energy-efficient solutions in the sense that they trade-off energy consumption for latency and accuracy. This is a central characteristic of human context recognition systems since they require low data delivery delay, high accuracy and long-term monitoring capacities. Moreover, we decided to concentrate on recent studies to provide the reader with up-to-date research results. Before discussing our classification of energy-efficient mechanisms developed for human context recognition applications, we highlight the main sources of energy consumption in sensor nodes and energy-constrained base station.

We represent the energy consumption profile of different devices, including sensors and mobile phones in figures 5.4a to 5.4e. As can be seen, the main draining tasks are sensing, communication and computation operations. Indeed, we can observe in figures 5.4b and 5.4c that the sensing task due to power-hungry sensors such as gyroscope can consume a

large amount of energy, dominating radio transmissions. This is why some solutions seek to minimize the wakeup time of sensor nodes. The communications also represent a high source of energy expenditure in mobile phones and sensor nodes. For example, in Figure 5.4a the Wi-Fi communications consume six times as much energy as the sensing task on accelerometer. Similarly, in Figure 5.4e the continuous transmission of raw data drains twelve times as much energy as sampling the accelerometer. Therefore, many existing solutions aim to reduce the amount of exchanged data between devices. Finally, we can observe that it is worthy to reduce the computation load, especially on mobile phones since the CPU energy consumption at high frequency can represent a non-negligible fraction of the energy consumption as illustrated in Figure 5.4d. Regarding sensor nodes, it has been observed in [176] that computing certain feature on sensor node is relatively inexpensive since the additional CPU energy cost can be compensated by the reduction of packet transmissions. However, it does not make sense to compute more computationally-demanding feature. For example, it appears in Figure 5.4c that the computation cost of a Fourier transform is of the same order of magnitude as the cost of transmitting raw data. In addition to these considerations, battery charging techniques scavenge energy from the environment or human activities, such as lower-limb motion or body heat, which have great potential to become sustainable power sources for wearable sensors.

Based on these observations, our proposed classification of energy-efficient mechanisms for HCR systems is summarized in Figure 5.5. We have distinguished four main categories of energy-efficient solutions, namely, *power-on time reduction*, *communication reduction*, *computation reduction* and *battery charging*. In the next sections, we survey these different approaches. For each technique, we provide a description of its principle, followed by a review of related solutions.

## 5.5 Power-on time reduction

In this section, we survey power-on time reduction schemes whose aim is to adapt the sensor operations in order to save energy by switching the nodes to the sleep mode. The radio, CPU and sensing unit are all turned off to reduce the energy spent for communication, computation and data acquisition.

### 5.5.1 Sensor set selection

The objective of sensor set selection techniques is to achieve a good trade-off between the number of sensors activated and the classification accuracy. Indeed, the usage of many

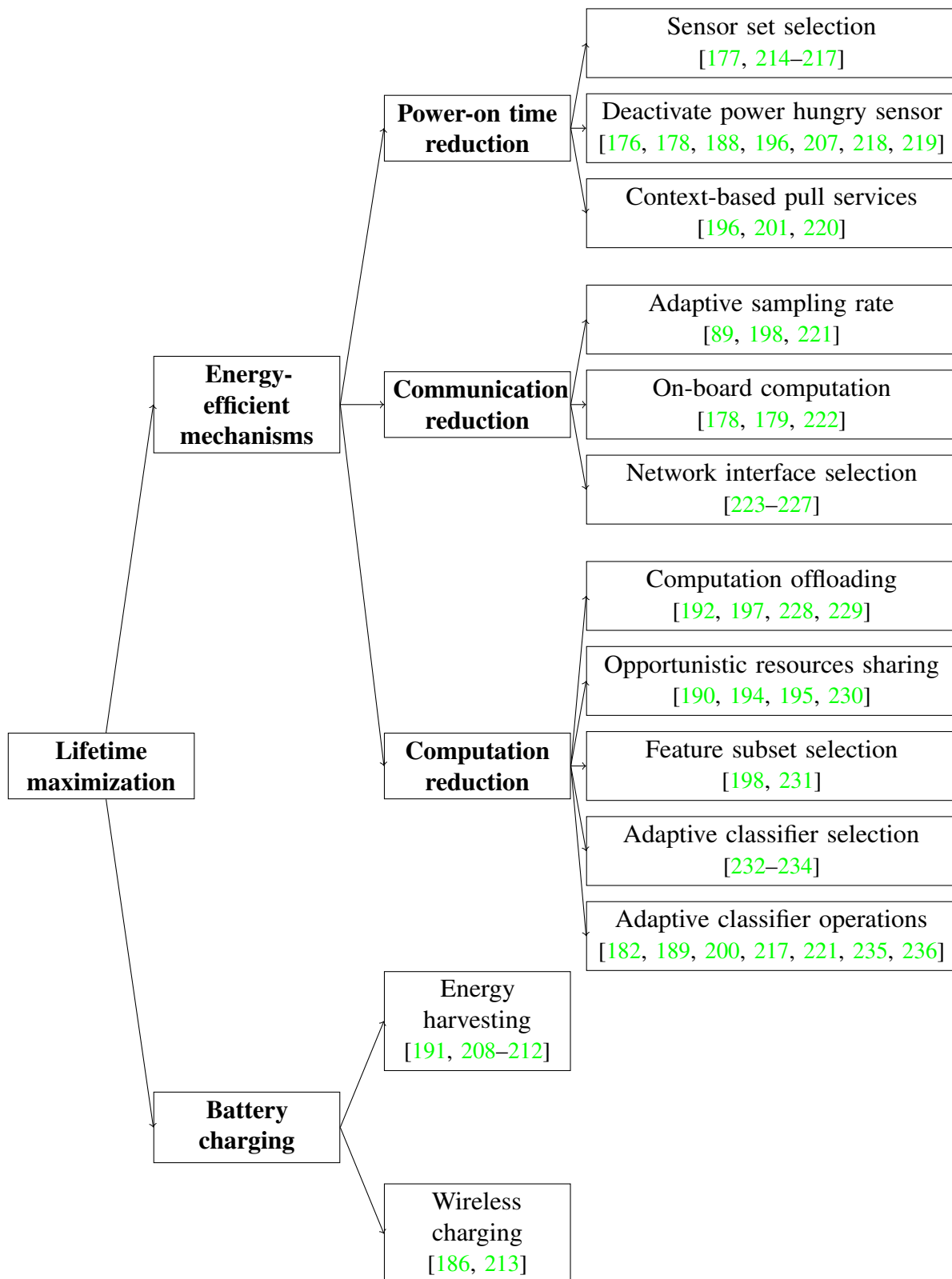

Fig. 5.5 Classification of the energy-efficient mechanisms and battery-charging mechanism for the lifetime maximization of human context recognition applications.

sensors may increase the recognition accuracy at the expense of additional energy consumption at the node level. Therefore, sensor set selection activate a subset of nodes depending on their contribution to keep a desired classification accuracy. Sensor set selection can be static [177] or dynamic [214]: the static approach makes the selection prior to deployment; the dynamic solution performs the selection at runtime, depending on some parameters such as the nodes residual energy, the required accuracy or the user activity.

Zappi et al. [214] developed a dynamic sensor selection scheme that selects a new cluster of sensors each time a sensor runs out of energy or fail. The cluster must be able to achieve a minimum desired classification accuracy and is such that even if a node fails, the other active sensors are still able to maintain the given accuracy. Noshadi et al. [177] consider the problem of selecting a subset of sensors, called predictors, so that it is still possible to infer the data of the not-selected sensors through prediction. These two selection schemes assume sensor redundancy (e.g Noshadi et al. consider up to 19 sensors attached to the arms of a user, Zappi et al. applied their method to a plantar pressure system with 99 sensors), but in body sensor network this assumption may not be practicable for sake of wearability. In SeeMon [217], Kang et al. dynamically select a small subset of sensors, called Essential Sensor Set (ESS), sufficient to answer the registered queries. Gao et al. [215] consider multi-modal sensing network for activity recognition and propose a framework that selects in real-time a subset of sensors to reduce energy consumption due to data transmission. They use convex optimization to minimize the number of active nodes while guaranteeing that the probability of misclassification using this subset is under a given threshold. Gordon et al. [216] use prediction to identify the future activities which are likely to occur and adapt the sensor subset accordingly. In a training phase, they first evaluate the dependency of each activity on the sensors, where the degree of dependency is the loss in accuracy compared to the usage of every sensor. At runtime phase, based on the classification history, future activities which are likely to occur are predicted. Then, only a subset of sensors is activated to distinguish the likely activities at little or no recognition cost.

### 5.5.2 Deactivate power-hungry sensors

The sensors have different energy consumption profiles, so it is worthwhile to deactivate the power-hungry devices when possible. Indeed, in [176], Lorincz et al. compare the energy consumption of different sensors and they measure a factor of 19 between sampling gyroscope (53163  $\mu\text{J}$ ) compared to sampling accelerometer (2805  $\mu\text{J}$ ). Thus, designers may consider disabling the gyroscope when the user is performing activities with low intensities

and turning off the GPS when the user is sitting or standing still [174].

Several solutions wake up power-hungry sensors on behalf of cheaper accelerometer measurements. Sun et al. [207] consider an ECG-based application where high physical activity can confound the signal. They propose the PEAR (Power Efficiency through Activity Recognition) architecture, which runs an on-board activity classification algorithm that determines whether the user is active or not by processing accelerometer data. If the user is in active state, the ECG stops sampling, transmitting and switches off its radio. In inactive mode, ECG data are sampled at 100 Hz and features are extracted from these data every 5 s and sent to the base station. Park et al. [178] propose the E-Gesture architecture for hand gesture recognition using hand-worn sensor device and a mobile phone. Their objective is to reduce the power-on time of the gyroscope while achieving high recognition accuracy under dynamic situations. Thus, the accelerometer continuously performs gesture recognition, and when it detects a gesture, it wakes up the gyroscope. Then, if the gyroscope confirms that the user is performing hand gesture, the sensor sends the data to the mobile phone. Lorincz et al. [176] proposed Mercury, a wearable sensor network platform for neuromotor disease studies, which uses accelerometer data to determine whether the node is moving or not. If the node is not moving, power-hungry sensors like gyroscopes are disabled and accelerometer data are dropped. Kim et al. present SensLoc [188], a place detection system which employs a movement detector to control active cycle of power-hungry sensors. Accelerometer data are used to awake WiFi beacon scans for place detection, while the GPS is awakened when the user leaves a place. The Energy Efficient Mobile Sensing System (EEMSS) proposed by Wang et al. [218] activates high-resolution power-hungry sensors only when low-consumption ones sense an interesting event. With a different frame of mind Laerhoven and Gellersen [219] suggest to replace a power-hungry gyroscope with nine cheaper and low-consuming accelerometers. They show that by increasing the number of sensors while decreasing their individual accuracy, it is possible to lower power consumption. Similarly, when the locality of a user is required, one can take advantage of the energy-accuracy trade-off between different techniques, where energy consumption increases from WiFi-based localization to GPS schemes, while the accuracy decreases from GPS to WiFi methodologies.

The solutions that consist in deactivating power-hungry sensors adapt the sensors operations to the user's context. Thus, the energy gain is dependent on the user activity profile. For instance, PEAR is designed in such a way that more energy is saved when the user is active because the solution switches off the ECG during high physical activity as it can confound the signal. In contrary, Mercury saves more energy when the user is inactive as power-hungry

sensors are disabled. Similarly, SensLoc saves more energy when the user mobility is low because both GPS and WiFi scans are deactivated.

### 5.5.3 Context-based pull services

An alternative approach towards reducing energy consumption exploits the correlation between contexts. Instead of continuously collecting data from sensors, these solutions decide whether or not acquire more data depending on statistical correlation across different forms of contexts.

The Acquisitional Context Engine (ACE) [196] uses intelligent sensor caching and activity correlation to reduce power consumption by using already inferred attributes or choosing less power hungry sensors to infer correlated activities. For example, when the system already knows that the user is driving and has learned the rule: 'if the user is driving, the user is not at home', ACE can deduce that the user is not at home without acquiring any sensor data. Similarly, ACE can first probe less energy consuming sensor – accelerometer – to determine whether the user is driving or not, and if the result imply that the user is not driving, it turns the GPS on and infers the actual user's location. Nath argues that ACE can be complemented with SeeMon [217] to integrate the temporal continuity of context in order to extract sophisticated rules such as 'if a user is in his/her office now, he cannot be at home in next 10 minutes'. MediAlly [220] adopts an Activity Triggered Deep Monitoring (ATDM) paradigm as an energy saving mechanism, where medical data streams are collected and relayed to a central server only when monitored context information is evaluated and satisfies given predicates. As an example, MediAlly can collect ECG data whenever the subject's context indicates physical or emotional stress. The ACQUA (Acquisition Cost-Aware Query Adaptation) [201] system avoids retrieving unnecessary sensor data by sequentially acquiring the data which has the highest probability to determine the result of the query. This choice is based on a-priori knowledge of energy consumption costs and probabilities, which can be inferred based on historical traces obtained for previous query executions. These approaches can save energy in the case of repetitive context, but are not applicable to detect more spontaneous contexts.

## 5.6 Communication reduction

In this section, we review techniques that aim to reduce the data communication costs, either by reducing the amount of data to be transmitted in the network or by carefully selecting the communication technology.

### 5.6.1 Adaptive sampling rate

In [237], Maurer et al. studied the impact of the accelerometer sampling rate on the recognition accuracy and they found that no significant gain in accuracy is achieved above 20 Hz for ambulation activities. Therefore, depending on the user activity and the type of sensor, it may not be necessary to sample at the maximum rate in order to achieve a desired accuracy. The key idea behind adaptive sampling rate is to adapt the frequency of data acquisition depending on the recognized context. This technique leads to fewer unneeded samples, which will result in less data to transmit.

In A3R (Adaptive Accelerometer-based Activity Recognition), Yan et al. [89] propose to adapt both the sampling rate (SR) and the classification feature (CF) in real-time. For each activity they compute offline the accuracy that can be achieved for different tuple  $\langle SR, CF \rangle$  of sampling rate and classification feature. Then, depending on the strategy, they determine per-activity the optimal tuple that can achieve a user-specified accuracy, or the tuple that have the highest ratio of accuracy over energy consumption. At runtime, when an activity is recognized, the application selects the corresponding tuple  $\langle SR, CF \rangle$  which enables to tradeoff energy and accuracy. Afterwards, in [198], Qi et al. introduced the idea that it requires a lower sampling rate to determine whether a specific activity happens or not than classifying multiple activities. Thus, their AdaSense architecture periodically decides whether the current activity changes or not through single activity event detection with a lower sampling rate. If a change is detected, AdaSense switches to the multi-activity classification at a higher sampling rate. Then the solution performs event detection of the new activity at a lower sampling rate. The major drawback of these solutions is the lack of flexibility as configurations are selected once and for all for a given activity, which requires a new training phase when considering new activities. In order to reduce the energy consumption and keep a low localization error, Liu et al. [221] consider that activities associated with faster speed need a higher GPS sampling rate and vice versa. The Jigsaw solution dynamically learns the optimal GPS duty cycle scheme given the remaining battery budget level, the expected duration of the tracking application and the user's runtime mobility level provided by the accelerometer.

### 5.6.2 On-board computation

On-board computation is used to reduce the amount of data to be transmitted towards the base station. The rationale behind this method is that computation requires less energy than communication. For example, a node can perform signal processing tasks such as feature

extraction in order to transmit the result instead of raw data. Similarly, compression encodes information in such a way that the number of bits needed to represent the initial message is reduced. This is energy-efficient because it reduces transmission times as the packet size is smaller. Another possibility that can be exploited jointly is to send burst of data instead of one data per packet.

Wang et al. [179] present a hierarchical architecture for real-time activity recognition, composed of accelerometer body sensors, two RFID readers positioned in each hand to detect handling of tagged objects and an UHF RFID reader in each room to locate the user who wears a UHF tag. The system operates in two stages. First, the accelerometers process their data to perform gesture recognition (e.g. right hand moving up, sitting down) at the node level. Then, recognized gestures, tagged objects and user locations information are transmitted to a PDA device, which runs the activity recognition (e.g. eating, making coffee, shaving) algorithm. Energy is saved at the sensor level thanks to reduced communication overhead, as nodes only transmit 1 byte data containing the gesture label every second. They demonstrate that the hierarchical approach enables to reduce the communication cost by 60% compared to a solution where all the sensor readings are transferred to the base station. The E-Gesture architecture [178] reduces packet transmissions by sending data only when a gesture is detected by both the accelerometer and the gyroscope sensors. Wang et al. [222] compare the energy/performance trade off between an on-node scheme where the classification is performed on the accelerometer, and an off-node scheme where the accelerometer sends its raw data to the base station. They show that with the on-node scheme 40% energy can be saved with 13% reduction in classification accuracy. So, their results suggest that it is more energy-efficient to perform all the tasks on the sensors. However, computation offloading is sometimes more energy-efficient than local computation without loss in accuracy (see subsection 5.7).

### **5.6.3 Network interface selection**

Sensors and mobile devices are often equipped with multiple network interfaces, such as ZigBee, Bluetooth, WiFi, and 3G. Each communication technology has different characteristics in terms of bandwidth availability, service area, economic costs and energy-consumption pattern. Thus, it is necessary to efficiently select the network interface in order to extend the lifetime of the mobile devices. This selection depends on the environment opportunities, that is, on the connection availability and on the application requirements (bandwidth, link quality, energy). Energy-efficient radio selection protocol have been proposed for both mobile phones and sensors.



In [224], Kim et al. privilege WiFi communications because they are more energy-efficient than 3G. Since 3G networks have wider service areas, their objective is to detect rapidly available WiFi access point while limiting the number of power-consuming WiFi scans. Similarly, Rhamati and Zhong [225] are interested in estimating the WiFi availability without turning on the interface because the energy cost for establishing a connection is very high, while it consumes less energy than cellular networks. They propose different selection policies based on the time, history, cellular network conditions (available access point, signal strength), and device motion. In [223], Paschou et al. select the most suitable data transfer technology to be used (e.g WiFi, 3G, SMS), depending on the volume and type of health data to be sent. The authors minimize the economic cost for the customer, but their work can be extended to consider other metrics.

Some studies consider sensors equipped with two radios: a low-power, low throughput radio, and a high-power, high throughput radio. Indeed, higher throughput radios have a lower energy-per-bit cost, but they also have higher start up time and cost. Therefore, high bandwidth radios become more energy efficient only when a large number of byte have to be transmitted, which compensate the wakeup energy overhead. The exact number of bytes above which a radio becomes more energy-efficient is called the *break-event point*. Nonetheless, not every healthcare application requires such a high data rate. Moreover, the energy consumption of high-power radio when idle is prohibitive, so it is imperative to turn it off when not in use. The transition overhead due to start-up cost can be amortized by buffering a minimum amount of data. In this context, Sengul et al. [227] propose the Bulk Communication Protocol (BCP) where the source node stores data in its buffer, and once it reaches a threshold (superior to the break-even point), it sends a message to the receiver over the low-power radio to ask him to turn on its high-power radio. Loseu et al. [226] accumulate data at local nodes and transmit them in bulk while not violating the timing constraint. The drawback of these solutions is the delay induced by the buffering process. Therefore, for strict deadline (e.g 20ms – 1s) healthcare applications it is preferable to use a low-power low-throughput radio since there is no time to accumulate enough packets in buffer.

Multi-radios devices offer new opportunities to save energy at both the sensors and the base station. However, even though the break-even point is indicative of the relative energy efficiency between two radios, it does not capture all parameters. For example, the radios may have different transmission range which will require more or less relay nodes depending on the used interface. Similarly, all the radios may not be available at the same time, or they may experiment different packet loss and interference profile, which directly impacts the energy consumption and robustness. Thus, there is a lot of trade-off to be explored between

energy-consumption, latency and robustness when designing network interface selection protocols in multi-radios systems [238].

## 5.7 Computation reduction

In this section, we focus on mechanisms that target the reduction of computation costs, as human context recognition applications require power-hungry and complex algorithms to process the signals and perform the classification task.

### 5.7.1 Computation offloading

For a node, computation offloading strategy consists in offloading a part of its computation tasks to another device. For example, a sensor can execute (a part of) its tasks on a more powerful base station (e.g. laptop, PDA), while a base station can offload its tasks on a back-end server. Thus, intensive calculation are performed on nodes with higher resources. This approach has proven to be energy-efficient under some conditions [192, 195, 239], and the usage of devices with different computing, storage and energy capabilities allows incorporating more complex algorithms and models. Thus, computation offloading leads to a trade-off between energy, latency and recognition accuracy.

In [192], Rachuri et al. propose SociableSense, an architecture dedicated to activity recognition for sociable interactions, where a phone with integrated sensors can offload its tasks to the cloud. SociableSense dynamically decides whether to perform the computation locally on the phone or remotely on back-end servers by maximizing a weight additive utility function that integrates the energy consumption, the latency and the amount of data sent over the network. The results show that it is more energy-efficient to offload the speaker identification task to the cloud when using the phone's microphone. This is also the configuration that achieves the lowest latency. CenceMe [197] performs audio and activity classification on the phone, while higher level forms of context such as social interaction and location are classified on a remote server. Liu et al. [228] developed a localization technique based on GPS sensing that offloads some calculations to the cloud. With few milliseconds of raw satellite's data, the server can estimate the device's past locations by exploiting information from public, on-line databases. Therefore, uploading data on a backend server can ease the execution of burdensome tasks when an appropriate strategy controls the impact of the communication load. However, custom-made application execution partitioning, such as the one used in CenceMe and SociableSense, requires significant effort from the developer's side. More general solutions allow an application developer to delegate the

partitioning task to a dedicated middleware. MAUI [229], for example, supports fine-grained code offloading to a cloud in order to maximize energy savings on a mobile device.

### 5.7.2 Opportunistic resources sharing

High density of sensing devices including mobile phone, wearable and ambient sensor networks has accelerated the rise of innovative collaborative sensing applications. Example of such application is Ear-Phone [236], which constructs a noise map from samples obtained by crowdsourcing data collection. On the one hand, the presence of other devices in close proximity to the user can be employed to increase the sensing capabilities of a unique device. On the other hand, many opportunities for establishing opportunistic connections between devices can be used for energy-efficient resources sharing.

The Remora architecture introduced by Keally et al. [194] exploits the physical proximity of several users to share resources among neighbouring Body Sensor Networks (BSN). Indeed, colleagues, family members or sport team may spend time together performing the same activity, in such a way that their respective BSN can overheard data transmission and collaborate. In this situation, if the proximity duration is long enough, resources sharing can provide an energy benefit. Remora implements a collaborative sensor node selection to improve accuracy while disabling as much sensors as possible, and duty-cycles classifiers so that one phone make the classification while other phones go into sleep mode. The CoMon platform [190] also addresses the energy problem through opportunistic cooperation among nearby users. CoMon first discovers nearby devices by periodic Bluetooth scans and selects candidates that will potentially stay in the vicinity for long period. This is to ensure that the cooperators will stay longer enough to breakeven the overhead due to the initiation of the cooperation. Then the devices negotiate a cooperation plan than will provide a mutual energy benefit. The authors highlight the difficulty of providing a fair negotiation process taking into consideration available sensing devices and their residual energy, user policies, and different sampling rate or accuracy requirements. ErdOS [230] is a mobile operating system that extends the battery life of mobile handsets by exploiting opportunistic access to resources in nearby devices using social connections between users. Notably, they distribute the sensing burden of shared ambient context by sharing GPS reads with nearby devices. Rachuri et al. [195] propose to offload some sensing tasks from user phone to remote sensors embedded in the environment. Their algorithm, called METIS, dynamically distributes the sensor tasks between the user phone and the infrastructure sensors based on the sensing power, sampling rate and user mobility. METIS first performs a discovery of the sensing

devices that are available in the environment and estimates the minimum amount of time the phone should suspend local sensing and use remote sensing to achieve energy gain.

Opportunistic resource sharing approaches are particularly suitable for *environmental* context monitoring, that is for contexts that are common to multiple neighboring nodes (e.g. noise level, speed movements). In this case, incentive mechanisms are likely to be necessary for crowdsourcing applications in order to enable collaboration between unknown users, and to obtain the requisite data. With another point of view, Rodriguez et al. [230] argue that if users notice a personal benefit in terms of energy savings and usability by sharing their resources in the long-term with subjects they personally know and trust, there is no need to implement potentially complex or costly incentive schemes to enforce cooperation.

### 5.7.3 Feature subset selection

Feature selection is generally used to select the features that are most discriminative and contribute more to the performance of the classifier. Indeed, some features may be irrelevant or redundant depending on the application (e.g. which activity we want to recognize) and the type of sensors. Moreover, some features like frequency-domain features are more computationally demanding than others. Therefore, there exists a delay/accuracy/energy trade off since using a lot of features certainly enhances the classification rate while it increases the delay and the energy consumption.

Cilla et al. [231] proposed a Pareto-based Multiobjective Optimization that selects feature subsets whose size is minimize while maximizing the accuracy of the classifier. Their approach provides the designer with diversified solutions closed to the Pareto-front. The advantage is that the expert does not have to set a priori tradeoff between accuracy and number of feature, but he will choose a posteriori the subset that best fits the application requirement knowing that these solutions are closed to the optimal. In AdaSense [198], Qi et al. design the offline SRO (Sampling Rate Optimization) algorithm that selects the optimal sampling rate and feature set of both single activity event detection and multiple activity classification under any accuracy requirements. It is a genetic programming based algorithm that explores the feature set with the objective to minimize the sampling rate while achieving a given accuracy.

### 5.7.4 Adaptive classifier selection

There exist different types of classifiers based on Decision trees, Bayesian approaches, Neural Networks, Markov models and so on. They differ from each other in terms of delay, memory size and computation requirements. Indeed, lightweight decision tree methods are usually preferred for embedded systems while distance-based classifiers that measure

a similarity between instances stored on a database are not convenient to be implemented on a mobile device. Similarly, ensembles of classifiers that combine the output of several classifiers to improve the classification accuracy are computationally expensive. Thus, every classifier has different energy, delay and accuracy properties. This is why some works propose to adapt the classifier to the available resources and application requirements, either in a static or dynamic way, in order to improve the system performances.

Martin et al. [232] developed a fuzzy-based on-line classifier selection that selects the best-suited classifier given *i*) offline classifier performance evaluation (trained accuracy, delay, memory need, complexity) *ii*) online accuracy and delay requirements (low, medium, high) and *iii*) the current device state (battery level, available memory, CPU load). In practice, given the current application requirements and device state, the fuzzy selector outputs a score indicating the desired quality level of the classification (i.e the desired accuracy, response time, complexity and memory use of an ideal classifier). Then, a distance-based algorithm selects the best classifier in the database that fulfils these scores. The results show that this approach enables to periodically choose the classifier that best suits the application requirements and device context. However, the difficulty of this study is to define the fuzzy rules used to score classifiers quality. Chu et al. [233] have developed the Kobe toolkit that performs profiling and optimization of mobile embedded classifiers to achieve an optimal energy-latency-accuracy trade-off. The developers have to specify the accuracy, latency and energy constraints. Then, Kobe tunes the classifier parameters (e.g. sample windows size, number of FT sample points). Kobe also adopts computation offloading at runtime: it decides whether to partially or entirely offload the computation to the cloud in response to system changes (phone battery levels, network bandwidth and latency, processor load). Their results show that for comparable levels of accuracy, traditional classifiers suffer between 66% and 176% longer latencies and use between 31% and 330% more energy. Orchestrator adaptively changes sets of features and classifiers for context recognition depending on current set of available sensors and pre-defined system policy [234].

### 5.7.5 Adaptive classifier operations

In traditional architectures, classifiers are usually triggered periodically and operate on a given data window size. However, it is possible to adjust the classifier behaviour depending on the recognized context in order to reduce the computation time of the classifiers.

Au et al. [200] introduce the episodic sampling technique which aims at adapting the classification rate depending on the activity variation. The proposed solution additively increases the interval between activity recognition when the classification result remains the

same, and multiplicatively decreases the interval when a change in the activity is detected. It trades-off accuracy with energy as nodes can go to sleep between two classification episodes. Nevertheless, the algorithm may exhibit lower performances when context changes experience high dynamics which necessitates a careful parameters setting. Srinivasan and Phan [235] focus on reducing the amount of time the activity recognition system stays awake while guaranteeing a high confidence prediction of the current activity being performed. The idea is that differentiating between idle and non-idle activities requires a smaller window of accelerometer samples compared to identifying specific user's physical activities. Thus, their two-tier classifier first uses a small window size to determine if the user is idle or not; if the user is not idle, the two-tier classifier acquires more sensor samples to identify the user's fine-grained activity. In [182], Lin et al. propose the BeWell+ architecture to continuously monitor user behaviour along three health dimensions: sleep, physical activity and social interaction. In order to save energy, the solution dynamically tunes the rate at which sampling, feature extraction and activity inference are performed, each time there is a change in the wellbeing scores. Thus, BeWell+ allocates energy to provide more accurate monitoring and responsive feedback for wellbeing dimension of highest concern, by giving priority on specific health dimension (e.g. sleep) where the user needs most help. In contrast, user with healthy behaviours are monitored less closely, with a feedback provided on a lower scale - therefore using less resources on the smartphone. As a result, the gain in energy-efficiency will depend on the user behaviour. That is, a user with poor wellbeing scores across all dimensions will consume more energy than a consumer who exhibits comparatively high wellbeing scores, allowing the adaptive scheme to lower energy used for these dimensions.

In order to spare computation resources, some researches aim at filtering out samples that are not likely to contain information at an early stage of the context monitoring process. SeeMon [217] makes early decision in the processing pipeline in order to significantly save computational overhead when no changes in the context are detected. SoundSense [189], EAR-phone [236] and Jigsaw [221] duty-cycle classifiers depending on the quality of sensed data: noise measurements that are not accurate enough for the target application are discarded. For example, Ear-Phone is a noise-mapping application that first determines the phone sensing context (in hand or in pocket / bag), and measurements that are detected as measured in the pocket or bag are not taken into account in the calculation of the user's noise exposure. The Jigsaw's admission control block throw away packets indicative of silence.

## 5.8 Battery charging

In this section, we present another approach for lifetime maximization which consists in charging batteries.

### 5.8.1 Energy harvesting

New technologies have been developed to enable sensors to harvest energy from their environment like sun, heat or movement [5, 240, 241]. Compared to traditional sensors, rechargeable motes can operate continuously and, theoretically, for an unlimited length of time. They convert ambient energy to electrical energy and then either consume it directly or store it for later use. For healthcare applications, body heat and body movement are two main sources of energy harvesting.

#### Body heat

The human body heat represents an interesting source of energy since the human metabolism generates and dissipates heat. Indeed, a human being generates more than 100W of heat on average, and about 1–2% of this heat can be used to obtain an electrical power of the order of milliwatts. At typical indoor conditions, the heat flow in a person mainly stays within the 1–10 mW/cm<sup>2</sup>. In this conditions, powering of a low-power health-monitoring sensor by using energy harvesters become feasible. In [191], Leonov study the efficiency of a thermoelectric energy harvester integrated into an office-style shirt. The system can generate power in 5-0.5 mW range at ambient temperatures of 15-27 °C respectively. The author also highlights that the power generated by wearable thermal devices does not depends on the user metabolic rate, but on the overall body heat, air speed and sweating rate. So, during exercise the harvesting power will not necessarily increase. In [208], Leonov et al. are able to power a watch-style sensor module that measures and transmits the battery voltage, the temperature and/or light intensity every 2s. The thermal energy generator successfully delivers 100  $\mu$ W at 22 °C, which is enough to power the system as it requires 50-75  $\mu$ W to operate. As can be seen, given the small efficiency of thermal harvesting, only low-power applications (below 1-2 mW) can run efficiently on human body heat.

#### Body movement

Human activities, such as walking or running are also potential sources of energy harvesting since mechanical vibrations can be converted into electrical energy by different mechanisms: electromagnetic, electrostatic, and piezoelectric. In [209], Gorlatova et al. quantify the inertial energy that can be harvested from the activities of 40 individuals over periods up to 9 days. The data were collected from three sensing units located on the shirt pocket, waist belt and trouser pocket. It appears that 20-second walking and running motion can generate up to 202  $\mu$ W and 808  $\mu$ W respectively. Cycling activity generates only 52

$\mu W$ , but in this case harvester placements on the lower legs should be considered. The authors highlighted other main findings: Walking downstairs generates more power than going upstairs because of the higher accelerations involved. Taller people generate around 20% more power than shorter people. People are passive most of the time since 95% of the total harvestable energy is generated during less than 7% of the day. In their survey, Paradiso and Starner argue that the most promising way to harvest energy from people is by taping their gait [241]. Therefore, the shoe designed by Shenck and Paradiso [212], which integrates piezoelectric elements beneath a standard running insole, scavenges energy from heel strike. Each shoe produces sufficient energy to transmit a 12-bit code via an on-board radio as the bearer walked. In practice, it is possible to generate more power, but the devices become bulky and heavy. For example, in [210], Donelan et al. present an energy harvester that generates electricity during human walking with minimal user effort. The energy harvester is mounted at the user knee and is only engaged during the decelerating portion of the stride cycle. In this way, the system assists the leg motion at the end of the swing phase. The authors demonstrate that the metabolic cost, that is the additional metabolic power required to generate 1 Watt, is reduced by the generative braking action of the device. An output power of 5 W is obtained when the subjects wear one device on each leg during normal walking motion. In [211], Rome et al. exploit the mechanical energy produced by the vertical movement of a backpack during walking and convert it to electricity. They observe that generally the electrical power increases with walking speed and the weight of the load in the backpack. Their system is able to generate up to 7.4 Watts when the user is wearing a 38 kg backpack during fast walking. For the time being, the weight of the backpack (between 20 kg and 38 kg) is a limitation as only serious hikers or military personnel will wear such a load.

Mitcheson [242] compare the performance of both kinetic and thermal energy harvesters. Theoretically, kinetic harvesters achieve higher power density of around  $300 \text{ mW}/\text{cm}^3$  compared to around  $20 \text{ mW}/\text{cm}^3$  with a thermal device. However, given the current state development of kinetic and thermal devices, Mitcheson shows that for equivalent volume, current thermoelectric devices achieve greater densities. Moreover, it appears that kinematic generators are more dependent on the user mobility. As a consequence, if the user is immobile or if the sensor is not worn on a limb, the generated power would be lower.

### 5.8.2 Wireless charging

Recent breakthroughs in wireless power transfer are expected to increase the sustainability of sensor networks and make them perpetually operational, since these techniques can be used to transmit power between devices without the need of any contact between the transmitter and the receiver. Wireless charging in wireless sensor networks can be achieved in two ways:



electromagnetic (EM) radiation and magnetic resonant coupling. Xie et al. [117] show that omni-directional EM radiation technology is applicable to a WSN with ultra-low power requirement and low sensing activities (like temperature, light, moisture). This is because EM waves suffer from rapid drop of power efficiency over distance, and active radiation technology may pose safety concerns to humans. In contrast, magnetic resonant coupling appears to be the most promising technique to address energy needs of WSNs thanks to an higher efficiency within several-meter range.

Wireless energy transfer has already been applied to power medical sensors and implantable devices. In [213], Damm et al. use inductive power supply in order to power *in vivo* hip prosthesis. The prosthesis is instrumented with 6 strain gauge sensors in order to measure the forces and moments acting in the hip joint prosthesis. An external coil is fixed around the patient implant during the experimentation in order to deliver the power of 5mW, required by system to acquire data and send them to the base station. Still, some challenges remain to be addressed: the energy transmission efficiency decays rapidly with the distance. Moreover, the system requires the usage of a large induction coil wired to an external device [243]. In a more pervasive manner, Gummeson et al. [186] designed a wearable ring for gesture recognition that opportunistically harvests energy from a NFC-enabled phone. The achieved scavenging performances depend on the relative positioning of coils, that is on the position of the user's finger when holding the phone.

Magnetic coupling, kinetic and thermal energy sources have been studied for both external and in-vivo sensors. While wireless charging is more controllable, it requires an external device or installation to power the sensor. This can be inconvenient and trouble the activities of the patients, but efforts are being made to develop small-size wearable device that can be placed over the implantation area to power implanted sensors and communicate with them [244]. We summarize in Table 5.3 the power that can be harvested from different sources of energy. For comparison, we give in Table 5.4 the power consumption of the different platforms. As can be seen, the power that can be harvested is still low, so that for the moment these solutions can only power specifically designed sensors with low duty-cycle.

## 5.9 Summary and discussion

In the previous sections, we have detailed four main strategies for energy optimization, namely, *power-on time reduction*, *communication reduction*, *computation reduction* and *battery charging*. Ideally, a designer will need to apply strategies from all these four categories to maximize the lifetime of his/her human context recognition system. Examples of studies that implement several of these mechanisms are: Mercury [176], which combines power-on time reduction through deactivation of power-hungry sensors, with communication reduction

Table 5.3 Energy harvesting opportunities for wearable sensors.

Power source	Reference	Power
<b>Thermal</b>	watch [208]	100 $\mu W$ at 22 °C
	shirt [191]	5-0.5 mW at 15-27 C
<b>Kinetic</b>	cycling [209]	52 $\mu W$
	walking [209]	202 $\mu W$
	running [209]	813 $\mu W$
	insole	1-2 mW per step
	knee [210]	5 W
	backpack [211]	7.4 W
<b>Wireless charging</b>	inductive charging [213]	5 mW
	wearable ring [186]	18 mW
<b>Solar for comparison</b>	indoor light [209]	50-100 $\mu W$ per cm <sup>2</sup>

Table 5.4 Power needs of different platforms.

Shimmer [245]	Hip prosthesis [213]	Watch [208]
70 mW	5 mW	50-75 $\mu W$

through on-board processing; A3R [89] and AdaSense [198] architectures implement a per-activity feature selection to reduce computation, in combination with adaptive sampling mechanisms in order to reduce communications. However, depending on the application or on the selected architecture, it may not always be possible to associate solutions. A cardiac monitoring application using a unique ECG sensor that transmits its data towards the user's mobile phone will not use sensor set selection nor adaptive sampling. However, it will be able to employ both feature subset selection and on-board computation in order to extract relevant characteristics of the signal and to reduce the number of transmissions. Moreover, energy harvesting technologies do not eliminate the need for the other energy optimization techniques. It is important to note that nodes remain energy-limited between two harvesting opportunities, so they still need to implement energy-saving mechanisms. For example, the wearable ring [186] scavenges energy opportunistically when the user interacts with his/her mobile phone. As a consequence, the ring platform also integrates energy-efficient mechanisms such as deactivation of power-hungry audio sensor, and classifier selection. Such an energy-aware design helps to reduce harvesting needs, which in turn enables embedded devices to conduct more useful tasks with the limited power they can scavenge.

It is hard to estimate the lifetime we can expect from a system that combines the best techniques. We represent in Figure 5.6 the lifetime achieved by different architectures in

hours of operation. Interestingly, we can see that globally the lifetime of mobile phones are shorter than the lifetime of sensors. This means that although mobile phones have higher battery capacity than sensor nodes, they deplete their energy faster. As a consequence, when designing energy-efficient heterogeneous architectures like the one introduced in Figure 5.2, the mobile phones used as base station may become serious bottlenecks. Therefore, there is a need to take into consideration the energy-limitation of every device involved in the activity recognition chain.

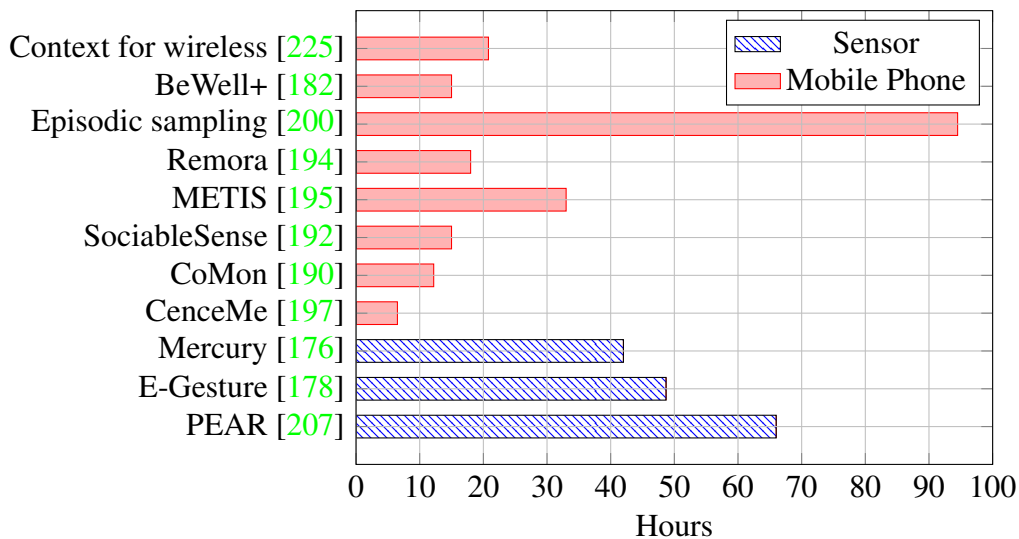

Fig. 5.6 The estimated battery lifetime in hours of different architectures.

We plot in Figure 5.7 the recognition accuracy achieved by different architectures. As we can see, most of the solutions experiment an accuracy superior to 90%. Two of the three architectures which have a recognition accuracy lower than 90% carry their classification task on sensor node. This may be explained by the fact that sensor nodes have fewer resources, so that the classification is limited to lightweight classifiers which may have lower classification performance. It is interesting to note that some solutions, such as Remora [194] or CoMon [190], save energy while improving the accuracy. These solutions carefully determine *when* and *what* resources to share among users, depending on the costs and benefits of sharing a resource.

Although latency is a requirement of importance, few studies report their achieved latency. Therefore, it is not clear how long complex architectures will take to recognized current context. For example, solutions based on opportunistic resource sharing need to detect available sensors, and estimate if the co-location time will be long enough to provide an energy benefit. The overhead induced by the initiation of the collaboration may be affordable in some applications, particularly for environment context recognition.

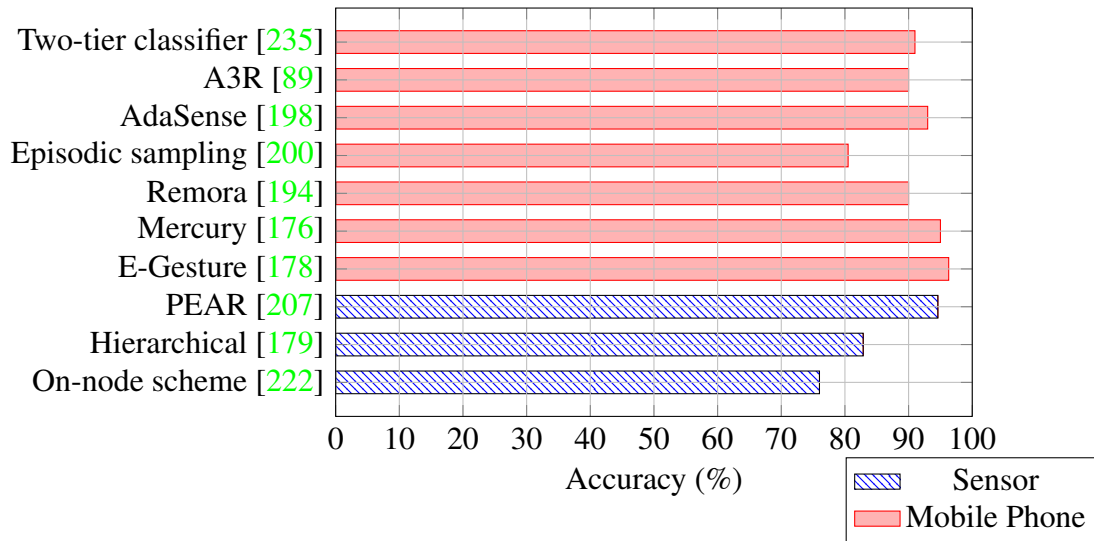

Fig. 5.7 The accuracy achieved by different architectures in percent.

Finally, it is possible to notice that in the proposed solutions the energy consumption is generally related with the user's context. For example, in some solutions the energy consumption of the system is directly related to the time spent by the user in active state. In other solutions, the energy consumption depends on the user location. This ability of a system to reduce its energy consumption in function of external parameters can be characterized as follows:

- **Agnostic:** The solution does not implement any adaptive mechanism and behaves in the same way whatever the user activity or environment are. The energy consumption is constant over the time. This is the case of the Hierarchical architecture [179], in which the sensors transmit 1 byte of data every seconds.
- **User level of activity:** The energy consumption of the architectures depends on the user level of activity. In Mercury [176], PEAR [207] and Two-tier classifier [235], the system operates differently depending on the user state (idle or not).
- **User type of activity:** The energy consumption of the system depends on the type of activities being performed by the patient. Typically, A3R [89], AdaSense [198] and E-Gesture [178] architectures adapt their policy in function of the current user activity.
- **User frequency change of context:** The solution consumes more energy when the user changes from one activity to another frequently. For example, the On-node scheme [222] sends a report only when the activity changes while the Episodic sampling technique [200] spaces signal processing when no changes are detected.

- **User location:** The energy saving opportunities depend on the user environment. As a direct illustration, SociableSense [192], METIS [195] and Context-for-wireless [225] monitor the user mobility and location in order to take advantage of the existence of external devices in the environment.
- **User co-location:** The monitoring system can take advantage of the existence of another system in the environment, and they can initiate a collaboration. For instance, the Remora [194] architecture shares sensing and computational resources among neighboring personal sensor networks in order to save energy.
- **User needs:** The system adapts to the user needs in terms of monitoring since some patients does not require to be monitored as closely as others. For example, BeWell+ [182] provides a lower feedback to patient that need less help in order to save resources. MediAlly [220] can trigger medical data acquisition whenever the subject's context indicates physical or emotional stress.

## 5.10 Conclusion and open research issues

In this section, we aim to shed some light on open research issues relating to energy-efficient human context recognition based on wearable sensing through the following points:

### 5.10.1 Unbalanced residual energy

Devices involved in context recognition may have unbalanced residual energy due to different energy consumption rates, and energy harvesting rates. Indeed, depending on their role, sampling frequency or communication technology, nodes will deplete their battery more or less rapidly. Furthermore, nodes may have an uneven residual energy distribution due to the difference in the quantity of the collected energy. For instance, the energy that can be harvested from human activities will not be the same for two identical sensors if one is located on the chest and the other one is located on the leg. As a consequence, nodes with low residual energy may be assigned lower sensing periods, while those with high residual energy may be preferred for running context recognition tasks. In addition, the same battery level at two different devices could have different implications: for example, 50% battery left at a sensor dedicated to a unique application represents a longer operating time compared to 50% battery left at a mobile phone running multiple applications. Thus, the fraction of the phone's energy dedicated to the context recognition application must not be as high as the one of the sensors: a part of phone's energy must be preserved to be dedicated to other tasks,

such as calling or text messaging. Therefore, it is possible to consider new decision metrics that include the desired implication of a device in the application in terms of energy usage. Finally, Lu et al [221] point out that the same battery level at a different time could mean a totally different thing. Indeed 50% battery left is really bad in the early morning, but is abundant in the early evening. These discrepancies between devices regarding unbalanced residual energy have to be taken into account when designing context recognition systems based on wearable sensors.

### **5.10.2 Mutual and cross technology interference mitigation**

As the popularity of sensing devices grows, we can expect that a single user will carry a number of context sensing devices. In this context, multiple devices will work together towards improved context sensing. We showed in section 5.7 that the cooperation of multiple body area networks can save energy through opportunistic resources sharing. However, the collocation of several wearable sensor networks sharing the same unlicensed band dramatically increases the level of interference, which in turn negatively affects the network performance [246]. Indeed, mutual (e.g. WiFi-WiFi, ZigBee-ZigBee) and cross (e.g. WiFi-ZigBee) technology interference arise when several body sensor networks operate in the same vicinity, due to the broadcast nature of the wireless channel. For instance, data transmission within ZigBee networks can completely starve due to WiFi communications, which uses 10 to 100 times higher transmission power. As a consequence, the increase of re-transmissions due to collisions, and multiple carrier sensing, result in increased energy consumption. Therefore, there is a need to develop interference-aware solutions in order to ensure an energy-efficient radio spectrum utilization.

### **5.10.3 Devices heterogeneity**

Mobile sensing is challenged by a growing number of devices used for context-aware applications. This combination of sensors leads to heterogeneous architectures composed of devices with different capabilities in terms of sensing, accuracy, computation, communications and battery power. Heterogeneous architectures offer a certain flexibility since the devices have different resources whose usage can be optimized, and the use of multiple sensors allow improving the context recognition. However, heterogeneity raises programmability issues since devices are provided by different manufacturers. This makes the design of sensing platform using different devices and OS types very hard. Envisioned solutions to the problem of heterogeneity are cloud sensing, which combine virtualization of nodes, and semantic-based query processing. The objective is to reduce the configuration time

by providing a common framework to represent and access information, while allowing optimization across multiple devices. While easing the development, cloud sensing requires communication between virtualized devices and cloud. In this context, communication overhead will have to be controlled.

#### **5.10.4 Collocation of concurrent application**

Until recently, most of the context recognition systems were developed for a unique application. Researchers adopted an application-driven approach: applications determine the types and amount of resources required to execute the program, and request the resource through the provided APIs. However, future systems are likely to run multiple context recognition applications at a time. In this context, if the device is not equipped with the underlying appropriate OS for concurrent resource management, energy performance will degrade. For example, a user may be willing to run both a wellbeing application that encourages healthy behavior such as BeWell+ [182], and a noise exposure mapping application such as Ear-Phone [236], which both use the microphone sensor on phone. In order to save energy, BeWell+ dynamically tunes the rate at which sampling, feature extraction and context inference are performed, while Ear-Phone does not take into consideration measurements taken when the phone is carried in the bag or pocket. If run simultaneously, it is not clear how energy gain of both solutions will be offset by the behavior of the other application. In Orchestrator [234], Kang et al. defend the need for a system-driven approach to tackle the complexity of resource management in dynamic and concurrent environment. The Live-Labs [247] experience confirms the difficulty of satisfying multiple applications accessing a sensing platform when considering different requirements in terms of type of information, sampling frequency, level of accuracy, or latency. Although some studies propose to manage resources of a mobile device or sensor node [248, 249], a general framework for multi-context recognition across heterogeneous devices is missing.

#### **5.10.5 Anticipatory energy saving**

Beyond context recognition, *context anticipation* represents a powerful tool for tackling a number of health and well-being issues, from obesity to stress and addiction [250]. Applications will anticipate changes in user's health and behaviour, and take proactive decisions in order to impact the future state, based on the predictions of the future state of the context. For instance, an application can proactively tackle depression by detecting decreased movement, the lack of socializing, and irregular sleep patterns of the patient, and then encourage the participant to go out and socialize, for example by sending a link to two discounted theater

tickets. These systems will offer great benefit for the patient follow up by allowing the development of innovative ways of delivering interventions. In addition to the social benefit, such anticipatory applications will help to proactively manage energy and wireless resources. Indeed, the ability to predict users' location, social encounters or health hazards will enable devices to predict future harvesting opportunities, resource sharing opportunities or application demands. For example, given good weather forecasts, a system can anticipate that the user will jog for one hour this weekend, thus expecting to recharge a part of its battery through body movement.

To conclude, we anticipate that energy management will be a huge challenge because it is a key enabler of real-world applications development and market penetration. In this context, we hope that this survey will be helpful to the pervasive and mobile research community willing to address the energy issues of health-related wearable sensing systems. With this objective, this chapter surveys existing energy-efficient approaches designed for human context recognition based on wearable sensors for healthcare and wellbeing applications. More particularly, we have proposed a new classification of these mechanisms, and we have reviewed up-to-date references in details.





# Chapter 6

## Energy-efficient gateway selection strategies for a wearable sensor architecture

In this chapter, we present a new energy-efficient architecture for health monitoring where sensors send the sensed data mainly via the user mobile phone, but they have the possibility to send data to access points when they are available in the user environment. The objective of the proposed strategies is to relieve a unique base station from receiving all the data, and it enables sensor nodes to select the best communication technology in terms of energy consumption. Contrary to existing approaches, our solution allows to optimize the lifetime of both the sensors and the base station. The simulation results show that the proposed approach effectively improves the energy efficiency of the system compared to traditional architectures where wearable sensors can only communicate with the user mobile phone.

### 6.1 Introduction

As surveyed in the previous chapter, many solutions have been proposed to save energy in health-related wearable sensor networks. Among them we can cite minimal sensor subset selection [177], deactivation of power-hungry sensors [207], adaptive sampling rate [198], communications reduction [179] and resource sharing [194]. However, these works are usually interested in the energy consumption of the sensors but never consider that the base station can also be energy-constrained. Traditionally, powerful laptop acted as base station, but for mobility consideration most of the works now consider mobile phone as base station. Although phones are more powerful devices compared to wearable sensors, the truth is that they also face energy consumption problems [202].

We believe that activity recognition architectures can take advantage of the proliferation of smart devices (phones, tablets, laptops) and their daily usage to balance the load among multiple base stations. For example, when at home and at the office, body sensors can send their data towards a laptop or an access point. When outdoor, a mobile phone or a tablet can alternatively take the relay depending on their availability. The advantages of this strategy are twofold. First, it prevents a unique base station from receiving all the data. Second, when the sensors are equipped with multiple radios, it enables to select the best suited communication technology depending on the available connections. Indeed, the different radios may have various performance profiles in terms of energy consumption, coverage area, bandwidth and link quality.

In this chapter, we propose a new architecture for body area networks in order to save energy at both the sensors and the mobile phone. We consider sensors equipped with Bluetooth and ZigBee communication interfaces, like SHIMMER sensors [245]. We assume that a sensor can always send its data to the user mobile phone through Bluetooth, but sometimes a ZigBee access point is available in the user environment. Our objective is to privilege ZigBee communications as they are less energy-consuming for the sensors, and during this period of time the mobile phone can switch off its Bluetooth interface, thus saving energy. In our solution, the sensors have to regularly perform tests - called network interface selection (NIS) - in order to check if there is an available ZigBee access point. Similarly, the mobile phone has to perform regular tests - called Bluetooth scan - in order to detect if a sensor needs to communicate with it when there is no available ZigBee access point.

Our contributions are as follows: first, we present a new energy-efficient architecture for wearable sensor networks that allows to optimize the lifetime of both the sensors and the mobile phone. We then propose three strategies to effectively implement our architecture: the *fixed*, *adaptive* and *SMS-based* approaches. These solutions determine when to perform the tests at the sensors and mobile phone in order to leverage energy-efficiency for latency. We also model and analyze the delay of the different proposed strategies. Finally, we evaluate our solutions through simulations and compare their performances to a reference architecture where the sensors can only stream their data to the mobile phone, like in [176, 178, 207].

The rest of this chapter is organized as follows. In the next section, we present recent studies related to network interface selection schemes. In Section 6.3, we introduce the general idea of our solution. In sections 6.4 and 6.5, we present respectively the adaptive and SMS-based versions of our approach. Then, in section 6.6, we model and analyze the delay of our different solutions since they trade-off energy for latency. Afterwards, in Section 6.7, we present our simulation results and we show how our approach increases the network lifetime compared to traditional architectures. Finally, Section 6.8 concludes the chapter.

## 6.2 Related works

Sensors and mobile phones are often equipped with multiple network interfaces, such as ZigBee, Bluetooth, WiFi, and 3G. Each communication technology has different characteristics in terms of bandwidth availability, coverage area, economic costs and energy-consumption pattern. Thus, it is necessary to efficiently select the network interface in order to extend the lifetime of the mobile device. This selection depends on the environment opportunities, that is, on the available connections and on the application requirements (bandwidth, link quality, energy).

At the mobile phone, existing research works are interested in selecting the best network interface (Wi-Fi / cellular network) in terms of energy consumption. Indeed, 3G consumes twice as much energy as Wifi connections, but 3G networks have wider service areas. Thus, the mobile device must communicate in Wi-Fi as much as possible. Kim et al. [224] proposed to adapt the interval between two network interface selections. This is because frequent network interface selections consume energy at the phone device for Wi-Fi scanning to discover an access point, while it reduces the communication time via 3G. The authors show that their solution improves energy-efficiency by 15% compared to the case where the phone is only using 3G. Rhamati and Zhong [225] propose to estimate the Wi-Fi availability without turning on the interface because the energy cost for establishing a connection is very high. They propose different selection policies based on the time, history, network conditions (available access point, signal strength), and device motion. In-field experiments demonstrate that this approach can achieve 35% improvement in battery lifetime. Paschou et al. [223] select the most suitable data transfer technology to be used (WiFi, 3G, SMS) in terms of economic costs for the user, depending on the volume and type of health data to be sent.

At sensor nodes, some studies are interested in the fact that higher throughput radios have a lower energy-per-bit cost [238]. However, high throughput radios also have higher start up time and energetic cost. Therefore, high bandwidth radios become more energy efficient only when a large number of bytes have to be transmitted, which offsets the wakeup energy overhead. Nonetheless, not every healthcare application requires such a high data rate. Moreover, the energy consumption of high-power radio when idle is prohibitive, so it is imperative to turn it off when it is not in use. The transition overhead due to start-up cost can be amortized by buffering a minimum amount of data. In this context, Sengul et al [227] and Loseu et al. [226] propose to accumulate data at local nodes and then transmit them. The drawback of these solutions is the delay induced by the buffering process. Therefore, for strict deadline (e.g 20ms – 1s) healthcare applications it is preferable to use a low-power low-throughput radio since there is no time to accumulate enough packets in buffer. Thus,

existing network interface selection approaches for sensor nodes aim to optimize the usage of a higher throughput interface. Our approach is different from previous solutions since our objective is to save energy at the sensor level by giving priority to a less-consuming communication technology when available. In the next section, we present our architecture model for energy-efficient network interface selection at personal wearable sensor networks.

We are aware that mutual and cross technology interference may occur when other wireless communications such as Bluetooth, Wi-Fi or ZigBee are ongoing in the user environment [251, 252]. Interference issues are beyond the scope of this study, but our architecture is enough open to integrate existing interference mitigating techniques. For example, in [251], the authors formulate an optimization problem for the assignment of Wi-Fi and ZigBee channels to dual radio devices, so that the mutual and cross technology interference are minimized.

### 6.3 Motivations and general idea of our solution

In the proposed architecture, we consider that a patient is equipped with a sensor that monitors his/her status health. We assume that a sensor can always connect and transfer its data to the smartphone of the patient through Bluetooth. We also consider that the sensor can connect to a ZigBee base station, whose access is possible only in some environments, for example at home or at the office. These base stations could be laptops or internet boxes equipped with a ZigBee receiver. Then, the mobile phone and the ZigBee access points can transfer the data to a remote server which centralizes the sensed data. This architecture is illustrated in Figure 6.1. Thus, Bluetooth is considered as a high-availability primary wireless network while the use of ZigBee is restricted to the coverage of particular access points. Generally, ZigBee consumes less energy than Bluetooth. Moreover, when the sensor is sending its data to a ZigBee access point, the smartphone can switch off its Bluetooth interface and thus saves energy. Thus, if ZigBee is available instead of Bluetooth in certain area, sensors will communicate via the ZigBee interface in order to reduce the energy cost of data transfer and to discharge the smartphone from communication for a while. We consider that the access points are not energy-limited. Therefore, they periodically broadcast beacons so that the sensor can discover an access point by listening the medium.

To use ZigBee interface, the sensor has to check for ZigBee availability and perform a vertical handover from Bluetooth to ZigBee. So, the sensor needs to perform periodic network interface selection in order to detect if a ZigBee access point is available. When the sensor communicate with a ZigBee access point, the smartphone can switch off its Bluetooth communication and save energy. When a ZigBee communication ends, the sensor puts itself

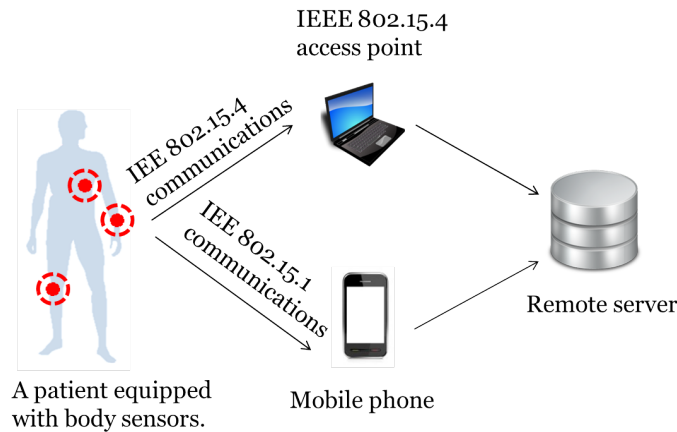

Fig. 6.1 The considered architecture.

in discoverable mode, so that the mobile phone can initiate a Bluetooth session. However, the mobile phone does not know the availability profile of ZigBee. This is why the mobile phone needs to perform periodic Bluetooth scan to detect if the sensor is willing to communicate with it. At the end, there will be a succession of ZigBee and Bluetooth connections at the sensor. A *network cycle* is defined as a Bluetooth session followed by a period of Zigbee communications.

We propose the following three strategies for the mobile phone to detect the sensor and/or the sensor to detect ZigBee access point.

### 6.3.1 Fixed approach

We first assume that the Bluetooth scan interval  $\delta_{scan}$  and the network interface selection interval  $\delta_{NIS}$  are constant. We denote this solution EENIS (Energy-Efficient Network Interface Selection) and we illustrate its behaviour in Figure 6.2. In the first place, the sensor is communicating with the mobile phone, and checks every  $\delta_{scan}$  seconds if a ZigBee access point is available (1). When the sensor detects that ZigBee is available, it sends its data towards the access point (2). At that time, the phone does not receive any more data: it switches off its Bluetooth interface and goes to sleep mode (3). Then, it periodically performs Bluetooth scan to detect if the sensor wants to communicate with it (4). Afterwards, as the user is moving the ZigBee access point becomes unavailable, thus the sensor enters in discoverable mode in order to be detected by the phone (5). The mobile phone will detect the sensor at its next Bluetooth scan, and it will initiate a Bluetooth communication with the sensor: a new network cycle begins (6).

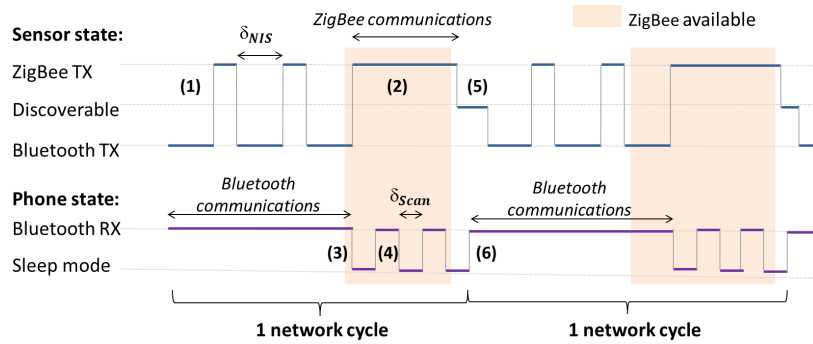

Fig. 6.2 Illustration of the behaviour of the EENIS solution.

### 6.3.2 Adaptive approach

The Bluetooth scan interval  $\delta_{scan}$  and the network interface selection interval  $\delta_{NIS}$  are critical parameters because they greatly impact the energy consumption of the smartphone and the sensor respectively. Indeed, frequent Bluetooth scans are costly for the smartphone because the power used when a mobile phone is performing a device discovery is not negligible [253]. Thus, scanning mode of Bluetooth is very power-demanding and should be used carefully. At the same time, frequent Bluetooth scans reduce the delay because when the sensor is waiting to be discovered, it cannot send data. Similarly, at the sensor side, frequent network interface selections consume a lot of energy to switch off/on the radios, but it allows reducing the time spent in Bluetooth when ZigBee access points are detected more rapidly. Therefore, there is a trade-off between frequent network interface selections and reducing transmissions over Bluetooth.

In the adaptive approach, the sensors and the mobile phone estimate the ZigBee availability in order to adjust the interval between two tests to the network conditions. This strategy is detailed in Section 6.4.

### 6.3.3 SMS-based approach

In the fixed and adaptive approaches, when the ZigBee access point is not anymore available and the mobile phone Bluetooth interface is still switched off, a high packet delivery delay may be observed. To tackle this shortcoming, we propose an SMS-based solution: the remote server detects when a sensor is no more connected to a ZigBee access point (since it does not receive data for a while), and sends a SMS to the patient's mobile phone. Upon receiving the text message, the mobile phone turns on its Bluetooth interface and initiate a connection, without any need for intervention from the user. The advantages of this strategy are twofold:

- First, this solution conserves the energy of the mobile phone since the mobile performs a Bluetooth scan only when needed, thus staying longer in sleep mode.
- Second, the delay is restricted to the time required by the server to send the SMS. In [254], Dondyk measured that it takes on average 9.8s to deliver a notification to the mobile phone, which may be a reasonable delay for some healthcare applications.

The SMS-based approach is detailed in section 6.5.

## 6.4 Adaptive approach

In the adaptive strategy, the sensor and the mobile phone learn the availability of ZigBee, and calculate the optimal interval between two tests. At the sensor side, our objective is to determine the optimal network interface selection interval  $\delta_{NIS}^*$  which achieves a good trade-off between the energy consumption due to Bluetooth communications and the additional energy consumption due to network interface selection. At the phone side, our objective is to determine the optimal Bluetooth scan interval  $\delta_{Scan}^*$  which offers a trade-off between the additional energy consumption due to Bluetooth discovery procedures and the latency introduced when the sensor is waiting to be discovered.

We can model the availability status of ZigBee with a two-state Markov chain [224] as given in Figure 6.3. Here,  $\lambda$  denotes the state transition rate of ZigBee from the unavailable to the available state, while  $\mu$  is the state transition rate from the available state to the unavailable state. We model the usage patterns of Bluetooth and ZigBee with a continuous Markov process. Both  $\lambda$  and  $\mu$  can change depending on the network environment and on the user mobility. In order to determine the optimal intervals  $\delta_{NIS}^*$  and  $\delta_{Scan}^*$  we need to model

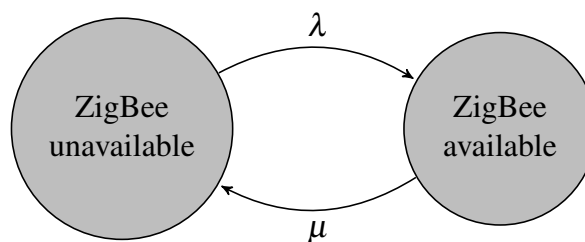

Fig. 6.3 Two-states diagram of ZigBee availability

the energy consumption of the devices in function of the ZigBee availability. We use the notations summarized in Table 6.1. We will consider the model introduced by Kim et al. in [224] and adapt it as follows:



Table 6.1 Notations and descriptions used for modeling the energy consumption.

Notations	Descriptions
$\lambda$	State transition rate of ZigBee from the unavailable to the available state.
$\mu$	State transition rate of ZigBee from the available state to the unavailable state.
$\mathbb{E}[T_{BT}]$	The expected Bluetooth usage time of the sensor and the phone during one network cycle.
$\mathbb{E}[T_{Zig}]$	The expected ZigBee usage time of the sensor during one network cycle.
$\mathbb{E}[T_{Sleep}]$	The expected sleep time of the mobile phone during one network cycle.
$e_{BT}$	The energy cost at the sensor for data transmission per Bytes over Bluetooth (J/Bytes).
$e_{Zig}$	The energy cost at the sensor for data transmission per Bytes over ZigBee (J/Bytes).
$e_{NIS}$	The energy cost at the sensor for one network interface selection operation.
$e_{Scan}$	The energy cost at the mobile phone for one Bluetooth scan operation.
$\mathbb{E}[AR]$	The expected average amount of data to be transferred by the sensor (Bytes/s).
$TC_{Sensor}$	Total energy consumption of the sensor during one network cycle.
$TC_{TX}$	Total energy consumption at the sensor due to transmissions during one network cycle.
$TC_{NIS}$	Total energy consumption of the sensor spent for network interface selection operations during one network cycle.
$TC_{Scan}$	Total energy consumption of the mobile phone for Bluetooth scan operations during one network cycle.
$\delta_{NIS}$	The network interface selection interval (sec).
$\delta_{Scan}$	The Bluetooth scan interval (seconds).
$P_{Succ}(\delta_{NIS})$	The probability that a network interface selection result is a success when using the $\delta_{NIS}$ interval.
$P_{Scan\_Succ}(\delta_{Scan})$	The probability that a Bluetooth scan result is a success when using the $\delta_{Scan}$ interval.
$\mathbb{E}[N(\delta_{NIS})]$	The expected number of network interface selection operations performed by the sensor during one network cycle when using the $\delta_{NIS}$ interval.
$\mathbb{E}[N_{Scan}(\delta_{Scan})]$	Expected number of Bluetooth scan operations performed by the mobile phone during one network cycle when using the $\delta_{Scan}$ interval.

### 6.4.1 Sensor side

The total energy consumption of the sensor  $TC_{Sensor}$  is composed of the energy used to transfer the data and the energy spent during the periodic network interface selection.

$$TC_{Sensor} = TC_{TX} + TC_{NIS} \quad (6.1)$$

We define the random variables  $\mathbb{E}[T_{BT}]$  and  $\mathbb{E}[T_{Zig}]$  respectively as the expected Bluetooth and ZigBee usage time of the sensor during one network cycle. We define the random variables  $\mathbb{E}[T_{BT}]$  and  $\mathbb{E}[T_{Sleep}]$  as the expected Bluetooth and Sleep usage time of the phone during one network cycle. Note that  $\mathbb{E}[T_{Zig}]$  and  $\mathbb{E}[T_{Sleep}]$  represents the same variable since the phone is sleeping when the sensor is sending its data to a ZigBee access point. However, it is convenient to distinguish the notation for the sensor and the phone in the following.

$e_{BT}$  (resp.  $e_{Zig}$ ) denotes the energy costs for transmission of data per Bytes over Bluetooth (resp. over ZigBee).  $\mathbb{E}[AR]$  represents the expected average amount of data to be transferred by the sensor in (Bytes/s). Thus, we can calculate the energy consumption of the sensor for data transfer as follows:

$$TC_{TX} = (e_{BT} \times \mathbb{E}[T_{BT}] + e_{Zig} \times \mathbb{E}[T_{ZIG}])\mathbb{E}[AR] \quad (6.2)$$

The sensor performs periodic network interface selection in order to detect if a ZigBee access point is available. The result of each network interface selection is either a success or a failure. We consider that there is a failure when there is no accessible ZigBee, so that Bluetooth must be used. The existence of a ZigBee access point is considered as a success. When a successful wireless interface selection occurs, a vertical handover is performed from Bluetooth to ZigBee. Each network interface selection is a Bernoulli trial. The probability that ZigBee is in an available state after  $t$  seconds given that it was unavailable can be calculated by the transient state probability of a continuous Markov process, as expressed in (6.3):

$$P[\text{ZigBee is available after } t \text{ seconds} \mid \text{unavailable}] = \frac{\lambda}{\lambda + \mu} - \frac{\lambda}{\lambda + \mu} e^{-(\lambda + \mu)t} \quad (6.3)$$

Using  $\delta_{NIS}$  as the network interface selection interval, the probability that a network interface selection is a success is:

$$P_{Succ}(\delta_{NIS}) = \frac{\lambda}{\lambda + \mu} - \frac{\lambda}{\lambda + \mu} e^{-(\lambda + \mu)\delta_{NIS}} \quad (6.4)$$

Thus, given  $P_{Succ}(\delta_{NIS})$  the expected number of performed network interface selection operations  $\mathbb{E}[N(\delta_{NIS})]$  is:

$$\mathbb{E}[N(\delta_{NIS})] = \frac{1}{P_{Succ}(\delta_{NIS})} \quad (6.5)$$

The expected usage time of Bluetooth  $\mathbb{E}[T_{BT}]$  during one network cycle can be calculated by (6.6) using  $\mathbb{E}[N(\delta_{NIS})]$  and  $\delta_{NIS}$ .

$$\mathbb{E}[T_{BT}] = \mathbb{E}[N(\delta_{NIS})] \times \delta_{NIS} \quad (6.6)$$

The expected usage time of ZigBee  $\mathbb{E}[T_{Zig}]$  during one network cycle is given by (6.7).

$$\mathbb{E}[T_{Zig}] = \frac{1}{\mu} \quad (6.7)$$

$TC_{NIS}(\delta_{NIS})$  denotes the energy cost of wireless interface selection during one network interface selection. When  $\delta_{NIS}$  is used as the interval, the total energy consumption of network interface selection during one network cycle can be calculated by (6.8).

$$TC_{NIS}(\delta_{NIS}) = e_{NIS} \times \mathbb{E}[N(\delta_{NIS})] \quad (6.8)$$

The optimal interval  $\delta_{NIS}^*$  is the interval that minimizes the energy consumption of the sensor, that is  $\delta_{NIS}^* = \arg \min_{\delta_{NIS}} TC_{Sensor}(\delta_{NIS})$ .

## 6.4.2 Phone side

We define the failure and success of a Bluetooth scan operation from the mobile phone's side. We consider that a failure occurs when the sensor is transmitting data to a ZigBee access point, i.e. when ZigBee is available, because the mobile phone will not detect the sensor during the scan. When there is no accessible ZigBee access point, it is a successful case because the sensor will be waiting to be discovered by the phone. Using  $\delta_{Scan}$  as the Bluetooth scan interval, the probability that a scan is a success after  $\delta_{Scan}$  seconds given that the last test was a failure (i.e. the probability that ZigBee is unavailable after  $\delta_{Scan}$  seconds given that ZigBee was available) can be calculated as follows.

$$\begin{aligned} P_{Scan\_Succ}(\delta_{Scan}) &= P[\text{ZigBee is unavailable after } \delta_{Scan} \text{ seconds} \mid \text{available}] \\ &= \frac{\mu}{\lambda + \mu} - \frac{\mu}{\lambda + \mu} e^{-(\lambda + \mu)\delta_{Scan}} \end{aligned} \quad (6.9)$$

From equation (6.9), the expected number of performed Bluetooth scan operations is:

$$\mathbb{E}[N_{Scan}(\delta_{Scan})] = \frac{1}{P_{Scan\_Succ}(\delta_{Scan})} \quad (6.10)$$

From equation (6.10), the expected sleep time  $\mathbb{E}[T_{Sleep}]$  of the phone during one network cycle is:

$$\mathbb{E}[T_{Sleep}] = \mathbb{E}[N_{Scan}(\delta_{Scan})] \times \delta_{Scan} \quad (6.11)$$

The expected usage time of Bluetooth can be calculated as follows, given the memory-less property of exponential distribution.

$$\mathbb{E}[T_{BT}] = \frac{1}{\lambda} \quad (6.12)$$

The total cost for Bluetooth scanning during one network cycle changes according to the Bluetooth scan interval, and can be expressed as in (6.13).

$$TC_{Scan}(\delta_{Scan}) = e_{Scan} \times \mathbb{E}[N_{Scan}(\delta_{Scan})] \quad (6.13)$$

The optimal interval  $\delta_{Scan}^*$  is the interval that trades-off the energy consumption of the phone and the delay. We propose that  $\delta_{Scan}^* = \arg \min_{\delta_{Scan}} TC_{Scan}(\delta_{Scan}) + \delta_{Scan}$ .

### 6.4.3 EENIS algorithms

In what follows, we present the EENIS algorithms that are implemented in the sensor (Algorithm 2) and in the mobile phone (Algorithm 3). The notations used in the algorithms are summarized in Table 6.2. At the beginning, the sensor is communicating with the user mobile phone and checks every  $\delta_{NIS}$  seconds if a ZigBee access point is available (1.2). When it detects that ZigBee access point is available (1.3), it is able to measure the time spent in Bluetooth during this network cycle  $T_{BT}[t]$  (1.6), and it can estimate the expected usage time of Bluetooth in the following network cycle  $\mathbb{E}[T_{BT}[t+1]]$ , using  $T_{BT}[t]$  and  $\mathbb{E}[T_{BT}[t]]$  (1.7-8).  $\alpha$  is a parameter between 0 and 1 that reflects if we give more importance to the recent measurements ( $\alpha$  near 1) or if we give more importance to the overall environment history ( $\alpha$  near 0). Then, the sensor can approximate the expected transition rate of ZigBee from unavailable to available  $\mathbb{E}[\lambda]$ , using  $\mathbb{E}[T_{BT}[t+1]]$  (1.9).

Afterwards, when ZigBee is no more available, the sensor switches back to Bluetooth communications (1.11). It is able to measure the time spent in ZigBee state  $T_{Zig}[t]$  and the amount of data transferred during this network cycle  $AR[t]$  (1.14). The sensor can estimate the expected usage time of ZigBee in the next network cycle  $\mathbb{E}[T_{Zig}[t+1]]$ , using  $T_{Zig}[t]$  and

Table 6.2 Notations and descriptions used in our algorithms.

Notations	Descriptions
$\mathbb{E}[\lambda]$	Expected state transition rate of ZigBee from the unavailable to the available state.
$\mathbb{E}[\mu]$	Expected state transition rate of ZigBee from the available state to the unavailable state.
$\mathbb{E}[T_{BT}[t]]$	The expected Bluetooth usage time of the sensor and the phone in the $t$ th network cycle.
$\mathbb{E}[T_{Zig}[t]]$	The expected ZigBee usage time of the sensor in the $t$ th network cycle.
$\mathbb{E}[T_{Sleep}[t]]$	The expected sleep time of the mobile phone in the $t$ th network cycle.
$T_{BT}[t]$	The Bluetooth usage time of the sensor and the mobile phone in the $t$ th network cycle.
$T_{Zig}[t]$	The ZigBee usage time of the sensor in the $t$ th network cycle.
$T_{Sleep}[t]$	The sleep time of the mobile phone in the $t$ th network cycle.
$\mathbb{E}[AR[t]]$	Expected average amount of data to be transferred by the sensor (B/s) in the $t$ th network cycle.
$AR[t]$	Average amount of data to be transferred by the sensor (Bytes/s) in the $t$ th network cycle.
$TC_{Sensor}$	Total energy consumption of the sensor.
$TC_{Scan}$	Total energy consumption of the mobile phone for Bluetooth scan operations.
$\delta_{NIS}$	The network interface selection interval (sec).
$\delta_{Scan}$	The Bluetooth scan interval (seconds).
$\delta_{NIS\_NEW}$	New network interface selection interface at the sensor.
$\delta_{Scan\_NEW}$	New Bluetooth scan interval at the phone.
$\alpha$	Coefficient value ( $0 \leq \alpha \leq 1$ ).

$\mathbb{E}[T_{Zig}[t]]$  (1.15-16). It also approximates the expected amount of data to be transferred in the next network cycle  $\mathbb{E}[AR[t+1]]$ , using  $AR[t]$  and  $\mathbb{E}[AR[t]]$  (1.17-18). The expected transition rate of ZigBee from available to unavailable can be approximated using  $\mathbb{E}[T_{Zig}[t+1]]$  (1.19). Finally,  $\delta_{NIS\_NEW}$  is calculated using  $\mathbb{E}[\mu]$ ,  $\mathbb{E}[\lambda]$  and  $\mathbb{E}[AR[t+1]]$ , and is assigned to  $\delta_{NIS}$  for the next network cycle (1.20).

When the sensor is communicating with the ZigBee access point, the mobile phone performs a device discovery every  $\delta_{Scan}$  seconds (1.24). When it detects the sensor, it starts to receive data from the sensor (1.25). At that time, the phone is able to measure the time spent in sleep mode  $T_{Sleep}[t]$  (1.28), and it approximates the expected time spent in sleep mode at the next network cycle  $\mathbb{E}[T_{Sleep}[t+1]]$  using  $T_{Sleep}[t]$  and  $\mathbb{E}[T_{Sleep}[t]]$  (1.29-30). Then, when the mobile phone does not receive any more data it goes in sleep mode (1.33), and it is able to measure the time spent in Bluetooth during this network cycle  $T_{BT}[t]$  (1.36). The phone can also estimate the expected usage time of Bluetooth in the following network

cycle  $\mathbb{E}[T_{BT}[t+1]]$  (1.37-38), and the expected transition rate of ZigBee from unavailable to available  $\mathbb{E}[\lambda]$  (1.39). Eventually, the phone calculates the new  $\delta_{Scan\_NEW}$ , using  $\mathbb{E}[\mu]$  and  $\mathbb{E}[\lambda]$ , and assigned this new value to  $\delta_{Scan}$  for the next network cycle (1.40).

---

**Algorithm 2** Sensor side
 

---

```

1: function NETWORK INTERFACE SELECTION
2:   Check ZigBee state every  $\delta_{NIS}$  seconds
3:   If (ZigBee is available) Call BTToZigBee
4: end function

5: function BTTOZIGBEE
6:   Measure  $T_{BT}[t]$ 
7:   Update  $\mathbb{E}[T_{BT}[t+1]]$  :
8:    $\mathbb{E}[T_{BT}[t+1]] := \alpha \times T_{BT}[t] + (1 - \alpha) \times \mathbb{E}[T_{BT}[t]]$ 
9:   Update  $\mathbb{E}[\lambda]$  :  $\mathbb{E}[\lambda] = \frac{1}{\mathbb{E}[T_{BT}[t+1]]}$ 
10:  Send data to ZigBee access point
11:  If (No more ZigBee access point) Call ZigBeeToBT
12: end function

13: function ZIGBEE TO BT
14:  Measure  $T_{Zig}[t]$  and  $AR[t]$ 
15:  Update  $\mathbb{E}[T_{Zig}[t+1]]$  :
16:   $\mathbb{E}[T_{Zig}[t+1]] := \alpha \times T_{Zig}[t] + (1 - \alpha) \times \mathbb{E}[T_{Zig}[t]]$ 
17:  Update  $\mathbb{E}[AR[t+1]]$  :
18:   $\mathbb{E}[AR[t+1]] := \alpha \times AR[t] + (1 - \alpha) \times \mathbb{E}[AR[t]]$ 
19:  Update  $\mathbb{E}[\mu]$  :  $\mathbb{E}[\mu] = \frac{1}{\mathbb{E}[T_{Zig}[t+1]]}$ 
20:  Update  $\delta_{NIS\_NEW}$ :  $\delta_{NIS\_NEW} = \arg \min_{\delta_{NIS}} TC_{Sensor}$  using  $\mathbb{E}[\mu]$ ,  $\mathbb{E}[\lambda]$  and  $\mathbb{E}[AR[t+1]]$ .
21:  Send data to the mobile phone
22: end function

```

---

When the architecture includes multiple body sensors, each sensor runs the EENIS algorithm independently. In case sensors have different data generation rate, they will calculate different  $\delta_{NIS}$  parameters. Thus, the sensors will detect the ZigBee access point at different times. The phone will remain in Bluetooth mode until at least one sensor is connected, that is until at least one sensor has not yet detected a ZigBee access point. In order to do that, the mobile phone only has to know the number of sensors involved in the applications. Then, it manages a variable that counts the number of sensors currently detected. Moreover, we need to consider a time division multiple access (TDMA) channel scheme in order to prevent contention if all sensors want to communicate.

**Algorithm 3** Phone side

---

```

23: function BLUETOOTH_SCAN
24:   Perform Bluetooth scan every  $\delta_{Scan}$  seconds
25:   If (Sensor is discoverable) Call SleepToBT
26: end function

27: function SLEEPTOBT
28:   Measure  $T_{Sleep}[t]$ 
29:   Update  $\mathbb{E}[T_{Sleep}[t+1]]$  :
30:    $\mathbb{E}[T_{Sleep}[t+1]] := \alpha \times T_{Sleep}[t] + (1 - \alpha) \times \mathbb{E}[T_{Sleep}[t]]$ 
31:   Update  $\mathbb{E}[\mu]$  :  $\mathbb{E}[\mu] = \frac{1}{\mathbb{E}[T_{Sleep}[t+1]]}$ 
32:   Receive data from sensor
33:   If (No more connection) Call BTToSleep
34: end function

35: function BTTO_SLEEP
36:   Measure  $T_{BT}[t]$ 
37:   Update  $\mathbb{E}[T_{BT}[t+1]]$  :
38:    $\mathbb{E}[T_{BT}[t+1]] := \alpha \times T_{BT}[t] + (1 - \alpha) \times \mathbb{E}[T_{BT}[t]]$ 
39:   Update  $\mathbb{E}[\lambda]$  :  $\mathbb{E}[\lambda] = \frac{1}{\mathbb{E}[T_{BT}[t+1]]}$ 
40:   Update  $\delta_{Scan\_NEW}$ :  $\delta_{Scan\_NEW} = \arg \min_{\delta_{Scan}} TC_{Scan} + \delta_{Scan}$ , using  $\mathbb{E}[\mu]$  and  $\mathbb{E}[\lambda]$ .
41:   Go in sleep mode
42: end function

```

---

## 6.5 SMS-based approach

The SMS-based approach introduces modifications at the server and mobile phone sides, but each sensor still runs the EENIS adaptive algorithm in order to detect ZigBee access points. In this SMS-based solution, the remote server is able to detect when a sensor is no more connected to a ZigBee access point. Indeed, in our architecture, the server centralizes all the generated data. Since the data generation rate is assumed to be constant, the server can detect when it has not received data from a sensor for a while. In order to do this, the server manages one timer per sensor, and sends a notification to the patient's mobile phone through a wakeup short message service (SMS) every time it detects that a sensor is disconnected from an access point (see Algorithm 4). Upon receiving the text message, the mobile phone can switch on its Bluetooth interface if in sleep mode, and initiate a communication with the sensor, without the intervention of the patient (Algorithm 5). Thus, this solution exploits the traditional cellular text messaging as a side channel in facilitating energy conservation as

illustrated in Figure 6.4. This strategy has several advantages in terms of latency and energy saving at the mobile phone. Indeed, with this solution, the phone performs a sensor discovery only once per network cycle, per sensor, that is only when a sensor is disconnected from a ZigBee access point. Moreover, this policy does not require the phone to be connected to a data network (3G, WiFi) to receive messages from the server while in sleep mode. In addition, the short message service (SMS) is inherently energy efficient, because the radio does not enter the high power state when receiving SMS [254]. Finally, regarding latency, a sensor will wait at most  $\delta_{SMS}$  seconds to be discovered by the phone, where  $\delta_{SMS}$  is the time required by the server to detect that a sensor is disconnected and send a SMS towards the phone. Dondyk [254] measured that it takes on average 9.8s to deliver a notification to the mobile phone. Zerfos et al. [255] found that 73.2% of messages are delivered within a ten seconds delay. Note that this solution is especially suitable for users who have unlimited or cheap text messaging. We also could imagine that the text messaging costs are included by the health application provider.

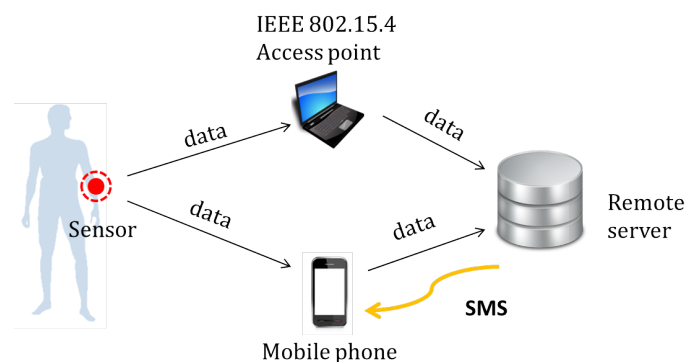

Fig. 6.4 The SMS-based approach.

---

**Algorithm 4** Server side

---

- 1: **function** RECEIVE DATA FROM SENSOR ( $i$ )
  - 2:     **Reinitialize** timer for sensor ( $i$ )
  - 3: **end function**
  
  - 4: **function** TRIGGER TIMER FOR SENSOR ( $i$ )
  - 5:     **Send SMS** to the mobile phone
  - 6: **end function**
-



---

**Algorithm 5** Phone side

---

```

1: function RECEIVE SMS FOR SENSOR(i)
2:   Perform Bluetooth scan
3:   If (Sensor i is discovered) Do nbConnected++
4:   Else if (nbConnected == 0) Go in sleep mode
5: end function

6: function NO MORE DATA FROM i
7:   Do nbConnected--
8:   If (nbConnected == 0) Go in sleep mode
9: end function

```

---

## 6.6 Delay modeling and analysis

### 6.6.1 Delay modeling

In this section, we model the expected delay of a single node under four data transfer policies: Bluetooth only, ZigBee only, using both Bluetooth and ZigBee communication technologies with the adaptive approach, and with the SMS-based approach. We use the notation summarized in Table 6.3.

**Using Bluetooth only** With this strategy the sensor can only send its data towards the mobile phone through Bluetooth communications. The expected delay  $E[D_{BT}]$  can be expressed as in equation (6.14) where  $D$  represents the amount of data to transfer (in MB), and  $E[R_{BT}]$  denotes the expected data transfer rate of Bluetooth (in MB/s).

$$E[D_{BT}] = \frac{D}{E[R_{BT}]} \quad (6.14)$$

**Using ZigBee only** When using the ZigBee-only policy, the sensor has to wait for available access point to send its data. The minimum number of network cycles required to transfer the data is denoted by  $NC_{Zig}$ , and can be expressed by equation (6.15).

$$NC_{Zig} = \left\lceil \frac{D}{E[T_{Zig}] \times E[R_{Zig}]} \right\rceil \quad (6.15)$$

The expected delay  $E[D_{Zig}]$  is given in equation (6.16). It includes the delay due to the effective transmission of data through ZigBee  $D/E[R_{Zig}]$  - where  $E[R_{Zig}]$  is the expected data transfer rate of ZigBee (in MB/s) - plus the non-used Bluetooth periods when ZigBee access

Notations	Descriptions
$\mathbb{E}[T_{BT}]$	The expected Bluetooth usage time of the sensor and the mobile phone during one network cycle.
$\mathbb{E}[T_{BT}^{Eff}]$	The effective time during which transmission can occur in Bluetooth.
$\mathbb{E}[T_{Zig}]$	The expected ZigBee usage time of the sensor during one network cycle.
$\delta_{NIS}$	The network interface selection interval (seconds).
$\delta_{Scan}$	The Bluetooth scan interval (seconds).
$E[D_{BT}]$	The expected delay when using the Bluetooth only policy.
$E[D_{Zig}]$	The expected delay when using the ZigBee only policy.
$E[D_{Zig/BT}]$	The expected delay when using both ZigBee and Bluetooth.
$D$	The amount of data to transfer at the sensor node (in MB).
$E[R_{BT}]$	The expected data transfer rate of Bluetooth (in MB/s).
$E[R_{Zig}]$	The expected data transfer rate of ZigBee (in MB/s).
$NC_{Zig}$	The minimum number of network cycles required to transfer the data when using the ZigBee only policy.
$NC_{Zig/BT}$	The minimum number of network cycles required to transfer the data when using both ZigBee and Bluetooth.
$E[A_{Zig}]$	The expected availability of ZigBee.
$p$	The time required to perform a network interface selection (in seconds).

Table 6.3 Notations and descriptions used for the delay modeling.

points are not available. When the data transfer begins with a ZigBee period, the non-used time is equal to  $(NC_{Zig} - 1) \times E[T_{BT}]$  while when the data transfer begins with a Bluetooth period, it is equal to  $NC_{Zig} \times E[T_{BT}]$ . Therefore, the expected delay  $E[D_{Zig}]$  depends on the availability of ZigBee  $E[A_{Zig}]$ , which can be estimated as  $E[A_{Zig}] = E[T_{Zig}] / (E[T_{Zig}] + E[T_{BT}])$ .

$$\begin{aligned}
E[D_{Zig}] = & E[A_{Zig}] \times \left( (NC_{Zig} - 1) \times E[T_{BT}] + \frac{D}{E[R_{Zig}]} \right) \\
& + (1 - E[A_{Zig}]) \times \left( NC_{Zig} \times E[T_{BT}] + \frac{D}{E[R_{Zig}]} \right)
\end{aligned} \tag{6.16}$$

**Using both Bluetooth and ZigBee with the adaptive approach** With this strategy, the sensors use both their Bluetooth and ZigBee interfaces to transfer their data depending on the ZigBee availability. During Bluetooth connection, the sensors periodically perform ZigBee access point detection which induces short Bluetooth disconnection. Thus, the sensor disconnects every  $\delta_{NIS}$  seconds for  $p$  seconds, where  $p$  is the time required to perform a ZigBee access point detection. Therefore, we have to distinguish between the expected time spent in Bluetooth  $E[T_{BT}]$  and the effective time during which transmission can occur in

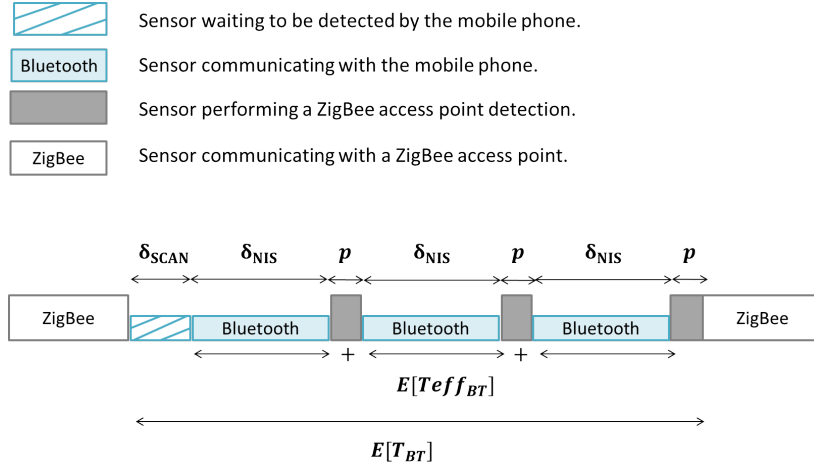

Fig. 6.5 Illustration of the difference between  $E[T_{BT}]$  and  $E[T_{BT}^{Eff}]$ .

Bluetooth  $E[T_{BT}^{Eff}]$ , as illustrated in Figure 6.5. Thus, the effective time during which the sensor can send its data through Bluetooth is equal to the expected time spent in Bluetooth minus the time spent while waiting to be discovered by the mobile phone, and the time spent by the sensor performing ZigBee access point detection. For simplicity, we estimate the time spent by the sensor waiting to be discovered by  $\delta_{SCAN}$ . In fact,  $\delta_{SCAN}$  is the maximum amount of time during which the sensor can wait before being discovered. Therefore, we will have an upper bound on the expected delay since it is a conservative approach.

$E[T_{BT}^{Eff}]$  can be expressed as in (6.17).

$$E[T_{BT}^{Eff}] = E[T_{BT}] - \delta_{SCAN} - p \times \left[ \frac{E[T_{BT}] - \delta_{SCAN}}{\delta_{NIS} + p} \right] \quad (6.17)$$

The minimum number of network cycles required to transfer the data is denoted by  $NC_{Zig/BT}$ , and can be expressed by (6.18).

$$NC_{Zig/BT} = \left\lceil \frac{D}{E[T_{Zig}] \times E[R_{Zig}] + E[T_{BT}^{Eff}] \times E[R_{BT}]} \right\rceil \quad (6.18)$$

The data transfer can begin during either a ZigBee or a Bluetooth cycle. Therefore, we have to consider the availability of ZigBee when calculating the delay. The expected delay when using ZigBee and Bluetooth together,  $E[D_{Zig/BT}]$ , can be expressed by:

$$E[D_{Zig/BT}] = E[A_{Zig}] \times ((NC_{Zig/BT} - 1) \times (E[T_{BT}] + E[T_{Zig}]) + \beta_1) + (1 - E[A_{Zig}]) \times ((NC_{Zig/BT} - 1) \times (E[T_{BT}] + E[T_{Zig}]) + \beta_2) \quad (6.19)$$

In (6.19),  $\beta_1$  and  $\beta_2$  represent the delay of the residual data (RD) that have to be transferred during the last network cycle where

$$RD = D - (NC_{Zig/BT} - 1) \times (E[T_{BT}^{Eff}] \times E[R_{BT}] + E[T_{Zig}] \times E[R_{Zig}]) \quad (6.20)$$

$\beta_1$  denotes the expected delay for the last network cycle when the data transfer begins with a ZigBee period. We have to distinguish two cases: the residual data can be transferred during the ZigBee period, and the residual data is transferred using both ZigBee and Bluetooth period.

$$\begin{aligned} \text{if } \left[ \frac{RD}{E[R_{Zig}] \times E[T_{Zig}]} \right] \leq 1 \text{ then } \beta_1 &= \frac{RD}{E[R_{Zig}]} \\ \text{else } \beta_1 &= E[T_{Zig}] + \delta_{SCAN} + \frac{(RD - E[R_{Zig}]E[T_{Zig}])}{E[R_{BT}]} \\ &+ \left[ \frac{(RD - E[R_{Zig}]E[T_{Zig}])}{\delta_{NIS}} \right] \times p \end{aligned} \quad (6.21)$$

Similarly,  $\beta_2$  denotes the expected delay for the last network cycle when the data transfer begins with a Bluetooth period. We have to distinguish two cases: the residual data can be transferred during the Bluetooth period, and the residual data is transferred using both Bluetooth and ZigBee period.

$$\begin{aligned} \text{if } \left[ \frac{RD}{E[R_{BT}] \times E[T_{BT}^{Eff}]} \right] \leq 1 \text{ then } \beta_2 &= \delta_{SCAN} + \frac{RD}{E[R_{BT}]} + \left[ \frac{E[R_{BT}]}{\delta_{NIS}} \right] \times p \\ \text{else } \beta_2 &= E[T_{BT}] + \frac{(RD - E[R_{BT}]E[T_{BT}^{Eff}])}{E[R_{Zig}]} \end{aligned} \quad (6.22)$$

**Using both Bluetooth and ZigBee with the SMS-based approach** With this policy, the mobile phone receives a notification from the server to switch on its Bluetooth interface. Therefore, the maximum time during which the sensor waits before being discovered is  $\delta_{SMS}$ , which represents the time required for the phone to receive the SMS. This time, which could be estimated to 10 seconds [254, 255], is generally lower than  $\delta_{SCAN}$ . In order to calculate the expected delay when using the SMS-based approach, we use the previous equations, replacing  $\delta_{SCAN}$  by  $\delta_{SMS}$ .

## 6.6.2 Delay analysis

Figure 6.6 shows the expected delay according to the amount of data to transfer, and different transfer policies. The Bluetooth only policy is the one that minimizes the delay since this technology provides the highest data rate. On the contrary, using only ZigBee access points to send the data induces the maximum delay. Indeed, the expected delay increases in a stair-case manner because ZigBee cannot be used continually. In-between, the delay achieved when using both ZigBee and Bluetooth to transmit the data stays within these two extremes and varies depending on the ZigBee availability.

When we increase the availability of ZigBee by varying the expected usage time of ZigBee from 60s in figure 6.6a to 120s in figure 6.6b, we can see that the delay of the ZigBee only policy decreases since the opportunities to communicate in ZigBee increase. On the contrary, the delay when using both ZigBee and Bluetooth communications increases since the sensor will spend more time in ZigBee which has a lower data rate than Bluetooth. However, this configuration is likely to save more energy both at the mobile phone and at the sensor. Indeed, the sensor will spend more time in ZigBee and the mobile phone will spend more time in sleep mode. Furthermore, the gap between the SMS-based and the adaptive approaches widens when ZigBee periods are longer. This is because the optimal  $\delta_{SCAN}$  increases to save energy while  $\delta_{SMS}$  remains constant.

Clearly, there is a trade-off between energy-efficiency and latency, since the communication technology with the highest data rate is also the one with the highest energy consumption pattern.

## 6.7 Simulation

### 6.7.1 Simulation settings

We used the OMNeT++ simulator to evaluate the performances of our approaches (fixed, adaptive and SMS-based intervals). We implemented the framework developed by Helgason and Kouyoumdjieva in [256] in order to model nodes equipped with multiple controllable radios that can be dynamically suspended and woken up. We consider a scenario composed of:

- A mobile sensor equipped with a Bluetooth radio and a Zigbee radio. It generates data at a constant rate.
- A mobile phone equipped with a Bluetooth network interface to receive data from the sensors, and a Wi-Fi connection to transfer the data to a remote server.

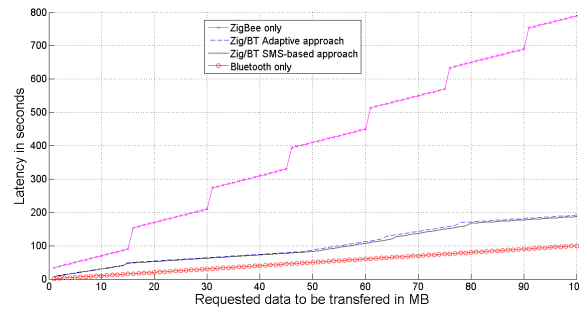

(a)  $E[T_{BT}] = 60s$ ,  $E[T_{Zig}] = 60s$ ,  $E[R_{BT}] = 1MB/s$  and  $E[R_{Zig}] = 0.25MB/s$ .

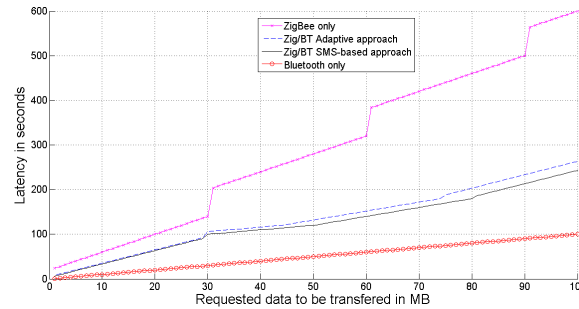

(b)  $E[T_{BT}] = 60s$ ,  $E[T_{Zig}] = 120s$ ,  $E[R_{BT}] = 1MB/s$  and  $E[R_{Zig}] = 0.25MB/s$ .

Fig. 6.6 Expected delay according to the amount of data to transfer.

- A static ZigBee access point (e.g a laptop), also having a Wi-Fi connection to communicate with a remote server.
- A static remote server that can be reached through Wi-Fi communication by both the mobile phone and the access point.

The sensor can send its data either to the mobile phone or to the access point. The phone and the access point can receive data from the sensor and they automatically transmit them through Wi-Fi towards the server which centralizes all the data. We consider that the user can be in two states: in state 1, the user is near the ZigBee access point, while in state 2 the user is not in the proximity of the access point. We used the following user mobility models to simulate the transition from one state to another.

- **Periodic** $[r]$ : In this model, the user changes from one state to another periodically every  $r$  seconds.
- **Random** $[q]$ : In this model, every 100s we decide whether the user changes its location or not. It moves from state 1 to state 2 with a probability  $q$ , and from state 2 to state 1 with probability  $1 - q$ .

We consider a healthcare application where the sensor samples 6 channels of data (eg. 3-axis accelerometer + 3-axis gyroscope) with 16-bit resolution at 50 Hz. Thus, a packet size is equal to 12 Bytes for payload plus 6 Bytes for header. The simulation parameters are summarized in Table 6.4.

Table 6.4 Simulation parameters.

simulation time	7200 <i>s</i>
sampling rate	50 <i>Hz</i>
packet size	18 <i>B</i>
$\alpha$	0.5
$e_{NIS}$	0.03 <i>J</i>
$e_{ZIG}$	2.88 $\mu J/B$
$e_{BT}$	Sensor: 41.2 $\mu J/B$ Phone: 3.6 <i>mJ/B</i>
$e_{SCAN}$	2.27 <i>J</i>
$\delta_{NIS} / \delta_{SCAN}$	fixed: 5 <i>s</i> adaptive: 1-300 <i>s</i>

## 6.7.2 Simulation results

### Fixed and adaptive approaches

We study the performances of our approaches (fixed and adaptive intervals) under different user mobility models. We compare our results to a reference architecture where the sensor can only send its data to the user mobile phone. In Fig. 6.7 (top), we represent the percentage of time spent by the sensor in Bluetooth and ZigBee, for varying values of the parameter  $p$ . The Fig. 6.7 (down) shows also the percentage of time spent by the phone in sleep mode and in Bluetooth. Regarding the random mobility, our first observation is that as ZigBee availability increases, the time spent by the sensor in ZigBee also increases. As a consequence, when the ZigBee availability increases, the phone spends less time in Bluetooth and more time in sleep mode. Therefore, the fixed and adaptive approaches are able to take advantage of the availability of an access point in the user environment in order to decrease the time spent in Bluetooth, at both the sensor side and the mobile phone side. Now, if we look at the periodic mobility in Fig. 6.7b, we can see that the sensor and the phone spend nearly 50% of their time in Bluetooth, which is consistent with the fact that we consider a periodic mobility where the user changes every  $p$  seconds from one state to another. Therefore, the availability of ZigBee is close to 50% in this case.

In Fig. 6.8 we plot the number of Network Interface Selection performed by the sensor in function of the user mobility, and the number of Bluetooth scan performed by the phone.

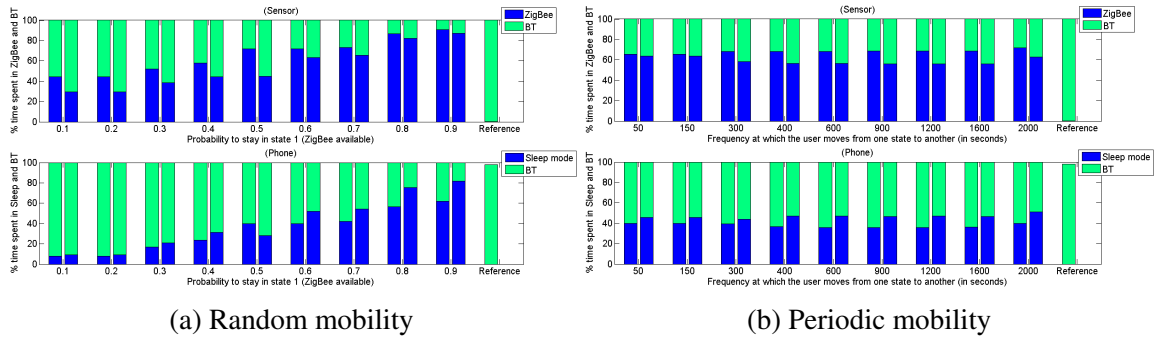

Fig. 6.7 The percentage of time spent by the sensor in Bluetooth and ZigBee, and by the phone in Bluetooth and sleep mode, in function of the user mobility.

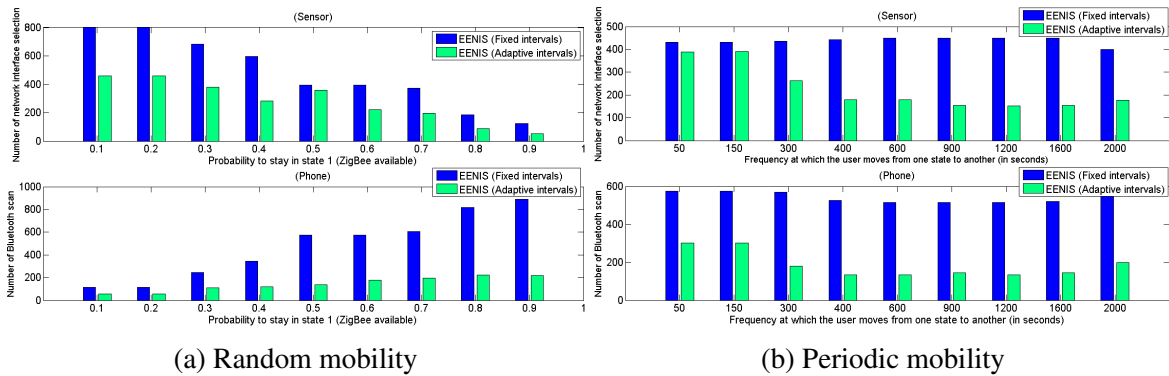

Fig. 6.8 Number of Network Interface Selection at the sensor, and number of Bluetooth scan performed at the mobile phone, in function of the user mobility.

Our first observation is that the adaptive approach enables to reduce the number of network interface selection at the sensor, and the number of Bluetooth scan at the phone side. When we consider the random mobility (Fig. 6.8a) as the availability of ZigBee increases, the number of tests performed by the sensor to detect a ZigBee access point decreases, since the sensor spends less time in Bluetooth. On the contrary, the number of Bluetooth scan increases, because the mobile phone spends more time in sleep mode. When considering the periodic mobility (Fig. 6.8b), as the time spent by the user in one state increases, both the number of network interface selection and Bluetooth scan decreases with the adaptive approach. This is because the adaptive solution adapts the  $\delta_{NIS}$  and  $\delta_{Scan}$  intervals to the network conditions. So, when the user tends to stay longer in one state, the intervals can be increased since the probability of success after a short period of time is low.

Fig. 6.9 shows the energy consumption of the sensor and the phone. At the sensor, the energy consumption is composed of the ZigBee and Bluetooth communication costs, as well as the cost of the network interface selection. At the phone side, the energy consumption includes the Bluetooth communication costs and the Bluetooth scan cost. We could have



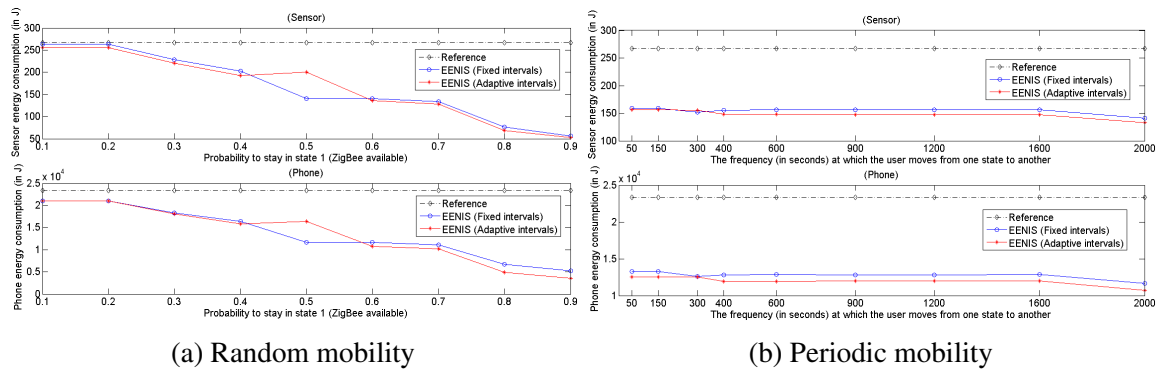

Fig. 6.9 Energy consumption in Joules at the sensor and at the phone, in function of the user mobility.

included the energy consumption due to the WiFi communications, since the phone has to relay the received data towards the remote server. We can see that our architecture enables to reduce the energy consumption at both devices compared to a reference architecture where the sensor can only communicate with the user mobile phone. The gap between the fixed and adaptive approaches can be explained by the additional energy consumption due to periodic network interface selection and Bluetooth scan in the fixed solution. Moreover, we can observe that the shapes of the energy consumption at the sensor and the phone are similar. This is because, with our settings, the energy consumption due to Bluetooth communications is predominant compared to the energy consumption of the ZigBee communications. For the random mobility (Fig. 6.9a), the energy consumption at both the sensor and the mobile phone decreases when the ZigBee availability increases. This is because the mobile phone can spend more time in sleep mode, and the sensor uses preferably its low-power ZigBee radio. With the periodic mobility (Fig. 6.9b), we can observe that the energy consumption of both devices corresponds to the energy consumption of the device when ZigBee availability is equal to 50%.

In Fig. 6.10 (top) we plot the average data latency achieved by the different solutions. The data latency corresponds to the time that elapses between the generation of the data at the sensor, and the reception of the data by the remote server. Our architecture introduces a reasonable latency compared to the reference architecture. This additional delay comes from the network interface selection and the Bluetooth scan. Indeed, when the sensor performs a network interface selection, it has to switch off its BT radio, switch on its ZigBee radio, listen for few seconds (3s in the simulation) if there is a ZigBee access point, and if the sensor does not detect a ZigBee access point, it has to switch off its ZigBee radio and switch on its BT interface. During this procedure, the sensor generates data but cannot send them, which introduces a delay. Furthermore, when the sensor is waiting to be discovered by the

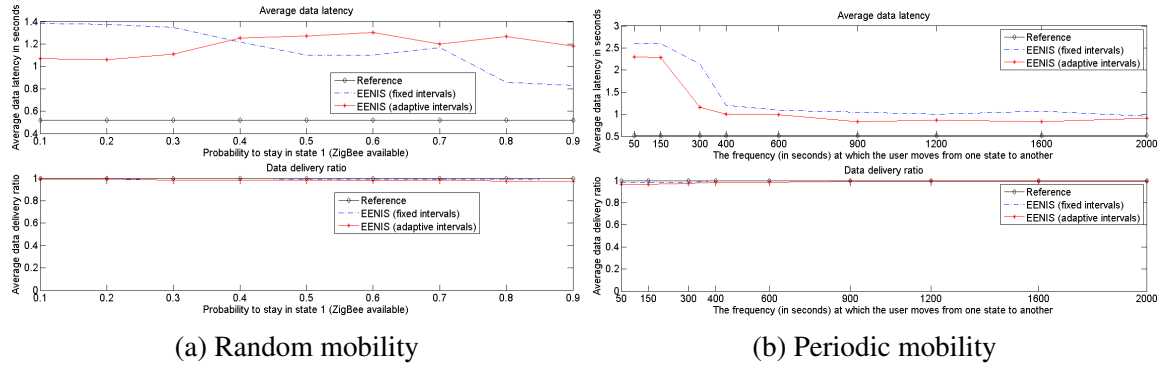

Fig. 6.10 Average data latency and data delivery ratio, in function of the user mobility.

mobile phone, it cannot send its data, while in the reference architecture, the sensor is always connected to the mobile phone and continuously sends its data.

Fig. 6.10 (bottom) shows the data delivery ratio at the remote server. We notice that the three solutions achieve a nice delivery ratio that stays above 97%. We could have expected packet loss when the ZigBee access point is not anymore available and the mobile phone Bluetooth interface is still switched off. However, it is possible to dimension the network in order to prevent packet loss. Indeed, we can introduce a local buffer at the sensor and an upper bound  $\delta_{ScanMax}$  on the maximum time between two Bluetooth scan. In this way, a sensor will wait at most  $\delta_{ScanMax}$  seconds before being discovered and the data accumulated in the local storage (which depends on the data generation rate) will be sent once a connection is established.

### Adaptive and SMS-based approaches

In what follows we compare the performances of our adaptive and SMS-based approaches, considering the random user mobility model. In Fig. 6.11 (top), we represent the percentage of time spent by the sensor in Bluetooth and ZigBee, for both solutions. Fig. 6.11 (down) shows the percentage of time spent by the phone in sleep mode and in Bluetooth. Right bars are for the SMS-based approach, while left bars represents the adaptive approach. Our first comment is that we do not observe much difference in the behavior of the devices between the two solutions. This can be explained by the fact that in our parameters setting, the energy consumption is dominated by the Bluetooth communications. Therefore, the adaptive solution tends to calculate short intervals  $\delta_{SCAN}$  that are close to the  $\delta_{SMS}$  delay. As a consequence, both solutions are able to detect rapidly the opportunities to communicate to the ZigBee access point, resulting in the same percentage of time spent in different modes.

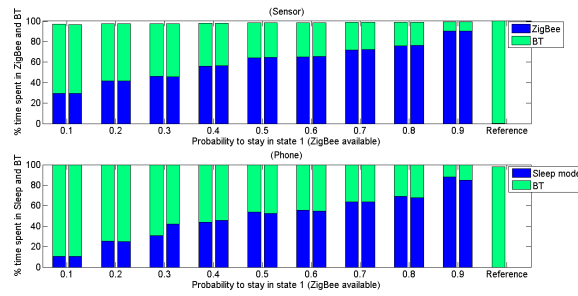

Fig. 6.11 The percentage of time spent by the sensor in Bluetooth and ZigBee, and by the phone in Bluetooth and sleep mode.

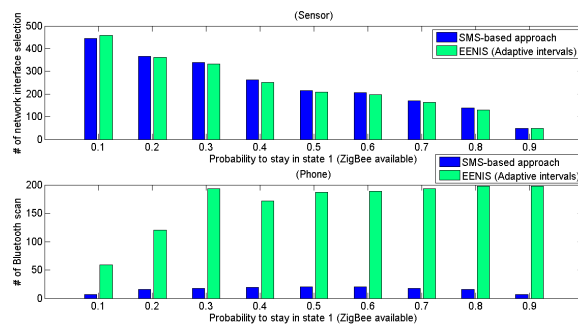

Fig. 6.12 Number of Network Interface Selection at the sensor, and number of Bluetooth scan performed at the mobile phone.

In Fig. 6.12 we plot the number of Network Interface Selections performed by the sensor, and the number of Bluetooth scans performed by the phone. As expected, the SMS-based approach enables to reduce the number of Bluetooth scans performed by the mobile phone. This is because the phone receives a text message from the server only when necessary. We can notice that for the SMS-based approach, the number of Bluetooth scan does not increase with the availability of ZigBee (compared to the adaptive approach). In fact, this number increases with the number of network cycles, since the mobile phone performs one Bluetooth scan per network cycle.

Fig. 6.13 shows the energy consumption of the sensor and the phone. We would have expected an higher reduction of the energy consumption at the phone with the SMS-based approach since the phone performs significantly less Bluetooth scans with this solution. However, the order of magnitude of the energy consumption due to Bluetooth communication offsets the energy gain due to the reduction of the number of Bluetooth scans at the phone.

In Fig. 6.14 (top) we can see that the average data latency achieved by the SMS-based solution is slightly better than the one achieved by the adaptive approach. This is because the SMS-based approach reduces the time spent by the sensor in discoverable mode while waiting to be discovered by the mobile phone.

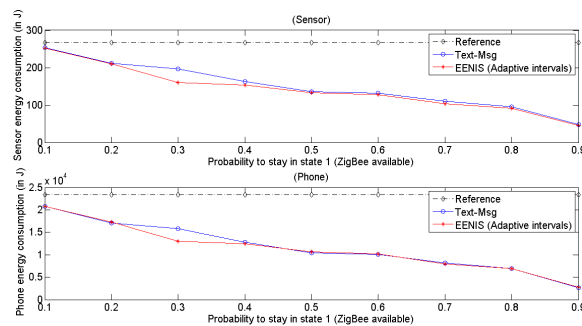

Fig. 6.13 Energy consumption in Joules at the sensor and at the phone.

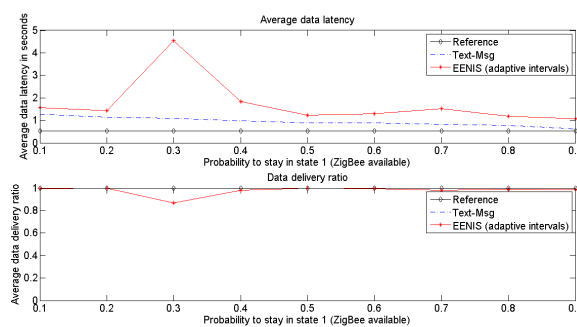

Fig. 6.14 Average data latency and data delivery ratio.

Fig. 6.14 (bottom) shows that all solutions achieve a high data delivery ratio at the remote server. The solutions compromise energy efficiency for latency.

### Multi node case

We study the impact of the number of sensors on the performances of the SMS-based approach. We use the random mobility with parameter  $q = 0.5$ . In Fig. 6.15 (left) we plot the average percentage of time spent by the sensors in ZigBee and Bluetooth mode. Fig. 6.15 (right) corresponds to the percentage of time spent by the phone in sleep mode and Bluetooth. Since the percentage of time spent by the devices in one mode or another depends on the ZigBee availability, we observe that this relation does not change with the number of nodes.

Fig. 6.16 illustrates the average number of network interface selections performed by a sensor, and the number of scans performed by the phone, in function of the number of sensors in the network. We can see that the average number of access point detection conducted by a sensor is constant. This is because  $\delta_{NIS}$  is influenced by the availability of ZigBee, but not by the number of sensors. On the contrary, the number of Bluetooth scans performed by the mobile phone increases linearly with the number of nodes. This is because in the SMS-based solution, the phone receives a text message for every sensor, and performs

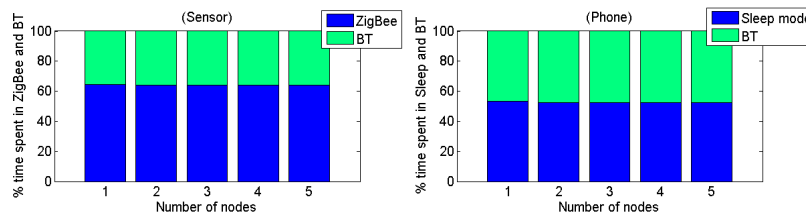

Fig. 6.15 The percentage of time spent by the sensors in Bluetooth and ZigBee, and by the phone in Bluetooth and sleep mode.

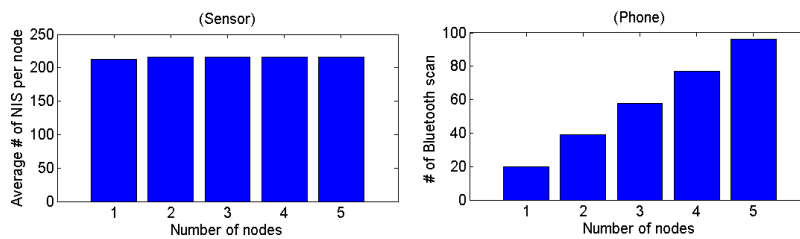

Fig. 6.16 Number of Network Interface Selection at the sensor, and number of Bluetooth scan performed at the mobile phone, in function of the number of sensors.

individual sensor detection. Still, note that the number of tests performed by the phone with the SMS-based approach when there is five nodes is around 100, which is half of the number of tests performed by the phone with the adaptive approach when there is only one sensor in the network (around 200 in Fig. 6.12 and 6.8a bottom).

In Fig. 6.17 we represent the average energy consumption of the phone, and per sensor. Our first observation is that the individual energy consumption of the sensors is not affected by the number of sensors in the network. This is because the sensors consume energy when transmitting their data and when performing network interface selections, but not when the other nodes transmit. On contrary, the energy consumption of the mobile phone increases linearly with the number of sensors, since the energy depletion at the mobile phone is mainly due to Bluetooth communications. The number of data received by the phone is multiplied by the number of sensors.

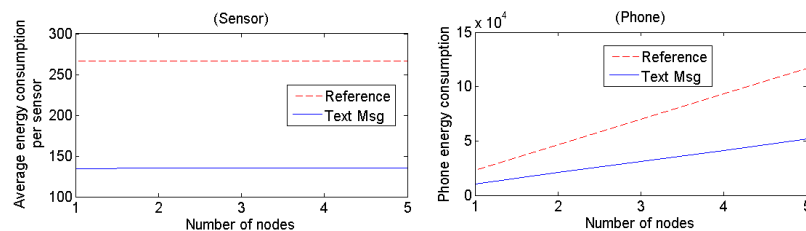

Fig. 6.17 Energy consumption in Joules at the sensors and at the phone, in function of the number of nodes.

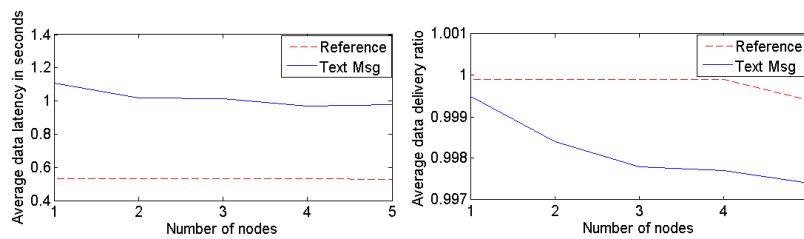

Fig. 6.18 Average data latency and data delivery ratio in function of the number of nodes.

Fig 6.18 (left) shows the average data latency achieved by both solutions with varying number of nodes. Fig. 6.18 (right) displays the data delivery ratio at the server. As can be seen, the data delivery ratio stays above 0.99 and the latency remains constant even when the number of nodes increases. This can be explained by the fact that although the access channel is divided between more nodes, the data generation rate, the ZigBee and Bluetooth data rate, and buffer size are sufficient enough to enable the transmission of every data.

## 6.8 Conclusion

In this chapter, we have proposed a new architecture that improves the energy-efficiency of personal area networks. Contrary to existing approaches, we optimize the lifetime of both the sensors and the base station. Indeed, traditional architectures consider that sensors send their data to a mobile phone in order to support the user mobility. However, mobile phone are also energy constraint, and continuously receiving data represents an additional burden task. So, the main idea of our solution is to offer the sensors the possibility to communicate with access points that are not always present in the user environment, but when they are available it enables to relieve the phone from receiving all the data. Our simulation results show that our approach increases the system lifetime, while keeping nice end-to-end data latency and delivery ratio.



# Chapter 7

## Implementation of an energy-efficient wearable sensor network prototype

In this chapter, we present the design and implementation of a light-weight wearable sensor network for remote patient supervision applications. The testbed has been developed in order to assess the efficiency of our architecture presented in Chapter 6 through a real-world prototype. The system consists of a sensor node that monitors patient's limbs movements as well as a mobile phone and a ZigBee access point which act as gateways, and are responsible for relaying the data to a remote medical server. The objective of our architecture is to privilege ZigBee communications as they are more energy-efficient for the sensor, and during this period of time the mobile phone can switch off its Bluetooth interface, thus saving energy. The proposed prototype is still under development, but early results demonstrate the feasibility of our approach.

### 7.1 Introduction

Remote patient monitoring applications make use of body-worn sensors that gather clinically relevant information such as heart rate, respiration rate or temperature. In order to support patient mobility, traditional architectures assume that sensors transmit their data towards the patient mobile phone which act as a mobile gateway. However, the mobile phone itself is subject to rapid energy depletion when it has to continuously receive and relay health data. Therefore, we have proposed in Chapter 6 an architecture that enables to save energy at both the sensors and the mobile phone, still supporting patient mobility.

The main idea of our solution is that sensors send the sensed data via the user mobile phone through Bluetooth communications, but they have the possibility to send data to



ZigBee access points when they are available in the user environment. This approach has two advantages: at the sensor side it privileges ZigBee communications as they are more energy-efficient for the sensor, and during this period of time the mobile phone can switch off its Bluetooth interface, thus saving energy.

In this Chapter, we aim to demonstrate the feasibility of our research work presented in Chapter 6 through the implementation of a real sensor platform. In section 2, we describe the general architecture of our remote patient monitoring system. In section 3, we detail the hardware and software implementation of the sensor node. In sections 4 and 5 we respectively describe the ZigBee gateway and the mobile application that we developed to collect data generated by the sensor node. In section 6, we describe services to be hosted on the remote medical server. In section 7, we conclude this chapter.

## 7.2 General architecture of our prototype

The different components of our wearable sensing system are shown in Figure 7.1. The first component is a sensor node deployed on the patient to collect information about his movement. The sensor is equipped with two radios, and sends its collected data either to the mobile phone through Bluetooth, or to the ZigBee access point when available using the IEEE 805.15.4 communication technology. Both mobile phone and access point re-transfer the data upon reception to the remote medical server through a Wide Area Network (WAN) interface such as Wi-Fi, ethernet or 3G.

In our prototype, we implemented the periodic approach of our energy-efficient architecture proposed in Section 6.3.1. In this configuration, the sensor runs a network interface selection algorithm in order to detect if the ZigBee access point is available, while the mobile phone runs a sensor node detection algorithm in order to detect if the sensor is willing to communicate in Bluetooth. In practice, the ZigBee gateway periodically broadcasts beacons so that the sensor can discover the access point by listening the medium. At the beginning, the sensor is in Bluetooth mode and regularly checks for a ZigBee access point. In order to do that, the sensor listen during few seconds for beacons from the ZigBee gateway. If it does not receive beacon, it switches back to Bluetooth. Otherwise, it sends its data to the ZigBee gateway. Then, if the sensor does not receive beacons for a while, it goes back to Bluetooth. Regarding the mobile phone, it periodically turns on its Bluetooth interface. If the sensor is waiting to communicate in Bluetooth, the mobile phone and the sensor will initiate a Bluetooth session. Afterwards, if the mobile detects that it does not receive any more data, it will switch off its Bluetooth interface.

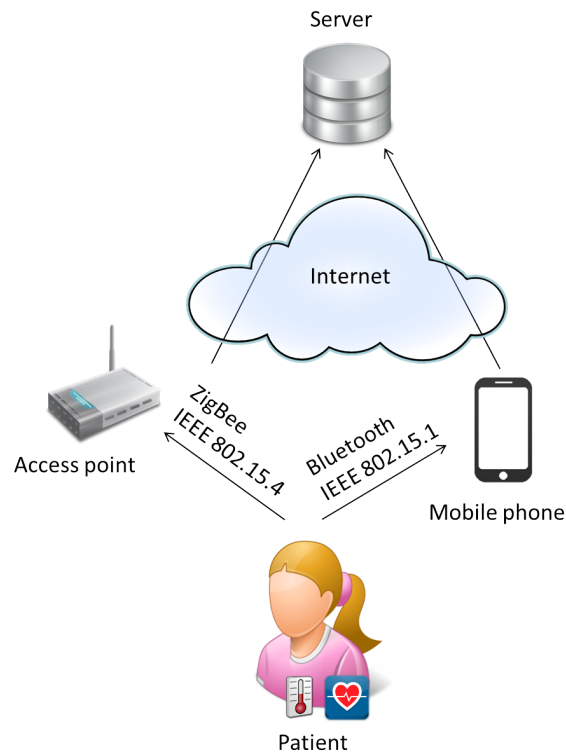

Fig. 7.1 General architecture.

Figure 7.2 depicts our wearable sensor architecture prototype and its components, namely, a motion sensor node, a ZigBee gateway, a mobile phone and a remote server.

In the next sections, we focus on the description of the hardware and software design of the architecture's components.

## 7.3 Sensor node

The motion sensor node is worn by the patient, and collect data as the patient moves his limbs. We use the lightweight (15g), and compact form factor (50mmx25mmx12.5mm) Shimmer platform with elastic adjustable bracelets for easy sensor node fixation. Shimmer (Sensing Health with Intelligence, Modularity, Mobility, and Experimentation Reusability) is an unobtrusive wireless sensor platform which provides kinematic sensing capabilities. In our prototype, the motion sensor integrates a three-axis accelerometer to measure the acceleration of the sensor node, and a Gyroscope to measure the angular velocity of the sensor along three axis.

The core component of the shimmer platform is the Texas Instrument MSP 430 MCU running at 8 MHz. This low power microcontroller has 10 KByte RAM, 48 KByte flash



Fig. 7.2 Wearable sensor network components.

and an integrated 8-channels 12-bits Analog to Digital Converter (ADC). We use six ADC channels to capture the accelerometer and the gyroscope sensor data (1 channel per axis). To be able to communicate wirelessly, sensor node integrates two radios: the IEEE 802.15.4 compliant Chipcon CC2420 radio-transceiver and the Roving Networks RN-46 Class 2 Bluetooth module. The two radio cannot be used at the same time, which require careful orchestrated mutually-exclusive startup and shutdown routines.

We developed a TinyOS applications that periodically samples the accelerometer and gyroscope sensors. It also implements a network interface selection algorithm in order to switch between the two communication technologies depending on ZigBee availability. As illustrated in Figure 7.3, the two radio are supervised by a communication module, and the network interface manager controls these two modules. The network interface manager ensures that only one radio is turned on at a time. When the CC2420 communication module is on, it triggers a receive event when a beacon packet is received. Upon receiving a beacon packet, the network interface manager will send sampled data through the CC2420 communication module. If the network interface manager detects that it has not received beacon messages for a while, it will turn off the CC2420 interface and turn on the RN-46 radio. Once the Bluetooth interface is turned on, the network interface manager tries to establish a connection.

## 7.4 ZigBee access point

The access point is responsible for receiving the data from the sensor node and transfer them towards the server. The ZigBee access point is emulated with a TelosB sensor node which has the same micro-controller and radio transceiver as Shimmer nodes. It is connected,

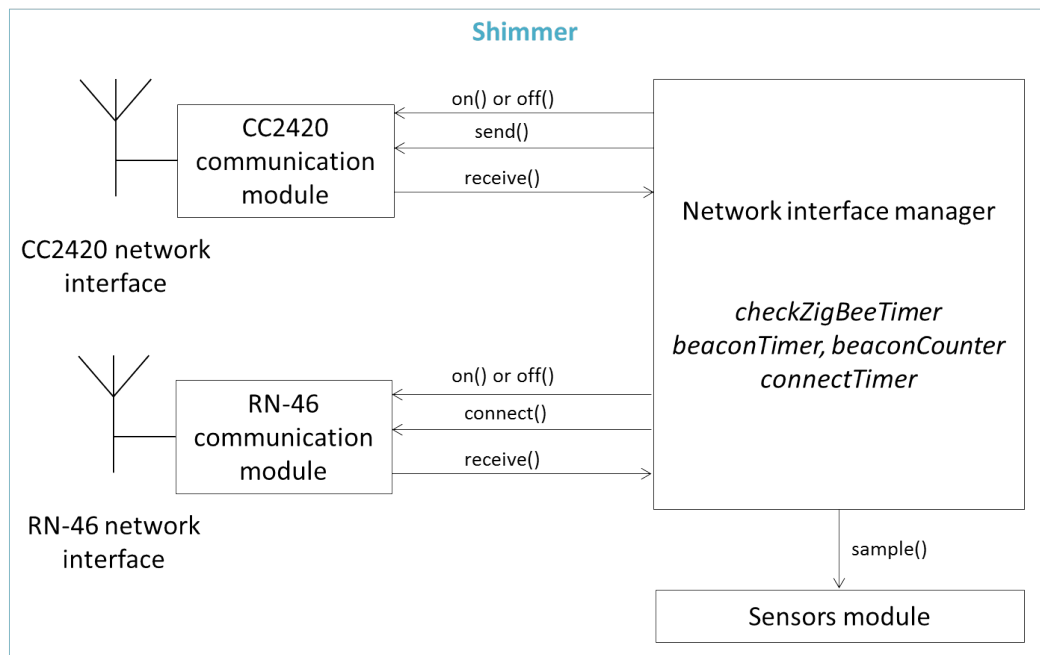

Fig. 7.3 Motion sensor software architecture.

through a USB port, to a laptop in order to relay received data. Indeed, the TelosB periodically broadcasts beacons to advertise its presence in the user's environment. Once it receives data from the sensor, the ZigBee access point transfers the data to the server.

We have developed a TinyOS application that acts as a relay between the motion sensor and the laptop as shown in Figure 7.4. The CC2420 radio of the ZigBee access point is supervised by the communication module which triggers a receive event when a packet is received. Upon receiving this event, the gateway manager extracts the data from the packet and forwards it to the serial communication module. The serial communication module sends this information to the PC through the serial USB connection. At the PC side, a serial listener module continuously listens for incoming packets. Once a packet is received, it sends this packets towards the server through HTTP requests. The communication module also periodically triggers a send event to send the beacons.

## 7.5 Mobile phone

The mobile phone is the default gateway of the sensor: it is responsible for receiving the data of the sensor when there is no available access point in the user environment. The sensor and the mobile phone exchange data using the Bluetooth technology.

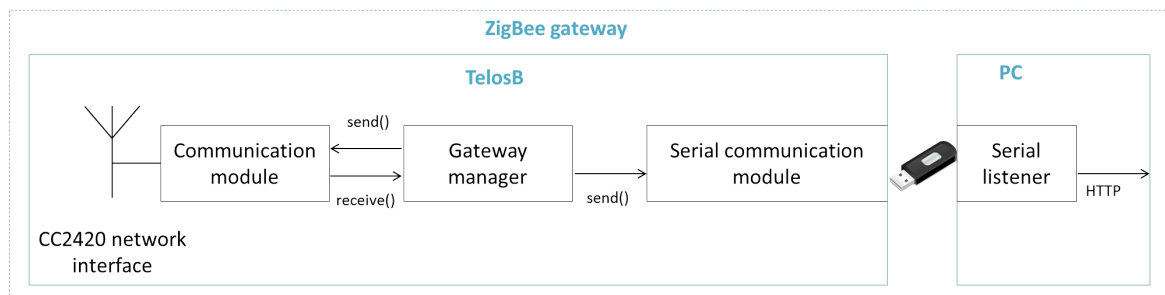

Fig. 7.4 ZigBee access point software architecture.

We developed an android application that regularly turns on the mobile phone Bluetooth interface and tries to connect to the sensor. If the application start receiving data, it directly forwards the packets to the server through WiFi.

## 7.6 Server

The server is responsible for centralizing the data for further processing and storage. Actually, the server only receives the data and update a web interface that displays the received data in real time. Further functionalities may be developed such as data filtering, patient profile management and health data storage. In parallel, a doctor application may be developed to access the stored data and check the patient physical performance. A doctor will be able to search for a patient profile, visualize the captured data, add comments or write a report.

The server is developed in python and receives data through HTTP requests from both the ZigBee gateway and the mobile phone. The data are then displayed on a web page using the Flask micro web application framework, as illustrated in Figure 7.5. In order to distinguish the communication interfaces, the data received through the Bluetooth interface are displayed with circle points. The screen-shot corresponds to a piece of program in which the sensor switches between its two radios every 30 seconds. We can see that it begins with 30 seconds Bluetooth communications, followed by 30 seconds ZigBee communications, and so on. It is interesting to note that our experiments have shown that the time required to power off an interface and then power on the other interface is around 20/30 seconds. This is an additional delay that have to be taken into account, but we expect that more recent platform integrating dual radio will allow both radios to be powered on simultaneously.

## Real-time updates

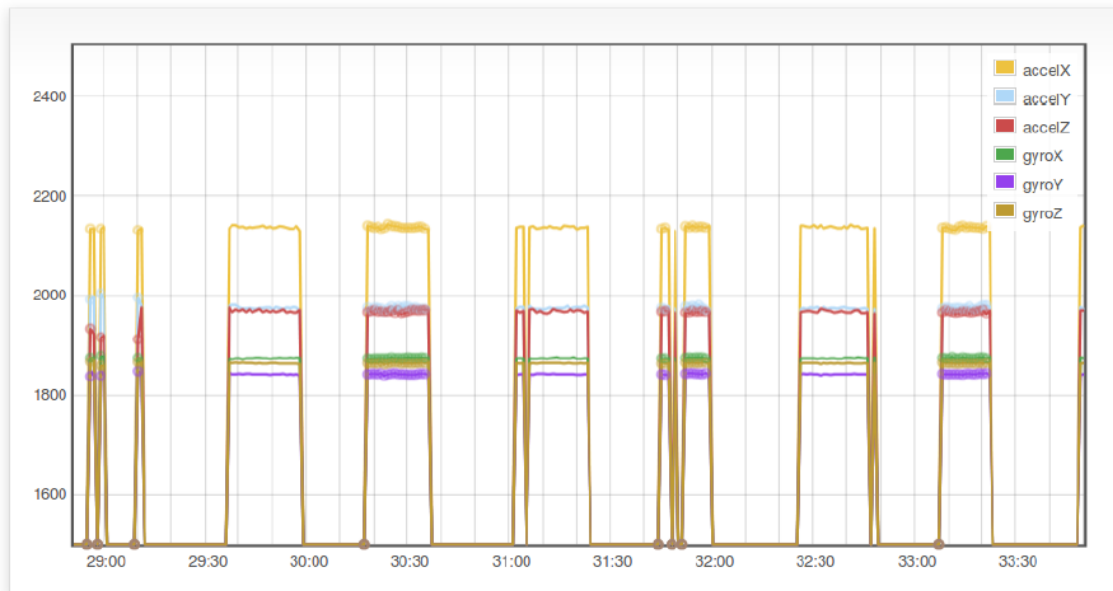

Fig. 7.5 Real-time data updates of received health data.

## 7.7 Conclusion

In this chapter, we have presented the design and implementation of a wearable sensor platform prototype based on our architecture proposed in Chapter 6. We described the different components of our system and how they communicate with each other. Our prototype is a proof-of-concept that our energy-efficient gateway selection strategy for patient monitoring is practically feasible. As future work, we plan to implement the adaptive version of our architecture and perform a campaign measurements.



# Chapter 8

## Conclusion

### 8.1 Summary

Advancements in wireless communications and Micro-Electro-Mechanical systems have enabled the development of wireless sensor networks (WSN), which in turn have fostered the emergence of a plethora of applications in various fields such as agriculture, healthcare supervision, and transportation systems. However, due to the energy limitation of battery-powered sensors, these applications still face a major energy issue that prevent their widespread adoption. In this thesis, we contributed to overcome this challenge through several contributions. We developed new architectures, models and distributed algorithms to improve the energy-efficiency of WSN, and we evaluated their performances through extensive numerical experiments and simulations.

A first part of this thesis is dedicated to general wireless sensor networks. We began with a proposal of a comprehensive review of existing energy-efficient mechanisms designed for wireless sensor networks. This top-down study surveys the different WSN application families and their specific requirements, and analyses how these requirements interact with the implementation of energy-efficient solutions. Afterwards, we proposed an energy-efficient data collection scheme with a mobile base station. We optimized the sojourn times of the mobile sink, as well as the buffer usage and data routing at the sensor nodes. We also proposed a solution for multi-hop wireless charging that optimizes the deployment of wireless chargers in the network, so that they can satisfy the energy-demand of every sensor.

The second part of this thesis contains an interdisciplinary study that aims to tackle the energy consumption of wearable sensor networks for healthcare-oriented applications. This work involved three persons of the computer science community, and one from the bio-mechanical community. We first introduced a new classification of energy-efficient architectures using wearable sensors for remote patient supervision. Then, we developed



a new architecture that allow to save energy at both the sensors and the base stations, by privileging a less consuming communication technology when available. Therefore, this is a context-aware solution that takes into account the effective opportunities that arise in the user environment.

## 8.2 Future work

Regarding the first part of this thesis, as a future work, we envisage to consider the coordination of multiple mobile sinks for data collection in WSN. This strategy will certainly decrease both the energy consumption at sensors and the data latency by reducing the average distance between nodes and the closest base station. It is also possible to design other decision rules at sensors to decide whether or not to send the data. For example, we could integrate data priorities in the function. Finally, in the distributed scenario, the base station moves randomly, whereas it would be interesting to design policies for the sink mobility. Concerning our multi-hop wireless charging scheme, future directions include the case when a transmitter can transfer energy to multiple receivers at a time. The wireless energy transfer to multiple receivers has already been considered in WSN [257, 258], but never in a multihop scenario. This will lead to more complex wireless energy transfer schemes but will certainly require less energy. Another issue that has not been addressed in this study is the recharging schedule. Indeed, once the chargers are deployed, it could be interesting to find out a schedule that minimizes the charging latency. Eventually, one could imagine to consider the joint optimization of mobile base stations that collect the data, and mobile chargers that recharge the network.

For the second part of this thesis, as a future work, we intend to finish the development of our wearable sensor architecture prototype in order to demonstrate the efficiency of our approach. Ideally, we will conduct in-field experiments and a measurements campaign in order to characterize the performance of our architecture.

# References

- [1] J. Yick, B. Mukherjee, D. Ghosal, Wireless sensor network survey, *Computer Networks* 52 (2008) 2292–2330.
- [2] G. Anastasi, M. Conti, M. Di Francesco, A. Passarella, Energy conservation in wireless sensor networks: A survey, *Ad Hoc Networks* 7 (2009) 537–568.
- [3] R. Rajagopalan, P. K. Varshney, Data-aggregation techniques in sensor networks: a survey, *IEEE Communications Surveys & Tutorials* 8 (2006) 48–63.
- [4] K. Akkaya, M. Younis, A survey on routing protocols for wireless sensor networks, *Ad Hoc Networks* 3 (2005) 325–349.
- [5] S. Sudevalayam, P. Kulkarni, Energy Harvesting Sensor Nodes: Survey and Implications, *IEEE Communications Surveys & Tutorials* 13 (2011) 443–461.
- [6] H. A. Nguyen, A. Forster, D. Puccinelli, S. Giordano, Sensor node lifetime: An experimental study, in: *IEEE International Conference on Pervasive Computing and Communications Workshops*, Seattle, WA, 2011, pp. 202–207.
- [7] A. Prayati, C. Antonopoulos, T. Stoyanova, C. Koulamas, G. Papadopoulos, A modeling approach on the TelosB WSN platform power consumption, *Journal of Systems and Software* 83 (2010).
- [8] I. Dietrich, F. Dressler, On the lifetime of wireless sensor networks, *ACM Transactions on Sensor Network* 5 (2009).
- [9] C. E. Jones, K. M. Sivalingam, P. Agrawal, J. C. Chen, A Survey of Energy Efficient Network Protocols for Wireless Networks, *Wireless Networks* 7 (2001).
- [10] [http://eetd.lbl.gov/ee/ee\\_1.html](http://eetd.lbl.gov/ee/ee_1.html), Lawrence Berkley National Laboratory “What is Energy Efficiency”, 2015.
- [11] H. Alemdar, C. Ersoy, Wireless sensor networks for healthcare: A survey, *Computer Networks* 54 (2010) 2688–2710.
- [12] J. Ko, C. Lu, M. B. Srivastava, J. A. Stankovic, A. Terzis, M. Welsh, Wireless Sensor Networks for Healthcare, *Proceedings of the IEEE* 98 (2010) 1947–1960.
- [13] A. Hadjidj, M. Souil, A. Bouabdallah, Y. Challal, H. Owen, Wireless Sensor Networks for Rehabilitation Application: Challenges and Opportunities, *J. of Network and Computer Applications* 36 (2013) 1–15.

## References

---

- [14] T. Gao, C. Pesto, L. Selavo, Y. Chen, J. Ko, J. Lim, A. Terzis, A. Watt, J. Jeng, B.-r. Chen, K. Lorincz, M. Welsh, *Wireless Medical Sensor Networks in Emergency Response: Implementation and Pilot Results*, in: *IEEE Conference on Technologies for Homeland Security*, Waltham, 2008, pp. 187–192.
- [15] R. Fensli, E. Gunnarson, T. Gundersen, *A Wearable ECG-Recording System for Continuous Arrhythmia Monitoring in a Wireless Tele-Home-Care Situation*, in: *18th IEEE Symp. on Computer-Based Medical Systems*, 2005, pp. 407–412.
- [16] J. Chen, K. Kwong, D. Chang, J. Luk, R. Bajcsy, *Wearable sensors for reliable fall detection*, in: *27th IEEE Conference of the Engineering in Medicine and Biology Society*, Shanghai, 2005, pp. 3551–3554.
- [17] A. Hadjidj, A. Bouabdallah, Y. Challal, *Rehabilitation supervision using wireless sensor networks*, in: *IEEE Int. Symposium on a World of Wireless, Mobile and Multimedia Networks (WoWMoM)*, Lucca, Italy, 2011, pp. 1–3.
- [18] W.-W. Chang, T.-J. Sung, H.-W. Huang, W.-C. Hsu, C.-W. Kuo, J.-J. Chang, Y.-T. Hou, Y.-C. Lan, W.-C. Kuo, Y.-Y. Lin, Y.-J. Yang, *A smart medication system using wireless sensor network technologies*, *Sensors and Actuators A: Physical* 172 (2011) 315–321.
- [19] H. Ren, M. Meng, X. Chen, *Wireless Assistive Sensor Networks for the Deaf*, in: *IEEE/RSJ Int. Conf. on Intelligent Robots and Systems*, Beijing, 2006, pp. 4804–4808.
- [20] I. Stoianov, L. Nachman, S. Madden, *PIPENET: A Wireless Sensor Network for Pipeline Monitoring*, in: *6th Int. Conf. on Information processing in sensor networks (IPSN)*, Cambridge, MA, 2007, pp. 264–273.
- [21] G. Owojaiye, Y. Sun, *Focal design issues affecting the deployment of wireless sensor networks for pipeline monitoring*, *Ad Hoc Networks* 11 (2013).
- [22] M. Erol-Kantarci, H. T. Mouftah, *Wireless multimedia sensor and actor networks for the next generation power grid*, *Ad Hoc Networks* 9 (2011) 542–551.
- [23] W. Wang, Y. Xu, M. Khanna, *A survey on the communication architectures in smart grid*, *Computer Networks* 55 (2011) 3604–3629.
- [24] M. Tubaishat, P. Zhuang, Q. Qi, Y. Shang, *Wireless sensor networks in intelligent transportation systems*, *Wireless Communications & Mobile Computing* 9 (2009) 287–302.
- [25] C. Wenjie, C. Lifeng, C. Zhanglong, T. Shiliang, *A Realtime Dynamic Traffic Control System Based on Wireless Sensor Network*, in: *Int. Conf. Workshops on Parallel Processing*, Oslo, Norway, 2005, pp. 258–264.
- [26] H. Qin, Z. Li, Y. Wang, X. Lu, W. Zhang, *An Integrated Network of Roadside Sensors and Vehicles for Driving Safety : Concept , Design and Experiments*, in: *IEEE Int. Conf. on Pervasive Computing and Communications (PerCom)*, Mannheim, 2010, pp. 79–87.

- 
- [27] A. Pascale, M. Nicoli, F. Deflorio, B. Dalla Chiara, U. Spagnolini, Wireless sensor networks for traffic management and road safety, *IET Intelligent Transport Systems* 6 (2012) 67–77.
- [28] K. Faez, M. Khanjary, UTOSPF: A distributed dynamic route guidance system based on Wireless Sensor Networks and Open Shortest Path First protocol, in: *IEEE Int. Symp. on Wireless Communication Systems*, Reykjavik, 2008, pp. 558–562.
- [29] D. Tacconi, D. Miorandi, I. Carreras, F. Chiti, R. Fantacci, Using wireless sensor networks to support intelligent transportation systems, *Ad Hoc Networks* 8 (2010) 462–473.
- [30] J. Tavares, F. J. Velez, J. a. M. Ferro, Application of Wireless Sensor Networks to Automobiles, *Measurement Science Review* 8 (2008) 65–70.
- [31] K. Sha, W. Shi, O. Watkins, Using Wireless Sensor Networks for Fire Rescue Applications: Requirements and Challenges, in: *IEEE Int. Conf. on Electro/information Technology*, East Lansing, MI, 2006, pp. 239–244.
- [32] X. Niu, X. Huang, Z. Zhao, Y. Zhang, C. Huang, L. Cui, The Design and Evaluation of a Wireless Sensor Network for Mine Safety Monitoring, in: *IEEE Global Telecommunications Conference*, Washington, DC, 2007, pp. 1291–1295.
- [33] N. Javaid, S. Faisal, Z. A. Khan, D. Nayab, M. Zahid, Measuring Fatigue of Soldiers in Wireless Body Area Sensor Networks, in: *Int. Conf. on Broadband and Wireless Computing, Communication and Applications*, Compiègne, 2013, pp. 227–231.
- [34] E. Cayirci, H. Tezcan, Y. Dogan, V. Coskun, Wireless sensor networks for underwater surveillance systems, *Ad Hoc Networks* 4 (2006) 431–446.
- [35] Y.-C. Tseng, M.-S. Pan, Y.-Y. Tsai, Wireless Sensor Networks for Emergency Navigation, *Computer* 39 (2006) 55–62.
- [36] F. Stajano, N. Hault, I. Wassell, P. Bennett, C. Middleton, K. Soga, Smart bridges, smart tunnels: Transforming wireless sensor networks from research prototypes into robust engineering infrastructure, *Ad Hoc Networks* 8 (2010) 872–888.
- [37] S. Kim, S. Pakzad, D. Culler, J. Demmel, G. Fenves, S. Glaser, M. Turon, Health Monitoring of Civil Infrastructures Using Wireless Sensor Networks, in: *6th Int. Symp. on Information Processing in Sensor Networks*, Cambridge, MA, 2007, pp. 254–263.
- [38] J.-u. Lee, J.-e. Kim, D. Kim, J. Kim, P. Jang, RFMS: Real-time Flood Monitoring System with wireless sensor networks, in: *5th IEEE Int. Conf. on Mobile Ad Hoc and Sensor Systems (MASS)*, Atlanta, GA, 2008, pp. 527–528.
- [39] G. Vellidis, M. Tucker, C. Perry, C. Kvien, C. Bednarz, A real-time wireless smart sensor array for scheduling irrigation, *Computers and Electronics in Agriculture* 61 (2008) 44–50.

## References

---

- [40] J.-A. Jiang, C.-L. Tseng, F.-M. Lu, E.-C. Yang, Z.-S. Wu, C.-P. Chen, S.-H. Lin, K.-C. Lin, C.-S. Liao, A GSM-based remote wireless automatic monitoring system for field information: A case study for ecological monitoring of the oriental fruit fly, *Bactrocera dorsalis* (Hendel), *Computers and Electronics in Agriculture* 62 (2008) 243–259.
- [41] J. I. Huircán, C. Muñoz, H. Young, L. Von Dossow, J. Bustos, G. Vivallo, M. Toneatti, ZigBee-based wireless sensor network localization for cattle monitoring in grazing fields, *Computers and Electronics in Agriculture* 74 (2010) 258–264.
- [42] K. H. Kwong, T.-T. Wu, H. G. Goh, K. Sasloglou, B. Stephen, I. Glover, C. Shen, W. Du, C. Michie, I. Andonovic, Practical considerations for wireless sensor networks in cattle monitoring applications, *Computers and Electronics in Agriculture* 81 (2012) 33–44.
- [43] A. Nanda, A. K. Rath, S. K. Rout, Wireless Sensor Network for Coastal Erosion : A National Perspective, *International Journal of Computer Science & Communication* 1 (2010) 1–5.
- [44] K. K. Khedo, R. Perseedoss, A. Mungur, A Wireless Sensor Network Air Pollution Monitoring System, *International Journal of Wireless & Mobile Networks* 2 (2010) 31–45.
- [45] P. Jiang, H. Xia, Z. He, Z. Wang, Design of a Water Environment Monitoring System Based on Wireless Sensor Networks, *Sensors* 9 (2009) 6411–6434.
- [46] P. Corke, T. Wark, R. Jurdak, W. Hu, P. Valencia, D. Moore, Environmental Wireless Sensor Networks, *Proceedings of the IEEE* 98 (2010) 1903–1917.
- [47] J. Valente, D. Sanz, A. Barrientos, J. del Cerro, A. Ribeiro, C. Rossi, An Air-Ground Wireless Sensor Network for Crop Monitoring, *Sensors* 11 (2011) 6088–6108.
- [48] V. Parameswaran, H. Zhou, Z. Zhang, Irrigation control using Wireless Underground Sensor Networks, in: *6th Int. Conf. on Sensing Technology, Kolkata, 2012*, pp. 653–659.
- [49] Z. Sun, P. Wang, M. C. Vuran, M. A. Al-Rodhaan, A. M. Al-Dhelaan, I. F. Akyildiz, BorderSense: Border patrol through advanced wireless sensor networks, *Ad Hoc Networks* 9 (2011) 468–477.
- [50] I. F. Akyildiz, E. P. Stuntebeck, Wireless underground sensor networks: Research challenges, *Ad Hoc Networks* 4 (2006) 669–686.
- [51] O. Bondarenko, S. Kininmonth, M. Kingsford, Underwater Sensor Networks, Oceanography and Plankton Assemblages, in: *IEEE Int. Conf. on Intelligent Sensors, Sensor Networks and Information, Melbourne, 2007*, pp. 657–662.
- [52] D. Pinto, S. Viana, J. Nacif, L. Vieira, M. Vieira, A. Vieira, A. Fernandes, HydroNode: A low cost, energy efficient, multi purpose node for underwater sensor networks, in: *IEEE Conf. on Local Computer Networks, Clearwater, 2012*, pp. 148–151.
- [53] I. F. Akyildiz, D. Pompili, T. Melodia, Underwater acoustic sensor networks: research challenges, *Ad Hoc Networks* 3 (2005) 257–279.

- 
- [54] [www.ieee802.org/15/pub/TG4.html](http://www.ieee802.org/15/pub/TG4.html), 2014.
- [55] [www.zigbee.org](http://www.zigbee.org), ZigBee Alliance, 2014.
- [56] [www.hartcomm.org](http://www.hartcomm.org), 2014.
- [57] Z. Jindong, L. Zhenjun, Z. Yaopei, ELHFR: A graph routing in industrial wireless mesh network, in: IEEE Int. Conf. on Information and Automation, Zhuhai, 2009, pp. 106–110.
- [58] G. Gao, H. Zhang, L. Li, A Reliable Multipath Routing Strategy for WirelessHART Mesh Networks Using Subgraph Routing, *J. of Computational Information Systems* 9 (2013) 2001–2008.
- [59] [www.isa.org](http://www.isa.org), ISA100, Wireless Systems for Automation, 2014.
- [60] [www.bluetooth.com/Pages/low-energy.aspx](http://www.bluetooth.com/Pages/low-energy.aspx), Bluetooth Low Energy, 2014.
- [61] <http://www.ieee802.org/15/pub/TG6.html>, IEEE 802.15 WPAN Task Group 6 (TG6) Body Area Networks, 2014.
- [62] [datatracker.ietf.org/wg/6lowpan/charter](http://datatracker.ietf.org/wg/6lowpan/charter), 2014.
- [63] [johnkooker.com/blog/wp-content/uploads/2009/05/jkooker\\_BTZigBeeWibree.pdf](http://johnkooker.com/blog/wp-content/uploads/2009/05/jkooker_BTZigBeeWibree.pdf), Bluetooth, ZigBee, and Wibree: A Comparison of WPAN technologies, 2013.
- [64] <http://datatracker.ietf.org/wg/roll/charter/>, Routing Over Low power and Lossy networks (roll), 2013.
- [65] <http://tools.ietf.org/html/draft-gnawali-roll-etxof-00>, The ETX Objective Function for RPL, 2010.
- [66] P. O. Kamgueu, E. Nataf, T. Djotio, O. Festor, Energy-based routing metric for RPL, *Research Report* (2013) 1–17.
- [67] O. Gaddour, A. Koubâa, RPL in a nutshell: A survey, *Computer Networks* 14 (2012) 3163–3178.
- [68] <http://mqtt.org/>, MQ Telemetry Transport, 2013.
- [69] [http://mqtt.org/MQTT-S\\_spec\\_v1.2.pdf](http://mqtt.org/MQTT-S_spec_v1.2.pdf), MQTT For Sensor Networks (MQTT-S) Protocol Specification, 2013.
- [70] U. Hunkeler, H. L. Truong, A. Stanford-Clark, MQTT-S — A publish/subscribe protocol for Wireless Sensor Networks, in: 3rd Int. Conf. on Communication Systems Software and Middleware and Workshops, Bangalore, 2008, pp. 791–798.
- [71] <http://mqtt.org/projects>, MQTT projects, 2013.
- [72] S. Cui, A. Goldsmith, A. Bahai, Energy-constrained modulation optimization, *IEEE Transactions on Wireless Communications* 4 (2005) 2349–2360.

- [73] F. M. Costa, H. Ochiari, A Comparison of Modulations for Energy Optimization in Wireless Sensor Network Links, *IEEE Global Telecommunications Conference* (2010) 1–5.
- [74] A. Nosratinia, T. Hunter, A. Hedayat, Cooperative communication in wireless networks, *IEEE Communications Magazine* 42 (2004) 74–80.
- [75] J. W. Jung, W. Wang, M. A. Ingram, Cooperative transmission range extension for duty cycle-limited wireless sensor networks, in: *Int. Conf. on Wireless Communication, Vehicular Technology, Information Theory and Aerospace and Electronic Systems Technology*, Chennai, 2011, pp. 1–5.
- [76] S. Cui, A. Goldsmith, A. Bahai, Energy-Efficiency of MIMO and Cooperative MIMO Techniques in Sensor Networks, *IEEE J. on Selected Areas in Communications* 22 (2004) 1089–1098.
- [77] S. Jayaweera, Virtual MIMO-based cooperative communication for energy-constrained wireless sensor networks, *IEEE Transactions on Wireless Communications* 5 (2006) 984–989.
- [78] S. Lin, J. Zhang, G. Zhou, L. Gu, J. A. Stankovic, T. He, ATPC: adaptive transmission power control for wireless sensor networks, *4th Int. Conf. on Embedded networked sensor systems* (2006) 223–236.
- [79] L. H. Correia, D. F. Macedo, A. L. dos Santos, A. A. Loureiro, J. M. S. Nogueira, Transmission power control techniques for wireless sensor networks, *Computer Networks* 51 (2007) 4765–4779.
- [80] X. Chu, H. Sethu, Cooperative topology control with adaptation for improved lifetime in wireless ad hoc networks, in: *IEEE INFOCOM*, Orlando, FL, USA, 2012, pp. 262–270.
- [81] E. Kranakis, D. Krizanc, E. Williams, Directional versus omnidirectional antennas for energy consumption and k-connectivity of networks of sensors, in: *8th Int. Conf. on Principles of Distributed Systems*, Grenoble, France, 2004, pp. 357–368.
- [82] H.-N. Dai, Throughput and delay in wireless sensor networks using directional antennas, in: *5th Int. Conf. on Intelligent Sensors, Sensor Networks and Information Processing*, Melbourne, 2009, pp. 421–426.
- [83] R. Choudhury, R. Ramanathan, N. Vaidya, On designing MAC protocols for wireless networks using directional antennas, *IEEE Transactions on Mobile Computing* 5 (2006) 477–491.
- [84] E. Karapistoli, I. Gragopoulos, I. Tsetsinas, F.-N. Pavlidou, A MAC protocol for low-rate UWB wireless sensor networks using directional antennas, *Computer Networks* 53 (2009) 961–972.
- [85] A. P. Subramanian, S. R. Das, Addressing Deafness and Hidden Terminal Problem in Directional Antenna based Wireless Multi-Hop Networks, *Wireless Networks* 16 (2010) 1557–1567.

- 
- [86] M. Masonta, Y. Haddad, L. D. Nardis, A. Kliks, O. Holland, Energy efficiency in future wireless networks: Cognitive radio standardization requirements, in: IEEE 17th Int. Workshop on Computer Aided Modeling and Design of Communication Links and Networks, Barcelone, 2012, pp. 31–35.
- [87] M. Naeem, K. Illanko, A. Karmokar, A. Anpalagan, M. Jaseemuddin, Energy-Efficient Cognitive Radio Sensor Networks: Parametric and Convex Transformations, *Sensors* 13 (2013) 11032–11050.
- [88] E. Fasolo, M. Rossi, J. Widmer, M. Zorzi, In-network aggregation techniques for wireless sensor networks: a survey, *IEEE Wireless Communications* 14 (2007) 70–87.
- [89] Z. Yan, V. Subbaraju, D. Chakraborty, A. Misra, K. Aberer, Energy-Efficient Continuous Activity Recognition on Mobile Phones: An Activity-Adaptive Approach, in: 16th International Symposium on Wearable Computers, Newcastle, UK, 2012, pp. 17–24.
- [90] S. Wang, A. Vasilakos, H. Jiang, X. Ma, W. Liu, K. Peng, B. Liu, Y. Dong, Energy efficient broadcasting using network coding aware protocol in wireless ad hoc network, in: IEEE Int. Conf. on Communications (ICC), Kyoto, 2011, pp. 1–5.
- [91] I.-H. Hou, Y.-E. Tsai, T. Abdelzaher, I. Gupta, AdapCode: Adaptive Network Coding for Code Updates in Wireless Sensor Networks, in: IEEE INFOCOM, Phoenix, AZ, 2008, pp. 1–9.
- [92] N. Kimura, S. Latifi, A survey on data compression in wireless sensor networks, in: Int. Conf. on Information Technology: Coding and Computing, Las Vegas, NV, 2005, pp. 8–13.
- [93] J. Hsu, S. Zahedi, A. Kansal, M. Srivastava, V. Raghunathan, Adaptive duty cycling for energy harvesting systems, in: Int. Symp. on Low power electronics and design, Tegernsee, 2006, pp. 180–185.
- [94] R. de Paz Alberola, D. Pesch, Duty cycle learning algorithm (DCLA) for IEEE 802.15.4 beacon-enabled wireless sensor networks, *Ad Hoc Networks* 10 (2012) 664–679.
- [95] R. Carrano, D. Passos, L. Magalhaes, C. Albuquerque, Survey and Taxonomy of Duty Cycling Mechanisms in Wireless Sensor Networks, *IEEE Communications Surveys & Tutorials* 16 (2014) 181–194.
- [96] H. Ba, I. Demirkol, W. Heinzelman, Passive wake-up radios: From devices to applications, *Ad Hoc Networks* 11 (2013) 2605–2621.
- [97] S. Misra, M. P. Kumar, M. S. Obaidat, Connectivity preserving localized coverage algorithm for area monitoring using wireless sensor networks, *Computer Communications* 34 (2011) 1484–1496.
- [98] E. Karasabun, I. Korpeoglu, C. Aykanat, Active node determination for correlated data gathering in wireless sensor networks, *Computer Networks* 57 (2013) 1124–1138.



## References

---

- [99] A. Bachir, W. Bechkit, Y. Challal, A. Bouabdallah, Temperature-Aware Density Optimization for Low Power Wireless Sensor Networks, *IEEE Communications Letters* 17 (2013).
- [100] J. Al-Karaki, A. Kamal, Routing techniques in wireless sensor networks: a survey, *IEEE Wireless Communications* 11 (2004) 6–28.
- [101] A. A. Abbasi, M. Younis, A survey on clustering algorithms for wireless sensor networks, *Computer Communications* 30 (2007) 2826–2841.
- [102] D. Kumar, T. C. Aseri, R. Patel, EEHC: Energy efficient heterogeneous clustered scheme for wireless sensor networks, *Computer Communications* 32 (2009) 662–667.
- [103] H. Li, Y. Liu, W. Chen, W. Jia, B. Li, J. Xiong, COCA: Constructing optimal clustering architecture to maximize sensor network lifetime, *Computer Communications* 36 (2013) 256–268.
- [104] A. Liu, J. Ren, X. Li, Z. Chen, X. S. Shen, Design principles and improvement of cost function based energy aware routing algorithms for wireless sensor networks, *Computer Networks* 56 (2012) 1951–1967.
- [105] Y. M. Lu, V. W. S. Wong, An energy-efficient multipath routing protocol for wireless sensor networks, *International Journal of Communication Systems* 20 (2007) 747–766.
- [106] Z. Wang, E. Bulut, B. Szymanski, Energy Efficient Collision Aware Multipath Routing for Wireless Sensor Networks, in: *IEEE Int. Conf. on Communications, Dresden, 2009*, pp. 1–5.
- [107] M. Radi, B. Dezfouli, K. A. Bakar, M. Lee, Multipath routing in wireless sensor networks: survey and research challenges, *Sensors* 12 (2012) 650–685.
- [108] M. Younis, K. Akkaya, Strategies and techniques for node placement in wireless sensor networks: A survey, *Ad Hoc Networks* 6 (2008) 621–655.
- [109] S. Ergen, P. Varaiya, Optimal Placement of Relay Nodes for Energy Efficiency in Sensor Networks, in: *IEEE Int. Conf. on Communications, Istanbul, 2006*, pp. 3473–479.
- [110] S. Misra, N. E. Majd, H. Huang, Constrained Relay Node Placement in Energy Harvesting Wireless Sensor Networks, in: *IEEE 8th Int. Conf. on Mobile Adhoc and Sensor Systems, Valencia, 2011*, pp. 2155–6806.
- [111] D. Dandekar, P. Deshmukh, Energy balancing multiple sink optimal deployment in multi-hop Wireless Sensor Networks, in: *IEEE 3rd Int. Advance Computing Conference, Ghaziabad, 2013*, pp. 408–412.
- [112] M. Di Francesco, S. K. Das, G. Anastasi, Data Collection in Wireless Sensor Networks with Mobile Elements, *ACM Transactions on Sensor Networks* 8 (2011) 1–34.
- [113] R. Sugihara, R. Gupta, Optimizing Energy-Latency Trade-Off in Sensor Networks with Controlled Mobility, in: *IEEE INFOCOM, Rio de Janeiro, 2009*, pp. 2566–2570.

- 
- [114] W. Liang, J. Luo, X. Xu, Prolonging Network Lifetime via a Controlled Mobile Sink in Wireless Sensor Networks, in: IEEE Global Telecommunications Conference, Miami, 2010, pp. 1–6.
- [115] P. Nintanavongsa, M. Naderi, K. Chowdhury, Medium access control protocol design for sensors powered by wireless energy transfer, in: IEEE INFOCOM, Turin, 2013, pp. 150–154.
- [116] K. Tutuncuoglu, A. Yener, Communicating Using an Energy Harvesting Transmitter: Optimum Policies Under Energy Storage Losses, Submitted to IEEE Transactions on Wireless Communications, available at arXiv:1208.6273 (2012) 1–11.
- [117] L. Xie, Y. Shi, Y. Hou, A. Lou, Wireless power transfer and applications to sensor networks, IEEE Wireless Communications 20 (2013) 140–145.
- [118] F. Zhang, S. A. Hackworth, X. Liu, H. Chen, S. R. J., M. Sun, Wireless energy transfer platform for medical sensors and implantable devices, in: Int. Conf. of the IEEE Engineering in Medicine and Biology Society, Minneapolis, MN, 2012, pp. 1045–1048.
- [119] O. Jonah, S. V. Georgakopoulos, Efficient wireless powering of sensors embedded in concrete via magnetic resonance, IEEE Int. Symposium on Antennas and Propagation (2011) 1425–1428.
- [120] B. Griffin, C. Detweiler, Resonant wireless power transfer to ground sensors from a UAV, in: IEEE Int. Conf. on Robotics and Automation, Saint Paul, MN, 2012, pp. 2660–2665.
- [121] Y. Shi, L. Xie, Y. T. Hou, H. D. Sherali, On renewable sensor networks with wireless energy transfer, in: IEEE INFOCOM, Shanghai, 2011, pp. 1350–1358.
- [122] R. Doost, K. R. Chowdhury, M. Di Felice, Routing and link layer protocol design for sensor networks with wireless energy transfer, in: IEEE Global Telecommunications Conference, Miami, 2010, pp. 1–5.
- [123] K. Li, H. Luan, C.-C. Shen, Qi-Ferry: energy-constrained wireless charging in wireless sensor networks, in: IEEE Wireless Communications and Networking Conference, Shanghai, 2012, pp. 2515–2520.
- [124] M. Erol-Kantarci, H. T. Mouftah, SuReSense: sustainable wireless rechargeable sensor networks for the Smart Grid, IEEE Wireless Communications 19 (2012) 30–36.
- [125] B. Gurakan, O. Ozel, J. Yang, S. Ulukus, Energy Cooperation in Energy Harvesting Communications, IEEE Transactions on Communications 61 (2013) 4884–4898.
- [126] K. Kaushik, D. Mishra, S. De, S. Basagni, W. Heinzelman, K. Chowdhury, S. Jana, Experimental demonstration of multi-hop RF energy transfer, in: IEEE 24th Int. Symp. on Personal Indoor and Mobile Radio Communications, London, UK, 2013, pp. 538–542.
- [127] M. Watfa, H. Al-Hassanieh, S. Selman, Wireless power transfer and applications to sensor networks, IEEE Communications Letters 15 (2011) 1275–1277.

- [128] D. Kandris, M. Tsagkaropoulos, I. Politis, A. Tzes, S. Kotsopoulos, PEMuR: Energy efficient and perceived QoS aware video routing over Wireless Multimedia Sensor Networks, *Ad Hoc Networks* 9 (2011) 591–607.
- [129] S. Ehsan, B. Hamdaoui, A Survey on Energy-Efficient Routing Techniques with QoS Assurances for Wireless Multimedia Sensor Networks, *IEEE Communications Surveys & Tutorials* 14 (2011) 265–278.
- [130] B. Carballido Villaverde, S. Rea, D. Pesch, InRout – A QoS aware route selection algorithm for industrial wireless sensor networks, *Ad Hoc Networks* 10 (2012) 458–478.
- [131] D. Tang, T. Jiang, J. Ren, Secure and Energy Aware Routing (SEAR) in Wireless Sensor Networks, *IEEE Global Telecommunications Conference* (2010) 1–5.
- [132] T. Zahariadis, H. C. Leligou, S. Voliotis, P. Trakadas, P. Karkazis, Energy-aware Secure Routing for Large Wireless Sensor Networks, *Wseas Transactions On Communications* 8 (2009) 981–991.
- [133] A. A. Ahmed, An enhanced real-time routing protocol with load distribution for mobile wireless sensor networks, *Computer Networks* 57 (2013) 1459–1473.
- [134] G. Miao, N. Himayat, Y. G. Li, A. Swami, Cross-layer optimization for energy-efficient wireless communications: a survey, *Wireless Communications and Mobile Computing* 9 (2009) 529–542.
- [135] L. D. Mendes, J. J.P.C. Rodrigues, A survey on cross-layer solutions for wireless sensor networks, *Journal of Network and Computer Applications* 34 (2011) 523–534.
- [136] Q. Gao, J. Zhang, X. S. Shen, B. Larish, A Cross-Layer Optimization Approach for Energy Efficient Wireless Sensor Networks: Coalition-Aided Data Aggregation, Cooperative Communication, and Energy Balancing, *Advances in Multimedia* (2007) 1–12.
- [137] C.-Y. Chang, H.-R. Chang, Energy-aware node placement, topology control and MAC scheduling for wireless sensor networks, *Computer Networks* 52 (2008) 2189–2204.
- [138] S. Liu, Y. Bai, M. Sha, Q. Deng, D. Qian, CLEEP: A Novel Cross-Layer Energy-Efficient Protocol for Wireless Sensor Networks, in: *Int. Conf. on Wireless Communications, Networking and Mobile Computing, Dalian, 2008*, pp. 1–4.
- [139] L. Shi, A. O. Fapojuwo, Cross-layer optimization with cooperative communication for minimum power cost in packet error rate constrained wireless sensor networks, *Ad Hoc Networks* 10 (2012) 1457–1468.
- [140] F. Cuomo, A. Abbagnale, E. Cipollone, Cross-layer network formation for energy-efficient IEEE 802.15.4/ZigBee Wireless Sensor Networks, *Ad Hoc Networks* 11 (2013) 672–686.
- [141] I. T. Almalkawi, M. G. Zapata, J. N. Al-Karaki, A Cross-Layer-Based Clustered Multipath Routing with QoS-Aware Scheduling for Wireless Multimedia Sensor Networks, *International Journal of Distributed Sensor Networks* (2012) 1–11.

- 
- [142] F. Xue, A. Sanderson, R. Graves, Multi-Objective Routing in Wireless Sensor Networks with a Differential Evolution Algorithm, in: IEEE Int. Conf. on Networking, Sensing and Control, Ft. Lauderdale, FL, 2006, pp. 880–885.
- [143] A. Konstantinidis, K. Yang, Q. Zhang, D. Zeinalipour-Yazti, A multi-objective evolutionary algorithm for the deployment and power assignment problem in wireless sensor networks, *Computer Networks* 54 (2010) 960–976.
- [144] R. Rajagopalan, Multi-objective optimization algorithms for sensor network design, *IEEE Annual Wireless and Microwave Technology Conference* (2010) 1–4.
- [145] R. Machado, S. Tekinay, A survey of game-theoretic approaches in wireless sensor networks, *Computer Networks* 52 (2008) 3047–3061.
- [146] H.-Y. Shi, W.-L. Wang, N.-M. Kwok, S.-Y. Chen, Game Theory for Wireless Sensor Networks: A Survey, *Sensors* 12 (2012) 9055–9097.
- [147] M. Felegyhazi, J.-P. Hubaux, L. Buttyan, Cooperative packet forwarding in multi-domain sensor networks, in: *IEEE Int. Conf. on Pervasive Computing and Communications Workshops*, Kauai Island, HI, USA, 2005, pp. 345–349.
- [148] E. Zeydan, D. Kivanc, C. Comaniciu, U. Tureli, Energy-efficient routing for correlated data in wireless sensor networks, *Ad Hoc Networks* 10 (2012) 962–975.
- [149] R. V. Kulkarni, A. Förster, G. Venayagamoorthy, Computational Intelligence in Wireless Sensor Networks: A Survey, *IEEE Communications Surveys & Tutorials* 13 (2011) 68–96.
- [150] M. D. Francesco, S. K. Das, G. Anastasi, Data Collection in Wireless Sensor Networks with Mobile Elements: A Survey, *IEEE/ACM TOSN* 8 (2011).
- [151] I. Papadimitriou, L. Georgiadis, Energy-aware routing to maximize lifetime in wireless sensor networks with mobile sink, *Journal of Communications Software and Systems* (2006).
- [152] J. Luo, J.-P. Hubaux, Joint mobility and routing for lifetime elongation in wireless sensor networks, *IEEE INFOCOM* (2005).
- [153] S. Basagni, A. Carosi, E. Melachrinoudis, C. Petrioli, Z. Wang, A New MILP Formulation and Distributed Protocols for Wireless Sensor Networks Lifetime Maximization, *IEEE ICC* (2006).
- [154] J. Luo, J. Panchard, M. Piorkowski, M. Grossglauser, J.-P. Hubaux, MobiRoute : Routing towards a Mobile Sink for Improving Lifetime in Sensor Networks, *IEEE DCOSS* (2006).
- [155] J. Luo, J.-P. Hubaux, Joint Sink Mobility and Routing to Maximize the Lifetime of Wireless Sensor Networks: The Case of Constrained Mobility, *IEEE/ACM Transactions on Networking* 18 (2010) 871–884.
- [156] S. Basagni, A. Carosi, C. Petrioli, C. A. Phillips, Coordinated and controlled mobility of multiple sinks for maximizing the lifetime of wireless sensor networks, *Wireless Networks* 17 (2011).

## References

---

- [157] S. Gandham, M. Dawande, R. Prakash, S. Venkatesan, Energy efficient schemes for wireless sensor networks with multiple mobile base stations, *IEEE GLOBECOM* (2003).
- [158] Y. Gu, D. Bozdag, E. Ekici, F. Ozguner, C. Lee, Partitioning based mobile element scheduling in wireless sensor networks, *IEEE SECON* (2005).
- [159] J. Rao, T. Wu, S. Biswas, Mobile element scheduling for efficient data collection in wireless sensor networks with dynamic deadlines, *IEEE WCNC* (2008).
- [160] D. Turgut, L. Boloni, Heuristic Approaches for Transmission Scheduling in Sensor Networks with Multiple Mobile Sinks, *The Computer Journal* 54 (2011).
- [161] A. Somasundara, A. Kansal, D. Jea, D. Estrin, M. Srivastava, Controllably mobile infrastructure for low energy embedded networks, *IEEE Transactions on Mobile Computing* 5 (2006).
- [162] J. Rao, S. Biswas, Network-assisted sink navigation for distributed data gathering: Stability and delay-energy trade-offs, *Computer Communications* 33 (2010).
- [163] L. Khachiyan, A polynomial algorithm in linear programming, *Soviet Math. Doklady* 244 (1979) 1093–1096.
- [164] N. Karmarkar, A new polynomial-time algorithm for linear programming, in: *Proceedings of the sixteenth annual ACM symposium on Theory of computing - STOC '84*, ACM Press, New York, New York, USA, 1984, pp. 302–311. URL: <http://portal.acm.org/citation.cfm?doid=800057.808695>. doi:10.1145/800057.808695.
- [165] G. B. Dantzig, A. Orden, P. Wolfe, The generalized simplex method for minimizing a linear form under linear inequality restraints, *Pacific J. Math.* 5 (1955) 183–195.
- [166] J. Rousselot, J.-D. Decotignie, M. Aoun, P. van der Stok, R. Oliver, G. Fohler, Accurate Timeliness Simulations for Real-Time Wireless Sensor Networks, *EMS* (2009).
- [167] I. Demirkol, C. Ersoy, F. Alagoz, MAC protocols for wireless sensor networks: a survey, *IEEE Communications Magazine* 44 (2006).
- [168] A. Kurs, A. Karalis, R. Moffat, J. Joannopoulos, P. Fisher, M. Soljagic, Wireless power transfer via strongly coupled magnetic resonances, *Science* 317 (2007).
- [169] M. K. Watfa, H. Al-Hassanieh, S. Salmen, The road to immortal sensor nodes, *Int. Conf. on Intelligent Sensors, Sensor Networks and Information Processing* (2008).
- [170] W. Yao, M. Li, M.-Y. Wu, Inductive charging with multiple charger nodes in wireless sensor networks, *Int. Conf. on Advanced Web and Network Technologies, and Applications* (2006).
- [171] Y. Peng, Z. Li, W. Zhang, D. Qiao, Prolonging sensor network lifetime through wireless charging, *IEEE RTSS* (2010).
- [172] Z. Li, Y. Peng, W. Zhang, D. Qiao, Study of joint routing and wireless charging strategies in sensor networks, *Int. Conf. on Wireless algorithms, systems, and applications* (2010).

- 
- [173] <http://www.un.org/esa/population/publications/worldageing19502050/>, World Population Ageing: 1950-2050, accessed december 2014. Online; Chapter II.
- [174] O. D. Lara, M. A. Labrador, A Survey on Human Activity Recognition based on Wearable Sensors, *IEEE Communications Surveys and Tutorials* 15 (2013) 1192–1209.
- [175] G. Bleser, D. Steffen, M. Weber, G. Hendebly, D. Stricker, L. Fradet, F. Marin, N. Ville, F. Carré, A personalized exercise trainer for the elderly, *Journal of ambient intelligence and smart environments* 5 (2013) 547–562.
- [176] K. Lorincz, B. rong Chen, G. W. Challen, A. R. Chowdhury, S. Patel, P. Bonato, M. Welsh, Mercury: a wearable sensor network platform for high-fidelity motion analysis, in: *7th ACM Conference on Embedded Networked Sensor Systems*, Berkeley, California, 2009, pp. 183–196.
- [177] H. Noshadi, F. Dabiri, S. Meguerdichian, M. Potkonjak, M. Sarrafzadeh, Energy optimization in wireless medical systems using physiological behavior, in: *Wireless Health Conference*, San Diego, CA, 2010, pp. 128–136.
- [178] T. Park, J. Lee, I. Hwang, C. Yoo, L. Nachman, J. Song, E-Gesture: a collaborative architecture for energy-efficient gesture recognition with hand-worn sensor and mobile devices, in: *9th ACM Conference on Embedded Networked Sensor Systems*, Seattle, WA, 2011, pp. 260–273.
- [179] L. Wang, T. Gu, X. Tao, J. Lu, A hierarchical approach to real-time activity recognition in body sensor networks, *Pervasive and Mobile Computing* 8 (2012) 115–130.
- [180] K. Zhan, S. Faux, F. Ramos, Multi-scale Conditional Random Fields for first-person activity recognition on elders and disabled patients, *Pervasive and Mobile Computing* (In Press) 1–27.
- [181] Q. Lin, D. Zhang, K. Connelly, H. Ni, Z. Yu, X. Zhou, Disorientation detection by mining GPS trajectories for cognitively-impaired elders, *Pervasive and Mobile Computing* (In Press) 1–15.
- [182] M. Lin, N. D. Lane, M. Mohammad, X. Yang, H. Lu, G. Cardone, S. Ali, A. Doryab, E. Berke, BeWell+: multi-dimensional wellbeing monitoring with community-guided user feedback and energy optimization, in: *Wireless Health Conference*, San Diego, USA, 2012, pp. 1–5.
- [183] J. K. Aggarwal, Q. Cai, Human Motion Analysis: A Review, *Computer Vision and Image Understanding* 73 (1999) 428–440.
- [184] R. E. Mayagoitia, A. V. Nene, P. H. Veltink, Accelerometer and rate gyroscope measurement of kinematics: an inexpensive alternative to optical motion analysis systems, *Journal of Biomechanics* 35 (2002) 537–542.
- [185] L. Bao, S. S. Intille, *Activity recognition from user-annotated acceleration data*, Springer Berlin Heidelberg (2004) 1–17.

## References

---

- [186] J. Gummeson, B. Priyantha, J. Liu, An energy harvesting wearable ring platform for gesture input on surfaces, in: 12th annual Int. Conf. on Mobile systems, applications, and services, Bretton Woods, NH, USA, 2014, pp. 162–175.
- [187] S. A. Hoseini-Tabatabaei, A. Gluhak, R. Tafazolli, A survey on smartphone-based systems for opportunistic user context recognition, *ACM Computing Surveys* 45 (2013) 1–51.
- [188] D. H. Kim, Y. Kim, D. Estrin, M. B. Srivastava, SensLoc: sensing everyday places and paths using less energy, in: 8th ACM Conference on Embedded Networked Sensor Systems, Zurich, Switzerland, 2010, pp. 43–56.
- [189] H. Lu, W. P. N. D. Lane, T. Choudhury, A. T. Campbell, SoundSense: scalable sound sensing for people-centric applications on mobile phones, in: 7th international conference on Mobile systems, applications, and services, Krakow, Poland, 2009, pp. 165–178.
- [190] Y. Lee, Y. Ju, C. Min, S. Kang, I. Hwang, J. Song, CoMon: cooperative ambience monitoring platform with continuity and benefit awareness, in: 10th Int. Conf. on Mobile systems, applications, and services, Low Wood Bay, UK, 2012, pp. 43–56.
- [191] V. Leonov, Thermoelectric Energy Harvesting of Human Body Heat for Wearable Sensors, *IEEE Sensors Journal* 13 (2013) 1–8.
- [192] K. K. Rachuri, C. Mascolo, M. Musolesi, P. J. Rentfrow, SociableSense: exploring the trade-offs of adaptive sampling and computation offloading for social sensing, in: ACM International Conference on Mobile computing and networking - MobiCom, Las Vegas, Nevada, USA, 2011, pp. 73–84.
- [193] D. Roggen, G. Troster, P. Lukowicz, A. Ferscha, J. del R. Millan, R. Chavarriaga, Opportunistic human activity and context recognition, *Computer* 46 (2012) 36–45.
- [194] M. Keally, G. Zhou, G. Xing, J. Wu, Remora: Sensing resource sharing among smartphone-based body sensor networks, in: 21st International Symposium on Quality of Service, Montreal, QC, 2013, pp. 1–10.
- [195] K. K. Rachuri, C. Efstratiou, I. Leontiadis, C. Mascolo, P. Rentfrow, METIS: Exploring mobile phone sensing offloading for efficiently supporting social sensing applications, in: IEEE International Conference on Pervasive Computing and Communications, San Diego, CA, 2013, pp. 85–93.
- [196] S. Nath, ACE: exploiting correlation for energy-efficient and continuous context sensing, in: 10th Int. Conf on Mobile Systems, Applications and Services, Low Wood Bay, UK, 2012, pp. 29–42.
- [197] E. Miluzzo, N. D. Lane, K. Fodor, R. Peterson, H. Lu, M. Musolesi, S. B. Eisenman, X. Zheng, A. T. Campbell, Sensing meets mobile social networks: the design, implementation and evaluation of the CenceMe application, in: 6th ACM conference on Embedded network sensor systems, Raleigh, NC, USA, 2008, pp. 337–350.

- 
- [198] X. Qi, M. Keally, G. Zhou, Y. Li, Z. Ren, AdaSense: Adapting Sampling Rates for Activity Recognition in Body Sensor Networks, in: 19th IEEE Real-Time and Embedded Technology and Applications Symposium, Philadelphia, PA, 2013, pp. 163–172.
- [199] A. Bulling, U. Blanke, B. Schiele, A tutorial on human activity recognition using body-worn inertial sensors, *ACM Computing Surveys* 46 (2014) 1–33.
- [200] L. Au, M. Batalin, T. Stathopoulos, A. Bui, W. Kaiser, Episodic sampling: Towards energy-efficient patient monitoring with wearable sensors, in: IEEE Engineering in Medicine and Biology Society, Minneapolis, Minnesota, USA, 2009, pp. 6901–6905.
- [201] L. Lim, A. Misra, T. Mo, Adaptive data acquisition strategies for energy-efficient, smartphone-based, continuous processing of sensor streams, *Distributed and Parallel Databases* 32 (2013) 321–351.
- [202] N. Balasubramanian, A. Balasubramanian, A. Venkataramani, Energy consumption in mobile phones: a measurement study and implications for network applications, in: 9th ACM SIGCOMM conference on Internet measurement conference, Chicago, Illinois, USA, 2009, pp. 280–293.
- [203] J. A. Ward, P. Lukowicz, H. W. Gellersen, Performance metrics for activity recognition, *ACM Transactions on Intelligent Systems and Technology* 2 (2011) 1–23.
- [204] N. Lane, E. Miluzzo, H. Lu, D. Peebles, T. Choudhury, A. Campbell, A survey of mobile phone sensing, *IEEE Communications Magazine* 48 (2010) 140–150.
- [205] F. B. Abdesslem, A. Phillips, T. Henderson, Less is more: energy-efficient mobile sensing with senseless, in: 1st ACM workshop on Networking, systems, and applications for mobile handhelds, Barcelona, Spain, 2009, pp. 61–62.
- [206] J. Furthmuller, O. Waldhorst, Energy-aware Resource Sharing with Mobile Devices, *Performance Metrics for Intelligent Systems* 56 (2012) 1920–1934.
- [207] F.-T. Sun, C. Kuo, M. Griss, PEAR: Power efficiency through activity recognition (for ECG-based sensing), in: 5th International Conference on Pervasive Computing Technologies for Healthcare, Dublin, Ireland, 2011, pp. 115–122.
- [208] V. Leonov, T. Torfs, P. Fiorini, C. Van Hoof, Thermoelectric Converters of Human Warmth for Self-Powered Wireless Sensor Nodes, *IEEE Sensors Journal* 7 (2007) 650–657.
- [209] M. Gorlatova, J. Sarik, M. Cong, I. Kymissis, G. Zussman, Movers and Shakers: Kinetic Energy Harvesting for the Internet of Things, Technical Report (2013) 1–11.
- [210] J. M. Donelan, Q. Li, V. Naing, J. A. Hoffer, D. J. Weber, A. D. Kuo, Biomechanical Energy Harvesting: Generating Electricity During Walking with Minimal User Effort, *Science* 319 (2008) 807–810.
- [211] L. Rome, L. Flynn, E. Goldman, T. Yoo, Generating Electricity While Walking with Loads, *Science* 309 (2005) 1725–1728.



## References

---

- [212] N. Shenck, J. Paradiso, Energy scavenging with shoe-mounted piezoelectrics, *IEEE Micro* 21 (2001) 30–42.
- [213] P. Damm, F. Graichen, A. Rohlmann, A. Bender, G. Bergmann, Total hip joint prosthesis for in vivo measurement of forces and moments, *Medical Engineering & Physics* 32 (2010) 95–100.
- [214] P. Zappi, T. Stiefmeier, E. Farella, D. Roggen, L. Benini, G. Troster, Activity recognition from on-body sensors by classifier fusion: sensor scalability and robustness, in: 3rd International Conference on Intelligent Sensors, Sensor Networks and Information, Melbourne, Qld., 2007, pp. 281–286.
- [215] L. Gao, A. Bourke, J. Nelson, Activity recognition using dynamic multiple sensor fusion in body sensor networks, in: *IEEE Engineering in Medicine and Biology Society*, San Diego, CA, 2012, pp. 1077–1080.
- [216] D. Gordon, J. Czerny, T. Miyaki, M. Beigl, Energy-Efficient Activity Recognition Using Prediction, in: 16th International Symposium on Wearable Computers, Newcastle, 2012, pp. 29–36.
- [217] S. Kang, J. Lee, H. Jang, Y. Lee, S. Park, J. Song, A Scalable and Energy-Efficient Context Monitoring Framework for Mobile Personal Sensor Networks, *IEEE Transactions on Mobile Computing* 9 (2006) 686–702.
- [218] Y. Wang, J. Lin, M. Annavaram, Q. A. Jacobson, J. Hong, B. Krishnamachari, N. Sadeh, A framework of energy efficient mobile sensing for automatic user state recognition, in: 7th International Conference on Mobile systems, applications, and services, Krakow, Poland, 2009, pp. 179–192.
- [219] K. V. Laerhoven, H.-W. Gellersen, Spine versus Porcupine: A Study in Distributed Wearable Activity Recognition, in: *Int. Symp. on Wearable Computers*, Washington, DC, USA, 2004, pp. 142–149.
- [220] A. Chowdhury, B. Falchuk, A. Misra, MediAlly: A provenance-aware remote health monitoring middleware, in: *IEEE Int. Conf on Pervasive Computing and Communications*, Mannheim, Germany, 2010, pp. 125–134.
- [221] H. Lu, J. Y. Z. Liu, N. D. Lane, T. Choudhury, A. T. Campbell, The Jigsaw continuous sensing engine for mobile phone applications, in: 8th ACM Conference on Embedded Networked Sensor Systems, Zurich, Switzerland, 2010, pp. 71–84.
- [222] N. Wang, G. V. Merrett, R. G. Maunder, A. Rogers, Energy and Accuracy Trade-Offs in Accelerometry-Based Activity Recognition, in: 22nd International Conference on Computer Communications and Networks, Nassau, Bahamas, 2013, pp. 1–6.
- [223] M. Paschou, E. Sakkopoulos, E. Sourla, A. Tsakalidis, Health Internet of Things: Metrics and methods for efficient data transfer, *Simulation Modelling Practice and Theory* (2013) 186–199.
- [224] B. Kim, Y. Cho, J. Hong, AWNIS: Energy-Efficient Adaptive Wireless Network Interface Selection for Industrial Mobile Devices, *IEEE Transactions on Industrial Informatics* (2014) 714–729.

- 
- [225] A. Rahmati, L. Zhong, Context-for-wireless: context-sensitive energy-efficient wireless data transfer, in: 5th International Conference on Mobile systems, applications and services, San Juan, Puerto Rico, USA, 2007, pp. 165–178.
- [226] V. Loseu, H. Ghasemzadeh, R. Jafari, A wireless communication selection approach to minimize energy-per-bit for wearable computing applications, in: Int. Conf. on Distributed Computing in Sensor Systems and Workshops - DCOSS, Barcelona, Spain, 2011, pp. 1–8.
- [227] C. Sengul, M. Bakht, A. Harris, T. Abdelzaher, R. Kravets, Improving Energy Conservation Using Bulk Transmission over High-Power Radios in Sensor Networks, in: Int. Conf. on Distributed Computing Systems -ICDCS, Beijing, China, 2008, pp. 801–808.
- [228] J. Liu, B. Priyantha, T. Hart, H. S. Ramos, A. A. F. Loureiro, Q. Wang, Energy efficient GPS sensing with cloud offloading, in: 10th ACM Conference on Embedded Network Sensor Systems, Toronto, Canada, 2012, pp. 85–98.
- [229] E. Cuervo, A. Balasubramanian, D. ki Cho, A. Wolman, S. Saroiu, R. Chandra, P. Bahl, MAUI: making smartphones last longer with code offload, in: 8th Int. Conf on Mobile Systems, Applications and Services, San Francisco, USA, 2010, pp. 49–62.
- [230] N. Vallina-Rodriguez, J. Crowcroft, ErdOS: achieving energy savings in mobile OS, in: 6th Int. workshop on MobiArch, Bethesda, USA, 2011, pp. 37–42.
- [231] R. Cilla, M. Patricio, A. Berlanga, J. Molina, Creating Human Activity Recognition Systems Using Pareto-based Multiobjective Optimization, in: 6 th IEEE International Conference on Advanced Video and Signal Based Surveillance, Genova, 2009, pp. 37–42.
- [232] H. Martin, J. Iglesias, J. Cano, A. M. Bernardos, J. R. Casar, Towards a fuzzy-based multi-classifier selection module for activity recognition applications, in: Workshop proceedings of the 10th IEEE International Conference on Pervasive Computing and Communications, Lugano, Switzerland, 2012, pp. 871–876.
- [233] D. Chu, N. D. Lane, T. T.-T. Lai, C. Pang, X. Meng, Q. Guo, F. Li, F. Zhao, Balancing energy, latency and accuracy for mobile sensor data classification, in: 9th ACM Conference on Embedded Networked Sensor Systems, Seattle, WA, USA, 2011, pp. 54–67.
- [234] S. Kang, Y. Lee, C. Min, Y. Ju, T. Park, J. Lee, Y. Rhee, J. Song, Orchestrator: An active resource orchestration framework for mobile context monitoring in sensor-rich mobile environments, in: IEEE Int. Conf on Pervasive Computing and Communications, Mannheim, Germany, 2010, pp. 135–144.
- [235] V. Srinivasan, T. Phan, An accurate two-tier classifier for efficient duty-cycling of smartphone activity recognition systems, in: 3rd International Workshop on Sensing Applications on Mobile Phones, Toronto, Canada, 2012, pp. 1–5.
- [236] R. Rana, C. T. Chou, N. Bulusu, S. Kanhere, W. Hu, Ear-Phone: A context-aware noise mapping using smart phones, *Pervasive and Mobile Computing (In Press)* 1–22.

## References

---

- [237] U. Maurer, A. Smailagic, D. Siewiorek, M. Deisher, Activity recognition and monitoring using multiple sensors on different body positions, in: *Int. Workshop on Wearable and Implantable Body Sensor Networks*, Cambridge, MA, 2006, pp. 1–5.
- [238] D. Lymberopoulos, N. Priyantha, M. Goraczko, F. Zhao, Towards Energy Efficient Design of Multi-radio Platforms for Wireless Sensor Networks, in: *Int. Conf. on Information Processing in Sensor Networks (IPSN)*, St. Louis, MO, 2008, pp. 257–268.
- [239] K. Kumar, Y.-H. Lu, Cloud Computing for Mobile Users: Can Offloading Computation Save Energy, *Computer* 43 (2010) 51–56.
- [240] P. Mitcheson, E. Yeatman, G. Rao, A. Holmes, T. Green, Energy Harvesting From Human and Machine Motion for Wireless Electronic Devices, *Proceedings of the IEEE* 96 (2008) 1457–1486.
- [241] J. Paradiso, T. Starner, Energy scavenging for mobile and wireless electronics, *IEEE Pervasive Computing* 4 (2005) 1–10.
- [242] P. Mitcheson, Energy harvesting for human wearable and implantable bio-sensors, in: *32th Annual Conference of the IEEE EMBS*, Buenos Aires, Argentina, 2010, pp. 3432–3436.
- [243] F. Graichen, R. Arnold, A. Rohlmann, G. Bergmann, Implantable 9-channel telemetry system for in vivo load measurements with orthopedic implants, *IEEE Transactions on Bio-medical Engineering* 54 (2007) 253–261.
- [244] J. Olivo, S. Carrara, G. De Micheli, IronIC patch: A wearable device for the remote powering and connectivity of implantable systems, in: *IEEE International Instrumentation and Measurement Technology Conference - I2MTC*, Graz, 2012, pp. 286–289.
- [245] [www.shimmersensing.com](http://www.shimmersensing.com), 2014.
- [246] J. Elias, S. Paris, M. Krunz, Cross Technology Interference Mitigation in Body Area Networks: an Optimization Approach, *IEEE Transactions on Vehicular Technology* (2014) 1–14.
- [247] R. Balan, Y. Lee, T. K. Wee, A. Misra, The challenge of continuous mobile context sensing, in: *6th Int. Conf. on Communication Systems and Networks*, Bangalore, Inde, 2014, pp. 1–8.
- [248] A. Lachenmann, P. J. Marron, D. Minder, K. Rothermel, Meeting lifetime goals with energy levels, in: *5th Int. Conf. on Embedded networked sensor systems*, Sydney, Australia, 2007, pp. 131–144.
- [249] K. Lorincz, B. rong Chen, J. Waterman, G. Werner-Allen, M. Welsh, Resource aware programming in the Pixie OS, in: *6th ACM conference on Embedded network sensor systems*, Raleigh, NC, USA, 2008, pp. 211–224.

- 
- [250] V. Pejovic, M. Musolesi, Anticipatory mobile computing for behaviour change interventions, in: ACM International Joint Conference on Pervasive and Ubiquitous Computing, Seattle, Washington, USA, 2014, pp. 1025–1034.
- [251] J. Elias, A. Jarray, J. Salazar, A. Karmouch, A. Mehaoua, A Reliable Design of Wireless Body Area Networks, in: Globecom, Atlanta, USA, 2013, pp. 1–7.
- [252] S. Paris, J. Elias, A. Mehaoua, Cross Technology Interference Mitigation in Body-to-Body Area Networks, in: IEEE 14th Int. Symp. and Workshops on a World of Wireless, Mobile and Multimedia Networks (WoWMoM), Madrid, Spain, 2013, pp. 1–9.
- [253] G. Perrucci, F. Fitzek, J. Widmer, Survey on Energy Consumption Entities on the Smartphone Platform, IEEE Vehicular Technology Conference - VTC (2011).
- [254] E. Dondyk, SPS: an SMS-based Push Service for Energy Saving in Smartphone's Idle State, Master's thesis, University of Central Florida, 2014. Available at <http://purl.fcla.edu/fcla/etd/CFE0005157>.
- [255] P. Zerfos, X. Meng, S. H. Wong, V. Samanta, S. Lu, A study of the short message service of a nationwide cellular network, in: 6th ACM SIGCOMM conference on Internet measurement, Brazil, 2006, pp. 263–268.
- [256] O. Helgason, S. Kouyoumdjieva, Enabling Multiple Controllable Radios in OMNeT++ Nodes, in: Proc. of the 4th International ICST Workshop on OMNeT++, Barcelona, Spain, 2012, pp. 1–4.
- [257] L. Xie, Y. Shi, Y. T. Hou, W. Lou, H. D. Sherali, S. F. Midkiff, On renewable sensor networks with wireless energy transfer: the multi-node case, IEEE SECON (2012).
- [258] B. Tong, Z. Li, G. Wang, W. Zhang, How wireless power charging technology affects sensor network deployment and routing, IEEE ICDCS (2010).