



**HAL**  
open science

# Contribution of the formulation of the links between Invention - Optimization in Inventive conceptual design

Thongchai Chinkatham

► **To cite this version:**

Thongchai Chinkatham. Contribution of the formulation of the links between Invention - Optimization in Inventive conceptual design. Computer Aided Engineering. Université de Strasbourg, 2016. English. NNT : 2016STRAD004 . tel-01473922

**HAL Id: tel-01473922**

**<https://theses.hal.science/tel-01473922v1>**

Submitted on 22 Feb 2017

**HAL** is a multi-disciplinary open access archive for the deposit and dissemination of scientific research documents, whether they are published or not. The documents may come from teaching and research institutions in France or abroad, or from public or private research centers.

L'archive ouverte pluridisciplinaire **HAL**, est destinée au dépôt et à la diffusion de documents scientifiques de niveau recherche, publiés ou non, émanant des établissements d'enseignement et de recherche français ou étrangers, des laboratoires publics ou privés.

École Doctorale Mathématiques, Sciences de l'Information et de l'Ingénieur

---

Laboratoire de Génie de la Conception (LGéCo) – INSA de Strasbourg

**THÈSE** présentée par:

**Thongchai CHINKATHAM**

soutenue le : 13 Janvier 2016

pour obtenir le grade de : **Docteur de l'université de Strasbourg**

Discipline/S spécialité : Génie Industriel/Conception

<p><b>Contribution à la formalisation des liens Invention – Optimisation en Conception Inventive</b></p>
--

**THÈSE dirigée par :**

Prof. CAVALLUCCI Denis

Professeur, INSA de Strasbourg, LGéCo

**RAPPORTEURS :**

Prof. NEGNY Stephane

Professeur, INP-ENSIACET

Prof. GOMES Samuel

Professeur, Université de Technologie de Belfort Montbéliard

**EXAMINATEURS :**

Prof. KNITTEL Dominique

Professeur, Université de Strasbourg

Prof. AUBRY Evelyne

Professeur, ENSISA

Prof. AOUSSAT Améziane

Professeur, Ecole Nationale Supérieure d'Arts et Métier

This thesis is dedicated to my parents.  
For their endless love, support and encouragement

## Acknowledgements

In every greatest journey, the first step is always played the crucial role. As well as, the achievement of this thesis will not happen without the kindness of Prof. Dominique KNITTEL who was introducing me to Prof. Denis CAVALLUCCI. I would like to thank Prof. Dominique for opening the first door of my research life.

I would like to express my sincere gratitude to Prof. Denis CAVALLUCCI, my supervisor, for everything that he did for me. Thank you for times, for many opportunities to learn, to understand the real world. Thank you for giving me the professional experience, not just the academic research life. All of thing that I got from him during my three years and a half will make me strong enough to find my own passions and destiny of life.

My mission will not be accomplished without the kindness of all members of the jury of my defense. I would like to thank Prof. Stephane NEGNY and Prof. Samuel GOMES for accepting to be my reportorial of my thesis. Their remarks and suggestions are a big part in improving the quality of this thesis and I am very grateful to them. Thank you Prof. Evelyne AUBRY, Prof. Améziene AOUSSAT, and again Prof. Dominique KNITTEL, for examining my thesis. Thank you for their observation and sharing both visions and experiences with me during my defense. I appreciate all of their participation, time, and energy that they have spent for on my research. It is my honor to have all of them as the jury of my defense.

I would like to thank all of LGéCo members. Exactly, Prof. Jean RENAUD, our director, without his signature, we will no further finish our thesis as we have to register in every year. Truth, not just for that but for many good things that happened during my three years and a half at LGéCo. Thank you, Ali, for being my big brother.



Thank you, Achille, to be my friend and also my personal photographer sometimes.  
Didier, thank you for being our tech-guy in all case.

I would like to thank you Alsace Region and INSA Strasbourg for their financial support of my research. Contributions in this thesis will not happen without their resources.

As I stay so far from home, far from my family. I would like to thank my Thai friends. Whenever they are for now. I am glad to know you all, I would like to thank for our great moment that we have had together. Thank you for our careful that we have shared. Because all of you I am not feel lonely for this long journey far from home, from Thailand.

Last but not the lease, I would like to thank my parent, sister, and brother for their unconditional support throughout my life.

**Thank you very much all of you,**  
Thongchai CHINKATHAM  
1<sup>st</sup> November 2015

# Contribution à la formalisation des liens Invention - Optimisation en Conception Inventive

**Thésard:** Thongchai CHINKATHAM

**Directeur:** Denis CAVALLUCCI

<b>Table des matières</b>	
1. Introduction	v
2. Contributions	vii
2.1 L'Approche SME(S)	viii
2.2 Concrete Solution Concept Modeler : CSC-Modeler	xi
2.3 L'Approche IMR	xiii
2.4 L'Approche Sim-TRIZ	xv
3. Conclusion et Perspectives	xvii

## 1. Introduction

L'une des contraintes en matière d'innovation est d'améliorer ou de trouver de nouvelles manières de résoudre des problèmes qui surviennent lors des processus de conception de nouveaux produits (NPDP). Un des enjeux majeurs auxquels sont confrontés les concepteurs lors de la création de produits innovants réside dans la définition des concepts et plus particulièrement dans la phase de génération des concepts. Les méthodologies classiques destinées à aider les concepteurs dans la génération de concepts sont limitées par la nécessité d'associer les exigences aux solutions existantes. En conséquence, la mise en place de solutions à la fois innovantes et répondant aux besoins initiaux constitue une source importante de pression sur les responsables du projet. La relation entre les besoins et la créativité se présente de manière dynamique et évolue entre une liberté de conception et un espace de solutions situé dans un ou plusieurs espaces de connaissances souvent distant du domaine d'origine du problème. Une bonne modélisation de cette relation pourrait à notre sens

conduire à une systématisation du processus de conception inventive. Néanmoins, le pipeline de l'innovation ne se contente pas d'analyser la situation initiale et en synthétiser la solution. Il consiste également en l'évaluation et la sélection de solutions à affiner pour les développer plus en détail.

Une des caractéristiques les plus frappantes de la conception inventive est le fait qu'évaluer des solutions peut se révéler être plus difficile que de les trouver. Avoir des idées peut être perçu comme inutile si celles-ci sont amenées à être rejetées à dès l'amont du processus. Dans de nombreuses évaluations qualitatives et méthodes sélectives (voir modèle de conception), les critères d'évaluation sont généralement constitués à partir des besoins de conception. Ces derniers sont fortement influencés par les préférences ou l'expérience des décideurs.

Les décisions nécessairement rapides durant les séances de créativité se confrontent souvent aux réactions immédiates des décideurs qui ont pour conséquence en général la production de jugements instinctifs basés sur l'expérience. Ces derniers ont alors tendance à manquer de précision. Une des réactions immédiates est l'abandon des idées considérées infaisables ou trop risquées, car en invention, ces dernières ont de fortes chances d'être en dehors de l'objectif initial du projet de conception.

La faisabilité d'un concept de solutions est déterminée par les propriétés physiques des concepts de solutions, telle que la configuration approximative potentielle, le dimensionnement de la géométrie et le comportement. Aucune de ces information n'est disponible à ce stade précoce de la conception et il n'y a pas suffisamment d'informations pour lancer des outils de hautes granularité telles que des outils de CAO ou DAO. Ces outils nécessitent une description détaillée des caractéristiques d'une définition de concepts et leurs limites résident au niveau extrême de l'expertise nécessaire pour les utiliser. En parallèle, le soutien informatique à cette étape est encore largement absent. Il existe différents systèmes d'Aide à l'innovation (CAI) basé

sur la TRIZ qui soutiennent les phases de conception créatives et inventives. Ceux-ci proposent des outils utiles d'aide à la conception lors des phases de génération de concepts. Cependant, très peu s'intéresse à l'évaluation de la faisabilité. Cela peut limiter l'intérêt pour des concepts innovants qui offrent potentiellement de meilleures performances. Plus particulièrement, pour les petites et moyennes entreprises (PME) car la problématique de l'accès à ces outils pour favoriser leurs capacités d'innovation est moins systématique et pourtant engage leur survie.

## 2. Contributions

Afin de tirer parti de l'inventivité des acteurs d'une entreprise en octroyant des chances supplémentaires quant à des concepts trop vite jugés impossibles, cette thèse présente des approches et des outils d'aide rapides à l'évaluation et à la sélection de concepts de solution obtenus dans le cadre de la Méthode de Conception Inventive. Les contributions de cette thèse peuvent servir comme des outils d'aide à la conception et à la prise de décision. Le cadre méthodologique de cette thèse dans le cadre de la MCI est présenté dans la Figure 1.

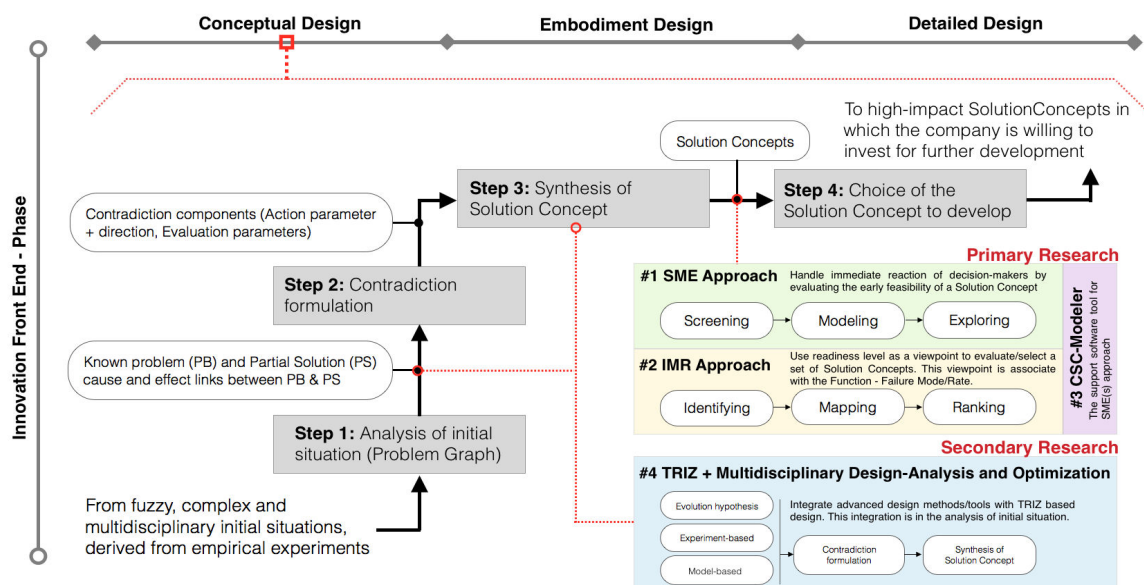

Figure 1. Méthodologique de cette thèse dans le cadre de la MCI

L'objectif principal de cette thèse repose sur l'évaluation effective, efficace et propose un cadre de sélection pour un ensemble de concepts de solution. Le SME (Screening, Modeling, Exploring) et l'IMR (Identifying, Mapping, Ranking) sont des démarches formelles mis au point pour enrichir ce domaine. Un prototype logiciel, à savoir « Concrete Solution Concept Modeler » (CSC-Modeler) est développé pour dépasser les limites liées au manque et de compétences pour initier les approches SME.

L'intégration d'outils de conception avancés inspiré de la TRIZ a été analysée et proposée. Dans toutes les contributions, l'utilisabilité des approches a été démontrée avec un cas d'étude. Cette thèse s'achève avec une conclusion, la mise en évidence de ses limites et les perspectives qui s'offrent à nous pour des développements ultérieurs.

## **2.1 L'Approche SME(s)**

Le processus d'évaluation et de sélection traditionnelle dans la conception inventive ne prennent pas en compte l'évaluation de la faisabilité. En conséquence, des concepts de solution pertinents ont été abandonnés prématurément pour des raisons intuitives et ont été éliminés par les réactions immédiates des décideurs. En outre, cet abandon hâtif peut être le résultat d'avoir suggéré une alternative impossible au "meilleur" concept de solution. Le danger de ces concepts de solution mis en œuvre sans estimer leur infaisabilité est que les coûts ou des pertes considérables peuvent être engagés.

Les Méthodes et outils pour évaluer la faisabilité du concept de solution par le calcul sont encore largement absents dans le processus de conception inventive. Les principaux obstacles qui se posent lorsque l'application de ce processus de calcul sont liés au développement de modèles d'analyse. Un tel processus est loin d'être automatique. La formulation de doutes et de conditions incertaines dans une forme analysable est un processus cognitif qui à notre connaissance n'est à ce jour pas pris en charge par des outils logiciels. En outre, la représentation conventionnelle pour la

construction de modèles d'analyse est l'utilisation d'équations mathématiques qui ne peuvent intégrer les hypothèses et justification des décisions de modélisation. Ces obstacles constituent un manque de connaissances de la conception-analyse aux étapes amont des processus de conception.

L'approche SME a été conçue comme une aide à la décision et accompagnée d'outils. Elle vise à aider le concepteur à affiner la confiance qu'il est susceptible de placer dans le concept de solution en fournissant une estimation rapide et / ou d'explorer la faisabilité d'un concept de solution considéré. De cette façon, un concepteur acquiert un degré de justification pour contourner l'intuition première de l'expert et le processus d'évaluation et de sélection peuvent être mis en œuvre avec plus de précision. L'approche SME se compose de trois étapes principales et les détails de chaque étape sont les suivants :

- 1) **Screening** : Les concepteurs commencent par examiner l'efficacité d'un concept de solution dans la perspective de TRIZ, avec des designers d'aide ultérieures en résumant des doutes ou des conditions incertaines du concepteur/expert ou projet de conception. Après le repérage et la capture des doutes et des conditions incertaines, le concept de solution est classé en trois types :
  - a. *Refinement* : Le concept de solution n'élimine pas la contradiction et il contient beaucoup de caractéristiques douteuse. Ce type de concept de solution doit être amélioré car il ne présente à aucun avantage.
  - b. *Conditional and Worth Consideration* : Le concept de solution manque de quelques informations, telles que des dimensions ou des configurations, ce qui induit des doutes quant à sa pertinence. Les concepteurs précisent les aspects intéressants de chaque concept de solution de ce type et les considèrent plus loin dans les étapes ultérieures.

c. *Adopt different techniques* : Le concept de solution présente un système dit complexe, nécessitant une interaction parmi ses caractéristiques (systèmes multi-physique), un grand nombre de paramètres critiques affectent plusieurs fonctionnalités et il est nécessaire d'aborder de nombreux domaines d'analyse. Ce type de concept de solution ne convient pas à l'outil ici proposé et décrit dans cette thèse. Les concepteurs doivent alors utiliser d'autres techniques et des outils multiphysiques pour évaluer sa faisabilité.

2) **Modeling** : A la condition où le concept mérite d'être examiné, les concepteurs sont alors invités à intégrer des informations lors des tâches de repérage et de formuler ou mettre à jour un modèle d'analyse exécutable assisté par le système d'assistance d'accès aux connaissances et aux informations. Dans cette étape de modélisation, deux directions peuvent être prises pour estimer et/ou explorer la faisabilité d'un concept de solution qui est testée :

- a. *Estimate* : Formuler ou mettre à jour les aspects d'analyse en un problème basé sur une équation et définir les valeurs initiales nécessaires pour effectuer le calcul.
- b. *Explore* : Formuler ou mettre à jour les aspects d'analyse pour en faire un problème d'optimisation. Le rôle de l'optimisation dans cette thèse est d'explorer l'espace de conception possible, pas nécessairement de trouver la solution optimale. Après avoir répondu aux exigences du modèle d'analyse, le concepteur complète le processus en générant un modèle d'analyse exécutable et passe à l'étape Exploring.

3) **Exploring** : concepteurs estiment et/ou explorent l'espace de conception en utilisant les outils déterminés dans l'analyse.

Cette approche s'impose lorsque l'utilisateur définit la "*Conditional and Worth Consideration*" pour un concept de solution à tester. Après que tous les concepts de solutions aient été testées, le processus d'évaluation et de sélection sur la base de MCI (étape 4) seront mis en œuvre. Le résultat d'une telle approche est que les concepts les plus appropriées seront alors sélectionnés et poussés plus avant dans le processus de développement.

La difficulté majeure dans l'exécution d'une analyse lors de la phase conceptuelle découle d'un manque d'information et de connaissance explicite lors de la formulation d'un modèle d'analyse. Les exigences d'information nécessaires pour gérer cette difficulté, y compris une série de questions, viennent en support de la connaissance et de l'information. Ils ont été développés sous la forme de modèles et ces modèles (Formulation et connaissances/informations) visent à faciliter la transition d'un descriptif à un niveau paramétrique de doutes ou de conditions incertaines entourant un concept de solution. De cette façon, un modèle d'analyse peut être formulé ou mis à jour comme un problème d'optimisation ou comme un simple problème de système basé sur l'équation. L'objectif ultime est de générer un modèle d'analyse exécutable.

## **2.2 Concrete Solution Concept Modeler : CSC-Modeler**

L'approche des SME(s) se compose de plusieurs sous-étapes. Plus précisément, dans le repérage et la modélisation d'étapes nécessaire à nos objectifs. En conséquence, le temps nécessaire pour effectuer des mesures globales est corrélé au nombre d'éléments de l'analyse. Afin de diminuer la durée globale du temps lors du repérage et de la modélisation, les modèles et les bases de connaissances ci-dessus sont présentés dans un prototype logiciel, à savoir Concrete Solution Concept Modeler : CSC-Modeler. Diminuer le temps d'estimation sans sacrifier à la précision du résultat est l'une des questions qui est traitée dans cette thèse.



Le cadre du système comprend deux parties principales :

- 1) Nous avons fait usage du client Java, il se divise en deux couches principales. La première couche est une interface utilisateur graphique (GUI) qui peut interagir avec les concepteurs. Dans chaque étape majeure, l'interface graphique visualise les possibilités de formulation de modèles spécifiques et des modèles de connaissances pertinentes. La deuxième couche est un système de gestion qui communique avec la base de données, contrôle la mise en œuvre des séquences de modèles et gère les fonctions de base du système d'information.
- 2) Concernant le serveur, il se compose de deux éléments principaux : a) Une version réduite de CSC-Modeler disposant d'un accès ouvert, mais ne fournissant pas un cadre d'exploration via une technique d'optimisation et b) un système pour gérer la couche connaissances/information. Avec cette fonctionnalité, les nouvelles connaissances et les informations peuvent être importées ou mises à jour par des partenaires ayant une expertise dans différentes disciplines. De cette façon, nous pouvons élargir l'espace de connaissance et d'information support et inclure un domaine d'analyse plus large englobant d'autres disciplines.

CSC-Modeler est conçu pour être un système à base de connaissances destiné au calcul. Afin de diminuer le laps de temps qui sépare la modélisation d'un aspect de l'analyse et un modèle analysable, le système de base de connaissances devient une réponse clé. Il y a beaucoup de contributions dans ce domaine. Actuellement, le système de base de connaissances tend à faire usage de bases de type SQL ou No-SQL. De nombreuses comparaisons, des analyses et la mise en évidence de compatibilités avec d'autres modules sont abordés. Dans cette thèse, ElasticSearch a été sélectionné et utilisé comme un système de base de connaissances.

Les modules utilisés pour l'exploration sont choisis parmi plusieurs développeurs. C'est le framework MOEA que nous avons choisis parce qu'il fournit une liste importante d'algorithmes d'optimisation et une structure de formulation du problème simple. En revanche, il n'y a que peu de calculs symboliques dans cet outil, en outre seul Jasymca est une bibliothèque open source de Java.

La facilité d'utilisation et de mise en œuvre de l'outil logiciel support (CSC- Modeler) dans des contextes industriels est également proposé dans cette thèse. Un projet de conception entrepris avec un de nos partenaires : Lohr Industrie (un fabricant de remorques) a été utilisé comme cas d'étude pour illustrer clairement notre démarche et ainsi que démontrer l'utilité de notre approche SME(s) et le logiciel java CSC-Modeler d'aide aux concepteurs. Avec cette étude de cas, notre prototype logiciel a mis en évidence des zones de conflit dans les décisions initiales des experts. Les résultats que nous avons obtenus nous portent à croire que la mise en œuvre de notre démarche peut apporter des résultats analogues sur d'autres cas de domaines similaires. Par conséquent, nous formulons l'hypothèse qu'il est possible de faire croître l'inventivité d'une entreprise en octroyant des chances supplémentaires à des concepts trop vite écartés et cependant possibles.

### **2.3 Approche IMR**

L'approche SME(s) a été proposée pour capter la réaction immédiate des décideurs. Il fournit des métriques utiles pour estimer et explorer la faisabilité technique sitôt l'émission d'un concept de solution. La durée globale du temps pour effectuer l'approche SME(s) est réduite en raison de l'aide apportée par son outil logiciel support : CSC-Modeler. Cependant, l'approche SME(s) ne peut être utilisée que dans des conditions spécifiques tout en revisitant les concepts approchant des limites en plaçant sur ces derniers des remarques comme suit ;

- 1) Si un concept de solution a été classé comme “*Adopt different techniques*” cela signifie, nous ne pouvons pas effectuer l'estimation ou l'exploration et évaluer sa faisabilité par l'usage de ressources limitées et dans un laps de temps acceptable.
- 2) Si nous considérons un concept de solution associable à une architecture système, l'impact de la relation entre les éléments n'est pas prises en compte lors de la sélection des concepts (évaluation/sélection).
- 3) Le point de vue d'évaluer et de sélectionner un ensemble de concept de solution est basé sur un point de vue spécifique. Mais en réalité, pour éclairer la prise de décision, la sélection d'un concept doit considérer plusieurs points de vue et différents scénarios doivent alors être pris en compte.

Nous avons également développé une nouvelle approche IMR (Identifying, Mapping, et Ranking). Cette approche vise à changer la perception de la sélection qualitative de concept en une mesure quantitative. L'approche IMR est basée sur l'existence d'une échelle très connue des entreprises : l'échelle technologique (TRL) qui propose une estimation des défaillances potentielles des éléments dans l'ensemble de l'architecture d'un concept de solution.

Dans l'approche IMR, chaque concept de solution est associé à une valeur TRL et les risques potentiels engendrés par les objets et leurs fonctions. Ces derniers sont identifiées dans chaque concept de solution. En outre, le niveau TRL d'un concept de solution permettra d'identifier et de cartographier l'état des différents TRL des concepts dans une échelle visuelle qui part de la norme de management du cycle de vie des systèmes d'ingénierie : ISO 15288 : 2008. Avec de telles représentations, nous postulons qu'un changement d'opinion aura lieu dans la perception des décideurs. Ils pourront mieux évaluer les chances de succès d'un concept et ses capacités à atteindre les objectifs d'une spécification fonctionnelle. Le concept clé de ce développement

réside en une intégration de plusieurs techniques, y compris l basée sur la TRIZ, considérant l'architecture du système, son potentiel et ses risques d'échec.

L'approche proposée commence par la construction d'un modèle simplifié de représentation de l'architecture du système testé. Ensuite, nous spécifions l'influence des objets qui agissent sur le système global. Une comparaison entre le système actuel (un artefact existant et / ou un produit) et le modèle construit et issu du concept de solution est ainsi effectuée. Les objets et les relations identifiés dans les étapes précédentes sont alors cartographiées avec le niveau de maturité et le niveau d'intégrité du système. Ensuite, les nouveaux éléments ajoutés dans le système (dans le concept de solution) sont identifiés et cartographiées avec son indicateur Fonction-Failure Mode/Rate (FFMR).

Les résultats obtenus dans les étapes précédentes sont alors cartographiés selon le point de vue normalisé de l'ingénierie des systèmes du cycle de vie : ISO 15288 : 2008 en représentant le FFMR potentiel associés aux nouveaux éléments présents dans le concept de solution.

## **2.4 Approche Sim-TRIZ**

Une méthode de conception performante doit à notre sens associer plusieurs techniques de conception et d'outils d'analyse afin de garantir un résultat inventif. Dans les premières phases de conception, généralement le processus est ouvert aux des activités inventives. Pour les phases suivantes de conception, des outils CAO/DAO s'avèrent nécessaires pour évaluer, estimer, analyser, et améliorer la performance du concept. En dépit du fait que la CAO/DAO fournit de nombreux outils et montre de nombreux avantages en conception tout comme MCI pour la partie inventive, l'intégration des deux faits toujours défaut. Les motivations quant à cette contribution reposent sur l'hypothèse que l'intégration réussie de la conception basée sur la simulation et MCI serait synonyme d'une forme de systématisation de l'invention.

Dans la conception basée sur la simulation, le concepteur indique les problèmes et les exigences de conception, puis génère les concepts de conception à l'aide de méthodes de créativité classiques reposant sur son expertise. Par la suite, un modèle de simulation de chaque concept est construit. Ensuite, la simulation et l'optimisation sont effectuées afin d'évaluer et d'optimiser les paramètres de conception. Les étapes de simulation-optimisation sont alors poursuivies avec d'autres concepts de solution. Dans la dernière étape, les concepts de solution les plus appropriés sont sélectionnés et développés dans les phases de conception ultérieures. Un des avantages de la conception basée sur la simulation est d'éviter des concepts de solution irréalistes en passant par une étape de sélection. En outre, cette étape fournit une évaluation-sélection quantitative et les concepts de solution ont un modèle paramétrique optimisé pour satisfaire des objectifs spécifiques. Ces objectifs, dans les problèmes d'optimisation, sont associés à chaque concept. Nous notons ici, qu'une évaluation-sélection quantitative est possible, mais uniquement si l'objectif entre les concepts est proche. Ce qui signifie qu'il y a un peu de différence entre les concepts (leur degré de variabilité est faible).

Un des fondamentaux sur lequel se base la TRIZ est un modèle qui identifie les composants indispensables à la production de sa fonction principale utile (FPU). Ils sont au nombre de 4 : moteur, transmission, travail et contrôle. Chaque élément comporte éventuellement un lien vers d'autres éléments avec lesquels il est connecté. Afin d'éviter une définition ambiguë, nous associons chaque élément à un module, au-delà donc d'un simple élément. L'exhaustivité des modules du système sont dérivées de l'observation de l'objet d'étude.

Dans des situations de re-conception, le concepteur a souvent la possibilité d'accéder à des modèles CAO/DAO utilisés lors de la conception de projet passé. Ces modèles CAO/DAO peuvent être considérée comme des modèles de simulation utilisés lors d'une activité de conception basée sur la simulation. Pour une intégration entre la

conception et MCI basée sur la simulation, la simulation-optimisation peut être appliquée afin d'explorer son espace de conception en ciblant les exigences de conception (ou les hypothèses d'évolution) définies dans l'étape initiale de MCI. Par la suite, la corrélation entre les paramètres de conception est mesurée et les paramètres influençant la plupart des objectifs visés sera utilisée pour formuler des contradictions. Par la suite, des Outils / méthodes issus de TRIZ seront utilisés pour synthétiser un ensemble de concepts de solution

### 3. Conclusion et Perspectives

En nous référant au titre de cette thèse, ses objectifs étaient de construire un lien entre l'invention et l'optimisation dans la perspective de rendre plus efficace la démarche de conception inventive. L'objectif principal de ce lien est de développer un cadre d'évaluation et de sélection efficace des concepts de solution. Nous voulons éviter le rejet de bons concepts de solutions et de filtrer au plutôt ceux irréalisables au cours de la phase de sélection des concepts. En outre, nous voulons investiguer d'autres méthodes de conception pour améliorer la performance de la conception inventive.

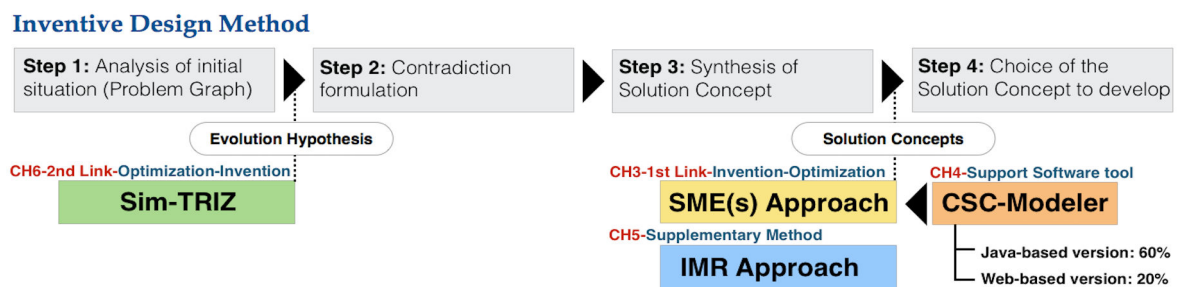

Figure 2. Contribution de cette thèse en perspective de MCI

Les contributions principales de cette thèse (Figure 2) sont que deux liens ont été formulés et leur structure peut revêtir la forme suivante :

Le premier lien (Invention-Optimisation) et ambitionne donner confiance aux décideurs dans l'évaluation et la sélection des concepts de solutions. Ce lien propose

d'appliquer l'optimisation comme un outil d'exploration destiné à estimer/explorer la faisabilité technique d'un concept de solution avant toute décision. L'approche SME(s) (Chapitre 3) et les logiciels CSC-Modeler (Chapitre 4) ont été développés pour servir dans ce cadre. Dans le chapitre 4, le blocage d'une voiture, le cas du système de blocage de la roue a révélé les limites d'un avis d'expert pour estimer la faisabilité d'un concept de solution. La viabilité de l'approche SME(s) et CSC-Modeler sont utilisés sur cette étude de cas. Le temps et les sources potentielles d'erreur lors de la formulation d'un modèle d'analyse dans l'approche SME(s) et CSC-Modeler sont les principales questions qui se posent comme des limites à nos propositions. Une approche constituée de plusieurs étapes pour éliminer les éventuelles erreurs de formulation représente une des perspectives de recherche dans nos travaux futurs concernant ce premier lien.

L'approche SME(s) comporte des conditions spécifiques dans lesquelles elle présente des limites. L'approche de l'IMR (Chapitre 5) a été proposée en complément pour l'évaluation et la sélection des concepts de solutions. L'approche SME(s) consiste essayer de réduire l'incertitude dans la sélection de concept par une estimation préalable de sa faisabilité. D'autre part, l'approche IMR traite un concept de solution par l'intermédiaire de l'exhaustivité (objet, relation) de l'ensemble de son architecture. Cette exhaustivité représente la prédisposition d'un concept de solution à être développé davantage. Le niveau d'abstraction de l'objet et de la relation dans un concept de solution est évalué par une échelle approximative de la représentation des connaissances. La fonction mode/taux d'échec potentiel de l'objet est l'un des critères d'évaluation qui permettra à l'approche IMR d'être prise en compte. L'approche IMR a été illustré par une étude de cas. Afin d'évaluer plus en profondeur et valider cette approche, de nombreux tests doivent encore être menés.

Concernant le deuxième lien (Optimisation-Invention), une nouvelle approche de conception présentée dans le Chapitre 6 consiste en une intégration de l'optimisation utilisé avant la phase d'invention. Cette approche est principalement utilisée dans des

projets de re-conception et n'est, donc pas limitée à des projets de conception de produits nouveaux. Lors d'une activité de re-conception d'un artefact, le concepteur a la possibilité d'accéder à un modèle de simulation existant ou objet physique. De cette façon, il permet au concepteur d'explorer le comportement de l'artefact par simulation. L'optimisation, dans ce lien, est utilisée pour explorer l'espace de conception d'un modèle de simulation (construit à partir d'une approche basée sur un modèle ou une approche basée sur l'expérience). En ce qui concerne le cadre de MDAO qui permet aux concepteurs de transformer facilement un modèle de simulation en fonction du comportement des objets qui peuvent être observé sous différents aspects. Avec le résultat obtenu, le concepteur peut initier la phase d'invention en indiquant les paramètres de conception les plus pertinents associés au projet. Par la suite, le concepteur peut utiliser ces paramètres pour formuler une série de contradictions. La résolution de la contradiction a une forte influence sur l'ensemble du système et peut alors apporter une solution plus largement acceptée. Toutefois, cette revendication n'est pas entièrement validée dans cette thèse.

Les travaux initiés dans cette thèse nécessitent de poursuivre leurs développements. La question de l'évaluation et de la validation des approches proposées et les outils de support logiciels constituent une des directions pour de futurs travaux de recherche. L'amélioration globale de ces travaux et de nos contributions passe par ces phases complémentaires d'évaluation et de validation. Tout d'abord, nous proposons de poursuivre le développement de CSC-Modeler, pour cela, ses fonctionnalités majeures doivent être pleinement mises en œuvre. Le développement actuel comprend à la fois une version java et une version Web. L'évaluation de l'approche des SME devra se faire en conduisant un certain nombre d'études de cas à la fois dans les milieux universitaires et l'industrie.

Un autre point de vue de l'approche SME repose sur l'étape de ciblage. L'hypothèse de recherche de cette étape repose sur le repérage amont de certains éléments associés



aux concepts. En utilisant la combinaison de critères issus des notions de TRIZ et les aspects d'analyse il est possible de mesurer la maturité d'un Concept Solution. Concernant la résolution d'une contradiction, un certain nombre d'aspects utiles et nuisibles associés aux concepts et repérés durant l'analyse et le repérage sont autant d'exemples de critères qui peuvent être utiles à l'amélioration de notre approche.

Un outil logiciel d'aide sera élaboré afin d'évaluer l'approche IMR. Cet outil logiciel d'aide doit à notre sens, intégrer la base de données fonctionnelle associée à la base de données associées au rapport mode/de taux d'échec de la fonction. En outre, d'autres fonctionnalités sont nécessaires pour faciliter l'approche IMR et assurer l'exactitude de ses résultats. La validation de cette approche doit se traduire par plusieurs améliorations. Ces améliorations seront apportées en fonction des analyses des résultats des cas d'études qu'il est nécessaire de conduire.

L'étude comparative permettra de valider les deux approches proposées. Dans chaque étude de cas, une tâche de sélection de concept sera réalisée par une approche classique, puis par une approche fondée sur MCI, par SME(s), puis par l'approche IMR. Cependant, il est difficile de prévoir quelle approche sera supérieure aux autres tant que les concepts de solution n'auront pu être fabriqués et testés.

Le Chapitre 6 concentre sur l'association automatique des préférences et des exigences de conception avec les lois de l'évolution du système technique. L'identification de paramètres de conception et leur relation avec les lois de l'évolution est l'une des orientations futures des recherches que cette approche propose.

**Mots-clés :** Méthode de conception inventive, TRIZ, décision, défaillance, simulation, TRL, optimisation.

## Abstract

One constraint of innovation is to improve or find new ways to solve emerging problems in the NPDP (New-Product Design Process). A key challenge facing designers that create innovative products lies in Innovation Front End (IFE) phase. More specifically, in the concept generation stage. Classical methodologies to assist the designer in generating a set of design concepts are limited by the need to associate requirements with existing solutions. As a result, forcing creativity (inventively) to both address requirements and pursue breakthrough solutions is a major source of pressure in this stage. The relation between requirements and creativity presents in the dynamics viewpoint where is characterized by design freedom and solution space. The solution can be found in a single or multiple knowledge domains. A well-modeled of this relation may lead to the systematical creativity process. Unfortunately, the innovative pipeline is not only analyzing the initial situation and synthesizing a solution, but also including evaluation then selection which solutions to refine for more in-depth development.

One of the most striking characteristics of inventive design is that evaluating solutions may prove to be more difficult than finding them. Having good ideas is useless if they are rejected at an early stage. In many existing qualitative evaluation and selection methods (see design model), evaluation criteria are usually taken from the design requirement, which is strongly influenced by customer preferences or decision makers' experience.

Early decision after the creative sessions faces the immediate reactions on the part of decision-makers that generally involve producing instinctive judgments based on experience and tends to lack accuracy. An immediate reaction is to abandon ideas considered *unfeasible* or overly risky since they are outside of the design project's primary focus.

The *feasibility* of a Solution Concept is determined through physical properties of Solution Concepts, such as approximate possible configuration, a dimension of geometry and behavior. None of this information is available in this early stage of design and there is not sufficient information to initiate high granularity tools such as CAD or CAE. These tools require a detailed description of the characteristics of a design concept and their obvious limitation lie in the extreme level of expertise required to be able to use them. In parallel, computer support in this stage is still largely absent. There exist various computer-aided innovation (CAI) systems based on TRIZ that support the creative/inventive ideas generation phases. They offer a useful tool for designers in the concept generation stage, but little support in feasibility evaluation. This can limit consideration of innovative designs that potentially offer better performance. Specifically, for the Small and Medium Enterprises (SMEs), because the accessibility to this tool is a source of problem to favor their innovative capacities and it is a crucial situation for their survival.

In order to leverage inventiveness of a company through additional chances of feasible concepts. This thesis presents approaches and support tools to evaluate and select Solution Concepts obtained from Inventive Design Method (IDM) framework. The contributions in this thesis can be used as a decision-making aid and tool.

The primary focus of this thesis relies on the effective and efficient evaluation and selection framework for a set of Solution Concepts. The SME (Screening, Modeling, Exploring) and IMR (identifying, Mapping, Ranking) are developed to serve this area. A software prototype, namely Concrete Solution Concept Modeler (CSC-Modeler) is developed to overcome the time restriction of the SME approach.

The integration used of advanced design methods/tools with TRIZ based design have been investigated and proposed. In all contributions, the usability of each approach has been demonstrated with a case study. This thesis ends with a conclusion, limitations, and perspective for further research and development.

**Keywords:** Inventive Design Method, TRIZ, evaluation, selection, failure, TRL, simulation, optimization

# Contents

<b>Acknowledgements</b>	iii
<b>Résumé</b>	v
<b>Abstract</b>	xxi
<b>Contents</b>	xxiv
<b>List of Abbreviations</b>	xxviii
<b>List of Figures</b>	xxix
<b>List of Tables</b>	xxxii
<b>1 Context and Scope</b>	1
1.1 Technical context	1
1.2 Research scope	4
1.2.1 Hypothesis, research questions, and thesis objective	5
1.2.2 Motivation	8
1.2.3 Research impact	9
1.3 Thesis outline and structure	10
<b>2 Technical background and literature surveys</b>	13
2.1 Brief on engineering design	13
2.1.1 Overview of design representation (theory, model, process)	14
2.1.2 A form, function, behavior perspective	16
2.1.3 Overview of knowledge representation	18
2.1.4 Reflection on engineering design	19
2.2 Early decision making process in engineering design	20
2.2.1 Concept selection method	22
2.2.2 Feasibility evaluation in concept selection	24
2.2.3 Risk-failure analysis as a part of concept selection	25
2.2.4 Observation on early decision making process	26
2.3 Paradigm shift in industry	27

2.3.1	Age of innovation	28
2.3.2	Innovation front end: IFE	30
2.3.3.1	Ideas generation	31
2.3.3.2	Ideas evaluation and selection	32
2.4	Theory of Inventive Problem Solving: TRIZ	32
2.4.1	System elements of TRIZ when describing as a theory	33
2.4.1.1	Fundamentals of TRIZ	33
2.4.1.2	Tools of TRIZ	39
2.4.1.3	Methods of TRIZ	39
2.4.2	When TRIZ has been observed as a design method	39
2.4.3	Evaluation and selection in TRIZ based design	40
2.4.4	Synergy used of TRIZ with other design methods/tools	41
2.4.5	Reflection on TRIZ	42
2.5	Inventive Design Method: IDM	43
2.5.1	Initial situation analysis and contradiction formulation	45
2.5.2	Deriving a Solution Concept	47
2.5.3	Evaluation and Selection of Solution Concepts	49
2.6	From technical background and literature surveys to research needs	49
<b>3</b>	<b>Early technical feasibility evaluation of a Solution Concept in IDM</b>	<b>51</b>
3.1	Reflection on technical background – literature surveys: #1	51
3.2	Development of the approach: SME	54
3.2.1	Screening	55
3.2.2	Modeling	57
3.2.3	Exploring	59
3.3	Development of the support tool	60
3.3.1	Template development: Formulation layer	60
3.3.2	Template development: Knowledge/Information layer	64

3.4 Revised version of SME approach: SME(s)	69
3.5 Discussion on SME approach	72
<b>4 Development of the software prototype: CSC-Modeler</b>	<b>73</b>
4.1 Reflection on technical background – literature surveys: #2	73
4.2 System framework design	75
4.3 Flowchart for conducting the CSC-Modeler	76
4.4 System framework implementation	77
4.5 CSC-Modeler in action: A car wheel blocking system	82
4.5.1 Context of design project and the issue to be resolved	82
4.5.2 Application of the SME approach and the software prototype	85
4.6 Discussion on CSC-Modeler	91
<b>5 System readiness level identification of a Solution Concept in IDM</b>	<b>93</b>
5.1 Reflection on technical background – literature surveys: #3	93
5.2 Development of the approach: IMR	96
5.2.1 Identifying	98
5.2.2 Mapping	100
5.2.3 Ranking	104
5.3 Case Study: A car wheel blocking system	105
5.3.1 Context of the design project	105
5.3.2 Application of the IMR approach	107
5.4 Discussion on IMR approach	110
<b>6 Enhancement the problem formulation in inventive design with the aid of simulation-based design</b>	<b>111</b>
6.1 Reflection on technical background – literature surveys: #4	111
6.2 Frame of reference	114
6.3 6.3 Development of the Sim-TRIZ contradiction system model	115
6.3 Development of the approach	117
6.3.1 Define evolution hypothesis	119

6.3.2 Collect information	119
6.3.3 Measure the correlation of design parameters	120
6.3.4 Formulate contradictions	121
6.3.5 Synthesize of new Solution Concepts	121
6.4 Case example 1: A redesign of a mini USB-Fridge	121
6.4.1 Context of the design project	122
6.4.2 Application of the proposed approach	123
6.5 Case example 2: A redesign of a solenoid actuator	128
6.5.1 Context of the design project	128
6.5.2 Application of the proposed approach	129
6.6 Discussion on problem formulation with the aid of simulation-based design methods/tools	133
<b>7 Conclusion and perspective</b>	<b>135</b>
7.1 Thesis conclusion	135
7.2 Perspective	137
<b>References</b>	<b>139</b>
<b>Appendix A</b> Function-Failure Mode/Rate database	<b>153</b>
<b>Appendix B</b> Information on model used in section 6.6	<b>156</b>
<b>Appendix C</b> The Contradiction Matrix and The 40 Inventive Principles	<b>161</b>
<b>Appendix D</b> Datasheet of thermoelectric module: TEC1-12702	<b>169</b>



## List of Abbreviations

NPDP	New-Product Design Process
IFE	Innovation Front End
TRIZ	Theory of Inventive Problem Solving
IDM	Inventive Design Method
CAD	Computer-Aided Design
CAE	Computer-Aided Engineering
CAI	Computer-Aided Innovation
RID	Research-Invention & Development
STEPS	Systematic Tool for Efficient Problem Solving
SME(s)	Screening, Modeling, Exploring, and selecting
IMR	Identifying, Mapping, Ranking
NIST	National Institute of Standards and Technology
FFB	Form, Function, Behavior
CMP	Core Product Model
QFD	Quality Function Deployment

## List of Figures

Fig. 1-1	The positioning of this thesis in IDM framework	4
Fig. 1-2	Research impact of this thesis to the Inventive Design	10
Fig. 1-3	Thesis outline and structure	11
Fig. 2-1	The engineering design process	15
Fig. 2-2	FFB framework for design-analysis integration	17
Fig. 2-3	Knowledge representation in product design	18
Fig. 2-4	The differences of scope between a design methodology, design process and a decision analysis technique	20
Fig. 2-5	The process of concept selection	22
Fig. 2-6	The operational funnel of innovation for implementing normative and strategic objectives	29
Fig. 2-7	Example of ideation methods	31
Fig. 2-8	System elements of TRIZ when describing as a theory	34
Fig. 2-9	General diagram of technical system evolution	35
Fig. 2-10	TRIZ model after considered as a design method	40
Fig. 2-11	Synergy used of TRIZ from the viewpoint of Design for Six Sigma	42
Fig. 2-12	Inventive Design Method	44
Fig. 2-13	A model to characterize the sources of model of problem: contradiction	46
Fig. 2-14	An example of poly-contradiction of a system	47
Fig. 2-15	A model to characterize the sources of model of problem: contradiction	48
Fig. 3-1	Gap to be fulfilled in the early concept selection in IDM	53
Fig. 3-2	Approach for increasing confidence of a Solution Concept within an IDM framework	56
Fig. 3-3	Usage scenario of developed templates and knowledge models	61
Fig. 3-4	Model for characterizing Zone & Time of Interest	65
Fig. 3-5	Model for characterizing phenomena (Meta-KB)	66
Fig. 3-6	Model for characterizing behavioral models	67
Fig. 3-7	Model for characterizing support information	68

Fig. 3-8	Pareto based selection of Solution Concept (Revised SME(s) approach)	70
Fig. 4-1	Time span used to construct an analysis model in SME(s) approach	74
Fig. 4-2	Framework of Concrete Solution Concept Modeler (CSC-Modeler)	75
Fig. 4-3	The overall flowchart for conducting SME(s) approach	77
Fig. 4-4	A screenshot of under development java-based version of CSC-Modeler	81
Fig. 4-5	A screenshot of ongoing development web-based version of CSC-Modeler	81
Fig. 4-6	The current system for blocking a wheel	83
Fig. 4-7	A screenshot of SC 1.2.2 context with screening template	86
Fig. 4-8	Screenshot of the Pre-Parameterized Template and the Meta-KB Template	87
Fig. 4-9	A screenshot of the formulation template of an analysis model and the BH-Model Template	88
Fig. 4-10	A screenshot of tracked information of the case study	89
Fig. 4-11	Results of the numerical search and optimization process, displacement vs. total mass of system under review	90
Fig. 4-12	Sources of error in engineering model that used in analysis task	92
Fig. 5-1	Context of Solution Concept during concept selection stage (viewed from the system architecture perspective)	94
Fig. 5-2	An approach to identify the readiness level of a Solution Concept	98
Fig. 5-3	Simplified model of system architecture	99
Fig. 5-4	The snippet of Function-Failure Mode/Rate database	102
Fig. 5-5	The matrix to populate Function-Failure Mode/Rate database	103
Fig. 5-6	System Readiness Level and Function-Failure Mode/Rate of Solution Concept 1.1.2, 1.1.5, and 1.3.4	109
Fig. 6-1	Overview of the integration between IDM and simulation-based design	113
Fig. 6-2	System completeness of TRIZ in simulation-based design model	114
Fig. 6-3	The Sim-TRIZ contradiction system model (system completeness viewpoint)	116

Fig. 6-4	An approach to enhance problem formulation in Inventive Design with the aid of simulation and/or DOE based design	118
Fig. 6-5	Mini USB-Fridge (a) current product, (b) a simple control board, and (c) a simplified system architecture model	122
Fig. 6-6	System under test and collect information	124
Fig. 6-7	A snippet of data collected from performing the experimental	124
Fig. 6-8	Response surface model of Mini USB-Fridge, (a) Object Temperature, and (b) Chamber Temperature	125
Fig. 6-9	Correlation between design parameters of Mini USB-Fridge	126
Fig. 6-10	System of contradiction model from simulation-based perspective: Mini USB-Fridge case study	127
Fig. 6-11	The simple solenoid (a) actual product, (b) Cross section diagram, (c) force-displacement characteristic, and (d) example of plunger shape	129
Fig. 6-12	(a) Simulation model and (b) Simplified model of a solenoid actuator in Openmodelica environment	131
Fig. 6-13	The snippet of parameter list used in performing the exploration	132
Fig. 6-14	The correlation matrix of some design parameters: A solenoid actuator	132
Fig. 6-15	Difference scopes of information evolving of proposed approach	134
Fig. 7-1	Positioning of contributions in the Inventive Design Method perspective	135

## List of Tables

Table 2-1	Three postulates and their corollaries of TRIZ	34
Table 2-2	The comparison between routine design and inventive design	44
Table 3-1	Screening Template model	62
Table 3-2	Pre - parameterized Template Model	63
Table 3-3	Analysis Model Template	64
Table 4-1	Environment and tools for the implementation of CSC-Modeler	78
Table 4-2	A sketch and description of the Solution Concepts after evaluation based on Step 4 of the IDM framework. The scenario is effectiveness of immobilization	83
Table 4-3	Assumptions and critical parameters, a result from the screening step	86
Table 4-4	Examples of a feasible set for Solution Concept 1.2.2	90
Table 5-1	Definition of each level of Object Readiness Level: ORL	101
Table 5-2	Definition of each level of Relation Readiness Level: RRL	102
Table 5-3	Original car wheel blocking system and a set of Solution Concepts	106
Table 5-4	System architecture of Solution Concept 1.2.2	107
Table 5-5	Solution Concept Readiness Level and Function-Failure Mode/Rate of Solution Concept 1.2.2	108





# Chapter 1

## Context and Scope

*“The greatest deception men suffer is from their own opinions”*

— Leonardo da Vinci

### 1.1 Technical context

In today’s competitiveness-fraught market, one constraint of innovation is to improve or find new ways to solve emerging problems in the NPDP (New-Product Design Process). A key challenge facing designers that create innovative products lies in Innovation Front End (IFE) phase. More specifically, in the concept generation stage. It consists in determining more accurately key specifications such as functionality, physical structure, and performance expectations of new products.

While there are various effective methodologies to assist the designer in generating a set of design concepts (refer to design methodology models [1–5]), these methods are limited by the need to associate requirements with existing solutions. As a result, forcing creativity to both address requirements and pursue breakthrough solutions is a major source of pressure. TRIZ (The Russian acronym for Theory of Inventive Problem Solving) [6,7] makes the difference by considering that technical systems evolve in similar ways, thus reducing any situation and its associated problems to an abstract level independent from the domain of the technical system, namely the *contradiction*. It is possible to apply standard solutions and problem-solving techniques generally from hundreds of thousands of patents in various fields of



technology. Consequently, it increases the range of design freedom and extends the solution space into different domains of knowledge. During two decades of existence in highly industrialized countries, TRIZ has led to impressive successes and is widely used in a number of corporate environments, for example, Samsung, GE and Intel.

Inventive Design Method (IDM) [8–10] was developed to solve classical TRIZ limits and consequently to address wider and more complex problematic situations, specifically in the concept generation stage. The context of concepts developed with the aid of IDM (in this thesis called *Solution Concepts*) is incomplete, conflicting and produces uncertain information due to the resolution of contradictions and the differences in knowledge domain between the Model of Solution and the Model of Problem. In addition, the differences between each Solution Concept are diverse. As a result, it becomes more difficult to evaluate then select which Solution Concepts to refine for more in-depth development.

The concept evaluation and selection (in this thesis simply referred to *concept selection*) process in the early stage of the IDM faces immediate reactions on the part of decision makers that usually exert a strong degree of influence and appear invariably to be negative when confronted with implementing an original solution that is subject to time restrictions in the design cycle. An obvious reaction to this is to abandon Solution Concepts that are considered *unfeasible* or overly risky.

According to the nature of conceptual design, which has an abstract, ambiguous and typically qualitative nature, feasibility is usually considered in qualitative terms and is used as one of the criteria during concept evaluation [11].

NIST [12] defines the feasible solution in the view point of optimization as the feasible region or feasible Pareto-Front of design space. Optimization is the act of obtaining the best result under given circumstances [13]. The words “optimization” and “conceptual design” arguably ought not appear in the same sentence. When a Solution

Concept is initially designed, a large amount of uncertainty characterizing its description prohibits it from being optimized in the traditional sense of the word. Clearly, the role of optimization in the context of proof of concept is to explore the feasible design space and not necessarily to find the optimized solution.

The *feasibility* of a Solution Concept is determined through physical properties of Solution Concepts, such as approximate possible configuration, a dimension of geometry and behavior. None of this information is available in this early stage of design and there is not sufficient information to initiate high granularity tools such as CAD or CAE. These tools require a detailed description of the characteristics of a design concept and their obvious limitation lie in the extreme level of expertise required to be able to use them.

In parallel, computer support in this stage is still largely absent. There exist various computer-aided innovation (CAI) systems based on TRIZ that support the creative and inventive design phases, such as Goldfire Innovator<sup>1</sup> and Innovation Workbench<sup>2</sup>. They offer a useful tool for designers in the concept generation stage, but little support in feasibility evaluation. This can limit consideration of innovative designs that potentially offer better performance. Particularly, for the Small and Medium Enterprises (SMEs), because the problematic to access such tools to favor their innovative capacities is crucial for their survival.

In order to leverage inventiveness of a company through additional chances for feasible concepts, this thesis presents approaches and support tools to evaluate and select Solution Concepts obtained from IDM framework. Several viewpoints have been considered and applied. The contributions in this thesis can be used as a decision-making aid and tool. The scope of the thesis is then presented in Section 1.2. As part

---

<sup>1</sup> <https://invention-machine.com>

<sup>2</sup> <http://www.ideationtriz.com>

of the research scope, the hypothesis and research question that establish the thesis foundation are presented. This is followed by a description of the thesis objectives, motivation, and potential impact of the research developments. An outline for the remainder of the thesis then provided in Section 1.3.

### 1.2 Research scope

The research works described in this thesis were conducted at the design engineering laboratory (LGéCo), INSA Strasbourg. The LGéCo is a well-known team that has been working for several years on inventive design aspects. The main research activity is the Research-Invention & Development (RID) process for the early stage of innovation. IDM is one of an example of our contributions to serve this activity. This framework has already been published and has been developed into a software prototype called STEPS<sup>3</sup> (Systematic Tool for Efficient Problem Solving).

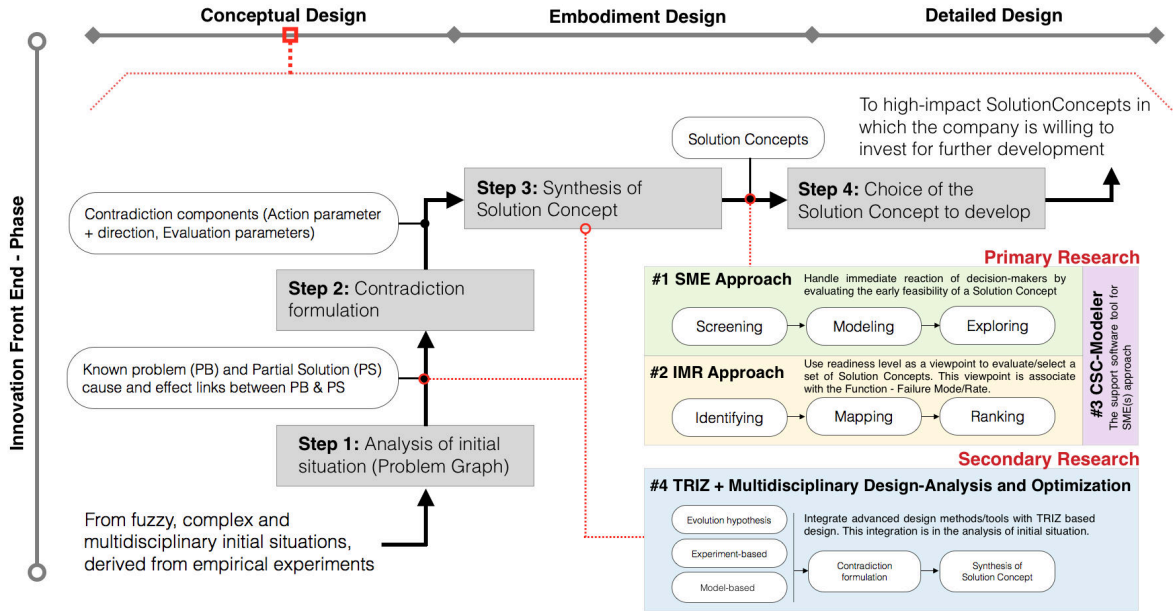

Fig. 1-1. The positioning of this thesis in IDM framework and engineering design process

<sup>3</sup> <http://www.time-to-innovate.com>

The positioning of this thesis in the viewpoint of IDM framework and engineering design process is presented in Fig. 1-1. In the third step, the key components of the contradictions are used as an input to generate Solution Concepts assisted by computer-based TRIZ techniques. Followed by a choice of the Solution Concepts to develop in Step 4. The main focus of this thesis relies on the effectively and efficiently concept selection framework for a set of Solution Concepts from Step 3 of IDM. The link between *invention and optimization* is formulated here by using SME approach and the CSC-Modeler software tool. Additionally, IMR approach has been proposed to provide another viewpoint on concept selection. Details of these two approaches and the software prototype will be given in the coming Chapters.

For the secondary research issue, one another link between *optimization and invention* is specified. This link is established by a design approach that is integrating the simulation-based design (experiment- and model-based) as a part of IDM. Fig 1-1 depicts this design approach which has been applied after Step 1 until Step 3 in the IDM framework.

In section 1.2.1, the hypothesis and research question that serve as a foundation for this thesis are presented; we also describe our objectives and motivation. We end this section by describing the potential impact of the proposed work.

### **1.2.1 Hypothesis, research question, and thesis objective**

#### **Hypothesis:**

- 1) A typical expert opinion judging a Solution Concept is often negative when it exceeds the boundaries of what they have previously experienced. Additionally, the context of Solution Concept and time restriction in design cycle are sources of abandoning them in the early concept selection. As a result, there is a high probability that in each R&D department, many

good Solution Concepts are abandoned on the basis of intuition, even though they could have proven feasible if a little more attention had been given to them.

**Answer to this hypothesis:**

- a) It is possible to leverage inventiveness of a company through additional chances for feasible concepts. The degree of confidence or credibility is directly related to the feasibility characteristics of the Solution Concept. This degree could be augmented by relying on a simple analysis task (simple calculation or exploration) before performing any decision-making. As a note, we view concept evaluation/selection as a poorly developed, yet critical role on the success of the whole design project.
  - b) As optimization strategies show many significant impacts on the latter stage of engineering design in exploring and optimizing the final results. In our viewpoint, optimization may be used in the early stage of design as the exploration tool to prove the feasibility of a Solution Concept. However, the use of optimization is possible in specific conditions and scenarios.
- 2) According to the context of a set of Solution Concepts, that is represented at a high degree of variety and novelty. This type of Solution concept is hard to evaluate (quality, feasibility) via a simple analysis task. Importantly, the evaluation techniques used in inventive design rely on a qualitative approach and evaluation criteria are usually taken from the design requirements, which is strongly influenced by customer preferences or decision makers' experience. Consequently, the accuracy of implementing decisions is still suffering from it. The most effective technique to evaluate

and select a Solution Concept for inventive design aspect still lies in challenging the inventive design-research link and have to be stated.

**Answer to this hypothesis:** The other viewpoints have to be taken into account. These viewpoints should be considered both from technical aspects and chance of success of the Solution Concepts. Precisely, it has to be practical, easy to understand and use, and accurate enough while comparing with other methods. The ideas of system maturity measurement and failure analysis could be used to serve this situation. The representation of results should lead to assist decisions, and the interpretation of results has to reveal the expectation facts, not only the designers' preferences.

- 3) As design consists of synthesis, analysis, and decision activities. Design method or tool can not alone bring impressive design results. Furthermore, the advancements in computer support design tools (CAD/CAE) has dramatically evolved and is showing significant advantages in the latter stage of design. However, this integration during the inventive session is still lacking. Our research in this area may lead to the performance enrichment from the inventive design perspective.

**Answer to this hypothesis:** Inventive design is considered as the input of innovation process. It is an open session that allows designers to portrait the characteristics of the future product. It shows a high degree of freedom in design and aims to explore the solution from different knowledge domains. It totally contrasts with the use of CAD/CAE tools that has a specific procedure for anticipating the optimized results. It is true that there are several possibilities to integrate these tools within the inventive design perspective. Yet, the application should be applied in specific stages and scenarios. Nevertheless, the results obtained from this integration will not guarantee that it offers better solutions or results.

## **Research Question:**

The research question of this thesis is two-fold;

- 1) What is an effective and efficient evaluation/selection framework for Solution Concepts obtained from the Inventive Design Method? This question is referred to the hypothesis #1 and #2.
- 2) How to enhance the performance of inventive design, any integration used of other design methods/tools should be made in order to obtain impressive design results? This question is referred to the hypothesis #3.

The premise is that the successful development of such a framework and a design method can significantly and positively impact design practice.

## **Research Objective:**

The title of this thesis focuses on the formulation of links between invention and optimization, but more precisely, *for what?* The main objective of this link is to develop an effective and efficient evaluation and selection framework for inventive design. The main objective behind this development is to prevent the rejection of good Solution Concepts and to screen out unfeasible ones as early as possible. Moreover, others viewpoint to improve the performance of Inventive Design will be investigated. These viewpoints include concept selection approaches and the integration used of design methods/tools in inventive design framework, specifically, IDM.

### **1.2.2 Motivation**

The motivation of this thesis has been defined according to the hypothesis, question, and objective of this research. It could be viewed three-fold;

- 1) *Concept selection*, to perform an accurate decision in the early concept selection (evaluation and selection) stage for the Solution Concepts obtained from the aid of IDM framework and STEPS software tool.
- 2) *Support tools*, to provide an open access of the software tool to assist the concept selection phase in IDM framework.
- 3) *Performance of inventive design*, to proposed a design approach that could enhance the performance of inventive design.

We seek effective and efficient methods and support tools to handle the immediate reaction of decision-makers in early evaluation/selection stage for IDM framework. These methods and support tools have to be logical and coherent in invention situations, in particular by becoming a mode of selecting concepts that do not “kill” the idea outside the limits of the simple analysis task, but which promote the idea whereby simple analysis task could help it gain ground in term of credibility and maturity. For support tool, it should be accessible from a larger audience, simplifying, integrating and accelerating the use of such tools.

### **1.2.3 Research impact**

Answering the research question stated above will result in more rigorous decision-making in Inventive Design, which has the potential to augment inventiveness capacities of a company through additional chances for concepts feasibility.

The framework developed in this thesis has the potential to significantly improve many fields beyond engineering. This includes such fields as decision sciences, economics, and production planning. From societal and industry perspectives, the framework developed in this thesis can result in products and systems that are higher performing and provoking inventiveness, through a more comprehensive evaluation and selection of Solution Concepts as depicted in Fig. 1-2.



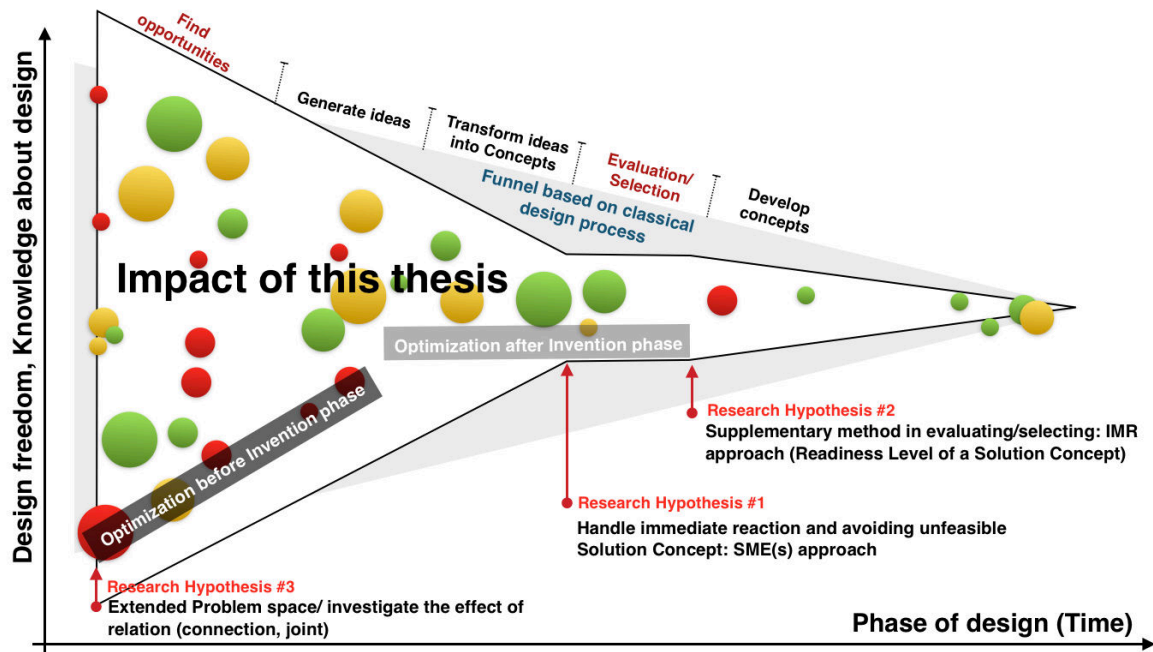

Fig. 1-2 Research impact to the Inventive Design

Also, the use of optimization to extend the problem space and investigate the most relevant Problem models (Contradictions) may lead to meaningful results. Notably, the support prototype software presented herein is considered as a knowledge base that could be used in many engineering fields. The open accessibility of knowledge sources and the simplicity of analysis tools may help engineering students in solving their problems using different ways.

### 1.3 Thesis outline and structure

The remainder of this thesis is organized as follow (Fig. 1-3):

#### ✚ Introduction

**Chapter 1** contains the technical context and research scope of this thesis.

#### ✚ Theoretical Foundations

**Chapter 2** presents the technical background and literature surveys of this thesis, including the background of IDM framework, the related literature and the needs of development of approaches and tools to evaluate and select Solution Concepts.

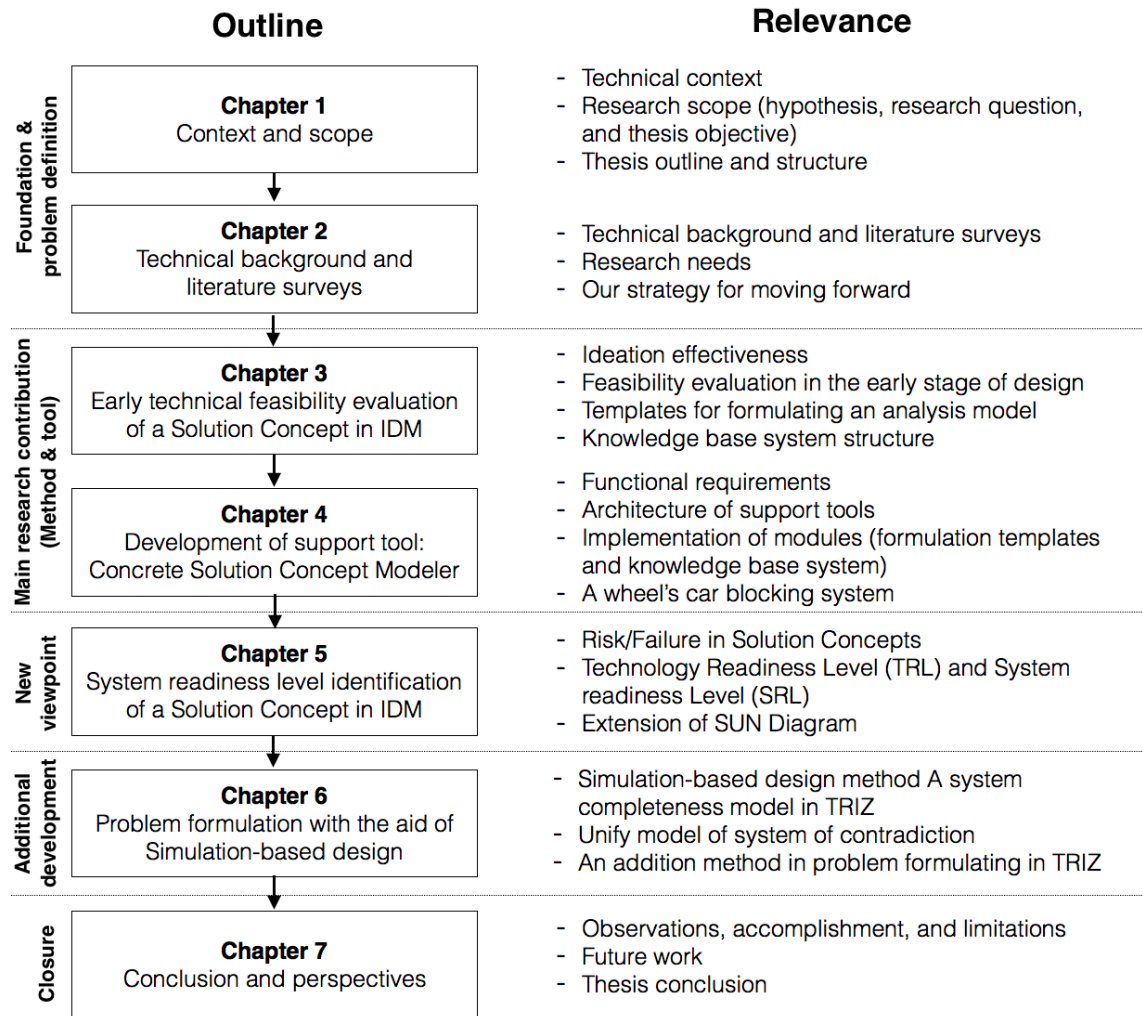

Fig. 1-3 Thesis outline and structure

### **Contributions: approaches**

**Chapter 3** discusses the SME approach (Screening, Modeling, and Exploring: SME). This approach has been intentionally used as a decision-making aid and tool. It aims to assist the designer in augmenting confidence in the Solution Concept by providing a rapid estimate and/or exploring the feasibility of a tested Solution Concept.

**Chapter 5** contains the IMR approach (Identifying, Mapping, and Ranking: IMR). The objective of this approach is to identify the readiness level of a Solution Concept regarding the system engineering viewpoint. This readiness level is presented in parallel with the potential risk/failure level of new characteristics (new element, new relation) of a Solution Concept.

**Chapter 6** focuses on the method to enhance the problem formulation in inventive design with the aid of simulation-based design. A design approach has been proposed in this chapter. The experiment-based and model-based are the scenarios to apply the proposed approach.

#### **Contribution: support software prototype**

**Chapter 4** presents the under development support tools of proposed approaches in Chapter 3 (SME approach). A case study is used to demonstrate the overall proposed approach along with the viability of support tools (Concrete Solution Concept Modeler: CSC-Modeler).

#### **Conclusion and Perspectives**

**Chapter 7** provides a summary and conclusion on the topics and application examples, as well as a discussion on future work that can be pursued in this area.

# Chapter 2

## Technical Background and Literature Surveys

*“Engineers like to solve problems. If there are no problems handily available, they will create their own problems”*

— Scott Adams

This chapter provides technical background and general literature surveys in three areas. The areas surveyed are 1) engineering design, 2) paradigm shift in the industry, and 3) Theory of Inventive Problem Solving. In each area provides also sub keys technical background. Importantly, this chapter ends with the general reflection on technical background, literature surveys and general frame of research needs.

### 2.1 Brief on engineering design

Design is considered as both an art and a science [14–16]. Design is an activity leading to “possible worlds satisfying specific to constraints” [17]. Consequently, *engineering design*, in particular, is a process that starts from a set of requirements and then utilizes scientific and technical knowledge to produce a solution to a human problem. Design activities can be grouped in three categories: 1) analysis, 2) synthesis, and 3) evaluation and decision. The performance of engineering design is determined via the combination of these activities.

In this section, we first overview the representation of design as it can be viewed as a theory, model, and process. Subsequently, we review the perspectives of Form, Function, and Behavior as results of design activities, the representation of knowledge in the design process is followed. The second part of this section is overviewing the early decision process in engineering design. Lastly, this section will conclude with a summary of the finding and the tendencies of engineering design in different aspects for the future direction of research on engineering design.

### **2.1.1 Overview of design representation (theory, model, process)**

Engineering design was established about two decades ago and one of the key aims of such is to support designers to enable the design process to be carried out in a systematic manner. Several reviews and surveys have been conducted on the contribution of several engineering design *theories* and *models* and the findings acknowledged their positive contributions to the *process of designing*.

Within these two decades, huge amounts of literature and research work on design engineering were published. Current established design theories and models are mostly guidelines that provide general guidance and advice on the management of the design process in phases. However, what design is, a theory or a model, it should describe the real world and its realities through a prism from which, when observed through, designers could envision useful insights as regarding their designing tasks [18].

A majority of the *engineering design methodology models* in the literature are based on managing design phases or stages of design and utilized an *analysis-synthesis-evaluation* procedure approach [1,2,4,19,20]. These methodologies have core similarities and are categorized as *prescriptive design models*. In addition to the prescriptive design models, from the literature studies, there are two more design methodologies models: *normative design models* (i.e. Axiomatic design [21,22],

Decision based design) and the *descriptive design models* (e.g. Question-based approach [23], descriptive reflective design model [24]).

Although, from the perspective of engineering design methodology models, descriptive design models describe *how design is carried out* while normative design models describe *how design should be carried out* and prescriptive models describe *how design should and can be carried out*.

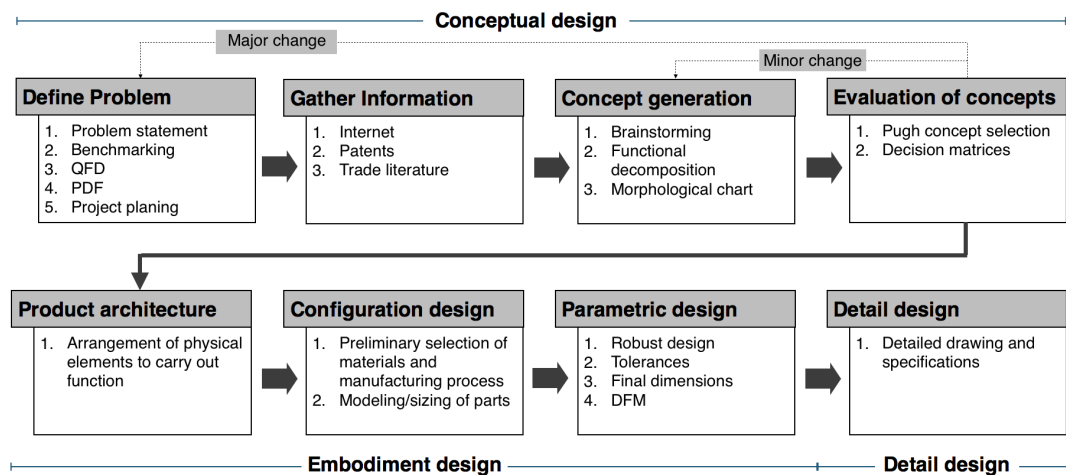

Fig. 2-1 The engineering design process (after [25])

Among design methodology models, the one proposed by Dieter [25] is a good representative of the engineering design process. As illustrated in Fig. 2-1, the design process is divided into conceptual design, embodiment design and detail design, each of which has one or more steps.

In the conceptual design phase, designing steps are starting by defining the problem, translating requirements into engineering characteristics. Then the necessary information from many sources such as, experts, patents, and internet, needs to be gathered to generate feasible concepts which have the potential to meet the design requirements. Many techniques are applied in this step that include approaches from prescriptive design methodology models (we simply referred these models as *routine design model*) and creativity approaches (refer to section 2.3). Consequently, the most

suitable concepts will be selected for embodiment design phase. In embodiment design, we first concern the architecture and configuration of elements of the product. Afterward, a parametrical design study will be performed to ensure the expectation characteristics. Lastly, detail design stage, any details, specifications are brought together to ensure the manufacturability.

As design considered as an iterative process, the changes are made if a result is not met the design requirements. The degree of freedom of design is narrow down according to phases of design, but it is contrasted to knowledge about being designed product. Any modification in the early phases of design is made much easier than the latter phases. This modification has strong influence to cost and performance expected of the final product. In addition, the effective and efficient of evaluation and selection stage are one of success keys in design. The difficulties in evaluation selection have depended on the representation of results of design. Details of such issues will be explored in the coming sections.

### **2.1.2 A Form, Function, Behavior perspective**

Design is a set of activities that operate on information that describes a being designed product. The result of design effort is a description, or specification, or what product looks like, what is it made of, how it functions, etc. [26]. Gero and Kannengiesser [27] stated that artifact that is designed can be characterized through three classes, in terms of *function*, *behavior*, and *structure*. In this thesis, we adhere to the definitions established by Shooter [26].

**Form**, the physical characteristics of a being designed artifact. This includes, its topology, geometry and material properties.

**Function** is defined as the teleological interpretation of a behavior under an intended goal. It means to what artifact is supposed to do. Function is often used synonymously

with intended behavior. A most popular referenced of functional basis for engineering design is proposed by NIST [28]. Function has been used in concept generation phase [29–32].

**Behavior** refers to how artifact implements its function. The behavior of physical systems is governed by engineering principles and is often incorporated into a causal or behavioral model.

The original FFB framework proposed by Gero [27,33] and several researchers [29,34,35] have proposed the representation of product from the perspective of form, function, and behavior (FFB). It is resulting in slightly different definitions of these terms. In Fig. 2-2 shows the FFB framework in the context of design-analysis integration. In general, designer starts with define desired functions, then search for engineering principles that can implement those functions. Subsequently, the form or structure will be synthesized according to behaviors. From this point, an analysis task will be made to explore the satisfaction of function with form. Design-analysis integration within the perspective of Form, Function, and Behavior is very useful and can be adapted in all major design phases. The comprehensive surveyed on this area is presented by Mocko et al. [28].

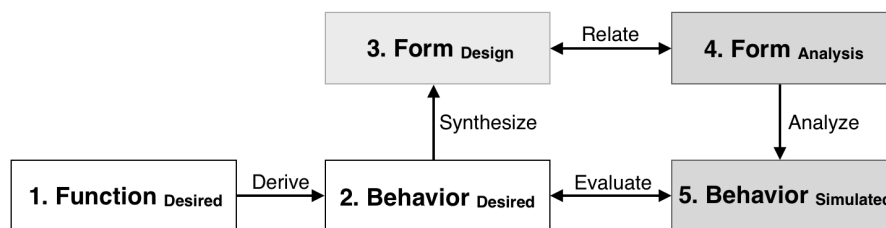

Fig. 2-2 FFB framework for design-analysis integration [29]

The FFB framework provides a consistent manner for describing products as several researchers have developed or proposed formal information models of products. Core Product Model (CPM) [30, 31] proposed by NIST is one of the formal models. This model serves as a conceptual product model for capturing a form, function, and



behavior about a complex product. Additionally, several product models based on FFB framework have been developed to support specific aspects of product development.

### 2.1.3 Overview of knowledge representation

According to Pahl and Beitz [7], engineering design activities require a sound of knowledge foundation in sciences, engineering fields, and design theory as well as knowledge and experience of the domain of interest (in house knowledge, experts, etc.). Knowledge representation in engineering design can cluster into three categories: 1) rule-based knowledge representation, 2) model-based knowledge representation, and 3) case-based knowledge representation. The representation of knowledge of being designed product could be viewed from the perspective of FFB frameworks and product models. One of the most comprehensive representation of knowledge in design has been proposed by Chandrasegaran et al. [32] as depicted in Fig. 2-3.

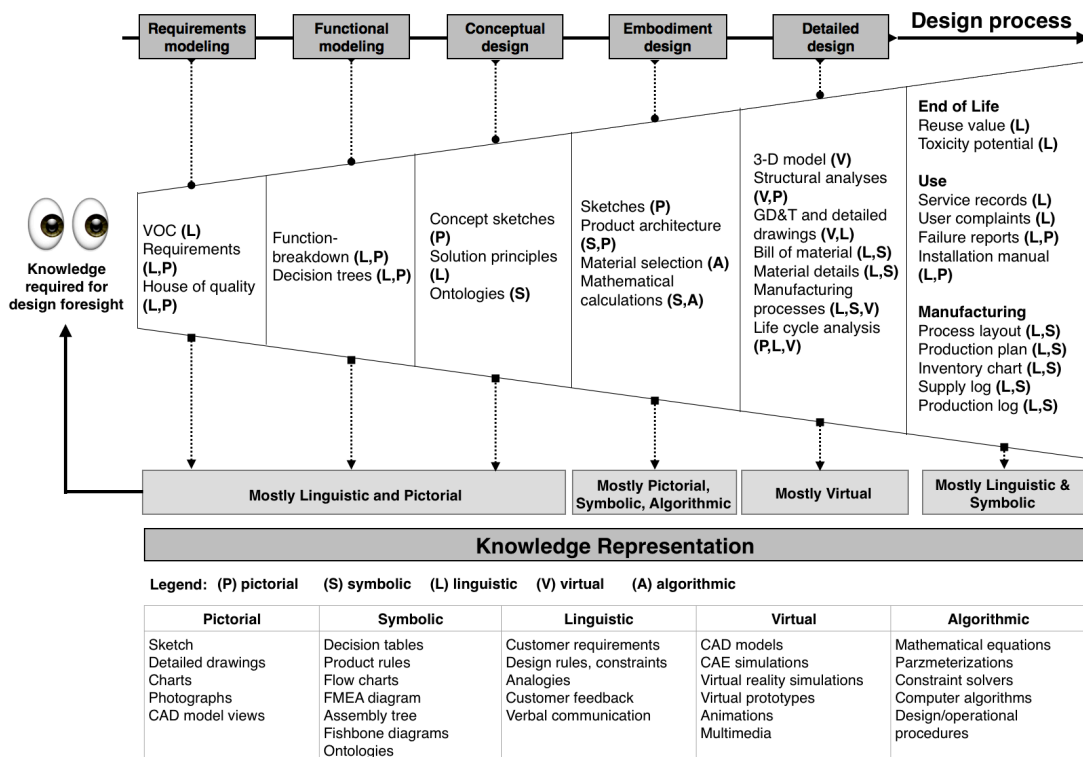

Fig. 2-3 Knowledge representations in product design (after [32])

The design stages shown at the top are based on Pahl and Beitz [7]. The columns below each stage of design show examples of representations of knowledge used at each stage. The classification of knowledge is coherent with the phase of design as in the early stage, the concept has been generated and described by a sketch [36] and text annotation, etc. In the latter stage of design, a virtual simulation will be performed to ensure the combination of elements and its working principle. The representation of knowledge plays a crucial role in all decision-making stages. Moreover, the completeness of knowledge in each stage of design is directly influenced to the result of design. Noted that other viewpoints concerning on knowledge are not interested in this thesis.

#### **2.1.4 Reflection on engineering design**

Design methodology should be practical, currently established engineering design methodologies are not widely used in practice, lacking in traceability and that most of the established design methodologies are of a prescriptive design model.

The new design methodology model should allow designer to design in accordance to his or her preference of natural way, enable traceability of minor design decisions and provide tracking of design progress and direction (decrease the knowledge gap in design phases). Additionally, it should be able to attract/encourage designer to use it by facilitating the meeting of design requirements while trying to generate the design solution and facilitate the reuse of design information and design knowledge. The product life cycle management (PLM) and Computer Aid Design (CAD) are answers to these requirements and there are many researches to serve this area [37].

Recently, many computer support software tools have been developed to serve specific purposes and specific phases of design. For example, PatExpert<sup>4</sup>, Thomson Data

---

<sup>4</sup> [http://cordis.europa.eu/ist/kct/patexpert\\_synopsis.htm](http://cordis.europa.eu/ist/kct/patexpert_synopsis.htm)

Analyzer<sup>5</sup>, and PatentInspiration<sup>6</sup> are designated for patent analysis. Design results have been improved before prototyping via many virtual simulations. Many aspects have been integrated into design process include green & environmental strategies, concurrent, collaborative among several business units, etc. Importantly, creativity or inventive activities are considered as the most necessary part in designing an artifact. The detail on innovation will be provided in the coming sections.

### 2.2 Early decision making process in engineering design

Design has been also described as an iterative decision-making process. In design, a list of concepts is required in order to perform the selection. From the design process perspective, early decision-making process can be carried out after conceptual design phase (Fig. 2-4). Over 70 percent of final product cost and quality is determined by the end of conceptual design phase [38].

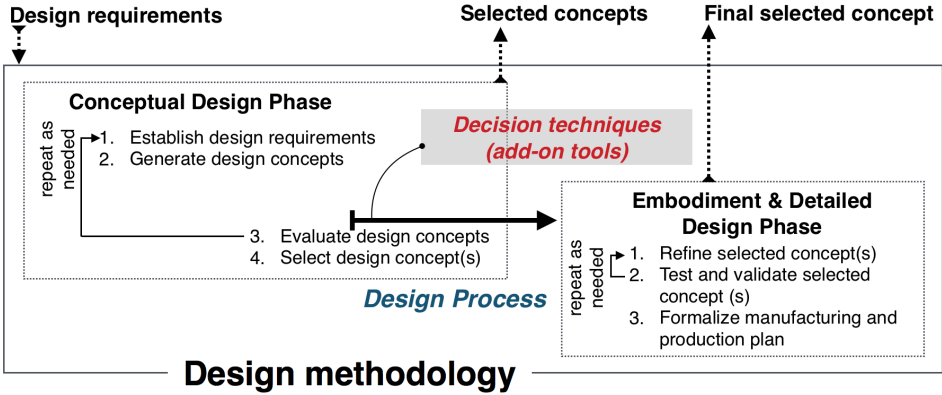

Fig. 2-4 The differences of scope between a design methodology, design process and decision-making techniques

The decision made early in the design process are viewed as paramount to the success of the design project [4]. It is considered as the most difficult, sensitive, and critical task in design.

<sup>5</sup> <http://thomsonreuters.com/>  
<sup>6</sup> <http://www.patentinspiration.com>

There are many decision-making techniques used in engineering design. These have foundations in a relatively few number of general strategies for coming to a decision. These strategies include sufficiency, experiential or recipe, scientific method, expected value, optimization, and intuitive aggregation.

Among these strategies, *expected value* has been adapted to many engineering decision situations. This methodology employs the use of probability of an event multiplied by its outcome to give an expected outcome. It is essentially a weighting principle where outcomes are weighted by their probabilities. Some techniques in this area include Value Analysis [39], QFD [40], Pugh[5], Subjective Weights [41], Multi-Criteria Decision Making, Pahl & Beitz [1], Analytical Hierarchy Process [42,43], and Decision Tree, to name a few.

Currently, optimization methods have become such a powerful tool for decision-making. It is a hybrid method that combine the idea of a measure of merit (expected value) with the scientific method. The techniques used in this area include the genetic algorithm, linear programming, non-linear optimization, and goal programming.

Decision-making, in general is affected from many external factors. There are many outside factors that affect the decision. These factors might be classified into two groups:

- 1) **Framing** is concerning on the perspective by which a problem is set up and depending on the position of a problem statement.
- 2) **Availability of data** during the decision. Sub factors of this group include, biases, anchoring, lemming and politics. *Biases* is preconceived notions as to how decision should be made regardless of the data available. *Anchoring*, bias focused on extreme points exhibited in previous results rather than on current data or the general body of data as a whole.

*Lemming* is blindly following a course of action without considering data available. Lastly, *politics* is using personal or organizational relationships to drive decision rather than pertinent data.

Such factors can be argued to cause the decision process to become irrational. In many cases, these factors affect the rational decision by the influence the subjective weighting of criteria and perception of probabilities.

### 2.2.1 Concept selection method

We note that the primary focus of this thesis is the important process of concept evaluation and selection, which we simply refer to *Concept Selection*. Concept selection is the process of evaluating disparate design concepts with respect to the established design requirements. The major goal of concept selection is to avoid conceptual vulnerability – or the risk of design process failure.

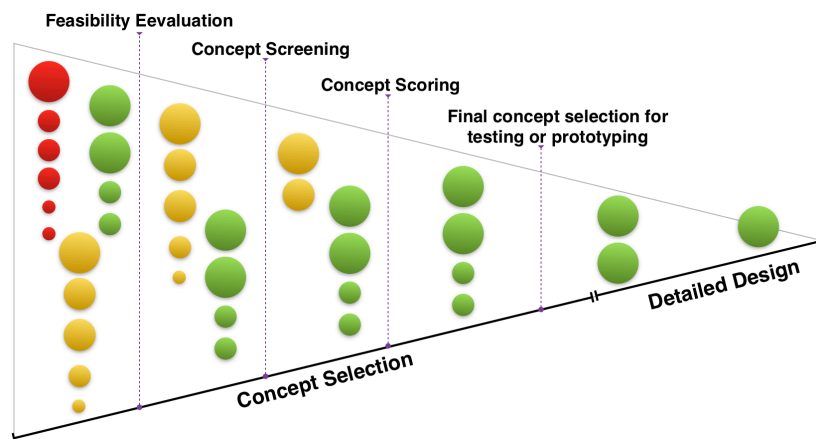

Fig. 2-5 The process of concept selection

In the early design process, concept selection typically involves various approaches regarding the phase of design. Fig. 2-5 shows the general objective of concept selection process, which is to progressively narrow the design concepts down to those of most promise. Concept selection can be divided into two main groups: non-numerical and

numerical concept selection approaches, which are adopted from decision techniques aforementioned. The detail of each group is briefly discussed below;

*Non-numerical concept selection* is qualitative and void of a mathematical basis.

Several methods include the following:

- 1) Selection approached based on individual *arbitrary preferences* such as external or internal decision makers, and voting [4].
- 2) Selection approaches based on methodical/structured preference such as feasibility judgment/intuition, go/no-go screening, and technology readiness assessment [2,4,44,45].
- 3) Selection methods based on *decision matrices* such as concept screening and the *Pugh* [5,46] concept selection method. Some of mentioned approaches may also be considered numerical approaches depending on how they are used.

*Numerical Concept selection* is quantitative in nature and includes the following methods; Decision matrices [2,4,25], Fuzzy approached, Utility Function Methods, and Quality Function Deployments. Numerical concept selection approaches can facilitate the evaluation process when uncertainty is considered. In term of consistency and repeatability, they are more likely to be achieved when using numerical approaches.

Fig. 2-5 illustrates that the different selection process, various concept selection approaches have been applied. For example, the designer may start with a non-numerical approach such as intuition to judge the feasibility of concepts. Then using the go/no-go screening to screening concepts. Afterward, the numerical selection method such as decision matrices will be applied to score the concepts. In the latest concept selection process, the optimization strategies may be used to evaluate the

performance of concepts if one can develop equations that define the cause and effect relationships of a phenomenon of decision problems.

Decision matrices are the most widely used as concept selection method. The popularity of these methods is that due to they are easy to use and the results are easy to interpret. However, decision matrices still have some pitfalls as stated by Mullur [47]. Pugh concept selection is a popular one, it overcomes the drawbacks of decision matrices. Nonetheless, in practical, the designer may find it difficult to evaluate the variety of concepts. This variety poses a strong influence to the decision phase, more specifically in inventive design. Further discussion on concept selection method for inventive design has been provided in Section 3.1.

### **2.2.2 Feasibility evaluation in concept selection**

Feasibility evaluation depicted in Fig. 2-5 will be performed to determine whether the requirements and constraints can be defined from designer preference. It might be applied in the first stage of early decision-making. Ullman [2] has classified the feasibility evaluation process in terms of the immediate reaction of designers and decision-makers into three types: 1) Not feasible, 2) Conditional, and 3) Worth consideration.

The notion of immediate reaction describes the degree of confidence decision-makers have in a Solution Concept, taking into account doubts and uncertain conditions surrounding it.

Several authors [1,2,48,49] have suggested using rough calculations based on simplified assumptions to investigate the feasibility of design concepts. By relying on simple physical and empirical equations, an approximate evaluation of the behavior of the concepts being studied can be achieved. Unfortunately, depending on time constraints

and limitations of knowledge requirements during the early design stage, this calculation is often made only after viable concepts have been selected.

As mentioned earlier, the feasibility of design concepts is explored through rough calculation, which relies on simple physical and empirical equations. This type of calculation requires the solution of quantitative, well-defined problems and there exists no form of analysis model to support this process. As such, the concept has to evolve to the point where a parametric model can represent one or more aspects of its performance [50].

The analysis model used in this conceptual stage is a physics-based model comprising mathematical expressions and equations derived from basic engineering and physics principles. In many cases [51,52], this type of analysis model is seen as a benefit to designers or decision-makers that assists them in producing rapid estimates to determine the feasibility of design concepts. Moreover, the concept is highly promising in several engineering applications [53,54] where this type of analysis model can be used during the conceptual stage with an optimization technique to explore large feasible design spaces.

### **2.2.3 Risk-Failure analysis as a part of concept selection**

In the various fields of engineering, risk/failure analysis is a part of decision-making process. It is divided into two branches:

- 1) Qualitative risk/failure analysis is centered on identification of failure and revelation of failure scenario.
- 2) Quantitative risk/failure analysis is based on probabilistic calculation or estimation of metric value which decision is made.



In traditional risk/failure analysis methods used during design include Fault Tree Analysis (FTA) [55], Reliability Block Diagram (RBD) [56–60], Failure Modes and Effect Analysis (FMEA) [56,61,62], Event Tree Analysis (ETA) [63–65], and Probabilistic Risk Assessment (PRA) [66–68]. These methods quantify risk and reliability, determine the initial cause of a failure, and enumerate system consequences in the event of failure [69].

Risk/failure plays crucial roles in early design phase [70,71]. Several authors have been proposed design methods for component development by relying on the relation of risk/failure and function [72,73]. Risk/failure in concept selection has been demonstrated by Goswami et al. [74] in the case of the roll over protection system. Time restriction in design cycle is one of an issue to be concerned while applying risk/failure in concept selection. As risk/failure analysis is grounded with a specific scenario and possible consequences. They are considered as the same external factors that have influences to the decision making.

#### **2.2.4 Observation on early decision-making process**

Early decision making has been made to evaluate and select the most suitable design concepts, as we simply referred to concept selection in this thesis. The methods used in concept selection depends on phases of design and importantly design methodologies. The better concept selection process is integrating several methods together and has to represent the characteristics of concept in multi-viewpoints that include: designer preferences, technical feasibility and the chance to success in term of risk/failure, etc.

It is true that in the early stage of concept selection the only qualitative approached can be applied according to the representation of design concept which is a sketch and text annotation. Questions are arriving here; *what criteria look like in order to avoid*

*the instant rejection of a good concept?* If time restriction is a constraint in concept selection; *how to make an informed decision in acceptable time span?* Answer of these questions is a part of issues that this thesis has debated on and our results will be given in the coming Chapters.

## **2.3 Paradigm shift in the industry**

The age of industry has been classified as productivity, quality, and innovation. *Productivity* era focuses on customer demands, optimizes production and increases the production rate. On the other hand, *Quality* age is concerning on the competitive, ensuring the quality of product and optimizing organization. Presently, *Innovation* era deals with the complexity of the technical system, manages knowledge and forecasts the evolution of product in order to be more competitively.

In innovation era, current design approaches in the literature (refer to section 2.1), for example, functional analysis, brainstorming, value engineering, design of experiments, FMEA-QFD. These are the quality driven approach, it is, therefore, legitimate that they fulfilled the expectation of the industry era. These approaches are grouped as the routine design and some limitations of these current approaches are:

- 1) Using the structured existing knowledge to synthesize the solution. In some cases, the designer usually applies known solution from the same domain of problem than finding the new one. It does not allow designer to investigate into unknown knowledge domains.
- 2) Routine design methods like to initiate (favor) trial & error, convincing the designer to optimize both technical skill and creativity. The overall process does not ensure and exhaustive search of solutions.
- 3) Do not direct to research and development efforts inventively.

- 4) Do not forecast product evolution, designing is relayed on customer preferences and requirements. The evolution hypothesis of a being design product is not taken into account and research direction is vastly defined in the early design stage.

Nevertheless, today's expectations are concerned with the problematic of innovation. It is true that an artifact should satisfy the customer preferences but in reality "*people don't know what they want until you show it to them*" [75]. However, the successful of innovation is impossible without integrating productivity and quality perspectives. In this section, a brief detail on innovation management is provided. The ideation and evaluation/selection methods as a part of innovation input have been surveyed and presented in the following.

### **2.3.1 Age of innovation**

According to OSLO<sup>7</sup> manual, innovation is an implementation of a new or significantly improved product (good or service), or process, a new marketing method, or a new organization method in business practices, workplace organization or external relations. Innovation pipeline (Fig. 2-6) is a more complex activity, it interrelated with many elements of the organization, product development department, marketing, and everyone in the business units. Innovation is considered as a less organizational or slack. Additionally, regarding the research annual survey of Booz & Company [76], there is no correlation between R&D spending and business performance. The measurement of innovation capabilities could be a key to bridge this correlation. The organizations of innovation are confused. Many firms are confused about innovation—what it is, what it can do and whether it can or should be formally managed.

---

<sup>7</sup> [www.oecd.org/sti/inno/2367580.pdf](http://www.oecd.org/sti/inno/2367580.pdf)

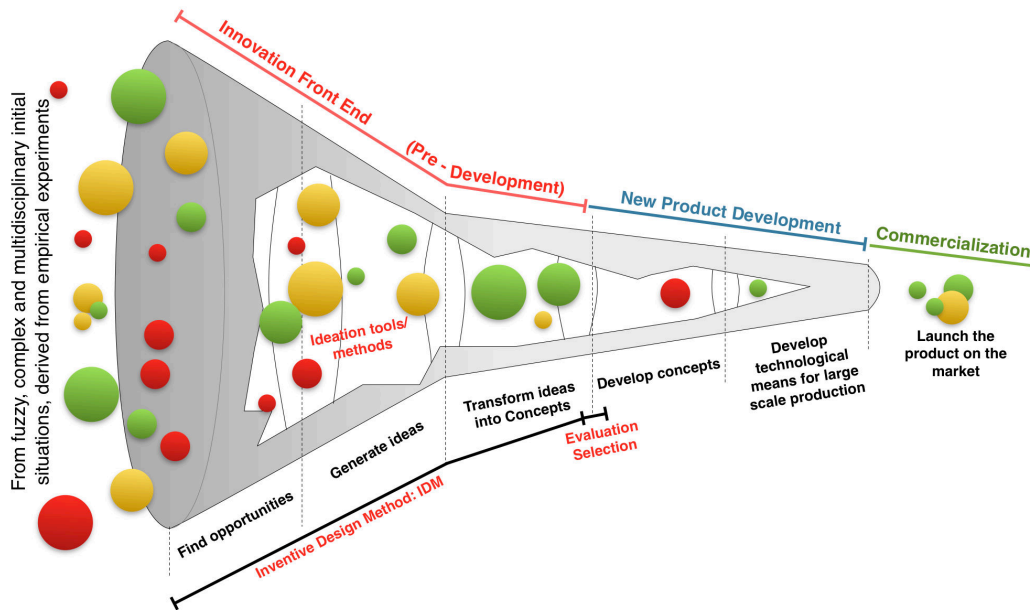

Fig. 2-6 The operational funnel of innovation for implementing normative and strategic objectives (after [77])

The operation funnels shown in Fig. 2-6 has illustrated the interconnection of phases of innovation pipeline. In this thesis, we note that the conceptual design phase in New Product Development Phase (NPDP) is merged with the Innovation Front End (IFE) phase. IFE consists of four main steps include: find opportunity, generate ideas, transform ideas into concepts, and evaluate and select the most suitable concepts. The output of IFE is put forward into the NPDP and the commercial phase respectively. The successive measurement of innovation might be considered the benefit of commercial phase. In order to guarantee this success, all element in the pipeline should be seamlessly interconnected.

Standardization is the voluntary process of developing technical specifications based on consensus among all interested parties (industry, including SMEs, consumers, trade unions, public authorities, etc.) it is carried out by independent standards bodies, acting at national, European (CEN) and international (ISO) level.

CEN<sup>8</sup> stated the innovation management system is a set of interrelated or interacting elements of an organization to establish innovation policies and objective, and processes to achieve those objectives. CEN/TS 16555: 2013 and ISO 20511: 2017 are the examples of past and ongoing standardization on innovation management. The benefit of innovation standard as it allows faster uptake of innovative solutions and enhance the economic value of research and innovation project.

### **2.3.2 Innovation Front End: IFE**

IFE is considered as the input of innovation pipeline. Garbage in garbage out (GIGO) is using to define the important of IFE phase. Several authors considered IFE phase as the invention phase [8,78,79] and it uses to describe design activities and design outputs. Here, *Invention* refers to the action of creating or designing something new (original) that not exist before [80]. Generally, IFE starts with identifying the opportunity to success, analyzing the initial situation or current state of a product under consideration, evaluate the performance of competitors in the same business, also specifying and forecasting the keys characteristics of the new product, etc. All information gathered from the previous step will be used to specify the R&D direction, several ideation methods have been applied to generate ideas. Most potential ideas are transforming into concepts. Next, the most suitable concepts will be evaluated and selected to develop in the next phases of innovation pipeline. In the following sections, the overview on ideation and concept selection methods used in innovation perspective are given.

---

<sup>8</sup> CEN is the European Committee for Standardization, is an association that brings together the National Standardization Bodies of 33 European countries. <https://www.cen.eu>

### 2.3.2.1 Ideas generation

There are several established methods (Fig. 2-7) to assist designers in deriving and generating ideas or concepts. However, it has been confirmed by many authors that routine design methods are inadequate for generating radical innovation ideas [81]. The most suitable ideation method should include the creativity activities, allow designers to investigate into the new knowledge domain. *Creativity* is defined as the ability to produce a valuable new form or combination of elements through a dynamic intuitive anticipation, imagination and unconscious [82]. It could be viewed as intellectual inventiveness [83]. In inventive design, creativity is considered as the departure point to generate inventions [79].

The combination of several ideation methods may lead to the impressive results. Nevertheless, it should be practical, not be a sophisticated approach and easy to interpret results. The focus of this thesis relies on the Inventive Design Method which has TRIZ as a core design theory/method. Further information on TRIZ and inventive design is given in section 2.4 and 2.5 respectively.

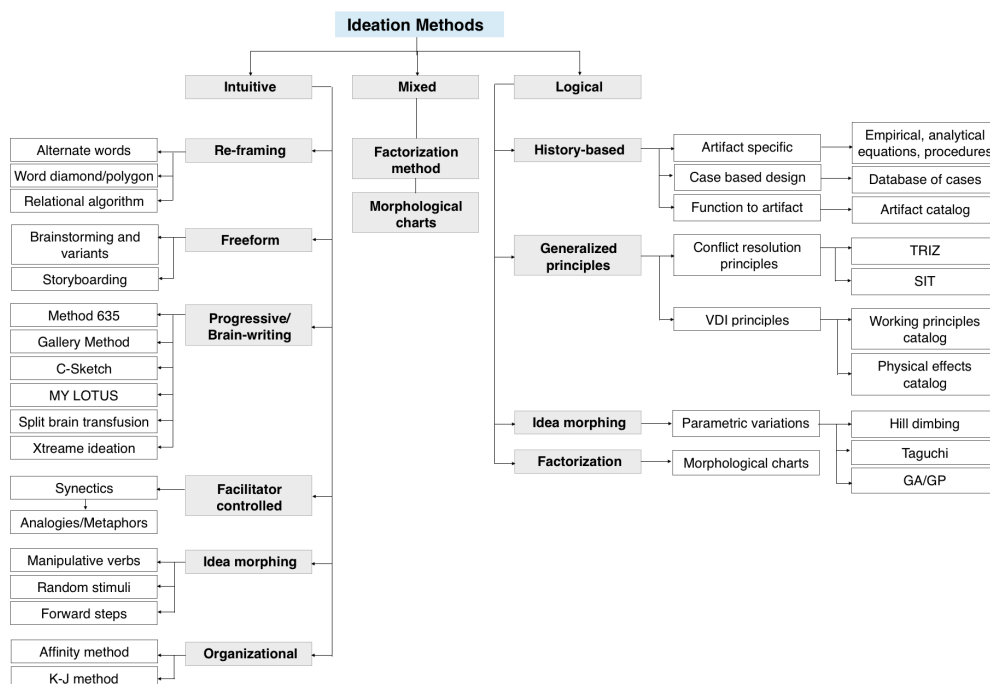

Fig. 2-7 Example of ideation methods [84]

### 2.3.2.2 Ideas evaluation and selection

The ideas are usually derived and evaluated based on the “satisficing” method. Precisely, qualitative evaluation on how well the concepts meet the design requirements. As in conceptual stage, concept selection method mentioned in section 2.2 can be used to evaluate and select ideas. However, the context of ideas depends on the ideation method. With classical (routine) design methods, an idea or a concept is more concretely described than one came from creative methods. In order to evaluate ideas from creative or inventive design, the modification in criteria will be made before applying the evaluation methods stated in section 2.2.

Another viewpoint to evaluate ideas from creative or inventive design is the ideation effectiveness matrix [85]. This matrix concerns on quantity, quality, variety, and novelty of ideas. Other criteria also taking into consideration, such as utility, relevance, valuable, flexibility and fluency [86–89]. However, designers may find it difficult to evaluate by using these criteria and end up with the simplest approaches as Pugh and decision matrices within the classical criteria such as technical feasibility, social acceptability or any customer and designer preferences. An effectively and efficiently concept selection method for innovation perspective still lies in challenging the inventive design research link [90].

## 2.4 Theory of Inventive Problem Solving: TRIZ

TRIZ is the acronym for the Russian phrase, “*Teoriya Resheniya Izobreatatelskikh Zadatch*”, roughly translated into English as ‘Theory of Inventive Problem Solving’ [6,7]. Genrich Altshuller and his colleagues in the former USSR started TRIZ research in 1946. A number of variants of TRIZ have been derived, Algorithm of Inventive Problems Solving (ARIZ) [7], Unified Structured Innovative Thinking (USIT) [91], General Theory on Powerful Thinking (OTSM) [92,93] and Systematic Inventive

Thinking (SIT)<sup>9</sup> are a few of the variants of TRIZ found in the literature. TRIZ is a qualitative theory, not a mathematical or quantitative one [94]. TRIZ is a body of theoretical knowledge used as a foundation for further instrument and development. The key problem that this theory address is *how to obtain a solution without a lot of trial and error?* TRIZ could be viewed as a theory or a method to resolve an inventive problem. It has been adapted into engineering design process as one of ideation tools.

This section presents the overview key concepts of TRIZ, main fundamentals, methods, tools and its body of knowledge. Some literature related to its current development will be provided. This section ends with the reflection and critical issues on TRIZ.

#### **2.4.1 System elements of TRIZ when describing as a theory**

TRIZ body of knowledge [95] is distinguished as 1) foundational concepts, 2) trends (laws) and sub-trends (lines) of technological system evolution, 3) algorithm for inventive problem solving (ARIZ), 4) substance-field analysis, 5) techniques for resolving contradictions, 6) scientific effects, and 7) system analysis methods. Fig. 2-8 describes the system of elements of TRIZ when viewing as a theory. The overall view of TRIZ's elements is divided into four groups, fundamentals, methods, tools, and meta-knowledge base. Briefly detail and literature surveys of each element are given as follow;

##### **2.4.1.1 Fundamentals of TRIZ**

All method, tool and meta-knowledge of TRIZ is grounded with three fundamentals include objective laws of technical system evolution, contradiction, and the specific situation's restriction (Table 2-1). The detail of each fundamental is as follows:

---

<sup>9</sup> <http://www.sitsite.com/>



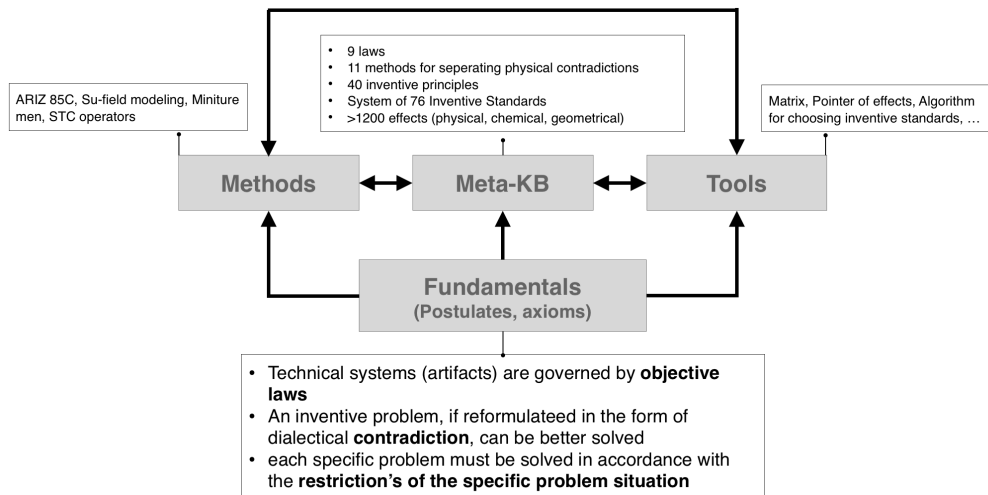

Fig. 2-8 System elements of TRIZ when describing as a theory

Table. 2-1 Three postulates and their corollaries of TRIZ

Postulate or axiom	Corollary
<p><b>1<sup>st</sup> axiom: Objective laws</b>            The evolution of a technical system is governed by objective laws. These laws are invariants of their evolution</p>	<p><b>1.1</b> The laws help to locate the state of maturity of the system and to better anticipate its evolutions</p> <p><b>1.2</b> A direction of design in accordance with these laws has statistically more chances to appear relevant</p>
<p><b>2<sup>nd</sup> axiom: Contradiction</b>            Any problematic situation can be translating in the elementary form a contradiction (within the meaning of dialectic)</p>	<p><b>2.1</b> An identified and formulated contradiction becomes an inventive opportunity when its resolution is refusing compromise</p> <p><b>2.2</b> Impossible of formulating a contradiction indicates that what appears as a problem might not be an inventive problem</p>
<p><b>3<sup>rd</sup> axiom: specific situation's restrictions</b>            Each specific problem must be solved in accordance with the restriction's of the specific problem situation</p>	<p><b>3.1</b> A good solution in a solution that involves as few resources as possible</p>

### 2.4.1.1.1 Objective laws of technical system evolution

A Technical System (TS) [96] is composed of parts, elements and they have a structure. It is designed for specific reasons (objectives) the fulfill the useful functions. Parts of TS are interconnected, they are designed and linked in a structured way in space and time. Every TS possesses in its whole a particular property additional from the sum of the properties of its constituent elements. A main useful function arises from a social need (man, group, society) which actively desired it or tacitly pushes its emergence. A function describes the ability of a TS to deliver a requested property in defined conditions.

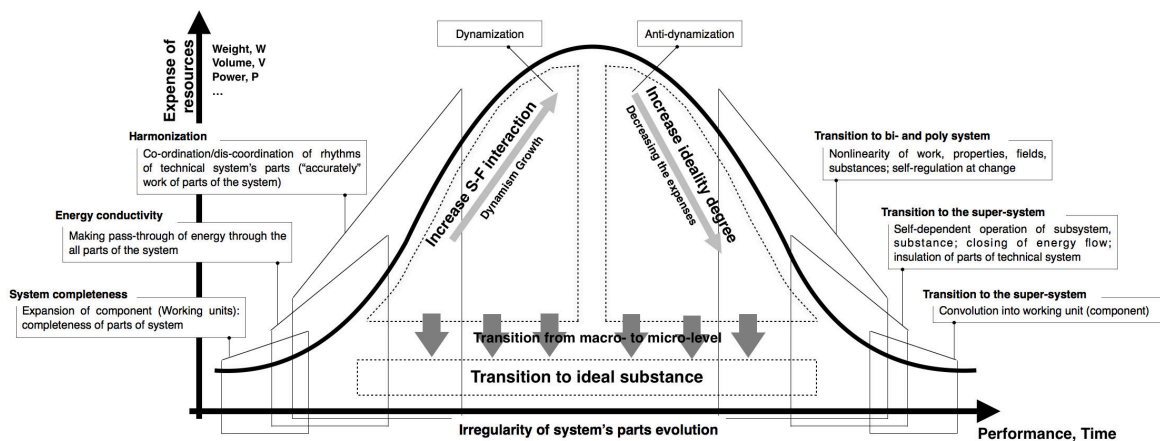

Fig. 2-9 General diagram of technical system evolution (after [97])

The evolution of successful technological systems is not random but is governed by certain laws or prevailing trends. Nine objective laws of technical system evolution are presented in Fig. 2-9. The detail of each law is given as follow:

- 1) **System completeness**, any technical system appears as a result of a synthesis of several parts into a single whole. In order to be viable, the main components of the technical system have to be presented and performed a minimal working efficiency. In each technical system consists in; 1) engine, 2) transmission, 3) work (tool), and 4) control. we note that,

for a reason to make a technical system controllable, at least one of its components must be controlled.

- 2) **Energy conductivity**, the energy flow that drives it must pass through all of its main components.
- 3) **Harmonization**, to maximize its performance, all of its main components must be coordinated or not coordinated.
- 4) **Increasing ideality**,  $\text{ideality} = \text{Sum}(\text{performance})/\text{sum}(\text{expenses})$  during its evolution the technical system tends to improve the ration between the system performance and express required to perform this performance. Three principal directions: 1) improvement the system's performance without increasing additional expenditures, 2) decreasing the expenditures without performance degradation, and 3) transition to the super-system.
- 5) **Irregularity evolution of parts in Technical system**, components of technical systems evolve irregularity. The more complex system, the more irregularity we will get. These irregularities lead to the birth of new contradiction preventing its evolution.
- 6) **Transition to the super-system**, during its evolution, technical systems merge to constitute bi- and poly systems. in the future, the system pursues its evolution as a part of the super-system.
- 7) **Transition from macro to micro level**, the evolution of the "tool" element within a given system, begins on the macro-level and tends towards the micro-level. This evolution is brought about by the advantages of using properties of dispersed materials and particles of physical fields.
- 8) **Dynamics growth**, in order to improve their performance, rigid systems should become more dynamic. By dynamic we mean, evolve to more flexible

and rapidly changing structure, adaptable to changes of working conditions and requirements of the environment.

- 9) **Inner Su-Field deployment**, in order to improve their performance, systems should become more controllable. By controllable, we intend to ease the realization of the Main Useful Function while minimizing substances and fields added into the system.

In literature, laws are sometimes called trends or tendencies. Each law should have observed as a generic interpretation based upon the observation and the synthesis of thousands of technical systems dynamic of evolution. In a more precise way,

- 1) There is a high probability that a given technical system's dynamic of evolution will follow the laws.
- 2) Based upon its maturity, the probability for a technical system to follow a given law (or several will increase).
- 3) When reaching the end of its static stage (law 1, 2, and 3), besides a permanent and generic ideality increase (law 4) and the emergence of a new contradiction (law 5), alternative ways of evolving should be observed through (law 6, 7, 8 and 9), and these last "more dramatic" evolutions may be interpreted a "S-curve" jumps.

#### **2.4.1.1.2 Contradiction**

A contradiction consists of a logical incompatibility between two or more propositions. It occurs when the propositions, taken together, yield two conclusions which form the logical, usually opposite inversions of each other. In TRIZ, there are three types of contradictions, that is, administrative contradiction, technical contradiction, and physical contradiction.

- 1) *Administrative contradiction*, refer to the problem description contains expectations from organizations and management. We are facing a conflict between human beings and a technical system. The answers are only partial and belong to the super-system. An administrative contradiction does not reveal any contradictory aspect, and it often describes a desire to improve a characteristic of a system without having an emerging direction of resolution.
- 2) *Technical contradiction*, conflict appears within existing technical systems. The answers to typical questions are incomplete but lie within the system. The resolution of a technical contradiction is mainly performed using reasoning by analogy, facilitated by the use of two TRIZ components: the inventive principles and the contradiction matrix.
- 3) *Physical contradiction*, the problem description contains concrete physical phenomena. A conflict appears between physical properties of a specific element of the system. Answers to typical questions are formulated at the level of sub- systems.

Contradiction formulation is one of the critical points to concern in TRIZ-based design. The resolving of the most influence contradiction may lead to the impressive results.

#### **2.4.1.1.3 Specific situation's restriction**

Each specific problem must be solved in accordance with the restrictions of the specific problem situation and by using available resources. A comprehensive review on resources of TRIZ is presented by Mueller [98]. Here, the creative utilization of the resources available in a system to increase the system's ideality is a cornerstone of inventive problem solving.

#### **2.4.1.2 Tools of TRIZ**

Tools of TRIZ are constituent elements of a theory allowing the realization of a precise action in coherence with the study in process. In the TRIZ body of knowledge we can note as tools:

- 1) The matrix for resolution of technical contradictions
- 2) Inventive principles to solve technical contradictions
- 3) Separation principles for resolving the contradictory properties of physical contradictions
- 4) The system of inventive standards

We note that, as we only overview the relevant technical backgrounds and general literature surveys, thus full detail of tools and methods of TRIZ is not provided in this section.

#### **2.4.1.3 Methods of TRIZ**

The methods represent structured procedures for using the TRIZ knowledge base. The system of steps that constitute the methods allows both problem reformulation and problem resolution. For example, Substance/field analysis and modeling, various version of ARIZ are methods in the body knowledge of TRIZ.

#### **2.4.2 When TRIZ has been observed as a method in engineering design**

Currently, the design problem is dramatically evolved. The complexity of a technical system has forced the designer to solve the problem from another level of observation. TRIZ is one of the problem-oriented approaches. The core concept is to consider the problem in the abstraction level in order to apply possible solution or knowledge from

another domain to resolve the problem. The abstraction model of problem in TRIZ-based design is a contradiction.

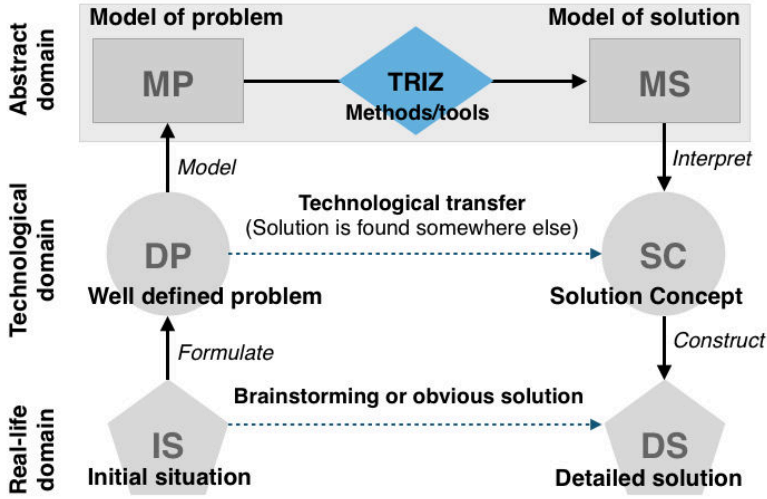

Fig. 2-10 TRIZ model after considered as a design method

The model to describe TRIZ as a design method presented in Fig. 2-10. With this model, the designer starts with observing the system in the real life domain and analysis of the initial situation (IS). The solution could be found in this phase by brainstorming method or any obvious solution from the designer. Afterward, the problem will be formulated in a concrete way, more specifically as it is a technical problem or another problem (DP). Consequently, the well defined problem is modeled as the contradiction (MP) and TRIZ’s methods and tools (MS) are applied to interpret a solution (SC). This solution has been evaluated accordance with the design requirements and then constructed in details (DS).

**2.4.3 Evaluation and Selection in TRIZ based design**

One of the most striking characteristics of design is that evaluating solutions may prove to be more difficult than finding them. Having good ideas is useless if they are rejected at an early stage. In many existing qualitative evaluation and selection methods (see concept selection in Section 2.2), evaluation criteria are usually taken

from the design requirement, which is strongly influenced by customer preferences or decision makers' experience.

In TRIZ based design, the evaluation stage will be viewed only as a hypothesis for the improvement of technical systems. Rantanen and Domb [99] proposed defining the evaluation criteria from the concept of ideality, where each solution offered is evaluated and compared with the ideality of known solutions by a simple pairwise comparison. Orloff [94] suggested a few practical techniques to verify the solution, such as the ideal final result, a functional ideal model, essential rules and the algorithm for verification of a solution.

As TRIZ is viewed as an ideation method, the effectiveness of ideation matrix mentioned in section 2.3.3.2 can be used to evaluate and select design concepts.

#### **2.4.4 Synergy used of TRIZ with other design methods/tools**

From previous section, TRIZ has been used as an ideation tool. In literature, TRIZ has been applied and integrated used in several design frameworks. For example, in the early design stage, TRIZ is applied with QFD technique [100–103]. Hu et al. [104] proposed to use TRIZ as a tool to identify the output parameters for Taguchi design method. Several authors [104–110] applied TRIZ for decoupling design matrix in axiomatic-based design. In addition, TRIZ can be applied in the area of CAD/CAE [111–113]. Moreover, TRIZ also used in non-technical domains [114].

The overall view to synergy used of TRIZ with others design methods/tools is presented in Fig. 2-11. The research in this area can positively impact design practice in a significant way.



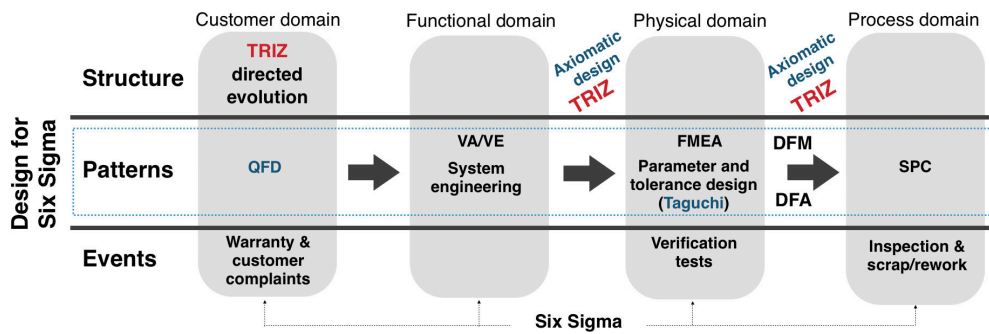

Fig. 2-11 Synergy used of TRIZ in Design for Six Sigma (DFSS) perspective [115]

### 2.4.5 Reflection on TRIZ

TRIZ is used in the ideation phase to serve the need of creativeness or inventiveness. TRIZ is increasingly used in many aspects. For example, some notions of TRIZ (e.g. ideality, objective law, ideal final results) have been used to analysis the patents [116–119]. Ideality can be used as criteria to evaluate/select design concepts. The synergy used of TRIZ in different design framework has been confirmed with the impressive results.

The drawbacks of classical TRIZ have been stated by Cavallucci [120]. Some conclusions are as follows;

- 1) *About initial and exhaustive investigations*, TRIZ is not designed to investigate complex initial situations (gathering thoroughly all knowledge necessary and known to document/understand the diversity and the problems quantity)
- 2) *About contradiction's quantity and choice*, TRIZ is designed for solving a single or few contradictions. How to disclose, represent and chose the most appropriate one since contradictions quantity increase exponentially with system's complexity

- 3) *About a methodology to disclose a contradiction*, there are no accurate ways o disclose appropriately a contradiction
- 4) *About TRIZ corpus consistency*, there is no logical links/coherence between TRIZ components in any “glossary” or “ontology” of TRIZ
- 5) *Where is TRIZ’s best solution?* There are no means in TRIZ to help the designer to decide, among a set of Solution Concepts (ideas - Concept - Solution Concept) being all inventive, which one is the one to choose

Additionally, there are many contributions that designed to improve the performance of TRIZ, for example, OTSM-TRIZ<sup>10</sup>, and I-TRIZ<sup>11</sup>. Inventive Design Method (IDM) is one of noticeable TRIZ improvement which is considered as the frame of reference of this thesis. The general details and points to be concerned of this method are provided in the next section.

## **2.5 Inventive Design Method: IDM**

The Inventive Design Method: IDM [8–10] was developed to solve classical TRIZ limits (refer to section 2.4.5) and consequently to address wider and more complex problematic situations specifically in the innovation front end stage as depicted in Fig. 2-6. The major differences of TRIZ, OTSM and IDM is mentioned in [120]. IDM uses the core postulates and meta-knowledge of TRIZ to systematically attract design problem, resolve and generate an inventive solution. The comparison between routine design and inventive design has been made and presented in Table 2-2.

---

<sup>10</sup> <http://otsm-triz.org/en>

<sup>11</sup> <http://www.ideationtriz.com>

Table 2-2 The comparison between routine design and inventive design

Routine design	Inventive design
1) Manage what is known	1) Discover what is unknown
2) What can be best obtained by optimizing existing data's	2) Going beyond what is obtained by optimizing existing data's
3) Accept compromise as a potential solution	3) Refuse compromise as a possible solution

The limitation of routine design approach has been stated in section 2.3. The four major steps of IDM depicted in Fig. 2-12 are:

- 1) Analysis of the initial situation
- 2) Contradiction formulation
- 3) Synthesis of Solution Concept
- 4) Choice of Solution Concepts to develop

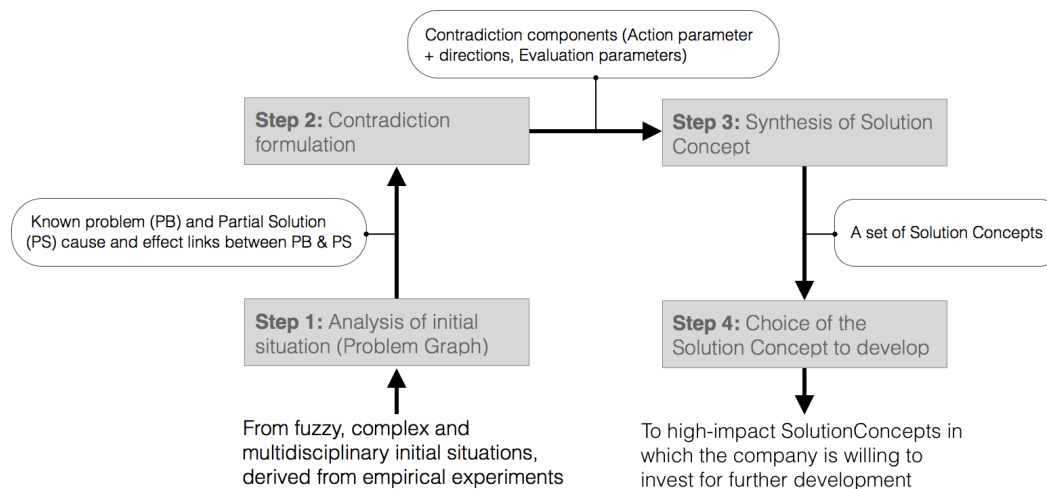

Fig. 2-12 Inventive Design Method: IDM

This framework has already been published and has been developed into a software prototype called **STEPS<sup>12</sup> (Systematic Tool for Efficient Problem Solving)**. Detail of each Major steps is further described in the next section.

<sup>12</sup> <http://www.time-to-innovate.com>

### 2.5.1 Initial situation analysis and Contradiction formulation

Initial situation analysis relies on two parts, one is the expertise of actors (engineers and experts) inside the company and another is the collection of current knowledge from patents or any publication sources that related to the technical system (TS) under consideration. Overall information in this early analysis is used to initiate the problem graph [121,122]. A Problem (PB) in the problem graph could be solved by one or more Partial Solutions (PS), and the PS may induce new PBs. In each PB or PS has one or more parameters that characterized its context. A parameter is one of the key element to define a properly contradiction from TRIZ viewpoint. The definition of the parameter should be made carefully in order to avoid fuzziness on problem's perception. There are several attributes in each parameter:

- 1) Typology (Action or Evaluation parameter)
- 2) Unit (how its evolution of states is measured)
- 3) Opposite states related to it (only concerning Action Parameter)

**Action Parameter (AP)** is defined as a parameter that designer has the power to modify its states. This type of formulation has generally two directions that can potentially result in positive impacts on the object or its super system.

**Evaluation Parameters (EP)** have the nature that they can be observed in their ability to evaluate both positive and negative results. This type of parameter has often one logical direction of progress (its positive direction seems obvious) while the other seems absurd.

Within the initial situation analysis, the requirements, expectations, and customer preferences are considered as problems which will be related with a partial solution or a problem. This notion of problem graph allows designers to observe the overall context of the design project. Consequently, the most impact direction to be solved is

identified and the expected results will have the positive influence to both technical and customer domains.

After problem graph has been filled, the **Evolution Hypothesizes** (EH) [95] of the new system will be specified with the aid of methods and tools in TRIZ, specifically, multi-screen, system completeness and objective laws of technical system evolution. Herein, evolution hypothesis is the logical interpretations of observed facts from the current system to portrait the specific characteristics of the future system.

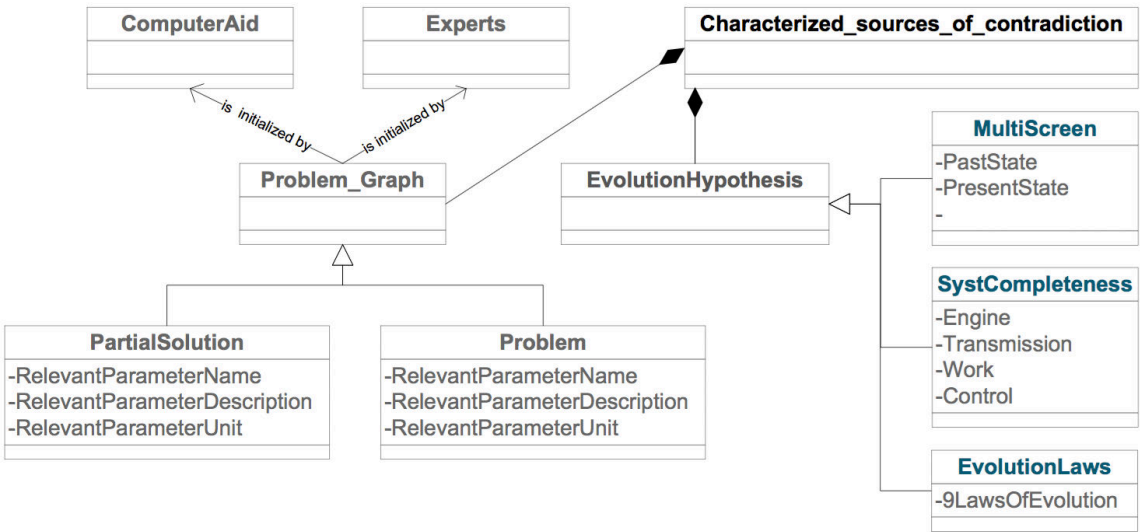

Fig. 2-13 A model to characterize the sources of model of problem: contradiction

A set of parameter identified in the previous steps (Fig. 2-13) has been formulated into a system of contradiction. One of the advancements that IDM stated is the **poly-contradiction**. As currently, a technical system is more complex, interconnected in many layers, combined with sophisticated elements. The relation of a pair of evaluation parameters is not sufficient to characterize the actual situation of the system. An example of network of problems of a complex system is provided by Cavallucci and Eltzer [123].

The notion of *poly-contradiction* presented by an example in Fig. 2-14 is based on the **ENV model** (Element, Parameter Name, and Values) [10]. An element (identified in

system completeness and considered as one of a resource) may have several APs, in each AP has two opposite state values (or directions, describing by adjectives). In each state of AP is affected to many EPs. Moreover, an EP may appear and related with another APs. A mono-contradiction is interpreted from this poly-contradiction.

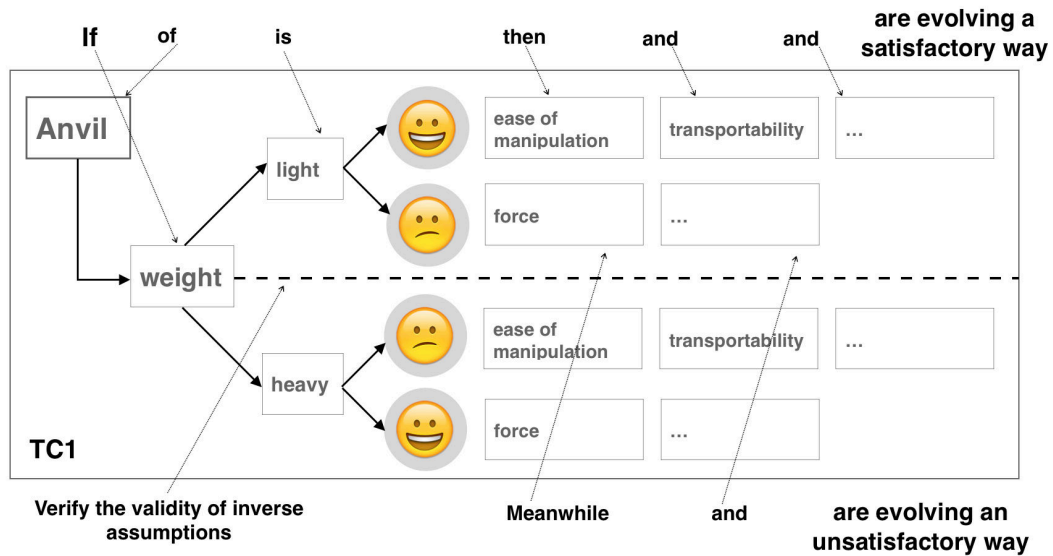

Fig. 2-14 An example of poly-contradiction of a system

The representation of the populations of contradictions is mentioned in [124,125] by considering the importance and universality of parameters (AP and Eps). The most effective contradiction will be selected and resolved in the next step.

### 2.5.2 Deriving a Solution Concept

In the third step of IDM, the key components of the contradictions are used as input to generate concepts assisted by computer-based TRIZ techniques. As concepts in the IDM framework is characterized in a concrete way (tractability, related to evolution hypothesizes), as such in this thesis concept is simply referred to as **Solution Concept (SC)**.

In this section, we review the characteristics of a Solution Concept from the standpoint of IDM framework. The main components of each Solution Concept are:

- (1) A description template, which describes an abstract context, general properties, performance functions and a Model of Problem
- (2) A sketch of the Solution Concept, which is synthesized from a Model of Solution, hypotheses and a technical systems' laws of evolution

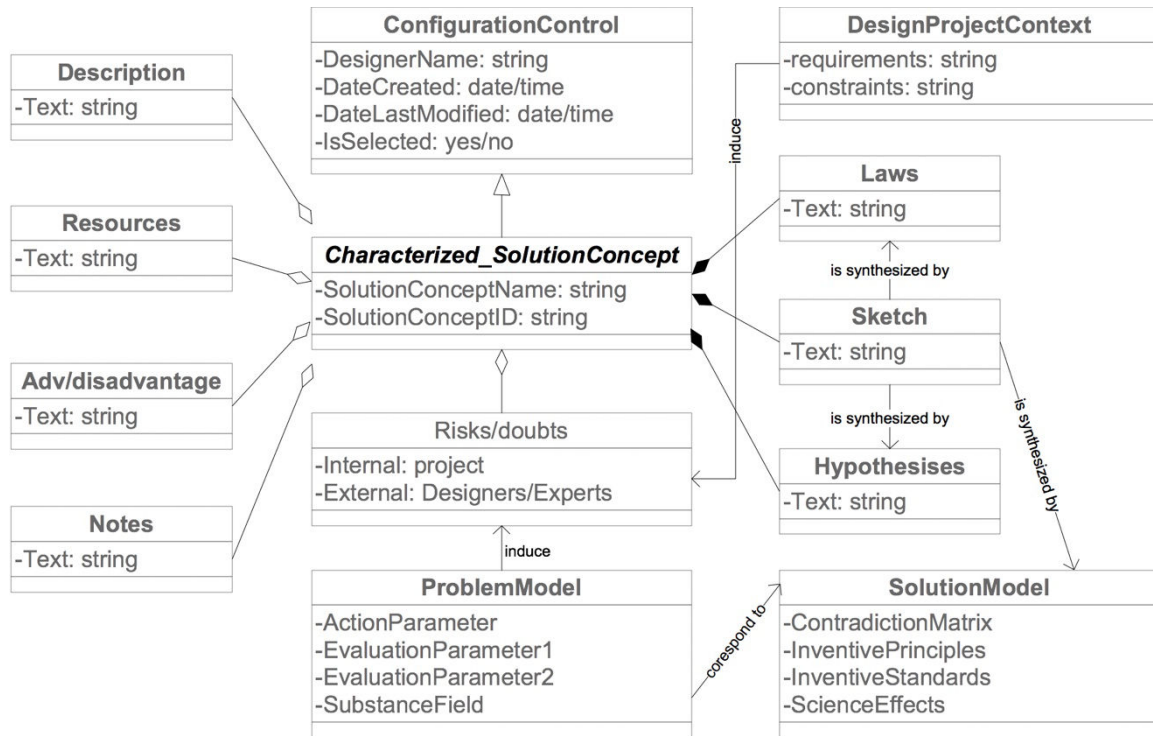

Fig. 2-15 A model to characterize the sources of model of problem: contradiction

The model for characterizing a Solution Concept is presented in Fig. 2-15. Conflicts among evaluation parameters should be eliminated after a Solution Concept has been interpreted. Nonetheless, a Problem Model often remains relevant to the Solution Concept and is a source of risks and doubts. Consequently, the existence of new uncertain conditions is often the main cause for abandoning Solution Concepts during the evaluation and selection process.

### **2.5.3 Evaluation and selection of Solution Concepts**

Pugh technique is applied to evaluate and select the most appropriate Solution Concepts by measuring the degree of adequacy between a problem model (Evaluation Parameter – Problems) and a Solution Concept. The evaluation techniques used in inventive design rely on a qualitative approach. The most effective technique to evaluate and select a Solution Concept for inventive design still lies in challenging the inventive design-research link.

## **2.6 From technical background and literature surveys to research needs**

The reflection on technical background and literature surveys regarding the research hypothesis and objective of this thesis are defined into two-folds:

- 1) Inventive Design Method was developed in order to serve the innovation front end phase. It grounded to the body of knowledge of TRIZ. According to the context of Solution Concept obtained from IDM as it is described by a sketch and text annotation with is represented as a high degree of variety, and novelty. Moreover, it is difficult to evaluate its quality (feasibility) via a simple qualitative approach (idea screening, simple feasibility evaluation). Ultimately, with time restriction in the design cycle, Solution Concept is instantly abandoned in the early decision stage. This can limit the performance of the inventive design. Here, an effectively and efficiently concept selection framework for IDM framework is needed.
- 2) As TRIZ is a problem-oriented approach, the extended problem space during the initial analysis phase can help in identifying the core problem and giving the positive result in design. Moreover, the application of



Multidisciplinary Design Analysis and Optimization (MDAO) framework has been widely used and shown many positive potentials in engineering design. The integration used of these methods and tools may give an another perspective in inventive design.

Further details of each reflection will be given in the beginning of each contribution. Chapter 3-5 are parts of the first reflection, and Chapter 6 is related to the second.

# Chapter 3

## Early Technical Feasibility Evaluation of a Solution Concept in IDM

*“If we worked on the assumption that what is accepted as true really is true, then there would be little hope for advance”*

— Orville Wright

This Chapter presents an approach to handle the immediate reaction of decision-makers. The problem statement is described in Section 3.1. In Section 3.2, the Screening, Modeling, and Exploring: SME approach is introduced, the development of support tool is followed. The revised version of SME has been proposed to address the Pareto-based selection for a set of Solution Concepts in section 3.4. Finally, this chapter closes with the discussion about limits and opportunity in this research area.

### Inventive Design Method

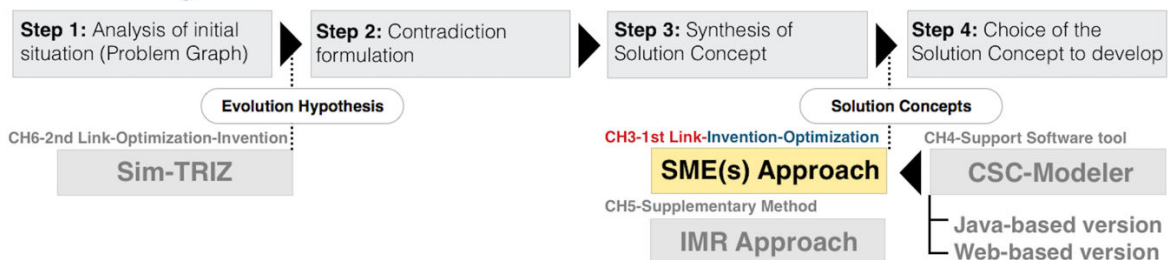

### 3.1 Reflection on technical background - literature surveys: #1

Recall Inventive Design Method in Section 2.5, early evaluation stages (Step 4 of IDM) usually comprise informal meetings held by expert personnel. This stage generally

involves producing instinctive judgments based on experience and tends to lack accuracy [11]. When experts confront the novelty of Solution Concepts and time restrictions in the design cycle, an immediate reaction is to abandon Solution Concepts considered unfeasible or overly risky, since they are outside of the design project's primary focus. In such situations, more reasonable Solution Concepts are chosen. As a consequence, there is a high probability that in each R&D department many potentially better Solution Concepts are abandoned based solely on experts' intuition. Frequently, abandoned Solution Concepts show a higher potential of completing all design requirements if only they can be explored in detail. Unfortunately, studies of these Solution Concepts are undertaken only after several rejections of higher ranked Solution Concepts that have been selected.

Several authors [1,2,49,85] have suggested the use of rough calculations based on simplified assumptions to investigate the feasibility of design concepts. By relying on simple physical and empirical equations, an approximate evaluation of the behavior of the concepts being studied can be achieved. Unfortunately, depending on time constraints and limitations of knowledge requirements during the early design stage, this calculation is often made only after viable concepts have been selected. The need for this calculation aid and tool has been discussed in previous work [90] and still poses a challenge to the inventive design-research link.

The traditional evaluation and selection process in inventive design (refer to Section 2.5) do not take the evaluation of feasibility into account. As a consequence, relevant Solution Concepts have been abandoned prematurely on intuitive grounds, driven by the immediate reactions of decision-makers. Moreover, this hasty abandonment may be the result of having suggested an infeasible alternative as the “best” Solution Concept. The danger of such Solution Concepts being implemented without recognizing their infeasibility is that considerable costs or loss may be incurred.

Methods and tools for assessing Solution Concept feasibility through calculation are still largely absent in the inventive design process. The main obstacles arising when applying this calculation process are related to the development of analysis models, a process that is far from automated. The formulation of doubts and uncertain conditions into an analyzable form is a cognitive process that is not supported by software tools. Furthermore, the conventional representation for building analysis models is the use of mathematical equations, which cannot integrate the assumptions and rationale behind modeling decisions. These obstacles make up the knowledge gap of design-analysis in the early stage of design [126]. Fig. 3-1 depicted situations and research gaps for overall issues mentioned.

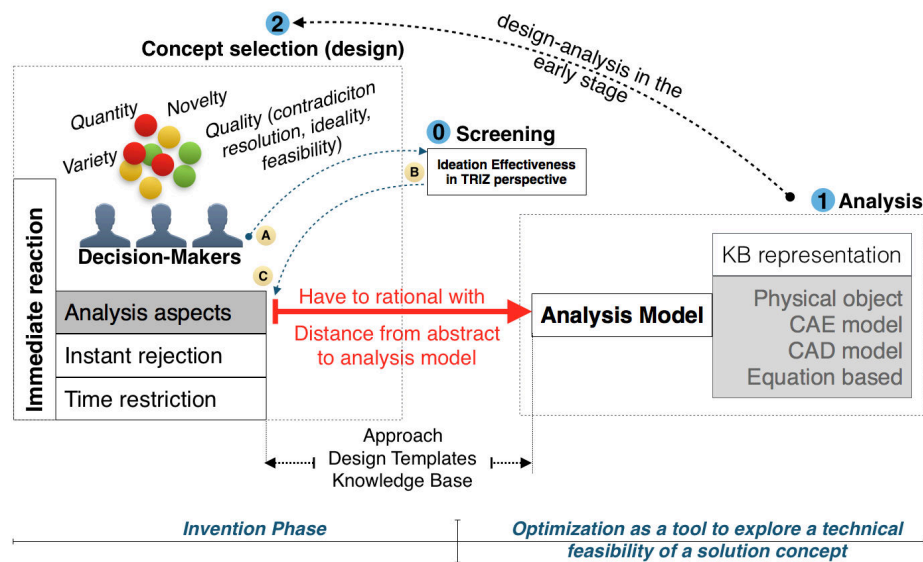

Fig. 3-1 Gap to be fulfilled in the early concept selection in IDM framework

In order to develop a more effective evaluation and selection technique for the IDM framework, we have integrated the traditional evaluation and selection technique of inventive design into the feasibility evaluation process. In this way, the Solution Concept has been considered for both ideality and feasibility. The method and tools for bridging the knowledge gap have been developed and our results in this area will be discussed further in the next section.

## 3.2 Development of the approach

The proposed approach has been intentionally used as a decision-making aid and tool. It aims to assist the designer in augmenting confidence in the Solution Concept by providing a rapid estimate and/or exploring the feasibility of a tested Solution Concept. In this way, a designer acquires a certain degree of justification in bypassing expert intuition and the evaluation and selection process can be implemented with accuracy. We base our proposed approach on the following:

- 1) Doubts or uncertain conditions could arise from the context of a Solution Concept itself and/or from immediate reactions of a designer or an expert, which are directly related to confidence in the Solution Concept.
- 2) Confidence in a Solution Concept is indicated by how much feasibility can be achieved within a specific context. In the conceptual stage, this feasibility is determined by a simple analysis task and it may be represented in terms of approximate dimensions, configuration, failed mode, material properties or behavior.
- 3) A simple analysis task can be performed while doubts and uncertain conditions evolve to the point that a parametric model can represent one or more aspects of its performance.
- 4) The performance model in 3) is related to an existing behavior model. This is a physics-based model with mathematical expressions and equations, derived from basic engineering and physics principles. Designers have access to these behavior model sources.
- 5) The analysis model in this thesis is composed of one or more behavior models. This analysis model is developed by means of design space exploration. It is accompanied by a symbolic calculator for obtaining a rough estimate of design constraints or determining which optimization

technique to explore within the area of feasibility delimited by design objectives and constraints.

Fig. 3-1 depicts the main approach; whose intent is to increase the confidence of a Solution Concept. It consists of three parts:

- 1) Screening
- 2) Modeling
- 3) Exploring

**3.2.1** Each step is achieved with the assistance of support templates (Formulation and Knowledge/Information layer). The details of each major step are described below:**Screening**

The proposed approach starts by considering the effectiveness of a Solution Concept from the perspective of TRIZ, with subsequent help designers in summarizing any doubts or uncertain conditions from the designer/expert or design project viewpoint.

**Step S1 Measure effectiveness of the ideation process:** A designer identifies the effectiveness of the ideation process with regard to:

- 1) Resolution of contradictions including the relevance of evaluation parameters and an action parameter for the Solution Concept.
- 2) Ideality by considering any harmful or useful features retained or present in the Solution Concept.

**Step S2 Summarize doubts and uncertain conditions:** Designers identify critical parameters (refer to Ullman [2] regarding immediate reaction and six metrics for measuring technological maturities, such as dimensions, configuration, material properties, or other behavior) for each Solution Concept by comparing them with project design requirements, limitations, or designer/decision-maker preferences. After

screening and capturing doubts and uncertain conditions, the Solution Concept will be classified into three types:

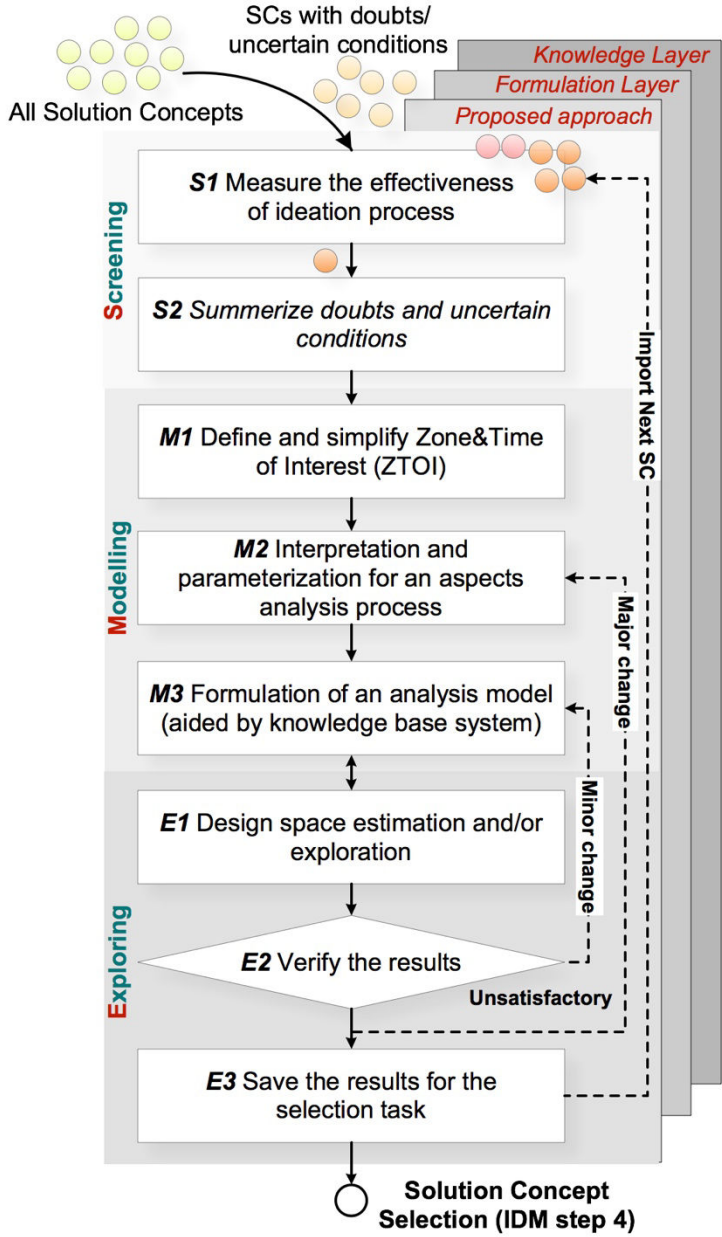

Fig. 3-2. Approach for increasing confidence of a Solution Concept within an IDM framework

- 1) *Refinement*: The Solution Concept does not eliminate contradiction and there are many harmful features present in the Solution Concept. This type of Solution Concept needs to be refined if there is any benefit.

- 2) *Conditional and Worth Consideration:* The Solution Concept is lacking certain information, such as dimensions or configuration, which induce doubts regarding its validity. Designers specify interesting aspects of each Solution Concept of this type and consider them further in the next step.
- 3) *Adopt different techniques:* The Solution Concept is represented in a complex or large system, requiring extensive interaction among its features (multi-physics body), a large number of critical parameters affecting several features and the need to address many analysis domains. This type of Solution Concept is not suitable for the proposed approach and support tool described in this thesis. Designers should use other techniques and tools to evaluate its feasibility.

### 3.2.2 Modeling

With the Conditional and Worth Consideration Solution Concept type, designers incorporate information from the screening task and formulate or update an executable analysis model assisted by the knowledge and information support system.

**Step M1 Define and simplify Zone & Time of Interest (ZTOI):** Designers transform doubts and uncertain conditions captured in the screening step into a list of interest aspects that includes parameters, variables, objectives, and constraints, depending on critical parameters.

**Step M2 Interpretation and parameterization for an Aspects Analysis process:** Designers specify a list of interest aspects for analysis, to include variables, parameters, objectives and constraints, depending on descriptive names, limits, values, units, etc. This step is classified into two scenarios:

- 1) If the information has evolved into some form of a performance model, a list of interest aspects can be used as a keyword list to search for specific



behavior models or physics and engineering principles from the knowledge base. A designer selects the most suitable model that describes the interest aspect, then associates a list of interest aspects for analysis with the selected model and proceeds to step **M3**.

- 2) Information is still lacking or a designer is not familiar with the Aspects Analysis process. With the specified ZTOI in step **M1**, designers can identify and detail the phenomena that govern ZTOI based on the flow of energy. They then summarize the information from selected phenomena to specify the list of interest aspects or search for specific behavioral models. Each phenomenon is associated with a specific disciplinary analysis domain, with each domain featuring its own attributes. The characterized ZTOI model and associated phenomena are detailed in Section 3.3. Designers then take up scenario 1).

**Step M3 Formulation of an analysis model:** Designers reuse or modify the model to formulate or update aspects of interest into an executable analysis model aided by the model selected in step **M2**. Another information is also obtained from the knowledge base. In contrast to step **M2**, a new analysis model will be formed with the assistance of the knowledge-based system when designers do not find any existing relevant model. In this modeling step, two directions can be taken to estimate and/or explore the feasibility of a Solution Concept that is being tested:

- 1) *Estimate:* Formulate or update analysis aspects into an equation-based system problem and define initial values needed for performing the calculation.
- 2) *Explore:* Formulate or update analysis aspects into an optimization problem. The role of optimization in this thesis is to explore the feasible design space and not necessarily to find the optimized solution.

After fulfill the requirements of analysis model, designer completes the process by generating an executable analysis model and proceed to the Exploring step.

### **3.2.3 Exploring**

In this part, designers estimate and/or explore the design space using the tools determined in the analysis.

**Step E1 Design space estimation and/or exploration:** Designers explore the design space of an executable analysis model from step M3 by using a symbolic calculator or an optimization framework, depending on the analysis direction taken in step M3.

**Step E2 Verify the results:** If results are unsatisfactory, designers should return to step M3 and adjust conditions by making minor changes, then update the executable analysis model. Designers then repeat Step E1. If results are satisfactory, designers proceed to step E3. Nevertheless, if results are still unsatisfactory after several attempts involving major changes, the tested Solution Concept will be considered unfeasible within this defined context and should be saved into the knowledge base alongside valid Solution Concepts in step E3.

**Step E3 Save the results:** Tested case results are saved in the knowledge database. These cases are utilized for the evaluation and selection task and may be consulted in subsequent design projects.

This approach is resumed with the next “Conditional and Worth Consideration” Solution Concept to be tested. After all Solution Concepts have been tested, the evaluation and selection process based on IDM (Step 4) will be implemented, as mentioned in Section 2.3. Ultimately, the most appropriate Solution Concepts will be selected and further developed in the next design process.

In order to make the method proposed applicable in the real conceptual design processes the overall steps have to be completed within a very short time cycle, be open to multidisciplinary aspect analysis and carried out systematically. In the screening and modeling step, we developed formulation and knowledge support templates to facilitate and speed up our proposed approach and we fashioned them into a software support tool. The interaction of these templates, their model for characterizing knowledge models are described in the next section.

### **3.3 Development of the support tool**

In this section, we will proceed with a general discussion of the generic model for templates and the characterized knowledge models which are used to support the Screening and Modeling step of the approach described in Section 3.2.

#### **3.3.1 Template development: Formulation layer**

The major difficulty in performing analyzes during the conceptual stage arises from a lack of information and explicit knowledge in the formulation of an analysis model. The information requirements necessary to handle this difficulty, including a set of questions, support knowledge, and information were developed in the form of templates. These templates aim to facilitate the transition from an abstract to a parametric level of doubts or uncertain conditions surrounding a Solution Concept. In this way, an analysis model can be formulated or updated as an optimization problem or as a simple equation-based system problem. The ultimate objective is to generate an executable analysis model. Fig. 3-3 summarizes the approach proposed in Section 3.2, with the **S**creening, **M**odeling and **E**xploring steps mapped into the usage scenario of developed templates and support knowledge models.

As shown in Fig. 3-3, the overall framework is divided into a Formulation and Knowledge/Information layer. A formulation layer provides the templates with a set of questions and tools to assist designers in encapsulating and incorporating information necessary to formulate an executable analysis model. The knowledge and information layer provide specific data that are very helpful during the modeling task. The relationship between its layers is designed to facilitate the searching and retrieving process. In this way, suitable behavioral models have been found with a few keywords.

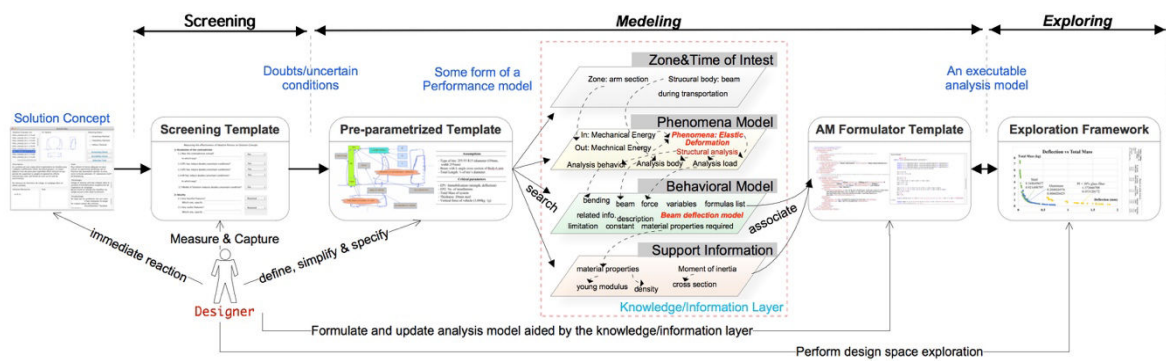

Fig. 3-3. Usage scenario of developed templates and knowledge models

Each type of template and the characteristics of each knowledge model are described in detail below:

### 3.3.1.1 Screening template

A set of questions in this screening template help designers to measure the effectiveness of a Solution Concept from the perspective of TRIZ and to capture doubts and uncertain conditions relating to the immediate reaction of a designer or an expert to a Solution Concept. These concepts are defined in terms of critical parameters that are related to a type of feasibility problem. The generic model of the screening template is presented in Table 3-1.

After this template was instructed, Solution Concept will be classified into three types, as follows:

- 1) Refinement
- 2) Conditional and worth consideration
- 3) Adopt other techniques.

The details of each type are presented in the screening step of Section 3.2.

Table 3-1 Screening Template model

<b>Effectiveness of Ideation Process on a Solution Concept</b>		
1) Resolution of the contradiction	Was the contradiction resolved? In which way?	
2) Ideality	Any harmful features: (Retained?/Present?) Any useful features: (Retained?/Present?)	
<b>Identification of interest aspects</b>		
1) Are the critical parameters identified? (relate to a type of interest aspect)	Type of feasibility problem (Design - Analysis)	Dimensioning? Configuration? Failed mode? Material properties? Behavior?
2) Are safe operating latitudes and sensitivity of parameters known?	Range of critical parameter (variables, parameters)?	
3) Have failure modes been identified?	During normal operation? When failure occurs in operation?	
<b>Effectiveness &amp; Immediate reaction</b>	<input type="checkbox"/> Refinement <input type="checkbox"/> Conditional and worth consideration <input type="checkbox"/> Adopt other techniques	

### 3.3.1.2 Pre-parameterized template

The pre-parameterized template presented in Table 3-2 is designed to support the modeling step. This template is used to capture the rough performance model of the analysis aspects based on the identified list of interests, some of which however come from the screening template. Should certain information needed to identify the list of interest aspects be lacking, we use the method for characterizing phenomena of a defined zone of interest based on the flow of energy. Each phenomenon provides disciplinary analysis domains. Each domain features its own information attributes, which assist designers in integrating the context of individual analysis aspects into the list of interests. This list will be made up as keywords to search for suitable behavioral

models, which will then be used to formulate or update an analysis model in the Analysis Model Formulation template.

Table 3-2 Pre – parameterized Template Model

<b>Simplify &amp; Identify the analysis aspect and capture information from the Meta-Knowledge</b>							
<b>Zone Of Interest</b>		<b>Phenomena Governed</b>		<b>Design/Analysis Discipline</b>		<b>List Of Interests</b>	
Object (Entity)	Principle	Flow of Energy	Input	Domain	Attribute 1	Descriptive Name of	Variables
			Output		Attribute 2		Parameters
				Attribute 3	Objectives		
				Attribute n	Constraints		
<b>Specify additional information if known (relate information to design project requirements, limitations and preferences)</b>							
<b>Variables</b>		<b>Parameters</b>		<b>Objectives</b>		<b>Constraints</b>	
Limits	Units	Value	Units	Units	Direction	Value	Type

Specified information involving limits, values, and units in the list of interest aspects is one of the requirements to be defined. This specified information may be used as a keyword (units) to search for the suitable behavioral model. Moreover, it will be used to measure the validity of a problem analysis in terms of objectives and constraints.

### 3.3.1.3 Template for the analysis model

Depending on knowledge and information obtained from previous templates, the suitable behavioral models or physics, and engineering principles will be listed and selected. Any missing information such as objective functions or auxiliary functions will be provided by selected models and support information. The model used to formulate an Analysis Model Template is presented in Table 3-3.

An executable analysis model that is an output of this template will be automatically integrated into the tracking information file. Designers then generate an executable analysis model and carry out design space exploration as described in the exploration

step of our proposed approach. In this work, MOEA Framework<sup>13</sup> will be used as the optimization framework and JASYMCA<sup>14</sup> as the symbolic calculation framework. It should be noted that the type or format of an executable analysis model is limited by the calculation framework used.

Table 3-3 Analysis Model Template

<b>Explore: Formulate or update an analysis model as an optimization problem mapped from behavioral models and support information.</b>	
□ MOEA: JAVA Programming syntax. <pre> Problem_Class{     problem_name();     evaluate(vars, params, objs, const);     solution(variable_bound); }; Main_Class{     Executor(problem, algorithm, evaluation); }; </pre>	System Variable of Interest ( $i = 1, 2, 3, \dots, n$ ) $\{Var_i \ Var_i\_Name \ Var_i\_UB \ Var_i\_LB \ Var_i\_Unit\}$ Parameter List ( $i = 1, 2, 3, \dots, m$ ) $\{Par_i \ Par_i\_Name \ Par_i\_val \ Var_i\_Unit\}$ Auxiliary Function ( $i = 1, 2, 3, \dots, p$ ) $\{Aux_i \ Aux_i\_Name \ Aux_i\_Func \ Aux_i\_Unit\}$ Objective Function & Direction ( $i = 1, 2, 3, \dots, q$ ) $\{Obj_i \ Obj_i\_Name \ Obj_i\_Func \ Obj_i\_Unit \ Obj_i\_Dir\}$ Constraints & Limits ( $i = 1, 2, 3, \dots, r$ ) $\{Con_i \ Con_i\_Name \ Con_i\_val \ Con_i\_Unit \ Con_i\_Type\}$
<b>Test: Equation-based system generalizes from selected behavioral models and support information.</b>	
□ JASYMCA: Symbolic Calculator	Parameter List ( $i = 1, 2, 3, \dots, m$ ) $\{Par_i \ Par_i\_Name \ Par_i\_val \ Var_i\_Unit\}$ Auxiliary Function ( $i = 1, 2, 3, \dots, p$ ) $\{Aux_i \ Aux_i\_Name \ Aux_i\_Func \ Aux_i\_Unit\}$ Objective Function ( $i = 1, 2, 3, \dots, q$ ) $\{Obj_i \ Obj_i\_Name \ Obj_i\_Func \ Obj_i\_Unit\}$

### 3.3.2 Template development: Knowledge/Information layer

#### 3.3.2.1 Zone & Time of Interest model (pre-parameterized template support and modeling step)

<sup>13</sup> The MOEA Framework is a free and open source Java library for developing and experimenting with multi-objective evolutionary algorithms (MOEAs) and other general-purpose multi-objective optimization algorithms. <http://moeaframework.org>

<sup>14</sup> JasyMca is an interactive System for solving math problems. <http://webuser.hs-furtwangen.de/~dersch/jasymca2/indexEN.html>

The model for characterizing Zone & Time of Interest is presented in Fig. 3-3. This model assists designers in identifying the zone of interest in specific operational time, which is related to the doubts and uncertain conditions captured from the screening template.

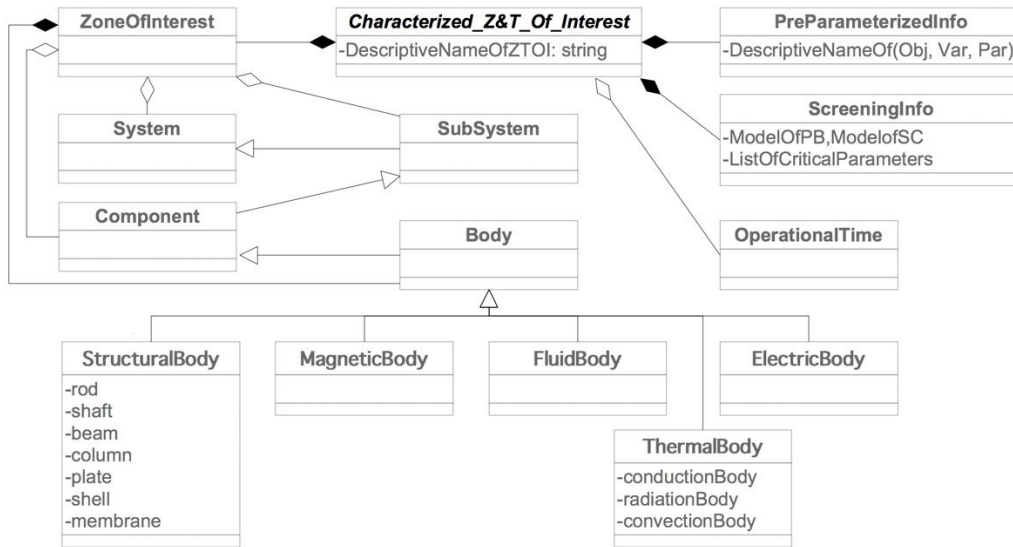

Fig. 3-4 Model for characterizing Zone & Time of Interest.

The zone is represented with respect to the hierarchical order of a technical system. A distinct zone may combine with multiple zones while each zone represents an analysis domain from different disciplines.

The zone of interest is demonstrated in this thesis as a body, in accordance with the assumptions inherent to the proposed approach and support tools used.

### 3.3.2.2 Phenomena model: Meta-KB Template (pre-parameterized template support and modeling step)

Fig. 3-5 shows the model for characterizing phenomena. It represents the phenomena derived from defining energy flows through the ZTOI (Analysis\_Body). For each phenomenon, related disciplinary analysis domains are included. Designers may use its attributes (i.e. Analysis\_Load, Analysis\_Behavior) to make up keywords for use



in searching for suitable behavior models and for use in formulating the template for the Analysis Model. The features of this model are visualized in the Meta-KB Template.

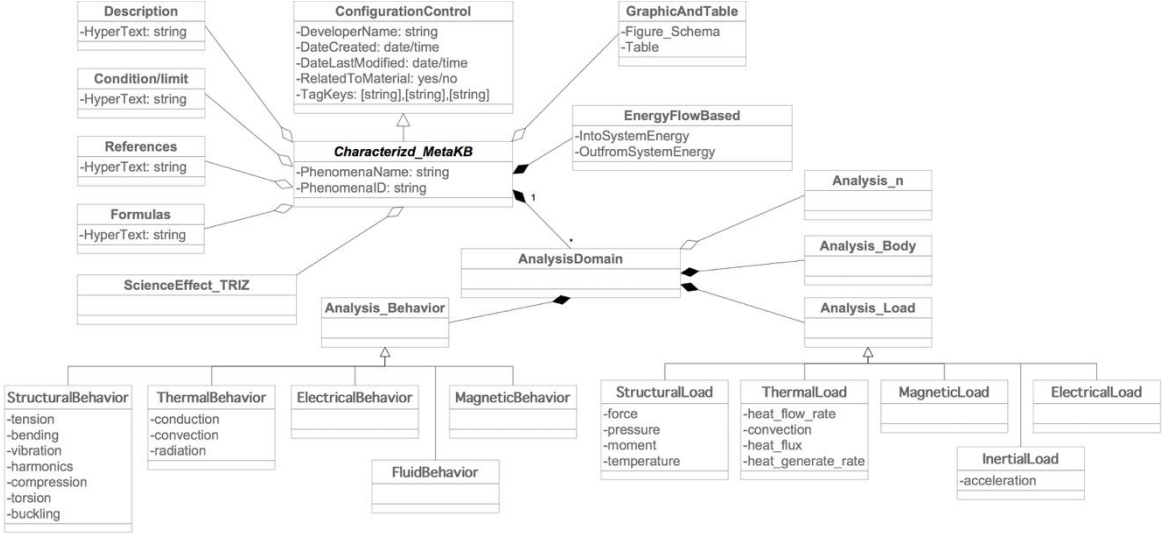

Fig. 3-5 Model for characterizing phenomena (Meta-KB)

**3.3.2.3 Behavioral model: BH-Model Template (AM formulator template support and modeling step)**

KIEF [127] is an example of existing knowledge-based systems that provide the physics-based analytical model and are very useful for the concept generation phase but tend not to be used for analysis. In addition, within the given set [128,129], they were developed to support the analysis task but focus on the level of mechanism, component, and product aspects that work with high granularity tools in the embodiment and detailed stage. None of them offer support in feasibility evaluation at the conceptual stage.

In this work, the behavior model is the model that captures the mathematical description of the physical behavior of a system. The model for characterizing behavior in Fig. 3-6 is intended to assist designers in formulating or updating an analysis model. It has been modified in accordance with [130]. The main features of this model are:

- 1) It provides the relevant knowledge and information to complete any required behavior of an analysis model, such as an objective function, an auxiliary function, etc.
- 2) It furnishes a set of executable analysis models for direct reuse in the exploration step, provided an analysis aspect match with all context and assumption data for a model. The existing executable analysis model in the BH-Model Template uses either Java programming syntax or symbolic equation-based (depending on the exploration framework used). The framework also can be used to integrate a related high fidelity analysis model such as CAD, CAE or CFD, with a solver for exploring its design space.

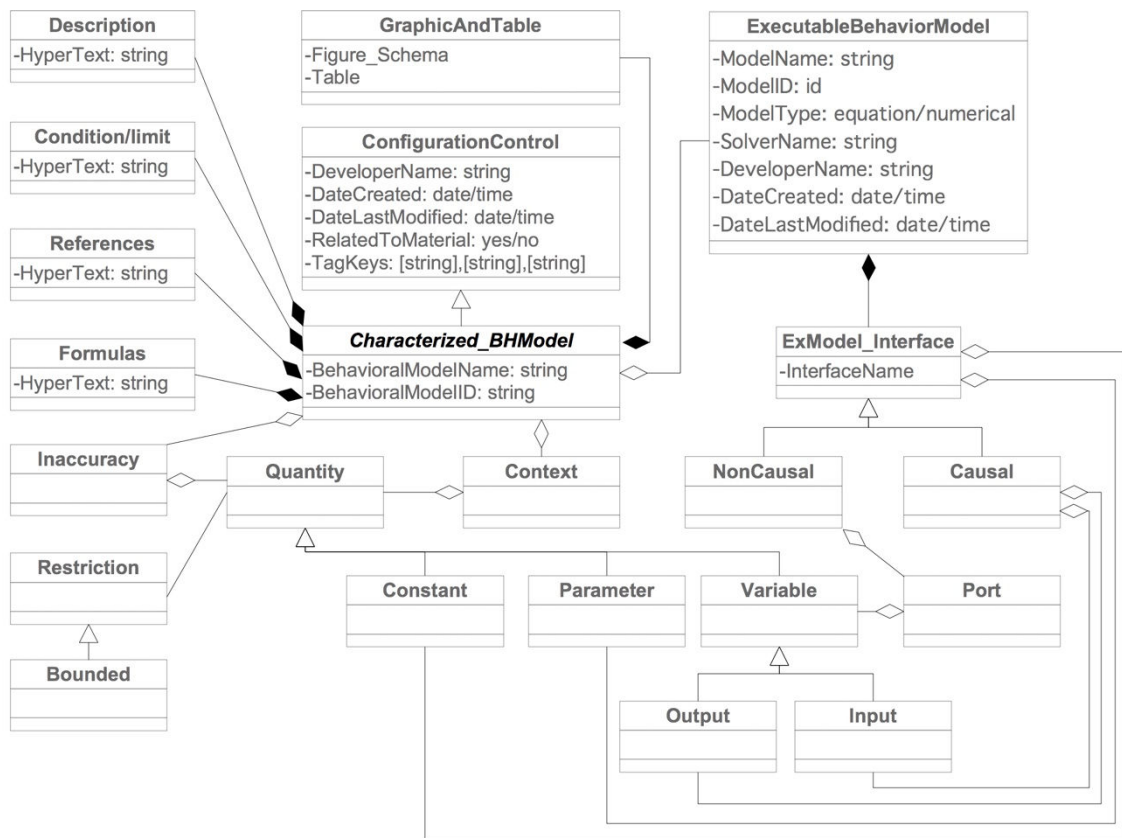

Fig. 3-6. Model for characterizing behavioral models

### 3.3.2.4 Information Template Support (AM template formulator support and modeling step)

The purpose of support information featured in the framework is to provide any useful information that can facilitate and speed up the modeling task. Fig. 3-7 shows a model for characterizing support information from the standpoint of a class of material behavior. Type of information such as lists of existing artifacts, mechanism, mathematical function, etc. will be represented with this model in the Support Information Template.

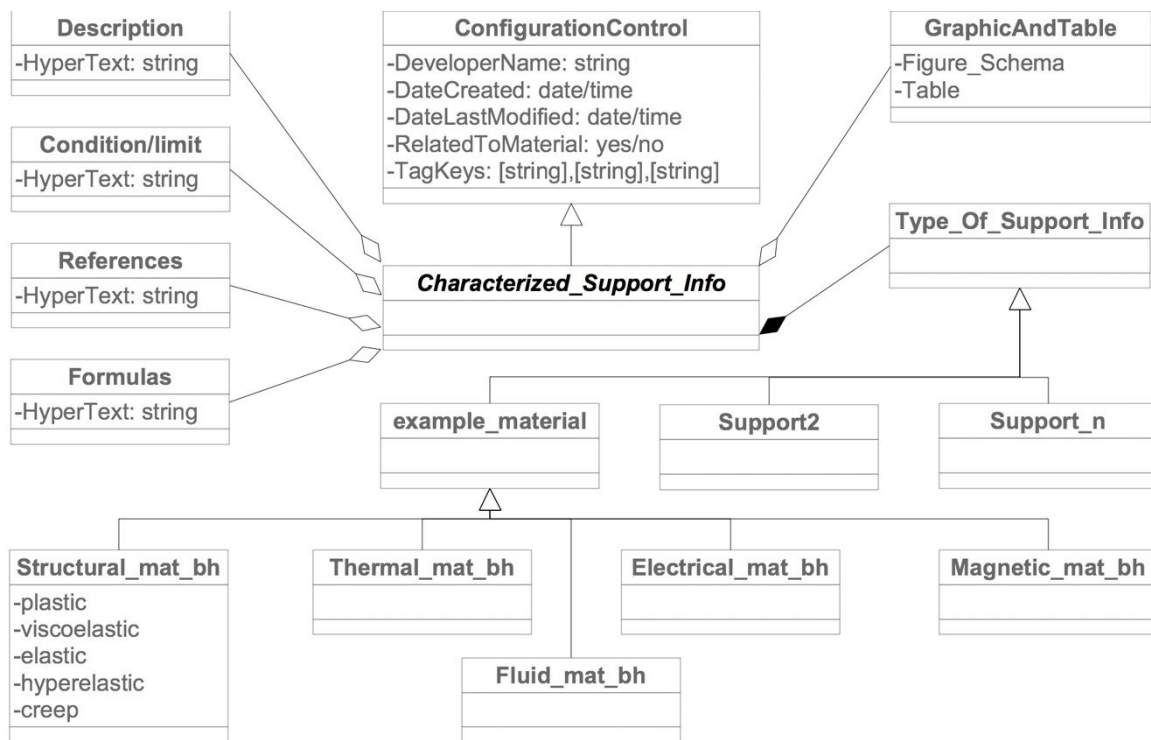

Fig. 3-7 Model for characterizing support information

The entire Knowledge/Information layer is designed to be interchangeable and adaptable with all formulation templates. Every characterized knowledge and information model features tagging keys located in the Configuration Control section to use as shortcuts in finding the relevant behavioral models or physics and engineering

principles. If a more related information is available, the support template provides a hypertext link to other models or information.

The briefly describe implementation of an ongoing software support tool, the Concrete Solution Concept Modeler (CSC-Modeler) for the SME approach is presented along with a case study in Chapter 4.

### **3.4 Revised version of SME approach**

Refer to our hypothesis, if doubts/uncertain conditions surround a Solution Concept are eliminated the selection task will be made effectively. Anyways, the selection methods used in Step 4 of IDM is based on the qualitative approach. The measurement of adequacy degree between a problem model (Evaluation Parameter – Problems) and a solution cannot trade-off the overall characteristics of a Solution Concept.

One of the advantages of exploration approaches with the aid of optimization techniques is the representation of results in a form of “Pareto front”. The application of Pareto front in the selection of design concepts has been mentioned in [50,131,132]. This method is reasonable between the evaluation criteria and actual performance of design concepts. However, from the context of design method based on TRIZ (also in IDM) a set of Solution Concepts is varied into difference knowledge domains. Moreover, the behavior and structure of them are diverse. As a result, the application of Pareto-based selection is not suitable for all cases.

In order to provide an effective approach to evaluate and select Solution Concepts. The possible way to apply Pareto-based selection in the IDM framework has been developed. Fig.3-8 describes the method proposed graphically. Details of each major step are described below:

**Step 1 Solution Concept Screening & Grouping:** Identifying the effectiveness of a solution concept with regard to the contradiction resolution, ideality and a list of critical parameters (e.g. dimension, configuration, material properties, or other behavior) of each solution concept. Then designer specify the Solution Concept into three categories as mentioned in section 3.2.1. The overall previous steps are resumed to all Solution Concepts.

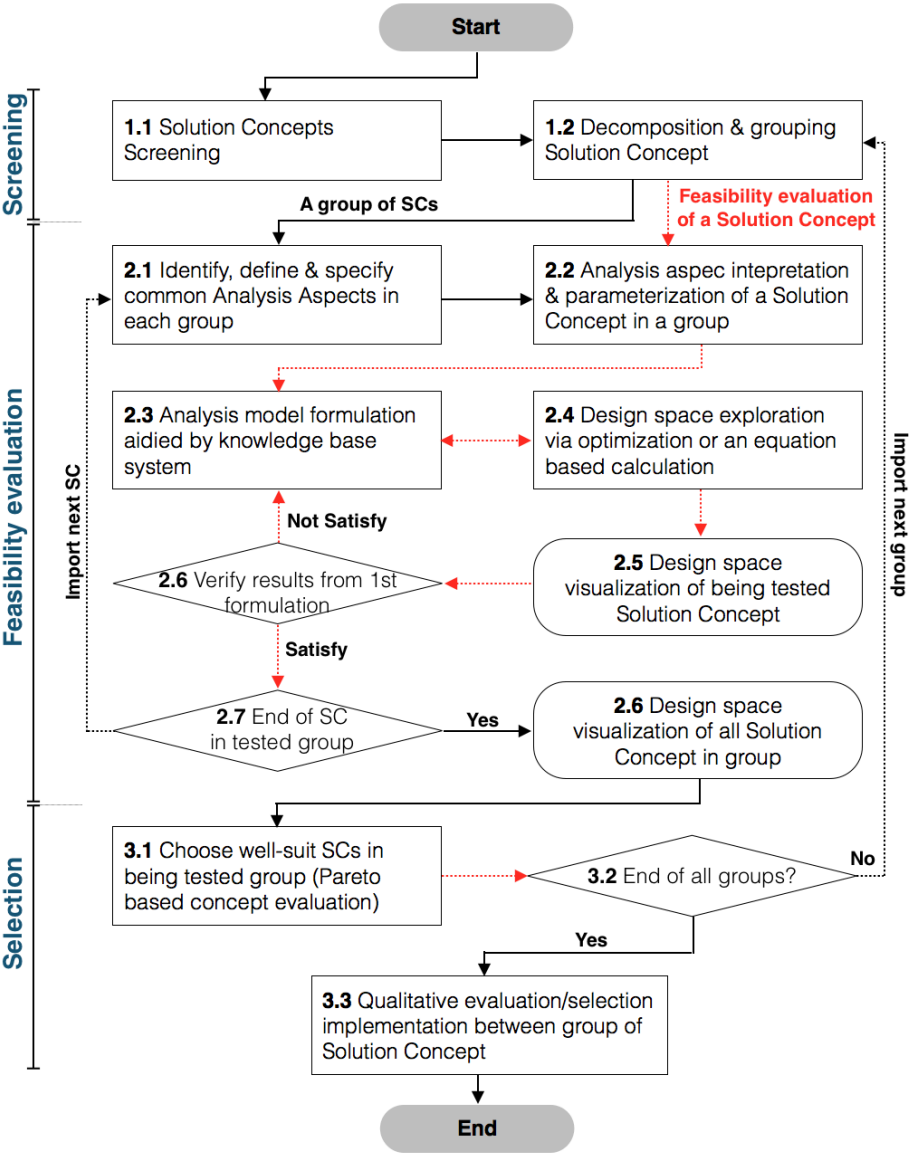

Fig. 3-8 Pareto based selection of Solution Concept (Revised SME(s) approach)

With the aid of FBS model [26,27,133], Solution Concept can be distinguished into several groups according to the similarity of FBS. In each group, designer specifies the common evaluation criteria and then transform these criteria into optimization problem (e.g. minimized deflection vs minimize total weight). Next, the feasibility of Solution Concepts in each group will be evaluated.

**Step 2 Feasibility Evaluation:** As in each group of Solution Concept, the common evaluation criteria is specified and transformed into an optimization problem. Designer formulates an analysis model of each Solution Concept then perform the exploration via optimization strategies. Then the visualization and verification of results will be made, any minor or major modification on analysis model is performed to ensure the feasibility of Solution Concept. These steps are resumed to all Solution Concept in the group. Then the selection will be implemented in the next step.

**Step 3 Selection:** In each group, designer visualizes the results (Pareto-front) of Solution Concepts, then select the most appropriate Solution Concepts for developing in the next design process.

Pareto-front based selection can be used only to evaluate and select the Solution Concept that have common criteria. The simple qualitative evaluation techniques (i.e. decision matrices, Pugh) will be used in selection task while there are several groups of Solution Concept.

The revised SME approach herein is named as SME(s) approach. It aims to narrow down the uncertainty in concept selection. The accuracy of selection will increase if one can avoid the unfeasible Solution Concept during decision-making. However, SME(s) approach can be applied only while the common criteria exist, importantly, its feasibility characteristics have to rational to one or more analysis models. In

addition, time span to perform exploration for all Solution Concept is one of the issues to consider.

### **3.5 Discussion on SME approach**

Throughout this chapter, we have proposed an approach and set of tools intended for supporting decision-making processes. The approach's purpose is to assist designers in increasing the confidence of Solution Concepts by providing rapid estimates and/or exploring the feasibility of a Solution Concept in testing. As part of this chapter, the systematical steps of Screening, Modeling and Exploring were integrated into support templates. These templates have bridged the knowledge and information gap within the design and analysis process.

It is true that where doubts and uncertain conditions demonstrate an easy-to-estimate physical situation, expert intuition will be both faster than our approach and at least as correct. On the other hand, if doubts and uncertain conditions of Solution Concepts in testing present a performance model in a highly complex context or multi-physics body system, such as the behavior of the adhesive mechanism of gecko feet, the design of experiment (DOE) or multidisciplinary design optimization (MDO) techniques can be used to evaluate and explore the feasibility of problem.

In the viewpoint of time span, it still takes time while modeling concepts in a group into the analytical form. Moreover, if there are more than one disciplinary analyzes required, time will be used more than expect and the final results depend on the accuracy of formulated analysis models. In addition, for SME(s) approach, if groups of Solution Concepts don't have any common objectives and/or constraints to be comparing, the qualitative approaches will be implemented for the final Solution Concept selection.

# Chapter 4

## Development of the software prototype: CSC-Modeler

*“Software is a great combination between artistry and engineering”*

— Bill Gates

In Chapter 3, SME(s) approach provides a rapid estimating and/or exploring the feasibility of a being tested Solution Concept. The support tool developed in Chapter 3 is fashioned into a software framework namely *Concrete Solution Concept Modeler: CSC-Modeler*. This prototype will be presented in this chapter. A wheel car blocking system is used as a case study to demonstrate the viability of proposed approach and CSC-Modeler. This Chapter ends with a discussion of limitations and perspective on research and development in this area.

### Inventive Design Method

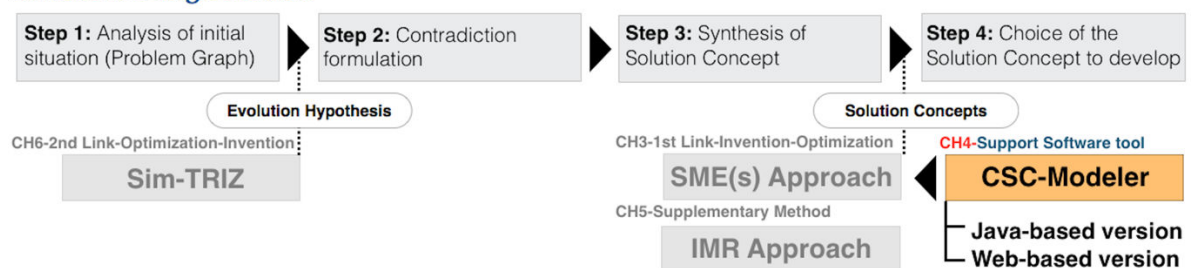

### 4.1 Reflection on technical background - literature surveys: #2

As mentioned in Chapter 3, the context of Solution Concepts is represented by a sketch and text annotation. Also, variety, novelty are criteria that usually arouse



decision-makers to instantly reject them during concept selection phase. Feasibility evaluation has been generally made by the qualitative approaches (based on decision-maker expertise) which not reveal the actual performance of the Solution Concept. Importantly, the time frame that decision-makers have, it is a little tight to perform any decision according to the time restriction in the design cycle. In addition to these issues, the commercial support software to evaluate the feasibility of a Solution Concept in this early stage is still lacking.

The SME(s) approach in Chapter 3 consists of several sub-steps. Specifically, in Screening and Modeling steps. According to that, time to perform overall steps is increasing and depending on the number of analysis aspects. The evolving of information while conducting the SME(s) approach is presented in Fig. 4-1.

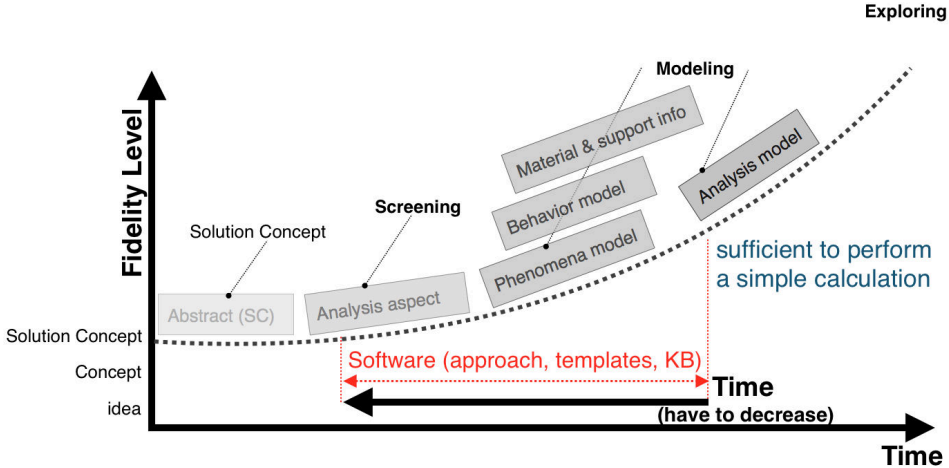

Fig. 4-1 Time span used to construct an analysis model in SME(s) approach

In order to decrease the overall time span during Screening and Modeling steps. The templates and knowledge base models in Chapter 3 are featured into a software prototype, namely *Concrete Solution Concept Modeler: CSC-Modeler*. Not only decrease time span, but the accuracy of the result is one of the issues to be ensured. The system framework design and implementation of CSC-Modeler are described in the following sections.

## 4.2 System framework design

The system framework of CSC-Modeler presented in Fig. 4-2 was designed according to generic templates and characterized knowledge models in Chapter 3. The system framework comprises main two parts:

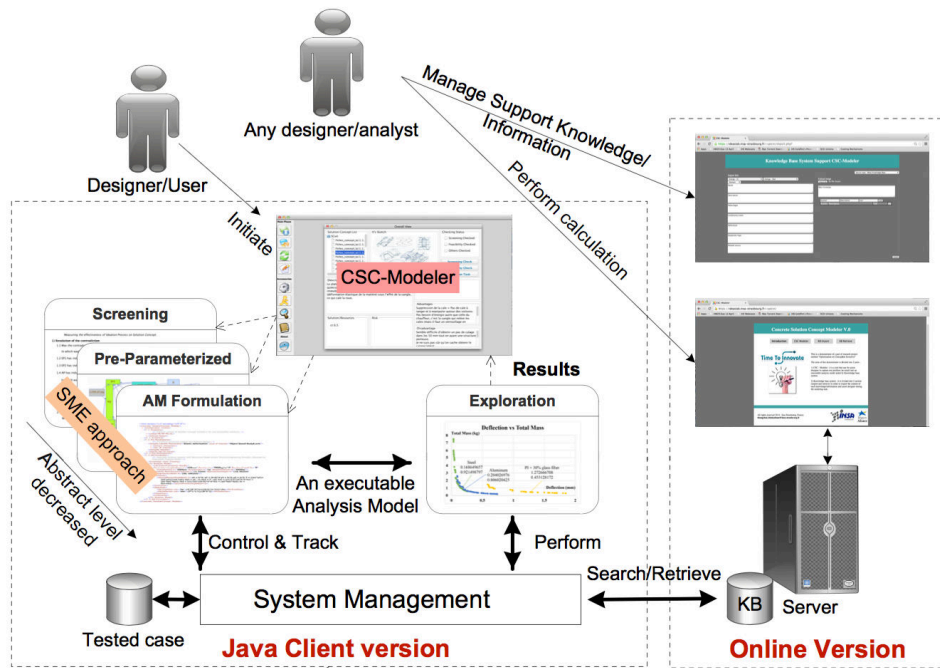

Fig. 4-2 Framework of Concrete Solution Concept Modeler (CSC-Modeler)

- 1) A *Java client side*, consisting in two main layers. The first layer is a graphic user interface (GUI) that designers can interact with. In each major step, the GUI visualizes specific Formulation Template possibilities and relevant Knowledge Templates. The second layer is a management system that communicates with the database, controls the sequence of templates and handles the basic functions of the information system. In all steps, information is systematically tracked with following objectives:
  - a) To ensure flexibility in order to be able to modify analysis models for any major or minor change before generating an executable model (in SME approach).

- b) To be retained as a reference in subsequent project design.
- 2) *A server side*, which consists of two main features:
- a) A reduced version of the CSC-Modeler, which features open access but does not provide an exploration framework via an optimization technique.
  - b) A system to manage the Knowledge/Information layer. With this feature, new knowledge and information can be imported or updated from partners with expertise in varying disciplines. In this way, we can expand the scale of support knowledge and information to include a wider analysis domain of disciplines.

### **4.3 Flowchart for conducting the CSC-Modeler**

The overall flowchart of SME(s) approach is presented in Fig. 4-3. There are two options, the first one is a full flow path (Red line) that includes the revised version of SME(s) approach mentioned in section 3.4. In this path, The Pareto-based selection will be used to select the most suitable Solution Concepts. Secondly, the minimal flow path (Green line), that is used in order to estimate the early technical feasibility of a Solution Concept even an idea or concept from other design methods. In this minimal flow path, it is not limited only the Solution Concept obtained from IDM framework.

The evolving of information in each step is traced. This evolving includes the viewpoint of decision-maker about doubts/uncertain conditions surrounding the Solution Concept and the relevant knowledge used to formulate the analysis model.

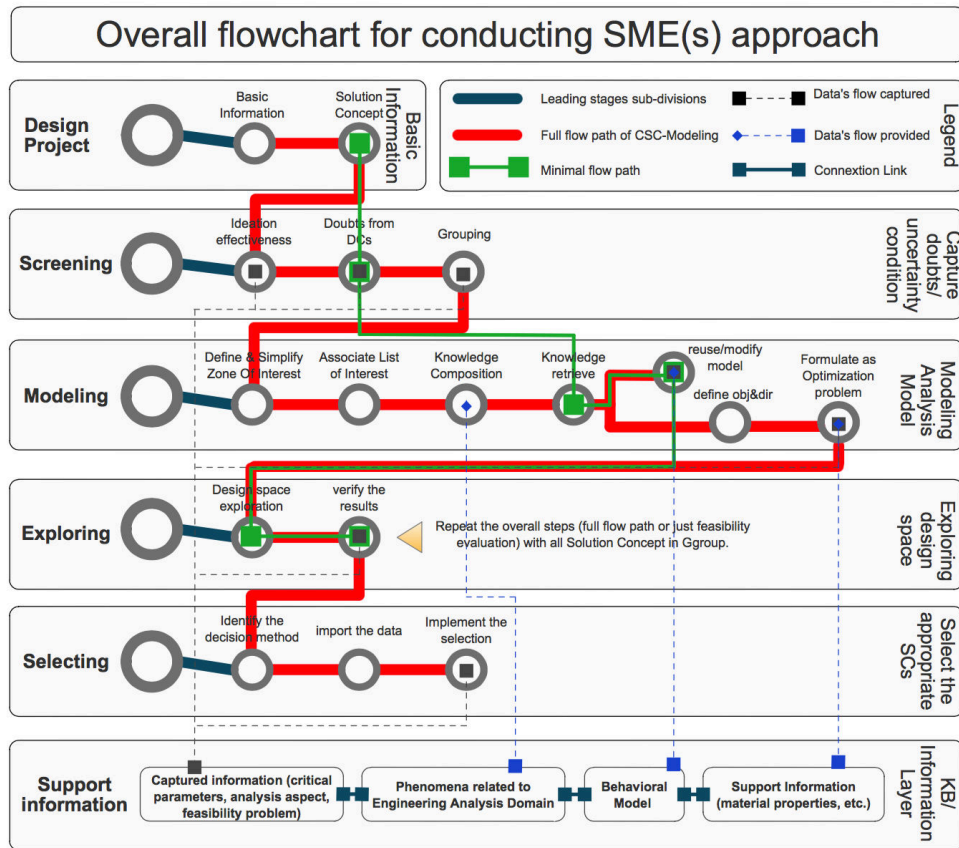

Fig. 4-3 The overall flowchart for conducting SME(s) approach

#### 4.4 System framework implementation

The CSC-Modeler system framework designed in the previous section is implemented with a platform-independent JAVA programming language for the client version and PHP for the online version. The specifications of our system are as follows.

- 1) Specifications from the user point of view:
  - a) A graphic user interface for human-machine interaction built by object-oriented programming and agent technologies.
  - b) Templates are rational in each step, logically and systematically.
- 2) Technological specifications:
  - a) Files system is interchangeable with XML, HTML, Excel and a (Java) programming syntax format.

- b) The Rational Database is a natural language, a multi-constraint search system that is represented in terms of textual description, graphically, and through tables, graphs and hypertext.
- c) Automatic generation of a specific and executable analysis model depends on the type of calculation framework (open- source not limited to commercial-off-the-shelf software).
- d) Results appear in multi-view (table and graph).

The main environment and tools for the implementation of CSC-Modeler are presented in Table. 4-1. As one of our final goals is to combine CSC-Modeler into the STEPS software tool. Consequently, all module (library) presented in this work is an open source license and developed with JAVA programming language.

In order to decrease time span from modeling an analysis aspect to an analyzable model, the knowledge base system is a key answer. There are many advancements in this area. Currently, knowledge base system tends to shift from SQL to No-SQL, for example, NeO4J<sup>15</sup>, Elasticsearch<sup>16</sup>, MongoDB<sup>17</sup>, and Cassandra<sup>18</sup>. From many comparisons, reviews and the compatibilities in combining with other modules (Table 4-1). In this thesis, Elasticsearch has been selected and used as a core knowledge base system.

Table 4-1 Environment and tools for the implementation of CSC-Modeler

<b>Name</b>	<b>Version</b>	<b>Description</b>
<b>Main environment</b>		
NetBeans IDE	8.0	NetBeans is an integrated development environment (IDE) for developing with Java. Key specifications: Java Development Kit (JDK 7.0) and GUI Builder to facilitate the interface design.

<sup>15</sup> <http://neo4j.com>

<sup>16</sup> <https://www.elastic.co>

<sup>17</sup> <https://www.mongodb.org>

<sup>18</sup> <http://cassandra.apache.org>

---

## Common modules

JAVA SE	1.7	Java Platform, Standard Edition, is a widely used platform for development and deployment of portable applications for desktop and server environments. It offers the rich user interface, performance, versatility, portability, and security.
JGraphX	3.4	JGraphX is a Java Swing diagramming library licensed under the BSD license. It provides functionality for visualization and interaction with node-edge graphs (not charts) and also includes functionality like XML stencils support, various import/export and layouting (automatically node/edge positioning).

---

## Knowledge base system

Elasticsearch	1.4.3	<p>Elasticsearch is an open-source search engine built on top of Apache Lucene™, a full-text search engine library. It can also be described as follows:</p> <ol style="list-style-type: none"><li>1) Distributed real-time document store where every field is indexed and searchable</li><li>2) Distributed search engine with real-time analytics</li><li>3) Capable of scaling to hundreds of servers and petabytes of structured and unstructured data</li></ol>
---------------	-------	---

---

## Exploration modules

MOEA	2.6	The MOEA Framework is a free and open source Java library for development and experiment with multiobjective evolutionary algorithms (MOEAs) and other general-purpose multiobjective algorithms.
Jasymca	2.0	Jasymca is an interactive System for solving math problems. It supports arbitrary precision numbers and symbolic variables.

---

The modules used for exploration are selected among several developers. MOEA framework is selected because it provides a significant list of optimization algorithms and a simple problem formulation structure. In contrast, there are a few symbolic calculators have been contributed and only Jasymca is a JAVA open source library.

As CSC-Modeler is designed to be a computation knowledge base system. Currently, one of the most advanced in this area is *WolframAlpha*<sup>19</sup>. It is an engine for computing answers, providing knowledge with accepting completely free-form input, and covers many fields of sciences and engineering as it retrieves information from the internet. However, it is still based on the input keywords from a user, the specific value of parameters and/or variables are needed to perform the calculation. There isn't a possibility to perform the exploration via an optimization technique. Moreover, it is not providing the systematical steps to associate an analysis aspect with required knowledge to perform the specific calculation and/or exploration. These are some reasons that why CSC-Modeler has been proposed and developed.

Fig. 4-4 shows a screenshot of a graphic user interface of the CSC- Modeler (Java client version). When designers interact with the software via the main menu corresponding to the major steps of Screening, Modeling, and Exploring, sub-windows appear inside the main window. The Knowledge/Information layer is retrieved from the server and operates independently from the main steps.

The full functional java-based CSC-Modeler is under development. A short screencast of the java-based version is provided on the following link:

<https://ideaslab.insa-strasbourg.fr/recherche/rsc-modeler>

---

<sup>19</sup> Wolframalpha is a computational knowledge engine or answer engine developed by Wolfram Research. <http://www.wolframalpha.com>

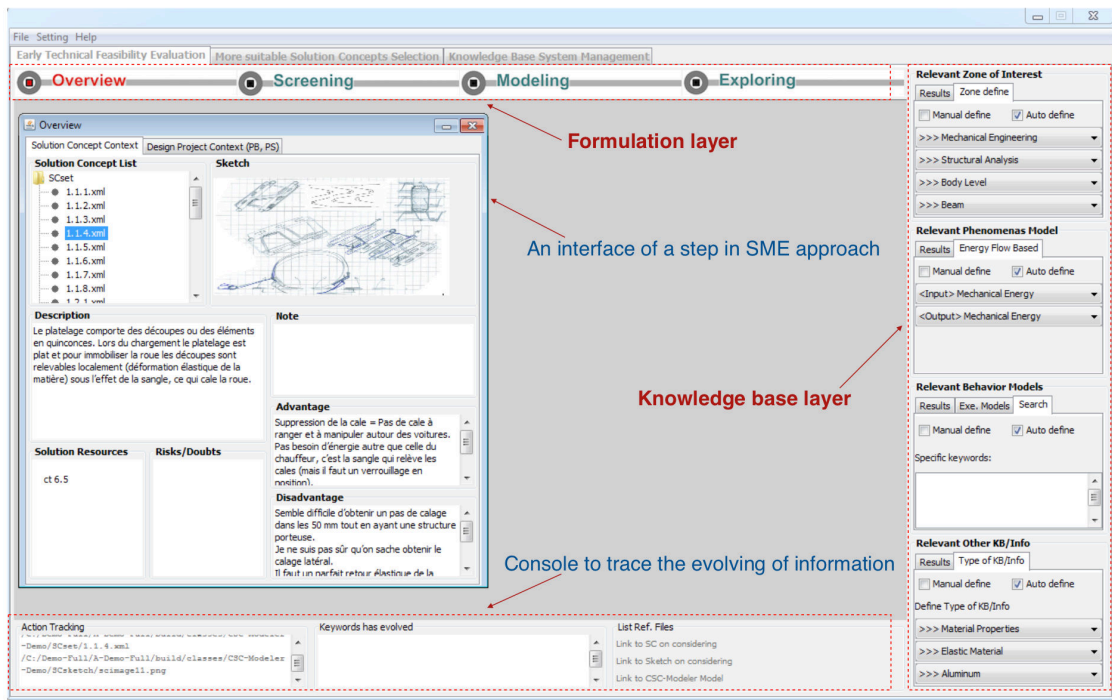

Fig. 4-4 A screenshot of under development java-based version of CSC-Modeler

A screenshot of ongoing development web-based version of CSC-modeler is presented in Fig. 4-5.

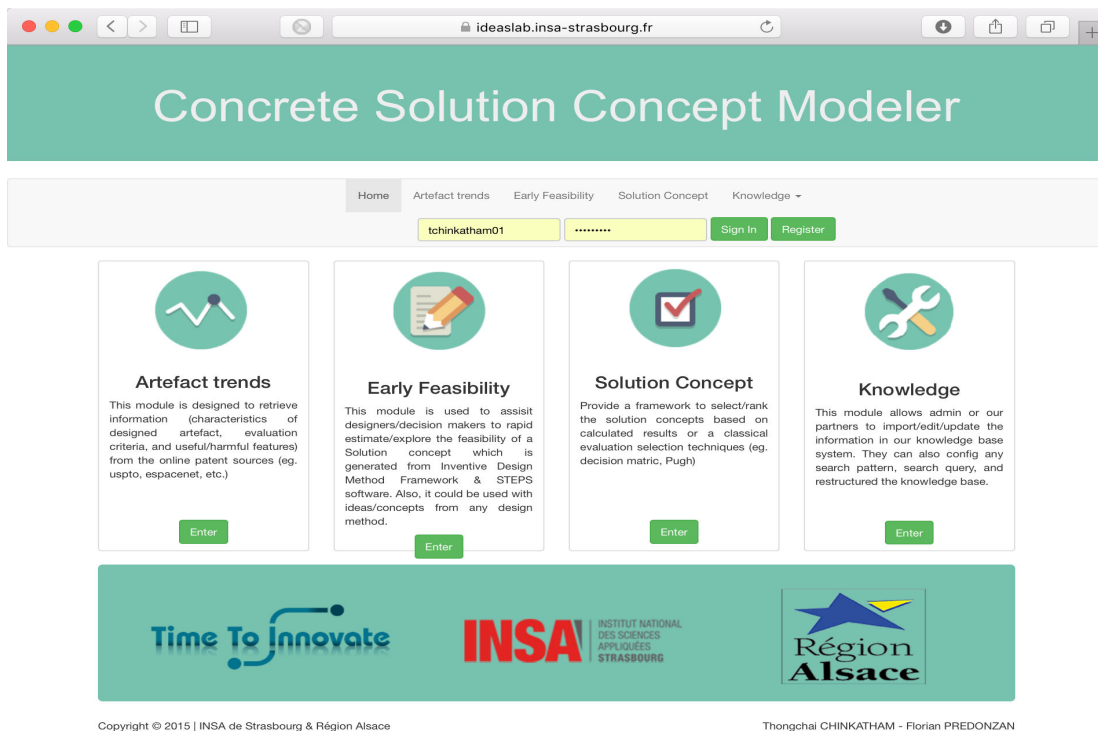

Fig. 4-5 A screenshot of ongoing development web-based version of CSC-Modeler



## 4.5 CSC-Modeler in action: A car wheel blocking system

The usability of the implementation of support software tool (CSC-Modeler) in industrial contexts is illustrated in this section. A design project undertaken with our partner, **Lohr Industry**<sup>20</sup> (a trailer manufacturer) will be used as a case study to clearly address the problem as well as to demonstrate the utility of our SME(s) approach and the java-based CSC-Modeler software support tool.

### 4.5.1 Context of design project and the issue to be resolved

In general, securing a vehicle should be accomplished using appropriate lashing points that are suitable in terms of quantity, position, and strength. The constraint arising from friction between the tires and the deck of a transport vehicle with the parking brake on is not sufficient to prevent movement of the vehicle during transportation.

The vehicle being transported must be secured to the transport vehicle using appropriate lashing equipment, tensioning devices, and blocks. Normally, the wheels of the vehicle should be lashed and blocked by means of components on the vehicles' or trailers' axles or chassis. Moreover, the tension of the lashings should be tested after the vehicle has traveled for a few miles for adequacy and again at intervals during the journey, with re-tensioning as necessary. The original car wheel blocking system is shown in Fig. 4-6.

---

<sup>20</sup> LOHR is a private French group established in Alsace near Strasbourg. It has several business units include: LOHR Automotive provides car-transporter vehicles and LOHR Railway system is a road-railway system (piggyback), to name a few. <http://lohr.fr>

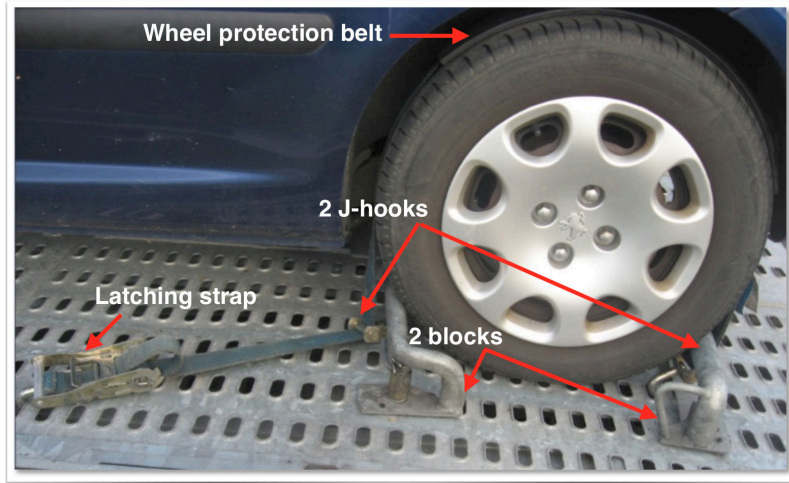

Fig. 4-6 The current system for blocking a wheel

The objective of this design project is to develop a new car wheel blocking system during transportation. The primary objective of the improvement is to facilitate truck drivers' securing operations and to reduce time spent securing vehicles. These objectives are related to the number of components, weight, and complexity of the system to be installed.

From the set of problems characterizing the case study, a set of 22 Solution Concepts were proposed by the team using the IDM methodology and STEPS software. Once an evaluation and selection were made based on Step 4 of the IDM framework, a rough sketch, and description of three Solution Concepts were prepared and ranked, as shown in Table 4-2.

Table 4-2 A sketch and description of the Solution Concepts after evaluation based on Step 4 of the IDM framework. The scenario is the effectiveness of immobilization.

<b>SC 1.3.4 (Rank: 1): Strap modification</b>	
	<p><b>Description:</b> The strap is made of a material allowing longitudinal but not lateral slide. A tensioning device, either different or identical to the current system, is used to tighten the strap once in place. This can be done through an electrical or pneumatic power source.</p>

---

#### SC 1.1.5 (Rank: 5): Deck modification

---

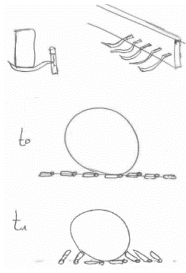

**Description:** In the new configuration, the vehicle is transported on curved semicircular bars, aligned one behind the other in a fish bone pattern. When the vehicle is at rest, a strap is placed on the tire and attached to the curved bars that rotate up to press against the tire. All bars, except those under the tire, rotate up once the vehicle is stationary, blocking it in place.

---

#### SC 1.2.2 (Rank: 8): Wedge modification

---

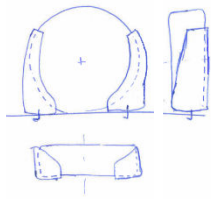

**Description:** This system is characterized by a rigid body in a form of a shell. Its geometry is designed to adapt to and support different sizes of tires. It exceeds the lateral axis of the tire to restrain vertical force, which removes the need for lashing and blocking pads and transverse forces, with a wedge shape on the two sides of the tire.

Note: Install 2 shells/wheel

---

Based on the IDM evaluation technique, Solution Concept 1.2.2, which was ranked 8th, will have little chance of being selected for development in the next design process. Even so, from our standpoint, while comparing this Solution Concept with higher ranking solutions, it is a potential number one solution in terms of a number of components, time for installation and level of complexity.

We asked one of the experts in the design team who abandoned Solution Concept 1.2.2 during the evaluation phase to give it further consideration, but the following statement was issued as a response:

***“The solution is impossible if thickness of the steel components is under 20 mm. This is the minimum thickness required to restrain the vertical force of a 3,000 kg vehicle with the acceleration of 1g during transportation.”***

We believe that this statement represents criteria that was subject to bias on the part of the expert in the evaluation and selection task. Consequently, the Solution Concept was ranked number 8. Recalling the proposed method in Section 3, this statement is presented as a form of performance model that is not difficult to handle with a simple

analysis task. *Why should it not be given more consideration? Is this due to a combination of time constraints, lack of knowledge and any immediately available support tool?*

According to this situation, there is a high probability that in each R&D department, many good Solution Concepts are abandoned on the grounds of intuition alone, even though they could have proven feasible if a little more attention had been given to them. Such situations are at the origin of the research debated in this paper. Our results will be demonstrated through Solution Concept 1.2.2 in the next section.

#### **4.5.2 Application of the proposed approach and the software support tool**

Solution Concept 1.2.2 was considered using the methodology and the software framework proposed in Chapter 3 and 5. The functionality of the support tool will be described generally along with the proposed approach.

##### **4.5.2.1 Screening**

Solution Concept 1.2.2 was screened and evaluated for effectiveness in the ideation process, then the immediate reaction of a designer or an expert was captured in the form of critical parameters through the answers to a set of questions. A screenshot of the screening template is shown in Fig. 4-7 below.

Answers to the set of questions consist of choices of Yes/No, Retained/Present, Dimension/Configuration/Behavior, etc. answers, depending on the question. Some questions include a box in which additional information may be entered.

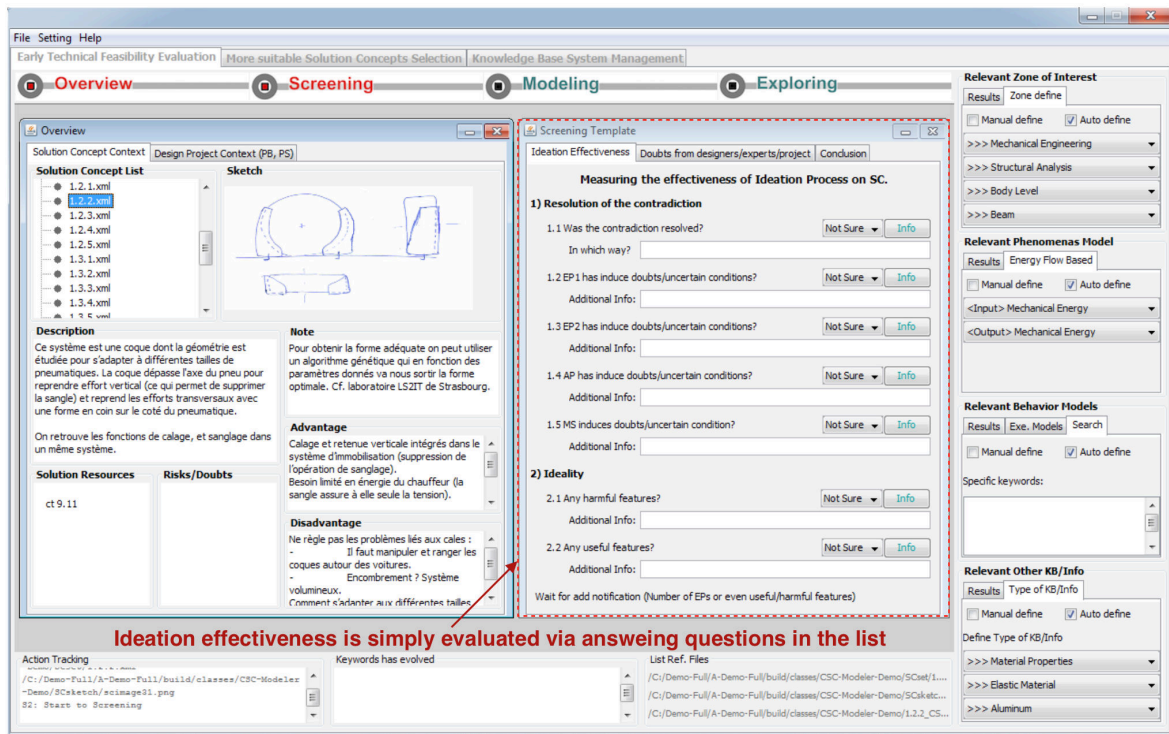

Fig. 4-7 A screenshot of SC 1.2.2 context with screening template

Expert statements as previously described are used during the screening step as well for Solution Concept 1.2.2. Table 4-3 lists doubt and uncertain conditions as perceived from the expert viewpoint, the Solution Concept context and the design project specifications in terms of assumptions and critical parameters. The analysis aspect of this Solution Concept relies on dimensions of the designed system to ensure the vertical immobilization of vehicles on a car-carrier and the total weight of this type of designed system. According to the information in Table 4-3, this Solution Concept is classified as “*Conditional & worth consideration*” and will be assessed further in the next step.

Table 4-3 Assumptions and critical parameters, a result from the screening step

Known Information & Assumptions	Critical Parameters
- Type of tire: 255/55 R15 (diameter 639mm, width 255mm)	- EP1: Immobilization (strength, deflection)
- Dimension related to Structural Analysis	- EP2: No. of installations
- Total Length: $\frac{3}{4}$ of tire's diameter.	- Total Mass of system
	- Thickness: 20 mm steel
	- Vertical force of vehicle (3,000 kg : 1g)

### 4.5.2.2 Modeling

In this step, designers identify and specify a list of interest aspects according to the model for the pre-parameterized template (Fig.4-8), with some items in this list originating from the information captured in the screening template. A list of interest aspects is overlaid on the Solution Concept sketch, with separate types identified by color and shape, links to define the relationship between objects and any known information such as value or units that could be assigned to each object.

The list of interest aspects will be made up as keywords to search for suitable behavior models from the knowledge base system. Then designers formulate or update an analysis model aided by the selected behavior model and support information. A screenshot of the Analysis Modeling Template and a BH-Model Template is presented in Fig.4-9.

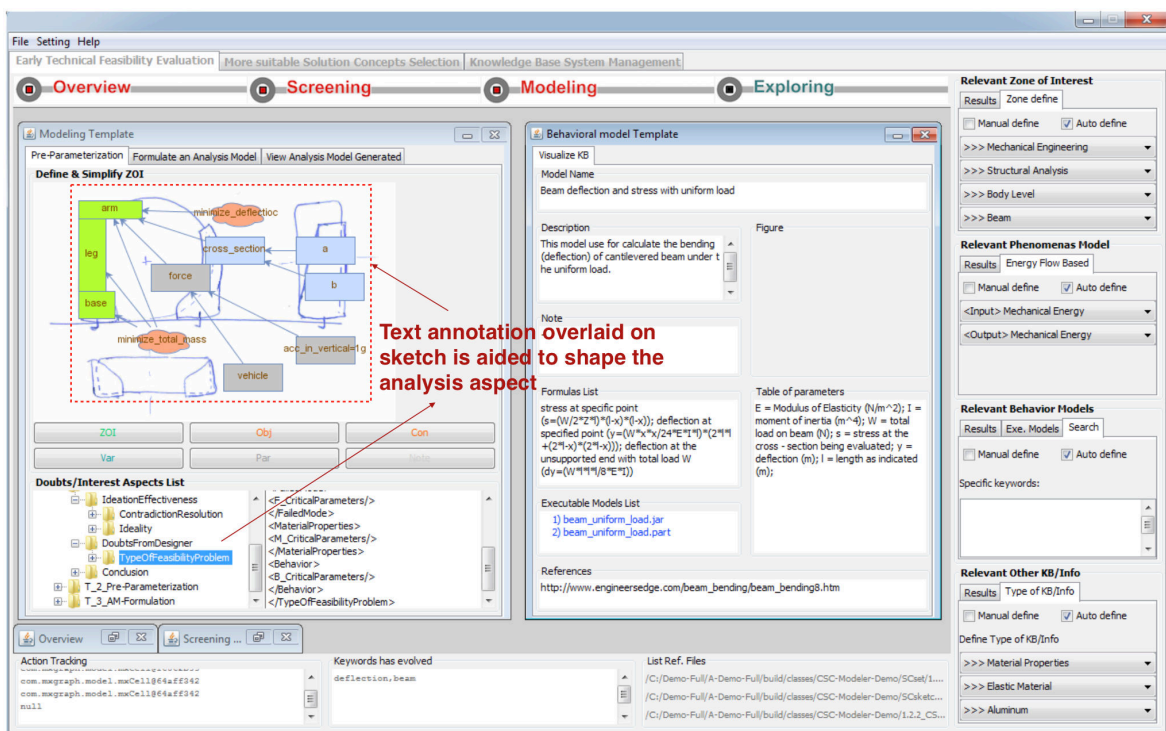

Fig. 4-8 Screenshot of the Pre-Parameterized Template and the Meta-KB Template.

Should captured information from the screening template be insufficient to search for a behavior model, designers can get assistance in filling in the list of interest aspects by defining the energy flow through the selected ZTOI and by choosing a relevant phenomenon to govern the behavior of the problem under review. Fig.4-8 shows a screenshot of the Meta-KB Template presenting the selected phenomena.

For this case study, the tip area (arm in Fig. 4-8) is defined as the zone of interest and is simplified as a structural beam with an L-angle section. The beam deflection with unified load is selected as a behavior model suitable to represent the performance model being studied.

In the screening and modeling step, the information is systematically tracked with respect to the template formulation model. Evolution of the case study from the screening to the analysis model is presented in Fig. 4-10.

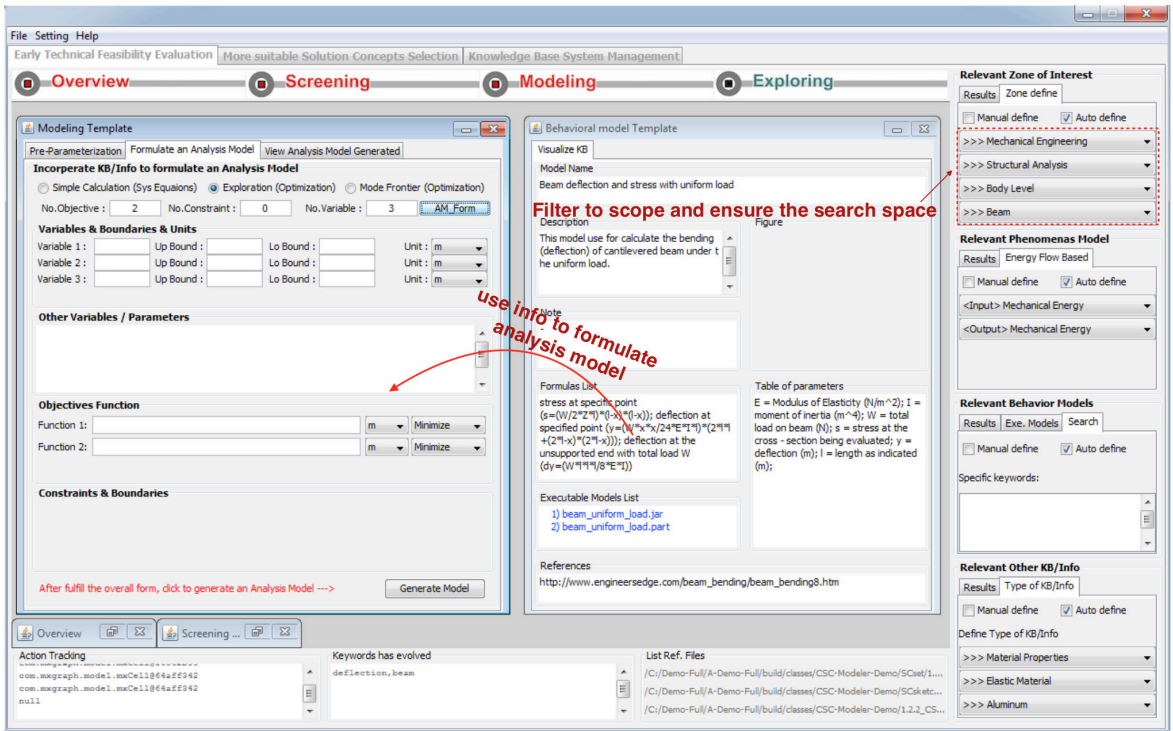

Fig. 4-9 A screenshot of the formulation template of an analysis model and the BH-Model Template



### 4.5.2.3 Exploring

From the tracked information file, we generate an equation-based analysis model and make a simple calculation with a set of initial values ( $B=100\text{mm}$ ,  $H=50\text{mm}$ ,  $t=10\text{mm}$ ). The defined zone of interest (the arm) could be implemented with steel as a material, featuring deflection of  $<0.01\text{mm}$  but the total mass of  $>5\text{kg}$ . Subsequently, we focused on minimizing the total mass. We generated an analysis model as an optimization problem according to the MOEA framework and using NSGA-2 (50 generations) as the optimization algorithm. The Pareto front between deflection vs. total mass is presented in Fig. 4-11. After testing with steel, we modified the modulus and density of the material to aluminum and polyimide + 30% glass fiber respectively.

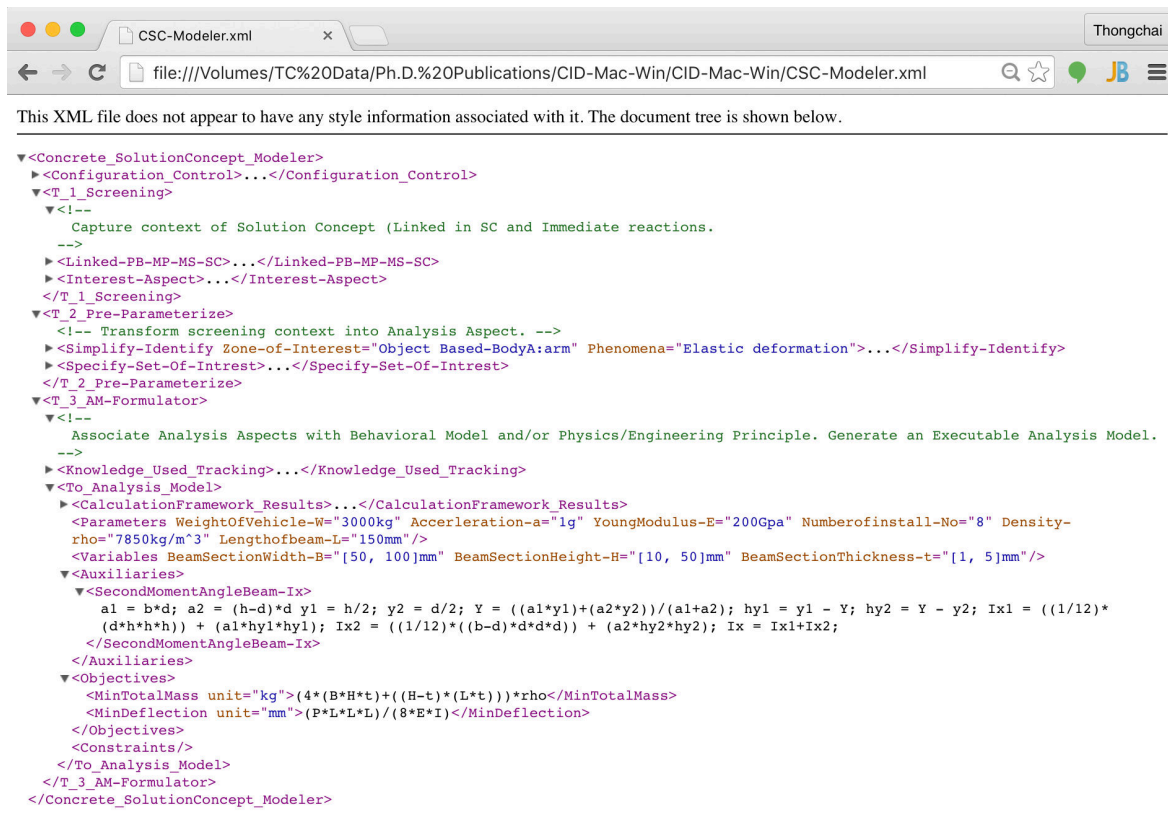

Fig. 4-10 A screenshot of tracked information of the case study



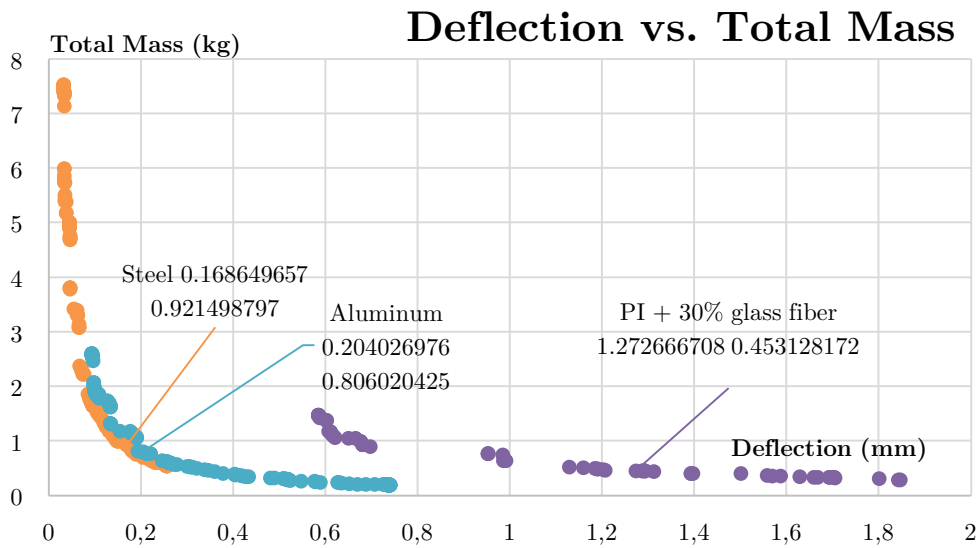

Fig. 4-11 Results of the numerical search and optimization process, displacement vs. total mass of system under review

With all calculation results obtained in **Table 4-4**, Solution Concept 1.2.2, initially considered as impossible to implement with steel less than 20 mm in thickness could be considered possible. According to the results, this Solution Concept could be implemented with aluminum or polyimide + 30% glass fiber as a choice of materials, with a thickness of <5mm, deflection <1mm and total mass <1kg.

Table 4-4 Examples of a feasible set for Solution Concept 1.2.2

Vehicle = 3,000 kg., acceleration = 1g., L=150mm	Objective & variable of interest				
	B - Section width (mm)	H - Section height (mm)	t - Section thickness (mm)	Deflection (mm)	Total Mass (kg)
Steel	117.42	49.91	1.51	0.168	0.921
Aluminum	108.82	49.50	4.12	0.204	0.806
PI + 30% glass fiber	110.88	49.95	4.01	1.272	0.453

We note that these results were obtained using the simplified model; improvements to properties and structure could be easily implemented during the next design phase. We have not simply evaluated the feasibility of problem, but also explored the

characteristics of the possibility for a Solution Concept, such as a type of material to be used or structural systems to implement in different forms or thicknesses and in various stipulated Zones of interest such as the arm, leg or base. Most importantly, the entire process was carried out within a short period of time.

Regarding the experts' initial opinions and the calculation results, designers have a robust counter argument for bypassing expert intuition that produces an accurate evaluation and selection process. As a result, this Solution Concept was ranked much higher, in the third position, and was selected for further review in the next design phase. In light of the results obtained, our method and software "saved" Solution Concept 1.2.2 while any traditional corporate stage-gate process would have killed this solution since at first glance intuition leads expert to characterize the solution as impossible.

#### **4.6 Discussion on CSC-Modeler**

As part of this research, a software support tool was built and named the Concrete Solution Concept Modeler (CSC-Modeler). The systematical steps of Screening, Modeling and Exploring were integrated into support templates. These templates have bridged the knowledge and information gap within the design-analysis process and their utility was demonstrated in the case study.

Furthermore, from our observation that the expert opinion judging a Solution Concept is often negative when it exceeds the boundaries of what they have previously experienced. In the car wheel blocking system case study, our software prototype highlighted areas of conflict in an expert's initial decisions. As a consequence of our process, this Solution Concept was classified in a higher rank and has an opportunity to undergo more detailed investigation.

The results we obtained cause us to believe strongly that this exercise can repeatedly bring about similar results. Therefore, we draw the hypothesis that it is possible to leverage inventiveness of a company through additional chances for feasible concepts.

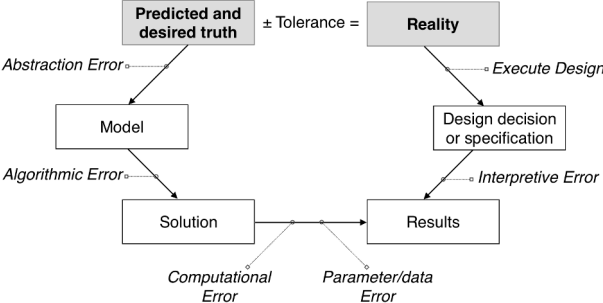

Fig. 4-12 Sources of error in engineering model that used in analysis task

As our SME(s) approach and CSC-Modeler relies on the simplification of analysis aspects before estimating or exploring the feasibility of a Solution Concept. Consequently, the accuracy of the result obtained is not a precise estimation. The sources of error that affecting the analysis results is presented in Fig. 4-12. For example, as in our case, if the assumption of analysis aspects is loosely described at the beginning, the accuracy of analysis model will have affected by abstraction error. The final analysis result is influenced by the sum of errors from different stages. However, the obtained result is sufficient to make an informed decision.

Our future work will focus mainly on the following two aspects. Firstly, as our approach and support tool are in the early development stages, we will continue to improve the technique and support tool to include a client and online version for mapping any doubts or uncertain conditions to instantiate the exploration step directly. We will also stabilize and enlarge the scale of the knowledge base to cover a wide range of problem analysis issues during conceptual design. Additionally, another direction we would like to investigate is the technique for implementing a selection where little-known information exists and where the problem is represented in a context of a high degree of complexity.

# Chapter 5

## System Readiness Level Identification of a Solution Concept in IDM

*“Nothing is too wonderful to be true if it be consistent with the laws of nature”*

— Michael Faraday

This Chapter presents an approach to evaluate and select the Solution Concepts by relying on the system readiness level and the potential failure of functions of a Solution Concept. A case study is provided to demonstrate the proposed approach. This Chapter closes with the discussion on limitations and opportunity of future work in this area.

### Inventive Design Method

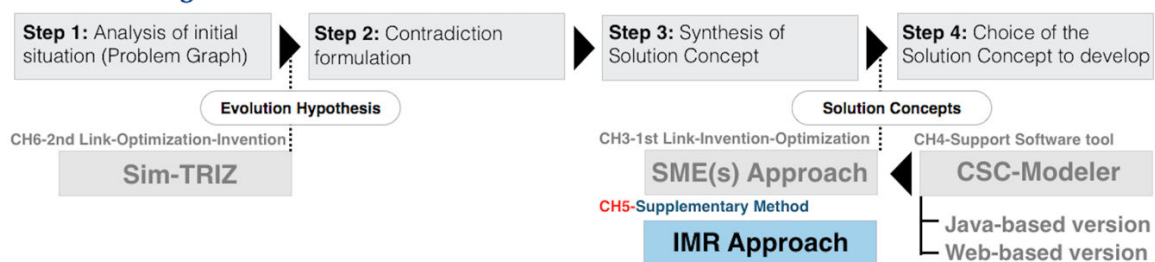

### 5.1 Reflection on technical background - literature surveys: #3

In chapter 3, the SME(s) approach has been proposed to handle the immediate reaction of decision makers. It provides useful steps to estimate and explore the early technical feasibility of a Solution Concept. Overall time span to perform SME(s)

approach is decreased due to the aid of support software tool, CSC-Modeler. This tool bridges the early design-analysis gap. It is true that the informed decision will be made after unfeasible Solution Concepts have been screened out. However, SME(s) approach can be used in specific conditions as mentioned in Chapter 3 and while revisiting the SME(s) approach some limits and remarks are identified as follows;

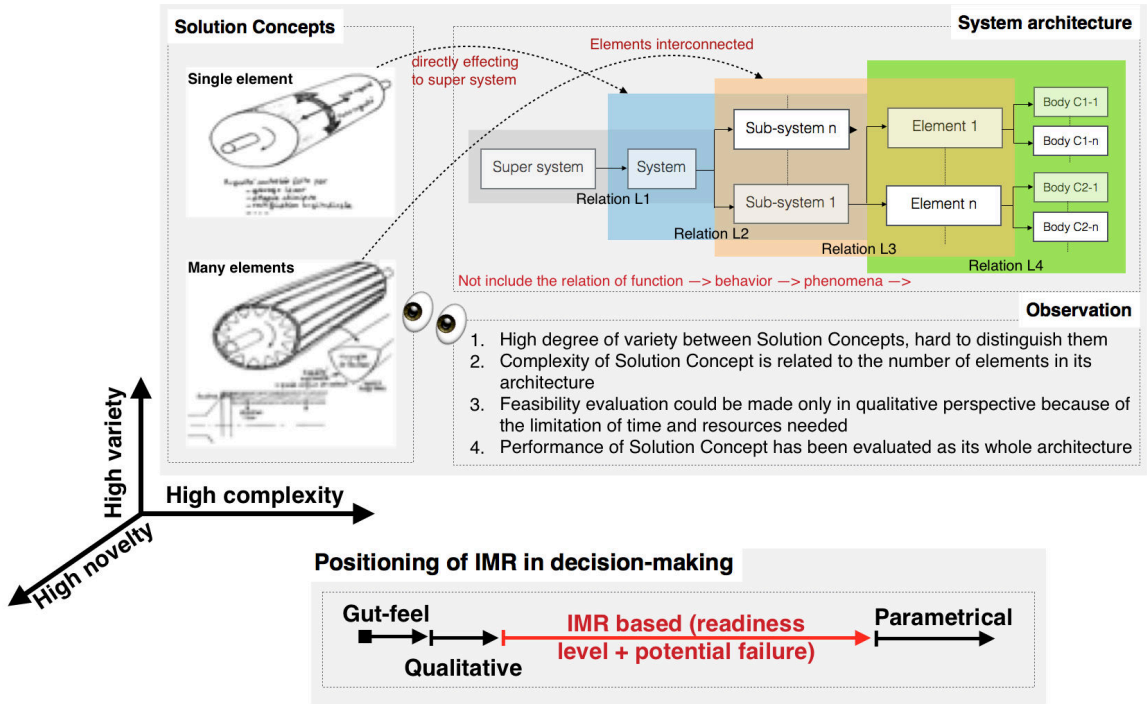

Fig. 5-1 Observation on Solution Concept evaluation/selection stage (viewed from the system architecture perspective)

- 1) If a Solution Concept has been classified as “*Adopt different techniques*” that means, we cannot perform the estimation or exploration to evaluate its feasibility within the limited resources and acceptable time span. This situation is presenting the high *complexity* of the Solution Concept and requiring an amount of time to identify and collect relevant knowledge for performing an analysis task. In such case, SME(s) approach is an inappropriate method. What is more, with inventive design manner,

complexity of solution is one of unavoidable issues. *How to handle this situation, new viewpoint to evaluate/select Solution Concepts is needed?*

- 2) If we view a Solution Concept regard to the system architecture<sup>21</sup> or the product model [134,135], the impact of the relation between elements is not taken into account during the concept selection (evaluation/selection). This limitation apparently occurred in both concept selection methods based on routine design model and TRIZ-based design (refer to Section 2.2 and 2.4 respectively). In our viewpoint, the relation between elements is one of a key maturity that guarantee the final success of its development and has to be considered at the earliest possible.
- 3) The viewpoint to evaluate and select a set of Solution Concept is grounded on a specific viewpoint. For example, the capability of function to perform the desired behavior, the degree of satisfaction on specific criteria. But in reality, to be an inform decision, concept selection must consider more than one viewpoint and the different scenarios have to take into account.

The summary of these limits and remarks is depicted in Fig. 5-1. Keeping them in mind, we developed a new IMR approach (Identifying, Mapping, and Ranking). This approach is intended to change the perception of concept selection from qualitative to quantitative measurement. IMR is largely based on the existence of a scale widely used in enterprises: The Technology Readiness Level (TRL) and potential failure of functions of elements in the whole architecture of a Solution Concept.

*Technology Readiness Levels (TRLs)* are a systematic metric/measurement system that supports assessments of the maturity of a particular technology and the consistent comparison of maturity between different types of technology [136–138]. Several

---

<sup>21</sup> System architecture is the conceptual model that defines the structure, behavior, and more views of a system. A system architecture can comprise system components, the externally visible properties of those components, the relationships (e.g. the behavior) between them.

contributions that applied TRL can be found in [139–142]. Nevertheless, TRL always applied in the system level, where every subsystem and/or component has been integrated completely.

*The Potential failure of functions* has widely used in analyzing and predicting the failure of components or elements in system engineering design<sup>22</sup>. In conceptual design, several authors [73,143–148] applied the failure of function to design a system for a reason to assure the reliability of the system. The concept of function failure also used to evaluate and select design concepts [149,150] as mentioned in section 2.2.3.

In IMR approach, each Solution Concept is associated with an extension of TRL and the potential failure of objects and their functions identified in the Solution Concept. In addition, as the concept of TRLs and potential function failure is grounded on engineering system life cycle. The readiness level of a Solution Concept will identify and map with a scale synthesized from engineering lifecycle management standard: ISO15288:2008 [151]. As such, we postulate that a change will take place in the perception of the decision-makers. They will better assess the chances of success than its capabilities to meet objectives of a functional specification. Details of IMR approach are on the following:

## **5.2 Development of the approach: IMR**

The proposed approach has been intentionally used as a decision-making aid and tool. It aims to assist the designer in identifying the readiness level of a Solution Concept. Additionally, the influence of a new element that affect the overall system will be considered and represented along with its readiness level. The key concept of this development is an integration of several techniques including TRIZ based design,

---

<sup>22</sup> Systems engineering is an interdisciplinary field of engineering that focuses on how to design and manage complex engineering systems over their life cycles.

system architecture design, and potential function risk-failure analysis. We base our proposed approach on:

- 1) A Solution Concept could be modeled or viewed as a system that could be identified its architecture in a simple and/or complex form.
- 2) The simple pairwise comparison method<sup>23</sup> [152] has been used to distinct the differences of the current system (product, artifact) and the new solution proposed. In this way, the new objects in the system could be identified. Consequently, the Function-Failure Mode/Rate of these objects can be determined. In our viewpoint, a function is one of the attributes of the relation. The details of this definition will be given further.
- 3) The influence of new objects in system architecture may cause a problem to the overall system. This situation is referred to the rule of occurrence of super-effect suggested by Orloff [94].
- 4) The ideality of the system could be observed via the degree of influence of potential Function-Failure Mode/Rate of objects in the system.
- 5) The accuracy of evaluation and selection depends on “*How deep we go for characterizing the system architecture of a Solution Concept, at sub-system, function, or sub-function level?*” Time and resources needed are the issues to be considered.

Fig. 5-2 show the overall steps of IMR (Identifying, Mapping, and Ranking) approach and detail of each step is as follows:

---

<sup>23</sup> Pairwise comparison generally is any process of comparing entities in pairs to judge which of each entity is preferred, or has a greater amount of some quantitative property, or whether or not the two entities are identical.



### 5.2.1 Identifying

The proposed approach starts by constructing the system architecture of the being tested Solution Concept. Then specifying the influence of objects that affect the overall system. The comparison of the current system (the existing one, artifact and/or product) and the system architecture of the Solution Concept will be made to identify the new objects. Detail of each step is as follows:

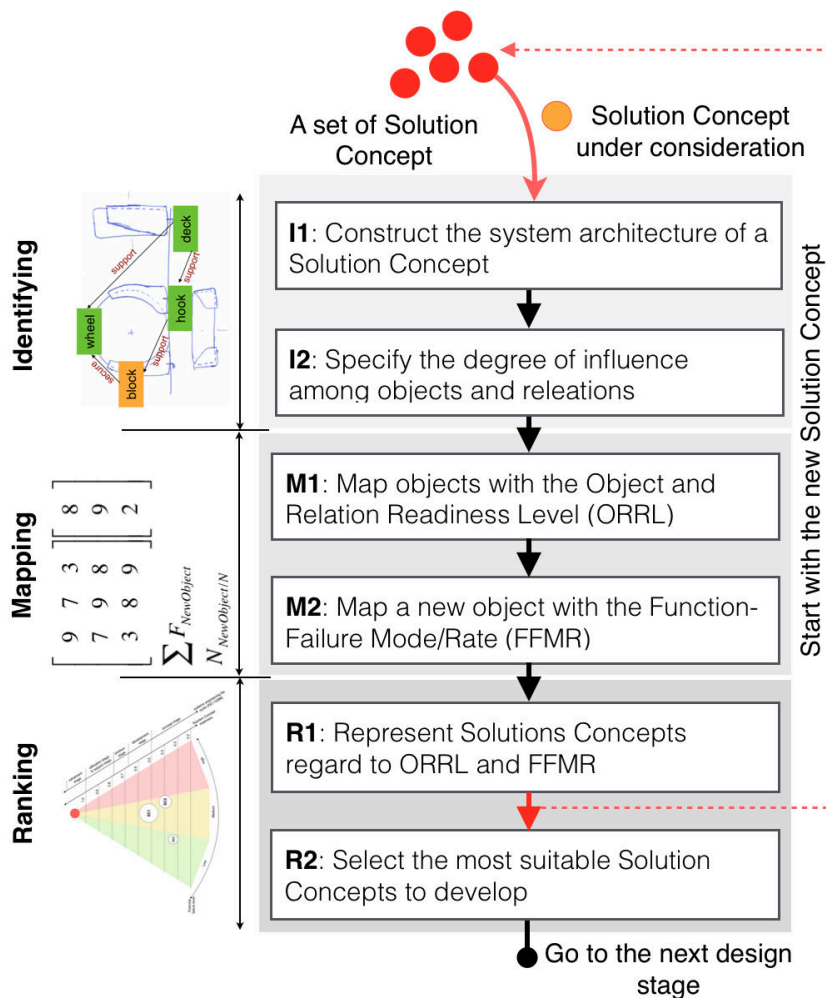

Fig. 5-2 An approach to identify the readiness level of a Solution Concept

#### Step I1: Construct the system architecture of a Solution Concept

The system architecture is identified and constructed regards to the model in Fig. 5-3. As every artifact serves a certain purpose or functionality. This purpose is realized

by the objects defining the structure model. Where more than one objects are involved, the relations between them become important to perform the accurate functionality. In this thesis, *Object* is a system, a sub-system, a component, and a body/section of a component. The *Relation* is referred to the physical part of the conjunction or the integration between objects. The product of this conjunction provides an effect. The *Effect* is defined as an outcome of an action in a system, mechanism, which is based on a natural (physical) phenomenon. We note that, the completeness of system architecture model is resulted in the accuracy of evaluation and selection. On the other hand, time and resources needed will be increased.

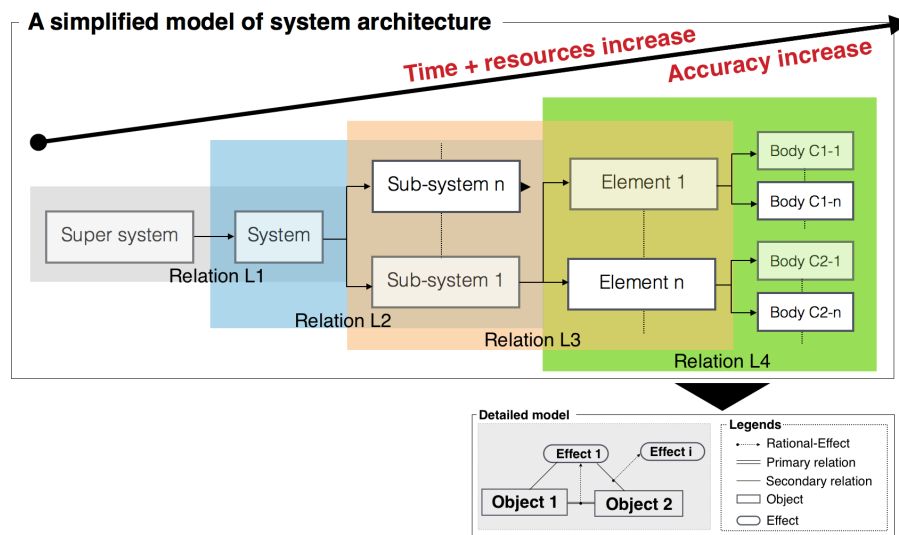

Fig. 5-3 Simplified model of system architecture (after [149,153,154])

### Step I2: Specify the influence of objects to the overall system

After **Step I1**, the influence level of objects and relations to the overall system of the Solution Concept is specified. The classification of this influence level is:

- 1) **Group 1** (Green), the element or the relation doesn't pose any negative effect to the overall system.

- 2) **Group 2** (Yellow), there are some possibilities that the element or the relation may cause the problem to the system. But it may have a clue to prevent or resolve the problem. For example, modifying the dimension of object, changing the material used, etc. In another viewpoint, the problem cause by an object can be observed and predicted regards to the abstraction level of knowledge that characterizing the object (phenomena, analytic model, CAD model, and so on). This abstraction level is referred to the knowledge representation mentioned in section 2.1.3.
- 3) **Group 3** (Red), the knowledge or information has lacked to prevent the problem that caused by the object and the relation. In order to prevent this problem, the designer must put an amount of effort and time.

The new object and its relation (a function or an effect) added into the system is identified and specified. We note that, the simple pairwise will be used to distinct and specify new object in the Solution Concept from current system. This relationship will be used to identify the Function-Failure Mode/Rate of a new object that have an influence to the overall system.

### **5.2.2 Mapping**

In this step, objects and relations identified in the previous steps are mapped with the level of maturity and level of integrality of system. Then, the new elements added into the system (in Solution Concept) are identified and mapped with the Function-Failure Mode/Rate (FFMR) data. Detail of each sub-step is as follows:

#### **Step M1: Map objects and relations with Object-Relation Readiness Level**

The objects and relations in the step I2 are mapped with the Object Readiness Level (ORL) and Relation Readiness Level (RRL) respectively. The definition of each level

shown in Table. 5-1 and Table. 5-2 respectively. In each definition of the ORL is adapted from the TRL. This ORL is focused on the abstraction level of knowledge characterizing the object. For example, level 2 is referred to an object in the system that possible to identify or observe its characteristic as a phenomenon that has a simple analytic form. For example, a resistor that resists the current flow through it in the electrical or electronics circuit. It can be represented as the analytic form:  $R=V/I$ .

Table 5-1. Definition of each level of Object Readiness Level: ORL

Level	Object Readiness Level
1	Basic principle observed and reported
2	Concept and/or application formulated. ( <i>phenomena model exist</i> )
3	Analytical and/or experimental critical function and/or characteristic Proof of Concept ( <i>analytical and/or numerical model exist</i> )
4	Object and/or physical prototype is validated in a laboratory and relevant environment. ( <i>full simulation model and/or physical prototype exist</i> )
5	Actual object completed, qualified through test/demonstration and proven through successful operations. ( <i>existing artefact</i> )

The RRL is observed and specified from the viewpoint of physical connection or integration of a system. The key concept of this RRL is from the simulation based design. The connection between element is considered as a source to deliver or a sink to receive the information. This connection has the specific types depending on the engineering domain. The completeness or capacity of this connection could be observed regards to this connection.

After mapping objects and relations with ORL and RRL respectively. The Solution Concept Readiness Level (SCRL) is determined via Eq. 5-1. The systems engineering life cycle standard [151] has been used as the reference to view this SCRL. We have normalized all readiness level equal to 1. The detail of this normalization will be presented in the Ranking Step.

Table 5-2. Definition of each level of Relation Readiness Level: RRL

Level	Relation Readiness Level
1	An interface ( <i>physical connection</i> ) has been identified with sufficient detail to allow characterization of the relationship.
2	There is some level of specification to characterize the interaction ( <i>ability to influence</i> ) between objects through their interface.
3	There is compatibility ( <i>common language</i> ) between objects to orderly and efficiently integrate and interact.
4	There is <i>sufficient detail</i> in the quality and assurance of the integration between objects.
5	There is <i>sufficient control</i> between objects necessary to establish, manage, and terminate the integration.

$$SCRL = [RRL]_{N \times N} \times [ORL]_{I \times N} \quad \text{Eq. 5-1}$$

### Step M2: Map new elements with Function-Failure Mode/Rate database

In parallel, the objects classified as level 1 to 4 in step M1 are taken into account. Several elements that may cause the most negative influence to the overall system are specified and the potential Function-Failure Mode/Rate (FFMR) of these objects are determined via Eq. 5-2. The snippet of this database is presented in Fig. 5-4 (**a part of Annex 1**).

$$FailMode / Rate_{Function-SC} = \sum (FailMode / Rate_{NewElement}) \quad \text{Eq. 5-2}$$

	galling and seizure	impact	latch-up	noise	other	Overstress of incorrect current magnitude	rupture	unknown	voiding	wear
actuate	7.7E-3	0	0	5.0E-4	2.3E-2	1.2E-1	6.0E-4	4.5E-2	0	5.8E-2
allow	8.0E-4	0	0	4.0E-4	7.0E-4	8.0E-4	1.0E-4	1.9E-3	0	8.0E-4
change	1.4E-2	0	0	8.6E-3	1.5E-2	1.5E-2	1.7E-2	1.3E-1	1.0E-4	3.3E-1
channel	0	0	0	0	0	0	0	1.0E-4	0	2.0E-4
collect	1.0E-4	0	0	0	0	1.9E-3	0	9.0E-4	0	0
condition	0	0	0	0	0	8.0E-4	0	2.6E-3	0	1.6E-3
connect	0	0	0	0	2.0E-4	0	1.0E-4	4.0E-4	0	2.5E-3
contain	0	0	0	0	0	0	0	1.0E-3	0	5.0E-4
convert	9.0E-2	4.0E-4	2.0E-2	3.1E-2	1.1E-1	1.9E-1	7.8E-3	2.7E-1	0	4.2E-1

Fig. 5-4 The snippet of Function-Failure Mode/Rate database [155]

The information in Fig. 5-4 is taken from the contribution of O'Halloran [155]. It should be noted that this work does not claim that functions have failure modes. Instead, this research links functions to components that have failure modes.

Fig. 5-5 depicts the procedure to populate the FFMR database. This database uses the Design Repository<sup>24</sup> to define the Function to Component Matrix (A). The data from Nonelectronic Parts Reliability Data 1995: NPRD-95 [156] was used as the source for constant component failure rate data to implement Constant Failure Rates into the Component to Failure Mode Matrix (Matrices B1 and B). The Failure Mode Data Source (Failure mode/mechanism distribution 1997: FMD-97 [157]) is used to define the Component to Failure Model Matrix (Matrix B2). To produce matrix B, the values in *row i* of matrix B1 are multiplied directly through *row i* in matrix B2. This scales each row in matrix B2 by the value of the failure rate. The matrix C, Function-Failure Mode/Rate is populated from the multiplication of matrix A and B.

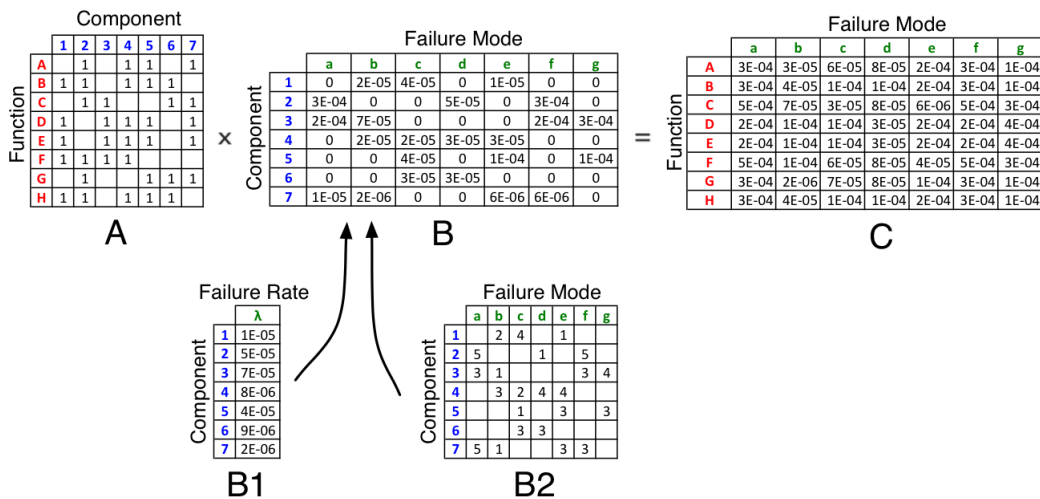

Fig. 5-5 The matrix to populate Function-Failure Mode/Rate database [155]

<sup>24</sup> The Design Repository is an ongoing research project to represent, archive and search product design knowledge in support of engineering design activities. The repository project (originally funded by NSF:DMI-9988817) involved researchers at UMR, The University of Texas at Austin and NIST. <http://design.engr.oregonstate.edu/repo>

As mentioned, the changes of the current system according to the new solution should be observed. The number of new elements counting the total number of elements in the system architecture will be used to represent the change ratio along with its readiness level and the potential FFMR.

This approach (from Step I1 to Step M2) is resumed with the next Solution Concept to be considered. After all Solution Concept has been tested, the ranking and selecting process will be implemented in the next step.

### **5.2.3 Ranking**

The results obtained in **Step M1** are mapped as the viewpoint of systems engineering life cycle standard: ISO 15288:2008 along with the potential FFMR of new elements in the Solution Concept (**Step M2**). The illustration of results will be described along with a case study in section 5.3. Detail of sub-step of ranking step is as follows:

#### **Step R1: Represent the Solution Concepts**

Solution Concepts evaluated by using **Step I1** to **Step M2** are represented in the form of an extension of SUN diagram [158]. The idea to develop this diagram is as follows:

- 1) The readiness of a Solution Concept is its achievement to be implemented. There are several system life cycle standards may be used to represent this achievement. An example of standards/models in this area such as ISO 15288, US-DoD and US-DoE. The comprehensive comparison of life cycle model has been provided by Forsberg et al. [159].
- 2) The affection of a potential failure of new elements in a Solution Concept to the overall system should be presented in a simple way and relevant to actual situation (in this thesis is referred to the failure rate; Fails/MHours).

Consequently, three different colors (Red, Orange, Green) have been used to characterize this affection. *Red* refers to the highly negative impact, *Orange* means the impact or probability of failure is in the middle range, and *Green* represents as it has a less negative impact to the system.

- 3) New elements added into the system may cause both positive and negative impact to the system. The ratio of a number of new elements and total elements in the system should be considered and may be used as an input to observe the ideality of the Solution Concept.

A case study presented in section 5.3 will be used to illustrate these three ideas, how the result should be visualization.

### **Step R2: Select the most suitable Solution Concept**

Finally, the most appropriate Solution Concepts will be selected and further developed in the next design process. From this step, design change (including minor and major change) will be performed to enhance the overall performance of the selected Solution Concepts.

## **5.3 Case Study: A car wheel blocking system**

Recall a design project undertaken with our partner, **Lohr Industry** (a trailer manufacturer) as presented in Chapter 4. A modification will be made concerning the suggestion of Inventive Principle deducted from TRIZ knowledge base. The Solution Concepts have been view as a system architecture with presenting its relation at level 1 to 3 (ref. to Fig. 5-3). The usability of IMR approach to handling the aforementioned issues (Section 5.1) will be presented along with this case study.

### **5.1.1 Context of the design project**



The objective of this design project is to develop a new car wheel blocking system during transportation. The primary objective of the improvement is to facilitate truck drivers' securing operations and to reduce time spent securing vehicles. These objectives are related to the number of components, weight, and complexity of the system to be installed. The original car wheel blocking system is shown in Table. 5-3.

From the set of problems characterizing the case study, a set of 22 Solution Concepts were proposed by the team using the IDM methodology and STEPS software. Once an evaluation and selection were made, a rough sketch and description of three Solution Concepts were prepared and ranked, as shown in Table 5-3.

Table. 5-3 Original car wheel blocking system and a set of Solution Concepts

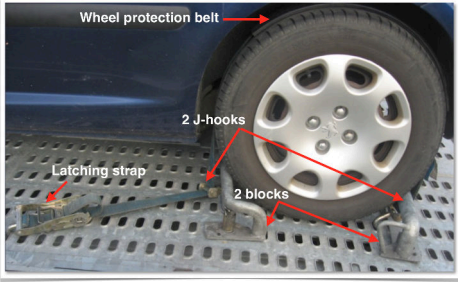
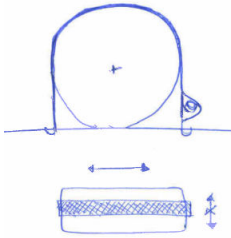
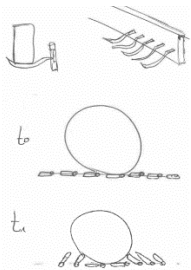
<b>An original car wheel blocking system</b>	
	<p>The vehicle being transported must be secured to the transport vehicle using appropriate lashing equipment, tensioning devices and blocks. Normally, the wheels of the vehicle should be lashed and blocked by means of components on the vehicles' or trailers' axles or chassis.</p>
<b>A sketch and description of the Solution Concepts after evaluation based on Step 4 of the IDM framework.</b>	
	<p><b>SC 1.3.4 (Rank: 1): Strap modification</b>  <b>Description:</b> The strap is made of a material allowing longitudinal but not lateral slide. A tensioning device, either different or identical to the current system, is used to tighten the strap once in place. This can be done through an electrical or pneumatic power source.</p>
	<p><b>SC 1.1.5 (Rank: 5): Deck modification</b>  <b>Description:</b> In the new configuration, the vehicle is transported on curved semicircular bars, aligned one behind the other in a fish bone pattern. When the vehicle is at rest, a strap is placed on the tire and attached to the curved bars that rotate up to press against the tire. All bars, except those under the tire, rotate up once the vehicle is stationary, blocking it in place.</p>

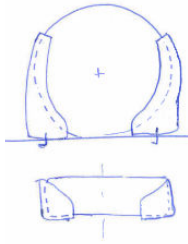

**SC 1.2.2 (Rank: 8): Wedge modification**

**Description:** This system is characterized by a rigid body in form of a shell. Its geometry is designed to adapt to and support different sizes of tires. It exceeds the lateral axis of the tire to restrain vertical force, which removes the need for lashing and blocking pads and transverse forces, with a wedge shape on the two sides of the tire. **Note:** Install 2 shells/wheel

**5.1.2 Application of the proposed approach**

We start with Solution Concept 1.2.2. The proposed approach in Section 5.2 is applied to this Solution Concept. Then we will resume with the Solution Concept 1.3.4 and 1.1.5 respectively. Detail of each major steps is as follows;

**5.1.2.1 Identifying**

Solution Concept 1.2.2 has been considered, the simplified model of it's system architecture was constructed and shown in Table 5-4. The object in this Solution Concept is classified into two groups (Group 1 and 2), same as the relations. Colors have been overlaid on the sketch to distinguish its influence level of objects and relations to the overall system.

Table 5-4. System architecture of Solution Concept 1.2.2

System model	Description
	<p><b>Object Group 1:</b> wheel, deck, hooks</p> <p><b>Object Group 2:</b> block</p> <p><b>Relation Group 1:</b> wheel-deck [surface contact], deck-hook [support &amp; fix], deck-block [surface contact]</p> <p><b>Relation Group 2:</b> hook-block [secure], block-wheel [secure]</p>

**5.1.2.2 Mapping**

The matrix to identify the ORL and RRL of Solution Concept 1.2.2 have been constructing and presented in Table 5-5. The determination of the Solution Concept

Readiness Level (SCRL) and Function-Failure Mode/Rate of the new element added into the system have been performed according to Eq. 5-1 and Eq. 5-2 respectively.

We repeat from Step I1 to Step M2 with the Solution Concept 1.3.4 and 1.1.5 respectively. Then we go to the *Ranking* step.

Table 5-5. Solution Concept Readiness Level and Function-Failure Mode/Rate

Solution Concept	Object list	Object Readiness Level	Relation Readiness Level	Solution Concept Readiness Level
	Wheel	$\begin{bmatrix} 5 & 5 & 5 & 2 \end{bmatrix}$	$\begin{bmatrix} 5 \end{bmatrix}$	$\begin{bmatrix} 3.16 \end{bmatrix}$
	Hook	$\begin{bmatrix} 5 & 5 & 4 & 3 \end{bmatrix}$	$\begin{bmatrix} 5 \end{bmatrix}$	$\begin{bmatrix} 3.04 \end{bmatrix}$
	Deck	$\begin{bmatrix} 5 & 4 & 5 & 3 \end{bmatrix}$	$\begin{bmatrix} 5 \end{bmatrix}$	$\begin{bmatrix} 3.04 \end{bmatrix}$
	Block	$\begin{bmatrix} 2 & 3 & 3 & 5 \end{bmatrix}$	$\begin{bmatrix} 2 \end{bmatrix}$	$\begin{bmatrix} 2.00 \end{bmatrix}$

Obj-1: wheel, deck, hooks  
 Obj-2: block  
 Re-1: wheel-deck [surface contact], deck-hook [support & fix], deck-block [surface contact]  
 Re-2: hook-block[secure], block-wheel[secure]

**Function-Failure Mode/Rate of new objects in the system**

Block-secure-wheel:  
 Secure solid – impact deformation – failure rate = 1.1E-3 Fails/MHours  
 $SC_{FFMR} = 1.1E-3$  Fails/MHours

**Changes ratio**  
 Change ratio = ratio of new objects/all objects  
 = (2/4) = 0.5

**5.1.2.3 Ranking**

The results obtained from previously steps will be mapped with the system engineering life cycle standard (ISO 15288:2008). The readiness level of each Solution Concept is normalized into 1. The failure rate is presented in the X-axis according to the three different colors. The diameter of each bubble on the chart is scaled from the changes ratio (the new element that considered as it has a potential failure function/total elements in system). The overall representation is like an SUN (Red dot) that has three different spectrums. The higher maturity Solution Concept will be placed near the SUN and its failure rate is placed into the specific spectrum.

The result obtained from this case study is illustrated in Fig. 5-6. For more comprehensive interpretation of the result, the sketch of them is placed along with its position on the diagram.

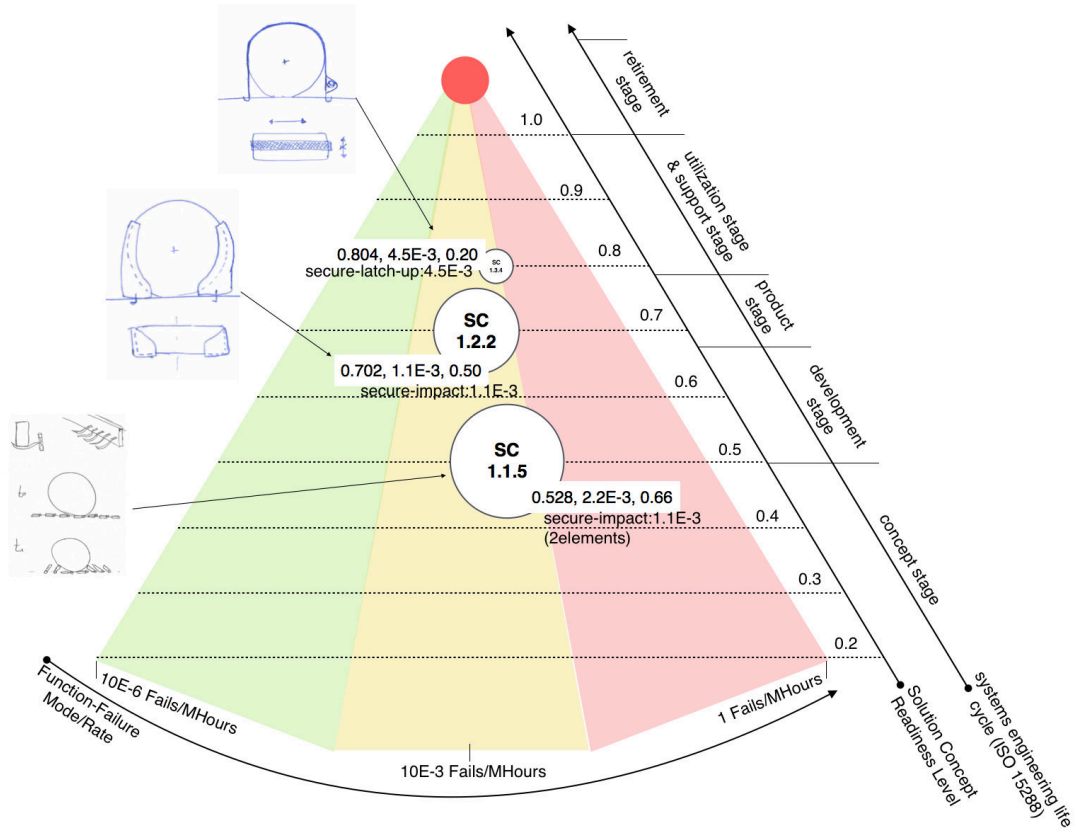

Fig. 5-6. System Readiness Level and Function-Failure Mode/Rate of Solution Concept 1.2.2, 1.1.5, and 1.3.4

From Fig. 5-6, Solution Concept 1.3.4 is represented as the highest readiness level, but it is a Solution Concept that has a highest failure rate. A gearbox is a new element will be added into the system of this Solution Concept, as well as the gearbox is considered as an existing artifact. But it seems to be contrasted to its failure rate, *the secure latch-up* function of an element from the database. It has a failure rate nearly red spectrum (quite high). There is a smallest change rate (1/5), as a result, it is the most readiness Solution Concept to be developed but its reliability of final development in term of its function failure is one of the issues to take into account while making a decision.

The position of SC1.2.2 and 1.1.5 is switched to the result obtained from IDM-based evaluation. This difference came from the influence of new objects added into the system and the relations between objects. In Solution Concept 1.1.2 only one new element will be added into the system, but Solution Concept 1.1.5 there at least new two elements. The results obtained presents the effect of changing of the new system. While there are many modifications in the system, the readiness level will reduce and the failure rate of elements will increase.

## 5.4 Discussion on IMR approach

As our approach is relied on the technical facts of the system, as each element and relation (physical connection, function) have been evaluated according to its abstraction level (knowledge). In addition, IMR approach provides the prediction of the successful of implementation (readiness) through both failure rate of potential functions and change rate of elements in the Solution Concept. Moreover, as IMR approach considers the level of integrality of a system, consequently, IMR approach can be used to evaluate a set of Solution Concept with a high variety degree. Ultimately, the evaluation and selection of Solution Concepts can be made in an acceptable time span. The complexity of Solution Concept is considered roughly through its knowledge, no need to make a fully analysis task same as the SME(s) approach in chapter 3.

We agree that the accuracy of evaluation and selection of the proposed approach is still depending on the expertise of the decision-maker. Anywise, we believe that the representation of result in this way must lead to an informed decision than the qualitative criteria solely. The future research in this area is focused on the testing and evaluating the IMR approach. A support software tool will be useful to serve this early evaluation and selection task. *Would be more logical and based on common sense to evaluate and selection Solution Concepts in multi-perspectives as illustrated by IMR approach?*

# Chapter 6

## Enhancement the Problem Formulation in Inventive Design with the aid of Simulation-based design methodology

*“Design is not just what it looks like and feels like. Design is how it works”*

— Steve Jobs

This chapter presents the used of simulation-based design (model-based and/or experiment-based approach) as the aiding tools for the initial situation analysis and problem formulation in Inventive Design perspective. The examples in each development are provided. This chapter ends with the discussion on the limitation and opportunity for future research in this area.

### Inventive Design Method

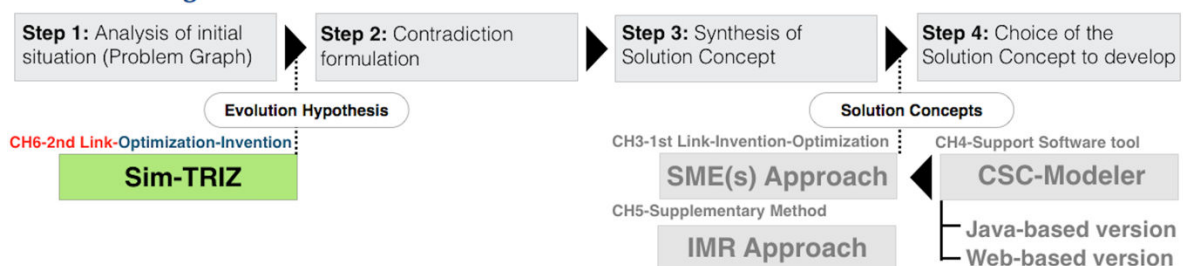

### 6.1 Reflection on technical background - literature surveys: #4

Engineering design method should integrate several design techniques/tools together in order to bring an impressive result. In the early phase of design, generally an open

session for conducting the creativities or inventive activities must be taking into account. The latter phases of design, several CAD/CAE tools will be used to evaluate, estimate, analyze, and improve the performance of the design concept.

Refer to the literature surveys mentioned in section 2.4.6, the synergy used of TRIZ is various in different domains (customer, function, parameter). It has synergy used with many design methods/tools, especially with axiomatic design [107,110,160]. The perspective of TRIZ with the axiomatic design is usually used to resolving the confliction of parameters in the design matrix. The application of TRIZ in the area of CAD/CAE is still limited, such as solving the problem of using CAD tools [111,112] or integration TRIZ in CAD tools for generating design concepts [113].

Presently, many good achievements of design engineering came from the advancement of CAD/CAE tools. More specifically, Multidisciplinary Design-Analysis and Optimization (MDAO)<sup>25</sup> framework. The example of this framework includes ModeFrontier<sup>26</sup>, and Isight Simulia<sup>27</sup>. These tools allow the designer to integrate multi design perspectives (structure, the dynamic behavior of the system, etc.) in order to evaluate, analyze and optimize the overall design results. Time span in design cycle is reduced and the integrability of over design is assured due to the aid of MDAO. In addition, many statistical tools and decision-making aids are also provided in MDAO tools. We note that in the design methods that using MDAO tools are simply referred to *simulation-based design*.

---

<sup>25</sup> MDAO is a field of engineering that uses optimization methods to analysis, and solve design problems incorporating a number of disciplines. It is also known as multidisciplinary optimization and multidisciplinary system design optimization (MSDO).

<sup>26</sup> <http://www.esteco.com/modefrontier>

<sup>27</sup> <http://www.3ds.com>

On the other hand, TRIZ-based design, precisely, Inventive Design Method: IDM has shown many advantage in analyzing the initial situation and proposing the method to solve an inventive problem systematically, it overcome the limits of routine design.

*It seems to be unfavorable?* In spite of the fact that CAD/CAE provides many tools and shows many advantages in design engineering same as IDM does. But importantly, the integration used of them is still lacking. The motivation of this chapter relies on the assumption that the integration of simulation-based design and IDM may bring an impressive result in someway.

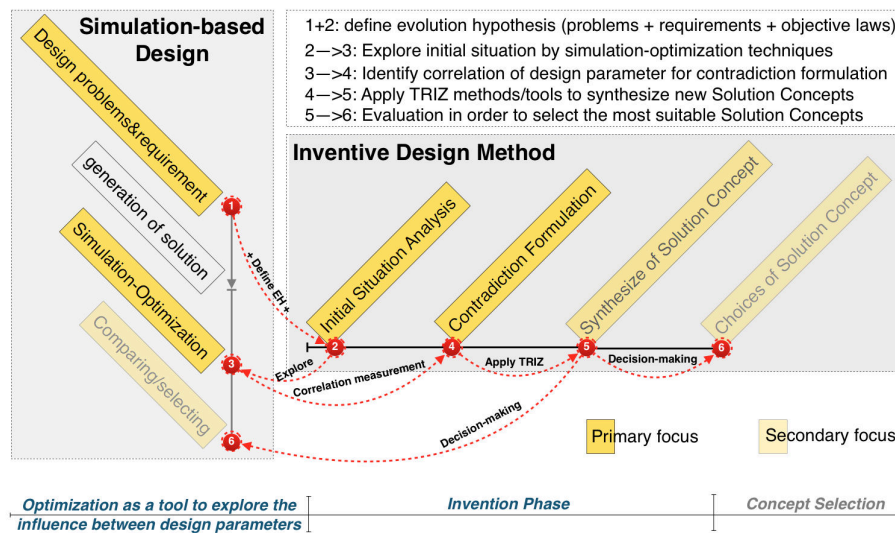

Fig. 6-1 Overview of the integration between IDM and Simulation-based design

Fig. 6-1 presents the overview of the proposed integration framework. As this framework is in the early stage of development. The overall content of this chapter will detail only the steps to enhance the problem formulation for IDM perspective (from step 1 to step 4 in Fig. 6-1). The result of this development is in the following sections.



## 6.2 Frame of Reference

First considering the design methodology model of simulation-based design and system completeness model of TRIZ-based design as shown in Fig. 6-2.

In simulation-based design, designer states the design problems and requirements, then generate the design concepts with the aid of routine design approaches (e.g. brainstorming, morphological chart, design matrix, etc.). Afterward, a simulation model of each design concept will be constructed. We note that the method to construct simulation model includes several modeling techniques, via a model-based design tools, or experimental approaches (e.g. DOE).

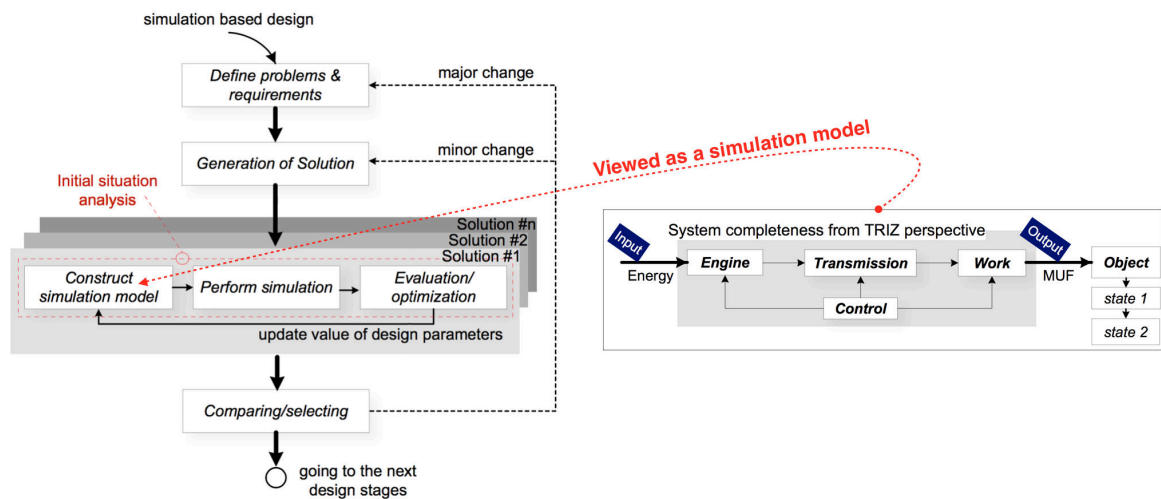

Fig. 6-2 System completeness of TRIZ in simulation-based design approach model

Next, simulation and optimization are performed to evaluate and optimize the design parameters. Simulation-optimization steps are resumed with other design concepts. In the latter stage, the most suitable design concepts will be selected and further developed in the next design phases. One of the advantages of simulation-based design is avoiding unfeasible design concepts pass through the selection stage. Furthermore, it provides a quantitative evaluation-selection, as design concepts have a parametrical model which is optimized to satisfy the common objectives. These common objectives are referred to the objectives in optimization problems that apparent in each design

concept. We note here, the quantitative evaluation-selection is only possible if there is a common objective between design concepts which means there is a slight difference between design concepts (variety degree is low).

System completeness of TRIZ-based design is a model used for identifying elements of artifact under observation. As depicted in Fig. 6-2, there are four main modules include engine, transmission, work, and control. In each module have several elements connected. For the reason to avoid ambiguous definition, we define its consistency as a module, not just an element. Modules in system completeness are derived from the observation on the artefact. From this statement, the designer has a possibility to access its CAD/CAE models that had been used during past design project. Additionally, the designer can perform any experiment to observe its behavior. This statement is the starting point of the proposed approach in this chapter.

According to Fig. 6-2, if the designer can access to CAD/CAE model of an artifact. This CAD/CAE model can be viewed as a simulation model that used in the simulation-based design. In the standpoint of integration used between simulation-based design and IDM (Fig. 6-1), simulation-optimization can be applied to explore its design space which tally to the design requirements (or evolution hypothesis) defined in the early design step. Subsequently, the correlation between design parameters are measured and the most influence design parameters will be used to formulate contradictions. Tools/methods of TRIZ will be used to synthesize a set of design concepts.

### **6.3 Development of the Sim-TRIZ contradiction system model**

In the viewpoint of this chapter, a system completeness model has been represented as a system, a sub-system or an element in the system architecture design model. This architecture has been derived from [134,149,153] as shown in Fig. 6-3. Between

hierarchical is linked by a relation. The Relation is referred to the physical part of the conjunction or the integration that can send or receive data and/or actions between elements. The product of this conjunction provides an effect. The Effect is defined as an outcome of an action in a system, mechanism, which is based on a natural (physical) phenomenon.

The proposed model depicted in Fig. 6-3 presents the system of the contradiction in the viewpoint of simulation-based design. In each module of system completeness (engine, transmission, work, and control) consists of elements, (for example, the element of Control Module is annotated as E-C<sub>x</sub>) that characterized by two typologies of the parameter. The roles of parameters can be an Action Parameter (AP<sub>x</sub>-C<sub>x</sub>), or an Evaluation Parameter (EP<sub>x</sub>-C<sub>x</sub>). In this model, roles of parameter are not specified in the early stage. The parameters of each element may have relations with others parameters indifference elements in the same module and/or with other parameters in other elements, other modules.

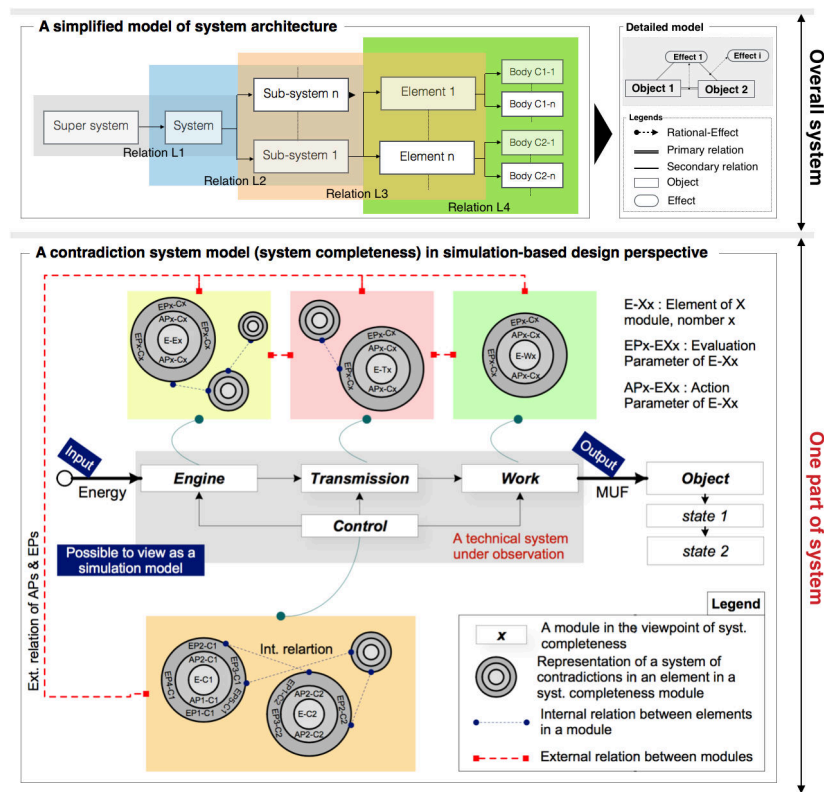

Fig. 6-3 The Sim-TRIZ contradiction system model (system completeness viewpoint)

In IDM framework, during the problem formulation, the roles of parameters (action or evaluation) have been specified at the beginning. The important of parameters is defined depending on the specific scenario or strategy by design team. In addition, the interaction of element in the system is viewed via the problem graph. The context of problem formulation in IDM is grounded on the standpoint of observation and expertise of design team.

Oppositely to the proposed approach in this chapter. The assumptions that we posed for this chapter is according to the model developed in Fig. 6-2 that include:

- a. The important of parameters should be identified via their interaction of elements in its whole system architecture,
- b. Roles of parameters are changeable (from action to evaluation and inversely) in order to explore other problem standpoints.

Regards to these two assumptions, we have proposed an approach to enhance the problem formulation in the inventive design perspective. Our result will present in the following section. *We note that the proposed approach is intended to investigate other lookouts of initial situation analysis and problem formulation (contradiction) not to argue with IDM framework.*

## **6.4 Development of the approach**

The proposed approach has been intentionally used as an additional tool to analysis the initial situation. It provides an approach to explore the design parameters of a technical system under observation. The correlation between elements is identified with the aid of statistical methods. A set of parameters and relations will be used for formulating a contradiction. Consequently, the techniques and tools in TRIZ will be used to resolve the contradiction and synthesize the new solutions. We base our approach on:

- 1) The technical system under observation has a simulation model or there is a possibility to perform an experiment on the physical object.
- 2) Requirements, needs, or customer preferences are considered as a part of *evolution hypothesis* which is the expectation of the being designed technical system

Fig. 6-4 presents the proposed approach; whose intent is to enhance the problem formulation in Inventive Design perspective. It consists of five steps and the details of each major step are described below:

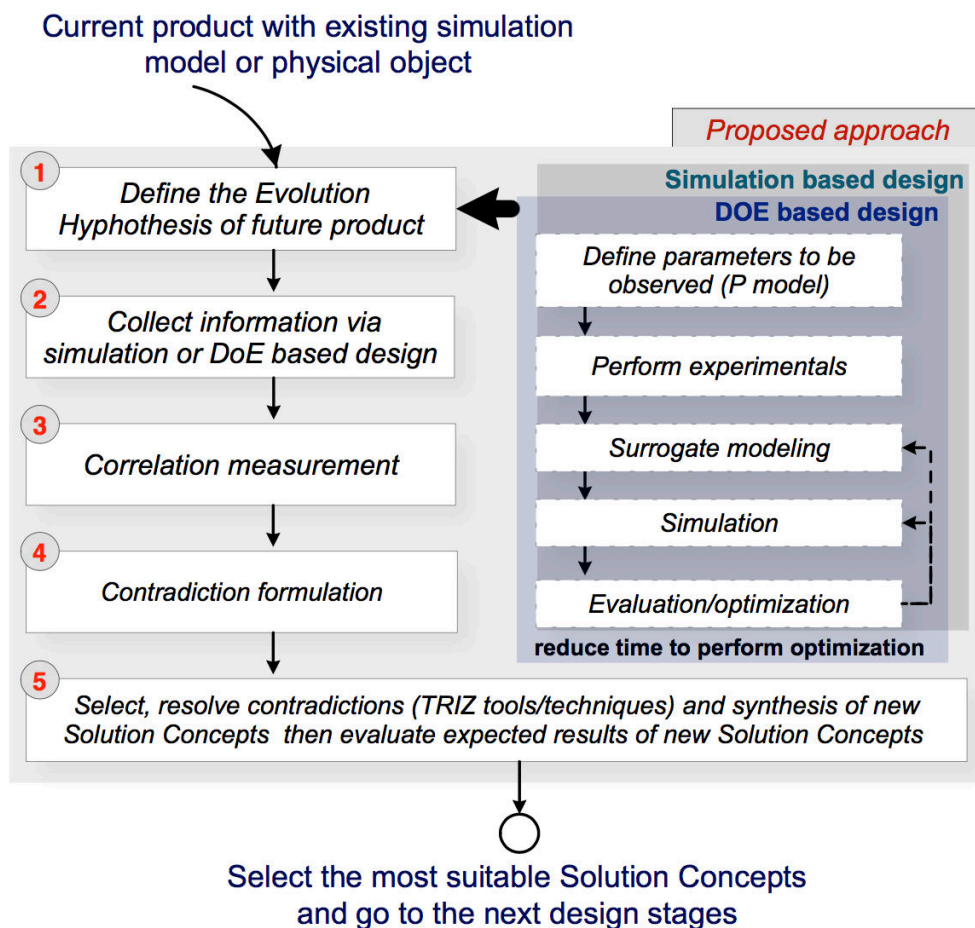

Fig. 6-4 An approach to enhance problem formulation in Inventive Design with the aid of simulation-based design

### 6.4.1 Define Evolution Hypothesis

Customer preferences, technical specifications, and any requirements are combined and used to identify the evolution hypothesis of the new technical system. In this step, multi-screen of TRIZ can be used as a tool to analysis the trends of technical system under consideration. Additionally, the laws of evolution of the technical system will be used as a guide to define the evolution hypothesis. Designers evaluate the importance of each evolution hypothesis and select adequate ones, then go to Step 2.

### 6.4.2 Collect information

In this step, information of the technical system is observed and collected. The ways to perform this step is divided into two scenarios:

#### 6.4.2.1 Experiment-based

If designer there is a possibility to access the physical object (technical system), an experimental technique will be applied to analyze and collect information. The designer starts with specifying the scope of observation by identifying the set of input/output parameters and control/uncontrolled parameters of the system. The Parameter-diagram (P-diagram [161]) is used to represent these parameters. Then designers associate parameters with the evolution hypothesis identified in Step 1 (section 6.4.1).

Designer performs the experiment to collect information. We note that the number of experiments depends on techniques used (e.g. full-factorial, half-factorial, random, etc.). If cost and time to perform an experiment are limited, the *surrogate modeling techniques* [52] will be used to construct the simulation model (Response Surface Model: RSM). Lastly, designer performs the simulation to explore the design space with the aid of optimization techniques. An integration platform for multi-objective

and multi-disciplinary optimization (MDAO) will be used to construct the surrogate model and perform the exploration. The examples of the platform are mentioned in section 6.1.

#### **6.4.2.2 Model-based**

If the designer has a simulation model in hand, they perform the simulation and collect the information. On the other hand, in the new design project, designer constructs the simulation model with the aid of CAD/CAE and performs the simulation afterward. The methods to construct the simulation model is varied and depended on the characteristic of the system under observation (dynamic problem, structural, magnetic properties, etc.).

In all two scenarios, the formulation of an optimization problem is defined to have a high degree of flexibility. The boundary of design variables is roughly defined and all constraints are soft constraints. In this thesis, optimization has been used to explore the design space of the technical system and not intends to find the optimized values.

#### **6.4.3 Correlation measurement**

From the information in Step 2, designer analysis the correlation between design parameters. The classical statistic tools (i.e. Correlation matrix, t-student) have been used in this step. The selection of a set of parameters to analyze is associated with the evolution hypothesis in Step 1.

The correlation matrix is the advantageous classical statistical tool, which evaluates the correlation coefficient between a pair of variables. The range of correlation is from +1 to -1, which reveals the strength of correlation. A zero value means lack of correlation.

#### 6.4.4 Formulate contradictions

With the aid of correlation matrix analysis in the previous step, designers identify the possible set of contradiction regarding the model in Fig. 6-3. The parameters that have a strong correlation to each other will have been considered first. A number of contradictions will be formulated in this step.

#### 6.4.5 Synthesize of new Solution Concepts

The designer selects the most relevant contradictions to resolve with the aid of techniques/tools of TRIZ. The most relevant contradiction may consider from the viewpoint of evolution hypothesis defined in Step 1. We note that, the contradiction that formulated from a set of highest correlation parameter is not the high impact choice in all case, it depends on the scenarios or objectives of the design project.

The synthesis of Solution Concepts is depending on the number of contradiction selected. After a set of Solution Concepts has been generated, designer evaluate and select the most suitable ones to study in details and moving to the next design stage (embodiment, detailed design respectively).

In order to demonstrate the overall design approach, two cases study are provided in the next sections. The re-design of a Mini-USB fridge in section 6.5 will be used for demonstrating the viability of proposed approach in the experiment-based scenario. Section 6.6, the case of a solenoid actuator will be used to illustrate the proposed approach in the model-based scenario. Detail of each case study is:

### 6.5 Case example 1: Redesign of the Mini USB-Fridge

In this section, the *experiment-based scenario* will be illustrated by the re-design of a Mini USB-Fridge case. The general context of this design project and the application of proposed approach are:



### 6.5.1 General context of Mini USB-Fridge

The overall view of the Mini USB-Fridge is shown in Fig. 6-5. The thermoelectric (datasheet of TEC1-1270240 is in **Appendix D**) module is a core component. This module is attached with a heat sink and a cooling plate. A simple control board is supplied by DC-current source. An LED connected with this board is used to show the status of the fridge. The fan will operate when the temperature reaches its set point. According to the datasheet of the thermoelectric module, the maximizing of cooling capacity is made by controlling the different temperature between hot and cool side. Unfortunately, it seems to be lacking fully control in the current product (Fig. 6-5(b)). The sensor or control loop are not integrated into this product.

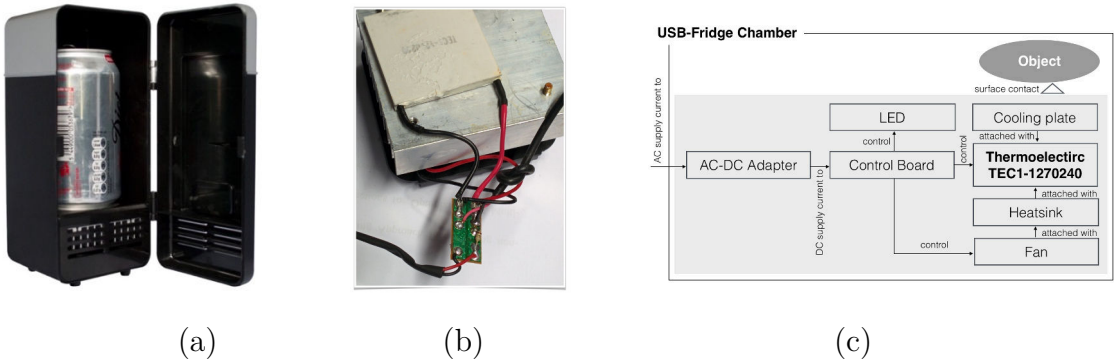

Fig. 6-5 Mini USB-Fridge (a) current product, (b) a simple control board, and (c) a simplified system architecture model

The product description is:

- 1) Easy installation, no driver required, plug and play. Powered by USB cable with a switch to a USB port located on your PC prior, no batteries required. Internal LED Light.
- 2) Compatible with all platforms. Dimension: 19 x 58 x 39.4cm.

### 6.5.2 Application of proposed approach

The evolving of information in each step of the proposed approach is described in this section:

#### *Step 1: Define evolution hypothesis*

Evolution hypothesizes of this re-design project are combined from 2 viewpoints:

- 1) Requirements in changes:
  - a. No change in the external dimension (keep current external structure)
  - b. Making a small change in term of elements added into the new system. For example, using a single thermoelectric, using the old control part.
- 2) Requirements from the user/customer specifications:
  - a. Energy efficiency (well-organized flow of energy)
  - b. Speed for cooling down
  - c. Extending temperature range for cooling down

While considering the requirements with the laws of evolution of the technical system, the evolution hypothesizes are relying on the system completeness, energy conductivity, and harmonization. These hypotheses are related to several design parameters, such as input current supplied to the thermoelectric module, the on/off status of the cooling fan, and the insulation between the fridge's chamber and the environment.

Several solutions can be applied directly, for example, add some insulation into the fridge's chamber, change the control board within a temperature sensor to measure the actual temperature and regulating the input current of the thermoelectric module. However, these existing solutions have been applied to the higher grade of Mini USB-

Fridge. *Except these solutions, there is another viewpoint that we can apply and satisfy the design requirement predefined?*

*Step 2: Collect information*

In this step, an experiment will be performed. Fig. 6-6 shows the P-diagram of mini USB-Fridge under observation. A snippet of data collected is presented in Fig. 6-7. The object in this experiment is a can of Coca-Cola 330ml.

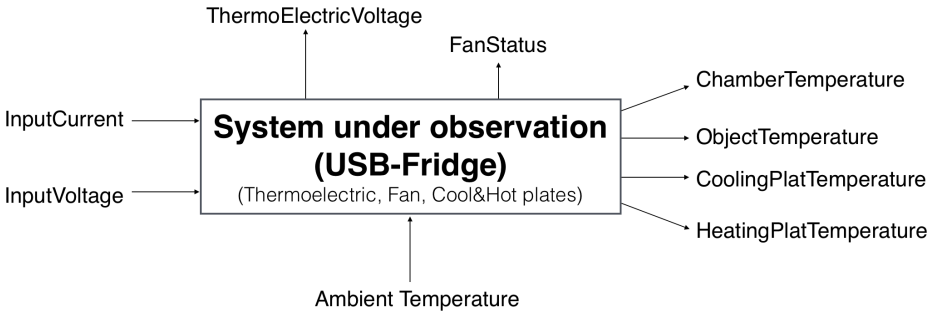

Fig. 6-6 System under test and collect information

ambient temperature	Temperature-Hotside	Current input	Dif Temp (hot-cool)	Voltage input	Cooling capacity	chamber Temp	Object Temp
30	27	2	0	7.8	25.5	13	7
30	27	2	10	8.2	21.5	14	7.5
30	27	3	10	12.5	27	13	7
30	27	3	60	15.5	5.1	17	8.6
30	50	2	20	9	20	13.6	8.2
30	50	3	20	13	28	12	7.3
30	50	3	50	14.7	14	14.5	8.4

Fig. 6-7 A snippet of data collected from performing the experimental

Next, data collected in the previous step is used to construct the surrogate model. The objective of this surrogate model is to minimize time and resources needed to perform the experiment. The surrogate model of Mini USB-Fridge is presented in Fig. 6-8. The Kriging<sup>28</sup> algorithm is used to create this model under ModeFrontier platform. We

<sup>28</sup> In statistics, originally in geostatistics, Kriging or Gaussian process regression is a method of interpolation for which the interpolated values are modeled by a Gaussian process governed by prior

note that details on surrogate modeling are not provided in this thesis. A comprehensive reference on the application of surrogate modeling in engineering design is provided by Forrester et al. [162].

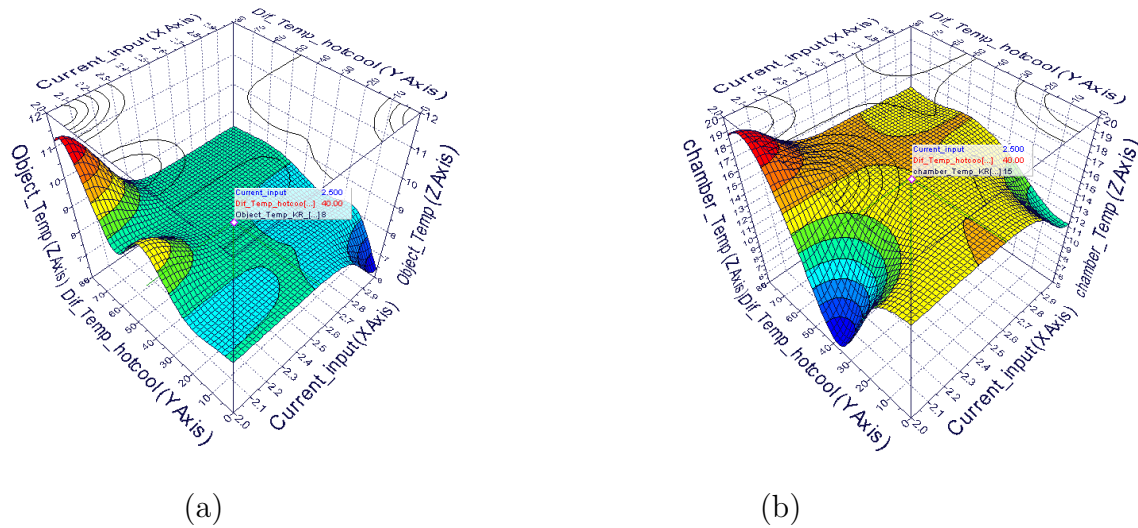

Fig. 6-8 Response surface model of Mini USB-Fridge, (a) Object Temperature, and (b) Chamber Temperature

From Fig. 6-8, the temperature of the object (a can of Coca-Cola) is a function of the input current and different temperature between the hot-cool side of thermoelectric module. The minimum point is 8°C with the current input is 2.5A and the temperature of chamber is 15°C. With this surrogate model, designer set up the simulation-optimization network to explore the large design space of the Mini USB-Fridge. And go to the next steps.

### *Step 3: Measure the correlation of design parameters*

The correlation between design parameter collected from previous step is measured and shown in Fig. 6-9. This measurement has been made under Modefrontier platform with Pearson correlation.

---

covariances, as opposed to a piecewise-polynomial spline chosen to optimize smoothness of the fitted values. Source: <https://en.wikipedia.org/wiki/Kriging>

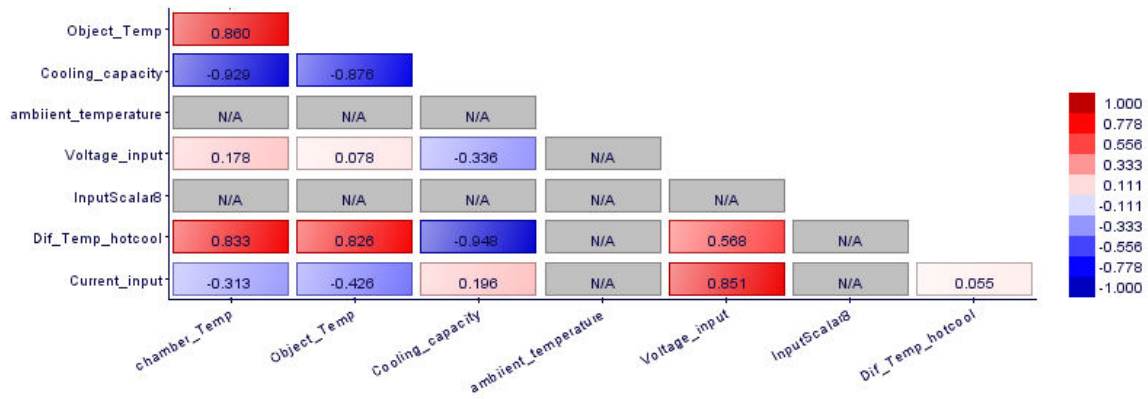

Fig. 6-9 Correlation between design parameters of Mini USB-Fridge

From correlation matrix presented in Fig. 6-9, the temperature of object is positively correlated with temperature of chamber. On the other hand, cooling capacity has a negative correlation with the different temperature between hot-cool side of thermoelectric module. From this correlation, designer can be used as a guideline to formulate a contradiction that correlate to the real behavior of the system under observation.

*Step 4-5: Formulate the contradictions and synthesis of new Solution Concepts*

If we focus on the temperature of the object to be cooled. Chamber’s temperature is a more correlate design parameter to be concerned. This design parameter is related to the structure of the Mini USB-Fridge. The possible contradiction may be formulated by this pair of Evaluation Parameter “*Chamber’s temperature – Shape of Chamber*” which is related to the Action Parameter: *surface area of cooling plate* (Fig. 6-10). With the contradiction matrix between temperature and shape is suggested to apply the *inventive principle #14: Spheroidality – curvature* which suggest using curvilinear instead of using rectilinear parts. With this suggestion, we can think about the form of insulation to put inside the chamber that may lead to a better result.

From the aid of proposed approach and results obtained in Fig. 6-9. There are several viewpoints to formulate contradictions, such as, focus on the cooling capacity which

is positively correlate with the different temperature between the hot-cool side of the thermoelectric module, the relation between input voltage and current of thermoelectric module, etc. The problem formulation is more flexible and wider than the classical TRIZ-based approach. An example of the system of contradiction regards to the model developed in section 6.3 is presented in Fig. 6-10.

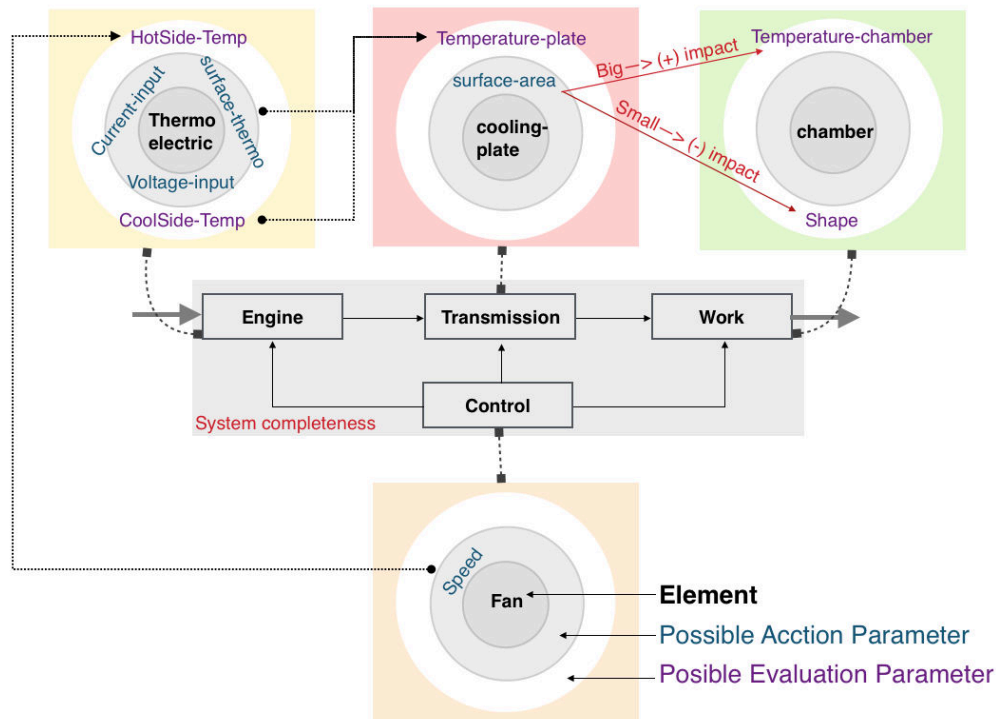

Fig. 6-10 System of contradiction model from simulation-based perspective: Mini USB-Fridge case study

It is true that the solution proposed with the experiment-based scenario is not different from the classical solution. This is according to the scope of observation that there are a few design parameters have taken into account. However, the proposed approach seems to assure the effect of the interaction of the system and provide several directions to focus on. We believe that within a more complex case, this approach will be useful and for sure it will reveal differences while comparing to the classical problem formulation in the inventive design perspective. A complex case study is one of our future research direction in this area.

## 6.6 Case example 2: A solenoid actuator design

In this section, a re-design of a simple solenoid is used to illustrate the viability of proposed approach in the *model-based scenario*. The details and remarks of this case study are presented along with the proposed approach.

### 6.6.1 Context of the design project

Linear solenoids are electromechanical devices which convert electrical energy into a linear mechanical motion used to move an external load a specified distance. Current flow through the solenoid coil winding creates a magnetic field which produces an attraction between a movable plunger and a fixed stop. When electrical power is applied, the solenoid's plunger and its external load accelerates and moves toward the solenoid's stop until an impact occurs. The plunger rides inside the core of the coil assembly. This core may be either a plastic bobbin or a non-magnetic metallic guide.

Removal of power from the solenoid eliminates the current flow through the coil. The plunger, with its external load, returns to the rest position, aided by a return spring, gravity, or the load itself, which could also be spring loaded. In some cases, when the solenoid is energized and in the seated position, the only load might be that of the plunger plus the opposing force of the compressed spring.

Some criteria in selecting a solenoid include:

- 1) Minimum force required at a specified maximum stroke
- 2) Available electrical input power, duty cycle
- 3) Maximum solenoid envelope dimensions

Fig. 6-11 (a) shows an open frame solenoid actuator that will be used as case study in the model-based scenario.

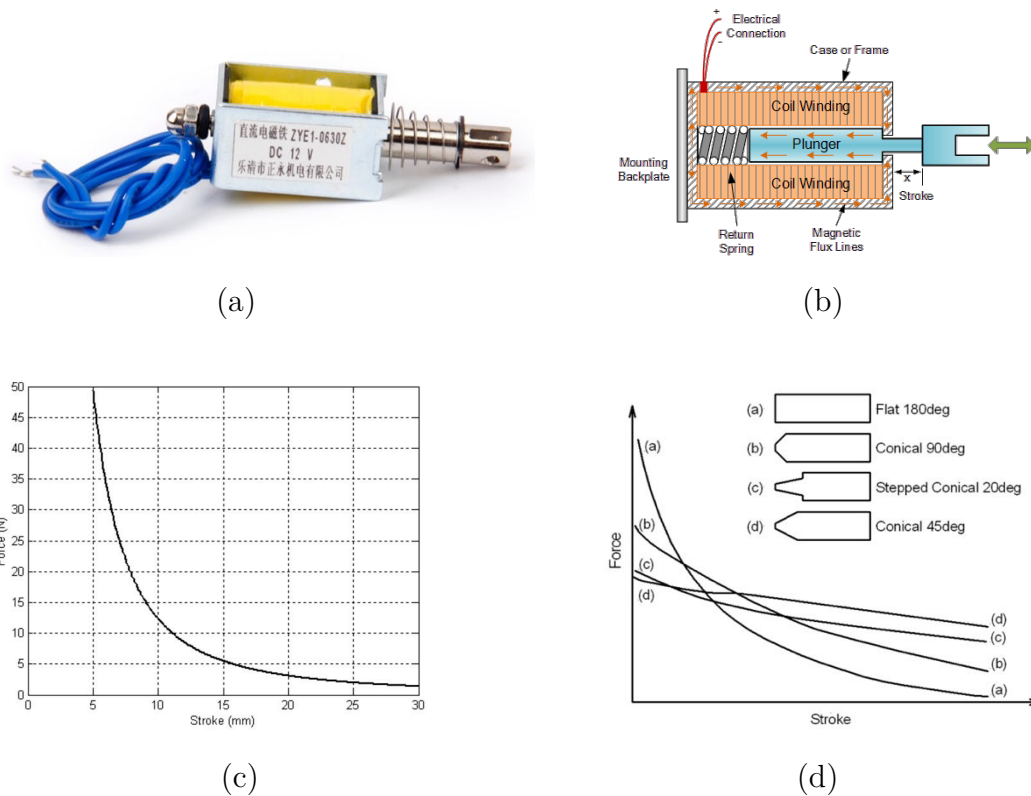

Fig. 6-11 The simple solenoid (a) actual product, (b) Cross section diagram<sup>29</sup>, (c) force-displacement characteristic, and (d) example of plunger shape

### 6.6.2 Application of proposed approach

The evolving of information in each step of the proposed approach is described in this section:

#### *Step 1: Define evolution hypothesis*

The main objective of this re-design project is to improve the overall performance of solenoid. The construction, magnetic efficiency, and others criteria to select solenoid have been taken into account. Therefore, energy conductivity is the evolution hypothesis that we used to define other design requirements. The improvement of energy conductivity will affect several characteristics of solenoid, such as, reduce

<sup>29</sup> Source: [http://www.electronics-tutorials.ws/io/io\\_6.html](http://www.electronics-tutorials.ws/io/io_6.html)



leakage energy in the magnetic circuit, minimize the force required at maximum stroke and responding time of solenoid.

$$F = \frac{dW_{mag}}{dl_g} = \frac{\mu_o N^2 I^2 A_g}{2l_g^2} \tag{Eq. 6-1}$$

The mechanical force generated from magnetic energy is described by Eq. 6-1. In order to maximize the force, the gap length ( $l_g$ ) is minimized, turn number and cross section area of the coil, and input current are maximized. Unfortunately, maximizing these variables is limited by the whole construction of the solenoid. The relation of force and displacement of solenoid is very nonlinear. The first-order approximation is like an exponential decay as illustrated in Fig.6-11(c).

As minimizing force required at the maximum stroke is one of the desired solenoid. According to its force-distance characteristic, designer can alter slightly by shaping the gap between plunger and winding coil. Several shape of the plunger can be used; such form of the plunger is shown in Fig. 6-11(d).

If we applied TRIZ-based design here, a contradiction can be formulated. The number of turn of winding coil (N) has a positive impact to the mechanical force (F) if N is set as the action parameter (max, min). On the other hand, the implementation of a huge number of winding coil into the solenoid frame is limited. From this statement, a contradiction can be formulated and then possible to apply TRIZ tools/techniques to resolve and generate a solution. This situation presents an advantage of parametrical model. Its existing can assist designer to scope down the research space, but it may force the designer to stick on the old solution.

*Step 2: Collect information*

A simulation model in this case study is presented in Fig. 6-12(a). This model is an example in OpenModelica<sup>30</sup> platform. It formulated in Modelica<sup>31</sup> language. The system of equation for this simulation is 194 equations, and there are 194 variables in the system. The simplified model of the solenoid is presented in Fig. 6-12 (b).

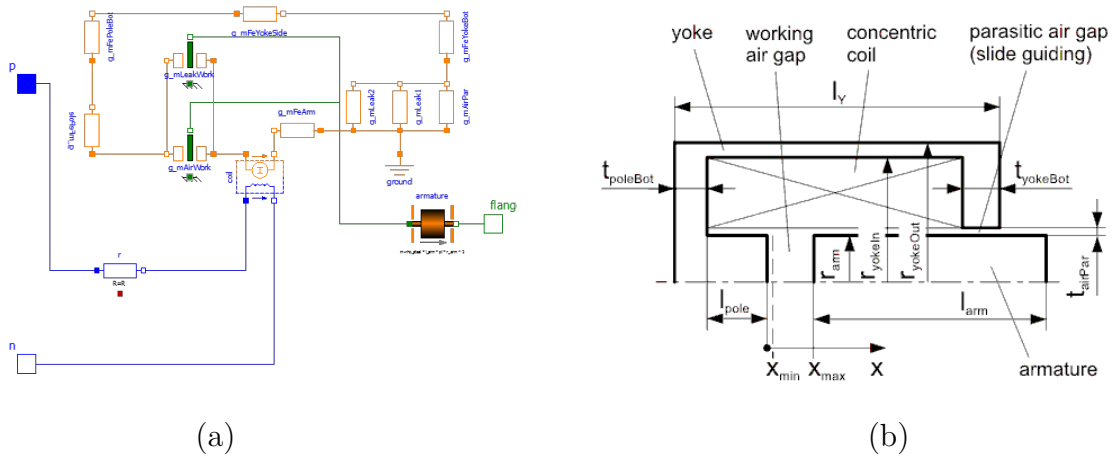

Fig. 6-12 (a) Simulation model and (b) Simplified model of a solenoid actuator in Openmodelica environment (More info in **Appendix B**)

At this point, the evolution hypothesis will be used to scope down a set of design parameters to be observed. Subsequently, the simulation-optimization will be performed to explore the behavior of the solenoid actuator. Fig. 6-13 shows the snippet of some interesting variable that will be used to formulate the optimization problem. Minimizing cut-off force, and maximizing the flux density while the overall dimension of solenoid actuator (Fig. 6-12(b) is defined as a soft constraint. The simulation-optimization has been performed afterward and go to the next step.

<sup>30</sup> Openmodelica is an open-source Modelica-based modeling and simulation environment intended for industrial and academic usage. <https://openmodelica.org>

<sup>31</sup> Modelica® is a non-proprietary, object-oriented, equation based language to conveniently model complex physical systems. <https://www.modelica.org>

mass1.L	0.1	Length of component, from left flange to right flange (= flange_b.s - flange_a.s)	Real	Input
mass1.m	0.01	Mass of the sliding mass	Real	Input
mass1.stateSelect		3 Priority to use s and v as states	Integer	Input
simpleSolenoid1.N	957	Number of turns	Real	Input
simpleSolenoid1.R	10	Armature coil resistance	Real	Input
simpleSolenoid1.g_mAirWork.A	7.85398163397448e-05	Cross-sectional area orthogonal to direction of flux	Real	Input
simpleSolenoid1.g_mLeakWork.r	0.003	Radius of leakage field	Real	Input
simpleSolenoid1.r_arm	0.005	Armature radius = pole radius	Real	Input
stepVoltage1.V	10	Height of step	Real	Input
simpleSolenoid1.armature.mass.m	1	Mass of the sliding mass	Real	Input
simpleSolenoid1.material.n	12.5	Exponent of approximation function	Real	Input
simpleSolenoid1.g_mAirPar.B	0	Magnetic flux density	Real	Output
simpleSolenoid1.g_mAirPar.H	0	Magnetic field strength	Real	Output
simpleSolenoid1.r.LossPower	0	Loss power leaving component via HeatPort	Real	Output
simpleSolenoid1.armature.L	0	Length of component from left flange to right flange (= flange_b.s - flange_a.s)	Real	Input
simpleSolenoid1.armature.c	100000000000	Spring stiffness between impact partners	Real	Input
simpleSolenoid1.armature.d	20000000	Damping coefficient between impact partners	Real	Input
simpleSolenoid1.armature.m	1	Armature mass	Real	Input
simpleSolenoid1.armature.mass.L	0	Length of component, from left flange to right flange (= flange_b.s - flange_a.s)	Real	Input
simpleSolenoid1.armature.mass.stateSelect	3	Priority to use s and v as states	Integer	Input
simpleSolenoid1.armature.n	2	Exponent of spring forces (f_c = c* s_rel ^n)	Real	Input
simpleSolenoid1.armature.stopper_xMax.c	1	Spring constant	Real	Input
simpleSolenoid1.armature.stopper_xMax.d	1	Damping constant	Real	Input
simpleSolenoid1.armature.stopper_xMax.n	2	Exponent of spring force (f_c = -c* s_rel-s_rel0 ^n)	Real	Input
simpleSolenoid1.armature.stopper_xMax.s_nominal	0.0001	Nominal value of s_rel (used for scaling)	Real	Input

Fig. 6-13 The snippet of parameter list used in performing the exploration

*Step 3: Measure the correlation of design parameters*

The correlation between a number of parameters (input/output) is measured and the correlation matrix is presented in Fig. 6-14. The flux density is positively correlated to the coil resistance. On the other hand, the loss power has a negative correlation with the flux density. According to the selection of a set of parameters, as a result, information in Fig. 6-14 does not reveal a significant meaning. However, it still has some interesting point to discuss. According to the Eq. 6-1 and the possible solution mentioned in step 1. Maximizing flux density is directed to the number of the winding coil but from the correlation matrix, flux density is positively correlated with the resistance of winding coil. With this result obtained, it may suggest designer into another viewpoint of searching solution.

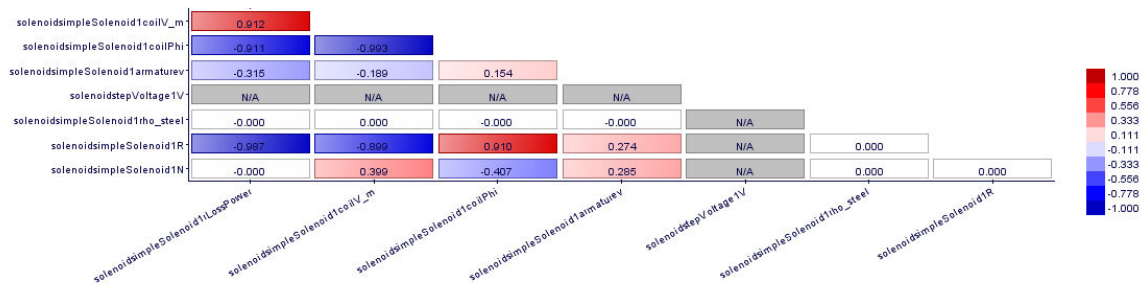

Fig. 6-14 The correlation matrix of some design parameters: A solenoid actuator

#### *Step 4-5: Formulate the contradictions and synthesis of new solutions*

According to the correlation matrix, resistance of the winding coil is considered as an action parameter that has a positive impact on flux density. Besides, it poses a negative impact to the structure (limit in structure) of the solenoid actuator. Decreasing resistance means to increase the diameter of the winding coil. A pair of evaluation parameter, in this case, is “*Productivity – volume of stationary object*”. With the contradiction matrix, the designer can apply inventive principle #35 to resolve this contradiction.

However, according to the low complexity of this case study which have only three sub-elements integrated. The result obtained is not reveal a significant meaning. For evaluation and validation this proposed approach in the model-based scenario, the complex case study is one of our future direction.

### **6.7 Discussion on problem formulation with the aid of simulation-based design**

In the experiment-based scenario, the case study does not expose many differences between the results mentioned in the early steps and result proposed by the experiment-based. The limitation is on the specifying design parameters as the P-diagram. Only a few parameters have taken into account. In order to evaluate and validate this proposed approach, a more complex case is one of our future research direction in this area.

The role of parameters is changeable as revealed in the case of Mini USB-Fridge and presented in Fig. 6-10. This change leads to the new problem model. Consequently, in order to resolve this problem another solution model will apply. The design freedom is increased via this changeable viewpoint.

In the model-based scenario, the used of model from CAD/CAE tool shows some advantage as it can represent all design parameters that related to the actual behavior of the system under observation. The real interaction of design parameters is lead to another viewpoint. As presented in the case study, not the turn number of winding coil is related to the flux density but it is the resistance of winding coil. However, this resistance is related to the number of turn number. Moreover, the existing of parametrical model of a technical system can suggest designer to another research space also. The evaluation and validation of model-based scenario are one of our future research directions.

The difference scope of information that evolving in each step of proposed approach is presented in Fig.6-15. The scope of the result (design concept) is represented under the scope of design problems, preferences, and requirements.

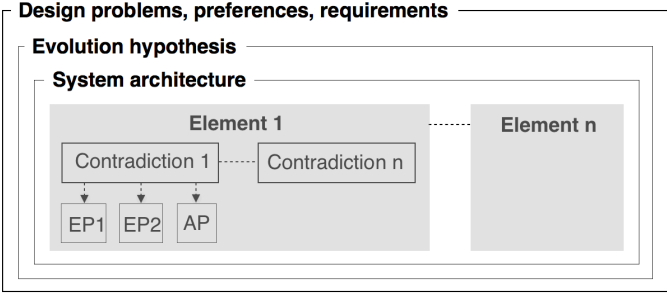

Fig. 6-15 Difference scopes of information evolving of proposed approach

The proposed approach is combined the open session in specifying the evolution hypothesis and also stay in the real facts of the technical system. The used of CAD/CAE is made design traceable. The overall step is seeming to be an option to answer the desired design methodology stated in section 2.1.5

# Chapter 7

## Conclusion and Perspective

*“In every branch of knowledge the progress is proportional to the amount of facts on which to build, and therefore to the facility of obtaining data”*

— James Clerk Maxwell

### 7.1 Thesis Conclusion

Referring to the title of this thesis its aims was to build the link between invention and optimization in the inventive design perspective. The main objective of this link is to develop an effective and efficient evaluation and selection framework for inventive design. We want to prevent the rejection of good Solution Concepts and to screen out unfeasible ones as early as possible during concept selection stage. Moreover, we want to investigate other viewpoints to enhance the performance of the inventive design. From the overall content of this thesis (Fig. 7-1), two links have been formulated and its conclusion of each link is:

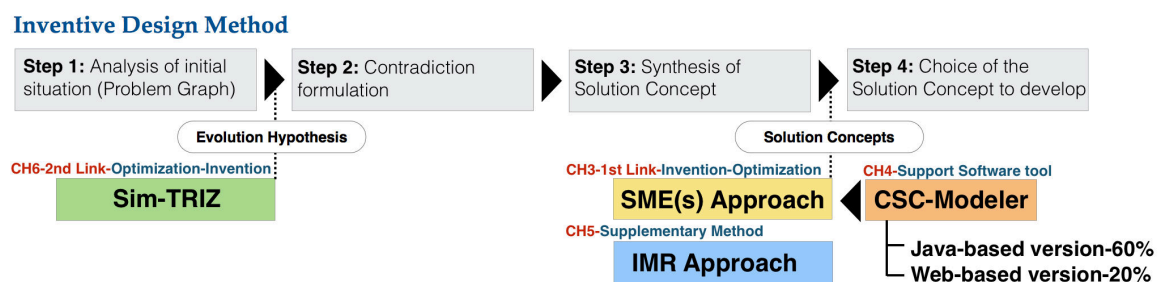

Fig. 7-1 Positioning of contributions in the Inventive Design Method perspective

*The first link (**Invention-Optimization**)* is formulated to raise the confidence of decision-makers in evaluating and selecting Solution Concepts. This link is applying optimization as an exploration tool to estimate/explore the technical feasibility of a Solution Concept before performing any decision. **SME(s) approach** (Chapter 3) and **CSC-Modeler** software (Chapter 4) have been developed to serve in this area. In Chapter 4, a wheel's car blocking system case revealed the border of expert's opinion in judging a Solution Concept. The viability of SME(s) approach and CSC-Modeler are presented along with a case study. Time and sources of error for formulating an analysis model in SME(s) approach and CSC-Modeler are major issues to be concerned. An approach or several steps to eliminate the error is one of the research perspectives in future work for the first link.

In addition to the first link, as SME(s) approach can be used in specific conditions and still have limitations. The **IMR approach** (Chapter 5) has been proposed to provide another standpoint in evaluating and selecting Solution Concepts. SME(s) approach is trying to reduce uncertainty in concept selection by estimating beforehand its feasibility. On the other hand, IMR approach treats a Solution Concept via the completeness (object, relation) of its whole architecture. This completeness represents the readiness of a Solution Concept to be further developed. The level of abstraction of object and relation in a Solution Concept are evaluated via a rough scale of knowledge representation. A potential function failure mode/rate of the object is one of evaluation criteria that IMR approach take into account. IMR approach has been proven to be an effective and efficient concept selection approach. But, in order to deeper evaluate and validate this approach, many tests need to be conducted.

*The second link (**Optimization-Invention**)*, a new design approach presented in Chapter 6 is an integration used of optimization in the invention phase. This approach is mainly used in re-design project, therefore not limited to new design project. As working on re-designing an artifact, the designer has a possibility to access an existing

simulation model or physical object. In this way, it allows designer to explore the behavior of the artifact through simulation. Optimization in this link is used for exploring the design space of a simulation model (constructed from model-based approach or experiment approach). Regarding the MDAO framework that allows the designer to modify simulation model easily, according to the artifact's behavior can be observed in different aspects. With the obtained result, the designer can start the invention phase by identifying the most relevant design parameters of the design project. Subsequently, the designer can use these parameters to formulate a set of contradictions. The resolving of the contradiction that have a strong influence to the overall system may bring more widely accepted solution. However, this statement is not properly confirmed yet in this thesis. This is why we put our motivation in this area as well.

The contributions of this thesis still have some limitations and need to be further addressed as mentioned in the end of each chapter. Last, we hope that this thesis will be used as a reference to initiate other research works in the area of inventive design or in the engineering design research communities.

## **7.2 Perspective**

The work initiated in this thesis will continue its development. The question of *evaluation and validation* of the proposed approaches and support software tools is one of the directions of future research work. The overall improvement of contributions is shaped by this evaluation and validation.

First, the effort will be put to the development of CSC-Modeler, major functionalities have to fully implement. This development includes both java-based version and a web-based version. The evaluation of SME approach will be made by conducting the test with a number of case study both in academia and industry. The validation in



this area will provoke several improvements regarding SME approach and CSC-Modeler.

Another perspective of SME approach relies on the screening step. The research hypothesis of this step is related to an ideas screening step. By using the combination of criteria from TRIZ standpoints and analysis aspects to measure the maturity of a Solution Concept. Resolving of contradiction, a number of useful and harmful function, and analysis aspects identified via the screening step are example of criteria that may be used.

A support software tool will be developed in order to evaluate the IMR approach. This support software tool should integrate the functional database that relates to the function failure mode/rate database. In addition, other functionalities will be taken into account to facilitate the used of IMR approach and also ensure the accuracy of results when using IMR approach. The validation of this approach will result in several improvements. These improvements will be made according to the feedback of many conducted cases study.

The comparative study will lead to validate the two proposed approaches. In each case study, the concept selection task will be performed by a classical approach, IDM-based approach, also by SME(s), and IMR approach. However, it is hard to anticipate which approach is better than the others until full implementation of Solution Concepts can be made and tested.

The perspective of the design approach in Chapter 6 is focused on the automatic association of design preferences and requirements with laws of technical system evolution. The identification of design parameter and its relation to laws of evolution is one of the future research directions of this proposed design approach.

# References

- [1] Engineering design: a systematic approach, 3rd ed, Springer, London, 2007.
- [2] D.G. Ullman, The mechanical design process, 3rd ed, McGraw-Hill, Boston, Mass, 2003.
- [3] K.N. Otto, Product design: techniques in reverse engineering and new product development, Prentice Hall, Upper Saddle River, NJ, 2001.
- [4] K.T. Ulrich, Product design and development, 5th ed, McGraw-Hill/Irwin, New York, 2012.
- [5] S. Pugh, Total design: integrated methods for successful product engineering, Addison-Wesley Pub. Co, Wokingham, England ; Reading, Mass, 1991.
- [6] G.S. Altshuller, Creativity as an exact science: the theory of the solution of inventive problems, Gordon and Breach Science Publishers, New York, 1984.
- [7] G.S. Altshuller, L. Shulyak, S. Rodman, The innovation algorithm: TRIZ, systematic innovation and technical creativity, Technical Innovation Center, Inc., Worcester, MA, 2007.
- [8] C. Zanni-Merk, D. Cavallucci, F. Rousselot, An ontological basis for computer aided innovation, *Computers in Industry*. 60 (2009) 563–574. doi:10.1016/j.compind.2009.05.012.
- [9] C. Zanni-Merk, D. Cavallucci, F. Rousselot, Use of formal ontologies as a foundation for inventive design studies, *Computers in Industry*. 62 (2011) 323–336. doi:10.1016/j.compind.2010.09.007.
- [10] F. Rousselot, C. Zanni-Merk, D. Cavallucci, Towards a formal definition of contradiction in inventive design, *Computers in Industry*. 63 (2012) 231–242. doi:10.1016/j.compind.2012.01.001.
- [11] M. Ferioli, E. Dekoninck, S. Culley, B. Roussel, Understanding the rapid evaluation of innovative ideas in the early stages of design, *International Journal of Product Development*. 12 (2010) 67–83.
- [12] NIST, feasible solution, (2014). <http://xlinux.nist.gov/dads//HTML/feasiblesltn.html> (accessed March 12, 2014).

- [13] S.S. Rao, *Engineering optimization: theory and practice*, 4th ed, John Wiley & Sons, Hoboken, N.J, 2009.
- [14] W.E. Eder, *Viewpoint Engineering design — art, science and relationships*, *Design Studies*. 16 (1995) 117–127. doi:10.1016/0142-694X(95)90650-5.
- [15] L. Finkelstein, A.C.W. Finkelstein, *Physical Science, Measurement and Instrumentation, Management and Education - Reviews*, *IEE Proceedings A*. 130 (1983) 213–222. doi:10.1049/ip-a-1.1983.0040.
- [16] P. Louridas, *Design as bricolage: anthropology meets design thinking*, *Design Studies*. 20 (1999) 517–535.
- [17] *Models of Bounded Rationality*, MIT Press. (n.d.).  
<https://mitpress.mit.edu/books/models-bounded-rationality> (accessed November 9, 2015).
- [18] D. Cavallucci, *Designing the Inventive Way in the Innovation Era*, in: A. Chakrabarti, L.T.M. Blessing (Eds.), *An Anthology of Theories and Models of Design*, Springer London, 2014: pp. 237–262. [http://dx.doi.org/10.1007/978-1-4471-6338-1\\_12](http://dx.doi.org/10.1007/978-1-4471-6338-1_12).
- [19] N. Cross, *Engineering design methods: strategies for product design*, 4th ed, J. Wiley, Chichester, England ; Hoboken, NJ, 2008.
- [20] N.F.M. Roozenburg, J. Eekels, *Product design: fundamentals and methods*, Wiley, Chichester ; New York, 1995.
- [21] N.P. Suh, *The principles of design*, Oxford University Press, New York, 1990.
- [22] N.P. Suh, *Axiomatic design: advances and applications*, Oxford University Press, New York, 2001.
- [23] I. Reymen, D.K. Hammer, others, *Structured reflection for improving design processes*, in: *DS 30: Proceedings of DESIGN 2002, the 7th International Design Conference*, Dubrovnik, 2002.  
[https://www.designsociety.org/publication/29668/structured\\_reflection\\_for\\_improving\\_design\\_processes](https://www.designsociety.org/publication/29668/structured_reflection_for_improving_design_processes) (accessed November 9, 2015).
- [24] O. Eris, *Effective inquiry for innovative engineering design*, Kluwer Academic Publishers, Boston, 2004.
- [25] G.E. Dieter, L.C. Schmidt, *Engineering design*, 5th ed, McGraw-Hill, New York, 2013.
- [26] S.B. Shooter, W.T. Keirouz, S. Szykman, S.J. Fenves, *A model for the flow of design information in product development*, *Engineering with Computers*. 16 (2000) 178–194.

- [27] J.S. Gero, U. Kannengiesser, The situated function–behaviour–structure framework, *Design Studies*. 25 (2004) 373–391.
- [28] J. Hirtz, R.B. Stone, D.A. McAdams, S. Szykman, K.L. Wood, A functional basis for engineering design: reconciling and evolving previous efforts, *Research in Engineering Design*. 13 (2002) 65–82.
- [29] M.E. Balazs, D.C. Brown, The use of function, structure, and behavior in design, in: *Workshop on Representing Function in Design, AID-94, AI in Design Conference, 1994*.  
[http://www.researchgate.net/profile/David\\_Brown107/publication/240725930\\_THE\\_USE\\_OF\\_FUNCTION\\_STRUCTURE\\_AND\\_BEHAVIOR\\_IN\\_DESIGN/links/54aabd4f0cf2bce6aa1d5e20.pdf](http://www.researchgate.net/profile/David_Brown107/publication/240725930_THE_USE_OF_FUNCTION_STRUCTURE_AND_BEHAVIOR_IN_DESIGN/links/54aabd4f0cf2bce6aa1d5e20.pdf) (accessed November 9, 2015).
- [30] C. Bryant, R. Stone, D. McAdams, T. Kurtoglu, M. Campbell, Concept generation from the functional basis of design, in: 2005: pp. 15–18.  
[http://prosedesign.tamu.edu/publications/concept\\_generation\\_from\\_the.pdf](http://prosedesign.tamu.edu/publications/concept_generation_from_the.pdf) (accessed February 10, 2014).
- [31] M.S. Erden, H. Komoto, T.J. van Beek, V. D’Amelio, E. Echavarria, T. Tomiyama, A review of function modeling: Approaches and applications, *AI EDAM*. 22 (2008). doi:10.1017/S0890060408000103.
- [32] K. Fu, J. Murphy, M. Yang, K. Otto, D. Jensen, K. Wood, Design-by-analogy: experimental evaluation of a functional analogy search methodology for concept generation improvement, *Research in Engineering Design*. 26 (2015) 77–95.  
 doi:10.1007/s00163-014-0186-4.
- [33] J.S. Gero, Design prototypes: a knowledge representation schema for design, *AI Magazine*. 11 (1990) 26.
- [34] E. Chang, X. Li, L.C. Schmidt, The need for a form, function, and behavior-based representation system, Available on-Line at [Www. Enme. Umd. edu/DATLab](http://www.enme.umd.edu/DATLab). (2000).  
[http://www.researchgate.net/profile/Linda\\_Schmidt/publication/2316420\\_The\\_Need\\_for\\_a\\_Form\\_Function\\_and\\_Behavior-based\\_Representation\\_System/links/0912f51192162975cc000000.pdf](http://www.researchgate.net/profile/Linda_Schmidt/publication/2316420_The_Need_for_a_Form_Function_and_Behavior-based_Representation_System/links/0912f51192162975cc000000.pdf) (accessed November 9, 2015).
- [35] Y. Iwasaki, B. Chandrasekaran, *Design verification through function-and behavior-oriented representations*, Springer, 1992.  
[http://link.springer.com/chapter/10.1007/978-94-011-2787-5\\_30](http://link.springer.com/chapter/10.1007/978-94-011-2787-5_30) (accessed November 9, 2015).
- [36] C. Bouchard, A. Aoussat, R. Duchamp, Role of sketching in conceptual design of car styling, *Journal of Design Research*. 5 (2006) 116–148.

- [37] M. Mahdjoub, D. Monticolo, S. Gomes, J.-C. Sagot, A collaborative Design for Usability approach supported by Virtual Reality and a Multi-Agent System embedded in a PLM environment, *Computer-Aided Design*. 42 (2010) 402–413. doi:10.1016/j.cad.2009.02.009.
- [38] J. (Ray) Wang, Ranking engineering design concepts using a fuzzy outranking preference model, *Fuzzy Sets and Systems*. 119 (2001) 161–170. doi:10.1016/S0165-0114(99)00104-9.
- [39] A.E. Mudge, *Value engineering: a systematic approach*, McGraw-Hill, New York, 1971.
- [40] D. Clausing, *Total quality development: a step-by-step guide to world class concurrent engineering*, ASME Press, New York, 1994.
- [41] C.H. Kepner, B.B. Tregoe, *The new rational manager: an updated edition for a new world*, Updated ed, Princeton Research Press, Princeton, NJ, 1997.
- [42] T.L. Saaty, *The analytic hierarchy process: planning, priority setting, resource allocation*, McGraw-Hill International Book Co, New York ; London, 1980.
- [43] T.L. Saaty, L.G. Vargas, *Decision making with the analytic network process: economic, political, social and technological applications with benefits, opportunities, costs and risks*, Springer, New York, 2006.
- [44] T. Kelley, J. Littman, *The art of innovation: lessons in creativity from IDEO, America's leading design firm*, 1st ed, Currency/Doubleday, New York, 2001.
- [45] K.N. Otto, Measurement methods for product evaluation, *Research in Engineering Design*. 7 (1995) 86–101.
- [46] S. Pugh, D. Clausing, R. Andrade, *Creating innovative products using total design: the living legacy of Stuart Pugh*, Addison-Wesley Pub. Co, Reading, Mass, 1996.
- [47] A.A. Mullur, C.A. Mattson, A. Messac, Pitfalls of the typical construction of decision matrices for concept selection, in: 41st Aerospace Sciences Meeting and Exhibit, Reno, NV, 2003. <http://arc.aiaa.org/doi/pdf/10.2514/6.2003-466> (accessed April 30, 2015).
- [48] J.J. Shah, S.M. Smith, N. Vargas-Hernandez, Metrics for measuring ideation effectiveness, *Design Studies*. 24 (2003) 111–134. doi:10.1016/S0142-694X(02)00034-0.
- [49] *Maintaining U.S. Leadership in Aeronautics: Breakthrough Technologies to Meet Future Air and Space Transportation Needs and Goals*, The National Academies Press, 1998. [http://www.nap.edu/openbook.php?record\\_id=6293](http://www.nap.edu/openbook.php?record_id=6293).

- [50] C.A. Mattson, A. Messac, Pareto Frontier Based Concept Selection Under Uncertainty, with Visualization, *Optimization and Engineering*. 6 (2005) 85–115. doi:10.1023/B:OPTE.0000048538.35456.45.
- [51] C.J. Kuehmann, G.B. Olson, Computational materials design and engineering, *Materials Science and Technology*. 25 (2009) 472–478. doi:10.1179/174328408X371967.
- [52] G.G. Wang, S. Shan, Review of Metamodeling Techniques in Support of Engineering Design Optimization, *J. Mech. Des.* 129 (2006) 370–380. doi:10.1115/1.2429697.
- [53] G.J. Barnum, C.A. Mattson, A Computationally Assisted Methodology for Preference-Guided Conceptual Design, *Journal of Mechanical Design*. 132 (2010) 121003. doi:10.1115/1.4002838.
- [54] S.K. Curtis, B.J. Hancock, C.A. Mattson, Usage scenarios for design space exploration with a dynamic multiobjective optimization formulation, *Research in Engineering Design*. 24 (2013) 395–409. doi:10.1007/s00163-013-0158-0.
- [55] B.S. Dhillon, C. Singh, *Engineering reliability: new techniques and applications*, Wiley, New York, 1981.
- [56] M. Modarres, M. Kaminskiy, V. Krivtsov, *Reliability engineering and risk analysis: a practical guide*, 2nd ed, CRC Press, Boca Raton, 2010.
- [57] A. Abd-Allah, Extending reliability block diagrams to software architectures, *System*. 97 (1997) 93.
- [58] W. Wang, J.M. Loman, R.G. Arno, P. Vassiliou, E.R. Furlong, D. Ogden, Reliability block diagram simulation techniques applied to the IEEE std. 493 standard network, *Industry Applications, IEEE Transactions on*. 40 (2004) 887–895.
- [59] H. Xu, DRBD: Dynamic Reliability Block Diagrams for system reliability modelling, University of Massachusetts Dartmouth, 2008.
- [60] E.R. Ziegel, System Reliability Theory: Models, Statistical Methods, and Applications, *Technometrics*. 46 (2004) 495–496.
- [61] D.H. Stamatis, *Failure mode and effect analysis: FMEA from theory to execution*, 2nd ed., rev. and expanded, ASQ Quality Press, Milwaukee, Wisc, 2003.
- [62] W.R. Blischke, D.N.P. Murthy, *Reliability: modeling, prediction, and optimization*, Wiley, New York, 2000.
- [63] J.X. Wang, M.L. Roush, *What every engineer should know about risk engineering and management*, Marcel Dekker, Inc, New York, 2000.

- [64] D. Huang, T. Chen, M.-J.J. Wang, A fuzzy set approach for event tree analysis, *Fuzzy Sets and Systems*. 118 (2001) 153–165.
- [65] R. Ferdous, F. Khan, R. Sadiq, P. Amyotte, B. Veitch, Handling data uncertainties in event tree analysis, *Process Safety and Environmental Protection*. 87 (2009) 283–292.
- [66] R. Fullwood, *Probabilistic safety assessment in the chemical and nuclear industries*, Butterworth-Heinemann, 1999.
- [67] T. Bedford, R. Cooke, *Probabilistic risk analysis: foundations and methods*, Cambridge University Press, 2001.
- [68] M. Stamatelatos, H. Dezfuli, G. Apostolakis, C. Everline, S. Guarro, D. Mathias, et al., *Probabilistic risk assessment procedures guide for NASA managers and practitioners*, (2011).
- [69] R. Houssin, A. Coulibaly, Safety-based availability assessment at design stage, *Computers & Industrial Engineering*. 70 (2014) 107–115. doi:10.1016/j.cie.2014.01.005.
- [70] P. Belliveau, A. Griffin, S. Somermeyer, *Product Development & Management Association*, eds., *The PDMA toolbook for new product development*, John Wiley & Sons, Inc, New York, 2002.
- [71] K.G. Lough, R. Stone, I.Y. Tumer, The risk in early design method, *Journal of Engineering Design*. 20 (2009) 155–173. doi:10.1080/09544820701684271.
- [72] I.Y. Tumer, R.B. Stone, Analytical method for mapping function to failure during high-risk component development, in: *Proceedings of the Design Engineering Technical Conferences*, 2001. [http://web.engr.oregonstate.edu/~itumer/publications/files/dfm\\_tumer01\\_21173.pdf](http://web.engr.oregonstate.edu/~itumer/publications/files/dfm_tumer01_21173.pdf) (accessed June 1, 2015).
- [73] K. Daniel, G.L. Katie, others, Risk due to function failure propagation, *Guidelines for a Decision Support Method Adapted to NPD Processes*. (2007). [https://www.designsociety.org/publication/25722/risk\\_due\\_to\\_function\\_failure\\_propagation](https://www.designsociety.org/publication/25722/risk_due_to_function_failure_propagation) (accessed March 31, 2015).
- [74] M. Goswami, M.K. Tiwari, A predictive risk evaluation framework for modular product concept selection in new product design environment, *Journal of Engineering Design*. 25 (2014) 150–171. doi:10.1080/09544828.2014.921806.
- [75] Five Dangerous Lessons to Learn From Steve Jobs - Forbes, (n.d.). <http://www.forbes.com/sites/chunkamui/2011/10/17/five-dangerous-lessons-to-learn-from-steve-jobs/> (accessed November 9, 2015).
- [76] B. Jaruzelski, J. Loehr, R. Holman, *The 2012 Global Innovation 1000 Key Findings*, Booz&co. (n.d.).

- [77] S.C. Wheelwright, K.B. Clark, *Revolutionizing product development: quantum leaps in speed, efficiency, and quality*, Simon and Schuster, 1992.
- [78] R. Bledow, M. Frese, N. Anderson, M. Erez, J. Farr, A dialectic perspective on innovation: Conflicting demands, multiple pathways, and ambidexterity, *Industrial and Organizational Psychology*. 2 (2009) 305–337.
- [79] D. Cropley, A. Cropley, A psychological taxonomy of organizational innovation: Resolving the paradoxes, *Creativity Research Journal*. 24 (2012) 29–40.
- [80] invention - definition of invention in English from the Oxford dictionary, (n.d.). <http://www.oxforddictionaries.com/definition/english/invention> (accessed November 9, 2015).
- [81] C. Herstatt, B. Verworn, The“ fuzzy front end” of innovation, Working Papers/Technologie-und Innovationsmanagement, Technische Universität Hamburg-Harburg, 2001. <http://www.econstor.eu/handle/10419/55454> (accessed February 13, 2014).
- [82] T.M. Amabile, A model of creativity and innovation in organizations, *Research in Organizational Behavior*. 10 (1988) 123–167.
- [83] M.A. Runco, S.R. Pritzker, eds., *Encyclopedia of creativity*. Vol. 2: J - Z, 2. ed, Elsevier [u.a.], Amsterdam, 2011.
- [84] J.J. Shah, S.V. Kulkarni, N. Vargas-Hernandez, Evaluation of idea generation methods for conceptual design: effectiveness metrics and design of experiments, *Journal of Mechanical Design*. 122 (2000) 377–384.
- [85] J.J. Shah, S.M. Smith, N. Vargas-Hernandez, Metrics for measuring ideation effectiveness, *Design Studies*. 24 (2003) 111–134. doi:10.1016/S0142-694X(02)00034-0.
- [86] D.L. Dean, J.M. Hender, T.L. Rodgers, E.L. Santanen, Identifying quality, novel, and creative ideas: Constructs and scales for idea evaluation, *Journal of the Association for Information Systems*. 7 (2006) 30.
- [87] P. Sarkar, A. Chakrabarti, Assessing design creativity, *Design Studies*. 32 (2011) 348–383. doi:10.1016/j.destud.2011.01.002.
- [88] P. Sarkar, A. Chakrabarti, Ideas generated in conceptual design and their effects on creativity, *Research in Engineering Design*. 25 (2014) 185–201. doi:10.1007/s00163-014-0173-9.
- [89] M. Batey, The measurement of creativity: From definitional consensus to the introduction of a new heuristic framework, *Creativity Research Journal*. 24 (2012) 55–65.



- [90] D. Cavallucci, A research agenda for computing developments associated with innovation pipelines, *Computers in Industry*. 62 (2011) 377–383. doi:10.1016/j.compind.2010.12.002.
- [91] E. Sickafus, *Unified structured inventive thinking: how to invent*, NTELLECK, Grosse Ile, Mich, 1997.
- [92] N. Khomenko, M. Ashtiani, *Classical TRIZ and OTSM as scientific theoretical background for non-typical problem solving instruments*, Frankfurt: ETRIA Future. (2007). [http://www.jlproj.org/this\\_bibl\\_e/ETRIA07Kh-p.pdf](http://www.jlproj.org/this_bibl_e/ETRIA07Kh-p.pdf) (accessed March 3, 2015).
- [93] N. Khomenko, R. De Guio, D. Cavallucci, Enhancing ECN’s abilities to address inventive strategies using OTSM-TRIZ, *International Journal of Collaborative Engineering*. 1 (2009) 98–113.
- [94] M.A. Orloff, *Inventive thinking through TRIZ: a practical guide*, 2nd ed, Springer, Berlin ; New York, 2006.
- [95] D. Cavallucci, F. Rousselot, Evolution hypothesis as a means for linking system parameters and laws of engineering system evolution, *Procedia Engineering*. 9 (2011) 484–499. doi:10.1016/j.proeng.2011.03.136.
- [96] W.E. Eder, others, *THEORY OF TECHNICAL SYSTEMS AND ENGINEERING DESIGN SCIENCE-LEGACY OF VLADIMIR HUBKA*, in: DS 48: Proceedings DESIGN 2008, the 10th International Design Conference, Dubrovnik, Croatia, 2008. [https://www.designsociety.org/publication/26651/theory\\_of\\_technical\\_systems\\_and\\_engineering\\_design\\_science-legacy\\_of\\_vladimir\\_hubka](https://www.designsociety.org/publication/26651/theory_of_technical_systems_and_engineering_design_science-legacy_of_vladimir_hubka) (accessed April 9, 2015).
- [97] S. Kwatra, Y. Salamatov, *Trimming, Miniaturization and Ideality via Convolution Technique of TRIZ*, Springer India, India, 2013. <http://link.springer.com/10.1007/978-81-322-0737-5> (accessed November 9, 2015).
- [98] S. Mueller, The TRIZ resource analysis tool for solving management tasks: previous classifications and their modification, *Creativity and Innovation Management*. 14 (2005) 43–58.
- [99] K. Rantanen, *Simplified TRIZ: new problem solving applications for engineers and manufacturing professionals*, 2nd ed, Auerbach Publications, New York, 2008.
- [100] C.-T. Su, C.-S. Lin, A case study on the application of Fuzzy QFD in TRIZ for service quality improvement, *Quality & Quantity*. 42 (2008) 563–578. doi:10.1007/s11135-006-9058-y.

- [101] S. Vinodh, V. Kamala, K. Jayakrishna, Integration of ECQFD, TRIZ, and AHP for innovative and sustainable product development, *Applied Mathematical Modelling*. 38 (2014) 2758–2770. doi:10.1016/j.apm.2013.10.057.
- [102] H. Yamashina, T. Ito, H. Kawada, Innovative product development process by integrating QFD and TRIZ, *International Journal of Production Research*. 40 (2002) 1031–1050. doi:10.1080/00207540110098490.
- [103] C.H. Yeh, J.C.Y. Huang, C.K. Yu, Integration of four-phase QFD and TRIZ in product R&D: a notebook case study, *Research in Engineering Design*. 22 (2011) 125–141. doi:10.1007/s00163-010-0099-9.
- [104] M. Hu, K. Yang, S. Taguchi, Enhancing robust design with the aid of TRIZ and axiomatic design (Part I), *TRIZ Journal*, October. (2000). <http://www.triz-journal.com/archives/2000/10/e/2000-10e.pdf> (accessed February 5, 2014).
- [105] Y. Borgianni, D.T. Matt, Axiomatic Design and TRIZ: Deficiencies of their Integrated Use and Future Opportunities, *Procedia CIRP*. 34 (2015) 1–6. doi:10.1016/j.procir.2015.07.002.
- [106] J.R. Duflou, W. Dewulf, On the complementarity of TRIZ and axiomatic design: from decoupling objective to contradiction identification, *Procedia Engineering*. 9 (2011) 633–639. doi:10.1016/j.proeng.2011.03.148.
- [107] Y.-S. Kim, D.S. Cochran, Reviewing TRIZ from the perspective of Axiomatic Design, *Journal of Engineering Design*. 11 (2000) 79–94. doi:10.1080/095448200261199.
- [108] G.O. Kremer, M.-C. Chiu, C.-Y. Lin, S. Gupta, D. Claudio, H. Thevenot, Application of axiomatic design, TRIZ, and mixed integer programming to develop innovative designs: a locomotive ballast arrangement case study, *The International Journal of Advanced Manufacturing Technology*. 61 (2012) 827–842. doi:10.1007/s00170-011-3752-1.
- [109] M. Ogot, Conceptual design using axiomatic design in a TRIZ framework, *Procedia Engineering*. 9 (2011) 736–744. doi:10.1016/j.proeng.2011.03.163.
- [110] R.A. Shirwaiker, G.E. Okudan, Triz and axiomatic design: a review of case-studies and a proposed synergistic use, *Journal of Intelligent Manufacturing*. 19 (2008) 33–47. doi:10.1007/s10845-007-0044-6.
- [111] H.-T. Chang, J.L. Chen, The conflict-problem-solving CAD software integrating TRIZ into eco-innovation, *Advances in Engineering Software*. 35 (2004) 553–566. doi:10.1016/j.advengsoft.2004.06.003.
- [112] Y.L. Lai, J.H. Chen, J.P. Hung, A Study on the Application of TRIZ to CAD/CAM System, *International Journal of Mechanical Systems Science and Engineering*. 2 (2008) 24–28.

- [113] K.L. Kitto, Using TRIZ, parametric modeling, FEA simulation, and rapid prototyping to foster creative design, in: *Frontiers in Education Conference, 2000. FIE 2000. 30th Annual*, IEEE, 2000: p. S2E–14.  
[http://ieeexplore.ieee.org/xpls/abs\\_all.jsp?arnumber=896654](http://ieeexplore.ieee.org/xpls/abs_all.jsp?arnumber=896654) (accessed September 26, 2015).
- [114] D. Mann, Application of TRIZ tools in a non-technical problem context, *The TRIZ Journal*, Aug. (2000). <http://www.systematic-innovation.com/assets/200008-applicationoftriztoolsinanon-technicalproblemcontext.pdf> (accessed October 15, 2015).
- [115] L.R. Smith, Six Sigma and the evolution of quality in product development, in: *Six Sigma Forum Magazine*, ASQ, 2001: pp. 28–35. <http://scinnovation.cn/wp-content/uploads/soft/100915/SixSigmaandtheevolutionofqualityinproductdevelopment.pdf> (accessed October 15, 2015).
- [116] H. Cong, L.H. Tong, Grouping of TRIZ Inventive Principles to facilitate automatic patent classification, *Expert Systems with Applications*. 34 (2008) 788–795. doi:10.1016/j.eswa.2006.10.015.
- [117] M. Li, X. Ming, L. He, M. Zheng, Z. Xu, A TRIZ-based Trimming method for Patent design around, *Computer-Aided Design*. 62 (2015) 20–30.  
 doi:10.1016/j.cad.2014.10.005.
- [118] H. Park, J.J. Ree, K. Kim, Identification of promising patents for technology transfers using TRIZ evolution trends, *Expert Systems with Applications*. 40 (2013) 736–743. doi:10.1016/j.eswa.2012.08.008.
- [119] J. Yoon, K. Kim, An automated method for identifying TRIZ evolution trends from patents, *Expert Systems with Applications*. 38 (2011) 15540–15548.  
 doi:10.1016/j.eswa.2011.06.005.
- [120] D. Cavallucci, Designing the Inventive Way in the Innovation Era, in: A. Chakrabarti, L.T.M. Blessing (Eds.), *An Anthology of Theories and Models of Design*, Springer London, 2014: pp. 237–262. [http://dx.doi.org/10.1007/978-1-4471-6338-1\\_12](http://dx.doi.org/10.1007/978-1-4471-6338-1_12).
- [121] D. Cavallucci, F. Rousselot, C. Zanni, Initial situation analysis through problem graph, *CIRP Journal of Manufacturing Science and Technology*. 2 (2010) 310–317. doi:10.1016/j.cirpj.2010.07.004.
- [122] A. Howladar, D. Cavallucci, Analysing complex engineering situations through problem graph, *Procedia Engineering*. 9 (2011) 18–29.  
 doi:10.1016/j.proeng.2011.03.097.

- [123] D. Cavallucci, T. Eltzer, Structuring knowledge in inventive design of complex problems, *Procedia Engineering*. 9 (2011) 694–701.  
doi:10.1016/j.proeng.2011.03.157.
- [124] D. Cavallucci, F. Rousselot, C. Zanni, On contradiction clouds, *Procedia Engineering*. 9 (2011) 368–378. doi:10.1016/j.proeng.2011.03.126.
- [125] D. Cavallucci, F. Rousselot, C. Zanni, Representing and selecting problems through contradictions clouds, in: *Computer-Aided Innovation (CAI)*, Springer, 2008: pp. 43–56. [http://link.springer.com/chapter/10.1007/978-0-387-09697-1\\_4](http://link.springer.com/chapter/10.1007/978-0-387-09697-1_4) (accessed September 30, 2015).
- [126] S.J. Fenves, Y. Choi, B. Gurumoorthy, G. Mocko, R.D. Sriram, Master Product Model for the Support of Tighter Integration of Spatial and Functional Design, US Department of Commerce, Technology Administration, National Institute of Standards and Technology, 2003.  
<http://www.mel.nist.gov/div826/library/doc/masterprod.pdf> (accessed October 1, 2014).
- [127] M. Yoshioka, Y. Umeda, H. Takeda, Y. Shimomura, Y. Nomaguchi, T. Tomiyama, Physical concept ontology for the knowledge intensive engineering framework, *Advanced Engineering Informatics*. 18 (2004) 95–113.  
doi:10.1016/j.aei.2004.09.004.
- [128] J. Kim, P. Will, S.R. Ling, B. Neches, Knowledge-rich catalog services for engineering design, *AI EDAM*. 17 (2003) 349–366.
- [129] I.R. Grosse, J.M. Milton-Benoit, J.C. Wileden, Ontologies for supporting engineering analysis models, *Ai Edam*. 19 (2005) 1–18.
- [130] G. Mocko, R. Malak, C. Paredis, R. Peak, A knowledge repository for behavioral models in engineering design, in: *ASME 2004 International Design Engineering Technical Conferences and Computers and Information in Engineering Conference*, American Society of Mechanical Engineers, 2004: pp. 943–952.  
<http://proceedings.asmedigitalcollection.asme.org/proceeding.aspx?articleid=1651676> (accessed September 26, 2014).
- [131] C.A. Mattson, A. Messac, Pareto frontier based concept selection under uncertainty, with visualization, *Optimization and Engineering*. 6 (2005) 85–115.
- [132] C.A. Mattson, A.A. Mullur, A. Messac, Case studies in concept exploration and selection with s-Pareto frontiers, *International Journal of Product Development*. 9 (2009) 32–59.
- [133] G. Mocko, J.F. J. Fenves, A Survey of Design-Analysis Integration Issues, NISTIR 6996, National Institute of Standards and Technology. (n.d.).

- [134] S.J. Fenves, S. Fofou, C. Bock, R.D. Sriram, CPM: a core model for product data, *Journal of Computing and Information Science in Engineering*. 8 (2008) 014501.
- [135] S.J. Fenves, *Core Product Model for Representing Design Information*, Citeseer, 2001.
- [136] J.C. Mankins, Technology readiness levels, White Paper, April. 6 (1995). [http://orion.asu.edu/Additional%20Reading/Mankins\\_trl.pdf](http://orion.asu.edu/Additional%20Reading/Mankins_trl.pdf) (accessed March 11, 2015).
- [137] J.C. Mankins, Technology readiness assessments: A retrospective, *Acta Astronautica*. 65 (2009) 1216–1223. doi:10.1016/j.actaastro.2009.03.058.
- [138] J.C. Mankins, Technology readiness and risk assessments: A new approach, *Acta Astronautica*. 65 (2009) 1208–1215. doi:10.1016/j.actaastro.2009.03.059.
- [139] D.W. Engel, A.C. Dalton, K.K. Anderson, C. Sivaramakrishnan, C. Lansing, Development of technology readiness level (TRL) metrics and risk Measures, Pacific Northwest National Laboratory, 2012. [http://www.pnnl.gov/main/publications/external/technical\\_reports/PNNL-21737.pdf](http://www.pnnl.gov/main/publications/external/technical_reports/PNNL-21737.pdf) (accessed March 11, 2015).
- [140] C.P. Graettinger, S. Garcia, J. Siviyy, R.J. Schenk, P.J. Van Syckle, Using the technology readiness levels scale to support technology management in the DoD's ATD/STO environments, DTIC Document, 2002. <http://oai.dtic.mil/oai/oai?verb=getRecord&metadataPrefix=html&identifier=ADA407785> (accessed March 11, 2015).
- [141] H. Nakamura, Y. Kajikawa, S. Suzuki, Multi-level perspectives with technology readiness measures for aviation innovation, *Sustainability Science*. 8 (2013) 87–101. doi:10.1007/s11625-012-0187-z.
- [142] B. Sauser, J.E. Ramirez-Marquez, R. Magnaye, W. Tan, A systems approach to expanding the technology readiness level within defense acquisition, DTIC Document, 2009. <http://oai.dtic.mil/oai/oai?verb=getRecord&metadataPrefix=html&identifier=ADA530242> (accessed March 11, 2015).
- [143] R. Ahmad, S. Kamaruddin, I.A. Azid, I.P. Almanar, Failure analysis of machinery component by considering external factors and multiple failure modes – A case study in the processing industry, *Engineering Failure Analysis*. 25 (2012) 182–192. doi:10.1016/j.engfailanal.2012.05.007.
- [144] D. Clausing, D.D. Frey, Improving system reliability by failure-mode avoidance including four concept design strategies, *Systems Engineering*. 8 (2005) 245–261. doi:10.1002/sys.20034.

- [145] K.A. Grantham Lough, R.B. Stone, I.Y. Tumer, Failure Prevention in Design Through Effective Catalogue Utilization of Historical Failure Events, *Journal of Failure Analysis and Prevention*. 8 (2008) 469–481. doi:10.1007/s11668-008-9160-7.
- [146] R.B. Stone, I.Y. Tumer, M.E. Stock, Linking product functionality to historic failures to improve failure analysis in design, *Research in Engineering Design*. 16 (2005) 96–108. doi:10.1007/s00163-005-0005-z.
- [147] D. Krus, K. Grantham Lough, Function-based failure propagation for conceptual design, *Artificial Intelligence for Engineering Design, Analysis and Manufacturing*. 23 (2009) 409. doi:10.1017/S0890060409000158.
- [148] B.M. O’Halloran, B. Haley, D.C. Jensen, R. Arlitt, I.Y. Tumer, R.B. Stone, The early implementation of failure modes into existing component model libraries, *Research in Engineering Design*. (2013) 1–19.
- [149] M. Derelöv, Qualitative modelling of potential failures: on evaluation of conceptual design, *Journal of Engineering Design*. 19 (2008) 201–225. doi:10.1080/09544820701255858.
- [150] T. Kurtoglu, I.Y. Tumer, D.C. Jensen, A functional failure reasoning methodology for evaluation of conceptual system architectures, *Research in Engineering Design*. 21 (2010) 209–234.
- [151] ISO/IEC 15288:2008 - Systems and software engineering -- System life cycle processes, (n.d.). [http://www.iso.org/iso/catalogue\\_detail?csnumber=43564](http://www.iso.org/iso/catalogue_detail?csnumber=43564) (accessed September 25, 2015).
- [152] C. Dym, W. Wood, M. Scott, Rank ordering engineering designs: pairwise comparison charts and Borda counts, *Res Eng Design*. 13 (2002) 236–242. doi:10.1007/s00163-002-0019-8.
- [153] H. Komoto, T. Tomiyama, Computational support for system architecting, in: *ASME 2010 International Design Engineering Technical Conferences and Computers and Information in Engineering Conference*, American Society of Mechanical Engineers, 2010: pp. 25–34. <http://proceedings.asmedigitalcollection.asme.org/proceeding.aspx?articleid=1612275> (accessed September 21, 2015).
- [154] H. Komoto, T. Tomiyama, A framework for computer-aided conceptual design and its application to system architecting of mechatronics products, *Computer-Aided Design*. 44 (2012) 931–946. doi:10.1016/j.cad.2012.02.004.
- [155] B.M. O’Halloran, A framework to model reliability and failures in complex systems during the early engineering design process, (2013).

<http://ir.library.oregonstate.edu/xmlui/handle/1957/39194> (accessed June 1, 2015).

- [156] W. Denson, G. Chandler, W. Crowell, A. Clark, P. Jaworski, Nonelectronic Parts Reliability Data 1995, DTIC Document, 1994.
- [157] W. Crowell, W. Denson, P. Jaworski, D. Mahar, Failure mode/mechanism distribution 1997, Reliability Information Analysis Center, Rome. (1997).
- [158] D. Cavallucci, S. Fuhlhaber, A. Riwan, Assisting decisions in Inventive Design of complex engineering systems, (2014).
- [159] K. Forsberg, H. Mooz, H. Cotterman, Visualizing project management: models and frameworks for mastering complex systems, 3rd ed, J. Wiley, Hoboken, N.J, 2005.
- [160] R.A. Shirwaiker, G.E. Okudan, Triz and axiomatic design: a review of case-studies and a proposed synergistic use, *Journal of Intelligent Manufacturing*. 19 (2008) 33–47. doi:10.1007/s10845-007-0044-6.
- [161] R. Jugulum, D.D. Frey, Toward a taxonomy of concept designs for improved robustness, *Journal of Engineering Design*. 18 (2007) 139–156. doi:10.1080/09544820600731496.
- [162] A.I.J. Forrester, A. Sóbester, A.J. Keane, *Engineering design via surrogate modelling a practical guide*, J. Wiley, Chichester, West Sussex, England; Hoboken, NJ, 2008. <http://app.knovel.com/web/toc.v/cid:kpEDSMAPG3> (accessed April 29, 2014).

# Appendix A

## Function-Failure Mode/Rate Database



	bonding defect	breakdown	contamination	control issue	corrosion	cracking	creep	artifact failure	fatigue	fretting
actuate	1.0E-4	0	1.1E-3	3.2E-2	1.7E-2	2.4E-3	5.4E-3	5.7E-2	9.0E-4	4.0E-4
allow	0	0	0	9.0E-4	4.5E-3	0	6.0E-4	4.0E-4	0	0
change	1.4E-2	0	3.2E-3	7.6E-3	1.1E-1	4.9E-2	1.2E-1	8.1E-2	1.9E-2	4.7E-2
channel	0	0	0	0	0	0	1.0E-4	1.0E-4	0	0
collect	0	0	0	2.0E-4	0	7.2E-3	2.4E-3	5.0E-4	0	0
condition	0	0	0	0	4.0E-4	8.0E-4	3.0E-3	5.6E-3	0	1.2E-3
connect	0	0	0	0	1.2E-3	3.0E-4	1.0E-4	7.0E-4	0	0
contain	0	0	0	0	2.0E-4	0	0	4.0E-4	0	0
convert	9.0E-4	1.0E-4	9.5E-3	2.8E-1	3.6E-1	5.4E-2	1.4E-1	1.6E-1	1.2E-2	4.1E-3
decrease	0	0	0	0	0	0	0	0	0	0
decrement	0	0	0	0	0	0	0	0	0	0
detect	0	0	0	2.0E-4	0	0	0	5.0E-4	0	0
display	0	0	0	5.8E-3	1.0E-2	2.6E-3	6.6E-2	1.9E-3	0	0
distribute	7.0E-4	0	1.0E-3	1.3E-2	3.1E-2	2.3E-2	2.0E-2	1.7E-2	1.0E-3	3.0E-3
export	1.4E-3	2.0E-4	1.7E-2	8.3E-2	1.3E-1	1.2E-1	2.1E-1	2.2E-1	2.6E-2	7.5E-3
extract	0	0	0	0	4.0E-4	7.0E-4	3.0E-4	0	0	0
guide	3.4E-2	2.0E-4	1.2E-2	1.2E-1	4.4E-1	2.2E-1	4.3E-1	4.4E-1	7.2E-2	1.1E-1
import	1.5E-3	9.0E-4	2.2E-2	3.3E-2	1.0E-1	1.7E-1	2.8E-1	3.2E-1	4.5E-2	9.1E-3
increase	0	0	0	0	0	0	0	0	0	0
increment	0	0	1.0E-3	1.0E-4	0	0	0	7.0E-4	0	0
indicate	0	0	0	8.1E-3	1.5E-2	1.0E-2	9.3E-2	1.3E-2	1.7E-3	1.0E-4
inhibit	0	0	0	0	2.2E-3	4.0E-4	1.1E-3	4.4E-3	0	0
join	3.0E-4	0	1.0E-4	1.1E-3	1.1E-2	9.2E-3	2.6E-2	3.3E-2	4.0E-4	1.6E-3
link	0	0	0	0	4.5E-3	7.2E-3	2.5E-3	1.0E-4	0	0
measure	0	0	0	0	0	0	0	0	0	0
mix	1.0E-4	0	0	6.0E-4	7.0E-4	2.0E-4	6.0E-4	5.0E-4	1.0E-4	4.0E-4
position	5.8E-3	2.2E-3	2.1E-2	4.5E-2	2.2E-1	2.2E-1	3.2E-1	4.1E-1	4.5E-2	2.8E-2
prevent	0	0	0	6.0E-4	1.6E-3	3.0E-4	3.0E-4	3.5E-3	0	0
process	0	0	1.0E-3	3.0E-4	0	5.6E-3	0	1.2E-3	0	0
provision	0	0	0	0	0	0	0	0	0	0
regulate	2.3E-3	0	1.6E-2	1.7E-2	4.1E-2	1.0E-2	6.5E-2	6.2E-2	4.1E-3	8.5E-3
remove	0	0	0	0	7.0E-4	0	7.5E-3	6.6E-3	0	2.0E-4
rotate	0	0	0	1.0E-2	8.0E-3	4.0E-4	0	4.0E-4	0	0
secure	7.7E-3	1.0E-3	2.4E-2	1.1E-1	2.6E-1	3.8E-1	3.6E-1	2.4E-1	2.4E-2	2.1E-2
sense	0	0	7.6E-3	4.9E-3	7.2E-3	3.0E-3	4.6E-2	1.7E-2	1.7E-3	0
separate	0	0	3.5E-3	6.0E-4	7.0E-4	7.7E-3	1.9E-2	6.5E-3	8.0E-4	1.0E-4
shape	0	0	0	3.8E-3	6.8E-3	1.8E-3	4.4E-2	1.2E-3	0	0
signal	0	0	0	0	2.0E-4	0	0	4.0E-4	0	0
stabilize	0	0	0	2.0E-4	4.0E-4	1.0E-4	1.0E-4	1.5E-3	0	0
stop	3.0E-4	0	3.0E-4	9.1E-3	6.6E-2	8.6E-2	1.0E-1	7.8E-2	1.6E-3	1.0E-3
store	0	2.3E-3	6.8E-3	1.2E-2	1.2E-2	1.6E-2	3.2E-2	3.1E-2	0	6.0E-4
supply	2.0E-4	2.3E-3	4.5E-3	6.0E-3	8.4E-3	1.3E-3	2.7E-2	2.8E-2	3.0E-4	1.3E-3
support	0	0	1.0E-4	0	4.7E-3	7.0E-4	1.5E-3	3.2E-3	8.0E-4	1.0E-4
transfer	1.3E-2	1.0E-3	1.3E-2	1.1E-1	2.5E-1	5.5E-2	1.4E-1	1.8E-1	2.7E-2	4.2E-2
translate	0	0	0	0	0	0	0	0	0	0
transmit	5.0E-4	0	1.0E-4	7.4E-3	2.1E-2	7.4E-3	7.4E-2	1.6E-2	7.0E-4	2.5E-3
transport	0	0	0	5.0E-3	4.0E-3	2.0E-4	0	2.0E-4	0	0

	galling and seizure	impact	latch-up	noise	other	Overstress of incorrect current magnitude	rupture	unknown	voiding	wear
actuate	7.7E-3	0	0	5.0E-4	2.3E-2	1.2E-1	6.0E-4	4.5E-2	0	5.8E-2
allow	8.0E-4	0	0	4.0E-4	7.0E-4	8.0E-4	1.0E-4	1.9E-3	0	8.0E-4
change	1.4E-2	0	0	8.6E-3	1.5E-2	1.5E-2	1.7E-2	1.3E-1	1.0E-4	3.3E-1
channel	0	0	0	0	0	0	0	1.0E-4	0	2.0E-4
collect	1.0E-4	0	0	0	0	1.9E-3	0	9.0E-4	0	0
condition	0	0	0	0	0	8.0E-4	0	2.6E-3	0	1.6E-3
connect	0	0	0	0	2.0E-4	0	1.0E-4	4.0E-4	0	2.5E-3
contain	0	0	0	0	0	0	0	1.0E-3	0	5.0E-4
convert	9.0E-2	4.0E-4	2.0E-2	3.1E-2	1.1E-1	1.9E-1	7.8E-3	2.7E-1	0	4.2E-1
decrease	0	0	0	0	0	0	0	0	0	0
decrement	0	0	0	0	0	0	0	0	0	0
detect	1.0E-4	0	0	0	0	1.9E-3	0	9.0E-4	0	0
display	2.0E-4	0	0	0	2.0E-3	1.0E-4	0	6.7E-2	0	7.1E-3
distribute	1.3E-2	3.0E-4	1.3E-3	1.1E-3	8.5E-3	1.1E-2	1.2E-3	3.0E-2	0	9.9E-2
export	7.0E-2	1.7E-3	5.7E-3	3.1E-3	5.0E-2	8.0E-2	5.3E-3	2.3E-1	0	7.0E-1
extract	0	0	0	0	4.0E-4	0	0	1.1E-3	0	4.9E-3
guide	9.1E-2	1.1E-3	7.0E-3	3.1E-2	9.1E-2	1.6E-1	3.9E-2	5.1E-1	0	1.5E+0
import	7.9E-2	1.7E-3	1.2E-3	2.5E-3	4.2E-2	1.7E-1	6.2E-3	2.7E-1	0	9.4E-1
increase	0	0	0	0	0	0	0	0	0	0
increment	3.0E-4	0	0	0	3.0E-4	1.7E-3	0	1.0E-4	0	4.0E-4
indicate	4.0E-4	0	0	0	3.0E-3	5.5E-3	2.0E-4	9.8E-2	0	3.1E-2
inhibit	1.1E-3	0	0	0	3.0E-4	3.0E-4	1.0E-4	6.4E-3	0	6.4E-3
join	2.3E-2	4.0E-4	0	2.0E-4	4.7E-3	6.6E-3	1.3E-3	3.7E-2	0	5.1E-2
link	0	0	0	0	1.0E-4	0	0	4.0E-4	0	5.0E-4
measure	0	0	0	0	0	0	0	0	0	0
mix	5.0E-4	0	0	1.0E-4	3.0E-4	2.0E-4	2.0E-4	2.2E-3	0	4.1E-3
position	6.2E-2	1.3E-3	1.3E-3	1.2E-2	6.5E-2	2.2E-1	1.4E-2	4.0E-1	0	9.0E-1
prevent	4.0E-4	0	0	0	2.0E-4	1.3E-3	0	1.0E-2	0	6.4E-3
process	4.0E-4	0	0	0	3.0E-4	4.4E-3	0	1.0E-3	0	6.0E-3
provision	0	0	0	0	0	0	0	0	0	0
regulate	3.3E-2	0	0	1.5E-3	1.9E-2	5.5E-2	4.0E-3	9.4E-2	1.0E-4	1.1E-1
remove	0	1.0E-4	0	0	6.0E-4	2.0E-4	4.0E-4	8.5E-3	0	3.6E-3
rotate	0	0	1.2E-3	0	1.2E-3	1.6E-3	0	0	0	8.0E-4
secure	7.5E-2	1.1E-3	4.5E-3	2.1E-2	7.6E-2	2.1E-1	1.2E-2	3.5E-1	0	6.6E-1
sense	1.0E-3	0	0	0	1.7E-3	1.7E-2	0	5.1E-2	0	1.9E-2
separate	4.0E-4	0	0	0	5.0E-4	9.0E-4	2.0E-4	1.2E-2	0	2.9E-2
shape	2.0E-4	0	0	0	1.4E-3	0	0	4.4E-2	0	4.8E-3
signal	0	0	0	0	0	8.0E-4	0	1.0E-3	0	5.0E-4
stabilize	1.0E-4	0	0	0	0	2.0E-3	0	3.0E-3	0	1.2E-3
stop	2.9E-2	4.0E-4	0	0	1.7E-2	1.7E-2	3.1E-3	1.4E-1	0	1.6E-1
store	1.0E-2	3.0E-4	1.2E-3	0	1.8E-2	1.5E-1	8.0E-4	3.5E-2	1.0E-4	5.5E-2
supply	8.5E-3	3.0E-4	6.0E-4	1.0E-4	1.7E-2	1.4E-1	1.0E-3	3.0E-2	0	3.1E-2
support	1.0E-4	0	0	0	1.0E-4	3.0E-4	0	1.6E-3	0	7.8E-3
transfer	5.4E-2	5.0E-4	7.5E-3	2.2E-2	5.7E-2	1.7E-1	1.8E-2	2.0E-1	0	6.7E-1
translate	0	0	0	0	0	0	0	0	0	0
transmit	1.7E-2	2.0E-4	0	3.0E-4	7.3E-3	7.5E-3	6.0E-4	8.7E-2	0	1.0E-1
transport	0	0	6.0E-4	0	6.0E-4	8.0E-4	0	2.1E-3	0	2.8E-2

# Appendix B

Information on model used in section 6.6

## Modelica.Magnetic.FluxTubes.Examples.SolenoidActuator.Components.SimpleSolenoid

### Simple network model of a lifting magnet with planar armature end face

#### Information

Please refer to the **Parameters** section for a schematic drawing of this axisymmetric lifting magnet. In the half-section below, the flux tube elements of the actuator's magnetic circuit are superimposed on a field plot obtained with FEA. The magnetomotive force imposed by the coil is modelled as one lumped element. As a result, the radial leakage flux between armature and yoke that occurs especially at large working air gaps cannot be considered properly. This leads to a higher total reluctance and lower inductance respectively compared to FEA for large working air gaps (i.e., armature close to  $x_{\text{max}}$ ). Please have a look at the comments associated with the individual model components for a short explanation of their purpose in the model.

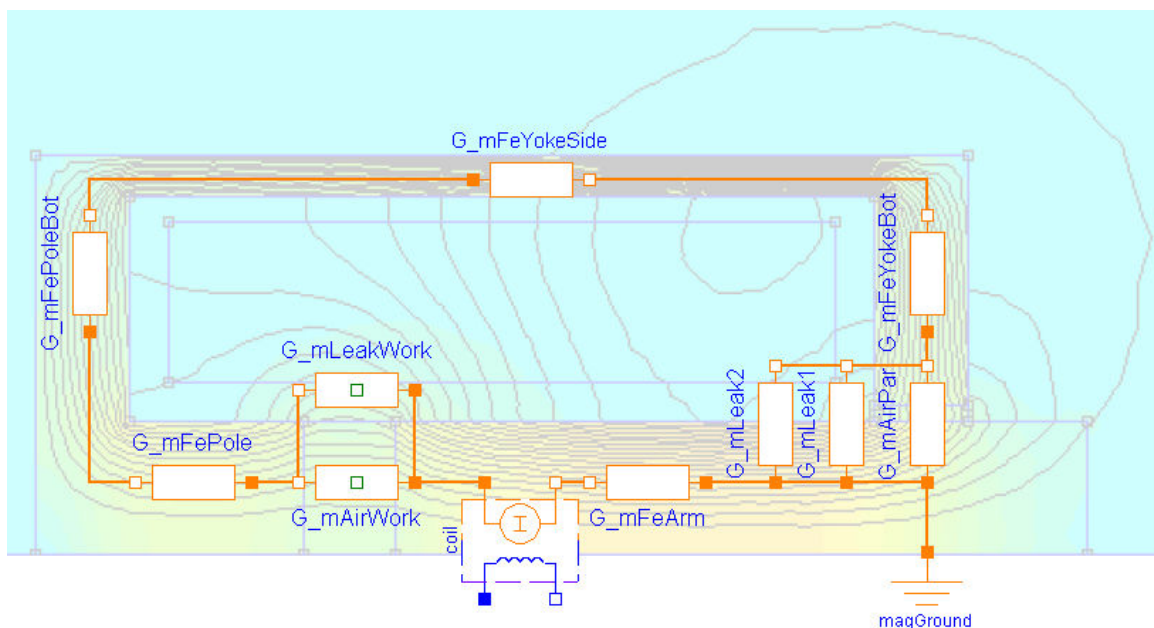

The coupling coefficient  $c_{\text{coupl}}$  in the coil is set to 1 in this example, since leakage flux is accounted for explicitly with the flux tube element  $G_{\text{mLeakWork}}$ . Although this leakage model is rather simple, it describes the reluctance force due to the leakage field sufficiently, especially at large air gaps. With decreasing air gap length, the influence of the leakage flux on the actuator's net reluctance force decreases due to the increasing influence of the main working air gap  $G_{\text{mAirWork}}$ .

During model-based actuator design, the radii and lengths of the flux tube elements (and hence their cross-sectional areas and flux densities) should be assigned with parametric equations so that common design rules are met (e.g., allowed flux density in ferromagnetic parts, allowed current density and required cross-sectional area of winding). For simplicity, those equations are omitted in the example. Instead, the found values are assigned to the model elements directly.

**Modelica.Magnetic.FluxTubes.Material.SoftMagnetic**

**Characteristics  $\mu_r(B)$  of common soft magnetic materials; hysteresis neglected**

**Information**

The magnetisation characteristics  $\mu_r(B)$  of all soft magnetic materials currently included in this library are approximated with a [function](#). Each material is characterised by the five parameters of this function. The approximated characteristics  $\mu_r(B)$  for most of the ferromagnetic materials currently included are shown in the plots below (solid lines) together with the original data points compiled from measurements and literature.

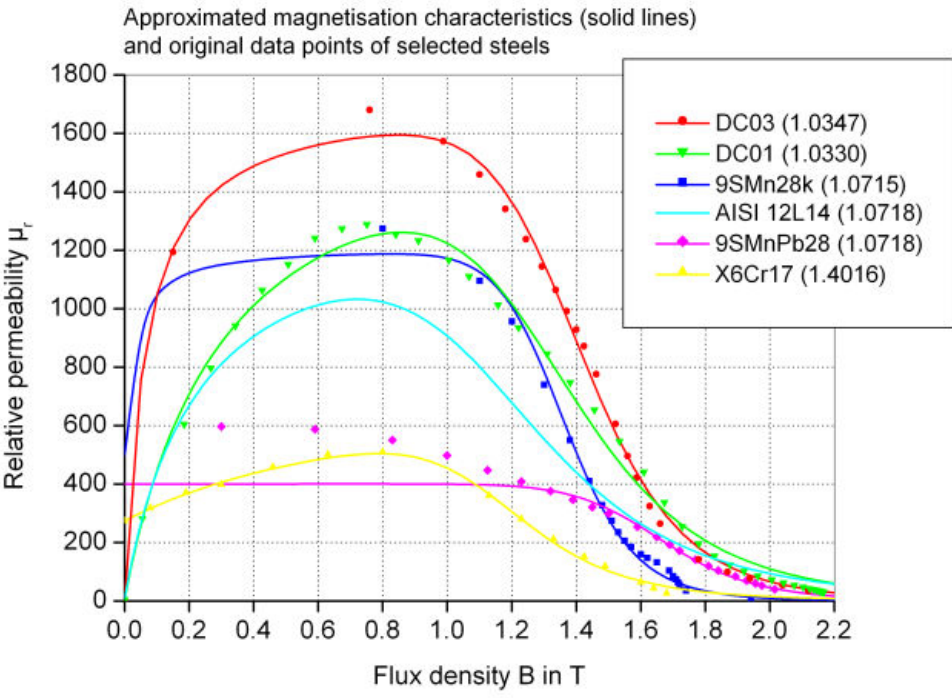

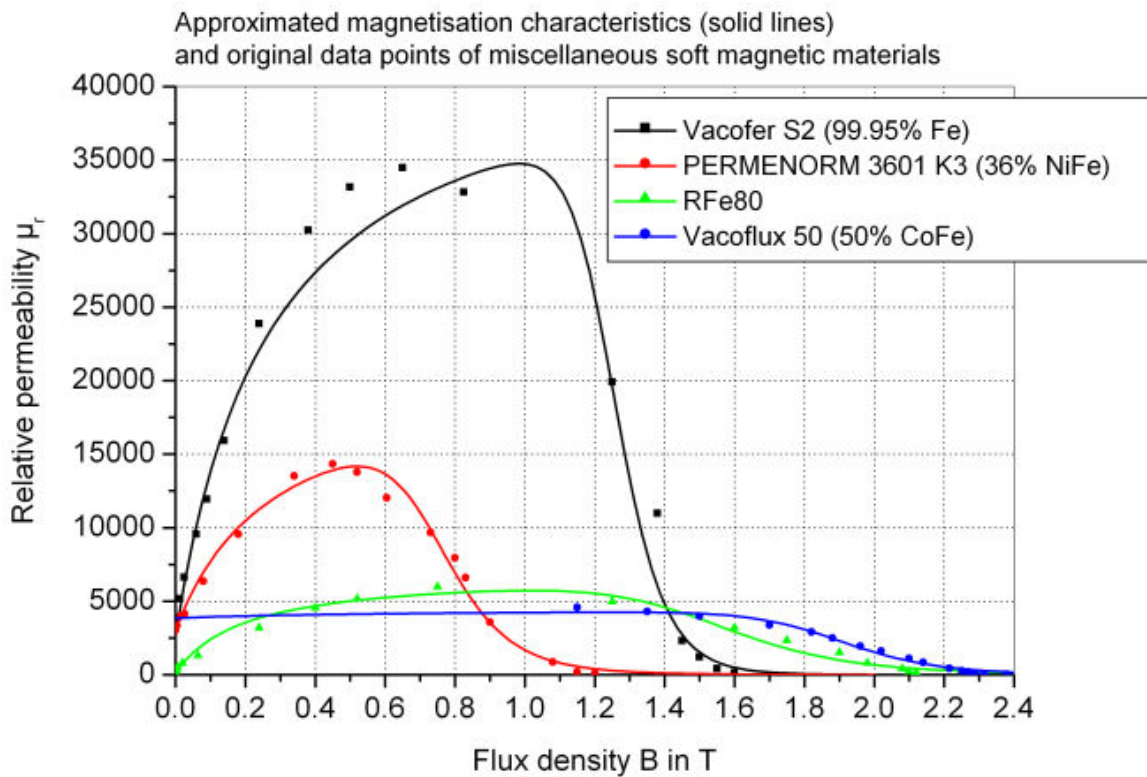
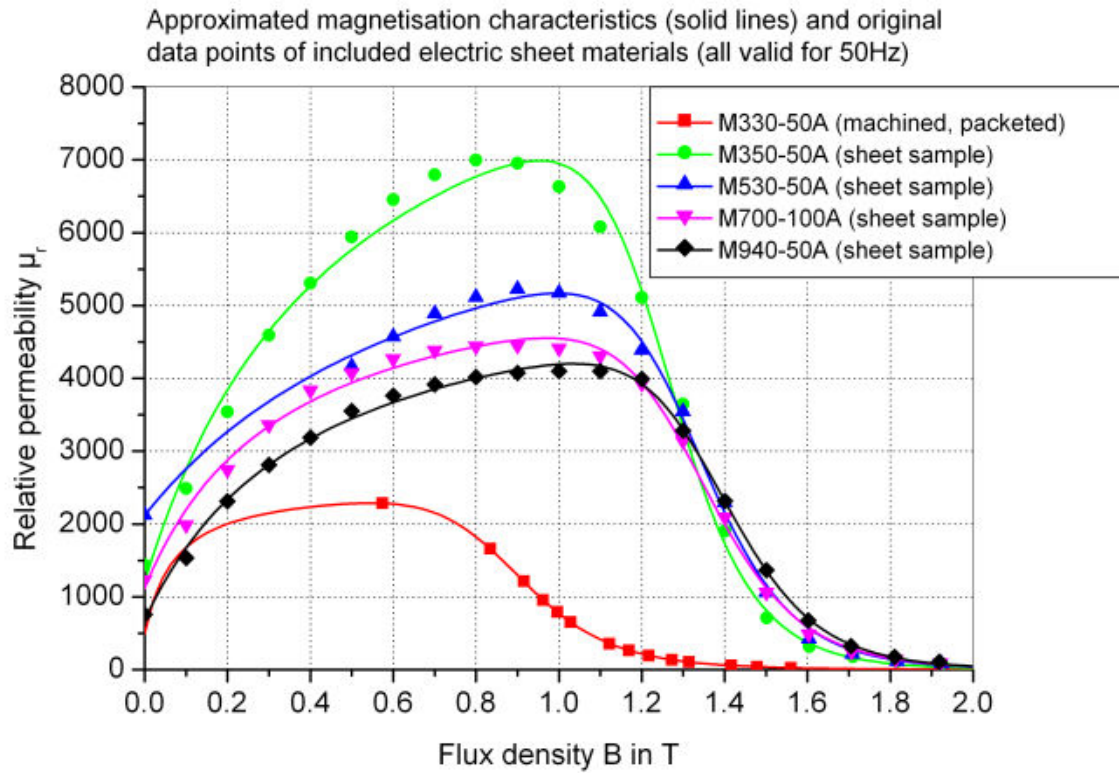

For the nonlinear curve fit, data points for high flux densities (approximately  $B > 1\text{T}$ ) have been weighted higher than the ones for low flux densities. This is due to the large impact of saturated ferromagnetic sections in a magnetic circuit compared to that of non-saturated sections with relative permeabilities  $\mu_r \gg 1$ .

Note that the magnetisation characteristics largely depend on possible previous machining and on measurement conditions. A virgin material normally has a considerably higher permeability than the same material after machining (and packet assembling in case of electric sheets). This is indicated in the above plots by different magnetisation curves for similar materials. In most cases, the original data points represent commutating curves obtained with measurements at 50Hz.

Additional user-specific materials can be defined as needed. This requires determination of the approximation parameters from the original data points, preferably with a nonlinear curve fit.



# Appendix C

## The Contradiction Matrix and The 40 Inventive Principles



# The Contradiction Matrix

Improving parameter	Worsening parameter	
	1	2
1 Weight of moving object	+	-
2 Weight of stationary object	-	+
3 Length of moving object	+	-
4 Length of stationary object	-	+
5 Area of moving object	+	-
6 Area of stationary object	-	+
7 Volume of moving object	+	-
8 Volume of stationary object	-	+
9 Speed	-	+
10 Force (intensity)	-	+
11 Stress or pressure	-	+
12 Shape	-	+
13 Stability of the object's composition	-	+
14 Strength	-	+
15 Duration of action of moving object	-	+
16 Duration of action of stationary object	-	+
17 Temperature	-	+
18 Illumination intensity	-	+
19 Use of energy by moving object	-	+
20 Use of energy by stationary object	-	+
21 Power	-	+
22 Loss of energy	-	+
23 Loss of substance	-	+
24 Loss of information	-	+
25 Loss of time	-	+
26 Quantity of substance/matter	-	+
27 Reliability	-	+
28 Manufacturing accuracy	-	+
29 Measurement precision	-	+
30 Object-affected harmful factors	-	+
31 Object-generated harmful factors	-	+
32 Ease of manufacture	-	+
33 Ease of operation	-	+
34 Ease of repair	-	+
35 Adaptability or versatility	-	+
36 Device complexity	-	+
37 Difficulty of detecting and measuring	-	+
38 Extent of automation	-	+
39 Productivity	-	+

# The 40 inventive Principles

The 40 Inventive Principles (IP) are used with the contradiction matrix to solve technical contradictions. This list with the so-called “sub-principles” that intend to help clarify the meaning of the principles was taken from the TRIZ Journal (<http://www.inventive-design.net>).

- *Inventive Principle 1: Segmentation*
  - a) Divide an object into independent parts
  - b) Make an object easy to disassemble
  - c) Increase the degree of fragmentation or segmentation
- *Inventive Principle 2: Taking out*
  - a) Separate an interfering part or property from an object, or single out the only necessary part (or property) of an object
- *Inventive Principle 3: Local quality*
  - a) Change an object’s structure from uniform to non-uniform, change an external environment (or external influence) from uniform to non-uniform
  - b) Make each part of an object function in conditions most suitable for its operation
  - c) Make each part of an object fulfill a different and useful function
- *Inventive Principle 4: Asymmetry*
  - a) Change the shape of an object from symmetrical to asymmetrical
  - b) If an object is asymmetrical, increase its degree of asymmetry
- *Inventive Principle 5: Merging*
  - a) Bring closer together (or merge) identical or similar objects, assemble identical or similar parts to perform parallel operations
  - b) Make operations contiguous or parallel; bring them together in time
- *Inventive Principle 6: Universality*
  - a) Make a part or object perform multiple functions; eliminate the need for other parts
- *Inventive Principle 7: “Nested doll”*
  - a) Place one object inside another; place each object, in turn, inside the other
  - b) Make one part pass through a cavity in the other

- *Inventive Principle 8: Anti-weight*
  - a) To compensate for the weight of an object, merge it with other objects that provide lift
  - b) To compensate for the weight of an object, make it interact with the environment (e.g. use aerodynamic, hydrodynamic, buoyancy and other forces)
  
- *Inventive Principle 9: Preliminary anti-action*
  - a) If it will be necessary to do an action with both harmful and useful effects, this action should be replaced with anti-actions to control harmful effects
  - b) Create beforehand stresses in an object that will oppose known undesirable working stresses later on
  
- *Inventive Principle 10: Preliminary action*
  - a) Perform, before it is needed, the required change of an object (either fully or partially)
  - b) Pre-arrange objects such that they can come into action from the most convenient place and without losing time for their delivery
  
- *Inventive Principle 11: Beforehand cushioning*
  - a) Prepare emergency means beforehand to compensate for the relatively low reliability of an object
  
- *Inventive Principle 12: Equipotentiality*
  - a) In a potential field, limit position changes (e.g. change operating conditions to eliminate the need to raise or lower objects in a gravity field)
  
- *Inventive Principle 13 : “The other way round”*
  - a) Invert the action(s) used to solve the problem (e.g. instead of cooling an object, heat it)
  - b) Make movable parts (or the external environment) fixed, and fixed parts movable)
  - c) Turn the object (or process) “upside down”
  
- *Inventive Principle 14 : Spheroidality - Curvature*
  - a) Instead of using rectilinear parts, surfaces, or forms, use curvilinear ones; move from flat surfaces to spherical ones; from parts shaped as a cube (parallelepiped) to ball-shaped structures
  - b) Use rollers, balls, spirals, domes
  - c) Go from linear to rotary motion, use centrifugal forces

- *Inventive Principle 15: Dynamics*
  - a) Allow (or design) the characteristics of an object, external environment, or process to change to be optimal or to find an optimal operating condition
  - b) Divide an object into parts capable of movement relative to each other
  - c) If an object (or process) is rigid or inflexible, make it movable or adaptive
  
- *Inventive Principle 16 : Partial or excessive actions*
  - a) If 100 percent of an object is hard to achieve using a given solution method then, by using 'slightly less' or 'slightly more' of the same method, the problem may be considerably easier to solve
  
- *Inventive Principle 17: Another dimension*
  - a) To move an object in two- or three-dimensional space
  - b) Use a multi-story arrangement of objects instead of a single-story arrangement
  - c) Tilt or re-orient the object, lay it on its side
  - d) Use 'another side' of a given area
  
- *Inventive Principle 18: Mechanical vibration*
  - a) Cause an object to oscillate or vibrate
  - b) Increase its frequency (even up to the ultrasonic)
  - c) Use an object's resonant frequency
  - d) Use piezoelectric vibrators instead of mechanical ones
  - e) Use combined ultrasonic and electromagnetic field oscillations
  
- *Inventive Principle 19: Periodic action*
  - a) Instead of continuous action, use periodic or pulsating actions
  - b) If an action is already periodic, change the periodic magnitude or frequency
  - c) Use pauses between impulses to perform a different action
  
- *Inventive Principle 20 : Continuity of useful action*
  - a) Carry on work continuously; make all parts of an object work at full load, all the time
  - b) Eliminate all idle or intermittent actions or work
  
- *Inventive Principle 21: Skipping*
  - a) Conduct a process , or certain stages (e.g. destructible, harmful or hazardous operations) at high speed

- *Inventive Principle 22 : “Blessing in disguise” or “Turn Lemons into Lemonade”*
  - a) Use harmful factors (particularly, harmful effects of the environment or surroundings) to achieve a positive effect
  - b) Eliminate the primary harmful action by adding it to another harmful action to resolve the problem
  - c) Amplify a harmful factor to such a degree that it is no longer harmful
  
- *Inventive Principle 23: Feedback*
  - a) Introduce feedback (referring back, cross-checking) to improve a process or action
  - b) If feedback is already used, change its magnitude or influence
  
- *Inventive Principle 24: “Intermediary”*
  - a) Use an intermediary carrier article or intermediary process
  - b) Merge one object temporarily with another (which can be easily removed)
  
- *Inventive Principle 25: Self-service*
  - a) Make an object serve itself by performing auxiliary helpful functions
  - b) Use waste resources, energy, or substances
  
- *Inventive Principle 26: Copying*
  - a) Instead of an unavailable, expensive, fragile object, use simpler and inexpensive copies
  - b) Replace an object, or process with optical copies
  - c) If visible optical copies are already used, move to infrared or ultraviolet copies
  
- *Inventive Principle 27: Cheap short-living objects*
  - a) Replace an inexpensive object with a multiple of inexpensive objects, comprising certain qualities (such as service life, for instance)
  
- *Inventive Principle 28: Mechanics substitution*
  - a) Replace a mechanical means with a sensory (optical, acoustic, taste or smell) means
  - b) Use electric, magnetic and electromagnetic fields to interact with the object
  - c) Change from static to movable fields, from unstructured fields to those having structure
  - d) Use fields in conjunction with field-activated (e.g. ferromagnetic) particles

- *Inventive Principle 29 : Pneumatics and hydraulics*
  - a) Use gas and liquid parts of an object instead of solid parts (e.g. inflatable, filled with liquids, air cushion, hydrostatic, hydro-reactive)
- *Inventive Principle 30 : Flexible shells and thin films*
  - a) Use flexible shells and thin films instead of three dimensional structures
  - b) Isolate the object from the external environment using flexible shells and thin films
- *Inventive Principle 31: Porous materials*
  - a) Make an object porous or add porous elements (inserts, coatings, etc.)
  - b) If an object is already porous, use the pores to introduce a useful substance or function
- *Inventive Principle 32: Color changes*
  - a) Change the color of an object or its external environment
  - b) Change the transparency of an object or its external environment
- *Inventive Principle 33: Homogeneity*
  - a) Make objects interacting with a given object of the same material (or material with identical properties)
- *Inventive Principle 34: Discarding and recovering*
  - a) Make portions of an object that have fulfilled their functions go away (discard by dissolving, evaporating, etc.) or modify these directly during operation
  - b) Conversely, restore consumable parts of an object directly in operation
- *Inventive Principle 35: Change of physical and chemical parameters*
  - a) Change the object's aggregate state
  - b) Change concentration or consistency of the object
  - c) Change the degree of flexibility of the object
  - d) Change the temperature of the object or environment
- *Inventive Principle 36: Phase transitions*
  - a) Use phenomena occurring during phase transitions (e.g. volume changes, loss or absorption of heat, etc.)
- *Inventive Principle 37: Thermal expansion*
  - a) Use thermal expansion (or contraction) of materials
  - b) If thermal expansion is being used, use multiple materials with different coefficients of thermal expansion

- *Inventive Principle 38: Strong oxidants*
  - a) Replace common air with oxygen-enriched air
  - b) Replace enriched air with pure oxygen
  - c) Expose air or oxygen to ionizing radiation
  - d) Use ionized oxygen
  - e) Replace ozonized (or ionized) oxygen with ozone
  
- *Inventive Principle 39: Inert atmosphere*
  - a) Use inert gases instead of usual ones
  - b) Add neutral parts or additives to the object
  
- *Inventive Principle 40: Composite materials*
  - a) Change from uniform to composite (multiple) materials

# Appendix D

Datasheet of thermoelectric module: **TEC1-12702**



## Specification of Thermoelectric Module

### TEC1-12702

#### Description

The 127 couples, 40 mm × 40 mm size module is a single stage module which is made of selected high performance ingot to achieve superior cooling performance and greater delta T up to 70 °C, designed for superior cooling and heating up to 100 °C applications. If higher operation or processing temperature is required, please specify, we can design and manufacture the custom made module according to your special requirements.

#### Features

- No moving parts, no noise, and solid-state
- Compact structure, small in size, light in weight
- Environmental friendly
- RoHS compliant
- Precise temperature control
- Exceptionally reliable in quality, high performance

#### Application

- Food and beverage service refrigerator
- Portable cooler box for cars
- Liquid cooling
- Temperature stabilizer
- CPU cooler and scientific instrument
- Photonic and medical systems

#### Performance Specification Sheet

Th (°C)	27	50	Hot side temperature at environment: dry air, N <sub>2</sub>
DT <sub>max</sub> (°C)	70	79	Temperature Difference between cold and hot side of the module when cooling capacity is zero at cold side
U <sub>max</sub> (Voltage)	16	16.6	Voltage applied to the module at DT <sub>max</sub>
I <sub>max</sub> (amps)	3.1	3.1	DC current through the modules at DT <sub>max</sub>
Q <sub>Cmax</sub> (Watts)	32.3	36.5	Cooling capacity at cold side of the module under DT=0 °C
AC resistance (ohms)	3.9~4.2	4.3~4.6	The module resistance is tested under AC

#### Geometric Characteristics Dimensions in millimeters

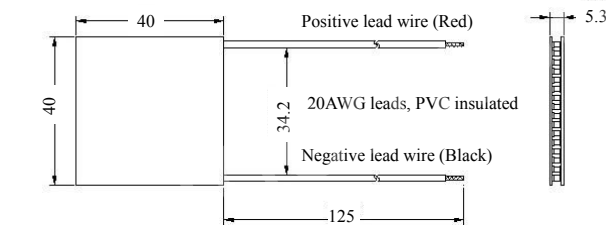

#### Sealing Option

Suffix	Sealant
NS	No sealing
SS	Silicone sealant
EPS	Epoxy
OS	Customer specify sealing other than above

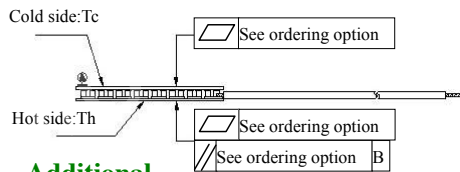

#### Ordering Option

Suffix	Thickness (mm)	Flatness/Parallelism (mm)	Lead wire length(mm) Standard/Optional length
TF	0:5.3±0.1	0:0.035/0.035	125±1/Specify
TF	1:5.3±0.05	1:0.025/0.025	125±1/Specify
TF	2:5.3±0.03	2:0.015/0.015	125±1/Specify

Eg. TF0: Thickness 5.3 ± 0.1 (mm) and Flatness 0.035/0.035(mm)

#### Additional

Ceramic material: Alumina (Al<sub>2</sub>O<sub>3</sub>, white 96%)  
Solder tinning: Bismuth Tin (BiSn) M.P. 138 °C

## Specification of Thermoelectric Module

TEC1-12702

Performance Curves at  $T_h=27^\circ\text{C}$

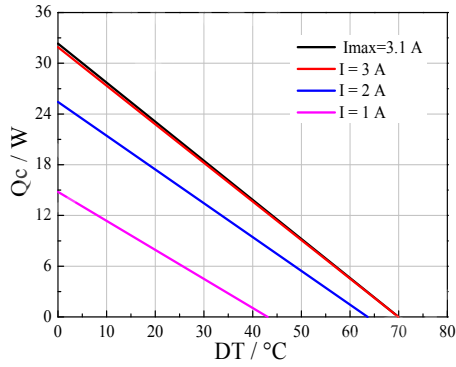

Performance Curves at  $T_h=50^\circ\text{C}$

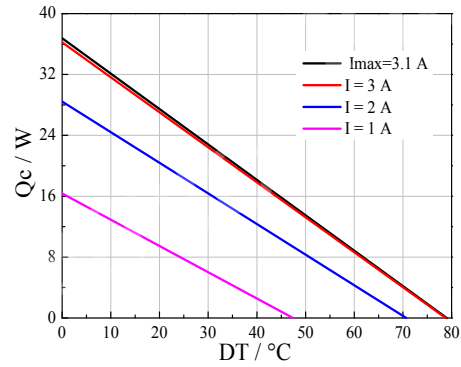

Standard Performance Graph  $Q_c = f(DT)$

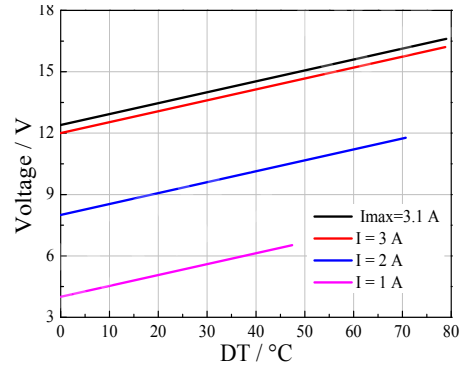
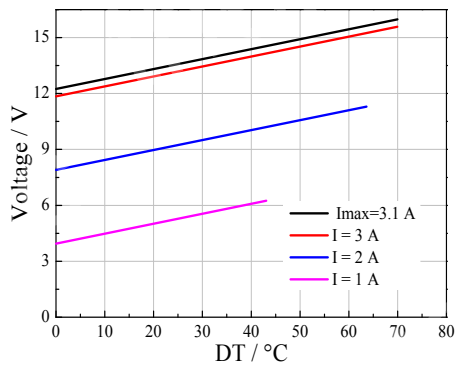

Standard Performance Graph  $V = f(\Delta T)$

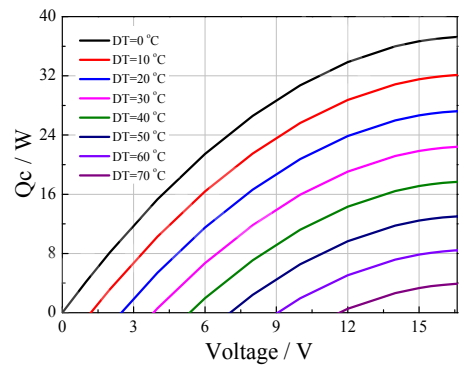
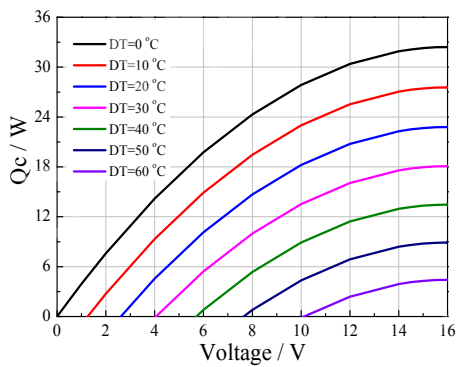

Standard Performance Graph  $Q_c = f(V)$

Creative technology with fine manufacturing processes provides you the reliable and quality products  
Tel: +86-791-88198288 Fax: +86-791-88198308 Email: [info@thermonamic.com](mailto:info@thermonamic.com) Web Site: [www.thermonamic.com](http://www.thermonamic.com)

## Specification of Thermoelectric Module

### TEC1-12702

#### Performance Curves at Th=27 °C

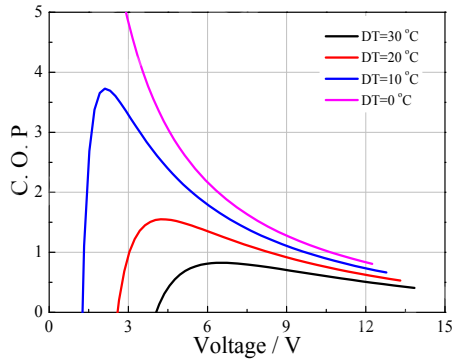

#### Performance Curves at Th=50 °C

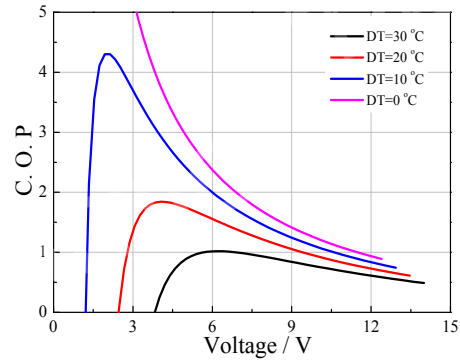

Standard Performance Graph COP = f(V) of ΔT ranged from 0 to 30 °C

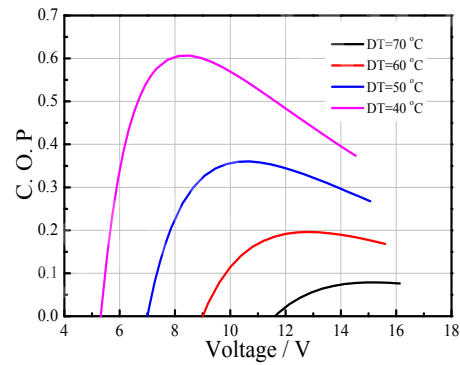
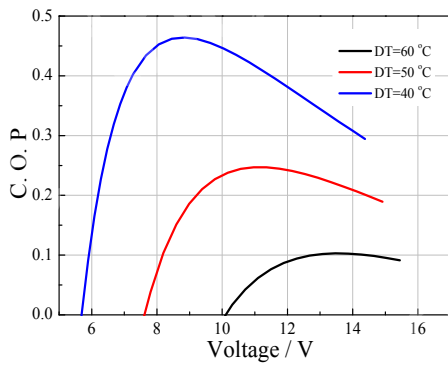

Standard Performance Graph COP = f(V) of ΔT ranged from 40 to 60/70 °C

Remark: The coefficient of performance (COP) is the cooling power  $Q_c$ /Input power ( $V \times I$ ).

#### Operation Cautions

- Cold side of the module stucked on the object being cooled
- Hot side of the module mounted on a heat radiator
- Operation or storage module below 100 °C
- Operation below  $I_{max}$  or  $V_{max}$
- Work under DC

Creative technology with fine manufacturing processes provides you the reliable and quality products  
Tel: +86-791-88198288 Fax: +86-791-88198308 Email: [info@thermonamic.com](mailto:info@thermonamic.com) Web Site: [www.thermonamic.com](http://www.thermonamic.com)

## Résumé

Une des caractéristiques les plus frappantes de la conception inventive est le fait qu'évaluer des solutions peut se révéler être plus difficile que de les trouver. Avoir des idées est inutile si celles-ci sont rejetées à un stade précoce. Dans de nombreuses évaluations qualitatives et méthodes sélectives, les critères d'évaluation sont généralement constitués à partir des besoins de conception qui sont fortement influencé par les préférences ou l'expérience des décideurs.

Afin de tirer parti de l'inventivité d'une entreprise en octroyant des chances supplémentaires quant à des concepts possibles, cette thèse présente des approches et des outils d'aide à l'évaluation et à la sélection de concepts de solution obtenus dans le cadre de la Méthode de Conception Inventive. Les contributions de cette thèse peuvent servir comme outils d'aide à la conception et à la prise de décision.

**Mots-clés :** Méthode de conception inventive, TRIZ, décision, échec, simulation, TRL

## Résumé en anglais

One of the most striking characteristics of inventive design is that evaluating solutions may prove to be more difficult than finding them. Having good ideas is useless if they are rejected at an early stage. In many existing qualitative evaluation and selection methods (see design model), evaluation criteria are usually taken from the design requirement, which is strongly influenced by customer preferences or decision makers' experience.

In order to leverage inventiveness of a company through additional chances of feasible concepts. This thesis presents approaches and support tools to evaluate and select Solution Concepts obtained from Inventive Design Method (IDM) framework. The contributions in this thesis can be used as a decision-making aid and tool.

**Keywords:** Inventive Design Method, TRIZ, evaluation, selection, failure, TRL, simulation, optimization