



HAL
open science

Essays on risk management in the presence of ambiguity

Nicolas Lampach

► **To cite this version:**

Nicolas Lampach. Essays on risk management in the presence of ambiguity. Economics and Finance. Université de Strasbourg, 2016. English. NNT : 2016STRAB009 . tel-01484495

HAL Id: tel-01484495

<https://theses.hal.science/tel-01484495>

Submitted on 7 Mar 2017

HAL is a multi-disciplinary open access archive for the deposit and dissemination of scientific research documents, whether they are published or not. The documents may come from teaching and research institutions in France or abroad, or from public or private research centers.

L'archive ouverte pluridisciplinaire **HAL**, est destinée au dépôt et à la diffusion de documents scientifiques de niveau recherche, publiés ou non, émanant des établissements d'enseignement et de recherche français ou étrangers, des laboratoires publics ou privés.

ÉCOLE DOCTORALE AUGUSTIN COURNOT

[UMR 7522 – Bureau d’Economie Théorique et Appliquée]

THÈSE présentée par :

Nicolas LAMPACH

soutenue le : 09 décembre 2016

pour obtenir le grade de : **Docteur de l’université de Strasbourg**

Discipline/ Spécialité : Sciences économiques

Essais sur la Gestion des Risques en Présence d’Ambiguïté

THÈSE dirigée par :

Madame SPAETER-LOEHRER Sandrine

Professeur, Université de Strasbourg

RAPPORTEURS :

Madame HIRIART Yolande

Professeur, Université de Franche Comté

Monsieur L’HARIDON Olivier

Professeur, Université de Rennes I

AUTRES MEMBRES DU JURY :

Madame CHARLIER Dorothée

Maître de conférences, Université de Montpellier

Monsieur VAN-NGUYEN Phu

Chargé de recherche, Université de Strasbourg

OPTIMAL TECHNOLOGICAL RISK MANAGEMENT

Insurance, Liability and Prevention

Nicolas LAMPACH

Strasbourg, 9th December 2016

Abstract

Modern technologies have huge promise for the future and are rapidly transforming the society even though those technologies are associated with scientific uncertainty about potential health and environmental risks. The thesis aims to establish an optimal technological risk management to ensure hazard reduction of new emerging risks without impeding the innovation path. The research work contributes to *ex-ante* and *ex-post* risk management strategies and provides theoretical and empirical evidence to address the management of new emerging risks. The first part of the thesis examines, from the perspective of Law and Economics, the effectiveness of the tort liability rule for the situation where the decision maker is lacking information about the probability of an event to occur. The second part of the thesis pays particular attention to the environmental energy transition in France and focus on the insurability of the energy performance in the housing sector. The theoretical and experimental findings from the first part of the research convey strong validity that tort law cannot provide *ex-ante* optimal incentives when there is lacking information about the probability of accident. The regime of unlimited and limited liability leads to overinvestment in prevention in regard to new emerging risks. The empirical results of the second part of the thesis reveal that 23.75% of households participated in the weatherization program "Je rénove BBC" do not achieve the required energy target but the severity of the energy performance gap is relatively low. The calculated energy savings, the age of occupants and energy behavior related to domestic hot water consumption significantly affect the energy performance gap. Though, applying multiple imputation methods render these results less robust. The findings of the research work imply several policy recommendations to manage new emerging technologies in the future.

Keywords: Tort law; Technological disaster; Laboratory experiment; Risk; Ambiguity; Energy transition; Energy performance; Insurance; Housing

JEL Classification: K13; O32; C91; D81; Q40; G22

Résumé de la thèse

Les technologies modernes sont riches de promesses pour l'avenir et sont en train de transformer rapidement la société, même si ces technologies sont associées à l'incertitude scientifique sur les risques sanitaires et environnementaux potentiels. La thèse vise à établir une gestion du risque technologique optimal pour assurer la réduction des dangers de nouveaux risques émergents, sans entraver le chemin de l'innovation. Les travaux de recherche apportent une contribution aux stratégies *ex-ante* et *ex-post* de la gestion des risques et fournissent des données théoriques et empiriques pour aborder la gestion des nouveaux risques émergents. La première partie de la thèse examine, du point de vue juridique et économique, l'efficacité de la règle de la responsabilité civile lorsque le décideur manque d'information sur la probabilité d'un événement. La deuxième partie de la thèse porte une attention particulière à la transition énergétique en France afin de se concentrer sur l'assurabilité de la performance énergétique dans le secteur du logement. Les résultats théoriques et expérimentaux de la première partie de la recherche attestent d'une forte validité empirique selon laquelle le droit de la responsabilité civile ne peut pas fournir des incitations optimales *ex-ante* en absence d'information sur la probabilité d'accident. Les régimes de la responsabilité illimitée et limitée conduisent à un surinvestissement dans la prévention par rapport aux nouveaux risques émergents. Les résultats empiriques de la deuxième partie de la thèse révèlent que 23,75 % des ménages, qui ont participé au programme de rénovation "Je Rénove BBC", ne peuvent pas atteindre l'objectif d'énergie prévu, mais l'amplitude de l'écart de performance énergétique est relativement faible. Les économies d'énergie conventionnelles, l'âge des occupants et le comportement de l'énergie liée à la consommation d'eau chaude sanitaire affectent de manière significative l'écart de performance énergétique. Bien que, l'application de la méthode d'imputation multiple rende ces résultats moins robustes. Les résultats des travaux de recherche impliquent plusieurs recommandations politiques pour gérer les nouvelles technologies émergentes dans le futur.

Mots clés: Responsabilité civile; Catastrophe technologique; L'expérience en laboratoire; Risque; Ambiguïté; Transition énergétique; Performance énergétique; Assurance; Logement

Classification JEL: K13; O32; C91; D81; Q40; G22

Acknowledgement

At this place, I would, first of all, like to express my deep gratitude to Professor Sandrine Spaeter-Loehrer, my research supervisor, for her patient guidance, enthusiastic encouragement and useful critiques of this research work.

My grateful thanks are also extended to the members of the jury, Assistant Professor Doroth e Charlier, Professor Olivier l’Haridon, Professor Yolande Hiriart, Miss Sabine Mirtain-Roth, Mister Ludovic Parisot and Research Assistant Professor Phu Van-Nguyen for their useful comments, advice and helpful suggestions.

I would like to thank various people for their contributions to this PhD thesis. I would like to express my very great appreciation to Mr. Kene Boun My, for his suggestions and help in conducting the experiments, to Miss Sabine Mirtain-Roth and Mr. Ludovic Parisot for their assistance during the weatherization project, to Prof. Guiseppe Attanasi, Assistant Prof. Mathieu Lefevbre and Prof. Anne Rozan, who gave me valuable suggestions for my experiments, to Miss Danielle Geneve for her kind support, and to Miss Marine Andr e and Mr. Nicolas Mazuy for proof reading.

Wishing to acknowledge the help provided by Mr. Jean-Luc Sadorge and EDF, the staff of the energy conservation program *Je r enove BBC* who helped me to set up the project and gave me constructive suggestions during the planning and development of this research.

Assistance provided by Leila Ch erifi, Maryline Delsart, Lucie Martin-Bonnel-De-Longchamp and D eborah Zaparova was greatly appreciated to carry out the household survey and collect the data on the energy consumption.

I gratefully acknowledge financial support by the project “Creative, Sustainable Economies and Societies” (CSES) coordinated by Robin Cowan, funded through the University of Strasbourg IDEX Unistra (Initiative of Excellence).

I would also like to thank the Doctoral School Augustin Cournot, the European Doctoral College, the research staff from the Bureau d’Economie Th eorique et Appliqu ee (BETA), the administrative staff from the department of Management and Economic Sciences, my precious colleagues and my friends for their support and joyful moments during this research work.

Finally, I wish to thank my parents and my girlfriend for their support and encouragement throughout my PhD thesis.

Contents

General Introduction	1
I <i>Ex-Ante</i> Risk Management	23
1 Literature Review	25
1.1 Introduction	26
1.2 Economic Analysis of Law	28
1.2.1 Incentives of the relevant actors	29
1.2.2 Unilateral accident model with the level of care	31
1.2.3 Related Literature	32
1.3 Behavioral Law and Economics	35
1.4 Decision Making under Ambiguity	38
1.4.1 Definition	38
1.4.2 Savage theory and the Ellsberg paradox	39
1.4.3 Modeling ambiguity	40
1.5 Nanotechnology and risks governance	44
1.6 Concluding remarks	48
2 The Efficiency of Strict Liability Rules Revised in Risk and Ambiguity	50
2.1 Introduction	51
2.2 The Basic Model	53
2.2.1 Private optimum when strict and unlimited liability holds	54
2.2.2 When the <i>ex post</i> potential injurer's liability is limited to her net value	55
2.3 Efficient rules with ambiguity	58
2.3.1 Private optima and ambiguity	61
2.4 Conclusion	65
Appendix A	68
A.1 Proposition	68
A.2 Assuming risk aversion	69

3	Evidence from Laboratory Experiments	73
3.1	Introduction	74
3.2	Economic Theory and Predictions	76
3.3	Experiment	77
3.3.1	Procedure	77
3.3.2	Experimental design	78
3.4	Results	87
3.4.1	Empirical results	87
3.4.2	Factors affecting the investment in prevention	97
3.4.3	Behavioral strategy	102
3.5	Sharing gains and losses	103
3.6	Concluding Remarks	106
	Appendix B Supplementary materials and information	110
B.1	Tables and Figures	110
B.1.1	Tables	110
B.1.2	Figures	115
B.2	Materials and Information	118
B.2.1	Screenshots of the experimental tasks	118
B.2.2	Sets of Instructions in French	124
B.3	Questionnaire in French	144
II	<i>Ex-Post</i> Risk Management	147
4	Ambiguity about the Energy Performance of Individual Buildings	150
4.1	Introduction	151
4.2	Energy Efficiency	153
4.3	Background and Context	156
4.3.1	Literature Review	157
4.3.2	Weatherization Program "Je rénove BBC"	164
4.4	Hypotheses	166
4.5	Final Remarks	167
	Appendix C Additional material	169
5	Household Survey and Data Sample	173
5.1	Methodology & Survey	174
5.1.1	Sampling	174
5.1.2	Survey Design	175
5.1.3	Data Collection	178

5.2	Data	179
5.2.1	Survey Sample	180
5.2.2	Thermal study - <i>Ex Ante</i> Evaluation	182
5.2.3	Measured Energy Consumption - <i>Ex Post</i> Billing Data	185
5.2.4	Variables	190
Appendix D Additional materials		194
D.1	Tables	194
D.2	Questionnaire	196
6	Estimating the Energy Performance Gap of Low Energy Buildings	206
6.1	Introduction	207
6.2	Statistical analysis	209
6.2.1	Descriptive Statistics	209
6.2.2	Energy savings	212
6.2.3	Missing data pattern	219
6.3	Econometric specification	222
6.3.1	Structural equations	222
6.3.2	Endogeneity	225
6.3.3	Multiple data imputations	228
6.4	Estimation results	231
6.5	Conclusion	237
Appendix E Additional material		240
E.1	Descriptive data	241
E.2	Missing data and multiple data imputation	244
General Conclusion		249

List of Figures

2.1	Compound ambiguous and risky lottery	60
3.1	Graphical assessment of the aggregated average investment in prevention by comparing unlimited and limited liability while fixing the domain	89
3.2	Graphical assessment of the aggregated average investment in prevention by comparing the domain of risk and ambiguity while fixing the liability regime	90
3.3	Ask versus Task: Cumulative distribution function between average investment in prevention and optimism index aggregated for both liability regimes in the domain of ambiguity	92
3.4	Graphical assessment of the observed versus predicted mean decision per round in the domain of risk for both unlimited and limited liability	94
3.5	Graphical assessment of the observed versus predicted mean decision per round in the domain of ambiguity for both unlimited and limited liability	95
3.6	Aggregated average investment per round per treatment (pooled)	96
3.7	Cumulative distribution functions of advantageous inequity aversion in the domain of gains and losses	106
B.1	Graphical assessment of the aggregated average investment in prevention by comparing the baseline with limited liability in the domain of ambiguity	115
B.2	Ask versus Task: Relationship between Optimism Index and average investment in prevention under unlimited liability in the domain of ambiguity	116
B.3	Ask versus Task: Relationship between Optimism Index and average investment in prevention under limited liability in the domain of ambiguity	116
B.4	Ask versus Task: Relationship between Optimism Index and average investment in prevention aggregated for both liability regimes in the domain of ambiguity	117
B.5	Screenshot of Task 1: Modified dictator game to elicit subject's attitudes toward advantageous inequity aversion	118
B.6	Screenshot of Task 2: MPL to elicit subject's attitudes toward risk aversion	118
B.7	Screenshot of Task 3: MPL to elicit subject's attitudes toward ambiguity aversion	119
B.8	Screenshot of subject's decision choice in RK treatment under unlimited liability	119

B.9 Screenshot of the draw of a blue or yellow ball in RK treatment under unlimited liability	120
B.10 Screenshot of the feedback table during round 4 in RK treatment under unlimited liability	120
B.11 Screenshot of subject’s decision choice in AMB treatment under limited liability	121
B.12 Screenshot of the first draw of an urn in AMB treatment under limited liability	121
B.13 Screenshot of the second draw of a yellow or blue ball from the drawn urn in AMB treatment under limited liability	122
B.14 Screenshot of the feedback table during round 4 in AMB treatment under limited liability	122
B.15 Screenshot of feedback table at the end of the experiment in AMB treatment under limited liability	123
4.1 Energy efficiency improvements by country in the household sector based on Odyssee and Mure database	155
4.2 Illustration of the direct prebound and rebound effect	161
C.1 Mapping the French climate zone	172
5.1 Mapping the density of individual households participating in the survey	180
5.2 Screen-shot of the modelling software Perrenoud U48 WinV2 to estimate <i>ex ante</i> energy savings based on engineering calculations	184
5.3 Single application	187
5.4 Mixed system	189
5.5 Separated heating and domestic hot water system	190
6.1 Graphical comparison of household’s measured energy consumption with respect to the conservation program’s target	213
6.2 Graphical assessment of the ratio between measured and calculated energy consumption before the retrofit intervention	214
6.3 Graphical assessment of the ratio between measured and calculated energy consumption before retrofit intervention	215
6.4 The ratio between measured and calculated energy consumption on the basis of measured energy consumption	217
6.5 The distribution of the total gross effect with respect to the energy efficiency upgrades	218
6.6 Illustration of the missing data pattern of the first block of variables	220
6.7 Illustration of the missing data pattern of the second block of variables	221
6.8 Illustration of the missing data pattern of the third block of variables	222
6.9 The density distribution of the observed and imputed data before and after energy efficiency initiatives	230

E.1 Energy savings before the energy conservation program	243
E.2 Discrepancy between ac after the energy conservation programs	243
E.3 The density distribution of the observed and imputed data for the first block of covariates	246
E.4 The density distribution of the observed and imputed data for the second block of covariates	247
E.5 The density distribution of the observed and imputed data for the third block of covariates	248

List of Tables

3.1	Eliciting subject's advantageous inequity aversion by applying the modified dictator game	79
3.2	Eliciting subject's risk and ambiguity aversion by applying multiple price list	80
3.3	Treatment	81
3.4	Endowment	83
3.5	Payoffs	84
3.6	Aggregated (pooled) average investment per treatment	87
3.7	Estimation results applying ordered probit model	97
3.8	Average marginal effects from ordered probit model estimation	100
3.9	Samples and treatments	104
3.10	Differences of payoffs between the tasks of sample 1 and sample 2	105
B.1	Decision choice for the RK treatment	110
B.2	Decision choice for the AMB treatment	110
B.3	Descriptive Statistics of experimental data	111
B.4	Distributive Justice (Others) Scale	112
B.5	Distributive Justice (Myself) Scale	112
B.6	Revised Orientation Test (R-LOT)	112
B.7	General Confidence Scale	113
B.8	Trust Scale	113
B.9	Frequency of chosen investment level using panel data	113
B.10	Estimation of the behavioral variation by applying random effects ordered probit model	114
C.1	Literature review of studies analyzing the link between occupants behavior and energy consumption in Europe over the last decades	169
5.1	Number of questions per topic put to the assisted self-administrated questionnaire	176
5.2	Snap shot of the assistant self-administrated questionnaire	177
5.3	List of variables	190
D.1	Summary of data collection of the first survey wave	194

D.2	Summary of data collection of the second survey wave	194
D.3	Summary of data collection of the third survey wave	195
D.4	Conversion rates regarding Annexe 3 of the Decree of 15 September 2006 relating to the diagnosis of energy performance for the existing buildings proposed with the sale in Metropolitan France	195
6.1	Summary statistics of the French households participated in the weatherization program	211
6.2	Estimation results from Heckman probit model and 2SLS without and with multiple data imputations	232
6.3	Estimating the energy performance gap without and with multiple data imputations by correcting for sample selection and endogeneity	234
E.1	Summary of the descriptive data before the retrofit intervention	241
E.2	Summary of the descriptive data after the retrofit intervention	242
E.3	Summary of missing data for the first block of variables	244
E.4	Summary of missing data for the second block of variables	245
E.5	Summary of missing data for the third block of variables	245

„The philosophers have only interpreted the world, in various ways. The point, however, is to change it.“

Karl Marx 1845, Eleven Theses on Feuerbach

General Introduction

Motivation and Background

Until the end of the 20th century the classical fundamental assumption in risk analysis implied that economic agents face decisions in risky environments, where the consequences of their decisions can be predicted. Under such circumstances, the agent chooses the decision equalizing the expected marginal costs and the marginal benefits. This approach represents the well-known, and widely applied cost-benefit analysis under risk.

Given that in most situations, decisions are irreversible and might bear high consequences in the long-term perspective, it is crucial to anticipate efficiently the challenges and the needs. In general, decision making is a process of selecting the best alternative among different possible configurations by evaluating the known advantages and disadvantages of each alternative. Nonetheless, decision makers essentially face difficulties by weighting up the overall *pros* and *cons* of actions when there is scarce knowledge about the probability of the occurrence of an event (e.g. financial shock, technological accident, natural disaster, economic crisis, climate change, terrorism).

For this purpose, the management of new emerging risks cannot be investigated with the above mentioned approach: Evidence, information and knowledge about risks related to technological innovations are not explicitly known at the time they are being developed. Nevertheless, the lack of information shall not lead the legislator to postpone the implementation of new legislations, the banks to refuse financing new innovative projects, or insurers to exclude technological risks associated with those projects. Moreover, no firm can be exempted from liability due to the paucity of knowledge about the risks. This approach reflects the basis of the precautionary principle and more fundamentally a question of good sense.

It is common knowledge that novel technologies in various fields of application present new opportunities, bring huge social and individual benefits and are particularly a driving force for the economic growth, prosperity and wealth. Likewise, nano- and biotechnology belong to the key emerging technologies of the 21st century and anticipate groundbreaking contribution in the field of health care, agriculture, renewable energy, food processing and the environment. On the other hand, these future technologies are likely to produce toxic substances that menace ecosystems

and emerge new diseases which can spread rapidly ([Mandel, 2009](#)).

Modern technology is associated with emerging risks which differ from other risks in the sense that we do not currently know the frequency, the direction and the severity of those risks in the future when we first become aware of it. Governing emerging risks poses a daunting challenge for regulators as there is lack of knowledge whether self-driving cars will lead to fewer accidents, whether shale gas extraction potentially pollutes air and groundwater or what effects nanoparticles will have on human skin penetration ([OECD, 2003](#); [Wansley, 2016](#)).

But also, insurers continue to face difficulties with quantifying the frequency and the severity of emerging risks characterized by uncertainty. The lack of historical data and the dynamic changes of relevant scientific evidence and policy regulation hamper the establishment of insurance in the long term perspective. As a consequence, investors are unwilling to invest in new innovative projects derived from the lack of insurance to protect them in the future against emerging risks and from uncertainties related to upcoming legislative and regulatory changes.

In this regard, an example could be given by the application of green technologies to improve the energy efficiency in the housing sector. One of the European long-term strategy is to meet the 2020 climate targets by improving energy efficiency in existing buildings ([European Commission, 2010a](#); [European Fuel Poverty and Energy Efficiency, 2010](#); [Lechtenböhmer and Schüring, 2010](#); [Lapillonne et al., 2015](#)). In the meanwhile, higher energy prices and the desire to reduce the carbondioxid (CO_2) emissions give rise to invest in energy efficiency initiatives.

So far, little is known about the efficiency of energy saving investments in the green renovation sector. To stimulate investments in energy efficiency measures and promote eco-friendly technologies, it is of vital importance to facilitate the access to insurance coverage especially for self-employed and small enterprises ([ELIOS, 2008](#)).

In this respect, energy savings insurance play a key role to build investor confidence in the feasibility of energy efficiency investments ([Micale and Deason, 2014](#)). Moreover, the energy savings insurance based on the establishment of an energy performance contract warrant costumers to achieve the projected energy performance target. The guarantee of the energy performance permits considerably to ensure bank loans for applicants investing in energy efficiency upgrades.

Nonetheless, legal uncertainties and the lack of historical data pose difficulties to the insurance industry to develop energy performance guarantee products (Mills (2003a) and Mills (2003b)).

Apart from that history confirms that certain emerging technologies caused human suffering, severe environmental degradation and huge economic costs (European Environmental Agency, 2001; Hansen and Gee, 2014). The cases of radiation, asbestos, benzene, sulfur dioxide and chlorofluorocarbons (CFCs) are common examples, to make visible that the hazards of these useful technologies were not known until the late discovery of highly negative and irreversible impacts. A very recent case about the potential carcinogenic risks to humans stems from the application of glyphosate (most widely used herbicide in agriculture) which has generated considerable attention and interest in many countries in the world. Scholars and international bodies reach different conclusions about food safety related to the application of the herbicide. Although, scientific controversy is hampering the decision making process whether it might be reasonable to prohibit glyphosate as the probability of cancer risks is remaining uncertain. However, how should we proceed in practice to avoid such failures in the future and what lessons could be drawn from the past?

Until now, several efforts have been undertaken to rethink the adoption of new emerging technologies by improving risk assessments and integrating public participation in the innovation paths. The precautionary principle aims to address the knowledge gaps of emerging technologies before their implementation by fostering anticipatory research. UNESCO (2005) reports on common elements, concepts and definitions in regard to the precautionary principle. The report states that the precautionary principle should be considerably applied in a situation where the risks can be characterized by poorly known outcomes and probability. In this respect, *ex-ante* risk management measures can contribute to reduce potential hazards (extensive losses) before there is a strong proof of risk exposure deriving from the application of novel technologies.

At the same time, the achievements of studies from economics, decision making, behavioral economics and psychology altogether with the development of novel methods have contributed to better understand how individuals perceive and manage risks in certain and uncertain situations. The remarkable works of Anscombe and Aumann (1963), Kahneman and Tversky (1984) and Ellsberg (1961) laid the foun-

dations in the mid of 20th century to better understand human behavior, especially the way how people perceive risk and uncertainty. The following centuries saw many applications and investigations of many researchers in different fields to further develop the management of new emerging risks.

European Union's framework program for research and innovation spends an overall budget of €399,5 million from 2016 to 2017 for research and innovation in future and emerging technologies (European Commission, 2016). A range of technologies, including nanotechnology, biotechnology, fracking, solar energy and energy efficiency technologies are expected by the scientific community to rapidly transform society even though these technologies are associated with scientific uncertainty and some of them pose potential health and environmental risks.

In the meanwhile, the evolution of novel technologies challenges the governance of new emerging risks. Steering the regulation of future technologies is a considerable task as the potential risks are presently not sufficiently known until the research about the emerging risks of these technologies makes progress (Székely et al., 2011; Mandel, 2009; Ludlow et al., 2015). Therefore, the precautionary principle foresees actions to be implemented in situations of potentially risks to humans and the environment where there is a need to put in place *ex-ante* prevention measures before there is strong proof of harm (European Environmental Agency, 2001).

For these reasons, amongst others, decision making under uncertainty plays a key role in prevention efforts regarding new technologies. Moreover, understanding firm's and individual's behavior in ambiguous situation is crucial for anticipating future paths and designing effective policy.

Nowadays, it is key to assess risks in a changing environment by combining knowledge from a wide variety of cross-disciplines (e.g. legal studies, economics, psychology, engineering) within a broader perspective (OECD, 2003).

Establishing an optimal technological risk management to ensure the hazard reduction of new emerging risks without impeding the innovation path persistently remain on the agenda of many international bodies and leading universities in a broad spectrum of disciplines.

Objective of the thesis

The thesis rethinks the primary approach of managing new emerging risks and aims to improve recently developed models addressing the paucity of information about the likelihood of the occurrence of an event. Furthermore, the thesis strives to evaluate unknown risks related to new emerging technologies, and proposes new tools to the economic agents (e.g. the firm, the insurer, the legislator) facing decisions in an uncertain ambiguous environment.

The overall purpose of the thesis contributes to establishing new environmentally sound technologies in a general framework. The thesis provides a broad perspective on the risk management of novel technologies by focusing on different methodologies and contributes to the literature on law and economics, behavioral economics and energy economics.

The first objective of the thesis aims on the economic analysis of tort law in an ambiguous situation. More precisely, the research investigates the effects of liability rules on the economic agent's behavior to invest in prevention in order to reduce the probability of an accident. In the context of novel technologies, it is postulated that the economic agent has scarce knowledge about the probability of an accident to occur. It is crucial to explore theoretically and experimentally whether the behavior of the economic agent alters due to the exposure to ambiguity.

The second objective is derived from the environmental energy transition and deals with the management of uncertain risks resulting from the application of green technologies to improve the energy efficiency of existing buildings. Essentially, it focusses on the insurability of the energy performance of individual buildings in the renovation sector. Unfortunately, only a few data are available on the energy performance of individual dwellings in the French renovation sector. Primary data has been collected by the means of questionnaire to determine empirically the key factors influencing the energy performance gap, the divergence between the calculated and measured energy savings. It is the intend to provide information about the frequency and intensity of the non-achievement of the energy performance to establish energy performance contracts and adequate insurance coverage for purchasers.

Outline of the thesis and main contributions

The general motivation of the present thesis is derived from a risk analysis approach by providing theoretical results and empirical evidence to address the management of emerging risks in the future. The thesis is motivated by ongoing topics including decision making under uncertainty, the governance and insurance of new emerging risks, the environmental energy transition toward a more sustainable future. Additionally, the thesis pays increasing attention to *ex-ante* risk management strategies and *ex-post* risk analysis related to novel technologies. The thesis encompasses two main parts, including three chapters in each part. The first part deals with an *ex-ante* risk management approach and the second part aims on the establishment of the insurability of new emerging risks.

Part I of the thesis seeks to examine from the perspective of Law and Economics the effectiveness of *ex-ante* risk management strategies for a situation where the decision maker is lacking information about the probability of an event to occur (e.g. shock, accident, disaster). Novel technologies continue to emerge and are used in a wide field of application, but however incorporate uncertainty about the potential effects on humans and the environment due to the lack of scientific evidence.

This part of the thesis serves to cope with environmental and technological accidents by focusing chiefly on *ex-ante* prevention measures. In this respect, liability rules may represent an effective economic tool to provide incentives for firms to invest *ex-ante* optimally in prevention measures to reduce the likelihood of an event to occur. In the first part of the thesis, the economic analysis of law is used which applies a coherent theory of decision making to examine legal rules for technological and environmental accidents. The first part contains three chapters which focus on the efficiency of legal rules in the situation of unknown risks related to new emerging technologies.

Chapter 1 reviews the literature on the relationship between tort law and decision making under risk and ambiguity. This chapter attempts to explain this interaction more comprehensively by providing an example from the field of nanotechnology. This chapter concentrates on the fundamental foundations of the economic analysis of law, summarizes the current state of behavioral law and economic literature, explains the recent advances in decision making under ambiguity and discuss more

comprehensively the governance of emerging risks in the case of nanotechnology. Chapter 1 contributes to identify major *lacuna* in the governance of new emerging risks and constitutes a baseline for the following two chapters.

Chapter 2 presents the theoretical model based on [Shavell \(1986\)](#) by focusing on the performance of liability rules in an ambiguous environment, referring to the papers of [Teitelbaum \(2007\)](#), [Mondello \(2013\)](#), [Chakravarty and Kelsey \(2016\)](#). In particular, this chapter models ambiguity by assuming that the potential injurer is a choquet expected utility maximizer who forms beliefs about accident risk by using a special kind of capacity, called a neoadditive capacity ([Chateauneuf et al., 2007](#)). The main contribution of chapter 2 refers to the investigation of the effect of limited liability on the potential injurer's decision behavior in the presence of ambiguity in the unilateral accident model. This chapter presumes that the subjective and personal belief built by the potential injurer depends on her degree of optimism but also on her investment in prevention. None of the results of risk hold when concurrently ambiguity matters and prevention affects the subjective beliefs. In particular, the potential injurer can overinvest in both unlimited and limited liability.

Chapter 3 pursues a twofold objective. First, the chapter discusses the contribution of laboratory experiments to test the theoretical predictions of chapter 2. In particular, the experiment of [Angelova et al. \(2014\)](#) is extended by introducing ambiguity and focusing essentially on the strict liability rule. Second, the chapter uses data from two distinct studies (between-subject design) to examine whether subjects' reactions to advantageous inequity aversion is impacted by the domain. Advantageous inequity aversion according to [Fehr and Schmidt \(1999\)](#) model is compared in the domains of gains and losses. The main contributions of chapter 3 are the investigation of the performance of strict but limited liability in an ambiguous situation and the comparison of advantageous inequity aversion by adopting the modified dictator game in the domains of gains and losses. With respect to the first objective, this chapter reveals on average high levels of investment under limited liability in the domain of risk, consistent with the theory, but lower levels of investment in prevention in the domain of ambiguity. The empirical results do not demonstrate that subjects' degree of optimism affect the decision choice albeit there is strong evidence pointing toward a link associating inequity aversion, fairness and risk preferences with the investment decision. With respect to the second objective, this chapter demonstrates

that individuals experience a stronger reaction to advantageous inequity aversion in the domain of losses than in the domain of gains.

Part II of the thesis devotes particularly attention to *ex-post* risk management strategies to cope with realized losses after the risk has materialized. This part of the thesis takes up the issue of the environmental energy transition in France and refers essentially to the energy economics literature by focusing on the insurability of the energy performance of low energy buildings.

The main objective of the second part of the thesis seeks to manage uncertain risks by focusing on the insurability of the energy performance in the housing sector. It comprises three chapters and aims to quantify the frequency and severity of the non-achievement of the energy performance of low energy buildings after carrying out energy efficiency upgrades. More precisely, this part intends to make the risks insurable so that investors, energy companies and owners are protected in the future by purchasing insurance in order to avoid extensive losses. The concrete idea about the frequency of the risks and the size of realized losses helps establishing insurance coverage and financial conditions to fund new innovative projects, such as national-wide energy conservation programs. In particular, this part attempts to grasp the key determinants, such as building shell properties, household and sociodemographic characteristics or energy-related behavior affecting the energy performance gap (energy deficits).

Chapter 4 gives a general background about energy efficiency at the European and French national level while identifying the emerging risks and the gaps in the insurance market in the green renovation sector. This chapter links ambiguity to the energy performance of existing buildings and presents the *ex-post* risk analysis to acquire information about the frequency and severity of the non-achievement of the energy performance of existing buildings after carrying out energy efficiency upgrades. Furthermore, this chapter concentrates *inter alia* on a literature review of the utmost achievements in the field of energy economics. Chapter 4 has a moderate contribution by proposing a general methodology in order to make new emerging risks insurable in the green renovation sector in France.

Chapter 5 describes the methodology and the design of the survey conducted to gather information on billing data, household characteristics and energy-related be-

havioral attitudes. The survey has been undertaken between April 2015 and July 2016 within the scope of the establishment of an insurance solution of the energy performance of existing buildings. The survey has been conducted with respect to the energy conservation initiative "*Je rénove BBC*", a pilot project supported by "*Energie de France*" (EDF) and the "*Regional Authority of Alsace*" (Région Alsace), in the upper and lower region of Alsace. Chapter 5 contributes by providing a novel database, which is unique in France, merging survey information, data from *ex-ante* prescribed thermal studies and *ex-post* billing data according to the French thermal regulation (Réglementation thermique 2005, 2012).

Chapter 6 addresses empirically the risk management problem by developing an econometric model. The econometric model is based on the empirical reasoning of the prebound and rebound effect by considering the problems of sample selection bias, endogeneity and omitted variable bias. We follow the approach proposed by Wooldridge (2010) by applying three structural equations including Heckman probit (Heckman, 1976, 1979) and instrumental variable estimation. To deal with missing data, this chapter implements predictive mean matching method generated from the multiple imputation chained equation (MICE) to create complete cases. The main contribution of chapter 6 refers to a novel concept of estimating the discrepancies between calculated and measured energy savings before and after energy efficiency upgrades. Furthermore, this chapter contributes by identifying the key determinants influencing the energy performance gap (total gross effect) by considering the total energy consumption (heating, domestic hot water, ventilation, lighting and auxiliaries) according to the French thermal regulation. The estimation results show that the age and the behavior related to domestic hot water consumption affect significantly and positively the gap between the calculated and measured energy consumption. Though, applying multiple imputations render these results less robust. This chapter also reveals that on average the household's calculated energy savings from prescribed thermal studies exceeds the measured energy savings.

General Conclusion reviews the previous chapters and opens up new avenues for discussion on the theoretical, experimental and empirical issues. The limitations of the research are presented, with prospects and outlooks for future research.

Introduction Générale

Motivation et Contexte

Jusqu'à la fin du 20^{ième} siècle l'hypothèse fondamentale classique dans l'analyse des risques implique que les agents économiques doivent prendre des décisions dans des environnements risqués, où les conséquences de leurs décisions peuvent être prédits. Dans de telles circonstances, l'agent choisit la décision égalisant l'anticipation des coûts marginaux et les bénéfices marginaux. Cette approche représente la bien connue, et largement appliquée analyse coûts-avantages dans le risque.

Étant donné que dans la plupart des situations, les décisions sont irréversibles et peuvent engendrer, dans une perspective de long terme, des conséquences élevées, il est essentiel d'anticiper efficacement les défis et les besoins. En général, la prise de décision suit un processus de sélection de la meilleure alternative entre les différentes configurations possibles, en évaluant les avantages connus et les inconvénients de chaque solution. Néanmoins, les décideurs, principalement, rencontrent des difficultés en pondérant les avantages globaux et les inconvénients des actions, quand il y a des connaissances limitées sur la probabilité de la survenue d'un événement (par exemple choc financier, accident technologique, catastrophe naturelle, crise économique, changement climatique, terrorisme etc).

A cet effet, la gestion des nouveaux risques émergents ne peut être étudiée avec l'approche mentionnée ci-dessus. En effet, les informations et les connaissances sur les risques liés aux innovations technologiques ne sont pas explicitement connues au moment où ils sont en cours de développement. Néanmoins, le manque d'information ne doit pas conduire le législateur à reporter la mise en œuvre de nouvelles législations, les banques à refuser le financement de nouveaux projets innovants, ou encore les assureurs à exclure les risques technologiques associés à ces projets. De plus, aucune entreprise ne peut être exemptée de toute responsabilité en raison de l'absence des connaissances sur les risques. Cette approche reflète la base du principe de précaution et plus fondamentalement une question de bon sens.

Il est de notoriété publique que les nouvelles technologies dans divers domaines d'application offrent des nouvelles possibilités. Elles apportent d'énormes avantages sociaux et individuels, et sont une force efficace pour la croissance économique, la prospérité et la richesse. De même, les nano- et biotechnologies font partie des principales technologies émergentes du 21^{ième} siècle et anticipent une contribution

révolutionnaire dans le domaine des soins de santé, l'agriculture, les énergies renouvelables, la transformation des aliments et de l'environnement. D'autre part, les technologies futures sont susceptibles de produire des substances toxiques qui menacent les écosystèmes et de faire émerger de nouvelles maladies qui peuvent se propager rapidement (Mandel, 2009).

La technologie moderne est associée à des risques émergents qui sont différents comparativement à d'autres risques dans le sens où nous ne savons pas actuellement la fréquence, la direction ni la gravité de ces risques liés à l'avenir, au moment où nous avons pris connaissance de celui-ci. Les risques émergents posent un défi de taille pour les organismes de réglementation, car il existe un manque de connaissances. Par exemple si les voitures d'auto-conduite conduiront à moins d'accidents, si l'extraction de gaz de schiste pollue potentiellement l'air et les eaux souterraines ou encore quels effets les nanoparticules auront sur la pénétration de la peau humaine? (OECD, 2003; Wansley, 2016).

De plus, les assureurs continuent de rencontrer des difficultés concernant la quantification de la fréquence et la gravité des risques émergents caractérisés par l'incertitude. L'absence des données historiques, les changements dynamiques de preuves scientifiques pertinentes et la réglementation politique entrave la mise en place de l'assurance dans une perspective de long terme. En conséquence, les investisseurs ne sont pas disposés à investir dans de nouveaux projets innovants étant donné l'absence d'assurance pour les protéger. D'autant plus que ces incertitudes peuvent également être liées aux changements législatifs et aux évolutions réglementaires.

A cet égard, un exemple peut être donné sur l'application des technologies vertes pour améliorer l'efficacité énergétique dans le secteur du logement. L'une des stratégies européennes à long-terme est de répondre aux objectifs climatiques 2020 en améliorant l'efficacité énergétique dans les bâtiments existants (European Commission, 2010b; European Fuel Poverty and Energy Efficiency, 2010; Lechtenböhmer and Schüring, 2010; Lapillonne et al., 2015). En attendant, les prix élevés de l'énergie et le désir de réduire le dioxyde de carbone (CO₂) les émissions donnent lieu à investir dans des initiatives d'efficacité énergétique.

Jusqu'à présent, nous en savons peu sur l'efficacité des investissements dans l'économie d'énergie dans le secteur vert de la rénovation. Pour stimuler les investissements dans

des mesures d'efficacité énergétique et la promotion des technologies respectueuses de l'environnement, il est d'une importance vitale de faciliter l'accès aux couvertures d'assurance, en particulier pour les entreprises employant des travailleurs autonomes et les petites entreprises (ELIOS, 2008).

A cet égard, l'assurance d'économies d'énergie jouent un rôle clé pour renforcer la confiance des investisseurs dans la faisabilité des investissements d'efficacité énergétique (Micale and Deason, 2014). En outre, l'assurance d'économies d'énergie en fonction de la mise en place d'un contrat de performance énergétique garantie les clients d'atteindre la cible de la performance énergétique projetée. La garantie de la performance énergétique permet également d'assurer des prêts bancaires pour les candidats qui investissent dans des améliorations de l'efficacité énergétique.

Néanmoins, les incertitudes juridiques et le manque de données historiques posent des difficultés à l'industrie de l'assurance pour développer et offrir des produits comme la garantie de performance énergétique (Mills (2003b) et Mills (2003a)).

Outre le fait que l'histoire confirme que certaines technologies émergentes ont causées de la souffrance humaine, ont causé la dégradation de l'environnement et ont provoqué des coûts économiques énormes (European Environmental Agency, 2001; Hansen and Gee, 2014). Les cas, de l'amiante, le benzène, le dioxyde de soufre et les chlorofluorocarbones (CFC) sont des exemples communs, pour rendre visible le fait que les dangers de ces technologies utiles ne sont pas connus jusqu'à la découverte tardive, enchaînant des impacts très négatifs et irréversibles. Un cas très récent sur les risques cancérigènes potentiels pour les humains provient de l'application de glyphosate (Herbicide le plus largement utilisé dans l'agriculture) qui a suscité une attention et un intérêt considérable dans de nombreux pays. Les chercheurs et les organismes internationaux parviennent à des conclusions différentes sur la sécurité alimentaire liée à l'application de l'herbicide. Bien que, la controverse scientifique entrave le processus de la prise de décision, il pourrait être raisonnable d'interdire le glyphosate, étant donné que la probabilité des risques de cancer reste incertaine. Cependant, en pratique, comment devons-nous procéder pour éviter ces échecs à l'avenir et quelles leçons peuvent être tirées du passé?

Jusqu'à présent, plusieurs efforts ont été entrepris pour repenser l'adoption de nouvelles technologies émergentes en améliorant l'évaluation des risques et l'intégration

de la participation du public dans la voie de l'innovation. Le principe de précaution vise à répondre aux lacunes dans les connaissances des nouvelles technologies avant leur mise en œuvre en favorisant la recherche d'anticipation. [UNESCO \(2005\)](#) rend compte des éléments communs, des concepts et des définitions en ce qui concerne le principe de précaution. Le rapport indique que le principe de précaution doit être appliqué dans une situation où les risques peuvent être caractérisés par des résultats et dont la probabilité mal connus. A cet égard, les mesures de la gestion des risques *ex-ante* peuvent contribuer à réduire les risques potentiels (de vastes pertes) avant qu'il y ait une forte preuve de l'exposition au risque découlant de l'application des nouvelles technologies.

Dans le même temps, les réalisations d'études de l'économie, la prise de décision, l'économie comportementale et la psychologie vont avec le développement de nouvelles méthodes et ont contribué à mieux comprendre comment les individus perçoivent et gèrent les risques dans situations certaines et incertaines. Les œuvres remarquables de [Anscombe and Aumann \(1963\)](#), [Kahneman and Twersky \(1984\)](#) et [Ellsberg \(1961\)](#) ont jeté les bases dans le milieu du 20ième siècle pour mieux comprendre le comportement humain, en particulier la manière dont les individus perçoivent le risque et l'incertitude. Le siècle suivant a vu de nombreuses applications et enquêtes ainsi que de nombreux chercheurs dans différents domaines pour développer d'avantage la gestion des nouveaux risques émergents.

L'Union Européenne pour la recherche et l'innovation dépense un budget générale de €399.5 millions pour la période 2016 - 2017, en particulier pour la recherche et l'innovation liées aux technologies émergentes ([European Commission, 2016](#)). Une gamme de technologies, y compris la nanotechnologie, la biotechnologie, la fracturation hydraulique, l'énergie solaire et l'efficacité énergétique, sont attendus par la communauté scientifique pour transformer rapidement la société. Même si ces technologies sont associées à l'incertitude scientifique et certaines d'entre elles présentent des risques sanitaires et environnementaux.

En attendant, l'évolution des nouvelles technologies défie la gouvernance des nouveaux risques émergents. Le pilotage de la réglementation des futures technologies est une tâche considérable, car les risques potentiels ne sont actuellement pas suffisamment connu jusqu'à ce que la recherche sur les risques émergents de ces technologies fasse des progrès ([Székely et al., 2011](#); [Mandel, 2009](#); [Ludlow et al., 2015](#)).

Par conséquent, le principe de précaution prévoit des actions à mettre en œuvre dans des situations de risque potentiels pour les humains et l'environnement, dans lesquels il est nécessaire de mettre en place des mesures de prévention *ex-ante*, pour lesquels il existe une forte preuve d'un préjudice ([European Environmental Agency, 2001](#)).

Pour ces raisons, entre autre, la prise des décisions dans les moments d'incertitude joue un rôle clé dans les efforts de prévention en ce qui concerne les nouvelles technologies. De plus, la compréhension de l'entreprise et le comportement de l'individu dans une situation ambiguë est cruciale pour anticiper la future voie et la conception de politiques efficaces.

De nos jours, il est essentiel d'évaluer les risques dans un environnement changeant en combinant les connaissances à partir d'une grande variété de disciplines croisées (par exemple des études juridiques, économie, psychologie, ingénierie) dans une perspective plus large ([OECD, 2003](#)).

L'établissement d'une gestion optimale des risques technologiques pour assurer la réduction du danger de nouveaux risques émergents, sans entraver le chemin de l'innovation, reste à l'ordre du jour de nombreux organismes internationaux et de grandes universités dans un large éventail de disciplines.

Objectives de la thèse

La thèse repense l'approche primaire de la gestion des nouveaux risques émergents et vise à améliorer les modèles récemment mis au point portant sur le manque d'information sur la probabilité de la survenance d'un événement. En outre, la thèse vise à évaluer les risques inconnus liés aux nouvelles technologies émergentes, et propose de nouveaux outils pour les agents économiques (par exemple la firme, l'assureur, le législateur) devant prendre des décisions dans un environnement ambigu.

L'objectif général de la thèse contribue à l'établissement des technologies écologiques dans un cadre général. La thèse fournit une large perspective sur la gestion des risques des nouvelles technologies en mettant l'accent sur des méthodologies différentes et contribue à la littérature en économie du droit, l'économie comportementale et l'économie de l'énergie.

Le premier objectif de la thèse vise à analyser en droit et en économie, la responsabilité civile dans une situation ambiguë. Plus précisément, notre recherche examine les effets des règles de la responsabilité civile sur le comportement de l'agent économique et s'investit dans la prévention afin de réduire la probabilité d'un accident. Dans le cadre des nouvelles technologies, il est postulé que l'agent économique a des connaissances limitées sur la probabilité d'un risque d'accident. Il est crucial d'explorer théoriquement et expérimentalement si le comportement de l'agent économique se modifie en fonction de l'exposition à l'ambiguïté.

Le deuxième objectif est dérivé de la transition énergétique et traite la gestion des risques incertains résultant de l'application des technologies vertes pour améliorer l'efficacité énergétique des bâtiments existants. Essentiellement, il s'intéresse à l'assurabilité de la performance énergétique des bâtiments individuels dans le secteur de la rénovation. Malheureusement, seules quelques données sont disponibles sur la performance énergétique des logements individuels dans le secteur de la rénovation française. Les données primaires ont été recueillies par un questionnaire pour déterminer empiriquement les facteurs clés influençant l'écart de la performance énergétique et la divergence entre les économies d'énergie calculées et mesurées. Nous avons l'intention de fournir des informations sur la fréquence et l'intensité de la non-atteinte de la performance énergétique pour établir des contrats de performance énergétique et de couverture d'assurance adéquate pour les acheteurs.

Aperçu de la thèse et les contributions principales

La motivation générale de la présente thèse est dérivée d'une approche d'analyse des risques en fournissant des résultats théoriques et empiriques pour aborder la gestion des risques émergents dans l'avenir. La thèse est motivée par des sujets d'actualité y compris la prise de décision en situation d'incertitude, la gouvernance et l'assurabilité des risques émergents, la transition énergétique de l'environnement vers un avenir plus durable. En outre, la thèse accorde une attention croissante à la gestion des stratégies *ex-ante* et l'analyse des risques *ex-post* liés aux nouvelles technologies.

La thèse contient deux parties principales comprenant trois chapitres dans chacune d'elle. La première partie traite d'une approche de gestion des risques *ex-ante* dans

le domaine du droit et de l'économie. La deuxième partie vise à la mise en place de l'assurabilité des nouveaux risques émergents dans le secteur de logement en France.

La partie I de la thèse vise à examiner, l'efficacité des stratégies de la gestion des risques *ex-ante* pour des situations où le décideur a un manque d'information sur la probabilité d'un événement (par exemple choc, accident, catastrophe). Les nouvelles technologies continuent d'émerger et sont utilisées dans un large champ d'application. Cependant elles intègrent une incertitude sur les effets potentiels des humains et de l'environnement en raison d'absence de preuves scientifiques.

Cette partie de la thèse contribue à faire face aux accidents environnementaux et technologiques en se concentrant principalement sur les mesures de prévention *ex-ante*. À cet égard, les règles de responsabilité civile peuvent représenter un outil économique efficace pour inciter les entreprises à investir *ex-ante* de manière optimale dans les mesures de prévention pour réduire la probabilité d'un événement. Dans la première partie de la thèse, l'analyse économique du droit est utilisée, et applique une théorie cohérente de la prise de décision en examinant les règles juridiques concernant les accidents technologiques et environnementaux. La première partie contient trois chapitres qui mettent l'accent sur l'efficacité des règles juridiques de la situation des risques inconnus liés aux nouvelles technologies émergentes.

Le chapitre 1 propose une revue de la littérature sur la relation entre le droit de la responsabilité civile et la prise de décision face au risque et à l'ambiguïté. Ce chapitre tente d'expliquer cette interaction de façon plus complète en fournissant un exemple dans le domaine de la nanotechnologie.

Ce chapitre se concentre sur les bases fondamentales de l'analyse économique du droit. Il résume l'état actuel du droit comportemental et de la littérature économique, explique les progrès récents dans la prise de décision en vertu de l'ambiguïté et discute de la gouvernance des risques émergents dans le cas de la nanotechnologie. Le chapitre 1 contribue à identifier les lacunes majeures dans la gouvernance des nouveaux risques émergents et constitue une base de référence pour les deux chapitres suivants.

Le chapitre 2 présente le modèle théorique basé sur [Shavell \(1986\)](#) en se concentrant sur la performance des règles de la responsabilité civile dans un environ-

nement ambigu, se référant aux articles de [Teitelbaum \(2007\)](#), [Mondello \(2013\)](#) et [Chakravarty and Kelsey \(2016\)](#). En particulier, ce chapitre modélise l'ambiguïté en supposant que l'offenseur potentiel maximise l'utilité choquée espérée qui forme ses croyances sur le risque d'accident en utilisant un type particulier de la capacité, appelée une capacité néo-additive ([Chateauneuf et al., 2007](#)).

La contribution principale du chapitre 2 se réfère à l'analyse de l'effet de la règle de la responsabilité limitée sur le comportement de la décision de l'offenseur potentiel en présence d'ambiguïté dans le modèle de l'accident unilatéral. Ce chapitre suppose que la croyance subjective et personnelle construite par l'offenseur potentiel, dépend de son propre degré d'optimisme, mais aussi de son investissement dans la prévention. Aucun des résultats de risque ne tient lorsque, simultanément, l'ambiguïté et la prévention affectent les croyances subjectives. En particulier, l'offenseur potentiel peut surinvestir dans les deux cas, la responsabilité illimitée et limitée.

Le chapitre 3 poursuit un double objectif. Tout d'abord, le chapitre traite la contribution des expériences de laboratoire pour tester les prédictions théoriques du chapitre 2. En particulier, l'expérience d'[Angelova et al. \(2014\)](#) est prolongée par l'introduction de l'ambiguïté en se concentrant essentiellement sur la règle de la responsabilité limitée. Deuxièmement, le chapitre utilise des données de deux études distinctes (entre sujets de conception) pour examiner si les réactions des sujets face à l'aversion à l'iniquité avantageuse sont influencées par le domaine dont lesquels les sujets appartiennent. Plus précise, l'aversion à l'iniquité avantageuse en fonction de modèle [Fehr and Schmidt \(1999\)](#) est comparée dans les domaines de gains et de pertes. Les principales contributions du chapitre 3 se basent sur l'analyse de l'efficacité de la règle de responsabilité limitée dans une situation ambiguë et sur la comparaison de l'aversion à l'iniquité avantageuse en adoptant le jeu du dictateur modifié dans les domaines des gains et des pertes.

En ce qui concerne le premier objectif, le présent chapitre révèle des moyennes d'investissement élevés au titre de la responsabilité limitée dans le domaine du risque, conformément à la théorie, mais indiquent des niveaux d'investissement moyen inférieurs dans la prévention dans le domaine de l'ambiguïté. Les résultats empiriques ne démontrent pas que le degré d'optimisme des sujets affecte le choix de la décision mais pointe vers un lien associant les préférences de l'aversion à l'iniquité, de l'équité et du risque avec la décision d'investissement. En ce qui concerne le deuxième objec-

tif, ce chapitre démontre le fait que les individus éprouvent une réaction plus forte à l'aversion à l'iniquité avantageuse la perte que dans le domaine de gains.

La **partie II** de la thèse consacre une attention particulière aux stratégies *ex-post* de la gestion des risques pour faire face aux pertes réalisées après que le risque eut été matérialisé. Cette partie de la thèse aborde la question de la transition énergétique et environnementale en France et se réfère essentiellement à la littérature économique sur l'énergie en se concentrant sur l'assurabilité de la performance énergétique des bâtiments de basse consommation d'énergie.

L'objectif principal de la deuxième partie de la thèse vise à gérer les risques incertains en se concentrant sur l'assurabilité de la performance énergétique dans le secteur de rénovation. Il comprend trois chapitres et vise à quantifier la fréquence et la gravité de la non-atteinte de la performance énergétique des bâtiments de basse consommation d'énergie après avoir effectué une amélioration de l'efficacité énergétique. Plus précisément, cette partie a l'intention d'assurer les risques émergents afin que les investisseurs, les sociétés d'énergie et les propriétaires soient protégés (afin d'éviter des pertes importantes), à l'avenir, par l'achat d'assurance. L'idée concrète est que la fréquence des risques et la taille des pertes réalisées aident à établir des assurances de couverture et des conditions financières pour financer de nouveaux projets innovants, tels que les programmes de conservation de l'énergie au niveau national. En particulier, cette partie tente de saisir les facteurs clés, tels que les propriétés techniques du bâtiment, les caractéristiques démographiques des ménages et des comportements liés à l'énergie affectant l'écart de la performance énergétique (déficits d'énergie).

Le chapitre 4 donne un aperçu général sur l'efficacité énergétique au niveau européen et au niveau français en particulier, tout en identifiant les risques émergents et les lacunes dans le marché de l'assurance dans le secteur de la rénovation verte. Ce chapitre lie l'ambiguïté avec la performance énergétique des bâtiments existants et présente l'analyse des risques *ex-post* pour acquérir des informations sur la fréquence et la gravité de la non-atteinte de la performance énergétique des bâtiments existants, après avoir effectué des mesures d'efficacité énergétique. En outre, ce chapitre se concentre, entre autre, sur une revue de la littérature des plus hautes réalisations dans le domaine de l'économie d'énergie. Le chapitre 4 présente une contribution modérée en proposant une méthodologie générale en vue d'assurer les nouveaux

risques émergents dans le secteur vert de la rénovation en France.

Le chapitre 5 décrit la méthodologie et la conception de l'enquête menée afin de cueillir des informations sur les données de la consommation d'énergie à partir de factures, des caractéristiques des ménages et des attitudes comportementales liées à l'énergie. L'enquête a été réalisée entre avril 2015 et juillet 2016 dans le cadre de la mise en place d'une solution d'assurance concernant la performance des bâtiments existants. L'enquête a été menée à l'égard de l'initiative de conservation de l'énergie "Je rénove BBC", un projet pilote soutenu par "Electricité de France" (EDF) et la "Région Alsace". Le chapitre 5 fournit une nouvelle base de données, contenant des informations sur l'enquête, des données sur les études thermiques *ex-ante* et des données sur la consommation d'énergie basée sur des factures *ex-post* selon la réglementation thermique (RT 2005,2012).

Le chapitre 6 adresse, empiriquement, le problème de la gestion des risques en développant un modèle économétrique. Le modèle économétrique est basé sur le raisonnement empirique des effets prébonds et rebonds en tenant compte des problèmes du biais de sélection de l'échantillon, d'endogénéité et du biais des variables omises. Nous suivons l'approche proposée par Wooldridge (2010) en appliquant trois équations structurelles, dont Heckman probit (Heckman, 1976, 1979) et l'estimation de la variable instrumentale. Pour faire face aux données manquantes, ce chapitre met en œuvre la méthode de la moyenne prévisionnelle générée à partir de la méthode d'imputations multiple pour générer une base de données complète. La contribution principale du chapitre 6 se réfère à un nouveau concept de l'estimation des écarts entre les économies d'énergie calculées et mesurées avant et après la rénovation. En outre, ce chapitre contribue en identifiant les principaux déterminants influençant l'écart de la performance énergétique (effet brut total) en considérant la consommation totale d'énergie (chauffage, eau chaude sanitaire, la ventilation, l'éclairage et auxiliaires) selon la réglementation thermique française. Les résultats de l'estimation montrent que l'âge et le comportement lié à la consommation d'eau chaude sanitaire affectent significativement et positivement l'écart entre la consommation d'énergie calculée et mesurée. Ce chapitre révèle également, qu'en moyenne, les économies d'énergie calculée par les études thermiques dépassent les économies d'énergie mesurées. Bien que, en appliquant la méthode d'imputations multiples rendent ces résultats moins robustes.

La conclusion générale examinera les chapitres précédents et ouvrira de nouvelles voies pour discuter des questions théoriques, expérimentales et empiriques. Les limites de la recherche sont présentées, avec des perspectives et des visions pour la recherche future.

Part I

Ex-Ante Risk Management

Introduction to part I

The first part of the thesis seeks to examine the effectiveness of *ex-ante* risk management strategies for a situation where the decision maker is lacking information about the probability of an event to occur (e.g. shock, accident, disaster). Novel technologies continue to emerge and are used in a wide field of application, but however incorporate uncertainty of potential effects on humans and the environment due to the paucity of scientific evidence.

Prevention and mitigation measures which are implemented before the occurrence of an event feature *ex-ante* risk management strategies. The overall aim of such measures is to prevent the occurrence of an event or to mitigate the effects of the risks whenever prevention measures are not realizable. Prevention measures seek to reduce *ex-ante* the probability and mitigation measures diminish *ex-ante* the magnitude of the event on individual welfare when it occurs.

This part of the thesis serves to cope with environmental and technological accidents by focusing chiefly on *ex-ante* prevention measures. In this respect, liability rules may represent an effective economic tool to provide incentives for firms to invest *ex-ante* optimally in prevention measures to reduce the likelihood of an event to occur. In the first part of the thesis, we use the economic analysis of law which applies a coherent theory of decision making to examine legal rules for technological and environmental accidents. The first part contains three chapters which focus on the efficiency of legal rules in the situation of unknown risks related to new emerging technologies.

In what follows, chapter 1 concentrates on the literature of law and economics and summarizes the recent advances in decision making under ambiguity. Additionally, the first chapter states an example about the lack of evidence in the sector of nanotechnology and explains the impediments for risks governance related to novel technologies. Chapter 2 presents the theoretical model based on tort law and decision making under risk and ambiguity. Subsequently, we assess the predictions of the theoretical model in chapter 3 through conducting laboratory experiments.

Chapter 1

Literature Review

1.1 Introduction

Major environmental and technological disasters not only trigger human losses and endanger environmental ecosystems but also impact economic stability and growth. A recent report from the European Environmental Agency (EEA) stress that in the period between 1998 and 2009 nearly 100 000 fatalities impacted more than 11 million people and caused economic losses of about EUR 150 billion in Europe ([European Environmental Agency, 2011](#)).

The catastrophic accident in the Italian town of Seveso in 1976 was the trigger for the adoption of the legislation¹ by the European Economic Community in 1982 on the control and prevention of such accidents. In the United States, the Comprehensive Environmental Response, Compensation and Liability Act² (CERCLA) encourage industrial operators to hold appropriate financial security to remedy environmental damage. The legislative provisions also seek to prevent contamination of future sites by designating strict liability. Since the adoption of the legislations in Europe and United States, several technological and environmental disasters occurred, such as the toxic waste water spills from mining activities in Spain (1999) and Romania (2000) or the Gulf of Mexico deep water horizon oil spill (2010) caused by the British Petroleum company. To put it briefly, these incidents can basically be attributed to errors or lack of prevention done by injurers (i.e. firms).

Tort and liability rules as an environmental policy instrument pursue to give injurers an incentive to internalize the social cost of their taken actions ([Brown, 1973](#); [Calabresi, 1970](#)). In general, liability rules engage injurers to restore or compensate for damages caused by their activities. An important feature of the literature on tort law has focused on the efficiency of different liability rules, likewise the negligence and the strict³ (limited and unlimited) liability under the assumption that injurers know the relevant probabilities. In law and economics, an extensive literature exists on analyzing theoretically the efficiency of liability rules by comparing the negligence and the strict and unlimited liability rules under risk. On the other hand, there

¹Directive 1982/501/EEC of the European Economic Community on the major-accident hazards of certain industrial activities.

²The Comprehensive Environmental Response, Compensation, and Liability Act of 1980 (42 U.S.C. 9601.9675), commonly known as "Superfund law," consists of Public Law 96510 (Dec. 11, 1980).

³Strict liability is deemed to impose absolute legal responsibilities on the injurer without proof of fault and under the negligence rule victims must be compensated only if the potential injurer is found negligence (with proof of fault). Note that we will explain more in detail both liability rules in the following sections of this chapter.

exist only scarce studies in the behavioral accident law and economics literature and empirical work covering liability rules almost non-exist.

In the meanwhile, the rapid growing industrialization of contemporary societies and new technologies might produce new potential hazards. Policy-makers are enacting laws on new emerging technologies, likewise new breeding technology, nanotechnology, shale gas or tar sand extraction by taken into account the Precautionary Principle⁴ (PP hereafter). For instance, the European Commission, as the regulator initiating and enforcing EU laws, uses the PP to cope with possible risks for which scientific knowledge is not fully available. UNESCO (2005) reports common elements, concepts and definitions regard the PP. The report underlines that risks with poorly known outcomes and poorly known probability is sufficient to foresee the consideration of the PP. It should be emphasized that the regulator turns the burden of proof⁵ to the injurer by requiring a sophisticated risk assessment on the potentially risks of the new emerging technology.

In general, public policy has witnessed an increased pace of technological progress that nevertheless challenges the governance of new emerging risks. In the meanwhile, a legal framework is needed to design an efficient legal regime for uncertain risks related to new technologies which should not dissuade potential investors from investing in new innovative products and at the same time not jeopardize public consent (World Economic Forum, 2015). For this reason, among others, the incentive effects of tort law is a major focus of technological disaster prevention efforts and understanding firm's behavior in ambiguous situation is crucial for anticipating future paths in decision making and implementing effective policies in this field.

This issue is motivated by the current debate on the performance of liability rules in sectors using nanotechnologies. In recent years, nanosilver has received ample attention by regulators because many scholars and scientific committee's express concern that the application of nanosilver in consumer and medical products may have negative impact on human health and the environment. The risk governance of nanotechnology is impeded through the lack of information on the possible contribution of nanosilver to environmental and human toxicity.

⁴Second paragraph of Article 191 of the Treaty on the Functioning of European Union (Maastricht Treaty).

⁵In the European law context, the regulator is acting on the basis of the "*guilty until proven innocent*" approach. See Van der Belt (2003) for more details. More generally, see Kayikci (2012) on the burden of proof within the scope of the Precautionary Principle in the international and European context.

The principal objective of this chapter is to review the literature on the relationship between tort law and decision making under risk and ambiguity. We attempt to explain this interaction more comprehensive by providing an example from the field of nanotechnology. This chapter is structured as follows: after introducing the fundamental foundations of the economic analysis of law (1.2), the current state of the behavioral law and economic literature is outlined (1.3), then the recent advances in decision making under ambiguity (1.4) are discussed and further we provide information about nanotechnology and risk governance (1.5). The chapter is concluded by a few final remarks (1.6).

1.2 Economic Analysis of Law

In this section, we discuss, among others, the following issues: the object of law and economics, the incentives of investing in prevention related to tort law (1.2.1), the unilateral accident model (1.2.2) and the related literature (1.2.3).

In general, the economic analysis of law deals with the effects of legal rules on the behavior of relevant actors and examines whether these effects are socially desirable under accident, property, contract and criminal law (Shavell, 1987). Since the early 1970s the economic analysis of law was vitalized by five main contributions: Coase's (1960) article on externalities and legal liability, Becker's (1964) article on crime and punishment, Calabresi's (1970) book on accident law, Posner's (1972) textbook on economic analysis of law and Shavell's (2004) general textbook on the fundamental economic analysis of law. Here, the survey will be analytical and focuses on the economic analysis of accident law. Tort law governs the legal liability of accidents and seeks to reduce the risk of harm by deterring potential injurers with having to compensate victims for the damage they cause. It should be noted that the deterrence efficiency is the principal aim of liability rules and not necessary victim compensation (Faure, 1995). We cover especially in this part how liability rules create incentives to reduce large-scale risks and we take up an important topic bearing on liability: the judgment-proof problem (potential injurer's wealth constraint in paying for the harm). In general, there are two basic liability rules: the *negligence rule* and the *strict liability rule*. Under the former rule, the potential injurer must only compensate victims if she is found negligence (with proof of fault), meaning that her level of care was less than the standard of care determined by the courts,

which is also called the level of due care. Under the latter rule, the potential injurer must always pay for the harm she caused with the occurrence of an accident (without proof of fault). The most prominent rule in Europe and United States is the negligence rule and the strict liability rule is more applied to certain dangerous activities related to nuclear energy, toxic and explosive substances and oil pollution damage.

Depending on the regime of strict liability, the potential injurer might be liable for the full cost of the damage or for a maximum amount of compensation which is limited. In Europe, but also in the United States, the liability rule that caps the financial liability of the injurer to the value of her net assets at the moment of the accident is widely applied and is the prevailing rule for cooperation: it is called limited liability. Potential injurers are called, in such a situation, judgment proof firms. Under the regime of strict but limited liability, the potential injurer is not exposed to full liability but her liability is capped to an amount which is lower than the total amount of damage caused by an accident. Therefore, strict but limited liability is known as being a regime that induces partial risk internalization by potential injurers and encompasses an *ex-post* cap payment for the shareholders (Shavell, 1986). On the other hand, limiting the potential injurers' liability to their net present value amplifies innovation and permits them to levy funds for research and development. However, Faure (1995) argues that limited liability is not effective for large-scale risks such as nuclear accidents or oil pollution damage as it leads to too low compensation for victims and lacks an adequate internalization of full costs. In contrast, (strict) unlimited liability is often considered as the rule that shall induce full compensation of victims. Nevertheless, strict and unlimited liability may also lead to price increases and may push some firms out of the market even though they took all required precautionary measures (Manning, 1994). A further concern by scholars is that unlimited liability may hamper the diversification of financial investments by companies (Leebron, 1991). In the next step, we are considering the incentive effects of the different liability rules.

1.2.1 Incentives of the relevant actors

Following on the scholarly tradition of tort law, we focus on liability and incentives by considering that two classes of parties, the potential injurer and victims,

which are not in a contractual relationship, are involved in an accident. For instance, the potential injurer might be a polluting firm and the victims suffering from the pollution are residents. We need to distinguish between two types of accident models in which the potential injurer solely influence the risks of an accident, *unilateral accident* and in which the potential injurer and victims can affect the risk of an accident, *bilateral accident model*⁶. We confine the survey to the former case for the sake of brevity. The potential injurer can affect the risks of an accident by determining their level of care (safety equipment) or their level of activity (operating time of the plant). [Dari-Mattiacci and De Geest \(2005\)](#) emphasize that the incentive effects depend on the precaution technology. Namely, the most dominant type of model applied in the law and economics literature is called the probability model: the potential injurer can reduce the probability of an accident but not the magnitude (harm or damage). For instance, a pilot of an air plane can be more cautious leading to fewer accidents but the magnitude of damage is exogenous. In the case of nuisance, such as noise, the potential injurer can control the magnitude of the harm but basically not the probability of the harm (less prevention yields more externalities to residents). The joint-probability-magnitude model depicts the situation in which for instance a truck controls the speed by diminishing simultaneously the likelihood of an accident and the magnitude (noise). The separated-probability-magnitude model portrays cases in which the potential injurer uses one precautionary measure to reduce the likelihood of an accident and an additional precautionary measure to diminish the magnitude of the harm. For example, the owner of a cruise liner invests in advanced navigation satellite systems to decline the probability of a shipwreck and decides to increase the amount of lifeboats to reduce the magnitude of the damages to the passengers.

Moreover, the costs of remedying the environmental damage often exceed the potential injurer's ability to pay. A large part of the literature assess whether the incentive effects seems to be diluted in case of bankruptcy. [Shavell \(1986\)](#) demonstrates that the potential injurer does always invest less than the social optimal level in prevention. Especially, this, however, is a central problem for the compensation of damages caused by nuclear and horizon oil spill accidents. [Faure \(1995\)](#) argues that limited liability causes a problem of underdeterrence and disruption in the compen-

⁶See [Shavell \(2004\)](#) and [Chakravarty and Kelsey \(2016\)](#) for more details on the incentive effects of liability rules for accidents that are in nature bilateral.

sation mechanism. Indeed, the potential injurer is limited to a certain amount and thus she will not be exposed to the total accident costs. As a result, the potential injurer will invest in prevention to avoid an accident with a magnitude equal to the limited amount. This finding has been recognized by several other scholars, however they also argue that under specific circumstances the potential injurer might invest more in prevention than what is socially desirable (Beard (1990), Lipowski-Posey (1993), Pitchford (1995), Dionne and Spaeter (2003), Dari-Mattiacci and De Geest (2006a)). This effect can be explained by the fact that it is less expensive today for the insolvent potential injurer to invest in prevention to reduce the available capital for tomorrow's liability (Dari-Mattiacci and De Geest, 2006a).

In other words, the results obtained by the literature are ambiguous, meaning that under specific conditions (limited liability) the potential injurer invests less or more in prevention than the social optimal level. The possibility of bankruptcy affects the choice of the level of prevention and pose serious difficulties to lawmakers to formulate adequate regulatory policy in many areas (Beard, 1990). This issue is in particular considered in the following chapters 2 and 3. Next, we are describing the different legal rules, such as strict liability and the negligence rule under the probability model for accidents that are in nature unilateral.

1.2.2 Unilateral accident model with the level of care

We assume that both parties are risk neutral and the potential injurer can affect the risks of an accident by choosing a pecuniary level of care. We denote x as the expenditure on care and $\pi(x)$ be the probability of an accident that causes damage l , where π is decreasing and convex in x . Following Shavell (1980), the social objective is to minimize the total expected costs, $x + \pi(x)l$ where x^S is the social optimal level. Under the rule of strict and unlimited liability the potential injurer would invest socially optimal in prevention since the potential injurer is required to compensate the damage equal to l . Thus, she minimize $x + \pi(x)d$ where d is the compensation fee which needs to be paid by the potential injurer to the victims in the occurrence of an accident. Under the negligence rule, it is assumed according to Shavell (1980) that the level of due care, \hat{x} determined by courts is set equal to the social optimal level x^S . In case the potential injurer, who causes damage to the victims, is investing less in prevention than the level of due care ($x < \hat{x}$), the potential injurer will have

to fully compensate the victims equal to the size of damage l . On the other hand, the potential injurer does not have to pay any compensation amount in case $x \geq \hat{x}$. The optimal private level of the potential injurer equals the social optimal level ($x_{NE}^P = x^S$) under the rule of negligence when the level of due care is set at the social optimal level. The potential injurer does not have an incentive to invest more (less) in prevention than the level of due care as it is far more costly (she will be held liable). [Shavell \(1980\)](#) concludes that both liability rules are leading to optimal prevention when the probability of an accident is known and the wrongdoer can be identified. Nonetheless, the courts need to determine the social optimal level to set up the level of due care correctly. Yet, in most real-world situations, the courts make errors or it is still not possible to calculate the social optimal level of prevention. In such a situation, the potential injurer might invest more than social desirable in prevention to reduce the possibility to be found negligent by the chance of errors made by courts. Next, we survey more comprehensively the literature about the performance of liability rules which is subsequently relevant for the chapters 2 and 3. We need to emphasize that the literature on tort law is wide-ranging. For the ease of reading we restrain the survey to the utmost aspects of the literature⁷.

1.2.3 Related Literature

Here, we distinguish between two parts of the literature: one considering that the potential injurer does know the probability of an accident (risky model) and second that she has inherently scarce information about the likelihood of an accident (ambiguous model). The literature has mainly based on the former case, while a few studies exist for the latter case. Note that section 1.4 explains more in detail the recent advances in modelling decision making under ambiguity.

Several articles examine the effect of potential bankruptcy on the prevention choice under strict liability in a risky environment. For instance, [Beard \(1990\)](#) demonstrates by applying a probability model that the potential injurer may overinvest in prevention relative to the social optimal level, because the prevention is

⁶In case of uncertainty about causation, the legal system foresees an approach of imposing the proportionality rule to the number of total injuries related to their product ([Rosenberg, 1984](#)). This means that a firm with 40% market share of their product would be liable to 40% of the damage in every case ([Shavell, 1985](#)).

⁷See [Landes and Posner \(1987\)](#), [Posner \(1992\)](#), [Shavell \(2004\)](#) and [Miceli and Baker \(2013\)](#) for textbooks on liability rules, see [Jacob and Lovat \(2016\)](#) for a survey and see the PhD thesis of [Jacob \(2011\)](#) and [Ropaul \(2015\)](#) on the economic analysis of tort law.

subsidized through a reduction in the exposure to liability. [Lipowski-Posey \(1993\)](#) has obtained similar results by considering that the potential injurer determines her level of prevention and her level of risky activity. Additionally the author concludes that the truncation of the payment caused by bankruptcy leads to excessive levels of prevention and lower level of activity by the potential injurer. Both papers do not allow for the situation that external funds can be borrowed from a bank. The same results have been obtained by [Pitchford \(1995\)](#), [Boyer and Laffont \(1997\)](#) and [Dionne and Spaeter \(2003\)](#) which show that under moral hazard, the potential injurer does not always invest less in prevention relative to the social optimal level in case of the presence of an external lender. Moreover, [Dari-Mattiacci and De Geest \(2005\)](#) find similar results for a different reason. They explain that the potential injurer overinvests in probability prevention (leading to a reduction of probability of facing liability) while saving on magnitude prevention (reduces the amount available to compensate the victims for the caused damage). They conclude that the potential injurer does not benefit from the reduction in magnitude since any damage which exceeds the assets of the potential injurer is borne by the victim but benefits from the reduction of the probability of an accident. Additionally, [Dari-Mattiacci and De Geest \(2006a\)](#) notice that over-prevention occurs only in probability models and is not concerned in magnitude models. On the other hand, [Miceli and Segerson \(2003\)](#) state that the potential injurer take less prevention than the optimal social level when prevention is considered as non-monetary⁸ and take more or less prevention when prevention is monetary. This result holds also for risk averse injurers ([Macminn, 2002](#)).

From a different perspective, [Endres and Bertram \(2006\)](#) deal with a more dynamic analysis (two period model) of strict liability and the negligence rule by including technological change. Under ideal conditions, strict liability and the negligence rule induce optimal investment into improvements of the care technology in a two period setting. While allowing for distortions in the model in the sense that the potential injurer knows the technology production function but the authority does not, thus implies that the authority is not able to set the due care standard at the social optimal level in the last period. With respect to this more restrictive form, the incentives of the negligence are distorted compared to strict liability in a

⁸This result is in line with [Shavell \(1986\)](#) who concludes under the judgment proof problem that potential injurers take less care and causes higher activity levels.

dynamic model. In a later theoretical reasoning, [Endres and Friehe \(2012\)](#) examine firm's incentives to invest in environmental technical progress under strict liability and the negligence rule by considering the discount rate as part of the inter-temporal economic analysis. They assume divergences between the private and social rate of discount and assess whether it affects the performance of liability law. The main finding of the paper is that the negligence rule is less sensitive to divergences compared to strict liability. In this regard, [Jacob and Spaeter \(2016\)](#) are developing a model in which a firm maximizes her expected net value by choosing between two risky technologies, one is safer but costlier than the other one. They conclude that limited liability may not lead systematically to partial risk internalization and is welfare improving when the firm is sufficient capitalized.

In the second part of this survey, we are focusing on the performance of the liability rules when the potential injurer is lacking knowledge about the probability of an accident. Most close to the chapters 2 and 3 are the papers of [Teitelbaum \(2007\)](#), [Mondello \(2013\)](#) and [Chakravarty and Kelsey \(2016\)](#). Under ambiguity, these three papers assume that the potential injurer is a choquet expected utility maximizer⁹ who forms beliefs about accident risks by using a special kind of capacity, called a neo-additive capacity. Further, they focus on the negligence rule and (strict) unlimited liability. As previously discussed, [Dari-Mattiacci and De Geest \(2005\)](#) refer to four different precaution models when risk is considered. [Teitelbaum \(2007\)](#) implements two models (probability and joint-probability model) in his analysis, whereas [Chakravarty and Kelsey \(2016\)](#) and [Mondello \(2013\)](#) discuss apart on one model (magnitude and probability model, respectively). [Teitelbaum \(2007\)](#) shows that neither strict liability nor the negligence rule is efficient when ambiguity is at stake. He finds that the negligence rule is more robust compared to the strict and unlimited liability rule. [Mondello \(2013\)](#) considers the situation in which the judge and the regulator agree on the optimal social level of care. Still in this setting, neither strict liability nor the negligence rule permits it to reach the first best level of care under ambiguity. [Chakravarty and Kelsey \(2016\)](#) show that an ambiguity averse injurer invests the optimal amount in prevention under the negligence rule but invests more in prevention than the social optimal level under strict and unlimited liability. The main difference between the three papers is that [Teitelbaum \(2007\)](#) and [Mondello \(2013\)](#) are considering the unilateral accident model in their analysis

⁹Note that we will describe comprehensively this kind of model in section 1.4.

while [Chakravarty and Kelsey \(2016\)](#) are performing the comparison of the liability rules in a bilateral accident model.

From another point of view, [Jacob \(2015\)](#) studies the situation in which the potential injurer's insolvency alters her technical choice when facing the possibility of a new and imprecise technology (the latter provides an imprecise probability of an accident). The firm's beliefs about the imprecise technology is based on the work of [Jaffray \(1989\)](#). The theoretical prediction shows that a potentially insolvent firm is less likely to adopt the imprecise technology than a solvent firm. Apart from that [Pannequin and Ropaul \(2016\)](#) focus on the effect of strict liability and negligence rule on the demand for both insurance and self-insurance under one-sided ambiguity. To predict theoretically the potential injurer's care choices, the authors rely on the smooth ambiguity model by [Klibanoff et al. \(2005\)](#). They find that both liability rules are equivalent and induce the potential injurer to choose the social optimal level of prevention if the purchase of insurance is available. Under ambiguity, their model predicts that an ambiguity-averse (ambiguity-seeking) injurer would increase (decrease) the demand for insurance when strict and unlimited liability is considered. Similar, [Franzoni \(2014\)](#) examines the optimal features of strict liability and negligence rule by applying KMM model. Different to the work of [Pannequin and Ropaul \(2016\)](#), the author addresses the interdependence of harm, meaning that the potential injurer can not only harm one victim but rather harms a large number of victims. He concludes that strict liability is preferred to negligence when harms are uncorrelated while the victims and potential injurer are ambiguity-averse. On the other hand, the negligence rule proves superior to strict liability rule when harms are correlated and the victims are numerous. Another part of the literature on tort law focuses on testing the theoretical predictions through experimental economics in the laboratory¹⁰. The relevant literature about the findings of the performance of liability rules are presented in the next subsection.

1.3 Behavioral Law and Economics

The traditional economic model of tort law (presented previously) has been criticized from large strands of literature. The critical legal studies movement (CLS)

¹⁰Note that no field experiments have been conducted yet to investigate the performance of specific liability rules.

has been founded by scholars in 1977 and has expressed several criticisms on the theory of the analysis of law and economics. Richard Abel, associated with CLS, argued that the analysis of the efficiency of tort law relies on unrealistic assumptions about economic rationality. Critics also underline that there is too little or no empirical evidence¹¹ that individuals would alter their behavior due to the exposure to liability (Faure, 2010). In a narrow sense, the behavioral analysis of law features a better understanding of decisions and choices (Sunstein, 1997). Broadly stated, behavioral law and economics does not attempt to criticize the accomplishments of law and economics but aims to improve it (Jolls (1998), Korobkin and Ulen (2000), Ulen (2014)). Now, let us offer a few details, highlighting some of the findings that emerge from the behavioral research in the context of tort law.

In general, the experimental studies on law and economics in the field of behavioral economics are scarce. In a seminal paper, Kornhauser and Schotter (1990) analyze the incentive effects of strict liability and negligence rule by conducting an individual decision making experiment which lasts 35 rounds. In each round, subjects are asked to choose a continuous decision number (level of prevention) which determines the probability of incurring a loss. The results show that subject's choices of prevention under the negligence rule correspond to the theory but the model does not predict well for the case of strict and unlimited liability. Moreover, they observe that the legal rule has a significant effect on subject's learning over the horizon of the experiment. Subjects choose high levels of prevention at early rounds but decrease them over time. In an investor-auditor game, King and Schwartz (2000) explore how legal regimes (strict liability and negligence rule) affect the social welfare by assessing Schwartz's (1997) theoretical predictions. The experiment is based on a strategic interpersonal decision making game over 30 rounds¹². They find that the experimental results are mostly consistent with the theoretical predictions. Despite, the authors reveal that subjects do more audit under the strict liability rule than

¹¹Note that Manning (1994) empirically examines the effects of changing liability rules on the market of childhood vaccines and Alberini and Austin (2002) empirically explore the effects of strict liability on uncontrolled releases to the environment related to the liability imposed by state mini-Superfund laws.

¹²In a first step, the computer randomly selects an asset either a good or bad (both assets have different probabilities to be selected). In the next step, the auditor does not know which asset will be selected, thus the auditor can purchase information about the selection of the asset. The quality of the report depends on how much the auditor is investing to acquire information (discrete number). Further, the investor is asked to make an investment choice (discrete number) at the same moment as the auditor is facing the information choice. The earnings of both players depend on the outcome of the selected asset and the quality of the auditor's report. Under the strict liability rule the auditor is held liable at all levels of audit. Moreover, the auditor is held liable under the negligence rule for damages leading from a misleading report only if the quality is less than the level of due care.

the negligence rule, but the level of choices are less extreme than predicted by the model. The authors conclude that the predictive power of Nash equilibrium may be context specific and recommend formulating hypotheses based on the decision context (e.g. information about other player's payoff, fairness preferences). Similar, Koch and Schunk (2013) apply an individual decision making experiment to compare the effect of limited and unlimited liability for auditors in the domains of risk and ambiguity. The amount of liability is manipulated in a way that subjects can suffer out of pocket losses. The experimental design seeks to make decisions between paired lotteries and the amount of loss is varied. The paired lotteries are adjusted with respect to the risk and ambiguous situation. To present ambiguity to the subjects in the experiment, they use a two-stage lottery. The findings of the experiment show that risk aversion and ambiguity aversion are lower under limited liability compared to unlimited liability and the two measures are correlated under unlimited liability. The authors infer from their results that it is important to consider risk and ambiguity attitudes in economic models on liability. Apart from this Angelova et al. (2014) explore the performance of no liability, strict liability and the negligence rule for managing environmental disaster. The experimental task is based on a dictator game and consists of two phases with five periods each¹³. They find that the experimental results are consistent with the theory, while both liability rules, the negligence and strict liability rule, are equally effective. Despite, the results demonstrate that the average number of investment is rather high in the absence of liability rules than predicted by the model. As a consequence, liability rules are much less effective. Moreover, Pannequin and Ropaul (2016) investigate the efficacy of liability regimes on the demand for both insurance and self-insurance in the presence of risk and ambiguity. The experiment involves a series of decisions (discrete variable choice) and ambiguity has been simulated by presenting an unknown urn (containing ten balls with seven yellow balls, one red ball and 2 unknown balls) to the subjects. The results are consistent with the theoretical predictions and indicate that both ambiguity-loving and ambiguity-averse individuals invest socially optimal in self-insurance under the negligence rule while the strict liability rule does

¹³Subjects are randomly selected as the role A (the potential injurer), role B (the victim) and A-B pairs. The victim cannot anticipate and is affected by the decision choice of player A. Subjects can decide whether to invest in prevention to diminish the probability of an accident (binary choice). At the beginning of each period all subjects play as the role A and are informed about their role at the end of the experiment. Losses are manipulated by considering low and high damages.

not provide efficient incentives. They find, contrary to the model predictions, that both liability rules are not inducing an equivalent deterrence effect in the risky model.

Overall, the experimental results of the mentioned studies actually manifest that subjects often deviate from model predictions. Specifically, it is crucial to scrutinize theoretical models to enhance the predictive validity to provide more accurate policy implications. Empirical evidence on the validity of theories can help theorists to improve models that are mainly not consistent with model predictions. Empirical evidence from laboratory experiments may explore the causes of a theory's failure, revise models or establish new theories (Smith, 1994). We deem that testing theoretical models by the means of conducting laboratory experiments essentially enhance the development of new fields, such as the economic analysis of tort law in the presence of ambiguity. Next, we devote particular attention to the recent advances in the field of decision making under ambiguity.

1.4 Decision Making under Ambiguity

In this section, we are defining ambiguity (1.4.1) and discuss the theories of decision making according to the Bayesian (1.4.2) and the Non-Bayesian approach (1.4.3).

1.4.1 Definition

Modern economic decision theory is mainly concerned about decision making in the presence of ambiguity or uncertainty. Dequech (2000) attempts to contribute to a better understanding and discusses the fundamental distinctions between ambiguity and uncertainty. A crucial aspect for the distinction between both thoughts refers to missing information that could be known (ambiguity) and that does not exist at the decision time (uncertainty) due to the indeterminacy of the future. The literature and the definitions on ambiguity are extensive. In Daniel Ellsberg's (1961) seminal work, ambiguity is associated with situations in which the probabilities of some events are known and whereas for other situations they are not known or vague. In particular, Camerer and Weber (1992, 130) propose a more adopted definition which originates with Frisch and Baron (1988) by stating that "*ambiguity is uncertainty about probability, created by missing information that could be known*".

When distinguishing between risk and ambiguity, [Eichberger and Kelsey \(2014\)](#) refer to situations where the decision maker is familiar with the relevant probabilities and where the decision maker cannot assign subjective probabilities to uncertain events. We properly define *ambiguity*¹⁴ in the sense of [Frisch and Baron \(1988\)](#) and [Camerer and Weber \(1992\)](#) as a situation in which the decision maker does not know the actual probabilities at the moment of the decision due to the paucity of information.

1.4.2 Savage theory and the Ellsberg paradox

[Ellsberg \(1961\)](#) thought experiment exemplified that the lack of information about probabilities is affecting the decision maker's behavior which cannot be explained by Subjective Expected Utility (SEU) theory developed by [Savage \(1954\)](#). Savage proposes a framework to model decision making under uncertainty by establishing a set of axioms. The core axiom of Savage's theory is named the *sure-thing* or *separability* principle. It states that a state with distinct consequences to both acts is independent of determining preferences between the acts ([Camerer and Weber, 1992](#)). Under Savage's theory the decision maker assigns a subjective probability distribution (subjective "personal" beliefs) over a set of possible events and chooses an act from the set that maximizes the expected value of an utility function weighted by a (subjective) probability measure on the states.

From the set S of possible states s with $S = \{s_1, s_2, \dots, s_n\}$, the consequences of an act F depend on which state s occurs. For instance, the consequences of F if s occurs is denoted by $f(s)$. The decision maker's subjective probabilities of the states is denoted $p(s)$. The aim of SEU is to represent preferences over acts by a utility function u and the subjective probabilities such that the act F is preferred to the act G if and only if the expected value of the utility function of F is larger than the one of G . Hence, the SEU of act F for a finite set of states and acts can be written

$$SEU(F) = \sum_{s \in S} p(s)u(f(s))$$

Savage imposes reasonable axioms which makes it possible that the decision under uncertainty can in some sense be assimilated to decision making under risk when beliefs are considered to be purely subjective ([Etner et al., 2012](#)). Ellsberg's (1961)

¹⁴See for more details about the definitions of ambiguity in the articles of [Schmeidler \(1989\)](#), [Epstein \(1999\)](#), [Epstein and Zhang \(2001\)](#) and [Klibanoff et al. \(2005\)](#) or in the context of experimental economics see the works of [Becker \(1964\)](#) and [Gollier \(2014\)](#).

remarkable paper challenges SEU by violating the sure-thing principle and presents the descriptive theory, termed the *Ellsberg paradox*. Daniel Ellsberg's urn thought experiments reveal that individuals preferred to bet on acts with a known probability rather than on acts with unknown probabilities of winning. Such behavior, called *ambiguity aversion*, is inconsistent with SEU theory and has been empirically confirmed over the last decades (Camerer and Weber, 1992; Dominiak, 2010). Several generalizations of Savage's subjective expected utility theory has been proposed which assert that the decision maker behaves as if she would have many priors in mind rather than a single one. This issue will be discussed as following.

1.4.3 Modeling ambiguity

Over the past of decades, the theoretical and experimental advances have significantly emerged in this field. Wakker (2000), Etner et al. (2012) and Gilboa and Marinacci (2013) survey the decision-theoretic literature about the latest improvements which focus on models of ambiguity sensitive preferences. In general, there are three widely applied approaches of modeling decisions under ambiguity which differ in the notion of subjective beliefs. The first approach considers that subjective beliefs are non-additive and these priors can be captured by a capacity. The second one involves that subjective beliefs are represented by set of priors, called multiple priors and the third by a second order prior (prior over a set of priors). For the sake of brevity, we present the most applied ambiguity models in the literature.

Non-additive beliefs

The first generation models, namely Choquet expected utility (CEU) model was developed by Schmeidler (1989). By weakening Savage's sure-thing principle, Schmeidler (1989) is considering beliefs which are not any more represented by a subjective probability but rather by a capacity which is a normalized and monotone but non-necessarily additive set function (Dominiak, 2010; Etner et al., 2012). In other words, CEU model posits a utility function which replaces the subjective probability measure with a non-additive capacity over events. Thus, an act F is preferred over an act G if and only if there exist a unique utility function u and a

unique capacity ν such that:

$$\int_{CH} u(f(s))d\nu(s) \geq \int_{CH} u(g(s))d\nu(s)$$

In this model expected utility is computed with the mean of the Choquet integral, introduced by [Choquet \(1954\)](#), due to the presence of non-additive beliefs. To calculate CEU of an act, the decision maker needs first to rank the different states with respect of the attractiveness of the outcomes ([Mangelsdorff and Weber, 1994](#)). Hence the decision maker is weighting the utility of an outcome with a transformed cumulative probability. This means that a successive increment which is weighted by the decision maker's personal estimation about the occurrence of this increment is added to the lowest outcome ([Etner et al., 2012](#)). Note that if the capacity is additive, the Choquet expected utility reduces to subjective expected utility.

The Non-Extreme-Outcome Expected Utility (NEO-EU) model is a special case of Choquet expected utility model ([Gilboa \(1987\)](#), [Schmeidler \(1989\)](#)) with a Non-Extreme-Outcome additive (NEO-additive) capacity. The name comes from the fact that NEO-additive capacities are additive for events yielding non-extreme outcomes. More generally, non-additive probabilities or capacities reflect the individual's beliefs about the likelihood of uncertain events. Individuals maximize an expected utility function with respect to a capacity instead of a probability distribution ([Mondello, 2013](#)). Situations in which an individual behaves as if she had an additive probability distribution, albeit doubts whether this distribution is the true one can be captured by a NEO-additive capacity. Both doubt and reaction to doubt are parameterized, representing the degree of ambiguity and the individual's attitude toward it ([Dominiak and Lefort, 2013](#)). [Chateauneuf et al. \(2007\)](#) introduce a specific weighting scheme to model ambiguity. NEO-additive capacity can be viewed as a linear combination of an additive capacity and a particular (non-additive) capacity, named Hurwicz capacity that only distinguish between whether an event is impossible, possible or certain. A NEO-additive capacity is a non-additive belief that represents a deviation from an additive belief, such that the degree of ambiguity measures the lack of confidence the individual has in some additive probability distribution ([Romm, 2014](#)). In the NEO-EU model, optimism and pessimism are defined with respect to the weights the individual applies to the extreme outcomes, which embed attitudes toward ambiguity: A concave capacity reflects optimism (ambiguity

loving), while a convex capacity reflects pessimism (ambiguity seeking) (Schmeidler (1989), Wakker (2001), Chateauneuf et al. (2007)).

Multiple priors

Another approach known as the maxmin expected utility (MEU) theory or multiple prior model was postulated by Schmeidler (1989). The basic idea behind this approach is that the subjective beliefs are captured by a set C of probability distributions. In other words, the decision maker might think of a possible probabilistic scenario for each prior (Dominiak, 2010). Under MEU, decision maker's subjective beliefs are represented by a set of probability distributions and seeks to maximize the minimal expected utility of the act chosen (Alon and Schmeidler, 2014). More precisely, the decision maker decides between two acts by comparing their lowest expected values of utility and selects the one that results the maximum of the lowest expected value of utility. Schmeidler (1989) specifies several axioms which satisfy the existence of a unique finitely set of probability distributions C and a unique utility u with a positive linear transformation such that an act F is preferred to an act G if and only if

$$\min_{p \in C} \int_S u(f(s)) dp(s) \geq \min_{p \in C} \int_S u(g(s)) dp(s)$$

If the decision maker's perception of ambiguity reduces to one singleton (single prior), $C = \{p\}$ than it returns to Savage's theory of subjective expected utility. In this case the decision maker behaves as a subjective expected utility maximizer by considering a single prior p . Furthermore, MEU especially overlaps to CEU when the non-additive probability is convex (Etner et al. (2012), Alon and Schmeidler (2014)). By extending MEU, Ghirardato et al. (2004) derive the α -maxmin expected utility with multiple priors. In this model, the decision maker's perception of ambiguity is represented by a given set C of probability distributions while applying the weights to the maximum and minimum expected utility over the set of C . More precisely, an act is evaluated as a linear combination of maximizing the worst (maxmin) and best (maxmax) expected utility. Moreover, the worst (maxmin) expected utility is weighted with the coefficient α with $\alpha \in [0, 1]$ the best (maxmax) expected utility which is weighted with $1 - \alpha$ with respect to a set of priors C . As abovementioned α resembles the Arrow–Hurwicz criterion and represents the decision maker's attitude

toward ambiguity. For instance, if $\alpha = 1$, it indicates an extreme aversion toward ambiguity (highly pessimistic) and thus it returns to MEU. In case $\alpha = 0$, the decision maker reflects a highly ambiguity-loving or optimistic behavior. One need to bear in mind that within a finite setups, the decision maker's preferences in the α -maxmin model only features two extreme attitudes toward ambiguity (Dominiak, 2010). Furthermore, this model is closely related to NEO-expected utility model. The NEO-expected utility model is not that restrictive and captures the decision maker's preferences within a finite setup (and not only for two extreme events).

Second order beliefs

The last concept of modeling decisions under ambiguity is proposed by Klibanoff et al. (2005) which is often referred to as the smooth ambiguity model. Under this approach, the individual decision is decomposed in a two-stage process (Etner et al., 2012) and the evaluation of an act is computed as follows. In a first stage, the decision maker evaluates the expected utilities of an act F , one for each possible probabilistic scenario. In a second stage, the decision maker is not taken the minimum of these expectations (such as in the multiple priors) but considers the expectation of the expected utilities transformed by an increasing function ϕ . An act F is preferred to an act G if and only if

$$\int_{\Delta(S)} \phi\left(\int_S u(f(s))dp(s)\right)du(p) \geq \int_{\Delta(S)} \phi\left(\int_S u(g(s))dp(s)\right)du(p)$$

with $\Delta(S) = \{p : S \rightarrow [0,1] \mid \sum_{s \in S} p(s) = 1\}$. The concave function ϕ reflects aversion toward ambiguity in the sense that the decision maker is putting larger weights on the "bad" outcome (lower expected utilities) and is said to be ambiguity-averse. By contrast, a convex function reflects ambiguity-loving behavior and a linear function captures ambiguity-neutral behavior. The model allows to distinguish between risk aversion, which is characterized by the shape of the utility function u and ambiguity aversion which is represented by the shape of the function ϕ .

In this section, we have presented the most prominent models coping with the problem raised by Ellsberg. In the situation where the decision maker is lacking information about the probability of an event, these models allow to capture the degree of ambiguity and the decision maker's attitudes toward ambiguity when

evaluating a decision. Most notably, these models have been criticized by several authors. [Machina \(2009\)](#) challenges the Choquet expected utility theory by coming up with a four color experiment and presume that a majority of subjects would reveal an intuitive pattern which cannot be explained by the theory. The so-called *Machina's paradox* has been experimentally confirmed by [Baillon et al. \(2011\)](#). It should be noted that the experimental results not only falsify the Choquet expected utility model but also four other ambiguity models of the literature, namely maxmin expected utility, variational preferences, α -maxmin, and the smooth model of ambiguity aversion.

Further, we are completing the so far discussed literature by delineating an example about the governance of nanotechnology when scientific uncertainty persists about the potential risks of the emerging technology.

1.5 Nanotechnology and risks governance

Nanotechnology is a rapidly evolving science and has seen a surge in investment by the public and private sectors worldwide. In the meanwhile, the level of innovation measured by patent applications to the European Patent Office has widely increased within the last 20 years ([EUROSTAT, 2016](#)). Nanotechnology brings huge benefits to research and application in different fields and is most notably expected to contribute to achieve economic growth as well as social and individual benefits ([The Royal Society \(2004\)](#), [European Commission \(2011\)](#)). In general, nanoparticles refer to materials of extremely small size ranging from 1 nm to 100 nm. In particular, the small size endows nanoparticles with valuable properties which gives promises that the emerging technology has high impacts in the application of medicine, food systems, agriculture and the environment ([Ray et al., 2010](#)).

The current and proposed governance initiatives attempt to regulate nanotechnology but no legal system has been yet elaborated to reasonably address the uncertain risks of nanotechnology ([Dana, 2012](#)). The European Commission adopted on the 18th October 2011 (Commission Recommendation 2011/696/EU) the international definition¹⁵ of *nanomaterials* for regulatory purposes. Nanomaterials are

¹⁵The [European Commission \(2011, 38\)](#) defines nanomaterial as "a natural, incidental or manufactured material containing particles, in an unbound state or as an aggregate or as an agglomerate and where, for 50% or more of the particles in the number size distribution, one or more external dimensions is in the size range 1 nm - 100 nm".

applicable under the general scheme of the European Environmental Liability Directive (ELD) ANNEX III. However, the ELD does not include specific provisions for nanomaterials. In the United States, the federal environmental regulation of engineered nanomaterials is most likely to occur under the Toxic Substances Control Act, the Federal Insecticide, Fungicide and Rodenticide Act, the Resource Conservation and Recovery Act, the Comprehensive Environmental Response Compensation and Liability Act (John and Van Calster, 2010).

Although, some scholars claim that nanotechnology is one of the key emerging technology of the twenty-first century even though there is scarce knowledge about the risks of nanotechnology (Corley et al., 2009). Furthermore, scientific controversy and the lack of scientific evidence further on persist about the safety of nanotechnology regarding environmental and health concerns. Scientific uncertainty may also lead to a polarized public perception about nanotechnology and the unwillingness of the industry to invest in the application of the emerging technology. Until now, no study exists about the evaluation of the risks which could be directly related to nanotechnology (Sinclair-Désagné et al., 2006). The difficulties in evaluating the risks (hazard and exposure) of nanoparticles stem from the lack of standardized methodologies to compare the results from different researchers and different nanomaterials. Major concerns have been expressed that nanoparticles might be more toxic than larger particles of the same unit and may penetrate the skin leading to cell damage (The Royal Society, 2004). Toxic effects of nanoparticles have been confirmed by several research groups, however the causes for the toxicity remain unknown due to the complex interaction of nanoparticles with the environment and ecological system (Ray et al., 2010). For these reasons, and others, the aim is to minimize or to decrease the risks with respect to the substantial expansion of the potential application of nanotechnology (Sinclair-Désagné et al., 2006).

We refer to the example of nanosilver which has received recently ample attention in academia as well as with regulators (Nowack and Bucheli (2007), Wiesner et al. (2009)). Nanosilver particles appear in daily life products, such as home goods (e.g., sport textiles, cosmetics, washing powder and deodorants) or medical care (e.g. wound dressings such as bandages or as coatings for medical devices) due to its antimicrobial characteristic. The worldwide production and usage of nanosilver is estimated in 2011 at 320 tons per year (Nowack et al., 2011). Silver has been

applied over 100 years, but with the advances of nanotechnology scholars currently debate whether nanoparticles should be considered as "new" chemicals. Also the environmental standards are based on ionic silver and may need to be re-evaluated concerning the effects in form of nanoparticles (Nowack et al., 2011). Moreover, the reports by the U.S. Environmental Protection Agency in August 2010 and the Scientific Committee on Emerging and Newly Identified Health Risks (SCENIHR) in June 2014, stress possible environmental and health effects due to the application of nanosilver (AG-NP). The Scientific Committee and the Environmental Protection Agency underline that more information is required on the possible contribution of AG-NP's to environmental and human toxicity. Additionally, more information is needed on the probability of the release of nanosilver. Scholars and international organizations claim that nanosilver remains a fairly poorly understood material (Federal Institute for Risk Assessment (2009), Environmental Protection Agency (2010), Ray et al. (2010), Seltenreich (2013) and SCENIHR (2014)).

As the foregoing example shows, it is not possible to make general statements about the risks of nanomaterials, such as nanosilver. The German Advisory Council on the Environment (2011) identify nano-specific regulatory gaps in the sense that only certain nanomaterials fall under the scope of existing legislations. Nanomaterials are covered by different pieces of EU legislations, such as the Biocidal Products Regulation (528/2012) and the Cosmetic Products Regulation (1223/2009) and other legislations are currently under revision to better address the management of the risks of nanoparticles (Amenta et al., 2015). As some nanomaterials are currently not subject to a specific authorization (since no registration of thresholds, standards or hazardous active substances for specific nanomaterials are available), the German Advisory Council on the Environment (2011) propose to implement strict liability for the management of nanomaterials which creates incentives for manufacturers and producers to carry out research into effects before entering the market.

With regards to uncertainty, social scientists agree that the development of nanotechnology is likely affected by the public perception about the risks of nanotechnology and thus determine whether the technology is accepted or rejected by the public (Roco (2003), Scheufele and Lewenstein (2005), Currall et al. (2006), Kahan et al. (2007), Currall (2009), Kahan (2009), Satterfield et al. (2009), Sahin and Ekli (2013)).

Social scientists explore the attitudes toward the risks and benefits of nanotechnology. For an overview, [Currall \(2009\)](#) provides a review about major studies focusing on public's perception of nanotechnology. [Satterfield et al. \(2009\)](#) conduct meta-analysis from 22 risk perception surveys (mostly US surveys) from 2004 to 2009. The results show that respondents have at least some familiarity with nanotechnology, however unfamiliarity is not strongly associated with risk aversion and the numbers of respondents who perceive greater benefits outweigh those who perceive greater risks. In a different context, [Scheufele and Lewenstein \(2005\)](#) strive to understand the impact of personal values, attitudes and processing information on the perceptions of nanotechnology by carrying out a national representative telephone survey in 2004 in the United States. The variable media has been identified as a key factor influencing the public perception of risks and benefits related to nanotechnology. Similar, student's perceptions of nanotechnology from Turkish middle schools have been elicited by questionnaire ([Sahin and Ekli, 2013](#)). Students have some knowledge and awareness of nanotechnology and most of them report positive emotions and opinions about it. The data show that student's lack in scientific knowledge is positively correlated to the perception of risks versus benefits. Furthermore, the results demonstrate that the student's interest in science is significantly correlated to positive attitudes and opinions of nanotechnology.

With regards to the comparison of data from Eurobarometer ([2010b](#)) and from the before mentioned US surveys exhibit that Americans are more optimistic about nanotechnology than Europeans ([Besley et al., 2008](#)). Data from the Eurobarometer report in ([2010b](#)) confirms that respondents have a low level of awareness about nanotechnology. For instance, the report highlights that respondents don't know whether nanotechnology is safe for their health, whether the technology helps people in developing countries and whether nanotechnology is good for them.

In contrast, [Besley et al. \(2008\)](#) and [Corley et al. \(2009\)](#) investigate experts' opinion, risks and benefits perception of nanotechnology. While studying the views of experts is useful, it may provide information about their support for nanotechnology regulation. [Besley et al. \(2008\)](#) assess experts' opinion based on factor analysis and conclude that many scientists involved in nanotechnology science indicate that the current regulation is not adequate and priority for regulation should be given to the field of health and environment. Additionally, [Corley et al. \(2009\)](#) use data

from 363 leading U.S. nanotechnology scientists and engineers in 2007 and conclude that nonscientists are more in favor of regulating nanotechnology when they perceive higher level of risks. Differences among disciplines and gender have been identified to impact the support for nanotechnology regulation. It seems also noteworthy that males are less supportive of regulating nanotechnology than female and material scientists are less supportive of nanotechnology regulation than others from different fields.

1.6 Concluding remarks

The survey leads to two major findings. The first finding concerns that there is a high degree of uncertainty associated with the risks of nanotechnology and it seems that many scientists see a need to adequately manage potential risks and regulate nanotechnology (Besley et al. (2008), Renn and Roco (2006)). Second, from a policy perspective, it is unclear which liability regime should be enforced to govern new emerging technologies such as nanotechnology. In particular, the [German Advisory Council on the Environment](#) plead for strict liability to give potential injurers incentives to invest in research to discover more comprehensively potential health and environmental effects of the new innovative products. In this respect, it is uncertain whether strict and unlimited liability or limited liability would be an efficient economic tool to provide incentives for optimal prevention measures. Both regimes, unlimited and limited liability have advantages and disadvantages, but it is hard to argue from an economic point of view which liability system would be most effective in reducing the risks of an accident with respect to new emerging technologies. In this case, we noted that the advantage of strict and unlimited liability is that the potential injurer will have an incentive to adopt efficiently prevention and victims will be fully compensated in the case of an accident. Despite, if the legislator allows the limitation of compensation to victims, thus it will not lead to a full internalization of the potential risks. Faure (1995) highlights that the problem of limiting compensation seriously limits the right of victims and hampers the full internalization of the externality caused by the firm's risky activity. On the other side, strict and unlimited liability would thus deter potential investors from investing in novel technologies on a large-scale due both to bearing uncertainty about the probability of an accident and to bearing high costs in the occurrence of an accident. To fill

this gap, we use the economic analysis of accident law to examine the performance of the liability rules for accidents of new emerging technologies.

In the next chapter, we are developing a theoretical model seeking to better understand the firm's decisions under ambiguity related to tort law by illustrating the forgoing example of uncertain risks associated to the application of nanotechnology.

Chapter 2

The Efficiency of Strict Liability

Rules Revised in Risk and

Ambiguity¹

¹This chapter has been published as BETA Working Paper 2016-29 co-written with Sandrine Spaeter, entitled "The Efficiency of (strict) Liability Rules Revised in Risk and Ambiguity".

2.1 Introduction

In this chapter, we develop a theoretical model based on the unilateral accident model (Shavell, 1980), which has been previously presented in chapter 1. We investigate the decision maker's behavior to invest optimally in pecuniary prevention measures. We assume that the potential injurer has a paucity of information about the likelihood of an accident. As discussed in chapter 1 the theoretical results in well-known risky environments are established and widely applied. The aim of this chapter is to demonstrate that these results should be put in doubt as soon as risk cannot be perfectly defined, as it is more and more frequently the case when dealing with new emerging products or processes. In that case, we have to deal with (scientific) uncertainty or ambiguity. With Ellsberg (1961) thought experiments, the necessary foundations on revealing the importance of attitudes toward ambiguity has been laid down. Ambiguity has become a central issue in the management and regulation of new emerging risks. However, we wonder how the current existing legislation, especially tort law, deals with new emerging technologies. This question is motivated by the current debate on the performance of liability rules in sectors using nanotechnologies (Federal Institute for Risk Assessment (2009), Environmental Protection Agency (2010), Ray et al. (2010) and SCENIHR (2014)).

The U.S. Environmental Protection Agency and Scientific Committee on Emerging and Newly Identified Health Risks in Europe emphasize that specific nanomaterials (such as nanosilver) might release possible environmental and health effects due to its application in consumer products. These independent organizations underline that more information is required on the possible contribution of nanomaterials to the environmental and human toxicity.

Nevertheless, a few papers deal with the question of ambiguity related to tort law (Jacob (2015), Pannequin and Ropaul (2016), among others). In this chapter, we refer to Mondello (2013), Chakravarty and Kelsey (2016) and Teitelbaum (2007) which focus on the performance of liability rules in an ambiguous environment. Under ambiguity, these three papers assume that the potential injurer is a choquet expected utility maximizer who forms beliefs about accident risk by using a special kind of capacity, called a neoadditive capacity. Further, they focus on the negligence rule and (strict) unlimited liability.

In line with Mondello (2013), Chakravarty and Kelsey (2016) and Teitelbaum

(2007), we analyze the efficiency of liability rules for situations where the potential injurer has inherently scarce knowledge about the probabilities of an accident to occur. We focus on the strict liability rule and we consider especially both regimes, unlimited and limited liability. To the best of our knowledge, this is the first work that shows how the potential injurer's behavior is affected by limited liability in the presence of ambiguity in the unilateral accident model. Moreover, it is implicitly assumed in the abovementioned studies that prevention only impacts the objective probability of accident announced by the regulator. In this chapter, we presume that the subjective and personal belief built by the potential injurer depends on her degree of optimism but also on her investment in prevention.

We apply the (NEO-EU) model developed by [Chateauneuf et al. \(2007\)](#) to embrace ambiguity in the basic unilateral accident model. The potential injurer assigns a degree of confidence to the preliminary probability of accident announced by the regulator. Furthermore, she builds simultaneously her own beliefs, which is considered with the complementary degree of confidence and her degree of optimism/pessimism. The latter indicator gives also information about the potential injurer's ambiguity attitude.

We show that none of the results with risk hold when ambiguity matters. In particular, the potential injurer tends to overinvest in prevention whenever she believes that she is able to better control for her "self-constructed" weight on the accident state than the regulator does with the preliminary probability. This result holds for both unlimited and limited liability. In the risk section, we also show that the potential injurer may invest more in prevention under limited liability compared to the social optimal level of prevention.

The remainder of this chapter is organized as follows. Section [2.2](#) presents the unilateral accident model and discusses the debate around "private level of prevention vs. social level of prevention". Section [2.3](#) explains how ambiguity about accident risk is performed in the framework of NEO-expected utility model and states the results of the model. Section [2.4](#) concludes the chapter. Proofs and additional materials are presented in the appendix [A](#).

2.2 The Basic Model

In this section we present the model which is based on the unilateral accident model proposed by [Shavell \(1980\)](#). There are two agents, a potential injurer (a firm whose activity is risky for Society for instance) and a representative victim. The utility of the firm's activity is assumed to have an equivalent in terms of income. We assume that both parties are risk-neutral such as expected income equals expected utility². The injurer's activity yields a risk of accident. An accident entails a damage L with realization in $[0, l]$, $l > 0$. We denote as d the payment made by the potential injurer to the victim if an accident occurs: We have $0 < d \leq l$ in case of strict liability, and $d = 0$ in case no liability rule is put in place. In the absence of liability, all accident losses fall on the victim and no compensation fee will be paid by the potential injurer. The probability π of an accident, with $\pi \in [0, 1]$, depends on the monetary amount³ x invested by the potential injurer in prevention, with $x \in [0, \bar{x}]$ and $\bar{x} > 0$. We assume $\pi'(x) < 0$ and $\pi''(x) > 0$. The potential injurer makes a net benefit b over the production of quantities⁴.

At this point, it shall be emphasized that neither causation, nor administrative or litigation costs are taken into account in the model. The potential injurer does not purchase liability insurance.

The regulator is in charge of maximizing the expected social welfare in a simple probability model. According to [Dari-Mattiacci and De Geest \(2005\)](#), the potential injurer can reduce the probability of accident by taking appropriate prevention measures, while the magnitude of the harm is not being affected.

The social expected welfare $E(\tilde{W}^S)$ is the sum of the potential injurer's profit and the expected costs of damage borne by Society. The regulator's program writes $\max_x b - \pi(x)l - x$. Since b is independent of the prevention level x , this program is equivalent to the following cost minimization program:

$$\min_x \quad \pi(x)l + x \quad (2.1)$$

For an interior solution, the social optimal level of prevention x^S that shall be

²Risk aversion does not affect the results about the (in)efficiencies of liability rules with regard to prevention. See appendix A.2 for more details.

³See for instance [Macminn \(2002\)](#) and [Miceli and Segerson \(2003\)](#) who compare the negligence rule with strict liability by distinguishing between non-monetary and monetary cost of care.

⁴We suppose that the level of activity is exogenous and constant so that profit maximization will be equivalent to cost minimization in many cases (but not always as we will show later on).

enforced by a regulator satisfies:

$$-\pi'(x^S)l = 1 \tag{2.2}$$

The left (right)-hand-side term is the well-known expected marginal benefit (cost) of prevention. The former corresponds to the reduction in the expected value of the loss following a one-unit investment in prevention. The latter corresponds merely to one monetary unit invested in prevention.

Now, let us consider the private decision taken by the potential injurer. In this section, we consider the main results at stake with strict liability⁵ when the risk is perfectly known by both parties and liability is successively unlimited as well as liability is limited to the net value of the potential injurer. Unlimited (respectively limited) liability is formalized by a payment $d = l$ (respectively $0 < d < l$) by the potential injurer to the victim in case of an accident.

When unlimited liability holds, the potential injurer will always have to pay for the whole damage induced by her activity: $d = l$. In the case of limited liability, the payment to the victim is capped by the net value of the firm so that the required compensation to be paid may be lower than the damage. As a consequence the potential injurer is pushed into bankruptcy. We are particularly interested in this last case, so that we assume that $d < l$: Meaning that the damage is always higher than the net value of the potential injurer confiscated for compensation when an accident occurs. We discuss first the results of (strict) unlimited liability then limited liability in a risky environment in the following subsections.

2.2.1 Private optimum when strict and unlimited liability holds

Under the rule of strict liability a potential injurer is held liable when she causes a harm even if she is not being found negligent (Shavell, 2004). Under the regime of unlimited liability a potential injurer has to pay *ex post* for all the damage caused by her activity whatever her level of prevention. The damage needs to be fully compensated even if it exceeds the net wealth of the potential injurer. As a result, the potential injurer's profit can be negative, and the victims do not have, *ex ante*, to bear the financial damage caused by the potential injurer. Accordingly, the potential

⁵We do not consider the negligence rule in this chapter. It has been extensively analyzed, for instance, in Shavell (1980), Brown (1973), Miceli and Segerson (2003), Teitelbaum (2007), Chakravarty and Kelsey (2016), and Mondello (2013).

injurer is required to internalize the full expected cost of accident. Hence her private program is

$$\min_x \quad \pi(x)l + x \tag{2.3}$$

This private program (2.3) fits with the social one (2.1). As a consequence, the optimal private level of prevention x_{UL}^P equals the social one x^S . When the risk is perfectly known and the potential injurer can be identified as wrongdoer, strict and unlimited liability is presented as an efficient regulatory tool regarding the optimal level of prevention; both induce full risk internalization by the potential injurer.

This is no longer the case when liability is limited to the net value of the potential injurer. Contrary to the first intuition and to some results of the literature (Pitchford (1995), Faure (1995)) we show that underinvestment in prevention is not systematically observed with limited liability. This result was also obtained by Beard (1990) and Dionne and Spaeter (2003), but by introducing an outside lender in the model. We show that this third party is not needed to obtain the result.

2.2.2 When the *ex post* potential injurer's liability is limited to her net value

Consider now the case of strict but limited liability, where the potential injurer is still liable for the harm she causes. However, her payment is limited to the net value of the potential injurer, which can never be negative under this regime. Let us assume that the loss l in case of an accident is always higher than the maximum possible value of the potential injurer: $b < l$. Let us denote the potential injurer's private wealth as $W_{LL}^P = b - x - \hat{d}$ in the accident state and $W_0^P = b - x$ in the no accident state. The level \hat{d} is the maximum amount of damage that a potential injurer pays given her level of prevention. Hence, we have $\hat{d} = b - x < l$ and $W_{LL}^P = 0$. Such as in Dari-Mattiacci and De Geest (2005) and Jacob and Spaeter (2016), the level of damage that pushes the potential injurer into bankruptcy is endogenous in the model: choosing x implies also choosing \hat{d} . We have $\hat{d} = \hat{d}(x)$. Finally, the potential injurer considers the following private program:

$$\begin{aligned} \max_x \quad & (1 - \pi(x))W_0^P \\ & = (1 - \pi(x))\hat{d}(x) \end{aligned} \quad (2.4)$$

Contrary to the preceding case, the profit maximizing program cannot be replaced by a cost minimizing program although the benefit b does not depend on x . Actually, it enters into the available funds for compensation in case of an accident and thus cannot be removed. Contrary to what is considered in [Dari-Mattiacci and De Geest \(2006b\)](#), profit maximization is no longer equivalent to cost minimization under limited liability. With $\hat{d}(x) = b - x$, the first order condition of Program (2.4) for an interior solution x_{LL}^P is:

$$-\pi'(x_{LL}^P)\hat{d}(x_{LL}^P) = 1 - \pi(x_{LL}^P) \quad (2.5)$$

We obtain the following results.

Proposition 1 *Let us assume that the potential injurer is an expected utility maximizer and the bankruptcy threshold \hat{d} is endogenous to the model*

(i) *The potential injurer can invest either more or less in prevention than the social optimal level. Formally $x_{LL}^P \leq x^S$ in optimum.*

(ii) *Whenever over-investment in prevention is observed, this does not imply social welfare improvement.*

A comparison of (2.5) with (2.2) yields the following comments. Both the expected marginal benefit (left-hand-side term) and the marginal cost (right-hand-side term) of prevention are affected by the introduction of limited liability. Indeed, as part $(l - \hat{d})$ of the loss is externalized toward the victims, the marginal benefit of prevention expected by the potential injurer decreases: $0 < -\pi'(x)\hat{d}(x) < -\pi'(x)l$ for any x . In the meantime, the marginal cost of prevention also decreases: $0 < 1 - \pi(x) < 1$. In fact one monetary unit invested in prevention will only be costly for the potential injurer whenever there is no accident. In the accident case, all assets net of prevention costs are confiscated and the potential injurer's profit falls to zero. Hence part of the cost of prevention is recovered by the potential injurer since they are deduced from her assets before compensation. As a direct consequence, it could be profitable for her to invest even more in prevention than the social optimum.

Finally, contrary to the first intuition, limited liability does not imply systematic underinvestment in prevention. Whenever the marginal cost declines more rapidly than the expected marginal benefit, the potential injurer invests more in prevention than the social level. This result was obtained by Beard (1990) and Lipowski-Posey (1993). Dionne and Spaeter (2003) also obtain this result under limited liability while considering extended liability for the bank⁶ which finances the potential injurer. In these three papers, an outside lender is financing the firm, so that the latter loses part of the money of the bank when she is pushed into bankruptcy. In our setting, there is no external lender. The fact that victims have to bear part of the loss can be considered as extending the (financial) liability toward them⁷. Whenever the firm decides her level of prevention x , she also decides her level of bankruptcy $\hat{d}(x)$ and as a direct consequence the level of loss $l - \hat{d}(x)$ is borne by the victims after compensation. Finally, the firm's decision x has a simultaneous impact on the probability of accident $\pi(x)$ and the magnitude of the non-compensated loss $l - \hat{d}(x)$.

The result of Point (i) of Proposition 1 stands in contrast with the widespread conclusion on underinvestment in prevention (or care) when liability is limited. Actually, this well-known result of the literature has been obtained in a cost minimizing setting. In such a framework, the level of damage that pushes the potential injurer into bankruptcy is exogenous in the model (Shavell, 1986). Thus maximizing expected profit with \hat{d} exogenously fixed is equivalent to minimizing the expected costs of prevention $\pi(x)\hat{d} + x$. The solution to this program is clearly a level of prevention strictly lower than the social one. Unfortunately, as shown above profit maximization does no longer correspond to cost minimization under limited liability.

Result (ii) is rather immediate. When the potential injurer decides to invest a level x_{LL}^P in prevention higher than the social level x^S , she decreases *ex ante* the probability of accident below the level $\pi(x^S)$. In the meantime, she also deteriorates the conditions of the *ex post* compensation by reducing the available funds for compensation. And if such a strategy is optimal for her, it is suboptimal for the victims since what is earned by the former due to partial risk internalization is lost by the latter.

⁶The bank must pay for the extra damage whenever the potential injurer is pushed into bankruptcy and cannot fully compensate the victims.

⁷See also Dari-Mattiacci and De Geest (2006a).

The suboptimality of limited liability compared to unlimited liability can be discussed further when relaxing the hypothesis of well-known risks. In other words, strict and unlimited liability does no longer perform so well when considering scientific uncertainty or, more generally, new and not yet well-defined risks or technologies. We focus on this point in the next section.

2.3 Efficient rules with ambiguity

In the seminal contribution by [Ellsberg \(1961\)](#) and in ensuing experiments, it has been acknowledged that the perception of unavailable information affects individuals' choice behavior.

In this section, we use the NEO-expected utility (NEO-EU) model axiomatized by [Chateauneuf et al. \(2007\)](#) to embrace ambiguity in the basic unilateral accident model. NEO-EU is a special case of Choquet expected utility model ([Gilboa, 1987](#); [Schmeidler, 1989](#)) with a Non-Extreme-Outcome additive (NEO-additive) capacity. The name comes from the fact that NEO-additive capacities are additive for events yielding non-extreme outcomes. More generally, non-additive probabilities or capacities reflect the individual's beliefs about the likelihood of uncertain events. Individuals maximize an expected utility function with respect to a capacity instead of a probability distribution ([Mondello, 2013](#)).

Situations in which an individual behaves as if she had an additive probability distribution, albeit doubts whether this distribution is the true one can be captured by a NEO-additive capacity. Both doubt and reaction to doubt are parameterized, representing the degree of ambiguity and the individual's attitude toward it ([Domiński and Lefort, 2013](#)). [Chateauneuf et al. \(2007\)](#) introduce a specific weighting scheme to model ambiguity. NEO-additive capacity can be viewed as a linear combination of an additive capacity and a particular (non additive) capacity, named Hurwicz capacity that only distinguish between whether an event is impossible, possible or certain.

A NEO-additive capacity is a non-additive belief that represents a deviation from an additive belief, such that the degree of ambiguity measures the lack of confidence the individual has in some additive probability distribution ([Romm, 2014](#)). In the NEO-EU model, optimism and pessimism are defined with respect to the weights the individual applies to the extreme outcomes, which embed attitudes toward am-

biguity: A concave capacity reflects optimism (ambiguity loving), while a convex capacity reflects pessimism (ambiguity seeking) (Schmeidler (1989), Wakker (2001), Chateauneuf et al. (2007)). Also, for the sake of comparison to previous works (Chakravarty and Kelsey (2016), Teitelbaum (2007), Mondello (2013)) we apply the NEO-EU model to our issue.

To illustrate our principal idea, let us recall our previous example about the issue of the uncertain evidence in the nanoscience. New nanotechnology products are hitting the market and, in the meantime, consumers and the environment are exposed to an uncertain risk. The regulator considers his currently available information on the likelihood of an accident related to the new technology as sufficient to approve the new products for sale. In other words, we purport that the regulator has sufficient preliminary scientific information on a small probability of accident to approve the new products. However, some scientific committees, agencies and scientists enhance the fact that these new products could have negative long-term effects on human health and the environment. They report that further scientific expertise is required. Since the knowledge about methodologies and the lack of analytical techniques for evaluating potential long-term risks are not available, no proof can yet be assigned.

Let us assume that ambiguity matters in a way we have described above and the potential injurer is a NEO-EU maximizer whose beliefs about the "preliminary" probability π of an accident announced by the regulator can be represented by a behavior-additive capacity (Chateauneuf et al., 2007). The potential injurer believes that this so-called preliminary probability π is the true probability with a degree of confidence δ , with $\delta \in [0, 1]$. As an illustration, on one hand the potential injurer believes with a given degree δ of confidence that nanosilver in medical care and products would have a negative impact on human body that can be evaluated by the probability π announced by the regulator. On the other hand, another level of risk shall not be ignored, and is considered with a degree of confidence $1 - \delta$. Besides the chance of bearing a loss in this second scenario and evaluated by the potential injurer depends on her degree of optimism/pessimism⁸.

⁸There exist no generally accepted definitions of optimism and pessimism. The most popular used in the psychology literature is Scheier and Carver (1985)'s definition who states that optimism and pessimism are two different concepts and are considered as forms of positive and negative illusions. See also, Chang et al. (1997), Pulford (2009), Dember et al. (1989), Hecht (2013) and Koebel et al. (2016). In this chapter, we consider confidence and optimism as a character trait.

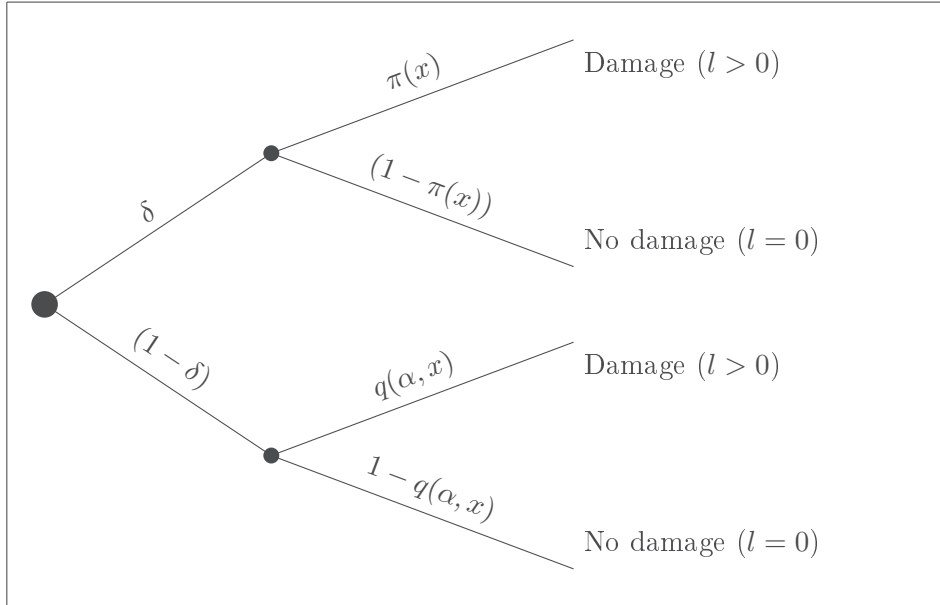

Figure 2.1: Compound ambiguous and risky lottery

Let us denote as α this degree of optimism with $\alpha \in [0, 1]$. We consider that the potential injurer is optimistic when $\alpha > 0.5$, pessimistic when $\alpha < 0.5$ and ambiguity neutral when $\alpha = 0.5$. We still denote as $q(\alpha, x)$ the belief built by the potential injurer on the accident state in the second scenario, with $q_\alpha < 0, q_x \leq 0$ and we assume that $q(\alpha, 0) \leq \pi(0)$ for $\alpha \leq 0.5$. It depends on her degree of optimism as explained above, and also on her investment in prevention. This assumption is different from what is considered in [Teitelbaum \(2007\)](#), [Chakravarty and Kelsey \(2016\)](#) and [Mondello \(2013\)](#). Indeed, these authors assume that prevention (or care) only impacts the probability, π , which we deem is a rather strong assumption. We consider a more general, and potentially more realistic, situation in which the potential injurer can also impact uncertainty by investing in prevention. Figure 2.1 presents the compound ambiguous and risky lottery.

It is important to notice that a recently published psychology study has shown that optimism is positively correlated with general confidence in the context of environmental uncertainty and threat ([Keller et al., 2011](#)). Other studies reveal a strong correlation between social trust and perceived risks for people who lacks knowledge about a hazard ([Siegrist and Cvetkovich, 2000](#); [Wachinger et al., 2013](#)).

In our setting this would indicate that the higher the potential injurer's degree of optimism, the higher is her degree of confidence. In the following subsections, we are comparing the results in a risky with an ambiguous environment fogged r both regimes, unlimited and limited liability.

2.3.1 Private optima and ambiguity

The potential injurer's objective remains to maximize her expected net profit and the expected costs caused by engaging in a risky, but now also ambiguous activity. Let us recall that the level of compensation paid by the potential injurer in the state "accident" is $d = 0$ (respectively $d = \hat{d} < l$, $d = l$) when no liability (respectively strict but limited liability, strict and unlimited liability) holds for the potential injurer.

Strict and unlimited liability

Under strict and unlimited liability, the potential injurer computes the following program:

$$\begin{aligned} \max_x \quad & \delta[\pi(x)(b - x - l) + (1 - \pi(x))(b - x)] \\ & + (1 - \delta)[q(\alpha, x)(b - x - l) + (1 - q(\alpha, x))(b - x)] \end{aligned}$$

After simplifying, we obtain the following program:

$$\max_x \quad b - x - [\delta\pi(x) + (1 - \delta)q(\alpha, x)]l \tag{2.6}$$

Proposition 2 *Let us assume that the potential injurer is a NEO-EU maximizer*

- i) If her belief about the accident state in the non-confident scenario is independent of her level of prevention, then she always invests less in prevention than in the risky, but non ambiguous environment. Formally if $q_x = 0$ then $x_{UL}^{amb} < x_{UL}^P = x^S$.*
- ii) If $q_x < 0$, the potential injurer invests more in prevention than the social optimum if the probability of accident announced by the regulator is less sensitive to prevention than her own subjective belief. This result holds whatever her degree of confidence in the regulator's announcement. Formally we have $x_{amb}^{UL} \leq x^S$ iff $|\pi'(x^S)| \geq |q_x(\alpha, x^S)|$, $\forall \delta < 1$.*
- iii) The more optimistic the potential injurer, the higher (lower) her private level of prevention if and only if $q_{x\alpha} < 0$ (> 0).*

Proof. See Appendix A. ■

Point i) is rather immediate. It fits with the framework proposed by [Teitelbaum \(2007\)](#), [Chakravarty and Kelsey \(2016\)](#) and [Mondello \(2013\)](#): the subjective belief

of the potential injurer is not affected by prevention. Thus the only probability that matters is the preliminary one π . As the impact of prevention on this probability π is only considered with a degree of confidence $\delta < 1$, the marginal benefit of prevention is lower than in the preceding case with risk but without any ambiguity. Thus in this setting, the private level of prevention is always lower than the social one obtained with risk while the marginal cost of prevention remains unchanged.

Point ii) is far more interesting for it considers also the possibility for the potential injurer to control her personal and subjective belief by investing in prevention. We deem that if the potential injurer can influence the preliminary objective probability π , then she also believes that she can influence her subjective belief q .

The level that the potential injurer will invest in optimum depends on the relative efficiency of prevention on the probability $\pi(\cdot)$ and the weight $q(\alpha, \cdot)$. Two important points shall be noticed. First, the fact that the potential injurer invests either more or less in prevention than the social optimum does not depend on her degree of confidence δ . Indeed even if the potential injurer is highly confident (high δ) in the announcement π made by the regulator she will underinvest in prevention if her personal belief q (considered with a degree of confidence $1 - \delta$) is relatively insensitive to prevention. The explanation is straightforward: In the first scenario the announcement of π made by the regulator is considered as identical to the scenario under risk. Thus this first scenario yields the same unit marginal benefit and unit marginal cost as in the situation with risk. The changing point is that a second scenario emerges in the ambiguity case: The possibility that the potential injurer considers simultaneously a subjective belief q of accident. In this second scenario, she compares the sensitivity of q to x with the sensitivity of π to x whatever her degree of confidence over this second scenario.

The second important point that shall be noticed deals with the optimal private level of prevention. In the ambiguous case, the potential injurer may overinvest in prevention compared to the social level under unlimited liability, whenever she believes that she is able to better control "her" probability q through prevention than the regulator does with π . It seems amazing to consider that a character trait, like optimism, can have an impact on the sensitivity of a probability or a weight, here the accident weight $q(\cdot, \cdot)$. Now recall that $q(\cdot, \cdot)$ is a subjective belief built by the potential injurer. Hence it seems actually fair to consider that an optimistic

individual may not only relativize the risk of accident (by considering, for instance, a small weight q on the accident state), but also believes that she can have some control on it. This can be illustrated by a function q that satisfies $q_{x\alpha} < 0$. The more optimistic the potential injurer the higher is her belief about her ability to control the (subjective) probability of accident through prevention. In such a setting we obtain a higher level of prevention from an optimistic injurer⁹.

Strict but limited liability

Now let us consider strict but limited liability in the NEO-EU model. Recall that we have denoted $W_{LL}^P = b - x - d$ as the worst realization of wealth for the potential injurer and $W_0^P = b - x$ as the best one (no accident). Under limited liability, we have $\widehat{d} = b - x < l$ and $W_{LL}^P = b - x - \widehat{d} = 0$. The potential injurer's maximization program writes

$$\begin{aligned} \max_x \quad & \delta[\pi(x)W_{LL}^P + (1 - \pi(x))W_0^P] + (1 - \delta)[q(\alpha, x)W_{LL}^P + (1 - q(\alpha, x))W_0^P] \\ & = [(1 - \delta)(1 - q(\alpha, x)) + \delta(1 - \pi(x))](b - x) \end{aligned} \quad (2.7)$$

In this expected wealth, only the no accident state matters since no wealth is available in the accident state: all the assets are confiscated for compensation such as previously in the risky environment. The total expected wealth $E(\widetilde{W}_{LL}^{amb}(x))$ corresponds to the sum of the expected wealth considered both in the first scenario (confident scenario) and in the second one (non-confident scenario). Consider the following notation:

$$j(\alpha, \delta, x) = (1 - \delta)(1 - q(\alpha, x)) + \delta(1 - \pi(x)) \quad (2.8)$$

Function $j(x)$ plays the role of a synthetic weight put by the potential injurer on the no-accident state. It depends on the personal trait such as α , personal beliefs δ and individual decision x . Recall that under risk, only limited liability may yield such a result. For an interior solution x_{LL}^{amb} and with $\widehat{d}(x) = b - x$, the first-order-condition

⁹Let us still notice that the coefficient α is also seen in some models as the parameter that measures the attitude toward ambiguity: pessimism (low α) is related to ambiguity aversion. If such an interpretation were considered in our model, it would mean that ambiguity-averse injurers invest less in prevention.

of Program (2.7) is:

$$j_x(\alpha, \delta, x_{LL}^{amb}) \widehat{d}(x_{LL}^{amb}) = j(\alpha, \delta, x_{LL}^{amb}) \quad (2.9)$$

Now, let us compare this first-order-condition with the one that prevails under risk, which is with (2.5). It writes:

$$|\pi'(x_{LL}^P)| \widehat{d}(x_{LL}^P) = 1 - \pi(x_{LL}^P) \quad (2.10)$$

In both first-order-conditions, the left-hand-side term is the expected marginal benefit of prevention, while the right-hand-side term is the expected marginal cost of prevention. In both cases, the expected marginal cost of a one unit expense is no longer one. Indeed, this one unit expense impacts the available wealth of the potential injurer only in the no accident state, which occurs with probability $(1 - \pi(x))$ in the risky situation, while it is weighted by the subjective synthetic weight $j(\alpha, \delta, x)$ in the model with ambiguity. Thus, shifting from a risky to an ambiguous environment, the variation of the expected marginal cost of prevention depends simultaneously on the potential injurer's degree of optimism/pessimism α and her degree of confidence in the regulator's announcement. In the meantime, the expected marginal benefit in case of ambiguity is affected by the degree of confidence and the ambiguity attitude of the potential injurer, but not only. The efficiency of the prevention technology also matters. This is captured by $j_x(\alpha, \delta, x_{LL}^{amb})$ in (2.9) and by $|\pi'(x_{LL}^P)|$ in (2.10). Finally, several different configurations are at stake when considering the potential injurer's ambiguity attitude, the degree of confidence and the belief in her ability to control through prevention and the subjective probability of accident she built in the non-confident scenario.

Proposition 3 *Let us assume that a regime of limited liability holds and that the potential injurer is a NEO-EU maximizer.*

(i) *It is not possible to conclude about the optimal level of prevention under ambiguity compared to risk, whatever the agent's level of confidence and her degree of optimism, even though $j_x(\alpha, \delta, \cdot)$ and $|\pi'(\cdot)|$ can be ranked.*

Proof. See Appendix A. ■

This result reinforces Point (ii) of Proposition 2 presented in the model with risk: limited liability does not always restrict prevention. Many different cases are

possible. As it states, without constraining the design of the probability functions used in our model, we are not able to isolate a case as more plausible than another one (for instance, more prevention than the unlimited liability level).

Our results are different from those proposed by the existing literature on the efficiency of liability rules when the probability of accident is not perfectly known. Indeed [Chakravarty and Kelsey \(2016\)](#) finds that a pessimistic injurer will invest more than an optimistic injurer in prevention under (strict) unlimited liability because pessimism causes her to overweight the accident outcome. [Teitelbaum \(2007\)](#) shows that the potential injurer invests throughout less than what is socially optimal in prevention under (strict) unlimited liability. Our findings are more in line with [Mondello \(2013\)](#) who shows that the potential injurer can invest either less or more in prevention compared to the first best level of prevention under (strict) unlimited liability.

To illustrate this result, let us consider again a case from the nanoscience. The treatment of wastewater relies mostly on a so-called "Five-day biological oxygen demand" test¹⁰ and represents a desirable measurement in wastewater treatment processes. Unfortunately toxic substances and nanoparticles affect bacteria making this technique unsuitable for monitoring and control. [Bridgeman et al. \(2013\)](#) stress that the test has an uncertainty of 15-20% in result accuracy. Therefore, the industry frequently has to over treat wastewater to be sure that they comply with the technical standards.

2.4 Conclusion

This chapter delves into the efficiency of strict liability (unlimited and limited) on prevention incentives when risk and ambiguity are considered. We assert that the potential injurer, whose activities cause a risk of environmental disaster can reduce the probability of accident by investing in prevention. We use the Non-Extreme Outcome (NEO) expected utility model ([Chateauneuf et al., 2007](#)) to represent the potential injurer's beliefs and decisions. One novelty of our contribution is that we introduce a belief function built by the potential injurer depending on her degree of optimism and also on her investment in prevention in the model with ambiguity.

¹⁰It is a common and most widely used test to determine at the beginning and end of a five-day period concentration of organic matter in wastewater samples.

In the risky model, we demonstrate that limited liability does not always induce low prevention compared to unlimited liability. The bankruptcy threshold is endogenous in our model so that limited liability may induce the potential injurer to overinvest in prevention compared to the social optimum to save value on the potentially confiscated assets. One should bear in mind, though, that overinvestment in prevention does not mean that it is socially welfare improving. Thus, by reducing *ex ante* the probability of accident, she deteriorates the conditions of the *ex post* compensation. The results we obtain contrast the widespread conclusion on underinvestment.

Nevertheless, the central result of the unilateral accident model is that none of the results with risk hold when ambiguity matters. In particular, the potential injurer tends to overinvest in prevention whenever she believes that she is able to better control for her subjective belief on the accident state than the regulator does with the preliminary probability. This finding is in contrast with the results by [Teitelbaum \(2007\)](#) who shows that the potential injurer is always investing less in prevention compared to the social optimal level. This result holds for both unlimited and limited liability. Obviously, we are not able to conclude which liability regime might perform better when ambiguity is considered.

It is worth mentioning that neither [Teitelbaum \(2007\)](#), [Chakravarty and Kelsey \(2016\)](#), [Mondello \(2013\)](#) nor we have analyzed the situation in which the regulator is ambiguous about the objective probability of a potential environmental disaster. It might be worth to model such a situation where both, the regulator and the potential injurer face a decision in an ambiguous environment. Further research would help to fill this void.

As far as possible, no general policy conclusion can be recommended as these results give an ambiguous message. Until now, it remains complicated to argue whether limited liability is an effective tool in preventing large scale accidents. [Faure \(1995\)](#) already points out that the rule may lead to underdeterrence and does not adequately internalize the risks in the nuclear sector. This problem becomes even more complicated in an ambiguous situation. The debate continues on whether unlimited or limited liability might generate appropriate deterrence efficiency and compensation to the victim when new emerging technologies are at the stake. It is obvious that we need to provide a better understanding of these effects to design

effective policy with respect to the regulation of new emerging technologies.

Of course, it is very difficult to provide hard data on the performance of liability rules and therefore this issue might be further explored with the means of experimental economics. In particular, we need to elicit subject's degree of confidence and attitudes toward ambiguity to test the correlation between both variables. This might give us some relevant information about the sign of $q_{x\alpha}$. Furthermore, experimental economics shall help to go ahead in the analysis of the potential injurer's decision behavior when risk and ambiguity hold. We seek to test our theoretical predictions by conducting laboratory experiments. This will be demonstrated in the next chapter.

Appendix A

A.1 Proposition

A.1.1 Proof of Proposition 2

A partial derivation of (2.6) with respect to x yields the following first-order-condition for an interior solution x_{UL}^{amb}

$$1 = -[\delta\pi'(x_{UL}^{amb}) + (1 - \delta)q_x(\alpha, x_{UL}^{amb})]l \quad (\text{A.1})$$

If $q_x(\alpha, \cdot) = 0$, it reduces to $1 = -\delta\pi'(x^S)l$. With $\delta < 1$, comparing this equality with (2.2) yields Point i).

If $q_x(\alpha, \cdot) < 0$, then the right-hand-side term of (A.1) may be either lower or higher than $-\pi'(x^S)l$. More precisely, when comparing the social marginal benefit $-\pi'(x^S)l$ obtained with risk with the private marginal benefit under ambiguity $-[\delta\pi'(x_{UL}^{amb}) + (1 - \delta)q_x(\alpha, x_{UL}^{amb})]l$, we obtain that:

$$\begin{aligned} x_{UL}^{amb} \leq x^S &\Leftrightarrow (1 - \delta) \left[\pi'(x^S) - q_x(\alpha, x^S) \right] \leq 0 \\ &\Leftrightarrow |q_x(\alpha, x^S)| \leq |\pi'(x^S)| \end{aligned}$$

This is Point ii). Now write (A.1) as follows:

$$\frac{\partial W_{amb}^P}{\partial x} = -1 - [\delta\pi'(x_{UL}^{amb}) + (1 - \delta)q_x(\alpha, x_{UL}^{amb})]l = 0 \quad (\text{A.2})$$

Point iii) is obtained thanks to a total differentiation applied to (A.2) with respect to x and to α . We have:

$$\frac{dx_{UL}^{amb}}{d\alpha} = \frac{l(1 - \delta)q_{x\alpha}}{\frac{\partial^2 W_{UL}^{amb}}{\partial x \partial x}}$$

The denominator corresponds to the expression of the second order condition. With $\pi_{xx} > 0$ and $q_{xx} \geq 0$ by assumptions, there are satisfied so that $\frac{\partial W_{UL}^{amb}}{\partial x \partial x} < 0$. The numerator is strictly positive (strictly negative, equal to zero) if and only if $q_{x\alpha} > 0 (< 0, = 0)$. Hence we obtain Point iii). Proposition 2 is demonstrated. \blacklozenge

A.1.2 Proof of Proposition 3

Let us subtract the first-order-condition under risk and limited liability (2.10) from the first-order-condition under ambiguity and limited liability (2.9), and let us evaluate this difference at point x_{LL}^P . We have

$$[(j_x(\alpha, \delta, x_{LL}^P) - |\pi'(x_{LL}^P)|)]\widehat{d}_{LL}^P \geq j(\alpha, \delta, x_{LL}^P) - (1 - \pi(x_{LL}^P)) \Leftrightarrow x_{LL}^{amb} \geq x_{LL}^P \quad (\text{A.3})$$

The left-hand-side term in (A.3) is the difference between the expected marginal benefits under risk and under ambiguity evaluated at the private risky optimum x_{LL}^P , while the right-hand-side term is the difference in the expected marginal costs. Let us denote the former as ΔB and the latter as ΔC .

By assumption for $\alpha \geq 0.5$, we have $j(\alpha, \delta, 0) - (1 - \pi(0)) > 0$. If $j_x(\alpha, \delta, x) < |\pi'(x)|$ for any x , then we are not able to conclude about the sign of $j(\alpha, \delta, x_{LL}^P) - (1 - \pi(x_{LL}^P))$. By assumption for $\alpha < 0.5$ we have $j(\alpha, \delta, 0) - (1 - \pi(0)) < 0$ and the same problem holds if $j_x(\alpha, \delta, x) > |\pi'(x)|$ for any x . Proposition 3 is demonstrated. \blacklozenge

A.2 Assuming risk aversion

We assume that the potential injurer's preferences are characterized by a utility function $U(W)$ ascertained to be strictly increasing and concave (with $U'(W) > 0$ and $U''(W) < 0$). In the next subsections, we provide the results about the efficiency of (strict) unlimited liability and limited liability in a risky and ambiguous environment by supposing that the potential injurer is risk-averse.

The regulator is assumed to be risk-neutral and his program writes

$$\max_x \quad b - \pi(x)l - x \quad (\text{A.4})$$

Since b is exogenous in the model and is independent of the prevention level x ,

this program is equivalent to the following cost minimization program:

$$\min_x \quad EU(\tilde{C}^S) = \pi(x)l + x \quad (\text{A.5})$$

For an interior solution, the social optimum level x^S that shall be enforced by the regulator satisfies:

$$-\pi'(x^S)l = 1 \quad (\text{A.6})$$

Now we consider the private decision taken by the potential injurer under unlimited then limited liability under risk.

A.2.1 Private optimum when strict and unlimited liability holds

A potential injurer is forced under strict and unlimited liability to internalize the full expected cost of accident. Hence, her private program writes

$$\min_x \quad \pi(x)U(l) + U(x) \quad (\text{A.7})$$

Supposing that the potential injurer is risk-averse does not change the principal results. Thus, the optimal private level of prevention x_{UL}^P equal the social one x^S .

A.2.2 When the *ex post* potential injurer's liability is limited to her net value

Under limited liability, the payment is limited to the net value of the potential injurer which cannot be negative under this regime. While assuming that the potential injurers is risk-averse and that strict but limited liability holds, thus she considers the following program

$$\begin{aligned} \max_x \quad & (1 - \pi(x))U(W_0^P) \\ & = (1 - \pi(x))U(\hat{d}(x)) \end{aligned} \quad (\text{A.8})$$

With $U(\hat{d}(x)) = U(b - x)$, the first-order-condition of program (A.8) for an interior solution x_{LL}^P is:

$$-\pi'(x_{LL}^P)U(\hat{d}(x_{LL}^P)) = U'(x_{LL}^P) - \pi(x_{LL}^P)U'(x_{LL}^P) \quad (\text{A.9})$$

The results in section 2.2 still hold under the assumption of risk aversion. In the next subsection, we consider the case when the risk about the probability of an accident is not perfectly known.

A.2.3 Private optima under strict and unlimited liability suited to ambiguity

The potential injurer's objective still remains to maximize her expected net profit and the expected costs in a risky and ambiguous environment. Under strict and unlimited liability, the potential injurer computes the following program:

$$\begin{aligned} \max_x \quad & \delta[\pi(x)U(b-x-l) + (1-\pi(x))U(b-x)] \\ & + (1-\delta)[q(\alpha, x)U(b-x-l) + (1-q(\alpha, x))U(b-x)] \end{aligned}$$

After simplifying, we obtain the following program:

$$\max_x \quad U(b-x) - [\delta\pi(x) + (1-\delta)q(\alpha, x)]U(l)$$

The first-order-condition of program (A.10) for an interior solution x_{UL}^{amb} is

$$U'(x_{UL}^{amb}) = -[\delta\pi'(x_{UL}^{amb}) + (1-\delta)q_x(\alpha, x_{UL}^{amb})]U(l) \quad (\text{A.10})$$

The results of proposition 2 still hold while supposing that the potential injurer is risk-averse.

A.2.4 Private optima under strict but limited liability suited to ambiguity

While assuming that the potential injurer is risk-averse and we consider strict but limited liability in an ambiguous environment, thus her maximization program writes

$$\max_x [(1-\delta)(1-q(\alpha, x)) + \delta(1-\pi(x))]U(\hat{d}(x)) \quad (\text{A.11})$$

where $U(\hat{d}(x)) = U(b-x)$. We consider the notation $j(\alpha, \delta, x)$ of section 2.3,

thus for an interior solution x_{LL}^{amb} , the first-order-condition of program (A.11) is

$$j_x(\alpha, \delta, x_{LL}^{amb})U(\widehat{d}(x_{LL}^{amb})) = j(\alpha, \delta, x_{LL}^{amb})U'(\widehat{d}(x_{LL}^{amb})) \quad (\text{A.12})$$

While assuming that the potential injurer is risk-averse and comparing A.12 with A.9 the principal results obtained in section 2.3. do not change. Thus, we can conclude that the proposition 3 holds for a risk-neutral and risk-averse injurer.

Chapter 3

Evidence from Laboratory

Experiments¹

¹This chapter has been published to a large extent as BETA Working 2016-30 co-written with Kene Boun My and Sandrine Spaeter, entitled "Risk, Ambiguity and Efficient Liability Rules: An Experiment" and partly as BETA Working Paper 2016-22 co-written with Kene Boun My, entitled, "Sharing is caring- Is this always true? A note on sharing gains and losses in the modified dictator game. Interested readers can find the instructions in English, the data of the experiments and the R code and Stata file on my personal website: <https://sites.google.com/site/nicolaslampach/home>.

3.1 Introduction

The main purpose of this chapter is to assess the theoretical predictions obtained in chapter 2 by conducting laboratory experiments. The contributions of behavioral studies related to tort law are increasing and of particular significance for the tort system to convey better understandings of decision and choice. [Sunstein \(1997\)](#) argues that rational choice models are often wrong and sensitive to cognitive errors resulting in inaccurate predictions. Economists and policymakers are questioning the standard assumption that people act rationally, so make decisions that are in their own best interests. This has conceivably led to suboptimal policies being implemented during recent years ([Bewley, 2003](#)). Literature concerning decision making in an interpersonal context has been growing fast in recent years. Evidence from experimental studies stresses that people do not act solely in their own best interests, but rather are willing to sacrifice personal gain to avoid inequity ([Fehr and Schmidt, 1999](#); [Heinrich and Weimann, 2013](#)).

The aim of this chapter is twofold. First, we discuss the contribution of laboratory experiments to test the theoretical predictions of chapter 2. Additionally, we explore the underlying determinants influencing the decision choice to invest in prevention. Second, we use data from between-subject design to seek whether subject's reaction to advantageous inequity aversion differ in the domains of gains and losses. We compare advantageous inequity aversion according to [Fehr and Schmidt \(1999\)](#) model in the domains of gains and losses.

As previously described in chapter 1, experimental studies on law and economics ([Kornhauser and Schotter, 1990](#); [King and Schwartz, 2000](#); [Koch and Schunk, 2013](#); [Angelova et al., 2014](#); [Pannequin and Ropaul, 2016](#)) are scarce in the field of behavioral economics. Our laboratory experiment is close to [Angelova et al. \(2014\)](#) who study the effect of liability rules for managing environmental disaster. The two main differences between our experimental framework and theirs are that we introduce ambiguity and focus on the strict liability rule (unlimited and limited). Besides, we include a framing effect by allowing for the occurrence of potential negative payoffs during the different tasks which however will be compensated at the end of the experiment by a show-up fee. To the best of our knowledge, this is the first experiment that examines the performance of strict but limited liability in an ambiguous environment.

As a part of the laboratory experiment, we adopt the modified dictator game (MDG hereafter) according to [Blanco et al. \(2011\)](#) to elicit subjects' advantageous inequity aversion in the domain of losses ([Zhou and Wu, 2011](#)). Since data is available for an identical sample which was performing exactly the same task to elicit advantageous inequity aversion in the domain of gain, we seek whether individuals behave systematically differently when facing potentially negative payoffs. We believe that it is vital to discuss this topic as it attracts more and more attention by researchers in behavioral and experimental sciences ([Fehr and Fischbacher, 2003](#); [Heinrich, 2004](#); [Blanco et al., 2011](#); [Zhou and Wu, 2011](#); [McAuliffe et al., 2013](#)).

First, in line with theory, our experimental results show that underinvestment in prevention under limited liability in the domain of risk does not systematically occur. We provide empirical evidence that individuals invest on average higher levels of investment in prevention under the regime of limited compared to unlimited liability in the domain of risk. It also appears from this research that subjects invest on average higher levels of investment under unlimited liability, but however invest on average lower levels of investment under limited liability in the domain of ambiguity compared to risk. Still different from what we would have expected, the subject's degree of optimism does not affect the decision choice. Finally, we find strong evidence related to inequity aversion, fairness and risk preferences.

Second, we demonstrate that individuals react more strongly to advantageous inequity, meaning that individuals experience a stronger reaction to inequity in the domain of losses than in the domain of gains.

The remainder of this chapter is organized as follows. Section [3.3](#) outlines the experimental design and procedures. Section [3.4](#) presents the empirical results by comparing the different treatments through non-parametric statistical tests. Moreover, we summarize the results of panel data estimation. Section [3.5](#) compares the elicitation of advantageous inequity aversion in the domains of gains and losses. Section [3.6](#) concludes and discusses several limitations of the chapter. Additional tables and figures, the set of instructions and the questionnaire can be found in the appendices [B.1](#), [B.2](#) and [B.3](#).

3.2 Economic Theory and Predictions

We consider the theoretical predictions given by chapter 2 in which the activity of a party involves a risk of accident. Recall that two regimes are at stake. Under the regime of unlimited liability, the injurer has to pay *ex post* for all the damage caused by her activity whatever her level of prevention and her level of assets. Under the regime of strict but limited liability, the injurer's compensation payment is limited to her net value, which can never be negative; otherwise the firm enters into bankruptcy. In what follows, we consider a risky - and subsequently an ambiguous activity. We follow the theoretical predictions given by chapter 2 and are formulating the necessary number of hypotheses to be tested.

In summary, the economic theory predicts rather ambiguous results in the domain of ambiguity, but as well as in risk. We are particularly interested in some specific cases under certain conditions for which we need to adjust the parameters of our experimental design to test the following hypotheses of chapter 2.

HYPOTHESIS 1:. *Under limited liability, a potential injurer will invest more in prevention than under unlimited liability in the domain of risk (Proposition 1 (i)).* Hence, we test this theoretical prediction that a potential injurer will invest on average higher levels of investment in prevention under limited liability compared to the social optimal level.

HYPOTHESIS 2:. *Under unlimited liability, a potential injurer will invest more in prevention in the domain of ambiguity than in the domain of risk (Proposition 2 (ii)).* We test this theoretical prediction under some specific conditions while setting the parameters of the experiment to satisfy the required condition.

HYPOTHESIS 3:. *Under limited liability, a potential injurer will invest more in prevention in the domain of ambiguity than in the domain of risk (Proposition 3).* As the result is ambiguous, we cannot even test a theoretical prediction under specific condition. As a consequence, we claim that the potential injurer will invest on average higher levels of investment under limited liability in the domain of ambiguity compared to risk.

HYPOTHESIS 4:. *Under ambiguity, an optimistic injurer will invest more in prevention than a pessimistic injurer (Proposition 2 (iii)).* We test this theoretical prediction under some condition while adjusting our parameters to satisfy the re-

quired condition.

Furthermore, we aim to identify the underlying determinants (advantageous inequity aversion, risk aversion, ambiguity aversion, degree of optimism and degree of confidence) affecting the decision choice to invest in prevention. In the next section, we are introducing the general structure of the laboratory experiment.

3.3 Experiment

In this section, we present the procedures of the experiment (subsection 3.3.1) and the experimental design (subsection 3.3.2).

3.3.1 Procedure

We conduct two sessions per treatment and run a total of 8 sessions², with 20 subjects in each session, in the Economic Experimental Laboratory at the University of Strasbourg (France). The subject pool consists of 160 undergraduate students from the University of Strasbourg which participate in November 2015 in the experiment. Subjects are recruited through ORSEE³. We are also interested in whether subjects have an economic background. Out of those taking part in the sessions, the majority (70%) study a quantitative subject such as Economics, Chemistry, Biology, Life Sciences, Engineering or Mathematics while others study a non-quantitative subject such as Psychology, Political Science, History or Language. All experiments are run on personal computers and the experiment is programmed in *EconPlay*⁴.

The payoffs are denominated in a fictitious currency called Experimental Currency Unit (ECU) for Task 4 and convert into euros at the end of the experiment at rate known by subjects. On average subjects earn €26 and the experiment lasts a maximum of 1 hour and 15 minutes, excluding payment.

Subjects arrive at the laboratory and are randomly assigned to a cubicle. In total, subjects receive four sets of instructions⁵ consecutively. Subjects are allowed to read the instructions by their own pace and are also read aloud by an experiment

²We have four treatments and repeat each one twice.

³A web-based Online Recruitment System for Economic Experiments developed by Greiner (2015).

⁴The program of this experiment has been designed by Kene Boun My with the web platform EconPlay (www.econplay.fr).

⁵Experimental protocols can be found in Appendix B.2.2.

administrator. Subjects have the opportunity to ask questions and the administrator answers any question individually. The experiment administrator ensures that everyone has understood the four different tasks. The corresponding computer screen is displayed and subjects submit their decisions. Once all participants have entered their decisions in for each task, the instructions for the following task are distributed. Upon completion of the fourth instruction task, subjects answer clarifying questions⁶.

3.3.2 Experimental design

We run four different games for the same sample size of experimental subjects and employ a between subject design. The experiment comprises two parts. The first part of the experiment encompasses three distinct tasks to elicit subject's attitudes toward advantageous inequity, risk and ambiguity. The second part of the experiment features the main experiment. Finally, we discuss several features and limitations of the experimental design.

Task 1 - Elicitation of advantageous inequity aversion

We employ the MDG to elicit subjects advantageous inequity aversion based on Fehr and Schmidt's (1999) in the domain of losses (Zhou and Wu, 2011). We refer to inequity aversion in the sense that individuals do not only care about their own payoffs, but also care about other's payoffs. Advantageous inequity implies the decision whether to harm another individual. As experimental studies have shown that the self-interested utility maximizer behavior is not compatible with the traditional economic assumptions in the dictator game (Kahneman et al., 1986; Forsythe et al., 1994; Blanco et al., 2011), thus we include the inequity aversion parameter in the experimental setting. Furthermore, we deem that the integration of the parameter allows to better understand the results and to control for possible other-regarding preferences of individuals.

The MDG is introduced by Andreoni and Miller (2002) and subsequently adopted by Blanco et al. (2011). In the experiment the dictator (Player A) has to decide about how much of the initial amount he is willing to sacrifice to Player B (advantageous inequity aversion) to attain an equal distribution of payoffs (Andreoni and

⁶Subjects complete a quiz comprising in total 10 questions. Four out of the ten questions refer to the calculation of the earnings.

Miller, 2002; Blanco et al., 2011). All subjects initially undertake the first task and are presented with a list of 10 pairs of payoff vectors. They have to choose sequentially one of the two payoff vectors of the corresponding line. Table 3.1 illustrates the modified dictator game to elicit subject's degree of advantageous inequity aversion. Subjects receive an endowment of €10 to compensate potential losses. The left payoff vector⁷ is always (€0;€-10) and the right payoff vector contains equally payoffs varying from (€-10,€-10), (€-9,€-9) throughout to (€0,€0). We need to emphasize that we set the first and last decision line to suppress inconsistent choices. For instance, in the first decision line, player A prefers option "Left" over option "Right" according to Fehr and Schmidt's (1999) model. Similar, player A prefers option "Right" over option "Left" in regard to the inequity model. Each subject makes a choice as the role of the dictator (Player A). At the end of the experiment, subjects are randomly assigned to player A or player B and one of the 10 payoff vector pairs is randomly chosen by the computer to determine the payment.

Table 3.1: Eliciting subject's advantageous inequity aversion by applying the modified dictator game

Decision	Option Left	Option Right	Your choice (circle left or right)
1	(€0,€-10)	(€-10,€-10)	Left or Right
2	(€0,€-10)	(€-9,€-9)	Left or Right
3	(€0,€-10)	(€-8,€-8)	Left or Right
4	(€0,€-10)	(€-7,€-7)	Left or Right
5	(€0,€-10)	(€-6,€-6)	Left or Right
6	(€0,€-10)	(€-5,€-5)	Left or Right
7	(€0,€-10)	(€-4,€-4)	Left or Right
8	(€0,€-10)	(€-3,€-3)	Left or Right
9	(€0,€-10)	(€-2,€-2)	Left or Right
10	(€0,€-10)	(€-1,€-1)	Left or Right
11	(€0,€-10)	(€0,€0)	Left or Right

⁷The vector contains player A and player B's payoff.

Task 2 & 3 - Elicitation of risk and ambiguity aversion

According to [Chakravarty and Roy \(2009\)](#), we apply the multiple price list ([Holt and Laury, 2002](#)) in the domain of losses to elicit subject's attitudes toward risk (Task 2) and ambiguity (Task 3). Before starting with the task, subjects are asked to choose the color blue or yellow (the chosen color constitutes the winning color and remains the same for the subsequent tasks). In task 2 (Risk task) and task 3 (Ambiguity task), subjects are provided with a series of binary choices in the domain of losses. Table 3.2 depicts the multiple price list to elicit subject's attitudes toward risk and ambiguity. Each task table comprises 2 options (Left or Right) for a path of 10 decisions. The option "Right" is represented by losing a sure amount of money varying between €-10, €-9 all the way to €0. The option "Left" in the domain of risk (Risk task) is captured by losing with known probability (one in two chance) €0 or €-10. In the domain of ambiguity (Ambiguity task), the option "Left" is sketched by losing with unknown probability €0 or €-10.

Table 3.2: Eliciting subject's risk and ambiguity aversion by applying multiple price list

	Option Left	Option Right	Option Right	Your choice
	If you pick the color you chose above	If you pick the color you did not chose above		
1	€0	€-10	€-10	Left or Right
2	€0	€-10	€-9	Left or Right
3	€0	€-10	€-8	Left or Right
4	€0	€-10	€-7	Left or Right
5	€0	€-10	€-6	Left or Right
6	€0	€-10	€-5	Left or Right
7	€0	€-10	€-4	Left or Right
8	€0	€-10	€-3	Left or Right
9	€0	€-10	€-2	Left or Right
10	€0	€-10	€-1	Left or Right
11	€0	€-10	€0	Left or Right

Risk Task: The urn contains 50 YELLOW and 50 BLUE BALLS

Ambiguity Task: The urn contains 0 YELLOW - 100 BLUE BALLS or 100 YELLOW - 0 BLUE BALLS

Subjects are instructed to report their risk and ambiguity preferences by choosing sequentially one of the two options, Left and Right, for the course of the 10 decision choices. Similar, we set the first and last decision line to suppress inconsistent choices. For instance, in the first decision line, subjects prefer option "Left" over option "Right" as well as subjects prefer option "Right" over option "Left".

Task 4 - Main Experiment

According to [Angelova et al. \(2014\)](#), the experiment consists of MDG, in which subjects face individual decisions for a sequence of ten rounds. In the fourth task, we apply four distinct treatments in the experiment. Table 3.3 briefly sketches the different treatments. They differ in the liability regime (UL, LL) and in the presence of risk (RK) and ambiguity (AMB).

Table 3.3: Treatment

	Strict and unlimited liability	Strict but limited liability
Risk	RK-UL	RK-LL
Ambiguity	AMB-UL	AMB-LL

Recall that both liability regimes differ in whether the injurer could fully (UL) or partially (LL) compensate the victim. At the beginning of the ten rounds, subjects are randomly assigned to roles (X and Y) and X-Y⁸ pairs. In line with [Angelova et al. \(2014\)](#), one can think of player X as the potential injurer and player Y as the victim. During the 10 rounds, player Y is affected by the decision of player X but cannot anticipate (stays passive). Subjects face individual decisions in a non-strategic set-up. Hence, we re-compose randomly the groups for each round so that the probability of being re-matched with the same person is exactly zero⁹. All subjects decide as if they would be assigned to role X.

In each of the 10 rounds, with a probability of $\pi(x) = \frac{(a-x)}{(b+x)}$ in the RK and $q_i(\alpha, x) = \frac{a_i-x}{b_i+x^{2\alpha}}$ with $i = A, B, C, D, E$ in AMB treatment, an event would occur and lead to a loss of endowment by both, X and Y. In this way, we specify five different probability functions based on the variation of the parameter a and b and presenting them to the subjects, named as "Urn A", "Urn B", "Urn C", "Urn

⁸To avoid a framing effect, we intentionally name both roles differently than those in Task 1.

⁹[Morton and Williams \(2010, p230\)](#) define perfect stranger matching as "in which researchers make sure that subjects always face a new set of other players and the contamination from previous play is not possible".

D" and "Urn E". Note that we are determining the parameter $a = 98$ and $b = 113$ in RK treatment. For the AMB treatment, we determine $\alpha = 0.5$ (degree of optimism/pessimism), $a_i = 104, 101, 98, 95, 92$ and $b_i = 107, 110, 113, 116, 119$.

According to [Attanasi et al. \(2014\)](#), we use a two-stage lottery to represent ambiguity to subjects. In the first stage, the 100-ball small urn is generated from an opaque big urn containing 100 small urns of urn A, urn B, urn C, urn D and urn E in an unknown composition. We randomly draw one 100-ball small urn from the big urn. In the second stage, we randomly pick one ball from the drawn urn comprising 100 balls of blue and yellow balls in a precisely known composition.

At the beginning of Task 4, subjects receive the information that "Urn C" will have a higher chance to be drawn than the other four urns. Nevertheless, the information does not have any effect on the five different probability/urn configurations. Subjects were free to believe whether the supplementary information is true or not. We introduce this information due to the theoretical framework given in chapter 2, in which we are modelling ambiguity with NEO expected utility model. Recall that an injurer in an ambiguous environment believes with a certain degree of confidence that the probability announced by the regulator will be the true one. Hence, this requires us to add additional information to adjust our experimental design to the theoretical model. In overall one probability configuration in RK and five probabilities in AMB treatment are at the issue.

We provide subjects in the RK treatment with an easily understandable payoff table. In AMB treatment, we supply subjects with a simulator, which returns the number of balls of their chosen color in the urns and payoffs of player X and Y according to the amount of investment. Furthermore, we explain to the subjects that payoffs in each round will depend on two random draws.

Player X is endowed with two pockets. It is such as if the potential injurer's *partner* pocket is endowed by the shareholder's capital, which is protected under limited liability (but not under unlimited liability) and the *benefit* pocket is endowed by the benefit from the production of a new innovative product.

Table 3.4 indicates the initial endowment of player X and Y for the different treatments.

Table 3.4: Endowment

	Strict and unlimited		Strict but limited	
	Partner pocket*	Benefit pocket	Partner pocket*	Benefit pocket
X : The potential injurer	100 ECU	80 ECU	100 ECU	80 ECU
Y : The potential victim	90 ECU		90 ECU	

*Note: Experimental Currency Unit (ECU); *: Show-up fee*

Subject X receives a one-time show up fee of 100 ECU which compensates potential losses. During each round, subject X receives an endowment of 80 ECU and subject Y receives an endowment of 90 ECU. Note that 10 ECU worth 1 Euro. In case an event occurs the victim will face a loss of her entire wealth but will be compensated by the injurer. Under UL treatment, subject X will have to fully compensate the victim (Player X 's payoff can be negative). Under LL treatment, subject X can solely compensate subject Y up to their net endowment (Endowment minus investment cost). In this case, player X 's payoff cannot be negative. In each round subject X is asked to decide whether she wants to reduce the probability of an event by investing the amount of 0, 20, 40, 60 or 80 ECU. In the RK and AMB treatment, it is explained to subjects that a higher amount of investment will cause that a higher number of balls of their chosen color (winning color) will be in the urn (See Appendix B.1.1 for more details). Table 3.5 sketches player X and Y 's payoffs for unlimited and limited liability in the domains of risk and ambiguity.

Table 3.5: Payoffs

Unlimited Liability	Decision choice				
	0 ECU	20 ECU	40 ECU	60 ECU	80 ECU
Winning color	(80; 90)	(60; 90)	(40; 90)	(20; 90)	(0; 90)
Other color	(-10; 90)	(-30; 90)	(-50; 90)	(-70; 90)	(-90; 90)

Limited Liability	Decision choice				
	0 ECU	20 ECU	40 ECU	60 ECU	80 ECU
Winning Color	(80; 90)	(60; 90)	(40; 90)	(20; 90)	(0; 90)
Other color	(0; 80)	(0; 60)	(0; 40)	(0; 20)	(0; 0)

Note that: Player X and Y's payoffs are given in parentheses

Furthermore, subjects respond to a detailed post-questionnaire¹⁰ consisting of 44 questions related to socio-economic status, altruism and risk preferences. Furthermore, we aim to gauge information about subject's fairness, confidence, optimism and trust preferences by using questions from psychology literature. More precisely, subjects are asked to express their agreement with 8 items regarding subject's fairness preferences according to the belief in justice world scale (Lucas et al., 2013). The first set of questions refers to subject's fairness preferences with respect to others (Distributive Justice for Others) and next set of questions with respect to themselves (Distribute Justice for Self). Subjects were asked to express their agreement on a 7-point Likert-type scale ranging from 1 (Strongly Agree) to 7 (Strongly Disagree). Furthermore, we ask subjects to express their level of confidence (Keller et al., 2011), optimism (Wimberly et al., 2008; Vautier et al., 2003; Scheier and Carver, 1992) and trust¹¹ (Yamagishi, 1986; Yamgishi and Sato, 1986) using a value between 1 (Strongly Agree) to 5 (Strongly Disagree).

¹⁰See Appendix B.3 for details and further information about the post-questionnaire.

¹¹It is important to bear in mind that the referents of trust are characterized by agents and the referents of confidence are characterized by objects or systems (Keller et al., 2011). More explicitly, trust is associated with values and intentions and confidence is associated with performance (Rotter, 1967). We deem that both, confidence and trust are relevant measures to disentangle the degree of ambiguity.

Discussion of the design

We decide not to allow multiple switching¹² in task 1, task 2 and task 3. We are simply telling subjects directly that we are interested in the amount for which they switch from preferring to gamble (by playing the lottery) or to receive the sure amount of money. To suppress any order effects, we are modifying the sequence of task 2 and task 3. Subjects receive an endowment of € 10 for each of the three tasks to compensate potential losses. At the beginning of the first part of the experiment, we inform subjects that the computer randomly selects one decision for each of the three tasks.

In Task 4, we do not inform subjects until the end of the ten rounds about their role. We acknowledge that subjects could expect to have a one in two chance to be at the end of the experiment player Y. Accordingly, this might affect subject's behavior. In a trust game it appears that playing both roles has an effect on trust and reciprocity (Burks et al., 2003). Furthermore, Brandts and Charness (2011) review the literature whether the strategy method leads to different results. They conclude that more studies find no differences than studies that do. According to the literature, we decide to apply this well established design (Blanco et al., 2011; Angelova et al., 2014) owing to probe treatment effects. Moreover, this approach permits to increase the sample size and thus to enhance the predictive power of statistical tests and panel regression analysis. Furthermore, we decide to include repetition in this task. The main reason is due to the mainly complex representation of ambiguity to subjects. We fear that subjects would make random decision choices in an once repeated one-shot game, especially when they do not understand the game. We are of the opinion that in our case repetition amplifies the comprehension of the game, specifically for the ambiguity treatment.

In Task 4, we do not inform subjects until the end of the ten rounds about their role. We acknowledge that subjects could expect to have a one in two chance to be at the end of the experiment player Y. Accordingly this might affect subject's behavior. In a trust game it appears that playing both roles has an effect on trust and reciprocity (Burks et al., 2003). Furthermore, Brandts and Charness (2011) reviews the literature whether the strategy method leads to different results. They

¹²In the literature, there still lacks a compliance whether multiple switching may be indicative of indifference or whether subjects do not understand the task. For this reason, we decide to allow subjects to switch solely once (Vieider et al., 2015; Charness et al., 2013).

conclude that more studies find no differences than studies that do. According to the literature, we decide to apply this well established design (Blanco et al., 2011; Angelova et al., 2014) owing to probe treatment effects. Moreover, this approach permits to increase the sample size and thus to enhance the predictive power of statistical tests and panel regression analysis. Furthermore, we decide to include repetition in this task. The main reason for this was due to the mainly complex representation of ambiguity to subjects. Our fear was that in a once repeated one-shot game, subjects would make random decision choices when they do not understand the game. We are of the opinion that in our case repetition amplifies the comprehension of the game, specifically for the ambiguity treatment.

Furthermore, the novel aspects in our design are that we introduce a two pocket endowment and allow for potential losses being compensated at the end of the task. This is different from Angelova et al. (2014) as we include a framing effect that subjects could feel potential losses. Nonetheless, we are convinced that our experimental design captures a realistic depiction of both liability regimes by embedding a two pocket mechanism.

We implement a twofold feedback mechanism. First, during each round subjects are informed about their decision choice, whether their winning color has been drawn and the payoffs of player X and Y. Second, at the end of the 10 rounds, subjects are informed about their ten decision choices, whether their winning color has been drawn, the payoffs of player X and Y and the urn drawn in the case of AMB treatment¹³ and actual role.

We adopt the random payment incentive mechanism¹⁴ as payment method in this experiment. When subjects face a sequence of decision choices, the main problem is that earnings on the previous periods may influence behavior in the later periods. Davis and Holt (1993) propose to apply a random selection of the payment to control for wealth effects. Furthermore, if subjects know that they will be paid for a random round, thus they treat each decision with care (See for further detail Charness and

¹³We were not given any feedback information during each round about which small urn has been picked among the five to suppress any revision of subject's beliefs in the AMB treatment. Note that we omit to ask subject's beliefs about which ball will be drawn from the urn in each round. This information could be useful to explain subject's investment decision.

¹⁴It should be notice that presenting the choices together in a list may lead to inconsistent choices through violating the incentive compatibility of the random problem selection mechanism. A possible solution to circumvent the violation of the incentive compatibility assumption would be to present the decision choices separated and randomly to the subjects (?). In the first part of the experiment, we are mainly interested in the switching point. In our context, the list can be considered as one decision choice and thus we do not violate the incentive compatibility assumption.

Genicot (2009)). For instance, once subjects have made all their decisions, we have randomly chosen one subject to pick at random a number between 1 and 10 indicating the round of task 4 which will be paid out. After completing the questionnaire, subjects randomly choose one row of task 1, task 2, and task 3 for which they will be paid out. All random draws are independent from each other. We used the computer to simulate the draws in the four tasks.

3.4 Results

First, we will analyze in subsection 3.4.1 our hypothesis while comparing the investment in prevention under both liability regimes (unlimited and limited) and both domains (risk and ambiguity). Second, we compare our theoretical predictions (optimal level) with subject's actual decision choices. With respect to our theoretical framework, we grasp whether optimists are investing higher levels in prevention compared to pessimists. Third, we will discuss the "learning effect" which might affect subject's choices of investment in prevention. In subsection 3.4.2 we apply Random Effects Ordered Probit (REOP) estimation to analyze accurately which underlying determinants are affecting the investment in prevention. Finally, we perform in subsection 3.4.3 REOP estimation to analyze whether subject's investment behavior is affected by specific factors.

3.4.1 Empirical results

For a general overview of the results, Table 3.6 summarizes the descriptive statistics for the average investment in prevention within each treatment. We need to emphasize that we are running two sessions per treatment as a consequence we pool the data within each treatment.

Table 3.6: Aggregated (pooled) average investment per treatment

	Risk & Unlimited	Risk & Limited	Ambiguity & Unlimited	Ambiguity & Limited
Average investment (SD)	23.40 (12.46)	33.00 (11.25)	28.85 (11.30)	28.50 (12.46)

Note: With N=1600 observations

The results reported in Table 3.6 show that the average investment in prevention

is the highest under RK-LL, lower under AMB-LL, lower under AMB-UL and the lowest under RK-UL. In the following, we are performing nonparametric statistical tests to verify our hypotheses, further we compare the model predictions with observed choices and discuss potential learning effects.

Nonparametric statistics of the treatment effects

We investigate a one-tailed Kolmogorov-Smirnov (KS hereafter) test¹⁵ test to assess whether the differences in treatment are significant by comparing pairwise the cumulative distribution function of the average investment across treatments. We apply a bootstrap¹⁶ version of KS test to generate reliable results. To verify the robustness of the statistical test, we perform alternatively Mann-Whitney (MW hereafter) test.

¹⁵We are in favor of applying KS test due to the hypotheses which are not based in a measure of central tendency (mean, median). Besides, the hypotheses of the KS test essentially relate to the equality of the two distribution functions. For a review on non-parametric tests, see [Siegel and Castellan \(1988\)](#).

¹⁶Bootstrapping allows for robust estimation of sampling variances, standard errors and confidence intervals by resampling a given data set a specified number of times.

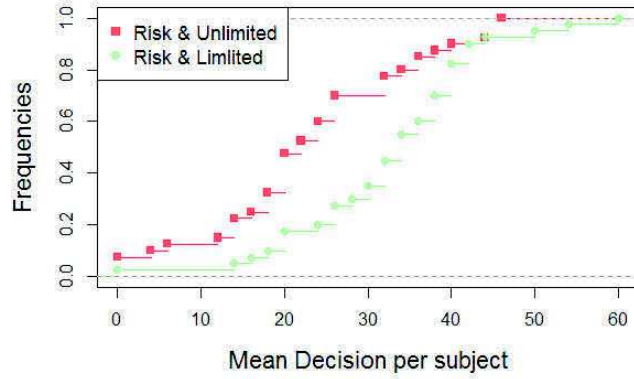

(a) Risk: Comparing UL and LL

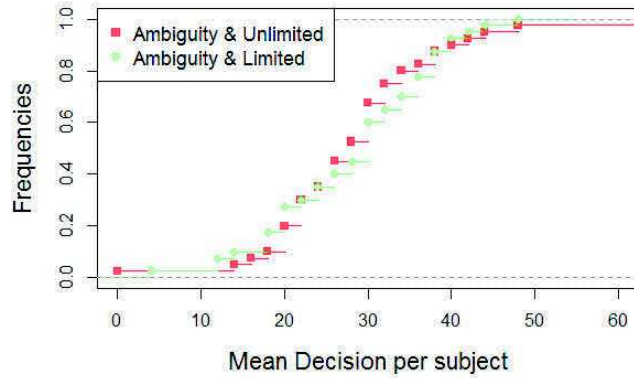

(b) Ambiguity: Comparing UL and LL

Figure 3.1: Graphical assessment of the aggregated average investment in prevention by comparing unlimited and limited liability while fixing the domain

Figures 3.1a and 3.2b illustrate that the cumulative distribution function of the average investment under RK-LL is significant higher than under RK-UL (KS test $p = 0.001$ and MW test $p = 0.000$) and under AMB-LL (KS test $p = 0.082$ and MW test $p = 0.023$). The first result is consistent with our model prediction (HYPOTHESIS 1). Hence, we show that underinvestment in prevention under limited liability does not systematically occur.

RESULT 1: *The aggregated level of investment in prevention is higher under the regime of limited compared to unlimited liability in the domain of risk*

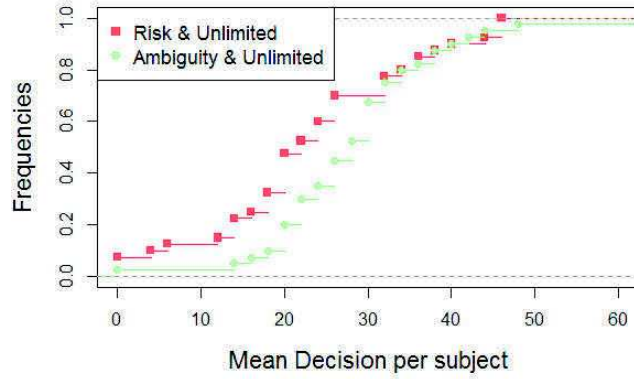

(a) UL: Comparing Risk and Ambiguity

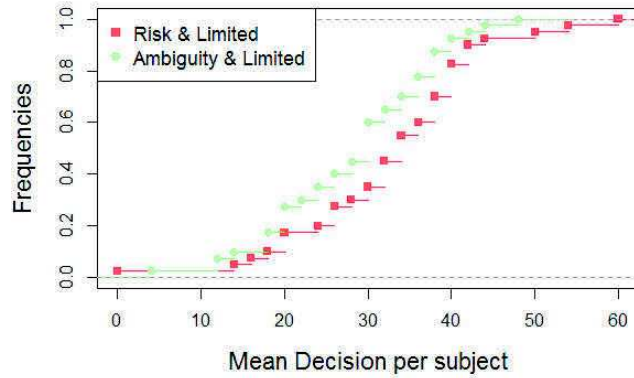

(b) LL: Comparing Risk and Ambiguity

Figure 3.2: Graphical assessment of the aggregated average investment in prevention by comparing the domain of risk and ambiguity while fixing the liability regime

Moreover, figure 3.2a shows that the cumulative distribution function of the average investment under AMB-UL is significant higher than under RK-UL (KS test $p = 0.049$ and MW test $p = 0.019$). This result confirms our HYPOTHESIS 2. Moreover, it stresses that subjects are sensitive to ambiguity under unlimited liability and tend to increase their levels of investment.

RESULT 2: *The investment in prevention in the domain of ambiguity is higher compared to the domain of risk under the regime of unlimited liability*

However, the third result is inconsistent with HYPOTHESIS 3. While shifting to the domain of ambiguity, it does not lead on average to higher levels of investment in prevention under the regime of limited liability. Interestingly, subjects tend to

invest lower levels of prevention in the domain of ambiguity compared to the regime of limited liability in the domain of risk. A possible explanation might be that ambiguity and limited liability cause an effect of underinvestment in prevention compared to the domain of risk.

Since ambiguity generates specific noise in the decision making and limited liability triggers in specific situations that less value of endowment is confiscated, it might be desirable for subjects to invest lower levels of prevention. However, if we compare the cumulative distribution function of average decision under limited liability in the domain of ambiguity to the baseline (RK-UL), we observe that investment levels are rather high under limited liability in the domain of ambiguity¹⁷.

RESULT 3: *The investment in prevention in the domain of ambiguity is lower compared to the domain of risk under the regime of limited liability.*

For the sake of completeness¹⁸, we test additionally whether there are differences in distributions of AMB-UL and AMB-LL (see figure 3.1b). Nonetheless, we do not find any significant effect (KS test $p = 0.670$ and MW test $p = 0.403$). One possible reason could be that ambiguity causes a high amount of noise or further ambiguity hampers the decision making under both liability regimes in a similar way that we are not able to disentangle any effect.

We report the comparative results of the cumulative distribution function of subjects optimism index¹⁹ and their average investment level pooled for both treatments in the domain of ambiguity (see Figure 3.3).

In figure 3.3a and 3.3b, we see that the average investment level among the groups of pessimism, neutral and optimism differ in the case of implementing an incentivized measure (Task) or applying a measurement method such as psychology

¹⁷We additionally compare the cumulative distribution function of the average investment under RK-UL (baseline) with AMB-LL and have found a significant differences (KS test $p = 0.027$ and MW test $p = 0.025$), which clearly shows that subjects tend to invest higher levels of prevention under ambiguity than compared to the baseline. See Figure B.1 in appendix B.1.2.

¹⁸Since subject's decision may be sensitive to their beliefs and the results of the ball drawn from the previous round, thus we perform KS- and MW test to verify whether our results hold for the first round. Both non-parametric tests confirm our results, except for Hypothesis 3.

¹⁹We distinguish between both elicitation methods, incentivized measures (Task) and measurement method (Ask) to compare properly our results. In the task approach, we determine the optimism index (ambiguity attitude) as such that subjects switching before the sixth row are in the group Pessimism-T, exactly at the sixth row are in the group Neutral-T and above the sixth row are in the group Optimism-T. In the Ask method, we determine the groups alike by setting the reference point of the optimism scale at 18.

scale (Ask).

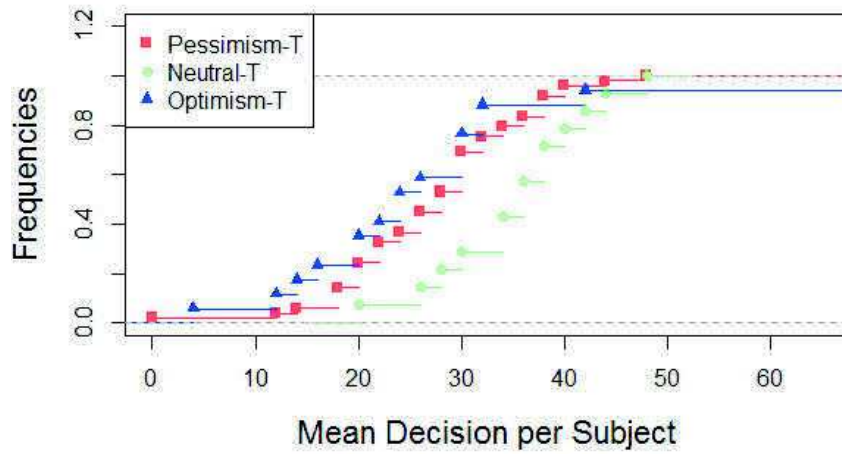

(a) Task: Optimism Index in AMB

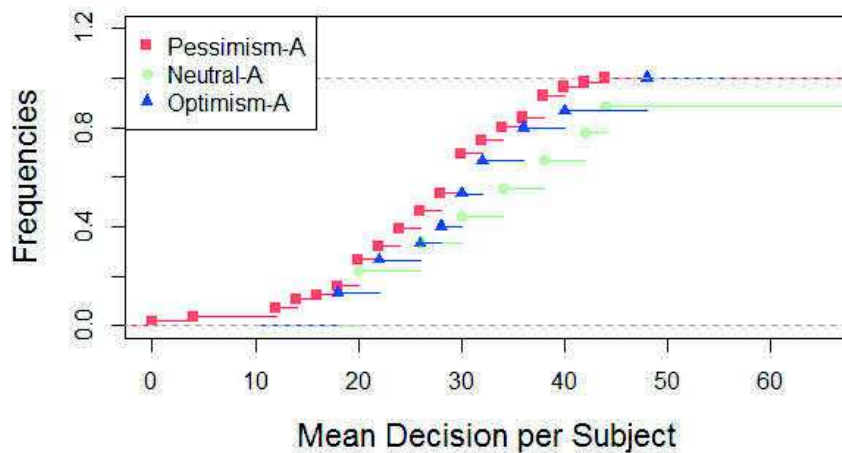

(b) Ask: Optimism Index in AMB

Figure 3.3: Ask versus Task: Cumulative distribution function between average investment in prevention and optimism index aggregated for both liability regimes in the domain of ambiguity

We find contradictory results among both measurement methods when we only focus on optimists and pessimists. We can see that in figure 3.3a the average investment level among the pessimists is higher compared to optimists (TASK). In fact, it seems puzzling that both measurement methods lead to different results. One could argue that the multiple price list design (Task) is susceptible to framing effects, as subjects are attracted to the middle of the ordered table regardless of the values

(Anderson et al., 2007).

In figure 3.3a and 3.3b, we see that the average investment level among the groups of pessimism, neutral and optimism differ in the case of implementing an incentivized measure (Task) or applying a measurement method, such as psychology scale (Ask). We find contradictory results among both methods when we only focus on optimists and pessimists. We can see that in figure 3.3a the average investment level among the pessimists is higher compared to optimists (TASK). In fact, it seems puzzling that both measurement methods lead to different results. One could argue that the multiple price list design is susceptible to framing effects, as subjects are attracted to the middle of the ordered table regardless of the values (Anderson et al., 2007).

In contrast, optimists invest on average higher levels compared to pessimist with respect to the measurement method (ASK). Nonetheless, we find that subjects being in the neutral group, for both methods (Task and Ask) choose significantly higher mean levels of investment compared to the groups of pessimism and optimism ($p = 0.000$). However, we find contradictory results among statistical tests between the groups of optimism and pessimism for the measurement method (KS test $p = 0.284$ and MW test $p = 0.039$). Hence, the Mann-Whitney test confirms our HYPOTHESIS 4 that optimistic subjects choose on average higher levels of investment compared to pessimistic subjects in the domain of ambiguity. Since KS test does not support these results, we need to be carefully with the interpretation. We find statistical differences in the medians between optimistic and pessimistic subjects in the measurement method but no differences can be found in the incentivized measurement method while applying both non-parametric statistical tests. We infer that these findings partially support HYPOTHESIS 4.

RESULT 4: *Optimistic subjects choose on average higher levels of investment compared to pessimistic subjects with respect to the incentivized measurement method in the domain of ambiguity.*

Next, we compare our model predictions with the observed data for each treatment.

Model prediction and observed data

Figure 3.4 and figure 3.5 depict subject's actual investment choices and the optimal level of investment predicted by the model round per round for each of the four treatments. Under RK-UL treatment, subjects invest slightly more than what is predicted by the model (optimal investment level equals 20 ECU).

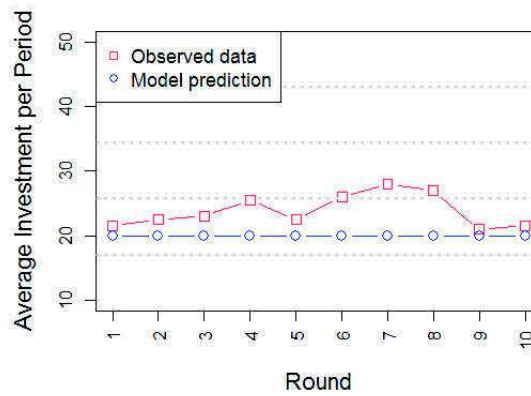

(a) Risk: Unlimited Liability

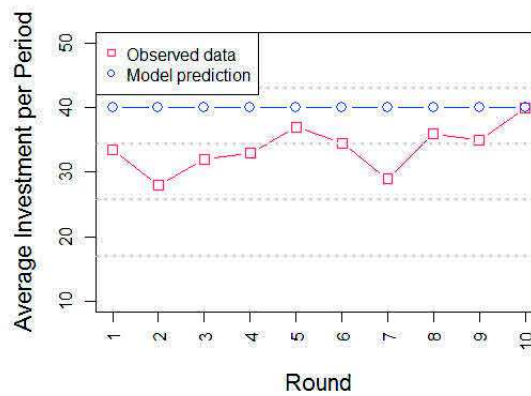

(b) Risk: Limited Liability

Source: Own calculations

Figure 3.4: Graphical assessment of the observed versus predicted mean decision per round in the domain of risk for both unlimited and limited liability

In contrast, in case of RK-LL treatment, subjects start out by choosing moderate investment levels and increase these levels until those predicted by the theory (optimal investment levels equals 40 ECU²⁰).

²⁰Furthermore, we need to stress that the optimal investment level under limited liability might be considered as a focal point. We include a question by asking subjects at the end of the experiment (before payment) on a four item scale (1 = "Never" to 4 = "Always") to report their investment decision on the following question "Have you chosen the investment level 40 ECU, because you didn't know which level of investment to select to maximize your potential earnings?". We find that 3 out of 160 subjects (2%) responded with "Always" and 14 out of 160 subjects (9%) responded with "Often".

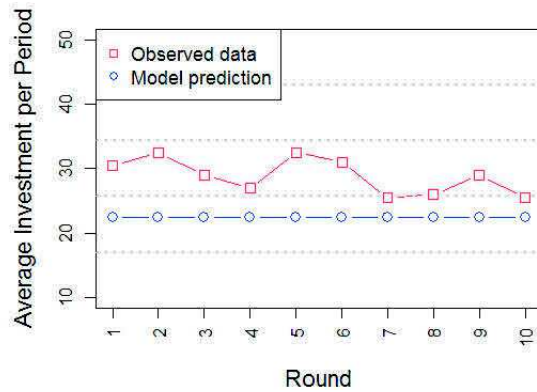

(a) Ambiguity: Unlimited Liability

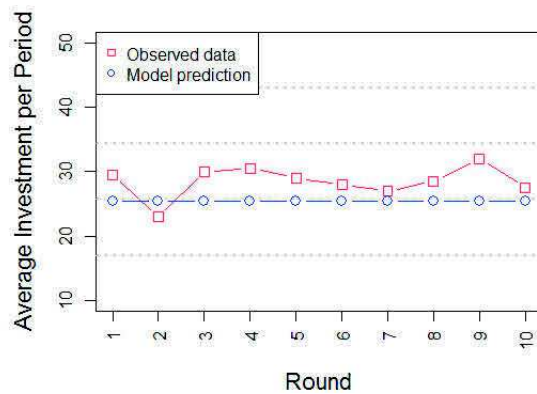

(b) Ambiguity: Limited Liability

Source: Own calculations

Figure 3.5: Graphical assessment of the observed versus predicted mean decision per round in the domain of ambiguity for both unlimited and limited liability

In the domain of ambiguity²¹ subjects start out by choosing slightly higher investment level and lower these until the optimum level predicted by the theory (optimal investment level equals 22.5 ECU). Subjects choose investment level for most of the time very close to the prediction (optimal investment level equals 25.5 ECU) under limited liability in the domain of ambiguity. In overall, we observe that subject's actual choices are mostly consistent with the point predictions.

Learning effect

We further discuss the effect of learning²² on subject's decision choice over rounds. Figure 3.6 illustrates the proportions of investment decision by treatment over time.

²¹It was not possible to calculate *ex ante* the optimal level of investment in the domain of ambiguity owing to the lack of information about the individuals degree of confidence and optimism.

²²We stress that we are not able to distinguish whether subjects are learning in terms of gaining a better understanding of the experimental task or in terms of altering their decision choice due to acquiring learning from previous rounds.

Therefore, we aggregate the investment decision per round and per treatment to investigate the hypothesis that the investment in mean are equal in the first and last round across all four treatments. To assess whether the members of a pair differ in size, we employ a non-parametric statistical test, the Wilcoxon Signed Rank Test. While pairwise comparing the first and last round for each treatment (Unlimited Liability & Risk $p = 1.000$; Limited Liability & Risk $p = 0.875$; Unlimited Liability & Ambiguity $p = 0.214$; Limited Liability & Ambiguity $p = 0.836$) confirms that they have identical distributions. Thus, we conclude that we do not observe in particular a learning effect, which is in line with the results of [Angelova et al. \(2014\)](#).

As can be seen graphically (Figure 3.6), we observe similar pattern across treatments. If we compare the first and last round for each treatment, we see that there are no significant differences across treatments. While subjects in the RK-UL treatment appear to choose rather lower level of investment compared to AMB-UL treatment, subjects in RK-LL treatment start out choosing higher investment level compared to subjects in AMB-LL treatment.

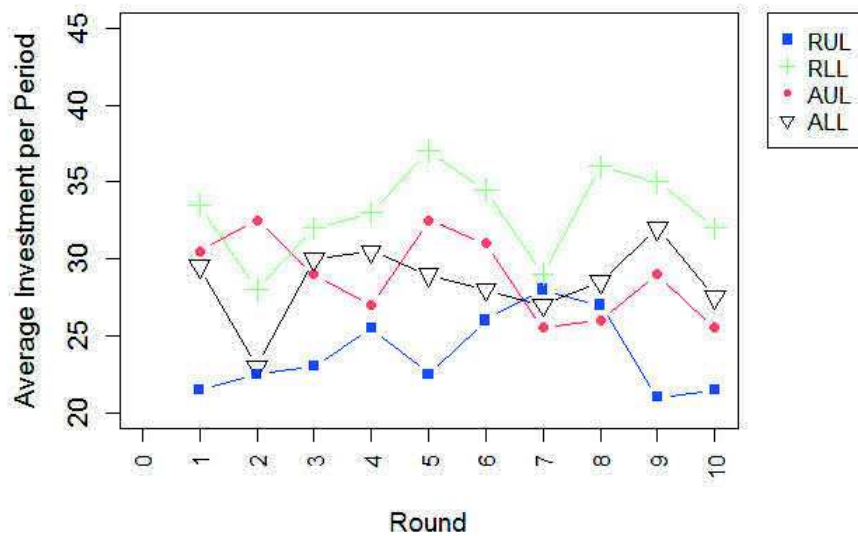

Figure 3.6: Aggregated average investment per round per treatment (pooled)

Note: RUL: Risk & Unlimited Liability; RLL: Risk & Limited Liability; AUL: Ambiguity & Unlimited Liability; ALL: Ambiguity & Limited Liability

It is of great interest to find out why subjects invest higher under the regime of limited liability in the domain of risk compared to the domain of ambiguity. To better understand subject's individual investment decision, we deploy panel regression analysis in the next subsection.

3.4.2 Factors affecting the investment in prevention

From now on, we do not test anymore our theoretical predictions but we pass to examine the key factors influencing the investment decision by using econometric methods.

In general, several factors might influence subject's investment decision. Our database allows us to control for treatment effects, personal traits²³, socio-demographic variables and specific preferences that can intervene with the liability rules. To present our experimental results, we apply panel regression analysis in which the dependent variable is the individual investment decision choice per round across treatments. We employ specifically balanced panel data and estimate²⁴ our parameters by applying REOP model estimation (Kuklys, 2005; Pfarr et al., 2011). Table 3.7 presents the estimated results (two model specification) of REOP estimator and reports cluster robust standard errors to correct for individual heterogeneity across treatments (Cameron and Miller, 2015). The first column summarizes the estimated results of Model (a) and respectively the second column presents the estimated results of Model (b).

Table 3.7: Estimation results applying ordered probit model

<i>Dependent variable: Individual investment per round</i>		
	Model (a)	Model (b)
Coefficient		
Treatment Risk & Limited	0.567*** (0.012)	0.498*** (0.030)
Treatment Ambiguity & Unlimited	0.316*** (0.008)	0.319*** (0.027)
Treatment Ambiguity & Limited	0.321*** (0.0017)	0.261*** (0.053)
Inequity aversion (TASK)	-0.047** (0.023)	-0.043** (0.019)
Risk aversion (TASK)	0.009 (0.017)	-0.004 (0.028)
Ambiguity aversion (TASK)	-0.003 (0.020)	0.015 (0.025)

²³In appendix B.1.1, we provide the results of the reliability of the test scales by reporting alpha Cronbach.

²⁴The estimation of the results has been programmed in R Software. Data and Code are available in the online appendix.

Age	-0.033	(0.023)
Gender	-0.091	(0.107)
Religion	0.002	(0.011)
Risk attitudes Q21 (ASK)	-0.040*	(0.020)
Risk attitudes Q22.1 (ASK)	0.010**	(0.029)
Risk attitudes Q22.2 (ASK)	0.047**	(0.021)
Risk attitudes Q22.3 (ASK)	0.049**	(0.025)
Risk attitudes Q22.4 (ASK)	-0.025**	(0.010)
Risk attitudes Q22.5 (ASK)	-0.053*	(0.031)
Risk attitudes Q22.6 (ASK)	0.042*	(0.025)
Risk attitudes Q23 (ASK)	-0.024*	(0.014)
Altruism towards others (ASK)	-0.044	(0.038)
Altruism toward my-self (ASK)	0.018	(0.067)
Inequity attitudes toward to others (ASK)	0.019***	(0.007)
Inequity attitudes toward my-self (ASK)	-0.012***	(0.005)
Degree of optimism	0.008	(0.010)
Degree of confidence	0.004	(0.013)
Degree of trust	-0.011	(0.017)
Event lag	0.096***	(0.016)
Threshold/Intercept parameter		
κ_1	-0.939***	-1.565
	(0.318)	(1.130)
κ_2	0.170	-0.491

	(0.264)	(1.105)
κ_3	1.424***	0.739
	(0.212)	(1.023)
κ_4	2.229***	1.593*
	(0.127)	(0.929)
Individual level variance component		
σ_u	0.437	0.379
	(0.125)	(0.094)
Goodness of fit		
Number of observations	N=1600	N=1440
Log pseudolikelihood	-2090.41	-1892.77
Likelihood Ratio (LR) Chi-Square test	219.34	51.00
Prob > chi2	0.000	0.000

Note: *p<0.1; **p<0.05; ***p<0.01; N=1440

Baseline: Treatment Risk & Unlimited Liability

We find high significant effects for the treatments and inequity aversion (Task) in both model specifications. While controlling for specific individual characteristics self-reported by subjects in the questionnaire, we find that the variables *Risk Attitudes Q21* (General) and *Risk Attitudes Q22.2* (Financial matters), *Risk Attitudes Q22.3* (Sports), *Risk Attitudes Q22.4* (Occupation), *Inequity attitudes toward to others (Ask)*, *Inequity attitudes toward my-self (Ask)* are significant at least at 10-percent level in model (b). Furthermore, the result of the draw of a blue or yellow ball from the previous round impacts significantly the investment decision.

The intercepts or threshold parameters of -0.939, 0.170, 1.424 and 2.229 regarding the model (A) and -1.565, -0.491, 0.739 and 1.593 regarding model (b) tell us the following. Since there are five possible values for the outcome variable, for instance the values regarding model (A) for outcome 1 (0 ECU) is less or equal than -0.939, outcome 2 (20 ECU) lies within the range -0.939 and 0.170, outcome 3 (40 ECU) lies within the range 0.170 and 1.424, outcome 4 (60 ECU) lies within the range 1.424 and 2.229 and outcome 5 (80 ECU) is greater or equal 2.229. The estimate of the panel-level variance estimate component is 0.437 for model (a) and 0.379 for model (b).

The REOP coefficients in panel estimation differ by a scale factor, thus we cannot interpret the magnitude of the coefficients, but rather we report the average (or mean) marginal effects of the explanatory variable. Thus, we summarize the average

marginal effects for the five outcomes (recall that the individual investment per round is an ordinal variable; 0 ECU = Outcome 1, 20 ECU = Outcome 2, 40 ECU = Outcome 3, 60 ECU = Outcome 4, 80 ECU = Outcome 5) subject to model (b). Table 3.8 presents the average marginal effects of REOP model estimation using balanced panel data and the explanatory variables may be divided into four groups: treatment variables, individual characteristics from TASK (parameters from the first three tasks), socio-demographic variables and individual characteristics from ASK (questionnaire). Furthermore, we include a lagged variable *Event lag* to control for the results from the previous round indicating whether the winning color was drawn. We especially control for this effect because the previous result from the draw might influence the decision choice.

Table 3.8: Average marginal effects from ordered probit model estimation

<i>Dependent variable: Individual investment per round</i>					
	Outcome 1	Outcome 2	Outcome 3	Outcome 4	Outcome 5
Treatment Risk & Limited	-0.124*** (0.012)	-0.063*** (0.004)	0.103*** (0.010)	0.062*** (0.004)	0.022*** (0.006)
Treatment Ambiguity & Unlimited	-0.079*** (0.010)	-0.041*** (0.003)	0.066*** (0.006)	0.040*** (0.005)	0.014*** (0.005)
Treatment Ambiguity & Limited	-0.647*** (0.015)	-0.033*** (0.006)	0.054*** (0.013)	0.033*** (0.005)	0.012*** (0.004)
Inequity aversion (TASK)	0.011*** (0.004)	0.006** (0.003)	-0.010** (0.004)	-0.005** (0.002)	-0.002*** (0.000)
Risk aversion (TASK)	0.001 (0.007)	0.001 (0.004)	-0.001 (0.005)	-0.001 (0.003)	-0.000 (0.001)
Ambiguity aversion (TASK)	-0.004 (0.006)	-0.002 (0.003)	-0.003 (0.005)	0.002 (0.003)	0.001 (0.001)
Age	-0.008 (0.005)	0.004 (0.003)	-0.007 (0.005)	-0.004 (0.003)	-0.001* (0.001)
Gender	0.023 (0.026)	0.012 (0.013)	-0.019 (0.021)	-0.011 (0.014)	-0.004 (0.005)
Religion	-0.001 (0.003)	-0.000 (0.001)	0.000 (0.002)	0.000 (0.001)	0.000 (0.000)
Risk attitudes Q21 (ASK)	0.010** (0.005)	0.005* (0.003)	-0.008* (0.005)	-0.005* (0.003)	-0.002*** (0.001)
Risk attitudes Q22.1 (ASK)	-0.002 (0.007)	-0.001 (0.003)	0.002 (0.006)	0.001 (0.004)	0.000 (0.001)
Risk attitudes Q22.2 (ASK)	-0.012** (0.005)	-0.006** (0.003)	0.010** (0.005)	0.006** (0.003)	0.002*** (0.001)
Risk attitudes Q22.3 (ASK)	-0.012** (0.006)	-0.006** (0.003)	0.010* (0.05)	0.006** (0.003)	0.002* (0.001)
Risk attitudes Q22.4 (ASK)	0.006** (0.003)	0.003** (0.001)	-0.005** (0.002)	-0.003** (0.001)	-0.001** (0.000)

OPTIMAL TECHNOLOGICAL RISK MANAGEMENT

Risk attitudes Q22.5 (ASK)	0.013*	0.007*	-0.011*	-0.007*	-0.002
	(0.008)	(0.004)	(0.006)	(0.003)	(0.002)
Risk attitudes Q22.6 (ASK)	-0.010	-0.005*	0.008	0.005*	0.002
	(0.006)	(0.003)	(0.005)	(0.003)	(0.001)
Risk attitudes Q23 (ASK)	0.006	0.003*	-0.005*	-0.003*	-0.001
	(0.004)	(0.002)	(0.003)	(0.002)	(0.001)
Altruism towards others (ASK)	0.011	0.006	-0.010	-0.006	-0.002
	(0.009)	(0.005)	(0.008)	(0.005)	(0.002)
Altruism toward my-self (ASK)	-0.004	-0.002	0.004	0.0022	0.001
	(0.016)	(0.008)	(0.013)	(0.008)	(0.003)
Inequity attitudes toward to others (ASK)	-0.005***	-0.002**	0.004**	0.002**	0.001***
	(0.002)	(0.001)	(0.002)	(0.001)	(0.000)
Inequity attitudes toward my-self (ASK)	0.003***	0.002**	-0.003**	-0.002**	-0.001***
	(0.001)	(0.007)	(0.001)	(0.001)	(0.000)
Degree of optimism	-0.002	-0.001	0.002	0.001	0.000
	(0.003)	(0.001)	(0.002)	(0.001)	(0.001)
Degree of confidence	-0.001	-0.001	0.001	0.000	0.000
	(0.003)	(0.002)	(0.003)	(0.002)	(0.001)
Degree of trust	0.003	0.001	-0.002	-0.001	-0.000
	(0.004)	(0.002)	(0.004)	(0.002)	(0.001)
Event lag	-0.023***	-0.012***	0.020***	0.012***	0.004***
	(0.004)	(0.002)	(0.003)	(0.003)	0.001

Note: *p<0.1; **p<0.05; ***p<0.01; N=1440

Cluster robust standard errors are given in parentheses

Baseline: Treatment Risk & Unlimited Liability

The estimation results show that all treatment variables *Treatment Risk & Limited*, *Treatment Ambiguity & Unlimited*, *Treatment Risk & Limited* are significant at 1-percent level for the five outcomes.

For instance, the average marginal effects of the variable *Treatment Risk & Limited Liability* compared to the baseline indicates that individuals are 12.4% less likely to have chosen Outcome 1, 6.3% less likely to have chosen Outcome 2, 10.3% more likely to have chosen Outcome 3, 6.2% more likely to have chosen Outcome 4 and 2.2% more likely to have chosen Outcome 5. Moreover, we find significant effects for the variables *Inequity aversion (Task)*. This means that subjects with a lower degree of inequity aversion are more likely to invest lower levels in prevention.

Furthermore, we find that individuals with a higher risk perception related to financial matters and during leisure and sport have a higher probability to invest more in prevention. Contrary, the results show that individuals with higher risk perception related to their occupation are less likely to invest higher levels of in-

vestment in prevention. Furthermore, the variable *Risk attitudes Q23* (Investment risks), perception of risk in the domain of losses, is significant at least at 10-percent level (Column 2 to 4), except for Outcome 1 and 5. In other words, subjects with a higher risk aversion in the domain of losses are more likely to invest lower levels in investment. After all, we do not find significant effects of subjects risk aversion (TASK) through a measurement measure, which is contrary to [Vieider et al. \(2015\)](#).

Next, one unit increase in *Inequity towards to others (Ask)* is associated with being 0.5% less likely to have chosen outcome 1, 0.2% less likely to have chosen Outcome 2, 0.4% more likely to have chosen Outcome 3, 0.2% more likely to have chosen Outcome 4 and 0.1% more likely to have chosen Outcome 5. More precisely, we find that subjects reporting higher fairness preferences toward to other (Ask) have a higher probability to choose higher levels of investment in prevention. In contrast, subjects reporting higher fairness preferences toward to oneself (Ask) have a lower probability to invest higher levels of investment in prevention. Besides, we do not find any significant effect for the variables *Degree of optimism*, *Degree of confidence* and *Degree of trust*. We infer that the self-reported fairness preferences are equally effective than the incentivized measure of advantageous inequity aversion. Both elicitation methods show highly significant effects in the econometric analysis.

Finally, the result of the draw of a blue or yellow ball from the previous round impacts the investment decision. The average marginal effect for the variable *Event lag* reports that individuals are 2.3% less likely to choose Outcome 1, 1.2% more likely to choose Outcome 2, 2.0% more likely to choose Outcome 3, 1.2% more likely to choose Outcome 4 and 0.4% more likely to choose Outcome 5. This finding shows that subjects are influenced from their previous result of the random draw. In fact, subjects whose winning color has not been drawn tend to choose higher levels of investment in prevention compared to those whose winning color has been drawn. Nevertheless, one could argue that this issue features a potential drawback of our experimental design, albeit we find very strong and robust treatment effects.

3.4.3 Behavioral strategy

Since the variable *Event lag* is highly significant in our estimation analysis, we wonder whether subject's investment behavior has altered during the ten rounds of Task 4. It might be worth discussing the effect of strategic behavior in repeated

games to rule out potential bias. We perform REOP estimation by correcting with cluster robust standard errors to assess the underlying determinants affecting the investment behavior. The dependent variable is a lag variable indicating subject's variation of investment choice within a range from -80 ECU (Outcome 1) to 80 ECU (Outcome 8) of round r compared to $r - 1$. For the sake of brevity, we are solely discussing the estimation results rather than reporting explicitly the marginal effects (see table B.10 in appendix B.1.1). The main results of the estimation can be summarized as following. First, we do not find any significant effect for the treatment effects, meaning that subject's choice varies independently of the treatments. This confirms that the strategic behavior do not diverge across treatments and support our previous results. Second, the behavioral variation is higher (from -80 to -60 to -40 to -20 to 0 to 20 to 40 to 80) with lower age, for women (compared to men), lower risk aversion related to occupation, higher risk aversion related to the faith in other people, higher level of altruism towards themselves, higher inequity aversion and for the draw of the wrong color. We are not able to avert that the draw of a ball of the previous round is affecting the decision choice. We confess that our experimental design reveals some shortcomings regarding this issue with the wisdom of hindsight. Finally, we could not find any significant effect neither for ambiguity aversion nor for the degree of optimism. The intercept/threshold parameters are significantly different from each other, which mean that the categories should not be combined into one.

Additionally to this first part of this chapter, we seek to analyze whether subjects advantageous inequity aversion differ in the domains of gains and losses. We discuss this point in the next section.

3.5 Sharing gains and losses

The second purpose of this chapter deals with a comparison of the elicitation method of advantageous inequity aversion in the domains of gains and losses. [Fehr and Schmidt \(1999\)](#) develop a simple model by considering that individuals do not only care about their own payoffs but they also care about other's payoffs. Until now only two real attempts have been undertaken, by [Zhou and Wu \(2011\)](#) and [Blanco et al. \(2011\)](#) to elicit an individual's aversion to inequity that works to their own advantage and disadvantage. [Zhou and Wu \(2011\)](#) investigate a novel variant

of ultimatum game and explore a participant’s reaction to unfairness in both gain and loss sharing situations. They find that unfair offers were perceived to be more unfair in the domain of losses than in the domain of gains. [Blanco et al. \(2011\)](#) assess the model of inequity by [Fehr and Schmidt \(1999\)](#) using data from MDG to elicit the parameter of advantageous inequity aversion in the domain of gains. They found support for Fehr and Schmidt’s model at the individual rather than at the aggregated level. Nevertheless, little is known about how people perceive unfair division of losses between individuals in MDG.

We used data from two identical samples²⁵ to assess whether subject’s reaction to advantageous inequity aversion differ in the domain of gains and losses. The data of sample 1 is provided by the first experimental task of [Attanasi et al. \(2016\)](#) and sample 2 contains data from the first experimental task of [Lampach et al. \(2016\)](#).

Following the reasoning of [Kahneman \(1992\)](#), we hypothesize that subjects are willing to sacrifice a lower amount of the initial endowment in the domain of losses compared to the domain of gains. We expect that losses loom larger than gains and affect more strongly an individual’s choice.

The principal task considered in our analysis for both samples is MDG as described in subsection 3.3.2. We apply a between-subject design and implement two distinct treatments which differ by the reference level: sample 1 is implemented in the domain of gains and sample 2 in the domain of losses. Table 3.9 displays the treatments and provides information about the sessions.

Table 3.9: Samples and treatments

Sample	Treatment	Number of subjects	Sessions
Attanasi et al. (2016)	Domain of gains	160	8
Lampach et al. (2016)	Domain of losses	160	8

In total we run eight sessions per treatment (sample) with 20 subjects each, and gather 160 independent observations per treatment. We need to emphasize that we only manipulate the payoff vectors in both tasks, but the subject’s end payoff is the same for both treatments. Table 3.10 illustrates the differences of the payoff vectors

²⁵Each session was run with 20 undergraduate students under the same conditions in the economic experimental laboratory at the University of Strasbourg.

between the tasks of both, sample 1 and sample 2.

Table 3.10: Differences of payoffs between the tasks of sample 1 and sample 2

Decision	Domain of gains (sample 1)		Domain of losses* (sample 2)	
	Option Left	Option Right	Option Left	Option Right
1	(€ 10,€ 0)	(€ 0,€ 0)	(€ 0,€ -10)	(€ -10,€ -10)
2	(€ 10,€ 0)	(€ 1,€ 1)	(€ 0,€ -10)	(€ -9,€ -9)
3	(€ 10,€ 0)	(€ 2,€ 2)	(€ 0,€ -10)	(€ -8,€ -8)
4	(€ 10,€ 0)	(€ 3,€ 3)	(€ 0,€ -10)	(€ -7,€ -7)
5	(€ 10,€ 0)	(€ 4,€ 4)	(€ 0,€ -10)	(€ -6,€ -6)
6	(€ 10,€ 0)	(€ 5,€ 5)	(€ 0,€ -10)	(€ -5,€ -5)
7	(€ 10,€ 0)	(€ 6,€ 6)	(€ 0,€ -10)	(€ -4,€ -4)
8	(€ 10,€ 0)	(€ 7,€ 7)	(€ 0,€ -10)	(€ -3,€ -3)
9	(€ 10,€ 0)	(€ 8,€ 8)	(€ 0,€ -10)	(€ -2,€ -2)
10	(€ 10,€ 0)	(€ 9,€ 9)	(€ 0,€ -10)	(€ -1,€ -1)
11	(€ 10,€ 0)	(€ 10,€ 10)	(€ 0,€ -10)	(€ 0,€ 0)

*Note: * Subjects receive an endowment of €10 to compensate potential negative payoffs*

More precisely, the task of sample 2 compared to the task of sample 1 differs by the sign of the payoff vectors for option "Left" and option "Right". Hence, the payoffs vectors in both samples can be considered as identical and solely differ by a framing effect.

The average number of advantageous inequity aversion in the sample 1 (domain of gains) is 4.76 and this average for sample 2 (domain of losses) is 5.96. These averages are significantly different by implementing both a parametric two-sided t-test ($p = 0.000$) and a non-parametric two-sided Mann-Whitney test ($p = 0.000$). Figure 3.7 sketches the cumulative distribution function of subject's advantageous inequity aversion parameter for each treatment. The parametric and non-parametric tests are highly significant and show that subjects have a lower advantageous inequity aversion in the domain of losses compared to the domain of gains. In other words, subjects are affected by losses, and unfairness looms larger in the domain of losses. Thus, the framing effect included in the task of sample 2 (domain of losses) has a significant impact on subjects choices compared to subjects decisions in the task of sample 1.

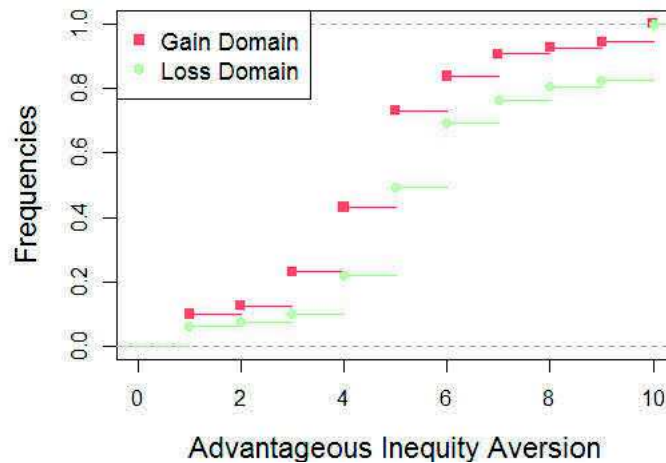

Figure 3.7: Cumulative distribution functions of advantageous inequity aversion in the domain of gains and losses

Our result confirms our hypothesis that losses loom larger, meaning that subjects perceive losses to be more painful. Furthermore, our finding systematic differs from [Zhou and Wu \(2011\)](#) who found that subjects have a higher demand for fairness when they have to share losses with others. Nevertheless, their findings have been obtained by applying an ultimatum game to determine disadvantageous inequity aversion by measuring responders' rejection rate. Hence, it is not surprisingly that our result diverges from theirs due to applying a different measurement variable.

3.6 Concluding Remarks

The purpose of this chapter is twofold. First, we explore whether strict liability is performing efficiently in the domains of risk and ambiguity. Specifically, we test the theoretical predictions of chapter 2 by setting carefully the parameters to satisfy the specific conditions in experimental tasks. In particular, we are interested to verify whether individuals overinvest in prevention for both liability regimes in an ambiguous environment and for a specific case under limited liability in the domain of risk. We assess the theoretical predictions to provide new insights on empirical validity to the literature on tort law for policymakers involved in dealing with new emerging technologies related to technological disasters or any external loss. Second, we seek to compare whether subjects behave systematically differently when perceiving unfair division of losses compared to gains between individuals in MDG.

Regarding the first objective of this chapter, our results are consistent with the

theoretical predictions showing that limited liability leads significantly to higher investment levels in prevention compared to unlimited liability in the domain of risk. However, [Angelova et al. \(2014\)](#) could not find any significant differences by comparing whether individuals were able to fully compensate victim's losses in the domain of risk. They conclude that agents do not invest more in prevention even when losses to third parties increase. Here, we do not manipulate the size of liability²⁶ albeit we allow for potential losses to occur under unlimited liability. This could be one possible reason why we find significant differences between both liability regimes in the domain of risk. On the other side, it is possible that this finding is unique due to our parameters setting. Nevertheless, we demonstrate for a specific case that underinvestment is not systematically observed in the domain of risk.

In addition, individuals significantly invest higher levels of prevention under unlimited liability in the domain of ambiguity compared to risk. On the other hand, limited liability in the domain of ambiguity leads on average to lower levels of investment in prevention compared to domain of risk. No significant effect of the individual's degree of optimism reported in the questionnaire nor from task has been identified to affect the decision choice to invest in prevention. On the other hand, the estimation results demonstrate strong evidence that individuals with a higher inequity aversion, higher fairness and risk preferences incline to choose higher levels of investment in prevention.

Regarding the second objective of this chapter, we demonstrate that losses loom larger, and that subjects are less averse to inequity that works to their advantage in the domain of losses. Since [Kahneman and Twersky \(1984\)](#) demonstrate that people strongly prefer to prevent losses than to earn gains, we note that subjects in our experiment behaved to some extent similarly in the context of inequity aversion. This result shows strong evidence that losses provoke a significant psychological impact on subjects.

Several limitations of this research should be stressed. It is indisputable that our experimental design mirrors specific drawbacks. As already mentioned, we acknowledge that MDG might influence subject's decision behavior. Nonetheless, we argue

²⁶[Koch and Schunk \(2013\)](#) also manipulate the size of liability in their experiment and found that both risk aversion and ambiguity aversion are higher and positively correlated under unlimited liability compared to limited liability.

that it remains essentially hypothetical and we decide to apply this well-established design (Andreoni and Miller, 2002; Fisman et al., 2007; Blanco et al., 2011; Heinrich and Weimann, 2013; Angelova et al., 2014) owing to probe treatment effects. Furthermore, we deem that our design aims to represent the decision problem as realistic as possible by including third parties and considering that the injurer could suffer from potential losses. Finally, we seek to combine approaches from both, economics and psychology literature to elicit subject's degree of optimism by implementing a measurement method (multiple price list) and incentivized measurement method (psychology scale). Another possibility would be to disentangle both ambiguity parameters by measuring the degree of ambiguity (Degree of confidence) and ambiguity attitudes (Degree of optimism) in a specific task (Eichberger and Kelsey, 2011). For instance, Kilka and Weber (2001) propose a two stage approach, similar to the method by Tversky and Craig (1995), to measure the degree of ambiguity and ambiguity attitudes. Moreover, Baillon et al. (2015) suggest a method to decompose ambiguity attitudes into pessimism and likelihood sensitivity.

These experimental findings can be useful for public policy in the context of governing new emerging technologies to design better regulations and foster knowledge on how the legal regimes are performing. Furthermore, it would be beneficial for future regulatory policies in the field of liability-sharing schemes to consider that individuals are to some extent less averse to inequity when they are facing losses.

It might be challenging to reason general conclusions from experiments due to the lack of external validity. The replication of experiments represents a possible solution to limit threats to external validity by varying treatments, outcomes, settings, and units (Garcia and Wantechekon, 2010).

However, the lessons we can learn from our experiments are that subjects show on average high levels of investment under both unlimited and limited in the domain of ambiguity.

Tort law cannot provide *ex-ante* optimal incentives in the domain of ambiguity. With respect to limited liability, overinvestment in prevention has the desirable effect to reduce the probability of an accident but causes a disruption in the compensation mechanism. Victims will not be fully compensated *ex-post* in the face of catastrophic accident. One crucial aspect is the need for public intervention measures in the sense of introducing a compulsory insurance or providing complementary funding for

compensation. Future research can help to provide evidence about the performance of liability rules while considering the possibility of public intervention.

To conclude, more empirical evidence is needed to obtain a better understanding of the driven factors influencing the decision making under risk and ambiguity to establish efficient liability rules. Future research could seek to use previous empirical findings to build and adjust economic models for the governance of new emerging risks. Besides, [Fehr and Schmidt \(1999\)](#) develop a crucial and simple model, without considering other underlying factors that play an important role in the interpersonal context, such as belief-dependent motivation ([Battigalli and Dufwenberg, 2009](#)) or empathy ([Singer and Ernst, 2005](#)). Future research should aim to better understand why people are actually seeking fairness and what basically are the driving forces (equal distribution, belief-dependent motivation, empathy and/or emotion) stimulating such behavior.

Appendix B

Supplementary materials and information

B.1 Tables and Figures

B.1.1 Tables

Table B.1: Decision choice for the RK treatment

	Decision variable [ECU]				
	0	20	40	60	80
Probability of an event [%]	87	59	38	22	9

Source: Own compilation

Table B.2: Decision choice for the AMB treatment

	Decision variable [ECU]				
	0	20	40	60	80
Probability A [%]	97	66	44	26	13
Probability B [%]	92	62	41	24	11
Probability C [%]	87	59	38	22	9
Probability D [%]	82	55	35	20	8
Probability E [%]	77	52	33	18	6

Source: Own compilation

Table B.3: Descriptive Statistics of experimental data

	Min	Max	Mean	Std. Deviation	Sample size
Decision choice	0	80	28.55	20.51	160
Inequity aversion (TASK)	1	10	5.96	2.44	160
Risk aversion (TASK)	3	10	5.92	1.61	160
Ambiguity aversion (TASK)	1	10	5.38	1.84	160
University degree	0	2	0.42	0.58	160
Studies	0	5	2.11	1.45	160
Age	18	34	21.45	2.94	160
Gender	0	1	0.5	0.50	160
Nationality	0	1	0.77	0.42	160
Sister	0	3	0.89	0.96	160
Brother	0	3	0.88	0.92	160
Couple	0	1	0.18	0.38	160
Religion	0	8	1.68	2.25	160
Participation	0	1	0.84	0.36	160
Altruism towards others (ASK)	1	6	3.89	1.20	160
Altruism toward my-self (ASK)	0	6	2.77	1.32	160
Inequity attitudes toward to others (ASK)	0	20	12.03	3.88	160
Inequity attitudes toward my-self (ASK)	4	24	15.44	4.07	160
Degree of optimism	8	28	19.23	3.69	160
Degree of confidence	6	27	15.57	4.43	160
Degree of trust	11	25	17.46	2.88	160

Table B.4: Distributive Justice (Others) Scale

	Observation	Sign	Average Correlation	Alpha Crombach
Q7.	160	+	0.2929	0.5541
Q8.	160	+	0.2938	0.5551
Q9.	160	+	0.2851	0.5447
Q10.	160	+	0.3949	0.6619
Test scale			0.3167	0.6496

Table B.5: Distributive Justice (Myself) Scale

	Observation	Sign	Average Correlation	Alpha Crombach
Q11.	160	+	0.4509	0.7113
Q12.	160	+	0.5530	0.7877
Q13.	160	+	0.4968	0.7476
Q14.	160	+	0.5401	0.7789
Test scale			0.5102	0.8065

Table B.6: Revised Orientation Test (R-LOT)

	Observation	Sign	Average Correlation	Alpha Crombach
Q24.	160	+	0.3870	0.7163
Q26.	160	-	0.3440	0.6772
Q30.	160	-	0.2909	0.6214
Q32.	160	-	0.2966	0.6278
Q33.	160	+	0.3127	0.6454
Test scale			0.5102	0.7077

Table B.7: General Confidence Scale

	Observation	Sign	Average Correlation	Alpha Crombach
Q24.	160	+	0.5609	0.8363
Q26.	160	+	0.5238	0.8148
Q30.	160	+	0.5223	0.8139
Q32.	160	+	0.4928	0.7954
Q33.	160	-	0.5865	0.8502
Test scale			0.5373	0.8531

Table B.8: Trust Scale

	Observation	Sign	Average Correlation	Alpha Crombach
Q24.	160	+	0.2033	0.5051
Q26.	160	+	0.2437	0.5631
Q30.	160	+	0.2870	0.6169
Q32.	160	-	0.2276	0.5410
Q33.	160	+	0.2815	0.6104
Test scale			0.2486	0.6233

Table B.9: Frequency of chosen investment level using panel data

	Frequency	Percentage	Cumulative Percentage
-80 ECU	16	1.11	1.11
-60 ECU	29	2.01	3.13
-40 ECU	84	5.83	8.96
-20 ECU	258	17.92	26.88
0 ECU	670	46.53	73.40
20 ECU	260	18.06	91.46
40 ECU	83	5.76	97.22
60 ECU	26	1.81	99.03
80 ECU	14	0.97	100.00

Sample size: N=1440

Table B.10: Estimation of the behavioral variation by applying random effects ordered probit model

<i>Dependent variable: Behavioral change (lag)</i>		
	Coefficient	Cluster Robust Std. Err.
Treatment Risk & Unlimited	Baseline	Baseline
Treatment Risk & Limited	-0.002	(0.013)
Treatment Ambiguity & Unlimited	-0.010	(0.010)
Treatment Ambiguity & Limited	-0.025	(0.024)
Inequity aversion (TASK)	-0.004	(0.003)
Risk aversion (TASK)	-0.018	(0.006)
Ambiguity aversion (TASK)	0.013	(0.019)
Age	-0.006***	(0.002)
Gender	-0.031*	(0.018)
Religion	-0.004	(0.004)
Risk attitudes Q21 (ASK)	-0.002	(0.011)
Risk attitudes Q22.1 (ASK)	0.006	(0.008)
Risk attitudes Q22.2 (ASK)	0.008	(0.009)
Risk attitudes Q22.3 (ASK)	0.004	(0.007)
Risk attitudes Q22.4 (ASK)	-0.008**	(0.003)
Risk attitudes Q22.5 (ASK)	-0.005	(0.007)
Risk attitudes Q22.6 (ASK)	0.009*	(0.005)
Risk attitudes Q23 (ASK)	-0.006	(0.012)
Altruism towards others (ASK)	-0.030	(0.019)
Altruism toward my-self (ASK)	0.020**	(0.010)
Inequity attitudes toward to others (ASK)	0.000	(0.004)
Inequity attitudes toward my-self (ASK)	0.005**	(0.002)
Degree of optimism	-0.003	(0.002)
Degree of confidence	0.001	(0.001)
Degree of trust	-0.004	(0.006)
Event lag	0.702***	(0.057)
Threshold/Intercept parameter		
κ_1	-2.327***	(0.311)
κ_2	-1.872***	(0.250)
κ_3	-1.327***	(0.175)
κ_4	-0.569***	(0.160)
κ_5	0.747***	(0.112)
κ_6	1.544***	(0.093)
κ_7	2.123***	(0.127)
κ_8	2.568***	(0.895)
Individual level variance component		
σ_u	0.000	(0.000)

Goodness of fit	
Number of observations	N=1440
Log pseudolikelihood	-2156.4
Likelihood Ratio (LR) Chi-Square test	245.82
Prob > chi2	0.000

*Note: *p<0.1; **p<0.05; ***p<0.01*

B.1.2 Figures

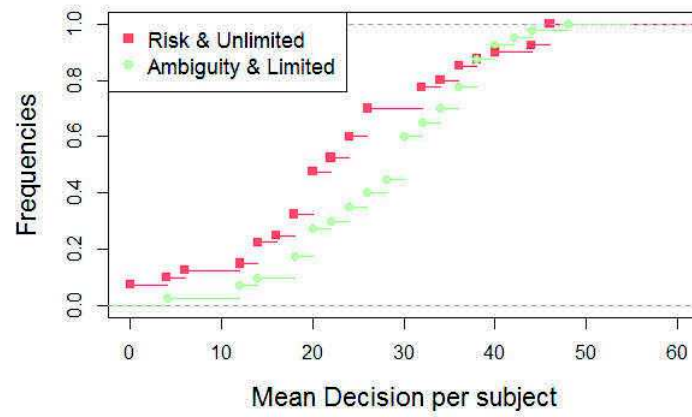

Source: Own calculations

Figure B.1: Graphical assessment of the aggregated average investment in prevention by comparing the baseline with limited liability in the domain of ambiguity

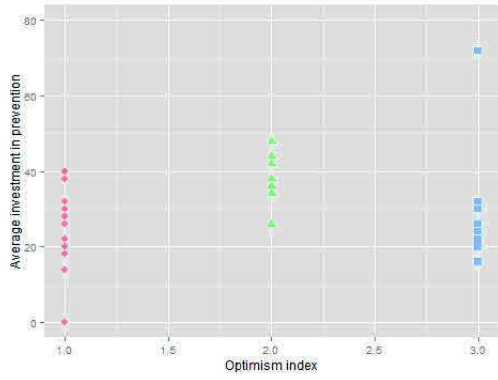

(a) Task: Optimism Index in AUL

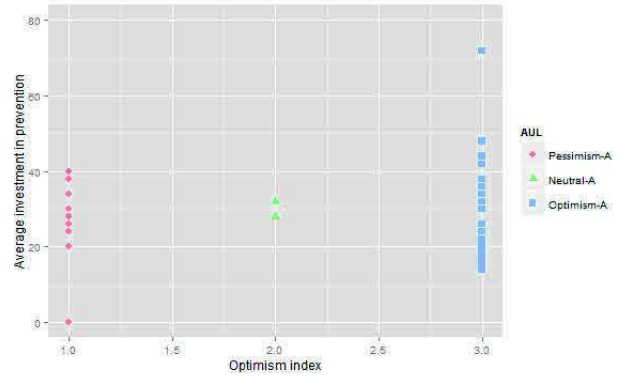

(b) Ask: Optimism Index in AUL

Source: Own calculations

Figure B.2: Ask versus Task: Relationship between Optimism Index and average investment in prevention under unlimited liability in the domain of ambiguity

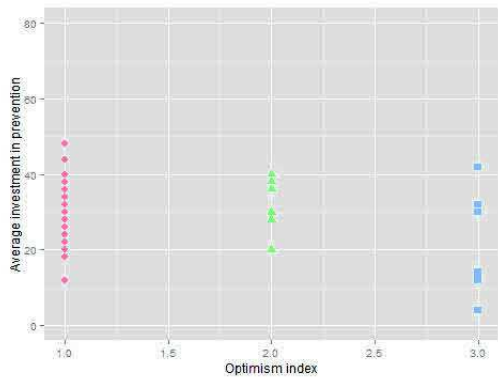

(a) Task: Optimism Index in ALL

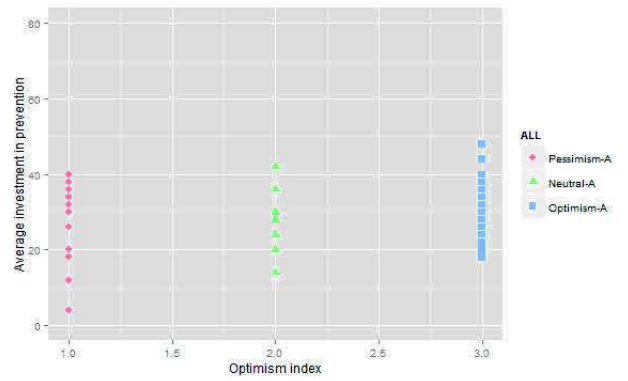

(b) Ask: Optimism Index in ALL

Source: Own calculations

Figure B.3: Ask versus Task: Relationship between Optimism Index and average investment in prevention under limited liability in the domain of ambiguity

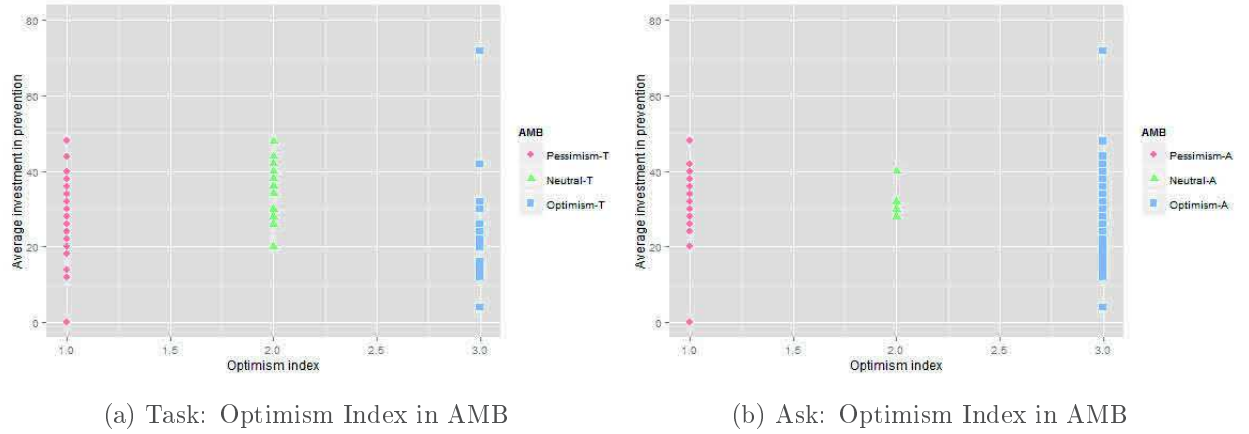

Source: Own calculations

Figure B.4: Ask versus Task: Relationship between Optimism Index and average investment in prevention aggregated for both liability regimes in the domain of ambiguity

B.2 Materials and Information

B.2.1 Screenshots of the experimental tasks

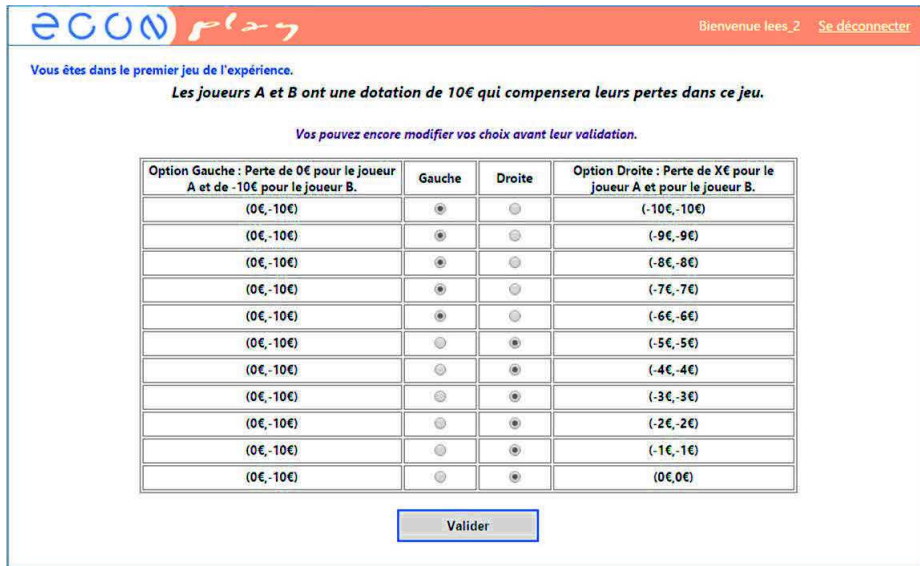

Figure B.5: Screenshot of Task 1: Modified dictator game to elicit subject's attitudes toward advantageous inequity aversion

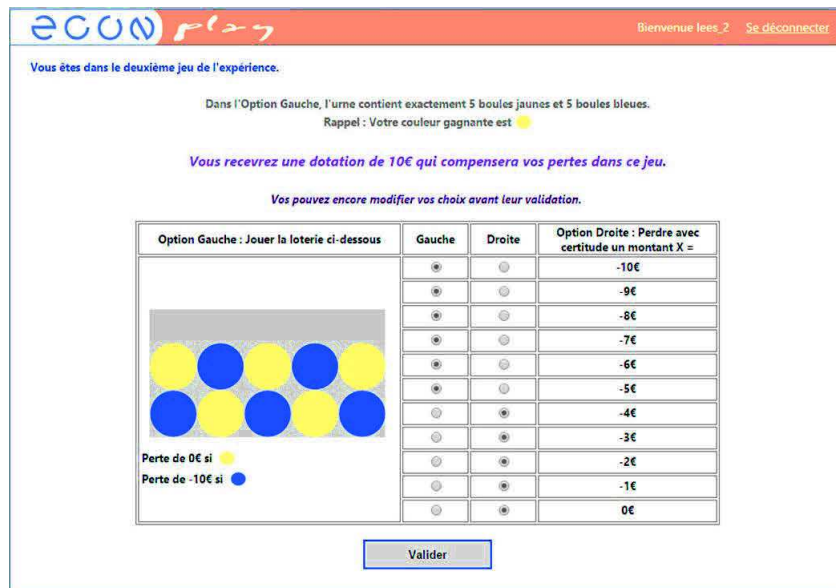

Figure B.6: Screenshot of Task 2: MPL to elicit subject's attitudes toward risk aversion

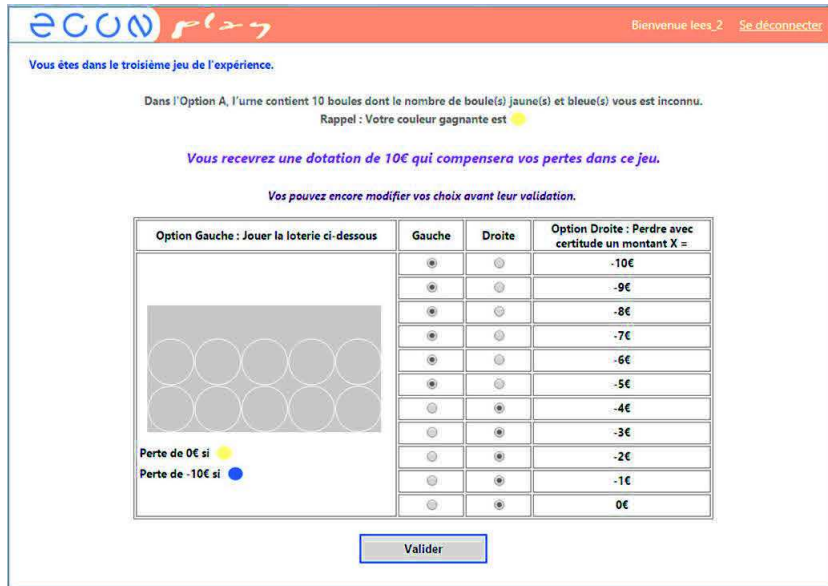

Figure B.7: Screenshot of Task 3: MPL to elicit subject's attitudes toward ambiguity aversion



Figure B.8: Screenshot of subject's decision choice in RK treatment under unlimited liability

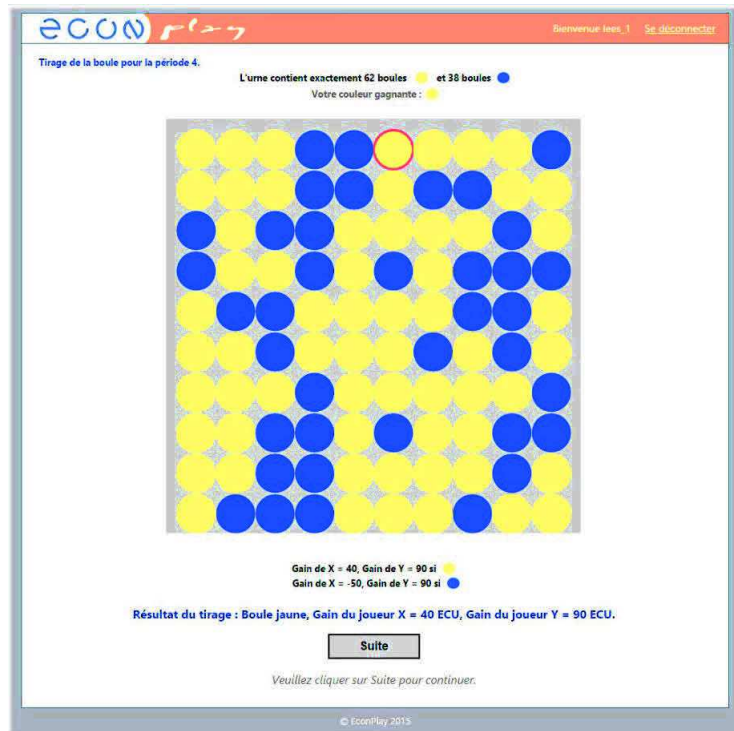

Figure B.9: Screenshot of the draw of a blue or yellow ball in RK treatment under unlimited liability

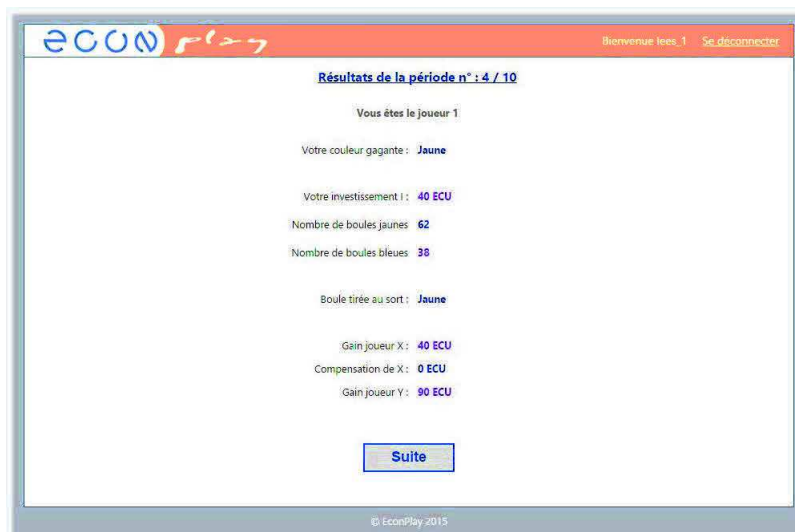

Figure B.10: Screenshot of the feedback table during round 4 in RK treatment under unlimited liability

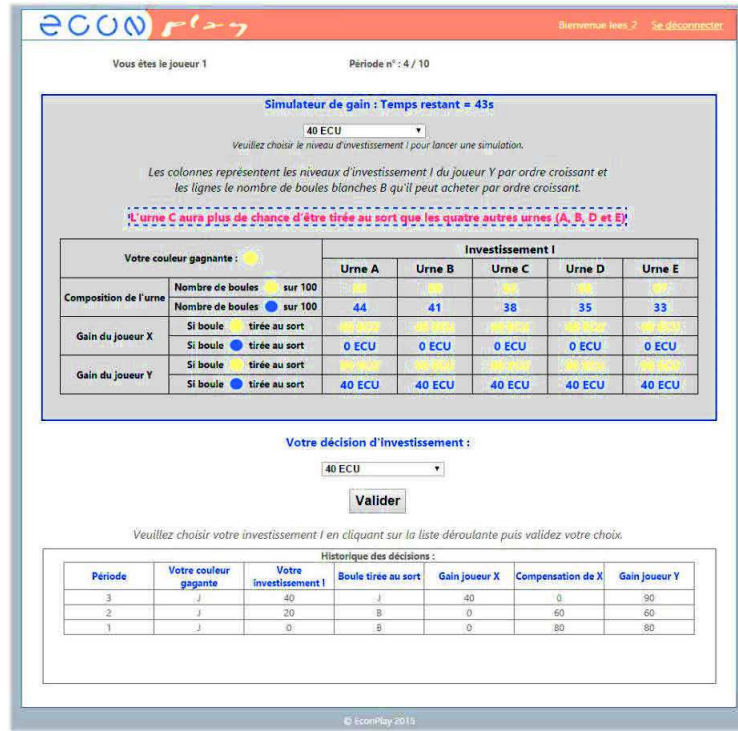

Figure B.11: Screenshot of subject's decision choice in AMB treatment under limited liability

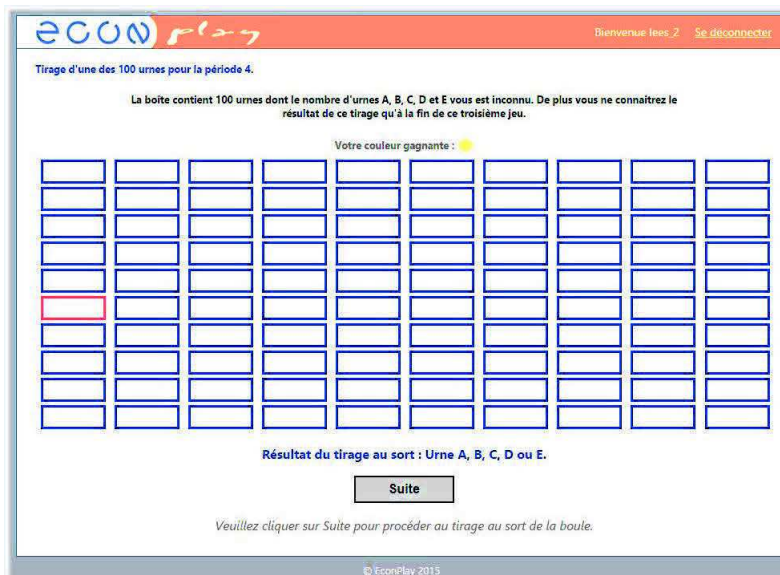

Figure B.12: Screenshot of the first draw of an urn in AMB treatment under limited liability

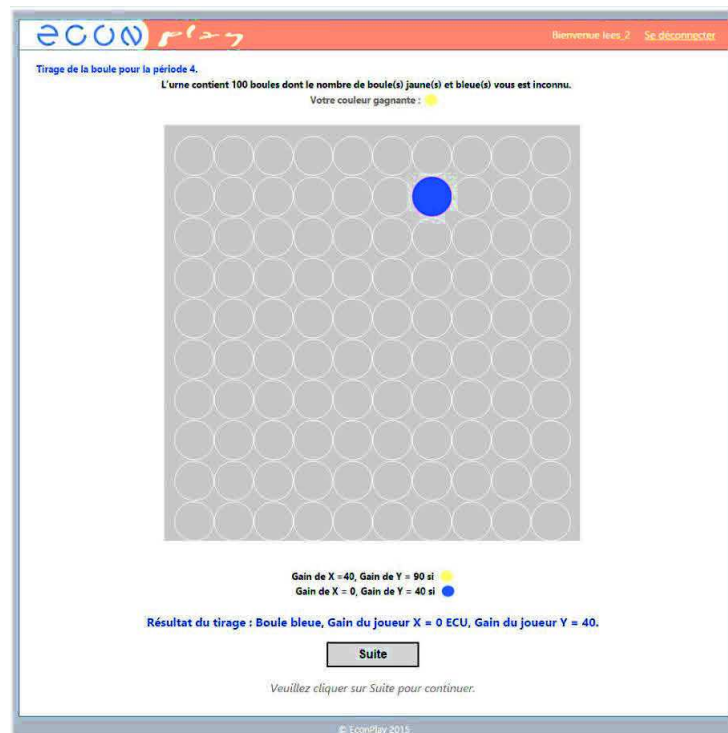

Figure B.13: Screenshot of the second draw of a yellow or blue ball from the drawn urn in AMB treatment under limited liability

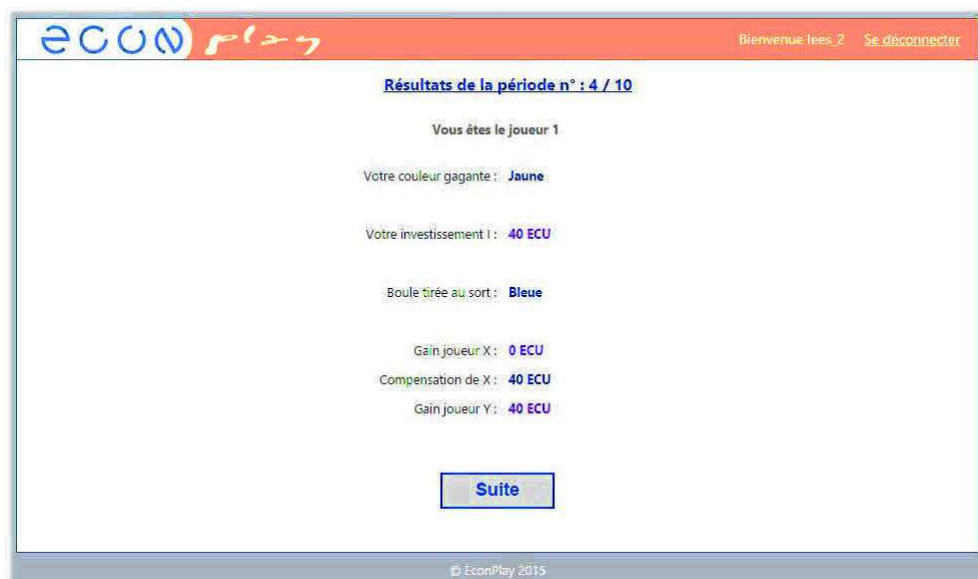

Figure B.14: Screenshot of the feedback table during round 4 in AMB treatment under limited liability

econPlay Bienvenue lees_2 Se déconnecter

Vous êtes le joueur 1

L'ordinateur vous a désigné comme joueur X

Le tableau ci-dessus rappelle l'ensemble de vos décisions en tant que joueur X ainsi que les gains des joueurs X et Y.

Rappel : En tant que joueur X, vous recevez une allocation d'un montant de 100 ECU pour ce jeu 4.

Nous allons procéder au tirage au sort de la période gagnante.

Historique des décisions :

Période	Couleur gagnante	Investissement I	Urne tirée au sort	Nombre de boules jaunes	Nombre de boules bleues	Boule tirée au sort	Gain joueur X	Compensation de X	Gain joueur Y
1	J	0	B	8	92	B	0	80	80
2	J	20	C	41	59	B	0	60	60
3	J	40	D	65	35	J	40	0	90
4	J	40	A	56	44	B	0	40	40
5	J	20	B	38	62	B	0	60	60
6	J	40	D	65	35	B	0	40	40
7	J	40	C	62	38	J	40	0	90
8	J	20	C	41	59	B	0	60	60
9	J	0	D	18	82	B	0	80	80
10	J	0	D	18	82	B	0	80	80

Veillez patienter...

© EconPlay 2015

Figure B.15: Screenshot of feedback table at the end of the experiment in AMB treatment under limited liability

B.2.2 Sets of Instructions in French

INSTRUCTIONS

Bonjour et bienvenue dans notre laboratoire.

Vous allez participer à une expérience sur les prises de décision. Si vous suivez scrupuleusement ces instructions, vos décisions vous permettront de gagner une certaine somme d'argent.

A la fin de cette lecture, n'hésitez pas à poser des questions, si vous le souhaitez. Tous les participants ont les mêmes instructions.

Les gains que vous allez recevoir durant cette expérience vont dépendre en partie de vos décisions, en partie des décisions des autres participants et en partie du hasard à travers des tirages au sort. Les sommes gagnées pendant l'expérience vous seront versées à la fin de l'expérience.

Cadre général de l'expérience

L'expérience comporte 4 jeux au total.

Les instructions pour le premier jeu vous seront distribuées tout de suite.

Les instructions pour le deuxième jeu vous seront distribuées à la fin du premier jeu.

Les instructions pour le troisième jeu vous seront distribuées à la fin du deuxième jeu.

Les instructions pour le quatrième jeu vous seront distribuées à la fin du troisième jeu.

Vous pouvez recevoir des gains pour chacun des quatre jeux.

Le gain total gagné pour l'expérience est la somme des gains obtenus dans chacun des quatre jeux.

Vous connaîtrez vos gains pour les trois premiers jeux seulement à la fin de l'expérience.

A la fin de l'expérience, vous serez appelé individuellement pour recevoir vos gains en liquide.

Premier jeu de l'expérience:

Durant ce jeu, vous aurez une série de décisions à prendre qui consiste à chaque fois à choisir entre deux options, l'option *Gauche* et l'option *Droite*. Ces options concernent la répartition d'un montant entre vous (joueur A) et un autre participant (joueur B) présent dans cette salle. Ce joueur B sera choisi de manière aléatoire à la fin de l'expérience.

Vous recevrez une dotation de 10 Euro qui compensera vos pertes dans ce jeu.

Les options :

- L'option *Gauche* vous rapporte toujours **0€** et fait perdre toujours **-10€** au joueur B.
- L'option *Droite*, quant à elle, donne toujours le même montant X à vous (joueur A) ainsi qu'au joueur B. Ce montant est croissant d'une ligne à l'autre lorsque l'on se déplace vers le bas du tableau.

Les joueur A et B ont une dotation de 10€ qui compensera leurs pertes dans ce jeu.

Veuillez choisir entre l'Option Gauche qui fait perdre 0€ au joueur A et -10€ au joueur B et l'Option Droite qui fait perdre -X€ aux 2 joueurs.

Option Gauche : Perte de 0€ pour le joueur A et de -10€ pour le joueur B.	Gauche	Droite	Option Droite : Perte de X€ pour le joueur A et pour le joueur B.
(0€, -10€)	<input checked="" type="radio"/>	<input type="radio"/>	(-10€, -10€)
(0€, -10€)	<input type="radio"/>	<input type="radio"/>	(-9€, -9€)
(0€, -10€)	<input type="radio"/>	<input type="radio"/>	(-8€, -8€)
(0€, -10€)	<input type="radio"/>	<input type="radio"/>	(-7€, -7€)
(0€, -10€)	<input type="radio"/>	<input type="radio"/>	(-6€, -6€)
(0€, -10€)	<input type="radio"/>	<input type="radio"/>	(-5€, -5€)
(0€, -10€)	<input type="radio"/>	<input type="radio"/>	(-4€, -4€)
(0€, -10€)	<input type="radio"/>	<input type="radio"/>	(-3€, -3€)
(0€, -10€)	<input type="radio"/>	<input type="radio"/>	(-2€, -2€)
(0€, -10€)	<input type="radio"/>	<input type="radio"/>	(-1€, -1€)
(0€, -10€)	<input type="radio"/>	<input checked="" type="radio"/>	(0€, 0€)

Remarque: Vous ne pouvez pas prendre de décisions incohérentes durant ce jeu. Plus précisément, si vous préférez l'option Gauche pour un montant X donné, alors il en sera de même pour tous les montants inférieurs à X. De même si vous préférez l'option Droite pour un montant X donné, alors il en sera de même pour tous les montants supérieurs à X. Il se peut donc que l'ordinateur modifie vos choix durant vos prises de décision afin qu'ils restent cohérents. De même, l'ordinateur vous imposera l'option Gauche pour un montant X égal à -10€ et l'option Droite pour un montant X égal à 0€.

Paiement:

À la fin de l'expérience, l'ordinateur déterminera de manière aléatoire si vous êtes un joueur A ou B. **Si vous êtes un joueur A**, vous tirerez de manière aléatoire le montant X d'après les choix des options que vous avez effectués auparavant. Dans le cas où vous avez choisi l'option Droite pour ce montant X, alors vous ainsi que le joueur B percevrez un gain qui est égale à votre dotation de 10€ moins la perte de X €. Si vous avez choisi l'option Gauche pour ce montant X, alors vous percevrez 10€ et le joueur B 0€.

Si vous êtes un joueur B, vous n'aurez pas de décisions à prendre et votre gain dépendra des choix d'options du joueur A et de son tirage au sort du montant X. Dans le cas où le joueur A a choisi l'option Droite pour ce montant X, alors vous ainsi que le joueur A percevrez le même gain qui est égale à votre dotation moins la perte du montant X. Si le joueur A a choisi l'option Gauche pour ce montant X, alors vous percevrez 0€ et le joueur A 10€.

Le tirage au sort pour ce jeu est fait de manière individuelle pour chaque joueur.

Deuxième jeu de l'expérience:

Durant ce deuxième jeu, vous aurez une série de décisions à prendre qui consiste à chaque fois à choisir entre deux options, l'option *Gauche* et l'option *Droite*.

Avant de commencer le deuxième jeu, l'ordinateur vous demandera de choisir une couleur, entre le jaune et le bleu, qui sera votre couleur gagnante. Vous garderez cette couleur durant toute l'expérience.

Vous recevrez une dotation de 10 Euro qui compensera vos pertes dans ce jeu.

L'option **gauche** consiste en un tirage au sort d'une boule dans une urne composée d'un certain nombre de boules jaunes et de boules bleues. L'urne pour le jeu 2 sera composée de 5 boules jaunes et de 5 boules bleues. Si la boule tirée au sort est de la même couleur que celle que vous avez désignée comme couleur gagnante, alors vous subirez une perte de 0€, sinon vous subirez une perte de -10€.

L'option **droite**, quant à elle, vous fait perdre avec certitude un montant X, X allant de -10€ à 0€.

Exemple avec une couleur gagnante jaune.

Dans l'Option Gauche, l'urne contient exactement 5 boules jaunes et 5 boules bleues.
Rappel : Votre couleur gagnante est ●

Vous recevrez une dotation de 10€ qui compensera vos pertes dans ce jeu.

Veillez choisir entre l'Option Gauche dont l'issue est incertaine et l'Option Droite qui consiste à perdre avec certitude -X€.

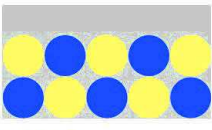
Option Gauche : Jouer la loterie ci-dessous	Gauche	Droite	Option Droite : Perdre avec certitude un montant X =
	<input type="radio"/>	<input type="radio"/>	-10€
	<input type="radio"/>	<input type="radio"/>	-9€
	<input type="radio"/>	<input type="radio"/>	-8€
	<input type="radio"/>	<input type="radio"/>	-7€
	<input type="radio"/>	<input type="radio"/>	-6€
	<input type="radio"/>	<input type="radio"/>	-5€
	<input type="radio"/>	<input type="radio"/>	-4€
	<input type="radio"/>	<input type="radio"/>	-3€
	<input type="radio"/>	<input type="radio"/>	-2€
	<input type="radio"/>	<input type="radio"/>	-1€
	<input checked="" type="radio"/>	<input type="radio"/>	0€

Remarque: Durant ce jeu, vous ne pouvez pas prendre de décisions incohérentes. Plus précisément, si vous préférez l'option Gauche pour un montant X donné, alors il en sera de même pour tous les montants inférieurs à X. De même, si vous préférez l'option Droite pour un montant X donné, alors il en sera de même pour tous les montants supérieurs à X. Il se peut donc que l'ordinateur modifie vos choix durant vos prises de décision afin qu'ils restent cohérents. De même, l'ordinateur vous imposera l'option Gauche pour un montant X égal à -10€ et l'option Droite pour un montant X égal à 0€.

Paiements du jeu 2:

Dans un premier temps, l'ordinateur choisit au hasard une valeur pour X (une des lignes pour chaque tableau est donc sélectionnée). Pour ce montant X :

- Si vous avez choisi l'option **Gauche**, une boule sera tirée au sort dans l'urne. Si cette boule est de la couleur gagnante alors vous percevrez 10€ (Dotation de 10€ moins 0€ de perte), sinon vous toucherez 0€ (Dotation de 10€ moins 10€ de perte).
- Si vous avez choisi l'option **Droite**, vous recevrez de manière certaine la dotation de 10 Euro moins la perte de X euro(s).

Le tirage au sort pour ce jeu est fait de manière individuelle pour chaque joueur.

Troisième jeu de l'expérience:

Durant ce troisième jeu, vous aurez une série de décisions à prendre qui consiste à chaque fois à choisir entre deux options, l'option *Gauche* et l'option *Droite*. Votre couleur gagnante choisie dans le jeu précédent restera la même pour ce troisième jeu. Comme dans le jeu précédent, **vous recevrez une dotation de 10 Euro qui compensera vos pertes dans ce jeu.**

L'option **gauche** consiste en un tirage au sort d'une boule dans une urne opaque (inconnue) qui sera composée de **10 boules** dont le **nombre de boule(s) jaune(s) et bleue(s) vous est inconnu**. L'urne inconnue peut donc contenir de 0 à 10 boules de couleur jaune et de 0 à 10 boules de couleur bleue. Si la boule tirée au sort est de la même couleur que celle que vous avez désignée comme couleur gagnante, alors vous subirez une perte de 0€, sinon vous subirez une perte de **-10€**.



L'option **droite**, quant à elle, vous fait perdre avec certitude un montant X, X allant de **-10€ à 0€**.

Exemple avec une couleur gagnante jaune.

Dans l'Option A, l'urne contient 10 boules dont le nombre de boule(s) jaune(s) et bleue(s) vous est inconnu.
Rappel : Votre couleur gagnante est 

Vous recevrez une dotation de 10€ qui compensera vos pertes dans ce jeu.

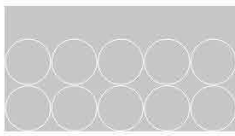
Veillez choisir entre l'Option Gauche dont l'issue est incertaine et l'Option Droite qui consiste à perdre avec certitude -X€.

Option Gauche : Jouer la loterie ci-dessous	Gauche	Droite	Option Droite : Perdre avec certitude un montant X =
 Perte de 0€ si  Perte de -10€ si 	<input type="radio"/>	<input type="radio"/>	-10€
	<input type="radio"/>	<input type="radio"/>	-9€
	<input type="radio"/>	<input type="radio"/>	-8€
	<input type="radio"/>	<input type="radio"/>	-7€
	<input type="radio"/>	<input type="radio"/>	-6€
	<input type="radio"/>	<input type="radio"/>	-5€
	<input type="radio"/>	<input type="radio"/>	-4€
	<input type="radio"/>	<input type="radio"/>	-3€
	<input type="radio"/>	<input type="radio"/>	-2€
	<input type="radio"/>	<input type="radio"/>	-1€
<input type="radio"/>	<input checked="" type="radio"/>	0€	

Remarque: Durant ce jeu, vous ne pouvez pas prendre de décisions incohérentes. Plus précisément, si vous préférez l'option Gauche pour un montant X donné, alors il en sera de même pour tous les montants inférieurs à X. De même, si vous préférez l'option Droite pour un montant X donné, alors il en sera de même pour tous les montants supérieurs à X. Il se peut donc que l'ordinateur modifie vos choix durant vos prises de décision afin qu'ils restent cohérents. De même, l'ordinateur vous imposera l'option Gauche pour un montant X égal à -10€ et l'option Droite pour un montant X égal à 0€.

Paiement du jeu 3:

Dans un premier temps, l'ordinateur choisit au hasard une valeur pour X (une des lignes pour chaque tableau est donc sélectionnée). Pour ce montant X :

- Si vous avez choisi l'option **Gauche**, une boule sera tirée au sort dans l'urne et si cette boule est de la couleur gagnante alors vous percevrez 10€ (Dotation de 10€ moins 0€ de perte), sinon vous toucherez 0€ (Dotation de 10€ moins 10€ de perte).
- Si vous avez choisi l'option **Droite**, vous recevrez de manière certaine la dotation de 10 Euro moins la perte de X euro(s).

Le tirage au sort pour ce jeu est fait de manière individuelle pour chaque joueur.

Traitement : Risque et règle Illimitée

Quatrième jeu de l'expérience:

Cadre général du jeu:

Le quatrième jeu est constitué de 10 périodes. Durant chaque période vous devrez prendre une décision. Les 10 périodes se dérouleront de la même manière. **Tous les participants prendront leurs décisions en tant que joueur X.**

Cependant, **à la fin de ce quatrième jeu**, on vous informera si vous étiez **joueur X** ou **joueur Y**. Vous ne pourrez donc pas connaître votre rôle avant la fin du jeu.

Vous conserverez votre rôle durant les 10 périodes. Si vous étiez joueur X, à chaque période vous serez associé à un joueur Y différent présent dans la salle. En aucun cas, vous ne jouerez deux fois avec le même joueur Y. De-même, si vous étiez joueur Y, vous serez associé à un joueur X différent à chaque période. A nouveau, le joueur X avec qui vous serez associé changera à chaque période, de telle façon que vous ne jouerez jamais deux fois avec le même joueur X.

En tant que joueur X, vous recevrez une allocation de 100 ECU pour compenser vos pertes éventuelles. Cette allocation ne s'appliquera pas au joueur Y.

Le joueur X prend les décisions pour le binôme XY. Les gains/pertes des deux joueurs X et Y vont dépendre uniquement des décisions prises par le joueur X. Au début de chaque période, le joueur X recevra une dotation de **80 ECU**. Le joueur Y recevra une dotation de **90 ECU**.

13 ECU sont équivalents à 1 EURO.

La suite des instructions détaille les décisions que vous devrez prendre **en tant que joueur X**.

Durant les 10 périodes du jeu, les gains des joueurs X et Y vont dépendre :

→ de l'investissement I du joueur X

→ du résultat d'un tirage au sort d'une boule dans une urne composée de 100 boules de couleur jaune et bleue.

Votre couleur gagnante choisie au début des jeux précédents restera la même pour ce jeu.

Investissement du joueur X:

Pour chacune des 10 périodes, le joueur X peut décider d'investir soit 0, 20, 40, 60 ou 80 ECU. Le montant investi va déterminer le nombre de boules jaunes et bleues présentes dans l'urne (voir tableau ci-dessous). Plus le montant investi sera élevé, plus le nombre de boules de la couleur gagnante sera élevé dans l'urne. L'investissement I va également engendrer un coût pour le joueur X, ce *coût sera égal au montant de l'investissement I .*

Gains/pertes des joueurs X et Y:

- Si la boule tirée au sort n'est pas de la même couleur que votre couleur gagnante, le joueur Y perdra sa dotation de 90 ECU mais cette perte sera entièrement compensée par le joueur X. Le joueur X subira une perte qui sera égale à sa dotation de 80 ECU moins son coût d'investissement moins la compensation versée au joueur Y (80 ECU - I - 90 ECU).
- Si la boule tirée au sort est de la même couleur que votre couleur gagnante, le joueur X recevra un montant égal à sa dotation de 80 ECU moins son coût d'investissement (80 ECU - I) et le joueur Y gardera sa dotation de 90 ECU.

Le tableau ci-dessous montre un exemple avec la couleur gagnante **JAUNE**. Ce tableau présente tous les gains/pertes possibles pour les deux joueurs X et Y selon l'investissement du joueur X.

		Investissement I				
		0 ECU	20 ECU	40 ECU	60 ECU	80 ECU
Votre couleur gagnante est le JAUNE	Composition de l'urne					
	Nombre de boules jaunes sur 100 boules	13	41	62	78	91
	Nombre de boules bleues sur 100 boules	87	59	38	22	9
Gain du joueur X	<i>Si une boule jaune est tirée au sort</i>	80 ECU	60 ECU	40 ECU	20 ECU	0 ECU
	<i>Si une boule bleue est tirée au sort</i>	-10 ECU	-30 ECU	-50 ECU	-70 ECU	-90 ECU
Gain du joueur Y	<i>Si une boule jaune est tirée au sort</i>	90 ECU	90 ECU	90 ECU	90 ECU	90 ECU
	<i>Si une boule bleue est tirée au sort</i>	90 ECU	90 ECU	90 ECU	90 ECU	90 ECU

Exemple :

Imaginons que votre couleur gagnante soit JAUNE.

Si vous investissez **0 ECU**, l'urne sera composée de 13 boules jaunes et 87 boules bleues. La probabilité qu'une boule jaune soit tirée au sort sera donc égale à 13% et à 87% pour la boule bleue.

Si une boule bleue est tirée au sort, alors *le joueur X* subira une perte de **-10 ECU**. Ce montant correspond à la dotation du joueur X moins son coût d'investissement moins le montant de la compensation versée au joueur Y (-10 ECU = 80 ECU - 0 ECU - 90 ECU). *Le gain du joueur Y* sera égal à **90 ECU**.

Si une boule jaune est tirée au sort, alors *le gain du joueur X* sera égal à **80 ECU**. Ce montant correspond à la dotation du joueur X moins son coût d'investissement (80 ECU = 80 ECU - 0 ECU). *Le gain de joueur Y* sera égal à **90 ECU**.

Notez que, toutes les périodes seront indépendantes les unes des autres ainsi que les tirages.

Historique du jeu:

En début de chaque période, vous aurez accès à l'historique du jeu. Celui-ci vous rappelle, pour chaque période passée, l'ensemble de vos décisions, le résultat du tirage au sort ainsi que le gain du joueur X et du joueur Y.

Résumé du déroulement du jeu :

- Chaque participant prendra ses décisions comme étant un joueur X, et ne connaîtra son rôle (X ou Y) qu'à la fin de l'expérience.
- Le joueur X recevra une allocation de 100 ECU pour compenser ses pertes éventuelles. Cette allocation ne s'appliquera pas au joueur Y.
- Le joueur X reçoit à chaque période une dotation de 80 ECU et le joueur Y reçoit 90 ECU.
- Les décisions du joueur X déterminent les gains/pertes du joueur X et du joueur Y.
- Le montant investi par le joueur X va déterminer le nombre de boules jaunes et bleues dans l'urne.
- Plus le montant investi sera élevé, plus le nombre de boules de votre couleur gagnante sera élevé dans l'urne.
- Si la boule tirée au sort est de la même couleur que votre couleur gagnante, le gain du joueur X sera égal à sa dotation moins son coût d'investissement ($80 \text{ ECU} - I$). Le gain du joueur Y sera égal à 90 ECU.
- Si la boule tirée au sort n'est pas de la même couleur que votre couleur gagnante, le joueur X subira une perte qui sera égale à sa dotation moins son coût d'investissement moins le montant de la compensation versée par le joueur X au joueur Y ($80 \text{ ECU} - I - 90 \text{ ECU}$). Le gain du joueur Y sera égal à 90 ECU.

Paiement

A la fin de ce quatrième jeu, l'ordinateur vous informera si vous êtes un joueur X ou Y. Un participant présent dans la salle sera également désigné au hasard par un expérimentateur pour tirer au sort une période qui déterminera le paiement pour le jeu 4. Il annoncera à voix haute la période sélectionnée aux autres participants.

Si vous êtes désigné comme joueur X, alors votre gain pour ce quatrième jeu va dépendre de la décision d'investissement que vous avez prise au cours de la période sélectionnée. Si vous êtes désigné comme joueur Y, alors votre gain pour ce quatrième jeu va dépendre de la décision d'investissement prise par le joueur X avec lequel vous avez été associé au cours de la période sélectionnée.

Votre gain total pour l'expérience sera la somme de vos gains obtenus dans le premier, deuxième, troisième et quatrième jeu.

Avant le début du jeu, des questions vous seront posées afin de vérifier votre bonne compréhension des instructions.

Traitement : Risque et règle limitée

Quatrième jeu de l'expérience:

Cadre général du jeu:

Le quatrième jeu est constitué de 10 périodes. Durant chaque période vous devrez prendre une décision. Les 10 périodes se dérouleront de la même manière. **Tous les participants prendront leurs décisions en tant que joueur X.**

Cependant, **à la fin de ce quatrième jeu**, on vous informera si vous étiez **joueur X** ou **joueur Y**. Vous ne pourrez donc pas connaître votre rôle avant la fin du jeu.

Vous conserverez votre rôle durant les 10 périodes. Si vous étiez joueur X, à chaque période vous serez associé à un joueur Y différent présent dans la salle. En aucun cas, vous ne jouerez deux fois avec le même joueur Y. De même, si vous étiez joueur Y, vous serez associé à un joueur X différent à chaque période. A nouveau, le joueur X avec qui vous serez associé changera à chaque période, de telle façon que vous ne jouerez jamais deux fois avec le même joueur X.

En tant que joueur X, vous recevrez une allocation de 100 ECU pour compenser vos pertes éventuelles. Cette allocation ne s'appliquera pas au joueur Y.

Le joueur X prend les décisions pour le binôme XY. Les gains/pertes des deux joueurs X et Y vont dépendre uniquement des décisions prises par le joueur X. Au début de chaque période, le joueur X recevra une dotation de **80 ECU**. Le joueur Y recevra une dotation de **90 ECU**.

13 ECU sont équivalents à 1 EURO.

La suite des instructions détaille les décisions que vous devrez prendre **en tant que joueur X**.

Durant les 10 périodes de jeu, les gains des joueurs X et Y vont dépendre :

→ de l'investissement I du joueur X

→ du résultat d'un tirage au sort d'une boule dans une urne composée de 100 boules de couleur jaune et bleue.

Votre couleur gagnante choisie au début des jeux précédents restera la même pour ce jeu.

Investissement du joueur X:

Pour chacune des 10 périodes, le joueur X peut décider d'investir soit 0, 20, 40, 60 ou 80 ECU. Le montant investi va déterminer la composition de boules jaunes et bleues dans l'urne (voir tableau ci-dessous). Plus le montant investi sera élevé, plus le nombre de boules de la couleur gagnante sera élevé dans l'urne. L'investissement I va également engendrer un coût pour le joueur X, *coût qui sera égal au montant de l'investissement I .*

Gains des joueurs X et Y:

- Si la boule tirée au sort n'est pas de la couleur gagnante, alors le joueur Y perdra sa dotation de 90 ECU. Dans ce cas, le joueur X devra compenser la perte du joueur Y. Cependant, le montant de compensation payé par X est égal à sa dotation moins son coût d'investissement ($80 \text{ ECU} - I$). Le joueur Y recevra le montant de compensation du joueur X. Le gain du joueur X sera égal à 0 ECU.
- Si la boule tirée au sort est de la couleur gagnante du joueur X, alors le joueur X recevra un montant égal à sa dotation de 80 ECU moins son coût d'investissement. Le joueur Y gardera alors sa dotation de 90 ECU.

Le tableau ci-dessous montre un exemple avec la couleur gagnante **JAUNE**. Le tableau présente tous les gains possibles pour les deux joueurs X et Y selon l'investissement du joueur X.

		Investissement <i>I</i>				
		0 ECU	20 ECU	40 ECU	60 ECU	80 ECU
Votre couleur gagnante est le JAUNE	Composition de l'urne					
	Nombre de boules jaunes sur 100 boules	13	41	62	78	91
	Nombre de boules bleues sur 100 boules	87	59	38	22	9
Gain du joueur X	<i>Si une boule jaune est tirée au sort</i>	80 ECU	60 ECU	40 ECU	20 ECU	0 ECU
	<i>Si une boule bleue est tirée au sort</i>	0 ECU	0 ECU	0 ECU	0 ECU	0 ECU
Gain du joueur Y	<i>Si une boule jaune est tirée au sort</i>	90 ECU	90 ECU	90 ECU	90 ECU	90 ECU
	<i>Si une boule bleue est tirée au sort</i>	80 ECU	60 ECU	40 ECU	20 ECU	0 ECU

Exemple :

Imaginons que votre couleur gagnante soit le JAUNE.

Si vous investissez **0 ECU**, l'urne sera composée de 13 boules jaunes et 87 boules bleues. La probabilité qu'une boule jaune soit tirée au sort sera donc égale à 13% et à 87% pour la boule bleue.

Si une boule bleue est tirée au sort, alors *le gain du joueur X* sera égal à **0 ECU**. Le joueur Y perdra sa dotation et sera compensé par le joueur X. Le montant de compensation correspond à la dotation moins le coût d'investissement du joueur X. *Le gain du joueur Y* est égal à **80 ECU** ($80 \text{ ECU} - 0 \text{ ECU}$).

Si une boule jaune est tirée au sort, alors *le gain du joueur X* sera égal à **80 ECU**. Ce montant correspond à la dotation moins le coût d'investissement du joueur X ($80 \text{ ECU} = 80 \text{ ECU} - 0 \text{ ECU}$). *Le gain du joueur Y* est égal à **90 ECU**.

Notez que, toutes les périodes seront indépendantes les unes des autres ainsi que les tirages.

Historique du jeu:

En début de chaque période, vous aurez accès à l'historique du jeu. Celui-ci vous rappelle, pour chaque période passée, l'ensemble de vos décisions, le résultat du tirage au sort ainsi que le gain du joueur X et du joueur Y.

Résumé du déroulement du jeu :

- Chaque participant prendra ses décisions comme étant un joueur X, et ne connaîtra son rôle (X ou Y) qu'à la fin de l'expérience.
- Le joueur X recevra une allocation de 100 ECU pour compenser ses pertes éventuelles. Cette allocation ne s'appliquera pas au joueur Y.
- Le joueur X reçoit à chaque période une dotation de 80 ECU et le joueur Y reçoit 90 ECU.
- Les décisions du joueur X déterminent les gains du joueur X et du joueur Y.
- Le montant investi par le joueur X va déterminer le nombre de boules jaunes et bleues dans l'urne.
- Plus le montant investi sera élevé, plus le nombre de boules de votre couleur gagnante sera élevé dans l'urne.
- Si la boule tirée au sort est de la couleur gagnante, le gain du joueur X est égal à sa dotation moins le coût d'investissement ($80 \text{ ECU} - I$). Le gain du joueur Y sera égal à 90 ECU.
- Si la boule tirée au sort n'est pas la couleur gagnante, le gain du joueur X est égal à 0 ECU. Le gain du joueur Y sera égal à la dotation moins le coût d'investissement du joueur X ($80 \text{ ECU} - I$).

Païement:

A la fin de ce quatrième jeu, l'ordinateur vous informera si vous êtes un joueur X ou Y. Un participant présent dans la salle sera également désigné au hasard par un expérimentateur pour tirer au sort une période qui déterminera le paiement pour le jeu 4. Il annoncera à voix haute la période sélectionnée aux autres participants.

Si vous êtes désigné comme joueur X, alors votre gain pour ce quatrième jeu va dépendre de la décision d'investissement que vous avez prise au cours de la période sélectionnée. Si vous êtes désigné comme joueur Y, alors votre gain pour ce quatrième jeu va dépendre de la décision d'investissement prise par le joueur X avec lequel vous avez été associé au cours de la période sélectionnée.

Votre gain total pour l'expérience sera la somme de vos gains obtenus dans le premier, deuxième, troisième et quatrième jeu.

Avant le début du jeu, des questions vous seront posées afin de vérifier votre bonne compréhension des instructions.

Traitement : Ambiguïté et règle illimitée

Quatrième jeu de l'expérience:

Cadre général du jeu:

Le quatrième jeu est constitué de 10 périodes. Durant chaque période vous devrez prendre une décision. Les 10 périodes se dérouleront de la même manière. **Tous les participants prendront leurs décisions en tant que joueur X.**

Cependant, **à la fin de ce quatrième jeu**, on vous informera si vous étiez **joueur X** ou **joueur Y**. Vous ne pourrez donc pas connaître votre rôle avant la fin du jeu.

Vous conserverez votre rôle durant les 10 périodes. Si vous étiez joueur X, à chaque période vous serez associé à un joueur Y différent présent dans la salle. En aucun cas, vous ne jouerez deux fois avec le même joueur Y. De-même, si vous étiez joueur Y, vous serez associé à un joueur X différent à chaque période. A nouveau, le joueur X avec qui vous serez associé changera à chaque période, de telle façon que vous ne jouerez jamais deux fois avec le même joueur X.

En tant que joueur X, vous recevrez une allocation de 100 ECU pour compenser vos pertes éventuelles. Cette allocation ne s'appliquera pas au joueur Y.

Le joueur X prend les décisions pour le binôme XY. Les gains/pertes des deux joueurs X et Y vont dépendre uniquement des décisions prises par le joueur X. Au début de chaque période, le joueur X recevra une dotation de **80 ECU**. Le joueur Y recevra une dotation de **90 ECU**.

13 ECU sont équivalents à 1 EURO.

La suite des instructions détaille les décisions que vous devrez prendre **en tant que joueur X**.

Durant les 10 périodes du jeu, les gains des joueurs X et Y vont dépendre :

→ de l'investissement I du joueur X

→ du résultat d'un premier tirage au sort d'une urne dans une boîte composée de 100 urnes différentes : Urne A, urne B, urne C, urne D et urne E.

→ du résultat d'un deuxième tirage au sort d'une boule dans l'urne (tirée au sort précédemment), composée de 100 boules de couleur jaune et bleue

Votre couleur gagnante choisie au début des jeux précédents restera la même pour ce jeu.

Tirage au sort:

Les gains du joueur X et Y vont dépendre des résultats de **deux tirages** au sort :

- Le tirage d'une urne provenant d'une boîte composée de 100 urnes dont le nombre d'urne A, urne B, urne C, urne D et urne E vous est inconnu. La boîte peut donc contenir de 0 à 100 urnes A, 0 à 100 urnes B, 0 à 100 urnes C, 0 à 100 urnes D et 0 à 100 urnes E.
- Le tirage d'une boule provenant de l'urne qui a été tirée au sort dans la boîte.

Les cinq urnes seront composées chacune de 100 boules de couleur jaune ou bleue. Le nombre de boules jaunes et bleues sera différent dans chacune des cinq urnes.

Un premier tirage au sort dans la boîte va donc déterminer l'urne, et un second tirage au sort dans cette urne va déterminer si la boule tirée au sort sera de la couleur gagnante.

Vous recevrez une information concernant l'urne C. Vous serez libre de prendre en compte, ou non, cette information. En aucun cas, cette information n'influencera la composition des différentes urnes (A, B, C, D et E) dans la boîte. C'est donc à VOUS de décider si vous accorder votre confiance à cette information.

Investissement du joueur X:

Pour chacune des 10 périodes, le joueur X peut décider d'investir soit 0, 20, 40, 60 ou 80 ECU. Le montant investi va déterminer le nombre de boules jaunes et bleues présentes dans l'urne (voir tableau en annexe). Plus le montant investi sera élevé, plus le nombre de boules de la couleur gagnante sera élevé dans l'urne. L'investissement I va également engendrer un coût pour le joueur X, ce coût sera égal au montant de l'investissement I .

Gains/pertes des joueurs X et Y:

- Si la boule tirée au sort n'est pas de la même couleur que votre couleur gagnante, le joueur Y perdra sa dotation de 90 ECU mais cette perte sera entièrement compensée par le joueur X. Le joueur X subira une perte qui sera égale à sa dotation de 80 ECU moins son coût d'investissement moins la compensation versée au joueur Y ($80 \text{ ECU} - I - 90 \text{ ECU}$).
- Si la boule tirée au sort est de la même couleur que votre couleur gagnante, le joueur X recevra un montant égal à sa dotation de 80 ECU moins son coût d'investissement ($80 \text{ ECU} - I$) et le joueur Y gardera sa dotation de 90 ECU.

Le tableau en annexe montre un exemple avec la couleur gagnante **JAUNE**. Le tableau présente tous les gains/pertes possibles pour les deux joueurs X et Y selon l'investissement du joueur X.

Exemple :

Imaginons que votre couleur gagnante soit le JAUNE (voir tableau en annexe).

Si vous investissez **0 ECU**, l'urne A sera composée de 3 boules jaunes et 97 boules bleues, l'urne B sera composée de 8 boules jaunes et 92 boules bleues, l'urne C sera composée de 13 boules jaunes et 87 boules bleues, l'urne D sera composée de 18 boules jaunes et 82 boules bleues, et l'urne E sera composée de 23 boules jaunes et 77 boules bleues. La probabilité qu'une boule jaune soit tirée au sort sera donc égale à 3%, 8%, 13%, 18% ou 23% si

l'urne A, B, C, D ou E est tirée au sort respectivement. De même, la probabilité qu'une boule bleue soit tirée au sort sera respectivement de 97%, 92%, 87%, 82% ou 77% si l'urne A, B, C, D ou E est respectivement tirée au sort.

Si une boule bleue est tirée au sort, alors *le joueur X* subira une perte de **-10 ECU**. Ce montant correspond à la dotation du joueur X moins son coût d'investissement moins le montant de la compensation versée au joueur Y ($-10 \text{ ECU} = 80 \text{ ECU} - 0 \text{ ECU} - 90 \text{ ECU}$). *Le gain du joueur Y* sera égal à **90 ECU**.

Si une boule jaune est tirée au sort, alors *le gain du joueur X* sera égal à **80 ECU**. Ce montant correspond à la dotation du joueur X moins son coût d'investissement ($80 \text{ ECU} = 80 \text{ ECU} - 0 \text{ ECU}$). *Le gain de joueur Y* sera égal à **90 ECU**.

Notez que, toutes les périodes, de même que les tirages, seront indépendants les uns des autres.

Historique du jeu:

En début de chaque période, vous aurez accès à l'historique du jeu. Celui-ci vous rappelle, pour chaque période passée, l'ensemble de vos décisions, le résultat du tirage au sort ainsi que le gain du joueur X et du joueur Y.

Résumé du déroulement du jeu:

- Chaque participant prendra ses décisions comme étant un joueur X, et ne connaîtra son rôle (X ou Y) qu'à la fin de l'expérience.
- Le joueur X recevra une allocation de 100 ECU pour compenser ses pertes éventuelles. Cette allocation ne s'appliquera pas au joueur Y.
- Le joueur X reçoit à chaque période une dotation de 80 ECU et le joueur Y reçoit 90 ECU.
- Les décisions du joueur X déterminent les gains/pertes du joueur X et du joueur Y.
- Le montant investi par le joueur X va déterminer le nombre de boules jaunes et bleues dans les cinq urnes.
- Le nombre de boules jaunes et bleues sera différent dans chacune des cinq urnes.
- Plus le montant investi sera élevé, plus le nombre de boules de votre couleur gagnante sera élevé pour chacune des cinq urnes.
- Les gains du joueur X et Y vont dépendre de deux tirages au sort.
- Une urne sera d'abord tirée au sort dans une boîte composée de 100 urnes dont le nombre d'urne A, urne B, urne C, urne D et urne E vous est inconnu.
- Vous recevrez une information concernant l'urne C.
- Vous serez libre de prendre en compte, ou non, cette information.
- Cette information n'influencera pas la composition des différentes urnes (A, B, C, D et E) dans la boîte.
- Si la boule tirée au sort est de la même couleur que votre couleur gagnante, le gain du joueur X sera égal à sa dotation moins son coût d'investissement ($80 \text{ ECU} - I$). Le gain du joueur Y sera égal à 90 ECU.
- Si la boule tirée au sort n'est pas de la même couleur que votre couleur gagnante, le joueur X subira une perte qui sera égale à sa dotation moins son coût d'investissement moins le montant de la compensation versée par le joueur X au joueur Y ($80 \text{ ECU} - I - 90 \text{ ECU}$). Le gain du joueur Y sera égal à 90 ECU.

Païement

A la fin de ce quatrième jeu, l'ordinateur vous informera si vous êtes un joueur X ou Y. Un participant présent dans la salle sera également désigné au hasard par un expérimentateur pour tirer au sort une période qui déterminera le paiement pour le jeu 4. Il annoncera à voix haute la période sélectionnée aux autres participants.

Si vous êtes désigné comme joueur X, alors votre gain pour ce quatrième jeu va dépendre de la décision d'investissement que vous avez prise au cours de la période sélectionnée. Si vous êtes désigné comme joueur Y, alors votre gain pour ce quatrième jeu va dépendre de la décision d'investissement prise par le joueur X avec lequel vous avez été associé au cours de la période sélectionnée.

Votre gain total pour l'expérience sera la somme de vos gains obtenus dans le premier, deuxième, troisième et quatrième jeu.

Avant le début du jeu, des questions vous seront posées afin de vérifier votre bonne compréhension des instructions.

ANNEXE

Le tableau ci-dessous montre un exemple avec une couleur gagnante JAUNE. Le tableau présente tous les gains/pertes possibles pour les deux joueurs X et Y selon l'investissement du joueur X.

Votre couleur gagnante est le JAUNE		0 ECU					Investissement /					20 ECU					40 ECU				
		Urne A	Urne B	Urne C	Urne D	Urne E	Urne A	Urne B	Urne C	Urne D	Urne E	Urne A	Urne B	Urne C	Urne D	Urne E					
Composition de l'urne	Nombre de boules jaunes sur 100 boules	3	8	13	18	23	34	38	41	45	48	56	59	62	65	67					
	Nombre de boules bleues sur 100 boules	97	92	87	82	77	66	62	59	55	52	44	41	38	35	33					
Gain du joueur X	Si une boule jaune est tirée au sort	80 ECU					60 ECU					40 ECU									
	Si une boule bleue est tirée au sort	-10 ECU					-30 ECU					-50 ECU									
Gain du joueur Y	Si une boule jaune est tirée au sort	90 ECU					90 ECU					90 ECU									
	Si une boule bleue est tirée au sort	90 ECU					90 ECU					90 ECU									
Votre couleur gagnante est le JAUNE		60 ECU					Investissement /					80 ECU					En tant que joueur X, vous recevrez une allocation de 100 ECU qui compensera vos pertes éventuelles. Cette allocation ne s'appliquera pas au joueur Y.				
		Urne A	Urne B	Urne C	Urne D	Urne E	Urne A	Urne B	Urne C	Urne D	Urne E	Urne A	Urne B	Urne C	Urne D	Urne E					
Composition de l'urne	Nombre de boules jaunes sur 100 boules	74	76	78	80	82	87	89	91	92	94	13	11	9	8	6					
	Nombre de boules bleues sur 100 boules	26	24	22	20	18	13	11	9	8	6	87	89	91	92	94					
Gain du joueur X	Si une boule jaune est tirée au sort	20 ECU					0 ECU														
	Si une boule bleue est tirée au sort	-70 ECU					-90 ECU														
Gain du joueur Y	Si une boule jaune est tirée au sort	90 ECU					90 ECU														
	Si une boule bleue est tirée au sort	90 ECU					90 ECU														

Traitement : Ambiguïté et règle limitée

Quatrième jeu de l'expérience:

Cadre général du jeu:

Le quatrième jeu est constitué de 10 périodes. Durant chaque période vous devrez prendre une décision. Les 10 périodes se dérouleront de la même manière. **Tous les participants prendront leurs décisions en tant que joueur X.**

Cependant, **à la fin de ce quatrième jeu**, on vous informera si vous étiez **joueur X** ou **joueur Y**. Vous ne pourrez donc pas connaître votre rôle avant la fin du jeu.

Vous conserverez votre rôle durant les 10 périodes. Si vous étiez joueur X, à chaque période vous serez associé à un joueur Y différent présent dans la salle. En aucun cas, vous ne jouerez deux fois avec le même joueur Y. De-même, si vous étiez joueur Y, vous serez associé à un joueur X différent à chaque période. A nouveau, le joueur X avec qui vous serez associé changera à chaque période, de telle façon que vous ne jouerez jamais deux fois avec le même joueur X.

En tant que joueur X, vous recevrez une allocation de 100 ECU pour compenser vos pertes éventuelles. Cette allocation ne s'appliquera pas au joueur Y.

Le joueur X prend les décisions pour le binôme XY. Les gains/pertes des deux joueurs X et Y vont dépendre uniquement des décisions prises par le joueur X. Au début de chaque période, le joueur X recevra une dotation de **80 ECU**. Le joueur Y recevra une dotation de **90 ECU**.

13 ECU sont équivalents à 1 EURO.

La suite des instructions détaille les décisions que vous devrez prendre **en tant que joueur X**.

Durant les 10 périodes du jeu, les gains des joueurs X et Y vont dépendre :

→ de l'investissement I du joueur X

→ du résultat d'un premier tirage au sort d'une urne dans une boîte composée de 100 urnes différentes : Urne A, urne B, urne C, urne D et urne E.

→ du résultat d'un deuxième tirage au sort d'une boule dans l'urne (tirée au sort précédemment), composée de 100 boules de couleur jaune et bleue

Votre couleur gagnante choisie au début des jeux précédents restera la même pour ce jeu.

Tirage au sort:

Les gains du joueur X et Y vont dépendre des résultats de **deux tirages** au sort :

- Le tirage d'une urne provenant d'une boîte composée de 100 urnes dont le nombre d'urne A, urne B, urne C, urne D et urne E vous est inconnu. La boîte peut donc contenir de 0 à 100 urnes A, 0 à 100 urnes B, 0 à 100 urnes C, 0 à 100 urnes D et 0 à 100 urnes E.
- Le tirage d'une boule provenant de l'urne qui a été tirée au sort dans la boîte.

Les cinq urnes seront composées chacune de 100 boules de couleur jaune ou bleue. Le nombre de boules jaunes et bleues sera différent dans chacune des cinq urnes.

Un premier tirage au sort dans la boîte va donc déterminer l'urne et un second tirage au sort dans cette urne va déterminer si la boule tirée au sort sera de la couleur gagnante.

Vous recevrez une information concernant l'urne C. Vous serez libre de prendre en compte, ou non, cette information. En aucun cas, cette information n'influencera la composition des différentes urnes (A, B, C, D et E) dans la boîte. C'est donc à VOUS de décider si vous accorder votre confiance à cette information.

Investissement du joueur X:

Pour chacune des 10 périodes, le joueur X peut décider d'investir soit 0, 20, 40, 60 ou 80 ECU. Le montant investi va déterminer le nombre de boules jaunes et bleues présentes dans l'urne (voir tableau en annexe). Plus le montant investi sera élevé, plus le nombre de boules de la couleur gagnante sera élevé dans l'urne. L'investissement I va également engendrer un coût pour le joueur X, ce coût sera égal au montant de l'investissement I .

Gains des joueurs X et Y:

- Si la boule tirée au sort n'est pas de la même couleur que votre couleur gagnante, alors le joueur Y perdra sa dotation de 90 ECU. Dans ce cas, le joueur X devra compenser une partie des pertes du joueur Y. Le montant de la compensation payé par le joueur X est égal à sa dotation moins son coût d'investissement ($80 \text{ ECU} - I$). Le joueur Y recevra le montant de cette compensation versée par le joueur X. Le gain du joueur X sera égal à 0 ECU.
- Si la boule tirée au sort est de la même couleur que votre couleur gagnante, alors le joueur X recevra un montant égal à sa dotation de 80 ECU moins son coût d'investissement. Le joueur Y gardera alors sa dotation de 90 ECU.

Le tableau en annexe montre un exemple avec la couleur gagnante **JAUNE**. Le tableau présente tous les gains possibles pour les deux joueurs X et Y selon l'investissement du joueur X.

Exemple :

Imaginons que votre couleur gagnante soit le JAUNE (voir tableau en annexe).

Si vous investissez **0 ECU**, l'urne A sera composée de 3 boules jaunes et 97 boules bleues, l'urne B sera composée de 8 boules jaunes et 92 boules bleues, l'urne C sera composée de 13 boules jaunes et 87 boules bleues, l'urne D sera composée de 18 boules jaunes et 82 boules bleues, et l'urne E sera composée de 23 boules jaunes et 77 boules bleues. La probabilité qu'une boule jaune soit tirée au sort sera donc égale à 3%, 8%, 13%, 18% ou 23% si

l'urne A, B, C, D ou E est tirée au sort respectivement. De même, la probabilité qu'une boule bleue soit tirée au sort sera respectivement de 97%, 92%, 87%, 82% ou 77% si l'urne A, B, C, D ou E est respectivement tirée au sort.

Si une boule bleue est tirée au sort, alors *le gain du joueur X* sera égal à **0 ECU**. Le joueur Y perdra sa dotation qui sera en partie compensée par le joueur X. Le montant de la compensation est égal à sa dotation moins le coût d'investissement du joueur X. *Le gain du joueur Y* est égal à **80 ECU** ($80 \text{ ECU} = 80 \text{ ECU} - 0 \text{ ECU}$).

Si une boule jaune est tirée au sort, alors *le gain du joueur X* sera égal à **80 ECU**. Ce montant correspond à sa dotation moins le coût d'investissement du joueur X ($80 \text{ ECU} = 80 \text{ ECU} - 0 \text{ ECU}$). *Le gain du joueur Y* est égal à **90 ECU**.

Notez que, toutes les périodes seront indépendantes les unes des autres ainsi que les tirages.

Historique du jeu:

En début de chaque période, vous aurez accès à l'historique du jeu. Celui-ci vous rappelle, pour chaque période passée, l'ensemble de vos décisions, le résultat du tirage au sort ainsi que le gain du joueur X et du joueur Y.

Résumé du déroulement du jeu :

- Chaque participant prendra ses décisions comme étant un joueur X, et ne connaîtra son rôle (X ou Y) qu'à la fin de l'expérience.
- Le joueur X recevra une allocation de 100 ECU pour compenser ses pertes éventuelles. Cette allocation ne s'appliquera pas au joueur Y.
- Le joueur X reçoit à chaque période une dotation de 80 ECU et le joueur Y reçoit 90 ECU.
- Les décisions du joueur X déterminent les gains du joueur X et du joueur Y.
- Le montant investi par le joueur X va déterminer le nombre de boules jaunes et bleues dans les cinq urnes.
- Le nombre de boules jaunes et bleues sera différent dans chacune des cinq urnes.
- Plus le montant investi sera élevé, plus le nombre de boules de votre couleur gagnante sera élevé pour chacune des cinq urnes.
- Les gains du joueur X et Y vont dépendre de deux tirages au sort.
- Une urne sera d'abord tirée au sort dans une boîte composée de 100 urnes dont le nombre d'urne A, urne B, urne C, urne D et urne E vous est inconnu.
- Vous recevrez une information concernant l'urne C.
- Vous serez libre de prendre en compte, ou non, cette information.
- Cette information n'influencera pas la composition des différentes urnes (A, B, C, D et E) dans la boîte.
- Si la boule tirée au sort est de la même couleur que votre couleur gagnante, le gain du joueur X est égal à sa dotation moins son coût d'investissement ($80 \text{ ECU} - I$). Le gain du joueur Y sera égal à 90 ECU.
- Si la boule tirée au sort n'est de la même couleur que votre couleur gagnante, le gain du joueur X est égal à 0 ECU. Le gain du joueur Y sera égal à sa dotation moins le coût d'investissement du joueur X ($80 \text{ ECU} - I$).

Païement

A la fin de ce quatrième jeu, l'ordinateur vous informera si vous êtes un joueur X ou Y. Un participant présent dans la salle sera également désigné au hasard par un expérimentateur pour tirer au sort une période qui déterminera le paiement pour le jeu 4. Il annoncera à voix haute la période sélectionnée aux autres participants.

Si vous êtes désigné comme joueur X, alors votre gain pour ce quatrième jeu va dépendre de la décision d'investissement que vous avez prise au cours de la période sélectionnée. Si vous êtes désigné comme joueur Y, alors votre gain pour ce quatrième jeu va dépendre de la décision d'investissement prise par le joueur X avec lequel vous avez été associé au cours de la période sélectionnée.

Votre gain total pour l'expérience sera la somme de vos gains obtenus dans le premier, deuxième, troisième et quatrième jeu.

Avant le début du jeu, des questions vous seront posées afin de vérifier votre bonne compréhension des instructions.

ANNEXE

Le tableau ci-dessous montre un exemple avec une couleur gagnante **JAUNE**. Le tableau présente tous les gains possibles pour les deux joueurs X et Y selon l'investissement du joueur X.

Votre couleur gagnante est le JAUNE		Investissement I														
		0 ECU					20 ECU					40 ECU				
		Urne A	Urne B	Urne C	Urne D	Urne E	Urne A	Urne B	Urne C	Urne D	Urne E	Urne A	Urne B	Urne C	Urne D	Urne E
Composition de l'urne	Nombre de boules jaunes sur 100 boules	3	8	13	18	23	34	38	41	45	48	56	59	62	65	67
	Nombre de boules bleues sur 100 boules	97	92	87	82	77	66	62	59	55	52	44	41	38	35	33
Gain du joueur X	Si une boule jaune est tirée au sort	80 ECU					60 ECU					40 ECU				
	Si une boule bleue est tirée au sort	0 ECU					0 ECU					0 ECU				
Gain du joueur Y	Si une boule jaune est tirée au sort	90 ECU					90 ECU					90 ECU				
	Si une boule bleue est tirée au sort	80 ECU					60 ECU					40 ECU				
Votre couleur gagnante est le JAUNE		Investissement I														
		60 ECU					80 ECU					En tant que joueur X vous recevrez une allocation de 100 ECU. Cette allocation ne s'appliquera pas au joueur Y.				
		Urne A	Urne B	Urne C	Urne D	Urne E	Urne A	Urne B	Urne C	Urne D	Urne E					
Composition de l'urne	Nombre de boules jaunes sur 100 boules	74	76	78	80	82	87	89	91	92	94					
	Nombre de boules bleues sur 100 boules	26	24	22	20	18	13	11	9	8	6					
Gain du joueur X	Si une boule jaune est tirée au sort	20 ECU					0 ECU									
	Si une boule bleue est tirée au sort	0 ECU					0 ECU									
Gain du joueur Y	Si une boule jaune est tirée au sort	90 ECU					90 ECU									
	Si une boule bleue est tirée au sort	20 ECU					0 ECU									

B.3 Questionnaire in French

Post-Questionnaire

Q1 : Diriez-vous que la plupart du temps les personnes essaient de s'entraider, ou qu'elles suivent uniquement leur propre intérêt ?

Aider les autres							Suivre uniquement son propre intérêt	
0	1	2	3	4	5	6		
○	○	○	○	○	○	○	○	○

Q2 : Diriez-vous que la plupart du temps vous essayez d'aider les autres, ou que vous suivez votre propre intérêt ?

Aider les autres							Suivre uniquement son propre intérêt	
0	1	2	3	4	5	6		
○	○	○	○	○	○	○	○	○

Dans les questions qui suivent nous sommes intéressés par la façon dont vous percevez l'injustice. En utilisant l'échelle ci-dessous, veuillez indiquer pour chacun des énoncés suivants, dans quelle mesure vous êtes d'accord avec ces phrases (0="totalement d'accord" et 6="Pas du tout d'accord"):

Q3 : J'ai le sentiment que les gens méritent généralement les récompenses qu'ils obtiennent et les punitions auxquelles ils font face dans la société.

Q4 : Les personnes récoltent en général ce qu'ils sèment.

Q5 : Les personnes méritent généralement ce qu'elles reçoivent.

Q6 : J'ai le sentiment que les gens obtiennent habituellement des résultats en accord avec leurs choix.

Dans les questions qui suivent nous sommes intéressés par la façon dont vous percevez l'injustice à votre encontre. En utilisant l'échelle ci-dessous, veuillez indiquer pour chacun des énoncés suivants, dans quelle mesure vous êtes d'accord avec ces phrases (0="totalement d'accord" et 6="Pas du tout d'accord"):

0	1	2	3	4	5	6
○	○	○	○	○	○	○

Q7 : J'ai le sentiment que je mérite les récompenses que j'obtiens en général et les punitions auxquelles je dois faire face dans la société.

Q8 : Je récolte en général ce que je sème.

Q9 : Je mérite généralement ce que je reçois.

Q10 : J'ai le sentiment que j'obtiens habituellement des résultats en accord avec mes choix.

Q11 : Êtes-vous généralement une personne qui prend des risques ou essayez-vous de les éviter? Veuillez cocher une case sur l'échelle ci-dessous, où 0 signifie "cherche toujours à éviter les risques" et 10 signifie "prêt à prendre des risques".

Cherche toujours à éviter les risques											Prêt à prendre des risques
0	1	2	3	4	5	6	7	8	9	10	
<input type="radio"/>	<input type="radio"/>	<input type="radio"/>	<input type="radio"/>	<input type="radio"/>	<input type="radio"/>	<input type="radio"/>	<input type="radio"/>	<input type="radio"/>	<input type="radio"/>	<input type="radio"/>	<input type="radio"/>

Les personnes peuvent se comporter de façon différente selon les situations.

Comment évaluez-vous votre disposition à prendre des risques dans les situations suivantes?

	0	1	2	3	4	5	6	7	8	9	10
Q12 : en conduisant?	<input type="radio"/>	<input type="radio"/>	<input type="radio"/>	<input type="radio"/>	<input type="radio"/>	<input type="radio"/>	<input type="radio"/>	<input type="radio"/>	<input type="radio"/>	<input type="radio"/>	<input type="radio"/>
Q13 : dans les investissements financiers?	<input type="radio"/>	<input type="radio"/>	<input type="radio"/>	<input type="radio"/>	<input type="radio"/>	<input type="radio"/>	<input type="radio"/>	<input type="radio"/>	<input type="radio"/>	<input type="radio"/>	<input type="radio"/>
Q14 : pendant les loisirs et le sport?	<input type="radio"/>	<input type="radio"/>	<input type="radio"/>	<input type="radio"/>	<input type="radio"/>	<input type="radio"/>	<input type="radio"/>	<input type="radio"/>	<input type="radio"/>	<input type="radio"/>	<input type="radio"/>
Q15 : dans votre travail?	<input type="radio"/>	<input type="radio"/>	<input type="radio"/>	<input type="radio"/>	<input type="radio"/>	<input type="radio"/>	<input type="radio"/>	<input type="radio"/>	<input type="radio"/>	<input type="radio"/>	<input type="radio"/>
Q16 : avec votre santé?	<input type="radio"/>	<input type="radio"/>	<input type="radio"/>	<input type="radio"/>	<input type="radio"/>	<input type="radio"/>	<input type="radio"/>	<input type="radio"/>	<input type="radio"/>	<input type="radio"/>	<input type="radio"/>
Q17 : dans vos relations avec les autres?	<input type="radio"/>	<input type="radio"/>	<input type="radio"/>	<input type="radio"/>	<input type="radio"/>	<input type="radio"/>	<input type="radio"/>	<input type="radio"/>	<input type="radio"/>	<input type="radio"/>	<input type="radio"/>

Veuillez considérer ce que vous feriez dans la situation suivante: Imaginez que vous avez gagné 100,000 Euros à la loterie. Presque immédiatement après avoir récupéré vos gains, vous recevez l'offre financière suivante de la part d'une banque réputée, les conditions sont les suivantes: Il y a une chance de doubler l'argent dans les deux ans. Il est également possible que vous perdiez la moitié du montant investi. Vous avez la possibilité d'investir tout l'argent que vous avez, une partie de cet argent ou de refuser l'offre.

Q18 : Quel part de vos gains à la loterie êtes-vous prêt à investir dans cet investissement lucratif mais néanmoins risqué?

100.000 Euros

- O 80.000 Euros
- O 60.000 Euros
- O 40.000 Euros
- O 20.000 Euros
- O Rien, je déclinerai l'offre

Veillez indiquer pour chacun des énoncés suivants, dans quelle mesure vous êtes d'accord ou pas d'accord.

Echelle (1=Pas du tout d'accord ; 2=Pas d'accord ; 3=Ni d'accord ni pas d'accord ; 4=D'accord ; 5=Totalement d'accord)

Q19 : Dans des périodes incertaines, je m'attends généralement à ce que ça se passe bien

Q20 : Il est facile pour moi de me détendre

Q21 : Si quelque chose peut tourner à mon désavantage, ce sera le cas

Q22 : Je suis toujours optimiste à propos de mon avenir

Q23 : J'apprécie beaucoup mes amis

Q24 : Il est important pour moi de rester occupé

Q25 : Je m'attends rarement à ce que les choses aillent dans mon sens

Q26 : Je ne me vexe pas facilement

Q27 : Je m'attends rarement à ce que de bonnes choses m'arrivent

Q28 : En général, je m'attends à ce qu'il m'arrive plus de bonnes que de mauvaises choses

Q29 : Dans l'avenir, la société fonctionnera au moins aussi bien qu'aujourd'hui.

Q30 : Notre société est capable de résoudre les problèmes futurs.

Q31 : La sûreté et la sécurité futures de notre population sont assurées.

Q32 : Notre société a un avenir prometteur.

Q33 : Aujourd'hui, les choses semblent devenir de plus en plus incontrôlables.

Q34 : Nous vivons dans un monde sûr et sécurisé.

Q35 : La plupart des gens mentent quand ils peuvent en tirer un bénéfice.

Q36 : Ceux qui se consacrent aux causes altruistes sont souvent exploités par d'autres.

Q37 : Certaines personnes ne coopèrent pas parce qu'elles poursuivent uniquement leur propre intérêt à court terme. Par conséquent, les actions qui pourraient être menées à bien si les gens coopéraient échouent souvent à cause de personnes non coopératives.

Q38 : En général, les gens sont honnêtes.

Q39 : Il y aura davantage de personnes qui ne travailleront pas si la protection sociale se développe plus.

Merci d'avoir participé à cette expérience. Veuillez rester assis jusqu'à ce qu'un expérimentateur vous appelle.

Part II

Ex-Post Risk Management

Introduction to part II

The second part of the thesis devotes particularly attention to *ex-post* risk management strategies to cope with realized losses after the risk has materialized. In general, *ex-post* risk management measures deal with control audits or the design of flexible reactive schemes that involve problems after the materialization of the risks. In particular, the inherent risks of novel technologies can hardly be evaluated before their implementation. Therefore, *ex-ante* risk mitigation measures are usually not or only scarce available to protect against expected losses. An *ex-post* risk analysis can be used to better understand the likelihood and the intensity of the inherent risks in order that more effective risk mitigation instruments could be developed to reduce potential losses.

This part of the thesis takes up the issue of the environmental energy transition in France and refers essentially to the energy economics literature by focusing on the insurability of the energy performance of low energy buildings.

The main objective of the second part of the thesis strives to quantify the frequency and the severity of not achieving the required target of the energy performance subject to low energy buildings after carrying out energy efficiency upgrades. More precisely, we intend to make the unknown risks insurable so that investors, energy companies and owners can be protected in the future against extensive losses induced by energy shortcomings. The concrete idea about the frequency of the emerging risks and the size of realized losses helps establishing insurance coverage and financial conditions to fund new innovative projects, such as national-wide energy conservation programs. This part is essential to deliver an answer to the question about which key determinants, such as building shell properties, household and sociodemographic characteristics or energy-related behavior are affecting the energy performance gap (energy deficits).

The energy performance gap captures the difference between *ex-ante* calculated and *ex-post* measured energy savings related to energy efficiency initiatives. In the following chapters we refer to energy conservation program, "*Je rénove BBC*", a pilot project supported by the "*Energie de France*" (EDF) and the "*Regional Authority of Alsace*" (Région Alsace) in the upper and lower region of Alsace. The pilot program permits us to pursue the *ex-post* risk analysis.

Chapter 4 outlines the energy efficiency target at the European and French national level while identifying the emerging risks and the existing gap in the insurance market in the green renovation sector. This chapter outlines the problem of ambiguity about the non-achievement of the energy performance of existing buildings after energy efficiency upgrades. Furthermore, it concentrates on a literature review of the utmost achievements in the field of energy economics.

Chapter 5 explains the household survey conducted from April 2015 until July 2016 to gather information on billing data, household's characteristics and energy-related behavior. In overall, 595 households request to undertake retrofit measures on their dwelling according to the program criterion. Until now, 215 dwellings have completed their retrofit and were eligible for the survey. Furthermore, we merge survey data with data from prescribed thermal studies, including information on the building shell, heating system and *ex-ante* engineering estimates of the energy consumption in terms of pre- and post-energy efficiency measures. The database is unique and novel in France as we consider the total energy consumption according to the French thermal regulation¹, known in France as "*Réglementation thermique*" (RT 2005, RT 2012).

Chapter 6 develops an econometric model to estimate the energy performance gap by correcting for endogeneity and sample selection bias in order to identify the key factors influencing the discrepancy between the measured and the calculated energy consumption before and after the energy efficiency upgrades.

¹The decree of 26 October 2010 relative to the thermal characteristics and energy performance of buildings.

Chapter 4

Ambiguity about the Energy

Performance of Individual Buildings

4.1 Introduction

This chapter introduces the *ex-post* risk analysis in regard to ambiguity about the energy performance of individual buildings in the green renovation sector. In general, it remains challenging, but crucial to evaluate unknown risks of new emerging technologies, especially when *ex-ante* prevention and mitigation measures are lacking. To implement an example, we are referring to the current debate on the environmental energy transition and the literature on energy economics.

The 21st conference of the parties (COP) has taken place in December 2015 in Paris to mark a significant milestone to alleviate climate change. Moreover, specific forms of pledges have been put forward by international stakeholders during the climate conference including greenhouse gas (GHG) emission targets. The main targets related to energy measures focus on increased renewables deployment and improved energy efficiency use. To ensure the European Union's (EU) climate targets in the year 2020, the EU energy policy sets up the 2020 package, including 20% cut of greenhouse gas emissions (from 1990 levels), increase the share of renewable energy by 20% and enhance energy efficiency by 20% (European Commission, 2010a).

On the other hand, the EU is facing several challenges such as increased dependence on energy imports, fuel poverty as a major social problem and the necessity to mitigate climate change. In the meanwhile, the issue of fuel poverty¹ is of paramount importance in EU since one household in seven lives on the margin of fuel poverty (European Fuel Poverty and Energy Efficiency, 2010). An effective answer to cope with these concerns may result from improving energy efficiency in buildings.

Unfortunately, little is known up to now about the efficiency of energy saving investments in the housing sector. In particular, there exist scarce studies on energy consumption and housing stock at the individual household level in France (Suerkemper et al. (2011), Broc et al. (2011), Charlier and Risch (2012), Reynaud (2014), Charlier (2015)). Only a few data are available on the energy performance of individual dwellings in the green renovation sector.

Several barriers implying the lack of information about the use of best available

¹Moore (2012) summarizes the existing definitions and states the concepts of fuel poverty. The first official definition appears in Brenda Boardman's book by emphasizing that a household is said to be fuel poor if it needs to spend more than 10% of its income on fuel to maintain an adequate level of warmth (Boardman, 1991).

energy saving techniques, financial trade-offs and the interaction of actors involved in decision making hamper the engagement in energy efficiency projects. For these reason, banks are reluctant to provide credit loans to households which are willing to renovate their dwellings owing to reduce their own carbon footprint. Similarly, insurers are also guardedly to offer insurance contracts owing to the lack of information on the effective risk of not achieving the proposed energy performance after retrofit measures.

To stimulate investments in energy efficiency measures and promote eco-friendly technologies, it is of vital importance to facilitate the access to insurance coverage especially for self-employed and small enterprises (ELIOS, 2008). In this respect, energy savings insurance play a key role to build investor confidence in the feasibility of energy efficiency investments (Micale and Deason, 2014). Moreover, the energy savings insurance based on the establishment of an energy performance contract warrant costumers to achieve the projected energy performance target. The guarantee of the energy performance permits considerably to ensure bank loans for applicants investing in energy efficiency upgrades. Nonetheless, legal uncertainties and the lack of historical data pose difficulties to the insurance industry to develop energy performance guarantee products (Mills (2003a) and Mills (2003b)).

With respect to the legal basis, the *Spinetta law*² protects the interest of the building owners and purchasers in France. In particular, the builders can be found liable up to ten years without any proof of fault, termed decennial liability, in case the building is suffering from severe damages. Individuals, business and corporate entities must be covered by compulsory liability insurance. The insurance contract covers primarily building repairs and material damages irrespective of cause and origin (ADEME, 2013).

In the meanwhile, the *energy transition law*³ was enacted by the French government in 2015 with the objective to apply the decennial liability on the non-achievement of the energy performance. However, the application of the decennial liability is limited for specific situations and is based on Article L-111-13-1 of the French Construction and Housing Code, "*impropriété à la destination de l'ouvrage*" (unsuitability for purpose). More precisely, the non-achievement of the energy performance resulting from damages based on a default of a guaranteed product, the

²The decree of 4 January 1978 relative to the liability and insurance in the field of construction.

³The degree of the 17 August 2015 relative to the energy transition to support green growth.

design, the implementation of the services or an overconsumption of the building resulting from damages leading to exorbitant costs should be covered by the decennial liability. Under these circumstances, the purchasers must be capable to proof the measured overconsumption (Bureau, 2015). In particular, the proof of overconsumption is burdensome as the calculated energy performance of the building is based on standards and is likely to deviate from the measured energy performance.

The Regional Authority of Alsace and the utility company Electricité de France (EDF hereafter) has signed a convention in 2008 to launch a pilot project, named *Je rénove BBC*⁴, in Alsace to reduce primary energy consumption and foster the renovation of individual buildings. The project is unique in France due to its pilot character and aims to retrofit buildings until the level of low energy buildings⁵. In this respect, a certain number of contractors, such as ARCIA-CONCEPT, AMCONCEPTION, DIAGNOS or KS CONSTRUCTION are available to insure and guarantee the purchaser against damages subject to the decennial liability.

This chapter provides some useful background information concerning energy efficiency initiatives. Moreover, this chapter gives an overview about the barriers and problems of the non-achievement of the energy performance (underperformance of energy savings) subject to energy-efficient renovations. The chapter establishes a solid basis for the subsequent chapters 5 and 6 in order to quantify the frequency and the severity of the risks of underperformance.

The remaining of this chapter is as following. Section 4.2 presents the current situation about the energy efficiency in Europe and France. Section 4.3 introduces the background by reviewing the literature and describing the weatherization program. Section 4.4 formulates the necessary hypotheses that will be tested in the following chapter 6. Finally, section 4.5 concludes this chapter.

4.2 Energy Efficiency

The European construction sector accounts for a yearly turnover of EU 1.6 trillion in 2011, including its extended value chain, and represents the biggest industrial employer (EUROSTAT, 2015). Shaping the built environment toward higher energy

⁴I am very grateful for the support of Sabine Mirtain-Roth and Ludovic Parisot. More detailed information can be found under <http://jerenovebbc.info/>.

⁵The European Commission defines nearly zero-energy buildings in the Council Directive 2010/31/EU as a building that has a very high energy performance and the energy should be covered to a very significant extent from renewable sources.

efficiency of the building stock is essentially encouraging and affects the quality of life of all EU-citizens.

Overall, the residential building accounts for 74% and non-residential for 26% of the global energy use (International Energy Agency, 2015). In Europe, the buildings utilize 40% of total energy consumption and produce 36% of greenhouse gas emissions. Furthermore, the existing building stock offers a promising future by representing the single biggest potential sector for energy savings. Despite, it's promising potential of about 80% in the building sector, achievements are very slow and political action needs to be enhanced (Lechtenböhmer and Schüring, 2010). Moreover, a recent report by Lapillonne et al. (2015) stress that energy efficiency in most countries in the EU has been slow down between 2008 and 2012 compared to 2000 and 2008 due to the economic crisis. Figure 4.1 displays the energy efficiency improvements by country in the household sector for the period 2000 to 2008 and 2008 to 2012. The lower horizontal line in the figure captures the target of the energy end-use and efficiency directive services⁶ (ESD) of EU29 countries.

Furthermore, Lechtenböhmer and Schüring (2010) underline that an insufficient volume of investment into refurbishment of residential building persists at the European level. The authors argue that current investments account for EU 55 billion per year and need to be increased as a maximum of five times to apply the existing potential to modernize 80% of the residential buildings in the EU.

In the EU, the 2010 Energy Performance of Buildings Directive⁷ (EPBD) and the 2012 Energy Efficiency Directive⁸ (EED hereafter) are the main legislations with regard to the reduction of energy consumption in buildings. Appropriate financial instruments have been established at the supranational level with the aim to boost and stimulate energy efficient initiatives (e.g. European investment bank-led "*Marguerite fund*", the 2020 European fund for energy, climate change and infrastructure, the energy efficiency finance facility).

Furthermore, Member States (MS) are required to draw up a national energy efficiency action plan every three years under EED. European MS need to set out estimated energy consumption, improved energy efficient measures and report the progress achieved.

⁶Council Directive 2006/32/EC on energy end-use efficiency and energy services [2006]. L 114.

⁷Council Directive 2010/31/EU on the energy performance of buildings [2010]. L153/13.

⁸Council Directive 2012/27/EU on energy efficiency [2012]. L315/1.

In the national context, the building sector in France represents 44.5% of final energy consumption in 2012. France primary aims to reduce energy consumption in existing buildings by 38% by 2020 and commits to two highly ambitious objectives: (i) to increase the number of low energy buildings (nearly zero-energy building) with new constructions and positive energy buildings in 2020; (ii) to renovate 500 000 old dwellings per year by 2017. The French government has launched the housing energy efficiency improvement plan on 21 March 2013, triggering to accelerate renovation of existing housing stock and include numerous measures and aspects in decision making, funding (e.g. sustainable development tax credit, interest free eco loans, energy saving certification system, reduced VAT rate for renovation work) and building strategies (Ministry of Ecology, Sustainable Development and Energy, 2014).

Figure 4.1: Energy efficiency improvements by country in the household sector based on Odyssee and Mure database

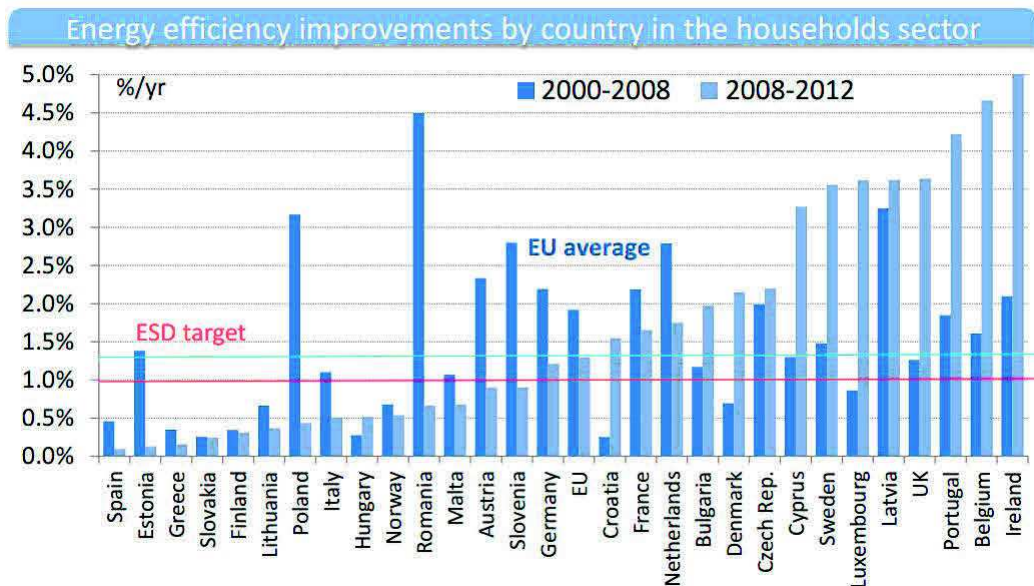

Source: Odyssee and Mure Databases 2015; The Odyssee database on energy efficiency indicators includes several types of indicator, such as energy savings, energy intensities, energy efficiency indices by sector and benchmark/target indicators by sector.

The French government seeks to fight energy poverty by launching the "Habiter mieux" (Living better) program administered by the French National Housing Agency (ANAH). This program helps owner-occupiers or landlords under a resources ceiling to facilitate carrying out retrofit measures by receiving subsidies. Moreover, a

white certification scheme has been enacted by the French law No 2005-781 in July 2005 which obliges energy market operators (e.g. EDF, ENGIE) to deliver energy savings to fulfill the EED. The white certification scheme represents one of the key components of the French strategy to achieve the EU policy targets ([Suerkemper et al., 2011](#); [Broc et al., 2011](#)).

The French government adopted, pursuant to EDD, the thermal regulation of existing buildings in 2007. Two applicable measures stem from the national regulation, the overall thermal regulations⁹ and the thermal regulation point by point¹⁰, differing in the work undertaken. We solely refer in this chapter to the last mentioned point, targeting minor renovation for buildings complying with insulation, heating, hot water, cooling and ventilation equipment standards.

Another key challenge is that the building market is very large and dispersed. This means that multiple agents (government, utilities, industry and consumer) take decisions based on their needs or objectives but do not react in a common framework. Furthermore, a potential drawback of projects related to retrofit existing buildings imply typically higher costs to upgrade, have less access to finance and the refurbishment work causes disruption of building uses. On the other hand, it creates opportunities for domestic businesses (small-medium enterprises) to provide energy saving options to industry and consumers. It is worth mentioning that ongoing efforts are needed from policy to establish incentives, improved price signals, demonstrate efficiency performance and promote cost-effective investments ([International Energy Agency, 2015](#)). In the next section, we describe in detail the background and the context regarding the energy economics literature and the weatherization program.

4.3 Background and Context

This section is organized as follows: We review the utmost aspects and the empirical findings of the literature in the field of energy economics (4.3.1) by categorizing it into different groups for ease of reading and then we explain the main objective, the financial incentives and the eligibility criteria of the weatherization program

⁹The Decree of 13 June 2008 relative to the energy performance of existing buildings larger than 1000m² when subject to major renovation work.

¹⁰Order of 3 May 2007 relative to the thermal characteristics and the energy performance of existing buildings.

(4.3.2).

4.3.1 Literature Review

Top-down and bottom-up approach

In general, two distinct approaches have been established in the literature of energy economics to model the energy consumption in the residential sector, termed the top-down and the bottom-up approach (Böhringer, 1998; TecMarket Works, 2004; Böhringer and Rutherford, 2008; Swan and Ugursal, 2009; Tuladhar et al., 2009; Kavgic et al., 2010).

The top-down approach deals with the evaluation of nationwide energy usage, trends and changes but does not account for individual end-uses. This concept uses aggregated energy data by considering the residential sector as an energy sink and regresses the energy usage as a function of macroeconomic variables (e.g. gross domestic product, unemployment and income), energy price and climate conditions (Swan and Ugursal, 2009). In particular, top-down models lack details on technological options (e.g. saturation effects, technological progress and structural change) as these models rather focus on the link between the energy sector and the economic output (Kavgic et al., 2010).

The bottom-up approach covers the individual household consumption on disaggregated level and relies on empirical database to estimate the energy consumption (Swan and Ugursal, 2009; Kavgic et al., 2010). The bottom-up concept consists of two main methodologies, such as the statistical and the engineering approach.

The statistical method relies on the consumption from a sample of households and utilize either regression, conditional demand or neural network analysis to investigate the link between the energy consumption and specific end-uses (Swan and Ugursal, 2009). The engineering method uses simulation programs to estimate the energy consumption of buildings. This method requires information about the physical characteristics and needs detailed description of the building shell as well as extensive user expertise (Aydinalp-Koksal and Ugursal, 2008). The engineering method allows for a complete thermodynamic and heat transfer analysis on all end-uses within the building. Nevertheless, the engineering method shows up difficulties for the integration of consumer behavior (e.g. window opening, occupancy, thermostat settings, heating pattern) and socioeconomic variables (e.g. number of household

members, age, profession, educational level and income).

Chapter 6 focuses on a bottom-up approach involving statistical and engineering methods to estimate the energy performance gap after retrofit measures of the dwellings. Therefore, we limit the following literature review of this chapter to the bottom-up approach which is discussed in the next parts.

Calculated *versus* measured energy consumption

Several studies address the evaluation of the discrepancies between *ex ante* engineering estimates (calculated energy savings) and *ex post* measured energy savings from billing data (Hewett et al., 1986; Nadel and Keating, 1991; Marchio and Rabl, 1991; Sanders and Phillipson, 2008; Haas and Biermayr, 2000; Cayre et al., 2011; Majcen et al., 2013; Scheer et al., 2013; Reynaud, 2014). The principal objective of these studies is to provide more reliable estimates of energy savings to homeowners who conduct retrofit investments. It is worth mentioning that these studies mainly differ in the outcome measurement, the survey technique, the data availability, the conservation program specification, the simulation program and the estimation technique.

In a seminal study, Hewett et al. (1986) use gas consumption data from energy bank files and calculated engineering estimates before and after retrofit intervention applying Princeton Scorekeeping method (PRISM)¹¹. Additionally, they conduct telephone survey to gather further information on the installed heating system. In overall, they find that on average the measured energy savings are lower than calculated by the energy simulation software. Furthermore, energy savings are highly variable across the sample and energy savings estimation can be improved by conducting infrared inspections for quality control and considering energy lifestyle issues.

By reviewing 42 impact evaluation studies, the measured energy savings ranged from 15% to 117% of the engineering estimates (Nadel and Keating, 1991). The discrepancy between the measured and the predicted energy savings emerged due to several reasons; such as inaccurate engineering estimates (highly optimistic or incorrect assumptions), no consideration of the interaction between the building and the occupants or the occurrence of changes in the participating households.

¹¹See Fels (1986) for an introduction and discussion on PRISM.

Furthermore, the authors underline that the predicted energy consumption were based on prototype buildings without considering how much energy were actually used.

Similar results have been obtained in the United Kingdom (Sanders and Phillipson, 2008), Austria (Haas and Biermayr, 2000), Netherlands (Majcen et al., 2013), Germany (Schuler et al., 2000b) and France (Marchio and Rabl, 1991; Cayre et al., 2011; Reynaud, 2014).

More specifically, Marchio and Rabl (1991) assess the relationship between the calculated and the measured energy consumption (heating and hot water) by using gas metered data of 220 residences. The authors find a slightly tendency toward overestimation, as the measured energy consumption on average is 6% higher than the calculated energy consumption. However, the scatter (gap) is larger for multi than for single dwellings due to the tendency that overestimation occurs with increasing floor area. In the same way, Cayre et al. (2011) gather a sample of 923 French single and multi-family houses characterized by different dwelling vintages (<1975, 1975-1982, 1982-1988) and energy resources (oil, gas, electricity). The results show that the basic engineering estimates strongly overestimate heating consumption in older housings, even though they calibrate the heating consumption for behavioral characteristics. Additionally, Reynaud (2014) evaluates the regional energy efficiency pilot program implemented in two departments of France, Haute Marne and Meuse, by using a sample of 119 single and multi-dwellings. Similar to Marchio and Rabl (1991) and Cayre et al. (2011), the calculated energy consumption for all end-uses¹² tend to be overestimated non-linearly with increasing value compared to measured energy consumption¹³. It should be notice that the variations of the energy consumption before and after retrofit measures seem to be less substantial when the gap between both measures is low before the intervention.

Using program evaluation method, Scheer et al. (2013) assess the impact of a residential retrofit scheme in Ireland by comparing a sample of 210 scheme participants with a control group from the population (n=153928). By applying *difference-in-difference* and matching estimator, they find a shortfall of approximate $36 \pm 8\%$ between measured and the potential expected energy savings. They conclude that

¹²Different to the before mentioned studies, Reynaud (2014) considers the total primary energy consumption, including electricity for appliances, lighting and cooking.

¹³Reynaud (2014) considers different sources of energy end-use. However, oil and gas have been identified to represent the most common source of primary energy usage in the data sample.

these shortfalls occur through the direct and the indirect rebound effects, the variation in *ex-ante* assumptions and u-values¹⁴.

On a common basis, studies from various countries demonstrate that the measured energy savings are lower than calculated with respect to energy efficiency measures. Scholars, politicians and practitioners highlight that the potential discrepancy between the calculated and measured energy consumption occurs due to an effect, which is well known in the literature, as the (in)direct *rebound effect*. We describe this point in the next part.

Rebound and prebound effect

In general, economists agree that energy conservation programs tend to overestimate the conservation potential. Novel technologies lead to higher energy efficiency and cheaper prices for the provided energy service and as a consequence it considerably increase the demand for the energy service (diminish the measured energy saving potential).

This effect is well known in the energy economic literature as the rebound effect (Khazzoom, 1980). Furthermore, Wirl (1997) states that there exist an *energy-saving paradox* by arguing that the rebound effect reduces the efficiency of conservation programs. It is important to bear in mind that there exist a direct and indirect rebound effect on the household scale. The direct rebound effect can be assigned to an increase in energy service demand, such as higher internal temperature or higher levels of illumination (price effect). The indirect rebound effect can be assigned to an increase in consumption of other goods and services (income effect). During the course of decades, there is a growing literature dedicated to measure the direct rebound effect¹⁵ (Dubin et al. (1986), Berkhout et al. (2000), Haas and Biermayr (2000), Binswanger (2001), Nesbakken (2001), Hong et al. (2006), Sanders and Phillipson (2008), Sorrell et al. (2009), Sunnika-Blank and Galvin (2012), Guerra (2013), Galvin (2014), Reynaud (2014) and among others) while more limited studies exist to quantify the indirect rebound effect (Druckman et al., 2011; Chitnis et al., 2013, 2014) in the residential sector.

We only refer to the direct rebound effect in the following chapters owing to the

¹⁴The u-value corresponds to the thermal performance of the building and measures the heat loss.

¹⁵For comprehensive reviews on the rebound effect, see (Berkhout et al., 2000; Binswanger, 2001; Sorrell et al., 2009; Chitnis et al., 2014).

objective to better understand the key factors influencing the discrepancy between calculated and measured energy consumption.

Several terms, such as the reduction factor, the comfort factor, the foregone savings, the take back or the rebound effect have been reported in several studies causing sometimes confusing terminologies in the literature (Sanders and Phillipson, 2008). Additionally, the notion of the *prebound effect* has been introduced by Sunnika-Blank and Galvin (2012).

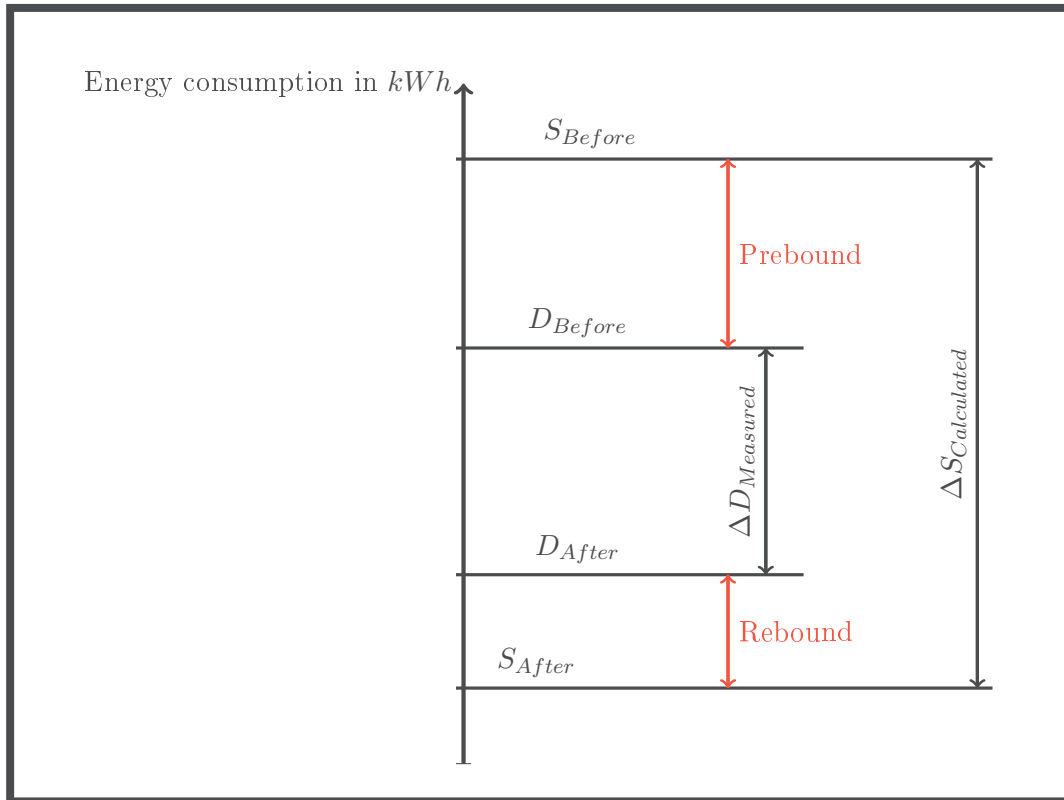

Figure 4.2: Illustration of the direct prebound and rebound effect

S : Calculated energy consumption; D : Measured energy consumption

Figure 4.2 sketches a possible pre- and post-retrofit situation of a household by illustrating the prebound and rebound effect. The prebound effect refers to a situation before retrofit by measuring how much energy is less consumed than expected. More generally, the rebound effect captures the *over*-consumption after retrofit measures and the prebound effect reflects the *under*-consumption *prior to* energy efficiency measures (Sunnika-Blank and Galvin, 2012; Galvin, 2014; Galvin, R. and Sunikka-Blank, M., 2016). With this respect, energy efficiency upgrades cannot save energy that is actually not consumed. The prebound effect can arise

for several reasons, likewise the occupants keep low-indoor temperature or heat only certain rooms due to either their personal choice or the awareness of a low insulation of the dwelling.

According to a recent study by Galvin (2014) the rebound effect is positively correlated with the measured energy consumption. This means that the higher (lower) the measured energy consumption, the lower (higher) is the rebound effect. While evaluating energy conservation programs, it is crucial to consider both behavioral effects. In this way, considerable inaccuracies in calculating payback time and substantial energy shortfalls can be circumvented. It should be mentioned that Sunnikka-Blank and Galvin (2012), Galvin (2014) and Galvin, R. and Sunnikka-Blank, M. (2016) focus mainly on space heating consumption in their studies. Haas and Biermayr (2000) report that the rebound effect is caused by occupant's behavioral factors. In addition, assessment tools used to estimate the calculated energy consumption are based on standard assumptions and do not account for measured energy consumption. This might increase potentially the rebound and the rebound effect.

It is natural to conjecture that the scale of the rebound effect is initiated by the energy-related behavior of households. This will be explained in the next part.

Impact of occupant behavior

Occupant behavior is a key determinant of the residential energy consumption. In the academic literature it is well accepted that human behavior (e.g. lifestyle, motivation, cultural aspects, interaction between occupants, perception of comfort), occupant modes (management of heating area, thermostat setting and natural ventilation) and household characteristics (e.g. age, family size, composition and income) lead to differences in occupancy patterns and affect the energy consumption (Van Raaij and Verhallen, 1983; Haas et al., 1998; Branco et al., 2004; Lindén et al., 2006; Martiskainen, 2007; Vringer et al., 2007; Andersen et al., 2009; Guerra and Itard, 2010; Guerra, 2013; Meester et al., 2013). A major challenge is that occupant behavior varies between individuals. Studies highlight that significantly differences persist in the variations of energy consumption among identical buildings (Seligman et al., 1978; Bahaj and James, 2007; Andersen et al., 2009). For this reason, the majority of studies explore the link or relationship between the occupant's behavior

and the energy consumption with the aim to quantify the characteristics of occupant behaviors. Furthermore, the results from such studies might help to design standard behavioral patterns which can be implemented in simulation tools to model more accurately the energy performance of buildings and to further improve their validity. Several studies explore the relationship between the occupant's behavior and the energy consumption in Europe through conducting questionnaire or qualitative interviews while employing statistical analysis.

For instance, [Van Raaij and Verhallen \(1983\)](#) study the link between the behavior of household members and their home characteristic's on the residential energy use by applying self-reports of 145 Dutch households. They especially focus on two energy contingency such as temperature and ventilation. Based on these two factors, they apply principal component, cluster and pattern analysis to distinguish between five distinct behavioral patterns: conservatives, spenders, cool, warm and average. These five clusters do not differ regarding their home characteristics but vary on sociodemographic and attitudinal characteristics.

Furthermore, [Haas et al. \(1998\)](#) employ a production function approach by using a non-representative sample of 400 Austrian multi-family and single family dwellings to assess the impact of consumer behavior on residential energy demand for space heating. In line with [Van Raaij and Verhallen \(1983\)](#) and [Guerra \(2013\)](#) they find that indoor temperature affects significantly the energy consumption. Moreover, variables such as the living area, the energy price and the thermal quality of the building shell determine significantly space heating consumption.

On the other hand, [Guerra and Itard \(2010\)](#) and [Guerra \(2013\)](#) undertake statistical analysis to explore a large set of determinants influencing space heating consumption by using representative data from questionnaire and self-reports of Dutch households. [Guerra and Itard \(2010\)](#) find statistical differences between the use of radiators, the use of windows and the use of mechanical ventilation system. Nevertheless, no statistical differences were found between household and sociodemographic characteristics, such as income, elderly, children, family size and educational level.

In contrast, [Meester et al. \(2013\)](#) show that the number of inhabitants and lifestyle affect heating loads of Belgium detached houses. Besides, [Cayla et al. \(2010\)](#) use self-administered survey to assess whether technical, weather, practices

or sociodemographic variables impact space heating consumption. The data is based on a representative sample of 923 French households. They find that mainly technical aspects (two thirds) and further household characteristics (one third) explain the variation of space heating consumption within the sample.

Moreover, [Lindén et al. \(2006\)](#) and [Andersen et al. \(2009\)](#) seek to quantify specific factors influencing the behavioral patterns by applying correlation analysis and multiple logistic regression. [Andersen et al. \(2009\)](#) demonstrate that the ventilation and the heating behavior are affected by household's perception, gender and ownership. Besides, [Lindén et al. \(2006\)](#) stress that occupants are energy unaware and ask for information about more user friendly technology, soft loans and bonus payments for lowering their energy usage.

Table C.1 in appendix C details the above mentioned studies by summarizing relevant information about the location, the dwelling type, the survey design, the variables, the estimation method and the results of the studies. In the next subsection, we are explaining the weatherization program.

4.3.2 Weatherization Program "Je rénove BBC"

The weatherization program, "*Je rénove BBC*" and "*50 pioneer yards*" have been launched by the utility company EDF in cooperation with the regional authority in Alsace from 2009 until 2016. The overall aim of this program is to enhance the energy efficiency of existing buildings by undertaken retrofitting measures according to requirement specifications. Recall that the pilot project is unique and novel due to representing the first weatherization program in France aiming to undertake retrofit work up to the level of low energy buildings. Low energy buildings combine several technologies to attain essentially a very high energy performance in terms of thermal quality ([ADEME, 2011](#)). In more details, low energy buildings use to a significant extend energy from renewable sources, maintain excellent air-sealing quality through improved ventilation system, covers a high pertinent building shell and requires a high-yield heating mode.

In line with the French thermal regulation (RT 2005), the energy performance of low energy buildings shall lie within the range of 40 to 80 kWh_{PE}/m^2y and needs to be adjusted for the climate zone and altitude ([ADEME, 2011](#)). Since the region

Alsace lies in a specific climate zone¹⁶ (H1b), the energy performance, expressed in primary energy has been adjusted to 104¹⁷ kilowatt per hours per square meter per year [kWh_{PE}/m^2y]. This threshold is the primary target and the main condition of the program's requirement specification. Furthermore, the weatherization program mainly aims on insulation measures related to accounted standards and puts forward a contractor (architect, design office, consultant or general enterprise) to guide and guarantee the accomplishment of the energy performance after the retrofit. The principal role of the contractor is to monitor and coordinate craftsman to ensure the success of the global renovation. Furthermore, the contractor represents a key player during and after the renovation work to avoid conflicts and bad experiences (such as mould growth or draught infiltration).

The program targets on five measures: (1) Prescribed thermal study of the building or compliance with accounting standards; (2) work control; (3) airtightness testing procedures (Blower Door Test); (4) financial support for applicants and experts of the building and (5) high performance of materials in compliance with accounting standards.

Applicants need to satisfy the following eligibility criteria to participate in the weatherization program: the building is an individual house in the territory of Alsace, it needs to be constructed before 2005, comprises not more than three dwellings and the landlord is homeowner or lessor. Eligible applicants can apply for several direct financial subsidies from the program initiative (applicants can receive subsidies for covering the contractor fees to a maximum of €3000 and for covering the insulation work and the airtightness test to a maximum of €10 000) and other subsidies dependent on the region, municipalities or commune. Furthermore, participants could also apply for other forms of financial support (tax credit, interest free eco-loan and support for disadvantaged persons with a limited access to credits) which have been put in place by the [Ministry of Ecology, Sustainable Development and Energy \(2015\)](#) to improve the energy performance of the buildings by carrying out retrofit measures.

In the next section, we deduce our hypotheses from the theory and the findings

¹⁶An illustration of the specific climate zones in France can be found in appendix C. With respect to the legislation, information can be found in the appendix I of the Decree of 28 December 2012 relative to thermal characteristics and performance requirement of new buildings.

¹⁷According to the French thermal regulation, the total energy consumption has been fixed to: $80 * (a + b) = 80 * (1.3 + 0) = 104kWh_{PE}/m^2y$, where a and b has been determined by the second article of the Decree of 29 September 2009

of the previously described literature review.

4.4 Hypotheses

In general, alterations might occur in the household over time due either to a change of the family composition, the occupation mode and the household size or aging of household members, however the building shell itself remains stationary. For example, a family comprising two children decides to renovate its building in a specific point of time. The retrofit measures last several years and the prescribed thermal study does not account for the occurrence of changes in the household. Over time, the children are growing up, are studying abroad or the parents get divorced leading to a considerable change of the household's energy consumption. For this reason it is crucial to evaluate the differences between the calculated and measured energy savings over a time horizon by controlling for individual and energy-related behavioral characteristics. We acknowledge that only specific hypotheses will be empirically tested in chapter 6 due to the small sample size¹⁸. Hence, the hypotheses can be categorized into three blocks and summarized as follows:

General aspect

- (i) **H1:** *Higher pre measured energy consumption increases the energy performance gap*
- (ii) **H2:** *Higher pre calculated energy consumption increases the energy performance gap*

Energy-related behavioral factors

- (iii) *Window opening increases the energy performance gap*
- (iv) **H3:** *Higher level of domestic hot water consumption increases the energy performance gap*
- (v) *Paying better attention to energy consumption decreases the energy performance gap*
- (vi) *Higher level of environmental concern decreases the energy performance gap*
- (vii) *Higher temperature settings increases the energy performance gap*

¹⁸Further information can be found in the chapters 5 and 6.

(viii) *Higher level of occupation time increases the energy performance gap*

Sociodemographic factors

(ix) **H4:** *Age of occupants have either a positive or negative effect on the energy performance gap*

(x) **H5:** *Households with children have either a positive or negative effect the energy performance gap*

(xi) **H6:** *Higher educational level increases the energy performance gap*

(xii) **H7:** *Higher level of income increases the energy performance gap*

(xiii) *Higher number of household size increases the energy performance gap*

(xiv) *The family composition have either a positive or negative effect on the energy performance gap*

4.5 Final Remarks

Throughout the writing of the present chapter, we identify several gaps in the residential sector. While at a first glance the energy policy targets are very ambitious to reduce primary energy consumption, however the achievements of energy efficiency initiatives are very slow and barriers also remain. The lack of historical data and the paucity of relevant information about the frequency and intensity of the non-achievement of the energy performance hamper substantially insurance coverage and thus energy saving investments.

With respect to the energy transition law, the energy performance guarantee subject to the decennial liability insures the purchaser to achieve the projected (calculated) energy savings. The guarantee of the energy performance offers a new product idea and holds tremendous promise for insurers to enter the energy efficiency market. Most notably, the insurers shy away from unfamiliar or unknown risk as the loss control (reducing the frequency and intensity of the losses) is crucial to the business of insurance (Mills, 2003a). Integrating the guarantee of the energy performance in the decennial liability may not only increase the risks, but also the insurance contribution for the purchasers. For this purpose, insurers are reluctant to integrate energy performance guarantee in the decennial liability as little is known about the viability of the insurance (ADEME, 2013; Tuccella and Devimes, 2015).

For these reasons, amongst others, it is crucial to evaluate the unknown risks and especially identify the potential of the energy performance guarantee. The main sector can benefit from the results of quantifying the frequency and the intensity of the non-achievement of the energy performance of existing buildings. The results provide an opportunity to establish efficient insurance coverage in the future and insure bank loans for applicants.

In the following chapter, we discuss the survey sampling method used to gather the necessary information for the adjacent econometric analysis and state the survey design. Moreover, we explain the database including information from prescribed thermal studies, billing data, sociodemographic characteristics and energy related behavioral attitudes.

Appendix C

Additional material

Table C.1: Literature review of studies analyzing the link between occupants behavior and energy consumption in Europe over the last decades

References Country	&	Dwelling type	Representative	Survey Design	Dependent variable	Estimation	Results
Van Raaij and Verhallen (1983) Netherlands (n=145)		Semi attached and fully at- tached houses	NA	Self-report	Temperature and ven- tilation	Principal component analysis, clustering and pattern analysis	Five distinct behavioral patterns (con- servers, spenders, cool, warm and aver- age) are obtained and do not differ re- garding their home characteristics but vary on sociodemographic and attitu- dinal characteristics

References & Country	Dwelling type	Representative	Survey Design	Dependent variable	Estimation	Results
Haas et al. (1998) Austria (n=400)	Multi-family and single-family dwellings	No	Energy accountings and questionnaire	Energy consumption without electricity demand for appliances	Production function approach	Living area, indoor temperature, price and quality of the building have a significant impact on energy consumption
Lindén et al. (2006) Sweden (n=600)	Apartments and private houses	Yes	Questionnaire and qualitative interviews	Energy friendly behavior (Behavior related to functional areas nutrition, cleanliness, entertainment)	Correlation analysis	Reveal those behavioral patterns that are efficient and those which are inefficient
Andersen et al. (2009) Denmark (n=4948)	Danish housing stock	Yes	Questionnaire	Window, heating, light and solar shading	Multiple logistic regression	9 out of 29 variables significant; They found that ventilation and heating behavior were influenced by perception, gender and ownership
Cayla et al. (2010) France(n=923)	Not specified	Yes	Self-administered survey	Space heating energy consumption	Multiple linear regression analysis	They found that mainly technical aspects (two thirds) and household characteristics (one third) explain the variation of space heating consumption
Guerra and Itard (2010) Netherlands (n=315)	Representative types of housing in the Netherlands	No	Questionnaire	NA	Statistical Analysis	Statistical difference was found for the use of radiators, use of windows and use of mechanical ventilation system. No statistical difference was found on the use of thermostat

References Country	&	Dwelling type	Representative	Survey Design	Dependent variable	Estimation	Results
Guerra (2013) Netherlands (n=4724)		Multi-family and single- family	Yes	Questionnaire and self-reported use of heating and venti- lation systems	Energy consumption for heating	Statistical analysis	They demonstrate statistical differ- ences for temperature control and ven- tilation systems and a negative corre- lation was found between income and energy consumption
Meester et al. (2013) Belgium (n=11)		Detached houses	No	Questionnaire	Heating loads	Statistical analysis	Heating loads depend on heated area of the house, number of inhabitants and lifestyle

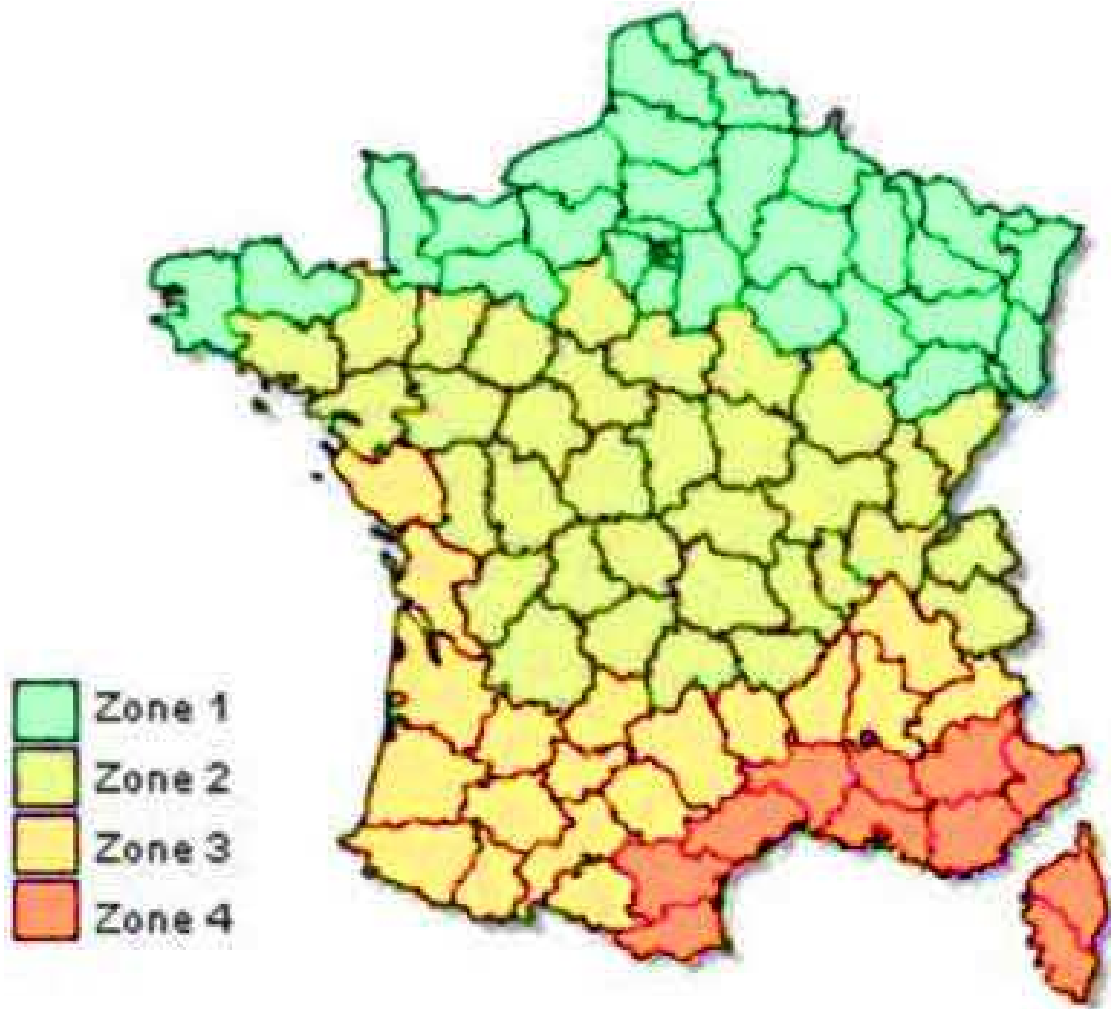

Figure C.1: Mapping the French climate zone

Source: Charlier (2015)

Chapter 5

Household Survey and Data Sample¹

¹This chapter has been realized in a mutually beneficial partnership with Electricité de France (EDF).

5.1 Methodology & Survey

In this chapter, we present the methodology and the design of the survey conducted to gather information on billing data, household characteristics and energy-related behavioral attitudes. Social survey measurement is not faultless and needs a carefully examination of the procedures used to conduct. Otherwise the effect arises that the resulting data will not describe what they are intended to represent. In this section, we are presenting the sample survey which aims on three major elements: sampling (5.1.1), designing questions (5.1.2) and data collection (5.1.3). We describe subsequently the thorough implementation of these three activities related to the weatherization program as it is crucial to obtain a good survey design (Fowler, 1995; De Leeuw et al., 2008; Fowler, 2014). Section 5.2 explains the nature and the structure of the data.

5.1.1 Sampling

The target population for the survey consists of the participants of the weatherization program, having completed the retrofit work and living in the dwelling for at least one heating period². The sample has been drawn randomly from a list of participants provided by EDF. More precisely, each participant has an equal chance to be selected for the survey, once a time, without replacement and independent of each other. This sampling technique is called random sampling and is the most basic way of probability sampling (Fowler, 2014).

A crucial aspect during the procedure in designing and conducting survey is to minimize non sampling errors. De Leeuw et al. (2008) explain that non sampling errors include all types of errors which can occur during the data collection and the data processing, such as coverage, nonresponse, measurement and coding errors. For instance, nonresponse errors occur when sample members do not respond or refuse to participate in the survey and they particularly differ in those who participate. This problem can be circumvent by face to face survey or by changing the contact date and time, which lead to an increase in the response rate. Furthermore, measurement errors occur when respondent's answer to a question is erroneous. This can be prevented by asking clear question, in such a way that participants are willing and capable to respond to the survey questions.

²A heating period is considered to last from 1st October to 20th May.

The determination of the sample size is essential to plan empirical analysis and to enhance statistical power. To determine accurately (parametric) the sample size and the true sample, one need to specify the desired error of margin, the confidence interval, the standard deviation and the total population size. In the survey method literature, the error of margins should lie within a range of 1 to 5%, confidence interval is often specified with 95%, the standard deviation is set to 0.5 (Dattalo, 2008) and the total number of population equals 215³. We determine the sample size according to Cochran (1977) such as

$$n = \frac{\text{Std. Deviation} * (1 - \text{Std.Deviation})}{(\text{Error of margins}/\text{Confidence Interval})^2} \quad (5.1)$$

While setting the parameter as discussed above, we find

$$n_{\text{Sample}} = \frac{0.5 * (1 - 0.5)}{(0.05/1.96)^2} = 384.16$$

We correct for the finit population (=215) and find the true sample following

$$n_{\text{True}} = \frac{215 * 384.16}{(215 + 384.16 - 1)} = 138.08 \sim 139 \quad (5.2)$$

Hence, we would need to survey at least 139⁴ (minimum sample size) out of 215 participants to have a 95% confidence level with a 5% margin of error in the results.

5.1.2 Survey Design

The survey method can be classified by the data collection (e.g. face to face, internet, questionnaire, mail-telephone interview) or by their content (e.g. attitudes, opinions, behaviors). It is worth mentioning that the survey design and the data collection are affecting the following data analysis (Fowler, 1995; Bowling, 2005; De Leeuw et al., 2008). The choice of the survey is based on the research question, the population, the expected response rate and the financial costs (De Leeuw et al., 2008).

We opt to apply an assisted self-administrated questionnaire⁵ due to our research

³Note that the total number of 595 households request to participate in the program. During the period of the survey, 329 households completed the renovation and 269 individual dwellings were carrying out retrofit work. For our purpose, 215 households are eligible (lasting one heating period after the renovation work) to participate in the survey.

⁴Note that 165 respondents have participated in the survey. See for further information section 5.2.

⁵The interviewer is sitting in front of the respondents, asks the questions to them and completes the questionnaire on the paper. This method slows down the pace of the interview, so that the respondents

question stated in chapter 4 and categorized the survey into ten parts. Most of the survey has been conducted face to face⁶. For an overview, table 5.1 summarizes the number of questions per topic put to the assisted self-administrated questionnaire.

Table 5.1: Number of questions per topic put to the assisted self-administrated questionnaire

Topic	Number of question
(A) Motivation to participate in the program	6
(B) Financial support	4
(C) Enterprise and materials	4
(D) Satisfaction	5
(E) Energy consumption from billing data	12
(F) Attitudes toward energy consumption	14
(G) Comfort	6
(H) Sociodemographic	10
(I) Income	2
(J) Remarks and suggestions	1

EDF launched a pre-survey questionnaire in 2013 to gauge a general feedback of the weatherization program from the "*50 pioneer yard*". The pre-survey lays out a first basis for our survey design. For the sake of clarity, we amend specific questions and add the category (*E*), (*F*) and (*I*) for the sake of our analysis. The design of the questionnaire is drafted in a chronologically order of the project flow. Moreover, we combine close and open-ended questions, depending on the category, to enable a specific variety to ease the answering of the questions. Furthermore, we try to avoid biases caused by the anchors and the central tendency effects by changing respondent's ratings (Podsakoff et al., 2003). An anchor effect arises when respondents tend to reply to the first item which has been raised by the interviewer.

have more time to reflect, resulting in more accurate responses (Bowling, 2005).

⁶Actually, we were not able to maintain the assisted self-administrated questionnaire guided by an interviewer (which was trained and informed about the objective of the study) during the entire survey period due to lacking availability of interviewers. Certain households also prefer to reply by phone or favor to fill out the questionnaire by themselves and send it back electronically by email to the responsible person in charge of the survey. We are aware that non-sampling errors may increase, however we aim to gather a maximum of the responses. The questionnaire can be found in French in the appendix D.2.

Moreover, we include an even number of item scaling to prevent respondents to choose the central item (Nairne and Crowder, 1982; Podsakoff et al., 2003).

We include at the beginning of the questionnaire an introductory part to inform participants in a simple and clear manner about the objective of the questionnaire without stating the overall purpose of the project and hypothesis. In this way, we prevent respondent’s answers to be affected by the expectation effect (Oliver, 1977). Furthermore, we clearly state that the questionnaire is completely anonymous and the participant’s responses are treated confidentially.

Part (A) comprises the motivation to enter the weatherization program and represents typically introductory questions to begin with the survey. Table 5.2 introduces the first question of the category (A).

Table 5.2: Snap shot of the assistant self-administrated questionnaire

	Not at all important	Less important	Moderately important	Very important
Environmentally friendly house	<input type="checkbox"/>	<input type="checkbox"/>	<input type="checkbox"/>	<input type="checkbox"/>
Energy savings	<input type="checkbox"/>	<input type="checkbox"/>	<input type="checkbox"/>	<input type="checkbox"/>
Financial savings	<input type="checkbox"/>	<input type="checkbox"/>	<input type="checkbox"/>	<input type="checkbox"/>
Facilitate the resale	<input type="checkbox"/>	<input type="checkbox"/>	<input type="checkbox"/>	<input type="checkbox"/>
Rehabilitate the dwelling	<input type="checkbox"/>	<input type="checkbox"/>	<input type="checkbox"/>	<input type="checkbox"/>
Value the property assets	<input type="checkbox"/>	<input type="checkbox"/>	<input type="checkbox"/>	<input type="checkbox"/>
Participate in the program	<input type="checkbox"/>	<input type="checkbox"/>	<input type="checkbox"/>	<input type="checkbox"/>

The four first parts (A), (B), (C) and (D), the seventh part (G) and the last part (J) are of major interested for EDF to obtain a general feedback of the customers participated in the weatherization program. EDF pays particular attention to those parts due both to an interest to evaluate the program and to enhance future retrofit programs.

We add part (E), (F) and amend (H), (I) to broaden our data analysis and be able to answer our research question. Notably, we include questions related to the energy consumption of the dwelling for the time period of pre- and post-retrofit. We request respondents to deliver billing data on the heating consumption for the duration of exactly one heating period and the electricity consumption⁷ for the duration of one year. Furthermore, we ask participants to specify the heating and the domestic hot water system. Furthermore, we want to know whether they have changed their heating system during the retrofit work⁸. Moreover, part (F) aims to

⁷There exist no common database regarding the electricity and the heating consumption since the program participants supply their energy from different operators.

⁸We would like to make the reader aware that the weatherization program does neither require par-

gauge information on individual's attitudes related to the energy consumption and the environmental concern. We are particular interested in the occupant's behavioral changes over the time period between pre- and post-retrofit work. Lastly, we improve part (H) and (I) by adding more detailed questions on how many members live in the household, the age, the gender of each household member, educational background and the net taxable income of the household.

We have tested the survey design in a first pre-survey stage by contacting randomly colleagues from EDF which are involved in the program to verify the clarity, the understanding and the length of the questionnaire. Overall, the survey lasts on average about thirty minutes and a maximum of one and a half hours.

5.1.3 Data Collection

In overall, the weatherization program attracts 595 households of which until now 326 completed the renovation. Of the remaining 269 individual dwellings, the retrofit work is currently on going. For our purpose, 215 households are eligible to participate in the survey.

At the beginning of the data collection, all the interviewers⁹ involved in the survey have been briefed to acquire all the necessary knowledge about the technical aspects of the heating and the domestic hot water system as well as the information about the background of the program. A training session has been undertaken for the main interviewers in March 2015 in the agency of EDF (Mulhouse). It is essential that the interviewers are confident with the underlying materials, i.e. reading billing data from different providers, to avoid measurement errors.

First, we send out an official letter on behalf of the program manager to inform participants that they will be contacted by the University of Strasbourg to participate in the survey. In the official letter, it has been explained to the participants that they are asked to provide their energy bills regarding the heating and the electricity consumption regarding the pre- and post-retrofit period.

Second, the questionnaire has been administrated in three survey waves. We conduct the first survey wave from April until July 2015. We achieve a high response

participants to change the heating system nor to use renewable energy sources. From the assisted self-administrated survey we infer that a majority of participants seek consultation from the contractor to decide whether to adopt a heating system using renewable energy sources, such as heat pumps or wood boiler.

⁹We grateful thank Leila Chérifi, Maryline Delsart, Lucie Martin-Bonnel-De-Longchamp, Ludovic Parisot and Déborah Zaparova for their effort and kind support during the data collection.

rate of 43.3%. The high response rate may result from the written convention between the utility company EDF and the participants which are prompted to provide additional information after the program intervention.

From November 2015 until February 2016, we launched a second wave of the survey to complete missing data¹⁰ from the previous survey wave and to further continue the survey work. In this period, we could increase the completed cases by 5 (pre- and post-retrofit) and by 15 (post-retrofit) households. More precisely, we complete the cases in which missing data (e.g. billing data, prescribed thermal studies) occurred in the previous survey wave. The nature of missing data¹¹ emerges because the participants respond to the questionnaire by phone, thus they could not provide directly their billing data. Hence, they are asked to send their billing data (energy bill) electronically by email to the responsible person in charge of the survey. However, some among the survey members obviously forget about it. Another source of missing data comes from wrong and incomplete reports of the prescribed thermal studies. The data collection is intensive and further efforts are required to deal with a high amount of missing data.

Finally, a third survey wave was launched from March 2016 until July 2016 to complete missing data from the first and second wave and to further continue to survey those participants which have not yet been contacted. In this period, we increase the completed cases by 15 (pre- and post-retrofit) and 25 (post-retrofit) households. In total we have a high response rate about 76.74% of our sample but we have on average around 29% missing information from billing data and 25% missing information from prescribed thermal studies.

All in all, we have surveyed 165 program members in the upper and lower Alsace from April 2015 until July 2016 by launching three survey waves. In the next section, we are describing especially the nature of the data.

5.2 Data

In this section, we are presenting the main part of the data and discuss certain limitations of the database (5.2.1). Moreover, we are describing the data from

¹⁰In the appendix D.1, we provide tables summarizing the sample size and missing data of the different survey waves.

¹¹In chapter 6, we are providing more information about the pattern of missing data regarding the survey, billing data and prescribed thermal studies.

prescribed thermal studies (5.2.2). Furthermore, we are exemplifying the calculation of the measured energy consumption (5.2.3). Lastly, we give an overview about the key variables (5.2.4).

5.2.1 Survey Sample

We use longitudinal data from 165 individual households by carrying out survey from April 2015 until July 2016 to gather the total energy consumption of the dwellings before and after program intervention. We note that the energy consumption presented in this descriptive part and adjacent in chapter 6 is indicated in primary energy consumption expressed in kilowatt-hours per square meter per annum ($kWh_{EP}/m^2/year$).



Figure 5.1: Mapping the density of individual households participating in the survey
Source: National Geographic (2016)

Figure 5.1 displays the survey sample of 165 individual households in the region Alsace located in North-East France. The region Alsace appears as the smallest and one of the densely populated regions in France. The region comprises two departments (upper and lower Rhine), is categorized in 9 districts (French administrative areas) and borders Germany and Switzerland. Alsace ranks among the most dy-

namic and prosperous regions with its Gross Domestic Product (GDP) of EU 29.767 Euros per capita (INSEE, 2016a) representing 2.7% of French GDP (CCI ALSACE, 2014). Its unemployment rate about 9.2% (INSEE, 2016b) lies below the national average (10%). Alsace is a region of high industrial density and activities in the automobile, petrochemical, biopharmaceutical and agro-food-stuffs sectors (Région Alsace, 2010). Nevertheless, our sample is lacking on representative nature. The weatherization program has been solely launched in the region Alsace and is explicitly restricted to individual buildings with no more than three dwellings. While our sample may not be nationally representative, we deem that the results obtained from the study can mainly be applied to the region of Alsace. For this reason, we cannot draw general conclusions, thus we infer directions from our results for the renovation sector. This problem especially stems from the nature of self-selection (Berry, 1983; Frondel and Schmidt, 2005; Suerkemper et al., 2011). Participants select themselves into the program based on specific personal characteristics (environmental conscious or high price response of energy source demand). Moreover, occupants of retrofit buildings tend to be very sensitive with respect to their energy consumption and are more likely to be environmentally conscious (Frondel and Schmidt, 2005).

We confine our sample to homeowners because the data is very rarely available for tenants¹². We need to emphasize that the billing data is not always available depending on the household's heating and the domestic hot water system. In this case, the energy consumption is based on self-declared energy consumption as it is for instance the case for the primary energy resources wood and fuel. We acknowledge that it is less precise but we are left out with no choice to enhance the small sample size. Third, we experience difficulties to calculate the energy performance for households applying heat pumps or electric boiler¹³. In this case, no specific study currently exists to disentangle the percentages of the different kind of energy end-uses. We are required to imply strong assumptions to calculate the measured total energy consumption for the case of the application of heat pumps/electric boiler. It would be beneficial for the future evaluation of energy conservation programs to provide a sufficient number of households with smart metering to measure more pre-

¹²We omit three households for which tenants are present in the dwelling from our sample. In the first place, we only have the contact of the homeowners. After having received the contacts of the tenants, we notice that it is rather difficult to motivate the tenants to participate in the survey as they were actually not involved in the weatherization program.

¹³In this case the total energy consumption of the dwelling is supplied in form of electricity energy

cisely the heating consumption, the domestic hot water and the energy consumption of domestic appliances of households. We suggest combining billing data with data from smart metering to measure more precisely the total energy consumption of households.

Moreover, we measure the total energy consumption before and after the program intervention at one point of time. This can eventually cause potential bias in our results. Ideally, researchers should consider conducting longitudinal survey to measure the energy consumption with all necessary information once before and once after the program intervention. In this case, it would be preferable to use a control group of households which have not participated in the program to evaluate more accurately the weatherization program. Nevertheless, we do not aim to analyze the impact of the weatherization program on the household's energy consumption but we rather seek to explain which underlying determinants are essentially causing the energy performance gap before and after retrofit measures.

Another concern is that the majority of the program participants were not living in the actual building before the retrofit work. This issue is of major concern as we are limited to gather data before retrofit measures and we need to further control for self-selection bias which causes endogeneity problems in the econometric analysis.

Our database is to some extent very limited, however very informative, since we are merging billing data with information from the prescribed thermal studies and household survey. We are the first who collect the total energy consumption according to the French thermal regulation and the database represents a valuable contribution to the residential energy sector in France. Next, we are describing the data from prescribed thermal studies.

5.2.2 Thermal study - *Ex Ante* Evaluation

In general, the energy consumption characteristics of the residential sector are complex and needs comprehensive models to assess the adoption of energy efficiency measures and renewable energy sources (Swan and Ugursal, 2009). These models rely on input parameters (e.g. geometry, envelope fabric, climate properties) and assumptions (e.g. occupants behavior, domestic hot water scenario, occupants activities, temperature control) to simulate and estimate the energy savings of the dwellings.

We refer mainly to the French method *TH-C-E-ex* according to (ADEME, 2008) which aims to compare different energy efficiency measures and engineering solutions. Simulation softwares calculate *ex ante* the annual total energy consumption for the dwelling before and after retrofit intervention. The regulatory calculation for the total energy consumption of the existing building considers five main components: heating, ventilation, cooling¹⁴, hot water, lighting, and auxiliaries, expressed in primary energy kilowatt-hours per square meter per annum ($kWh_{PE}/m^2/year$) by taking into account the climate sensitivity. The climate sensitivity or the severity of winter is measured by the heating degree days and is only valid for the heating consumption of the building. The heating degree days are calculated according to the French Meteorological Institute (Meteo France, 2005) by summing up the temperature difference between the daily mean internal base temperature (18°) and the daily mean external temperature. A heating degree day can be expressed as following

$$\begin{aligned}
 HDD &= T_{\text{Base}} - T_{\text{Ext}} && \text{if } T_{\text{Base}} > T_{\text{Ext}} \\
 HDD &= 0 && \text{if } T_{\text{Base}} \leq T_{\text{Ext}} \\
 HDD &= T_{\text{Base}} - T_{\text{Ext}} * (0.08 + 0.42) * \frac{(T_{\text{Base}} - T_{\text{Min}})}{(T_{\text{Max}} - T_{\text{Min}})} && \text{if } T_{\text{Min}} < T_{\text{Base}} \leq T_{\text{Max}}
 \end{aligned}$$

where HDD is the heating degree day ($^\circ C$), T_{Base} is the mean internal base temperature ($^\circ C$), T_{Ext} is the daily average external temperature ($^\circ C$), T_{Min} is the daily minimum external temperature ($^\circ C$) and T_{Max} is the daily maximum external temperature ($^\circ C$). The heating degree days over the monitored period (1st of October until 20th of May), comprising 232 days, per household i , with $i = 1, 2, \dots, n$ in the time period t with $t = \{\text{Pre}, \text{Post}\}$, can be expressed

$$HDD_{i,t} = \sum_{232 \text{ days}} HDD_{i,t} \tag{5.3}$$

According to the Decree of 13 June 2008 relative to the energy performance of existing buildings, the *ex ante* calculated total energy performance $S_{i,t}$ of the existing building *per* household i , with $i = 1, 2, \dots, n$ in the time period t , with

¹⁴Existing buildings in the region Alsace are not equipped with air conditioning due to the climate conditions and thus can be neglected in the regulatory calculation.

$t = \{\text{Pre}, \text{Post}\}$ can be expressed as following

$$S_{i,t} = \frac{Y_{i,t}^{HW} * \xi_k + Y_{i,t}^{Light} * \xi_k + Y_{i,t}^{Vent} * \xi_k + Y_{i,t}^{Aux} * \xi_k}{A_{i,t}^{Floor}} + \frac{Y_{i,t}^{Heat} * \xi_k}{A_{i,t}^{Floor}} * \frac{HDD_{i,t}^{30 \text{ years}}}{HDD_{i,t}} \quad (5.4)$$

where $Y_{i,t}^{HW}$ is the calculated domestic hot water final energy consumption, $Y_{i,t}^{Light}$ is the calculated lighting final energy consumption, $Y_{i,t}^{Vent}$ is the calculated ventilation final energy consumption and $Y_{i,t}^{Aux}$ is the calculated auxiliaries final energy consumption, $Y_{i,t}^{Heat}$ is the calculated heating final energy consumption, $A_{i,t}^{Floor}$ is the net surface area of the building; $HDD_{i,t}^{30 \text{ years}}$ is the average heating degree days of thirty years coefficient, $HDD_{i,t}$ is the heating degree days coefficient of the heating period and ξ_k represents the coefficient which converts final into primary energy consumption related to heating, domestic hot water, lighting, ventilation and auxiliaries. The conversion coefficients are determined by the Decree of 13 June 2008 and correspond to 2.58 for electricity, 0.6 for wood and 1 for gas and fuel.

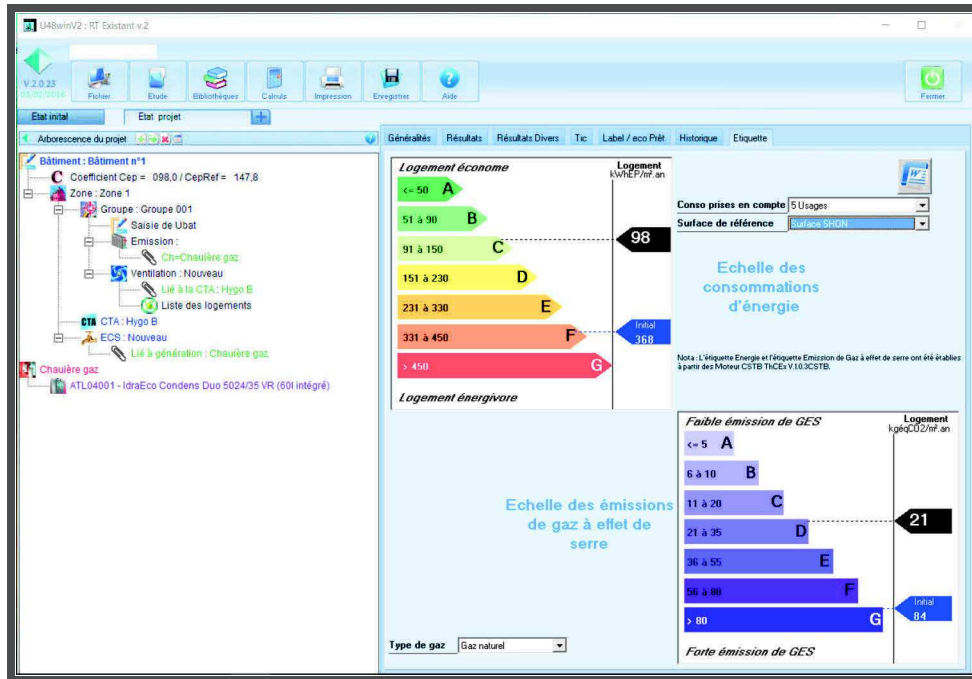

Figure 5.2: Screen-shot of the modelling software Perrenoud U48 WinV2 to estimate *ex ante* energy savings based on engineering calculations

As explained in section 4.3.1 in chapter 4, the engineering estimates of the total energy consumption (energy performance) does not correspond to the measured

energy consumption due either to accounting standards, assumptions, modelling bias or non-appropriated scenarios (Nadel and Keating, 1991; Sanders and Phillipson, 2008; ADEME, 2011; Reynaud, 2014). The regulatory approach comprises data about all technical aspects (e.g. insulation, ceilings, floor covering and heat loss) of the building shell and heating installation of the existing building. Furthermore, several commercial softwares exist at the national level such as Perrenoud U21 Win, Climwin, Pleiades or Comfie to calculate the energy performance and energy rating of the existing building. Figure 5.2 illustrates the software Perrenoud U48winV2 to assess *ex ante* engineering estimates of the primary energy consumption of the existing building before and after energy efficiency measures.

Several limitations about the basic regulatory method need to be stressed. First, the method mainly represents a static modelling approach which considers the building as a lifeless object and simply sum up the required materials. On the other hand, dynamic models consider the building as lively object, specific heating patterns and occupant's behavior. However, the last mentioned point is far more costly for the costumer and time demanding for the commissioned engineering consultant. Second, modelling the temperature control of individual buildings can be complex and thus the indoor temperatur is assumed to be $18^{\circ}C$ in all the rooms of the building (ADEME, 2011). Third, the simulation technique is sensitive to demographic, economic and technological factors (Swan and Ugursal, 2009). In the next subsection, we are explaining the calculation of the measured total energy consumption from billing data.

5.2.3 Measured Energy Consumption - *Ex Post* Billing Data

In general, the calculation of the measured total energy consumption $D_{i,t}$ of the household i , with $i = 1, 2, \dots, n$ and in the time period t , with $t = \{\text{Pre}, \text{Post}\}$ is similar to the equation 5.4, which can be adjusted and rewritten as

$$\begin{aligned}
 D_{i,t} = & \frac{C_{i,t}^{HW} * \xi_k + C_{i,t}^{Light} * \xi_k + C_{i,t}^{Vent} * \xi_k + C_{i,t}^{Aux} * \xi_k}{A_{i,t}^{Floor}} \\
 & + \frac{C_{i,t}^{Heat} * \xi_k}{A_{i,t}^{Floor}} * \frac{HDD_{i,t}^{30 \text{ years}}}{HDD_{i,t}}
 \end{aligned} \tag{5.5}$$

We need to emphasize that the calculation of the measured total energy con-

sumption (before and after retrofit measures) from billing data¹⁵ is not straightforward. The electricity consumption deduced from billing data contains the specific electricity consumption of domestic appliances which however is not considered in the calculation of the measured total energy consumption. To obtain the measured electricity consumption regarding ventilation, auxiliaries and lighting, we subtract the specific electricity consumption of 21% according to CEREN (2015) from the measured total electricity consumption $C_{i,t}^{ElecTotal}$ which can be expressed as

$$C_{i,t}^{Light} + C_{i,t}^{Vent} + C_{i,t}^{Aux} = 0.21 * C_{i,t}^{ElecTotal} \quad (5.6)$$

The measured total energy consumption merely depends on the household's specific heating circuit and we need to distinguish between three substantial configuration of heating and domestic hot water systems: (i) Single application of heating and domestic hot water system; (ii) Mixed system; (iii) Dual separated heating and domestic hot water system. Hence, we display each configuration consecutively by stating the calculation of the measured heating and the domestic hot water consumption expressed in final energy consumption.

Single application of heating and domestic hot water system

This type of heating circuit is straightforward since one single heating system, such as gas, oil or wood boiler as well as heat pump and electric boiler, supplies both the heating and the domestic hot water path. Figure 5.3 illustrates an example of a dependent heating and domestic hot water circuit. The box with flame in the illustration 5.3 sketches the main heater supplying simultaneously the radiators and the domestic hot water with energy (box with the shower). In this case, we use the information from the prescribed thermal study to obtain the percentage¹⁶ of the domestic hot water consumption.

¹⁵In the appendix D, we provide additional information about the conversion coefficients to convert billing data from different energy sources into *kWh* in terms of lower calorific value (LCV).

¹⁶It is not always possible to apply the percentage due to incomplete or wrong thermal studies reports. In this case, we calculate the average of those households with a similar heating and hot domestic circuit and apply the average percentage to those households with the missing information about the percentage.

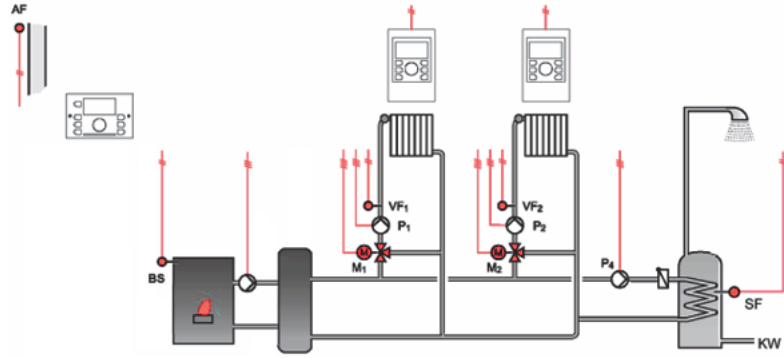

Figure 5.3: Single application

Source: *Xpair (2011)*

The measured heating and domestic hot water consumption¹⁷ in the case of wood, oil and gas boiler can be written such as

$$\begin{aligned} C_{i,t}^{Heat} + C_{i,t}^{HW} &= (C_{i,t}^{Heat} - \rho_{i,t} C_{i,t}^{Heat}) + \rho_{i,t} C_{i,t}^{Heat} \\ &= [(1 - \rho_{i,t}) C_{i,t}^{Heat}] + \rho_{i,t} C_{i,t}^{Heat} \end{aligned} \quad (5.7)$$

where ρ is the specific percentage of the domestic hot water from the total energy consumption of the boiler according to the prescribed thermal study for the household i in time t .

In the case a heat pump (or an electric boiler) is installed, we need to consider the measured total electricity consumption since the heat pump is supplied by electricity energy. There exist until now no study in France which distinguishes between the measured electricity consumption according to the French thermal regulation and the measured electricity consumption of domestic appliances in a low energy building. Hence, the calculation is slightly different, because we do not actually know the precise percentage of the electricity for domestic appliances regarding low energy buildings. In this case, we need to imply strong assumptions to subtract the percentage of the measured specific electricity (ventilation, auxiliaries and lighting) consumption from the measured total electricity consumption. Hence, we use in a first step the percentage of 34%¹⁸ according to [CEREMA \(2015\)](#) to extract the amount of energy consumption, which we call here thermal amount, accounting

¹⁷Note that we need to distinguish both types of consumption because the heating consumption is normalized by the severity of the winter (Ratio HDD_{30}/HDD) in equation (5.5) which is not applicable for the domestic hot water consumption.

¹⁸Note that [CEREMA \(2015\)](#) conduct a large study by supplying specific individual low energy buildings with smart metering's. Nonetheless, the sample size used in their study is very small for the case of heat pump/electric boiler, however we had no other alternative.

for the energy consumption related to the five components (heating, domestic hot water, auxiliaries, ventilation, lighting).

The principle calculation of the thermal amount C^{TR} for a household i in time t in the case of heat pump (or electric boiler) is described by the formulae (5.8)

$$C_{i,t}^{TR} = 0.34 * C_{i,t}^{ElecTotal} \quad (5.8)$$

where C^{TR} is the measured thermal amount which corresponds to the measured total energy consumption related to the French thermal regulation. To gather a precise percentage of the heating and domestic hot water consumption from the thermal amount, we use a study¹⁹ conducted by ADEME (2012). In this case, we deduce 41.37% for the measured heating, 26.86% concerning the measured domestic hot water and 41.77% for the measured electricity consumption from the measured thermal amount.

Equation (5.9) illustrates the calculation of the measured heating, domestic hot water and specific electricity consumption from the measured thermal amount $C_{i,t}^{TR}$ for the household i in time t in the case of the household is supplied by a heat pump (or electric boiler) and follows

$$\begin{aligned} C_{i,t}^{TR} &= C_{i,t}^{Heat} + C_{i,t}^{HW} + C_{i,t}^{Elec} \\ \text{where } C_{i,t}^{Heat} &= 0.4137 * C_{i,t}^{TR} \\ \text{and } C_{i,t}^{HW} &= 0.2686 * C_{i,t}^{TR} \\ \text{and } C_{i,t}^{Elec} &= 0.4177 * C_{i,t}^{TR} \end{aligned} \quad (5.9)$$

Mixed system of heating and domestic hot water

The next type of heating circuit considers the heating and domestic hot water supply as a mixed system (see figure 5.4). For instance, the principal heating plant (first square on the left-hand-side) is considered to be an oil furnace, wood, electric or gas boiler, which supplies the heating and the domestic hot water with energy (box with the shower). Additional installed solar panels (on the right-hand-side) have been put in place to supply supplementary the heater and the domestic hot water with energy produced from the solar panels²⁰.

¹⁹It should be noticed that we choose the study which fits most appropriately to our conditions.

²⁰In practice, it could be also possible that the solar system is replaced for instance by wood heater, heat pump or electric heater.

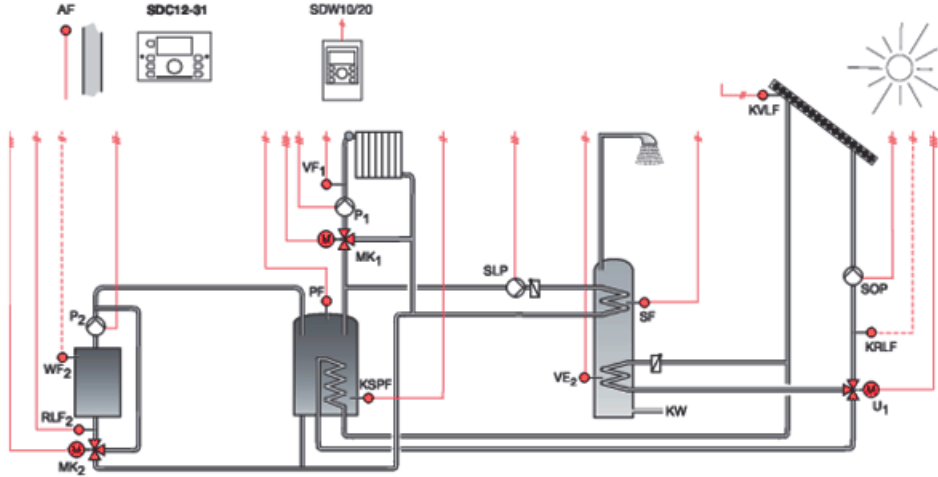

Figure 5.4: Mixed system

Source: *Xpair (2011)*

In such a case, the calculation is not straightforward and again we are required to use the information from the prescribed thermal study to calculate the measured total energy consumption. The equation of the measured heating and the domestic hot water consumption of a household i in time t follows

$$\begin{aligned} C_{i,t}^{Heat} + C_{i,t}^{HW} &= (C_{i,t}^{HeatAlt1} - C_{i,t}^{HeatSol}) + \rho_{i,t} C_{i,t}^{HeatAlt1} - C_{i,t}^{HWSol} \\ &= [(1 - \rho_{i,t}) C_{i,t}^{HeatAlt1} - C_{i,t}^{HeatSol}] + \rho_{i,t} C_{i,t}^{HeatAlt1} - C_{i,t}^{HWSol} \end{aligned} \quad (5.10)$$

where $C^{HeatAlt1}$ is the measured heating consumption of the principal heat plant, $C^{HeatSol}$ is the production of heating energy from the solar panels, ρ is the percentage of the measured domestic hot water from the measured total heating consumption of the principal boiler and C^{HWSol} is the production from heating the domestic hot water with solar energy.

Dual separated heating and domestic hot water system

Lastly, we consider the heating type comprising an independent heating and the domestic hot water circuit. For example, the heater (box with a flame) is supplied, likewise by a gas furnace and the domestic hot water is provided by a solar energy (box with the shower) (See figure 5.5).

In this case, the calculation of the measured heating and the domestic hot water

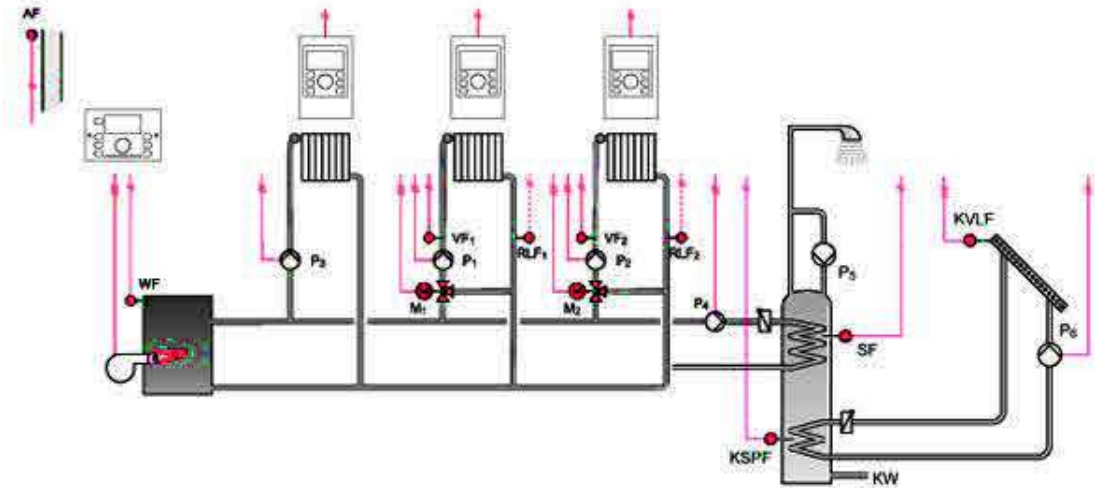

Figure 5.5: Separated heating and domestic hot water system
 Source: *Xpair (2011)*

energy consumption is described by formulae (5.11)

$$C_{i,t}^{Heat} + C_{i,t}^{HW} = C_{i,t}^{HeatAlt1} - C_{i,t}^{HWAlt2} \quad (5.11)$$

where $C_{i,t}^{HeatAlt1}$ represents the measured heating consumption of the principal boiler, $C_{i,t}^{HWAlt2}$ is the production of domestic hot water in the secondary boiler from the solar energy.

Several configurations regarding the heating and the domestic hot water circuits are possible which need to be carefully considered for the calculation of the measured total energy consumption. In the following subsection, we are presenting the variables.

5.2.4 Variables

For the sake of completeness, we are describing the variables used to run panel regression analysis in chapter 6. The variables can be categorized into four main blocks: Outcome, technical, energy related behavior and sociodemographic variables. Table 5.3 lists all variables.

Table 5.3: List of variables

Variables	Definitions	Nature
-----------	-------------	--------

Outcome measurement

$S_{i,t}$	Household's calculated total energy consumption at time t expressed in $kWh_{EP}/m^2/y$	continuous
$D_{i,t}$	Household's measured total energy consumption at time t expressed in $kWh_{EP}/m^2/y$	continuous
$TIME_{i,t}$	Retrofit work has been conducted at time t (1 if yes, 0 otherwise)	dummy

Technical characteristics

$DH_{i,t}$	Household lived in the dwelling at time t (1 if yes, 0 otherwise)	dummy
PIO_i	Household is in the sample of the 50 pioneer yards (1 if yes, 0 otherwise)	dummy
$AREA_{i,t}$	Household's net surface area of the dwelling at time t in m^2 (1 if yes, 0 otherwise)	continuous
$U_{i,t}$	U values of the dwelling at time t	continuous
$CONS_i$	Construction date of the dwelling	continuous
$BDT_{i,t-1}$	Blower Door Test at time $t - 1$ expressed in $m^3/h/m^2$	continuous
$SYST_{i,t,j}$	Heating and domestic hot water system at time t in category j (1=conventional energy, 2=mixed energy, 3=renewable energy)	category

Energy related behavioral attitudes

$OCCUP_{i,t}$	Household's hours of occupancy on a day-to-day basis at time t	continuous
$TEMP_{i,t}$	Household's temperature setting during the day at time t	continuous
$BW_{i,t-1,j}$	Window opening with respect to the situation before the retrofit work at time $t - 1$ in category j (1=less, 2=equally, 3=more)	category

$BH_{i,t-1,j}$	Tendency of domestic hot water consumption with respect to the situation before the retrofit work at time $t - 1$ in category j (1=less, 2=equally, 3=more)	category
$BE_{i,t-1,j}$	Tendency to pay attention to the energy consumption with respect to the situation before the retrofit work at time $t - 1$ in category j (1=less, 2=equally, 3=more)	category
$BC_{i,t-1,j}$	Level of environmental concern with respect to the situation before the retrofit work at time $t - 1$ in category j (1=less, 2=equally, 3=more)	category
$BCH_{i,t-1}$	General change of energy related behavior with respect to the situation before the retrofit work at time $t - 1$ (1 if yes, 0 otherwise)	dummy

Sociodemographic characteristics

$GENDER_i$	Gender of the respondent (1 if female, 0 otherwise)	dummy
$HSIZE_{i,t}$	Household size at time t	continuous
$HSIT.f_{i,t}$	Lives in a couple at time t (1 if yes, 0 otherwise)	dummy
$CHILD.f_{i,t}$	Children are living in the household at time t (1 if yes, 0 otherwise)	dummy
$AGE.f_i$	Respondent is older than 45 years (1 if yes, 0 otherwise)	dummy
$PROF.f_i$	Intellectual profession (1 if yes, 0 otherwise)	dummy
$EDU.f_i$	Higher education level (1 if yes, 0 otherwise)	dummy
$INC.f_i$	The household's net taxable income is higher than €4000 (1 if yes, 0 otherwise)	dummy

We need to emphasize that we recode the data based on the median related to the question items in the sociodemographic part of the survey. First, we do not observe a sufficient frequency in each category and second our sample size is too small to include all categories as variables in the panel regression analysis due to a

loss of the degree of freedoms. As a consequence, it would bias our results, thus we favor to recode the categorical into dummy variables.

In this chapter we have stated all the necessary information about the household survey, data collection, sample size and the technical aspects regarding the calculation of the total energy consumption. In the next chapter, we especially seek to analyze the data accurately by using appropriate econometric tools.

Appendix D

Additional materials

D.1 Tables

Table D.1: Summary of data collection of the first survey wave

	N		Pre- and Post-Retrofit			Post Retrofit			
	187	n	Completed	Billing	Thermal study	n	Completed	Billing	Thermal study
Frequency		30	15	8	7	80	36	25	19
Percentage			50%	27%	23%		45%	31%	24%
Total		16%				43%			

Completed: Data full available;

Billing: Missing billing data;

Thermal study: Missing data in thermal study.

Table D.2: Summary of data collection of the second survey wave

	N		Pre- and Post-Retrofit			Post Retrofit			
	187	n	Completed	Billing	Thermal study	n	Completed	Billing	Thermal study
Frequency		45	20	12	13	101	51	29	21
Percentage			44%	27%	29%		50%	29%	21%
Total		24%				54%			

Completed: Data full available;

Billing: Missing billing data;

Thermal study: Missing data in thermal study.

Table D.3: Summary of data collection of the third survey wave

	N		Pre- and Post-Retrofit			Post Retrofit			
	215	n	Completed	Billing	Thermal study	n	Completed	Billing	Thermal study
Frequency		59	36	16	7	166	77	43	46
Percentage			61%	27%	12%		46%	26%	28%
Total		27%				77%			

Completed: Data full available;

Billing: Missing billing data;

Thermal study: Missing data in thermal study.

Table D.4: Conversion rates regarding Annexe 3 of the Decree of 15 September 2006 relating to the diagnosis of energy performance for the existing buildings proposed with the sale in Metropolitan France

Energy source	Conversion rate
Wood billets, pellets	4600 kWh LCV per tonne
Chunk of wood	1680 kWh LCV per tonne
Natural gas	11,628 kWh LCV per m^3
Natural gas (kWh HCV)	1/1,1 kWh LCV
Domestic heating oils	9,97 kWh LCV per liter

Note: Higher Caloric Value (HCV) is the gross caloric value regarding the heat of combustion and Lower Caloric Value (LCV) is determined by subtracting the water vapor from HCV.

D.2 Questionnaire



Questionnaire à l'attention des propriétaires ayant rénové leur maison dans le cadre du programme « Je rénove BBC »

Ce questionnaire a pour objectif de réaliser un retour d'expérience sur le programme « Je rénove BBC » auquel vous avez participé, ainsi que d'étudier les habitudes des ménages vivant dans une maison BBC.

Cette étude est menée conjointement par EDF et l'Université de Strasbourg. Nous souhaitons encore améliorer l'évaluation de la performance énergétique qu'un ménage peut attendre de la rénovation de sa maison. Votre participation à cette enquête nous permettra de récolter des données précieuses, et anonymisées, sur l'avant-après rénovation.

EDF, ES et l'Université de Strasbourg s'engagent à ce que vos réponses restent entièrement anonymes et soient utilisées dans les seuls buts expliqués ci-dessus.

EDF, ES et l'Université de Strasbourg vous remercie pour votre participation.

Lucie, étudiante en master, et Nicolas, étudiant en doctorat à l'Université de Strasbourg.

X. Le client habitait-il déjà dans la maison avant la rénovation ? Oui Non

A. MOTIVATIONS de rénovation et du choix du programme « Je rénove BBC »

A.1. Qu'est ce qui vous a essentiellement motivé à vous lancer dans des travaux de rénovation BBC?

Laisser le client répondre spontanément :

S'il ne sais pas trop, lui proposer les motifs suivants en demandant l'importance qu'il y accorde :

	Pas du tout important	Peu important	Assez important	Très important
• Posséder une maison respectueuse de l'environnement	<input type="checkbox"/>	<input type="checkbox"/>	<input type="checkbox"/>	<input type="checkbox"/>
• Réaliser des économies d'énergies	<input type="checkbox"/>	<input type="checkbox"/>	<input type="checkbox"/>	<input type="checkbox"/>
• Réaliser des économies financières	<input type="checkbox"/>	<input type="checkbox"/>	<input type="checkbox"/>	<input type="checkbox"/>
• Avoir un meilleur confort	<input type="checkbox"/>	<input type="checkbox"/>	<input type="checkbox"/>	<input type="checkbox"/>
• Rénover une maison récemment acquise/ Faciliter la revente de mon bien	<input type="checkbox"/>	<input type="checkbox"/>	<input type="checkbox"/>	<input type="checkbox"/>
• Réhabiliter une maison inhabitable, voire insalubre	<input type="checkbox"/>	<input type="checkbox"/>	<input type="checkbox"/>	<input type="checkbox"/>
• Valoriser mon patrimoine immobilier	<input type="checkbox"/>	<input type="checkbox"/>	<input type="checkbox"/>	<input type="checkbox"/>
• Entrer dans le programme « Je rénove BBC »	<input type="checkbox"/>	<input type="checkbox"/>	<input type="checkbox"/>	<input type="checkbox"/>
• Autre : _____	<input type="checkbox"/>	<input type="checkbox"/>	<input type="checkbox"/>	<input type="checkbox"/>

A.2. Vous avez eu connaissance du programme « Je rénove BBC » grâce à...

Plusieurs réponses possibles

- | | |
|---|---|
| <input type="checkbox"/> Une publicité dans la presse | <input type="checkbox"/> La présence du stand JRBBBC à un salon |
| <input type="checkbox"/> Un spot radio / spot télé | <input type="checkbox"/> Recommandation (Qui ? _____) |
| <input type="checkbox"/> Internet (Quel site ? _____) | <input type="checkbox"/> Collectivité locale |
| <input type="checkbox"/> La plaquette d'info (récupérée où ? _____) | <input type="checkbox"/> Région Alsace |
| <input type="checkbox"/> Autre : _____ | |

A.3. Quels avantages vous a apporté le programme « Je rénove BBC » ?

Plusieurs réponses possibles

- Les aides financières du programme
 L'ingénierie pour l'atteinte de la performance finale
 Autre: _____

A.4.1. Auriez-vous réalisé tous ces travaux **sans** le programme « Je rénove BBC » ?

- Oui (Répondre à A.4.2.) Non (Répondre à A.4.3.)

A.4.2. Si **oui**, seriez-vous allé jusqu'au niveau BBC dans la performance énergétique ? Oui Non

A.4.3. Si **non**, qu'est ce qui vous en aurait empêché ?

Plusieurs réponses possibles

- | | |
|---|--|
| <input type="checkbox"/> Manque de moyens financiers | <input type="checkbox"/> Manque d'expertise BBC |
| <input type="checkbox"/> Manque d'assistance et de conseils | <input type="checkbox"/> Méconnaissance des prestataires |
| <input type="checkbox"/> Autre : _____ | |

B. FINANCEMENT DE LA RENOVATION

B.1. Concernant l'obtention d'aides financières du programme « Je rénove BBC », d'après vous ...

- Les formalités administratives étaient-elles simples et claires ? oui non

Si **non**, pourquoi ?

B.2.1. De quelles autres aides financières avez-vous pu bénéficier en dehors du programme ?

- | | |
|---|--|
| <input type="checkbox"/> Crédit d'impôt | <input type="checkbox"/> Aides financières de la communauté d'agglomération (commune, ...) |
| <input type="checkbox"/> Prêt à taux zéro | <input type="checkbox"/> Autre aide financière : _____ |

B.2.2. Avez-vous rencontré des difficultés (obtention d'un prêt bancaire, formalités administratives, délais d'obtention, ...) pour l'une ou l'autre aide ?

- oui non

B.2.3. Si **oui**, pourquoi ?

C. CHOIX DES ENTREPRISES ET DES MATERIAUX/EQUIPEMENTS

C.1. Avez-vous choisi le maître d'œuvre parmi plusieurs proposés ou vous a-t-il été suggéré?

- Parmi plusieurs proposés par EDF/ES Suggéré par une connaissance/votre propre choix

C.2. Quelle a été l'importance pour vous des critères suivants dans le **choix du maître d'œuvre** ?

Classer les critères suivants de 1 à 5 (1 étant le critère le plus important).

- Sa maîtrise des techniques BBC / Qualité du travail : _____
- Son prix : _____
- Son ancienneté / sa notoriété : _____
- Connaissance du maître d'œuvre : _____
- Sa proximité : _____

C.3. Quelle a été l'importance pour vous des critères suivants dans le **choix des matériaux** ?

	Très important	Assez important	Peu important	Pas du tout important
• Leur performance / qualité	<input type="checkbox"/>	<input type="checkbox"/>	<input type="checkbox"/>	<input type="checkbox"/>
• Leur prix	<input type="checkbox"/>	<input type="checkbox"/>	<input type="checkbox"/>	<input type="checkbox"/>
• Leur respect de l'environnement	<input type="checkbox"/>	<input type="checkbox"/>	<input type="checkbox"/>	<input type="checkbox"/>

C.4. Si vous avez été conseillé pour le choix des matériaux, qui vous a conseillé ?

- EDF / ES Maître d'œuvre
 Entreprises (corps de métier) Connaissance
 Bureau d'étude thermique Autre : _____
 Je n'ai pas été conseillé

D. SATISFACTION du programme « Je rénove BBC »

D.1.1. Etes-vous satisfait...

- du travail général de la maîtrise d'œuvre ? oui non
- du travail général des entreprises ? oui non
- du programme « Je rénove BBC » ? oui non
- du résultat final des travaux ? oui non

D.1.2. Si vous avez répondu **non** à l'un des points ci-dessus, pouvez-vous indiquer pourquoi ?

D.2. Habitez-vous dans votre maison lors des travaux de rénovation ? oui non

D.3.1. Quel est le **nom du maître d'œuvre** qui a encadré l'ensemble de vos travaux de rénovation ?

D.3.2. Etes-vous satisfait de sa prestation ?

	Pas du tout important	Peu important	Assez important	Très important
• Relation client-corps de métier :	<input type="checkbox"/>	<input type="checkbox"/>	<input type="checkbox"/>	<input type="checkbox"/>
• Qualité de la coordination en général :	<input type="checkbox"/>	<input type="checkbox"/>	<input type="checkbox"/>	<input type="checkbox"/>
• Coût total de la prestation :	<input type="checkbox"/>	<input type="checkbox"/>	<input type="checkbox"/>	<input type="checkbox"/>
• Adéquation devis-facture :	<input type="checkbox"/>	<input type="checkbox"/>	<input type="checkbox"/>	<input type="checkbox"/>
• Respect des délais de travaux :	<input type="checkbox"/>	<input type="checkbox"/>	<input type="checkbox"/>	<input type="checkbox"/>

E. CONSOMMATION D'ENERGIE avant et après les travaux de rénovation

E.1. CONSOMMATION D'ENERGIE AVANT RENOVATION

E.1.1. Indiquez votre **consommation d'électricité totale** indiquée sur une facture datant d'AVANT la rénovation :

_____ kWh

E.1.2. Quelle est la **période** concernée par la facture utilisée ci-dessus ?

E.1.3. Complétez les informations suivantes et cochez le **système de chauffage** concerné AVANT RENOVATION :

Système (cocher)	Unité (à titre indicatif)	Energie (à titre indicatif)	Période (MM/AA à MM/AA) ou (MM à MM)	Consom- mation	Unité	Sous- compteur? (cocher si oui)
Gaz condensation	m ³	GAZ				
Gaz atmosphérique	m ³	GAZ				
Chaudière fioul	litres	FIOUL				
Chaudière granulés	kg, t	GRANULES				
Poêle à granulés	kg, t	GRANULES				
Chaudière bois	stères	BOIS				
Poêle à bois	stères	BOIS				
Réseau de chaleur	kWh	EAU CHAUDE				
Chaudière électrique	kWh	ELECTRIQUE				
Radiateurs électrique	kWh	ELECTRIQUE				
Pompe A Chaleur (PAC) air/eau	kWh	ELECTRIQUE				
PAC eau/eau	kWh	ELECTRIQUE				
PAC géothermie	kWh	ELECTRIQUE				
Autre						

E.1.4. Quelle était l'ancienneté du système de chauffage AVANT rénovation ?

0-5 ans 6-10 ans 11-15 ans Plus de 15 ans : Pouvez-vous préciser ? _____

E.1.5. Complétez les informations suivantes et cochez le **système d'eau chaude sanitaire (ECS)** concerné AVANT RENOVATION :

Système (cocher)	Unité (à titre indicatif)	Energie (à titre indicatif)	Période (MM/AA à MM/AA) ou (MM à MM)	Consom- mation	Unité	Sous- compteur? (cocher si oui)
Chauffe-eau thermodynamique	kWh	ELECTRIQUE				
Chauffe-eau électrique	kWh	ELECTRIQUE				
Système Solaire (Panneau solaire)	m ³	EAU CHAUDE				
Réseau de chaleur	kWh	EAU CHAUDE				
Autre						

E.1.6 Système entièrement électrique ?

oui (remplir l'annexe)

non

E.2. CONSOMMATION D'ENERGIE APRES RENOVATION

E.2.1. Indiquez votre **consommation d'électricité totale** indiquée sur une facture datant d'APRES la rénovation :
_____ kWh

E.2.2. Quelle est la **période** concernée par la facture utilisée ci-dessus ?

E.2.3. Avez-vous changé de système de chauffage lors de la rénovation ? oui non

E.2.4. Complétez les informations suivantes et cochez le **système de chauffage** concerné APRES RENOVATION :

Système (cocher)	Unité (à titre indicatif)	Energie (à titre indicatif)	Période (MM/AA à MM/AA) ou (MM à MM)	Consom- mation	Unité	Sous- compteur? (cocher si oui)
Gaz condensation	m ³	GAZ				
Gaz atmosphérique	m ³	GAZ				
Chaudière fioul	litres	FIOUL				
Chaudière granulés	kg, t	GRANULES				
Poêle à granulés	kg, t	GRANULES				
Chaudière bois	stères	BOIS				
Poêle à bois	stères	BOIS				
Réseau de chaleur	kWh	EAU CHAUDE				
Chaudière électrique	kWh	ELECTRIQUE				
Radiateurs électrique	kWh	ELECTRIQUE				
Pompe A Chaleur (PAC) air/eau	kWh	ELECTRIQUE				
PAC eau/eau	kWh	ELECTRIQUE				
PAC géothermie	kWh	ELECTRIQUE				
Autre						

E.2.5. Avez-vous changé de **système d'eau chaude sanitaire (ECS)** lors de la rénovation ? oui non

E.2.6. Complétez les informations suivantes et cochez le **système d'eau chaude sanitaire (ECS)** concerné APRES RENOVATION :

Système (cocher)	Unité (à titre indicatif)	Energie (à titre indicatif)	Période (MM/AA à MM/AA) ou (MM à MM)	Consom- mation	Unité	Sous- compteur? (cocher si oui)
Chauffe-eau thermodynamique	kWh	ELECTRIQUE				
Chauffe-eau électrique	kWh	ELECTRIQUE				
Système Solaire (Panneau solaire)	m ³	EAU CHAUDE				
Réseau de chaleur	kWh	EAU CHAUDE				
Autre						

E.2.6 Système entièrement électrique ? oui (remplir l'annexe) non

F. HABITUDES avant et après rénovation

F.1.1. Quel type de contrôle de température possédiez-vous avant rénovation et quel type possédez-vous après rénovation ?

AVANT rénovation :

- Robinet thermostatique
 Thermostat d'ambiance (répondre à F.1.2.)
 Aucun
 Autre : _____

APRES rénovation :

- Robinet thermostatique
 Thermostat d'ambiance (répondre à F.1.2.)
 Aucun
 Autre : _____

F.1.2. Si vous aviez un **thermostat** avant rénovation ou en avez un maintenant après rénovation, dans quelle pièce se situait ou se situe-t-il ?

AVANT rénovation : _____

APRES rénovation : _____

F.2.1. A quelle température aviez-vous l'habitude de chauffer avant rénovation...

- a. ... en journée lorsque vous étiez dans la maison ? _____ °C
 b. ... lorsque vous n'étiez pas dans la maison ? _____ °C
 c. ... la nuit ? _____ °C
 Je ne sais pas

F.2.2. A quelle température avez-vous l'habitude de chauffer depuis la rénovation...

- a. ... en journée lorsque vous êtes dans la maison ? _____ °C
 b. ... lorsque vous n'êtes pas dans la maison ? _____ °C
 c. ... la nuit ? _____ °C
 Je ne sais pas

F.3.1.1. Y avait-il des pièces non utilisées dans votre maison avant rénovation ? oui non

F.3.1.2. Si oui, étaient-elles chauffées comme les autres pièces ? oui non

F.3.2.1. Y a-t-il des pièces non utilisées dans votre maison après rénovation ? oui non

F.3.2.2. Si oui, sont-elles chauffées comme les autres pièces ? oui non

F.4.1. Quel était environ votre temps d'occupation de la maison pendant une journée ordinaire en semaine **avant rénovation**? Marquer les heures où la maison était occupée nombre d'heures : _____

6h	7h	8h	9h	10h	11h	12h	13h	14h	15h
----	----	----	----	-----	-----	-----	-----	-----	-----

16h	17h	18h	19h	20h	21h	22h	23h	00h	
-----	-----	-----	-----	-----	-----	-----	-----	-----	---

F.4.2. Quel est environ votre temps d'occupation de la maison pendant une journée ordinaire en semaine **depuis la rénovation**? Marquer les heures où la maison est occupée nombre d'heures : _____

6h	7h	8h	9h	10h	11h	12h	13h	14h	15h
----	----	----	----	-----	-----	-----	-----	-----	-----

16h	17h	18h	19h	20h	21h	22h	23h	00h	
-----	-----	-----	-----	-----	-----	-----	-----	-----	---

F.5.1. Etiez-vous souvent dans la maison rénovée pendant le weekend **avant rénovation** ? oui non

F.5.2. Etes-vous souvent dans la maison rénovée pendant le weekend **après rénovation** ? oui non

F.6. En moyenne, combien de semaines par an êtes-vous absents de votre maison (vacances, ...) ?

- moins d'1 semaine par an de 1 à 2 semaines par an
 de 2 à 3 semaines par an de 3 à 4 semaines par an
 plus d'1 mois par an : Pouvez-vous préciser ? _____

F.7. Par rapport à avant la rénovation :

	Moins	Autant	Plus
• Ouverture des fenêtres :	<input type="checkbox"/>	<input type="checkbox"/>	<input type="checkbox"/>
• Tendance à consommer de l'eau chaude :	<input type="checkbox"/>	<input type="checkbox"/>	<input type="checkbox"/>
• Tendance à porter attention à la consommation d'énergie :	<input type="checkbox"/>	<input type="checkbox"/>	<input type="checkbox"/>
• Soucieux des problèmes écologiques et environnementaux : (p.ex. en réalisant des éco-gestes)	<input type="checkbox"/>	<input type="checkbox"/>	<input type="checkbox"/>

G. CONFORT avant et après rénovation

G.1. Sur un barème de 1 à 10, comment évalueriez-vous le **confort** à l'intérieur de votre maison AVANT rénovation ?

1 2 3 4 5 6 7 8 9 10

G.2. Sur un barème de 1 à 10, comment évalueriez-vous le **confort** à l'intérieur de votre maison APRES rénovation ?

1 2 3 4 5 6 7 8 9 10

G.3.1. Y avait-il des sources d'**inconfort** dans votre maison avant rénovation ? oui non

G.3.2. **Si oui**, à votre avis, par quoi était-il provoqué?

	Oui	Non
• Sensation de courant d'air	<input type="checkbox"/>	<input type="checkbox"/>
• Sensation de paroi froide	<input type="checkbox"/>	<input type="checkbox"/>
• Température intérieure trop basse en hiver	<input type="checkbox"/>	<input type="checkbox"/>
• Température intérieure trop élevée en été	<input type="checkbox"/>	<input type="checkbox"/>
• Manque de renouvellement de l'air	<input type="checkbox"/>	<input type="checkbox"/>
• Présence de poussière dans l'air	<input type="checkbox"/>	<input type="checkbox"/>
• Infiltration d'eau / moisissures	<input type="checkbox"/>	<input type="checkbox"/>

G.4.1. Y a-t-il encore des sources d'**inconfort** dans votre maison après rénovation ? oui non

G.4.2. **Si oui**, à votre avis, par quoi est-il provoqué?

	Oui	Non
• Sensation de courant d'air	<input type="checkbox"/>	<input type="checkbox"/>
• Sensation de paroi froide	<input type="checkbox"/>	<input type="checkbox"/>
• Température intérieure trop basse en hiver	<input type="checkbox"/>	<input type="checkbox"/>
• Température intérieure trop élevée en été	<input type="checkbox"/>	<input type="checkbox"/>
• Manque de renouvellement de l'air	<input type="checkbox"/>	<input type="checkbox"/>
• Présence de poussière dans l'air	<input type="checkbox"/>	<input type="checkbox"/>
• Infiltration d'eau / moisissures	<input type="checkbox"/>	<input type="checkbox"/>

H. CLIENT

H.1. Veuillez s.v.p. indiquer vos nom et prénom :

NOM : _____

Prénom : _____

H.2. Vous êtes... un homme une femme

H.3. Situation familiale :

- En couple (marié(e), en concubinage, PACS, ...)
 Célibataire
- Divorcé(e)
 Veuf/veuve

H.4. Combien de personnes vivent au quotidien dans la maison rénovée BBC ?

- | | | | | |
|-----------------------------|----------------------------|----------------------------|----------------------------|------------------------------------|
| • Filles (0-5 ans) : | <input type="checkbox"/> 0 | <input type="checkbox"/> 1 | <input type="checkbox"/> 2 | <input type="checkbox"/> 3 et plus |
| • Filles (6-9 ans) : | <input type="checkbox"/> 0 | <input type="checkbox"/> 1 | <input type="checkbox"/> 2 | <input type="checkbox"/> 3 et plus |
| • Filles (10-17 ans) : | <input type="checkbox"/> 0 | <input type="checkbox"/> 1 | <input type="checkbox"/> 2 | <input type="checkbox"/> 3 et plus |
| • Femmes (18 ans et plus) : | <input type="checkbox"/> 0 | <input type="checkbox"/> 1 | <input type="checkbox"/> 2 | <input type="checkbox"/> 3 et plus |
| • Garçons (0-5 ans) : | <input type="checkbox"/> 0 | <input type="checkbox"/> 1 | <input type="checkbox"/> 2 | <input type="checkbox"/> 3 et plus |
| • Garçons (6-9 ans) : | <input type="checkbox"/> 0 | <input type="checkbox"/> 1 | <input type="checkbox"/> 2 | <input type="checkbox"/> 3 et plus |
| • Garçons (10-17 ans) : | <input type="checkbox"/> 0 | <input type="checkbox"/> 1 | <input type="checkbox"/> 2 | <input type="checkbox"/> 3 et plus |
| • Hommes (18 ans et plus) : | <input type="checkbox"/> 0 | <input type="checkbox"/> 1 | <input type="checkbox"/> 2 | <input type="checkbox"/> 3 et plus |

H.5. Y a-t-il le même nombre de personnes vivant au quotidien dans la maison avant et après rénovation ?

- oui non, il y a **plus** de personnes non, il y a **moins** de personnes

H.6. Dans quelle tranche d'âge vous et votre conjoint vous situez-vous ?

- | Vous | Votre conjoint | | Vous | Votre conjoint | |
|--------------------------|--------------------------|-----------|--------------------------|--------------------------|----------------|
| <input type="checkbox"/> | <input type="checkbox"/> | 18-24 ans | <input type="checkbox"/> | <input type="checkbox"/> | 45-59 ans |
| <input type="checkbox"/> | <input type="checkbox"/> | 25-34 ans | <input type="checkbox"/> | <input type="checkbox"/> | 60-69 ans |
| <input type="checkbox"/> | <input type="checkbox"/> | 35-44 ans | <input type="checkbox"/> | <input type="checkbox"/> | 70 ans et plus |

H.7. Quelle profession vous et votre conjoint exercez-vous ?

- | Vous | Votre conjoint | |
|--------------------------|--------------------------|---|
| <input type="checkbox"/> | <input type="checkbox"/> | Agriculteur exploitant |
| <input type="checkbox"/> | <input type="checkbox"/> | Artisan, commerçant, chef d'entreprise |
| <input type="checkbox"/> | <input type="checkbox"/> | Cadre, profession libérale/ intellectuelle supérieure |
| <input type="checkbox"/> | <input type="checkbox"/> | Profession intermédiaire |
| <input type="checkbox"/> | <input type="checkbox"/> | Employé |
| <input type="checkbox"/> | <input type="checkbox"/> | Ouvrier |
| <input type="checkbox"/> | <input type="checkbox"/> | Retraité |
| <input type="checkbox"/> | <input type="checkbox"/> | Au foyer (assistante maternelle, travail à domicile, ...) |
| <input type="checkbox"/> | <input type="checkbox"/> | Sans activité professionnelle, étudiant(e) |
| <input type="checkbox"/> | <input type="checkbox"/> | Autre : _____ |

H.8. Quel est votre niveau d'étude, ainsi que celui de votre conjoint ?

Vous	Votre conjoint		Vous	Votre conjoint	
<input type="checkbox"/>	<input type="checkbox"/>	Sans diplôme	<input type="checkbox"/>	<input type="checkbox"/>	Bac+1, +2
<input type="checkbox"/>	<input type="checkbox"/>	Brevet, CAP, BEP, certificat d'étude	<input type="checkbox"/>	<input type="checkbox"/>	Bac+3, +4
<input type="checkbox"/>	<input type="checkbox"/>	Baccalauréat	<input type="checkbox"/>	<input type="checkbox"/>	Bac+5 et +

H.9. Le logement que vous avez rénové dans le cadre du programme « Je rénove BBC » est...

votre résidence principale une résidence que vous louez
 votre résidence secondaire autre : _____

H.10. Vous êtes...

propriétaire du logement BBC **locataire** du logement BBC

I. RESSOURCES DU MENAGE

I.1.1. Quelles sont les ressources de l'ensemble de votre ménage ?

I.1.2. Si vous ne souhaitez ou ne pouvez pas donner un montant précis des ressources nettes de l'ensemble du ménage, à combien environ les estimez-vous pour un mois ordinaire ?

<input type="checkbox"/> jusqu'à 1000€	<input type="checkbox"/> entre 6000€ et 7000€
<input type="checkbox"/> entre 1000€ et 2000€	<input type="checkbox"/> entre 7000€ et 8000€
<input type="checkbox"/> entre 2000€ et 3000€	<input type="checkbox"/> entre 8000€ et 9000€
<input type="checkbox"/> entre 3000€ et 4000€	<input type="checkbox"/> entre 9000€ et 10000€
<input type="checkbox"/> entre 4000€ et 5000€	<input type="checkbox"/> plus de 10000€
<input type="checkbox"/> entre 5000€ et 6000€	

J. REMARQUES éventuelles

J.1. Avez-vous des suggestions d'amélioration du programme « Je rénove BBC » ou des remarques sur le programme ?

K. ANNEXE – Appareils électroménagers

K.1. Complétez les informations correspondantes aux **appareils électroménagers** que vous possédez :

Appareils électroménagers (cocher)	Quantité	Classe énergétique (A++, A+, A, B, C, D, E, F, G)	Capacité [W]	Temps d'utilisation pendant une journée [h]	Âge approximatif de l'appareil [a]
Réfrigérateur					
Congélateur					
Lave-vaisselle					
Cuisinière/four					
Lave-linge					
Sèche-linge					
Equipement de bureau (PC, ordinateur portable)					
Electronique de loisirs (TV, ...)					
<i>Autre</i>					

K.2. Complétez les informations correspondantes aux **équipements d'éclairage** que vous possédez :

Type (cocher)	Quantité	Classe énergétique (A++, A+, A, B, C, D, E, F, G)	Capacité [W]	Temps d'utilisation pendant une journée [h]	Âge approximatif de l'appareil [a]
Ampoule électrique					
Lampe fluorescente					
Tube fluorescent (néon)					
Ampoule à basse consommation					
Lampe halogène					
<i>Autre</i>					

Chapter 6

Estimating the Energy Performance Gap of Low Energy Buildings¹

¹This chapter has been realized in a mutually beneficial partnership with EDF. A part of the results of this chapter has been published in the report entitled, Retour d'expérience des programmes "Je rénove BBC". Fascicule H : Enseignements sociologiques des programmes « JRBBC » co-written by Leila Chérifi, Andreas Huber, Nicolas Lampach and Lucie Martin-Bonnel de Longchamp. Interested readers can find the data and the R code on my personal website: <https://sites.google.com/site/nicolaslampach/home>.

6.1 Introduction

Improving energy efficiency in existing buildings to meet the European 2020 climate targets and alleviate fuel poverty is of paramount concern for the European Union's long-term strategy. In the meanwhile, higher energy prices and the desire to reduce the carbon dioxide (CO_2) emissions give rise to invest in energy efficiency initiatives. With respect to financing energy efficiency upgrades, the projects often demand to be secured against energy saving shortfalls or future energy costs savings. Nonetheless, the central problem is that the current lack of information on the non-achievement of the energy performance of existing dwellings related to energy conservation programs deter investors and banks from financing energy saving initiatives. On the other hand, occupants and private owners might be reluctant to undertake energy efficiency measures due to a low degree of confidence that the energy saving project will meet the proposed target.

This chapter seeks to address this problem by providing empirical evidence on the energy performance gap between the calculated and measured energy consumption with respect to energy efficiency initiatives. The chapter attempts to cast light upon the likelihood and the risk exposure of not achieving the required energy target in order to secure the funding of energy efficiency upgrades in the future. More precisely, we aim on the insurability of the energy performance in the housing sector. Therefore, we seek to quantify the frequency and the effective risk exposure of not accomplishing the predicted energy performance of French households participated in the weatherization program "*Je rénove BBC*". It is the intend of this chapter to determine the key factors influencing the energy savings gap in order to quantify the probability about the non-achievement of the energy performance.

As described in chapter 5, we develop a novel database by merging panel data from prescribed thermal studies, billing and survey data. To the best of our knowledge, we are the first focusing on the total energy consumption according to the French thermal regulation and perform statistical bottom-up and adjusted engineering model to identify the characteristics influencing the energy performance gap. Our empirical analysis contributes to the large energy economics literature. Furthermore, our results would help to design energy efficiency insurance policy for investors and energy companies involved in energy efficiency upgrades.

We develop an econometric model to appropriately estimate the energy perfor-

mance gap by using longitudinal data. With respect to energy conservation programs, it is important to notice that the estimation results are prone for being inefficient and biased caused by sample selection and endogeneity problems (Berry, 1983; Frondel and Schmidt, 2005). Especially, endogeneity might occur as a number of participants of the weatherization program were living in the existing building (while others not) before the retrofit intervention which may affect the household's pre measured energy consumption. Additionally, a common problem in empirical research is that omitting missing observations in the regressors might cause substantial variable bias. Abrevaya and Donald (2011) report that a large majority of the empirical papers of the four top leading empirical economics journals (American Economic Review, Journal of Human Resources, Journal of Labor Economics and Quarterly Journal of Economics) have simply omitted the missing observations. In the meanwhile, scholars are questioning the methods of discarding incomplete cases as it leads to inaccurate results (Rubin (1976), Schafer (1997), Barnes et al. (2006), Roderick and Fraser (2008a), Dong and Peng (2013), amongst others).

The econometric model is based on the empirical reasoning of the prebound and rebound effect by considering the problem of sample selection bias, endogeneity and omitted variable bias. To deal with it, we follow the approach proposed by Wooldridge (2010) through applying three structural equations to overcome the problem of self-selection bias and endogeneity. Furthermore, we explore the missing data mechanism, missing rate and missing data patterns to implement an appropriate method to generate complete cases. Furthermore, we apply Durbin-Wu-Hausman test to check for the source of endogeneity and seek to compare the estimation results of the energy performance gap without and with multiple data imputations.

The instrumental variable estimation solved the problem of endogeneity and makes the estimates consistent. Our estimation results show that sample section bias is not present. The total gross effect analysis identifies that the age and the behavior related to the domestic hot water consumption affect significantly and positively the gap between the calculated and measured energy consumption. According to previous studies (Haas and Biermayr, 2000; Scheer et al., 2013; Majcen et al., 2013; Reynaud, 2014), we also reveal that on average the household's calculated energy savings from prescribed thermal studies exceeds the measured energy savings in

the context of the weatherization program. Though, applying multiple imputations renders these results less robust.

The remaining of this chapter is organized as following. Section 6.2 provides descriptive statistics about the panel data, presents graphically the energy performance gap and outlines missing data patterns. Section 6.3 states the econometric specification to analyze the energy performance gap by highlighting potential sources of endogeneity and explaining the multiple imputations method. Finally, section 6.4 summarizes the results and discusses the findings with the literature. Section 6.5 concludes and provides policy implication for the green renovation sector.

6.2 Statistical analysis

In this section, we summarize the descriptive statistics of our data by providing general information about the households participated in the weatherization program (6.2.1). Moreover, we discuss graphically the energy performance gap between the measured and calculated energy consumption (6.2.2). Furthermore, we are illustrating the missing data patterns from prescribed thermal studies, billing data and survey responses (6.2.3).

6.2.1 Descriptive Statistics

We report the descriptive statistics² of the panel data in table 6.1. Overall, we can see from the table that the panel data is unbalanced and contains a high amount of missing data³. In the following, we describe the variables by categorizing them into three blocks: Technical, energy-related behavior and sociodemographic characteristics.

The variable S is expressed in primary energy in kilowatt hours per square meter per year [$kWh_{EP}/m^2/y$] and represents the household's calculated energy consumption⁴. The average household's calculated energy consumption is about 211.66 with a standard deviation of 175.33 and a range of 1076.84 which indicates a large variability in the *ex-ante* engineering estimates from prescribed thermal studies. The variable D constitutes household's measured energy consumption, also expressed in

²The explanation and the nature of the variables are discussed in the subsection 5.2.4 of chapter 5.

³Recall that the nature of missing data occurs due both to self-reporting the energy consumption from billing data and to lacking information from the prescribed thermal studies.

⁴In this chapter, we refer to the total energy consumption (heating, domestic hot water, lighting and auxiliaries) according to the French thermal regulation (RT 2005, 2012).

primary energy in kilowatt hours per square meter per year [$kWh_{EP}/m^2/y$], with an average of 110.88, standard deviation of 68.34 and a range of 368.51. Hence, the variability of the measured energy consumption is much lower compared to the calculated energy consumption.

On average 42% of the respondents were living before the retrofit intervention in the building (*DH*) and 19% were in the sample of the 50 pioneer yards (*PIO*). The average net surface floor area of the building is about 188.41 square meter with a standard deviation of 62.18. The building shell of the households comprises on average the U value of 1.08 with a standard deviation of 0.72 (*U*). The average construction date (*CONS*) of the existing buildings is 1943 with a standard deviation of 45. The average number of the variable *BDT* representing the Blower Door Test is about 0,7 $m^3/h/m^2$ with a standard deviation of 0.35. The French thermal regulation requires that the value of BDT should be less than 0.8 for low energy buildings. The average installed heating system in the household's buildings is 1.61 with a standard deviation of 0.74 which displays a tendency toward mixed energy sources (such as a combination of conventional and renewable energy sources).

The average hours of household's occupancy on a day-to-day basis (*OCCUP*) are 15.53 with a standard deviation of 5.86. Household members spend on average more than half a day at home. The average indoor temperature during the day is about 20.32 with a standard deviation of 1.2. It clearly shows that households set higher indoor temperature compared to the standard assumption (18°) presumed for modeling the calculated energy consumption.

The categorical variable *BW* represents the behavior of window opening with respect to the situation before the retrofit work and is on average 1.7 with a standard deviation of 0.65. Similar, the variable *BH* captures the household's tendency of domestic hot water consumption with respect to the situation before the retrofit work and is on average 1.98 with a standard deviation of 0.48. Moreover, the tendency to pay attention to the energy consumption with respect to the situation before the retrofit work (*BE*) is on average 2.29 with a standard deviation of 0.63. The variable *BC* depicts the level of environmental concern regarding the situation before the retrofit work and is on average 2.3 with a standard deviation of 0.48. In total, the household's energy behavior has only changed marginally.

Table 6.1: Summary statistics of the French households participated in the weatherization program

Variables	N	Mean	SD	Median	Min	Max	Range	SE
S	175	211.66	175.33	133.90	21.16	1098.00	1076.84	13.25
D	170	110.88	68.34	86.83	20.49	389.00	368.51	5.24
DH	131	0.42	0.50	0.00	0.00	1.00	1.00	0.04
PIO	262	0.19	0.39	0.00	0.00	1.00	1.00	0.02
AREA	242.00	188.41	62.18	180.60	84.10	420.00	335.90	4.00
U	60	1.08	0.72	0.85	0.30	2.90	2.60	0.09
CONS	252	1942.61	44.50	1950.00	1700.00	2012.00	312.00	2.80
BDT	89	0.70	0.35	0.69	0.20	2.90	2.70	0.04
SYST	172	1.61	0.74	1.00	1.00	3.00	2.00	0.06
OCCUP	155	15.53	5.86	14.00	4.00	24.00	20.00	0.47
TEMP	149	20.32	1.20	20.00	17.00	24.00	7.00	0.10
BW	106	0.76	0.95	0.00	0.00	3.00	3.00	0.06
BH	120	0.95	1.05	0.00	0.00	3.00	3.00	0.07
BE	119	1.09	1.22	0.00	0.00	3.00	3.00	0.08
BC	106	1.03	1.19	0.00	0.00	3.00	3.00	0.08
GENDER	241	0.23	0.42	0.00	0.00	1.00	1.00	0.03
HSIT.f	244	0.10	0.30	0.00	0.00	1.00	1.00	0.02
HSIZE	244	3.18	1.26	3.00	1.00	7.00	6.00	0.08
CHILD.f	242	0.56	0.50	1.00	0.00	1.00	1.00	0.03
AGE.f	242	0.45	0.50	0.00	0.00	1.00	1.00	0.03
PROF.f	244	0.45	0.50	0.00	0.00	1.00	1.00	0.03
EDU.f	210	0.56	0.50	1.00	0.00	1.00	1.00	0.03
INC.f	220	0.53	0.50	1.00	0.00	1.00	1.00	0.03
REHAB.f	168	0.55	0.50	1.00	0.00	1.00	1.00	0.04

Despite, participants have received a leaflet from EDF to adopt accordingly their energy behavior to the circumstances of a low energy building. For instance, the opening of the windows in a low energy building is causing a high decrease of the energy performance because the air circulation is managed by controlled ventilation system. However, we observe that the participants on average slightly alter their behavior with respect to window opening.

On average 23% of the respondents were female. Moreover, the average household size of participants is 3.18 with a standard deviation of 1.26 where households are living on average 90% in a couple (*HSIT.f*) and on average 56% of households

have children (*CHILD.f*). On average 45% are older than 45 years (*AGE.f*), 45% are carrying out an intellectual profession (*PROF.f*), 56% have a higher education (*EDUC.f*) and 53% of households have wages higher than EUR 4000 (*INC.f*). The summary of the sociodemographic data evinces that most of the households participated in the weatherization program are wealthier, higher educated and maintains a family status. Hence, we can conclude from the summary statistics that a marginal proportion of the respondents of our sample is affected by fuel poverty. With respect to participant's motivation to take part in the weatherization program, the variable *REHAB.f* states whether it was important for the individuals to restore the building. The variable points out that 55% of the individuals with a standard deviation of 0.04 express that it was important for them. In the appendix E we provide additional summary statistics before (see table E.1) and after the retrofit intervention (see table E.2).

6.2.2 Energy savings

In a first step, we are graphically comparing whether the household's measured energy consumption corresponds to the calculated energy consumption. If the measured energy consumption is lower (higher) than the calculated energy consumption of the individual building, it states that the household would save higher (lower) levels of energy than what has been theoretically predicted by the energy simulation programs. We define the discrepancy of the measured and calculated energy consumption by their ratio such as:

$$\text{Ratio}_t = \frac{D_t}{S_t}$$

with $t = \{\text{Pre}, \text{Post}\}$ indicating the time period. The ratio equals one for the case that the measured consumption corresponds exactly to the calculated consumption and thus represents the most ideal situation.

Figure 6.1 presents the comparison of the actual measured energy consumption after the energy efficiency initiatives with the program's objective. The black horizontal line represents the weatherization program's low energy building target⁵ of $104 \text{ kWh}_{EP}/\text{m}^2/\text{y}$. At a first glance, most of the household's post measured en-

⁵Note that we have explained the low energy building target more in detail in the subsection 4.3.2 of chapter 4.

energy consumption is lower or equal to the program's target. Nevertheless, 23.75% of our sample, where the relevant data was available, could not achieve the low energy building target. In other words, around three quarters of the participants does achieve the target of the low energy building after investing in energy efficiency solutions, where one quarter does not attain the required level.

Figure 6.1: Graphical comparison of household's measured energy consumption with respect to the conservation program's target

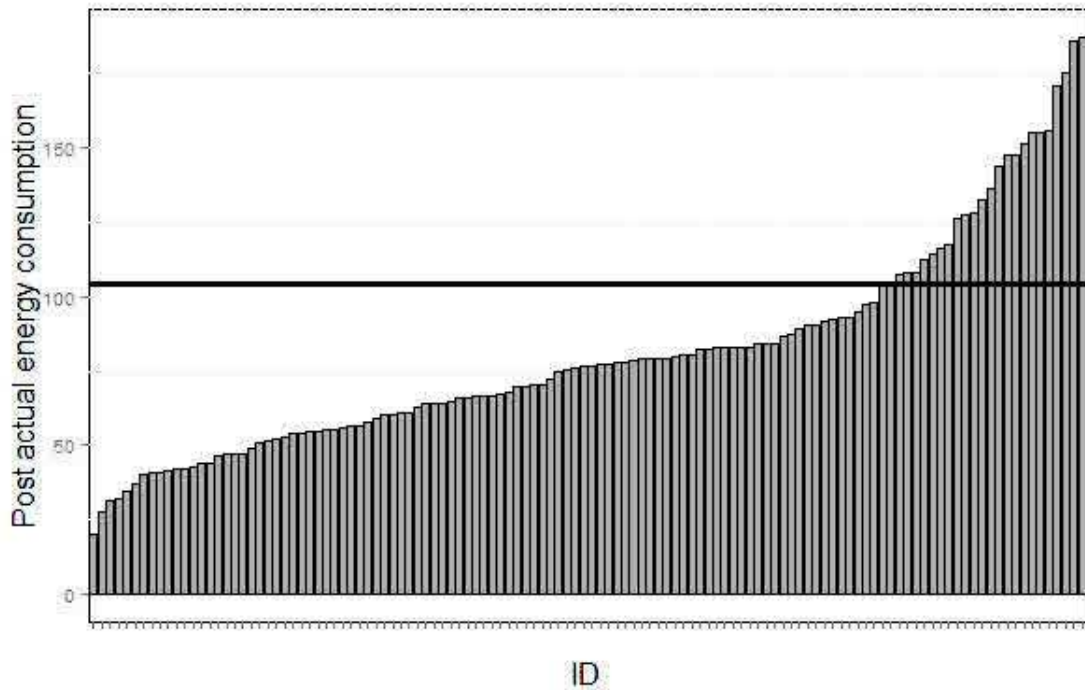

Note: Sample size equals 120; ID represents the identification number of participants

Source: Own calculations

One need to bear in mind that about 68% of participants have changed their heating system toward a new and more efficient energy heating system. One may argue that a remaining part of the households could achieve the energy target by changing their heating and domestic hot water system. Notwithstanding, there are several reasons why certain households may fail to obtain the low energy building target. One argument is that the rebound effect may lead to smaller units of energy savings than *ex-ante* expected. Another reason might be that inaccurate engineering assumptions (standards; highly optimistic assumptions; no interaction between the building and occupants) may lead to inadequate energy efficiency solutions to obtain the low energy building target.

As an illustration, the figures 6.2 and 6.3 displays the size of the discrepancy between the *ex-ante* calculated and *ex-post* measured energy consumption in the situation before and after the retrofit intervention. Figure 6.2 portrays the comparison (ratio) of both measures before the retrofit intervention. The black horizontal line constitutes the most ideal case. In such a case no direct prebound effect occurs.

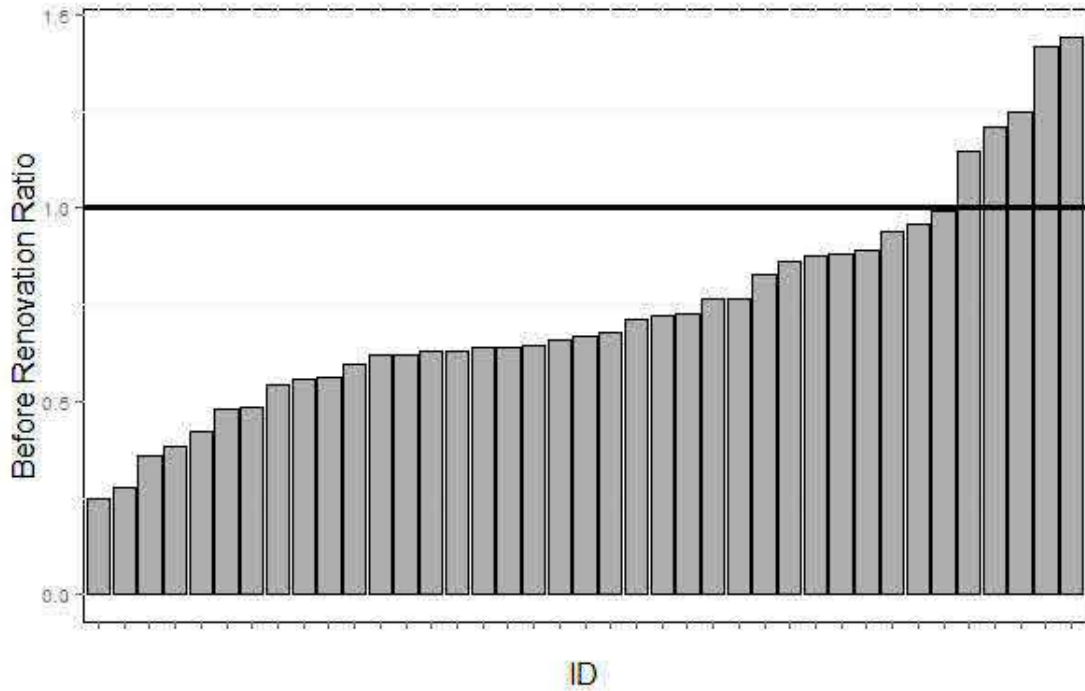

Figure 6.2: Graphical assessment of the ratio between measured and calculated energy consumption before the retrofit intervention

Note: Sample size equals 39; ID represents the identification number of participants

Source: Own calculations

The sample size is very modest for the reason that a majority of the participants (58%) were not living before the renovation in the building. Despite, the figure illustrates for a sufficient high number of cases that the calculated energy consumption mainly exceeds the measured energy consumption (87.19%). This result reflects partly the prebound effect and reports that individual households consume less energy than what has been theoretically estimated by simulation programs.

Empirical evidence on the prebound effect has been observed prior to energy efficiency upgrades in France (Cayla et al., 2010), Germany (Waldberg et al., 2011), United Kingdom (Kelly, 2011) and Netherlands (Tigchelaar et al., 2011). Galvin, R. and Sunikka-Blank, M. (2016) explains that the prebound effect can be driven

by the personal choice of occupants by keeping a low indoor temperature or heating only certain rooms. It is generally argued that a high rebound effect points out that occupants are not getting a sufficient level of thermal comfort (Galvin, R. and Sunikka-Blank, M., 2016).

It is also important to look at the energy performance gap after implementing the energy efficiency measures of the weatherization program. Figure 6.3 presents the discrepancy (ratio) between the measured and calculated energy consumption after retrofit intervention. Similar as previously, the black horizontal line represents the most ideal case for which no direct rebound effect occurs.

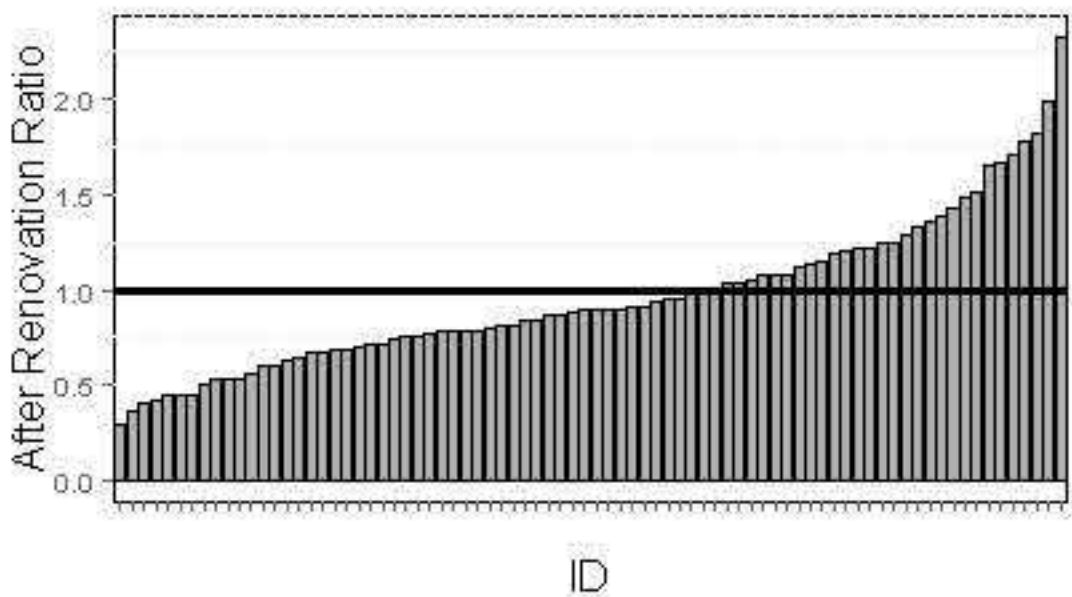

Figure 6.3: Graphical assessment of the ratio between measured and calculated energy consumption before retrofit intervention

Note: Sample size equals 80; ID represents the identification number of participants

Source: Own calculations

We observe that among the participants, 67.03%, the measured energy consumption is lower than calculated. This means that the post measured energy consumption is for one third (two thirds) of the total number of participants higher (lower) than the calculated energy consumption. More precisely, we find that the calculated energy consumption is on average $5.601 \text{ kWh}/\text{m}^2/\text{y}$ over-estimated compared to the measured energy consumption. Several studies have obtained similar results in different countries and demonstrate that measured energy consumption exceeds the calculated energy consumption (Nadel and Keating (1991), Marchio and Rabl

(1991), Haas and Biermayr (2000), Cayre et al. (2011), Majcen et al. (2013), Reynaud (2014)). The reason for this can be found in changes at the household level, such as household size, internal temperatures or other energy-related behavior.

Figure 6.4 depicts the ratio between measured and calculated energy consumption on the basis of the measured energy consumption for the situation before and after energy efficiency upgrades. Figure 6.4a indicates that the energy consumption has been theoretically over-estimated for households with low pre measured energy consumption. On the other hand, the higher the pre energy consumption, the higher is the pre energy consumption theoretically under-estimated. Furthermore, Schuler et al. (2000a) notice that the theoretical energy consumption is likely to be over-estimated with higher age of the building. Figure 6.4b displays that the higher the household's post measured energy consumption, the higher is the energy consumption theoretically under-estimated. With this respect, energy simulation programs predict especially too low energy consumption for those households which are particularly energy hungry.

These descriptive results are consistent with the findings obtained by Marchio and Rabl (1991), Branco et al. (2004) and Reynaud (2014). We need to bear in mind that these studies do not consider the total energy consumption related to five components (heating, hot water, ventilation, lighting and auxiliaries). For instance, Reynaud (2014) analyzes the deviation between observed and calculated energy consumption including all end uses such as the specific electricity (lighting and electrical appliances) and cooking. Similar as Reynaud (2014), we identify a positive relationship between the ratio and the measured energy consumption.

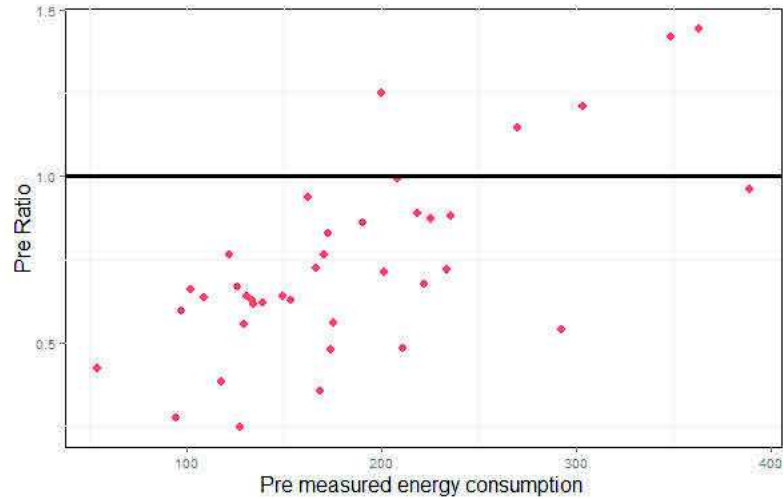

(a) Before renovation

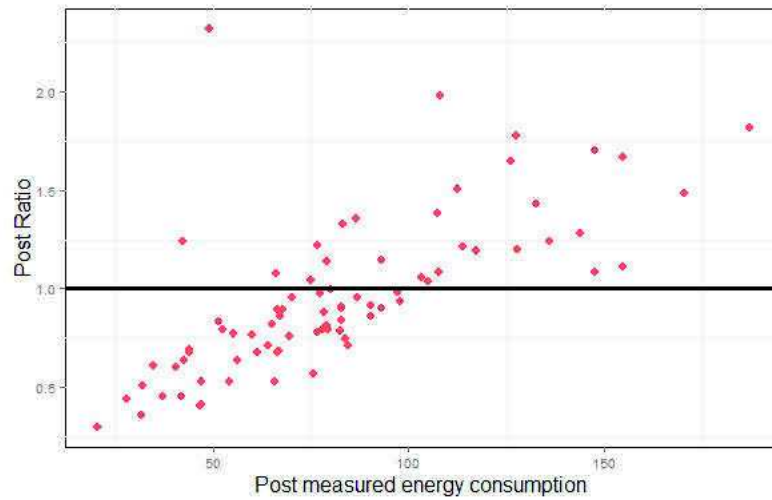

(b) After renovation

Figure 6.4: The ratio between measured and calculated energy consumption on the basis of measured energy consumption

Note: Sample size equals 39 before renovation and 80 after renovation

Source: Own calculations

To better visualize the discrepancy (differences) between the calculated and measured energy consumption before and after energy efficiency initiatives, figure 6.5 sketches the distribution of the total gross effect. The total gross effect (TGE hereafter) is identified as the difference between the calculated and measured energy savings, including both behavioral effects, the prebound and rebound effect. The dashed and the solid horizontal line constitute the median and mean of TGE, respectively. As can be seen graphically from figure 6.5, the average value of the TGE equals $24,53 \text{ kWh}_{EP}/\text{m}^2/\text{y}$ and the median represents $12,87 \text{ kWh}_{EP}/\text{m}^2/\text{y}$. Both

measures are positive which demonstrates that the *ex-ante* calculated energy savings are over-estimated compared to measured energy savings. In particular, we are interested to estimate the total gross effect while controlling for technical, household and behavioral characteristics. In this way, we can better understand the size of the different behavioral effects and the factors influencing the energy performance gap in order to design efficient insurance protection to cover against energy shortcomings.

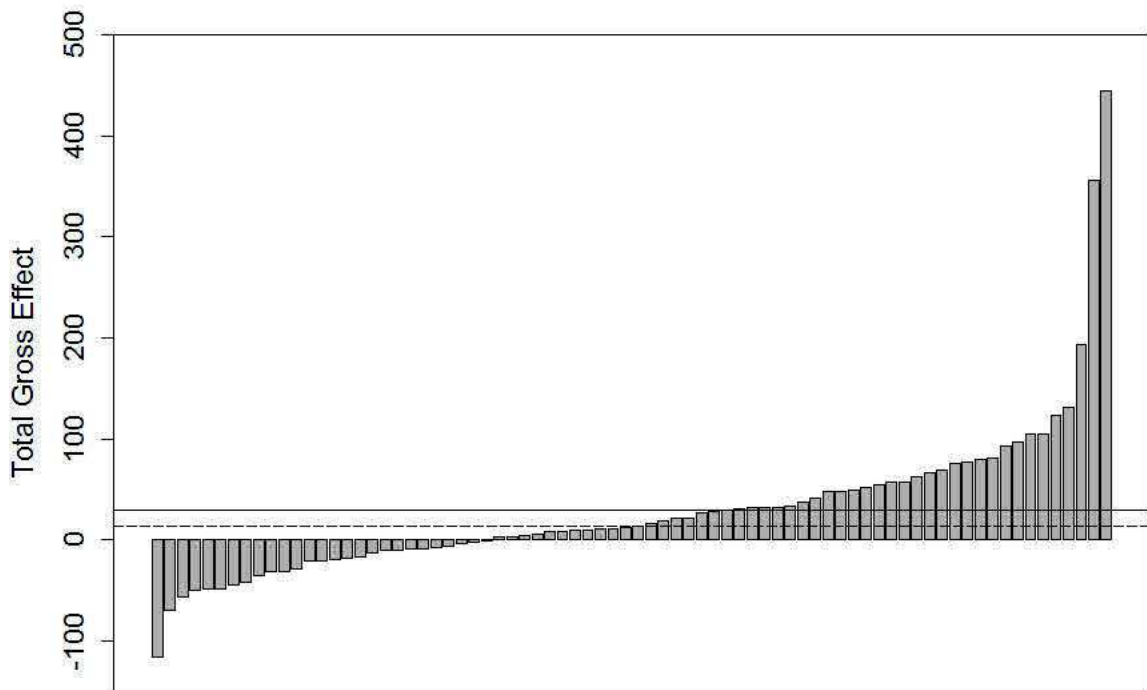

Figure 6.5: The distribution of the total gross effect with respect to the energy efficiency upgrades

Note: Sample size equals 76; Dashed horizontal line is the median and solid horizontal line represents the mean of the total gross effect

Source: Own calculations

The descriptive results give us some information about the substantial size of the deviation between the measured and the calculated energy consumption. Though, it seems necessary to understand basically which underlying determinants are affecting this discrepancy (before and after energy efficiency measures). We need to be carefully with the analysis of the size effects of the energy performance gap as our data comprises missing data which need to be examined throughout to rule out

potential variable bias in our estimation results. In the following, we explain the pattern of missing values.

6.2.3 Missing data pattern

The problem of missing data is ubiquitous in social research. Survey respondents in our sample might have left items blank on the questionnaire due either to lack of understanding or unwillingness to respond the question. Analyzing the distribution of nonresponse (missing data) is an important aspect in the decision to impute with multiple imputations methods. Scholars highlight that failings to account for missing data might cause substantial parameter bias and influence efficiency and power (Roderick and Fraser, 2008a; Shadish et al., 2002). Thus, omitting missing data might pose a threat to the internal validity of inferences, especially when the size of missing data is of a substantial size. Multiple imputations methods and a range of missing data issues have received ample attention in the applied literature (Graham et al., 2007). Multiple imputations methodology can be a powerful tool to produce less biased estimators in the presence of missing data if the measures in the imputation model are associated with the missing values.

Multiple imputations analysis needs to be conducted very carefully since consistent results can only be obtained when data is missing completely at random (MCAR). MCAR means that there is no relationship between the data point and the missing data (Little, 1988). Thus, MCAR assumes that the probability of the observation being missing does not depend on observed and unobserved measurement. Deleting missing data would be desirable if MCAR assumption does not hold.

Dong and Peng (2013) provide a practical guideline for the assessment of missing data and recommends to explore the missing rate, missing data mechanism, missing pattern before choosing an appropriate procedure to deal with missing data. The proportion of the missing data in our sample is 21.71%. Yet, Bennett (2001) argues that the statistical analysis might be biased when the data contains more than 10%. Nevertheless, Tabachnick and Fidell (2012) stress that the missing data mechanism and missing data patterns have a higher impact on the research results than the missing rate.

To verify the missing data mechanism, we employ Little MCAR test to check

whether our missing data is missing completely at random. MCAR test is statistically significant at 1% level (p-value=0.000). Thus, the MCAR test confirms that our missing data is missing completely at random.

Figure 6.6: Illustration of the missing data pattern of the first block of variables

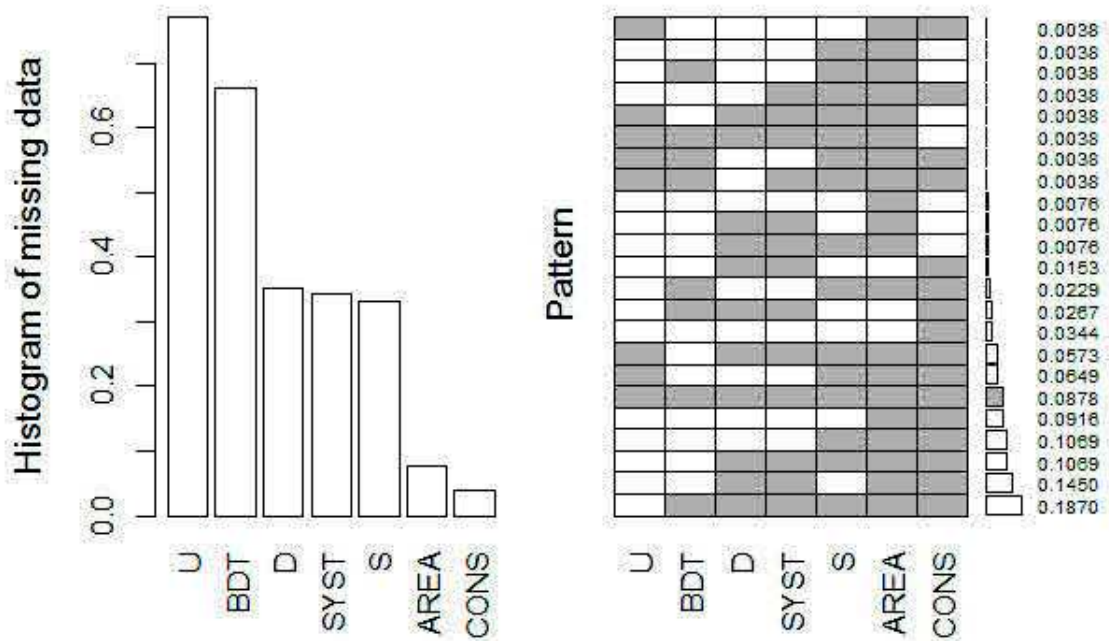

Note: White refers to the missing data and grey refers to the observed data

Source: Own calculations

Further, we explore the patterns of missingness while categorizing our variables, as previously, into three blocks for the ease of reading the illustrations below. For the sake of comprehension, we explain the pattern of missing data here graphically and numerically in appendix E (see tables E.3, E.4 and E.5).

The figure 6.6 displays the proportion of missing data in the first block of variables. The illustration on the right-hand-side indicates the pattern of missing data and portrays that all variables contain missing data. For instance, the highest frequency of missing data is observed in the variable U with 77.09%. Furthermore, the measured energy consumption D accounts for 35.45% of missing observations.

The figures 6.7 and 6.8 illustrate the second and third block of variables with respect to the survey responses. We can see from both figures that almost 43% (second block variables) and 70% (third block variables) of the samples are not missing any information. Figure 6.7 depicts that the highest frequency of missing

data is observed in the variables *TEMP* and *OCCUP*.

Figure 6.7: Illustration of the missing data pattern of the second block of variables

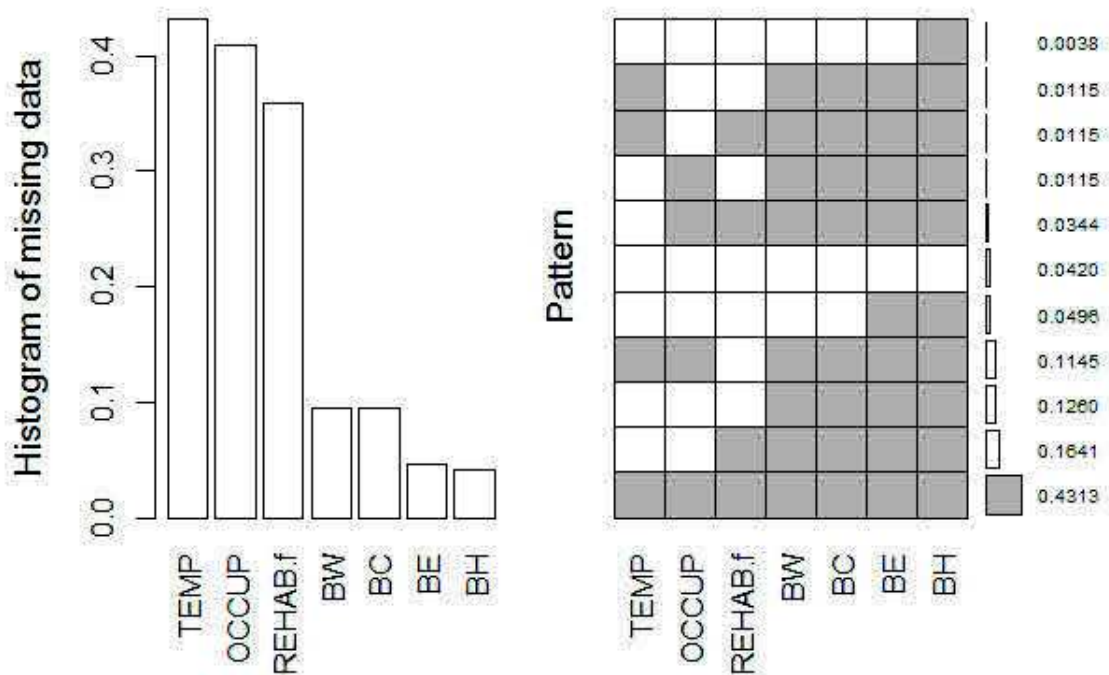

Note: White refers to the missing data and grey refers to the observed data

Source: Own calculations

In the third block of variables with respect to the survey responses (figure 6.8), the variable *EDUC.f* shows the highest frequency of missing data with a percentage of 19.84%. The missing value analysis allows us to gain a better understanding on how extensive and where exactly the missing data is located. We observe that a large part of missing data stems from prescribed thermal studies and billing data. The graphical illustrations indicate that there is no systematic pattern observed on any variables. A systematic pattern would mean that for instance, lower-income participants are less likely to provide billing data and thus would affect the conclusions about income and the energy consumption. The illustrations point out that the pattern of missing data is univariate. This means that the same participants have missing data on one or more of the different variables. Univariate patterns pose fewer problems to deal computationally with missing data than monotone and arbitrary patterns (Dong and Peng, 2013). Thus, we use multiple imputations to avoid omitting relevant information through discarding any cases with missing data. Note that dealing with missing data is necessary and that several statistical meth-

ods⁶ are available for solving this kind of problem. The imputation of missing data and the estimation method will be explained in the next section.

Figure 6.8: Illustration of the missing data pattern of the third block of variables

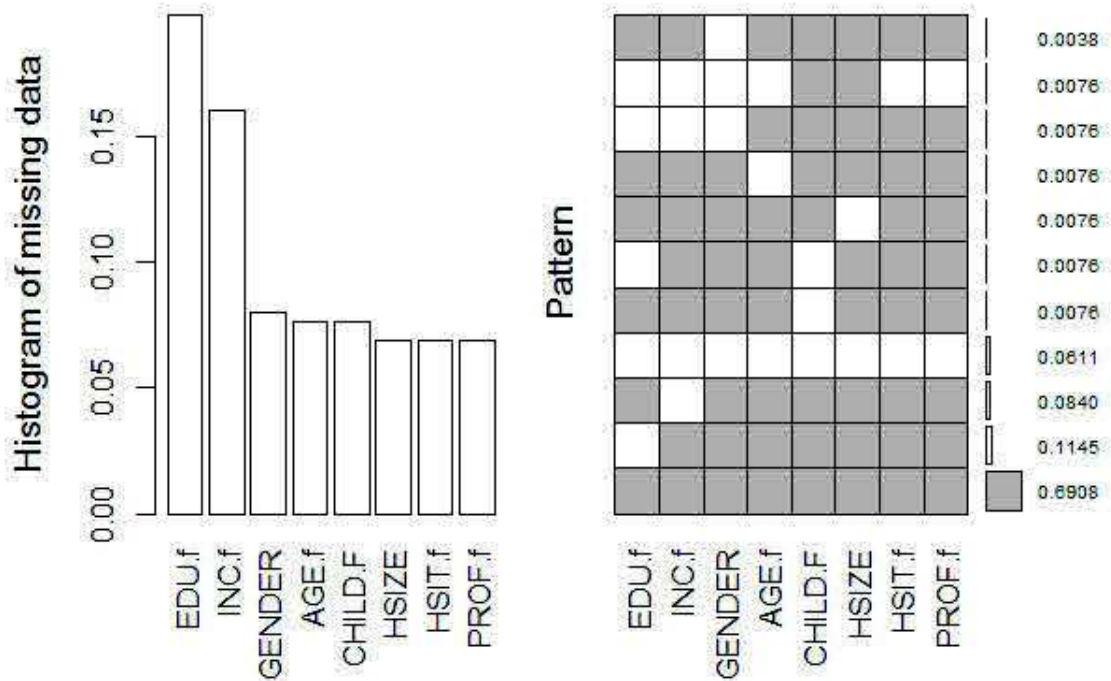

Note: White refers to the missing data and grey refers to the observed data

Source: Own calculations

6.3 Econometric specification

In this section, we will discuss the following issues: The equations of interest to be estimated (6.3.1), the problems of endogeneity (6.3.2) and the method of multiple data imputations (6.3.3).

6.3.1 Structural equations

The principal idea of our estimation approach is deduced from the figure 4.2 in chapter 4 explaining the energy performance gap between the measured and calculated energy consumption before and after the energy efficiency measures. Therefore, we seek to estimate the overall effect, namely the total gross effect. In this way, we compare three model specifications which differ whether to consider the rebound

⁶In R five main packages are commonly used to apply multiple imputations, namely MICE, AMELIA, missForest, Hmisc, mi. In Stata, the most used command is mi.

and prebound effects. The first model specification, termed *Model I* compares the energy performance gap between pre and post measured energy consumption. In this case, no rebound and prebound effect would occur. It should be notice that the dynamic panel estimation simplifies to a linear regression equation due to the inclusion of lagged dependent and independent variables and thus the first model specification is given by:

$$D_{Post,i} - D_{Pre,i} = \rho D_{Pre,i} + \beta_d X_i' + u_i \quad (6.1)$$

and equation (6.1) can be rewritten and takes the following form:

$$D_{Post,i} = (1 + \rho_d) D_{Pre,i} + \beta_d X_i' + u_i \quad (6.2)$$

where D_{Post} is the dependent variable (measured energy consumption after retrofit measures); D_{Pre} is the pre measured energy consumption; X_i represents the exogenous variables and u_i is the error term.

Now, we are considering the rebound effect in the estimation (*Model II*) and the equation (6.2) can be expressed as:

$$S_{Post,i} = (1 + \rho_s) D_{Pre,i} + \beta_s X_i' + \epsilon_i \quad (6.3)$$

where S_{Post} is the dependent variable and represents the calculated energy consumption after the retrofit intervention. While assuming that the prebound effect is constant, we only consider the rebound effect to compare the calculated with the measured energy consumption. Lastly, we allow for both the prebound and rebound effect in the estimation. Therefore, we estimate the Total Gross Effect *TGE* of the individual households which can be calculated as:

$$TGE = (S_{Pre,i} - S_{Post,i}) - (D_{Pre,i} - D_{Post,i}) = D_{Post,i} - S_{Post,i} + S_{Pre,i} - D_{Pre,i} \quad (6.4)$$

where S_{Pre} indicates the calculated energy consumption of the individual household before the retrofit intervention. To estimate the total gross effect of the individual house-

holds (*Model III*), thus we include the equations (6.2) and (6.3) in equation 6.4 which follows:

$$\begin{aligned} TGE &= (1 + \rho_d)D_{Pre,i} + \beta_d X'_i + u_i - (1 + \rho_s)D_{Pre,i} + \beta_s X'_i + \gamma_z X^K + S_{Pre,i} - D_{Pre,i} \\ \Leftrightarrow TGE &= [(1 + \rho_d) - (1 + \rho_s)]D_{Pre,i} + (\beta_d - \beta_s)X'_i + \gamma_z X^K + S_{Pre,i} - D_{Pre,i} + (u_i - \epsilon_i) \end{aligned} \quad (6.5)$$

and thus equation (6.5) can be expressed by:

$$TGE = (\rho_d - \rho_s - 1)D_{Pre,i} + (\beta_d - \beta_s)X'_i + S_{Pre,i} + \gamma_z X^K + (u_i - \epsilon_i) \quad (6.6)$$

where ρ_d and ρ_s are the estimated coefficients of the pre measured energy consumption; β_d and β_s are the estimated coefficients of the exogenous variables from the equations (6.2) and (6.3) respectively; γ_z are the estimated coefficients of additional exogenous variables which are not included in the two first equations and u_i is the error term.

As previously discussed the pre measured energy consumption comprises a substantial size of missing observations. To increase the number of observations for this variable without presuming too strict assumptions, we use the information from the pre calculated energy consumption by including a measurement error such as

$$D_{Pre} = S_{Pre} + v \quad (6.7)$$

While including equation (6.7) in the structural equations (6.2), (6.3) and (6.6), we can simply rewrite a more general form of the structural equations by assuming that the error terms ($\rho v + \epsilon$) are positive correlated with S_{Pre} which can be written as:

$$\begin{aligned} y &= \rho D_{Pre} + X' \beta + \epsilon \\ \Leftrightarrow y &= \rho(S_{Pre} + v) + X' \beta + \epsilon \\ \Leftrightarrow y &= \rho S_{Pre} + X' \beta + \rho v + \epsilon \end{aligned} \quad (6.8)$$

In this way, we can use additional information from prescribed thermal studies to enhance the predictive power of the estimated parameters without restricting the functionality of the estimation method. In the following, we devote particular attention to the problems of potential endogeneity and sample selection bias in the estimation method.

6.3.2 Endogeneity

A central problem studied in the econometric literature is that of endogeneity causing potential bias in the estimation results. Endogeneity arises when the regressor x is correlated with the error term u . The causes of endogeneity are diverse and occur due to measurement errors, omitting variables, errors-in-variables or reverse causality. In particular, endogeneity can become an issue in unbalanced panel data when relevant time-varying variables are omitted (Semykina and Wooldridge, 2010). Applications to program evaluation such as energy conservation programs in observational studies suffer from endogeneity caused by sample selection bias. Individuals who choose to select themselves into the energy conservation program are by definition different from those who do not choose the program (Imbens and Wooldridge, 2009). We do not pursue to establish the causal effect of the program initiative, however thus sample selection bias matters in our estimation approach. As a number of participants of the weatherization program were living in the existing building (while others not) before the retrofit intervention, it may affect the household's pre measured energy consumption. In other words, the pre measured energy consumption could only be observed for those who were living before the energy efficiency upgrades in the building (while for the others not).

We argue that the variable D_{Pre} (actual measured energy consumption before the renovation work) is an endogenous regressor because not all participants were living in the building before the retrofit work. Therefore, sample selection and omitting variables are potential sources of endogeneity. In other words, households who were living in the building before the energy efficiency measures might have different motivations to refurbish the building (for instance higher comfort) than those who were not living before in the building. We need to consider that the binary variable, DH , is effectively causing the regressor D_{Pre} to be endogenous. To control for potential endogeneity and sample selection, we follow the methodology proposed by Wooldridge (2010) and applied by Renders and Gaeremynck (2006) consisting of three structural equations (steps) which can be presented as follows:

(Step 3:) Structural equation

Dependent variable=f(predicted value of endogenous variable from the reduced form equation, inverse Mills ratio from the selection equation and control variables)

(Step 2:) Reduced form equation

Endogenous variable=f(instruments, inverse Mills ratio from the selection equation and control variables)

(Step 1:) Selection equation

Probit(Lived before the renovation in the building)=f(variables that define self-selection)

The main objective of this methodology is to purge the pre measured energy consumption (D_{Pre}) from endogeneity and to include the predicted values (fitted values) of D_{Pre} with respect to the three structural model specifications in the equations (6.2), (6.3) and (6.6), respectively.

We begin by discussing the methodology by working our way down through the model. As previously explained, step 3 presents the equation of interest which consists in our case of the three model specifications. The model specifications include the endogenous variable D_{pre} which we seek to correct by implementing two additional steps.

In the second step, we apply the instrumental variable estimation to circumvent that the unobservable errors are correlated with the regressor(s). The principal idea of the instrumental variable estimation involves finding an instrument (proxy for omitting variables) that is associated with the regressors but not with the error term by applying a two-stage-least square (2SLS) estimation. As the name indicates, the setup of the instrumental approach is based on two structural equations. A crucial property in this approach is that a change of the instrumental variable z is associated with changes in the regressors x but does not lead to changes in the dependent variable y (Cameron and Trivedi, 2005). In the second step⁷, the endogenous variable is estimated in function of instruments and control variables. On these grounds, it is reasonable to choose DH (dummy variable) as an appropriate instrument for the endogenous regressor D_{Pre} .

We estimate the endogenous variable, D_{Pre} , on the exogenous regressor and the instrumental variables. The equation of the second step can then be written as:

$$D_{Pre} = \beta_0 + X' \beta_k + \gamma DH + u \quad (6.9)$$

⁷Note that the model refers to three stages, termed step 1, step 2 and step 3 to avoid confusion with the two stages of the 2SLS.

where X' comprises the variables $INC.f$ and $CHILD.f$; DH represents the instrumental variable; D_{Pre} is the estimated endogenous regressor and u is the error term. The instrumental variable corrects for the correlation between the endogenous regressor and the error term and thus can remove the source of endogeneity.

However, we need to consider that the instrument (DH) by itself is endogenous due to the nature of the sample selection. For this reason, we apply the Heckman probit model to correct for the selection bias (Heckman (1976), Heckman (1979)). In our case a specific selection problem occurs, such that participants choose whether to live in the existing building before the retrofit. For this reason, the sample is biased (not random) and the pre measured energy consumption is potentially endogenous. Therefore, we estimate the probability for each individual household of being in the selected sample based on the number of explanatory variables. Then, we calculate the inverse Mills ratio from the probit model by including it in the reduced form (second step) and the structural equation (third step). The inverse Mills ratio λ can be expressed as $\lambda = \frac{\phi(X'\mu)}{\Phi(X'\mu)}$, where the term ϕ and Φ are the probability density and cumulative distribution function of the standard normal distribution, respectively and X' represents all variables included in the Heckman probit model (Greene, 1997).

The first step equation can be written such as:

$$\Pr(DH = 1|X) = \Phi(X'\beta) \quad (6.10)$$

where the dependent variable is a dummy variable and expresses whether the household have lived before the renovation in the existing building (DH) and the exogenous variables X' include the age of respondent ($AGE.f$), the net area of surface ($AREA$) and respondents having expressed that the rehabilitation of the building is important to them ($REHAB.f$) to participate in the weatherization program.

By adding the inverse Mills ratio from the Heckman probit model (first step) to the reduced form equation (second step) and the structural equation (third step), the coefficient of the pre measured energy consumption can be corrected and we can control for the sample selection without hampering any conditions of the instrumental variable estimation (Wooldridge, 2010).

We need to bear in mind that missing data is an issue in our data, and therefore we seek to handle missing data on the explanatory and instrumental variables. This approach is motivated by a recently published article by Abrevaya and Donald (2011) which

achieve higher efficiency in the results by using complete cases (by applying multiple data imputations) for instrumental variables. To generate complete cases for the exogenous and instrumental covariates, we are considering multiple imputations by chained equation (MICE) which we discuss in the following.

6.3.3 Multiple data imputations

Listwise and pairwise deletions are common methods to deal with missing observations in applied economics. Despite, these two methods are especially known to substantially lead to biased and inefficient estimates (Rubin (1976), Schafer (1997)). In the meanwhile, several statistical methods have been developed to handle missing data in a more rigorous manner. Multiple imputations or full information maximum likelihood estimation are methods, where the data is estimated from observed data (such as regression) and can produce more efficient and unbiased estimates (Schafer (1997), Graham et al. (2007), Roderick and Fraser (2008b), Dong and Peng (2013)). Multiple imputations methods with chained equation (MICE) have emerged as the principle method to deal with missing data, as it represents a very flexible approach by addressing variables of different types (e.g. continuous, binary) (Azur et al., 2011).

This approach seeks to replace missing observations with values continually drawn from conditional probability distributions by using Markov Chain Monte Carlo simulation method. It should be noted that the number of covariates to be included in the imputation model differs from fitting standard regression model as the imputation process is more related to forecasting and thus the set of variables for imputation should be large (Roderick and Fraser, 2008a). Most notably, we implement the predictive mean matching by MICE to generate imputed values for missing data on exogenous and instrumental variables (Vink et al., 2014; Morris et al., 2014). More precisely, the predictive mean matching method imputes a value randomly from a set of observed values, whose predicted value is matched (closest) with the predicted value from the specified regression model (Heitjan and Little (1991), Schenker and Taylor (1996), Horton and Kleinman (2007)).

To generate accurate imputations, we specify two conditions to the data imputation model. The two conditions imply that the pre calculated and measured energy consumption is greater than the post calculated and measured energy consumption, respectively. In this manner, the predictions from the imputation correspond concisely to the observed data of the covariates. The figure 6.9 illustrates the density of the observed (solid line) and the imputed data (dashed line) for each imputed dataset with respect to the calculated and

measured energy consumption before and after the energy efficiency upgrades.

Figure 6.9 demonstrates that the distribution of the imputed data is similar to the observed data which implies that the assumption about missing completely at random (MCAR) holds for our data. Note that the illustration of the density distribution of the remaining variables can be found in appendix E.2. For all the covariates, included in the specification of the multiple imputation regression model, the assumption of MCAR holds. The predictive mean matching method generates substantially concise data which we implement in our estimation method.

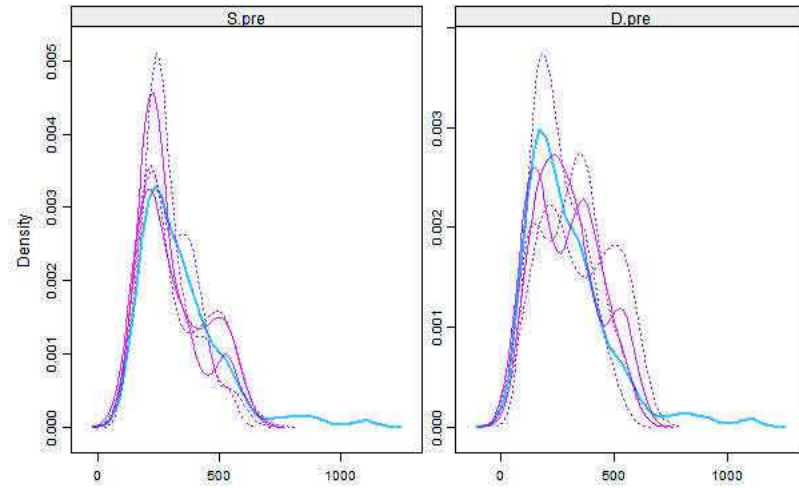

(a) Before renovation

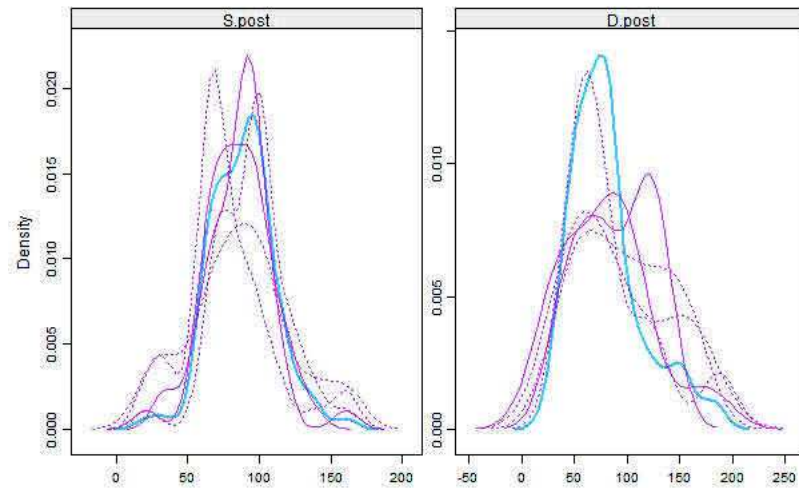

(b) After renovation

Figure 6.9: The density distribution of the observed and imputed data before and after energy efficiency initiatives

Note: Solid line represents the observed data and dashed line captures the imputed data; S.pre and D.pre correspond to the calculated and measured energy consumption before retrofit measures; S.post and D.post correspond to the calculated and measured energy consumption after retrofit measures

Source: Own calculations

In the subsequent section, we report the results of the Heckman probit model and 2SLS estimation without and with multiple data imputations. To estimate the energy performance gap with respect to the three model specifications, we perform linear multiple regression estimation by including the fitted values of the endogenous variable \widehat{D}_{Pre} in the estimation by comparing them without and with multiple data imputations.

6.4 Estimation results

In the first step, we present the results of the Heckman probit and 2SLS estimations without and with multiple data imputations by reporting bootstrap standard errors⁸ (Wooldridge, 2010). We proceed later to the results of the multiple linear regressions model. In table 6.2, we present the estimated⁹ results of the first and second step of the econometric approach.

The estimation of the probit model without (first column) and with multiple data imputations (second column) shows that living in the building before the retrofit work is highly significant and more likely for older occupants (*AGE.f*), for occupants having expressed that the rehabilitation of the building (*REHAB.f*) is not an important motivation to participate in the energy conservation program and for occupants living in buildings with smaller net surface area (*AREA*). We conduct Hosmer and Lemeshow (1980) goodness of fit test to verify whether there is no significant differences between the model and the observed data. The test is not significant for the model without $p = 0.689$ (χ -squared = 5.622) and with multiple data imputations $p = 0.680$ (χ -squared = 5.701) which indicates a sufficient large goodness of fit of both models. We do not report the marginal effects of the Heckman probit model as it is not the primary objective of the estimation method.

Moreover, we include the inverse mills ratio (*IMR*) in the reduced form equation (second step) and report the estimation results without (third column) and with multiple data imputations (fourth column). In both models, with and without multiple data imputations, neither a significant effect of the control variables nor of the inverse mills ratio can be found. The estimation results point that there is no sample selection bias since the variable *IMR* is not significant.

The estimation results show that occupants with higher net income consume lower units of measured energy consumption before energy efficiency upgrades compared to occupants with lower net income. We do not find a significant effect of the net income, in contrast previous studies underline that households with larger incomes consume significantly higher levels of energy use for space and domestic hot water consumption (Guerra-Santin et al., 2009; Biesiot and Noorman, 1999).

Furthermore, households with children consume lower units of pre measured energy consumption compared to those without children. A possible explanation can be found in

⁸The standard errors are incorrect and lead to biased results if the coefficient of the inverse mills ratio is not zero. Applying bootstrap standard errors help to deal with this problem. In general, the method of bootstrap is similar to a resampling method by applying alternative (non-parametric) asymptotic distributions for calculating standard errors, confidence intervals or p-values (Wooldridge, 2010).

⁹The estimation has been conducted in R.

the study of [Guerra and Itard \(2010\)](#) which explain that households with children tend to ventilate less than households without children leading to lower levels of heating energy consumption.

Table 6.2: Estimation results from Heckman probit model and 2SLS without and with multiple data imputations

	<i>Dependent variable</i>			
	DH		D_{Pre}	
	<i>Probit</i>		<i>OLS</i>	
	(Without Imputation)	(With Imputation)	(Without Imputation)	(With Imputation)
	<i>Coefficient</i>	<i>Coefficient</i>	<i>Coefficient</i>	<i>Coefficient</i>
AGE.F	1.052*** (0.341)	0.510*** (0.191)		
REHAB.F	-1.011*** (-0.330)	-0.600*** (-0.222)		
AREA	-0.005*** (-0.001)	-0.002*** (-0.001)		
IMR			94.077 (97.300)	56.525 (55.235)
INC.F			-21.882 (-21.526)	-45.329 (-44.715)
CHILD.F			-11.550 (-12.093)	-33.291 (-32.121)
Constant	0.735 (0.701)	0.284 (0.599)	215.063 (214.060)	274.471 (275.689)
Observations	80	131	48	131
R ²			0.127	0.032
Adjusted R ²			0.067	0.010
Log Likelihood	-41.554	-81.901		
Akaike Inf. Crit.	91.108	171.801		
Residual Std. Error			156.358 (df = 44)	165.809 (df = 127)
F Statistic			2.126 (df = 3; 44)	1.422 (df = 3; 127)

*Note: *p<0.1 **p<0.05 ***p<0.01; Bootstrap robust standard errors are given in parentheses*

Table 6.3 displays the results of the multiple linear regressions with respect to the three model specifications with and without multiple data imputations by reporting bootstrap standard errors. The statistical effects of the regressors on the energy performance gap can be observed by the sign and size of the estimates of the variables (significant effects are

given in bold). We need to emphasize that it is not possible to test all our hypotheses stated in chapter 4. As the sample size is very small, we are extremely limited in the estimation analysis. We aim to compare the results under both situations without and with multiple data imputations and therefore we are required to diminish the size of testable hypothesis. It should be notice that we cannot include certain variables due to the high amount of missing observations. Otherwise it would drastically decrease the degree of freedom of our models (thus lead to over-parameterizing).

Based on the estimation results of *Model I*, we do not find any significant effect of the variables without multiple data imputations (column 1). The measured energy consumption after the energy efficiency upgrades is estimated at 31.804 $kWh_{EP}/m^2/y$ (constant).

With respect to column 4, the results with multiple data imputations suggest that older respondents have a positive and significant effect at 1% level on the measured energy consumption after energy efficiency initiatives compared to younger respondents. The result is in line with the findings of Liao and Chang (2002), Lindén et al. (2006) and Guerra-Santin et al. (2009) which find also that older respondents tend to consume higher levels of energy than younger. On the other hand, the sign of the estimated parameter with regard to the variable *AGE.f* changes with the imputation of the data. Hence, the estimated results should be taken under significant consideration. Furthermore, the post measured energy consumption is estimated in column 4 at 97.111 $kWh_{EP}/m^2/y$.

Moreover, we apply Durbin-Wu-Hausman test (Durbin, 1954; Wu, 1973; Hausman, 1978) to verify whether the regressor D_{pre} is endogenous. The statistical test is significant at 10% level ($p = 0.074$) and suggests that the pre measured energy consumption is endogenous without multiple data imputations. In contrast, the Durbin-Wu-Hausman test is not significant ($p = 1.000$) with respect to *Model I* with multiple data imputations. The test shows that the regressor D_{pre} is in this case exogenous.

The results of the second model specification *Model II* without and with multiple data imputations reveal no significant effect of all the variables on the calculated energy consumption. We also include different variables in the estimation, but without obtaining any significant effect.

Table 6.3: Estimating the energy performance gap without and with multiple data imputations by correcting for sample selection and endogeneity

	<i>Dependent variable</i>					
	Without multiple data imputations			With multiple data imputations		
	D.post	S.post	TGE	D.post	S.post	TGE.iv
	(1)	(2)	(3)	(4)	(5)	(6)
	<i>Coefficient</i>	<i>Coefficient</i>	<i>Coefficient</i>	<i>Coefficient</i>	<i>Coefficient</i>	<i>Coefficient</i>
D.pre.iv	0.352 (0.354)	-0.618 (-0.630)	-2.932 (-5.458)		-0.270 (-0.282)	
S.pre			0.272* (0.140)			0.900 (0.892)
D.pre				0.029 (0.030)		-0.883 (-0.876)
AGE.F	-9.090 (-9.088)		9.592 (-17.253)	0.175*** (0.013)		-2.336 (-2.646)
CHILD.F	7.562 (7.359)			10.280 (10.352)		
EDU.F			-33.830 (-22.978)			-8.106 (-8.140)
INC.F		-20.708 (-21.270)	-86.087 (-135.951)		-19.541 (-20.232)	-5.477 (-5.151)
BH2		11.057 (11.401)	19.761*** (1.063)		10.594 (10.549)	1.078 (1.133)
BH3		1.293 (2.240)	104.565 (92.387)		2.288 (2.135)	1.183 (1.041)
IMR	-50.836 (-50.796)	47.133 (48.708)	248.324 (490.944)	-30.882 (-31.397)	-3.282 (-3.295)	-12.144 (-11.596)
Constant	31.804 (31.388)	217.909 (219.870)	590.644 (1,224.233)	97.111 (97.184)	172.842 (176.593)	9.691 (9.426)
Observations	61	48	36	131	131	131
R ²	0.062	0.212	0.453	0.076	0.118	0.799
Adjusted R ²	-0.005	0.118	0.291	0.047	0.083	0.786
Residual Std. Error	37.768 (df = 56)	19.106 (df = 42)	59.249 (df = 27)	35.226 (df = 126)	22.159 (df = 125)	32.604 (df = 122)
F Statistic	0.925 (df = 4; 56)	2.259* (df = 5; 42)	2.792** (df = 8; 27)	2.592** (df = 4; 126)	3.347*** (df = 5; 125)	60.601*** (df = 8; 122)
DWH test	p-value=0.074	p-value=0.000	p-value=0.000	p-value=1.000	p-value=0.015	p-value=1.000

Note: *p<0.1 **p<0.05 ***p<0.01; Bootstrap robust standard errors are given in parentheses; DWH test: Durbin-Wu-Hausman test

The Durbin-Wu-Hausman test is significant for both, without ($p = 0.000$) and with multiple data imputations ($p = 0.015$) and thus we include the pre measured energy consumption corrected for endogeneity in both estimation models.

The calculated energy consumption before the energy efficiency initiative is positive and

significant at 10% level with respect to the third model specification *Model III* (column 3) without multiple data imputations. A one unit increase in the pre calculated energy consumption leads to 0.272 units increase of the total gross effect. This confirms our HYPOTHESIS (2) and indicates that the higher the simulation programs over-estimate the energy consumption before the retrofit intervention, the higher is the gap between the calculated and measured energy savings. Similar, Reynaud (2014) finds that the higher the pre gap (between calculated and measured energy consumption before the energy efficiency upgrades) is, the higher is the post gap (after initiating energy saving measures).

- **R1:** *The higher the pre calculated energy consumption, the higher is the gap between the calculated and measured energy savings*

Furthermore, table 6.3 suggests that the behavioral variable *BH* with respect to the consumption of domestic hot water affects significantly the total gross effect. This confirms our HYPOTHESIS (3). Those respondents declaring no behavioral change related to the domestic hot water consumption have on average 19.761 higher units of the total gross effect compared to those respondents who declared a lower consumption.

- **R2:** *Higher level of domestic hot water consumption increases the gap between calculated and measured energy savings*

For instance, Lindén et al. (2006) explain that shower and bathing behavior affects the household's energy consumption. On the other hand, Reynaud (2014) could not find a significant effect for the change of the behavior with respect to the hot domestic water consumption but shows that a change of the internal temperature significantly affects the gap between calculated and measured energy consumption. Our model estimate the expected mean value of the total gross effect at $590.644 \text{ kWh/m}^2/\text{y}$. The positive value of the total gross effect signifies that the calculated energy savings highly exceeds the measured energy savings. It is worth mentioning that several studies have noticed that energy simulation programs highly over-estimate the calculated energy savings (Haas and Biermayr, 2000; Scheer et al., 2013; Majcen et al., 2013; Reynaud, 2014). Most of these studies estimate the energy savings of heating and domestic hot water in individual buildings. We obtain similar results, even if we concentrate on the total energy consumption and on low energy buildings. Nonetheless, we need to be carefully with the interpretation of the estimated parameters, as the third model specification is likely to be over-parametrized (low degree of freedoms). With respect to the remaining hypotheses, we do neither find a significant

effects for the pre measured energy consumption (HYPOTHESIS 1), the age of the respondents (HYPOTHESIS 4), the presence of children (HYPOTHESIS 5), the educational level (HYPOTHESIS 6) nor for the net income level (HYPOTHESIS 7).

- **R3:** *The variables $D.pre$, $AGE.f$, $CHILD.f$, $EDU.f$ and $INC.f$ do not have a significant effect on the gap between calculated and measured energy savings*

However, the results $R1$ and $R2$ no longer hold when we consider multiple data imputations with respect to the third model specification (column 6). The sign of the parameters do not change compared to the model without multiple data imputations, however the variable $S.pre$ and $BH2$ do not significantly affect the total gross effect. The expected mean value of the total gross effect is positively estimated at $9.691 \text{ kWh/m}^2/\text{y}$ which points as previously to an over-estimation of the calculated energy savings. With regard to the third model specification without multiple data imputations (column 3), the pre measured energy consumption is endogenous ($p = 0.000$), while in column 6 the instrument is exogenous ($p = 1.000$).

- **R4:** *The variable pre measured energy consumption is identified to be endogenous in the three model specifications without multiple data imputations and the instrumental variable estimation makes the estimates consistent*

Further comparison shows that the inverse mills ratio (IMR) is not significant which demonstrates that sample selection bias is not present in the estimation. Individuals living in the building before the retrofit work are not significantly different from those who were not living in the building with respect to the total gross effect.

- **R5:** *Sample selection bias does not influence the estimation results*

It should be noticed that generally the sign of the estimated parameters should remain the same between the model without and with multiple data imputations. This applies for most of all coefficients, except for the variables; age of the respondents ($AGE.f$) and the inverse mills ratio (IMR). The differences of the sign related to the estimated parameters might be an indication toward a higher sensitivity of the robustness of the results. On the other hand, the relatively small sample is certainly hampering the performance of the estimation, as the degree of freedom is proportionally small.

It should be notice that the method of the multiple data imputations is statistically valid if the sample size is sufficient large. The number of small sample sizes is a common

problem in several fields of research, such as clinical trials. Barnes et al. (2006) assess the validity of the performance of multiple data imputations when fully observed respondents measurement is very low and partially available. They compare the efficiency of six multiple imputation methods (last observation carried forward, Bayesian least squares, predictive mean matching, local random residual, modified propensity scores and completion score) for a number of 20, 30 and 50 observations with 20, 30 and 40 per cent rates of missingness. The authors conclude that the choice of the missing imputation method is critical but the predictive mean matching provide throughout accurate estimates.

6.5 Conclusion

We have proposed a novel concept of estimating the discrepancies between calculated and measured energy savings before and after energy efficiency upgrades. Methodologically, this chapter has developed a method to control for sample selection bias and endogeneity problems while estimating the energy performance gap with respect to the weatherization program "*Je rénove BBC*". Furthermore, we apply a novel database including billing data, sociodemographic characteristics, energy-related behavioral attitudes and data from prescribed thermal studies. Empirical analysis applied to draw conclusions from the effects on the energy performance gap will be complicated by the common problem of discarding missing observations. Therefore, we carry out multiple data imputations by using predictive mean matching method to generate a complete set of data.

The main objective of this chapter is to provide empirical results about the likelihood and the risks exposure of not accomplishing the required energy target of the energy conservation program. Moreover, this chapter intend to reveal the key determinants causing potentially the energy performance gap in order to put in place effective financial mechanism and insurance contracts to guarantee more secure forms of investment in energy efficiency projects, such as protecting investors, owners and occupants in the future against energy saving deficits.

With regard to the descriptive statistics, our data points out that 23.75% of the participants have not achieved the required energy target of the low energy building. Despite, the large majority of the households attain energy savings due to the program intervention, but however one quarter of the participants is likely to not accomplish the required energy level of a low energy building. It should be noticed that the weatherization program seeks to accomplish the low energy target for the building shell. For this reason, the energy efficiency solutions proposed by the prescribed thermal studies have been calculated based

on ideal conditions. Furthermore, the likelihood of the non-achievement of the energy performance is relatively high, while the severity of the energy performance gap (total gross effect) is relatively low (with multiple imputations). This appears to be a complicating factor for energy-efficiency insurers as it increases the purchasers sensitivity to pricing and the size of deductibles (Mills, 2003b).

The instrumental variable estimation solved the problem of endogeneity and makes the estimates consistent. Correcting for sample selection bias by using Heckman probit model estimation does not impact the results. The total gross effect analysis identifies that the age and the behavior related to the domestic hot water consumption affect significantly and positively the gap between the calculated and measured energy consumption. Though, applying multiple imputations method renders these results less credible. We are not able to identify any significant effect on the energy performance gap while considering multiple data imputations. We need to bear in mind that the small sample size and the large amount of missing observations for specific variables are certainly limiting the estimation analysis. Different to Reynaud (2014) who demonstrate that the energy heat loss of the building and precise technical information of the heating system impacts the discrepancy between calculated and measured energy consumption before the energy efficiency initiative, we are not able to test technical variables as the amount of missing data is too large.

With respect to the non-achievement of the energy performance of low energy buildings, the French government enacted on the 17th August 2015 the law on the energy transition by including the guarantee of the energy performance into the decennial insurance. Currently, it remains a vigorous debate among various professionals, companies and insurance providers whether it might be economic feasible to insure the level of the energy performance of a building over a time period of 10 years. Tuccella and Devimes (2015) argues that the non-achievement of the energy performance should be subject to the two-year performance warranty for separate parts installed.

It is important to ensure that energy efficiency initiatives deliver on their projected savings. To foster increased energy efficiency investments for existing buildings, energy savings insurance would mitigate the risk of not being able to pay back the energy efficiency investments and improve the confidence of investors. Our empirical analysis provides a basis on the dimension of the risk exposure and the likelihood of not achieving the energy performance goal. Nonetheless, more efforts are needed in France to give general statements of the energy performance gap.

Policymakers should set up larger national-wide projects to assess the energy perfor-

mance gap for different types of dwellings. Our empirical analysis could provide a basis for the evaluation of the risks related to energy efficiency savings and investments. We argue that there is a need for a larger and representative set of data for the evaluation of the energy performance gap as several factors are influencing the outcome of energy efficiency initiatives. Furthermore, we recommend supporting in the future the evaluation of energy efficiency programs by endowing a sample of households with smart-metering to capture more accurately the measured energy consumption.

In this chapter, the measured energy consumption was mainly collected in the short term after the programs intervention. It might be worth to assess an *ex-post* evaluation of the energy performance of the building in the long term to determine whether it makes economic sense to include the non-achievement of the energy performance in the decennial insurance of the Spinetta law. Future research in this direction could help to fill this void.

Appendix E

Additional material

E.1 Descriptive data

Table E.1: Summary of the descriptive data before the retrofit intervention

Variables	N	Mean	SD	Median	Min	Max	Range	SEe
S	85	342.15	172.19	296.80	128.50	1098.00	969.50	18.68
D	50	183.42	74.43	167.31	54.33	389.00	334.67	10.53
DH	131	0.42	0.50	0.00	0.00	1.00	1.00	0.04
PIO	131	0.19	0.39	0.00	0.00	1.00	1.00	0.03
AREA	120.00	185.42	63.08	176.15	84.10	420.00	335.90	5.76
U	33	1.60	0.58	1.50	0.60	2.90	2.30	0.10
CONS	126	1943	45	1950	1700	2012	312	3.97
BDT	0	-	-	-	-	-	-	-
SYST	51	1.35	0.72	1.00	1.00	3.00	2.00	0.10
OCCUP	50	15.62	6.07	14.00	4.00	24.00	20.00	0.86
TEMP	49.00	20.32	1.26	20.00	17.00	23.00	6.00	0.18
BW	0	-	-	-	-	-	-	-
BH	0	-	-	-	-	-	-	-
BE	0	-	-	-	-	-	-	-
BC	0	-	-	-	-	-	-	-
GENDER	120.00	0.23	0.42	0.00	0.00	1.00	1.00	0.04
HSIT.f	122.00	0.09	0.29	0.00	0.00	1.00	1.00	0.03
HSIZE	122.00	3.16	1.25	3.00	1.00	7.00	6.00	0.11
CHILD.f	121.00	0.55	0.50	1.00	0.00	1.00	1.00	0.05
AGE.f	121.00	0.45	0.50	0.00	0.00	1.00	1.00	0.05
PROF.f	122.00	0.45	0.50	0.00	0.00	1.00	1.00	0.05
EDU.f	105.00	0.56	0.50	1.00	0.00	1.00	1.00	0.05
INC.f	110.00	0.53	0.50	1.00	0.00	1.00	1.00	0.05
REHAB.f	84	0.55	0.50	1.00	0.00	1.00	1.00	0.05

Table E.2: Summary of the descriptive data after the retrofit intervention

Variables	N	Mean	SD	Median	Min	Max	Range	SE
S	90	88.43	22.29	90.43	21.16	160.50	139.34	2.35
D	120	80.66	34.94	76.80	20.49	187.16	166.67	3.19
DH	131	1.00	0.00	1.00	1.00	1.00	0.00	0.00
PIO	131	0.19	0.39	0.00	0.00	1.00	1.00	0.03
AREA	122.00	191.36	61.40	183.05	90.00	420.00	330.00	5.56
U	27	0.45	0.12	0.40	0.30	0.70	0.40	0.02
CONS	126	1943	45	1950	1700	2012	312	3.97
BDT	89	0.70	0.35	0.69	0.20	2.90	2.70	0.04
SYST	121	1.72	0.73	2.00	1.00	3.00	2.00	0.07
OCCUP	105	15.49	5.79	14.00	4.00	24.00	20.00	0.57
TEMP	100	20.33	1.18	20.00	18.00	24.00	6.00	0.12
BW	106	1.70	0.65	2.00	1.00	3.00	2.00	0.06
BH	120	1.98	0.48	2.00	1.00	3.00	2.00	0.04
BE	119	2.29	0.63	2.00	1.00	3.00	2.00	0.06
BC	106	2.30	0.48	2.00	1.00	3.00	2.00	0.05
GENDER	121	0.23	0.42	0.00	0.00	1.00	1.00	0.04
HSIT.f	122	0.11	0.31	0.00	0.00	1.00	1.00	0.03
HSIZE	122	3.20	1.28	3.00	1.00	7.00	6.00	0.12
CHILD.f	121	0.57	0.50	1.00	0.00	1.00	1.00	0.05
AGE.f	121	0.45	0.50	0.00	0.00	1.00	1.00	0.05
PROF.f	122	0.45	0.50	0.00	0.00	1.00	1.00	0.05
EDU.f	105	0.56	0.50	1.00	0.00	1.00	1.00	0.05
INC.f	110	0.53	0.50	1.00	0.00	1.00	1.00	0.05
REHAB.f	84	0.55	0.50	1.00	0.00	1.00	1.00	0.05

Figure E.1: Energy savings before the energy conservation program

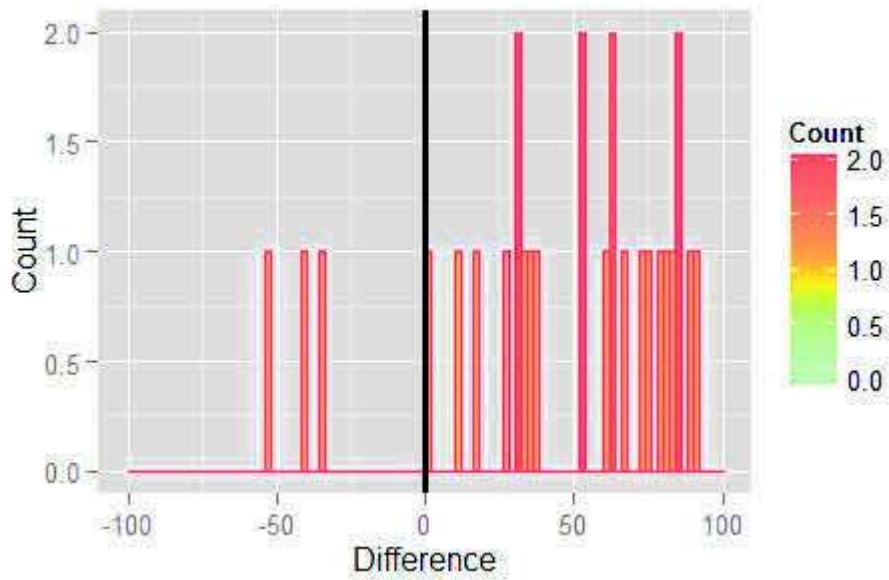

Note: Sample size equals 39; Difference represents the discrepancy between theoretical predicted and actual measured total energy consumption before the retrofit intervention. The black vertical line indicates the ideal case.

Source: Own calculations

Figure E.2: Discrepancy between ac after the energy conservation programs

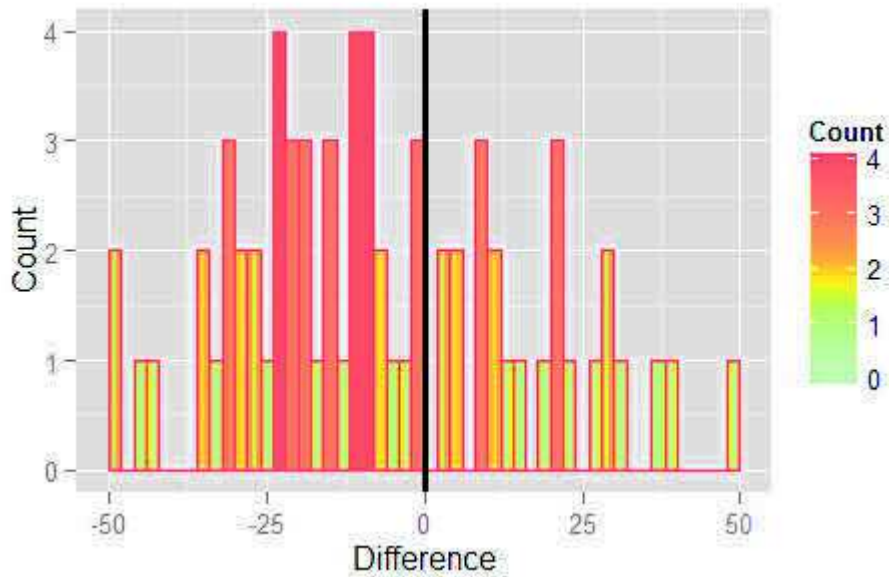

Note: Sample size equals 80; Difference represents the discrepancy between actual and theoretical total energy consumption after the retrofit intervention. The black vertical line indicates the ideal case.

Source: Own calculations

E.2 Missing data and multiple data imputation

Table E.3: Summary of missing data for the first block of variables

	AREA	S	U	CONS	BDT	D	SYST	Missing
1	1	1	1	1	1	1	1	0
2	1	1	1	1	1	1	0	1
3	0	1	1	1	1	1	1	1
4	1	1	1	1	1	0	1	1
5	1	1	1	1	0	1	1	1
6	1	1	1	1	1	0	0	2
7	0	1	1	1	1	0	1	2
8	1	1	1	0	0	1	1	2
9	1	0	0	1	1	1	0	3
10	1	1	0	1	1	0	0	3
11	0	1	1	1	1	0	0	3
12	1	1	1	1	0	0	0	3
13	1	1	1	0	0	1	0	3
14	1	1	1	0	0	0	1	3
15	1	0	0	1	1	0	0	4
16	0	1	0	1	1	0	0	4
17	0	1	1	0	0	1	0	4
18	1	1	0	0	0	0	1	4
19	1	1	1	0	0	0	0	4
20	1	1	0	0	0	0	0	5
21	0	1	1	0	0	0	0	5
22	1	0	0	0	0	0	0	6
23	0	1	0	0	0	0	0	6
24	10	20	87	90	92	173	202	674

Table E.4: Summary of missing data for the second block of variables

	BW	BH	BC	BE	OCCUP	TEMP	REHAB.f	Missing
1	1	1	1	1	1	1	1	0
2	1	1	1	1	1	0	1	1
3	1	1	1	1	1	1	0	1
4	1	1	1	1	0	1	1	1
5	1	1	1	1	1	0	0	2
6	1	1	1	1	0	0	1	2
7	1	1	1	1	0	1	0	2
8	1	1	1	1	0	0	0	3
9	1	1	0	0	0	0	0	5
10	1	0	0	0	0	0	0	6
11	0	0	0	0	0	0	0	7
12	11	12	25	25	94	107	113	387

Table E.5: Summary of missing data for the third block of variables

	GENDER	AGE.f	H SIZE	H SIZE.F	PROF.f	EDU.f	INC.f	CHILD.F	Missing
1	1	1	1	1	1	1	1	1	0
2	1	1	1	1	1	0	1	1	1
3	1	1	1	0	1	1	1	1	1
4	0	1	1	1	1	1	1	1	1
5	1	1	1	1	1	1	1	0	1
6	1	1	1	1	1	1	0	1	1
7	1	1	1	1	0	1	1	1	1
8	1	1	1	1	0	1	1	0	2
9	1	1	1	1	1	0	0	0	3
10	1	0	0	0	1	0	0	0	6
11	0	0	0	0	0	0	0	0	8
12	18	18	18	20	20	21	42	52	209

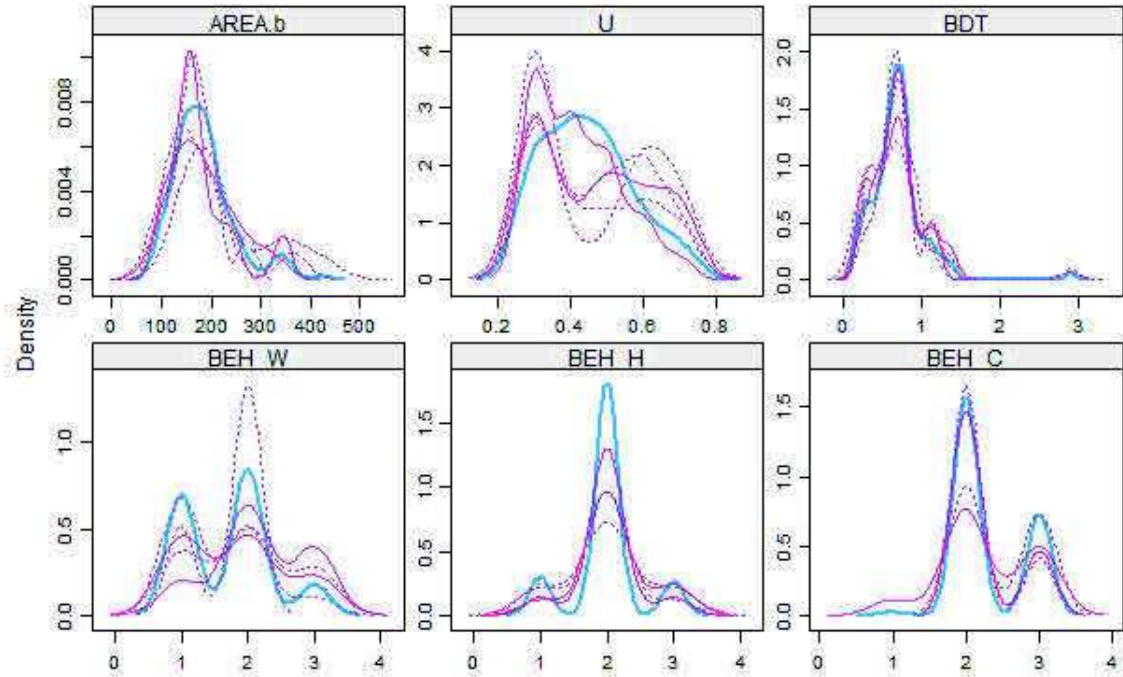

Figure E.3: The density distribution of the observed and imputed data for the first block of covariates

Note: Solid line represents the observed data and dashed line captures the imputed data; Area.b: Net surface area before the renovation; U: Heat loss coefficient of the building; BDT: Coefficient of the blower door test; BEH.W: Behavioral change related to the window opening; BEH.H: Behavioral change related to hot domestic water; BEH.C: Behavioral change related to energy consumption

Source: Own calculations

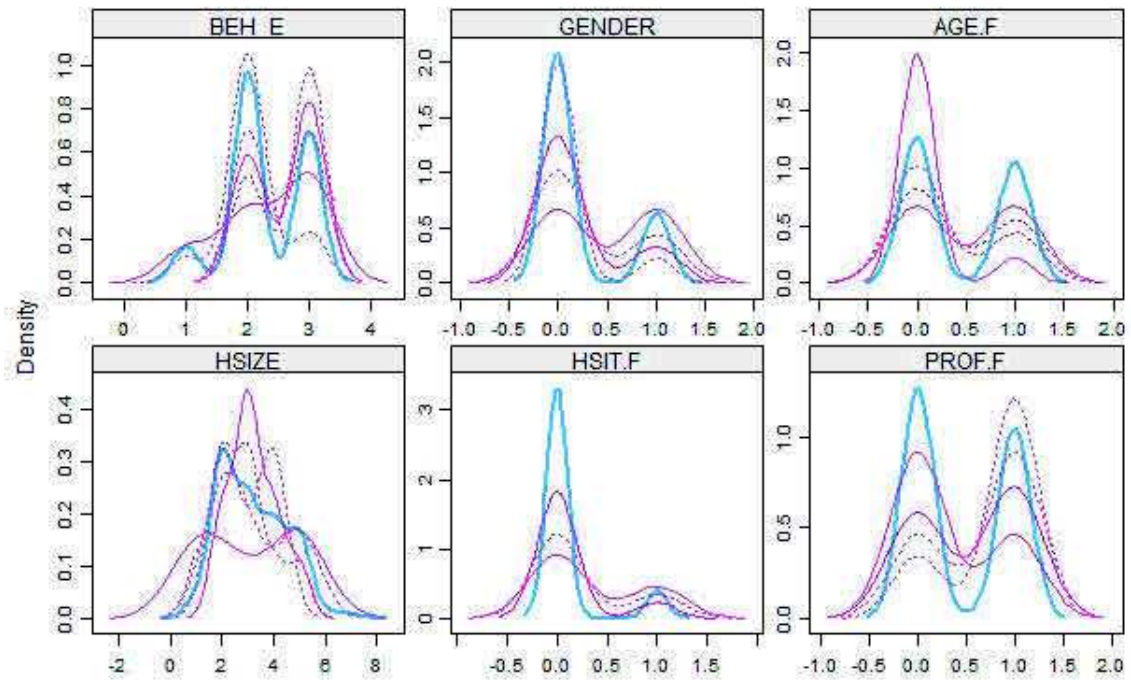

Figure E.4: The density distribution of the observed and imputed data for the second block of covariates

Note: Solid line represents the observed data and dashed line captures the imputed data; BEH.E: Behavioral change related to environmental concern; Gender: Gender of the respondents; AGE.F: Age of the respondents; Hsize: Household size; Hsit.f: Family composition; Prof.f: Profession of the respondents
Source: Own calculations

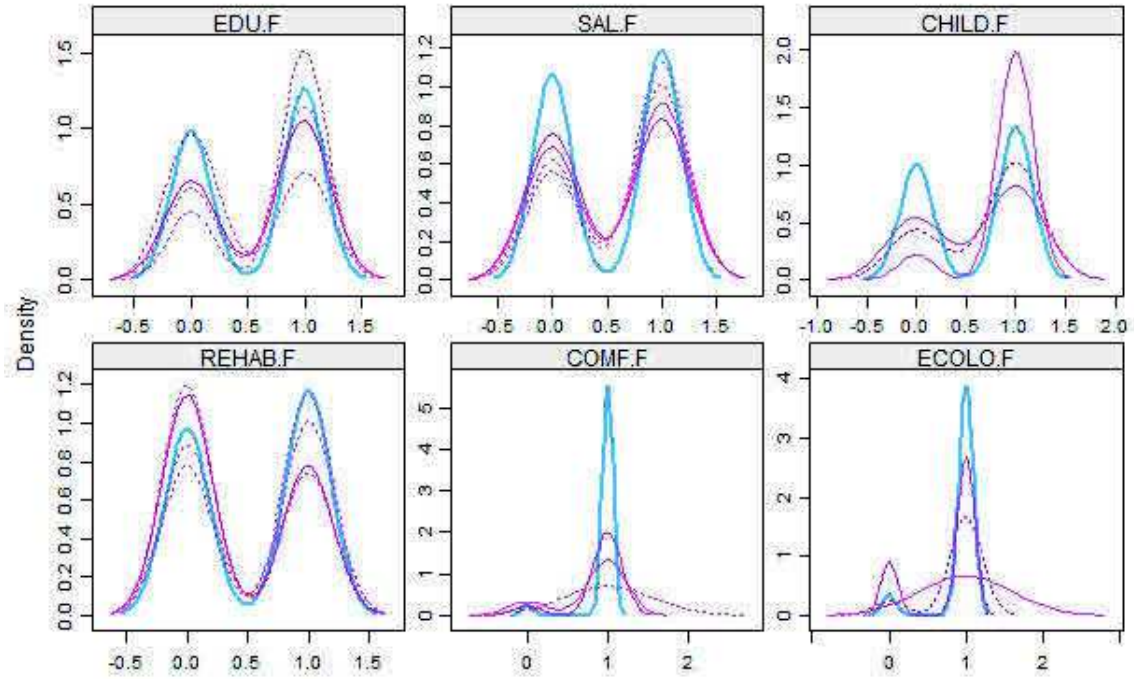

Figure E.5: The density distribution of the observed and imputed data for the third block of covariates

Note: Solid line represents the observed data and dashed line captures the imputed data; *Edu.f:* Education of the respondents; *Sal.f:* Net income of the household; *Child.f:* Presence of children in the household; *Rehab.f:* Participate in the program due to the motivation to rehabilitate the building; *Comf.f:* Participate in the program due to the motivation to gain higher comfort in the building; *Ecolo.f:* Participate in the program due to environmental concern

Source: Own calculations

General Conclusion

The main objective of the thesis deals with the management of novel technologies and considers primarily a situation where the risks are not explicitly known at the time they are being developed. This research approaches the objective from both *ex-ante* and *ex-post* risk management side.

The chapters on the *ex-ante* risk management side are motivated by reducing potential hazards (technological and environmental disasters) while investing *ex-ante* in prevention measures to reduce the likelihood of the occurrence of an external loss in a risky and ambiguous environment. The research work refers to the literature on law and economics and identifies the need to assess the performance of liability rules when there exists scarce information about the likelihood of emerging risks derived from the application of novel technologies. From a policy perspective, it remains still unclear which liability regime provides optimal deterrence efficiency to govern new emerging technologies.

On the *ex-post* risk management side, the chapters address the problem of lacking mitigation measures, such as insurance coverage to seek hazard reduction. Uncertainty about the frequency and the severity of the risks challenge insurers to establish adequate insurance contracts in the longterm perspective. In this context, the research gives an example from application of green technologies to improve energy efficiency in the housing sector. The chapters aim to evaluate unknown risks related to energy efficiency measures by assessing the insurability of the energy performance of individual buildings. This part of the thesis is motivated by the issue of the environmental energy transition and seeks to quantify the frequency and intensity of the non-achievement of the energy performance of existing individual buildings after carrying out energy efficiency upgrades.

The research investigates efforts on the *ex-ante* and *ex-post* risk management strategies. The thesis addresses the objective from a theoretical, experimental and empirical perspective in order to improve future investments in novel technologies while minimizing the likelihood and the intensity of the potential risks.

The thesis leads to several major findings and discusses in the following important economic policy implications.

On the *ex-ante* risk management side, **chapter 1** identifies that a high degree of uncertainty is associated with the risks of nanotechnology (Besley et al., 2008; Renn and Roco, 2006). Furthermore, nanoscientists, independent committees and international bodies urge to manage potential risks and regulate adequately nanotechnology (Corley et al., 2009; Environmental Protection Agency, 2010; German Advisory Council on the Environ-

ment, 2011; SCENIHR, 2014; Amenta et al., 2015). From a policy perspective, it remains unclear which liability regime induces *ex-ante* optimal incentives for the potential injurer to invest in prevention measures in the context of novel technologies, likewise nanotechnology, biotechnology, new breeding technologies or renewable energy technologies.

The research in **chapter 2** addresses this problem by developing a theoretical model based on Shavell (1986) by comparing the incentive effects of (strict) unlimited and limited liability in a risky and ambiguous environment. Presuming that the potential injurer forms beliefs about the accident risks by using neo-additive capacity (Chateauneuf et al., 2007), the chapter highlights that the potential injurer can overinvest in prevention under unlimited and limited liability. This finding contrasts the results by Teitelbaum (2007) showing that the potential injurer invests always less in prevention than the social optimal level under strict and unlimited liability in an ambiguous environment. As far as possible, no general policy conclusion can be recommended as the results of the chapter gives an ambiguous message. In the risky environment, the literature emphasizes that limited liability lacks an adequate internalization of the risks and particularly leads to insufficient compensation for the victims. While shifting to an ambiguous environment, this becomes even more complicated.

Experimental evidence on the validity of theories can help theorists to enhance models that are mainly not consistent with model predictions (Smith, 1994). For this purpose, amongst others, the theoretical predictions of **chapter 2** have been tested by the means of conducting laboratory experiments in **chapter 3**. The chapter alters the experiment (modified dictator game) of Angelova et al. (2014) by introducing ambiguity and investigates mainly the performance of (strict) unlimited and limited liability rule. In contrast to the findings of Angelova et al. (2014), we demonstrate that underinvestment is not systematically observed in the domain of risk. The difference can result from the fact that this chapter does not manipulate the size of liability albeit it allows for the occurrence of losses under unlimited liability.

The central result reveals that subjects choose on average higher levels of investment under unlimited and limited liability compared to the social optimal level in the domain of ambiguity. The empirical results of the random effects ordered probit estimation do not confirm that subject's degree of optimism and confidence affect the investment decision. On the other hand, the chapter underlines strong evidence pointing toward a link associating advantageous inequity aversion, fairness and risk preferences with the decision choice.

By comparing the measurement method of advantageous inequity aversion in the domains of gains and losses, it can be inferred from the results that subjects experience stronger reaction to advantageous inequity aversion in the domain of losses than in the domain of gains.

The findings from the first part of the research can be useful for public policy in the context of governing new emerging risks to design effective regulations. The theoretical and experimental aspects of the first part convey strong validity on how legal rules are performing. The general conclusion is that tort law cannot provide *ex-ante* optimal incentives when there is lacking information about the probability of an accident. Under the current system, unlimited and limited liability lead to overinvestment in prevention in regard to new emerging risks. Hence, the potential injurer and the victim benefit from the reduction of the probability of an accident. On the other hand, limited liability causes a disruption in the compensation mechanism and hampers the full internalization of the externalities caused by the firm's risky activity. This effect is even stronger when the potential injurer overinvests in prevention as it reduces the firm's available assets to compensate the victims. Hence, it is argued that the prevailing legal rule (limited liability) for cooperation could only be an acceptable prevention instrument if higher amounts of compensation are available. Combining the legal rule with public intervention in the sense of introducing compulsory insurance and guaranteeing complementary funding for compensation could provide a minimum compensation to victims (OECD, 2003). Nonetheless, such schemes could also lead to severe moral hazard problems. A further alternative system would be to implement a mutual pooling system. In this way, all the operators of the activity involved would share the costs of an accident when it occurs (Faure, 1995).

Another crucial point is that advantageous inequity aversion can be useful to explain individual's behavior in liability-sharing schemes.

On the *ex-post* risk management side, **chapter 4** ascertains that several barriers hamper substantially the establishment of insurance coverage to compensate potential losses after the risk has materialized. The access of insurance coverage plays a key role to promote eco-friendly technologies and to foster investments in energy efficiency measures. Lacking data about the non-achievements of the energy performance, together with legal uncertainties about the guarantee of energy performance pose huge difficulties to the insurance industry to develop and offer adequate insurance coverage.

Following **chapters 4** and **5**, a novel concept of estimating the discrepancies between

calculated and measured energy savings (energy performance gap) with respect to the weatherization program, "*Je rénove BBC*", is proposed in **chapter 6**. The econometric model controls for sample selection and endogeneity problems and solves the problem of missing data by applying multiple data imputations. The chapter states that the percentage of households who do not achieve the required energy performance is about 23.75%. It appears further from the research that the severity of the energy performance gap (total gross effect) is relatively low (with multiple imputations). This encompasses to be a complicating factor for energy-efficiency insurers as it increases the purchasers sensitivity to pricing and the size of deductibles (Mills, 2003b).

The estimation results show that the age of the respondent and the behavior related to hot domestic water consumption impact significantly and positively the energy performance gap. In line with Reynaud (2014), the chapter demonstrates that the higher the simulation programs over-estimate the energy consumption before the retrofit intervention, the higher is the gap between the calculated and measured energy savings. However, these results seem to be less credible when applying multiple data imputations.

The findings of the second part of the thesis raise several points and concerns in the context of the energy performance guarantee subject to the decennial liability. In general, the jurisprudence seems to favor that the non-achievement of the energy performance should be subject to the decennial liability. However, various professionals, companies and insurance providers react rather skeptically on this legislative idea as no evidence is currently available about the viability of insurance for a time period of 10 years. Under the current form of the legislation, it should be noticed that decennial liability is only applicable if the purchaser can prove an overconsumption of energy at exorbitant operation costs (Article L-111-13-1 of the French Construction and Housing Code). This seems to be difficult as our research and many other studies proof that energy savings are basically overestimated compared to measured energy savings. As long as simulation programs do not account for relevant factors (energy-related behavior, heating patterns, the interaction between occupants and the building, and dynamic modeling techniques), it remains a daunting task for the purchaser to demonstrate an overconsumption at exorbitant costs due to a default product.

Policymakers could set up larger national-wide projects to assess the energy performance gap for different types of dwellings. There is a need for a larger and representative set of data collected over a certain time period to draw more general conclusions about the economic viability of the energy performance guarantee. In the current state of knowl-

edge, it can be suggested that the evaluation of energy conservation programs should be supported by data from smart-metering to capture more accurately the measured energy consumption.

Finally, it is worth mentioning that the management of new emerging risks is very complex and involves many decisions of various stakeholders. Nonetheless, the thesis provides some lessons on how to improve the assessment and the management of new emerging risks.

Even though the thesis points out *ex-ante* and *ex-post* risk management strategies, the management of new emerging risks is very complex and further exploration would enable a better understanding about it. This research is to some extent limited which leaves room for discussion and improvements in the future.

A common feature of the analysis of tort law is that the underlying models are static. Investigating the dynamic incentives for different liability rules might be a further step to understand the behavior of the potential injurer in an accident model. Furthermore, the unilateral accident model could be extended by allowing the potential injurer to learn about previous environmental and technological accidents. This could be achieved by applying full Bayesian updates on a capacity proposed by [Jaffray \(1992\)](#).

It is worth mentioning that neither [Teitelbaum \(2007\)](#), [Chakravarty and Kelsey \(2016\)](#), [Mondello \(2013\)](#) nor we have analyzed the situation in which the regulator is ambiguous about the objective probability of a potential environmental disaster. It might be worth to model such a situation where both, the regulator and the potential injurer face a decision in an ambiguous environment (two-sided ambiguity).

With respect to chapter 3, it might be challenging to draw general conclusion from the experimental studies due to the lack of external validity. The replication of experiments by varying treatments, outcomes, settings, and units represents a possible solution to limit threats to external validity ([Garcia and Wantechekon, 2010](#)).

Another limitation in the experimental design might be that we do not control for subject's beliefs about the draw of the winning color ball in each round. Another crucial issue is that students as a subject pool are not adequately representative for firms. Further efforts need to be undertaken to address both issues. Future research could also seek to conduct experiments with experts in the field.

More empirical evidence is needed to obtain a better understanding of the driven factors influencing the decision making under risk and ambiguity to establish efficient liability

rules. Empirical jurisprudence has a huge potential to improve the knowledge about how liability rules are performing in real-world situations. Nonetheless, the lack of empirical data impedes the empirical approach. Future research could take place by setting up a database at the European and international level in order to gain a number of key insights into the efficiency of legal rules.

Several limitations of the research in the second part of the thesis need to be stressed. First, the *ex-post* gathered data is based large parts on self-declared energy consumption which is less precise than billing or smart metering data. Second, we experience difficulties to calculate the energy performance of households applying heat pumps or electric boiler. Currently, no specific study exists to disentangle the percentages of the different kind of energy end-uses in low energy buildings. Further efforts need to be undertaken to calculate more concise and accurate the energy performance in the future.

Furthermore, we measure the household's energy consumption before and after the energy efficiency upgrades at one point of time. However, this can cause potential bias in the estimation results. Future research should aim to conduct longitudinal studies by measuring the energy behavior and consumption once before and once after the program intervention. In this way, program evaluation methodology, likewise regression discontinuity design or difference in difference with propensity score matching method could be used to quantify the impact effect of the program on the energy consumption.

Another substantial limitation is the small sample size which causes problems in the empirical analysis. As several factors are influencing the energy performance gap, it would be beneficial to replicate our study in **chapter 6** with a larger sample size.

Further efforts are needed to better understand the energy-related behavior of occupants. Energy conservation behavior plays an important role in reducing the energy consumption as well as to guarantee the energy performance of existing buildings after energy efficiency initiatives. A recently published article by [Delmas et al. \(2013\)](#) stress that information campaigns leads to lower energy consumption than pecuniary feedback and incentives. Further research could explore the effects of soft incentives, such as social norms or symbolic rewards to promote green technologies and reduce the energy consumption of individual buildings.

Bibliography

- Abrevaya, J. and S. G. Donald (2011). A gmm approach for dealing with missing data on regressors and instruments. *Review of Economics and Statistics Forthcoming*, na-na.
- ADEME (2008). Méthode de calcul TH-C-E-ex. Technical report, Agence de l'environnement et de la maîtrise de l'énergie.
- ADEME (2011). Bâtiments basse consommation. Un bilan à l'énergie positif. Technical report, Agence de l'environnement et de la maîtrise de l'énergie.
- ADEME (2012). Bâtiments à énergie positive. REMSES Maison individuelle - Saint-Hilaire-de-Riez (85). Technical report, Agence de l'environnement et de la maîtrise de l'énergie.
- ADEME (2013). EPC and Deep Retrofit in France. Agence de l'environnement et de la maîtrise de l'énergie. ESCO Conference 2013.
- Alberini, A. and D. Austin (2002). Accidents waiting to happen: Liability policy and toxic pollution releases. *The Review of Economics and Statistics* 84(4), 729–741.
- Alon, S. and D. Schmeidler (2014). Purely subjective maxmin expected utility. *Journal of Economic Theory* 152, 382–412.
- Amenta, V., K. Aschberger, M. Arena, H. Bouwmeester, F. B. Moniz, P. Brandhoff, S. Gotardo, H. J. Marvin, A. Mech, L. Q. Pesudo, H. Rauscher, R. Schoonjans, M. V. Vettori, S. Weigel, and R. J. Peters (2015). Regulatory aspects of nanotechnology in the agri/feed/food sector in EU and non-EU countries. *Regulatory Toxicology and Pharmacology* 73(1), 463 – 476.
- Andersen, R. V., J. Toftum, K. K. Andersen, and B. W. Olesen (2009). Survey of occupant behaviour and control of indoor environment in Danish dwellings. *Energy and Buildings* 41(1), 11 – 16.

- Anderson, S., G. Harrison, I. Morten, and E. Rutstrom (2007). Valuation using multiple price list formats. *Applied Economics* 39, 675–682.
- Andreoni, J. and J. Miller (2002). Giving according to garp: An experimental test of the consistency of preferences for altruism. *Econometrica* 70(2), 737–753.
- Angelova, V., O. Armantier, G. Attanasi, and Y. Hiriart (2014). Relative performance of liability rules: Experimental evidence. *Theory and Decision* 77(4), 531–556.
- Anscombe, F. J. and R. J. Aumann (1963). A definition of subjective probability. *The Annals of Mathematical Statistics* 34(1), 199–205.
- Attanasi, G., K. Boun My, N. Georgantzis, and M. Ginés (2016). Strategic altruism as complementarity-building investment. mimeo.
- Attanasi, G., C. Gollier, A. Montesano, and N. Pace (2014). Eliciting ambiguity aversion in unknown and in compound lotteries: a smooth ambiguity model experimental study. *Theory and Decision* 77, 485–530.
- Aydinalp-Koksal, M. and V. I. Ugursal (2008). Comparison of neural network, conditional demand analysis, and engineering approaches for modeling end-use energy consumption in the residential sector. *Applied Energy* 85(4), 271 – 296.
- Azur, M. J., E. A. Stuart, C. Frangakis, and P. J. Leaf (2011). Multiple imputation by chained equations: what is it and how does it work?. *International Journal Of Methods In Psychiatric Research* 20(1), 40 – 49.
- Bahaj, A. and P. James (2007). Urban energy generation: The added value of photovoltaics in social housing. *Renewable and Sustainable Energy Reviews* 11(9), 2121 – 2136.
- Baillon, A., H. Bleichrodt, U. Keskin, O. L’Haridon, and C. Li (2015). The effect of learning on ambiguity attitudes. *mimeo*.
- Baillon, A., O. L’Haridon, and L. Placido (2011). Ambiguity models and the machina paradoxes. *American Economic Review* 101(4), 1547–1560.
- Barnes, S. A., S. R. Lindborg, and J. W. Seaman (2006). Multiple imputation techniques in small sample clinical trials. *Statistics in Medicine* 25(2), 233–245.
- Battigalli, P. and M. Dufwenberg (2009). Dynamic psychological games. *Journal of Economic Theory* 144(1), 1 – 35.

- Beard, T. R. (1990). Bankruptcy and care choice. *The RAND Journal of Economics* 21(4), 626–634.
- Becker, G. (1964). Crime and punishment: an economic approach. *Journal of Political Economy* 76, 169–217.
- Bennett, D. A. (2001). How can i deal with missing data in my study? *Australian and New Zealand Journal of Public Health* 25(5), 464–469.
- Berkhout, P. H., J. C. Muskens, and J. W. Velthuisen (2000). Defining the rebound effect. *Energy Policy* 28(6–7), 425 – 432.
- Berry, L. (1983). Residential Conservation Program Impacts. Methods of reducing self-selection bias. *Evaluation Review* 7(6), 753–775.
- Besley, J., V. Kramer, and S. Priest (2008). Expert opinion on nanotechnology: risks, benefits, and regulation. *Journal of Nanoparticle Research* 10(549-558).
- Bewley, T. (2003). Behavioural science: Fair’s fair. *Nature* 422, 125–126.
- Biesiot, W. and K. J. Noorman (1999). Energy requirements of household consumption: a case study of the netherlands. *Ecological Economics* 28(3), 367 – 383.
- Binswanger, M. (2001). Technological progress and sustainable development: what about the rebound effect? *Ecological Economics* 36(1), 119 – 132.
- Blanco, M., D. Engelmann, and H. T. Normann (2011). A within-subject analysis of other-regarding preferences. *Games and Economic Behavior* 72(2), 321 – 338.
- Boardman, B. (1991). *Fuel Poverty: From Cold Homes to Affordable Warmth*. Belhaven Press, London.
- Böhringer, C. (1998). The synthesis of bottom-up and top-down in energy policy modeling. *Energy Economics* 20(3), 233 – 248.
- Böhringer, C. and T. F. Rutherford (2008). Combining bottom-up and top-down. *Energy Economics* 30(2), 574 – 596.
- Bowling, A. (2005). Mode of questionnaire administration can have serious effects on data quality. *Journal of Public Health* 27(3), 281–291.
- Boyer, M. and J. Laffont (1997). Environmental risks and bank liability. *European Economic Review* 41, 1427–1459.

- Branco, G., B. Lachal, P. Gallinelli, and W. Weber (2004). Predicted versus observed heat consumption of a low energy multifamily complex in Switzerland based on long-term experimental data. *Energy and Buildings* 36(6), 543 – 555.
- Brandts, J. and G. Charness (2011). The strategy versus the direct-response method: a first survey of experimental comparisons. *Experimental Economics* 14(3), 375–398.
- Bridgeman, J., A. Baker, C. Carliell-Marquet, and C. Carstea (2013). Determination of changes in wastewater quality through a treatment works using fluorescence spectroscopy. *Environmental Technology* 34(23), 3069–3077.
- Broc, J., D. Osso, P. Baudry, J. Adnot, and B. Bodineau, L. and Bourges (2011). Consistency of the French white certificates evaluation system with the framework proposed for the European energy services. *Energy Efficiency* 4, 371–392.
- Brown, J. P. (1973). Toward an economic theory of liability. *The Journal of Legal Studies* 2(2), 323–349.
- Bureau, P. (2015). La répartition du défaut de performance énergétique par la garantie décennale des constructeurs. Lettre des Juristes de l'Environnement.
- Burks, S., J. Carpenter, and E. Verhoogen (2003). Playing both roles in the trust game. *Journal of Economic Behavior & Organization* 51, 195–216.
- Calabresi, G. (1970). *The Costs of Accidents*. Yale University Press.
- Camerer, C. and M. Weber (1992). Recent developments in modeling preferences: Uncertainty and ambiguity. *Journal of Risk and Uncertainty* 5(4), 325–370.
- Cameron, A. and P. Trivedi (2005). *Microeconometrics: Methods and Applications*.
- Cameron, C. and D. Miller (2015). A practitioner's guide to cluster-robust inference. *Journal of Human Resources* 50(2).
- Cayla, J., B. Allibe, and M. Laurent (2010). From Practices to Behaviors: Estimating the impact of household behavior on space heating energy consumption. In *ACEEE Summer Study on Energy Efficiency in Buildings*, Number 7-26.
- Cayre, E., B. Allibe, M. Laurent, and D. Osso (2011). There are people in the house! how the results of purely technical analysis of residential energy consumption are misleading for energy policies. In *ECEEE 2011 Summer Study. Energy Efficiency First: The Foundation of Low-Carbon Society*.

- CCI ALSACE (2014). Key Figures Alsace 2015. Technical report, Chambre de Commerce et de l'Industrie de Région Alsace.
- CEREMA (2015). Bâtiments démonstrateurs à basse consommation d'énergie. Enseignements opérationnels tirés de 60 constructions et rénovations du programme PREBAT 2012 - 2015. Technical report, Centre d'études et d'expertise sur les risques, l'environnement, la mobilité et l'aménagement.
- CEREN (2015). Données statistiques du CEREN. Technical report, Centre d'Etudes et de Recherches économiques sur l'énergie.
- Chakravarty, S. and D. Kelsey (2016). Ambiguity and accident law. *Journal of Public Economic Theory*, n/a–n/a.
- Chakravarty, S. and J. Roy (2009). Recursive expected utility and the separation of attitudes towards risk and ambiguity: an experimental study. *Theory and Decision* 66(3), 199–228.
- Chang, E. C., A. Maydeu-Olivares, and T. J. D'Zurilla (1997). Optimism and pessimism as partially independent constructs: Relationship to positive and negative affectivity and psychological well-being. *Personality and Individual Differences* 23(3), 433 – 440.
- Charlier, D. (2015). Energy efficiency investments in the context of split incentives among French households. *Energy Policy* 87, 465 – 479.
- Charlier, D. and A. Risch (2012). Evaluation of the impact of environmental public policy measures on energy consumption and greenhouse gas emissions in the French residential sector. *Energy Policy* 46(0), 170 – 184.
- Charness, G. and G. Genicot (2009). Informal risk sharing in an infinite-horizon experiment. *The Economic Journal* 119(537), 796–825.
- Charness, G., U. Gneezy, and A. Imas (2013). Experimental methods: Eliciting risk preferences. *Journal of Economic Behavior & Organization* 87, 43–51.
- Chateauneuf, A., J. Eichberger, and S. Grant (2007). Choice under uncertainty with the best and worst in mind: Neo-additive capacities. *Journal of Economic Theory* 137(1), 538–567.
- Chitnis, M., S. Sorrell, A. Druckman, S. K. Firth, and T. Jackson (2013). Turning lights into flights: Estimating direct and indirect rebound effects for UK households . *Energy*

- Policy 55*, 234 – 250. Special section: Long Run Transitions to Sustainable Economic Structures in the European Union and Beyond.
- Chitnis, M., S. Sorrell, A. Druckman, S. K. Firth, and T. Jackson (2014). Who rebounds most? Estimating direct and indirect rebound effects for different UK socioeconomic groups. *Ecological Economics 106*, 12 – 32.
- Choquet, G. (1954). Theory of capacities. *Annales de l'institut Fourier 5*, 123–133.
- Coase, R. H. (1960). The problem of social cost. *The Journal of Law and Economics 3*, 1–44.
- Cochran, W. (1977). *Sampling Techniques* (3 ed.). New York: John Wiley & Sons.
- Corley, E. A., D. A. Scheufele, and Q. Hu (2009). Of risks and regulations: how leading U.S. nanoscientists form policy stances about nanotechnology. *Journal of Nanoparticle Research 11* (7), 1573–1585.
- Currall, S. (2009). New insights into public perception. *Nature Nanotechnology 4*, 79–80.
- Currall, S., E. King, N. Lane, J. Madera, and S. Turner (2006). What drives public acceptance of nanotechnology? *Nature Nanotechnology 1*, 153–155.
- Dana, D. (2012). *The nanotechnology challenge. Creating legal institutions for uncertain risks*. Cambridge: Cambridge University Press.
- Dari-Mattiacci, G. and G. De Geest (2005). Judgment proofness under four different precaution technologies. *Journal of Institutional and Theoretical Economics JITE 161* (1), 38–56.
- Dari-Mattiacci, G. and G. De Geest (2006a). When will judgment proof injurers take too much precaution? *International Review of Law and Economics 26*, 336–354.
- Dari-Mattiacci, G. and G. De Geest (2006b). When will judgment proof injurers take too much precaution? *International Review of Law and Economics 26*, 336–354.
- Dattalo, P. (2008). *Determining sample size. Balancing Ower, Precision and Practicality*. New York: Oxford University Press.
- Davis, D. and L. Holt (1993). *Experimental Economics*. New Jersey: Princeton University Press.

- De Leeuw, E. D., J. J. Hox, and D. A. Dillman (2008). *International Handbook of Survey Methodology*. New York: Psychology Press, Taylor & Francis.
- Delmas, M. A., M. Fischlein, and O. I. Asensio (2013). Information strategies and energy conservation behavior: A meta-analysis of experimental studies from 1975 to 2012. *Energy Policy* 61, 729 – 739.
- Dember, W., S. Martin, M. Hummer, S. Howe, and R. Melton (1989). The measurement of optimism and pessimism. *Current Psychology* 8(2), 102–119.
- Dequech, D. (2000). Fundamental uncertainty and ambiguity. *Eastern Economic Journal* 26(1), 40–60.
- Dionne, G. and S. Spaeter (2003). Environmental risk and extended liability: The case of green technologies. *Journal of Public Economics* 87, 1025 – 1060.
- Dominiak, A. (2010). *Decision Making Under Ambiguity*. Ph. D. thesis, University of Heidelberg.
- Dominiak, A. and J.-P. Lefort (2013). Agreement theorem for neo-additive beliefs. *Economic Theory* 52(1), 1–13.
- Dong, Y. and C. Y. Peng (2013). Pirincipled missing data methods for researchers. *SpringerPlus* 222, 1–16.
- Druckman, A., M. Chitnis, S. Sorrell, and T. Jackson (2011). Missing carbon reductions? Exploring rebound and backfire effects in UK households. *Energy Policy* 39(6), 3572 – 3581.
- Dubin, J. A., K. Allen, R. Miedema, and V. Chandran (1986). Price effects of energy-efficient technologies: A study of residential demand for heating and cooling. *The RAND Journal of Economics* 17(3), 310–325.
- Durbin, J. (1954). Errors in variables. *Revue de l'Institut International de Statistique / Review of the International Statistical Institute* 22(1/3), 23–32.
- Eichberger, J. and D. Kelsey (2011). Are the treasures of game theory ambiguous? *Economic Theory* 48(2), 313–339.
- Eichberger, J. and D. Kelsey (2014). Optimism and pessimism in games. *International Economic Review* 55(2), 483–505.

- ELIOS (2008). Liability and insurance regimes in the construction sector; national schemes and guidelines to stimulate innovation and sustainability. Official Journal of the European Union 02/12/2008.
- Ellsberg, D. (1961). Risk, ambiguity, and the savage axioms. *The Quarterly Journal of Economics* 75(4), pp. 643–669.
- Endres, A. and R. Bertram (2006). The development of care technology under liability law. *International Review of Law and Economics* 26(4), 503 – 518.
- Endres, A. and T. Friehe (2012). Generalized progress of abatement technology: Incentives under environmental liability law. *Environmental and Resource Economics* 53(1), 61–71.
- Environmental Protection Agency (2010). Scientific, technical, research, engineering and model support. state of the science literature review: Everything nanosilver and more. Technical report, Environmental Protection Agency.
- Epstein, L. G. (1999). A definition of uncertainty aversion. *Review of Economic Studies* 66(3), 579 – 608.
- Epstein, L. G. and J. Zhang (2001). Subjective probabilities on subjectively unambiguous events. *Econometrica* 69(2), 265–306.
- Etner, J., M. Jeleva, and J.-M. Tallon (2012). Decision theory under ambiguity. *Journal of Economic Surveys* 26(2), 234–270.
- European Commission (2010a). Communication from the Commission. Europe 2020. A strategy for smart, sustainable and inclusive growth. Com(2010) 2020 final. Technical report, European Commission.
- European Commission (2010b). Special Eurobarometer 341. Biotechnology. Technical report, European Commission.
- European Commission (2011). Impact of Engineered Nanomaterials on Health: Considerations for Benefit-Risk Assessment. EASAC Policy Report 15, Joint Research Center, Institute for Health and Consumer Protection.
- European Commission (2016). Horizon 2020. Work Program 2016-2017, assessed 13 September 2016. <http://cerneu.web.cern.ch/open-calls>.

- European Environmental Agency (2001). Late lessons from early warnings: the precautionary principle 1896-2000. Luxembourg: Office for Official Publications of the European Communities.
- European Environmental Agency (2011). Disasters in Europe: More frequent and causing more damage. Technical report, European Environment Agency.
- European Fuel Poverty and Energy Efficiency (2010). EPEE project: European fuel Poverty and Energy Efficiency. Technical report, Alphééis.
- EUROSTAT (2015). Annual detailed enterprise statistics for construction (NACE Rev. 2, F), assessed 12 March 2016. http://ec.europa.eu/eurostat/web/products-datasets/-/sbs_na_con_r2.
- EUROSTAT (2016). Patent applications to the EPO by priority year. http://ec.europa.eu/eurostat/statistics-explained/index.php/Patent_statistics.
- Faure, M. (1995). Economic models of compensation for damage caused by nuclear accidents: Some lessons for the revision of the Paris and Vienna Conventions. *European Journal of Law and Economics* 2(1), 21–43.
- Faure, M. (2010). Behavioral accident law and economics. *The Journal of Applied Economy* 13, 11–68.
- Federal Institute for Risk Assessment (2009). BfR rät von Lebensmitteln und Produkten des täglichen Bedarfs ab. Technical report, BfR.
- Fehr, E. and U. Fischbacher (2003). The nature of human altruism. *Nature* 425, 785–791.
- Fehr, S. and K. Schmidt (1999). A theory of fairness competition and cooperation. *The Quarterly Journal of Economics* 114(3), 817–868.
- Fels, M. (1986). Prism: An introduction. *Energy and Building* 9, 5–18.
- Fisman, R., S. Kariv, and D. Markovits (2007). Individual preferences for giving. *American Economic Review* 97(5), 1858–1876.
- Forsythe, R., J. L. Horowitz, N. Savin, and M. Sefton (1994). Fairness in simple bargaining experiments. *Games and Economic Behavior* 6(3), 347 – 369.
- Fowler, F. (1995). *Improving survey questions. Design and Evaluation*, Volume 38. Sage Publication. Applied Social Research Methods Series.

- Fowler, F. (2014). *Survey Research Method* (5 ed.). Sage Publication.
- Franzoni, L. (2014). Liability law and uncertainty spreading. Available at SSRN: <http://ssrn.com/abstract=2432861>.
- Frisch, D. and J. Baron (1988). Ambiguity and rationality. *Journal of Behavioral Decision Making* 1(3), 149–157.
- Frondel, M. and C. M. Schmidt (2005). Evaluating environmental programs: The perspective of modern evaluation research. *Ecological Economics* 55(4), 515 – 526.
- Galvin, R. (2014). Making the rebound effect more useful for performance evaluation of thermal retrofits of existing homes: Defining the energy savings deficit and the energy performance gap. *Energy and Buildings* 69(0), 515 – 524.
- Galvin, R. and Sunikka-Blank, M. (2016). Quantification of (p)rebound effects in retrofit policies – why does it matter? *Energy* 95, 415 – 424.
- Garcia, F. and L. Wantchekon (2010). Theory, external validity, and experimental inference: Some conjectures. *The ANNALS of the American Academy of Political and Social Science* 628(1), 132–147.
- German Advisory Council on the Environment (2011). Precautionary strategies for managing nanomaterials. Technical report, German Advisory Council on the Environment.
- Ghirardato, P., F. Maccheroni, and M. Marinacci (2004). Differentiating ambiguity and ambiguity attitude. *Journal of Economic Theory* 118, 133–173.
- Gilboa, I. (1987). Expected utility with purely subjective non-additive probabilities. *Journal of Mathematical Economics* 16(1), 65–88.
- Gilboa, I. and M. Marinacci (2013). *Ambiguity and the Bayesian paradigm*. In D. Acemoglu, M. Arellano, and E. Dekel (Eds.), *Advances in Economics and Econometrics, 10th World Congress*. Cambridge University Press.
- Gollier, C. (2014). Optimal insurance design of ambiguous risks. *Economic Theory* 57(3), 555–576.
- Graham, J., A. Olchowski, and T. Gilreath (2007). How many imputations are really needed? some practical clarifications of multiple imputation theory. *Prevention Science* 8, 206–2.

- Greene, W. H. (1997). *Econometric Analysis* (3 ed.).
- Greiner, B. (2015). Subject pool recruitment procedures: Organizing experiments with ORSEE. *Journal of the Economic Science Association* 1(1), 114–125.
- Guerra, S. (2013). Occupant behaviour in energy efficient dwellings: Evidence of a rebound effect. *Journal of Housing and the Built Environment* 28, 311–327.
- Guerra, S. and L. Itard (2010). Occupant’s behaviour: Determinants and effects on residential heating consumption. *Building Research & Information* 38(3), 318–338.
- Guerra-Santin, O., L. Itard, and H. Visscher (2009). The effect of occupancy and building characteristics on energy use for space and water heating in dutch residential stock. *Energy and Buildings* 41(11), 1223 – 1232.
- Haas, R., H. Auer, and P. Biermayr (1998). The impact of consumer behavior on residential energy demand for space heating. *Energy and Buildings* 27(2), 195 – 205.
- Haas, R. and P. Biermayr (2000). The rebound effect for space heating. Empirical evidence from Austria. *Energy Policy* 28(6–7), 403 – 410.
- Hansen, S. and D. Gee (2014). Adequate and anticipatory research on the potential hazards of emerging technologies: a case of myopia and inertia? *Journal of Epidemiology and Community Health* 68, 1–6.
- Hausman, J. A. (1978). Specification tests in econometrics. *Econometrica* 46(6), 1251–1271.
- Hecht, D. (2013). The neural basis of optimism and pessimism. *Experimental Neurobiology* 22(3), 173–199.
- Heckman, J. (1976). The common structure of statistical models of truncation, sample selection and limited dependent variables and a simple estimator for such models. *Annals of Economic and Social Measurement* 5(4), 475– 492.
- Heckman, J. J. (1979). Sample selection bias as a specification error. *Econometrica* 47(1), 153–161.
- Heinrich, J. (2004). Animal behaviour (communications arising): Inequity aversion in capuchins? *Nature* 428, 139.
- Heinrich, T. and J. Weimann (2013). A note on reciprocity and modified dictator games. *Economics Letters* 121(2), 202 – 205.

- Heitjan, D. F. and R. J. Little (1991). Multiple imputation for the fatal accident reporting system. *Journal of the Royal Statistical Society: Series C (Applied Statistics)* 40(1), 13–29.
- Hewett, M. J., T. S. Dunsworth, T. A. Miller, and M. J. Koehler (1986). Measured versus predicted savings from single retrofits: a sample study. *Energy and Buildings* 9(1–2), 65 – 73.
- Holt, C. A. and S. K. Laury (2002). Risk aversion and incentive effects. *American Economic Review* 92(5), 1644–1655.
- Hong, S. H., T. Oreszczyn, and I. Ridley (2006). The impact of energy efficient refurbishment on the space heating fuel consumption in English dwellings. *Energy and Buildings* 38(10), 1171 – 1181.
- Horton, N. and K. Kleinman (2007). Much ado about nothing: A comparison of missing data methods and software to fit incomplete data regression models. *The American statistician* 61(1), 79–90.
- Hosmer, D. W. and S. Lemeshow (1980). Goodness of fit tests for the multiple logistic regression model. *Communications in Statistics - Theory and Methods* 9(10), 1043–1069.
- Imbens, G. W. and J. M. Wooldridge (2009). Recent developments in the econometrics of program evaluation. *Journal of Economic Literature* 47(1), 5–86.
- INSEE (2016a). GDP in Euro per capita - Alsace-Champagne-Ardenne-Lorraine, assessed 13 July 2016. <http://www.bdm.insee.fr/>.
- INSEE (2016b). Unemployment rates localized by region-Alsace, assessed 13 July 2016. <http://www.insee.fr/en/bases-de-donnees/bsweb/serie.asp?idbank=001515852>.
- International Energy Agency (2015). Energy Efficiency. Market Report 2015. Market Trends and Medium-Term Prospects. Technical report, International Energy Agency.
- Jacob, J. (2011). *Règles de responsabilité optimales face aux risques et choix technologiques des firmes*. Ph. D. thesis, Université Nancy 2.
- Jacob, J. (2015). Regulation of new and imprecise technologies: (in)solvency as a new criterion? Mimeo.

- Jacob, J. and B. Lovat (2016). Economic analysis of liability apportionment among multiple tortfeasors: A survey , and perspectives in large-scale risks management. *Chicago-Kent Law Review* 91(2), 659–683.
- Jacob, J. and S. Spaeter (2016). Large-scale risks and technological change: What about limited liability? *Journal of Public Economic Theory* 18(1), 125–142.
- Jaffray, J.-Y. (1989). Generalisation du critere de l'utilite espérée aux choix dans l'incertain regulier. *RAIRO - Operations Research - Recherche Operationnelle* 23(3), 237–267.
- Jaffray, J. Y. (1992). Bayesian updating and belief functions. *IEEE Transactions on Systems, Man, and Cybernetics* 22(5), 1144–1152.
- John, C. M. J. and G. Van Calster (2010). Chapter 4 - a nanotechnology legal framework. In M. Hull and D. Bowman (Eds.), *Nanotechnology Environmental Health and Safety, Micro and Nano Technologies*, pp. 97 – 140. Boston: William Andrew Publishing.
- Jolls, C. (1998). Behavioral economic analysis of redistributive legal rules. *Vanderbilt Law Review* 1(1), 1653–1678.
- Kahan, D. (2009). The evolution of risk perceptions. *Nature Nanotechnology* 4, 705–706.
- Kahan, D., P. Slovic, D. BRaman, J. Gastil, and G. Cohen (2007). Affect, Values, and Nanotechnology Risk Perception: An experimental Investigation. Cultural and Cognition Working Paper No. 22.
- Kahneman, D. (1992). Decision processes in negotiation reference points, anchors, norms, and mixed feelings. *Organizational Behavior and Human Decision Processes* 51(2), 296 – 312.
- Kahneman, D., J. L. Knetsch, and R. H. Thaler (1986). Fairness and the assumptions of economics. *Journal of Business* 59(4), S285 – S300.
- Kahneman, D. and A. Twersky (1984). Choices, values, and frames. *American Psychologist* 39(4), 341–350.
- Kavgic, M., A. Mavrogianni, D. Mumovic, A. Summerfield, Z. Stevanovic, and M. Djurovic-Petrovic (2010). A review of bottom-up building stock models for energy consumption in the residential sector. *Building and Environment* 45(7), 1683 – 1697.

- Kayikci, M. S. (2012). The burden of proof within the scope of the precautionary principle: International and European perspectives. Available at SSRN: <http://ssrn.com/abstract=2101613> or <http://dx.doi.org/10.2139/ssrn.2101613>.
- Keller, C., M. Siegrist, M., T. C. Eare, and H. Gutscher (2011). The general confidence scale: Coping with environmental uncertainty and threat. *Journal of Applied Social Psychology* 41(9), 2200–2229.
- Kelly, S. (2011). Do homes that are more energy efficient consume less energy? a structural equation model for england’s residential sector. *Energy* 45(8), 5610–5620.
- Khazzoom, J. (1980). Economic implications of mandated efficiency standards for household appliances. *The Energy Journal* 1(4), 21–40.
- Kilka, M. and M. Weber (2001). What determines the shape of the probability weighting function under uncertainty? *Management Science* 47(12), 1712–1726.
- King, R. R. and R. Schwartz (2000). An experimental investigation of auditors’ liability: Implications for social welfare and exploration of deviations from theoretical predictions. *The Accounting Review* 75(4), 429–451.
- Klibanoff, P., M. Marinacci, and S. Mukerji (2005). A smooth model of decision making under ambiguity. *Econometrica* 73(6), 1849–1892.
- Koch, C. and D. Schunk (2013). Limiting Liability? Risk and Ambiguity under Real Losses. *Schmalenbach Business Review* 65, 54–75.
- Koebel, B., A. Schmitt, and S. Spaeter (2016). Théories implicites et excès de confiance: Une expérience de terrain. *Revue économique. Forthcoming*.
- Kornhauser, L. and A. Schotter (1990). An experimental study of single-actor accidents. *The Journal of Legal Studies* 19(1), 203–233.
- Korobkin, R. B. and T. S. Ulen (2000). Law and behavioral science: removing the rationality assumption from law and economics. *California Law Review* 88(4), 1052–1144.
- Kuklys, W. (2005). *Amartya Sen’s Capability Approach: Theoretical Insights and Empirical Applications*. Springer.
- Lampach, N., K. Boun My, and S. Spaeter (2016). Risk, ambiguity and efficient liability rules: An experiment. BETA Working Paper 2016-30.

- Landes, W. and R. Posner (1987). *The Economic Structure of Tort Law*. Harvard University Press.
- Lapillonne, B., K. Pollier, and N. Samci (2015). Energy Efficiency Trends for household in the EU. Technical report, EnerData.
- Lechtenböhmer, S. and A. Schüring (2010). The potential for large-scale savings from insulating residential buildings in the EU. *Energy Efficiency* 4(2), 257–270.
- Leebron, D. (1991). Limited liability, tort victims, and creditors. *Columbia Law Review* 91, 1565–1650.
- Liao, H.-C. and T.-F. Chang (2002). Space-heating and water-heating energy demands of the aged in the {US}. *Energy Economics* 24(3), 267 – 284.
- Lindén, A.-L., A. Carlsson-Kanyama, and B. Eriksson (2006). Efficient and inefficient aspects of residential energy behaviour: What are the policy instruments for change? *Energy Policy* 34(14), 1918 – 1927.
- Lipowski-Posey, L. (1993). Limited liability and incentives when firms can inflict damages greater than net worth. *International Review of Law and Economics* 13(3), 325 – 330.
- Little, R. J. A. (1988). A test of missing completely at random for multivariate data with missing values. *Journal of the American Statistical Association* 83(404), 1198–1202.
- Lucas, T., L. Zhdanova, C. Wendorf, and S. Alexander (2013). Procedural and distributive justice beliefs for self and others: Multilevel associations with life satisfaction and self-rated health. *Journal of Happiness Studies* 14(4), 1325–1341.
- Ludlow, K., D. M. Bowman, J. Gatof, and M. G. Bennett (2015). Regulating emerging and future technologies in the present. *NanoEthics* 9(2), 151–163.
- Machina, M. J. (2009). Risk, ambiguity, and the rank-dependence axioms. *American Economic Review* 99(1), 385–92.
- Macminn, R. (2002). On the judgment proof problem. *The GENEVA Papers on Risk and Insurance Theory* 27(2), 143–152.
- Majcen, D., L. Itard, and H. Visscher (2013). Theoretical vs. actual energy consumption of labelled dwellings in the Netherlands: Discrepancies and policy implications . *Energy Policy* 54(0), 125 – 136.

- Mandel, N. (2009). Regulating emerging technologies. Legal studies research paper series No. 18.
- Mangelsdorff, L. and M. Weber (1994). Testing choquet expected utility. *Journal of Economic Behavior and Organization* 25, 437–457.
- Manning, R. L. (1994). Changing rules in tort law and the market for childhood vaccines. *Journal of Law and Economics* 37(1), 247–275.
- Marchio, D. and A. Rabl (1991). Energy-efficient gas-heated housing in france: predicted and observed performance. *Energy and Buildings* 17(2), 131 – 139.
- Martiskainen, M. (2007). Affecting consumer behaviour on energy demand. Technical report, Sussex Energy Group.
- McAuliffe, K., P. Blake, G. Kim, R. Wrangham, and F. Warneken (2013). Social influences on inequity aversion in children. *PLoS One* 8.
- Meester, T. D., A.-F. Marique, A. D. Herde, and S. Reiter (2013). Impacts of occupant behaviours on residential heating consumption for detached houses in a temperate climate in the northern part of Europe . *Energy and Buildings* 57(0), 313 – 323.
- Meteo France (2005, March). Annexe: Fiche méthode Degrès Jours, assessed 10 November 2015. Electronic version: <http://services.meteofrance.com/e-boutique/climatologie/dju-detail.html>.
- Micale, V. and J. Deason (2014). Energy saving insurance. Technical report, The Lab. The Global Innovation Lab for Climate Finance.
- Miceli, T. and M. J. Baker (2013). Introduction to: Research handbook on economic models of law. Working papers 2013-07, University of Connecticut, Department of Economics.
- Miceli, T. J. and K. Segerson (2003). A note on optimal care by wealth-constrained injurers. *International Review of Law and Economics* 23, 273–284.
- Mills, E. (2003a). The insurance and risk management industries: newplayers in the delivery of energy-efficient and renewable energy products and services. *Energy Policy* 31, 1257–1272.
- Mills, E. (2003b). Risk transfer via energy-savings insurance. *Energy Policy* 31(3), 273–281.

- Ministry of Ecology, Sustainable Development and Energy (2014). Energy efficient action plan for France - 2014. Technical report, Directorate General for Energy and Climate.
- Ministry of Ecology, Sustainable Development and Energy (2015). La transition énergétique pour la croissance verte. Aides financières 2015. Technical report, Ministry of Ecology, Sustainable Development and Energy.
- Mondello, G. (2013). Ambiguous beliefs on damages and civil liability theories. Working Paper, UMR 7321, CNRS 75.2013, University of Nice Sophia Antipolis.
- Moore, R. (2012). Definitions of fuel poverty: Implications for policy. *Energy Policy* 49, 19 – 26. Special Section: Fuel Poverty Comes of Age: Commemorating 21 Years of Research and Policy.
- Morris, T., I. White, and P. Royston (2014). Tuning multiple imputation by predictive mean matching and local residual draws. *BMC Medical Research Methodology* 14, 75–87.
- Morton, R. and K. Williams (2010). *Experimental Political Science and the Study of Causality: From Nature to the Lab*. Cambridge University Press.
- Nadel, S. and K. Keating (1991). Engineering estimates versus impact evaluation results: how do they compare and why? In *Energy program evaluation: Uses, methods, and results, proceedings of the 1991 international energy program evaluation conference*.
- Nairne, J. S. and R. G. Crowder (1982). On the locus of the stimulus suffix effect. *Memory & Cognition* 10(4), 350–357.
- National Geographic (2016). Mapmaker interactive, assessed 14 april 2015. <http://mapmaker.nationalgeographic.org/>.
- Nesbakken, R. (2001). Energy consumption for space heating: A discrete-continuous approach. *Scandinavian Journal of Economics* 103(1), 165–184.
- Nowack, B. and T. D. Bucheli (2007). Occurrence, behavior and effects of nanoparticles in the environment. *Environmental Pollution* 150(1), 5 – 22.
- Nowack, B., H. F. Krug, and M. Height (2011). 120 Years of Nanosilver History: Implications for Policy Makers. *Environmental Science & Technology* 45(4), 1177–1183.
- OECD (2003). Emerging risks in the 21st century. An OECD international future project. Technical report, Organisation for Economic Co-operation and Development.

- Oliver, R. (1977). Effect of expectation and disconfirmation on postexposure product evaluation: An alternative interpretation. *Journal of Applied Psychology* 62(4), 480–486.
- Pannequin, F. and M. Ropaul (2016). Self-insurance and liability insurance under one-sided ambiguity. Mimeo.
- Pfarr, C., A. Schmid, and U. Schneider (2011). Estimating ordered categorical variables using panel data: A generalised ordered probit model with an autofit procedure. *Journal of Economics and Econometrics* 54(1), 7–23.
- Pitchford, R. (1995). How Liable Should a Lender Be? The Case of Judgment-Proof Firms and Environmental Risk. *The American Economic Review* 85(5), 1171–1186.
- Podsakoff, P., S. MacKenzie, J. Lee, and N. Podsakoff (2003). Common method biases in behavioral research: a critical review of the literature and recommended remedies. *Journal of Applied Psychology* 55(5), 879–903.
- Posner, R. (1972). *Economic Analysis of Law* (1 ed.). Little, Brown and Company, Boston.
- Posner, R. (1992). *Economic Analysis of Law* (4th ed.).
- Pulford, B. (2009). Is luck on my side? Optimism, pessimism and ambiguity aversion. *Quarterly Journal of Experimental Psychology* 62(6), 1079–1087.
- Ray, P., H. Yu, and P. Fu (2010). Toxicity and environmental risks of nanomaterials: Challenges and future needs. *J Environ Sci Health C Environ Carcinog Ecotoxicol Rev.* 27(1), 1–35.
- Région Alsace (2010). Alsace in a few words. Strasbourg: Région Alsace.
- Renders, A. and A. Gaeremynck (2006). Corporate governance and performance: Controlling for sample selection bias and endogeneity. KU Leuven Working Paper DTEW AFI 0606.
- Renn, O. and M. C. Roco (2006). Nanotechnology and the need for risk governance. *Journal of Nanoparticle Research* 8(2), 153–191.
- Reynaud, M. (2014, Février). *Evaluation ex-post de l'efficacité de solutions de rénovation énergétique en résidentiel*. Ph. D. thesis, Ecole nationale supérieure des mines de Paris.
- Roco, M. (2003). Broader societal issues of nanotechnology. *Journal of Nanoparticle Research* 5(3), 181–189.

- Roderick, A. and M. Fraser (2008a). A simplified framework for using multiple imputation in social work research. *Social Work Research* 32(3), 171–178.
- Roderick, A. and M. W. Fraser (2008b). A simplified framework for using multiple imputation in social work research. *Social Work Research* 32(3), 171–178.
- Romm, A. (2014). An interpretation of focal point responses as non-additive beliefs. *Judgment and Decision Making* 9(5), 387–402.
- Ropaul, M. (2015). *Essais sur l'analyse économique de la responsabilité civile des entreprises*. Ph. D. thesis, Université Panthéon Assas (Paris II).
- Rosenberg, D. (1984). The causal connection in mass exposure cases: A "public law" vision of the tort system. *Harvard Law Review* 97(4), 849–929.
- Rotter, J. B. (1967). A new scale for the measurement of interpersonal trust. *Journal of Personality* 35(4), 651–665.
- Rubin, D. (1976). Inference and missing data. *Biometrika*, 581–592.
- Sahin, N. and E. Ekli (2013). Nanotechnology awareness, opinions, risk perceptions among middle school students. *International Journal of Technology and Design Education* 23, 867–881.
- Sanders, C. and M. C. Phillipson (2008). An analysis of the difference between measured and predicted energy savings when houses are insulated. In *Proceedings of the 8th Symposium on Building Physics in the Nordic Countries (NSB2008)*. 2008. p. 1087-1094.
- Satterfield, T., M. Kandlikar, C. Beaudrie, and J. Conti (2009). Anticipating the perceived risks of nanotechnology. *Nature Nanotechnology* 4, 752–758.
- Savage, L. (1954). *The Foundations of Statistics*. New York: Wiley.
- SCENIHR (2014). Nanosilver: Safety, health and environmental effects and role in antimicrobial resistance. Technical report, European Commission: Scientific Committee on Emerging and Newly Identified Health Risks.
- Schafer, J. (1997). Analysis of incomplete multivariate data. *Technometrics* 42(2), 213–214.
- Scheer, J., M. Clancy, and Ní Hógáin (2013). Quantification of energy savings from Ireland's Home Energy Saving scheme: an ex-post billing analysis. *Energy Efficiency* 6, 35–48.

- Scheier, M. and C. Carver (1985). Optimism, coping, and health: assessment and implications of generalized outcome expectancies. *Health Psychology* 4, 219–247.
- Scheier, M. and C. Carver (1992). Effects of optimism on psychological and physical well-being: Theoretical overview and empirical update. *Cognitive Therapy and Research* 16(2), 201–228.
- Schenker, N. and J. M. Taylor (1996). Partially parametric techniques for multiple imputation. *Computational Statistics & Data Analysis* 22(4), 425 – 446.
- Scheufele, D. A. and B. Lewenstein (2005). The public and nanotechnology: How citizens make sense of emerging technology. *Journal of Nanoparticle Research* 7, 659–667.
- Schmeidler, D. (1989). Subjective probability and expected utility without additivity. *Econometrica* 57(3), 571–587.
- Schuler, A., C. Weber, and U. Fahl (2000a). Energy consumption for space heating of West-German households: Empirical evidence, scenario projections and policy implications. *Energy Policy* 28(12), 877 – 894.
- Schuler, A., C. Weber, and U. Fahl (2000b). Energy consumption for space heating of West-German households: Empirical evidence, scenario projections and policy implications. *Energy Policy* 28(12), 877 – 894.
- Schwartz, R. (1997). Legal regimes, audit quality and investment. *The Accounting Review* 72(3), 385–406.
- Seligman, C., J. M. Darley, and L. J. Becker (1978). Behavioral approaches to residential energy conservation. *Energy and Buildings* 1(3), 325 – 337.
- Seltenreich, N. (2013). Nanosilver: Weighting the risk and benefits. *Environmental Health Perspectives* 121, 221–225.
- Semykina, A. and J. M. Wooldridge (2010). Estimating panel data models in the presence of endogeneity and selection. *Journal of Econometrics* 157(2), 375 – 380.
- Shadish, W., T. Cook, and D. Campbell (2002). *Experimental and quasi-experimental designs for generalized causal inference*. Boston: Houghton Mifflin.
- Shavell, S. (1980). Strict liability versus negligence. *The Journal of Legal Studies* 9(1), 1–25.

- Shavell, S. (1985). Uncertainty over causation and the determination of civil liability. *The Journal of Law & Economics* 28(3), 587–609.
- Shavell, S. (1986). The judgment proof problem. *International Review of Law and Economics* 6, 45–58.
- Shavell, S. (1987). *Economic Analysis of Accident Law*. Cambridge, Mass: The Harvard University Press.
- Shavell, S. (2004). *Foundations of economic analysis of law*. Belknap Press of Harvard University.
- Siegel, S. and N. Castellan (1988). *Nonparametric statistics for the behavioral sciences* (Second Edition ed.).
- Siegrist, M. and G. Cvetkovich (2000). Perception of hazards: The role of social trust and knowledge. *Risk Analysis* 20(5), 713–720.
- Sinclair-Désagné, B., D. Feigenbaum, and A. Nsamirizi (2006). Les nanotechnologies: bénéfiques et risques potentiels. Report, Centre interuniversitaire de recherche en analyse des organisations (CIRANO).
- Singer, T. and F. Ernst (2005). The neuroeconomics of mind reading and empathy. *American Economic Review* 95(2), 340–345.
- Smith, V. L. (1994, March). Economics in the laboratory. *Journal of Economic Perspectives* 8(1), 113–131.
- Sorrell, S., J. Dimitropoulos, and M. Sommerville (2009). Empirical estimates of the direct rebound effect: A review. *Energy Policy* 37(4), 1356 – 1371.
- Suerkemper, F., S. Thomas, D. Osso, and P. Baudry (2011). Cost-effectiveness of energy efficiency programmes. Evaluating the impacts of a regional programme in France. *Energy Efficiency* 5(1), 121–135.
- Sunnika-Blank, M. and R. Galvin (2012). Introducing the prebound effect. the gap between performance and actual energy consumption. *Building Research & Information* 40(3), 260–273.
- Sunstein, C. (1997). Behavioral analysis of law. *The University of Chicago Law and Review* 64(4), 1175–1195.

- Swan, L. and V. Ugursal (2009). Modeling of end-use energy consumption in the residential sector: A review of modeling techniques. *Renewable and Sustainable Energy Reviews* 13, 1819–1835.
- Székely, I., D. Máté, and B. Vissy (2011). Regulating the future? Law, ethics, and emerging technologies. *Journal of Information, Communication and Ethics in Society* 9(3), 180–194.
- Tabachnick, B. and L. Fidell (2012). *Using multivariate statistics* (6 ed.). MA: Allyn & Bacon.
- TecMarket Works (2004). The california evaluation framework. Technical report, Oregon: TecMarket Works Framework Team.
- Teitelbaum, J. C. (2007). A unilateral accident model under ambiguity. *The Journal of Legal Studies* 36(2), 431–477.
- The Royal Society (2004). Nanoscience and nanotechnologies: Opportunities and uncertainties. Technical report, The Royal Society & The Royal Academy of Engineering.
- Tigchelaar, C., M. Menkveld, and B. Daniëls (2011). obligations in the existing housing stock: who pays the bill? ECEEE 2011 Summer Study, Energy Efficiency First: The foundation of a low-carbon society.
- Tuccella, J. and E. Devimes (2015). Loi transition énergétique. Niveaux sinistres pour l’assurance décennale? SCOR Global P&C.
- Tuladhar, S. D., M. Yuan, P. Bernstein, W. D. Montgomery, and A. Smith (2009). A top–down bottom–up modeling approach to climate change policy analysis. *Energy Economics* 31, Supplement 2, S223 – S234. International, U.S. and E.U. Climate Change Control Scenarios: Results from EMF 22.
- Tversky, A. and R. Craig (1995). Weighing risk and uncertainty. *Psychological Review* 102(2), 269–283.
- Ulen, T. (2014). Behavioral law and economics: Law, policy, and science. *Supreme Court Economic Review* 21(1), 5–42.
- UNESCO (2005). The precautionary principle. World commission on the ethics of scientific knowledge and technology (COMEST). Technical report, United Nations, Educational Scientific and Cultural Organization.

- Van der Belt, H. (2003). Debating the Precautionary Principle: "Guilty until Proven Innocent" or "Innocent until Proven Guilty". *Plant Physiology* 132, 1122–1126.
- Van Raaij, F. and T. Verhallen (1983). Patterns of residential energy behavior. *Journal of Economic Psychology* 4, 85–106.
- Vautier, S., E. Raufaste, and M. Cariou (2003). Dimensionality of the revised life orientation test and the status of filler items. *International Journal of Psychology* 38(6), 390–400.
- Vieider, F. M., M. Lefebvre, R. Bouchouicha, T. Chmura, R. Hakimov, M. Krawczyk, and P. Martinsson (2015). Common components of risk and uncertainty attitudes across contexts and domains: Evidence from 30 countries. *Journal of the European Economic Association* 13(3), 421–452.
- Vink, G., L. Frank, J. Pannekoek, and S. Van Buuren (2014). Predictive mean matching imputation of semicontinuous variables. *Statistica Neerlandica* 68(1), 61–90.
- Vringer, K., T. Aalbers, and K. Blok (2007). Household energy requirement and value patterns. *Energy Policy* 35(1), 553 – 566.
- Wachinger, G., O. Renn, C. Begg, and C. Kuhlicke (2013). The risk perception paradox—implications for governance and communication of natural hazards. *Risk Analysis* 33(6), 1049–1065.
- Wakker, P. (2000). *Prospect Theory: For Risk and Ambiguity*. Cambridge: Cambridge University Press.
- Wakker, P. P. (2001). Testing and characterizing properties of nonadditive measures through violations of the sure-thing principle. *Econometrica* 69(4), 1039–1059.
- Waldberg, D., A. Holz, T. Gniechwitz, and T. Schulze (2011). Wohnungsbau in Deutschland 2011. Modernisierung oder Bestandsersatz: Studie zum Zustand und der Zukunftsfähigkeit des deutschen Kleinen Wohnungsbaus. Arbeitsgemeinschaft für zeitgemäßes Bauen, eV, Kiel.
- Wansley, M. (2016). Regulation of emerging risks. *Vanderbilt Law Review* 69(2), 401–474.
- Wiesner, M. R., G. V. Lowry, K. L. Jones, J. Michael F. Hochella, R. T. D. Giulio, E. Casman, and E. S. Bernhardt (2009). Decreasing uncertainties in assessing environmental

- exposure, risk, and ecological implications of nanomaterials. *Environmental Science & Technology* 43(17), 6458–6462.
- Wimberly, S., C. Carver, and M. Antoni (2008). Effects of optimism, interpersonal relationships, and distress on psychosexual well-being. *Psychology and Health* 23, 57–72.
- Wirl, F. (1997). *The Economics of Conservation Programs*. London: Springer Science & Business Media.
- Wooldridge, J. M. (2010). *Econometric Analysis of Cross Section and Panel Data* (Second ed.). The MIT Press.
- World Economic Forum (2015). Global risks 2015. Technical report, World Economic Forum.
- Wu, D.-M. (1973). Alternative tests of independence between stochastic regressors and disturbances. *Econometrica* 41(4), 733–750.
- Xpair (2011). Régulation des Energies Renouvelables, assessed 03 July 2016. <http://conseils.xpair.com>.
- Yamagishi, T. (1986). The provisioning of a sanctioning system as a public good. *Journal of Personality and Social Psychology* 51, 110–116.
- Yamagishi, T. and K. Sato (1986). Motivational base of the public goods problem. *Journal of Personality and Social Psychology* 50, 67–73.
- Zhou, X. and Y. Wu (2011). Sharing losses and sharing gains: Increased demand for fairness under adversity. *Journal of Experimental Social Psychology* 47(3), 582 – 588.

Essais sur la Gestion des Risques en Présence d'Ambiguïté

Résumé

La thèse vise à établir une gestion du risque technologique optimal pour assurer la réduction des dangers de nouveaux risques émergents, sans entraver le chemin de l'innovation. Les travaux de recherche apportent une contribution aux stratégies *ex-ante* et *ex-post* de la gestion des risques et fournissent des données théoriques et empiriques pour aborder la gestion des nouveaux risques émergents. La première partie de la thèse examine, du point de vue juridique et économique, l'efficacité de la règle de la responsabilité civile lorsque le décideur manque d'information sur la probabilité d'un événement. La deuxième partie de la thèse porte une attention particulière à la transition énergétique en France afin de se concentrer sur l'assurabilité de la performance énergétique dans le secteur du logement. Les résultats théoriques et expérimentaux de la première partie de la recherche attestent d'une forte validité empirique selon laquelle le droit de la responsabilité civile ne peut pas fournir des incitations optimales *ex-ante* en absence d'information sur la probabilité d'accident. Les régimes de la responsabilité illimitée et limitée conduisent à un surinvestissement dans la prévention par rapport aux nouveaux risques émergents. Les résultats empiriques de la deuxième partie de la thèse révèlent que 23,75% des ménages, qui ont participé au programme de rénovation "Je Réнове BBC", ne peuvent pas atteindre l'objectif d'énergie prévu, mais l'amplitude de l'écart de performance énergétique est relativement faible. Les résultats des travaux de recherche impliquent plusieurs recommandations politiques pour gérer les nouvelles technologies émergentes dans le futur.

Résumé en anglais

The thesis aims to establish an optimal technological risk management to ensure hazard reduction of new emerging risks without impeding the innovation path. The research work contributes to *ex-ante* and *ex-post* risk management strategies and provides theoretical and empirical evidence to address the management of new emerging risks. The first part of the thesis examines, from the perspective of Law and Economics, the effectiveness of the tort liability rule for the situation where the decision maker is lacking information about the probability of an event to occur. The second part of the thesis pays particular attention to the environmental energy transition in France and focus on the insurability of the energy performance in the housing sector. The theoretical and experimental findings from the first part of the research convey strong validity that tort law cannot provide *ex-ante* optimal incentives when there is lacking information about the probability of accident. The regime of unlimited and limited liability leads to overinvestment in prevention in regard to new emerging risks. The empirical results of the second part of the thesis reveal that 23.75% of households participated in the weatherization program "Je Réнове BBC" do not achieve the required energy target but the severity of the energy performance gap is relatively low. The findings of the research work imply several policy recommendations to manage new emerging technologies in the future.