



HAL
open science

Delta opioid receptor expression in various models of chronic clinical conditions

Rhian Alice Ceredig

► **To cite this version:**

Rhian Alice Ceredig. Delta opioid receptor expression in various models of chronic clinical conditions. Neurons and Cognition [q-bio.NC]. Université de Strasbourg, 2016. English. NNT : 2016STRAJ100 . tel-01493122

HAL Id: tel-01493122

<https://theses.hal.science/tel-01493122v1>

Submitted on 21 Mar 2017

HAL is a multi-disciplinary open access archive for the deposit and dissemination of scientific research documents, whether they are published or not. The documents may come from teaching and research institutions in France or abroad, or from public or private research centers.

L'archive ouverte pluridisciplinaire **HAL**, est destinée au dépôt et à la diffusion de documents scientifiques de niveau recherche, publiés ou non, émanant des établissements d'enseignement et de recherche français ou étrangers, des laboratoires publics ou privés.

ÉCOLE DOCTORALE DES SCIENCES DE LA VIE ET DE LA SANTÉ

UPR3212

THÈSE présentée par :

Rhian Alice CEREDIG

soutenue le : 23 juin 2016

pour obtenir le grade de : **Docteur de l'université de Strasbourg**

Discipline/ Spécialité : Neurosciences

**Delta Opioid Receptor Expression in
Various Models of Chronic Clinical
Conditions**

***Expression du Récepteur aux Opioides Delta dans
Différents modèles de Pathologies Chroniques***

THÈSE dirigée par :

Mme Dominique MASSOTTE

Directeur de Recherche, Université de Strasbourg

RAPPORTEURS :

M. Rafael MALDONADO

Professeur à l'Université de Pompeu Fabra, Barcelone

Mme Halina MACHELSKA STEIN

Professeur à l'Université de Médecine La Charité, Berlin

AUTRES MEMBRES DU JURY :

M. Rémy SCHLICHTER

Professeur à l'Université de Strasbourg

Acknowledgements and thanks

The work presented here was done in the laboratory lead by Dr Michel Barrot, whom I would particularly like to thank for providing invaluable input and support. This thesis project was directed by Dr Dominique Massotte, to whom I am very grateful for giving me the opportunity to work and learn under her supervision, but also for her help at the bench, sound guidance and unfaltering support.

I would also like to thank the jury members Prof Halina Machelska, Dr Rafael Maldonado and Prof Rémy Schlichter for agreeing to evaluate my work. Thank you also to the invited jury members Prof Claire Gaveriaux-Ruff and Dr Katia Befort.

I am very much indebted to Dr Ipek Yalcin, for the fruitful discussions, your help and your time, it is very much appreciated. Special thanks to Dr Jean-Luc Rodeau and Dr Syvain Hugel for the advice they provided and their assistance. Many thanks go to Prof Pierre Veinante and Prof Marie-José Freund-Mercier, for their teaching and interest, and to Dr Eric Salvat for his enthusiasm and helpful contributions.

I would also like to thank Sylvette Chasserot from the imaging platform and members of the Chronobiotron animal facility, in particular Edouard and Stéphane for their excellent care and assistance.

Many thanks to all the lab members; Betty, Clémentine, Dorothée, Fanny, Florian, Jim, Jiahao, Julie, Mélanie, Müzzeyen, Pierre-Eric, Unai and Xavier, the former students Florent, Salim and Romain; and members of my previous team, in particular Anne, Audrey, David and Paul.

Last but not least, I would like to thank my family and friends, the students from the INCI and the IGBMC, and the players from my handball team for their support.

1. Introduction	11
A. Chronic pain	11
1. Definition and components.....	11
a) Nociceptive pain and chronic pain	11
(1) Nociceptive pain.....	11
(2) Chronic pain	12
b) Molecular actors in the detection of nociceptive stimuli modalities	13
(1) Thermal sensitivity	13
(2) Chemical sensitivity	15
(3) Mechanical sensitivity	16
c) Primary Sensory afferents	18
d) Dorsal root ganglia	20
e) Central pathways	23
(1) Spinal circuits	23
(i) Primary afferent projection patterns	23
(ii) Spinal cord interneurons	26
(iii) Neuroanatomical organization of projection neurons.....	28
(iv) Local circuitry modifications in pain conditions	30
(2) Ascending projections and roles of central circuits.....	32
(3) Descending controls	37
2. Inflammatory pain	37
3. Visceral pain.....	40
4. Neuropathic pain: Central and peripheral sensitization.....	43
a) Etiology and symptoms	44
b) Peripheral Sensitization Mechanisms.....	45
c) Central sensitization	47
d) Treatment strategies.....	49
(1) Antidepressants	50
(2) Antiepileptics.....	51
(3) Opioid treatment in neuropathic pain	52
5. Studying neuropathic pain.....	53
a) Different animal models	53
b) Animal models of chemotherapy-induced NP.....	53
c) Traumatic models	55
6. Cuff model characteristics	56
B. The Endogenous Opioid System	58

1. Central components and roles	58
a) Peptides	60
b) Receptors	62
(1) Receptor structure.....	62
(2) Cellular dynamics.....	64
(3) Anatomical Distribution	66
(a) Opioid Gene Expression in the Central Nervous System (CNS)	66
(b) Opioid gene expression in peripheral tissues	71
2. Opioids in drug addiction and mood regulation	72
3. Roles of the Endogenous Opioid System in Digestion and Visceral Perception	74
a) Effects on gastrointestinal motility.....	74
4. Pain Modulation by the Opioid System.....	75
a) Antinociception	75
b) Tolerance: involvement of MOP-DOP receptor interaction.....	76
(1) Functional interactions between MOP and DOP receptors	78
(a) Clues indicating MOP-DOP physical proximity	78
(b) Disruption of MOP-DOP physical proximity induces functional changes.....	79
(2) MOP-DOP heteromerization may underlie opiate tolerance.....	80
5. Opioid receptors and peptides involvement in chronic pain	80
a) Roles of MOP and KOP receptors and Opioid Peptides	80
(1) MOP receptor	80
(2) KOP receptor	82
b) DOP receptor in pain mechanisms	83
C. Tools for studying DOP receptors <i>in vivo</i>	84
1. Pharmacological studies.....	84
2. Gene deletion models	85
a) DOP receptor knock-out mice	85
b) Conditional Knock out mouse	86
3. DOPeGFP Knock-in mouse	87
a) Fluorescent Knock-in mice: genetic tools to directly visualize receptors <i>in vivo</i>	87
b) GPCR-FP fusion for <i>in vivo</i> functional and mapping studies	90
(1) Mapping of OR expression with neuronal resolution.....	90
(2) <i>In vivo</i> trafficking, desensitization and behavioral output.....	92
(3) Methodological improvements	95
c) Concerns about the use <i>in vivo</i> of GPCR-FP fusions for functional studies.....	95
d) Conclusions and impact for drug design	97

2.	Aim of the thesis	101
3.	Chapter One: Article in preparation.....	103
1.	Introduction	103
2.	Article.....	105
4.	Chapter Two: Article in preparation	193
1.	Introduction	193
2.	Article.....	195
5.	Chapter Three: The antiallodynic action of pregabalin in neuropathic pain is independent from the opioid system.	235
1.	Introduction	235
2.	Article.....	238
6.	Chapter Four: Colon sensitivity in opioid receptor knock-out mice	240
1.	Introduction	240
2.	Article.....	242
7.	Chapter Five: Impact of Chronic Morphine on Delta Opioid Receptor-expressing Neurons in the Mouse Hippocampus	244
1.	Introduction	244
2.	Article.....	246
8.	General Conclusions and Perspectives	248
A.	General conclusions of the thesis projects.....	248
A.	Perspectives	249
1.	DRG neuronal distribution changes and antiallodynic treatments	249
a)	Short term and immediate perspectives.....	249
b)	Medium and long term complementary investigations	251
2.	Anxio-depressive consequences of neuropathic pain.....	255
a)	Immediate complementary experiments.....	255
b)	Perspective in the medium and long term	255
9.	References	258
10.	Annex 1: Published Review	283
1.	Introduction	284
2.	Article.....	286
11.	Annex 2: Le Nouveau Chapitre de la Thèse (en français).	288

List of Figures :

Figure 1 : The nociceptive Pain Circuit (page 3).

Figure 2 : Schematic representation of cell bodies and peripheral projections of sensory neurons (page 14).

Figure 3: Functionally distinct subtypes of cutaneous mechano-sensory neurons have specific threshold sensitivities and encoding capabilities that may transduce specific kinds of mechanical stimuli (page 17).

Figure 4: DRG neuron illustrations (page 21).

Figure 5: Primary afferent projection patterns in the spinal cord dorsal horn (page 25).

Figure 6: Neuronal circuits involving projection neurons in the spinal cord (page 27).

Figure 7: Simplified schematic organization of central nociceptive projections (page 31).

Figure 8 : Anatomy of the pain pathways (page 33).

Figure 9 : Central pain processing (page 35).

Figure 10 : Nociceptor plasticity (page 39).

Figure 11 : Inflammatory pain (page 41).

Figure 12 : Sciatic nerve cuff implantation (page 54).

Figure 13 : Physiological roles of the endogenous opioid system (page 59).

Figure 14 : Endogenous opioid peptide maturation (page 61).

Figure 15 : Selectivity of some commonly used opioid agonists and antagonists, determined in an expression system (page 63).

Figure 16 : Structure of opioid receptors (page 65).

Figure 17 : Illustration of the best-characterized pathways of effector activation of opioids (page 67).

Figure 18 : Illustration of the GPCR life cycle (page 68).

Figure 19 : Anatomical distribution of opioid receptors in the rodent brain (rat and mouse) (page 69).

Figure 20 : Anatomical distribution of opioid peptides in the rodent brain (rat and mouse) (page 70).

Figure 21 : Summary of responses to drugs and spontaneous behaviours in opioid receptor knock-out mice (page 77).

Figure 22 : Schematic diagram of genetic constructions of knock-in mice expressing a fluorescent protein (FP) under the control of an endogenous GPCR promoter (page 88).

Figure 23 : *In vivo* pharmacological internalization and degradation of DOPeGFP receptors (page 91).

Figure 24 : Endogenous antinociceptive mechanisms within peripheral injured tissue (page 251).

Figure 25 : Schematic representation of DOP receptor involvement in antidepressant and β_2 mimetic treatment effects (page 255).

Abbreviation list

ACTH: adrenocorticotrophic hormone	KI: knock-in
AEA: endogenous cannabinoid anandamine	KO: knock-out
AMPA: α -amino-3-hydroxy-5-methyl-4-isoxazolepropionic acid	KOP: kappa opioid receptor
APN: aminopeptidase N	mAChR: muscarinic acetylcholine receptor
AR: Adrenoreceptor	MAPK: mitogen activated protein kinase
Arc: Arcuate nucleus	Mg ²⁺ : magnesium ion
ASICs: acid-sensing ion channels	MOP: mu opioid receptor
ATP: adenosine triphosphate	Mrgprd: mas related g protein receptor
BBB: blood-brain barrier	MSCs: mammalian mechanosensitive ion channels
BDNF: brain derived growth factor	MSH: melanocyte-stimulating hormone
BNB: blood-nerve barrier	NA: noradrenalin
CamKII: calcium/calmodulin-dependent kinase	Nav: voltage gated sodium channel
cAMP: cyclic adenosine monophosphate	NEP: neutral endopeptidase
CCI: chronic construct injury	NF: neurofilament
CFA: complete Freund adjuvant	NGc: gigantocellular lateral paragigantocellular nucleus
CGRP: calcitonin gene related peptide	NGF: nerve growth factor
CNS: central nervous system	NK1R/2R: neurokinin receptor
Cox-2: Cyclo-oxygenase 2	nNos: neuronal nitric oxide synthase
CREB: cAMP element binding protein	nor-BNI: norbinaltorphimine
CRFR: corticotrophin-releasing factor receptor	NPY: neuropeptide Y
DAMGO: [D-Ala ² , N-MePhe ⁴ , Gly-ol]-enkephalin	NTS: nucleus tractus solitaries
DH: dorsal horn	OR: opioid receptor
DOP: delta opioid receptor	P2X3: purinoceptor type 2X3
DRG: dorsal root ganglion	PAG: periaqueductal gray matter
ERK: Extra-cellular signal Regulated Protein Kinase	PB: parabrachial nucleus
eGFP: enhanced Green Fluorescent Protein	PDYN: prodynorphin
fMRI: functional Magnetic Resonance Imaging	PENK: preproenkephalin
FP: fluorescent protein	PKA: Proatein Kinase A
GABA: gamma aminobutyric acid	PKC γ : Protein Kinase C
GAD: glutamate decarboxylase	PLC β : phospholipase C β
GIRKs: G protein-activated inwardly rectifying K ⁺ channels	PN: pontine nucleus
GLYT: glycine transporters	PNS: peripheral nervous system
GPCR: G protein coupled receptor	Po: posterior nuclear group of the thalamus
GRKs: G protein-coupled receptor kinase	POA: preoptic area
HEK: human embryonic kidney	POMC: pro-opiomelanocortin
HIV: Human Immunodeficiency Virus	PoT: trigular posterior nucleus
HNC: Hyperpolarization-activated cyclic nucleotide-gated channel	RVM: rostral ventral medulla
IB4: isolectin B4	SGC: satellite glial cell
IBD: inflammatory bowel disease	SNC80: 4-[(R)-[(2S,5R)-4-allyl-2,5-dimethylpiperazin-1-yl](3-methoxyphenyl)methyl]-N,N-diethylbenzamide
ICC: Interstitial Cell of Cajal	SNL: spinal nerve ligation
IHC: immunohistochemistry	SNRI: Selective serotonin and noradrenalin reuptake inhibitor
IL1- β : interleukin 1 β	SP: substance P
IRES: internal ribosomal entry site	SRD: subnucleus reticularis dorsalis
KCC2: potassium-chloride transporter	TCA: tricyclic antidepressant
KCNK: potassium channel subfamily K	TG: trigeminal ganglia
kD: kilo dalton	TH: tyrosine hydroxylase

TLR5: toll-like receptor 5
TNF α : tumor necrosis factor α
Trk: tyrosine kinase receptor
TRP: transient receptor potential
TRPA1: TRP ankirin 1
TRPM8: TRP melastatin 8
TRPV: TRP vanilloid
VGAT: vesicular GABA transporter
VGCC: voltage gated calcium channel
VGLUT: vesicular glutamate transporters
VLM: ventrolateral medulla
cVLM: caudal VLM
VPL: ventral posterolateral nucleus
WT: wild-type

List of Annexes :

Annex 1 : Published review: Fluorescent knock-in mice to decipher the physiopathological role of G protein-coupled receptors (page 285).

Annex 2 : Le Nouveau Chapitre de la Thèse (NCT) ® (page 289).

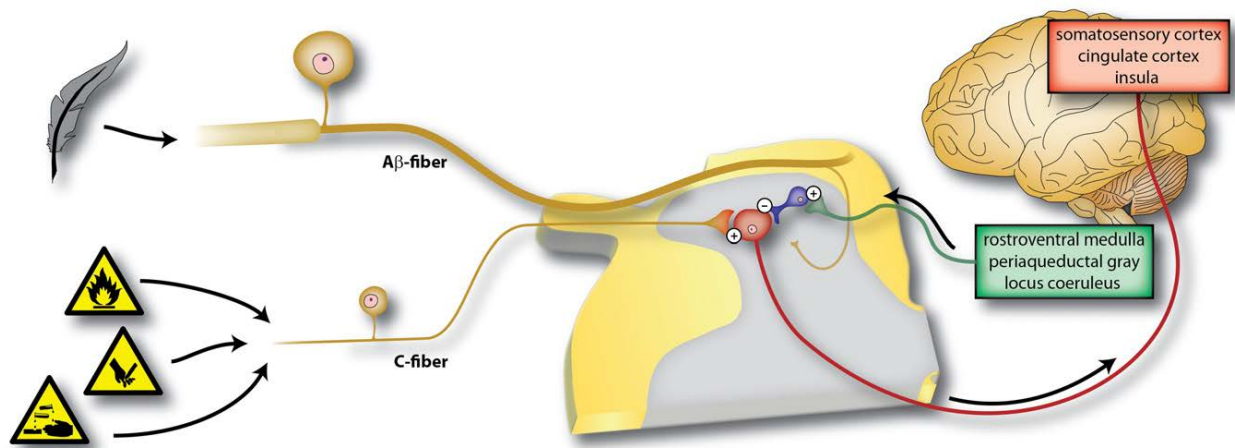

Figure 1: The Nociceptive Pain Circuit

High-threshold nociceptors are activated by intense mechanical, thermal, or chemical stimuli and feed this information to nociceptive neurons in the spinal cord, which project via the thalamus to cortical areas generating the sensory and emotional qualities of pain. These spinal cord pathways are subject to descending inhibitory and facilitatory influences from the brainstem. Normally, activity in low-threshold afferents is carried by independent peripheral and central pathways and only generates innocuous sensations.

Adapted from Von Hehn 2012.

1. Introduction

A. Chronic pain

1. Definition and components

a) *Nociceptive pain and chronic pain*

Pain, essentially, is the sensory manifestation of imminent or ongoing tissue damage, and its primary function is to act as a warning sign so as the individual can take action for pain to cease. Pain can be described in terms of intensity or severity, duration and type (inflammatory, nociceptive or neuropathic). The pain experience is highly charged with emotional processes, cultural attitudes and personal experience which, added to the variety of stimuli which can cause pain, make every individuals' pain experience different (Rainville, 2002). Nociceptive pain is the conscious awareness of noxious stimulus and/or the subjective emotional state which accompanies the sensory experience of such stimuli (see Figure 1). Persistent or chronic pain results from distinct peripheral and central sensitization mechanisms through which pain is felt in the absence of noxious stimuli, and is related to plasticity-induced changes in sensory circuits (Basbaum et al., 2009; Todd, 2010; von Hehn et al., 2012; Campbell and Meyer, 2006). These maladaptive changes no longer serve the physiological purpose of nociceptive pain, and if left untreated, can facilitate the development of emotional states of defective coping strategies and mood disorders (Arnouk et al., 2011; Sullivan et al., 2005; Radat et al., 2013).

(1) Nociceptive pain

Nociceptive pain is acute sensory processing resulting from the activation of nociceptors in the periphery (either somatic sensory system or viscera) by mechanical, thermal and/or chemical noxious stimuli, undefiled by sensitization (Carr, 1999). Upon activation, primary afferents (nociceptors) transduce the detected danger into a neural signal (action potentials) which is transmitted to central structures that perceive and process the information by engaging distinct cortical areas (sensation of "pain" *per se*), and can modulate the flow of nociceptive information through descending control mechanisms (Besson, 1999; Carr, 1999) (Figure 1). Nociceptive information is detected and encoded by specialized nerve endings in skin or viscera, which react to

the mechanical, thermal and/or chemical nature and intensity of the stimulus. The primary afferents transmit the information to the spinal cord through their fibres (either unmyelinated or myelinated) which project to distinct laminae in the dorsal horn of the spinal cord. Within the spinal cord, a network of morphologically and molecularly distinct neurons receives and processes the information, and transmits the input to the brain. Three main projections then target cortical and limbic structures through central pain processing pathways (spinothalamic, spinoparabrachial, spinoreticular tracts) which mediate the sensory information, engage autonomous and emotional homeostatic processing, and prime homeostatic motor control related to coping mechanisms (Gauriau and Bernard, 2002). Following injury, reversible adaptive changes take place in the peripheral nervous system; hypersensitivity to noxious stimuli aims to protect the injured area and thus contributes to the healing process.

(2) Chronic pain

Chronic pain develops in pathological conditions and the primary role of pain sensation is no longer the alarm in response to physical threats, but is an ongoing pathological mechanism. In clinical terms, pain is considered chronic if painful symptoms do not regress after three or six months, however many clinicians and researchers agree that acute and chronic pain mechanisms differ, and that this arbitrary temporal definition is incomplete (Basbaum, 1999). Persistent pain results from a combination of alterations of primary sensory nerves which have heightened sensitivity thresholds to all stimuli modalities and enhanced nociceptive processing in central structures maintained by a state of hyperexcitability.

Neuropathic pain arises as a consequence of metabolic, toxic, ischemic or traumatic injury of the nervous system and manifestations include positive and negative symptoms, which we will describe further in dedicated sections. Neuropathic pain can be considered as resulting from pathological plasticity of the nervous system in response to pain (von Hehn et al., 2012). Chronic visceral and somatosensory inflammatory pain (Crohn's disease, fibromyalgia or rheumatoid arthritis) also involve pain circuit modifications and immune dysfunction.

b) Molecular actors in the detection of nociceptive stimuli modalities

(1) Thermal sensitivity

For heat detection, temperatures which exceed 43°C can cause tissue damage in mammals, and consequently, this temperature triggers activity of heat-sensitive nociceptors (C and A δ fibres). A small proportion of heat-sensitive primary afferents have activation thresholds at higher temperatures (50°C) (Nagy and Rang, 1999; Leffler et al., 2007). Heat sensitivity is conferred by the expression of capsaicin receptor Transient Receptor Potential Vanilloid 1 or TRPV1, a member of ion channel receptors. TRPs are nonselective cation channels that are permeable to Ca²⁺ and Na⁺, and their activation increases opening probability, leading to membrane depolarization and action potential firing. TRPV1 is activated by temperatures exceeding 42°C and acidic pH (Mickle et al., 2015). As a polymodal receptor, TRPV1 also binds the main component of hot chili peppers and produces a burning-type pain, mediated by TRPV1-positive nociceptors (C and A δ fibres). TRPV1 is also responsible for the detection of noxious chemical environments in somatic tissue, and TRPV1 activity is greatly enhanced in the presence of proalgesic and proinflammatory agents, which account for the thermal hypersensitivity of injured tissues (Tominaga et al., 1998). Deletion of TRPV1 results in reduced heat sensitivity, especially regarding intensity of heat discrimination, but does not affect responses to cold stimuli. Other mechanisms of heat detection independent of TRPV1 have been postulated (i.e. TRPV2 activity), however TRPV1 is considered to be the main substrate of noxious heat detection (for review see Basbaum et al., 2009). TRPV1 also binds the endogenous cannabinoid anandamide (AEA) at high concentrations (Zygmunt et al., 1999; Ross, 2003), which therefore mediates pronociceptive endogenous cannabinoid effects (Starowicz and Przewlocka, 2012) (See Figure 2).

TRPM8 (TRP melastatin 8) is a channel receptor expressed in subpopulations of nociceptors (both C and A δ fibres) (Peier et al., 2002) activated by innocuous cooling (26-15°C), noxious cold (15-8°C) and cooling compounds such as menthol, icilin and eucalyptol. These molecules act by shifting the the cold sensitivity or activation threshold of TRPM8 channels towards higher temperatures (Voets et al., 2004; Mickle et al., 2015). Most primary afferents which respond to cold are sensitive to menthol, however there is evidence of menthol-insensitive cold activated neurons. TRPV1 knock-out animals show normal responses to cold stimuli, and

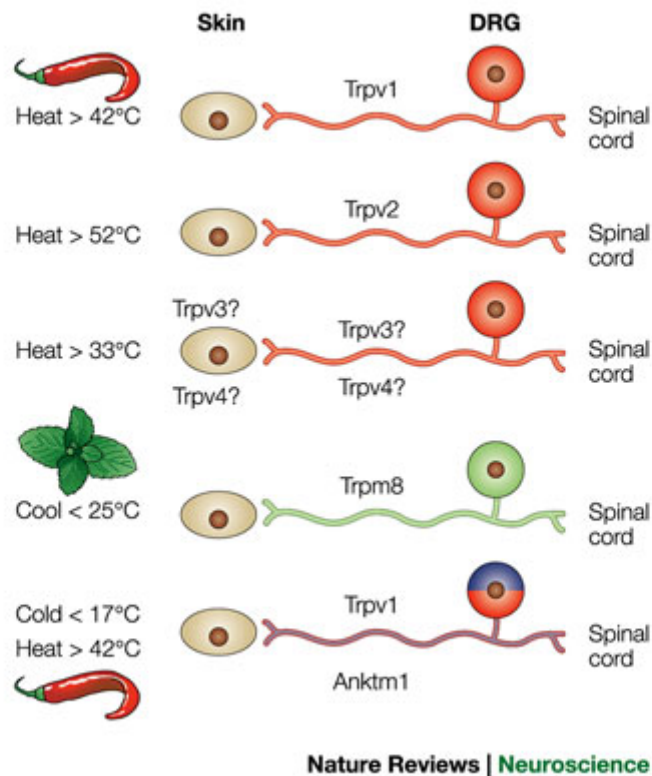

Figure 2: Schematic representation of cell bodies and peripheral projections of sensory neurons. ThermoTRPs with unique temperature thresholds that are expressed in distinct subsets of neurons have been identified. The model presented here is mainly based on pairwise comparisons of expression patterns, and a more complicated scenario might be more realistic. The relevant expression of the warm-activated channels Trpv3 and Trpv4 is not clear. The last neuron in this figure illustrates a putative 'polymodal nociceptor'. The expression of Anktm1 in a subset of the noxious-heat-sensing Trpv1-expressing cells indicates that these neurons are tuned to respond to multiple types of painful stimuli. DRG, dorsal root ganglia. From (Patapoutian et al., 2003).

TRPV1 and TRPM8 are expressed in separate neuronal primary afferents, which is in favour of the theory whereby subpopulations of primary afferents are dedicated to detection of distinct thermal stimuli, and that these two systems do not overlap (Julius and Basbaum, 2001a) (See Figure 2).

TRP Ankirin 1 (TRPA1) is predominantly expressed in nociceptors, peripheral small fibres in both peptidergic and nonpeptidergic subpopulations. TRPA1 responds to a large variety of compounds, including modulators such as isothiocyanates (for example mustard oil, horseradish and wasabi), acidic pH and many other chemicals. Rodent and primate TRPA1 ion channels may differ in their contribution to cold sensitivity. Indeed, rodent TRPA1 seems to be cold-insensitive, as opposed to primate TRPA1. Other molecules may be involved in detection of cold temperatures, such as voltage-gated sodium and voltage-gated potassium channels, Nav1.8 or KCNK family members for example, which are involved in adjusting and calibrating thresholds of cold-sensing afferents (Noël et al., 2009; Zimmermann et al., 2007) (See Figure 2).

(2) Chemical sensitivity

Chemical noxious detection relies in great part on the TRP family. These nonselective cation channels bind diverse environmental and endogenous irritants (produced by physiological stress) and transduce the chemical signal by depolarizing the cell membrane. As mentioned above, TRPV1 is known to bind capsaicin, TRPM8 is sensitive to menthol, among other cooling compounds, and TRPA1 can bind covalently to a diverse chemical entities through their thiol group (Mickle et al., 2015). Acid-sensing ion channels (ASICs) are specialized in the detection of protons which are released in the case of tissue damage or ischemic insult. ASICs are proton-gated sodium channels, function as trimeric complexes and are expressed in termini of mechanosensory primary afferents, such as the skin Meissner's corpuscles, Merkel nerve endings, free nerve endings, and hair follicles. They are involved in detection of acidosis, changes of osmolarity, glucose levels and arachidonic acid produced following inflammation (Osmakov et al., 2015). For example, Bradykinin, a bioactive peptide produced at the site of injury, activates its receptor (a G protein coupled receptor) leading to membrane depolarization via indirect or direct activity on TRPV1 channel (Mizumura et al., 2009; Burgess et al., 1989). In particular, chemical noxious compounds as well as endogenous proalgesic products which are released after tissue damage

are known to sensitize nociceptors to other noxious stimuli, and participate in the initiation of the transition from acute to persistent pain (Basbaum et al., 2009) (See Figure 2).

(3) Mechanical sensitivity

Noxious mechanical stimulus is primarily associated with the activity of C and A δ nociceptive fibres which have high activation thresholds, as opposed to A β fibres which transmit light touch modality and have low activation thresholds (See Figure 3).. The identity of the molecular substrates of mechanosensation has not yet been clearly established, and the discrimination of touch as opposed to pain mechanosensation involves several levels of integration as we will see further on. Mechanosensitive ion channels in the somatic system confer to neurons the ability to detect and transduce the mechanical stimulus. They are nonselective cation channels which respond to mechanical stimulus. However no valid candidate genes have been identified so far in nociceptors.

Piezo 1 & 2 which are proteins expressed chiefly in skin and viscera were proposed as candidate mammalian mechanosensitive ion channels (MSCs) (Volkers et al., 2014; Coste et al., 2010). Piezo 2 is also highly expressed in dorsal root ganglia and subsets of large primary afferent neurons as well as Merkel cells (Woo et al., 2014; Sharif-Naeini, 2015). However this remains to be confirmed.

Studies in nematodes enabled the identification of mammalian orthologs of the ASIC family, these genes were proposed as mechanotransducer channels. However, mice in which ASIC family members were inactivated showed that their involvement in detection of mechanical stimulus was unlikely (Drew et al., 2004), although ASICs contribute to transduction inflammatory, ischemic and musculoskeletal pain (for review see Basbaum et al., 2009). Potential candidates involved in mechanotransduction include members of the TRPV family. TRPV2, which is expressed in medium- and large-diameter afferents (Greffrath et al., 2003) is involved in the detection of mechanical and noxious thermal stimuli, as well as osmotic stretch of cell membranes. TRPV4 is involved in mechanotransduction following injury, but does not contribute to basal detection of mechanical stimuli in somatic tissue. TRPA1 was also proposed to play a role in the detection of mechanical stimuli in heterologous systems (Hill and Schaefer, 2007), however TRPA1 knock-out animals display normal responses to acute

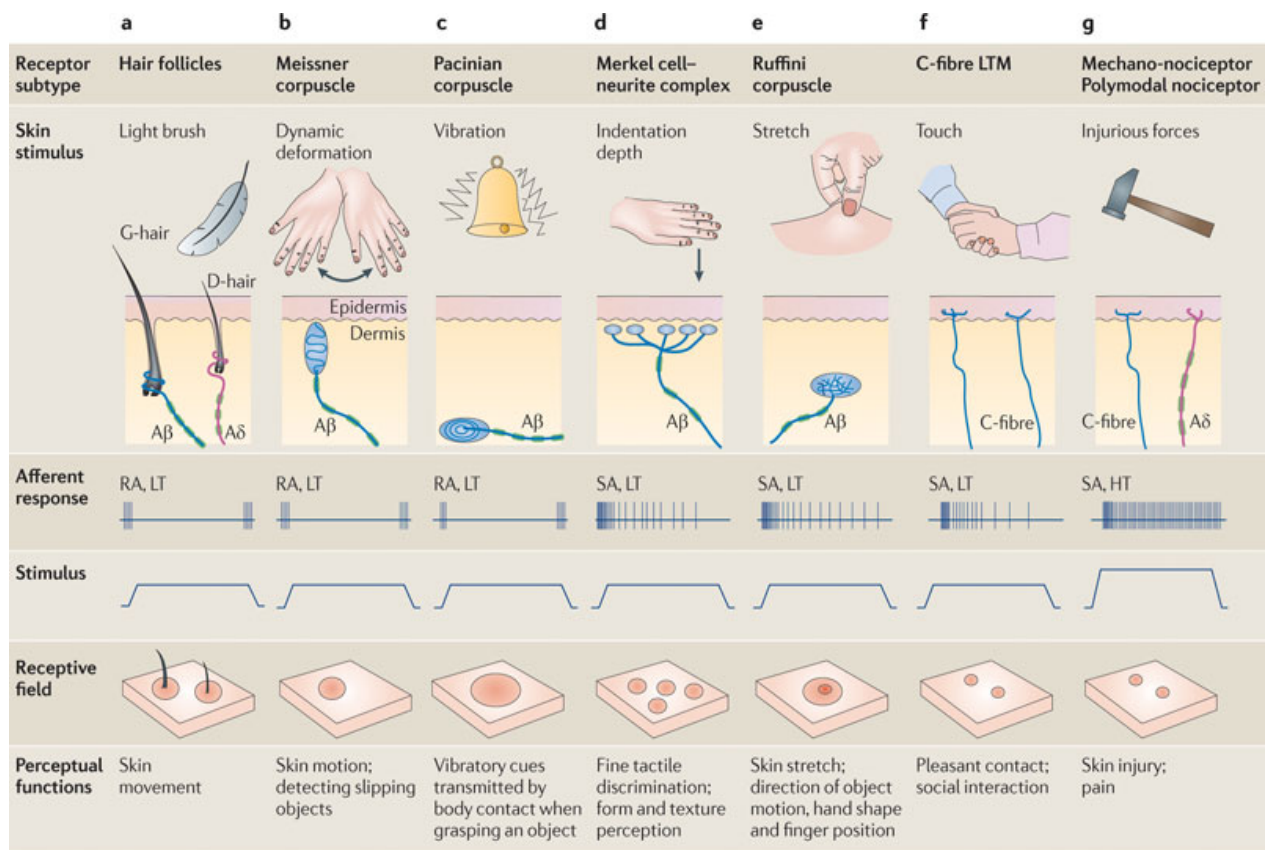

Figure 3: Functionally distinct subtypes of cutaneous mechanosensory neurons have specific threshold sensitivities and encoding capabilities that may transduce specific kinds of mechanical stimuli.

- A. Guard hair (G-hair) and down hair (D-hair) follicles contain nerve endings that form a circumferential array of unmyelinated nerve terminals derived from myelinated axons. These receptors are rapidly adapting (RA), low threshold (LT) afferents and detect light touch.
- B. Meissner corpuscles are situated in the glabrous skin. They are RA LT mechanoreceptors (LTMs) and transmit information about skin motion.
- C. Pacinian corpuscles have a typical structure and are RA LTMs that allow perception of distant events through transmitted vibrations.
- D. Merkel cell–neurite complexes lie at the base of the epidermis and are formed of clusters of 50–70 cells connected to terminals of a myelinated A β axon. They function as slowly adapting (SA) LTMs and are responsible for form and texture perceptions.
- E. Ruffini corpuscles lie in the dermis, with the distinct outer capsule surrounding a fluid-filled capsule space. They are SA cutaneous mechanoreceptors and contribute to the perception of object motion.
- F. Free nerve endings and unmyelinated receptors terminate in the subepidermal corium. C-fibre LTMs (f) respond to innocuous tactile stimulation and signal pleasant stimulation. The perception of painful touch is initiated by high-threshold (HT) C-fibre and A δ nerve endings (g), which can be mechanosensitive or polymodal in nature.

Adapted from (Delmas et al., 2011).

mechanosensory stimulation (Bautista et al., 2006; Petrus et al., 2007). Nonetheless, TRPA1 may modulate mechanosensation through sensitization in the context of inflammation or nerve damage (Mickle et al., 2015).

Members of KCNK potassium channels have also been examined as potential candidates contributing to mechanosensitivity (Bautista 2008), but it appears more likely that KCNK regulate activation threshold rather than having direct involvement in mechanosensation (for review see Basbaum et al., 2009). Overall, the distinct substrates of modality transduction are being actively investigated, bearing hope that identification of the molecular actors involved in specific pain modalities will yield therapeutic targets for chronic pain states.

c) Primary Sensory afferents

Somatosensory innervations can be classified in two main systems; cranial innervation which transmits sensation of the face, teeth and scalp, and spinal innervations transmitting sensation from the rest of the body. Primary afferents are pseudo-unipolar neurons, the cell bodies of which are located in dorsal root ganglia (DRG) and trigeminal ganglia (TG) and can transmit touch, thermal sensation, proprioception or pain. Classifications of the afferents rely on their functional properties (conduction velocities and responses to stimuli), target innervations and marker expression patterns (Carr and Nagy, 1993).

The first category of neurons is A β fibres which have large cell bodies, high degree of axon myelination and very fast conduction velocities. These afferents innervate skin and muscle fibres, with specialized terminals including Meissner and Pacini corpuscles for the former, and muscle spindle and Golgi tendon organs for the latter. A β fibres transmit innocuous cutaneous mechanosensation or proprioception, depending on the target innervations. The main structural marker for this category is neurofilament 200kD, NF200 (Ruscheweyh et al., 2007; Perry and Lawson, 1998). These afferents project to spinal cord dorsal horn intermediate laminae (III and IV), sending collaterals to deep laminae; the central targets of this circuit are chiefly responsible for tactile sensation and discriminative localization (Gauriau and Bernard, 2002) (see Figure 3).

A δ fibres have medium to large cell bodies, thinly myelinated axons and consequently have intermediate conduction velocities, they innervate mainly the skin. Termini can be either specialized or free endings, depending on the modality they subserve. Low Threshold mechanoreceptors in the skin innervate hair follicles

and are associated with transmission of innocuous touch modality; A δ thermoreceptors have free nerve endings in the skin sensitive to thermal stimuli; low threshold polymodal nociceptors have free nerve ending innervating the skin and transmit mechanical and thermal pain signals; lastly non-polymodal nociceptors are either high threshold mechanoreceptors or mechano-cold sensitive fibres (Kestell et al., 2015; for review Djouhri, 2016). A δ fibres project to the superficial laminae of the dorsal horn of the spinal cord (I, II) and send collaterals to laminae V, VI and X (Gauriau and Bernard, 2002). All A fibres express the structural marker NF200. Until recently, there appeared to be no known molecular markers which could differentiate the two types of A fibres. Classifications were based solely on conduction velocities and responses to stimuli. Expression of Toll-like Receptor 5 (TLR5) seems a possible marker expressed exclusively by A β fibres (Xu et al., 2015). The same study argues in favour of a predominant role of A β fibres in mechanical allodynia following neuropathy, which we will discuss further on.

C fibres have small cell bodies, unmyelinated axons and slow conduction speed, which innervate skin but also viscera. As for A δ fibres, low threshold mechanoreceptors innervate the skin hair follicles and transmit touch sensation; these particular cells express Tyrosine Hydroxylase (TH). C thermoreceptors have free nerve endings in the skin; and C fiber mechano-heat nociceptors are polymodal nociceptors. Peptidergic C fibres express TrkA (tyrosine kinase receptor for nerve growth factor) and contain Substance P (SP) and Calcitonin Gene Related Peptide (CGRP). These peptidergic fibres are supposedly segregated from nonpeptidergic C fibres which contain D-galactosyl in their membranes, are identified by binding of Isolectin B4 (IB4), express glial derived growth factor receptor (GDNF) and P2X3 purinergic receptors, a subtype of ATP-gated ion channel subunit (Basbaum et al., 2009; Julius and Basbaum, 2001b). One should nonetheless bear in mind that opposed to mouse DRG neuronal populations which are clearly segregated, there is a less clear distinction between peptidergic and nonpeptidergic nociceptor subclasses in rats and that neurochemical classification comparison among species is therefore limited (Price and Flores, 2007). More generally, target innervations and functions which afferents subserve should not be extrapolated for neurochemical identity characterization (Price and Flores, 2007). A δ fibres are more likely to be specialized in noxious stimuli detection, in primates and humans (Lawson, 2002). C-fibres project to laminae I and II of the spinal cord dorsal horn, with distinct projection

areas: peptidergic C fibres which innervate deep epidermis and various organs terminate in laminae I and dorsal part of lamina II, and nonpeptidergic C fibres, which innervate the epidermis, including the Mrgprd-expressing afferents, project to the mid-section of lamina II (Snider and McMahon, 1998; Braz et al., 2005). Mas related G protein receptor (Mrgprd) are a separate class of nonpeptidergic afferents, which are nociceptive C fibres innervating the skin. A selective ablation of these fibres leads to selective loss of noxious mechanosensation (Liu et al., 2007; Seal et al., 2009).

The heterogeneity of primary afferents reflects the complexity of somatosensory information and processing resulting in integrated signals which enable vertebrates to sense stimuli of specific modalities arising from precise locations and react to the environmental stimuli. Contrary to findings in rats, there is genetic evidence of a segregation of unmyelinated primary sensory fibers mediating responses to thermal and mechanical painful stimuli in mice (Cavanaugh et al., 2009). Functional studies in animal models of gene inactivation have brought additional insight to the modality specific activity of primary afferents. Noteworthy, ablation of neurons which express Mrgprd in mice resulted in absence of mechanical pain alone, whilst heat and cold noxious sensations were intact (Cavanaugh et al., 2009). The same study reported that selective pharmacological inhibition of the central projections expressing TRPV1 induced deficient noxious heat sensation, with conserved cold and mechanical pain sensitivities. These studies show that specific neuronal subpopulations expressing distinct sets of receptor or ion channel substrates are involved in specific pain modality transduction.

Sensory specificity of the particular primary afferents is conferred by the unique combination of the ion channels and receptors the cell expresses, which is designed to respond only to distinct high threshold mechanical, thermal and chemical stimuli (Ramsey et al., 2006). Nociceptive primary afferents have been studied in particular, and have been described as bearing singular adaptive capacities. The plasticity of these components is revealed in the context of pathological pain as the result of specific mechanisms which we will describe further on (for review see Woolf and Ma, 2007; Reichling and Levine, 2009).

d) Dorsal root ganglia

Dorsal root ganglia are similar to small bulges in the dorsal root of peripheral nerves, situated in the neural foramina. This location protects the DRGs from trauma, but the cell bodies it contains remain accessible to

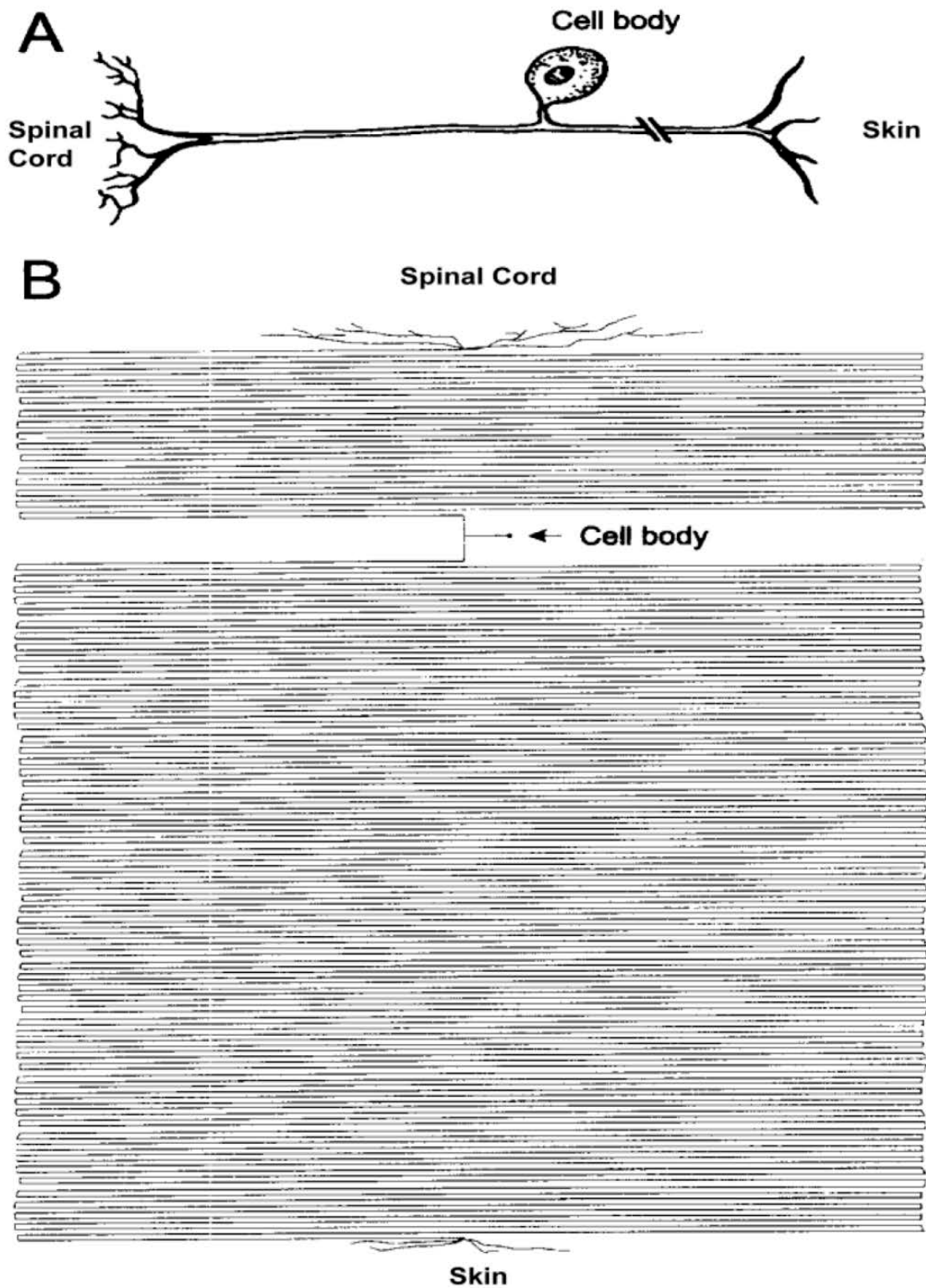

Figure 4: DRG neuron illustrations

A: Typical textbook representation of pseudounipolar DRG neurons showing the cell soma (cell body), the dorsal root axon branch (left) and the peripheral nerve axon branch (right).

B: Proportional drawing of the different cellular regions of a DRG neuron giving the perception of the geometrical relations among the cell soma, T-stem, dorsal root and peripheral nerve axons in a human primary afferent innervating skin of the foot.

(Adapted from Devor, 1999).

chemicals via the blood stream (see below). DRGs contain the cell bodies of the primary afferents which have been described above, and their protective satellite glial cells (SGCs), which outnumber DRG neurons by about 5:1, as two or three SGCs envelop a single DRG soma (Pannese et al., 2003; Krames, 2014; Ledda et al., 2004). The main role of the soma of primary sensory neurons is to provide trophic support to their axon. For a long time, DRGs were considered to be inert supportive tissue, however some evidence shows that the DRGs' contribution to detection of chemical milieu and modulation of afferent signal transduction are unrecognized and underestimated (Krames, 2014).

DRG neurons are pseudounipolar cells which distinguish themselves from other neurons by having no dendrites, only an axon. The T-junction structure ensures that the conduction of action potentials is not impeded by the capacitative load of the cell soma, which would slow the propagation of neural signals. There is a common misconception regarding the relative size of the DRG soma compared to the axon. Proportionally, the cell body of a DRG neuron represents 0.2% of the total cytoplasmic volume, meaning that in proportion, the metabolism and energy demands of the axon are substantial (see Figure 4). The specific molecules (ion channels and receptors) which enable detection of sensory stimuli and transduction are produced in the cell soma and are delivered via the axoplasmic transport, but therefore also expressed at the cell body membrane (for review see Devor, 1999).

The nervous system has unique protection structures which isolate the tissue from systemic circulation and the molecules carried in the blood. These barriers are formed by tight junctions between endothelial cells in blood capillaries irrigating the central nervous system (CNS) and an astrocyte lining which, together, ensure complete separation from the external environment. In the brain, there are some structures which are in direct contact with general circulation. These important chemosensory organs are situated in areas where the BBB is lacking; circumventricular organs, area postrema and median eminence. Peripheral afferent nerves are protected by the blood-nerve barrier (BNB). As opposed to the CNS and PNS, DRGs are not protected, neither by the BBB nor by the BNB of the peripheral nervous system. Assuming that this lack of protective barrier has a functional significance, it has been proposed that DRG cell bodies may have specific sensory roles in the detection of circulating homeostatic signals, given that this structural particularity exposes DRG cell bodies to substances in

the blood or in the intrathecal space (for reviews, see Krames, 2014, 2015) and leucocytes can penetrate the tissue easily (Hu and McLachlan, 2002). DRG neuron cell bodies also express a wide variety of receptors (cytokine receptors, purinergic receptors, opioid receptors, for example) which therefore suggests sensitivity to ligands (Gadient and Otten, 1996; Kobayashi et al., 2013; Scherrer et al., 2009).

DRG somata are excitable cells, capable of receiving subthreshold-depolarization which enable the cell to monitor activity and adjust metabolic supplies to the axon. DRG neuron cell bodies express receptors which enable cross-talk among DRG cells, and there is evidence of cross-depolarization within DRG cell populations which supports that they are functionally linked via their glial network (for review see Devor, 1999). Satellite glial cells (SGCs) wrap the DRG cell bodies and create an envelope around them, separating neurons from one another. SGCs express cytokine receptors and purinergic receptors, they participate in modulation of DRG neuron activity and signal transmission (Hanani, 2005). Central glial cells, astrocytes, and SGCs are involved in maintenance of pathological pain conditions (Pannese et al., 2003; Old et al., 2015). By releasing pro-inflammatory mediators within the DRG in response to injury, SGCs contribute to decreased threshold of primary afferents and the resultant hypersensitivity (for review see Krames, 2014).

The DRG is therefore a unique nervous system component, which has attracted attention as a target for pain therapies given its specificities and involvement on the setting of pathological pain (Krames, 2014, 2015).

e) Central pathways

(1) Spinal circuits

(i) Primary afferent projection patterns

The dorsal horn (DH) of the spinal cord receives, processes and transmits sensory information which arrives from the periphery via primary afferents, and thereby represents a first step of central processing and integration of somatosensory information. The sensory inputs undergo modulation and transmission via a complex circuit within the DH of the spinal cord which comprise excitatory and inhibitory interneuron influences, and supraspinal modulation. Here, we will focus mainly on the network within superficial laminae, as these are crucial in nociceptive transmission. However, involvement of deeper laminae in nociceptive processing has

been shown and the modulation of nociceptive messages is undoubtedly complex (Petitjean et al., 2014, 2012; Seibt and Schlichter, 2015). We will briefly present the organization of primary afferent projection patterns, the cellular components which compose the networks in the DH of the spinal cord, with specific attention to how these circuits handle/govern nociceptive inputs and how they may contribute to pathological pain conditions (Todd, 2010).

The main input to the spinal circuits originates in the periphery, transmitted by primary afferents. The DH of the spinal cord also receives descending inputs which comprise excitatory and inhibitory control pathways. The DH has been described in a laminar organization (parallel layers of neurons) with anatomical borders determined according to histological changes (density of neurons and cell size). All primary afferents are excitatory, and release glutamate (main excitatory amino-acid transmitter in the nervous system). In the DH, most nonpeptidergic C fibres and A δ fibres form axodendritic synapses on their targets, and receive some axoaxonic inputs from other primary afferents. Central terminals of A β fibres and A δ nociceptors have fewer axoaxonic inputs, and also form axodendritic synapses in the DH. Peptidergic afferents have almost no axoaxonic inputs, and are presynaptic to axodendritic inputs (Ribeiro-da-Silva and Coimbra, 1982; Ribeiro-da-Silva et al., 1989).

Primary afferent projection patterns terminating in the DH are organized according to the sensory information modality which is transmitted, their functional properties and somatotopy. A β tactile and hair afferents project to lamina III–IV, with some collaterals ending in internal lamina II (Ii). A δ fibres, which innervate hair follicles, have central projections which spread at the boundary between laminae II and III, whereas A δ nociceptors project to lamina I, with some collaterals to laminae V and X. Peptidergic primary afferents (some of which are A δ nociceptors) project to lamina I and the outer (dorsal) part of lamina II, with occasional deeper projections. The majority of non-peptidergic C fibres terminate in the centre area of lamina II (see Figure 5).

Laminae I and II receive mainly thermal and mechanical noxious inputs, lamina Ii receives low threshold mechanical stimuli and lamina I also receives input from C afferents specialized in the detection of cooling thermal information (Todd, 2010). In summary, nociceptive afferents (A δ and C fibres) project mainly to the superficial layers, laminae I and II, and they send collateral projections to deeper laminae (V, VI, VII and X) (Gauriau and Bernard, 2002). Tactile afferents, A β fibres, target the intermediate layers of the dorsal horn of the

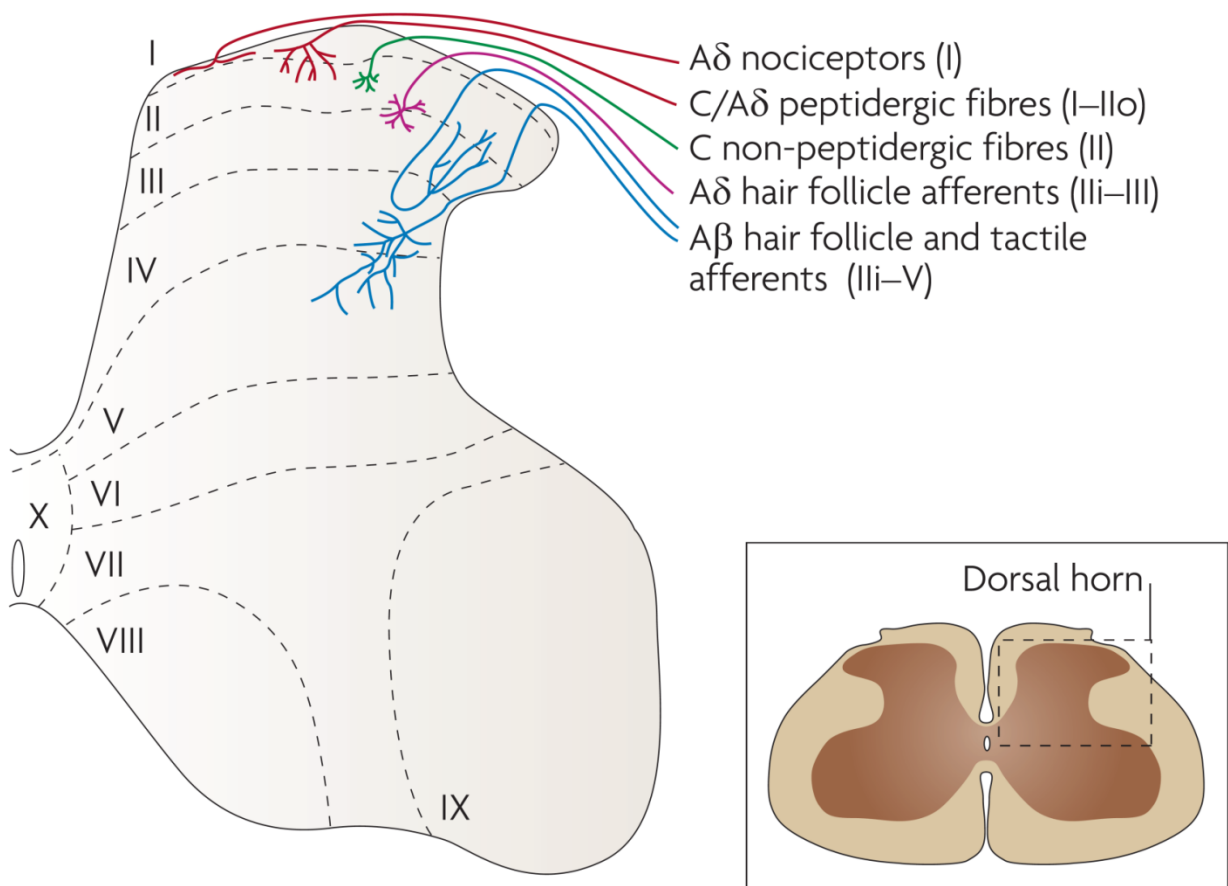

Figure 5: Primary afferent projection patterns in the spinal cord dorsal horn.

Primary afferents arborize within the dorsal horn in an orderly way: a laminar termination pattern based on fibre diameter and function is superimposed on a somatic distribution that determines mediolateral and rostrocaudal location. The central terminals of the major primary afferent types (except proprioceptors) are represented. A β tactile and hair afferents end mainly in lamina III-V, with some extension into lamina Iii. A δ hair follicles afferents arborize on either side of the border between lamina II and lamina III, whereas A δ nociceptors end mainly in lamina I, with some giving branches to lamina V and lamina X. More recent studies have identified myelinated nociceptors with conduction velocities in the same range as that of A β bfibres that arborize throughout lamina I and lamina Iio, with some fibres penetrating more deeply whereas most non-peptidergic C fibres form a band that occupies the central part of lamina II.

Adapted from Todd, 2010.

spinal cord; they terminate in laminae III to VI and also send collateral projections to the deeper laminae. These deeper laminae receive innocuous and nociceptive information, and have activities which cover wider dynamic ranges than spinal neurons from superficial layers (which receive precise modality and intensity stimuli from restricted localizations in the periphery). Thus, anatomy of the dorsal horn of the spinal cord reflects functional organization (for review, see Gauriau and Bernard, 2002 and references therein).

(ii) *Spinal cord interneurons*

Interneurons in the DH of the spinal cord arborize within the spinal cord grey matter, and represent almost all of the neurons from lamina II as well as most of the cells in laminae I and III, pointing to their importance in sensory information processing. Interneurons are excitatory (glutamatergic) or inhibitory (GABAergic and/or glycinergic). Sparse cholinergic GABAergic neurons in the DH also modulate excitatory inputs from nociceptors (which express muscarinic Acetylcholine receptors mAChR) (Mesnage et al., 2011). Inhibitory interneurons represent 25, 30 and 40% of interneurons in laminae I, II and III, respectively. Glycinergic interneurons are often also GABAergic, meaning that both inhibitory neurotransmitters are co-released by these cells; however purely glycinergic interneurons are also present (Prescott, 2015).

Lamina II interneurons have been the most investigated, and can be classified into four main types according to their dendritic arborization, and each category represents a functional subpopulation (see figure X) (Yasaka et al., 2010). There are lamina II islet cells (which are always GABAergic), central interneurons (which can be either excitatory or inhibitory), vertical and radial interneurons which are mostly glutamatergic. Lamina I interneurons are more difficult to study, given that projection neurons are also present in this lamina. Interneurons in this lamina are also classified with respects to their morphology: there are pyramidal, fusiform and multipolar interneurons. There is evidence of a relationship between interneuron morphology and their functional category (for review see Todd, 2010) (see Figure 6).

Immunohistochemical classifications of DH interneurons have been described, with some markers which are specific to excitatory or inhibitory interneurons, and other markers which are not restricted to a distinct category (dynorphin and enkephalin). Glutamatergic interneurons (which are identified by the presence of vesicular glutamate transporters VGLUT) express calcium-binding proteins calretinin and calbindin, and sometimes

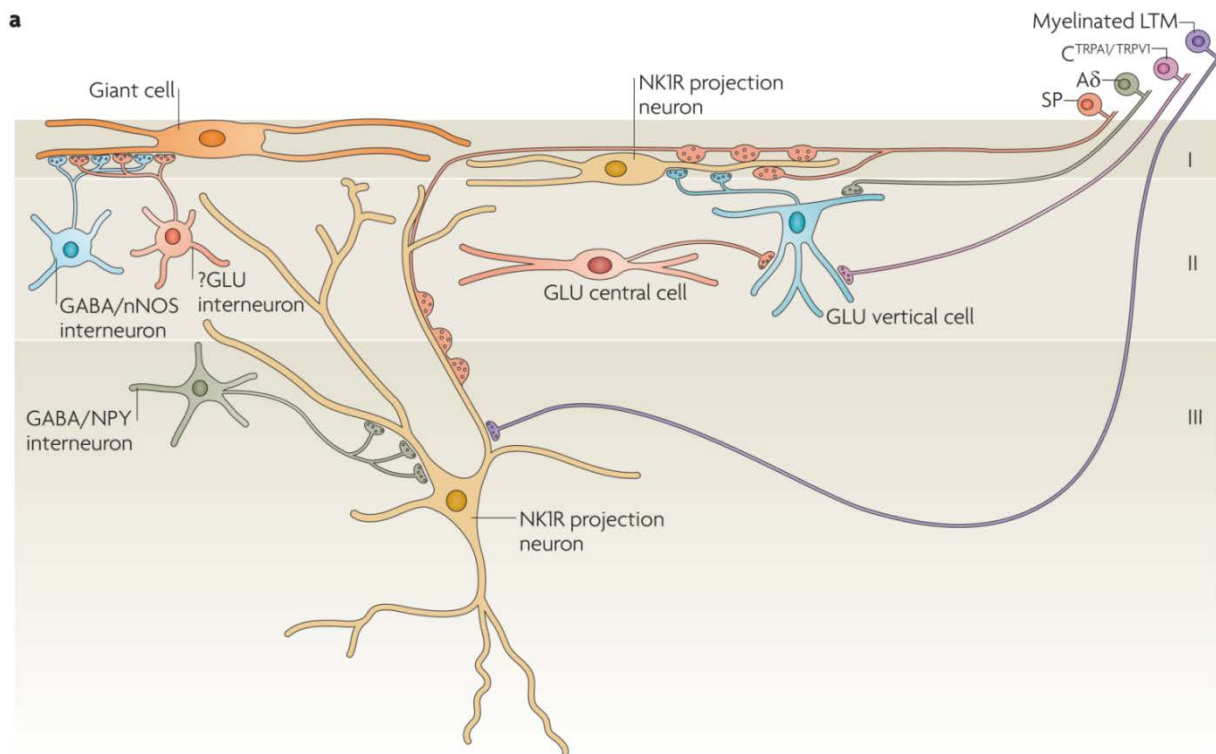

Figure 6: Neuronal circuits involving projection neurons in the spinal cord

a A diagram showing some of the synaptic circuits identified in laminae I-III. Three types of projection neurons are shown : a neurokinin I receptor (NKR1)-expressing cell in lamina I, an NKR1+ cell in lamina II and a giant lamina I neuron. Both types of NKR1+ projection neurons are densely innervated by Substance P-containing primary afferents (SP), and the lamina III neurons also have an input from myelinated low threshold mechanoreceptors (LTM afferents). The lamina III NKR1 cells receive a substantial input from GABAergic interneurons that contain Neuropeptide Y (GABA/NPY), whereas inhibitory interneurons that contain neuronal nitric oxide synthetase (GABA/nNOS interneuron) innervate the giant lamina I cells. These cells receive a high density of synapses from vesicular glutamate transporter 2-containing boutons derived from unknown populations of glutamatergic interneurons. NKR1-expressing lamina I projection neurons also receive input from glutamatergic vertical cell which are innervated by glutamatergic central cells. The primary afferents that synapse onto vertical cells includes A δ fibres as well as C fibres that express both TRPA1 receptor and TRPV1.

Adapted from Todd, 2010.

somatostatin, neurotensin, Substance P or Neurokinin B (Antal et al., 1991; Todd, 2010). GABAergic and glycinergic interneurons (which express vesicular GABA transporters VGAT, glutamate decarboxylase GAD or glycine transporters GLYT) can also be identified using parvalbumin, neuropeptide Y (NPY), galanin or neuronal nitric oxide synthase nNOS markers (Todd and Spike, 1993; Polgár et al., 2006; reviewed in Todd, 2010).

(iii) *Neuroanatomical organization of projection neurons*

Lamina I contains a moderate population of projection neurons, and so do laminae III-V. Lamina II contains relatively few projection neurons. Projection neurons receive either direct or polysynaptic sensory inputs from primary afferent neurons, and exit the DH of the spinal cord to transmit the processed information to supraspinal integration centres; their axons cross the midline of the spinal cord and ascend via contralateral fasciculi, projecting to brain areas (brainstem and or thalamic nuclei).

The majority of lamina I projections transmit nociceptive information, as opposed to rarer projections conveying innocuous cooling or cold sensory information. These fibres terminate in multiple brain areas; most individual fibres project to several central targets in the brain. Lamina I projection neurons are found in the caudal ventrolateral medulla, the nucleus of the solitary tract, the lateral parabrachial area, the periaqueducal grey matter and thalamic nuclei (Almarestani et al., 2007; Villanueva et al., 1995; Gauriau and Bernard, 2004). There are relatively few spinothalamic lamina I projection neurons; as this tract transmits the purely sensory information, compared to spinoparabrachial projections. Lamina I projections are involved in sensory discriminative, motivational and emotional or autonomous components of the pain experience. Classification of lamina I projection neurons according to morphology or neurochemical features can be correlated with functional roles, and there are consistent observations which identify distinct subpopulations (Han et al., 1998; Bester et al., 2000). 80% of lamina I projection neurons are NK1R-positive, which is restricted to nociceptive fibres and they therefore respond to SP. NK1R-negative cells that are present in lower proportions, are generally giant cells which receive very dense inhibitory and excitatory inputs and are not specific to noxious stimuli transmission.

In lamina III, projection neurons which are NK1R-positive have dendritic trees extending into lamina I, and project to brain areas which are more restricted than lamina I transmission patterns.

Neuronal circuits in laminae I-III are complex and intermingled. Most DH spinal cord neurons receive primary afferent sensory input and modulatory influences from both inhibitory and excitatory interneurons. The specific type and relative contributions of each input defines separate subpopulations of spinal cord neurons.

Projection neurons can receive direct synaptic input from the sensory afferents, despite the fact that interneurons are the main target of primary afferents. NK1R-positive projection neurons from both laminae I and III are strongly innervated by SP-containing afferents (Naim et al., 1997; Todd et al., 2002). Lamina III projection neurons have arborizations throughout the DH, and are not contacted by IB4-binding afferent fibres. These neurons have wide receptive fields, with wide dynamic ranges of stimuli input, and receive numerous synaptic influences from local inhibitory interneurons within laminae II and III.

Lamina I interneurons receive substantial A β nociceptive input. Interneurons in the DH receive strong input from primary afferents especially lamina II. In this lamina, islet and central cells are innervated almost exclusively by sensory terminals of C fibres. Vertical and radial interneurons from lamina II receive monosynaptic or direct sensory information from TRPV1- and TRPA1-expressing C fibres, as well as A δ afferents. Low threshold mechanoreceptive myelinated afferents (A β fibres) project onto excitatory PKC γ -expressing interneurons, which are situated in the ventral (inner) layer of lamina II (Ili) or lamina III (Uta et al., 2010).

Upon entering the DH, primary afferents receive axoaxonic synapses, which are commonly GABAergic and/or glycinergic, which mediate presynaptic inhibition of primary afferent transmission (Todd, 1996; Watson et al., 2002). This inhibitory input is likely to be provided by a specific subpopulation of GABAergic interneurons from the DH. Thus, sensory information can be modulated either by local circuits, or descending monoaminergic projections (see further on).

In summary, spinal circuits are a crucial point of sensory processing and transmission, with several levels of complementary modulating influences which encode specific modality and localization to the supraspinal

targets. Sensory inputs undergo complex multisynaptic modulation before reaching projection neurons for sensory transmission. The spinal circuits are interesting therapeutic targets in pain management, provided precise targeting can be defined, and offer the opportunity of harnessing pathological pain transmission (Todd, 2010).

(iv) *Local circuitry modifications in pain conditions*

In normal physiological conditions, innocuous touch and pain are processed in segregated pathways, ensuring that sensory processing is uncorrupted, although this does not exclude that there may be connections or communicating circuits between them in the spinal cord. In pathological pain conditions, hyperalgesia (exaggerated response to painful stimuli), allodynia (pain response following non-noxious stimulation) and spontaneous pain arise following peripheral and/or central circuit component rearrangements resulting in abnormal pain processing (see sections Peripheral Sensitization Mechanisms and Central Sensitization, for review see von Hehn et al., 2012). There is evidence of spinal circuit changes which underlie pathological pain processing. These mechanisms include reduction of inhibitory modulation of sensory transmission or disinhibition, long term potentiation in DH neuronal populations facilitating pain transmission, changes in DH neuronal excitability or plasticity, and modifications occurring at the level of primary afferent excitability (Todd, 2010).

Recently, research has provided cellular and network clues which strongly support that there are existing connections between the two pathways in normal physiological conditions, implying that allodynia can be pharmacologically evoked in healthy individuals by disrupting endogenous inhibitory influences acting on sensory processing (Torsney and MacDermott, 2006), and that locally enhancing GABAergic and/or glycinergic transmission can reverse nerve-injury-induced allodynia (Bráz et al., 2012). This is also in favour of long-standing gate-control theorems (Prescott, 2015), but the actual structural depiction of the circuits was lacking; two recent studies aimed to discover them.

The majority of A β primary afferents project to lamina III, however lamina II excitatory interneuron expressing somatostatin receive A β fibre inputs, and these interneurons are connected to lamina I projection neurons which transmit nociceptive information. These excitatory somatostatin-positive interneurons are under strong

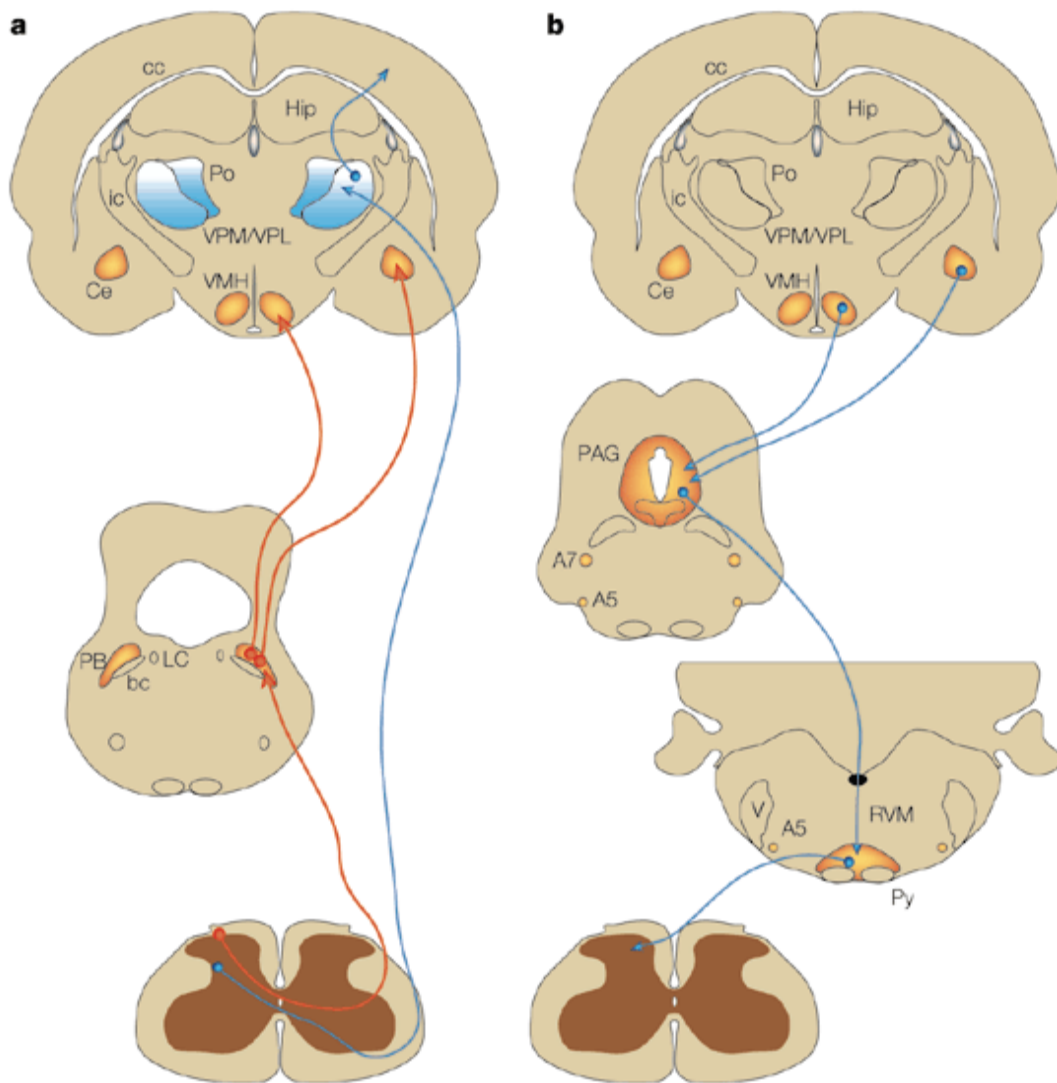

Figure 7: Simplified Schematic Organization of Central Nociceptive Projections

A There are two primary ascending nociceptive pathways. The spinoparabrachial pathway (red), which originates from the superficial dorsal horn and projects to areas of the brain dealing with affect, and the spinothalamic pathway (blue), which probably distributes nociceptive information to areas of the cortex that process both discrimination and affect.

B The descending pathway highlighted originates from the amygdala and hypothalamus and terminates in the periaqueductal grey (PAG). Neurons project from the PAG to the lower brainstem and control many of the antinociceptive and autonomic responses that follow noxious stimulation.

(A, adrenergic nucleus; bc, brachium conjunctivum; cc, corpus callosum; Ce, central nucleus of the amygdala; Hip, hippocampus; ic, internal capsule; LC, locus coeruleus; PB, parabrachial area; Po, posterior group of thalamic nuclei; Py, pyramidal tract; RVM, rostromedial ventral medulla; V, ventricle; VMH, ventral medial nucleus of the hypothalamus; VPL, ventral posterolateral nucleus of the thalamus; VPM; ventral posteromedial nucleus of the thalamus.)

Adapted from (Hunt and Mantyh, 2001)

inhibitory control by dynorphin-expressing inhibitory neurons in lamina II, which monitor the excitatory interneurons' activity via reciprocal projections and also receive A β fibre input. Thus, the modulation precludes transmission of pain in response to innocuous touch (Duan et al., 2014). Following the observation that VGLUT3 knock-out animals presented impaired mechanical allodynia and reduced mechanical pain detection (Seal et al., 2009), genetic approaches were implemented to specifically delete the VGLUT3 transporter in restricted tissues, and demonstrated that the lamina III neurons receiving direct A β fibre input are glutamatergic VGLUT3-expressing cells are the crucial to the development of mechanical allodynia following innocuous touch stimulation in both inflammatory and neuropathic pain models, whilst retaining normal thermal sensory transmission. The study also demonstrated that these VGLUT3-expressing excitatory interneurons are under strong inhibitory control, and project to calretinin interneurons in the allodynia-evoking network of the DH (Peirs et al., 2015).

These mechanisms are one of the supposed mechanisms involved in the development of pathological pain conditions, and as more light is shed on central circuits mediating allodynia, there is hope to discover and probe new targets for therapeutic management of chronic pain.

(2) Ascending projections and roles of central circuits

After processing, nociceptive information is transmitted to reticular, limbic, thalamic and cortical structures which integrate and analyze the nociceptive message. As mentioned earlier, pain perception generates attention, aversion, and motivated behaviours which aim to make pain cease. The sensory and emotional responses are generated by the recruitment of specific brain areas, and we will briefly describe the circuits through which the specific integrated outcomes are produced (see Figures 7 to 9).

Deep laminae receiving converging nociceptive inputs tactile inputs via A β afferent fibres mainly send the projections to caudal reticular nuclei, and, for a modest part, also project to the thalamus. Lamina V projection neurons terminate in three reticular structures, which include the lateral Reticular Nucleus (involved in motor aspects of pain reactions), the Subnucleus Reticularis Dorsalis (SRD), and Gigantocellular lateral paragigantocellular nucleus (NGc) (Villanueva et al., 1995; Raboisson et al., 1996), and to Parabrachial nucleus (PB); which all project to the Thalamus. The thalamic pathways terminate in medial thalamus which projects to

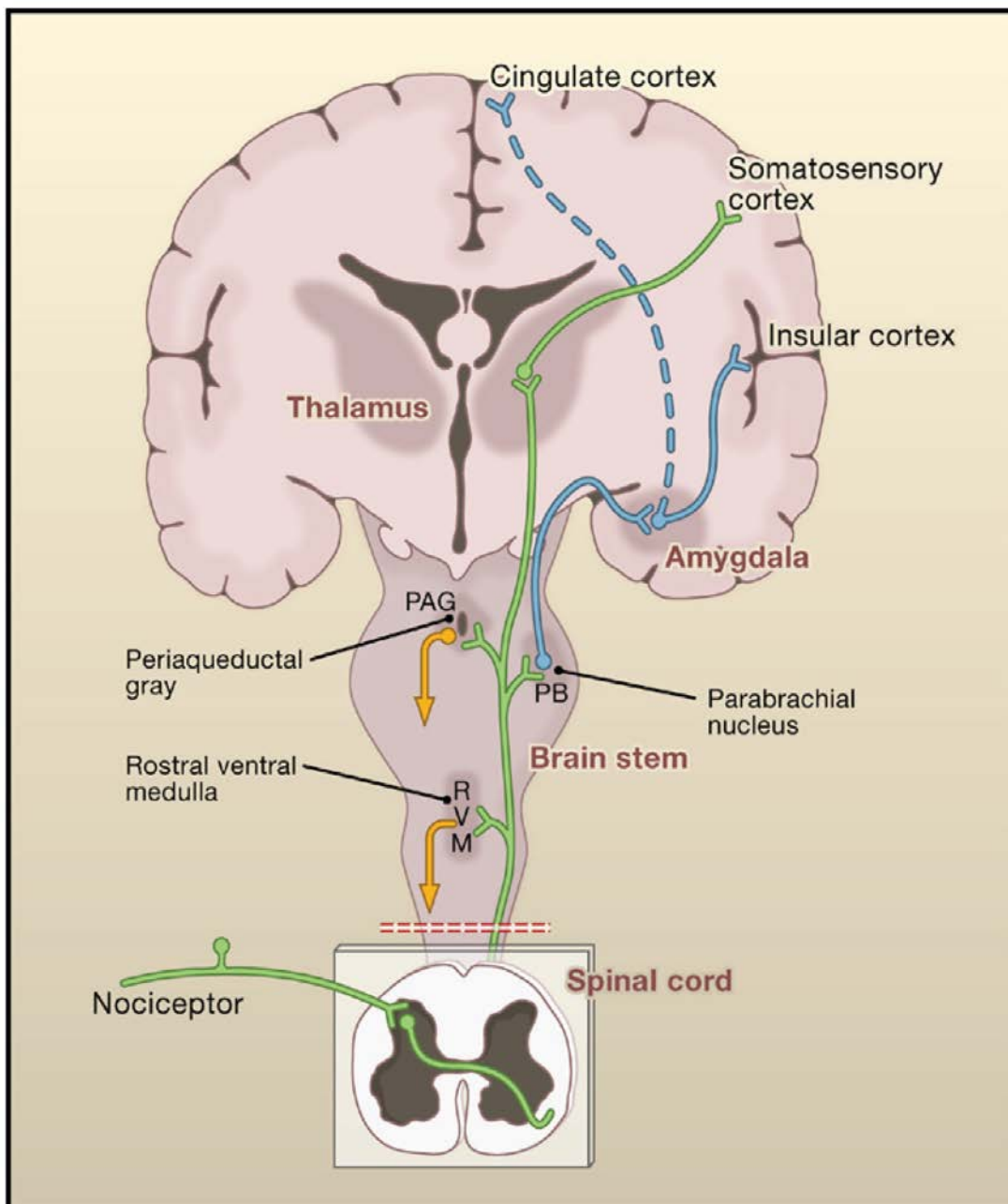

Figure 8: Anatomy of the Pain Pathways

Primary afferent nociceptors convey noxious information to projection neurons within the dorsal horn of the spinal cord. A subset of these projection neurons transmits information to the somatosensory cortex via the thalamus, providing information about the location and intensity of the painful stimulus. Other projection neurons engage the cingulate and insular cortices via connections in the brainstem (parabrachial nucleus) and amygdala, contributing to the affective components of the pain experience. This ascending information also accesses neurons of the rostral ventral medulla and the midbrain periaqueductal gray to engage descending feedback systems that regulate the output from the spinal cord.

Adapted from Basbaum, 2009.

cortico-striatal areas which are responsible for attention and motivation, enabling general arousal of the prefrontal cortical areas. The motor reticular areas are involved in the motor reaction to pain, and the SRD projects back to nociceptive areas to provide modulation (Gauriau and Bernard, 2002).

The superficial laminae, as mentioned earlier, receive monosynaptic A δ and C fibre input, conveying nociception as well as innocuous heat sensation, emanating from restricted receptive fields and therefore providing information about precise localization of the various stimuli (Bester et al., 2000). The projections from lamina I ascend via the contralateral lateral funiculus, forming two strong projections (Spinothalamic and Spinoparabrachial pathways), that terminate in the Ventral Thalamus (Ventral Posterolateral nucleus VPL, Triangular Posterior nucleus PoT and the Posterior nuclear group Po of the Thalamus) and in the Lateral Parabrachial area (LPb) responsible for sensori-discriminative aspects of pain and autonomous and emotional responses.

The thalamic targets receive tactile input, and project directly to the Primary and Secondary Somatosensory Cortices; the tactile and nociceptive information processed by the Thalamic nuclei and sent to the Primary Somatosensory cortex are involved in the sensory-discriminative aspects of nociceptive integration. The Po and PoT send sensory information to the Secondary Sensory, insular and perirhinal cortices, enabling a specific recognition of nociceptive and thermal characteristics of thermal sensation. The medial Thalamus projects to the insular and cingulate cortices, and are responsible for the cognitive and affective aspects of the pain experience, by initiating aversion and negative emotional states (Bushnell et al., 2013) (See Figure 9).

Lamina I projections to the Lateral Parabrachial area are then relayed to the forebrain; namely the central Extended Amygdala, to the medial Thalamus, the Hypothalamus, and also to the Brainstem, i.e. the Periaqueducal Gray Matter (PAG) and the Ventrolateral Medulla (VLM). The forebrain areas which receive input following lamina I input to the PB area are likely to be responsible for characteristic aversive emotions associated with pain, and anxiety, fear and avoidance behaviours (Extended Amygdala), and defensive aggressive behaviours or rage (Hypothalamus, which projects to the PAG). Thus, following nociceptive stimulation, this circuit generates intense aggression and flight/escape behaviours. The Brainstem areas which

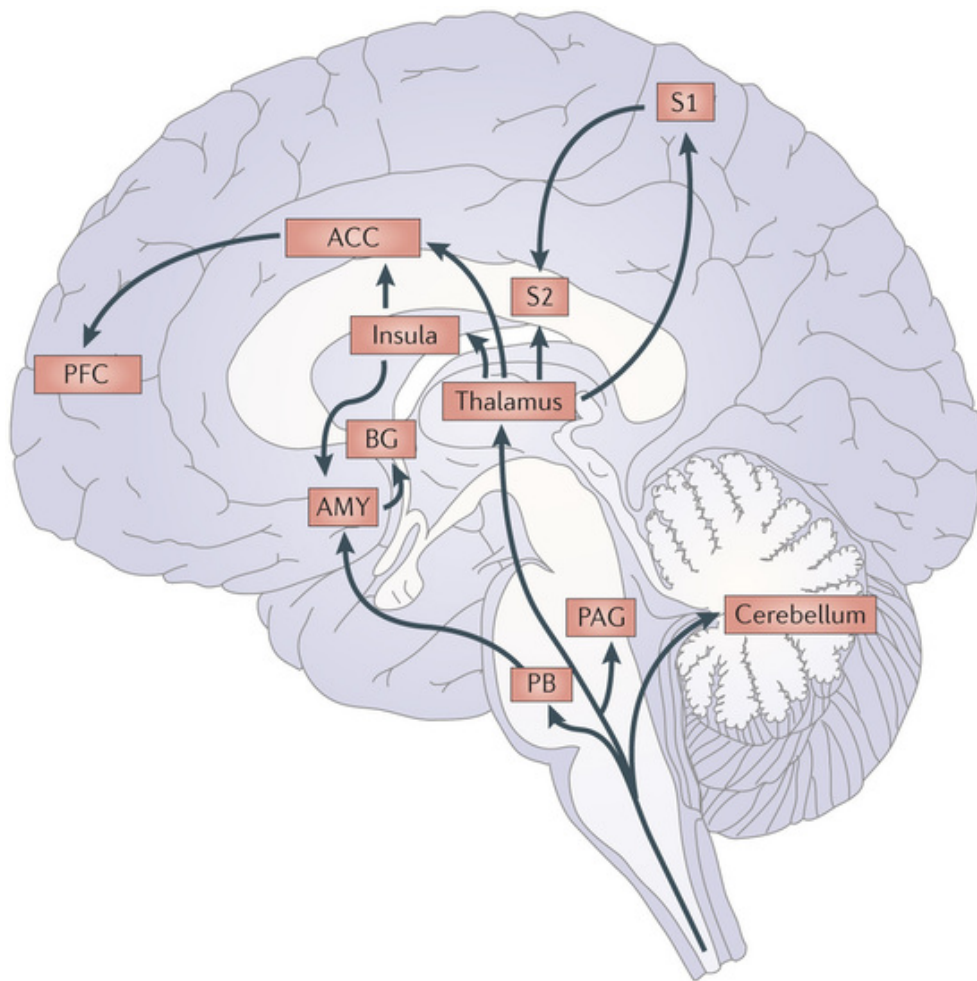

Figure 9: Central pain processing

Afferent nociceptive information enters the brain from the spinal cord. Afferent spinal pathways include the spinothalamic, spinoparabrachio-amygdaloid and spinoreticulo-thalamic pathways. Nociceptive information from the thalamus is projected to the insula, anterior cingulate cortex (ACC), primary somatosensory cortex (S1) and secondary somatosensory cortex (S2), whereas information from the amygdala (AMY) is projected to the basal ganglia (BG). See the main text for references. PAG, periaqueductal grey; PB, parabrachial nucleus; PFC, prefrontal cortex
 From (Bushnell et al., 2013).

the Parabrachial circuit recruits following lamina I input are involved in emotional (PAG) and autonomous alertness (VLM). The ventral PAG mediates passive emotional coping, and the lateral PAG mediates acute analgesia and recruits areas involved in preparing the individual for either confrontation or escape behaviours. The PAG sends opioidergic projections to the Rostral Ventral Medulla (RVM) which projects to the spinal cord to modulate pain transmission and also computes aversive components of the pain experience. The PAG receives converging projections emanating from lamina I (direct projection or via PB areas), is involved in triggering adequate behaviours by integrating the different nociceptive and pain sensations, and is therefore important regarding decisions between passive and active coping strategies, and emotionally coping with danger. The VLM activity following nociceptive inputs via the spinoparabrachial circuit induces cardiorespiratory changes and projects to the hypothalamus in order to coordinate the energy metabolism and endocrine components which may be required in the face of the ongoing noxious or dangerous situation encountered by the individual. This circuit ensures the practical aspects and prepares the individual to physically cope with danger.

Superficial laminae also project via other Spinoreticular projections (Craig, 1991; Zhang et al., 2000; reviewed in Gauriau and Bernard, 2002). The projections from lamina I target the deep lamina of the Superior Colliculus which is involved in orientation, and the Caudal NTS which regulates autonomous functions (the NTS also receives information from the hypothalamus). Thus, the spinothalamic projections from lamina I are a specialization of tactile sensation pathways, which are probably involved in the pain sensation related to interoception, responsible for the processing of modality and localization aspects of noxious stimuli (reviewed in Gauriau and Bernard, 2002).

Overall, the supraspinal structures which are recruited may be essential not only essential for the discriminative aspects of pain, but also for both emotional behaviours and autonomous homeostatic coping with threats to the individual's integrity (reviewed in Gauriau and Bernard, 2002).

(3) Descending controls

The DH of the spinal cord is under the influence of descending control from supraspinal structures, the role of these influences is to mitigate the transmission of excitatory nociceptive inputs and provide endogenous pain control. Several neurotransmitter systems are involved.

The brainstem modulating system includes the midline PAG-RVM system, the dorsal reticular nucleus (DRt, which is more lateral and caudal), and the caudal ventral lateral medulla (cVLM). PAG-RVM descending inhibitory influences are activated by opioids and cannabinoids, however PAG neurons do not directly project to the spinal cord, but densely innervate RVM neurons, and these neurons project to the DH of the spinal cord via the dorsolateral funiculus. DRt projections may terminate in lamina I, and are pro-nociceptive excitatory projections. The cVLM is the main endogenous pain inhibition component, and produces intense analgesia via descending projections which terminate in laminae I, IV, V and X, involving release of noradrenalin (for review Boadas-Vaello et al., 2016).

In the spinal cord, incoming monoaminergic projections include serotonergic projections from the Nucleus Raphe Magnus, and noradrenergic (NA) projections from the locus coeruleus. Both projection types have diffuse innervation patterns in the spinal cord, and mostly exert their modulatory action via non-synaptic neuromodulator release, otherwise known as volume transmission (Zoli et al., 1999). The role of NA on nociceptive transmission in lamina II of the DH has been described, as this lamina almost exclusively receives inputs from nociceptive A δ and C fibres (Bráz and Basbaum, 2009). Most DH neurons express α 2-ARs, and are inhibited by NA whereas some inhibitory DH interneurons are depolarized by NA via α 1-AR activity (Gassner et al., 2009). At central terminals of A δ nociceptive primary afferents, NA activates α 2-ARs, and decreases glutamatergic transmission (Kawasaki et al., 2003). GABAergic inhibitory projections from the Rostral Ventromedial Medulla synapse on lamina II interneurons (Kato et al., 2006) and dampen activity of these cells.

2. Inflammatory pain

Inflammation is characterized by characteristic features: pain, heat, swelling, redness and loss of function of the injured area of the body. Inflammation involves plasma, protein and immune cell extravasation in response to infection, irritation or trauma (Kidd and Urban, 2001; Marchand et al., 2005). Tissue inflammation aims to limit

the damage, contain infection, clear pathogens and debris, and facilitate wound healing (which is helped by immobility or decreased use of the inflamed limb or tissue), however in conditions such as rheumatoid arthritis, inflammation no longer serves physiological purpose and chronic inflammatory pain ensues. We will briefly describe the mechanisms which underlie the development of inflammation-induced hypersensitivity to pain.

Following injury to somatic tissue, damaged cells and blood vessels release proinflammatory mediators (cytokines) which recruit and activate immune cells, such as circulating macrophages. These cells invade the site of injury, add their own proinflammatory mediators to the extracellular milieu, and immune cells accumulate at the site of injury. Thus, mast cell degranulation, production of enzymes (cyclooxygenase II, serine proteases) and secretion of proinflammatory mediators by both somatic tissue and immune actors maintain high concentrations of cytokines, chemokines, kinins (Bradykinin), amines (serotonin, histamine), prostanoids, growth factors, ATP and protons at the site of injury. Nociceptive termini and axons exposed to the “inflammatory soup” are sensitized by these mediators (Basbaum et al., 2009), as it has been shown that inflammation destroys the perineural barrier (Stein and Machelska, 2011; Rittner et al., 2009) see Figure. Peripheral sensitization comprises several activation mechanisms of which direct activation of ion channels or secondary messenger mechanisms following metabotropic receptor activation (Basbaum et al., 2009). For example, TRPV1 channels are directly activated in acidic conditions following inflammation (Mickle et al., 2015), leading to nociceptive activity of primary afferents. Nociceptor transduction pathways can be activated by protease-activated GPCR; and/or tumor necrosis factor TNF α , nerve growth factor NGF, Bradykinin and ATP which bind to their respective receptors at nociceptive termini. These mediators initiate intracellular transduction pathways which include several kinases: PKC (Hucho et al., 2005), PKA (Varga 2006), PI3K (Malik-Hall et al., 2005), and ERK and p38 MAPK (Jin and Gereau, 2006). As a result, kinase activity increases and therefore phosphorylation of their substrates, mainly TRPV1 and sodium channels, also increases, establishing heightened sensitivity to nociceptive stimuli. Actors of peripheral sensitization include TRPV1, TRPA1 (Zhang et al., 2005; Caterina et al., 2000; Bautista et al., 2006; Kwan et al., 2006), sodium channels Nav 1.7, Nav 1.8 and Nav 1.9 (Nassar et al., 2004, 2005, 2006; reviewed in Woolf and Ma, 2007). In addition, peripheral inflammation can induce transcriptional changes via transduction of extracellular signals to the soma

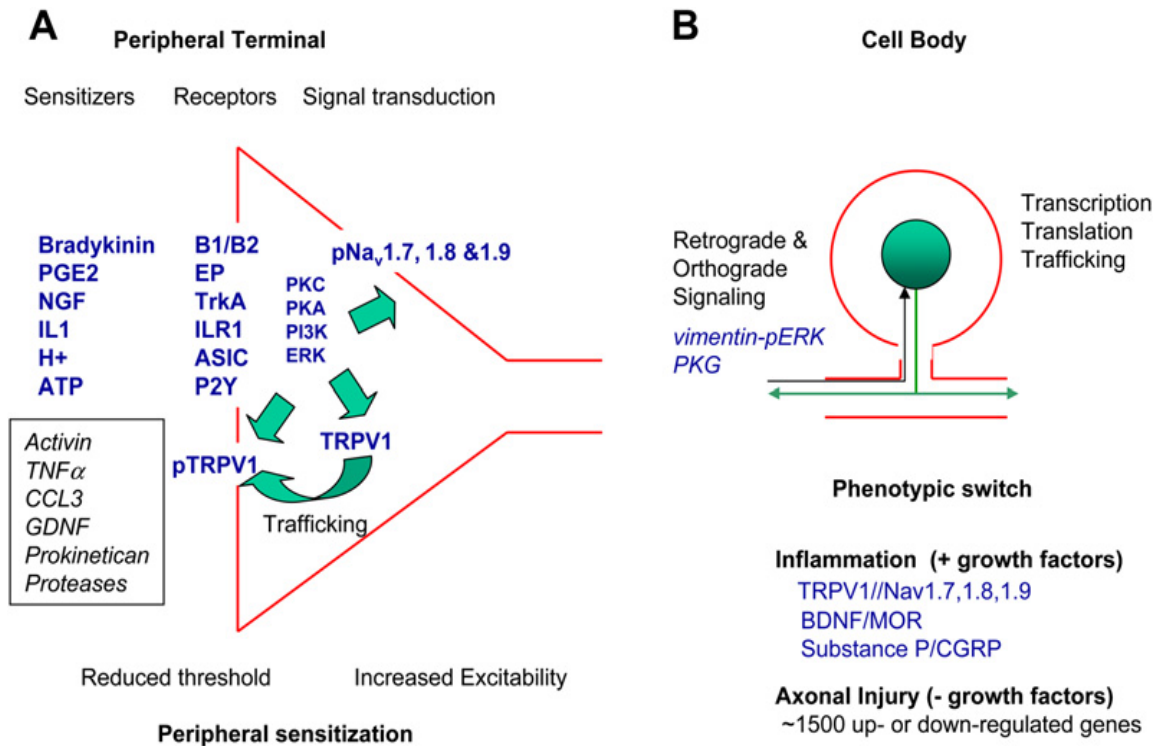

Figure 10: Nociceptor Plasticity

(A) Peripheral sensitization involves a lowering of the threshold of the nociceptor in response to inflammatory sensitizers that activate, via diverse signal transduction pathways in the peripheral terminal, alterations in the trafficking and properties of transducer and sodium channels, largely as a result of phosphorylation.

(B) Phenotypic switches occur in nociceptors in response to inflammation and axonal injury by virtue of exposure to retrogradely transported signal molecules or absence of target derived signals.

Adapted from Woolf 2009

of primary afferents. This phenotypic switch leads to increased expression of TRP and voltage-gated sodium channels, increasing pain transduction (Ji et al., 2002; Mannion et al., 1999), but also increased expression of mu opioid receptors, thereby enhancing the sensitivity to opioids (Puehler et al., 2004). The changes in neurochemical expression and functional properties of primary afferents caused by transcription alterations of receptors and channels lead to continuous nociceptive input transmission to central processing areas (Latremoliere and Woolf, 2009), which paves the way to central sensitization by persistent activation of AMPA and NMDA receptors and pain “memory” (Price and Inyang, 2015) (see Figures 10 and 11).

Following stimulation of intracellular pathways by the various proinflammatory ligands, nociceptors acquire reduced activation thresholds leading them to depolarize in response to stimuli of lower intensities and subsequently release SP, CGRP (vasodilators) and glutamate (excitatory neurotransmitter) generating increased pain transmission and hypersensitivity. Primary sensory nociceptive fibres undergo short-lived inflammation-induced functional plasticity, which is essential for recovery from injury (Woolf and Ma, 2007). In normal conditions, injuries are resorbed, physiological properties of nociceptors are restored to their initial state and tissue repair is complete following the anti-inflammatory processes (Ninković and Roy, 2013).

3. Visceral pain

As opposed to somatic tissue, viscera do not evoke conscious innocuous sensations, and the only perceived painful sensations are related to lethal danger (for example heart attacks). Hollow internal organs can be considered as the continuation of the interface between the exterior environments. However in the event of noxious stimulation of mucosa, the individual cannot escape from the potential threat. Instead most vertebrates have acquired protection mechanisms involving emesis reflex, immobilization and reduced appetite in order to cope with intestinal pain for example. Here, we will focus on visceral pain associated with the digestive tract, briefly overview the characteristics of visceral pain sensation, as opposed to somatic nociception, and the circuit modifications resulting from chronic inflammation.

Visceral pain emanating from hollow viscera (bladder or intestines for example) is more common than solid organs (liver or lungs), and can be related to ischemia, inflammation, mechanical stimuli (abnormal distention or compression by tumoral mass) or traction of the mesentery. Visceral pain is notoriously difficult to treat, related

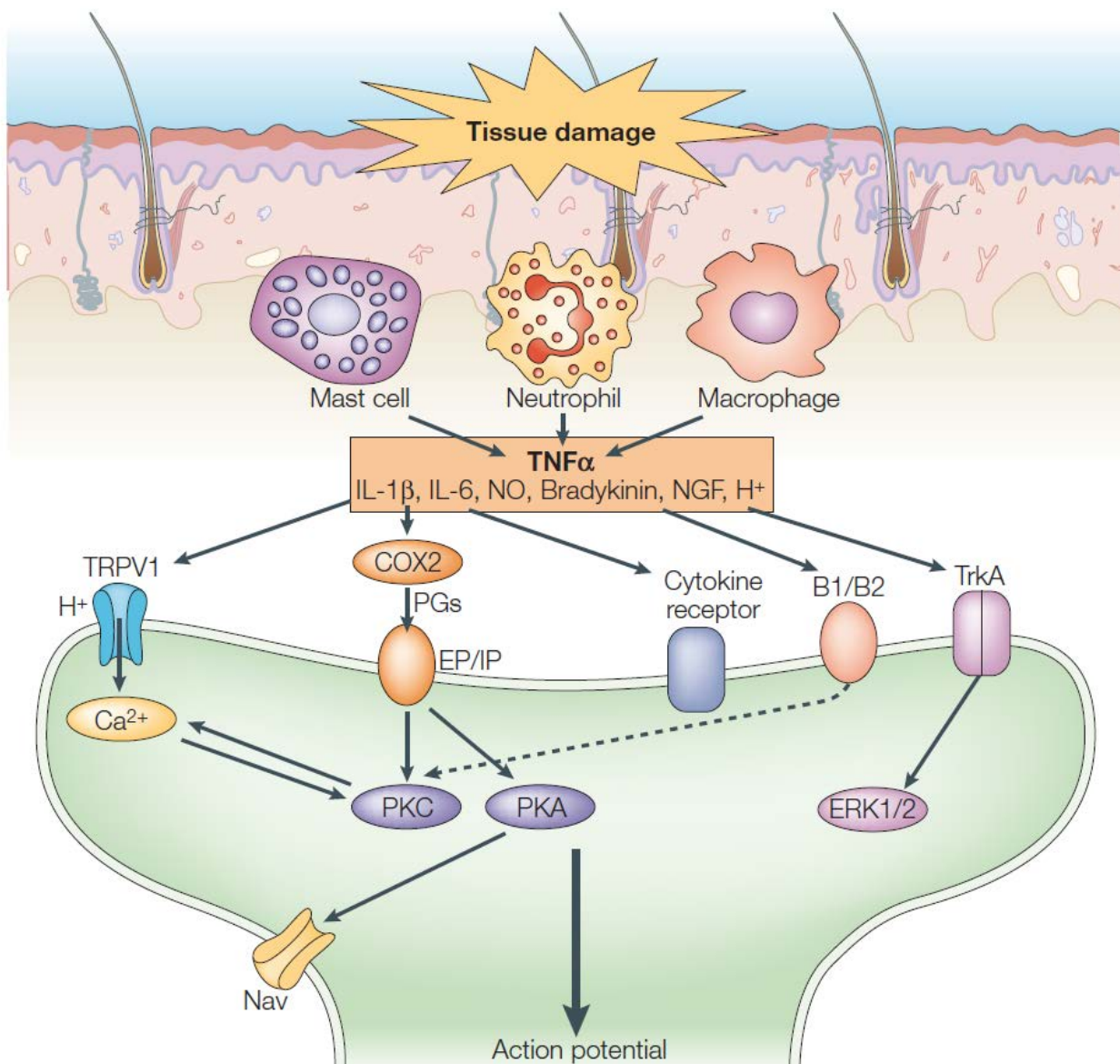

Figure 11: Inflammatory Pain

After tissue damage, mast cells and macrophages are activated and leukocytes, including neutrophils, may be recruited. Immune mediators are released (Tumor necrosis Factor α , interleukins IL1 β and IL6, Nitric Oxide NO, bradykinin, nerve growth factor NGF and protons), which exert their algogenic effect by acting directly on nociceptors or indirectly through the release of other mediators, most notably prostanoids. Intracellular cascades are activated in nociceptors by the inflammatory mediators, which ultimately either activate or sensitize these neurons. COX2 cyclooxygenase 2, B1/B2 bradykinin receptor, EP/IP prostanoid receptor, ERK1/2, extracellular signal-regulated kinase, PKA/PKC protein kinase A/C, TrkA tyrosine receptor kinase A, TRPV1 transient receptor potential channel.

to features which distinguish it from somatic pain sensation (Davis, 2012). Firstly, there are no specialized nerve terminals responsible for stimuli detection and primary afferents express higher levels of receptors and ion channels (TRPV1, ASICs and Nav1.8 for example) than somatic primary afferents (Cervero and Laird, 2004). What is more, visceral pain is conveyed by two parallel systems: vagal innervations and splanchnic or spinal projections (Kahle and Frotscher, 2006). Additionally, visceral pain, unlike somatic sensation, is known to evoke diffuse pain, often associated with pain seeming to originate from somatic localizations; this manifestation is named “referred pain” (McMahon et al., 1995). Visceral nociceptive terminals spread widely in several spinal segments, and therefore information is processed by DH segments which are also responsible for somatic innervations; thus convergence of the two types of projections (viscero-somatic convergence) induces sensitization of somatic tissue, thereby modifying the processing of somatic information and causing “referred pain” (Sikandar and Dickenson, 2012). The viscero-somatic convergence can impede diagnosis, and the innervations of viscera have widely overlapping fields, accounting for the imprecise and diffuse localization of visceral pain sensations, and viscerovisceral hypersensitivity can ensue. As opposed to somatic projections, visceral sensitivity in the DH segments and laminae is not organized according to somatotopy and is poorly represented in supraspinal sensory structures. Importantly, the impact of visceral pain on emotional processing is greater than for somatic sensitivity, and can evoke intense emotional and autonomic responses (Davis, 2012).

In chronic inflammatory intestinal diseases, such as Crohn’s disease or Inflammatory Bowel Disease, the immune system is activated and causes recurrent mucosal inflammation and tissue damage (Wendelsdorf et al., 2010; Cho, 2008; Raza et al., 2012). The enteric nervous system is part of the autonomous nervous system, and is composed of two ganglionic plexi (Auerbach and Meissner’s plexi) comprising primary afferents, interneurons and motorneurons. Within these plexi, circuits are formed and are responsible for sensory processing and digestive functions such as secretion and absorption, motility and bloodflow to the organs which compose the digestive tract (Geboes et al., 1998). Following chronic inflammation, the enteric nervous system undergoes plasticity-associated changes and stress-related damage, named enteric neuropathy, which modifies digestive functions and sensory processing.

Histological observations of human tissue from patients suffering from Crohn's disease reported hypertrophic and hyperplastic enteric ganglia, associated with inflammatory cell infiltration, which expressed antibodies directed against neuronal antigen. Axons were swollen and vacuolar, indicating neuronal death and degeneration. Oxidative stress possibly due to inflammatory processes are involved in neuronal degeneration, however this is still under investigation (Lakhan and Kirchgessner, 2010).

In patients suffering from IBD, modifications of many neurotransmitter systems have been described. Of interest, opioid receptors are expressed in the enteric nervous system, and all three opioid receptors and the peptide ligand β endorphin have increased expressions in the context of an inflamed digestive system (Pol et al., 2001, 2003; Verma-Gandhu et al., 2007). SP containing neurons are more abundant in enteric nervous tissue (Neunlist et al., 2003), both NK1R and NK2R (SP targets) are over-expressed in patients with Crohn's disease (Goode et al., 2000), indicating specific nociceptive modifications, which may enhance visceral pain perception. In enteric tissue, potassium channel expression was reduced in patients suffering from IBD (Arnold et al., 2003), and ASICs expression in colonic tissue from patients was increased, which could be linked to nociceptive signals in patients suffering from chronic inflammatory diseases, seeing as inflammation induces tissue acidosis (Yiangou et al., 2001; Vasina et al., 2006). Electrophysiological data shows that inflammation induced hyperexcitability of inferior mesenteric ganglion neurons which control gastrointestinal motility, which may account for transit modifications under acute inflammatory conditions, in a model of chemically-induced colitis (trinitrobenzene sulfonic acid) (Linden, 2012).

In IBD, specific adaptive modifications occur in the enteric nervous system, but the underlying cause of inflammation and immune imbalance has not yet been identified (Cho, 2008; Sartor, 2008; Qin, 2012). Enteric ganglion neuron degeneration and neurochemical changes have been substantially described, however therapy for IBD is still limited to strategies aiming to reduce inflammation (Speight and Mansfield, 2013).

4. Neuropathic pain: Central and peripheral sensitization

Neuropathic pain can be considered as a painful syndrome which develops following a lesion or a disease affecting the nervous system (Treede et al., 2008; Jensen et al., 2011; Attal et al., 2011), either situated in the periphery (nerve fibres, plexi, sensory ganglia) or in the central nervous system (CNS), in the spinal cord or the

brain). All injury types and locations share a common feature which is the disruption of normal physiological nervous function. We will briefly describe neuropathic pain symptoms and the underlying mechanisms; which therapies are prescribed and/or pharmacological approaches are currently investigated, and how preclinical models are employed to elucidate and treat neuropathic pain.

a) Etiology and symptoms

By definition, neuropathic pain involves lesions in nervous tissue, and as a consequence, all lesions leading to pain must involve nociceptive pathways (Boivie, 1989). There are many pathologies which result in nerve lesion and neuropathic pain, namely autoimmune diseases (ex: multiple sclerosis), infectious or metabolic diseases (ex: shingles, diabetic neuropathy), ischemic or traumatic injuries and cancer. Iatrogenic nervous system injuries include anti-retroviral and chemotherapy molecules (HIV treatments, vincristine, oxaliplatin etc).

Neuropathic pain semiology is characterized by a combination of different types of pain and abnormal somatic sensations, associated with neurological deficits affecting a distinct nerve territory (Bouhassira et al., 2005). Each individual symptom does not specifically indicate pathological pain, and each patient presents, with individual variations, signs which, as a whole, define a particular case of neuropathic pain (Attal et al., 2008).

Painful sensations related to spontaneous pain are either sudden and paroxysmic (intense), or continuous. The former is described as debilitating pain attacks, like electric shocks or daggers; the latter are described as burning sensations or compression, which are permanent. In opposition to spontaneous pain symptoms, patients feel pain in response to everyday life stimuli. Allodynia (pain in response to non-noxious stimuli) is a type of pain evoked by environmental stimuli, which can be thermal (hot or cold temperatures), or mechanical (static mechanical allodynia in response to either light touch or pressure; or dynamic allodynia evoked by stroking). Hyperalgesia is an increased painful response to painful stimuli; that reach higher intensities. Hyperpathia occurs in response to the repetition of non-noxious stimuli and reacts to extremely intense and bursting pain. Abnormal sensations include paresthesias and dysesthesias, which are spontaneous or evoked, described as “pins and needles”, prickling and numbness; all these abnormal sensory experiences are associated with unpleasantness. Sensory deficit can be associated with the particular localization of the neuropathic pain

symptoms, in the specific nerve territory. Lower responses to either thermal or nociceptive sensations can be observed, reflecting either slight barely noticeable or complete anesthesia of the nerve territory.

Persistent pain can dramatically alter the patients' quality of life, affecting sleep, cognitive processes and mood (Attal et al., 2011; Radat et al., 2013). Anxiety and depression are frequently observed mood disorders in patients suffering from chronic pain, with a mean prevalence rate of 30% for major depressive disorder (Bair et al., 2003; Maletic and Raison, 2009). The biological substrates and mechanisms underlying psychiatric comorbidities in neuropathic pain are still under investigation, and therapeutic intervention aiming to significantly improve healthcare for patients suffering from chronic pain and the emotional consequences is often lacking.

Our knowledge regarding pathophysiology of neuropathic pain was mainly acquired from clinical and preclinical research which has sought to understand and describe the mechanisms which may lead to such abnormal painful sensations. Neuropathic pain is heterogenous, and results from various combinations of etiological, environmental and genetic causes (von Hehn et al., 2012). The main approaches for studying neuropathic pain involve behavioral, cellular and molecular analysis of peripheral nerve injury in animal models, which may not be the most representative type of clinical neuropathic pain (epidemiology of post-herpetic and diabetic neuropathy show high incidence rates (Bouhassira et al., 2008; Dieleman et al., 2008; van Hecke et al., 2014)), but has brought considerable insight regarding molecular and functional rearrangements at work in the establishment of neuropathic pain.

b) Peripheral Sensitization Mechanisms

Following tissue injury or inflammation, heightened sensitivity to stimuli develops in order to protect the lesioned area from further damage (see Inflammatory Pain section). Reversible plasticity of nociceptors is elicited by the plethora of inflammatory mediators, and endows them with reduced activation thresholds and increased excitability, enabling enhanced nociceptive stimuli transduction. Nerve tissue damage also engages these sensitization mechanisms, with or without inflammation. In most patients, healing of injured tissue and nerves is accompanied by reversal of peripheral sensitization, however when damaging stimuli persist (on-going disease for example), alterations in sensory afferents may become permanent (Cohen and Mao, 2014).

As explained earlier, enhanced transduction of nociceptive signals during inflammatory pain is driven by reduced activation thresholds of primary afferents, which is the net result of reduced activation thresholds of the various channels (permeable to sodium or potassium ions or both) that the primary afferents express. The most characterized channel involved is TRPV1, known to participate in inflammatory pain and also undergoes posttranslational changes expression and trafficking alterations after nerve injury. In neuropathic pain models, TRPV1 is upregulated (Hudson et al., 2001) and expressed by non-nociceptive A β fibres (Hong and Wiley, 2005), illustrating the phenotypic switch which can occur in pathological conditions. TRPA1, TRPM8 and P2X3 channels may also undergo expression changes and be involved in sensitization. As in inflammatory processes, inflammatory mediators such as cytokines are present following nerve lesion, along with increased levels of neurotrophin NGF (Dogrul et al., 2011; Gaudet et al., 2011; Leung and Cahill, 2010). Upon ligand binding, neurotrophin receptors activate intracellular cascades which in turn activate kinases involved in expression and trafficking of TRPV1, and decreased expression of potassium channels (Dib-Hajj et al., 2010; Mantyh et al., 2011; Zhang et al., 2012).

Spontaneous pain described by patients suffering from neuropathic pain is characteristically experienced in the absence of stimuli. There is evidence of ectopic discharge activity of primary afferents (Devor, 1991), most frequently. Spontaneous activity could occur throughout the nociceptive pathways and engage injured and uninjured afferent fibres, generating the manifestations described by patients (von Hehn et al., 2012; Djouhri et al., 2006). In animal models, spontaneous activity following nerve injury may be caused by changes in expression, trafficking and activation of many ion channels which alter the membrane potentials and generate ectopic activity (Basbaum et al., 2009). Overall, here are many ion channel components which are suspected to contribute to ectopic activity of primary afferents following nerve damage, and these changes are the reflection of the maladaptive plasticity of primary afferents, which are the result of persistent sensitization following injury. These ion channels are the target of therapeutic strategies aiming to reduce spontaneous activity as it is thought to be the main cause of spontaneous pain symptoms (for review see von Hehn et al., 2012; Liu and Wood, 2011).

Downregulation of potassium channels can lead to membrane depolarization (Tulleuda et al., 2011), and sodium currents largely contribute to ectopic activity (Amir et al., 1999). Reduced expression of voltage gated potassium channels in nerve lesion conditions also contributes to ectopic firing of action potentials (Kim et al., 2002b; Rose et al., 2011). Hyperpolarization-activated cyclic-nucleotide gated channels (HNC) which are permeable to cations are also involved in spontaneous activity in neuropathic pain (Chaplan et al., 2003; Lee et al., 2005), and by leading to membrane potential oscillations could lead to repetitive firing patterns (Biel et al., 2009). Voltage-gated sodium channels undergo expression and activity changes in nerve injury settings. Notably, Nav 1.3, which is only expressed during development, reappears following nerve injury (Fukuoka et al., 2008) and may contribute to membrane depolarization (Devor, 2006). Although Nav 1.6, Nav 1.7, Nav 1.8 and Nav 1.9 expression is reduced in DRG following nerve injury (Kim et al., 2002a), Nav 1.8 levels increase in axons of injured primary afferents (Novakovic et al., 1998; Thakor et al., 2009). MAPK phosphorylation of voltage gated sodium channels (Nav 1.3, Nav 1.7, Nav 1.8 and Nav 1.9) enhances their activity by lowering activation thresholds (Czeschik et al., 2008; Kim et al., 2002a; Jin and Gereau, 2006). After nerve injury, expression of $\alpha_2\delta$ calcium channels are increased in DRG, which contributes to increased excitability of primary afferents (for review see von Hehn et al., 2012).

c) Central sensitization

Central sensitization is the term used to describe overall modifications of neuronal circuits which cause augmented responses of central components to nociceptive signals (Latremoliere and Woolf, 2009). Many mechanisms contribute to this process which instates the state of central nervous system hyperexcitability resulting in enhanced pain responses. Although supraspinal structures are involved in central sensitization, spinal mechanisms are the most described, and therefore we will present how molecular, cellular and functional changes in the spinal cord impact sensory processing and lead to enhanced pain perception, with particular focus on alteration of glutamatergic transmission, disinhibition mechanisms and the influence of glial cells (for review see Campbell and Meyer, 2006).

Nociceptors, and primary afferents in general, are excitatory neurons which release glutamate and SP or CGRP for peptidergic nociceptors. Postsynaptic DH neurons express AMPA, kainate and NMDA subtypes of

ionotropic glutamatergic receptors, and excitatory postsynaptic currents are generated through AMPA and kainate receptors. The NMDA channel is usually inactive as it is blocked by a magnesium ion (Mg^{2+}), in a voltage dependent manner. Nociceptive signals depolarize the postsynaptic DH neurons enough to displace the magnesium block and activate NMDA receptors. The long term potentiation (like in memory processes, see Drdla 2008) increases the synaptic strength and participates in the establishment of primary hyperalgesia. Postsynaptic CGRP receptors and NK1R activate PKC and PKA pathways, which phosphorylate AMPARs and NMDARs, modifying their conductance properties and enhancing their responses to glutamate, thus contributing to hyperalgesia. NMDAR activation activates PKC, CaMKII and ERK intracellular signaling pathways, which recruit AMPARs to the synaptic membrane, and engage transcriptional changes via phosphorylation of CREB by ERK, increasing expression of genes (c-fos, NK1, TrkB and Cox-2) which ensures the development of synaptic strengthening (Latremoliere and Woolf, 2009). These processes are homosynaptic (the same stimulation from the site of injury evokes increased pain responses, is processed by the same circuit), and are accompanied by heterosynaptic rearrangements which are responsible for secondary hyperalgesia. Innocuous touch stimulation for example, transduced by A β afferents innervating the areas around the lesion, causes pain via heterosynaptic facilitation, by abnormal circuit processing in the context of injury (Latremoliere and Woolf, 2009).

As described above, the activity of GABAergic and glycinergic inhibitory interneurons from DH superficial laminae reduces the excitatory activity of primary afferents via their presynaptic receptors. In the setting of injury, the spinal disinhibition mechanisms which lead to hypersensitivity may involve GABAergic cell death by selective apoptosis (Moore et al., 2002; Scholz et al., 2005), and the downregulation of potassium-chloride transporter KCC2 in lamina I nociceptive projection neurons, following BDNF release by microglial cells. The decrease in potential equilibrium reduces or reverses Chloride entry upon GABA A receptor activation, and thus cause disinhibition of the lamina I nociceptive neurons, enhanced excitability and increased pain transmission (Coull et al., 2003, 2005; Miletic and Miletic, 2008). Modification of glycine transmission is also involved in disinhibition, following the activity of inflammatory molecules such as prostaglandins. In the context of injury, increased levels of spinal prostaglandins activate the cAMP-PKA pathway in excitatory interneurons from the

DH via the activity of prostaglandin receptors GCPR EP2, which induces the phosphorylation of the glycine receptors leading to their inactivation (Harvey et al., 2004).

The immune system and inflammatory cytokines are involved in the establishment of neuropathic pain mechanisms (Marchand et al., 2005). $\text{TNF}\alpha$, $\text{IL1-}\beta$, bradykinin and prostaglandins enhance pain mechanisms and initiate neuropathic pain (Xu et al., 2006). In the spinal cord, microglial activation occurs following peripheral nerve lesion and nociceptive inputs (Beggs and Salter, 2010; Hathway et al., 2009; Suter et al., 2009). Cells involved in the adaptive immune response are also recruited to the spinal cord following injury, and secrete cytokines which also activate microglia. Lymphocyte deficiency in mice has been linked to reduced mechanical allodynia in response to acute nerve injury (Costigan et al., 2009; Tsuda et al., 2009). Preventing microglial activity shortly after injury may represent an interesting therapeutic strategy; however whether the immune involvement described in rodents occurs in humans has not yet been verified.

In conclusion, central sensitization involves short term, phosphorylation-dependent rapid changes in glutamatergic ion channel properties; whilst late phase processes of central sensitization rely on transcription-dependent mechanisms such as de novo protein synthesis, which underly circuit rearrangements. The cellular processes of central sensitization result in altered function of nociceptors, following their increased activity in the context of pain. Intense nociceptive inputs induce changes in threshold and activation kinetics of AMPARs, engage AMPAR trafficking modification, and alterations of ion channel activity (increased inward currents and decreased outward currents), along with reduced release or activity of inhibitory neurotransmitters in the spinal cord circuits. As a result, increased membrane excitability of primary afferents, synaptic facilitation and disinhibition ensue, enabling the development of spontaneous activity of primary afferents, reduced activation thresholds of projection neurons in the spinal cord in response to primary afferent input, and the enlargement of receptive fields whereby nociceptive-specific neurons in the DH become responsive to both innocuous and nociceptive inputs.

d) Treatment strategies

Neuropathic pain affects a high proportion of European or North American populations (Schmader; Sadosky et al.), the most common etiologies include diabetic polyneuropathy, shingles and cancer or HIV treatment related

neuropathy (Veves et al., 2008). Treatment recommendations depend on the type of painful manifestations the patient suffers from, and are based on randomized clinical trials (Attal et al., 2006; Dworkin et al., 2007; Attal et al., 2008). Generally, nociceptive pain treatments (paracetamol for example) show little or no efficacy in treating neuropathic pain. Nociceptive analgesic pain medications are classified as molecules recommended for defined levels of pain intensity, neuropathic treatments are not. Two main classes of molecules are currently prescribed in the clinic as first line treatments: antidepressants (tricyclic and Serotonin and Noradrenalin Recapture Inhibitors SNRIs) and antiepileptics (gabapentinoids). As only 30 to 50% of patients experience pain relief following first in treatment strategies, opioids represent a therapeutic option in 25% of patients (Breivik, 2005).

(1) Antidepressants

Over thirty years ago, the effect antidepressant treatments on neuropathic pain was described, in cases of shingles and diabetic neuropathy (Max et al., 1987; reviewed in Finnerup et al., 2015), and since then many studies have shown the efficiency of tricyclic antidepressants (imipramine, amitriptyline, nortriptyline or desipramine for example) and SNRIs (venlafaxine or duloxetine) for treating painful neuropathic symptoms (independently of depression) (Sindrup et al., 2005; Attal et al., 2010). Interestingly, the analgesic effect of such treatments requires long term treatment and the effect appears after prolonged administration, very similarly to the antidepressive properties of these molecules; this supposes that the therapeutic effect depends on mechanisms of action involving molecular and cellular modifications (Duman, 2002; Nestler et al., 2002; Sindrup et al., 2005). Selective noradrenalin recapture inhibitors (reboxetine) are also efficient (reviewed in Mattia et al., 2002), however selective serotonin recapture inhibitors (fluoxetine) alone do not efficiently relieve painful symptoms, indicating that the main mechanisms of action whereby antidepressants relieve neuropathic pain symptoms involves selective inhibition of noradrenalin recapture (Sindrup et al., 2005). TCA treatment may be more potent in reducing neuropathic pain symptoms compared to other antidepressants, and this may be due to supplemental mechanisms of action (Sindrup et al., 2005). Indeed, their other properties involve α AR and/or NMDAR antagonism, or sodium and calcium channel blockade (Wang et al., 2004; Finnerup and Jensen, 2007). In addition, prolonged TCA treatment may reverse spinal circuit modifications resulting from nerve

injury, via the inhibition of intracellular signaling pathways responsible for the maintenance of sensory deficits associated with nerve lesion (Rantamäki et al., 2007; Kusuda et al., 2013).

In terms of clinical efficiency, TCA treatments were evaluated in various forms of peripheral and central neuropathic conditions, whereas SNRIs have mainly been investigated in the context of diabetic polyneuropathy (Attal et al., 2010; Baron et al., 2010). TCA treatment can have adverse side effects which mainly involve anticholinergic effects (dry mouth, blurred vision, constipation, tachycardia or emesis), and therefore drug indications are limited to patients which do not have glaucoma or heart disease for example (Roose 2000). SNRIs are generally better tolerated by patients, but treatment discontinuation due to intolerance is frequent (Goldstein et al., 2005).

Previous work in our laboratory has evidenced that TCA- and SNRI-elicited activity of β_2 Adrenergic receptors (β_2 AR) relieves neuropathic allodynia in mice. Similarly, pain relief was observed following direct β_2 AR activation by agonists (Yalcin et al., 2009b, 2009a; Choucair-Jaafar et al., 2009; Yalcin et al., 2010). Further studies then showed that satellite glial cells in DRG are involved in the reduction of membrane-bound TNF α following antidepressant treatment. β_2 ARs on glial cells were suspected to be recruited by antidepressant treatment (Bohren et al., 2010).

(2) Antiepileptics

Gabapentin and pregabalin do not bind GABA receptors and are not GABA precursors (as their names could indicate) (Lanneau et al., 2001). Their pharmacological effect relies on binding voltage gated calcium channel (VGCC) $\alpha_2\delta_1$ subunit (Bian et al., 2006), the expression of which is increased in response to nerve injury (Wang et al., 2002; Li et al., 2004). The VGCC $\alpha_2\delta_1$ subunit may be involved in DH neuron hyperexcitability (Li et al., 2006), and upon gabapentin binding, membrane export of channels and presynaptic calcium currents may be reduced, thereby inhibiting the release of excitatory neurotransmitters and peptides from central terminals (Hendrich et al., 2008; Bauer et al., 2009; Cunningham et al., 2004; Takasusuki and Yaksh, 2011). Gabapentinoids also dampened microglial activation and subsequent neuropathic allodynia in a rodent model of diabetes-induced neuropathy (Wodarski et al., 2009). Gabapentinoids are generally well tolerated in patients

suffering from either chronic neuropathic pain (for example diabetic polyneuropathy) or acute post-surgical pain (Wiffen et al., 2005; Attal et al., 2010; Kong and Irwin, 2007).

Carbamazepin treatment, an antiepileptic, is the gold standard treatment for trigeminal neuralgia (Attal 2010), the mechanism of action relies on the blockade of voltage-gated sodium channels (Bräu et al., 2001). It may also block calcium channel activity in the CNS (Todorovic and Lingle, 1998; Ambrósio et al., 1999). Although widely used for cranial nerve painful syndromes, it has not yet been fully investigated in the context of other types of peripheral neuropathic pain diseases.

(3) Opioid treatment in neuropathic pain

Opioids are powerful pain relieving compounds and the mechanisms by which they exert their analgesic action will be described in the dedicated section (See Opioid System Section), however their chronic use leads to tolerance and dependence. Tolerance manifests as decreased effects for the same dose over time, and the need to increase drug administration to obtain the same pharmacological effect. It may occur for some or all of the substance's pharmacological effects, and therefore represents a clinical complication of drug use. Despite their adverse effects on respiratory function and the decreased efficiency due to tolerance, some opioid molecules have approved indications for diabetic neuropathy (for review see Smith, 2012) and they are also widely used for treating cancer pain. Several clinical trials have shown efficiency of long term use of oxycodone (a semisynthetic opioid molecule) in diabetic and cancer-induced neuropathic pain or post-herpetic neuralgia (Watson and Oaklander, 2002; Gimbel et al., 2003; Ong, 2008; Watson and Babul, 1998). Tramadol, which binds opioid receptors but also inhibits monoaminergic reuptake, is presented as useful in neuropathic pain treatment (Hollingshead et al., 2006), and this molecule has also been evaluated in clinical trials for treating diabetic neuropathy (Harati et al., 1998; Freeman et al., 2007), cancer-related neuropathic pain (Arbaiza 2007) and pain following spinal cord injury (Norrbrink and Lundeberg).

In summary, neuropathic pain treatment is challenging, by its chronicity, severity and repercussions on the patients' quality of life. We have not discussed surgical interventions which may be recommended in specific neuropathic pain cases. Future treatments for neuropathic pain aim to decrease inflammatory mediators that

drive plasticity changes (which may lead to sensitization), voltage gated sodium channel blockade is also an attractive therapeutic possibility

5. Studying neuropathic pain

a) *Different animal models*

Preclinical approaches should reproduce the ethiology, symptoms and consequences of chronic pain syndromes which are observed in humans. They should reproduce traumatic peripheral nerve injuries, diabetic- or chemotherapy-induced neuropathy and respond to treatments which are used in the clinic in order to be validated (Sorkin and Yaksh, 2009; Colleoni and Sacerdote, 2010; Jaggi et al., 2011; for review see Barrot, 2012). The predominance of traumatic nerve injury models may not match the clinical situation (Percie du Sert and Rice, 2014), however these animal models have demonstrated therapeutic relevance. We will briefly present the traumatic and chemical neuropathic pain models, with particular interest in the sciatic nerve cuffing model characterization, which is used in our laboratory.

b) *Animal models of chemotherapy-induced NP*

In humans, chemotherapeutic molecules (taxol family and platinum compounds) are associated with neuropathy, as the nervous system is particularly vulnerable to these compounds (especially molecules which inhibit microtubules) (Windebank and Grisold, 2008). Animal models of neuropathy have been established following taxel and vincristine administrations (Flatters and Bennett, 2004).

Streptozocin, a glucosamine-nitrosourea compound derived from *Streptomyces achromogenes* is a chemotherapeutic agent for the treatment of pancreatic β cell carcinoma (Courteix et al., 1993). The toxic compound preferentially damages pancreatic β cells, resulting in hypoinsulinemia and hyperglycemia (Lenzen 2008). Administration of Streptozocin is used to induce toxic neuropathy. After injection, mice develop diabetes and diabetic neuropathy. Hyperalgesia can be measured and this model can be studied to characterize mechanisms of pain development and evaluate treatment efficiency (Ahlgren and Levine, 1993).



Figure 12: Sciatic Nerve Cuff Implantation.

Sciatic nerve cuff model entails a unilateral implantation of a piece of split PE tubing 2mm long around the main branch of the sciatic nerve. (Benbouzid et al., 2008; Yalcin et al., 2014).

c) *Traumatic models*

Rodent models of peripheral nerve injury typically target the sciatic nerve, which is easy to access and its function can easily be assessed in pain behavioral tests. Almost thirty years ago, an animal model of neuropathic pain was established, following the observation that loose chrome ligatures around the sciatic nerve (chronic constriction injury CCI) provoked behaviours resembling neuropathic pain in humans (Bennett and Xie, 1988), which was later partly attributed to the immune reaction to the chromic suture material (Maves et al., 1993), and the subsequent edema was linked to axotomy. Complete or partial spinal nerve transections (axotomy) also cause the development of pain (Kim and Chung, 1992), and are still frequently used to study neuropathic pain and investigate therapeutic effects of drugs in both rats and mice. These approaches have the advantage of allowing the study of both injured and uninjured DRG neurons (in the case of partial sciatic nerve injury) (Seltzer et al., 1990). Axotomy frequently causes autotomy behaviours (self-mutilation when the animal chews the affected hindpaw). Although some may interpret this as the sign of ongoing pain and the animal attempts to eliminate the painful limb (Devor, 1991), it is more likely that the loss of sensation rather than unbearable pain drives the animal to engage in such behaviours. Self mutilation of the injured limb is ethically questionable, and this had lead to the development of milder section models, such as spared nerve injury for example (two branches of the three which compose the sciatic nerve are tightly ligated) (Decosterd and Woolf, 2000).

Another model of peripheral nerve injury by compression was established in rats and later in mice by the implantation of short polyethylene cuffs around the main branch of the sciatic nerve (Mosconi and Kruger, 1996) with minimal constriction, which induces pain behaviours similar to human neuropathic pain condition (heat hyperalgesia, mechanical allodynia, development of anxio-depressive-like behaviours) (Pitcher et al., 1999; Benbouzid et al., 2008c) (see Figure 12). Further characterization of the model in subsequent studies has provided evidence of predictive validity (i.e. response to drugs used in the clinic) as well (Kremer et al., 2016; Choucair-Jaafar et al., 2009; Yalcin et al., 2009b; Choucair-Jaafar et al., 2014). Recently, a model of constriction of saphenous nerve, a main branch of the femoral nerve, innervating the inner part of the hindlimb, has been described. However despite development of neuropathic pain, the model failed to show antiallodynic

effect of amitriptyline treatment (TCA) and therefore may not be completely adequate for studying neuropathic pain development and antiallodynic medication (Walczak et al., 2006).

All the neuropathic pain models which target the sciatic nerve induce long-lasting mechanical allodynia, and some thermal hyperalgesia, both of which are main symptoms reported by patients. Animal models of chronic pain do however have limitations. Hyperalgesia and allodynia are relatively easily demonstrated using behavioral test, but spontaneous or ongoing pain assessment in rodents is more challenging. Some argue that spontaneous foot lifting could be the sign of spontaneous pain discharge (Djoughri et al., 2006), however more investigations are needed in order to identify cellular markers of neuronal activation. Increased expression of the immediate early gene protein c-Fos in the DH or functional imaging (fMRI or PET imaging) in small animals may bring indications of ongoing pain experience in rodents.

Behavioral test for nociceptive pain such as those classically used in preclinical studies partly rely on the reflex measures of pain (reviewed in Barrot, 2012) and some argue in favour of operant models for pain testing, facial coding scales, or the assessment of chronic pain impact on autonomic controls, social interaction, and cognitive function (reviewed in Barrot, 2012). We can argue that despite the fact that the Von Frey nociceptive test involving paw withdrawal may engage motor reflexes, this approach has shown pharmacological relevance and demonstrated that in the rodent models of spinal nerve ligation or cuffing, hyperalgesia could be relieved by gabapentin and amitriptyline for example, two drugs with demonstrated clinical efficiency (LaBuda et al., 2000; Benbouzid et al., 2008a). Concern regarding face validity and predictive value of models has been raised in the light of possible biological differences between rodent and human pain processing, however animal models have enabled the development of drugs and approaches which are useful for clinical pain management.

6. Cuff model characteristics

The sciatic nerve cuffing model was initially developed in rats, and consisted in the implantation of several pieces of polyethylene tubing (cuffs) around the main branch of the sciatic nerve, although single cuff implantation is now widespread and also used in mice, with the opportunity to use of transgenic animals (Mosconi and Kruger, 1996; Fisher et al., 1998; Pitcher et al., 1999; Benbouzid et al., 2008c). In mice, surgical procedures have been described in detail (Yalcin et al., 2014), and this experimental approach offers a

calibrated, and therefore standardized, sciatic nerve constriction technique (more reproducible than CCI and low inter-individual variability), which induces persistent characteristic ipsilateral mechanical allodynia and transient thermal hyperalgesia. These pain symptoms are classically measured using the Von Frey and Plantar[®] tests respectively. Spontaneous mechanical allodynia recovery begins between 12 and 14 weeks post-surgery whereas thermal hyperalgesia resolves after three weeks in mice (Benbouzid et al., 2008c). The cuff model has minor effects on spontaneous pain (Benbouzid et al., 2008c). Neuropathic pain mechanisms as well as morphological and functional changes of following cuff implantation have been studied. In particular, implementation of the cuff model showed the involvement of glial activation and changes in spinal nociceptive neuron activity following nerve injury with a shift in neuronal anion gradient (Coull et al., 2005). Genetic and pharmacological approaches have shown that Acetylcholine signaling through nicotinic receptors within spinal cord circuits is critical in the establishment of nociceptive thresholds in nociception, and in inflammatory or neuropathic pain (Yalcin et al., 2011b). Pharmacological inhibition of glutamate receptors in the spinal cord reduces cuff-induced hyperalgesia (Fundytus et al., 1998; Fisher et al., 1998). Delta opioid (DOP) receptors are critical for the antiallodynic treatment effects by TCA in the cuff induced neuropathic pain model, whereas Mu and Kappa opioid receptors are not (Benbouzid et al., 2008b; Bohren et al., 2010; Megat et al., 2015; Yalcin et al., 2014 and references therein).

The cuff model responds to gabapentinoids and antidepressants, with doses and kinetics which parallel those observed in the clinic (Benbouzid et al., 2008b; Yalcin et al., 2009a; Benbouzid et al., 2008a, 2008c; Yalcin et al., 2009b; Bohren et al., 2010, 2013). In addition, the model also induces anxio-depressive consequences of persistent pain (Yalcin et al., 2011a), with anxiety-like behaviours appearing six weeks after the induction of neuropathic pain, followed by depressive-like symptoms which begin eight weeks after cuff implantation. As in humans, mood disorder comorbidities do not affect all the animals, with approximately 70 to 75% of animals which develop such symptoms (personal observation).

As a whole, the cuff model has face validity, as it faithfully reproduces sensory and emotional consequences of neuropathic pain to a satisfactory extent and enables to study clinically relevant pain

B. The Endogenous Opioid System

1. Central components and roles

The opioid system is a neuromodulatory system composed of three receptors mu (MOP), delta (DOP) and kappa (KOP) opioid receptors belonging to class A GPCR family and three peptides, the endorphins, enkephalins and dynorphins (Akil et al., 1998). The roles held by the endogenous opioid system are manifold, and the physiological processes it modulates reflect the widespread expression of both receptors and peptides (Kieffer and Gavériaux-Ruff, 2002; Bodnar, 2014). Opioid peptides attune diverse autonomous functions such as respiration (Lalley 2008), thermoregulation (Rawls et al., 2005), immune functions, the cardiovascular system (Saraiva 2004) and the digestive system (Mehendale and Yuan, 2006). The opioid system also regulates endocrine functions and responses to stress (Drolet et al., 2001), and is involved in emotional processing, feeding behaviours, learning and memory; the most well-known and investigated roles of the opioid system are the modulation of pain and their rewarding properties. Opiate analgesic drugs prescribed for severe pain are also associated with side-effects, such as; respiratory depression, nausea, drowsiness, constipation and tolerance (defined as decreased effects for the same dose of pharmacological compound over time, and the need to increase drug administration to obtain the same pharmacological effect). They also impact mood and cognitive processes. Nevertheless, opiates remain a fundamental class of analgesic drugs used to treat severe pain in the clinic. Opioid receptors and peptides are expressed throughout the nervous system, in the peripheral (both somatic and visceral) (Sternini et al., 2004; Stein and Lang, 2009) and central nervous systems (reviewed in Le Merrer et al., 2009) (see Figure 13).

Opiates are a diverse family of molecules, some are natural alkaloids from the opium poppy resin and some are synthetic derived from the natural alkaloids. Opioid is the term used when referring to endogenous peptides that bind and activate opioid receptors. The endogenous opioid system was discovered using opiate pharmacological approaches, and is composed of opioid receptors and the opioid peptides that are their endogenous ligands. We will briefly describe the peptides and receptors of the endogenous opioid system, functional aspects of receptor activity and the physiological roles of this neuromodulatory system. Particular interest is given to the delta

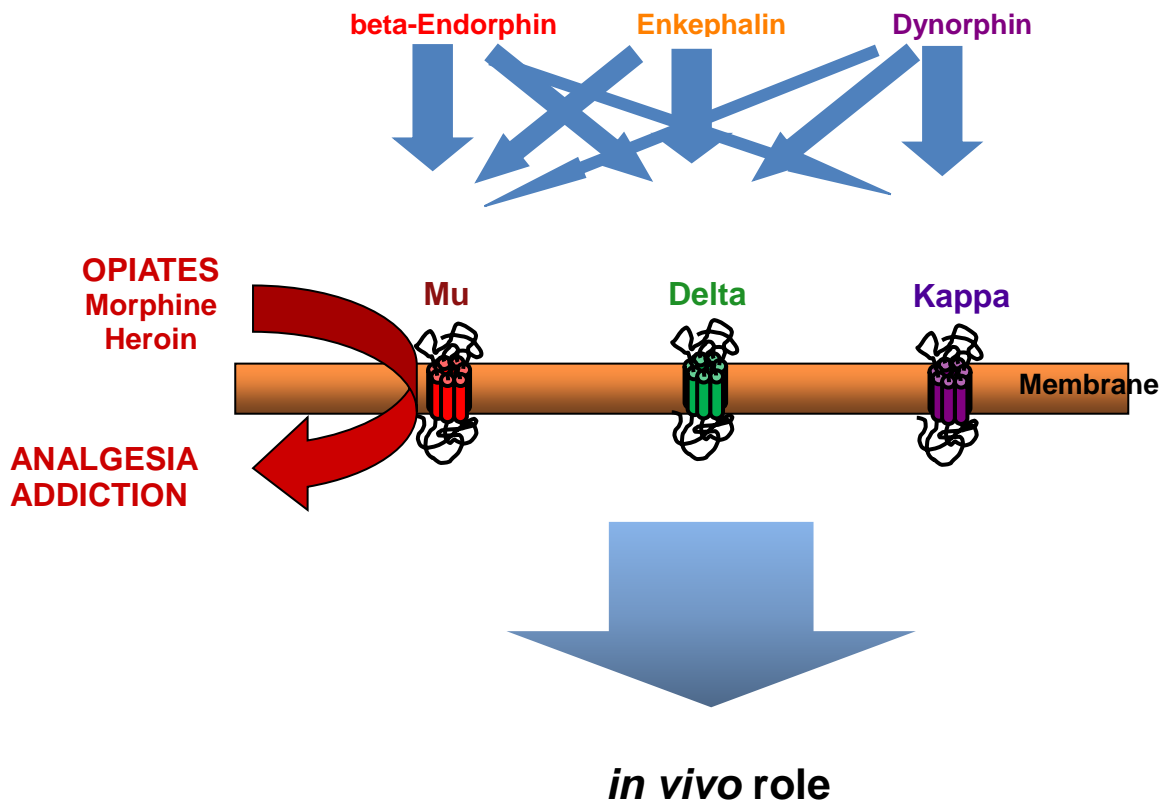

Figure 13: Physiological Roles of Endogenous Opioid System

The opioid system modulates physiological functions and participates in learning and memory, modulates immune responses, stress and mood. It is also involved in autonomous functions (gastrointestinal transit, temperature, respiration), and mediates reward and nociception.

opioid receptor and its involvement in pain modulation; as well as the tools which have been developed to study the opioid receptors in vivo.

a) *Peptides*

Endogenous ligands for opioid receptors were first discovered in brain tissue, and the large family of endogenous opioid peptides was identified. These peptides are composed of 5 to 30 amino-acids, and all have the Tyr-Gly-Gly-Phe amino-terminal opioid motif (Akil et al., 1998). The endogenous opioid peptides are derived from three precursor proteins pro-opiomelanocortin (POMC), preproenkephalin (PENK) and prodynorphin (PDYN), which are encoded by three separate genes and therefore endogenous opioid peptides are classified in three families according to their precursor protein gene *Penk* for Met- and Leu-enkephalins, *Pomc* for β -endorphins and *Pdyn* for dynorphins. Endogenous opioid peptide genes encode the prepropeptide which is transported to the endoplasmic reticulum where it undergoes enzymatic processing. Each propeptide can generate several biologically active peptides following enzymatic cleavage (at pairs of basic residues Lysine and Arginine) which takes place in secretory granules.

The *Pomc* gene encodes a precursor protein POMC which gives rise to one 31aa β -endorphin opioid peptide bearing a Met-enkephalin motif, and several other non-opioid peptides (adrenocorticotrophic hormone ACTH and melanocyte-stimulating hormones MSH) involved in hormonal stress responses. The 31aa β -endorphin opioid peptide can undergo further enzymatic processing, and give rise to bioactive peptides of varying lengths. *Penk* gene encodes the PENK polypeptide which contains four copies of Met-enkephalin, one of Leu-enkephalin, and other enkephalins. The *Pdyn* gene encodes a PDYN polypeptide which undergoes proteolytic cleavage and generates two opioid peptides of various lengths which all include a Leu-enkephalin motif. The neuroanatomical distribution of *Penk*, *POMC* and *Pdyn* mRNA has been described using in situ hybridization and IHC (for review see Le Merrer et al., 2009) (see Figures 14 and 15).

Given that there are three families of opioid peptides and three opioid receptors, one would expect that one family of peptides would bind to one OR subtype; but this is not the case, as the interactions between opioid peptides and ORs is much more complex (Williams et al., 2001). Kappa OR selectivity for endogenous peptides

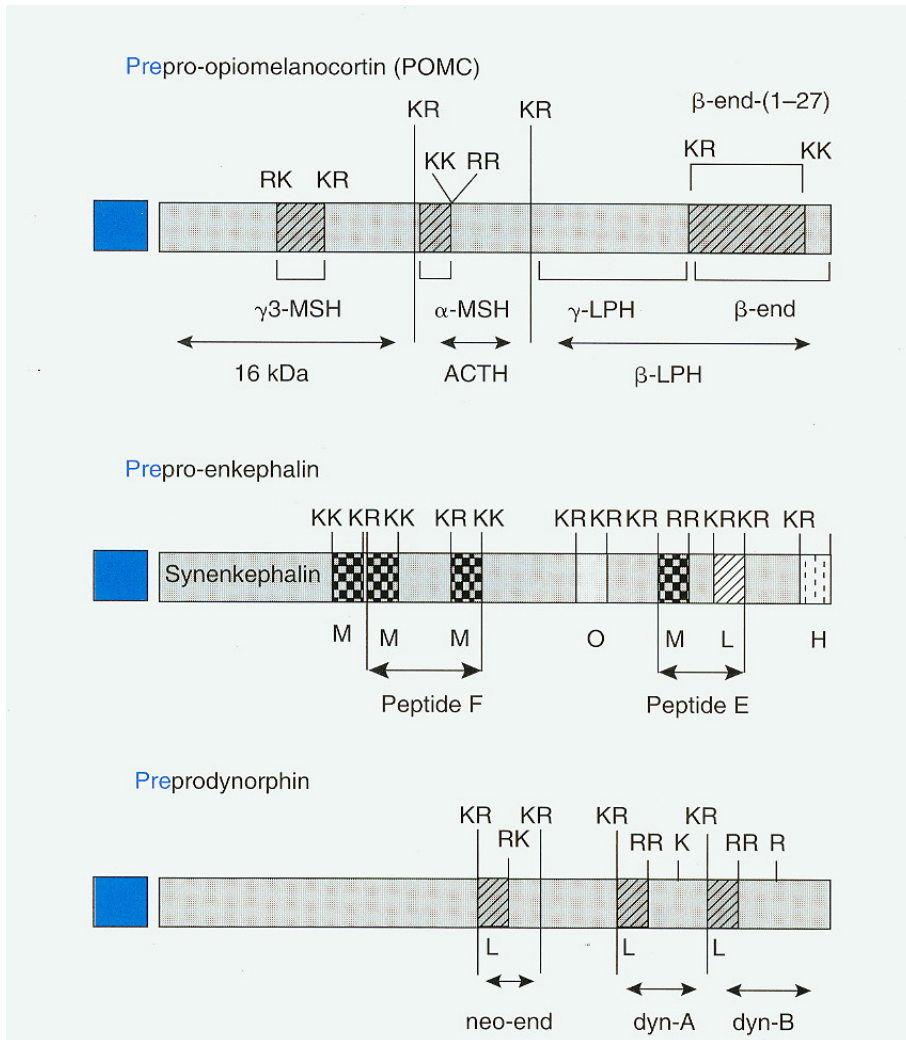

Figure 14: Endogenous opioid peptide maturation

Illustration of the cleavage sites of precursor peptides by peptidases, and their respective opioid peptide products *Top*: Prepro-opiomelanocortin. *Middle*: Prepro-enkephalin *Bottom*: Preprodynorphin.

is high, and preferentially binds dynorphin, whereas DOP and MOP receptors have lower fold differences between their most and least preferred ligands (see Figure 15).

Two other peptides which do not have the opioid motif have been recently described. Endomorphin-1 and -2 are described as atypical opioid peptides which bind to the mu opioid receptor with high specificity and affinity (Zadina et al., 1997). Other natural peptides which have opioid-like activities have been discovered, such as dermorphin and deltorphin (heptapeptides extracted from frog skin extracts) which do not have the opioid motif, but which appear to have high affinity and selectivity for mu and delta opioid receptors respectively.

The physiological effect of neuropeptides is generally modulated by the enzymatic degradation processes which remove neuropeptides from the synaptic cleft as opposed to neurotransmitters which are recaptured via dedicated transporters. Endogenous opioid peptides are degraded by aminopeptidases which cleave amide bonds. The major degradation enzymes are neutral endopeptidase (NEP or enkephalinase) and aminopeptidase N (APN), and both release inactive degradation products (Roques, 1991). Inhibition of NEP and /or APN provides reduced degradation of endogenous opioid peptides which are used as antidiarrheal treatment, but is also an interesting approach to enhance endogenous pain relief in the context of inflammation (Schreiter et al., 2012).

b) Receptors

Opioid receptors (ORs) were discovered in the 1970's, following the experiments which revealed binding sites of radio-labeled opiates in the rat brain, and shortly after, the three opioid receptors MOP, DOP and KOP were cloned, studied and characterized (for review see Kieffer, 1995).

(1) Receptor structure

ORs are type A members of the G Protein Coupled Receptor (GPCR) family, the structure of which is characteristic: seven α helix transmembrane domains, extracellular N-terminus with the opiate binding site, and intracellular C-terminus. Both transmembrane domains and the extracellular loop (N terminus) are involved in opiate binding (Befort et al., 1996). Modulation of OR activity by phosphorylation and G protein coupling take place along the intracellular loop and C-terminus. The three opioid receptors share roughly 60% sequence

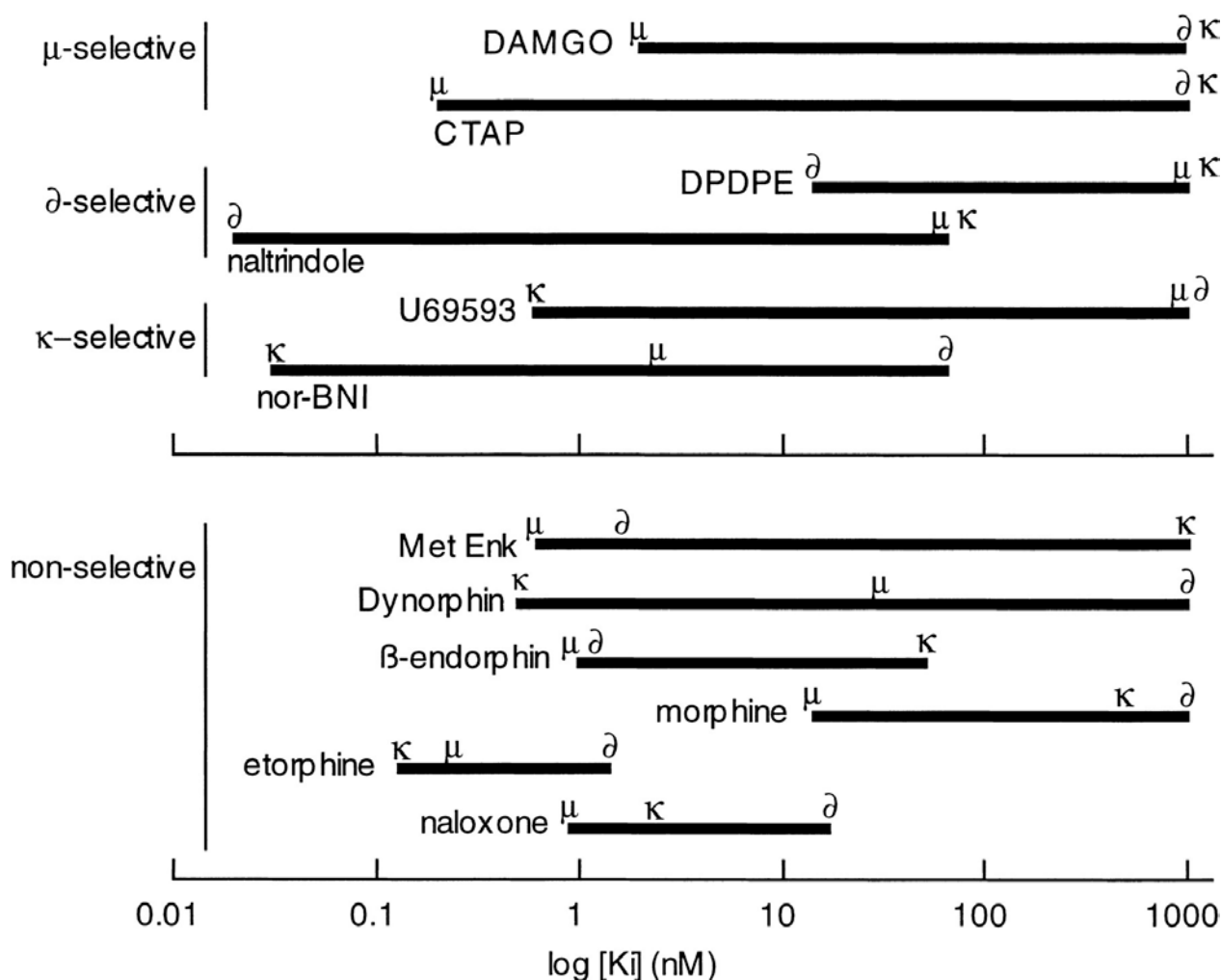

Figure 15: Selectivity windows of some commonly used opioid agonists and antagonists, determined in an expression system.

Top: compounds that are selective for each of the opioid receptors. Note that although nor-BNI is highly selective, the inhibition constant (K_i) at μ -receptors is ~ 3 nM. *Bottom:* the selectivity of the endogenous opioids and other commonly used opioids. Again note that none of the endogenous opioids show a high degree of selectivity. DAMGO, [d-Ala²,N-Me-Phe⁴,Gly⁵-ol]-enkephalin; nor-BNI, norbinaltorphimine; CTAP, H-d-Phe-c[Cys-Tyr-d-Trp-Arg-Thr-Pen]-Thr-NH₂; DPDPE, [d-Pen(2),(5)]-enkephalin.

From Williams 2001.

homology, with high variability in N-terminal sequences, whereas C-terminal and transmembrane sequences are very similar. X-ray crystallography structures of all three OR (murine MOP and DOP, human KOP receptors) were recently published (Granier et al., 2012; Manglik et al., 2012; Wu et al., 2012), bringing structural knowledge regarding OR conformation, dynamics and structure-activity relationships, which may contribute to drug design (see Figure 16).

Mutational analysis, chimeric receptor studies and computational modeling have shown that ORs may share common structural features which define a binding cavity located in an inner region composed of transmembrane helices 3, 4, 5, 6, and 7. ORs are predominantly coupled to pertussis toxin-sensitive, heterotrimeric G_i/G_o proteins; (for review see Waldhoer et al., 2004). Ligand-induced transmembrane motions have been suggested to activate mechanisms of receptor signalling, resulting from exposure of the intracellular loops and making them more accessible to G proteins (Waldhoer et al., 2004). Following receptor activation, G-protein α and $\beta\gamma$ subunits interact with several cellular effector components, inhibiting adenylyl cyclases and voltage-gated Ca^{2+} channels and stimulating G protein-activated inwardly rectifying K^+ channels (GIRKs) and phospholipase $C\beta$ (PLC β). Activation of $G\beta\gamma$ subunits also recruits intracellular effectors which activate mitogen-activated protein kinase MAPK pathways such as Extracellular signal Regulated Kinase 1 and 2, (ERK1 and 2). The MAPK pathway engages transcription factor phosphorylation including cAMP Response Element Binding protein CREB, estrogen receptors, c-jun, c-fos, activator protein 1 AP-1 (c-jun and c-fos heteromer), ultimately initiating modifications in gene expression and long-term adaptation (Bilecki et al., 2004; Martin-Kleiner et al., 2006; Shoda et al., 2001).

(2) Cellular dynamics

Following agonist activation of GPCRs, phosphorylation by G protein-coupled receptor kinases (GRKs) and β -arrestin recruitment enable rapid receptor desensitization by facilitating the uncoupling of the receptor from the G protein. Following this process, ORs are rapidly endocytosed and can then be either recycled back to the membrane, or downregulated if the endocytosed OR is targeted for degradation in lysosomes. Agonist-induced activation of both the MOP and DOP receptors leads to their endocytosis via clathrin-coated pits following GRK phosphorylation, and association with cytoplasmic β -arrestins, however they follow different intracellular

MOR/DOR/KOR/ORL1

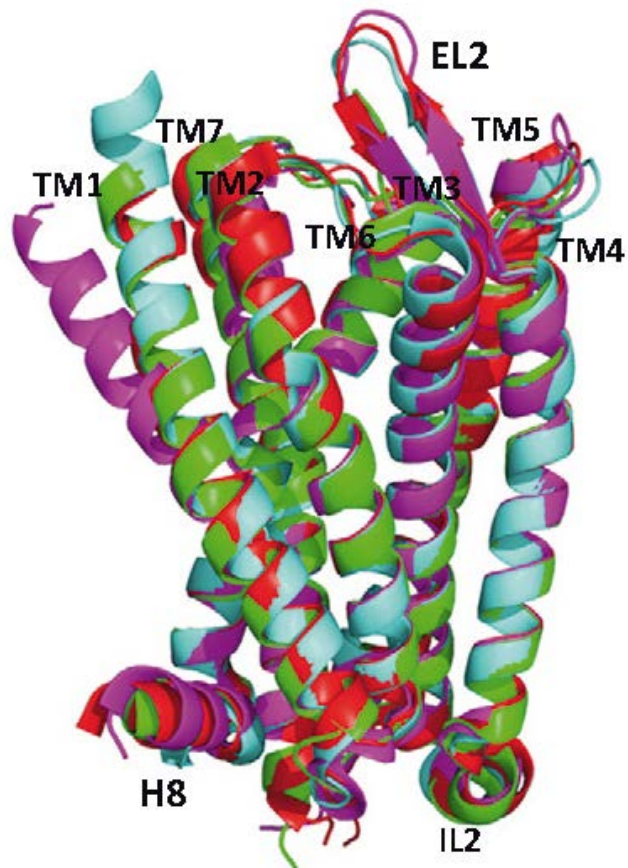

Figure 16: Structure of Opioid Receptors

Opioid receptors, Class A rhodopsin-like G-protein Coupled Receptors (GPCRs) which are eukaryotic proteins and are composed of seven transmembrane α helices
Filizola & Devi 2013

paths after endocytosis. Whereas MOP receptors are rapidly recycled following their endocytosis, DOP receptors are rapidly degraded in the lysosomal compartment. Modulation of OR signaling thus involves endocytic events (desensitization) and post-endocytic sorting events (resensitization or downregulation) (Waldhoer et al., 2004) (see Figure 17 and 18).

(3) Anatomical Distribution

(a) *Opioid Gene Expression in the Central Nervous System (CNS)*

Opioid receptors and peptides are both widely expressed throughout the CNS. ORs are expressed in the cortex, limbic system, and brain stem, as shown by either radioligand binding, mRNA detection, or fluorescent receptor fusion proteins. The sites of OR expression (mRNA) generally match the distribution of binding sites (OR protein). The distribution patterns of the three ORs mostly overlap but their respective expression levels vary across the different brain areas. MOP receptor is highly expressed in the amygdala, thalamus (TH), mesencephalon, medial habenula and some brainstem nuclei such as the raphe nuclei. DOP receptor is the most abundant receptor in the olfactory tract, medial amygdala and in the cortex, the basolateral amygdala and is also highly expressed in the basal ganglia and the pontine nucleus (PN). KOP receptor is mostly expressed in the basal anterior forebrain, olfactory tubercle, preoptic area (POA), hypothalamus, and amygdala (Erbs et al., 2015; for review see Le Merrer et al., 2009) (see Figures 19 and 20).

Opioid peptide distribution patterns have been described using in situ hybridization and were also detected in projection fibres by immunohistochemistry. POMC distribution is restricted and is only synthesized in two regions of the brain: the arcuate nucleus of the hypothalamus (Arc), nucleus tractus solitaries (NTS, brain stem), and pituitary gland. Penk is abundantly and widely distributed in a number of brain areas and is best detected in the basal ganglia, the amygdala, the Periaqueducal Gray Matter and the hypothalamus. Pdyn is present in most brain structures, with the highest density in the hypothalamus, the striatum and dentate gyrus of the hippocampus (Le Merrer et al., 2009).

In the spinal cord, radioligand binding studies revealed that MOP receptors are expressed predominantly in DH lamina I and the outer part of lamina II, and lower expression levels are observed in deeper laminae (III to VIII and X), which was also observed using fluorescent MOP-mCherry mice (Erbs et al., 2015). DOP receptor was

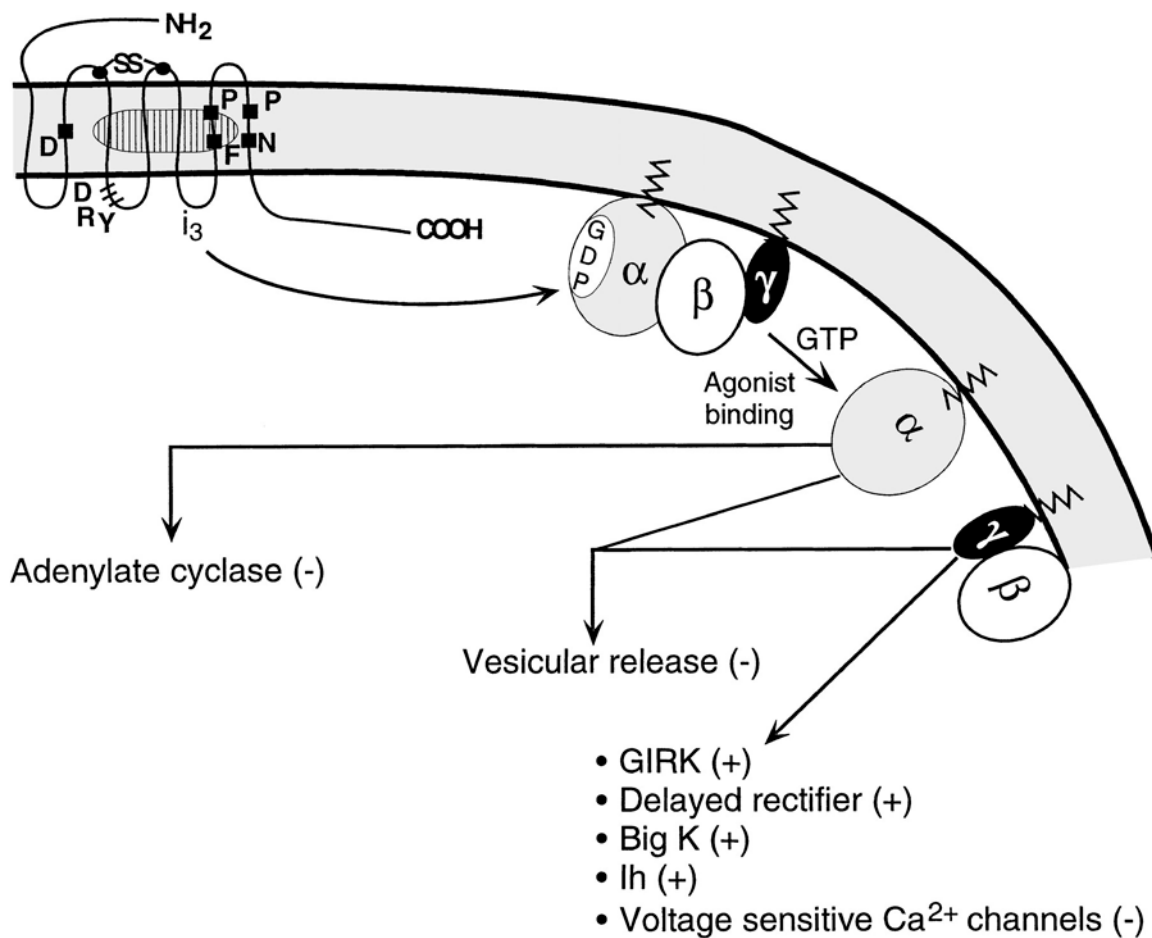

Figure 17: Illustration of the best-characterized pathway of effector activation of opioids.

Three primary classes of effectors include the inhibition of adenylyl cyclase, inhibition of vesicular release, and interactions with a number of ion channels. These effectors are affected by both the GTP-bound form of the α-subunit as well as free β/γ-subunits of pertussis toxin-sensitive G proteins. GIRK, G protein inwardly rectifying conductance.

From Williams 2001.

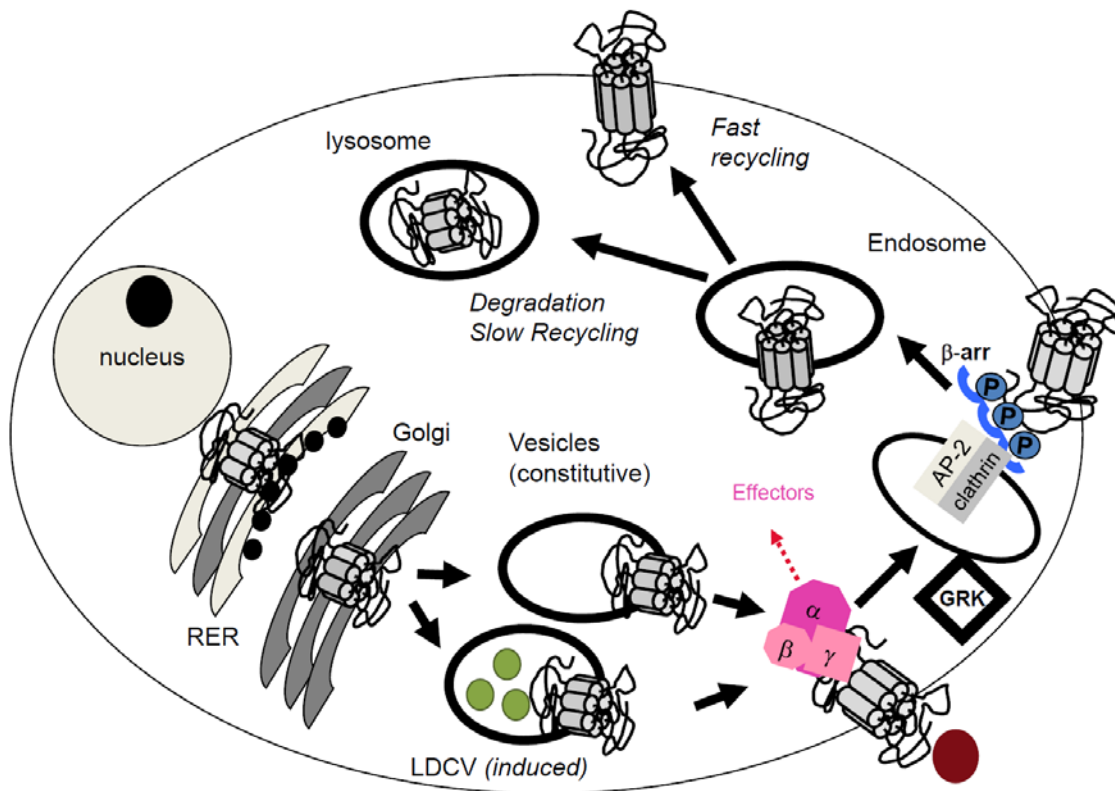

Figure 18: Illustration of the GPCR life cycle.

GPCRs are folded and assembled within the rough endoplasmic reticulum (RER). Properly folded receptors are transported from the RER through the Golgi complex to the plasma membrane by either the constitutive pathway or the induced pathway via low density core vesicles (LDCV). Activation of GPCRs occurs by binding of the agonist that stimulates heterotrimeric G proteins. This G protein-dependent signaling results in the production of second messengers. Simultaneously, GRKs phosphorylate the receptor leading to arrestin binding and inhibition of G protein-dependent signaling (desensitization). In addition to desensitizing the receptor by uncoupling the receptor from G proteins, arrestins also recruit clathrin and adaptin molecules to target the desensitized receptor to clathrin-coated pits. Following internalization via the endosomal pathway, receptors undergo fast recycling and return to the plasma membrane, or are degraded in lysosomes.

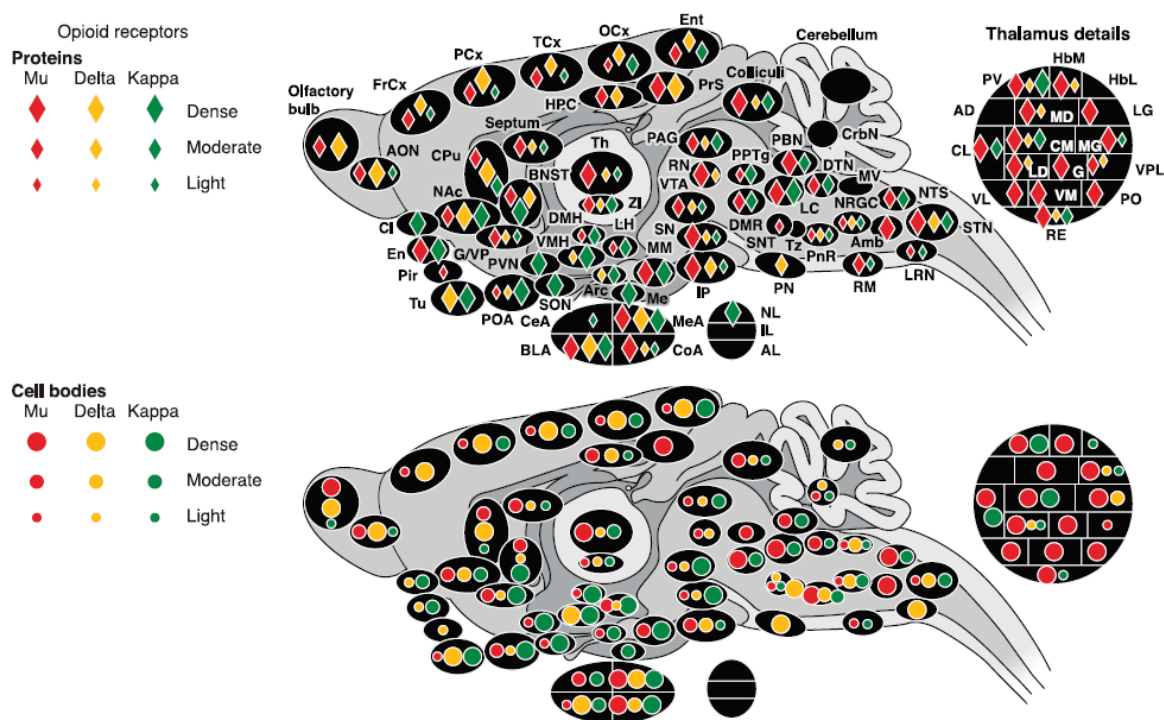

Figure 19: Anatomical distribution of opioid receptors in the rodent brain (rat and mouse).

Colors correspond to each of the three opioid receptor or peptide precursor. Densities are represented by symbols of different sizes, from low to high.

Receptors. *Top panel* represents the distribution of opioid receptor proteins as determined by ligand autoradiography. *Bottom panel* summarizes the localization of cell bodies expressing opioid receptors based on the detection of mRNAs by in situ hybridization.

Abbreviations: Amb, nucleus ambiguus; AD, anterodorsal thalamus; AL, anterior lobe, pituitary; AON, anterior olfactory nucleus; Arc, arcuate nucleus, hypothalamus; BLA, basolateral nucleus, amygdala; BNST, bed nucleus of the stria terminalis; CeA, central nucleus, amygdala; Cl, claustrum; CL, centrolateral thalamus; CoA, cortical nucleus, amygdala; CPu, caudate putamen; CrbN, cerebellar nuclei; DMH, dorsomedial hypothalamus; DMR, dorsal and medial raphe; DTN, dorsal tegmental nucleus; En, endopiriform cortex; Ent, entorhinal cortex; FrCx, frontal cortex; G, nucleus gelatinosus, thalamus; G/VP, globus pallidus/ventral pallidum; HbL, lateral habenula; HbM, medial habenula; HPC, hippocampus; IL, intermediate lobe, pituitary; IP, interpeduncular nucleus; LC, locus coeruleus; LD, laterodorsal thalamus; LG, lateral geniculate, thalamus; LH, lateral hypothalamus; LRN, lateral reticular nucleus; MD, mediodorsal thalamus; Me, median eminence; MEA, median nucleus, amygdala; MG, medial geniculate; MM, medial mammillary nucleus; MV, medial vestibular nucleus; NAc, nucleus accumbens; NL, neuronal lobe, pituitary; NRGC, nucleus reticularis gigantocellularis; NTS, nucleus tractus solitarius; OCx, occipital cortex; PAG, periaqueductal gray; PCx, parietal cortex; Pir, piriform cortex; PN, pontine nucleus; PnR, pontine reticular; PO, posterior thalamus; POA, preoptic area; PPTg, pedunculo-pontine nucleus; PrS, presubiculum; PV, paraventricular thalamus; PVN, paraventricular hypothalamus; RE, reuniens thalamus; RN, red nucleus; RM, raphe magnus; SON, supraoptic nucleus; SN, substantia nigra; SNT, sensory trigeminal nucleus; STN, spinal trigeminal nucleus; TCx, temporal cortex; Th, thalamus; Tu, olfactory tubercle; Tz, trapezoid nucleus; VL, ventrolateral thalamus; VM, ventromedial thalamus; VMH, ventromedial hypothalamus; VPL, ventroposterolateral thalamus; VTA, ventral tegmental area; ZI, zona incerta.

Adapted from LeMerrer 2009.

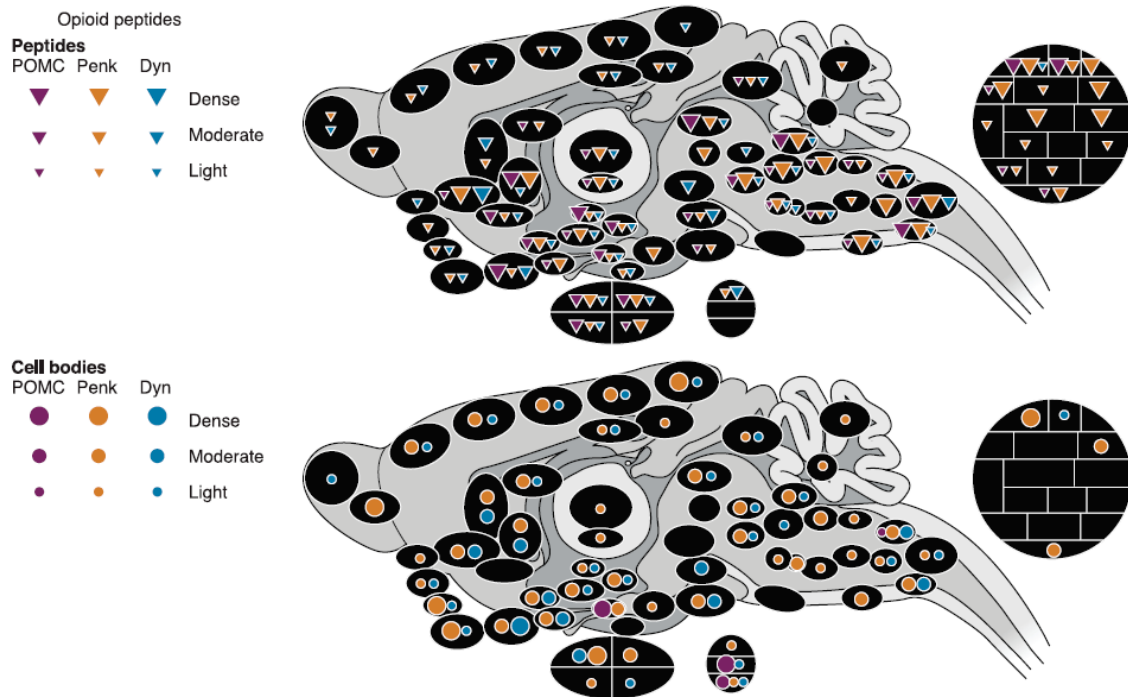

Figure 20: Anatomical distribution of opioid peptides in the rodent brain (rat and mouse).

Colors correspond to each of the three opioid receptor or peptide precursor. Densities are represented by symbols of different sizes, from low to high.

Peptides. *Top panel* depicts the pattern of distribution of opioid peptides by immunohistochemistry. *Bottom panel* maps cell bodies expressing opioid peptides

Abbreviations: Amb, nucleus ambiguus; AD, anterodorsal thalamus; AL, anterior lobe, pituitary; AON, anterior olfactory nucleus; Arc, arcuate nucleus, hypothalamus; BLA, basolateral nucleus, amygdala; BNST, bed nucleus of the stria terminalis; CeA, central nucleus, amygdala; Cl, claustrum; CL, centrolateral thalamus; CM, centromedial thalamus; CoA, cortical nucleus, amygdala; CPu, caudate putamen; CrbN, cerebellar nuclei; DMH, dorsomedial hypothalamus; DMR, dorsal and medial raphe; DTN, dorsal tegmental nucleus; En, endopiriform cortex; Ent, entorhinal cortex; FrCx, frontal cortex; G, nucleus gelatinosus, thalamus; G/VP, globus pallidus/ventral pallidum; HbL, lateral habenula; HbM, medial habenula; HPC, hippocampus; IL, intermediate lobe, pituitary; IP, interpeduncular nucleus; LC, locus coeruleus; LD, laterodorsal thalamus; LG, lateral geniculate, thalamus; LH, lateral hypothalamus; LRN, lateral reticular nucleus; MD, mediodorsal thalamus; Me, median eminence; MEA, median nucleus, amygdala; MG, medial geniculate; MM, medial mammillary nucleus; MV, medial vestibular nucleus; NAc, nucleus accumbens; NL, neuronal lobe, pituitary; NRG, nucleus reticularis gigantocellularis; NTS, nucleus tractus solitarius; OCx, occipital cortex; PAG, periaqueductal gray; PCx, parietal cortex; Pir, piriform cortex; PN, pontine nucleus; PnR, pontine reticular; PO, posterior thalamus; POA, preoptic area; PPTg, pedunculo-pontine nucleus; PrS, presubiculum; PV, paraventricular thalamus; PVN, paraventricular hypothalamus; RE, reuniens thalamus; RN, red nucleus; RM, raphe magnus; SON, supraoptic nucleus; SN, substantia nigra; SNT, sensory trigeminal nucleus; STN, spinal trigeminal nucleus; TCx, temporal cortex; Th, thalamus; Tu, olfactory tubercle; Tz, trapezoid nucleus; VL, ventrolateral thalamus; VM, ventromedial thalamus; VMH, ventromedial hypothalamus; VPL, ventroposterolateral thalamus; VTA, ventral tegmental area; ZI, zona incerta.

Adapted from LeMerrer 2009.

detected throughout the gray matter in the DH, and dense bands fluorescence were detected in laminae I, II (inner part) of DOPeGFP knock-in mice (Scherrer et al., 2009). KOP receptor expression is very high in DH laminae I and II (Minami et al., 1995; Mennicken et al., 2003; Gray et al., 2006; Scherrer et al., 2009). Projection neurons from the brainstem (Nucleus of the Solitary Tract) are the main source of β endorphin in the DH, whereas PENK precursor protein is widely expressed by neurons in the peripheral nervous system and DH interneurons. PDYN is expressed by DH interneurons as well, especially by those situated in laminae I and II (Przewłocki and Przewłocka, 2001).

(b) *Opioid gene expression in peripheral tissues*

OR expression in the peripheral nervous system was described over twenty years ago (Stein 1993, 1995), and has been detected in cell bodies of small, medium and large DRG neurons (Wang et al., 2010a; Stein and Lang, 2009). The sensitive fibres express ORs at central and peripheral termini, as well as at the axonal level via axonal transport (Stein et al., 2001; Bardoni et al., 2014). In the autonomous nervous system, postganglionic sympathetic nerve terminals also express opioid receptors. In the brainstem, several nuclei expressing MOP and KOP receptors are linked to the vagus nerve afferences, which are involved in visceral nociception and digestive functions.

Immune cells express MOP DOP and KOP receptor mRNA transcripts, which have been detected by q-RT-PCR (Chuang et al., 1995; Gaveriaux et al., 1995; for review see Ninković and Roy, 2013) and by radioligand binding (for review see Bidlack et al., 2006). In immune cells, OR activation engages the same intracellular pathways as the ones described in neuronal cells, namely Adenylate Cyclase inhibition and ERK phosphorylation. DOP receptor expression has been particularly investigated in the light of a possible role in maturation and activation of immune cells, or inhibition of proliferation (Sharp, 2006). The activation of the T cell Receptor (TCR) upon the detection of its specific antigen induces DOP receptor expression (Sharp, 2006; Stein and Machelska, 2011). Immune cells are probably the main, and undoubtedly most investigated, non-neuronal source of peripheral endogenous opioid peptides (Rittner et al., 2009; Hua and Cabot, 2010; Boué et al., 2011; Stein and Machelska, 2011). Opioid peptide synthesis and secretion is a common feature of macrophages, granulocytes, monocytes and lymphocytes (Mousa et al., 2001; Labuz et al., 2006; Zöllner and

Schäfer, 2008). Endogenous opioid peptide release by immune cells is induced by their activation with various signals and ligands; corticotrophin-releasing factor receptors (CRFR), and β -adrenergic receptors (β AR), chemokine and/or IL-1 β receptors (Cabot, 2001) that produce calcium-dependent opioid peptide release. PENK and POMC mRNA and enzymatic machinery for proteolytic precursor cleavage have been detected in leukocytes (Mousa et al., 2004).

The enteric nervous system is composed of two ganglionic plexi, which innervate the whole digestive tract. The myenteric plexus (Auerbach's plexus) is situated between longitudinal and circular muscle layers, and controls gut motility and peristalsis. The submucosal plexus (Meissner's plexus) is located between the circular muscle layer and the intestinal mucosa. This network regulates gland and cellular secretory functions of the digestive system. The enteric nervous system, the visceral sensitive fibres and the vagus nerve nuclei all express opioid receptors, which were detected by autoradiography (Atweh et al., 1978; Sternini et al., 2004; Wood and Galligan, 2004; Belvisi and Hele, 2009). Species and cell type account for differences in OR expression patterns, however, MOP receptor is highly expressed in enteric and myenteric neurons, and in the muscular cell layer, close to interstitial cells of Cajal (ICC) that have pacemaker activity generating gut motility. In human tissue, the MOP receptor is highly expressed in myenteric and submucosal neurons, and in resident macrophages or monocytes which populate the lamina propria. DOP receptor immunoreactivity was detected in myenteric and submucosal neurons, smooth muscle cells and the digestive mucosa (Brown et al., 1998; Poonyachoti et al., 2002; Sternini et al., 2004; Poole et al., 2011). The KOP may only be expressed in myenteric neurons in humans, and less is known about KOP receptor expression (Bagnol et al., 1997; Sternini et al., 2004). Despite the fact that opioids are known to induce smooth muscle contraction in the digestive system, little or no expression was detected in these tissues. Enkephalins are colocalized with MOP expression, in myenteric neurons (Furness et al., 1983), which suggests that the opioid system activity exerts paracrine negative feedback on peristalsis. Enkephalins and dynorphins are both detected in the digestive system (Sternini et al., 2004).

2. Opioids in drug addiction and mood regulation

Repeated use of drugs leads to addiction, which is a chronic relapsing disorder characterized by compulsive drug-seeking and drug-taking behaviours despite the appearance of adverse side effects, and is dissociated from

recreational use of the substance. Addiction can be characterized by a progressive shift in endogenous reward mechanisms and hedonic homeostasis (Koob and Volkow, 2010; Lutz and Kieffer, 2013b). According to DSM V, the state of addiction is defined by the occurrence of impairments and distresses including compulsive and persistent desire to consume the substance, difficulties to control drug use, increasing time spent seeking to obtain the substance, among other signs. MOP receptor is the main receptor which mediates the reinforcing and rewarding effects of opiates (morphine and heroin) and other drugs, but also endogenous opioid peptides released in the context of pleasurable natural stimuli (Contet et al., 2004; Le Merrer et al., 2009). The euphoric state which follows drug intake has been described in both animals and humans (Sauriyal et al., 2011). Endogenous and exogenous stimuli both have powerful reinforcing properties which increase the individual's motivation to obtain the rewarding stimulation. Indeed, social interactions such as peer or maternal attachment are also mediated by MOP receptors (Cinque et al., 2012).

The KOP receptors and endogenous ligands, the dynorphins, are the main opioid components involved in mediating opposing effects to the reward processing (Wee and Koob, 2010), and thus balancing the reinforcing message by mediating aversion and dysphoria which can appear during a state of abstinence (Lutz and Kieffer, 2013a, 2013b). KOP mediated dysphoria and aversion supposedly progressively instate pro-depressive mechanisms (Knoll and Carlezon, 2010). Overall, aversive and pro-depressive tone exerted by endogenous KOP receptor/dynorphin system intensifies over time during drug use and may be an important component in relapse versus abstinence (Lutz and Kieffer, 2013b).

The involvement of DOP receptor activity in reward processes engaged in drug addiction is still debated, as DOP receptor activity is not required for the manifestation of the addictive qualities of drugs of abuse. However, evidence is accumulating for a crucial role in drug-context association (Faget et al., 2012 and references therein) and predictive reward evaluation upon pavlovian conditioning (Laurent 2015), that would designate DOP receptors as key players in relapse (Gutiérrez-Cuesta et al., 2014). The involvement of DOP receptors in the anxiodepressive state has also been shown to have an impact on drug addiction. Indeed, genetic approaches have demonstrated that DOP receptor deficient mice exhibit increased ethanol consumption, which was correlated to anxiety-like symptoms (Roberts et al., 2001).

Anxiety is characterized by a state of uncertainty and fear resulting from the anticipation of adverse or dangerous situations (either realistic or not), and can impair physical and psychological processes (Fuchs and Flügge, 2006). Anxiety evaluation in rodents by behavioral approaches entail exposure to stressful stimuli such as open spaces, novelty, light, anxiogenic compounds. DOP receptor deficient animals have exacerbated anxiety traits (Filliol et al., 2000). Mice which lack Penk precursor gene exhibit increased fear reactions in a stressful context (Ragnauth et al., 2001), and enhancing endogenous opioid tone by using enkephalinase inhibitor RB 101 reduced anxious-like behaviours (Nieto et al., 2005). Additionally, selective DOP receptor agonist SNC80 decreased anxiety; therefore the endogenous DOP receptor activation regulates anxiety-like behaviours in animals.

Depression is a mood disorder in which individuals suffer from preoccupation, extremely negative thoughts, sleep disturbances, feelings of despair and difficulties to concentrate. In preclinical investigations, DOP receptor knock-out animals manifested increased despair-like behavior and had a depressive-like phenotype (Filliol 2000). Accordingly, DOP receptor agonists attenuate depressive-like behaviours in preclinical tests (Baamonde et al., 1992; Saitoh et al., 2004; Tejedor-Real et al., 1998; Torregrossa et al., 2006). Additionally, administration of the enkephalinase inhibitor RB101 decreases depressive-like behaviours in wild type and MOP receptor deficient animals, an effect which is reversed by the selective DOP receptor antagonist naltrindole revealing that DOP receptor mediated alleviation of depressive-like symptoms depends on the endogenous enkephalinergic system (Nieto et al., 2005).

3. Roles of the Endogenous Opioid System in Digestion and Visceral Perception

Opiate effects in the gut are mediated via their effect on the enteric nervous system, where the ORs are widely expressed (see Section I.b.4 *b Expression in Peripheral Tissues*) and we will present the neurophysiological effects of endogenous and exogenous opiates on gastro-intestinal smooth muscle fibres and secretory glands.

a) Effects on gastrointestinal motility

Opiates globally decrease the activity of the enteric network resulting in decreased motility and inhibition of secretory functions. Dynorphin or enkephalin administration reduces acetylcholine release via facilitation of serotonergic tone (Yau et al., 1990; Wu et al., 1982). Morphine decreases peristalsis, by disrupting the

rhythmic contraction of circular and longitudinal smooth muscles of the gut, desynchronized contractions lead to lower peristaltic propulsion, and constipation (Cherubini et al., 1985; Wood and Galligan, 2004). Morphine administration activates ORs in the spinal cord DH and supraspinal structures, and this leads decreased neurotransmitter release with lower levels of Acetylcholine released at neuromuscular junctions, thus morphine also acts indirectly to decrease gut motility (Galligan and Burks, 1983; Porreca and Burks, 1983). Opiates also slow down gastric emptying and reduce gastric motility (Thörn et al., 1996; Asai, 1998; Wood and Galligan, 2004), reduce biliary secretion and increase the contraction of Oddi sphincter (Coelho et al., 1986). Opiates reduce the activity of secretory processes of all digestive fluids by the digestive system (pancreas, liver, cells of the gut epithelium) which also contributes to constipation. Peripherally acting MOP receptor agonists (Racécadotril and Loperamid, Immodium®) are used to treat diarrhea. Chronic administration causes decreased potency of opiates, which resembles tolerance mechanisms (North and Karras, 1978; see *Tolerance* Section).

4. Pain Modulation by the Opioid System

a) Antinociception

Opioid receptors are expressed in all the structures which are involved in nociceptive signal transmission and processing (Erbs et al., 2015; Le Merrer et al., 2009). The implication of each OR in pain modulation has been investigated using pharmacological and genetic approaches. Individual ORs have distinct expression patterns within the pain circuit at the supraspinal level. MOP receptors are the most important actors in the modulation of responses to thermal, mechanical and chemical irritant nociception. KOP receptors influence spinal mediation of thermal and chemical nociceptive stimuli and are involved in visceral pain perception, and DOP are involved in modulation of mechanical nociception and inflammatory pain, especially in the setting of chronic pain (Martin et al., 2003; Gavériaux-Ruff et al., 2011; Simonin et al., 1998). Constitutive DOP receptor knock-out animals showed no difference in acute chemical, thermal or mechanical pain behaviours (Kieffer and Gavériaux-Ruff, 2002) whereas MOP receptors are the main mediators of the three types of acute nociceptive stimuli processing (Martin et al., 2003). Evidence supports that DOP receptor agonists reduce inflammatory pain perception (Gavériaux-Ruff et al., 2008), and animals lacking the DOP receptor exhibited reduced

inflammatory and neuropathic pain compared to wildtype animals (Gavériaux-Ruff et al., 2008; Nadal et al., 2006) (see Figure 21).

In the spinal cord, MOP receptors are expressed by primary afferent terminals (Li 1998) in a population of neurons located in laminae I–II of the DH (Marvizón et al., 2009). MOP receptors in primary afferent terminals inhibit neurotransmitter release, particularly the release of excitatory neuropeptides such as SP (Yaksh et al., 1980; Mauborgne et al., 1987; Kondo et al., 2005; Zhang et al., 2010; Chen et al., 2014). OR activity on postsynaptic DH neurons also reduces excitability of these neurons (Aicher et al., 2000). Thus, the processes which underlie nociceptive transmission are inhibited by endogenous opioid peptides, which are mainly released by intrinsic spinal neurons (Pohl et al., 1997), and also from terminals of bulbospinal neurons, which both contain peptides derived from proenkephalin A and prodynorphin (Weihe, 1992).

In the CNS, endogenous opioids activate the descending control mechanisms, which involve the projections to the spinal cord and decreased nociceptive transmission in the DH. The main central areas involved are the PAG and the RVM (see Section on Descending Control).

In the peripheral nervous system, MOP and DOP receptors are expressed by primary sensory neurons including nociceptors (Scherrer et al., 2009; Bardoni et al., 2014) and during inflammation for example, OR activation reduces the release of pro-algesic mediators at the peripheral level (CGRP, SP) (Stein and Lang, 2009). KOP receptors are predominantly localized in small myelinated and unmyelinated nociceptive afferent neurons in the DRG and spinal cord; particularly, high expression is seen in the DH and the substantia gelatinosa with lower expression in the ventral horn (Peckys and Landwehrmeyer, 1999).

Overall, MOP is considered to be the main mediator of pain inhibition; however the roles of both KOP and DOP appear to be essential in the modulation of visceral and chronic pain state respectively (Kivell and Prisinzano, 2010; Gavériaux-Ruff and Kieffer, 2011).

b) Tolerance: involvement of MOP-DOP receptor interaction

Tolerance manifests as decreased effects for the same dose over time, and the need to increase drug administration to obtain the same pharmacological effect. It therefore represents a clinical complication of drug use. In the case of opioid treatments, tolerance to analgesic and to euphoric effects may give rise to opioid-

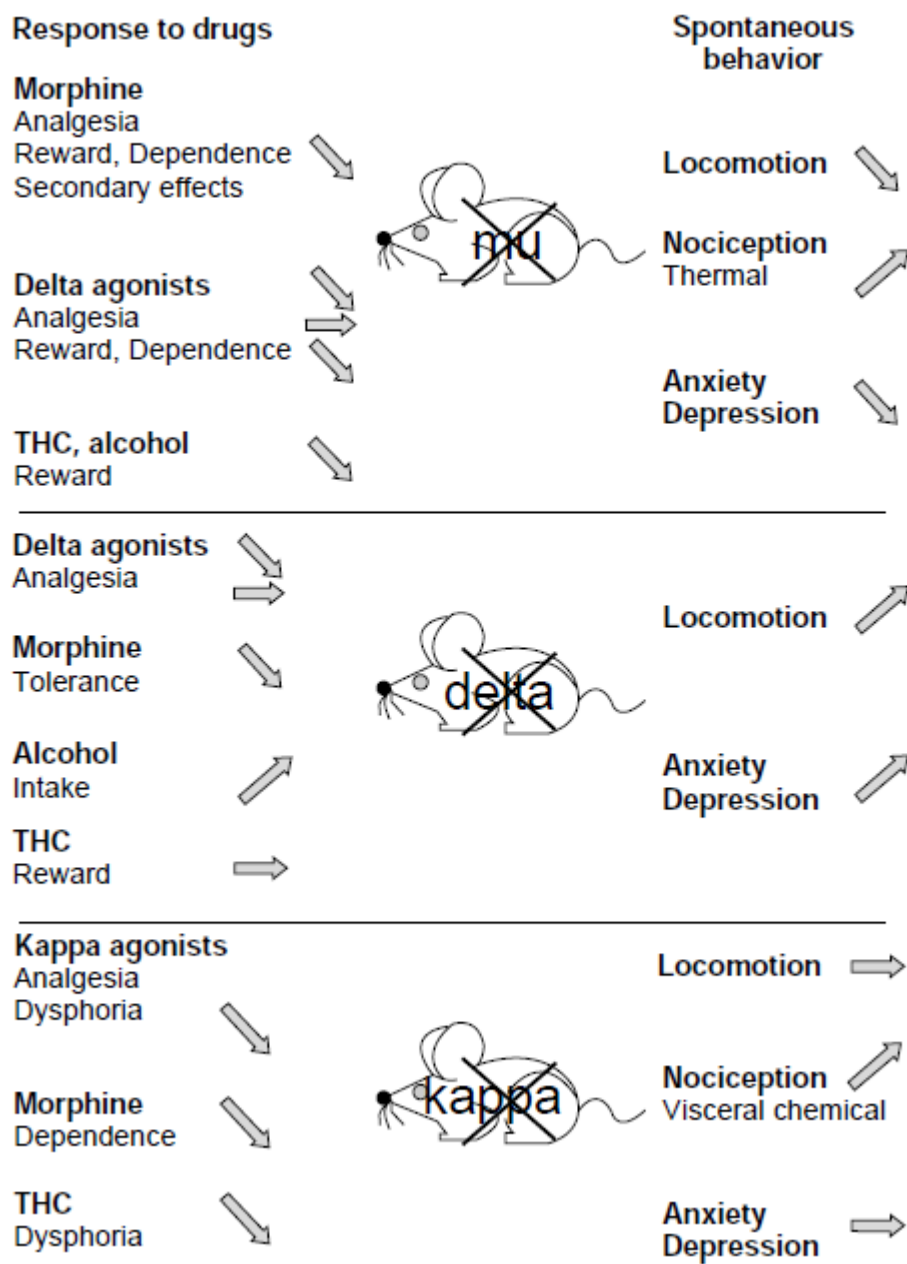

Figure 21: Summary of responses to drugs and spontaneous behaviours in opioid receptor knock-out mice. Mutant mice are indicated in the middle, responses to drugs are shown on the left with drugs indicated, and behaviours in the absence of drugs are shown on the right.

- ↘ Strongly reduced or abolished
- ↗ Increased
- Unchanged or decreased depending on the experimental conditions.

From Gaveriaux-Ruff & Kieffer 2002.

induced hyperalgesia and compulsive escalating consumption in opioid addiction respectively (Trang et al., 2015; Allouche et al., 2014; Brush, 2012). Tolerance to analgesia can be modeled in rodents, and depends on doses and the duration of administration. To explain tolerance, OR trafficking and activity changes have been described that include receptor phosphorylation and endocytosis inducing receptor desensitization and downregulation following chronic opiate exposure (for review, see Allouche et al., 2014).

(1) Functional interactions between MOP and DOP receptors

Several decades of opioid pharmacology have uncovered the complexity of the opioid system physiology. Analysis of the effects of opioid drugs *in vivo* has revealed functional interactions across receptors, especially between MOP and DOP receptors. However, whether these interactions occur at circuitry, cellular or molecular level remains highly debated. MOP receptors constitute the primary molecular target of opiates and mediate their analgesic and euphoric properties whereas DOP receptors are critical for the development of morphine tolerance. Indeed, genetic deletion and pharmacological blockade of DOP receptors reduce morphine tolerance (for review Cahill et al., 2007; Gendron et al., 2015). There is pharmacological evidence of functional interactions between MOP and DOP receptors. In particular, both chronic pain and chronic morphine treatment induce MOP-dependent trafficking to the plasma membrane of DOP receptors which affect MOP signalling (Erbs et al., 2016; also reviewed in Cahill et al., 2007; Gendron et al., 2015). Conversely, surface expression of MOP receptors and MOP agonists coupling efficacy to voltage-dependent calcium channels are both decreased in DRGs from DOP knock-out mice, suggesting that DOP receptors also affect MOP receptor trafficking and signaling (Walwyn et al., 2009). Functional interactions between MOP and DOP receptors thus play a crucial role in the development of tolerance that appears upon chronic administration of opiates and represent a very active field of research.

(a) Clues indicating MOP-DOP physical proximity

A number of studies have addressed the question of physical association between class A GPCRs and investigated the functional impact of heteromer formation in heterologous systems, however in these models the receptors are not naturally produced and are often expressed at levels that exceed endogenous receptor expression (Birdsall, 2010; Gupta et al., 2011). In the case of MOP and DOP receptors, numerous reports

indicate that co-expression in heterologous systems affects binding and signaling properties through MOP-DOP heteromer formation (recently reviewed in Fujita et al., 2014), indicating that MOP-DOP co-expression in heterologous systems alters receptor trafficking and results in specific functional properties.

Several studies have attempted to establish MOP-DOP physical proximity *in vivo*. Convincing evidence has been brought by MOP-DOP co-immunoprecipitation in rat dorsal root ganglia (DRG) (Xie et al., 2009), mouse spinal cord (Gomes et al., 2004; He et al., 2011) and mouse hippocampus (Erbs et al., 2015). MOP-DOP proximity in several brain areas was also evidenced by using heteromer-specific antibodies (Gupta et al., 2010). Interestingly, 3D crystallization of MOP and DOP receptors also provided arguments which are in favour of MOP-DOP physical association. MOP receptors were crystallized in a parallel dimeric form suggesting that the receptor can easily dimerize (Manglik et al., 2012). Additional experiments also pointed to an involvement of the receptor C-termini in heteromer formation (reviewed in Massotte, 2015). Altogether, structural, biochemical and *in silico* data suggest that MOP TM 1 and DOP TM 4/TM 5 participate in the receptor interface within opioid heteromers with additional interactions between the C-termini and support *in vivo* MOP-DOP physical proximity.

(b) Disruption of MOP-DOP physical proximity induces functional changes

Importantly, interfering with MOP-DOP physical proximity modified the functional outcome. Expression of the MOP TM1 fused to the TAT sequence not only blocked endogenous MOP-DOP co-immunoprecipitation but also MOP-DOP degradation in the lysosomal compartment (He et al., 2011). Expression of this fusion construct in the spinal cord also increased morphine thermal analgesia and decreased morphine tolerance (He et al., 2011). Likewise, expression of the DOP C-terminus fused to the TAT sequence in the rat nucleus accumbens decreased co-immunoprecipitation and reduced anxiolytic and antidepressant effects induced by UFP 512, which is proposed to be MOP-DOP biased agonist (Kabli et al., 2010, 2014). Finally, a peptide corresponding to the DOP second intracellular loop fused to the TAT sequence reduced morphine tolerance in rat and reduced DOP cell surface expression in DRGs (Xie et al., 2009). Collectively, these studies strongly suggest MOP-DOP physical proximity *in vivo* and an important functional impact of MOP-DOP heteromers.

(2) MOP-DOP heteromerization may underlie opiate tolerance

Using double knock-in mice co-expressing MOP and DOP receptors in fusion with a red and a green fluorescent protein respectively (Erbs et al., 2015), abundant MOP-DOP neuronal co-expression in circuits associated with nociception was described (Erbs et al., 2015). In addition, MOP-DOP selective antibodies revealed increased abundance of MOP-DOP heteromers in various brain regions of the nociceptive pathway upon chronic morphine treatment (Gupta et al., 2010). Pharmacological data also support a role for MOP-DOP heteromers in opiate tolerance and dependence. MDAN-19, a bivalent ligand in which the MOP agonist oxymorphone and the DOP antagonist naltrindole are tethered at a length consistent with the distance separating the binding pockets of two GPCRs making physical contact, elicits analgesic responses with attenuated tolerance and physical dependence (Daniels et al., 2005). Activation of MOP-DOP heteromers by the biased agonist CYM51010 produces acute thermal analgesia comparable to morphine but induces less tolerance upon repeated administration (Gomes et al., 2013). In addition, the MOP agonist DAMGO induces DOP receptor internalization and recycling in primary cultures from DRGs after prolonged morphine treatment (Ong et al., 2015) and MOP-dependent DOP receptor trafficking to the plasma membrane is increased upon chronic morphine treatment in DRGs (reviewed in Cahill et al., 2007; Gendron et al., 2015) and hippocampus (Erbs et al., 2016). Collectively, these observations point to MOP-DOP heteromers as a molecular entity underlying the development of tolerance and dependence through molecular mechanisms that remain however poorly characterized.

5. Opioid receptors and peptides involvement in chronic pain

a) Roles of MOP and KOP receptors and Opioid Peptides

(1) MOP receptor

Conventional and conditional knock-out animals continue to yield valuable information regarding the multiple roles that opioid receptors play in pathophysiological conditions. MOP receptor knock-out animals (MOP KO) have shown that in basal conditions, these animals display increased thermal nociception and are less sensitive to acute chemical visceral stimulation (decreased acetic acid writhing) which suggests a role for endogenous MOP receptor activity in the modulation of thermal and visceral nociception in physiological conditions (Filliol

et al., 2000; Sora et al., 1997, 1999). MOP KO mice had lower levels of stress-induced analgesia for thermal and mechanical stimuli and higher responses to mechanical stimuli following formalin injection (acute noxious chemical stimulation) (LaBuda et al., 2000; reviewed in Gavériaux-Ruff and Kieffer, 2002). In MOP KO animals, the analgesic effects of morphine are abolished (Matthes et al., 1998; Gavériaux-Ruff and Kieffer, 2002). However conditional knock-out strategies which delete the MOP receptor in peripheral afferents expressing Nav1.8 show that this population of peripheral MOP receptors are not essential to morphine effects, as acute morphine analgesia is unchanged under physiological conditions of thermal, chemical and mechanical stimulation in MOP cKO mice (Weibel et al., 2013) (see Figure 21).

In acute and chronic intestinal inflammation following the administration of croton oil, MOP receptor agonists displayed enhanced effects: transit inhibition was greater in animals suffering from colitis (Puig and Pol, 1998) and this effect may be attributed to higher expression of MOP receptors in inflammatory conditions. Indeed, during painful visceral inflammation, MOP receptor mRNA and protein levels are increased in the myenteric plexus, and it has been suggested that MOP receptor activity inhibits electrolyte and water secretion into the gut lumen and also promotes the recovery of the gut epithelium by enhancing maturation and migration of cells in the gut wall (Galligan and Akbarali, 2014). Morphine induces constipation via the MOP receptor, and MOP KO mice do not show reduced transit upon morphine administration whereas Nav1.8 conditional MOP receptor knock-out animals (MOP cKO) display unchanged effects of morphine in the charcoal test, which suggests that MOP receptors in primary afferents expressing Nav1.8 are not involved in morphine-induced constipation (Weibel et al., 2013). The specific role of central and peripheral MOP receptor populations in acute or chronic visceral inflammation has not yet been explored by genetic approaches.

Inflammation models such as Complete Freund Adjuvant (CFA) injection in the plantar surface of the hindpaw are sensitive to morphine analgesia and MOP KO animals are not relieved by morphine administration in inflammatory conditions (Qiu et al., 2000). Surprisingly, these animals recover faster from inflammatory thermal hyperalgesia, which suggests that MOP receptor may play a role in the maintenance of persistent inflammatory pain (Qiu et al., 2000). In the CFA inflammatory pain model, analgesic effects of morphine on mechanical and thermal modalities was diminished in Nav1.8 MOP cKO mice, and the analgesic effect of the

peripherally acting MOP receptor agonist loperamid was abolished, indicating the involvement of MOP receptors expressed in these neurons (Weibel et al., 2013) (see Figure 21).

Acute and subchronic morphine alleviates neuropathic pain in the cuff model, however tolerance develops after 5 days of administration at 10mg/kg (Benbouzid et al., 2008c). MOP KO animals are not relieved by morphine following neuropathy (Bohren et al., 2010). In neuropathic pain conditions, MOP KO animals responded to nortriptyline, the antiallodynic effect of which was unchanged (Bohren et al., 2010). MOP receptors do not appear to participate in therapeutic effects of gabapentinoids, another class of prescribed drugs which alleviates neuropathic pain, as recently been established.

(2) KOP receptor

Total KOP receptor knock-out animals (KOP KO) displayed increased nociceptive responses to acute chemically-induced visceral pain (Gebhart et al., 2000; Gavériaux-Ruff and Kieffer, 2002), whereas there were no obvious alterations of physiological nociception in these animals lacking KOP receptors. Interestingly, KOP KO animals also display increased mechanical allodynia and thermal hyperalgesia in the context of neuropathic pain following SNL, similar to mice treated with norbinaltorphimine (nor-BNI), a KOP receptor antagonist (Xu 2004) (for review, see Gaveriaux-Ruff and Kieffer, 2002). In the cuff model, KOP KO animals show mechanical allodynia which is similar to that observed in wild type (WT) animals (Megat et al., 2015) (see Figure 21).

Persistent inflammatory pain and neuropathy induced by SNL both induce up-regulation of dynorphin in the DH of the spinal cord (Parra 2002, Wang 2001), and release of endogenous prodynorphin-derived opioid peptides and increased KOP receptor activation in the spinal dorsal horn produces antinociceptive effects (Xu et al., 2004). During neuropathy, KOP receptor agonists produce a significant antinociceptive effect, reversed by the co-administration of nor-BNI (Keïta et al., 1995). Mice lacking the gene encoding Prodynorphin (PdynKO) have increased thermal nociception in physiological conditions and recover faster from SNL-induced neuropathy (König et al., 1996; Wang et al., 2001). The upregulation of prodynorphin and the transient neuropathic pain phenotype of PdynKO mice suggests that prodynorphin is pro-nociceptive and that the KOP receptor and endogenous agonists may play a role in the establishment of chronic neuropathic pain. A

pharmacological study in neuropathic mice treated with the TCA nortriptyline showed that nor-BNI could acutely reverse the antiallodynic action of the chronic TCA treatment of the cuff-induced mechanical allodynia (Benbouzid et al., 2008a), however KOP receptors are not necessary for the therapeutic effect of TCA drugs in the cuff model (Megat et al., 2015).

The role of KOP receptor and endogenous dynorphins in neuropathic pain is complex, as dynorphins exert pro- and anti-nociceptive effects in the context of injury (Xu et al., 2004; Wang et al., 2003). Nevertheless, KOP receptor agonists are powerful analgesic drugs, their effects have been described in animal pain models, especially visceral pain (Simonin et al., 1998; Rivière, 2004; Wang et al., 2010b). Indeed, KOP receptor agonists U-50,488 and fedotozine but not MOP or DOP agonists (morphine and fentanyl or delta- ([D-Pen2, D-Pen5] enkephalin DPDPE and SNC80) attenuated reactions to colorectal distention in a rat model of colonic inflammation following acetic acid applications (Sengupta et al., 1996). It has been suggested that peripherally restricted KOP agonists may therefore be of use to relieve inflammatory, visceral, and neuropathic chronic pain (Vanderah, 2010). KOP agonists have lower abuse potential, however, centrally mediated side effects of KOP receptor agonists include dysphoria, diuresis and emesis, which limited their therapeutic development in pain research (for review Gavériaux-Ruff and Kieffer, 2002). Nonetheless, Asimadoline, a KOP receptor agonist, has been successfully used in humans to treat inflammatory bowel syndrome-associated pain (Camilleri, 2008).

b) DOP receptor in pain mechanisms

In physiological conditions, DOP receptor agonists have little noticeable effect on nociception, as demonstrated by pharmacology and DOP receptor knock-out (DOP KO) animals (Gavériaux-Ruff and Kieffer, 2011). In pathological settings however, DOP KO animals show increased pain phenotypes, in particular in inflammatory and neuropathic types of models which points to a role for DOP receptors in the modulation of chronic pain (Nadal et al., 2006; Gavériaux-Ruff et al., 2008). Notably, DOP receptor agonists have potent analgesic activity in chronic pain (Pradhan et al., 2011).

In chronic inflammatory, neuropathic and cancer pain conditions, administration of DOP receptor agonists has been shown to decrease heat, mechanical and chemical pain modalities (Kabli and Cahill, 2007; Hervera et al., 2010; Mika et al., 2001) and DOP receptor expression has been reported to be up- or down-regulated, or

unchanged (for review Gavériaux-Ruff and Kieffer, 2011). Pharmacological studies using DOP receptor agonists showed that DPDPE and SNC did not reduce visceral pain sensitivity to colorectal distention, and therefore the role of the DOP receptor do not indicate a role of DOP receptors in visceral pain (Sengupta et al., 1996), however these observations were not completed by gene deletion approaches, which may enable more precise conclusions as to the involvement of DOP receptors in acute or chronic visceral pain.

Peripheral analgesia has raised particular interest and offers the opportunity to target DOP receptors outside the CNS, thus avoiding centrally mediated opiate side effects (Stein et al., 1990; Stein and Lang, 2009; Hua and Cabot, 2010). Endogenous opioid peptides exert analgesic effects in the periphery after release by immune cells in the site of injury (Stein et al., 1990; for review see Busch-Dienstfertig and Stein, 2010), which suggested that peripheral ORs could modulate pain perception in disease settings.

C. Tools for studying DOP receptors *in vivo*

1. Pharmacological studies

Recent pharmacological studies have evaluated the analgesic potency of selective DOP receptor agonists such as SNC80, AR-M1000390 (Pradhan et al., 2009, 2010), ADL5747, ADL5859 (Nozaki et al., 2012) and KNT127 (Nagase et al., 2010; Pradhan et al., 2014; Nozaki et al., 2014) in models of migraine, chronic neuropathic or inflammatory pain. KNT217 also reduced depressive-like behaviours in the forced swim test. These promising developments show that DOP receptor agonists produce beneficial analgesia and mood-promoting effects, however repeated administration of all these agonists produces analgesic tolerance (Pradhan et al., 2009, 2010; Nozaki et al., 2014).

Pharmacological approaches also evidenced the involvement of peripheral DOP receptor-mediated analgesia in chronic neuropathic pain induced by cuff or CCI models. Indeed, subcutaneous or intraplantar administrations of selective DOR agonists DPDPE and deltorphin II or nonpeptidic DOP agonist SNC80 in the hindlimb suggest that activation of peripheral DOP receptor populations by DOP receptor selective peptidic and nonpeptidic agonists reversed neuropathic allodynia and thermal hyperalgesia (Kabli and Cahill, 2007; Obara et al., 2009; Pacheco et al., 2005); thereby suggesting that developing peripherally restricted DOP receptor agonists may be an interesting therapeutic strategy in preclinical research.

2. Gene deletion models

a) *DOP receptor knock-out mice*

Constitutive DOP receptor knock-out model, using a homologous recombination approach, were generated in the Kieffer lab (Filliol et al., 2000). In the targeting vector, the first coding exon of the *Oprd1* gene (which encodes the extracellular N-terminal and first transmembrane regions and the translation initiation sequence) was replaced by a neomycine cassette. Following integration of the vector in embryonic stem cells, blastocysts from C57BL/6 were implanted with selected embryonic stem cells, and homozygous mutant mice were obtained and maintained on a 50:50 SvPas/C57BL/6J genetic background.

DOP receptor knock-out animals showed little or no change in the responses to acute pain (Filliol et al., 2000; Contet et al., 2006; Nadal et al., 2006; Gavériaux-Ruff et al., 2008; Pradhan et al., 2010), noteworthy, stress-induced analgesia was observed in these animals (Contet et al., 2006). However, DOP receptor knock-out mice had increased levels of pain in neuropathic and inflammatory pain models and were insensitive to SNC-80, which relieves allodynia in chronic pain models, thus confirming this pharmacological agent as DOP receptor-selective (Nadal et al., 2006; Gavériaux-Ruff et al., 2008). These observations are in favour of a view in which DOP receptor activity is involved in the maintenance of endogenous opioid pain relief in chronic pain (Gavériaux-Ruff and Kieffer, 2011) (see Figure 21).

In the cuff model of neuropathic pain (polyethylene cuff implantation around the main branch of the sciatic nerve), tricyclic antidepressants did not relieve neuropathic allodynia in DOP receptor knock-out animals (Benbouzid et al., 2008b), which revealed that DOP receptor function in particular is necessary for antidepressant-mediated pain alleviation in the context of nerve injury, and that the antiallodynic effect of antidepressant treatments do not rely on the MOP or the KOP receptor (Bohren et al., 2010; Megat et al., 2015). DOP receptors are also essential for the effect of chronic β_2 -mimetics treatment in the cuff model and the diabetic mouse model (Choucair-Jaafar et al., 2014). In addition, subcutaneous administration of Naltrindole, a DOP receptor antagonist, immediately reversed the antiallodynic effect of β_2 AR agonists (Yalcin et al., 2010) which points to close interaction between DOP and β_2 AR systems in pain control mechanisms.

Despite the significant advances that total DOP receptor knock-out animals have brought to the understanding of pain control, this approach does not allow to inactivate the gene of interest in a time- or tissue-dependent manner. In addition, the specific roles of the DOP receptor may be partly concealed by compensatory mechanisms which may take place. Therefore, the tools for spatially and/or temporally controlled DOP receptor gene ablation were developed, with hope to appropriately tackle the delineation of the subtle roles of DOP receptors in specific cell populations, in pain conditions particularly.

b) Conditional Knock out mouse

Conditional gene knock-out approaches, based on the Cre/loxP system, have been developed to enable gene inactivation in precise time-frames (inducible excision) or tissular localizations, thus restricting gene inactivation to specific cell types for example. Cre recombinase, a tyrosine recombinase enzyme expressed in bacteriophage P1, mediates specific recombination between two loxP sites, palindromic sequences which Cre enzyme recognizes. Depending on the orientation of the loxP sites, the sequence between them can be excised (same loxP orientation) or inverted (if the loxP sites are opposed). To obtain conditional knock-out mouse lines, mice which express the Cre recombinase gene under a specific promoter are crossed with mice which express the gene of interest which is flanked with loxP sites. Cre recombinase can also be provided by viral infection (Scammell et al., 2003; Thévenot et al., 2003).

Oprd1 floxed mice were generated by the Kieffer team (Gavériaux-Ruff and Kieffer, 2011), in which exon 2 of the *Oprd1* sequence is flanked with two loxP sites, and these homozygous floxed animals were maintained on a 50:50 129SvPas/C57BL6/J mice. The heterozygous Nav1.8-Cre mutant mouse line express Cre recombinase under the promoter of Nav1.8, a voltage-gated sodium channel which is expressed unmyelinated C and thinly myelinated A δ nociceptive neurons (Shields et al., 2012) (Shields 2012). The Nav1.8-Cre driver line was used to specifically inactivate DOP receptors in primary afferents, thus peripheral DOP receptor function could be investigated in the Nav1.8 cKO mice (Gaveriaux-Ruff et al., 2011; Nozaki et al., 2012). In these mice, inflammatory and neuropathic pain was not relieved by systemic or intraplantar administration of SNC80, demonstrating the essential role for peripheral DOP receptors in mediating analgesia in the context of both inflammatory and neuropathic chronic pain models (Gavériaux-Ruff and Kieffer, 2011).

3. DOPeGFP Knock-in mouse

a) *Fluorescent Knock-in mice: genetic tools to directly visualize receptors in vivo*

To overcome the limitations associated with the use of transgenic mice, efforts were made to generate knock-in animals in which a fluorescent protein (FP) is introduced at the locus of interest by homologous recombination. Several strategies are used (see Figure 22). Models in which an FP is expressed either under the control of an endogenous GPCR promoter are valuable and reliable tools for localization and characterization of cell population which express the GPCR of interest. However, such strategies present a significant drawback since the GPCR is non-functional following partial or total replacement of its coding sequence by the FP coding one. The FP is thus expressed in appropriate cells, but the precise subcellular localization and function of the receptor cannot be examined and the final outcome, in the case of homozygous animals, is the absence of the functional GPCR, equivalent to a knock-out phenotype. This limitation can be circumvented by the introduction of an internal ribosomal entry site (IRES) sequence, whereby expression of the endogenous GPCR is maintained and the chosen FP is expressed under control of the endogenous promoter.

Fusions between a GPCR and an FP as tools to monitor the GPCR subcellular localization and trafficking were first studied in heterologous systems. Two fusion options were considered: either the FP at the N-terminus or at the C-terminus. A vast majority of GPCRs do not have cleavable N-terminus signal sequences that target them to the plasma membrane. Introduction of a foreign sequence ahead of their N-terminus has been shown to disrupt surface addressing, and correct membrane targeting and insertion therefore requires introduction of an additional foreign signal sequence in front of the fusion construct (McDonald et al., 2007). If proper cell surface expression is indeed restored, introduction of such a signal sequence nonetheless strongly impacts on the relative ratio between surface expression and intracellular distribution by substantially increasing the amount of protein at the cell surface (Dunham and Hall, 2009, and references therein). Hence, such fusion proteins are not well suited to mimic the responses of endogenous GPCRs to agonist stimulation and were not used for *in vivo* studies.

Concerns have also been raised regarding in frame insertion of the FP at the C-terminus of the GPCR by

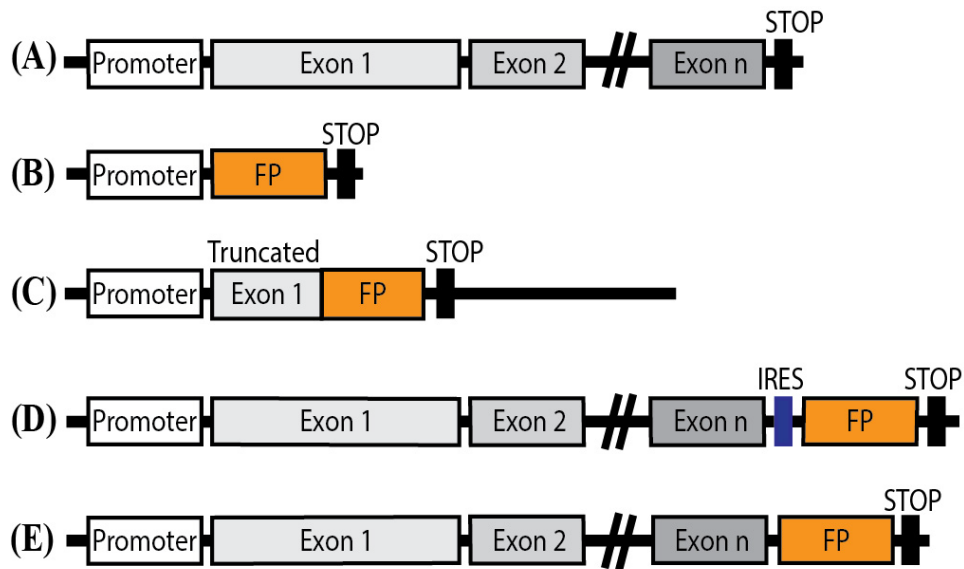

Figure 22: Schematic diagram of genetic constructions of knock-in mice expressing a fluorescent protein (FP) under the control of an endogenous GPCR promoter.

(A) Endogenous GPCR gene layout. (B) Knock-in FP expressed under the control of the endogenous GPCR promoter: the endogenous GPCR gene is replaced by the FP coding sequence. (C) The FP coding sequence is knocked into the truncated gene coding for the native GPCR, resulting in genetic invalidation of the receptor. (D) Insertion of an internal ribosomal entry site (IRES) downstream of the endogenous GPCR gene, ahead of the FP coding sequence. Native GPCR expression is maintained, and the FP is also expressed under the control of the endogenous GPCR promoter. (E) The FP sequence is inserted in frame in place of the stop codon in the endogenous GPCR gene giving rise to a fluorescent fusion protein in which the FP is fused to the C-terminus of the functional GPCR in conditions of native expression.

substitution of the stop codon. The presence of a 27kDa beta barrel at the intracellular extremity of the GPCR could indeed interfere with intracellular scaffold partners and modify signaling or internalization processes thus defeating the object when studying GPCR signaling properties. However, many studies performed in mammalian cells on a large number of GPCRs strongly suggest that addition of GFP at the C-terminus does not significantly affect subcellular distribution in the basal/unstimulated state, ligand binding or agonist induced receptor phosphorylation and internalization (for review Kallal and Benovic, 2000). McLean & Milligan expressed β_1 - and β_2 -adrenergic receptors fused to a C-terminal eGFP mutant in human embryonic kidney (HEK 293) cells (McLean and Milligan, 2000). These authors concluded that the presence of the eGFP did not influence ligand binding but decreased the agonist-induced internalization kinetics without affecting the intracellular fate of the receptor. Trafficking of the fusion protein was qualitatively maintained, but was quantitatively slightly modified compared to native proteins. This study therefore supports the use of such fusions to monitor endogenous receptor subcellular localization. Similarly, the genetic construction encoding the delta opioid (DOP) receptor fused with eGFP protein at the C-terminus was expressed in transfected HEK 293 cells, and the fusion did not alter opioid ligand binding affinity or signaling (Scherrer et al., 2006). This construct was later successfully used to express a functional DOPeGFP fusion in mice by knock-ing the modified sequence into the endogenous DOP receptor locus (Scherrer et al., 2006, see below).

In some cases, however, FP fusion at the GPCR C-terminus had deleterious effects. Defective targeting to the cell surface was reported for the melanocortin 2 receptor fused to the GFP in HEK 293 cells (Roy et al., 2007) and no recycling was observed for the muscarinic M4 receptor fused to a C-terminal red variant of GFP in neuroblastoma/glioma hybrid cells (NG108-15 cells) (Madziva and Edwardson, 2001). In both cases, impairment was more likely to be due to gross overexpression rather than fusion of the FP to the C-terminus. High levels of expression of a GPCR in a non-native environment can indeed artificially elicit properties and interactions that would not occur *in vivo*. Moreover, cell lines used for heterologous expression may provide different intracellular machinery for complex protein folding or post-translational modifications compared to naturally producing cells. This represents an additional limitation to the study of GPCR functions and prompted to develop *in vivo* approaches.

b) *GPCR-FP fusion for in vivo functional and mapping studies*

(1) Mapping of OR expression with neuronal resolution

In 2006, Scherrer and collaborators generated a DOPeGFP knock-in mouse line by homologous recombination in which the coding sequence for the DOP receptor fused to its C-terminus to the eGFP was inserted at the *Oprd1* locus (Scherrer et al., 2006). These DOPeGFP knock-in mice proved very helpful to map DOP receptors in the nervous system and remedy the lack of highly specific antibodies. In the peripheral nervous system, DOPeGFP receptors were detected in cell bodies of specific peripheral sensory neuronal populations which process sensory stimuli, namely mostly in large diameter myelinated (Neurofilament 200 positive), and in small diameter unmyelinated non-peptidergic (Isolectin B4 positive) neurons with almost no expression in small diameter unmyelinated peptidergic (SP) neurons (Scherrer et al., 2009; Bardoni et al., 2014). The expression pattern of DOPeGFP receptors was also reported in mechanosensory organs in the skin (Bardoni et al., 2014). Another study focused on the distribution of DOPeGFP in enteric neurons with DOPeGFP expression mainly in secretomotor neurons of the submucosal plexus of the digestive tract (Poole et al., 2011) reflecting functional roles of DOP receptors in inhibition of intestinal motility and absorption.

In the CNS, DOPeGFP mapping was performed in the brain and spinal cord (Erbs et al., 2015). Detailed DOPeGFP expression was also reported in the hippocampus, where functional DOPeGFP was found to be mainly expressed in GABAergic interneurons, mostly parvalbumin-positive ones (Erbs et al., 2012; Rezai et al., 2013). The DOPeGFP knock-in mice also enabled to resolve the debate concerning the presence of DOP receptors in principal cells. The absence of colocalization with calbindin (Erbs et al., 2012) and presynaptic expression restricted to afferents to glutamatergic principal cells established that no functional DOP receptors are expressed under basal conditions in those cells (Rezai et al., 2012). These results are consistent with a modulation of principal cell activity in the hippocampus by DOP receptors, and therefore an impact of the receptors in learning and memory.

More recently, a knock-in mouse line expressing a MOP receptor fused with a red fluorescent protein at the C-terminus, MOP-mcherry, was generated by Erbs and collaborators (Erbs et al., 2015). At the *Oprm1* locus, mcherry cDNA was introduced into exon 4 of the MOP gene in frame and 5' from the stop codon. This FP is

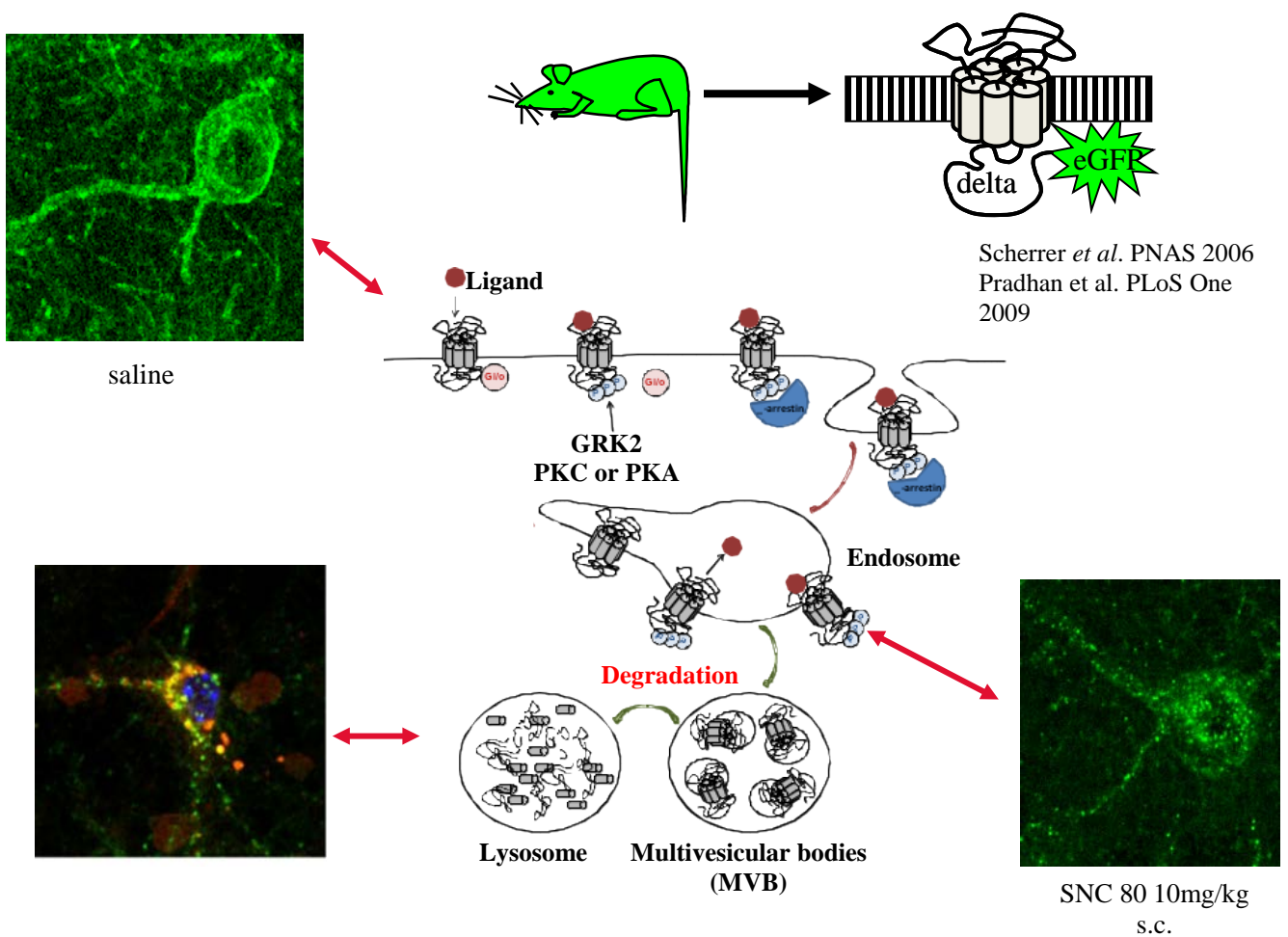

Figure 23: *In vivo* Pharmacological Internalization and Degradation of DOPeGFP receptors

DOPeGFP knock-in animals are a tool for studying DOP receptor trafficking events in response to ligand stimulation. Following activation, DOPeGFP receptors are internalized, transported to endosomes and ultimately undergo degradation in lysosomes.

monomeric and highly photostable, and the strong red signal of MOP-mcherry fusion protein enabled direct identification of neurons expressing MOP in the nervous system (Erbs et al., 2015). The authors compiled the DOPeGFP and MOP-mcherry distributions in a neuroanatomical atlas available at <http://mordor.ics-mci.fr>.

Several studies in heterologous systems or cell culture had suggested that MOP and DOP receptors may interact to form heteromers (Rozenfeld et al., 2012; Stockton and Devi, 2012; van Rijn et al., 2010) but their existence *in vivo* remains debated. Extensive mapping of MOP-DOP neuronal colocalization using double knock-in mice co-expressing DOPeGFP and MOP-mcherry provided sound data to investigate MOP-DOP physical proximity and functional interactions. In the hippocampus, a brain area where the two receptors are highly co-expressed, co-immunoprecipitation experiments using antibodies raised against the FPs indeed confirmed physical proximity (Erbs et al., 2015). These animals will now be useful to address MOP-DOP specificities in ligand binding, signaling and trafficking as well as functional output and to investigate the potential of MOP-DOP heteromers as a novel therapeutic target.

(2) *In vivo* trafficking, desensitization and behavioral output

The DOPeGFP mouse line is the first example of the use of a knock-in line to study GPCR functions *in vivo* (Scherrer et al., 2006). DOP agonist-induced internalization was observed *in vivo* upon activation by the alkaloid [(+)-4-[(alphaR)-alpha-((2S,5R)-4-allyl-2,5-dimethyl-1-piperazinyl)-3-methoxybenzyl]-N,N-diethylbenzamide] (SNC-80) and the endogenous peptide Met-enkephalin (Scherrer et al., 2006). The two agonists induce receptor internalization in heterologous systems with receptor phosphorylation as the first step of a cascade of events leading to termination of G protein dependent signaling, receptor removal from the cell membrane and trafficking to intracellular compartments (Ferguson et al., 1996; von Zastrow and Williams, 2012; Walther and Ferguson, 2013). DOPeGFP mice revealed that these agonists also induce receptor phosphorylation, internalization via clathrin coated pits *in vivo*, degradation in the lysosomal compartment in the brain (Scherrer et al., 2006; Pradhan et al., 2009; Faget et al., 2012) (see Figure 23) and peripheral nervous system in the myenteric plexus (Poole et al., 2011) and DRGs (Scherrer et al., 2009). Moreover, these animals prove to be instrumental to decipher molecular mechanisms underlying receptor desensitization leading to a loss of responsiveness of the receptor upon stimulation by an agonist. Scherrer and collaborators were indeed able,

for the first time, to establish the correlation between receptor trafficking *in vivo* and the behavioral response: namely that the receptor internalization induced by acute administration of the agonist SNC-80 was responsible for the observed locomotor desensitization (Scherrer et al., 2006). This paper was followed by additional studies exploring the consequences of receptor pharmacological stimulation in more detail, in particular the concept of biased agonism.

GPCRs have a flexible and highly dynamic nature (Moreira, 2014) which enables a given ligand to show functional selectivity, that is, preferential activation of signal transduction pathways, otherwise termed biased agonism (Giguere et al., 2014; Ostrom and Insel, 2004; Kenakin, 2014). DOPeGFP mice offer the possibility of addressing this concept *in vivo* and to link it to a functional response. DOPeGFP mice were used to analyze the properties of two DOP receptor agonists possessing similar signaling potencies and efficacies but with different internalization profiles (Pradhan et al., 2009). SNC-80 and N,N-diethyl-4-(phenyl-piperidin-4-ylidenemethyl)-benzamide (AR-M100390), with high and low internalization properties respectively, were systemically administered to mice, and receptor trafficking was correlated to induced anti-allodynic effect in the context of inflammatory pain (Pradhan et al., 2009). As expected, acute SNC-80 administration resulted in receptor phosphorylation, decreased G protein coupling and receptor degradation in the lysosomal compartment, leading to desensitization with loss of anti-allodynic properties. On the other hand, acute injection of AR-M100390 did not result in receptor phosphorylation, did not reduce G protein coupling, did not induce receptor internalization or desensitization but retained analgesic properties. This study demonstrated that DOP receptor localization determines its function *in vivo* and highlights the importance of receptor tracking in order to extricate behavioral and cellular correlates of specific agonist properties (Pradhan et al., 2009).

In a following study, DOPeGFP mice were used to assess the physiological impact of distinct signaling pathway recruitment and/or adaptive responses upon chronic administration of two DOP receptor agonists (Pradhan et al., 2010). Chronic administration of SNC-80, which has high internalization properties, led to marked receptor downregulation and degradation in SNC-80-tolerant animals. Receptor internalization prevented any additional activation through physical disappearance from the cell surface leading to general desensitization, as assessed by thermal and mechanical analgesia, locomotor activity and anxiety-related behavior. On the other hand,

chronic administration of AR-M100390, with weak internalization properties, did not cause changes in DOPeGFP localization and induced tolerance restricted to analgesia, with no effect on locomotor activity or anxiolytic responses. These data show that a selective internalization-independent tolerance was elicited and suggest the occurrence of adaptative mechanisms that are network dependent. These findings reinforce the importance of understanding agonist specific signaling underlying biased agonism and tolerance. Considering that drug design has focused on offering orthosteric or allosteric modulators of GPCRs (Bradley et al., 2014), research groups need to explore the downstream signaling cascades of these drugs in more detail in order to understand and target the molecular events which underlie their efficacy. This is an essential progress for the understanding of drug action and opens new possibilities for drug design.

Direct visualization of the receptor also permitted to decipher the functional role of delta receptors in neuronal networks and to understand the complex relation between behavior and receptor subcellular distribution. Of particular interest is the observation that DOP subcellular distribution is modified in two brain areas involved in the processing of information associated with emotional value or predicted outcome. The CA1 area of the hippocampus is known to operate as a coincidence detector that reflects association of the context with strong emotional stimuli of positive or aversive value (Duncan et al., 2012). Accordingly, increased c-Fos immunoreactivity revealed activation of this region in a drug-context association paradigm, and DOPeGFP internalization in this area therefore suggested a modulatory role of the receptor in behavioral responses linked to context-induced withdrawal (Faget et al., 2012). Along the same line, persistent increase of DOPeGFP expression at the cell surface of cholinergic interneurons was induced by conditioned training in the NAc shell, which is involved in decision making and predictive reward evaluation upon pavlovian conditioning (Bertran-Gonzalez et al., 2013; Laurent et al., 2014).

Finally, the knock-in strategy revealed that the DOPeGFP internalization profile in response to endogenous opioid release is distinct from what is observed upon pharmacological stimulation (Faget et al., 2012). Indeed, only part of the receptor population present at the cell surface underwent internalization under physiological conditions. This observation further highlights the need to take into account the extent of changes that drug administration induces in receptor cellular distribution.

(3) Methodological improvements

Interestingly, DOPeGFP knock in mice also bring useful technical insight. During the process of acute brain slice preparation for electrophysiological recordings, DOPeGFP revealed spontaneous receptor internalization (Rezai et al., 2013). This event was likely due to high glutamatergic activity in the hippocampus upon slicing that leads to excitotoxicity. Direct visualization of the receptor therefore revealed a bias associated with previously unrecognized receptor trafficking that can now be addressed by initiating optimization of slice preparation conditions for electrophysiological recording (Rezai et al., 2013). This observation may be of particular relevance when addressing cellular responses elicited by drug application.

c) Concerns about the use in vivo of GPCR-FP fusions for functional studies

Despite the undeniably wide advances which have been and will be brought by genetically engineered mice encoding fluorescent endogenous GPCRs, concerns were raised regarding the inherent consequences of genetic manipulation. The possibility that the observed localization does not entirely reflect the wild type receptor distribution appears irrelevant since both MOP-mcherry and DOPeGFP receptor distributions in the brain are in full agreement with reports in mice and rats based on ligand binding (Slowe et al. 1999; Lesscher et al. 2003; Kitchen et al. 1997; Goody et al. 2002), GTP γ S incorporation (Tempel and Zukin 1987; Pradhan and Clarke 2005) or mRNA detection (Mansour et al. 1995; George et al. 1994; Cahill et al. 2001) (for a review see (LeMerrer et al. 2009). Also, in a more detailed study, DOPeGFP expression in the hippocampus, mainly in parvalbumin-positive GABAergic interneurons (Erbs et al., 2012), was corroborated by ISH studies on DOP receptors (Stumm et al., 2004).

In the peripheral nervous system, despite previous reports suggesting SP-dependent trafficking of DOP receptors to the cell membrane (Guan et al., 2005), Scherrer and colleagues reported that DOPeGFP almost never co-localized with substance P (SP) in peripheral sensory neurons (Scherrer et al., 2009), a finding that was debated by others (Wang et al., 2010a). A more recent study addressed this discrepancy by comparing DOPeGFP cellular distribution to that of the native DOP receptor using an ultrasensitive and specific ISH technique, which can detect single mRNA molecules (Bardoni et al., 2014). Patterns of DOPeGFP distribution and *Oprdl* mRNA expression were found to be very similar and detectable in the same neuronal populations,

namely mostly in large diameter myelinated cells (Neurofilament 200 positive), and in small diameter unmyelinated non-peptidergic neurons (isolectin B4 positive) (Bardoni et al., 2014). These data unambiguously confirm that the expression profile of the fluorescent constructs mimics the endogenous one and that fluorescent knock-in mice can be reliably used for mapping receptors in the central and peripheral nervous system.

Regarding functional aspects, there has been no evidence so far of any overt phenotypical or behavioral differences between the DOP receptor knock-in strain and wild type animals (Scherrer et al., 2006; Pradhan et al., 2009, 2010; Rezai et al., 2013), despite a two fold increase in mRNA and protein levels as well as increased G protein activation compared to wild type animals (Scherrer et al., 2006). However, the possibility that the subcellular distribution of the fluorescent fusion does not recapitulate that of the native untagged receptor is still debated. Indeed, high surface expression of DOPeGFP is observed under basal conditions in several brain regions, particularly in the hippocampus (Scherrer et al., 2009; Erbs et al., 2012; Faget et al., 2012; Erbs et al., 2015). This does not correlate with previous studies on wild type receptors using electron microscopy or fluorescent ligands that indicated a predominant intracellular localization under basal conditions and surface recruitment upon chronic morphine or chronic pain condition (Cahill et al., 2001; Morinville et al., 2004; Gendron et al., 2006; for review see Cahill et al., 2007; Gendron et al., 2014). Surface expression of DOPeGFP however varies across CNS regions and neuronal type whereas high fluorescence is always visible within the cytoplasm (Erbs et al., 2015). Accordingly, high surface expression appears to be restricted to some neuronal types such as GABAergic interneurons in the hippocampus or large proprioceptors in DRGs (Scherrer et al., 2006; Erbs et al., 2015). In many areas where DOP receptors are highly expressed such as the striatum, the basal ganglia, the amygdala or the spinal cord, DOPeGFP is not readily detected at the cell surface (Erbs et al., 2015) suggesting that DOPeGFP subcellular localization is predominant in those neurons. Importantly, surface expression of DOPeGFP can be augmented under physiological stimulation (Bertran-Gonzalez et al., 2013; Laurent et al., 2014; see above) or increased upon chronic morphine treatment as previously reported for wild type receptors (Erbs et al., 2016), strongly supporting that the fused fluorescent protein does not impact on the native subcellular distribution of the receptor and that the latter can be modulated according to the physiological state or modified upon pharmacological treatment.

In the case of MOP-mCherry knock-in mice, the red fluorescent signal is stronger inside the cell than at the plasma membrane (Erbs et al., 2015). This distribution reflects actual receptor intracellular distribution, as evidenced by comparison with MOP-specific immunohistochemistry in heterozygous mice, which confirms that the fusion protein does not cause defective receptor localization or surface trafficking (Erbs et al., 2015). Importantly, MOP-mCherry retained unchanged receptor density as well as [D-Ala², N-MePhe⁴, Gly-ol]-enkephalin (DAMGO) binding and efficacy and agonist-induced internalization compared to MOP. Moreover, behavioral effects of morphine in knock-in mice were similar to wild type animals: acute and chronic thermal analgesia, physical dependence, sensitization and rewarding properties revealed no significant differences with wild type animals (Erbs et al., 2015). These data suggest that predominant intracellular localization of MOP-mCherry receptors with low expression at the cell surface indeed reflect endogenous wild type receptor subcellular distribution under basal conditions, as observed in enteric neurons (Poole et al., 2011). In addition, internalization kinetics of MOP-mCherry upon activation by the agonist DAMGO in hippocampal primary neuronal cultures (Erbs et al., 2015) were similar to those reported for DAMGO promoted internalization of endogenous wild type receptors in the rat spinal cord (Trafton et al., 2000) and in organotypic cultures of guinea pig ileum (Minnis et al., 2003) or to Fluoro-dermorphin-induced sequestration in rat cortical primary neurons (Lee et al., 2002). This supports once again the use of fluorescent knock-in mice to study endogenous receptor trafficking. Of note, DAMGO promotes Flag-MOP receptor internalization with similar kinetics in transfected striatal primary neurons (Haberstock-Debic et al., 2005), in adenovirus infected primary cultures from DRG (Walwyn et al., 2006) or in neurons of the locus coeruleus in brain slices from transgenic FLAG-MOP receptor mice (Arttamangkul and Quillinan, 2008).

d) Conclusions and impact for drug design

Fluorescent knock-in mice represent a substantial technical improvement in basic science. Precise identification and localization of the neurons expressing the GPCR of interest and reliable monitoring of receptor subcellular localization are both essential in understanding the physiopathological roles of endogenous GPCRs. This was greatly anticipated, given the difficulties encountered by many on the grounds of poor specificity of the available antibodies for GPCR targeting. The main surprising finding is maybe that the presence of the

fluorescent protein at the C-terminus of the GPCR does not significantly alter the behavioral output although this observation fully validates the technology. However, fluorescent knock-in animals available to date target a handful of class A GPCRs only. Besides MOP and DOP receptors, knock-in mice expressing NOPeGFP (Ozawa 2015), another receptor of the opioid family, were successfully used to visualize the receptor in vivo. Two additional fluorescent knock-in mice were reported, the Galanin receptor 1 (GalR1-mCherry) and 2 (GalR2-hrGFP) (Kerr et al., 2015), that enable receptor visualization in DRGs. The potency of the model being now clearly established, one would expect rapid expansion to other receptors in particular those with critical roles in human pathologies.

2. Aim of the thesis

Given the growing involvement of DOP receptors in chronic painful diseases and drug tolerance, we sought to clarify and bring forward the changes in DOP receptor expression in murine models of chronic pathological states, with the aim to shed light on the contribution of DOP receptors in each context, using genetically modified animals in particular fluorescent knock-in mice for DOP (DOPeGFP) and MOP (MOPmcherry) receptors.

These chronic conditions include neuropathic pain (cuff model), chronic inflammatory visceral pain (colitis model induced by a chemical agent) and morphine dependence (repeated administration of morphine).

In my main project, we investigated chronic neuropathic pain, the cuff model that reproduces sensory and emotional consequences of chronic neuropathic pain. In this model, the peripheral DOP receptor is known to play an essential role in the establishment of antiallodynic treatment effect by either antidepressant or β 2AR agonists. However, the impact of chronic pain on the distribution of DOP receptors is not clearly described, and the neurochemical identity of cells which drive recovery from mechanical allodynia remains unknown. We therefore identified changes in DOP receptor expression and distribution patterns in DRG induced by the neuropathic condition and following treatment administration, by combining genetic, behavioral and immunofluorescence imaging approaches. In addition, we examined the implication of the opioid system in the alleviation of mechanical allodynia by the gabapentinoid pregabalin in the cuff model. Finally, we examined the impact of the neuropathic condition on MOP/DOP neuronal co-expression at central and peripheral levels using double knock-in fluorescent mice to explore new putative therapeutic strategies in pain and mood disorder pharmacotherapy.

In a second study, we investigated the role of DOP and MOP receptors in endogenous pain modulation on nociceptive perception in the mouse digestive system by a combination of genetic (DOP receptor knock-out and conditional knock-out mice), molecular, behavioral and histological approaches in a model of colitis, to delineate the contribution of central and peripheral ORs in visceral nociceptive and inflammatory pain.

In the third study, we explored another chronic condition by examining the impact of chronic morphine administration on DOP receptor expression at central level using DOPeGFP knock-in mice and its persistence after four weeks of abstinence.

3. Chapter One: Article in preparation

1. Introduction

Neuropathic pain occurs following metabolic, traumatic or chemically-induced nerve damage (Jensen et al., 2011) and involves neural and immunological changes, ultimately leading to central and peripheral sensitization, which increases pain signal transduction in chronic pain settings (Latremoliere and Woolf, 2009). Clinical alleviation of chronic neuropathic pain symptoms relies on anticonvulsants such as Pregabalin, antidepressants such as serotonin and noradrenalin reuptake inhibitors (SNRI, Duloxetine for example) (Finnerup et al., 2015) and opioids (Smith, 2012) but treatment strategies are not always successful and this chronic condition is notoriously difficult to manage (Bouhassira et al., 2008). Preclinical studies implementing the cuff model showed that chronic systemic $\beta 2$ mimetic administration relieved mechanical allodynia to the same extent as chronic SNRIs (Yalcin et al., 2010; Benbouzid et al., 2008a) opening additional perspectives for treating neuropathic pain.

Peripheral Delta Opioid receptors (DOP) have been proposed to be potential pharmacological targets in analgesia and relief from chronic pain (Gavériaux-Ruff et al., 2008; Gaveriaux-Ruff et al., 2011; Kabli and Cahill, 2007; Scherrer et al., 2009) since neuropathic condition induced changes in DOP receptor or mRNA distribution in primary afferent populations (Obara et al., 2009; Kabli and Cahill, 2007; Pol et al., 2006) . In particular, DOP receptors in neurons expressing the voltage gated sodium channel Nav1.8 are essential to mediate peripheral DOP receptor agonist analgesia (Gaveriaux-Ruff et al., 2011; Nozaki et al., 2012). Most importantly, the cuff model has been instrumental for demonstrating that peripheral DOP receptors are mandatory for the therapeutic effects of both chronic antidepressant and $\beta 2$ agonist treatments (Benbouzid et al., 2008a; Choucair-Jaafar et al., 2014).

In this context, we used a conditional DOP receptor knockout mouse in which DOP receptors are selectively ablated in Nav1.8 expressing primary afferents and found that these animals were not relieved by treatment with the antidepressant Duloxetine or the $\beta 2$ agonist Formoterol. We then sought to investigate in more detail DOP receptor expressing populations by implementing the mouse line expressing fluorescent DOP receptors

(DOPeGFP) (Scherrer et al., 2006) to assess changes taking place in the neuropathic condition, and potential impact of the two treatments. We describe a selective loss of small primary afferent neurons and peptidergic nerve endings in the plantar surface of the hindpaw following cuff implantation. We also report a decrease in DOPeGFP expressing neurons in Cuff animals that was partially reversed by chronic antiallodynic treatments, but in different neuronal populations depending on the treatment. In addition, the neuropathic condition induced translocation of DOPeGFP receptors at the plasma membrane, which was reversed by both chronic treatments.

**Neuropathy-Induced Changes in Peripheral Delta Opioid Receptor
Distribution Are Differentially Reversed by Chronic Treatment with
Duloxetine or Formoterol**

Ceredig RA^{1,2}, Yalcin I¹, Rodeau JL¹, Pierre F¹, Alduntzin U², Kolovu A.³, Melwig R³, Schwab Y³,
Gavériaux-Ruff C.⁴, Salvat E¹, Barrot M¹, Massotte D¹.

¹Institut des Neurosciences Cellulaires et Intégratives INCI, UPR3212, Strasbourg, France.

²Université de Strasbourg, France.

³European Molecular Biology Laboratory, Heidelberg, Germany.

⁴Institut de Génétique et de Biologie Moléculaire et Cellulaire, UMR7104, Illkirch, France.

Abstract

Peripheral delta opioid (DOP) receptors represent novel attractive targets for chronic pain management and are essential for antiallodynic effect of antidepressant and β -mimetics. We first addressed the impact of neuropathic pain by examining changes in DOP receptor distribution using a knock in mouse expressing a fluorescent version of the DOP receptor (DOPeGFP). Neuronal loss was observed 8 weeks after cuff surgery that affected small size neurons and decreased free nerve endings in the glabrous skin of the hindpaw. Also, remaining small peptidergic and non-peptidergic neuronal populations expressing DOPeGFP were decreased. Oral chronic treatment with antidepressant or β 2-mimetic molecules reversed mechanical allodynia in wild type animals but not in conditional knock out mice that do not express DOP receptors in Nav 1.8 positive neurons establishing that DOP receptor expression in this population is required for treatment effectiveness. More precisely, we observed that both antidepressant and β 2 agonist treatments partially reversed neuropathy-induced changes but restored DOPeGFP distribution in different neuronal populations. Also, we found that chronic neuropathy increased DOPeGFP translocation to the plasma membrane, which was reversed by both antiallodynic treatments.

Introduction

Neuropathic pain arises as a direct consequence of a traumatic lesion or a disease affecting the somatosensory system; the latter includes metabolic, ischemic, cancerous or infectious causes. Sensory nerve injury, abnormal spontaneous activity of nociceptors, peripheral and central maladaptive changes in pain processing and network connectivity all contribute to the appearance of spontaneous pain, mechanical allodynia and thermal hypersensitivity which characterize neuropathic pain symptoms (von Hehn et al., 2012). The high prevalence, complexity of the neuropathic pain syndrome and low efficacy of chronic pharmacotherapies make treatment of this syndrome a challenging unmet medical need (Bouhassira et al., 2008; Attal et al., 2008; Finnerup et al., 2015), which facilitates the development of psychiatric disorders such as anxiety and depression (Radat et al., 2013). The main therapeutic approaches differ with regards to the cause, and pharmacology consists in chronic administration of anticonvulsants, antidepressants and opioids (Smith, 2012; Attal et al., 2008; Dworkin et al., 2007).

Among the pharmacological approaches for treating neuropathic pain, antidepressants are proposed to enhance peripheral adrenergic tone, by blocking re-uptake transporters of biogenic amines (Mico et al., 2006). They also produce relief from chronic pain (Briley, 2004) via β 2-adrenergic receptors, by reducing peripheral inflammatory mediators (Bohren et al., 2013). Interestingly, preclinical studies revealed that, in a mouse model of sciatic nerve cuffing, the antiallodynic effect of antidepressant treatment is dependent on the peripheral delta opioid (DOP) receptor (Benbouzid et al., 2008b, 2008a). However, there are currently very few clues as to which population of DOP-expressing cells is affected in neuropathic conditions, and the mechanisms by which DOP receptor contributes to antiallodynic activity of antidepressants.

Similarly to many G-protein coupled receptors (GPCR), studying the expression pattern of opioid receptors in neuronal tissue was indeed hampered by the lack of appropriate tools. For the DOP receptor, this was overcome by using a knock in mouse line expressing the native DOP receptor fused to the green fluorescent protein eGFP. These mice expressing the fluorescent version of the DOP receptor (DOPeGFP) enabled to study its physiological distribution and functions (Scherrer et al., 2009; Pradhan et al., 2010; Erbs et al., 2012, 2016).

In particular, the use of DOPeGFP knock in animals to provide detailed description of neuronal subtypes of primary sensory afferents which express DOP receptor has been validated by *in situ* hybridization (Wang et al., 2010; Scherrer et al., 2009; Bardoni et al., 2014). The DOP receptor has been reported as expressed essentially in large myelinated non-peptidergic which convey touch and would differ from the small peptidergic nociceptive fibres that mainly express mu opioid receptors and transmit thermal nociceptive stimuli (Scherrer et al., 2009). This view is however currently debated (Gendron et al., 2015) since DOP receptors are widely expressed in large DRG neurons but also present in medium and small peptidergic and nonpeptidergic neurons (Wang et al., 2010). In addition, DOP receptors are co-expressed with MOP receptors in neurons from all size categories (Wang et al., 2010; Erbs et al., 2015).

Recently, enhanced mechanical allodynia following sciatic nerve ligation that was not relieved upon local administration of DOP receptor agonists was described in a mouse line in which peripheral DOP receptors are selectively knocked out in Nav 1.8 positive neurons (Nav1.8 cKO) (Gavériaux-Ruff et al., 2008; Nozaki et al., 2012). Other studies also outlined DOP receptors as attractive therapeutic targets in chronic painful diseases (Gavériaux-Ruff and Kieffer, 2002; Vanderah, 2010; Cahill et al., 2007; Bie and Pan, 2007; Zhang et al., 2006), with a particular interest for neuropathic pain. Indeed, a study revealed an endogenous tone of DOP receptor which minimizes mechanical allodynia following neuropathy induction, given that DOP null mutants showed exacerbated allodynia (Nadal et al., 2006).

Using the DOPeGFP knock in mice, we therefore sought to describe overall DRG neuronal population following neuropathy induction and to identify changes in DOP receptor distribution patterns. To pinpoint neuronal subpopulations, we used classically described neurochemical categories of primary afferents and proceeded to a detailed size classification of all the subpopulations. In parallel, we investigated the possible effect of chronic antiallodynic antidepressant or β 2-mimetic treatment on distribution changes, which occur in the sciatic nerve cuffing model. We showed a decrease in DOPeGFP labeling in small neurons in neuropathic conditions, reversed by antidepressant treatment in small peptidergic populations and by β -mimetic treatment in small non-peptidergic populations.

Experimental procedures

Animals

DOPEGFP knock-in mice expressing the DOP receptor fused to a green fluorescent protein were generated by homologous recombination. In these mice, the eGFP cDNA preceded by a five amino acid linker (G-S-I-A-T) was introduced into the exon 3 of the DOP receptor gene, in frame and 5' from the stop codon as described previously (Scherrer et al., 2006). The DOP-floxed (*Oprd1fl/fl*) mouse line was interbred with Nav1.8-Cre mice to produce conditional knockout (cKO) of DOP in primary nociceptive neurons (Nav1.8-Cre x *Oprd1fl/fl* or DOPcKO) as described previously (Gaveriaux-Ruff et al., 2011). Conditional DOP knock-out animals and their floxed controls were bred at the ICS animal facility in Illkirch and kindly provided by Pr. Claire Gavériaux-Ruff. Total DOP knockout (DOPKO) animals were generated as previously described (Filliol et al., 2000). The genetic background of DOPeGFP and Nav1.8Cre mice was C57/BL6J;129SvPas (50%:50%), and 100% C57/BL6J for DOPKO mice. Experiments were performed on adult male and female mice aged 6 to 20 weeks, weighing 20-32g for females and 20-38g for males. Animals were group-housed 2-5 per cage, under standard laboratory conditions (12h dark/light cycle, lights on at 7am) in temperature (21±1°C) and humidity (55±10%) controlled rooms with food and water *ad libitum*. All experiments were approved by the “Comité d’Ethique en Matière d’Expérimentation Animale de Strasbourg” (authorization number 20 1503041113547 (APAFIS#300).02).

Neuropathic pain model

Neuropathic pain was induced by cuffing the main branch of the right sciatic nerve as previously described (Benbouzid et al., 2008c; Yalcin et al., 2014). Surgeries were performed under ketamine (Vibrac, Carros, France) / xylazine (Rompun, Kiel, Germany) anesthesia (100/10mg/kg, i.p.). The common branch of the right sciatic nerve was exposed, and a cuff of PE-20 polyethylene tubing (Harvard Apparatus, Les Ulis, France) of standardized length (2mm) was unilaterally inserted around it (Cuff group). The shaved skin was closed using sutures. Sham-operated animals underwent the same surgical procedure without cuff implantation (Sham group).

Assessment of mechanical allodynia

Mechanical allodynia was tested using von Frey filaments and results were expressed in grams. Tests were performed in the morning (9am to 1pm). Mice were placed in clear Plexiglas boxes (7cm x 9cm x 7cm) on an elevated mesh screen, and allowed to habituate to the test conditions. Calibrated von Frey filaments (Bioseb, Vitrolles, France) were applied to the plantar surface of each hindpaw until they just bent, in a series of ascending forces up to the mechanical threshold. Filaments were tested five times per paw and the paw withdrawal threshold (PWT) was defined as the lower of two consecutive filaments for which three or more withdrawals out of the five trials was observed (Yalcin et al., 2014).

Treatment procedures

The long-term treatment with Duloxetine or Formoterol began four weeks after the surgical procedure, and lasted four weeks. Duloxetine (Cat. Nr 4223, Tokyo Chemistry Industry, Tokyo, Japan) 20 mg/kg/day and Formoterol (Cat. Nr BG0369, Biotrend AG, Switzerland) 0.05 mg/kg/day were delivered *per os* dissolved in drinking water with *ad libitum* access and as sole source of fluid. Drugs were dissolved in water with 0.2% saccharin (Cat. Nr S1002, Sigma Aldrich, St Louis, USA) to increase palatability and control sham animals were given 0.2% saccharin solution (control) alone. Experimental groups were defined as Sham group (n=36, 29 females and 7 males) and Cuff group (n=29, 16 females and 13 males), both of which received control saccharin solution in drinking water (0.2%); cuff animals treated with Duloxetine comprised the Duloxetine group (n=20, 11 females and 9 males), and likewise, Formoterol group was composed of cuff-implanted animals treated with Formoterol (n=20, 11 females and 9 males).

Tissue preparation and immunohistochemistry

Mice were anaesthetised with ketamine (Vibrac, Carros, France) /xylazine (Rompun, Kiel, Germany) anaesthesia (100/10mg/kg, i.p.) and perfused intracardially with 100mL of ice-cold (2-4°C) 4% paraformaldehyde (Ref 3291471 Electron Microscopy Science, Hatfield, USA) in PB (Sigma Aldrich, St Louis, USA) 0.1M pH 7.4 solution, cryoprotected at 4°C in 30% sucrose (Sigma Aldrich, St Louis, USA) in PB 0.1M pH7.4 solution for 24hours and finally embedded in OCT (Optimal Cutting Temperature medium, Thermo Scientific) frozen and kept at -80°C. DRG longitudinal sections (16µm thick) were cut

with a cryostat (Microm Cryo-star HM560) and kept floating in PB 0.1M pH7.4. For NeuroTrace® experiments, 10µm-thick sections were processed on slides. For all immunohistochemistry experiments, serial sectioning was used, ensuring that non-successive sections were observed.

Immunohistochemistry was performed according to standard protocols. Briefly, 16µm-thick DRG sections were incubated in blocking solution PB 0.1M pH 7.4, 0.2% Tween 20 (PBT) (Cat. Nr 85114, ThermoFisher Scientific), 3% normal goat serum (Invitrogen, Paisley, UK) and 3% donkey serum when necessary (D9663 Sigma-Aldrich, St Quentin Fallavier, France), for 1 hour at room temperature (RT). Sections were incubated overnight at 4°C in the blocking solution with the appropriate primary antibodies or biotinylated isolectin IB4. The following primary antibodies were used: polyclonal rabbit anti eGFP (Cat. Nr A-11122 Invitrogen dilution 1:1000), mouse polyclonal anti-NF200 (neurofilament 200) (Cat Nr. N0142 Sigma dilution 1:1000), sheep polyclonal anti-CGRP (Calcitonin Gene Related Peptide) (Cat Nr. AB 22560, Abcam, dilution 1:2000), IB4 (isolectin B4) biotin conjugate (Cat. Nr L2140, Sigma, dilution 1:100). Sections were washed three times with PBT, incubated with the appropriate AlexaFluor conjugated secondary antibodies or Streptavidin as follows: goat anti-mouse IgG AlexaFluor 594 conjugate (Cat. Nr A-11020, Molecular Probes, dilution 1:500), goat anti-rabbit IgG AlexaFluor 488 conjugate (Cat. Nr A-11012, Molecular Probes dilution 1:2000), donkey anti-sheep IgG AlexaFluor 594 conjugate (Cat. Nr A-11016, Molecular Probes, dilution 1:2000), Streptavidin AlexaFluor 594 conjugate (Cat. Nr S-11227, Molecular Probes, dilution 1:200) for two hours at RT in dim light. Sections were washed three times with PBT and mounted on Superfrost™ glass (Gehrad Menzel, Braunschweig, Germany) with MOWIOL (Calbiochem, Darmstadt, Germany) and 4,6-diamino-phenylindole (DAPI) (Roche Diagnostic, Mannheim, Germany) (0.5µg/mL). Double-labelling was performed to co-localize DOPEGFP fluorescence with the chosen neuronal marker. DOPEGFP fluorescence was enhanced by detection with an anti-GFP antibody and a secondary antibody coupled to AlexaFluor 488. Antibodies specific for the neuronal markers were detected with a secondary antibody coupled to AlexaFluor 594, as listed above.

For NeuroTrace® experiments, slides were incubated with NeuroTrace® (Cat. Nr N21483640/660 deep-red fluorescent Nissl Stain, Molecular Probes™, dilution 1:200) diluted in PBT for 20 minutes in dim

light, mounted with MOWIOL (Calbiochem, Darmstadt, Germany) and 4,6-diamino-phenylindole (DAPI) (Roche Diagnostic, Mannheim, Germany) (0.5µg/mL).

For paw tissue samples, mice were killed by cervical dislocation. Plantar skin of both hindpaws was taken using a scalpel, footpad and glabrous skin (1cm long) was fixed at 4°C in the 4% PFA solution overnight, cryoprotected overnight in 30% sucrose PB 0.1M pH7.4 (Sigma Aldrich, St Louis, USA) solution for 24hours, embedded in OCT (Optimal Cutting Temperature medium, Thermo Scientific) frozen and kept at -80°C. Longitudinal sections (50µm thickness) were cut with a cryostat (MicromCryo-star HM560) and directly mounted on slides or kept floating in PB 0.1M pH7.4.

To visualize primary afferent terminals in the skin of the hindpaw, paw tissue samples were processed as for fluorescent immunohistochemistry. Sections were incubated in blocking solution (PBT, 3% normal goat serum and normal donkey serum when appropriate) for 30 min at RT, incubated overnight at 4°C in the blocking solution with the primary antibodies against PGP9.5 (Mouse anti-human Protein gene peptide 9.5, Cat. Nr 7863-1004, AbD Serotec®, 1:1000), anti-CGRP and/or anti-GFP antibody. Sections were washed three times with PBT, incubated with the goat anti-mouse IgG AlexaFluor 647 conjugate (Cat. Nr A-21236, Molecular Probes, dilution 1:500). If applicable, DOPeGFP and CGRP detection was performed as in DRGs. Samples were mounted with Vectashield (Vector Labs, Burlingame, Ca, USA) and 4,6-diamino-phenylindole (DAPI) (Roche Diagnostic, Mannheim, Germany) (0.5µg/mL).

Image acquisition and analysis

Image acquisition was performed with the Leica TCS SP5 confocal microscope using a 20x dry objective (NA :0.7), the 40x resolution was achieved with a digital zoom factor. Confocal acquisitions in the sequential mode (single excitation beams: 405, 488 and 568 nm) were used for marker co-localization to avoid potential crosstalk between the different fluorescence emissions. Images were acquired with the LCS (Leica) software. Neurons expressing a given fluorescent marker were manually and blindly counted on screen using Image J® software cell counter (approximately 15 non-adjacent sections per condition and per animal). Threshold was applied to fluorescence detection. Only neurons from L4-L6 DRGs with a

visible nucleus were considered. Cells expressing a given marker and eGFP fluorescence were analyzed separately. During the analysis, all cell surface areas were recorded for the separate markers.

DOPeGFP subcellular distribution was expressed as a ratio of membrane associated versus cytoplasmic fluorescence densities determined as described in Erbs 2016. Acquisitions using 63x (NA: 1.4) oil objective were performed to determine subcellular distribution of DOPeGFP. Briefly, quantification of internalization was performed using the IMAGE J software on 8-bit raw confocal images from neurons randomly sampled. Nuclear fluorescence was used to define the background level (no threshold was applied). Cytosolic fluorescence intensity was subtracted from whole cell fluorescence intensity to obtain surface fluorescence intensity. Fluorescence intensity values were divided per surface unit (pixel) to obtain densities. Ratio of membrane-associated ($D_f \text{ memb}$) versus cytoplasmic ($D_f \text{ cyto}$) fluorescence densities was calculated to normalize data across neurons examined. A value of 1.0 results from equal densities of DOPeGFP at the cell surface and in the cytoplasm.

Primary afferent terminals were visualized in the skin by epifluorescence microscopy (Leica DMR) and a CCD camera or with the Leica TCS SP5 confocal microscope using 63x oil objective. Counting of the free nerve endings in the glabrous part of the skin was performed manually under the microscope on blinded samples on three randomly chosen sections per animal. Density was obtained by dividing the number of afferents within the upper dermis by the total length of the section.

Electron microscopy

Animals were first injected with SNC80 (Tocris) at 10 mg/kg (s.c.) dissolved in NaCl 0.9% 30-60mins before perfusion. SNC80 is a compound that strongly induces DOP internalization, thus facilitating the identification of neurons expressing DOPeGFP in DRG. These animals were perfused intracardially with 100mL of ice-cold (2-4°C) 4% paraformaldehyde in PHEM buffer pH 7.8 (60mM PIPES, 25mM HEPES, 20mM EGTA, 2mM MgCl₂, 0.2% glutaraldehyde (Ref 16000 Electron Microscopy Science, Hatfield, USA)). Ipsilateral (right) and contralateral (left) L4 to L6 lumbar DRGs were dissected out and post-fixed for 90-120mins at 4°C in 4% PFA in PHEM buffer, and kept at 4°C in 1% PFA in PHEM buffer until processing.

Sections 60 nm thick prepared by the Tokoyasu method (Tokuyasu, 1980) were used for immunohistochemistry. Briefly, sections on carbon coated 100 mesh grids were incubated for 15 min with 2 % gelatin in PBS at 37°C, rinsed with 0.15% glycine in PBS. Sections were then incubated in blocking solution (1% BSA in PBS) for 15 min, incubated in blocking buffer with rabbit anti glutamine synthase (Sigma G2781 1:250) for 45 min then with Protein A gold 5nm (1:50) for 30 min in blocking buffer. Sections were fixed with 1% glutaraldehyde in PBS for 5 min, incubated in blocking solution (1% BSA in PBS) for 5 min then with chicken anti-GFP (Abcam ab13970, 1:300) in blocking buffer for 45 min. This was followed by incubation with a rabbit anti chicken secondary antibody (Rockland, 1:50) in the blocking solution for 30 min and incubation for 30 min with protein A gold 20 nm (1:50). Sections were fixed with 1% glutaraldehyde in PBS and incubated with uranyl acetate in methylcellulose before observation.

Statistical analysis

Statistical analysis was performed with different programs as follows. Statistica v12 (StatSoft, France) was used for behavioral analysis of von Frey testing: Two sample Student's t test was used to assess gender effect on Baseline paw withdrawal threshold (PWT), one-way repeated measure ANOVA analysis was performed to compare the impact of experimental treatment on paw withdrawal threshold (PWT) for separate gender groups, followed by Tukey HSD post-hoc test. Graph-Pad Prism v4 (GraphPad, San Diego, CA) was used to analyze DOPEGFP subcellular distribution and skin fiber analysis (one-way ANOVA analysis followed by Newman-Keuls post-hoc test), and global co-localization of DOPEGFP and the various neuronal markers (non parametric Kruskal Wallis with Dunn's posthoc test). RCommander was used for cell population descriptions. For cell area measures, data were pooled per treatment group for each marker (NF200, CGRP, IB4, and eGFP). In order to determine Gaussian components of cellular populations according to size, Non-linear Least Square approach enabled curve fitting and models were compared (RCommander nls2 and pracma packages). For cell surface area data, normality was tested using Shapiro-Wilk test except for Neurotrace for which Anderson-Darling normality test was used and Kolmogorov Smirnov test was used to compare distributions among groups using R Commander. To compare the frequencies in successive area bins of 100 μm^2 , data were pooled

and sorted in contingency tables for each marker (per experimental treatment group) and for each co-localization group (eGFP-expressing cells for cell markers NF200, CGRP or IB4 for each experimental treatment group), and were analyzed using Chi-square approach, to enable the analysis of treatment effect on cell population distributions using R Commander. For cell size distribution studies, the experimental treatment groups included 7 Sham, 6 Cuff, 5 Duloxetine and 5 Formoterol animals.

Results

Validation of the neuropathic pain model in DOPeGFP knock-in mice

Previous work in the laboratory on C57Bl6J mice showed that cuff-implantation induced mechanical allodynia which develops directly after surgery, is maintained until up to 12 weeks, and that treatment by antidepressants or β 2-mimetics (i.p. or *per os* administration) relieves mechanical allodynia (Benbouzid et al., 2008a; Choucair-Jaafar et al., 2009; Yalcin et al., 2010). Using our fluorescent knock in animals, we first verified that the presence of the fluorescent protein and/or the difference in genetic background had no detectable behavioral effect. The mechanical sensitivity of the DOPeGFP mice was assessed using Von Frey hairs. Male and female animals were used in each experimental group. Females had significantly lower baseline mechanical thresholds compared to males (between 2 and 4g for females vs. between 5 and 6g for males, Student's t test for baseline values: $t=7.18$ $p<0.0001$). Sham surgery did not influence mechanical thresholds (Figure 1). Cuff implantation induced an ipsilateral mechanical allodynia (Figure 1, F (males)=178.32, $p<0.0001$; F (females)=163.14, $p<0.0001$) which lasted for at least 8weeks (time of sacrifice) but did not affect the contralateral hindpaw (data not shown).

Duloxetine and Formoterol treatments in drinking water supplemented with 0.2% saccharin, at doses 60 mg/kg/day and 0.05 mg/kg/day respectively, began 28 days after surgery. Sham and Cuff groups received saccharin 0.2% alone (control). Duloxetine relieved mechanical allodynia at treatment day 19 in males and females; paw withdrawal threshold (PWT) was not significantly different compared to Baseline PWT (Tukey HSD post-hoc test: Treatment day 19 vs Baseline: p (Males)=0.403; p (Females)=0.997, Figure 1). Formoterol relieved mechanical allodynia at treatment day 22 in males and females, with PWT values returning to Baseline values (Tukey HSD post-hoc test: Treatment day 22 PWT vs Baseline p (Males)=0.873, p (Females)=0.524, Figure 1). Neither the genetic modification nor the genetic background had an influence on the nociceptive threshold under baseline conditions or affected the time course associated with the development of mechanical allodynia nor its relief by treatments with an antidepressant or a β 2-mimetic compared to previous data in male C57Bl6J mice.

Absence of antiallodynic action of either Duloxetine or Formoterol in DOP-Nav1.8-cKO mice.

Previous studies have shown that peripheral DOP receptors play an essential role in antidepressant antiallodynic action in the Cuff model (Benbouzid et al., 2008b). We took advantage of the conditional knockout mice where DOP receptors are deleted specifically in primary afferents (peripheral DRG neurons) expressing Nav1.8, a voltage-gated sodium channel (Gaveriaux-Ruff et al., 2011) to investigate the contribution of this DOP receptor population to antiallodynic treatment effects. In control floxed DOP, conditional Nav1.8cKO and total DOP KO animals, mechanical sensitivity was assessed using Von Frey filaments. Duloxetine and Formoterol treatments in drinking water supplemented with 0.2% saccharin, at doses 60 mg/kg/day and 0.05 mg/kg/day respectively, began 15 days after surgery, Sham and Cuff control groups received 0.2% saccharin alone. Mechanical thresholds for sham animals were not affected by genotype (not shown) and cuff implantation induced a unilateral mechanical allodynia in operated animals regardless of genotype. DOPcKO animals did not recover after 19 days of either of the *per os* treatments (Figure 1 C), whereas DOP*fl/fl* cuff animals treated with either Duloxetine or Formoterol recovered their initial Baseline PWT at treatment days 14 and 19 (Supplementary Figure 1). Cuff-implanted DOPcKO mice had sustained mechanical allodynia when treated with either Duloxetine or Formoterol similar to total DOPKO mice suggesting that DOP receptors in Nav 1.8 positive neurons are mandatory to observe treatment effect.

Neuron size distribution in sham animals.

In sham animals, DRG neuron size distribution was assessed using NeuroTrace® Nissl stain. Neurons from L4-6 DRGs were examined (Figure 2 A). All cells from sham animals were pooled in an experimental group and distribution analysis was performed (n=6727 cells, 6 animals). The density curve showed a high proportion of NeuroTrace® positive cells with cross-section areas $\leq 500\mu\text{m}^2$ (Figure 2 B). The histogram in Figure 2 C shows that NeuroTrace® positive cells in sham animals can be distributed into $100\mu\text{m}^2$ -bins according to cell area, that a large majority of cells (>95%) have areas between 100 and $1100\mu\text{m}^2$ and are not normally distributed (Anderson-Darling normality test: A=256.6 p-value $< 2.210^{-16}$). Histogram bin size value of $100\mu\text{m}^2$ was attributed according to area measurement error, which was approximately $10\mu\text{m}^2$ (this bin size was therefore used for all data analysis and representations). The

curve fitting analysis clearly showed that size distribution of NeuroTrace® positive cells in sham animals could be described as a sum of three Gaussian functions (Figure 2 C) with means of $167.1\mu\text{m}^2$, $279\mu\text{m}^2$ and $260.5\mu\text{m}^2$ respectively. The introduction of three Gaussian components to describe the cumulative distribution function significantly reduced the error between the calculated fit model and the data, which validates the fit model (Residual Sum of Squares $0.0038\mu\text{m}^2$, Supplementary Figures 2 A & 3 A).

Neuropathy induced a shift in cell surface area distribution

As for the Sham group, all NeuroTrace®-stained neurons from Cuff animals were pooled into the Cuff group for distribution analysis ($n=7704$, 6 animals). Data were not normally distributed (Anderson-Darling normality test: $A=77.85$, $p\text{-value} < 2.2 \times 10^{-16}$), and the Kolmogorov-Smirnov test (KS test), which compares relative rank cumulative distributions, showed a significant difference between the Sham and Cuff distributions (Figure 2 D, two-sample Kolmogorov-Smirnov test $D = 0.07572$, $p\text{-value} = 5.563 \times 10^{-08}$). As shown by the cumulative distribution curves, there was a shift in Cuff distribution towards larger surface area values, consistently observed along the area axis. As for Sham animals, the fit model described the data as a sum of three Gaussian functions, with values centered in 224.0 , 361.8 , $707.4\mu\text{m}^2$ respectively (Residual Sum of squares for data fitting for the Cuff NeuroTrace® model was $0.1097\mu\text{m}^2$, Supplementary Figures 2 B & 3 B) that were higher than those observed in the Sham group. Pearson's Chi-squared test showed significant differences of proportions in the categorical data ($X^2 = 108.34$, $df = 14$, $p\text{-value} < 2.2 \times 10^{-16}$) as assessed using Chi-Squared Standardized Residuals. Because a high number of categories composed the contingency table, standardized residuals were considered significant when the absolute value of calculated residuals was greater than 2 and very significant when greater than 4. Data showed a significantly lower proportion of small neurons in Cuff samples ($<200\mu\text{m}^2$) compared to Sham group and significantly more medium and large sized neurons in cuff samples compared to sham animals ($300\text{-}500\mu\text{m}^2$ and $800\text{-}1000\mu\text{m}^2$, Figure 2 E, Table 1). Overall, these findings showed that our neuropathic pain model induced a shift in cell surface area distribution towards larger cell sizes and suggested specific neuronal loss in small diameter neurons.

Table 1 X-Squared Standardized Residuals

The proportion of Neurotrace positive neurons per 100 μm^2 bin categories was analyzed using the non-parametric Pearson's Chi-squared test. Differences between Sham and Cuff animals were assessed using Chi-Squared Standardized Residuals. Values in red and blue boxes respectively indicate a significant decrease or increase compared to sham animals.

Area range (μm^2)	0-100	100-200	200-300	300-400	400-500	500-600	600-700	700-800	800-900	900-1000	1000-1100	1100-1200	1200-1300	1300-1400	>1400
Sham	2.85	8.22	-0.91	-4.46	-3.03	0.41	0.2	-0.32	-4.03	-2.03	-1.37	0.84	0.27	0.19	0.73
Cuff	-2.85	-8.22	0.91	4.46	3.03	-0.41	-0.2	0.32	4.03	2.03	1.37	-0.84	-0.27	-0.19	-0.73

Neuropathy alters neurochemical marker distributions in DRG populations.

Following the finding that neuropathy induced a shift in DRG neuronal population distribution, we sought to determine which size category and/or subpopulation was affected. We therefore investigated DOPeGFP distribution, and performed neurochemical characterization of DRG neurons in sham animals, based on immunoreactivity to classically used neuronal markers for primary afferents, namely myelinated A β and A δ fibers, and unmyelinated C fibers. We chose to investigate presence of NF200 or CGRP as markers to discriminate large A fibers and all sizes of peptidergic primary sensory fibers. In addition we used the isolectin IB4-binding to characterize small, unmyelinated non-peptidergic neurons. In agreement with previously published data, we did not observe co-expression between DOPeGFP and tyrosine hydroxylase, a marker for C fibers with low threshold mechanical receptors (Bardoni 2014) (Supplementary Figure 7).

Using the same analytical approach as for NeuroTrace® comparison between Sham and Cuff animals, we examined whether Cuff neuropathy affected the expression DOPeGFP and/or neurochemical markers. All data sets were non-normally distributed in sham, cuff as well as duloxetine and formoterol treated animals (Supplementary Table 1). For Sham animals, NF200 positive (NF200+), CGRP-positive (CGRP+), IB4-binding (IB4+) and their corresponding co-localized DOPeGFP+ populations were all best described as sums of three distinct Gaussian functions, except IB4-binding population and IB4-binding+DOPeGFP+ populations, where the fit consisted of two Gaussian functions (Supplementary Table1). Since all data

sets were non-normally distributed, we adopted a non-parametric approach for distribution comparisons throughout the analysis. We therefore used Pearson's Chi-Squared test to compare the four experimental groups at a time, with cells distributed in categorical data of 100 μm^2 -wide area bins.

DOPeGFP

DOPeGFP distribution in neurons was previously described under basal conditions (Bardoni et al., 2014). We first examined whether DOP receptors were also present in satellite cells by investigating DOPeGFP co-localization with the glial marker glutamine synthase using electron microscopy. DRG samples were prepared by the Tokoyasu method to preserve ultra-structural organization. In addition, DRG samples were collected from animals pretreated for one hour with 10mg/kg SNC80, a selective DOP receptor agonist to concentrate the receptor in the lysosomal compartment (Pradhan et al., 2009; Rezai et al., 2012) and facilitate identification of the cells expressing the receptor. No co-localization could be detected with glutamine synthase (Figure 3), strongly suggesting that the DOPeGFP receptor expression was restricted to neurons, although we could not entirely exclude low or rare expression in glial cells.

Surface area distributions of DOPeGFP+ cells from Sham and Cuff experimental groups were pooled and analyzed (n=3080, 7 animals for Sham and n=3123 neurons n=6 Cuff animals). In Sham, 98% of DOPeGFP+ cells had surface areas between 100 μm^2 and 1200 μm^2 with two peaks in the histogram representation (Figure 4 A-C). Sham DOPeGFP distribution was consistent with DOPeGFP expression in all cell size categories for DRG neurons as previously published ((Bardoni et al., 2014) see also Discussion).

Sham and Cuff cumulative distributions (Figure 4 D) were statistically different (KS test for cumulative distribution comparison: $D=0.10595$, $p\text{-value}=1.443 \times 10^{-15}$) with Cuff distribution shifted towards larger cell surface areas compared to Sham. This shift appeared at small cell sizes and indicated a statistically significant loss of DOPeGFP expression in small and/or medium neurons 8 weeks after cuffing. Importantly, there was no gain of expression, as the shift was observed consistently along surface area scale. This indicated a loss of small DOPeGFP+ neurons.

In order to determine in which size category changes occurred, we then compared the proportion of DOPeGFP+ cells in each 100 μm^2 bin. Non-parametric Pearson's Chi-squared test ($X\text{-squared} = 348.35$, df

= 42, p-value < 2.2 x10⁻¹⁶) showed significant differences between Sham and Cuff with a low proportion of neurons in 0-300µm² area categories compared to Sham (Figure 4 E, Table 2), consistent with the decrease in small area categories observed in NeuroTrace® analysis of this experimental group. Other differences between Cuff and Sham samples included a higher proportion of neurons in 1000-1100µm² category. Since cumulative distribution showed no gain of expression, this increase only reflected a compensatory effect to the loss of small neurons in the relative distribution of DOPEGFP+ neurons.

Table 2 X-Squared Standardized Residuals

The proportion of DOPEGFP positive neurons per 100 µm² bin categories was analyzed using the non-parametric Pearson's Chi-squared test. Differences between the different groups (sham, cuff, Duloxetine and Formoterol treated animals) were assessed using Chi-Squared Standardized Residuals. Values in red and blue boxes respectively indicate a significant decrease or increase compared to sham animals.

Area range (µm ²)	0-100	100-200	200-300	300-400	400-500	500-600	600-700	700-800	800-900	900-1000	1000-1100	1100-1200	1200-1300	1300-1400	1400+
Sham	0.71	10.31	3.75	-3.15	0.84	3.28	1.8	-0.66	-3.02	-1.35	-5.87	-5.65	-4.04	-3.27	-4.18
Cuff	-2.23	-7.13	-3.59	0.71	0.82	0.52	-0.16	1.28	3.51	0.72	3.31	1.67	-0.32	0.36	-0.11
Dulox	1.48	-1.76	0.94	-0.21	-1.64	-2.88	-2.71	-1.32	0.24	1.05	2.01	3.24	4.58	3.96	6.3
Formo	0.34	-2.05	-1.15	3.17	-0.34	-1.68	0.77	0.58	-0.86	-0.31	1.05	1.52	0.62	-0.51	-1.22

NF200

NF200+ cells were pooled for Sham and Cuff animals and distribution was analyzed on both conditions. For the Sham group, 94% of NF200+ cells had surface areas between 300 and 1300µm² (Figure 5 A, Supplementary Figure 4 A and B and Supplementary Table 1). Cumulative distributions of NF200+ neurons were significantly different between Sham and Cuff groups (KS test: D = 0.073686, p-value = 2.536x10⁻⁷) showing a shift in large cell populations (Figure 5 A). Accordingly, comparison of the relative distribution of NF200+ cells across the 100µm² bin categories revealed lower proportions of NF200+ cells mainly in the 400-600µm² categories (X-squared = 461.75, df = 36, p-value < 2.2 x10⁻¹⁶) (Figure 5 B, Table 3).

Table 3 X-Squared Standardized Residuals

The proportion of NF200 positive neurons per 100 μm^2 bin categories was analyzed using the non-parametric Pearson's Chi-squared test. Differences between the different groups (sham, cuff, Duloxetine and Formoterol treated animals) were assessed using Chi-Squared Standardized Residuals. Values in red and blue boxes respectively indicate a significant decrease or increase compared to sham animals.

Area range (μm^2)	0- 300	300- 400	400- 500	500- 600	600- 700	700- 800	800- 900	900- 1000	1000- 1100	1100- 1200	1200- 1300	1300- 1400	1400- +
Sham	-11.87	-1.35	2.77	2.35	-0.88	-0.10	-0.88	-2.99	-2.89	0.32	-1.50	-0.20	15.55
Cuff	10.01	1.98	-2.20	-2.60	-1.56	0.98	-0.76	0.81	2.44	-0.16	-0.61	0.11	-8.38
Duloxetine	2.99	1.45	0.10	0.17	0.19	-2.14	0.47	1.49	0.32	-0.62	1.24	1.42	-6.37
Formoterol	-1.84	-2.41	-0.57	0.34	2.76	1.14	1.47	0.89	-0.03	0.48	1.19	-1.40	-0.89

CGRP

CGRP-positive distributions were significantly different between the sham and cuff conditions (KS test for cumulative distribution comparison: $D = 0.19057$, $p\text{-value} < 2.2 \times 10^{-16}$, and $X\text{-squared} = 362.56$, $df = 42$, $p\text{-value} < 2.2 \times 10^{-16}$) (Figure 5 C, Supplementary Table 1). For Sham CGRP+ cells, a large majority of neurons had surface areas between 100 and 1000 μm^2 (>94%) (Supplementary Figure 5 A and B). Bin analysis confirmed a shift towards large neurons in Cuff animals, indicating a loss in small diameter neurons with significantly lower proportions of small (0-300 μm^2) neurons compared to the Sham group (Figure 5 D, Table 4).

Table 4 X-Squared Standardized Residuals

The proportion of CGRP positive neurons per 100 μm^2 bin categories was analyzed using the non-parametric Pearson's Chi-squared test. Differences between the different groups (sham, cuff, Duloxetine and Formoterol treated animals) were assessed using Chi-Squared Standardized Residuals. Values in red and blue boxes respectively indicate a significant decrease or increase compared to sham animals

Area range (μm^2)	0-100	100-200	200-300	300-400	400-500	500-600	600-700	700-800	800-900	900-1000	1000-1100	1100-1200	1200-1300	1300-1400	1400+
Sham	5.07	5.97	3.16	0.25	-1.99	-3.34	-1.44	-2.86	-1.55	-3.87	-1.51	-2.72	-3.51	-3.63	-3.44
Cuff	-5.17	-7.17	-2.80	1.47	0.54	5.10	3.69	3.46	2.13	6.84	0.81	-0.32	0.54	2.08	-0.42
Dulox	5.80	3.40	0.30	-2.49	-1.34	-3.55	-1.94	-1.42	-1.56	-0.46	0.90	0.77	2.34	1.42	3.10
Formo	-7.38	-4.07	-1.61	0.75	3.43	2.87	0.16	1.70	1.49	1.66	0.23	3.07	1.63	1.18	1.72

IB4

A majority (>94.5%) of Sham IB4+ cells had cell surface areas between 50 μm^2 and 400 μm^2 (Figure 5 E, Supplementary Figure 6 A and B, Supplementary Table 1). Similarly to other markers, there were significant changes in IB4+ neuron distributions between Sham and Cuff groups (KS test: D = 0.19057, p-value < 2.2x10⁻¹⁶, X-squared= 725.95, df = 18, p-value < 2.2x10⁻¹⁶) (Figure 5 E). A general decrease was observed with a significant loss affecting neurons in area categories 0-100 μm^2 in the Cuff IB4-binding population (Figure 5 F, Table 5).

Table 5 X-Squared Standardized Residuals

The proportion of IB4 positive neurons per 100 μm^2 bin categories was analyzed using the non-parametric Pearson's Chi-squared test. Differences between the different groups (sham, cuff, Duloxetine and Formoterol treated animals) were assessed using Chi-Squared Standardized Residuals. Values in red and blue boxes respectively indicate a significant decrease or increase compared to sham animals.

Area range (μm^2)	0-100	100-200	200-300	300-400	400-500	500-600	600+
Sham	7.77	10.76	-5.32	-9.20	-7.17	-2.99	2.63
Cuff	-4.97	0.62	5.21	-0.71	-3.25	-3.06	-0.79
Duloxetine	6.95	0.42	-4.43	-1.94	0.19	-0.02	5.83
Formoterol	-9.75	-12.99	4.35	12.82	11.36	6.73	-1.81

Overall, our analysis indicates that 8 weeks after cuff surgery, neuropathy induces a shift in population distributions of all neurochemical markers towards larger cell sizes that mainly reflects a loss in small peptidergic and non-peptidergic cell populations.

Neurochemical characterization of DOPeGFP expressing cells and identification of changes induced by neuropathy

Cells co-expressing DOPeGFP and one of the neurochemical markers of interest were examined (Supplementary Figure 8), to further identify the subpopulation of DOPeGFP affected by distribution changes in the cuff model. In a first approach, we performed a global analysis in which we compared the distribution of the DOPeGFP cells co-localized with IB4-binding, NF200+ and small CGRP-expressing cells (<300 μm^2) that corresponded to non-overlapping subpopulations (Figure 6). Data revealed that overall, small peptidergic and non-peptidergic categories of DOPeGFP-expressing neurons were significantly decreased in neuropathic animals (DOPeGFP+CGRP+ $p=0.005$ and DOPeGFP+IB4+ $p=0.022$ respectively, Mann-Whitney non parametric t test) (Figure 6).

Refined analysis according to size distribution in 100 μm^2 bins was then performed as previously. When compared, the Sham and Cuff NF200+DOPeGFP+ distributions were significantly different and shifted towards larger surface area values (KS test on Cumulative distribution data: $D=0.22826$, $p\text{-value}=6.461 \times 10^{-13}$, $X\text{-squared} = 82.281$, $df = 36$, $p\text{-value} = 1.757 \times 10^{-5}$) (Figure 7 A Supplementary Table 1). No significant changes in any particular size category of NF200+DOPeGFP+ neurons was observed

(Table 6) confirming that the apparent increase observed when considering the whole population (Figure 7 B) reflected the relative decrease in small CGRP+ or IB4-binding neurons.

Table 6 X-Squared Standardized Residuals

The proportion of neurons co-expressing NF200 and DOPeGFP per 100 μm^2 bin categories was analyzed using the non-parametric Pearson's Chi-squared test. Differences between the different groups (sham, cuff, duloxetine and formoterol treated animals) were assessed using Chi-Squared Standardized Residuals. Values in red and blue boxes respectively indicate a significant decrease or increase compared to sham animals

Area range (μm^2)	0-300	300-400	400-500	500-600	600-700	700-800	800-900	900-1000	1000-1100	1100-1200	1200-1300	1300-1400	1400-2100
Sham	-1.81	0.84	2.29	0.91	1.67	0.17	-1.49	-0.79	-2.09	-2.21	-0.2	-0.77	-0.81
Cuff	0.19	-0.81	-1.67	1.77	-0.54	1.28	0.64	-1.25	-1.44	1.12	0.24	0.3	0.27
Duloxetine	2.7	1.46	2.67	-0.7	-0.63	-2.86	-0.31	-0.25	1.18	-0.8	0.15	-0.3	0.17
Formoterol	-0.91	-1.47	-3.34	-2.65	-0.63	1.13	1.27	2.83	3.13	2.02	0.39	0.84	0.44

We next compared CGRP+DOPeGFP+ Sham and Cuff distributions (KS test: $D=0.14301$ p-value= 1.848×10^{-5} and X-Squared 117.02, $df = 42$, p-value = 5.294×10^{-9}) (Figure 7 C) and found that overall Cuff samples had lower proportions of small-sized neurons, mainly in categories 100-300 μm^2 (Table 7, Figure 7 D) which paralleled the decrease observed in both CGRP+ and DOPeGFP+ cell populations (see above). We also analyzed changes in the expression of DOPeGFP in myelinated CGRP+NF200+ neurons ($>300\mu\text{m}^2$) but did not evidence any changes (data not shown). Our data therefore pointed to a loss of the small peptidergic neurons in neuropathic conditions.

Table 7 X-Squared Standardized Residuals

The proportion of neurons co-expressing CGRP and DOPeGFP per 100 μm^2 bin categories was analyzed using the non-parametric Pearson's Chi-squared test. Differences between the different groups (sham, cuff, duloxetine and formoterol treated animals) were assessed using Chi-Squared Standardized Residuals. Values in red and blue boxes respectively indicate a significant decrease or increase compared to sham animals.

Area range (μm^2)	0- 100	100- 200	200- 300	300- 400	400- 500	500- 600	600- 700	700- 800	800- 900	900- 1000	1000- 1100	1100- 1200	1200- 1300	1300- 1400	1400+
Sham	0.34	2.65	2.67	2.28	1.52	-0.15	1.19	-1.45	-0.74	-2.22	-2.07	-2.21	-2.21	-2.21	-2.45
Cuff	-0.40	-3.64	-2.42	-0.41	0.33	1.39	0.82	1.95	-0.36	0.30	0.78	0.58	-0.73	1.67	-0.64
Duloxetine	-1.13	1.29	0.86	-0.58	-2.32	-1.45	-2.00	-1.43	-0.08	0.98	2.44	-0.09	2.85	1.65	4.85
Formoterol	1.19	-0.72	-1.70	-2.02	-0.03	0.10	-0.49	1.20	1.51	1.63	0.65	2.42	0.87	-0.66	-1.00

We found significant changes in small non-peptidergic IB4+ DOPeGFP+ DRG cell populations between sham and neuropathic samples KS test: $D=0.29774$ $p\text{-value}=7.942 \times 10^{-15}$, X-squared = 80.022, $df = 18$, $p\text{-value} = 8.495 \times 10^{-10}$) with a decreased number of IB4+DOPeGFP+ neurons in small size categories (Figure 7 E, Supplementary Table 1). Despite that no statistical difference in Cuff X-Squared Residuals appeared, there were higher proportions of small IB4-DOPeGFP+ cells in the Sham group (Table 8, Figure 7 F), supporting a decrease of labeling in this population in Cuff animals.

Table 8 X-Squared Standardized Residuals

The proportion of neurons co-expressing IB4 and DOPeGFP per 100 μm^2 bin categories was analyzed using the non-parametric Pearson's Chi-squared test. Differences between the different groups (sham, cuff, duloxetine and formoterol treated animals) were assessed using Chi-Squared Standardized Residuals. Values in red and blue boxes respectively indicate a significant decrease or increase compared to sham animals.

Area range (μm^2)	0-100	100-200	200-300	300-400	400-500	500-600	600+
Sham	2.28	4.90	1.78	-3.29	-4.08	-1.77	-2.56
Cuff	-0.99	-1.43	-0.74	2.15	-0.01	-0.10	0.99
Duloxetine	-0.81	-1.28	-1.42	-0.47	2.78	1.02	4.07
Formoterol	-0.98	-3.01	-0.03	2.07	2.12	1.18	-1.69

Chronic Duloxetine restored small DOPeGFP expressing populations to Sham levels

For neuropathic animals treated with Duloxetine *per os*, we pooled and analyzed the DOPeGFP+ neuronal population as described in previous sections. When compared, Sham and Duloxetine-treated group distributions and bin counts were statistically different (KS: $D=0.12683$, $p\text{-value} < 2.2 \times 10^{-16}$, X-squared = 320.69, $df = 36$, $p\text{-value} < 2.2 \times 10^{-16}$) (Figure 4 D, Supplementary Table 1). The duloxetine-treated group had distributions mostly similar to Sham for small size categories (up to $500\mu\text{m}^2$) compared to Sham (Figure 4 E, Table 2), indicating recovery of DOPeGFP expression in small size DRG neurons.

Chronic Duloxetine restored neurochemical marker distributions to Sham proportions

The cumulative distribution of NF200+ neurons in Duloxetine-treated animals was no statistically significant compared from the Sham group (KS: $D=0.036951$, $p\text{-value}=0.1003$) (Figure 5 A, Supplementary Table 1). Accordingly, Duloxetine NF200+ population distribution appeared to be similar to Sham with the exception of the extreme size categories that showed a higher percentage of small ($<300\mu\text{m}^2$) neurons and a loss of very large ($1400+\mu\text{m}^2$) cells (Figure 5 B, Table 3)

The cumulative distribution of CGRP+ neurons in Duloxetine-treated animals was significantly different from Sham mice (KS: $D=0.048957$, $p\text{-value}=0.01722$, X Squared= 362.56, $p\text{-value} < 2.2 \times 10^{-16}$) (Figure 5

C, Supplementary Table 1). Importantly, cumulative distribution as well as analysis in bin categories indicated that distributions in small size categories ($<300\mu\text{m}^2$) were very similar in duloxetine-treated and sham animals (Figure 5 D, Table 4) indicating that the changes in distribution of CGRP+ populations seen in neuropathic condition are reversed by Duloxetine treatment in these populations.

Cumulative distributions of IB4+ population in Duloxetine-treated and Sham animals were not statistically different (KS: $D = 0.17488$, $p\text{-value} < 2.2 \times 10^{-16}$, $X\text{-squared} = 725.95$, $df = 18$, $p\text{-value} < 2.2 \times 10^{-16}$) (Figure 5 E, Supplementary Table 1). In particular, the proportion of very small ($0\text{-}100\mu\text{m}^2$) and small ($300\text{-}400\mu\text{m}^2$) IB4-binding neurons in Duloxetine samples was similar to that of Sham indicating a recovery of marker expression. (Figure 5 F, Table 5).

Overall, Duloxetine treatment appeared to restore levels of expression similar to Sham conditions in small size neurons.

Duloxetine treatment restored the small peptidergic CGRP+DOPeGFP+ neuronal population.

NF200+DOPeGFP+ cell population was statistically different from Sham cumulative distribution data (KS: $D=0.091436$, $p\text{-value}=0.04456$) (Figure 7 A, Supplementary Table 1) and categorical distribution comparison showed statistically different proportions of NF200+DOPeGFP+ neurons in the area bins ($X\text{-Squared}=82.281$, $df=36$, $p\text{-value}=1.757 \times 10^{-5}$) (Figure 7 B, Table 6). However, since this neuronal population was not significantly affected in Cuff animals, changes observed here are likely to be of limited biological relevance.

Cumulative distribution and binned area values for CGRP+DOPeGFP+ cells were statistically different between Duloxetine and Sham groups (KS: $D=0.17441$ $p\text{-value}=1.405 \times 10^{-6}$, $X\text{-Squared}=117.02$, $df=42$, $p\text{-value}=5.294 \times 10^{-9}$) (Figure 7 C, Supplementary Table 1) with similar proportions of CGRP+DOPeGFP+ neurons in small cell-size categories ($100\text{-}300\mu\text{m}^2$) (Figure 7 D, Table 7). This data clearly supports that Duloxetine treatment reversed the loss of CGRP+DOPeGFP+ expression in small neurons induced by the neuropathic condition (Figure 6).

The distribution of DOPeGFP+IB4+ remained similar to Cuff group (KS: $D=0.12404$, $p\text{-value}=0.2086$, $X\text{-Squared}=80.022$, $df=18$, $p\text{-value}=8.495 \times 10^{-10}$) (Figure 7 E, Supplementary Table 1). The proportion of IB4+DOPeGFP+ cells in small size categories ($100\text{-}200\mu\text{m}^2$) was lower in Duloxetine group compared to

Sham, with a relative increase of medium-sized cells (400-500 μm^2 and 600+ μm^2). The latter however represent less than 3% of total the population (Figure 7 F, Table 8). In comparison, Cuff and Duloxetine IB4-binding-DOPeGFP+ distributions were almost identical. This data indicated that Duloxetine treatment had little or no effect on the IB4+ DOPeGFP+ population and therefore did not restore DOPeGFP expression in small non-peptidergic neuronal populations.

Chronic Formoterol partially reversed Cuff-induced changes in DOPeGFP expression.

Pooled surface area data of DOPeGFP+ neurons was significantly different from Sham (KS test: $D = 0.14212$, $p\text{-value} < 2.2 \times 10^{-16}$, $X=348.35$, $df=42$, $p\text{-value} < 2.2 \times 10^{-16}$) (Figure 4 D, Supplementary Table 1) with comparatively fewer Formoterol DOPeGFP-expressing cells in small size categories (<300 μm^2) as observed in Cuff animals. However, Formoterol reversed changes in the 300-400 μm^2 category to the level of Sham controls (Figure 4 E, Table 2).

Chronic Formoterol did not restore neurochemical marker expression to Sham level

Next we investigated whether Formoterol treatment of neuropathic mice had an impact on marker distribution changes observed following neuropathy.

In Formoterol treated mice, NF200+ distribution pattern was significantly different from Sham (KS: $D = 0.098109$, $p\text{-value} = 1.103 \times 10^{-8}$, $X\text{-Squared} = 461.75$, $df=36$, $p\text{-value} < 2.2 \times 10^{-16}$) (Figure 5 A, Supplementary Table 1) but analysis in bin categories indicated a shift in size distribution towards larger values compared to Cuff (Figure 5 B, Table 3).

The CGRP+ distribution was significantly different from Sham (KS $D = 0.090945$, $p\text{-value} = 3.398 \times 10^{-7}$, $X\text{-Squared} = 362.56$, $df=42$, $p\text{-value} < 2.2 \times 10^{-16}$) (Figure 5 C, Supplementary Table 1). Compared to Sham, there were significantly fewer neurons in small cell categories (0-300 μm^2) and Formoterol CGRP+ neuron area distribution remained similar to Cuff (Figure 5 D, Table 4). Formoterol treatment did not reverse neuropathy-induced loss of small CGRP+ neurons in lumbar DRG.

Compared to Sham, the cumulative distribution of small non-peptidergic neurons in the Formoterol group was statistically different and remained shifted towards large area populations (KS $D = 0.15672$ $p\text{-value} < 2.2 \times 10^{-16}$, $X\text{-Squared} = 725.95$, $df = 18$, $p\text{-value} < 2.2 \times 10^{-16}$) (Figure 5 E, Supplementary Table 1).

Analysis in bin categories indicated that Formoterol distribution showed a statistically significant increase in the proportion of 300-400 μm^2 surface area counts, compared to Cuff (Figure 5 F, Table 4) suggesting that treatment selectively induced IB4 expression in this population.

Overall, the distributions of surface area for all investigated markers following Formoterol treatment closely resembled Cuff distributions with the exception of a category of IB4+ cells (300-400 μm^2).

Chronic Formoterol increased DOPeGFP and IB4 co-expression.

Comparison of NF200+DOPeGFP+ surface area cumulative distribution and bin count showed that it was significantly different from Sham (KS D = 0.2111, p-value = 1.59×10^{-8} , X-Squared=82.281, df=36, p-value= 1.757×10^{-5}) (Figure 7 A, Supplementary Table 1). Only small changes were detected in the bin analysis (Figure 7 B, Table 6) but they are likely to be of limited biological relevance since this neuronal population was not significantly affected in Cuff animals.

The cumulative distribution of the CGRP+DOPeGFP+ population in Formoterol samples was statistically different, and remained shifted towards larger surface area values compared to Sham (KS D = 0.16739, p-value = 1.158×10^{-5} , X-Squared=117.02, df=42, p-value= 5.294×10^{-9}) (Figure 7 C, Supplementary Table 1). This observation was confirmed by binned co-localization data with significantly less co-localization in small surface area categories (<400 μm^2) compared to Sham (Figure 7 D, Table 7) suggesting that the treatment did not restore the loss in CGRP+ DOPeGFP+ small neurons induced by neuropathy (Figure 6).

Cumulative distribution of IB4+ DOPeGFP+ neurons from Formoterol treatment group was significantly different from Sham (KS D = 0.28832, p-value = 2.286×10^{-8} , X-Squared=80.022, df=18, p-value= 8.495×10^{-10}) and remained shifted to larger cell sizes (Figure 7E, Supplementary Table 1). Accordingly, analysis of categorical data, detected a significantly lower proportion of co-localization in small neurons (< 300 μm^2) and increased co-localization in the 300-400 μm^2 category compared to Sham (Figure 7 F, Table 8) suggesting that the latter population is essential for Formoterol antiallodynic effect (Figure 6).

Taken together, these results showed that cuff-induced shift in surface area distribution of all neurochemical categories expressing DOPeGFP were not reversed following Formoterol treatment with the exception of the 300-400 μm^2 non-peptidergic neuronal category.

Chronic neuropathic pain condition induced DOPeGFP subcellular redistribution in DRG neurons

We sought to determine whether neuropathy also induced DOPeGFP subcellular redistribution, by quantifying the fluorescence respectively associated with the membrane and the cytoplasm in DRG neurons from all experimental groups (Figure 8). The ratio of fluorescence associated with the cell surface compared to the fluorescence associated with the intracellular compartment was significantly increased after chronic neuropathic condition (Cuff: 1.34 ± 0.21 versus 1.15 ± 0.19 in Sham animals, One-Way ANOVA $F=21.42$ Post-hoc: Newman-Keuls multiple comparison test *vs* Sham $p\text{-value} < 0.0001$). Both Duloxetine and Formoterol treatments decreased membrane-associated fluorescence to values lower than those of Sham neurons (1.05 ± 0.18 and 0.97 ± 0.18 for Duloxetine and formoterol respectively, One-Way ANOVA $F=21.42$ Post-hoc: Newman-Keuls multiple comparison test *vs* Sham: $p < 0.05$ and $p\text{-value} < 0.001$ for Duloxetine and formoterol respectively and comparison *vs* cuff $p < 0.001$ for both treatments). This analysis strongly suggests that, compared to basal Sham conditions, chronic neuropathic pain induced a recruitment of DOPeGFP to the cell membrane that was reversed by treatment with either Duloxetine or Formoterol *per os*.

Chronic Duloxetine and Formoterol partially restored the loss of CGRP+free nerve endings induced by chronic neuropathic pain in the skin

Reduced CGRP+ innervation corresponding to terminals of nociceptive primary afferents has been recently described 8 weeks after cuff surgery in rat (Nascimento et al 2015). We therefore investigated whether the density of CGRP+ free nerve endings was also affected in our neuropathic mice. Under basal conditions, CGRP+ axons were a subpopulation of neuronal PGP 9.5 positive fibers. As expected, a proportion was also co-labelled with DOPeGFP (Figure 9 A). We then examined changes in nerve ending density in DOP fl/fl floxed mice and DOPcKO that do not express DOP receptors in Nav1.8 positive neurons. The density of CGRP+ free endings was significantly decreased in DOP fl/fl floxed mice 8 weeks following cuff surgery (OneWay ANOVA, $F=6.53$, $p < 0.05$) (Figure 9 B). Both treatment with Duloxetine

and Formoterol tended to reverse this effect. In DOPcKO, a decrease was observed in the density of free CGRP+ afferents under neuropathic condition that did not reach statistical significance (Figure 9B). Interestingly, our preliminary data suggested that Duloxetine and Formoterol treatments were ineffective to restore nerve ending density in these animals (Figure 9 B).

Overall, changes in CGRP+ free nerve endings following cuff surgery and antiallodynic treatment appeared to match those observed in DRGs.

Discussion

In this study, we used a knock in mouse expressing the DOP receptor fused to a fluorescent protein in order to provide a detailed description of how delta receptor distribution was affected following neuropathy and antiallodynic treatment. Electron microscopy data supported a view in which DOP receptors were expressed in neurons. Accordingly, we found that the DOP receptor subpopulation in Nav1.8 expressing neurons was mandatory for the antiallodynic action of both antidepressant and β 2-mimetic treatments in the cuff model. We first developed a mathematical approach to model population distribution to reliably identify changes in the overall DRG population and neurochemically distinct subpopulations. Our data indicated neuronal loss 8 weeks after cuff surgery that affected small size neurons, as well as a decrease in DOPeGFP positive neurons in the remaining population. Similarly, the density of primary afferents decreased in the skin under neuropathic conditions. Antidepressant and β 2-mimetic treatments that both alleviate pain partially reversed neuropathy-induced changes, but targeted different neuronal populations with the effect of antidepressants observed in peptidergic small size neurons ($< 300\mu\text{m}^2$) and the effect of β 2-mimetics restricted to one category of non-peptidergic neurons ($300\text{-}400\mu\text{m}^2$). We also found that sustained neuropathic pain condition was associated with increased DOP receptor translocation to the membrane, which was reversed by chronic antidepressant or β 2-mimetic treatment.

Methodological considerations

Defining distribution changes in the cuff model required complex statistical analysis. Neuronal populations being non-normally distributed, non-parametric distribution comparisons were performed using the Kolmogorov-Smirnov test. This test is extremely sensitive, and the large numbers of counted cells tend to highlight minute distribution differences that may be not biologically relevant. In addition, our approach is somewhat limited by a commonly encountered problem in this type of analysis, which is evaluation of relative changes in distribution of a given marker across the different populations. The choice of size categories is also critical, given that arbitrary cut-off values may mask changes occurring in a subpopulation which may be split by the bin limit, and within every bin,

distributions are not homogenous either. Finally, non-parametric Pearson's Chi Squared test was used to compare population proportions in size categories, however the Standardized Residuals make interpretation difficult, as the significance of changes is not readily observable. Despite these limitations, we believe that the statistical approach proposed here is appropriate to describe changes occurring in the different conditions.

DOP receptor distribution in sham animals

Using the knock in DOPeGFP mouse line, we found DOPeGFP expression in all size categories of DRG neurons. The proportions of DOPeGFP in each 100 μm^2 size category were similar to published data, consistent with the literature using knock in animals or *Oprd1* detection by *in situ* hybridization (Mennicken et al., 2003; Guan et al., 2005; Wang et al., 2010; Gaveriaux-Ruff et al., 2011; Scherrer et al., 2009). In particular, the DOPeGFP expression pattern in neurochemical subpopulations closely matched the distributions established by others, using the same mouse line, in the basal state. Indeed, we found that $58 \pm 5\%$ of all DOPeGFP cells expressed NF200, which was in good agreement with the 56% and 67% previously reported (Scherrer 2009, Bardoni 2014). We also reported that $22 \pm 5\%$ of NF200 cells were DOPeGFP+, similar to the 27% previously observed (Bardoni et al., 2014). Regarding non-peptidergic small size neurons, we found that $28 \pm 3\%$ of DOPeGFP+ cells were IB4+ and that $14\% \pm 3\%$ IB4+ cells expressed DOPeGFP. These values were in good agreement with the 36% previously reported (which represented 91% of NF200- cells) and 19% respectively (Bardoni et al., 2014). The peptidergic population of small DOPeGFP+ neurons was identified using CGRP as a marker. We considered size to discriminate between myelinated A δ nociceptors and unmyelinated C nociceptors expressing CGRP (Djoughri, 2016) to compare with published data using SP+ as a marker for peptidergic small C fibres (Bardoni et al., 2014; Ruscheweyh et al., 2007 and references therein). In our distribution, $16 \pm 1\%$ of DOPeGFP neurons $<300\mu\text{m}^2$ were peptidergic, and $9.5 \pm 0.5\%$ of small peptidergic cells were DOPeGFP+, considerably higher compared to 5% of DOPeGFP+ neurons expressing SP, and less than 2% of SP cells expressing DOPeGFP previously reported (Scherrer et al., 2009; Bardoni et al., 2014) but lower than the 30% based on DOP receptor detection by ISH combined with immunohistochemical detection of CGRP or SP (Wang et al., 2010). Compared to the study by

Wang et al., our lower percentage of peptidergic DOPeGFP+ neurons may account for lower sensitivity when detecting the fluorescent protein and/or a large proportion of untranslated DOP mRNA. Additionally, differences may arise from the lumbar DRG population examined, L4-L6 in our case compared to L2-L6 (Scherrer et al., 2009; Bardoni et al., 2014) or L5-L6 (Wang et al., 2010).

Overall, the DOPeGFP distribution we described here in Sham animals is in good agreement with previously published data stating DOP receptor expression in small unmyelinated as well as, medium and large myelinated neurons (Scherrer et al., 2009; Bardoni et al., 2014; Mennicken et al., 2003; Guan et al., 2005; Wang et al., 2010; Gaveriaux-Ruff et al., 2011). We however observed higher expression level of DOP receptors in peptidergic small size neurons.

The DOP receptor distribution reported here, despite lacking functional assessment, can be placed in a wider field regarding the role of opioid receptors in analgesia. Receptor cellular and subcellular localizations, the latter being regulated by trafficking, can give clues as to their role in nociceptive information modulation, which is still controversial. Indeed, one view supports that among primary afferents, there is a clear distinction between mechanical and thermal pain modalities based on neurochemical categories; pertaining a neat segregation between the roles of DOP and MOP receptors, respectively alleviating touch versus heat nociceptive signals. In this scheme, DOP receptor is expressed in unmyelinated non-peptidergic nociceptors, and DOP agonists alleviate mechanical but not thermal pain (Scherrer et al., 2009; Bardoni et al., 2014). This hypothesis is opposed to a large number of studies demonstrating that local or spinal administration of DOP receptor agonists relieves both heat and mechanically-induced pain (for review see Gendron et al., 2015 and references therein). Our results also challenge the concept of modality-specific role of DOP, on the basis of the distribution patterns we described, namely significant expression in small peptidergic neurons.

Changes in neuronal populations in neuropathic condition

Neuropathy can be induced using different surgical procedures; which complicates comparison of cellular and molecular markers across published studies. Indeed, different models may induce a variety of distribution modifications, and therefore account for the various particular pain symptoms in the respective models. Despite the paucity of experimental data, there appears to be consistent reports of

decreased labeling of small peptidergic and non-peptidergic neurons following either spinal nerve ligation or spared nerve injury models in rats and mice, at different time points ranging from 4 days to 20 weeks (Ruscheweyh et al., 2007; Hammond et al., 2004; Wang et al., 2003; Honore et al., 2000; Schafers et al., 2003). Our cuff model does not entail axotomy, and our findings point to similarities between the effects of sciatic nerve cuffing and chronic constriction injuries at the 8week time point, which was chosen in order to assess treatment effects and chronic neuropathic pain symptoms. Importantly, reports in the literature do not always clearly point out cell death as opposed to transient loss of marker expression following axotomy or constriction. Ruscheweyh et al (2007) proposed that given the absence of change in overall DRG neuron population, the scarcer labeling of subpopulations of small neurons was not caused by cell death but rather by decreased or disrupted epitope expression or substrate availability (D-galactose which binds IB4), as hypothesized by others in the SNL model (Hammond et al., 2004 and references therein). We consider that the two phenomena coexist in our cuff model, given that (1) following cuff implantation, overall DRG neuronal population is shifted towards larger cell sizes indicating cell death affecting preferentially small DRG neurons, but also that (2) treatment restores DOPEGFP, CGRP and IB4 relative expression in small-sized population.

In our model, small IB4+ cell population decreased significantly after 8 weeks of cuff-induced neuropathy. Similarly, a marked decrease in IB4-positive small neurons was reported one week after sciatic nerve ligation in rats (Wang et al., 2003; Hammond et al., 2004), and 4 to 12 days after chronic constriction injury (CCI) in both mice and rats (Schafers et al., 2003; Ruscheweyh et al., 2007). Interestingly, in rat DRGs affected by ligation, IB4+ labeling then progressively increased over time, returning to control levels by week 20, suggesting that there was no neuronal death, but rather a disruption of expression patterns (Hammond et al., 2004).

We also observed a significantly lower proportion of small cells expressing CGRP+ in DRGs from cuff animals. Similarly, CCI induced a reduction of CGRP labeling which was still detectable 8 weeks after surgery in rats, whereas the same model did not induce changes in CGRP immunoreactivity 4 days following surgery (Schafers et al., 2003). Also, a shift in CGRP+ population distribution towards larger cell sizes at 14 days was observed in this model, similar to our own observations at 8 weeks (Ruscheweyh et al., 2007). Notably, following SNL in rats, a sustained loss of peptidergic CGRP+

labeling in all size categories was reported, but the loss of labeling appeared proportionally greater in large DRG neuron size categories (Hammond et al., 2004). Interestingly, when comparing SNL, CCI and partial nerve transection (PNT) in rats, there was reportedly no change (CCI, PNT) or a marked decrease (SNL) in SP ISH or immunoreactive signal intensity at 4 and 14 days after surgery; indicating no change or a decrease in the protein expression, however there was an increase in the number of cells expressing SP (Ma and Bisby, 1998).

Regarding NF200+ DRG neurons, we observed modest changes in distribution patterns following 8 weeks of cuff-induced neuropathy, with what appeared to be increased labeling of smaller cell populations (<300µm). Interestingly, in rats, SNL did not alter total lumbar DRG N52+ cell numbers (N52 clone recognizes neurofilament 200kD protein, NF200) at investigated time points, however neuropathic groups showed a significant change in size distribution of these myelinated neurons (Hammond et al., 2004). The authors presented evidence of the appearance of a category of very small-sized N52+ DRG neurons, representing 14 and 10% of overall N52+ population 1 and 8 weeks after ligation respectively, whereas this size category only represented 2% of the overall myelinated neuronal population in sham animals. As a corollary, N52+ cells from ligated animals seemed to be shifted towards smaller cell sizes, in compensation of a loss in large myelinated neurons (Hammond 2004). However, the fact that a smaller-sized population could start to express unusual markers can also be explained by a phenotypic modification of small afferents following injury: cellular stress resulting in increased synthesis and/or phosphorylation of neurofilament protein by small cells. Indeed, neurofilament staining selectivity for large myelinated fibres is not due to absence of this protein in small cells, only to a lower density compared to medium and large fibres (Hammond 2004 and references therein). It therefore appears more likely that the cuff model does induce distribution changes in NF200+ DRG neurons, with a decrease in labeling occurring in large neurons, which increased the relative proportion of small NF200+ categories, without a new small-sized population appearing.

Regarding DOPeGFP distribution, various effects were reported in rats depending on the model of neuropathy and the considered time point. Peripheral nerve injury by cuffing induced a bilateral increase in DOP receptor protein in DRG neurons 14 days after surgery together with an increase in

the percentage of small and large neurons expressing the receptor (Kabli and Cahill, 2007). On the opposite, CCI in 2 rat strains led to ipsilateral decrease in DOP mRNA level after 4 weeks (Herradon et al., 2008). Similarly, DOP mRNA is strongly decreased in rats at days 3 and 14 post CCI (Obara et al., 2009) whereas it remained unchanged at day 16 after partial sciatic nerve ligation (Pol et al., 2006). In our model, we found a decreased proportion of small size neurons expressing DOPeGFP 8 weeks after induction of neuropathy. However, we did not investigate levels of mRNA or protein expression and cannot therefore rule out increased DOPeGFP expression in other size categories that would parallel the observed cell distribution rearrangements.

In the skin, we observed decreased density of CGRP positive free nerve ending similarly to what was recently reported using the cuff model in rats (Nascimento et al., 2015). Interestingly, this paralleled our observation in the DRG where labeling of CGRP+ neurons significantly decreased in neuropathic condition.

Effect of antiallodynic treatments on DOP receptor expression and function

Peripheral analgesia by the DOP agonist SNC 80 is mediated by DOP receptor expressed in Nav1.8+ neurons in the CFA inflammatory and partial sciatic nerve ligation neuropathic models (Gaveriaux-Ruff et al., 2011). We found that treatment effects of both Duloxetine and Formoterol on neuropathic allodynia were also abolished in Nav1.8 conditional knockout mice, in which DOP receptor was specifically ablated in Nav1.8-expressing primary afferents. Nav1.8 channels are expressed in 90% of nociceptors, both peptidergic and non-peptidergic and in all VGlut3+ CLTMRs; but is also found in 40% of myelinated A fibres (Shields et al., 2012 and references therein). However, myelinated A fibres expressing Nav1.8 represent only 10% of the overall Nav1.8 labeled cells, and their vast majority are nociceptors.

Treatment with Duloxetine partially restored DOPeGFP expression in small peptidergic neurons (200-300 μm^2). In addition, no co-localization was found between DOPeGFP and the tyrosine hydroxylase marker specific of LTMC neurons (Bardoni et al., 2014). Our own study suggested scarce or no co-localization of the two markers. It is therefore reasonable to consider that Duloxetine treatment recruits DOP receptors mainly expressed in peptidergic C nociceptors.

There are few clues as to what mechanisms are uphill of antiallodynic action of Duloxetine. Ongoing studies suggest that Duloxetine may reduce membrane bound TNF α in DRGs, and circulating levels of proinflammatory cytokines, which points to neuron-glia interactions (Bohren et al., 2013). Satellite glial cells that wrap the DRG neuron somas become activated in conditions of nerve injury, and have been shown to express membrane-bound proinflammatory TNF α (Bohren et al., 2013). This proinflammatory cytokine could presumably strongly activate TNF α receptors TNFR1 or 2 expressed by neighboring DRG neuronal cells (Pollock et al., 2002; Shubayev and Myers, 2002; Schafers et al., 2003), especially in conditions of nerve injury since TNFR expression in DRG tissue is upregulated following CCI (Shubayev and Myers, 2002; Schafers et al., 2003). TNFR is an essential mediator in the development of mechanical allodynia, as TNFR knockout animals develop reduced mechanical hypersensitivity (Cunha et al., 2005). TNFR pathways recruit TNFR adaptor proteins TRAF2/5 (Cabal-Hierro and Lazo, 2012) leading to increased nuclear translocation of the proinflammatory transcription factor NF- κ B (Hauer et al., 2005). They also activate mitogen activated protein kinase MAPK (Liu et al., 2001; Joseph et al., 2005) in particular p38. P38 MAPK activity is involved in inflammatory and neuropathic pain (Jin and Gereau, 2006 and references therein) and p38 activation has been linked to increased expression and function of voltage gated sodium channels (Nav channels). Nav1.8 in particular has been shown to have a considerable number of potential p38 phosphorylation sites (Akopian et al., 1997; Sharrocks et al., 2000). Indeed, exogenous TNF α is sufficient to induce mechanical hypersensitivity in naïve animals (He et al., 2010; Homma et al., 2002; Schafers et al., 2003), and rapidly enhances both tetrodotoxin-resistant and -sensitive (TTX-R and TTX-S) sodium currents (Chen et al., 2011) via a TNFR1- and p38-dependent mechanism (Czeschik et al., 2008; Jin and Gereau, 2006). Spontaneous pain and ectopic discharges of primary afferent fibres after nerve injury are known to be linked to alterations in voltage gated sodium channel function (Yang et al., 2014; Garrison et al., 2014), therefore TNF α -induced neuronal hyperexcitability may underlie the development of mechanical hypersensitivity in the context of nerve injury. Membrane depolarization of DRG cells activates L-type calcium channels, which become permeable to calcium ions (Buzas et al., 1998). Increased intracellular calcium enhances calcium-modulated protein activity such as calmodulin, which in turn activates the p38 MAPK pathways and increases nuclear

translocation of ATF2 transcription factor that binds the DOP receptor promoter site (Buzas et al., 1998). This intracellular cascade may thus contribute to progressively restore DOP receptor expression.

Antidepressants such as Duloxetine exert their action by non-selective blockade of catecholamine or serotonin reuptake, and the antiallodynic effects rely on local endogenous noradrenalin production by sprouting sympathetic fibres which enter the DRG following nerve injury (Bohren et al., 2013) but which also innervate lymph nodes (Panuncio et al., 1999). Increased endogenous noradrenalin concentrations also lead to activation of the α 1-, α 2- and β -adrenoreceptors expressed by leukocytes (Rittner et al., 2009; Machelska, 2011) which may promote release of enkephalin and dynorphin by these immune cells (Binder et al., 2004). Increased endogenous opioid peptides then activate DOP receptors leading to enhanced BDNF signaling which would reduce TNF α expression via CREB inhibition and reverse Nav 1.8 current increase and thus reduce peripheral afferent sensitivity (Tian et al., 2013; He et al., 2010; Leung et al., 2001).

In summary, Duloxetine may exert DOP dependent allodynia by a dual mechanism that restores DOP receptor expression by dampening TNF α dependent pathway and that promotes DOP receptor function by enhancing endogenous opioid peptide release.

Formoterol treatment did not restore DOPeGFP distribution pattern but the proportion of 300-400 μm^2 non-peptidergic neurons co-expressing IB4 and DOPeGFP was increased compared to the Cuff group and similar to Sham mice. Formoterol antiallodynic action is therefore correlated to restored DOPeGFP expression in what is likely to be non-peptidergic nociceptors.

Formoterol is a selective agonist of β 2-adrenoreceptors and therefore can increase endogenous opioid peptide release from immune cells similarly to antidepressant molecules. Increased endogenous opioid peptides may then activate DOP receptors and reduce neuronal excitation and peripheral sensitivity. Any other mechanism by which formoterol may influence DOP receptor expression and function remains to be determined.

Neuropathy increased membrane translocation of DOPeGFP

We showed increased membrane localization of DOPeGFP following 8 weeks of cuff-induced neuropathy, and this effect was consistent regardless of the examined size category the DRG neurons belonged to. Increase in membrane translocation of DOP receptor is known to occur in chronic inflammatory pain conditions (for review see Cahill et al., 2007, 2003; Pettinger et al., 2013; Patwardhan et al., 2005) in a PKC-dependent manner and following chronic morphine administration (Erbs et al., 2016; Lee et al., 2002; Morinville et al., 2003; Lucido et al., 2005; Gendron et al., 2006); there is evidence that this increased membrane targeting of DOP depends on MOP receptor, possibly through heteromerization between these two opioid receptors (Xie et al., 2009). In order to address this possibility, co-localization deserves further investigation. Nonetheless, *in vivo* and *in vitro* studies have shown that DOP receptor membrane insertion is increased following chronic pain or application of inflammatory mediators, and the increased availability of DOP receptors at membranes of neurons of the periphery or spinal cord are in favor of an enhanced antinociceptive effect of DOP agonists in the context of chronic painful diseases (Mousa et al., 2001; Zollner et al., 2003; reviewed in Machelska and Stein, 2006; Cahill et al., 2007). Our own results show that increased DOP receptor expression at the plasma membrane also occurs under neuropathic conditions. However, the mechanism underlying DOP receptor export remains incompletely understood. DOP receptor sorting to the cell surface is thought to take place via the regulated secretory pathway (Cahill et al., 2007). In particular, direct interaction with SP would be essential for DOP receptor sorting in large dense core vesicles as preassembled complexes (Zhao et al., 2011; Guan et al., 2005). This mechanism is however challenged by the observation of intact DOP analgesia in preprotachykin PPTA knockout animals in a model of inflammatory pain (Dubois and Gendron, 2010). In our case, increased translocation of DOPeGFP signal to the plasma membrane was observed regardless of cell size, which strongly suggests that SP is not mandatory for receptor export. It also supports the view in which, in chronic pain conditions, the increased membrane expression of DOP receptors and presumably, signaling complexes, could rapidly alter the sensitivity of the afferents to DOP agonists, modulators and endogenous ligands. Interestingly, treatment of neuropathic allodynia by either Duloxetine or

Formoterol reversed the high level of membrane insertion of the fluorescent DOPeGFP receptor following cuff surgery, which was even significantly decreased compared to Sham control conditions.

In conclusion, in the cuff model of neuropathic pain, expression of DOP receptor in small nociceptive fibres is largely decreased, and DOP receptor membrane translocation is increased. DOP receptor expression is restored in small peptidergic neurons that express Nav1.8 by treatment with antidepressant whereas β -mimetics appear to require DOP receptors expressed in non-peptidergic neurons to exert their antiallodynic effect.

Acknowledgements

The authors would like to thank the Chronobiotron Animal Facility and the Imaging Platform of the Institut des Neurosciences Cellulaires et Intégratives for their assistance. The authors also acknowledge Dr Sylvain Hugel for contributions to scientific discussions. R.A.C. was funded by the Fondation pour la Recherche Médicale

References

- Akopian, A. N., Souslova, V., Sivilotti, L., and Wood, J. N. (1997). Structure and distribution of a broadly expressed atypical sodium channel. *FEBS Lett.* 400, 183–7.
- Attal, N., Fermanian, C., Fermanian, J., Lanteri-Minet, M., Alchaar, H., and Bouhassira, D. (2008). Neuropathic pain: are there distinct subtypes depending on the aetiology or anatomical lesion? *Pain* 138, 343–53. doi:10.1016/j.pain.2008.01.006.
- Bardoni, R., Tawfik, V. L., Wang, D., François, A., Solorzano, C., Shuster, S. a, et al. (2014). Delta opioid receptors presynaptically regulate cutaneous mechanosensory neuron input to the spinal cord dorsal horn. *Neuron* 81, 1312–27. doi:10.1016/j.neuron.2014.01.044.
- Benbouzid, M., Choucair-Jaafar, N., Yalcin, I., Waltisperger, E., Muller, A., Freund-Mercier, M. J., and Barrot, M. (2008a). Chronic, but not acute, tricyclic antidepressant treatment alleviates neuropathic allodynia after sciatic nerve cuffing in mice. *Eur. J. Pain* 12, 1008–17. doi:10.1016/j.ejpain.2008.01.010.
- Benbouzid, M., Gavériaux-Ruff, C., Yalcin, I., Waltisperger, E., Tessier, L.-H., Muller, A., Kieffer, B. L., Freund-Mercier, M. J., and Barrot, M. (2008b). Delta-opioid receptors are critical for tricyclic antidepressant treatment of neuropathic allodynia. *Biol. Psychiatry* 63, 633–6. doi:10.1016/j.biopsych.2007.06.016.
- Benbouzid, M., Pallage, V., Rajalu, M., Waltisperger, E., Doridot, S., Poisbeau, P., Freund-Mercier, M. J., and Barrot, M. (2008c). Sciatic nerve cuffing in mice: a model of sustained neuropathic pain. *Eur. J. Pain* 12, 591–9. doi:10.1016/j.ejpain.2007.10.002.
- Bie, B., and Pan, Z. Z. (2007). Trafficking of central opioid receptors and descending pain inhibition. *Mol. Pain* 3, 37. doi:10.1186/1744-8069-3-37.
- Binder, W., Mousa, S. a, Sitte, N., Kaiser, M., Stein, C., and Schäfer, M. (2004). Sympathetic activation triggers endogenous opioid release and analgesia within peripheral inflamed tissue. *Eur. J. Neurosci.*

20, 92–100. doi:10.1111/j.1460-9568.2004.03459.x.

Bohren, Y., Tessier, L.-H., Megat, S., Petitjean, H., Hugel, S., Daniel, D., et al. (2013). Antidepressants suppress neuropathic pain by a peripheral β 2-adrenoceptor mediated anti-TNF α mechanism. *Neurobiol. Dis.* 60, 39–50. doi:10.1016/j.nbd.2013.08.012.

Bouhassira, D., Lantéri-Minet, M., Attal, N., Laurent, B., and Touboul, C. (2008). Prevalence of chronic pain with neuropathic characteristics in the general population. *Pain* 136, 380–7. doi:10.1016/j.pain.2007.08.013.

Briley, M. (2004). Clinical experience with dual action antidepressants in different chronic pain syndromes. *Hum. Psychopharmacol.* 19, 19–23. doi:10.1002/hup.621.

Buzas, B., Rosenberger, J., and Cox, B. M. (1998). Ca²⁺/calmodulin-dependent transcriptional activation of delta-opioid receptor gene expression induced by membrane depolarization in NG108-15 cells. *J. Neurochem.* 70, 105–12.

Cabal-Hierro, L., and Lazo, P. S. (2012). Signal transduction by tumor necrosis factor receptors. *Cell. Signal.* 24, 1297–305. doi:10.1016/j.cellsig.2012.02.006.

Cahill, C. M., Holdridge, S. V., and Morinville, A. (2007). Trafficking of delta-opioid receptors and other G-protein-coupled receptors: implications for pain and analgesia. *Trends Pharmacol. Sci.* 28, 23–31. doi:10.1016/j.tips.2006.11.003.

Cahill, C. M., Morinville, A., Hoffert, C., O'Donnell, D., and Beaudet, A. (2003). Up-regulation and trafficking of delta opioid receptor in a model of chronic inflammation: implications for pain control. *Pain* 101, 199–208.

Chen, X., Pang, R.-P., Shen, K.-F., Zimmermann, M., Xin, W.-J., Li, Y.-Y., and Liu, X.-G. (2011). TNF- α enhances the currents of voltage gated sodium channels in uninjured dorsal root ganglion neurons following motor nerve injury. *Exp. Neurol.* 227, 279–86. doi:10.1016/j.expneurol.2010.11.017.

- Choucair-Jaafar, N., Yalcin, I., Rodeau, J.-L., Waltisperger, E., Freund-Mercier, M.-J., and Barrot, M. (2009). Beta2-adrenoceptor agonists alleviate neuropathic allodynia in mice after chronic treatment. *Br. J. Pharmacol.* 158, 1683–94. doi:10.1111/j.1476-5381.2009.00510.x.
- Cunha, T. M., Verri, W. A., Silva, J. S., Poole, S., Cunha, F. Q., and Ferreira, S. H. (2005). A cascade of cytokines mediates mechanical inflammatory hypernociception in mice. *Proc. Natl. Acad. Sci. U. S. A.* 102, 1755–60. doi:10.1073/pnas.0409225102.
- Czeschik, J. C., Hagenacker, T., Schäfers, M., and Büsselberg, D. (2008). TNF-alpha differentially modulates ion channels of nociceptive neurons. *Neurosci. Lett.* 434, 293–8. doi:10.1016/j.neulet.2008.01.070.
- Djoughri, L. (2016). A δ -fiber low threshold mechanoreceptors innervating mammalian hairy skin: A review of their receptive, electrophysiological and cytochemical properties in relation to A δ -fiber high threshold mechanoreceptors. *Neurosci. Biobehav. Rev.* 61, 225–38. doi:10.1016/j.neubiorev.2015.12.009.
- Dubois, D., and Gendron, L. (2010). Delta opioid receptor-mediated analgesia is not altered in preprotachykinin A knockout mice. *Eur. J. Neurosci.* 32, 1921–1929. doi:10.1111/j.1460-9568.2010.07466.x.
- Dworkin, R. H., O'Connor, A. B., Backonja, M., Farrar, J. T., Finnerup, N. B., Jensen, T. S., et al. (2007). Pharmacologic management of neuropathic pain: evidence-based recommendations. *Pain* 132, 237–51. doi:10.1016/j.pain.2007.08.033.
- Erbs, E., Faget, L., Ceredig, R. A., Matifas, A., Vonesch, J.-L., Kieffer, B. L., and Massotte, D. (2016). Impact of chronic morphine on delta opioid receptor-expressing neurons in the mouse hippocampus. *Neuroscience* 313, 46–56. doi:10.1016/j.neuroscience.2015.10.022.
- Erbs, E., Faget, L., Scherrer, G., and Kessler, P. (2012). Distribution of delta opioid receptor-expressing neurons in the mouse hippocampus. *Neuroscience* 221, 203–213.

doi:10.1016/j.neuroscience.2012.06.023.

Erbs, E., Faget, L., Scherrer, G., Matifas, A., Filliol, D., Vonesch, J.-L., et al. (2015). A mu-delta opioid receptor brain atlas reveals neuronal co-occurrence in subcortical networks. *Brain Struct. Funct.* doi:10.1007/s00429-014-0717-9.

Filliol, D., Ghozland, S., Chluba, J., Martin, M., Matthes, H. W., Simonin, F., et al. (2000). Mice deficient for delta- and mu-opioid receptors exhibit opposing alterations of emotional responses. *Nat. Genet.* 25, 195–200. doi:10.1038/76061.

Finnerup, N. B., Attal, N., Haroutounian, S., McNicol, E., Baron, R., Dworkin, R. H., et al. (2015). Pharmacotherapy for neuropathic pain in adults: a systematic review and meta-analysis. *Lancet Neurol.* 14, 162–173. doi:10.1016/S1474-4422(14)70251-0.

Garrison, S. R., Weyer, A. D., Barabas, M. E., Beutler, B. A., and Stucky, C. L. (2014). A gain-of-function voltage-gated sodium channel 1.8 mutation drives intense hyperexcitability of A- and C-fiber neurons. *Pain* 155, 896–905. doi:10.1016/j.pain.2014.01.012.

Gavériaux-Ruff, C., Karchewski, L. a, Hever, X., Matifas, A., and Kieffer, B. L. (2008). Inflammatory pain is enhanced in delta opioid receptor-knockout mice. *Eur. J. Neurosci.* 27, 2558–67. doi:10.1111/j.1460-9568.2008.06223.x.

Gavériaux-Ruff, C., and Kieffer, B. L. (2002). Opioid receptor genes inactivated in mice: the highlights. *Neuropeptides* 36, 62–71. doi:10.1054/npep.2002.0900.

Gaveriaux-Ruff, C., Nozaki, C., Nadal, X., Hever, X. C., Weibel, R., Matifas, A., et al. (2011). Genetic ablation of delta opioid receptors in nociceptive sensory neurons increases chronic pain and abolishes opioid analgesia. *Pain* 152, 1238–48. doi:10.1016/j.pain.2010.12.031.

Gendron, L., Lucido, A. L., Mennicken, F., O'Donnell, D., Vincent, J.-P., Stroh, T., and Beaudet, A. (2006). Morphine and pain-related stimuli enhance cell surface availability of somatic delta-opioid

- receptors in rat dorsal root ganglia. *J. Neurosci.* 26, 953–62. doi:10.1523/JNEUROSCI.3598-05.2006.
- Gendron, L., Mittal, N., Beaudry, H., and Walwyn, W. (2015). Recent advances on the δ opioid receptor: from trafficking to function. *Br. J. Pharmacol.* 172, 403–19. doi:10.1111/bph.12706.
- Guan, J.-S., Xu, Z.-Z., Gao, H., He, S.-Q., Ma, G.-Q., Sun, T., et al. (2005). Interaction with vesicle luminal protachykinin regulates surface expression of delta-opioid receptors and opioid analgesia. *Cell* 122, 619–31. doi:10.1016/j.cell.2005.06.010.
- Hammond, D. L., Ackerman, L., Holdsworth, R., and Elzey, B. (2004). Effects of spinal nerve ligation on immunohistochemically identified neurons in the L4 and L5 dorsal root ganglia of the rat. *J. Comp. Neurol.* 475, 575–89. doi:10.1002/cne.20209.
- Hauer, J., Püschner, S., Ramakrishnan, P., Simon, U., Bongers, M., Federle, C., and Engelmann, H. (2005). TNF receptor (TNFR)-associated factor (TRAF) 3 serves as an inhibitor of TRAF2/5-mediated activation of the noncanonical NF-kappaB pathway by TRAF-binding TNFRs. *Proc. Natl. Acad. Sci. U. S. A.* 102, 2874–9. doi:10.1073/pnas.0500187102.
- He, X., Zang, Y., Pang, R., Zhou, X., Wei, X., Li, Y., Xin, W., Qin, Z., and Liu, X. (2010). TNF- α contributes to up-regulation of Nav1.3 and Nav1.8 in DRG neurons following motor fiber injury. *Pain* 151, 2–3. doi:10.1016/j.pain.2010.05.010.
- von Hehn, C. A., Baron, R., and Woolf, C. J. (2012). Deconstructing the neuropathic pain phenotype to reveal neural mechanisms. *Neuron* 73, 638–52. doi:10.1016/j.neuron.2012.02.008.
- Herradon, G., Ezquerra, L., Nguyen, T., Wang, C., Siso, A., Franklin, B., Dilorenzo, L., Rossenfeld, J., Silos-Santiago, I., and Alguacil, L. F. (2008). Noradrenergic and opioidergic alterations in neuropathy in different rat strains. *Neurosci. Lett.* 438, 186–9. doi:10.1016/j.neulet.2008.03.095.
- Homma, Y., Brull, S. J., and Zhang, J.-M. (2002). A comparison of chronic pain behavior following local

application of tumor necrosis factor alpha to the normal and mechanically compressed lumbar ganglia in the rat. *Pain* 95, 239–46.

Honore, P., Rogers, S. ., Schwei, M. ., Salak-Johnson, J. ., Luger, N. ., Sabino, M. ., Clohisy, D. ., and Mantyh, P. . (2000). Murine models of inflammatory, neuropathic and cancer pain each generates a unique set of neurochemical changes in the spinal cord and sensory neurons. *Neuroscience* 98, 585–598. doi:10.1016/S0306-4522(00)00110-X.

Jin, X., and Gereau, R. W. (2006). Acute p38-mediated modulation of tetrodotoxin-resistant sodium channels in mouse sensory neurons by tumor necrosis factor-alpha. *J. Neurosci.* 26, 246–55. doi:10.1523/JNEUROSCI.3858-05.2006.

Joseph, T., Look, D., and Ferkol, T. (2005). NF-kappaB activation and sustained IL-8 gene expression in primary cultures of cystic fibrosis airway epithelial cells stimulated with *Pseudomonas aeruginosa*. *Am. J. Physiol. Lung Cell. Mol. Physiol.* 288, L471–9. doi:10.1152/ajplung.00066.2004.

Kabli, N., and Cahill, C. M. (2007). Anti-allodynic effects of peripheral delta opioid receptors in neuropathic pain. *Pain* 127, 84–93. doi:10.1016/j.pain.2006.08.003.

Lee, M., Cahill, C., Vincent, J., and Beaudet, A. (2002). Internalization and trafficking of opioid receptor ligands in rat cortical neurons. *Synapse* 111, 102–111.

Leung, A., Wallace, M. S., Ridgeway, B., and Yaksh, T. (2001). Concentration-effect relationship of intravenous alfentanil and ketamine on peripheral neurosensory thresholds, allodynia and hyperalgesia of neuropathic pain. *Pain* 91, 177–87.

Liu, W., Kato, M., Itoigawa, M., Murakami, H., Yajima, M., Wu, J., Ishikawa, N., and Nakashima, I. (2001). Distinct involvement of NF-kappaB and p38 mitogen-activated protein kinase pathways in serum deprivation-mediated stimulation of inducible nitric oxide synthase and its inhibition by 4-hydroxynonenal. *J. Cell. Biochem.* 83, 271–80.

- Lucido, A. L., Morinville, A., Gendron, L., Stroh, T., and Beaudet, A. (2005). Prolonged morphine treatment selectively increases membrane recruitment of delta-opioid receptors in mouse basal ganglia. *J. Mol. Neurosci.* 25, 207–14. doi:10.1385/JMN:25:3:207.
- Ma, W., and Bisby, M. A. (1998). Increase of preprotachykinin mRNA and substance P immunoreactivity in spared dorsal root ganglion neurons following partial sciatic nerve injury. *Eur. J. Neurosci.* 10, 2388–2399.
- Machelska, H. (2011). Dual peripheral actions of immune cells in neuropathic pain. *Arch. Immunol. Ther. Exp. (Warsz)*. 59, 11–24. doi:10.1007/s00005-010-0106-x.
- Machelska, H., and Stein, C. (2006). Leukocyte-derived opioid peptides and inhibition of pain. *J. Neuroimmune Pharmacol.* 1, 90–7. doi:10.1007/s11481-005-9002-2.
- Mennicken, F., Zhang, J., Hoffert, C., Ahmad, S., Beaudet, A., and O'Donnell, D. (2003). Phylogenetic changes in the expression of delta opioid receptors in spinal cord and dorsal root ganglia. *J. Comp. Neurol.* 465, 349–60. doi:10.1002/cne.10839.
- Mico, J., Ardid, D., Berrocoso, E., and Eschalier, a (2006). Antidepressants and pain. *Trends Pharmacol. Sci.* 27, 348–354. doi:10.1016/j.tips.2006.05.004.
- Morinville, A., Cahill, C. M., Esdaile, M. J., Aibak, H., Collier, B., Kieffer, B. L., and Beaudet, A. (2003). Regulation of Delta-Opioid Receptor Trafficking via Mu Opioid Receptor Stimulation: Evidence from Mu-Opioid Receptor Knock-Out Mice. *J. Neuroscience* 23, 4888–4898.
- Mousa, S. A., Zhang, Q., Sitte, N., Ji, R., and Stein, C. (2001). beta-Endorphin-containing memory-cells and mu-opioid receptors undergo transport to peripheral inflamed tissue. *J. Neuroimmunol.* 115, 71–8.
- Nadal, X., Baños, J.-E., Kieffer, B. L., and Maldonado, R. (2006). Neuropathic pain is enhanced in delta-opioid receptor knockout mice. *Eur. J. Neurosci.* 23, 830–4. doi:10.1111/j.1460-9568.2006.04569.x.

- Nascimento, F. P., Magnussen, C., Yousefpour, N., and Ribeiro-da-Silva, A. (2015). Sympathetic fibre sprouting in the skin contributes to pain-related behaviour in spared nerve injury and cuff models of neuropathic pain. *Mol. Pain* 11, 59. doi:10.1186/s12990-015-0062-x.
- Nozaki, C., Le Bourdonnec, B., Reiss, D., Windh, R. T., Little, P. J., Dolle, R. E., Kieffer, B. L., and Gavériaux-Ruff, C. (2012). δ -Opioid mechanisms for ADL5747 and ADL5859 effects in mice: analgesia, locomotion, and receptor internalization. *J. Pharmacol. Exp. Ther.* 342, 799–807. doi:10.1124/jpet.111.188987.
- Obara, I., Parkitna, J. R., Korostynski, M., Makuch, W., Kaminska, D., Przewlocka, B., and Przewlocki, R. (2009). Local peripheral opioid effects and expression of opioid genes in the spinal cord and dorsal root ganglia in neuropathic and inflammatory pain. *Pain* 141, 283–91. doi:10.1016/j.pain.2008.12.006.
- Panuncio, A. L., De La Peña, S., Gualco, G., and Reissenweber, N. (1999). Adrenergic innervation in reactive human lymph nodes. *J. Anat.* 194 (Pt 1, 143–6.
- Patwardhan, A. M., Berg, K. A., Akopain, A. N., Jeske, N. A., Gamper, N., Clarke, W. P., and Hargreaves, K. M. (2005). Bradykinin-induced functional competence and trafficking of the delta-opioid receptor in trigeminal nociceptors. *J. Neurosci.* 25, 8825–32. doi:10.1523/JNEUROSCI.0160-05.2005.
- Pettinger, L., Gigout, S., Linley, J. E., and Gamper, N. (2013). Bradykinin controls pool size of sensory neurons expressing functional δ -opioid receptors. *J. Neurosci.* 33, 10762–71. doi:10.1523/JNEUROSCI.0123-13.2013.
- Pol, O., Murtra, P., Caracuel, L., Valverde, O., Puig, M. M., and Maldonado, R. (2006). Expression of opioid receptors and c-fos in CB1 knockout mice exposed to neuropathic pain. *Neuropharmacology* 50, 123–32. doi:10.1016/j.neuropharm.2005.11.002.
- Pollock, J., McFarlane, S. M., Connell, M. C., Zehavi, U., Vandenabeele, P., MacEwan, D. J., and Scott,

- R. H. (2002). TNF-alpha receptors simultaneously activate Ca²⁺ mobilisation and stress kinases in cultured sensory neurones. *Neuropharmacology* 42, 93–106.
- Pradhan, A. A. A., Becker, J. A. J., Scherrer, G., Tryoen-Toth, P., Filliol, D., Matifas, A., Massotte, D., Gavériaux-Ruff, C., and Kieffer, B. L. (2009). In vivo delta opioid receptor internalization controls behavioral effects of agonists. *PLoS One* 4, e5425. doi:10.1371/journal.pone.0005425.
- Pradhan, A. A. A., Walwyn, W., Nozaki, C., Filliol, D., Erbs, E., Matifas, A., Evans, C., and Kieffer, B. L. (2010). Ligand-directed trafficking of the δ -opioid receptor in vivo: two paths toward analgesic tolerance. *J. Neurosci.* 30, 16459–68. doi:10.1523/JNEUROSCI.3748-10.2010.
- Radat, F., Margot-Duclot, a, and Attal, N. (2013). Psychiatric co-morbidities in patients with chronic peripheral neuropathic pain: a multicentre cohort study. *Eur. J. Pain* 17, 1547–57. doi:10.1002/j.1532-2149.2013.00334.x.
- Rezaï, X., Faget, L., Bednarek, E., Schwab, Y., Kieffer, B. L., and Massotte, D. (2012). Mouse δ opioid receptors are located on presynaptic afferents to hippocampal pyramidal cells. *Cell. Mol. Neurobiol.* 32, 509–16. doi:10.1007/s10571-011-9791-1.
- Rittner, H. L., Hackel, D., Yamdeu, R.-S., Mousa, S. A., Stein, C., Schäfer, M., and Brack, A. (2009). Antinociception by neutrophil-derived opioid peptides in noninflamed tissue--role of hypertonicity and the perineurium. *Brain. Behav. Immun.* 23, 548–57. doi:10.1016/j.bbi.2009.02.007.
- Ruscheweyh, R., Forsthuber, L., Schoffngger, D., and Sandkuhler, J. (2007). Modification of Classical Neurochemical Markers in Identified Primary Afferent Neurons With AB-, AD-, and C-Fibers After Chronic Constriction Injury in Mice. *J. Comp. Neurol.* 504, 287–297. doi:10.1002/cne.
- Schafers, M., Geis, C., Svensson, C. I., Luo, Z. D., and Sommer, C. (2003). Selective increase of tumour necrosis factor-alpha in injured and spared myelinated primary afferents after chronic constrictive injury of rat sciatic nerve. *Eur. J. Neurosci.* 17, 791–804. doi:10.1046/j.1460-9568.2003.02504.x.

- Scherrer, G., Imamachi, N., Cao, Y. Q., Contet, C., Mennicken, F., O'Donnell, D., Kieffer, B. L., and Basbaum, A. I. (2009). Dissociation of the opioid receptor mechanisms that control mechanical and heat pain. *Cell* 137, 1148–1159. doi:10.1016/j.cell.2009.04.019.
- Scherrer, G., Tryoen-to, P., Filliol, D., Matifas, A., Laustriat, D., Cao, Y. Q., Vonesh, J., Gaveriaux, C., Kieffer, B. L., and Basbaum, A. I. (2006). Knockin mice expressing fluorescent delta -opioid receptors uncover G protein-coupled receptor dynamics in vivo. *PNAS* 103.
- Sharrocks, A. D., Yang, S. H., and Galanis, A. (2000). Docking domains and substrate-specificity determination for MAP kinases. *Trends Biochem. Sci.* 25, 448–53.
- Shields, S. D., Ahn, H.-S., Yang, Y., Han, C., Seal, R. P., Wood, J. N., Waxman, S. G., and Dib-Hajj, S. D. (2012). Nav1.8 expression is not restricted to nociceptors in mouse peripheral nervous system. *Pain* 153, 2017–30. doi:10.1016/j.pain.2012.04.022.
- Shubayev, V. I., and Myers, R. R. (2002). Anterograde TNF alpha transport from rat dorsal root ganglion to spinal cord and injured sciatic nerve. *Neurosci. Lett.* 320, 99–101.
- Smith, H. S. (2012). Opioids and neuropathic pain. *Pain Physician* 15, ES93–110.
- Tian, X., Hua, F., Sandhu, H., Chao, D., Balboni, G., Salvadori, S., He, X., and Xia, Y. (2013). Effect of δ -Opioid Receptor Activation on BDNF-TrkB vs. TNF- α in the Mouse Cortex Exposed to Prolonged Hypoxia. *Int. J. Mol. Sci.* 14, 15959–15976. doi:10.3390/ijms140815959.
- Tokuyasu, K. T. (1980). Immunocytochemistry on ultrathin frozen sections. *Histochem. J.* 12, 381–403.
- Vanderah, T. W. (2010). Delta and kappa opioid receptors as suitable drug targets for pain. *Clin. J. Pain* 26 Suppl 1, S10–5. doi:10.1097/AJP.0b013e3181c49e3a.
- Wang, H.-B., Zhao, B., Zhong, Y.-Q., Li, K.-C., Li, Z.-Y., Wang, Q., et al. (2010). Coexpression of delta- and mu-opioid receptors in nociceptive sensory neurons. *Proc. Natl. Acad. Sci. U. S. A.* 107, 13117–22. doi:10.1073/pnas.1008382107.

- Wang, R., Guo, W., Ossipov, M. H., Vanderah, T. W., Porreca, F., and Lai, J. (2003). Glial cell line-derived neurotrophic factor normalizes neurochemical changes in injured dorsal root ganglion neurons and prevents the expression of experimental neuropathic pain. *Neuroscience* 121, 815–24.
- Xie, W.-Y., He, Y., Yang, Y.-R., Li, Y.-F., Kang, K., Xing, B.-M., and Wang, Y. (2009). Disruption of Cdk5-associated phosphorylation of residue threonine-161 of the delta-opioid receptor: impaired receptor function and attenuated morphine antinociceptive tolerance. *J. Neurosci.* 29, 3551–64. doi:10.1523/JNEUROSCI.0415-09.2009.
- Yalcin, I., Megat, S., Barthas, F., Waltisperger, E., Kremer, M., Salvat, E., and Barrot, M. (2014). The sciatic nerve cuffing model of neuropathic pain in mice. *J. Vis. Exp.*, 1–7. doi:10.3791/51608.
- Yalcin, I., Tessier, L.-H., Petit-Demoulière, N., Waltisperger, E., Hein, L., Freund-Mercier, M.-J., and Barrot, M. (2010). Chronic treatment with agonists of beta(2)-adrenergic receptors in neuropathic pain. *Exp. Neurol.* 221, 115–21. doi:10.1016/j.expneurol.2009.10.008.
- Yang, Q., Wu, Z., Hadden, J. K., Odem, M. A., Zuo, Y., Crook, R. J., Frost, J. A., and Walters, E. T. (2014). Persistent pain after spinal cord injury is maintained by primary afferent activity. *J. Neurosci.* 34, 10765–9. doi:10.1523/JNEUROSCI.5316-13.2014.
- Zhang, X., Bao, L., and Guan, J.-S. (2006). Role of delivery and trafficking of delta-opioid peptide receptors in opioid analgesia and tolerance. *Trends Pharmacol. Sci.* 27, 324–9. doi:10.1016/j.tips.2006.04.005.
- Zhao, B., Wang, H.-B., Lu, Y.-J., Hu, J.-W., Bao, L., and Zhang, X. (2011). Transport of receptors, receptor signaling complexes and ion channels via neuropeptide-secretory vesicles. *Cell Res.* 21, 741–53. doi:10.1038/cr.2011.29.
- Zollner, C., Shaqura, M. A., Bopaiah, C. P., Mousa, S., Stein, C., and Schafer, M. (2003). Painful inflammation-induced increase in mu-opioid receptor binding and G-protein coupling in primary afferent neurons. *Mol. Pharmacol.* 64, 202–10. doi:10.1124/mol.64.2.202.

Figure legends

Figure 1: Chronic Duloxetine or Formoterol treatment *per os* relieves neuropathic allodynia in DOPeGFP KI mice.

Following cuff implantation surgery, animals have lowered paw withdrawal thresholds (PWT), displaying sustained mechanical allodynia. Four weeks after nerve injury, antidepressant (Duloxetine 60 mg/kg/day) and β 2-mimetic (Formoterol 0.05 mg/kg/day) or saccharin 0.2% control *per os* treatments started and were maintained for 4 weeks. The right (ipsilateral) hindpaw mechanical threshold was tested using Von Frey calibrated filaments in male (A) and female (B) DOPeGFP KI mice. Data from three separate experiments are expressed as means \pm SEM. Sham group (29 females and 7 males) and Cuff group (16 females and 13 males), cuff animals treated with Duloxetine comprised the Duloxetine group (11 females and 9 males), cuff-implanted animals treated with Formoterol (11 females and 9 males). One-Way ANOVA F (males)=178.32, *** $p < 0.0001$; F (females)=163.14, *** $p < 0.0001$; Tukey HSD post-hoc test: Duloxetine Treatment day 19 vs Baseline: p (Males)=0.403; p (Females)=0.997; Formoterol Treatment day 22 vs Baseline: p (Males)=0.8738, p (Females)=0.5240. (C) The right (ipsilateral) hindpaw mechanical threshold was tested using Von Frey calibrated filaments in DOP cKO male and female mice. Data is expressed as means \pm SEM. Sham group (n=3) and Cuff group (n=3), cuff animals treated with Duloxetine (n=6), cuff-implanted animals treated with Formoterol (n=8).

Figure 2: Neuron size distribution in sham animals.

- (A) Representative confocal image of fluorescent Nissl stain (NeuroTrace®, far red Alexa 647) of Sham DRG sections, all neurons in lumbar (L4, 5, 6) dorsal root ganglia (DRG) sections are positive.
- (B) Density distribution of NeuroTrace® positive cells in Sham lumbar DRG from DOPeGFP mice. Representation of pooled area data from 6 DOPeGFP animals, n=6727 neurons. A high proportion of DRG cells (>95%) have areas between 100 and 1100 μ m² and overall area data is

- not normally distributed (Anderson-Darling normality test $A=256.6$ $p\text{-value} < 2.210^{-16}$). On the horizontal axis, the distribution of the neurons according to size is presented with every vertical line representing one cell.
- (C) Fitted histogram of binned NeuroTrace® positive neurons. Blue bar graph represents respective percentages of cells in successive $100\mu\text{m}^2$ -wide area bins. A black curve representing the overall population model is plotted. The three Gaussian functions that compose the overall population model are represented as blue curves. The modes of the individual Gaussian curves are $167.1\mu\text{m}^2$, $279\mu\text{m}^2$ and $560.5\mu\text{m}^2$ respectively.
- (D) Comparative cumulative distribution plot of NeuroTrace® positive neurons for pooled Sham and Cuff groups. For each group, cross-sections areas are sorted from smallest to largest and ranks are assigned. Cumulative rank is calculated relative to total population. Cuff cumulative distribution curve (grey) is shifted towards larger cell cross-section areas compared to Sham (black) cumulative distribution: Cuff overall population is composed of relatively larger cells than Sham. Sham and Cuff distributions are very significantly different, non-parametric Kolmogorov-Smirnov distribution comparison test: $D = 0.07572$, $p\text{-value} = 5.563 \times 10^{-08}$.
- (E) Categorical data plot of size distribution for NeuroTrace® positive neuron cross-section areas in DOPeGFP mice from Sham and Cuff experimental groups. For each $100\mu\text{m}^2$ -wide area bin, the number of cells from the size category was counted, and relative percentage of cells in individual bins was calculated, for both groups: Sham (white bars) and Cuff (black bars). Categorical data sets were compared using a non-parametric Pearson's Chi-squared test: $X\text{-squared} = 108.34$, $df = 14$, $p\text{-value} < 2.2 \times 10^{-16}$. Standardized Chi-Square Residuals summarized in Table 1 indicate that Sham and Cuff relative percentages are statistically different for the $100\text{-}200\mu\text{m}^2$ cross-section area bin.

Figure 3: DOPeGFP does not co-localize with glutamine synthase

Representative micrographs showing (A) detection of the glial cell marker glutamine synthase with small gold particles (5 nm), (B) detection of DOPeGFP with large gold particles (20 nm) in the lysosomal compartment and (C) background level. Scale bar 500 nm

Figure 4: DOPeGFP distribution in sham animals

- (A) Representative confocal image of fluorescent DOPeGFP expressing neurons in lumbar (L4, 5, 6) dorsal root ganglia (DRG) of sham animals.
- (B) Density distribution of DOPeGFP positive cells in Sham lumbar DRG from DOPeGFP mice. Representation of pooled area data from 7 DOPeGFP animals, n=3080 neurons. A high proportion of DRG cells (>97%) have areas between 100 and 1100 μm^2 and overall area data is not normally distributed (Shapiro-Wilk normality test: $W = 0.96235$, p-value < 2.210^{-16}). On the horizontal axis, the distribution of the neurons according to size is presented with every vertical line representing one cell.
- (C) Fitted histogram of binned DOPeGFP positive neurons. Green bar graph represents respective percentages of cells in successive 100 μm^2 -wide area bins. A black curve representing the overall population model is plotted. The three Gaussian functions composing the overall population model are represented as blue curves. The modes of the individual Gaussian curves are 231 μm^2 , 471.3 μm^2 and 706.6 μm^2 respectively.
- (D) Comparative cumulative distribution plot of DOPeGFP positive neurons for pooled Sham, Cuff, Duloxetine and Formoterol groups. For each group, cross-sections areas are sorted from smallest to largest and ranks are assigned. Cumulative rank is calculated relative to total population. Cuff cumulative distribution curve (black), Duloxetine (dark grey) and Formoterol (light blue) are shifted towards larger cell cross-section areas compared to Sham (light grey) cumulative distribution. Sham distribution is significantly different from other experimental groups, non-parametric Kolmogorov-Smirnov distribution comparison test: $D = 0.073898$, p-value = 5.563×10^{-08} , $D=0.12683$ p-value < 2.2×10^{-16} and $D = 0.14212$, p-value < 2.2×10^{-16} .
- (E) Categorical data plot of size distribution for DOPeGFP positive neuron cross-section areas in DOPeGFP mice from Sham, Cuff, Duloxetine and Formoterol experimental groups. For each 100 μm^2 -wide area bin, the number of cells from the size category was counted, and relative

percentage of cells in individual bins was calculated, for all groups: Sham (white bars), Cuff (black bars), Duloxetine (light grey bars) and Formoterol (dark grey bars). Categorical data sets were compared using a non-parametric categorical distribution comparison: Pearson's X-Squared $X=348.35$, $df=42$, $p\text{-value}<2.2\times 10^{-16}$. Standardized Chi-Square Residuals summarized in Table 2.

Figure 5: Distribution of neuronal markers in Sham, Cuff, Duloxetine and Formoterol groups.

- (A) Comparative cumulative distribution plot of NF200 positive neurons for pooled Sham, Cuff, Duloxetine and Formoterol groups. For each group, cross-sections areas are sorted from smallest to largest and ranks are assigned. Cumulative rank is calculated relative to total population for each experimental group. Sham (light grey), Cuff (black), Duloxetine (dark grey) and Formoterol (light blue) cumulative distribution curves are represented. Sham and Duloxetine overall populations are similar (non-parametric Kolmogorov-Smirnov distribution comparison test: $D=0.036951$, $p\text{-value}=0.1003$). Cuff and Formoterol distributions are significantly different from Sham (non-parametric Kolmogorov-Smirnov distribution comparison test: $D=0.22826$, $p\text{-value}=6.461\times 10^{-13}$, $D = 0.098109$, $p\text{-value} = 1.103\times 10^{-8}$ respectively).
- (B) Categorical data plot of size distribution for NF200 positive neuron cross-section areas in DOPeGFP mice from Sham, Cuff, Duloxetine and Formoterol experimental groups. For each $100\mu\text{m}^2$ -wide area bin, the number of cells from the size category was counted, and relative percentage of cells in individual bins was calculated, for all groups: Sham (white bars), Cuff (black bars), Duloxetine (light grey bars) and Formoterol (dark grey bars). Categorical data sets were compared using a non-parametric categorical distribution comparison: Pearson's X-Squared $X\text{-Squared}= 461.75$, $df=36$, $p\text{-value}<2.2\times 10^{-16}$. Standardized Chi-Square Residuals summarized in Table 3.
- (C) Comparative cumulative distribution plot of CGRP positive neurons for pooled Sham, Cuff, Duloxetine and Formoterol groups. For each group, cross-sections areas are sorted from smallest to largest and ranks are assigned. Cumulative rank is calculated relative to total population for each experimental group. Sham (light grey), Cuff (black), Duloxetine (dark grey) and Formoterol (light blue) cumulative distribution curves are represented, Cuff distribution is shifted towards

larger cell sizes compared to other experimental groups, and all distributions are significantly different from Sham (non-parametric Kolmogorov-Smirnov distribution comparison test: $D = 0.19057$, $p\text{-value} < 2.2 \times 10^{-16}$, $D=0.048957$ $p\text{-value}=0.01722$, $D = 0.090945$, $p\text{-value} = 3.398 \times 10^{-7}$ for Cuff, Duloxetine and Formoterol respectively).

(D) Categorical data plot of size distribution for CGRP positive neuron cross-section areas in DOPeGFP mice from Sham, Cuff, Duloxetine and Formoterol experimental groups. For each $100\mu\text{m}^2$ -wide area bin, the number of cells from the size category was counted, and relative percentage of cells in individual bins was calculated, for all groups: Sham (white bars), Cuff (black bars), Duloxetine (light grey bars) and Formoterol (dark grey bars). Categorical data sets were compared using a non-parametric categorical distribution comparison: Pearson's X-Squared $X\text{-Squared}= 362.56$, $df=42$, $p\text{-value}<2.2 \times 10^{-16}$. Standardized Chi-Square Residuals summarized in Table 4.

(E) Comparative cumulative distribution plot of IB4 positive neurons for pooled Sham, Cuff, Duloxetine and Formoterol groups. For each group, cross-sections areas are sorted from smallest to largest and ranks are assigned. Cumulative rank is calculated relative to total population for each experimental group. Sham (light grey), Cuff (black), Duloxetine (dark grey) and Formoterol (light blue) cumulative distribution curves are represented. Cuff, Duloxetine and Formoterol distributions are significantly shifted towards larger cell sizes compared to Sham (non-parametric Kolmogorov-Smirnov distribution comparison test: $D = 0.19057$, $p\text{-value} < 2.2 \times 10^{-16}$, $D = 0.17488$, $p\text{-value} < 2.2 \times 10^{-16}$, $D = 0.15672$ $p\text{-value} < 2.2 \times 10^{-16}$ for Cuff, Duloxetine and Formoterol respectively).

(F) Categorical data plot of size distribution for IB4 positive neuron cross-section areas in DOPeGFP mice from Sham, Cuff, Duloxetine and Formoterol experimental groups. For each $100\mu\text{m}^2$ -wide area bin, the number of cells from the size category was counted, and relative percentage of cells in individual bins was calculated, for all groups: Sham (white bars), Cuff (black bars), Duloxetine (light grey bars) and Formoterol (dark grey bars). Categorical data sets were compared using a non-parametric categorical distribution comparison: Pearson's X-Squared $X\text{-Squared}= 725.95$, $df= 18$, $p\text{-value} < 2.2 \times 10^{-16}$. Standardized Chi-Square Residuals summarized in Table 5.

Figure 6: Global impact of the neuropathic condition and antiallodynic treatments on DOPeGFP distribution

Bar graph representing the percentage of DOPeGFP cells expressing neuronal markers for small peptidergic CGRP neurons with areas $<300\mu\text{m}^2$, non-peptidergic IB4+ neurons and myelinated NF200+ neurons in sham animals (white bar). Neuropathy induced a decrease in small peptidergic and nonpeptidergic DOPeGFP neurons (black bar). Duloxetine treatment (light grey bar) and Formoterol (dark grey bar) treatment restored co-expression in small peptidergic neurons or small non-peptidergic neurons respectively. Values expressed as mean \pm SEM. Number of animals: sham n=6, cuff n=5, duloxetine n=4, formoterol n=4. Kruskal Wallis test DOPeGFP+CGRP+ p=0.002, DOPeGFP+IB4+ p=0.022, DOPeGFP+NF200+ p= 0.031. Dunn's post test. * p <0.05 versus sham, # p<0.05 versus cuff.

Figure 7: Distribution of the different neuronal populations expressing DOPeGFP

- (A) Comparative cumulative distribution plot of DOPeGFP+ cells expressing NF200 for pooled Sham, Cuff, Duloxetine and Formoterol groups. For each group, cross-sections areas are sorted from smallest to largest and ranks are assigned. Cumulative rank is calculated relative to total population for each experimental group. Sham (light grey), Cuff (black), Duloxetine (dark grey) and Formoterol (light blue) cumulative distribution curves are represented. Cuff, Duloxetine and Formoterol distributions are significantly shifted towards larger cell sizes compared to Sham (non-parametric Kolmogorov-Smirnov distribution comparison test: D = 0.22826, p-value = 6.461×10^{-13} , D = 0.091436, p-value = 0.04456, D = 0.2111, p-value = 1.59×10^{-8} for Cuff, Duloxetine and Formoterol respectively)
- (B) Categorical data plot of size distribution for DOPeGFP+NF200+ positive neuron cross-section areas in DOPeGFP mice from Sham, Cuff, Duloxetine and Formoterol experimental groups. For each $100\mu\text{m}^2$ -wide area bin, the number of cells from the size category was counted, and relative percentage of cells in individual bins was calculated, for all groups: Sham (white bars), Cuff

(black bars), Duloxetine (light grey bars) and Formoterol (dark grey bars). Categorical data sets were compared using a non-parametric categorical distribution comparison: Pearson's X-Squared $X\text{-Squared} = 82.281$, $df = 36$, $p\text{-value} = 1.757 \times 10^{-5}$. Standardized Chi-Square Residuals summarized in Table 6.

(C) Comparative cumulative distribution plot of DOPeGFP+ cells expressing CGRP for pooled Sham, Cuff, Duloxetine and Formoterol groups. For each group, cross-sections areas are sorted from smallest to largest and ranks are assigned. Cumulative rank is calculated relative to total population for each experimental group. Sham (light grey), Cuff (black), Duloxetine (dark grey) and Formoterol (light blue) cumulative distribution curves are represented. Cuff, Duloxetine and Formoterol distributions are significantly shifted towards larger cell sizes compared to Sham (non-parametric Kolmogorov-Smirnov distribution comparison test: $D=0.14301$ $p\text{-value}=1.848 \times 10^{-5}$, $D=0.17441$ $p\text{-value}=1.405 \times 10^{-6}$, $D = 0.16739$, $p\text{-value} = 1.158 \times 10^{-5}$ for Cuff, Duloxetine and Formoterol respectively).

(D) Categorical data plot of size distribution for DOPeGFP+CGRP+ positive neuron cross-section areas in DOPeGFP mice from Sham, Cuff, Duloxetine and Formoterol experimental groups. For each $100\mu\text{m}^2$ -wide area bin, the number of cells from the size category was counted, and relative percentage of cells in individual bins was calculated, for all groups: Sham (white bars), Cuff (black bars), Duloxetine (light grey bars) and Formoterol (dark grey bars). Categorical data sets were compared using a non-parametric categorical distribution comparison: Pearson's X-Squared $X\text{-Squared} = 117.02$, $df = 42$, $p\text{-value} = 5.294 \times 10^{-9}$. Standardized Chi-Square Residuals summarized in Table 7.

(E) Comparative cumulative distribution plot of DOPeGFP+ cells expressing IB4 for pooled Sham, Cuff, Duloxetine and Formoterol groups. For each group, cross-sections areas are sorted from smallest to largest and ranks are assigned. Cumulative rank is calculated relative to total population for each experimental group. Sham (light grey), Cuff (black), Duloxetine (dark grey)

and Formoterol (light blue) cumulative distribution curves are represented. Cuff, Duloxetine and Formoterol distributions are significantly shifted towards larger cell sizes compared to Sham (non-parametric Kolmogorov-Smirnov distribution comparison test: $D=0.29774$ p-value= 7.942×10^{-15} , $D=0.30293$ p-value= 1.142×10^{-7} , $D = 0.28832$, p-value = 2.286×10^{-8} for Cuff, Duloxetine and Formoterol respectively).

(F) Categorical data plot of size distribution for cross-section areas of DOPeGFP+IB4+ neurons in DOPeGFP mice from Sham, Cuff, Duloxetine and Formoterol experimental groups. For each $100 \mu\text{m}^2$ -wide area bin, the number of cells from the size category was counted, and relative percentage of cells in individual bins was calculated, for all groups: Sham (white bars), Cuff (black bars), Duloxetine (light grey bars) and Formoterol (dark grey bars). Categorical data sets were compared using a non-parametric categorical distribution comparison: Pearson's X-Squared $X\text{-squared} = 80.022$, $df = 18$, p-value = 8.495×10^{-10} . Standardized Chi-Square Residuals summarized in Table 8.

Figure 8: Chronic neuropathic pain induced DOPeGFP subcellular redistribution that was reversed by antiallodynic treatments.

(A) Representative fluorescence micrographs of DOPeGFP-positive neuron in a Sham (A), Cuff (B), Duloxetine (C) and Formoterol (D) animal. Scale bar $5 \mu\text{m}$

(B) Duloxetine or Formoterol treatments both reversed the cuff-induced subcellular redistribution.

Data are represented as means \pm SEM. Sham: $n=32$ cells from 4 animals; Cuff: $n=30$ cells from 3 animals ; Duloxetine: $n=31$ cells from 2 animals; Formoterol: $n= 30$ cells from 2 animals. One-way ANOVA * $p<0.5$, *** $p<0.01$ versus sham, ### $p<0.01$ versus cuff

Figure 9: Density of terminals of primary afferents co-expressing DOPeGFP and CGRP in the skin was affected by the neuropathic condition and the antiallodynic treatments.

(A) Representative image of terminals co-expressing DOPeGFP and CGRP markers in the glabrous skin of the hindpaw: PGP9.5 (magenta), CGRP (red), DOPeGFP (green), DAPI (blue), merge. Arrowhead indicates a fiber with co-labeling for CGRP and DOPeGFP.

Scale bar 25 μ m

(B) Comparison of fibre density in the glabrous skin of the hind paw in Nav 1.8cKO and floxed mice. Sham, Cuff, Duloxetine- and Formoterol- treated animals n=2 mice per condition. * $p < 0.05$ compared to floxed sham

Supplementary figure legends

Supplementary figure 1: Chronic Duloxetine or Formoterol treatment *per os* relieved neuropathic allodynia in DOP cKO mice.

Following cuff implantation surgery, animals had lowered paw withdrawal thresholds (PWT), displaying sustained mechanical allodynia. Four weeks after nerve injury, antidepressant (Duloxetine 60mg/kg/day) and β 2-mimetic (Formoterol 0.05 mg/kg/day) or saccharin 0.2% control *per os* treatments started and maintained for 4 weeks. The hindpaw mechanical threshold was tested using Von Frey calibrated filaments, for DOP cKO male and female mice right (ipsilateral) hindpaws. Data from one preliminary experiment is expressed as means \pm SEM. Sham group (n=3) and Cuff group (n=3), cuff animals treated with Duloxetine comprised the Duloxetine group (n=6), cuff-implanted animals treated with Formoterol (n=8).

Supplementary figure 2: Neuron size distribution in cuff animals.

- (A) Experimental and calculated cumulative distributions for NeuroTrace® positive Sham neuronal population. Data points are black circles, calculated fitted distribution points are light blue dots, both represent scatterplots of area values (horizontal axis) according to relative rank (vertical axis). Cumulative rank is calculated relative to total population.
- (B) Experimental and calculated cumulative distributions for NeuroTrace® positive Cuff neurons. Data points are black circles, calculated fitted distribution points are light blue dots, both represent scatterplots of area values (horizontal axis) according to relative rank (vertical axis). Cumulative rank is calculated relative to total population.

Supplementary figure 3: NeuroTrace® fit model

- (A) Density fit for Sham NeuroTrace® positive neuronal population (n=6727 cells). Experimental density plot is fitted with calculated Gaussian components (sum of three Gaussian functions in black), arrows indicate the mode of each Gaussian curve (blue). On the horizontal axis, the

distribution of the neurons according to size is presented with every vertical line representing one cell.

- (B) Fitted histogram of Sham NeuroTrace® positive areas distributed in 100µm² bins, expressed as relative proportions (light blue bars). The calculated fit model for NeuroTrace® positive areas is composed of three Gaussian functions (blue curves), the sum of which is represented in black.

Supplementary figure 4: Distribution model of NF200 positive cells in Sham animals

- (A) Density distribution of NF200 positive cells in Sham lumbar DRG from DOPeGFP mice. Representation of pooled area data from 7 DOPeGFP animals. On the horizontal axis, the distribution of the neurons according to size is presented with every vertical line representing one cell.
- (B) Fitted histogram of binned NF200 positive neurons. Purple bar graph represents respective percentages of cells in successive 100µm²-wide area bins. A black curve representing the overall population model is plotted. The three Gaussian functions composing the overall population model are represented as blue curves.

Supplementary figure 5: Distribution model of CGRP-positive cells in Sham animals

- (A) Density distribution of CGRP positive cells in Sham lumbar DRG from DOPeGFP mice. Representation of pooled area data from 7 DOPeGFP animals. On the horizontal axis, the distribution of the neurons according to size is presented with every vertical line representing one cell.
- (B) Fitted histogram of binned CGRP positive neurons. Pink bar graph represents respective percentages of cells in successive 100µm²-wide area bins. A black curve representing the overall population model is plotted, the three Gaussian functions which compose the overall population model are represented as blue curves.

Supplementary figure 6: Distribution model of IB4 positive cells in Sham animals

- (A) Density distribution of IB4 positive cells in Sham lumbar DRG from DOPeGFP mice. Representation of pooled area data from 7 DOPeGFP animals. On the horizontal axis, the

distribution of the neurons according to size is presented with every vertical line representing one cell.

(B) Fitted histogram of binned IB4 positive neurons. Orange bar graph represents respective percentages of cells in successive 100 μm^2 -wide area bins. A black curve representing the overall population model is plotted. The two Gaussian functions composing the overall population model are represented as blue curves.

Supplementary figure 7: DOPeGFP does not co-localize with Tyrosine hydroxylase

(A) Tyrosine hydroxylase (TH), a marker for LTMR detected with AlexaFluor 647, (B) MOPmcherry, (C) DOPeGFP, (D) DAPI, (E) merge. Arrowheads point to neurons expressing TH but not MOPmcherry or DOPeGFP. Scale bar 50 μm .

Supplementary figure 8: Representative micrographs of co-localized DOPeGFP-expressing neurons.

- a. NF200 (red), DOPeGFP (green), overlay
- b. IB4 (red) DOPeGFP (green), overlay
- c. CGRP (red), DOPeGFP (green), overlay.

White arrows designate co-localized neurons. Scale bar: 100 μm .

Figure 1

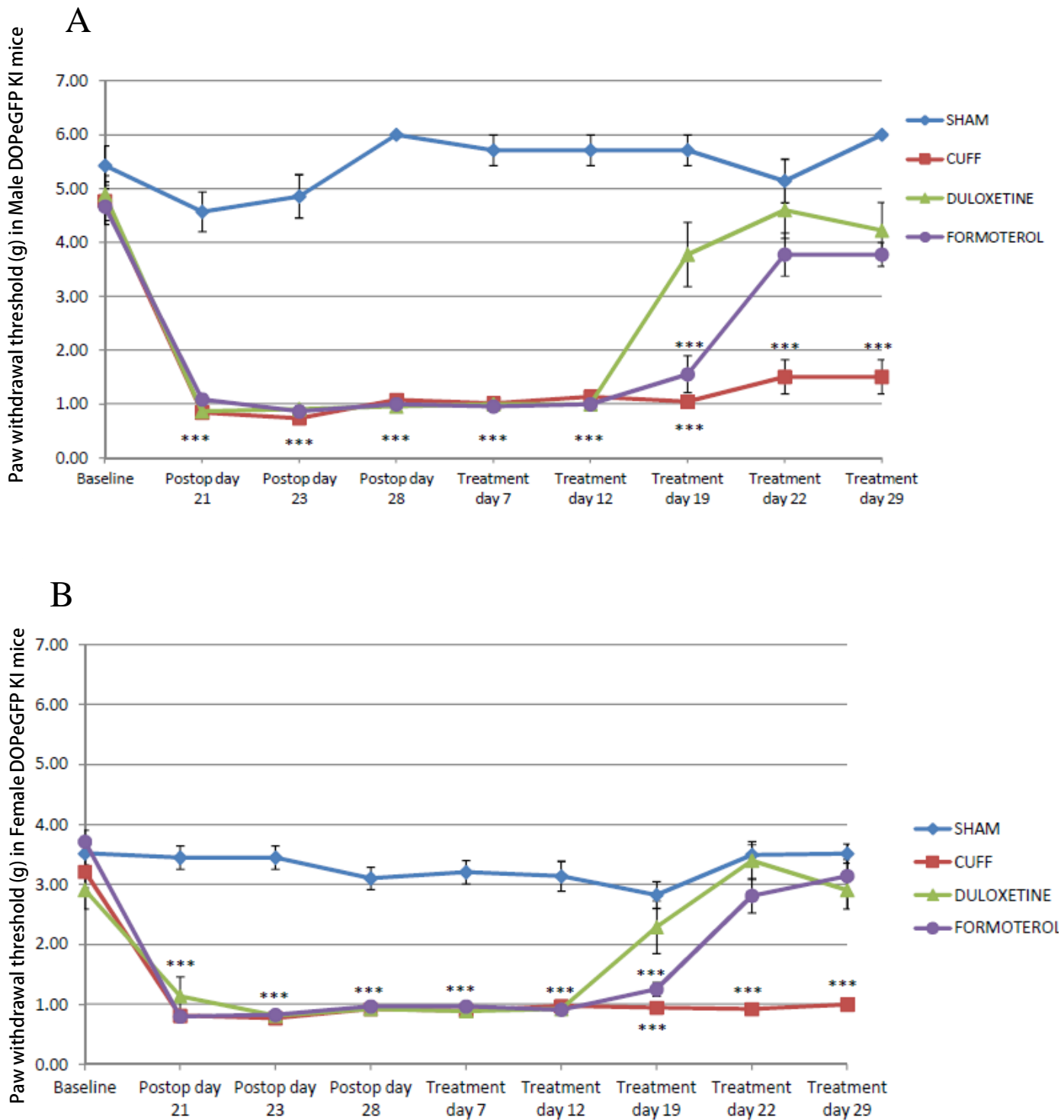

Figure 1C

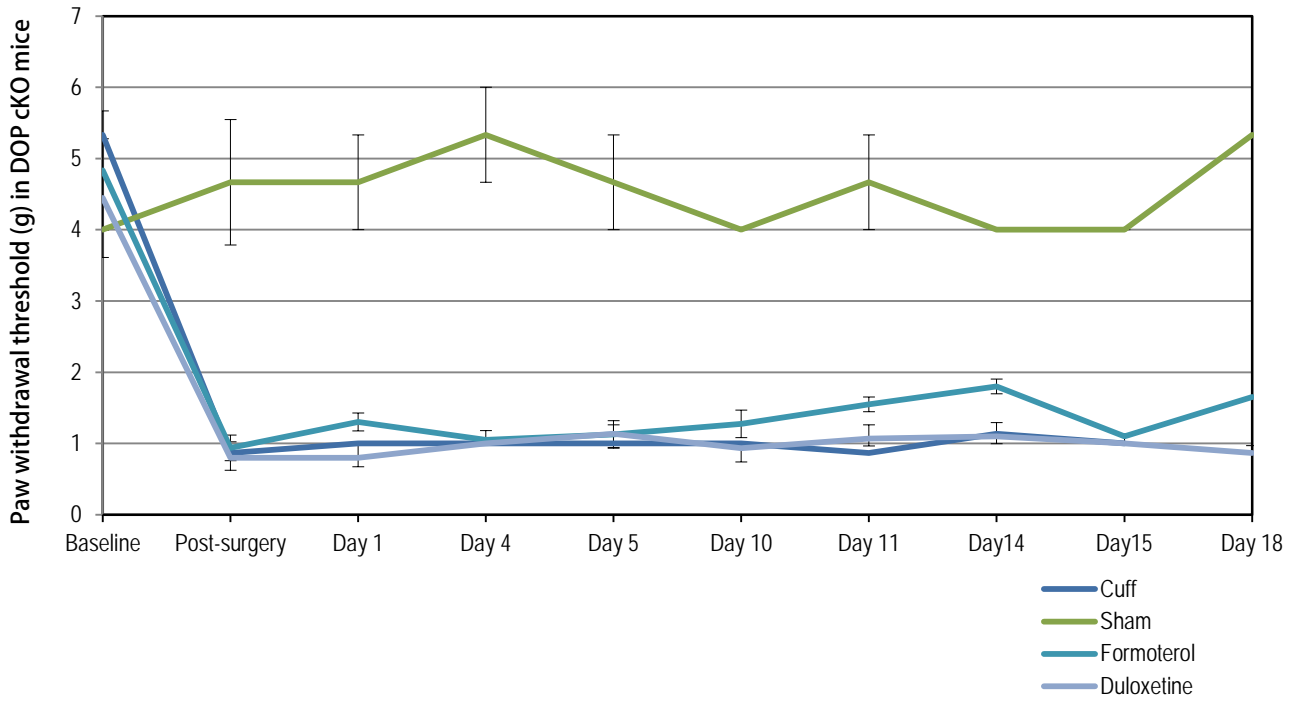

Figure 2

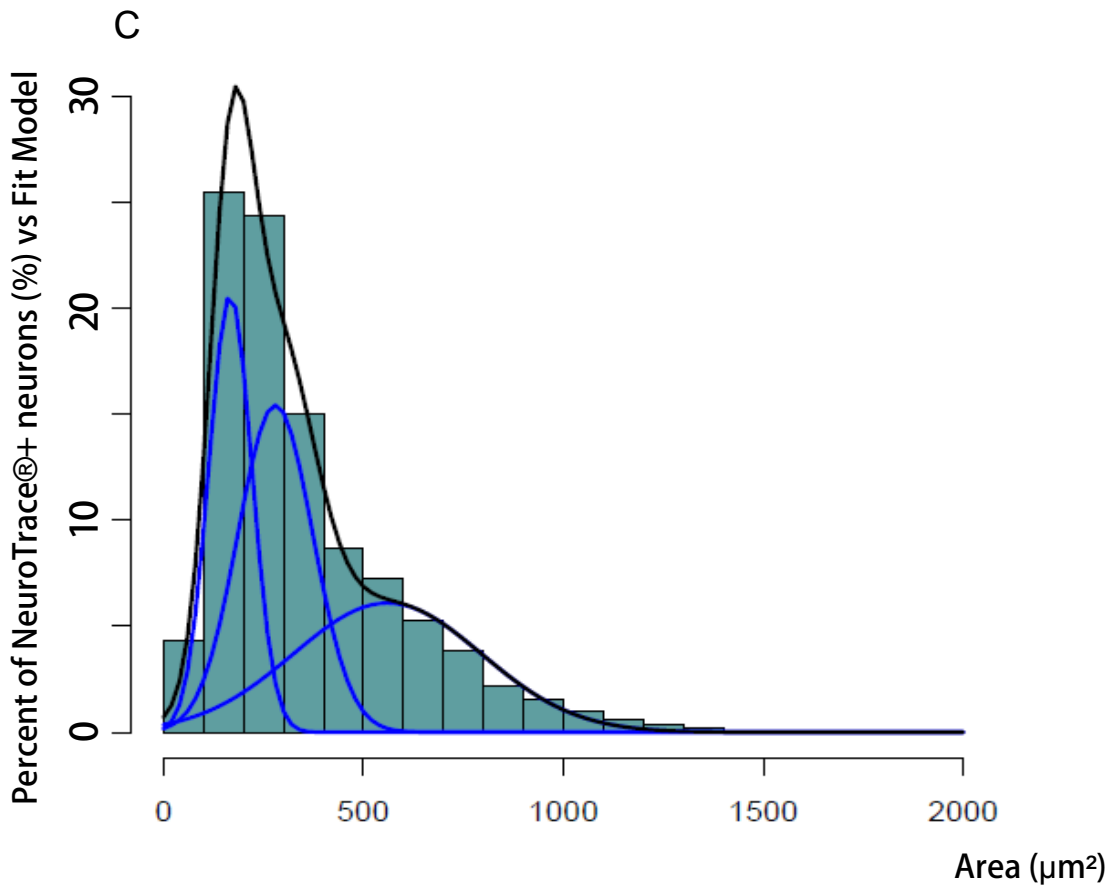
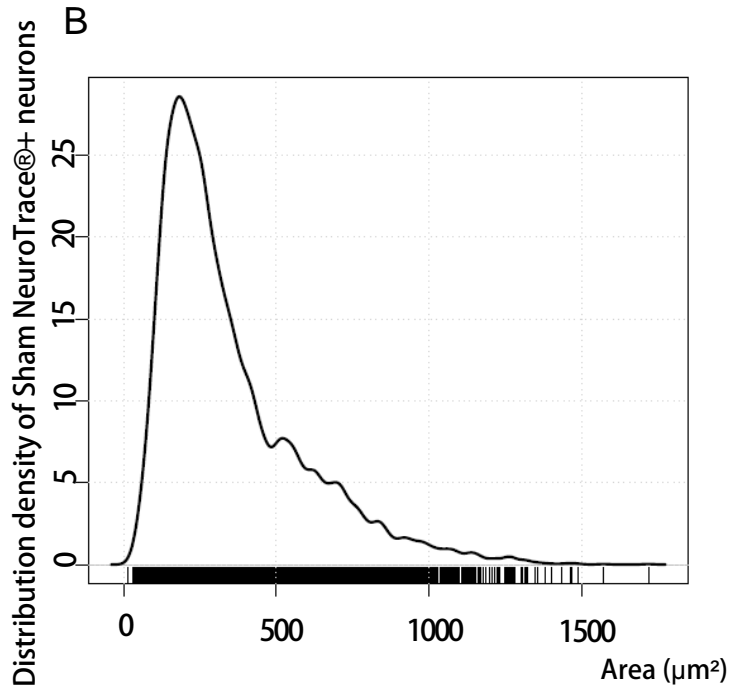
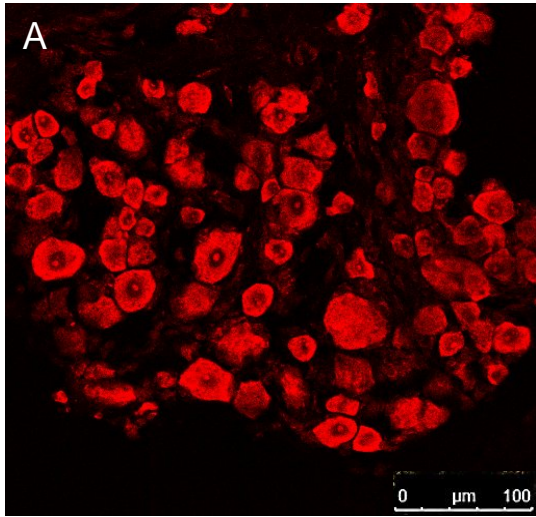

Figure 2

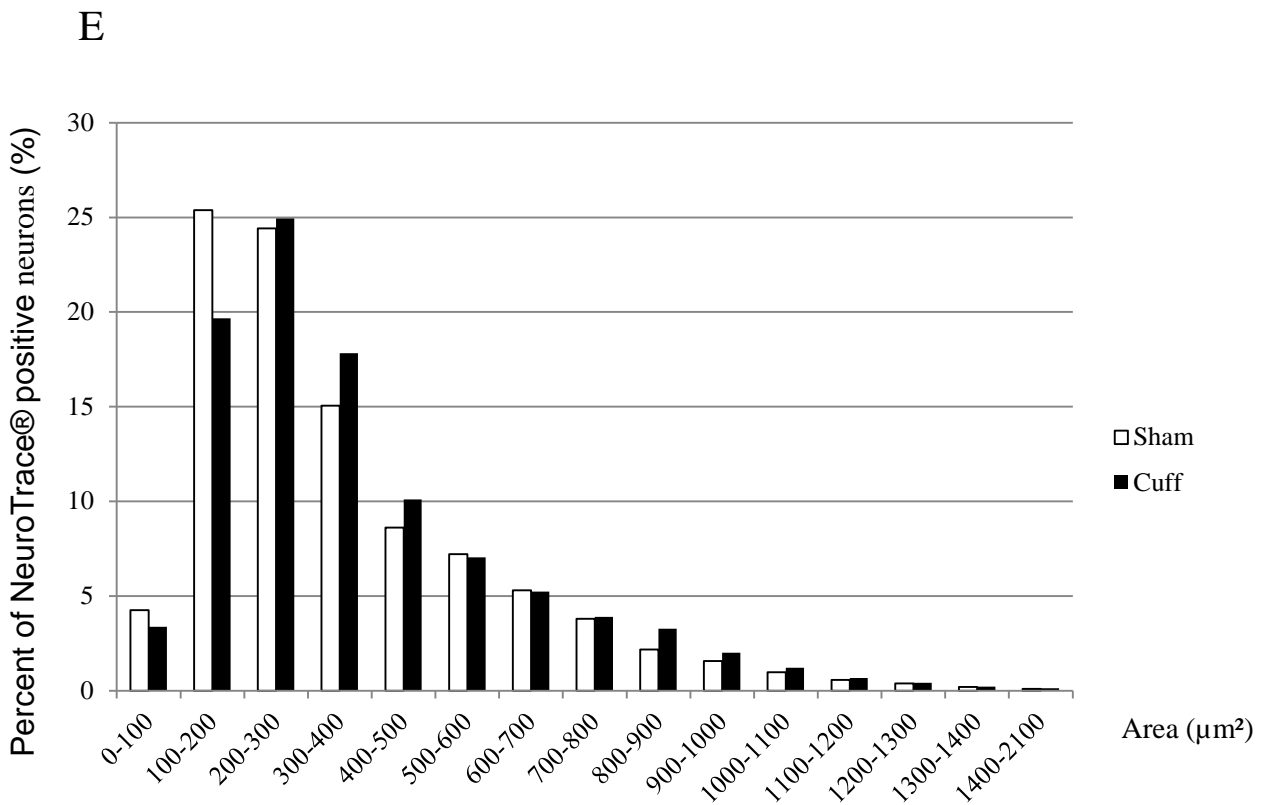
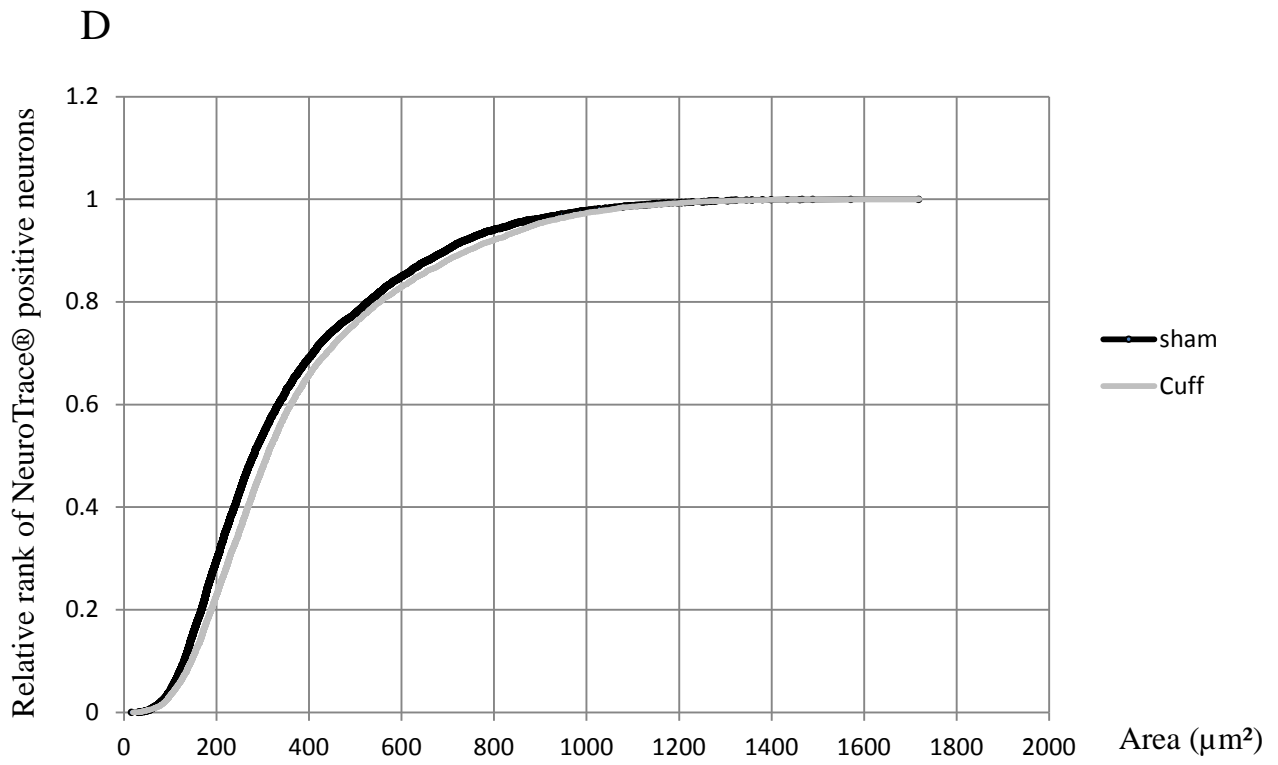

Figure 3

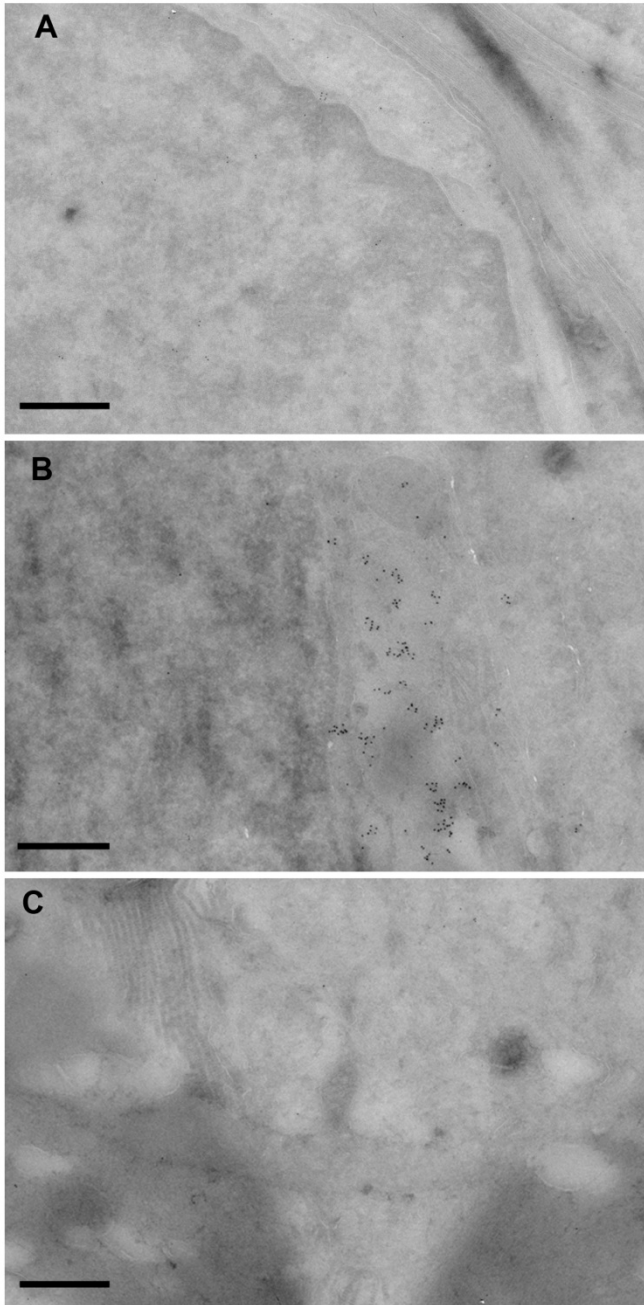

Figure 4

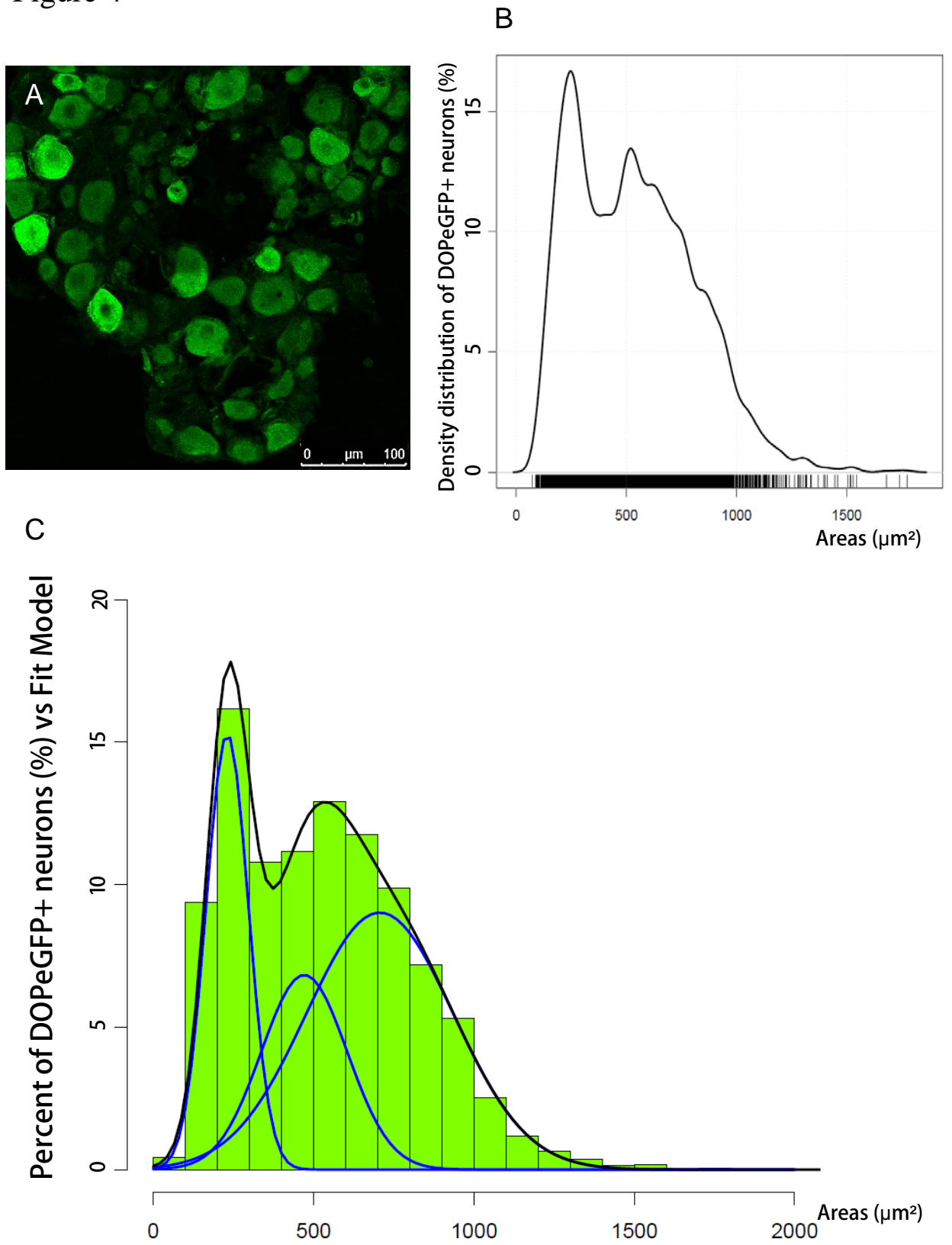

Figure 4

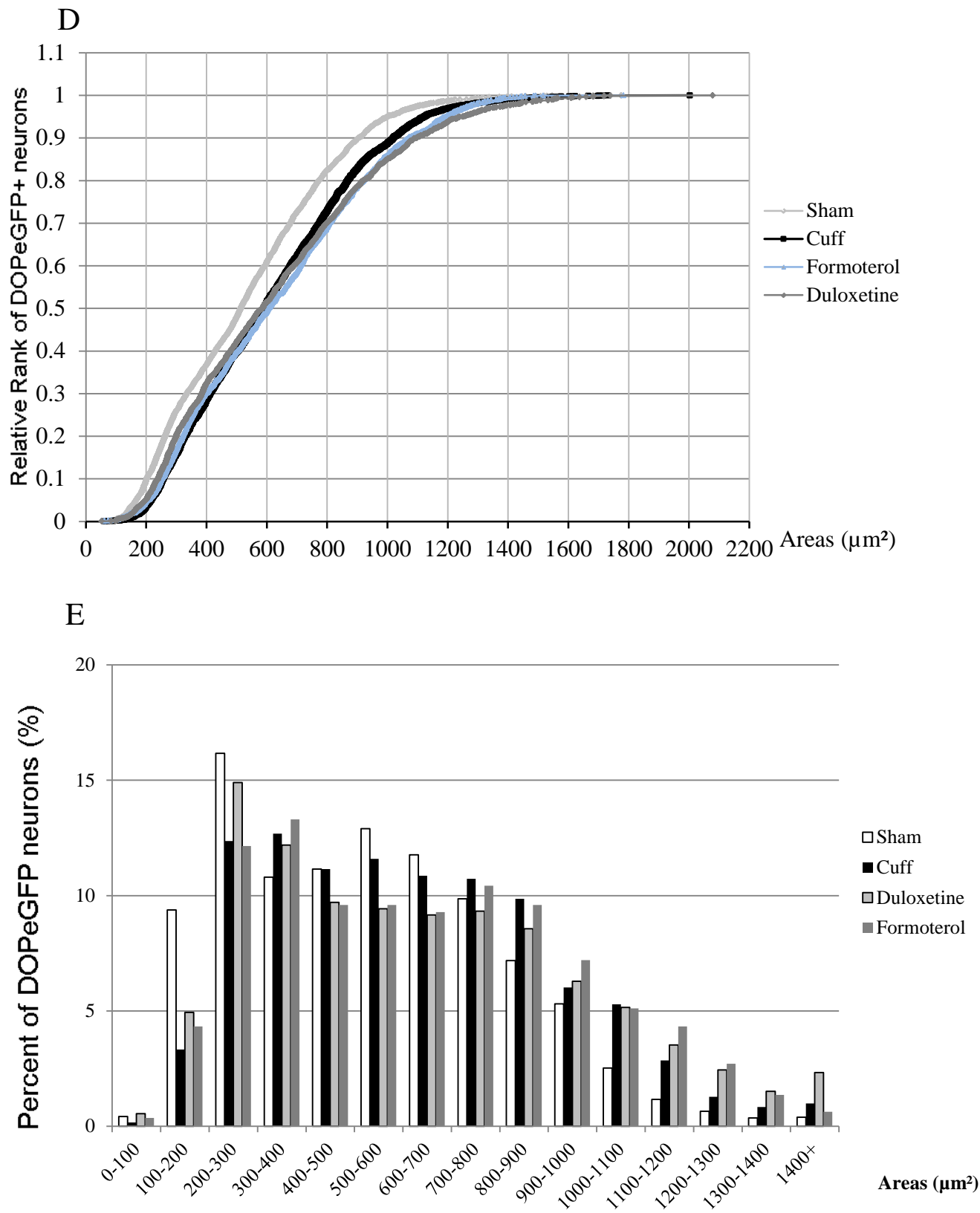
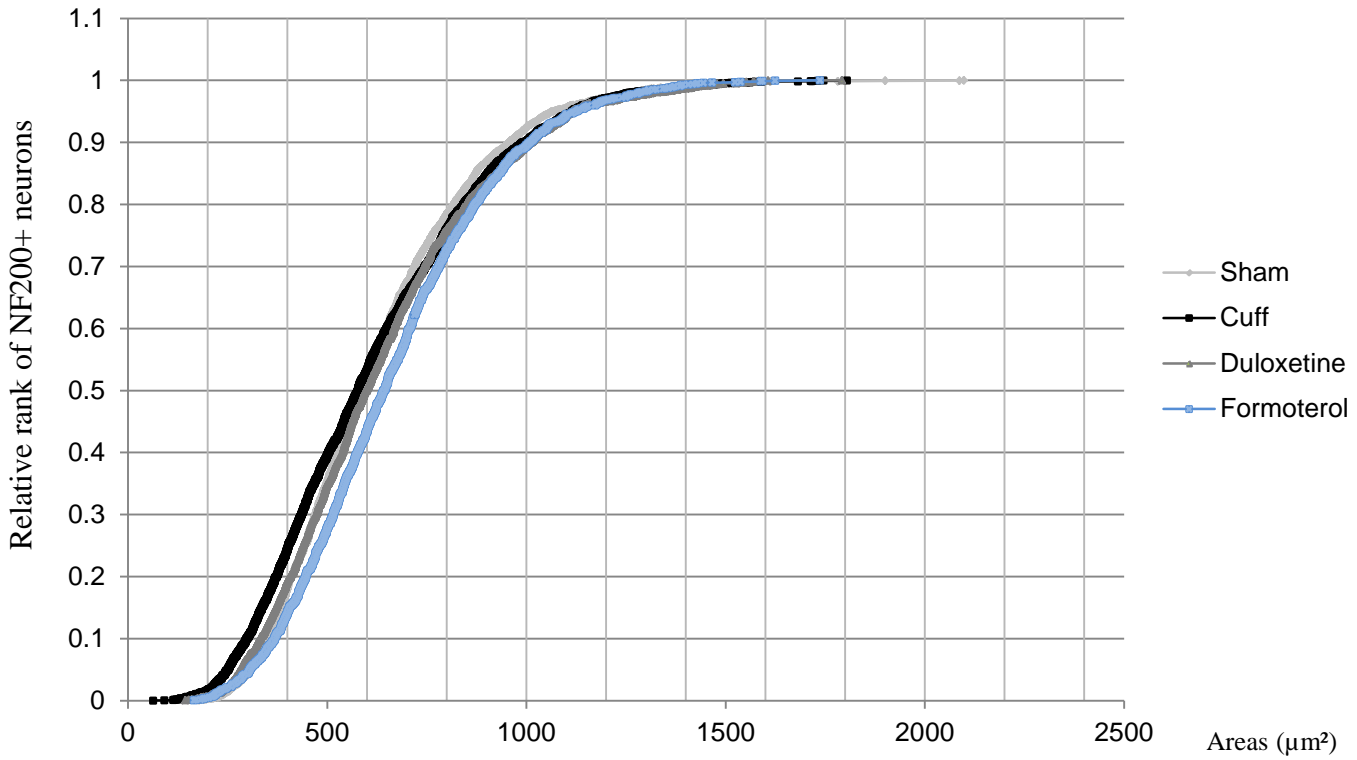

Figure 5

A



B

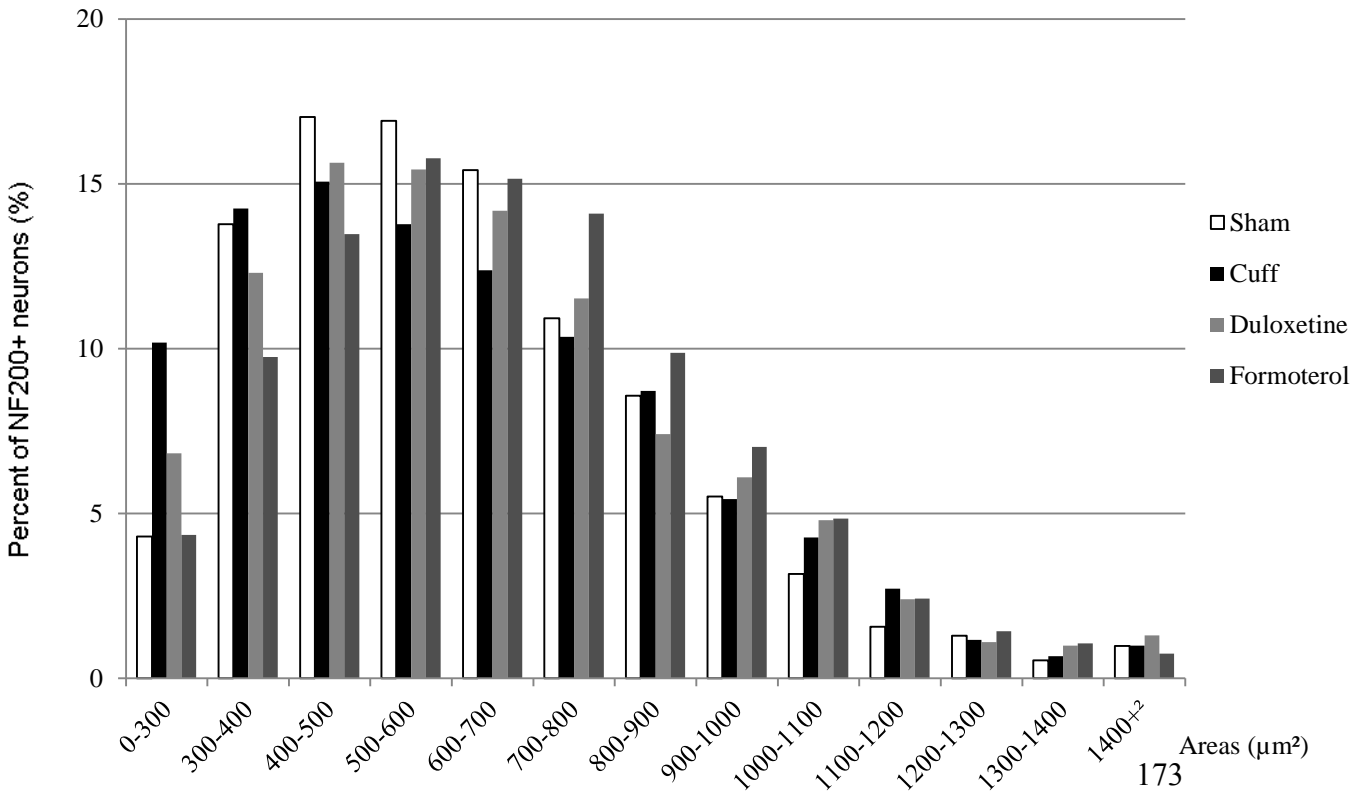
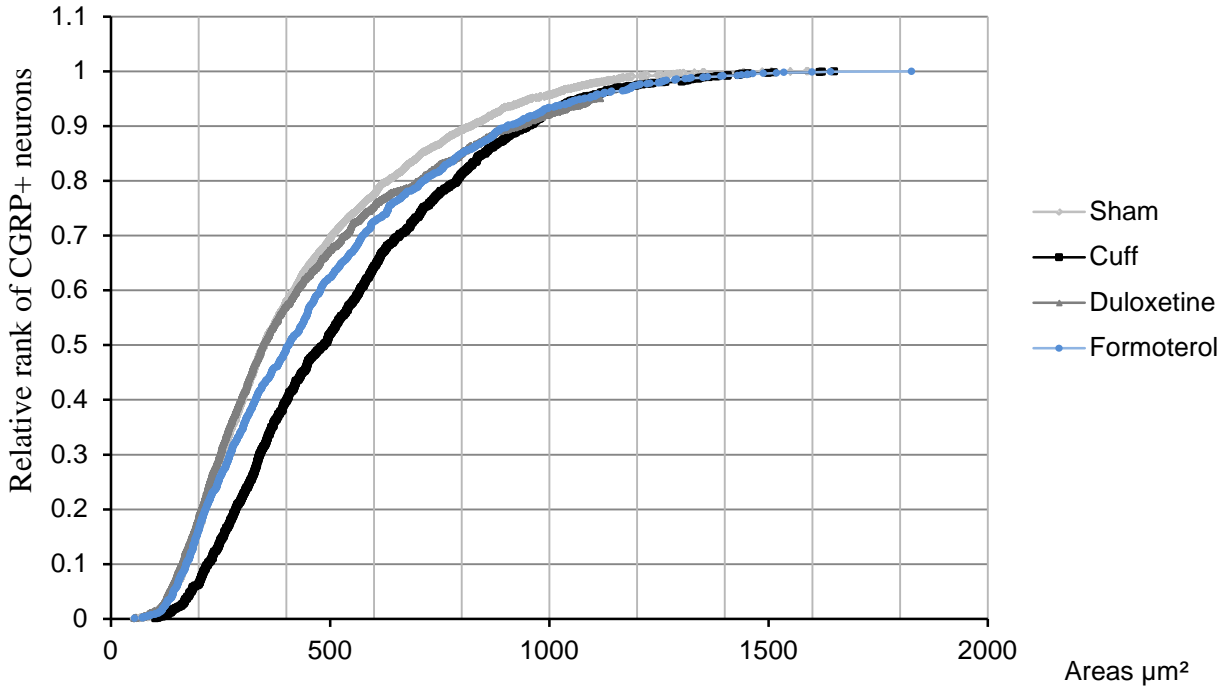

Figure 5

C



D

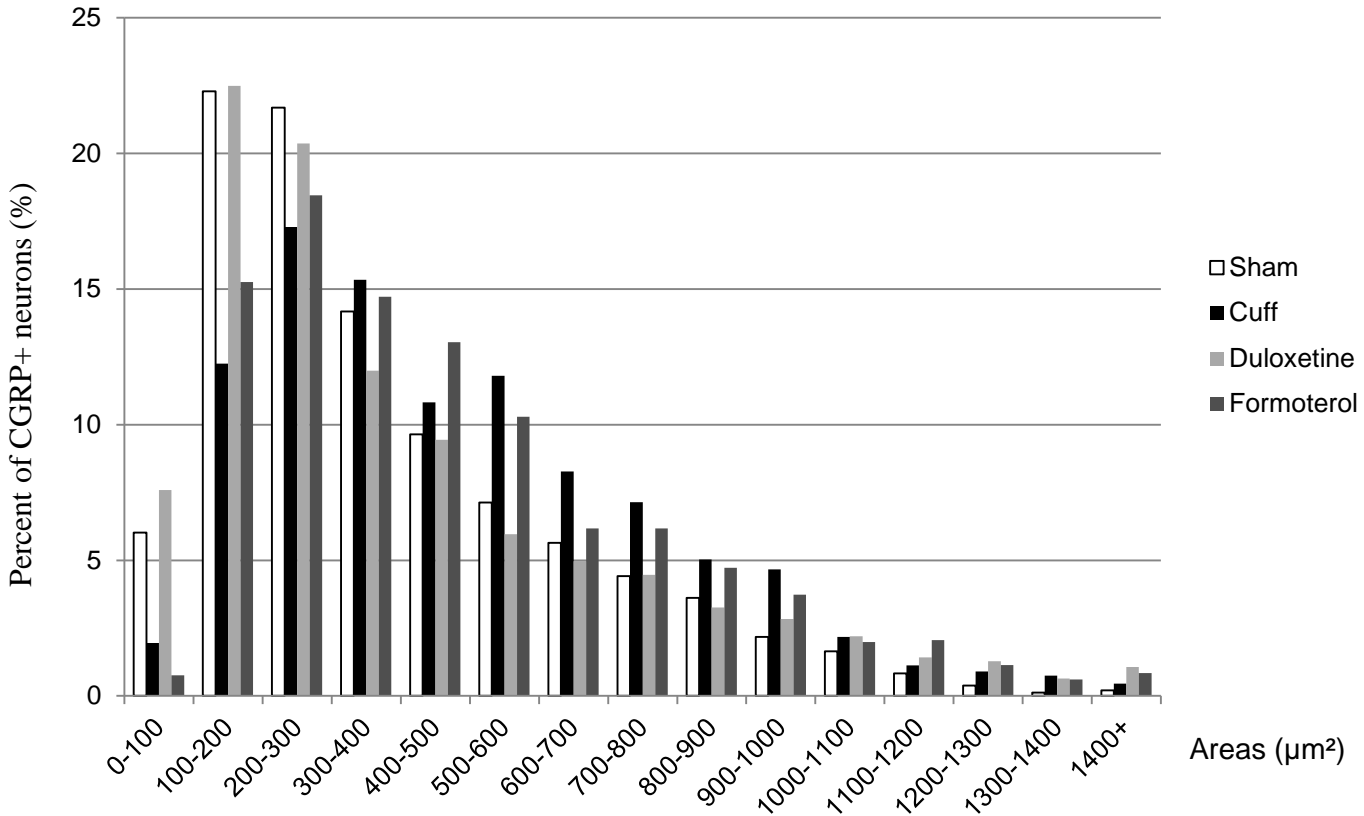
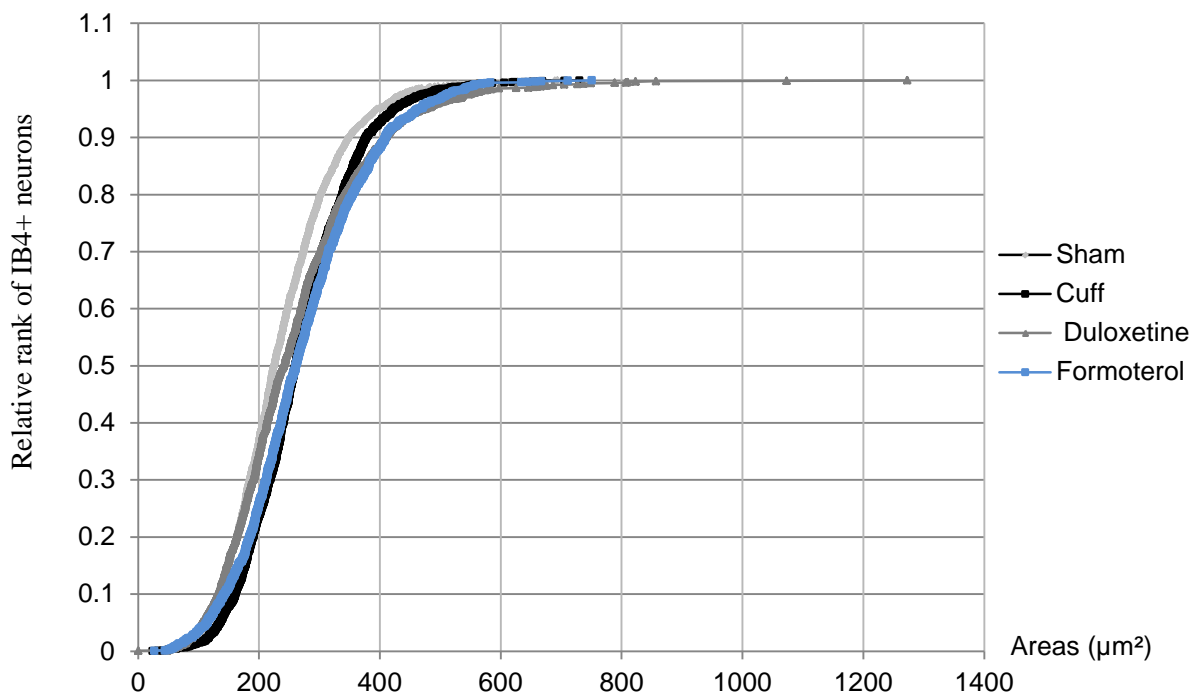

Figure 5

E



F

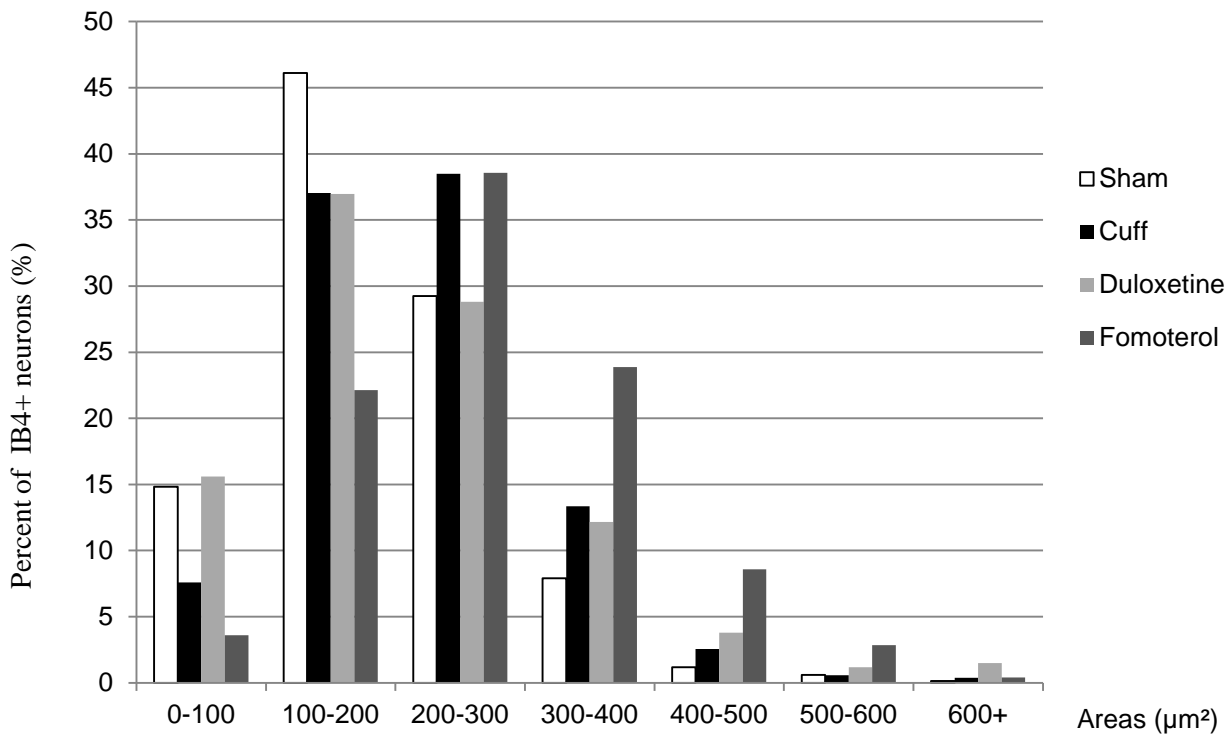

Figure 6

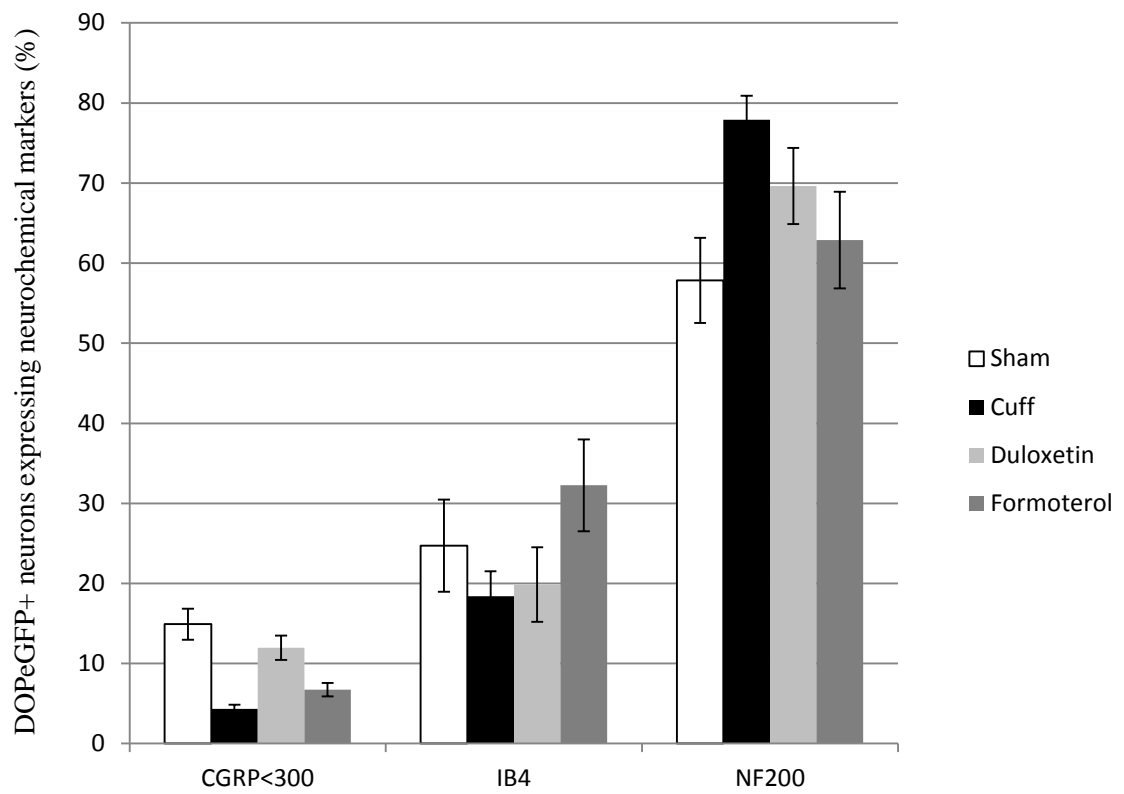

Figure 7

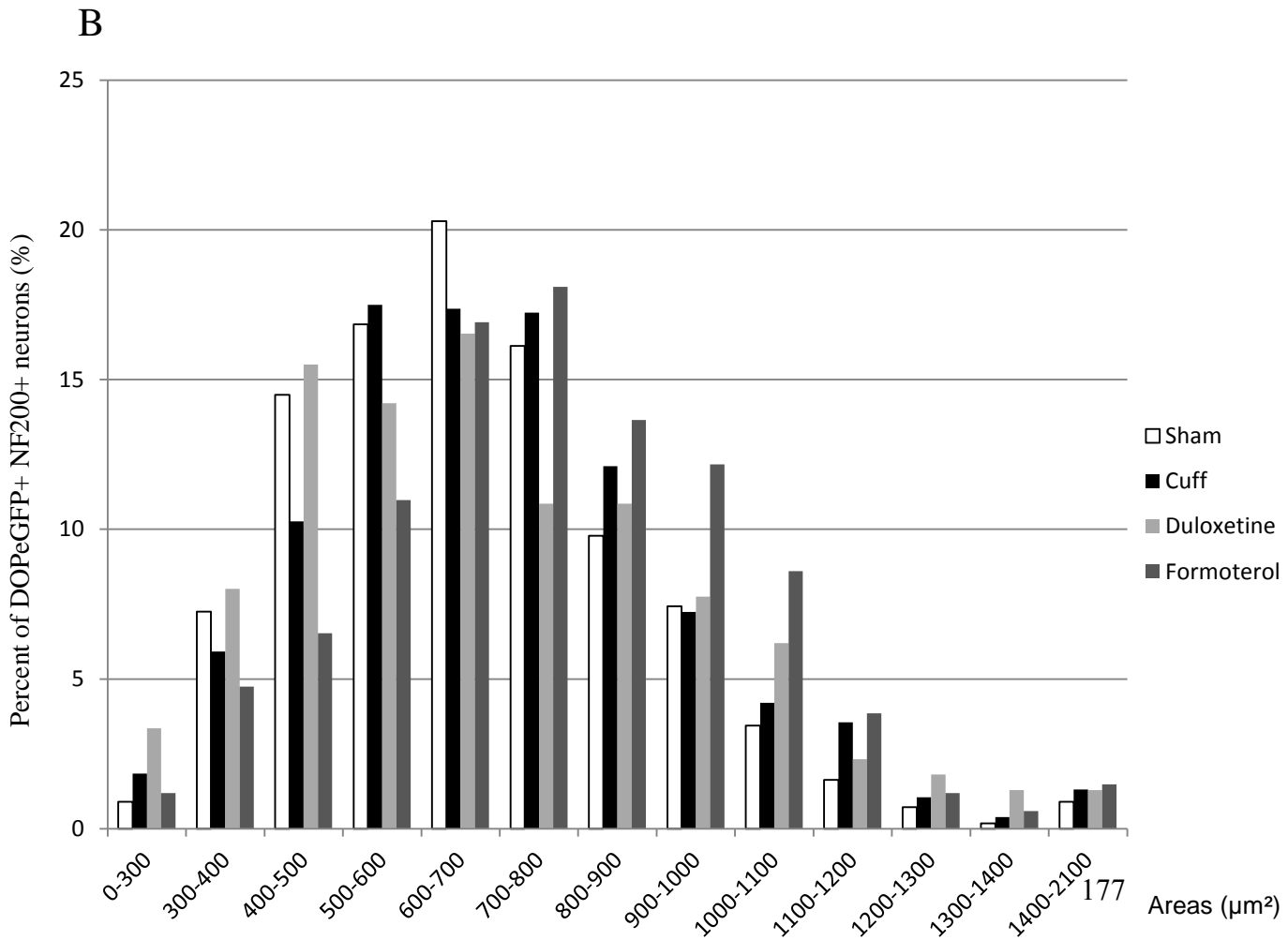
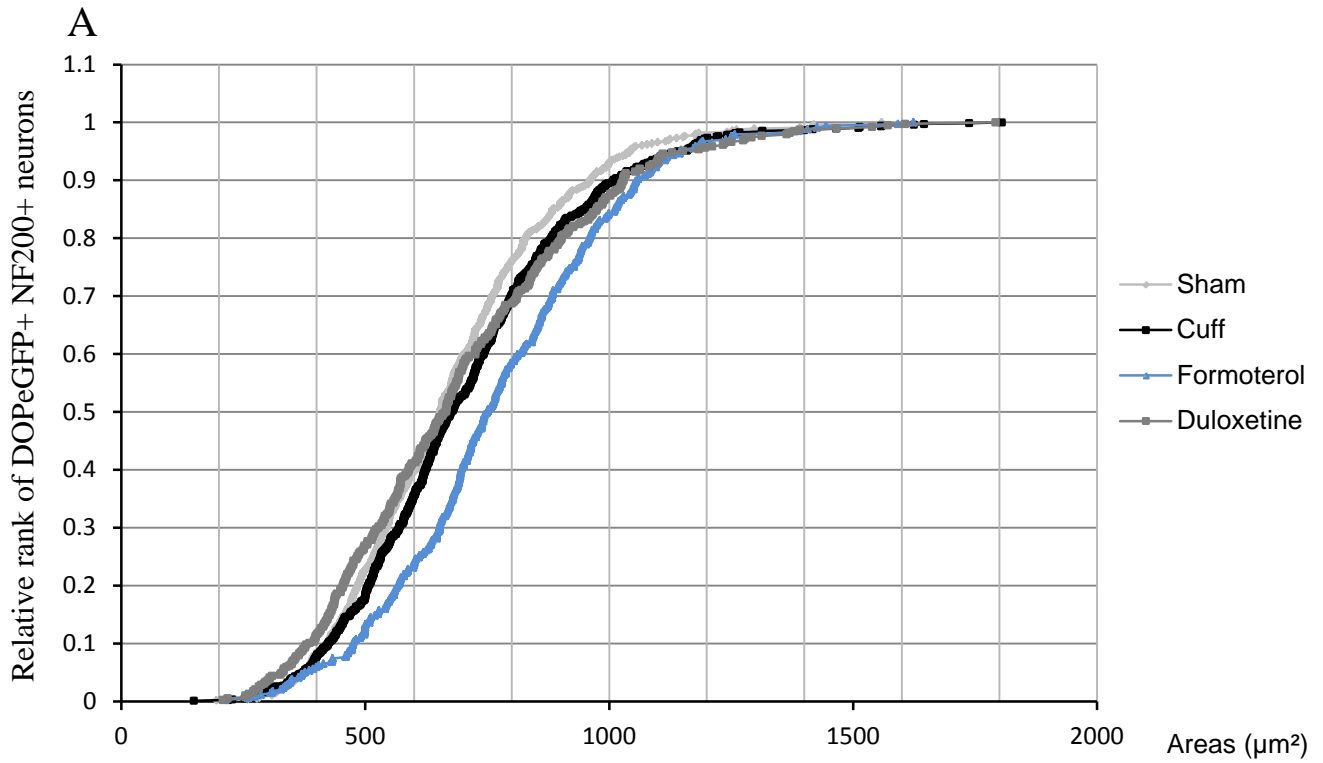
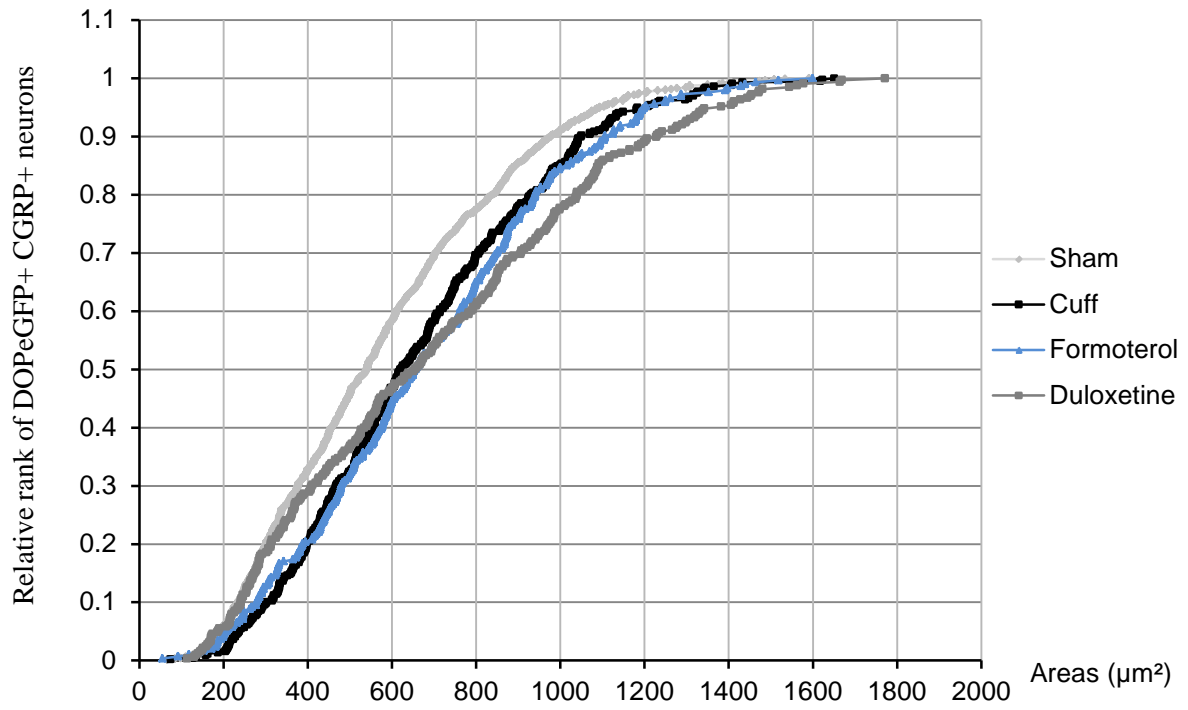

Figure 7

C



D

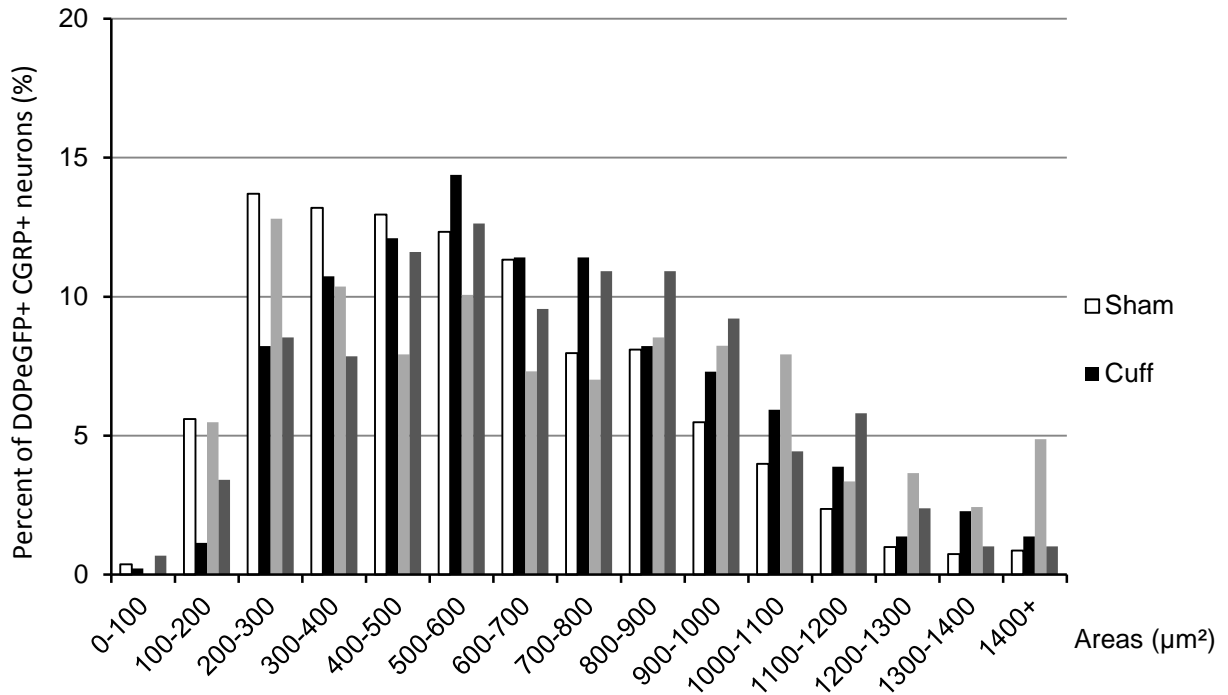
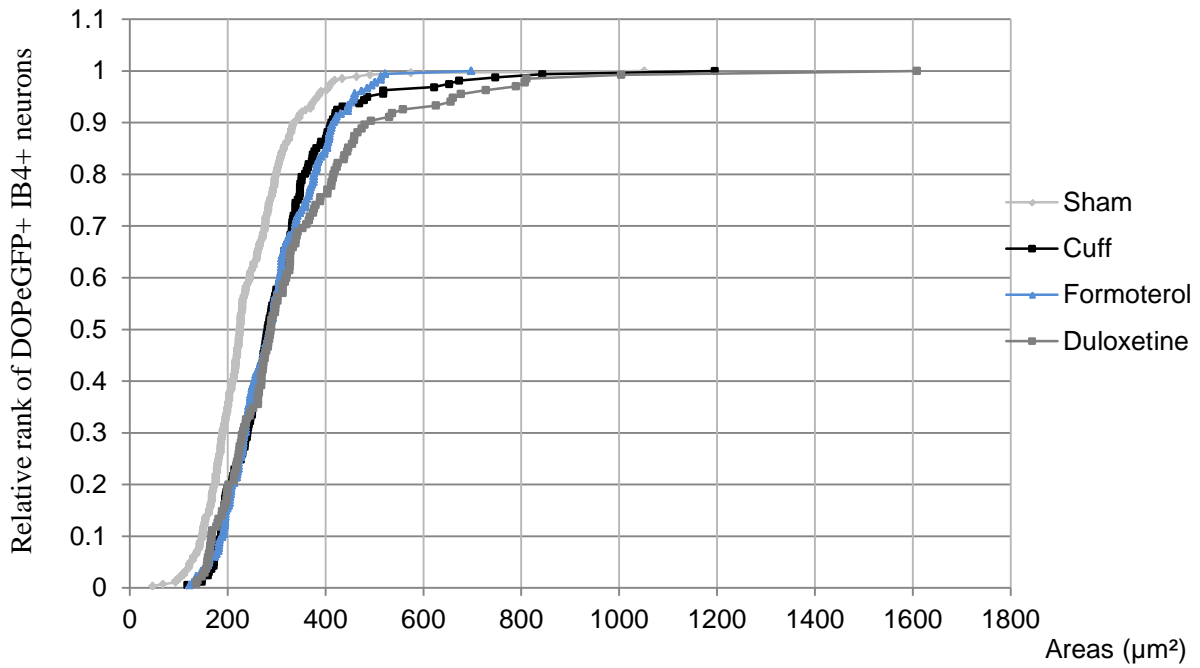

Figure 7

E



F

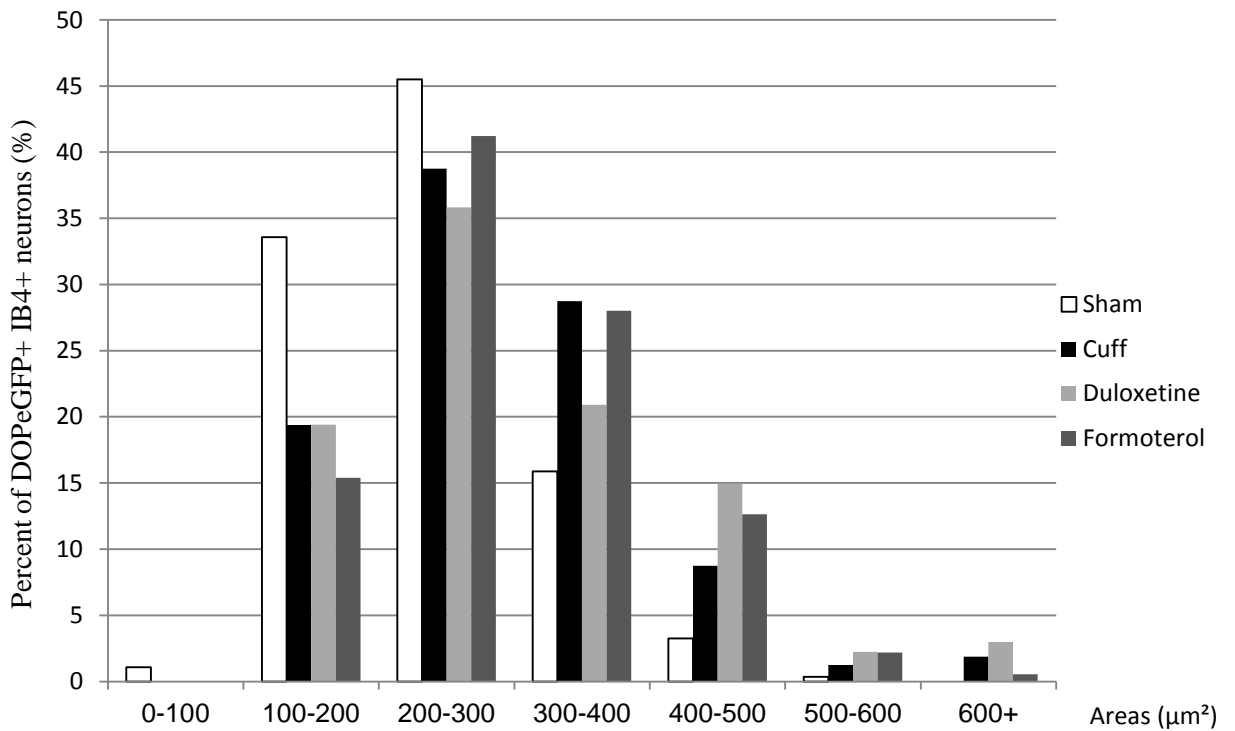

Figure 8

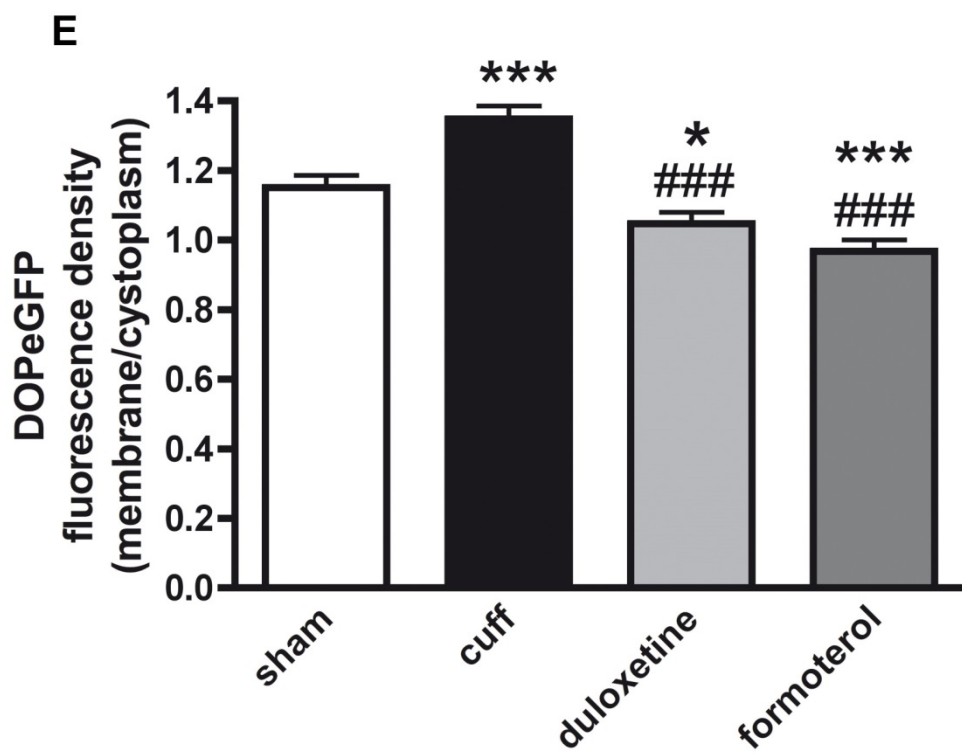
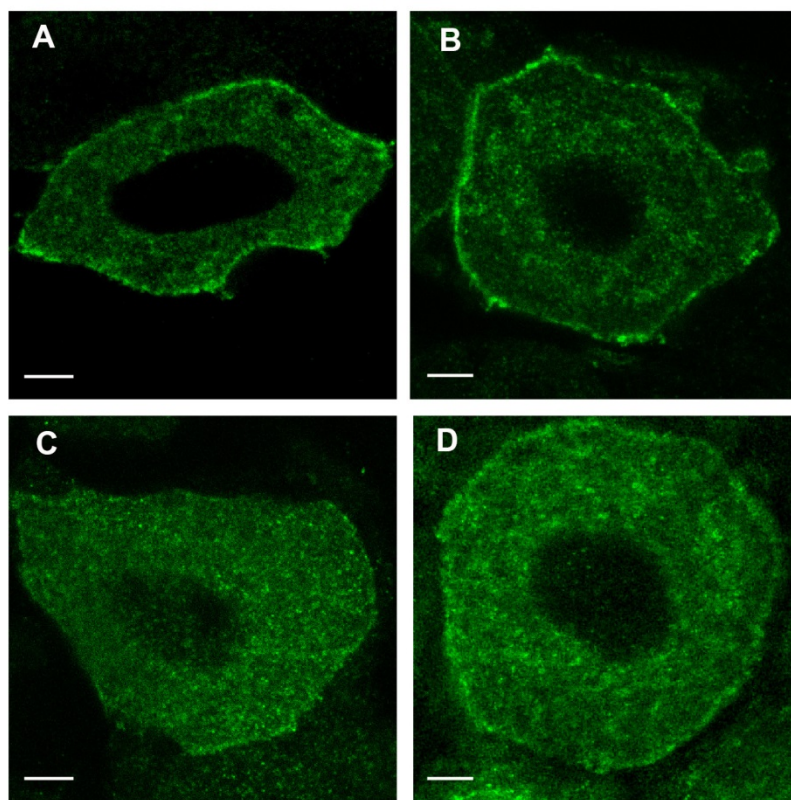
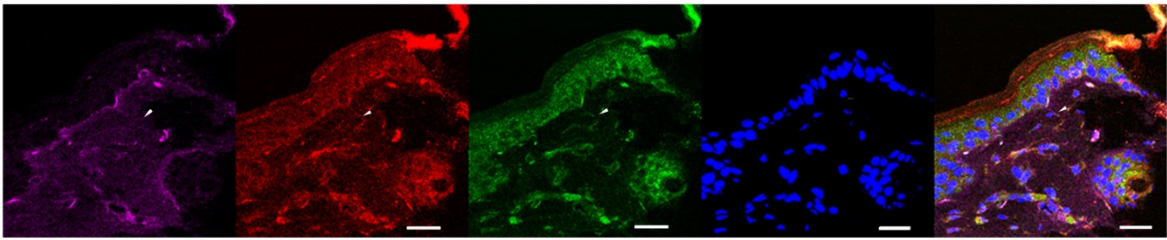
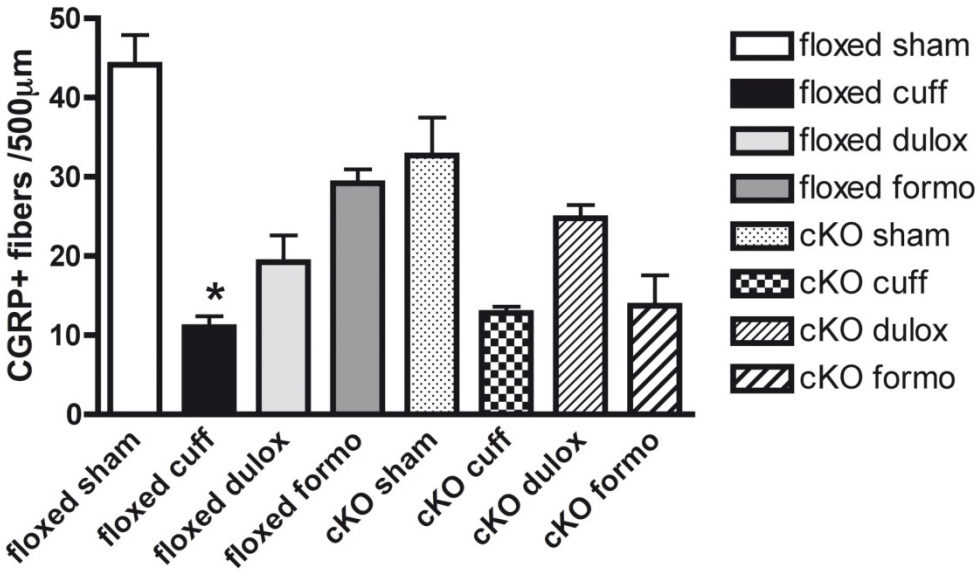

Figure 9

A



B



Supplementary Figure 1A

C

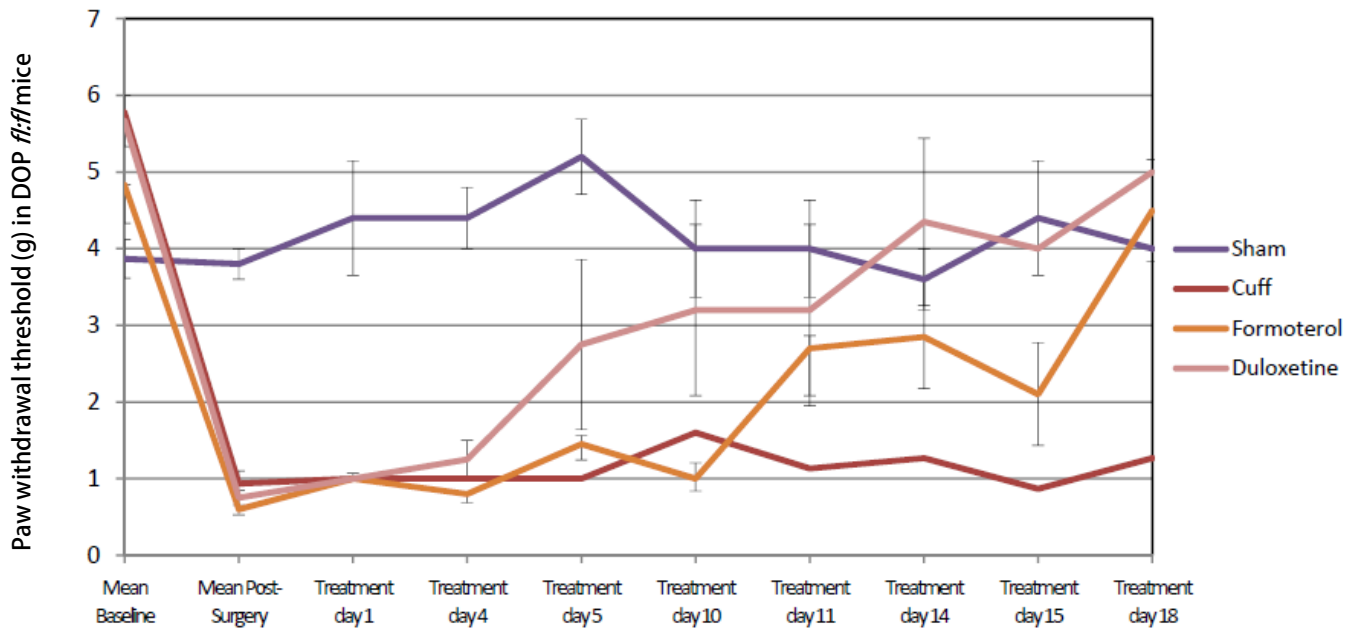

Supplementary Figure 2

A

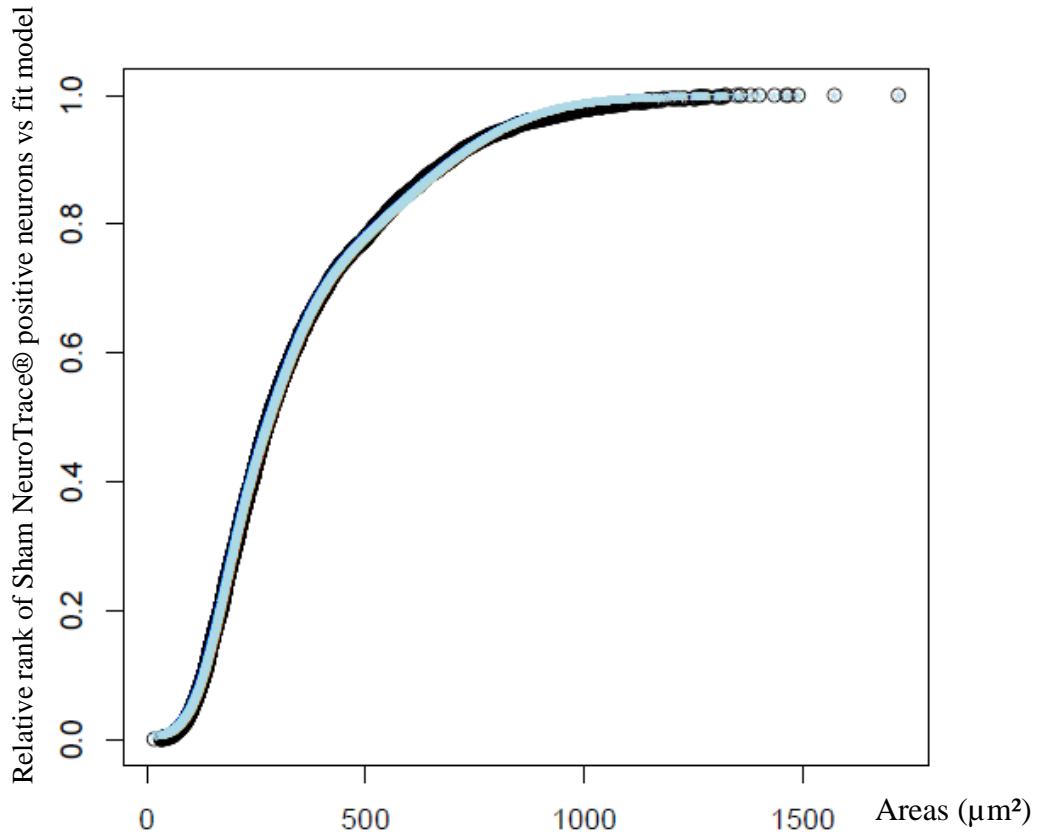

B

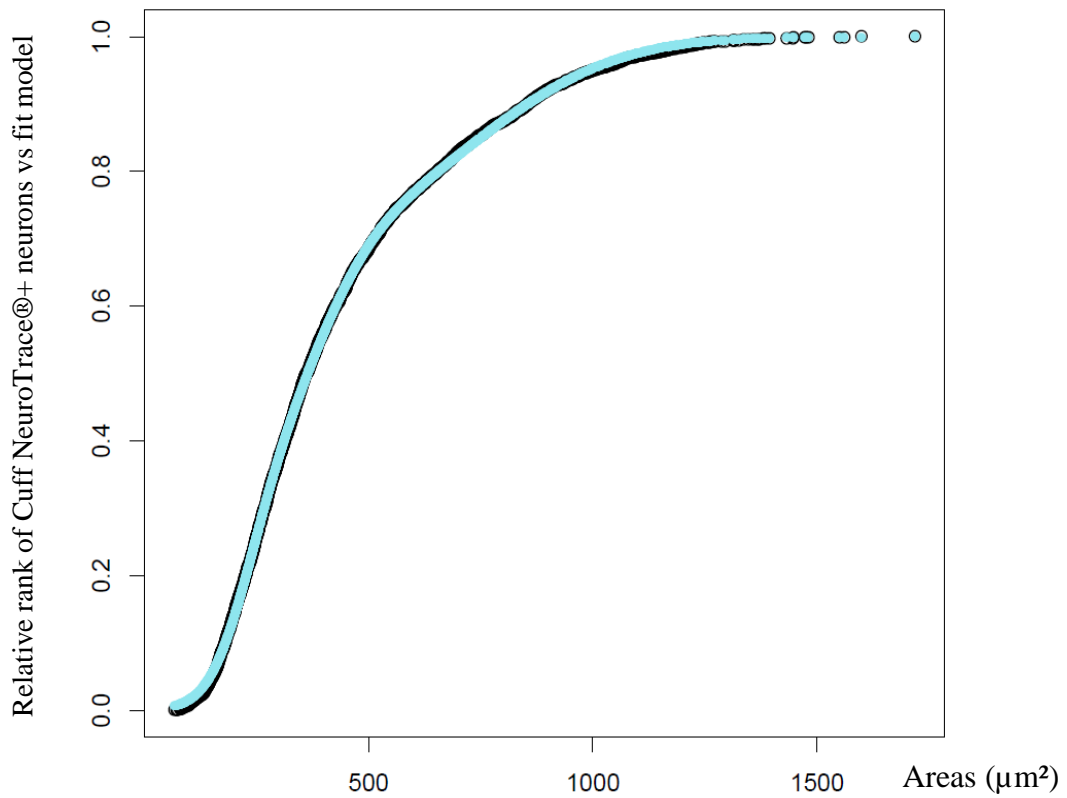

Supplementary Figure 3

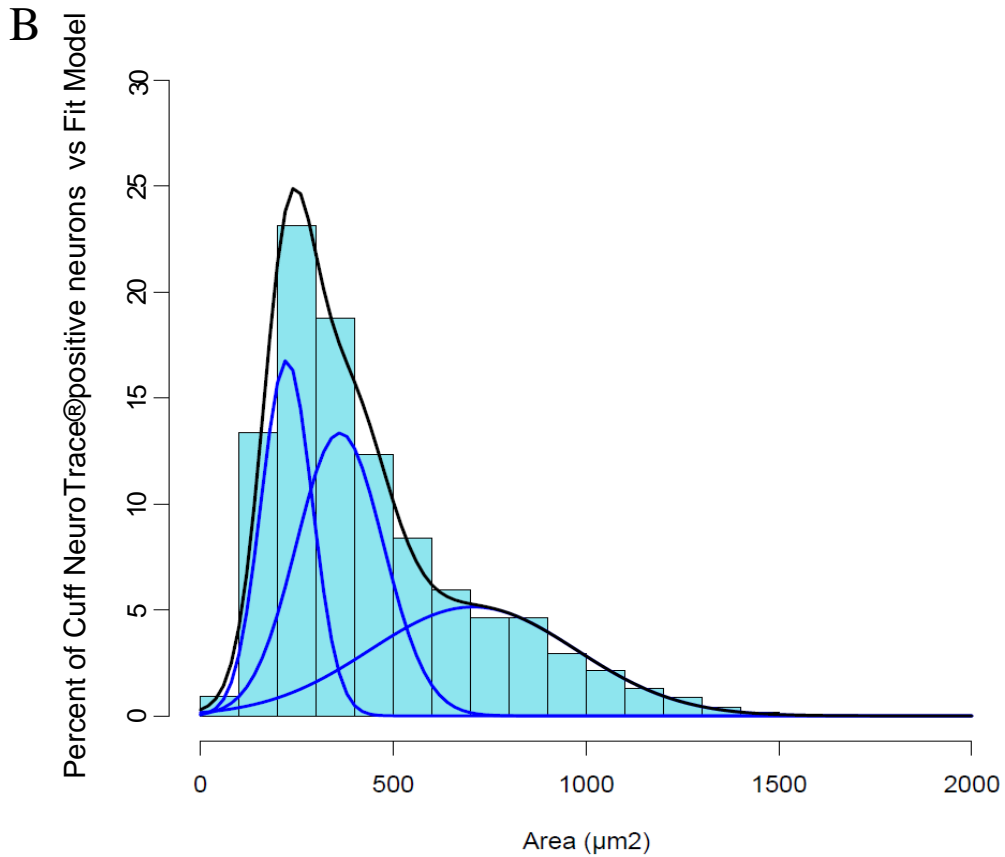
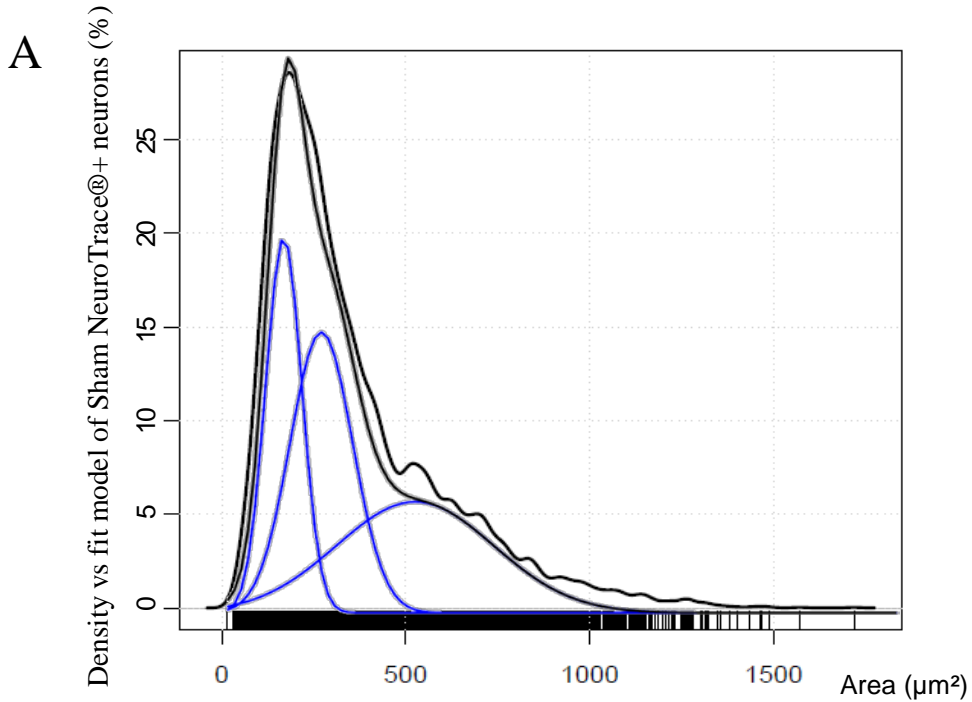

Supplementary Figure 4

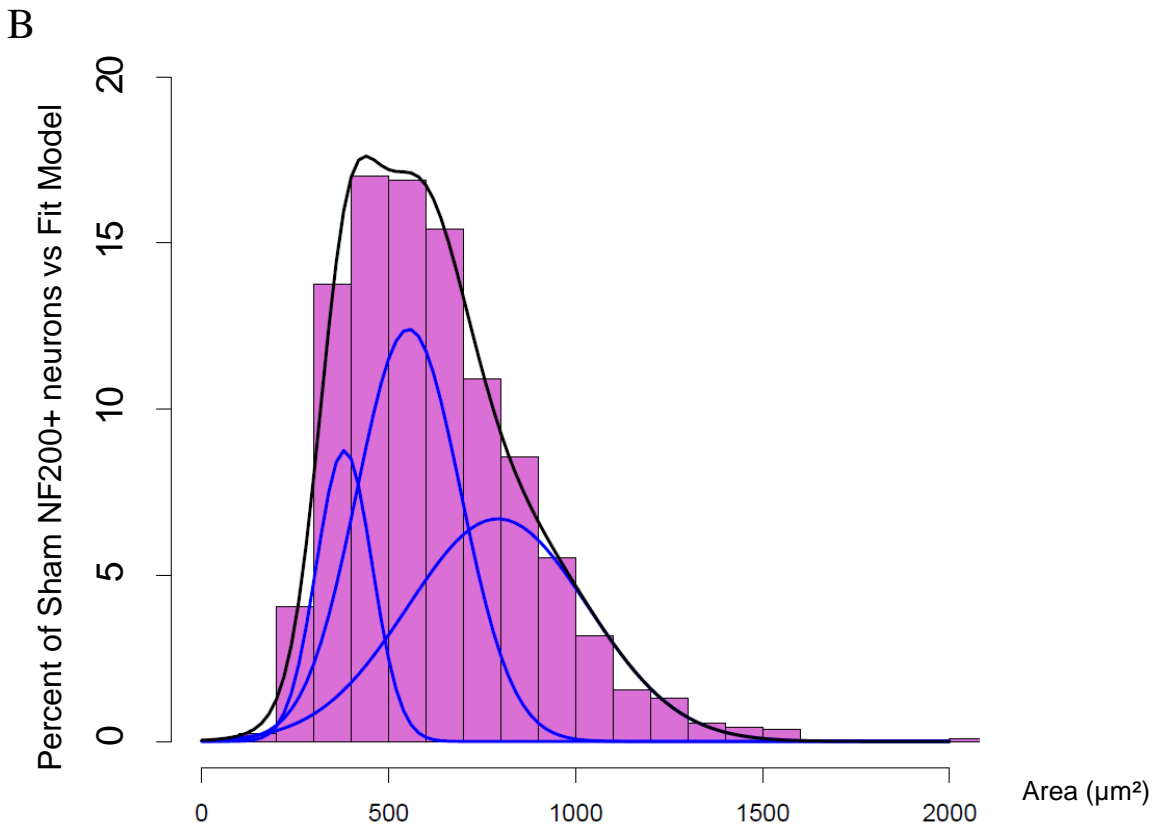
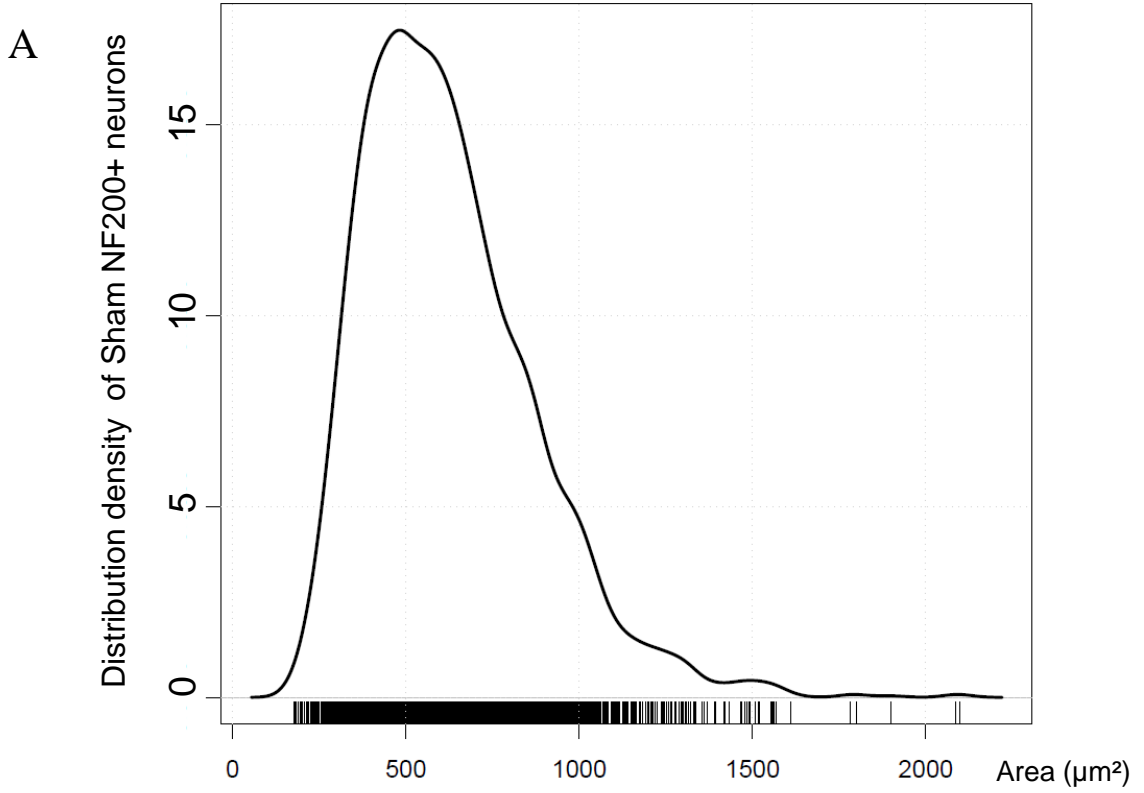

Supplementary Figure 5

A

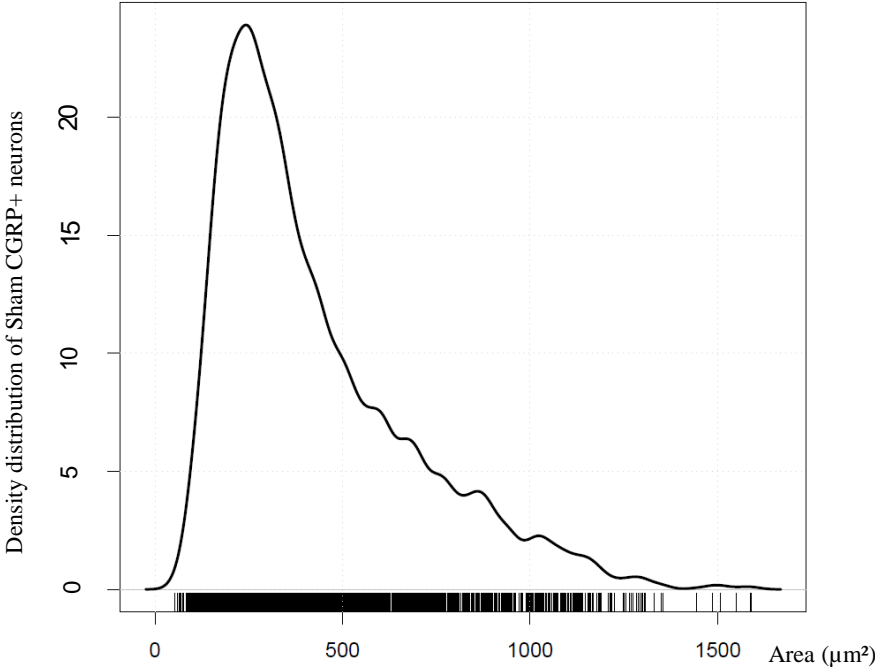

B

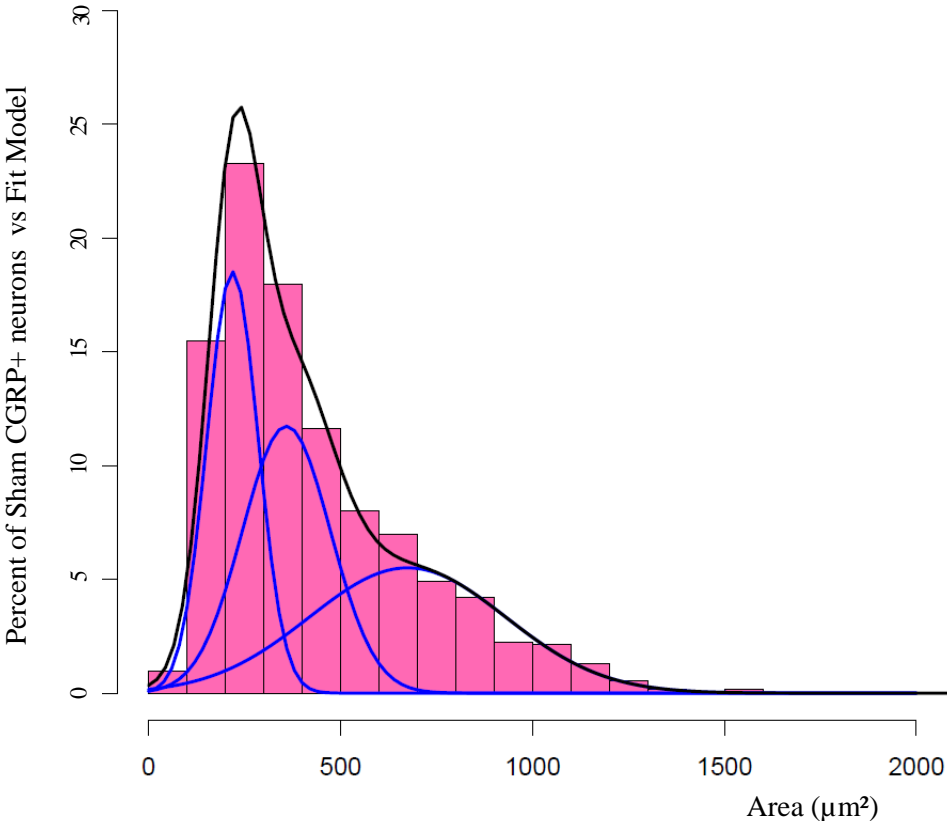

Supplementary Figure 6

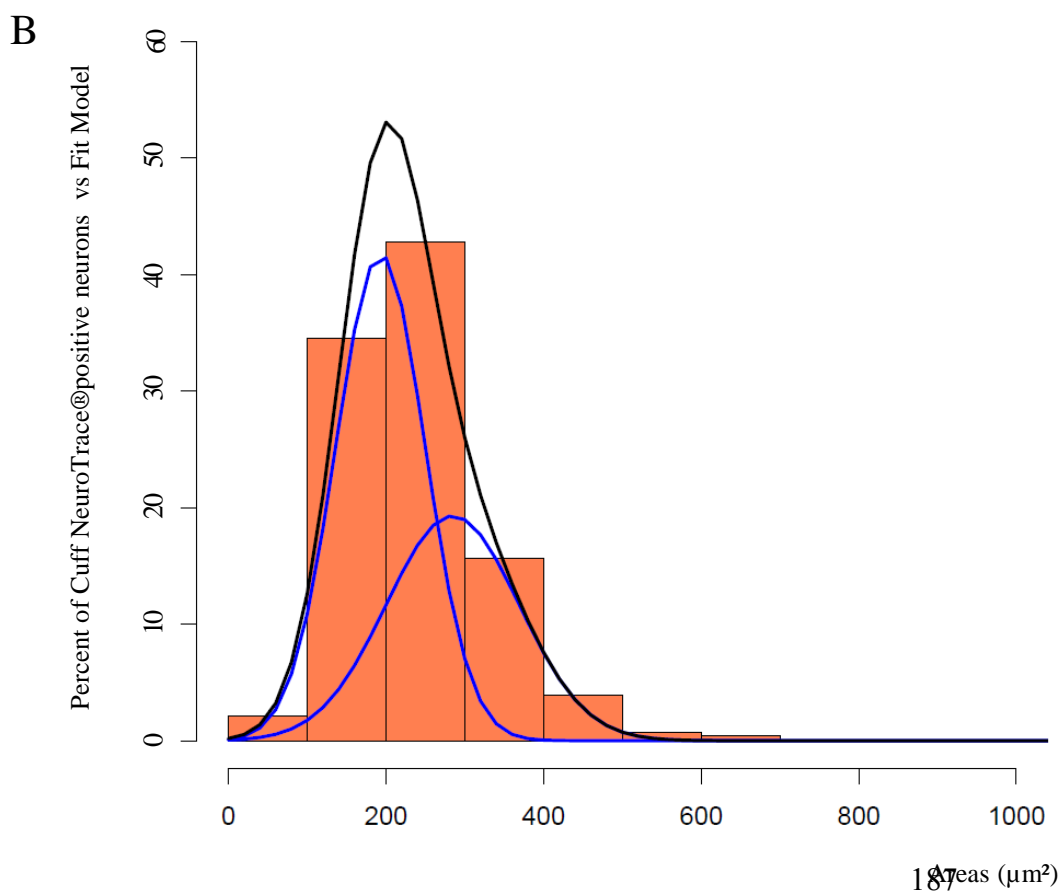
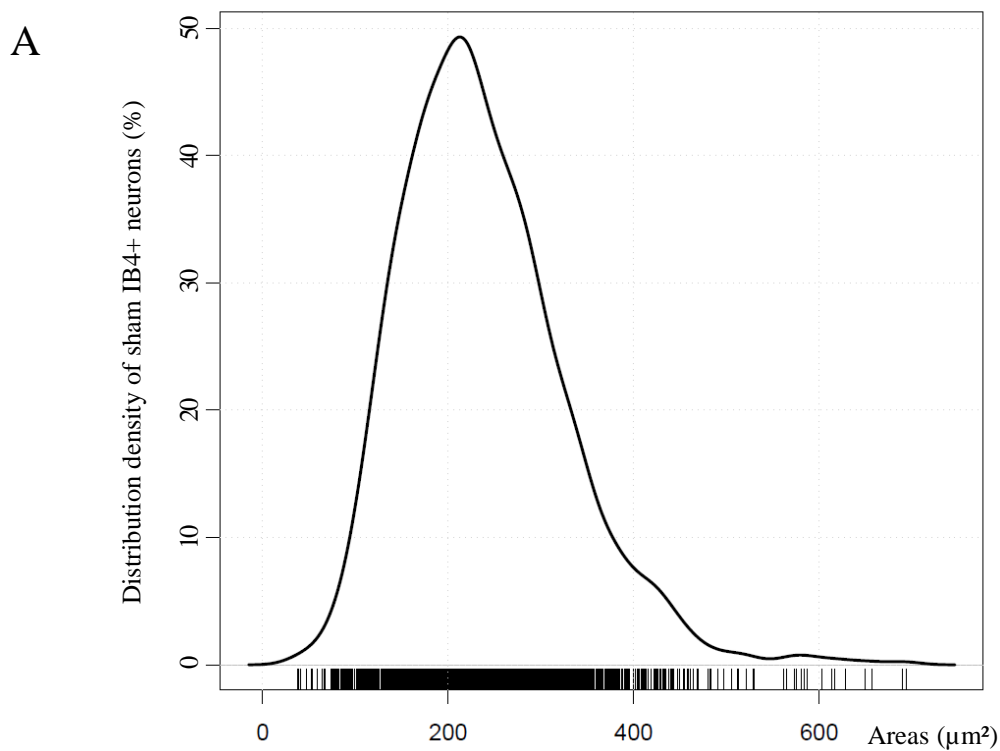

Supplementary Figure 7

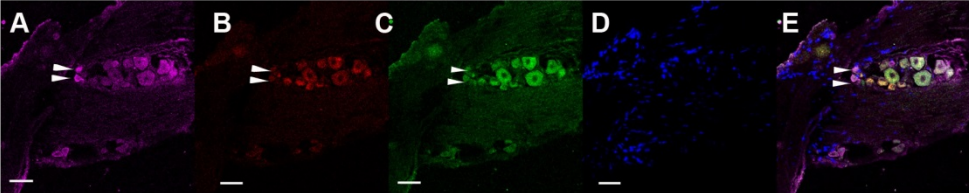

Supplementary figure 8

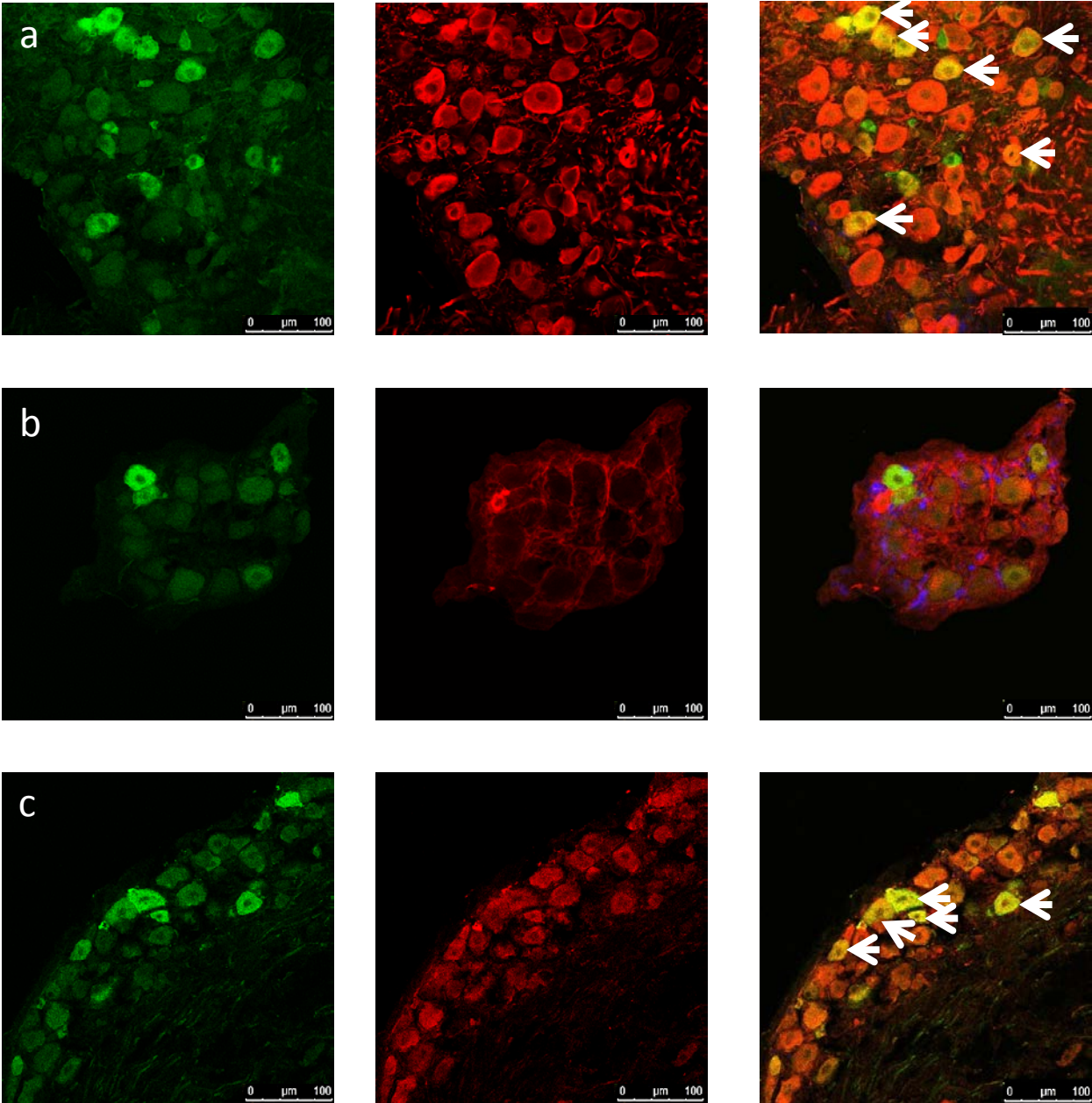

Group	Marker or population	N	Shapiro-Wilk normality test	Gaussian centre values	Residual Sum of Squares fit vs data (μm^2)
Sham	DOPeGFP	3080	W = 0.96235, p-value < 2.210^{-16}	231 μm^2 , 471.3 μm^2 and 706.6 μm^2	0.0153
	NF200	2556	W = 0.93958, p-value < 2.2×10^{-16}	381.7 μm^2 , 554.0 μm^2 and 792.3 μm^2	0.02082
	CGRP	3351	W = 0.93734, p-value < 2.2×10^{-16}	219 μm^2 , 359 μm^2 , and 674.0 μm^2 .	0.05308
	IB4	2042	W = 0.9555, p-value < 2.2×10^{-16}	193.0 and 284.6 μm^2	0.05346
	DOPeGFP+ NF200+	552	W=0.96544, p-value= 4.155×10^{-10}	576.2 μm^2 793.3 μm^2 844.6 μm^2	0.01926
	DOPeGFP+ CGRP+	803	W=0.9596 p-value= 1.145×10^{-15}	253.3 μm^2 475.4 μm^2 793.8 μm^2	0.008955
	DOPeGFP+ IB4-binding	278	W=0.838 p-value= 2.468×10^{-16}	190.6 and 251.3 μm^2	0.03164
Cuff	DOPeGFP	3123	W=0.96711, p-value< 2.2×10^{-16}	276 μm^2 , 438 μm^2 and 725 μm^2	0.03126
	NF200	3418	W = 0.96161, p-value < 2.2×10^{-16}	392 μm^2 , 539 μm^2 and 787 μm^2	0.02248
	CGRP	1331	W = 0.89435, p-value < 2.2×10^{-16}	278 μm^2 and 603 μm^2	0.008419
	IB4	2069	W = 0.97484, p-value < 2.2×10^{-16}	216 μm^2 and 309 μm^2	0.004105
	DOPeGFP+ NF200+	760	W= 0.9632 p-value= 6.827×10^{-13}	595 μm^2 and 839 μm^2	0.005688
	DOPeGFP+ CGRP+	438	W=0.73847 p-value= 4.475×10^{-14}	Convergence failure	
	DOPeGFP+ IB4-binding	161	W=0.76358 p-value= 7.942×10^{-15}	191 and 267 μm^2	0.009414
Duloxetine	DOPeGFP	1838	W=0.95326, p-value< 2.2×10^{-16}		
	NF200	1918	w=0.95614 p-value< 2.2×10^{-16}		
	CGRP	1409	W=0.8657 p-value< 2.2×10^{-16}		
	IB4	1347	W=0.9555 p-value< 2.2×10^{-16}		
	DOPeGFP+ NF200+	387	W=0.96051, p-value = 1.08×10^{-8}		
	DOPeGFP+ CGRP+	328	W=0.73358, p-value= 2.368×10^{-14}		
	DOPeGFP+ IB4-binding	135	W=0.73358 p-value= 2.368×10^{-14}		
Formoterol	DOPeGFP	1916	W = 0.96646, p-value < 2.2×10^{-16}		
	NF200	1311	W=0.97404, p-value < 2.2×10^{-16}		
	CGRP	1610	W = 0.90626, p-value < 2.2×10^{-16}		
	IB4	1504	W = 0.98118, p-value = 3.962×10^{-13}		
	DOPeGFP+ NF200+	337	W = 0.9882, p-value = 0.007771		
	DOPeGFP+ CGRP+	294	W = 0.98306, p-value = 0.001502		
	DOPeGFP+ IB4-binding	182	W = 0.961, p-value = 6.327×10^{-5}		

4. Chapter Two: Article in preparation

1. Introduction

Chronic pain management is widely recognized as an unmet medical need (Attal et al., 2008), which represents a social and economic burden (Meyer-Rosberg et al., 2001). Patients suffering from neuropathic pain, in particular, are insufficiently relieved by prescribed drugs (Bouhassira et al., 2008) and, in addition, are at risk of developing psychological co-morbidities such as anxiety and depression (Radat et al., 2013). Classically prescribed medicines in neuropathic pain pharmacotherapy include opiates, anticonvulsants and antidepressants (Dworkin et al., 2007; Finnerup et al., 2015; Smith, 2012). Importantly, analgesic efficacy of antidepressants is independent from their anxiolytic or antidepressant properties (Max et al., 1987; Wolfe and Trivedi, 2004; Sindrup et al., 2005; Mico et al., 2006).

The opioid system is known for mediating pain relief and regulating emotional states (Gavériaux-Ruff and Kieffer, 2002; Chu Sin Chung and Kieffer, 2013; Lutz and Kieffer, 2013a). Recent pharmacological and genetic evidence has brought attention to the role of the Delta opioid (DOP) receptor in the context of chronic pain (Gavériaux-Ruff and Kieffer, 2011). Moreover, DOP receptors are required for both antidepressants and β_2 mimetics to relieve mechanical allodynia after cuffing of the sciatic nerve, a preclinical model of neuropathic pain (Benbouzid et al., 2008c; Yalcin et al., 2014; Choucair-Jaafar et al., 2014). Importantly, this model reproduces sensory and emotional consequences of chronic pain, as neuropathic animals develop allodynia and anxio-depressive-like behaviors (Benbouzid et al., 2008c; Yalcin et al., 2014).

Neuronal co-expression of DOP and mu opioid (MOP) receptors was reported in dorsal root ganglia (Wang et al., 2010a; Bardoni et al., 2014; Erbs et al., 2015). Co-immunoprecipitation studies suggested close physical proximity (Xie et al., 2009) and led to postulate that the two receptors associate to form MOP-DOP heteromers exhibiting specific binding and signaling properties (see Massotte, 2015 for a recent review). Specific targeting of MOP-DOP receptors has been postulated as a novel strategy for pain management with less tolerance and dependence (Gomes et al., 2013) and as potential target to reduce anxio-depressive symptoms (Kabli et al., 2014).

Double fluorescent knock-in mice co-expressing DOPeGFP and MOPmcherry constructs have been used to map MOP-DOP neuronal co-expression in the nervous system and revealed abundant DOP-MOP neuronal co-localization in subcortical brain areas related to the nociceptive pathway (Erbs et al., 2015).

Here, we show that chronic anti-allodynic treatment with antidepressant Duloxetine or a β_2 agonist Formoterol relieves mechanical allodynia and differentially impacts emotional consequences of neuropathic pain in the cuff model. We also present preliminary data about changes in the distribution patterns of MOP-DOP neuronal co-expression at peripheral and central level in the cuff model.

Neuronal Co-localization of Mu and Delta opioid receptors : a novel target for neuropathic pain and comorbid anxiodepressive symptoms ?

Ceredig R.A., Yalcin I., Rodeau J.-L., Pierre F., Fillinger C., Veinante P., Barrot M., Massotte D.

Institut des Neurosciences Cellulaires et Intégratives, UPR 3212, Strasbourg, France

Abstract

Neuropathic pain is a chronic pathological state that induces cellular changes in the nociceptive pathway at peripheral and central level and is often accompanied by high prevalence of comorbid anxiodepressive symptoms. We therefore explored development of mechanical allodynia and anxiodepressive-like symptoms and their reversal by chronic oral administration of the antidepressant Duloxetine or β 2-mimetic Formoterol. We confirmed that both Duloxetine and Formoterol alleviate mechanical allodynia and that male cuff animals develop anxiodepressive signs 8 weeks after surgery. Surprisingly, only chronic administration of Formoterol reversed neuropathy-induced anxiodepressive traits in the splash test. We also investigated neuronal co-expression of mu and delta opioid receptors at peripheral and central level using double fluorescent knock in mice expressing fluorescent versions of the mu and delta opioid receptors, respectively MOPmcherry and DOPeGFP. Opposite regulation was observed 8 weeks following cuff surgery with decreased MOPmcherry-DOPeGFP neuronal co-localization in dorsal root ganglia and increased MOPmcherry-DOPeGFP neuronal co-expression in supraspinal structures involved in pain processing.

Introduction

Neuropathic pain arises following a lesion or a disease affecting the somatosensory system. During the course of neuropathic pain, peripheral and central cellular and nociceptive networks undergo changes, which alter sensitivity to both innocuous and noxious stimuli, contribute to the development of hypersensitivity and exacerbated pain reactions such as mechanical allodynia and thermal hyperalgesia (von Hehn et al., 2012; Latremoliere and Woolf, 2009; Julius and Basbaum, 2001). Patients suffering from chronic neuropathic pain are at higher risk of developing mood disorders such as anxiety (Radat et al., 2013). The use of powerful analgesic opiate drugs in neuropathic pain pharmacotherapy is somewhat limited due to centrally-mediated side effects and the establishment of opioid tolerance. Despite this, prescribed drugs for chronic neuropathic pain management include opiates, although first-line treatment classically relies on antidepressants and antiepileptics (Smith, 2012; Attal et al., 2008; Dworkin et al., 2007; Moulin et al., 2007).

In DRGs, both Delta and Mu (DOP and MOP) opioid receptor expression has been reported in all size categories of DRG primary afferent neurons (Scherrer et al., 2009; Wang et al., 2010; Rau et al., 2005) using either *in situ* hybridization (ISH) or quantitative PCR approaches for mRNA detection (Obara et al., 2009; Wang et al., 2010; Gaveriaux-Ruff et al., 2011; Bardoni et al., 2014); or immunofluorescence (either classical IHC or knock in mice expressing fluorescent versions of DOP and/or MOP receptors) (Kabli and Cahill, 2007; Scherrer et al., 2009; Schmidt et al., 2013; Bardoni et al., 2014; Erbs et al., 2015). Interestingly, studies also brought evidence of MOP-DOP receptor co-localization in DRG neurons ranging from restricted populations (Bardoni et al., 2014) to all size categories (Wang et al., 2010; Erbs et al., 2015). Studies in both heterologous expression systems and neurons have shown that MOP and DOP receptors may associate with each other to form heteromeric receptor complexes which may have trafficking and signaling properties which differ from those of individual monomeric receptors and may be involved in opiate analgesia and morphine tolerance (recently reviewed in Ong and Cahill, 2014; Fujita et al., 2015; Massotte, 2015). In the CNS, receptor co-expression in brain regions involved in nociception (Erbs et al., 2015) supports the view that targeting heteromers represents an interesting approach for analgesic drug development which may

reduce MOP receptor mediated side effects such as tolerance whilst offering substantial pain relief (Gomes et al., 2013).

Based on animal models of neuropathic pain, molecular and cellular modifications have been investigated and many studies aimed to determine the impact of chronic pain on the endogenous opioid system. In neuropathic pain models, depending on the type and localization of the nerve lesion, MOP receptor expression in dorsal root ganglia (DRG) appeared either increased (Truong et al., 2003; Labuz and Machelska, 2013) unchanged (Kolesnikov et al., 2007; Lee et al., 2011), or decreased (Rashid et al., 2004; Zhang et al., 1998; Lee et al., 2011; Kohno et al., 2005). In models of sciatic nerve cuffing, the level of DOP receptor expression was reported as increased 14 days later in rats (Kabli and Cahill, 2007), whereas we observed a decrease in DOP-expressing small neurons 8 weeks post surgery (unpublished observations). mRNA levels were either decreased (Herradon et al., 2008; Hervera et al., 2011; Obara et al., 2009) or increased (Kabli and Cahill, 2007) depending on the time point and the types of nerve injuries. To our knowledge, no study addressed so far the changes in opioid receptor co-localization in chronic pain conditions.

In the cuff model of neuropathic pain, mice develop characteristic ipsilateral mechanical allodynia which is relieved by chronic antidepressant or β 2-mimetic treatment (Yalcin et al., 2009; Benbouzid et al., 2008a). Mood disorders, typically anxiety, also develop following chronic neuropathic pain in the cuff model and have been characterized using behavioral approaches (Yalcin et al., 2011). Interestingly, MOP-DOP heteromers activation has been described as promoting anxiolytic and antidepressant-like effects (Kabli et al., 2014).

Using double knock in fluorescent mice co-expressing the red fluorescent protein mCherry in fusion with functional MOP receptors together with the DOPeGFP fusion protein (Erbs et al., 2015; Scherrer et al., 2006), we aimed to assess the impact of neuropathy induced by sciatic nerve cuffing (Benbouzid et al., 2008b) on peripheral and central distribution of neurons co-expressing both fluorescent opioid receptors. We also investigated mechanical allodynia and anxio-depressive-like behaviors following

sciatic nerve cuffing and how these were reversed by chronic treatment in drinking water, with either antidepressant (Duloxetine) or β 2-mimetic (Formoterol), 8 weeks after neuropathy induction.

Experimental procedures

Animals

DOR-eGFP knock in mice expressing the delta opioid receptor fused to its C-terminus to a green fluorescent protein were generated by homologous recombination. In these mice, the eGFP cDNA was introduced into exon 3 of the delta opioid receptor gene, in frame and 5' from the stop codon (Scherrer et al., 2006). MOR-mcherry knock in mice expressing the mu opioid receptor fused to its C-terminus to the red protein mcherry were generated by homologous recombination following a procedure similar to the one used for DOR-eGFP knock in mice and were characterized previously (Erbs et al., 2015). DOR-eGFP mice were crossed with MOR-mcherry mice to obtain mice homozygous for both constructs (Erbs 2015). The genetic background of all mice was C57/Bl6/J:129svPas (50:50 %). Experiments were performed on adult male and female mice aged 6 to 20 weeks, weighing 20-32g for females and 20-38g for males. Animals were group-housed 2-5 per cage, under standard laboratory conditions (12h dark/light cycle, lights on at 7am) in temperature ($21\pm 1^{\circ}\text{C}$) and humidity ($55\pm 10\%$) controlled rooms with food and water *ad libitum*. All experiments were approved by the "Comité d'Ethique en Matière d'Expérimentation Animale de Strasbourg" (CREMEAS number 20 1503041113547 (APAFIS#300.2)).

Neuropathic pain model

Neuropathic pain was induced by cuffing the main branch of the right sciatic nerve as previously described (Benbouzid et al., 2008b; Yalcin et al., 2014). Surgeries were performed under ketamine (Vibrac, Carros, France) / xylazine (Rompun, Kiel, Germany) anesthesia (100/10mg/kg, i.p.). The common branch of the right sciatic nerve was exposed, and a cuff of PE-20 polyethylene tubing (Harvard Apparatus, Les Ulis, France) of standardized length (2mm) was unilaterally inserted around it (Cuff group). The shaved skin was closed using sutures. Sham-operated animals underwent the same surgical procedure without cuff implantation (Sham group).

Assessment of mechanical allodynia

Mechanical allodynia was tested using von Frey filaments and results were expressed in grams. Tests were performed in the morning (9am to 1pm). Mice were placed in clear Plexiglas boxes (7cm x 9cm x 7cm) on an elevated mesh screen, and allowed to habituate to the test conditions. Calibrated von Frey filaments (Bioseb, Vitrolles, France) were applied to the plantar surface of each hindpaw until they just bent, in a series of ascending forces up to the mechanical threshold. Filaments were tested five times per paw and the paw withdrawal threshold (PWT) was defined as the lower of two consecutive filaments for which three or more withdrawals out of the five trials was observed (Yalcin et al., 2014).

Splash test

This test, based on grooming behavior, was performed as previously described (Santarelli et al., 2001; Yalcin et al., 2011). The Splash Test was performed during the dark period under red lighting. Frequency of grooming behavior was measured for 5 minutes after the dorsal coat of the mouse was vaporised with 20% sucrose solution (each mouse received two sprays). Grooming is an important aspect of rodent behavior and decreased grooming in this test may be related to the loss of interest in performing self-oriented minor tasks (Yalcin et al., 2008). The test was performed 8 weeks after the peripheral nerve injury.

Treatment procedures

The long-term treatment with Duloxetine or Formoterol began four weeks after the surgical procedure, and lasted four weeks. Duloxetine (Cat. Nr 4223, Tokyo Chemistry Industry, Tokyo, Japan) 20mg/kg/day and Formoterol (Cat. Nr BG0369, Biotrend AG, Switzerland) 0.05mg/kg/day were delivered *per os* dissolved in drinking water *ad libitum* access as sole source of fluid. Drugs were dissolved in water with 0.2% saccharin (Cat. Nr S1002, Sigma Aldrich, St Louis, USA) to increase palatability and control sham animals were given 0.2% saccharin solution (control) alone. Experimental groups were defined as Sham group (n=36, 29 females and 7 males) and Cuff group (n=29, 16 females and 13 males), both of which received control saccharin solution in drinking water;

cuff animals treated with Duloxetine comprised the Duloxetine group (n=20, 11 females and 9 males), and likewise, Formoterol group was composed of cuff-implanted animals treated with Formoterol (n=20, 11 females and 9 males).

Tissue preparation and immunohistochemistry

For dorsal root ganglia dissection, mice were anaesthetised with ketamine (Vibrac, Carros, France) /xylazine (Rompun, Kiel, Germany) anaesthesia (100/10mg/kg, i.p.) and perfused intracardially with 100mL of ice-cold (2-4°C) 4% paraformaldehyde (Ref 3291471 Electron Microscopy Science, Hatfield, USA) in PB (Sigma Aldrich, St Louis, USA) 0.1M pH 7.4. Ipsilateral (right) and contralateral (left) to the operated side, L4 to L6 lumbar DRGs were dissected out and post-fixed for 90-120mins at 4°C in the 4% PFA solution PB 0.1M pH7.4, cryoprotected at 4°C in a 30% sucrose (Sigma Aldrich, St Louis, USA) PB 0.1M pH7.4 solution for 24 hours and finally embedded in OCT (Optimal Cutting Temperature medium, Thermo Scientific) frozen and kept at -80°C.

Mice from which brains were to be taken were first injected with SNC80 (Tocris) at 10 mg/kg (s.c.) dissolved in NaCl 0.9% 30-60mins before perfusion. SNC80 is a delta selective agonist which strongly induces DOP internalization, thus facilitating the identification of neurons expressing DOPeGFP in central structures. Brains were dissected out for animals injected with SNC80, and post-fixed for 24hours at 4°C in 4% PFA solution PB 0.1M pH7.4, cryoprotected at 4°C in a 30% sucrose (Sigma Aldrich, St Louis, USA) PB 0.1M pH7.4 solution for 24 hours and finally embedded in OCT (Optimal Cutting Temperature medium, Thermo Scientific) frozen and kept at -80°C. Coronal brain sections 30µm thick were cut with a cryostat (Microm Cryo-star HM560), and processed floating in PB 0.1M pH7.4.

Immunohistochemistry was performed according to standard protocols, on floating DRG (16µm-thick) or brain (30µm thick) sections. Briefly, sections were incubated in blocking solution PB 0.1M pH 7.4, 0.2% Tween 20 (Cat. Nr 85114, ThermoFisher Scientific), 3% normal goat serum (Invitrogen, Paisley, UK) and 3% donkey serum when necessary (D9663 Sigma-Aldrich, St Quentin Fallavier, France) for 1 hour at room temperature (RT). Sections were incubated overnight at 4°C in the blocking solution with primary rabbit anti eGFP (Cat. Nr A-11122 Invitrogen dilution 1:1000), then washed three times

with PB 0.1M pH7.4, 0.2% Tween 20, incubated with goat anti-rabbit IgG AlexaFluor 488 conjugate (Cat. Nr A-11012, Molecular Probes dilution 1:2000). Sections were washed three times with PB 0.2% Tween 20 and mounted on Superfrost™ glass (Gehard Menzel, Braunschweig, Germany) with MOWIOL (Calbiochem, Darmstadt, Germany) and 4,6-diamino-phenylindole (DAPI) (Roche Diagnostic, Mannheim, Germany) (0.5µg/mL). Colocalization was performed by detection of enhanced GFP (with anti-GFP antibody) and MOP-mcherry direct fluorescence.

Image acquisition

For all DRG immunohistochemistry experiments, serial sectioning was used, ensuring that non-successive sections were observed. Image acquisition was performed with the Leica TCS SP5 confocal microscope using a 20x dry objective (NA :0.7), the 40x resolution was achieved with a digital zoom factor. Confocal acquisitions in the sequential mode (single excitation beams: 405, 488 and 568 nm) to avoid potential crosstalk between the different fluorescence emissions, were used for marker co-localizations. Images were acquired with the LCS (Leica) software. We examined neurons from approximately 15 sections L4-6 DRGs which expressed DOPeGFP per condition per animal. Neurons expressing a given fluorescent marker were manually and blindly counted on screen using Image J® software cell counter. Only neurons with a visible nucleus were counted. Threshold was applied to fluorescence detection. During the analysis, all cell surface areas were recorded for the separate markers. Cells expressing a given marker and eGFP fluorescence were then analyzed in separate images.

For brain sections, image acquisition was performed with the slide scanner NanoZoomer 2 HT and fluorescence module L11600-21 (Hamamatsu Photonics, Japan). The light source LX2000 (Hamamatsu Photonics, Japan) consisted in an ultra high-pressure mercury lamp coupled to an optical fiber. Single RGB acquisition was made in the epifluorescence mode with the 3-chip TDI camera equipped with a filter-set optimized for DAPI, fluorescein and tetramethylrhodamine detection. The scanner was equipped with a time delay integration camera and performed line scanning that offered fast acquisition at high resolution of the fluorescent signal. The acquisition was performed using a dry 20x objective (NA: 0.75). The 40x resolution was achieved with a lens converter. The latter mode

used the full capacity of the camera (resolution: 0.23 $\mu\text{m}/\text{pixel}$). Neurons expressing a given fluorescent marker are visualized using the NDP viewer system with an integrated high-resolution zoom and possibility to separate the different fluorescent components.

Statistical Analysis

Statistical analysis was performed using Statistica v12 (StatSoft, France) for behavioral analysis of von Frey testing. One-way repeated measure ANOVA analysis was performed to compare the impact of experimental treatment on paw withdrawal threshold (PWT) for separate gender groups, followed by Tukey HSD post-hoc test. One-way ANOVA analysis was performed to compare the grooming behavior in the different experimental groups followed by Newman-Keuls post-hoc test.

For cell area measures, data were pooled per treatment group. In order to determine Gaussian components of cellular populations according to size, Non-linear Least Square approach enabled curve fitting and models were compared (RCommander nls2 and pracma packages). For cell surface area data, normality was tested using Shapiro-Wilk test and Kolmogorov Smirnov test was used to compare distributions among groups (RCommander nls2 and pracma packages). To compare the frequencies in successive area bins of $100\mu\text{m}^2$, data were pooled and sorted in contingency tables (per experimental treatment group), and were analyzed using Chi-square approach, to enable the analysis of treatment effect on cell population distributions.

Results

Validation of the neuropathic pain model

Previous work in the laboratory on C57Bl6J mice showed that cuff-implantation induced mechanical allodynia which develops directly after surgery, is maintained until up to 12 weeks, and that treatment by antidepressants or β 2-mimetics (i.p. or *per os* administration) relieves mechanical allodynia (Benbouzid et al., 2008a; Choucair-Jaafar et al., 2009; Yalcin et al., 2010). Using our double fluorescent knock in animals, we first verified that the presence of the fluorescent proteins and/or the difference in genetic background had no detectable behavioral effect. The mechanical sensitivity of the DOPeGFP-MOPmCherry mice was assessed using Von Frey hairs. Male and female animals were used in each experimental group. Females had significantly lower baseline mechanical thresholds compared to males (between 2 and 4g for females vs. between 5 and 6g for males) as described previously. Sham surgery did not influence mechanical thresholds, neither for the ipsilateral (Figure 1), nor the contralateral hindpaw (data not shown). Cuff implantation induced an ipsilateral mechanical allodynia (Figure 1, $F(\text{males})= 193.44$, $p<0.0001$; $F(\text{females})= 85.7$, $p<0.0001$) which lasted for at least 8weeks (time of sacrifice). Contralateral sensitivity was not affected by surgery or treatment (data not shown).

Duloxetine and Formoterol treatments in drinking water supplemented with 0.2% saccharin, at doses 20mg/kg/day and 0.05mg/kg/day respectively, began 28 days after surgery. Sham and Cuff groups received saccharin 0.2% alone (control). Duloxetine relieved mechanical allodynia at treatment day 19 in males and females; paw withdrawal threshold (PWT) was not significantly different compared to Baseline PWT (Tukey HSD post-hoc test: Treatment day 19 vs Baseline: $p(\text{Males})=0.266$; $p(\text{Females})=1.00$, Figure 1). Formoterol relieved mechanical allodynia at treatment day 22 in males and females, with PWT values returning to Baseline values (Tukey HSD post-hoc test: Treatment day 22 PWT vs Baseline $p(\text{Males})=0.873$, $p(\text{Females})=0.531$, Figure 1). Treatments at these doses did not affect the mechanical sensitivity of the contralateral paw (data not shown). Our genetically modified animals (on a 50:50 genetic background see Methods) showed similar nociceptive thresholds under baseline conditions, male and female animals developed mechanical allodynia with a similar time

course to C57Bl6J (Benbouzid et al., 2008b), that was relieved by treatment with an antidepressant or a β 2-mimetic to a similar extent and with a similar time course to what was previously observed in male C57Bl6J mice (M Kremer personal communication).

Validation of anxio-depressive-like behaviors in double fluorescent knock in mice.

Sustained neuropathic pain following cuff surgery can induce anxio-depressive-like behaviors in mice, which have been described to develop from 6 weeks following neuropathy induction in male C57Bl6J mice (Yalcin et al., 2011). In our study, we sought to verify that gender, genetic background and/or presence of the fluorescent proteins had no detectable behavioral effect. For each gender group, the time spent grooming was recorded, and relative grooming time (% of 5mins) was compared among treatment groups (Figure 2). Overall, there was no difference in relative grooming time for female animals (one-way ANOVA $F=1.68$, $p=0.179$), however in males, one-way ANOVA showed that treatment group had a significant effect on relative grooming time in the splash test ($F=5.623$, $p=0.0296$). Indeed, male animals suffering from neuropathic pain spent significantly less time grooming compared to Sham animals (Newman-Keuls post-hoc: Sham vs Cuff $p=0.0212$), as previously described in male C57/Bl6J mice (Yalcin et al., 2011). Surprisingly, Duloxetine did not reverse anxio-depressive-like behavior, as animals treated with antidepressant spent significantly less time grooming than Sham animals (Newman-Keuls post-hoc: Sham vs Duloxetine $p=0.0210$). In contrast, Formoterol-treated animals were not distinguishable from Sham group, the relative time they spent grooming was not statistically different from controls and therefore showed lower anxio-depressive-like behavior (Newman-Keuls post-hoc: Sham vs Formoterol $p=0.78$).

Analysis of DRG neuronal populations

The effect of cuff implantation on overall DRG population distribution has already been described (Ceredig, unpublished results). Briefly, data indicated that the cuff model induced a significant loss of small sized neurons at 8 weeks after surgery, and that there was decreased labeling in both peptidergic and non peptidergic small size DOPeGFP expressing cells in neuropathic DRGs.

Here, we investigated changes in MOPmCherry distributions, and in MOPmcherryDOPEGFP populations. All data sets were non-normally distributed in sham and cuff animals except for cuff co-localized neurons. For Sham animals, MOPmCherry and co-localized cell populations were all best described as sums of three and two distinct Gaussian functions respectively (Supplemental Table1). Since all data sets were non-normally distributed (Supplemental Table 1), we adopted a non-parametric approach for distribution comparisons throughout the analysis. We therefore used Pearson's Chi-Squared test to compare the four experimental groups at a time, with cells distributed in categorical data, i.e. cell areas were used to classify all counted cells in 100 μm^2 -wide area bins.

Distribution of neurons expressing MOPmcherry in Sham and Cuff animals.

All MOPmCherry-positive cells from Sham and Cuff experimental groups were pooled into two groups (n=4481, 4 animals for Sham and n=2031 neurons n=4 Cuff animals) and their surface area (μm^2) distributions were examined. Sham MOPmCherry distribution was consistent with expression in all cell size categories for DRG neurons. Sham and Cuff cumulative distributions (Figure 3 A) were statistically different (KS test for cumulative distribution comparison: $D=0.101615$, $p\text{-value}=5.93 \times 10^{-13}$). Cuff distribution pattern was shifted towards smaller cell surface areas compared to Sham, a shift that appeared at small cell sizes and indicated a statistically significant increase in MOPmCherry expression in small and/or medium neurons following 8 weeks of neuropathy. There was no loss of expression for neurons of larger sizes, as the shift was observed consistently along surface area scale (Figure 3 B). This indicates an increase of small MOPmCherry+ neurons.

In order to determine in which neuronal populations changes occurred, we analyzed the proportion of MOPmCherry+ cells in each 100 μm^2 bin. Non-parametric Pearson's Chi-squared test on MOPmCherry Sham and Cuff data (bins of 100 μm^2 width based on the precision of area measures, $X\text{-squared} = 61.85$, $df = 14$, $p\text{-value} = 5.54 \times 10^{-8}$) showed significant differences between Sham and Cuff with a higher proportion of neurons in 100-300 μm^2 area categories compared to Sham (Figure 3 B, Table 1). Differences between sham and cuff groups were assessed using Chi-Squared Standardized Residuals. Because a high number of categories composed the contingency table, standardized residuals were considered significant when the absolute value of calculated residuals was greater than 2 and very

significant when greater than 4. Other differences between Cuff and Sham samples included a lower proportion of neurons in 400-800 μm^2 categories. Since cumulative distribution showed no gain of expression, this increase only reflected a compensatory effect to the increase of small neurons in the relative distribution of MOPmCherry+ neurons.

Table 1: Chi Squared Standardized Residuals

The proportion of MOPmcherry positive neurons per 100 μm^2 bin categories was analyzed using the non-parametric Pearson's Chi-squared test. Differences between sham and cuff animals were assessed using Chi-Squared Standardized Residuals. Values in red and blue boxes respectively indicate a significant decrease or increase compared to sham animals.

Area range (μm^2)	0-100	100-200	200-300	300-400	400-500	500-600	600-700	700-800	800-900	900-1000	1000-1100	1100-1200	1200-1300	1300-1400	1400+
Sham	1.99	-2.41	-4.94	-0.75	2.33	2.65	2.18	3.17	1.59	-1.05	1.21	-1.26	1.21	0.94	-0.08
Cuff	-1.99	2.41	4.94	0.75	-2.33	-2.65	-2.18	-3.17	-1.59	1.05	-1.21	1.26	-1.21	-0.94	0.08

Distribution of neurons co-expressing MOPmcherryDOPeGFP in Sham and Cuff animals.

All MOPmCherry/DOPeGFP double-positive cells from Sham and Cuff experimental groups were pooled into two groups (n=516, 4 animals for Sham and n=176 neurons n=4 Cuff animals) and their surface area (μm^2) distributions were examined. In Sham, global distribution of neurons co-expressing MOPmCherry and DOPeGFP is consistent with co-expression in all cell size categories for DRG neurons. Sham and Cuff cumulative distributions were statistically different (KS test for cumulative distribution comparison: $D=0.21468$, $p\text{-value}=8.66 \times 10^{-6}$) (Figure 4 A). Cuff distribution pattern was shifted towards larger cell surface areas compared to Sham, a shift that appeared at small cell sizes and indicated a statistically significant decrease in MOPmCherry and DOPeGFP co-expression in small and/or medium neurons (Figure 4 B). Indeed, the proportion of MOPmcherryDOPeGFP small neurons ($<300 \mu\text{m}^2$) dropped from 11% in Sham to 7% in Cuff mice. In this population, $4 \pm 2\%$ (n=3) MOPmcherry positive neurons also expressed DOPeGFP and $14 \pm 5\%$ (n=3) DOPeGFP positive neurons co-expressed MOPmcherry but these values were significantly reduced in cuff animals ($1.1 \pm$

0.6 % for MOPmcherry positive neurons co-expressing DOPeGFP and $4 \pm 2\%$ for DOPeGFP positive neurons co-expressing MOPmcherry) (Supplementary Figure 1)

Non-parametric Pearson's Chi-squared test on MOPmCherry/DOPeGFP double-positive Sham and Cuff data (bins of $100\mu\text{m}^2$ width, Figures 4d, X-squared = 31.59, df = 14, p-value=0.0045) showed significant differences between Sham and Cuff with a lower proportion of neurons in 900-1100 μm^2 area categories compared to Sham according to the Standardized Chi-Squared Residuals (Figure 4 B, Table 2). One would note that the proportion of MOPmCherry expressing neurons is increased following neuropathy whereas the proportion of DOPeGFP expressing cells is decreased (Ceredig unpublished results). Accordingly, only 9% of all MOPmcherry+ neurons co-expressed DOPeGFP in Cuff animals compared to 31% in Sham mice. Interestingly, the proportion of DOPeGFP+ neurons co-expressing MOPmcherry also decreased in Cuff (9%) compared to Sham (18%) suggesting that complex changes are induced in neuropathic condition (Supplementary Figure 1).

Table 2: Chi Squared Standardized Residuals

The proportion of MOPmcherryDOPeGFP positive neurons per 100 μm^2 bin categories was analyzed using the non-parametric Pearson's Chi-squared test. Differences between sham and cuff animals were assessed using Chi-Squared Standardized Residuals. Values in red boxes indicate a significant decrease compared to sham animals.

Area range (μm^2)	0-100	100-200	200-300	300-400	400-500	500-600	600-700	700-800	800-900	900-1000	1000-1100	1100-1200	1200-1300	1300-1400	1400+
Sham	-0.56	-0.53	-1.56	-0.7	-1.55	-1.24	-1.25	0.6	0.95	2.37	2.84	1.24	1.18	1.74	1.9
Cuff	0.56	0.53	1.56	0.7	1.55	1.24	1.25	-0.6	-0.95	-2.37	-2.84	-1.24	-1.18	-1.74	-1.9

Analysis of MOPmCherry and DOPeGFP co-expression in the brain of neuropathic mice

We qualitatively assessed co-expression in brain regions of Sham and Cuff animals. Both Sham and Cuff mice showed MOPmcherryDOPeGFP neuronal co-expression in all regions previously reported in basal conditions and encompassing subcortical brain areas involved in the processing of aversive noxious stimuli (Erbs et al., 2015). Cuff animals also showed MOPmcherryDOPeGFP neuronal co-expression in additional regions involved in nociceptive processing such as cuneate nucleus, the

median raphe nucleus, the deep mesencephalic nucleus, the ventral tegmental area or the spinal trigeminal nucleus (Figure 5).

Discussion

In this study, we examined changes in peripheral and central distribution patterns of MOP-DOP receptor neuronal co-localization following neuropathy using double fluorescent knock-in mice. We also provided preliminary data describing behavioral outcomes of chronic pain and chronic oral antiallodynic treatment by antidepressant or β 2-mimetic molecules.

Treatment of mechanical allodynia

Duloxetine, a potent selective serotonin and noradrenalin reuptake inhibitor, is indicated for anxiety-depressive disorders and human diabetic neuropathy (Bymaster et al., 2001; Wong et al., 1993; Wright et al., 2011). Several studies examined acute effects of Duloxetine in rodent models of CCI or diabetic neuropathy (Mixcoatl-Zecuatl et al., 2000; Wattiez et al., 2011; Kuhad et al., 2009) but there are few reports in the literature illustrating anti-allodynic effects of chronic oral administration of Duloxetine in mice (Iyengar et al., 2004a; Murai et al., 2014), and fewer still in neuropathic models (Bomholt et al., 2005). In rats, chronic Duloxetine treatment (14 days) at doses ranging 5-30mg/kg i.p. reversed thermal hyperalgesia and hypersensitivity but had no effect on mechanical allodynia (Bomholt et al., 2005). Doses of 3-30mg/kg of Duloxetine are used for acute oral administrations (gavage) in mice or rats, for assessing nociceptive responses in naïve animals, and chronic or acute pain models (Le Cudennec and Castagné, 2014; Nikaido et al., 2015; Iyengar et al., 2004b). Noteworthy, our previous results report that using 20mg/kg/day dose (Ceredig et al, unpublished data) of Duloxetine reverses mechanical allodynia in the cuff model at 19 days of treatment. Double knock in animals recovered from mechanical allodynia in similar time frames to what was shown for C57BL6J mice (Kremer in preparation).

Formoterol, a β 2-mimetic, has been shown to reverse cuff-induced mechanical allodynia in mice after 25 to 27 days of chronic treatment (two daily i.p. administrations at 0.5 to 0.005mg/kg) (Yalcin et al., 2010). Our time frame of recovery at 22 days for chronic oral administration 0.05 mg/kg/day for double knock in fluorescent mice is in accordance with these findings.

Anxio-depressive consequences of chronic neuropathic pain

In rodents, decreased grooming or low hygiene reflect an anxio-depressive-like state in which animals spend less time taking care of their coat (Yalcin et al., 2008). In chronic mild stress, low hygiene or decreased self-care can be reversed by chronic antidepressant treatment (Yalcin et al., 2008). Mood disorders which arise 6-8 weeks following sciatic nerve cuffing also affect grooming behaviors in male C57Bl6/J (Yalcin et al., 2011; Barthas et al., 2015). However their reversal by chronic antidepressant or β 2-mimetic treatment has not yet been investigated.

Similarly to previous report, male Sham animals were grooming approximately 50% of the time when tested 8 weeks post-surgery whilst male Cuff animals spent less than 30% of the test time engaged in grooming behaviors (Yalcin et al., 2011; Barthas et al., 2015). Since chronic mild stress is known to induce decreased grooming behaviors in female C57Bl6/J mice in the Splash Test (Franceschelli et al., 2015), we also assessed the behaviour of female mice from the Cuff group. However, in our conditions, female mice behaved as sham controls possibly revealing differences linked to the nature of the stressor.

Duloxetine treatment was maintained for four weeks, and recovery from mechanical allodynia was robust, however this time frame did not reverse cuff-induced anxio-depressive-like behaviors in the Splash test. This may indicate that the dose of Duloxetine used in our study was sufficient to alleviate mechanical allodynia but not the anxio-depressive state. Anxiolytic and anti-depressive properties of Duloxetine administered at similar and lower doses have been reported in mice using protocols of oral administration over 21-28 days with behavioral reversal of anxio-depressive phenotypes in the Elevated Plus Maze (Patel et al., 2015), Zero-Maze (Mirza et al., 2007) (robust anxiolytic activity at 21 days (Troelsen et al., 2005)), forced swim and tail suspension (Kale et al., 2013; Kale and Addepalli, 2014) tests. These tests however are based on the motor activity of the animals, as opposed to the Splash test, which assesses self-oriented motivation for self-care. Interestingly, Duloxetine tended to reverse anxiety-like behaviors of Cuff mice in the marble burying test (data not shown), which suggests that the Splash test may not be sensitive enough to assess the effect of Duloxetine on anxio-depressive symptoms.

Our results show for the first time that chronic administration of Formoterol reversed the anxiodepressive consequences of chronic neuropathic pain in the Splash Test, and in the marble burying test (data not shown). This opens new perspectives and designates β -mimetics as novel candidates for efficacious treatment of neuropathic pain and associated anxiodepressive state.

MOPmCherry expression and neuronal co-localization with DOPeGFP

We report for the first time changes induced in MOP receptor distribution in the cuff model and show significant increase in the proportion of small neurons expressing MOP receptor by direct visualization of L5-L6 DRGs 8 weeks after cuff surgery. Previous reports in the literature mentioned decreased MOP receptor expression at both mRNA and protein level at various times after nerve injury or axotomy (Zhang et al., 1998; Rashid et al., 2004; Aley and Levine, 2002; Kohno et al., 2005) whereas others described increased (Truong et al., 2003; Labuz and Machelska, 2013; Walczak et al., 2006; Pol et al., 2006; Schmidt et al., 2012; Cayla et al., 2012) or unchanged (Kolesnikov et al., 2007; Lee et al., 2011; Chen et al., 2014) MOP receptor expression in DRGs. The reason underlying such discrepancy is unclear but one may suggest that the choice of the model is crucial.

In DRGs, Bardoni *et al.* reported that about 30% of MOP or DOP positive myelinated neurons co-expressed the other receptor but only 1% of MOP positive non-myelinated neurons expressed DOP receptors and 7% of DOP positive non-myelinated neurons expressed MOP receptors (Bardoni et al., 2014). On the opposite, others observed neuronal co-expression in all size categories (Erbs et al., 2015) and abundant co-expression was reported in 50 % of peptidergic and 20% of non-peptidergic small neurons using single cell PCR (Wang et al., 2010). Our observations are in favor of a somewhat higher MOP-DOP co-expression than described in DOPeGFP mice using ISH detection for MOP receptor (Bardoni et al., 2014) with about 4% MOPmcherry positive neurons also expressing DOPeGFP and about 15% DOPeGFP co-expressing MOPmcherry.

After 8 weeks of neuropathy, we observed a significant shift to larger cell surface areas for neurons co-expressing MOPmCherry and DOPeGFP (Figure 4, Table 2). This corresponded to a loss of about one third of MOPmcherryDOPeGFP neurons in populations with a size $<300\mu\text{m}^2$, which paralleled the decrease in DOPeGFP receptor expression at this time point in non-myelinated CGRP and IB4

positive populations (Ceredig et al. unpublished data). These findings suggest that developing analgesic drugs targeting MOP-DOP receptor heteromers at peripheral level would have limited efficacy in the context of neuropathic pain.

Neuronal co-localization of MOPmCherry and DOPeGFP in the brain of neuropathic animals

In a previous study, double knock in animals were used to describe MOP-DOP neuronal co-expression in the brain under basal conditions (Erbs et al., 2015). Neuronal co-localization was observed in subcortical networks essential for survival, that are involved in eating and sexual behaviors or perception and response to aversive stimuli including noxious ones. Our current analysis indicates that, in neuropathic condition, MOP-DOP neuronal co-expression was still present in all brain regions previously identified. Moreover, neuronal co-localization in cuff animals was detected in additional brain areas of the nociceptive pathway regulated in the neuropathic condition following peripheral nerve injury. This includes regions with increased pronociceptive activity such as the cuneate nucleus (Jaggi and Singh, 2011) or the spinal trigeminal nucleus (Michot et al., 2012), areas with an antinociceptive role such as the locus coeruleus (Jaggi and Singh, 2011) or the deep mesencephalic nucleus (Jones et al., 2009), or structures involved in the emotionally affective component of neuropathic pain such as the median raphe nucleus and the ventral tegmental area (Sagheddu et al., 2015).

Our data show for the first time opposite regulation of MOP-DOP co-expression in neuropathic condition. Indeed, increased MOP-DOP co-expression took place at the supraspinal level whereas MOP-DOP neuronal co-localization was decreased in the peripheral nervous system. Interestingly, systemic administration of drugs targeting MOP-DOP heteromers produced potent anti-nociceptive effect on thermal pain with reduced tolerance (Gomes et al., 2013) and could have anti-depressant and anxiolytic effects (Kabli 2014). Targeting heteromers in pain management and for treating mood disorders therefore represents an attractive approach, which now requires in-depth molecular and behavioral studies.

Acknowledgements

The authors would like to thank Dr Sylvain Hugel for scientific discussions, the imaging platform of the Institut des Neurosciences Cellulaires et Intégratives and the Chronobiotron animal facility. R.A.C. was funded by the Fondation pour la recherche Médicale.

References

- Aley, K. O., and Levine, J. D. (2002). Different peripheral mechanisms mediate enhanced nociception in metabolic/toxic and traumatic painful peripheral neuropathies in the rat. *Neuroscience* 111, 389–97.
- Attal, N., Fermanian, C., Fermanian, J., Lanteri-Minet, M., Alchaar, H., and Bouhassira, D. (2008). Neuropathic pain: are there distinct subtypes depending on the aetiology or anatomical lesion? *Pain* 138, 343–53. doi:10.1016/j.pain.2008.01.006.
- Bardoni, R., Tawfik, V. L., Wang, D., François, A., Solorzano, C., Shuster, S. a, et al. (2014). Delta opioid receptors presynaptically regulate cutaneous mechanosensory neuron input to the spinal cord dorsal horn. *Neuron* 81, 1312–27. doi:10.1016/j.neuron.2014.01.044.
- Barthas, F., Sellmeijer, J., Hugel, S., Waltisperger, E., Barrot, M., and Yalcin, I. (2015). The anterior cingulate cortex is a critical hub for pain-induced depression. *Biol. Psychiatry* 77, 236–45. doi:10.1016/j.biopsych.2014.08.004.
- Benbouzid, M., Choucair-Jaafar, N., Yalcin, I., Waltisperger, E., Muller, A., Freund-Mercier, M. J., and Barrot, M. (2008a). Chronic, but not acute, tricyclic antidepressant treatment alleviates neuropathic allodynia after sciatic nerve cuffing in mice. *Eur. J. Pain* 12, 1008–17. doi:10.1016/j.ejpain.2008.01.010.
- Benbouzid, M., Pallage, V., Rajalu, M., Waltisperger, E., Doridot, S., Poisbeau, P., Freund-Mercier, M. J., and Barrot, M. (2008b). Sciatic nerve cuffing in mice: a model of sustained neuropathic pain. *Eur. J. Pain* 12, 591–9. doi:10.1016/j.ejpain.2007.10.002.
- Bomholt, S. F., Mikkelsen, J. D., and Blackburn-Munro, G. (2005). Antinociceptive effects of the antidepressants amitriptyline, duloxetine, mirtazapine and citalopram in animal models of acute, persistent and neuropathic pain. *Neuropharmacology* 48, 252–63. doi:10.1016/j.neuropharm.2004.09.012.
- Bymaster, F. P., Dreshfield-Ahmad, L. J., Threlkeld, P. G., Shaw, J. L., Thompson, L., Nelson, D. L., Hemrick-Luecke, S. K., and Wong, D. T. (2001). Comparative affinity of duloxetine and venlafaxine for serotonin and norepinephrine transporters in vitro and in vivo, human serotonin receptor subtypes, and other neuronal receptors. *Neuropsychopharmacology* 25, 871–80. doi:10.1016/S0893-133X(01)00298-6.
- Cayla, C., Labuz, D., Machelska, H., Bader, M., Schäfer, M., and Stein, C. (2012). Impaired nociception and peripheral opioid antinociception in mice lacking both kinin B1 and B2 receptors. *Anesthesiology* 116, 448–57. doi:10.1097/ALN.0b013e318242b2ea.
- Chen, W., McRoberts, J. a, and Marvizón, J. C. G. (2014). μ -Opioid receptor inhibition of substance P release from primary afferents disappears in neuropathic pain but not inflammatory pain. *Neuroscience* 267, 67–82. doi:10.1016/j.neuroscience.2014.02.023.
- Choucair-Jaafar, N., Yalcin, I., Rodeau, J.-L., Waltisperger, E., Freund-Mercier, M.-J., and Barrot, M. (2009). Beta2-adrenoceptor agonists alleviate neuropathic allodynia in mice after chronic treatment. *Br. J. Pharmacol.* 158, 1683–94. doi:10.1111/j.1476-5381.2009.00510.x.
- Le Cudennec, C., and Castagné, V. (2014). Face-to-face comparison of the predictive validity of two models of neuropathic pain in the rat: analgesic activity of pregabalin, tramadol and duloxetine. *Eur. J. Pharmacol.* 735, 17–25. doi:10.1016/j.ejphar.2014.04.003.
- Dworkin, R. H., O'Connor, A. B., Backonja, M., Farrar, J. T., Finnerup, N. B., Jensen, T. S., et al. (2007). Pharmacologic management of neuropathic pain: evidence-based recommendations. *Pain* 132, 237–51. doi:10.1016/j.pain.2007.08.033.
- Erbs, E., Faget, L., Scherrer, G., Matifas, A., Filliol, D., Vonesch, J.-L., et al. (2015). A mu-delta opioid receptor brain atlas reveals neuronal co-occurrence in subcortical networks. *Brain Struct. Funct.* doi:10.1007/s00429-014-0717-9.
- Franceschelli, A., Sens, J., Herchick, S., Thelen, C., and Pitychoutis, P. M. (2015). Sex differences in the rapid and the sustained antidepressant-like effects of ketamine in stress-naïve and “depressed” mice exposed to chronic mild stress. *Neuroscience* 290, 49–60. doi:10.1016/j.neuroscience.2015.01.008.

- Fujita, W., Gomes, I., and Devi, L. a (2015). Heteromers of μ - δ opioid receptors: new pharmacology and novel therapeutic possibilities. *Br. J. Pharmacol.* 172, 375–87. doi:10.1111/bph.12663.
- Gaveriaux-Ruff, C., Nozaki, C., Nadal, X., Hever, X. C., Weibel, R., Matifas, A., et al. (2011). Genetic ablation of delta opioid receptors in nociceptive sensory neurons increases chronic pain and abolishes opioid analgesia. *Pain* 152, 1238–48. doi:10.1016/j.pain.2010.12.031.
- Gomes, I., Fujita, W., Gupta, A., Saldanha, S. A., Negri, A., Pinello, C. E., et al. (2013). Identification of a mu-delta opioid receptor heteromer-biased agonist with antinociceptive activity. *Proc. Natl. Acad. Sci.* 110, 17162–17160. doi:10.1073/pnas.1317701110.
- von Hehn, C. A., Baron, R., and Woolf, C. J. (2012). Deconstructing the neuropathic pain phenotype to reveal neural mechanisms. *Neuron* 73, 638–52. doi:10.1016/j.neuron.2012.02.008.
- Herradon, G., Ezquerra, L., Nguyen, T., Wang, C., Siso, A., Franklin, B., Dilorenzo, L., Rossenfeld, J., Silos-Santiago, I., and Alguacil, L. F. (2008). Noradrenergic and opioidergic alterations in neuropathy in different rat strains. *Neurosci. Lett.* 438, 186–9. doi:10.1016/j.neulet.2008.03.095.
- Hervera, A., Negrete, R., Leánez, S., Martín-Campos, J. M., and Pol, O. (2011). Peripheral effects of morphine and expression of μ -opioid receptors in the dorsal root ganglia during neuropathic pain: nitric oxide signaling. *Mol. Pain* 7, 25. doi:10.1186/1744-8069-7-25.
- Iyengar, S., Webster, A. A., Hemrick-luecke, S. K., Xu, J. Y., and Simmons, R. M. A. (2004a). Efficacy of Duloxetine , a Potent and Balanced Serotonin- Norepinephrine Reuptake Inhibitor in Persistent Pain Models in Rats. *J. Pharmacol. Exp. Ther.* 311, 576–584. doi:10.1124/jpet.104.070656.mentum.
- Iyengar, S., Webster, A. A., Hemrick-Luecke, S. K., Xu, J. Y., and Simmons, R. M. A. (2004b). Efficacy of duloxetine, a potent and balanced serotonin-norepinephrine reuptake inhibitor in persistent pain models in rats. *J. Pharmacol. Exp. Ther.* 311, 576–84. doi:10.1124/jpet.104.070656.
- Jaggi, A. S., and Singh, N. (2011). Role of different brain areas in peripheral nerve injury-induced neuropathic pain. *Brain Res.* 1381, 187–201. doi:10.1016/j.brainres.2011.01.002.
- Jones, K. L., Finn, D. P., Governo, R. J. M., Prior, M. J., Morris, P. G., Kendall, D. A., Marsden, C. A., and Chapman, V. (2009). Identification of discrete sites of action of chronic treatment with desipramine in a model of neuropathic pain. *Neuropharmacology* 56, 405–13. doi:10.1016/j.neuropharm.2008.09.010.
- Julius, D., and Basbaum, A. (2001). Molecular mechanisms of nociception. *Nature* 413, 203–210. doi:10.1038/35093019.
- Kabli, N., and Cahill, C. M. (2007). Anti-allodynic effects of peripheral delta opioid receptors in neuropathic pain. *Pain* 127, 84–93. doi:10.1016/j.pain.2006.08.003.
- Kabli, N., Nguyen, T., Balboni, G., O’Dowd, B. F., and George, S. R. (2014). Antidepressant-like and anxiolytic-like effects following activation of the μ - δ opioid receptor heteromer in the nucleus accumbens. *Mol. Psychiatry* 19, 986–94. doi:10.1038/mp.2013.115.
- Kale, P. P., and Addepalli, V. (2014). Augmentation of antidepressant effects of duloxetine and bupropion by caffeine in mice. *Pharmacol. Biochem. Behav.* 124, 238–44. doi:10.1016/j.pbb.2014.06.005.
- Kale, P. P., Addepalli, V., and Ghadawale, S. R. (2013). Impact of pre-exposure of tail suspension on behavioural parameters like locomotion, exploration, and anxiety in mice. *Indian J. Exp. Biol.* 51, 732–8.
- Kohno, T., Ji, R.-R., Ito, N., Allchorne, A. J., Befort, K., Karchewski, L. a., and Woolf, C. J. (2005). Peripheral axonal injury results in reduced μ opioid receptor pre- and post-synaptic action in the spinal cord. *Pain* 117, 77–87. doi:10.1016/j.pain.2005.05.035.
- Kolesnikov, Y., El-Maarouf, A., El-Maarouf Abderrahman, A., Rutishauser, U., Rutishauser, U., and Pasternak, G. (2007). Reorganization of dorsal root ganglion neurons following chronic sciatic nerve constriction injury: correlation with morphine and lidocaine analgesia. *Eur. J. Pharmacol.* 568, 124–33. doi:10.1016/j.ejphar.2007.04.045.
- Kuhad, A., Bishnoi, M., and Chopra, K. (2009). Anti-nociceptive effect of duloxetine in mouse model of diabetic

- neuropathic pain. *Indian J. Exp. Biol.* 47, 193–7.
- Labuz, D., and Machelska, H. (2013). Stronger antinociceptive efficacy of opioids at the injured nerve trunk than at its peripheral terminals in neuropathic pain. *J. Pharmacol. Exp. Ther.* 346, 535–44. doi:10.1124/jpet.113.205344.
- Latremoliere, A., and Woolf, C. J. (2009). Central sensitization: a generator of pain hypersensitivity by central neural plasticity. *J. Pain* 10, 895–926. doi:10.1016/j.jpain.2009.06.012.
- Lee, C.-Y., Perez, F. M., Wang, W., Guan, X., Zhao, X., Fisher, J. L., Guan, Y., Sweitzer, S. M., Raja, S. N., and Tao, Y.-X. (2011). Dynamic temporal and spatial regulation of mu opioid receptor expression in primary afferent neurons following spinal nerve injury. *Eur. J. Pain* 15, 669–75. doi:10.1016/j.ejpain.2010.11.018.
- Massotte, D. (2015). In vivo opioid receptor heteromerization: where do we stand? *Br. J. Pharmacol.* 172, 420–34. doi:10.1111/bph.12702.
- Michot, B., Bourgoin, S., Viguier, F., Hamon, M., and Kayser, V. (2012). Differential effects of calcitonin gene-related peptide receptor blockade by olcegepant on mechanical allodynia induced by ligation of the infraorbital nerve vs the sciatic nerve in the rat. *Pain* 153, 1939–1948. doi:10.1016/j.pain.2012.06.009.
- Mirza, N. R., Nielsen, E. Ø., and Troelsen, K. B. (2007). Serotonin transporter density and anxiolytic-like effects of antidepressants in mice. *Prog. Neuropsychopharmacol. Biol. Psychiatry* 31, 858–66. doi:10.1016/j.pnpbp.2007.01.020.
- Mixcoatl-Zecuatl, T., Aguirre-Bañuelos, P., and Granados-Soto, V. (2000). Sildenafil produces antinociception and increases morphine antinociception in the formalin test. *Eur. J. Pharmacol.* 400, 81–7.
- Moulin, D. E., Clark, A. J., Gilron, I., Ware, M. A., Watson, C. P. N., Sessle, B. J., et al. (2007). Pharmacological management of chronic neuropathic pain - consensus statement and guidelines from the Canadian Pain Society. *Pain Res. Manag. J. Can. Pain Soc. = J. la société Can. pour le Trait. la douleur* 12, 13–21.
- Murai, N., Tsukamoto, M., Tamura, S., Aoki, T., and Matsuoka, N. (2014). Antinociceptive effects of AS1069562, the (+)-isomer of indeloxazine, on spinal hypersensitivity induced by intrathecal injection of prostaglandin in mice: comparison with duloxetine and amitriptyline. *Eur. J. Pharmacol.* 733, 54–61. doi:10.1016/j.ejphar.2014.03.038.
- Nikaido, Y., Kurosawa, A., Saikawa, H., Kuroiwa, S., Suzuki, C., Kuwabara, N., et al. (2015). In vivo and in vitro evaluation of novel μ -opioid receptor agonist compounds. *Eur. J. Pharmacol.* 767, 193–200. doi:10.1016/j.ejphar.2015.10.025.
- Obara, I., Parkitna, J. R., Korostynski, M., Makuch, W., Kaminska, D., Przewlocka, B., and Przewlocki, R. (2009). Local peripheral opioid effects and expression of opioid genes in the spinal cord and dorsal root ganglia in neuropathic and inflammatory pain. *Pain* 141, 283–91. doi:10.1016/j.pain.2008.12.006.
- Ong, E. W., and Cahill, C. M. (2014). Molecular Perspectives for mu/delta Opioid Receptor Heteromers as Distinct, Functional Receptors. *Cells* 3, 152–79. doi:10.3390/cells3010152.
- Patel, S., Kale, P. P., Addepalli, V., Sarkar, A., and Savai, J. (2015). Effect of a combination of duloxetine with hydroxyzine on experimental models of anxiety in mice. *Indian J. Pharmacol.* 47, 173–6. doi:10.4103/0253-7613.153424.
- Pol, O., Murtra, P., Caracuel, L., Valverde, O., Puig, M. M., and Maldonado, R. (2006). Expression of opioid receptors and c-fos in CB1 knockout mice exposed to neuropathic pain. *Neuropharmacology* 50, 123–32. doi:10.1016/j.neuropharm.2005.11.002.
- Radat, F., Margot-Duclot, a, and Attal, N. (2013). Psychiatric co-morbidities in patients with chronic peripheral neuropathic pain: a multicentre cohort study. *Eur. J. Pain* 17, 1547–57. doi:10.1002/j.1532-2149.2013.00334.x.
- Rashid, M. H., Inoue, M., Toda, K., and Ueda, H. (2004). Loss of peripheral morphine analgesia contributes to the reduced effectiveness of systemic morphine in neuropathic pain. *J. Pharmacol. Exp. Ther.* 309, 380–7.

doi:10.1124/jpet.103.060582.

- Rau, K. K., Caudle, R. M., Cooper, B. Y., and Johnson, R. D. (2005). Diverse immunocytochemical expression of opioid receptors in electrophysiologically defined cells of rat dorsal root ganglia. *J. Chem. Neuroanat.* 29, 255–64. doi:10.1016/j.jchemneu.2005.02.002.
- Sagheddu, C., Aroni, S., De Felice, M., Lecca, S., Luchicchi, A., Melis, M., et al. (2015). Enhanced serotonin and mesolimbic dopamine transmissions in a rat model of neuropathic pain. *Neuropharmacology* 97, 383–93. doi:10.1016/j.neuropharm.2015.06.003.
- Santarelli, L., Gobbi, G., Debs, P. C., Sibille, E. T., Blier, P., Hen, R., and Heath, M. J. (2001). Genetic and pharmacological disruption of neurokinin 1 receptor function decreases anxiety-related behaviors and increases serotonergic function. *Proc. Natl. Acad. Sci. U. S. A.* 98, 1912–7. doi:10.1073/pnas.041596398.
- Scherrer, G., Imamachi, N., Cao, Y. Q., Contet, C., Mennicken, F., O'Donnell, D., Kieffer, B. L., and Basbaum, A. I. (2009). Dissociation of the opioid receptor mechanisms that control mechanical and heat pain. *Cell* 137, 1148–1159. doi:10.1016/j.cell.2009.04.019.
- Scherrer, G., Tryoen-to, P., Filliol, D., Matifas, A., Laustriat, D., Cao, Y. Q., Vonesh, J., Gaveriaux, C., Kieffer, B. L., and Basbaum, A. I. (2006). Knockin mice expressing fluorescent delta -opioid receptors uncover G protein-coupled receptor dynamics in vivo. *PNAS* 103.
- Schmidt, Y., Gavériaux-Ruff, C., and Machelska, H. (2013). μ -Opioid receptor antibody reveals tissue-dependent specific staining and increased neuronal μ -receptor immunoreactivity at the injured nerve trunk in mice. *PLoS One* 8, e79099. doi:10.1371/journal.pone.0079099.
- Schmidt, Y., Labuz, D., Heppenstall, P. A., and Machelska, H. (2012). Cutaneous nociceptors lack sensitisation, but reveal μ -opioid receptor-mediated reduction in excitability to mechanical stimulation in neuropathy. *Mol. Pain* 8, 81. doi:10.1186/1744-8069-8-81.
- Smith, H. S. (2012). Opioids and neuropathic pain. *Pain Physician* 15, ES93–110.
- Troelsen, K. B., Nielsen, E. Ø., and Mirza, N. R. (2005). Chronic treatment with duloxetine is necessary for an anxiolytic-like response in the mouse zero maze: the role of the serotonin transporter. *Psychopharmacology (Berl)*. 181, 741–50. doi:10.1007/s00213-005-0032-5.
- Truong, W., Cheng, C., Xu, Q.-G., Li, X.-Q., and Zochodne, D. W. (2003). Mu opioid receptors and analgesia at the site of a peripheral nerve injury. *Ann. Neurol.* 53, 366–75. doi:10.1002/ana.10465.
- Walczak, J., Pichette, V., and Beaulieu, P. (2006). Characterization of Chronic Constriction of the Saphenous Nerve , a Model of Neuropathic Pain in Mice Showing Rapid Molecular and Electrophysiological Changes. *J. Neurosci. Res.* 1322, 1310–1322. doi:10.1002/jnr.
- Wang, H.-B., Zhao, B., Zhong, Y.-Q., Li, K.-C., Li, Z.-Y., Wang, Q., et al. (2010). Coexpression of delta- and mu-opioid receptors in nociceptive sensory neurons. *Proc. Natl. Acad. Sci. U. S. A.* 107, 13117–22. doi:10.1073/pnas.1008382107.
- Wattiez, A.-S., Libert, F., Privat, A.-M., Loiodice, S., Fialip, J., Eschalier, A., and Courteix, C. (2011). Evidence for a differential opioidergic involvement in the analgesic effect of antidepressants: prediction for efficacy in animal models of neuropathic pain? *Br. J. Pharmacol.* 163, 792–803. doi:10.1111/j.1476-5381.2011.01297.x.
- Wong, D. T., Bymaster, F. P., Mayle, D. A., Reid, L. R., Krushinski, J. H., and Robertson, D. W. (1993). LY248686, a new inhibitor of serotonin and norepinephrine uptake. *Neuropsychopharmacology* 8, 23–33. doi:10.1038/npp.1993.4.
- Wright, A., Luedtke, K. E., and Vandenberg, C. (2011). Duloxetine in the treatment of chronic pain due to fibromyalgia and diabetic neuropathy. *J. Pain Res.* 4, 1–10. doi:10.2147/JPR.S12866.
- Yalcin, I., Bohren, Y., Waltisperger, E., Sage-Ciocca, D., Yin, J. C., Freund-Mercier, M.-J., and Barrot, M. (2011). A time-dependent history of mood disorders in a murine model of neuropathic pain. *Biol. Psychiatry* 70, 946–53. doi:10.1016/j.biopsych.2011.07.017.

- Yalcin, I., Choucair-Jaafar, N., Benbouzid, M., Tessier, L.-H., Muller, A., Hein, L., Freund-Mercier, M.-J., and Barrot, M. (2009). Beta(2)-Adrenoceptors Are Critical for Antidepressant Treatment of Neuropathic Pain. *Ann. Neurol.* 65, 218–25. doi:10.1002/ana.21542.
- Yalcin, I., Coubard, S., Bodard, S., Chalon, S., and Belzung, C. (2008). Effects of 5,7-dihydroxytryptamine lesion of the dorsal raphe nucleus on the antidepressant-like action of tramadol in the unpredictable chronic mild stress in mice. *Psychopharmacology (Berl)*. 200, 497–507. doi:10.1007/s00213-008-1227-3.
- Yalcin, I., Megat, S., Barthas, F., Waltisperger, E., Kremer, M., Salvat, E., and Barrot, M. (2014). The sciatic nerve cuffing model of neuropathic pain in mice. *J. Vis. Exp.*, 1–7. doi:10.3791/51608.
- Yalcin, I., Tessier, L.-H., Petit-Demoulière, N., Waltisperger, E., Hein, L., Freund-Mercier, M.-J., and Barrot, M. (2010). Chronic treatment with agonists of beta(2)-adrenergic receptors in neuropathic pain. *Exp. Neurol.* 221, 115–21. doi:10.1016/j.expneurol.2009.10.008.
- Zhang, X., Bao, L., Shi, T. J., Ju, G., Elde, R., and Hökfelt, T. (1998). Down-regulation of mu-opioid receptors in rat and monkey dorsal root ganglion neurons and spinal cord after peripheral axotomy. *Neuroscience* 82, 223–40.

Figure legends

Figure 1: Chronic Duloxetine or Formoterol treatment *per os* relieved neuropathic allodynia in double DOPeGFP MOPmCherry KI mice.

Following cuff implantation surgery, double KI animals have lowered paw withdrawal thresholds (PWT), displaying sustained mechanical allodynia. Four weeks after nerve injury, antidepressant (Duloxetine 60mg/kg/day) and β 2-mimetic (Formoterol 0.05mg/kg/day) or saccharin 0.2% control *per os* treatments started and were maintained for 4 weeks. The hindpaw mechanical threshold was tested using Von Frey calibrated filaments, for double KI male (A) and female (B) mice right (ipsilateral) hindpaws. Data from three separate experiments are expressed as means \pm SEM. Sham group (6 males and 11 females) and Cuff group (5 males and 10 females), cuff animals treated with Duloxetine comprised the Duloxetine group (4 males and 7 females), cuff-implanted animals treated with Formoterol (4 males and 7 females). One-Way ANOVA F(males)= 193.44, $p < 0.0001$; F(females)= 85.7, $p < 0.0001$; Duloxetine :Tukey HSD post-hoc test: Treatment day 19 vs Baseline: p(Males)=0.266; p(Females)=1.00; Formoterol : Tukey HSD post-hoc test: Treatment day 22 PWT vs Baseline p(Males)=0.873, p(Females)=0.531.

Figure 2: Effect of antidepressant or β -mimetic treatment on anxiodepressive symptoms

In the Splash Test, grooming was observed and time spent grooming was recorded over 5 minutes. Relative grooming time was expressed as percentage of total test time.

(A) Group effect was observed for Male double KI mice: Cuff animals (n= 13) spent significantly less time grooming compared to Sham animals (n= 5). Chronic Duloxetine (60mg/kg/day) did not reverse neuropathy-induced reduction of grooming time (n= 9). Animals treated with Formoterol (n= 9) presented grooming behaviours similar to Sham group (One-Way ANOVA F=5.623, $p=0.0296$ Newman-Keuls post-hoc: Sham vs Cuff $p=0.0212$ Sham vs Duloxetine $p=0.0210$ Sham vs Formoterol $p=0.78$).

(B) No significant difference of relative grooming time in Female double KI animals for treatment groups

Figure 3: Impact of neuropathy on the distribution of MOPmcherry expressing neurons

(A) Comparative cumulative distribution plot of MOPmCherry positive neurons for pooled Sham and Cuff groups. For each group, cross-sections areas are sorted from smallest to largest and ranks are assigned. Cumulative rank is calculated relative to total population. Cuff cumulative distribution curve (black), is shifted towards smaller cell cross-section areas compared to Sham (light grey) cumulative distribution. Sham distribution is very significantly different from Cuff group, non-parametric Kolmogorov-Smirnov distribution comparison test: $D=0.101615$, $p\text{-value}=5.93 \times 10^{-13}$.

(B) Categorical data plot of size distribution for DOPeGFP positive neuron cross-section areas in DOPeGFP mice from Sham and Cuff experimental groups. For each $100\mu\text{m}^2$ -wide area bin, the number of cells from the size category was counted, and the relative percentage of cells in individual bins was calculated, for all groups: Sham (white bars) and Cuff (black bars). Categorical data sets were compared using a non-parametric categorical distribution comparison: Pearson's X-squared = 61.85, $df = 14$, $p\text{-value}= 5.54 \times 10^{-8}$). Standardized Chi-Square Residuals are summarized in Table 1.

Figure 4 Size distribution of DOPeGFPMOPmCherry expressing neurons

(A) Comparative cumulative distribution plot of DOPeGFP+ MOPmCherry+ double positive neurons for pooled Sham and Cuff groups. For each group, cross-sections areas are sorted from smallest to largest and ranks are assigned. Cumulative rank is calculated relative to total population for each experimental group. Sham (light grey) and Cuff (black) and cumulative distribution curves are represented. Sham and Cuff overall populations are significantly different non-parametric Kolmogorov-Smirnov distribution comparison test: $D=0.21468$, $p\text{-value}=8.66 \times 10^{-6}$.

- (B) Categorical data plot of size distribution for DOPeGFP+ MOPmCherry+ double positive neuron cross-section areas in double KI mice from Sham and Cuff experimental groups. For each 100 μm^2 -wide area bin, the number of cells from the size category was counted, and the relative percentage of cells in individual bins was calculated, for all groups: Sham (white bars) and Cuff (black bars). Categorical data sets were compared using a non-parametric categorical distribution comparison: Pearson's X-Squared $X\text{-squared} = 31.59$, $df = 14$, $p\text{-value} = 0.0045$. Standardized Chi-Square Residuals are summarized in Table 2 and indicate that compared to Sham, there is a significant increase of large-sized neurons in Cuff group (900-1100 μm^2).
- (C) Representative fluorescence micrographs of DOPeGFP+ MOPmCherry+ DRG neurons. Top panel from left to right: NF200 (magenta), MOPmCherry non-amplified fluorescence (red), DOPeGFP (green), DAPI (blue), Merge. Bottom panel from left to right: IB4 (magenta), MOPmCherry non-amplified fluorescence (red), DOPeGFP (green), DAPI (blue), merge.

Figure 5: Schematic representation of DOPeGFP/MOPmCherry supraspinal co-expression in neuropathic animals.

(A) Abundant MOP-DOP neuronal co-localization was observed in the hind- and mid-brain under basal conditions (yellow cercles) (Erbs 2016). Additional MOP-DOP neuronal co-localization was detected in 8 weeks following cuff surgery (blue circles).

(B) MOP-DOP neuronal co-localization in the hind- and mid-brain is present in nociception-related pathways under basal conditions (black cercles) (Erbs 2016). Additional MOP-DOP neuronal co-localization is detected in these circuits 8 weeks following cuff surgery (blue circles).

Abbreviations :

7N: facial nucleus; 12N: hypoglossal nucleus; AHP: anterior hypothalamic area, posterior part; Amb: ambiguous nucleus; B (Meynert): basal nucleus; BSTIA: bed nucleus of the stria terminalis, intraamygdaloid division; Cu: cuneate nucleus; ; DpMe: deep mesencephalic nucleus; ; DTgC: dorsal tegmental nucleus, central part; GiA: gigantocellular reticular nucleus, alpha part; GiV: gigantocellular reticular nucleus, ventral part; GrC: granular layer of the cochlear nuclei; HPC: hippocampus; InG: intermediate grey layer of the superior colliculus; IRt: intermediate reticular nucleus; Lat: lateral (dentate) cerebellar nucleus; LC: locus coeruleus; LGP: lateral globus pallidus; LH: lateral hypothalamic area; LL: nucleus of the lateral lemniscus; LPB: lateral parabrachial nucleus; LPGi: lateral paragigantocellular nucleus; LRt: lateral reticular nucleus; LVPO: lateroventral periolivary nucleus; MdD: medullary reticular nucleus, dorsal part; MnR: median raphe nucleus; MPL: medial paralemniscal nucleus; medial tuberal nucleus; Mve: medial vestibular nucleus; MVeMC: medial vestibular

nucleus, magnocellular part; MVePC: medial vestibular nucleus, parvicellular part; MVPO: medioventral periolivary nucleus; Pa4: parathrochlear nucleus; PC5: parvicellular motor trigeminal nucleus; PCRtA: parvicellular reticular nucleus, alpha part; ; PH: posterior hypothalamic area; Pir: piriform cortex; PMnR: paramedian raphe nucleus; Pn: pontine nucleus; PnC: pontine reticular nucleus,caudal part; PnO: pontine reticular nucleus,oral part; PO: periolivary region; PPTg: pedunculopontine tegmental nucleus; Pr5: principal sensory trigeminal nucleus; ; PSTh: parasubthalamic nucleus; Reth: retroethmoid nucleus; RMC: red nucleus, magnocellular part; RPC: red nucleus, parvicellular part; RPF: retroparafascicular nucleus; RMg: raphe magnus; RPa: raphe pallidus; RPO: rostral periolivary region; RR: retrorubral nucleus; RtTg: reticulotegmental nucleus of the pons; RVL: rostroventrolateral reticular nucleus; Shi: septohippocampal nucleus; SNR: substantia nigra, reticular part; Sp5: spinal trigeminal nucleus, STh: subthalamic nucleus; SubB: subbrachial nucleus; SuMM: supramammillary nucleus, medial part; Tz: nucleus of the trapezoid body; VC: ventral cochlear nucleus; Ve: vestibular nucleus; VTA: ventral tegmental area

Supplementary Figure legends

Figure 1: Neuropathy decreases neuronal MOP-DOP co-expression in DRG neurons

(A) Percent of DOPeGFP-positive cells expressing MOPmcherry in the overall DRG neuronal population for Sham and Cuff animals. Percent of MOPmcherry-positive cells which express DOPeGFP in the overall population for Sham (n=3) and Cuff animals (n=4).

(B) Percent of DOPeGFP-positive cells expressing MOPmcherry in DRG neurons with areas $<300\mu\text{m}^2$ for Sham and Cuff animals. Percent of MOPmcherry-positive cells which express DOPeGFP in DRG neurons with areas $<300\mu\text{m}^2$ for Sham (n=3) and Cuff animals (n=4).

Figure 1

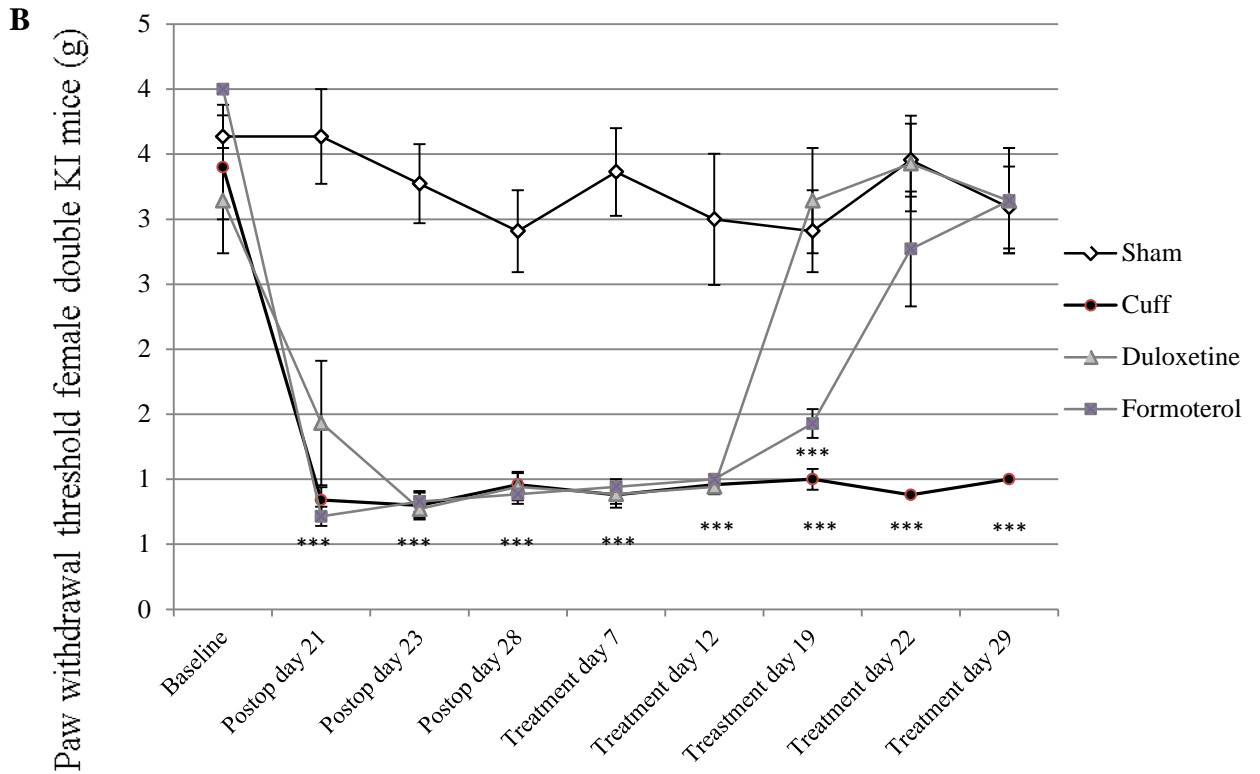
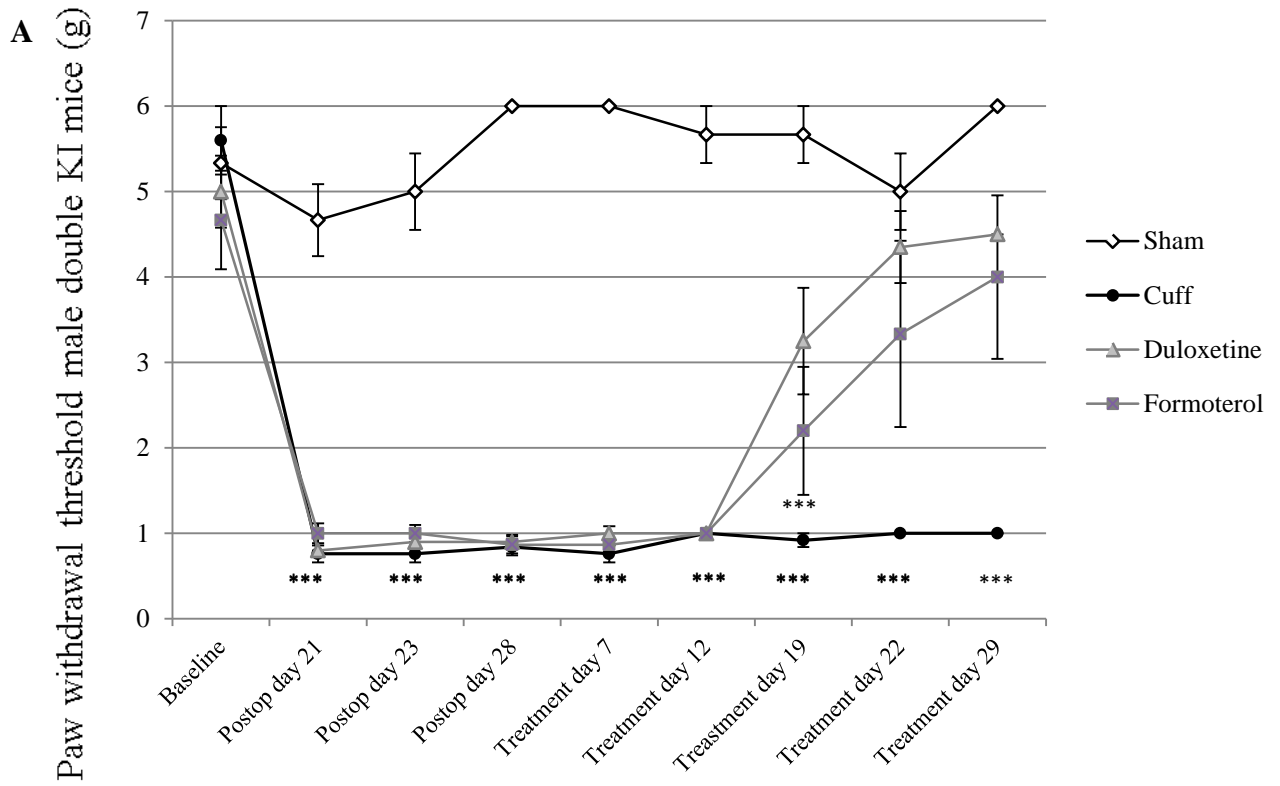

Figure 2

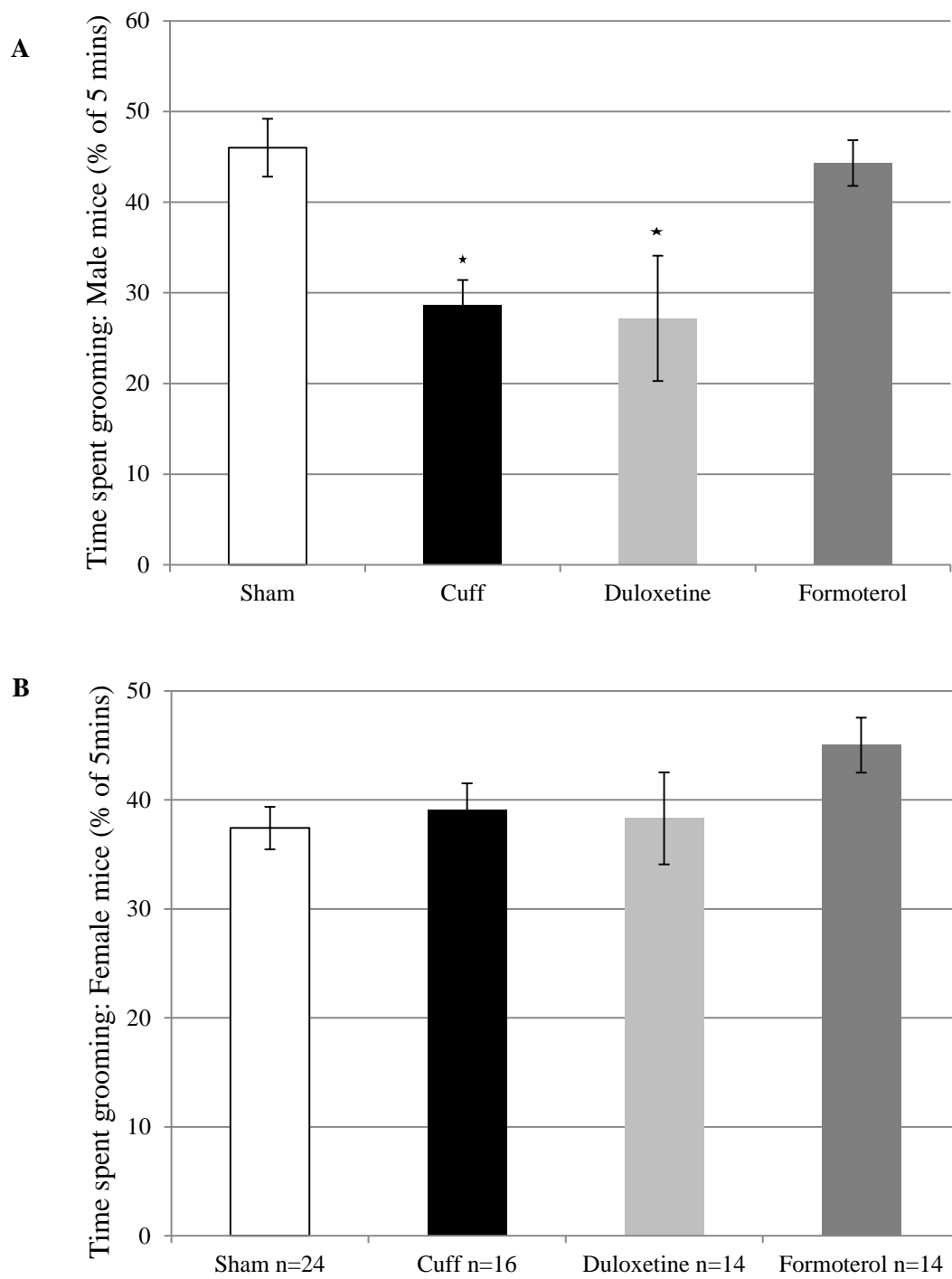

Figure 3

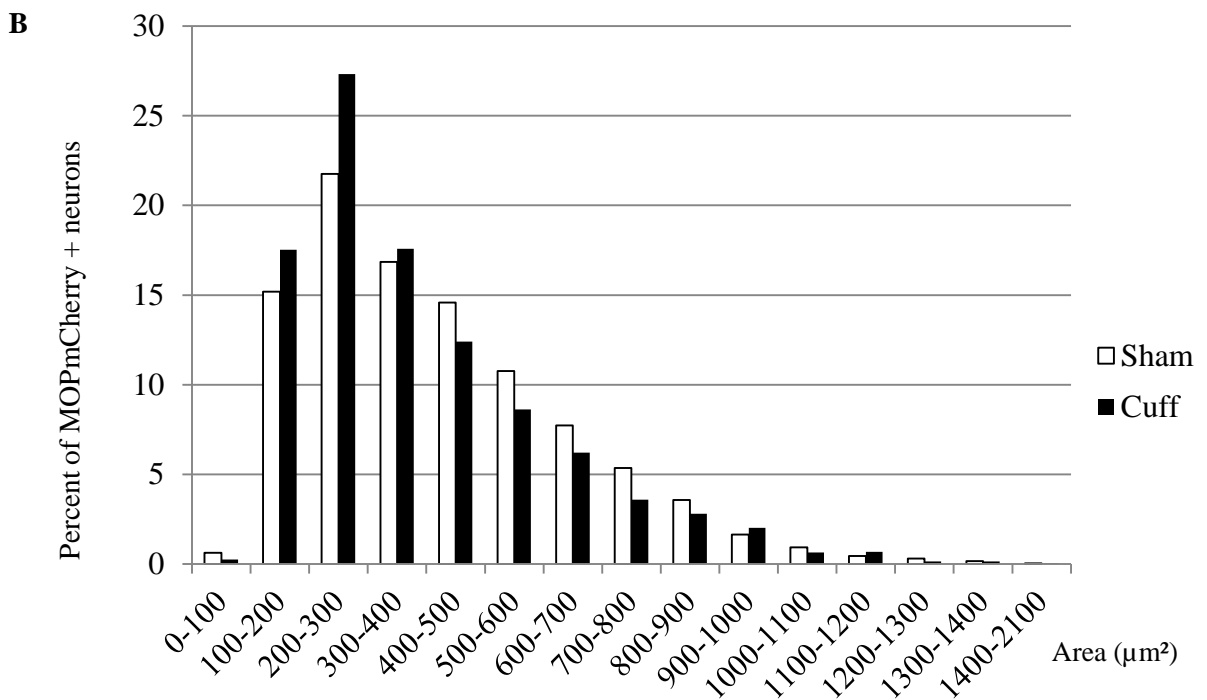
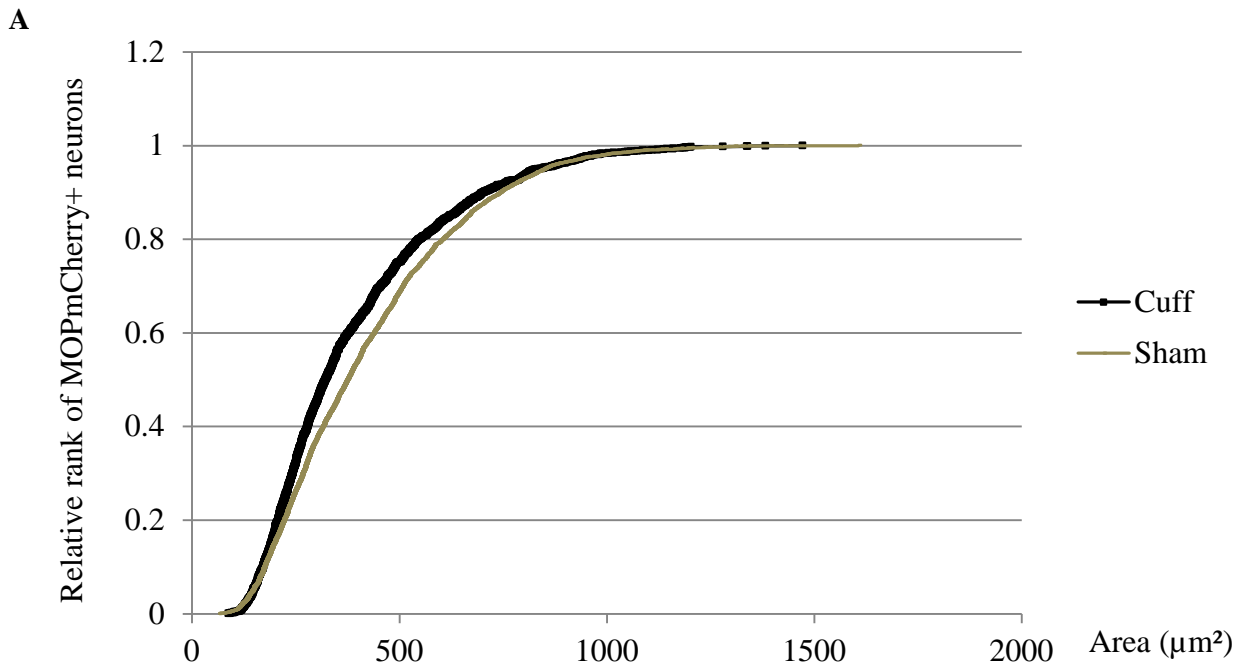
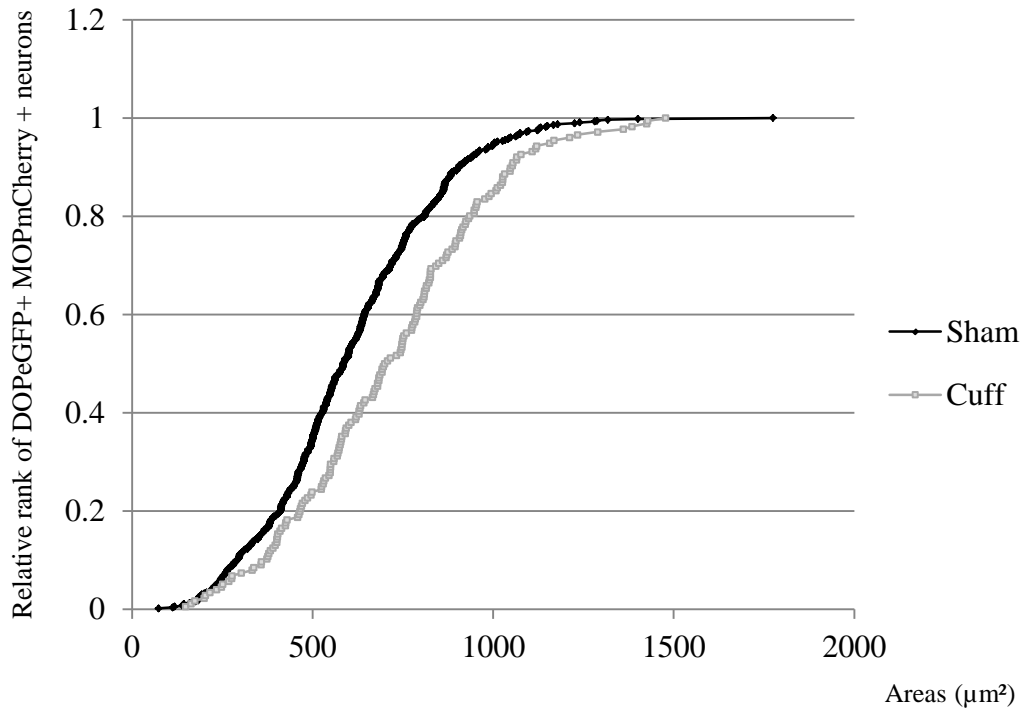

Figure 4

A



B

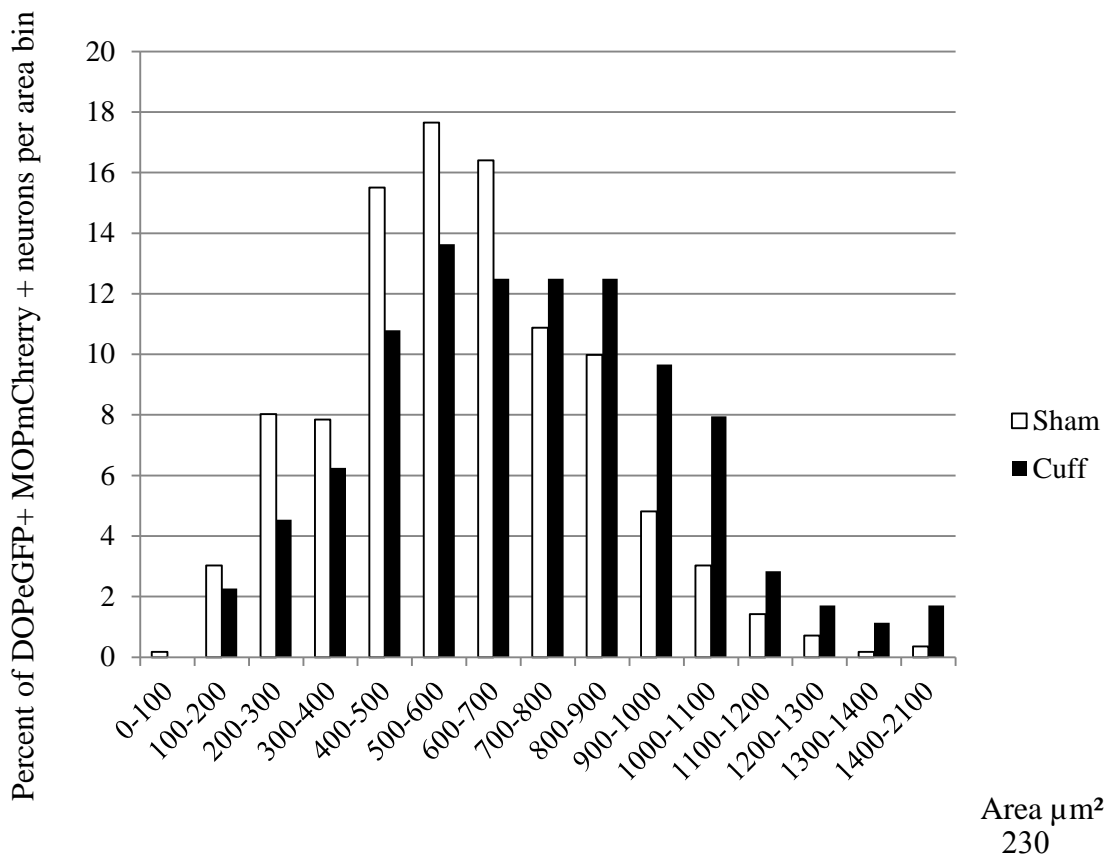

Figure 4 C

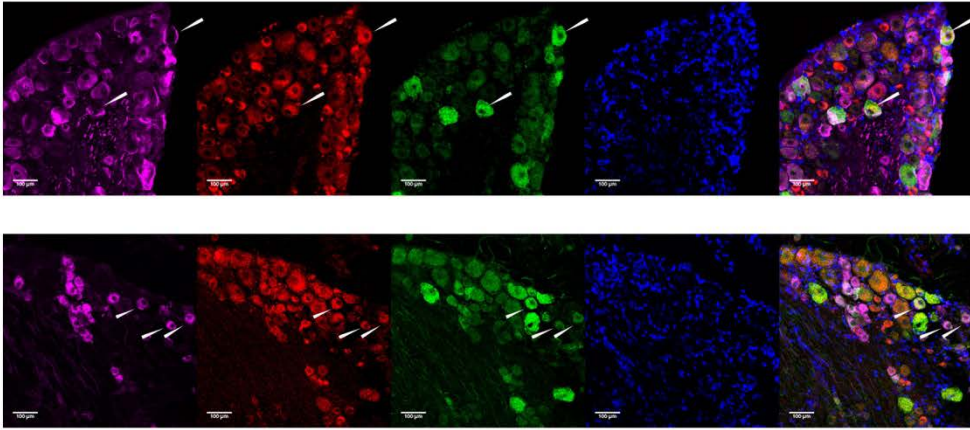
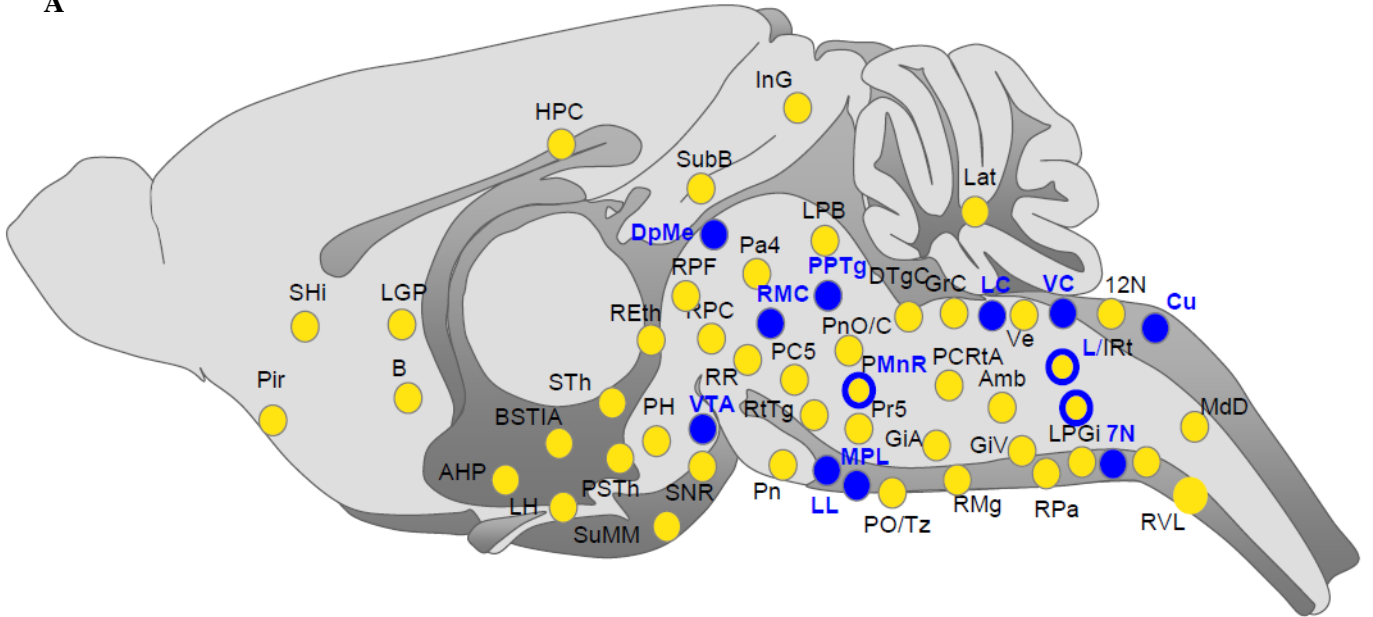
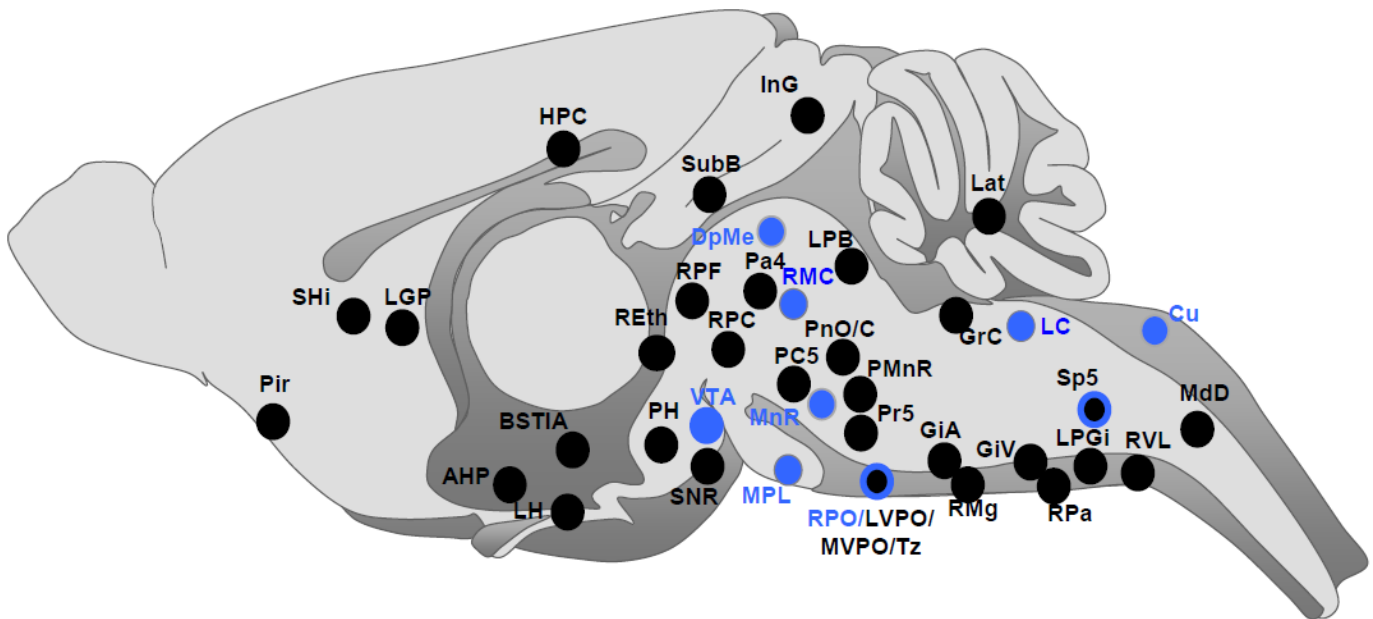

Figure 5

A



B



Supplementary Figure 1

A

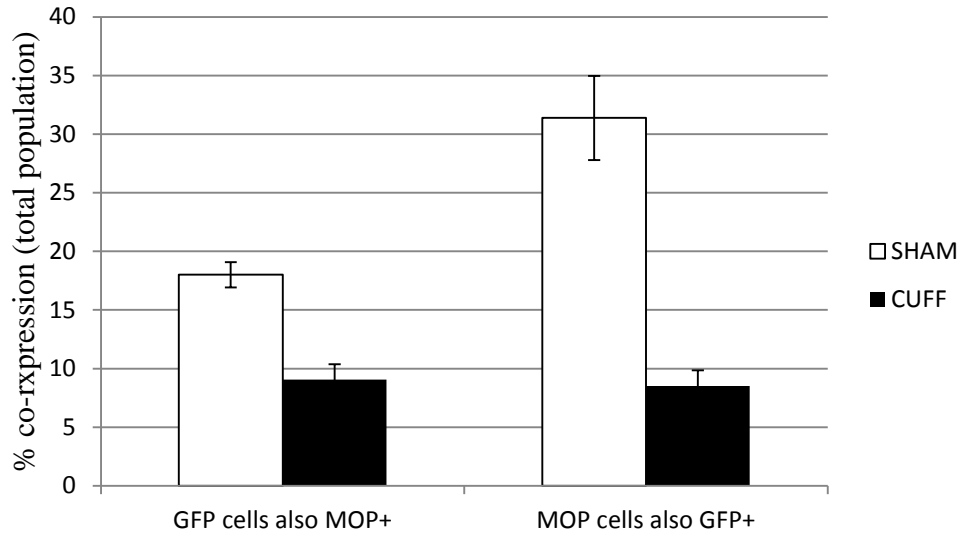

B

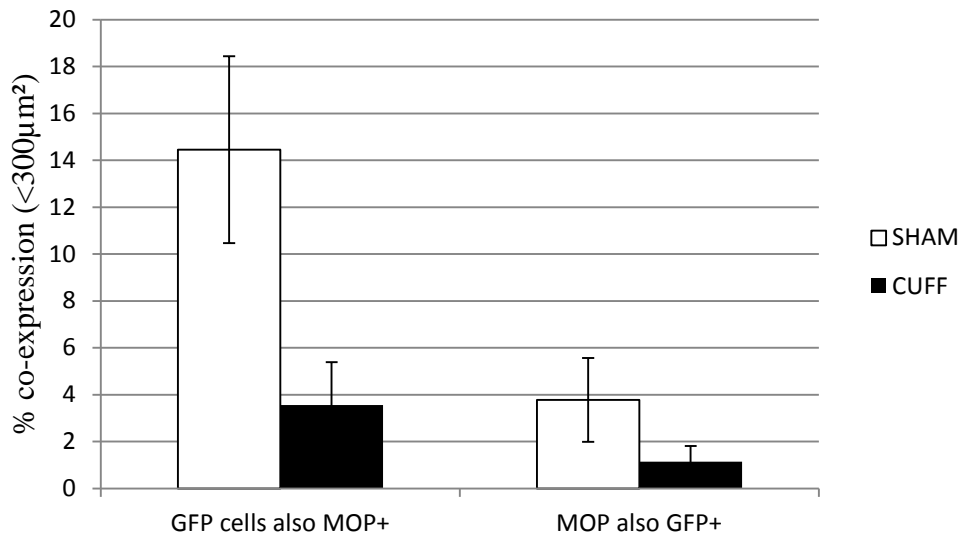

Supplementary Table 1: Distribution Analyses and Fit Models for MOPmCherry and colocalized DOPEGFP+MOPmCherry+ neurons for Sham and Cuff series

Group	Marker or population	N	Shapiro-Wilk normality test	Gaussian centre values	Residual Sum of Squares fit vs data (μm^2)
Sham	MOPmCherry+	4431	W = 0.92957, p-value < 2.2×10^{-16}	211.6 μm^2 377.9 μm^2 629.9 μm^2	0.04955
	DOPEGFP+ MOPmCherry+	2081	W = 0.98331, p-value = 4.936×10^{-6}	554.8 μm^2 952.6 μm^2	0.03163
Cuff	MOPmCherry+	516	W = 0.88599, p-value < 2.2×10^{-16}	220.4 μm^2 209.8 μm^2 649.7 μm^2	0,04769
	DOPEGFP+ MOPmCherry+	176	W = 0.98887, p-value = 0.1825	525.5 μm^2 861.5 μm^2 and 850.1 μm^2	0.01743

5. Chapter Three: The antiallodynic action of pregabalin in neuropathic pain is independent from the opioid system.

Kremer et al. 2016 (Published article).

1. Introduction

Neuropathic pain is a chronic debilitating syndrome, which occurs following metabolic, traumatic or chemically-induced nerve damage (Jensen et al., 2011). The development of neuropathic pain involves neural and immunological changes, the former result in central and peripheral sensitization (von Hehn et al., 2012), which increases pain signal transduction and the latter increase inflammatory mediators which maintain sensitization (Latremoliere and Woolf, 2009). Besides pain, patients suffering from neuropathic pain are also at risk of developing mood disorders. Long term pharmacotherapy of neuropathic pain is challenging (Bouhassira et al., 2008; Attal et al., 2008) , given the poor responsiveness rate and the development of tolerance to opiates, the most prescribed pain-killers. Among treatment options for neuropathic pain, gabapentinoids are proposed as anticonvulsant drugs which act by inhibiting excitatory calcium currents and in the clinic, reduce perception of painful stimuli (Finnerup et al., 2015). Certain aspects of pregabalin mechanism of action have not yet been described, such as the possible contribution of the opioid system to the antiallodynic effect.

Rodent models of neuropathic pain have provided valuable preclinical insight. Indeed, surgical or chemical nerve lesions can easily be induced (Yalcin et al., 2014), and given the availability of genetic manipulations in mice, the investigation of disease mechanisms or treatment effects are at hand. Almost a decade ago, previous work in the lab reported that the antinociceptive effects of antidepressants, widely used in chronic pain therapy, was dependent on peripheral delta opioid receptor populations, using mice in which delta opioid receptor was genetically inactivated (Benbouzid

et al., 2008b). A recent study confirmed the role of peripheral DOP receptors in analgesia for both inflammatory and neuropathic pain conditions (Gaveriaux-Ruff et al., 2011).

We sought to investigate the mechanism of action of acute and chronic doses of pregabalin, administered *per os* by using pharmacological and genetic approaches. Here, we show that pregabalin mechanisms of action, following acute or chronic administration, do not require the activity of opioid receptors, and that gabapentinoids decrease inflammatory mediators in the context of chronic antiallodynic treatment of neuropathic pain.

The antiallodynic action of pregabalin in neuropathic pain is independent from the opioid system

Molecular Pain
Volume 12: 1–12
© The Author(s) 2016
Reprints and permissions:
sagepub.co.uk/journalsPermissions.nav
DOI: 10.1177/1744806916633477
mpx.sagepub.com



Mélanie Kremer, MSc^{1,2}, Ipek Yalcin, PharmD, PhD¹, Laurent Nexon, PhD¹, Xavier Wurtz, MSc^{1,2}, Rhian Alice Ceredig, PharmD, MSc^{1,2}, Dorothée Daniel, BSc¹, Rachael Aredhel Hawkes, BSc^{1,2}, Eric Salvat, MD, PhD^{1,3*} and Michel Barrot, PhD^{1*}

Abstract

Background: Clinical management of neuropathic pain, which is pain arising as a consequence of a lesion or a disease affecting the somatosensory system, partly relies on the use of anticonvulsant drugs such as gabapentinoids. Therapeutic action of gabapentinoids such as gabapentin and pregabalin, which act by the inhibition of calcium currents through interaction with the $\alpha 2\delta$ -1 subunit of voltage-dependent calcium channels, is well documented. However, some aspects of the downstream mechanisms are still to be uncovered. Using behavioral, genetic, and pharmacological approaches, we tested whether opioid receptors are necessary for the antiallodynic action of acute and/or long-term pregabalin treatment in the specific context of neuropathic pain.

Results: Using the cuff model of neuropathic pain in mice, we show that acute pregabalin administration at high dose has a transitory antiallodynic action, while prolonged oral pregabalin treatment leads to sustained antiallodynic action, consistent with clinical observations. We show that pregabalin remains fully effective in μ -opioid receptor, in δ -opioid receptor and in κ -opioid receptor deficient mice, either female or male, and its antiallodynic action is not affected by acute naloxone. Our work also shows that long-term pregabalin treatment suppresses tumor necrosis factor- α overproduction induced by sciatic nerve constriction in the lumbar dorsal root ganglia.

Conclusions: We demonstrate that neither acute nor long-term antiallodynic effect of pregabalin in a context of neuropathic pain is mediated by the endogenous opioid system, which differs from opioid treatment of pain and antidepressant treatment of neuropathic pain. Our data are also supportive of an impact of gabapentinoid treatment on the neuroimmune aspect of neuropathic pain.

Keywords

pregabalin, neuropathic pain, mechanical allodynia, opioid system, tumor necrosis factor- α , μ -opioid, δ -opioid, κ -opioid

Date received: 20 January 2016; accepted: 22 January 2016

Background

Neuropathic pain is defined as a direct consequence of a lesion or disease affecting the somatosensory system.¹ It can result from a wide range of conditions including diabetes, nerve root compression, herpes zoster infection, cancer, stroke, thus affecting millions of persons worldwide. This complex syndrome involves maladaptive changes in injured sensory neurons and along the entire nociceptive pathway within the central nervous system.² The recommended pharmacotherapy for neuropathic pain includes the use of anticonvulsant drugs, such as the gabapentinoids, pregabalin, and gabapentin.³

¹Institut des Neurosciences Cellulaires et Intégratives, Centre National de la Recherche Scientifique, Strasbourg, France

²Université de Strasbourg, Strasbourg, France

³Centre d'Etude et de Traitement de la Douleur, Hôpitaux Universitaires de Strasbourg, Strasbourg, France

*These authors contributed equally.

Corresponding author:

Michel Barrot, Institut des Neurosciences Cellulaires et Intégratives, 5 rue Blaise Pascal, 67084 Strasbourg, France.
Email: mbarrot@inci-cnrs.unistra.fr



Despite their structural similarity to the inhibitory transmitter γ -aminobutyric acid (GABA), neither gabapentin nor pregabalin binds to GABA_A or GABA_B receptors or interact with GABA uptake transporters.^{4,5} Their therapeutic effect is mediated through binding to the $\alpha\delta$ -1 subunit of voltage-dependent calcium channels (VDCCs).^{6,7} The interaction between gabapentinoids and the $\alpha\delta$ -1 subunit inhibits calcium currents, thus decreasing excitatory transmitter release.⁵ This subunit also plays a role in trafficking VDCC complexes to cell surface⁸ and in synaptogenesis, and these functions are blocked by gabapentin.⁹

The opioid system is involved in the action of different pain medications. This implication concerns on one hand the direct analgesic action of opioids targeting the μ -opioid (MOP) receptor¹⁰ and on the other hand the indirect requirement of opioid receptors for the action of antidepressants against neuropathic pain.^{11–13} During the past decade, it has been preclinically and clinically proposed that gabapentinoids and opioid drugs can have a synergistic action in neuropathic pain.^{14–17} However, this does not mean that gabapentinoids require the endogenous opioid system. A potential role of the opioid system has been recently suggested in the central, acute, analgesic effect of a high dose of pregabalin in the tail flick test in naive mice,¹⁸ and in the antinociceptive response induced by acute gabapentin in a model of acute inflammatory pain, the orofacial formalin test in mice.¹⁹ On the contrary, previous pharmacological studies reported no effect of opioid antagonists on gabapentinoid action.^{20–22} For example, naloxone do not block acute pregabalin action on abdominal contractions in the lipopolysaccharide (LPS)-induced rectal hypersensitivity model of visceral pain,²¹ and naloxone do not block acute gabapentin action in the formalin test, a model of inflammatory pain.²² However, these studies did not really model the specific clinical use of gabapentinoids, i.e. in a neuropathic pain context, and did not either address the consequences of a long-term treatment.

Gabapentinoids have also been proposed to act on inflammatory mechanisms. Gabapentin may, for example, decrease the expression of pro-inflammatory cytokines,^{16,23,24} this action has been associated with an upregulation of the anti-inflammatory cytokine interleukin (IL)-10.²⁴ Interestingly, experimental evidence supports a role of glial and/or immune cells in the pathophysiology of neuropathic pain, particularly through the recruitment of cytokines.²⁵ In sustained neuropathic pain, some pro-inflammatory cytokines such as tumor necrosis factor α (TNF- α) still display enhanced expression,^{26–29} and blocking TNF- α has been preclinically postulated to relieve neuropathic pain symptoms.^{26,30} It is, however, not known whether the expression of TNF- α is also targeted by pregabalin in a context of neuropathic pain.

In the present study, we used both genetic and pharmacological approaches to evaluate whether opioid receptors are critical for the antiallodynic action of acute and/or long-term pregabalin treatment. We demonstrate that neither the acute nor the long-term antiallodynic effect of pregabalin requires the endogenous opioid system. We also show that long-term pregabalin treatment inhibits the neuropathy-induced TNF- α overproduction in dorsal root ganglia (DRG).

Methods

Animals

Experiments were performed using male C57BL/6J mice (Charles River, L'Arbresle, France) with ages between 8 and 10 weeks at surgery time, or with mice lacking μ -opioid (MOP), δ -opioid (DOP), or κ -opioid (KOP) receptors and their littermate controls. The generation of mice lacking MOP, DOP, or KOP receptors has been previously described.^{31–33} All mice were under a C57BL/6J background for over 10 generations. Heterozygote mice were bred in our animal facilities (breeders were kindly provided by Pr Kieffer and Pr Gavériaux-Ruff), genotyping of the litters was done, and the experiments were conducted on adult male and female wild type and knockout littermate mice weighing 20–30 g. We used the same number of males and females in each experimental group. As the wild type animals have the same background and the same behavior, they were pooled to form the control groups. Mice were group housed two to five per cage and kept under a 12 hr light/dark cycle with food and water *ad libitum*. A total of 104 C57BL/6J mice, 43 MOP-related, 43 DOP-related, and 43 KOP-related transgenic mice were used for the experiments. All animals received proper care in agreement with European guidelines (EU 2010/63). At the end of the experiments, mice were killed by cervical dislocation for immunoblot experiments, or by CO₂ inhalation (CO₂ Euthanasia programmer 6.5 version, TEMSEGA, Pessac, France) followed by cervical dislocation for other experiments, according to the institutional ethical guidelines. The animal facilities Chronobiotron UMS3415 are registered for animal experimentation under the Animal House Agreement A67-2018-38. All protocols were approved by the “Comité d’Ethique en Matière d’Expérimentation Animale de Strasbourg” (CREMEAS, CEEA35).

Model of neuropathic pain

Neuropathic pain was induced by cuffing the main branch of the right sciatic nerve.^{34,35} Surgeries were performed under ketamine (68 mg/kg)/xylazine (10 mg/kg)

intraperitoneal (i.p.) anesthesia (Centravet, Tadden, France). The common branch of the right sciatic nerve was exposed and a cuff of PE-20 polyethylene tubing (Harvard Apparatus, Les Ulis, France) of standardized length (2 mm) was unilaterally inserted around it (Cuff group). The shaved skin was closed using suture. Sham-operated mice underwent the same surgical procedure without implantation of the cuff (Sham group).

Measure of mechanical allodynia

Mechanical allodynia was tested using von Frey hairs, and results were expressed in grams. Tests were done during the morning, starting at least 2 hr after lights on. Mice were placed in clear Plexiglas boxes (7 cm × 9 cm × 7 cm) on an elevated mesh screen. Calibrated von Frey filaments (Bioseb, Vitrolles, France) were applied to the plantar surface of each hind-paw until they just bent, in a series of ascending forces up to the mechanical threshold. Filaments were tested five times per paw, and the paw withdrawal threshold (PWT) was defined as the lower of two consecutive filaments for which three or more withdrawals out of the five trials were observed.^{35–37} The person who conducted the tests was blinded to the treatments.

Treatment procedures

The long-term treatment with pregabalin began two weeks after the surgical procedure (cuff implantation or sham surgery). Pregabalin (Lyrica[®], Pfizer, Sandwich, UK), 300, 100, 50, or 5 µg/mL, was delivered per os through the drinking water with ad libitum access as sole source of fluid. This anticonvulsant drug was dissolved in water with 0.02% saccharin to increase palatability, and control mice were given a solution of 0.02% saccharin in water (vehicle solution). For acute administration, pregabalin was dissolved in 0.9% NaCl and administered intraperitoneally (30 mg/kg, 5 mL/kg). The injection of naloxone hydrochloride (Sigma-Aldrich, St. Quentin Fallavier, France), a competitive non selective MOP, DOP, and KOP receptors antagonist at high dose, was performed 25 days after surgery, i.e. after 11 days of pregabalin treatment; or 30 min after the acute administration of pregabalin. Naloxone hydrochloride was dissolved in 0.9% NaCl and administered subcutaneously (s.c., 1 mg/kg, 5 mL/kg). Long-term and acute treatment experiments were conducted on independent sets of mice.

Immunoblot analysis

In a separate experiment, DRG were collected from Sham-vehicle, Cuff-vehicle, and Cuff-pregabalin (300 µg/mL) group after two weeks of oral treatment.

Mice were killed by cervical dislocation, the back was dissected, and a midline incision was done in the lumbar vertebrae to extract the L4, L5, and L6 DRG ipsilateral to the surgery. The three DRG were pooled per animal, quickly frozen, and stored at -80°C until protein extraction.

Total proteins were extracted in 150 µL lysis buffer (20 mM Tris pH 7.5; 150 mM NaCl; 10% glycerol; 1% NP-40; Protease Inhibitors Cocktail, Roche), quantitated with Bio-Rad Protein Assay Dye Reagent Concentrate and stored in Laemmli buffer (2% sodium dodecyl sulfate (SDS); 25% glycerol; 0.01% bromophenol blue; 0.125 M Tris pH 6.8); 10 µg of total protein from individual animals was resolved by 12% SDS-polyacrylamide gel electrophoresis under reducing conditions, and then transferred to polyvinylidene fluoride (PVDF) membrane (Immobilon, transfer membranes, Millipore, IPVH00010). The blots were incubated for 1 h in blocking agent (ECL kit, Amersham Biosciences), overnight with the antibodies specific for either TNF- α (1:500, R&D Systems, AF-410-NA) or β -tubulin (1:50,000, Abcam, ab108342), followed by rabbit anti-goat horseradish peroxidase (HRP)-conjugated secondary antibodies (1:12,000, Abcam, ab97100) or goat anti-rabbit HRP-conjugated secondary antibodies (1:10,000, Millipore, AP307P), respectively. Blots were revealed by chemiluminescence (ECL Prime Western Blotting Detection Reagent, Amersham Biosciences, RPN 2232) using Hyperfilm substrates (Amersham Biosciences, RPN 1674K). Relative protein expression was determined using the densitometry tool of Adobe Photoshop CS5 software. The bands were evaluated in grayscale, subtracting the background value, and the TNF- α / β -tubulin ratio was calculated for each sample.

Statistical analysis

Mechanical thresholds measured with the von Frey test provide discrete values corresponding to filaments' values, thus limiting the relevance of classical parametric multi-factor analysis of variance (ANOVA). An ANOVA-type multiple-factor nonparametric methodology for longitudinal data, which can take into account both within and between factors, has recently been developed³⁸ as a package (nparLD) for R (version 3.2.1). We used the nparLD function to analyze the effects of time, side (left vs. right paw), sex (male vs. female), and of treatment (e.g. surgery and/or drug dose). The asymptotic ANOVA-type statistic (ATS) is provided as $\text{ATS}_{(d.f.)}$, with its adjusted degrees of freedom (d.f.) and p value. Multiple comparisons between groups at a given time point were performed with the two-sample Wilcoxon test, with the corresponding Bonferroni adjustment. The Wilcoxon test was also used for

comparison of the mechanical sensitivity thresholds between males and females. Immunoblotting experiments were analyzed with the nonparametric Kruskal–Wallis test, followed by multiple comparisons with the Wilcoxon test. The significance level was set at $p < 0.05$. Data were represented as mean \pm SEM.

Results

Antiallodynic action of chronic oral pregabalin: Dose response

The mechanical sensitivity of the C57BL/6J mice was assessed using von Frey hairs. Although sham surgery did not influence mechanical thresholds (Figure 1(a) and (b)), cuff implantation induced an ipsilateral mechanical allodynia (Figure 1(a); surgery \times time interaction, $ATS_{(2,9)} = 3.9$, $p < 0.005$ on postsurgery days 1–19). We did not observe any change in the nociceptive threshold of the left paw, contralateral to the cuff implantation; 19 days after surgery, we started treatment with different doses of pregabalin (300, 100, 50, or 5 $\mu\text{g}/\text{mL}$) or with vehicle solution (0.02% saccharin). Pregabalin treatment at doses 100 and 300 $\mu\text{g}/\text{mL}$ alleviated the cuff-induced allodynia after about three days of treatment (Figure 1(a); group \times time interaction, $ATS_{(13,9)} = 2.8$, $p < 0.001$; multiple comparisons: “Cuff Vehicle” $<$ “Cuff Pregabalin 100 $\mu\text{g}/\text{mL}$ and Pregabalin 300 $\mu\text{g}/\text{mL}$ ” at $p < 0.05$ on postsurgery days 22–40). A partial antiallodynic effect was also present with the 50 $\mu\text{g}/\text{mL}$ dose of pregabalin after eight days of treatment (Figure 1(a); multiple comparisons: “Cuff Vehicle” $<$ “Cuff Pregabalin 50 $\mu\text{g}/\text{mL}$ ” $<$ “Sham Vehicle” at $p < 0.05$ on postsurgery days 27–40). Treatments at different doses did not affect the contralateral nociceptive thresholds (Figure 1(a)). The 5 $\mu\text{g}/\text{mL}$ dose of pregabalin had no significant effect (Figure 1(a)).

Chronic oral treatment with pregabalin at 300 $\mu\text{g}/\text{mL}$ suppressed cuff-induced allodynia (Figure 1(a)), but it did not affect mechanical thresholds of mice of the Sham group (Figure 1(b)).

The drinking bottles were regularly weighed during the experiment. Considering the volume of solution drank by the mice per 24 h, the 5 $\mu\text{g}/\text{mL}$ solution was equivalent to 0.78 ± 0.05 mg/kg/day, the 50 $\mu\text{g}/\text{mL}$ solution was equivalent to 8.09 ± 0.38 mg/kg/day, the 100 $\mu\text{g}/\text{mL}$ solution was equivalent to 15.64 ± 0.65 mg/kg/day, and the 300 $\mu\text{g}/\text{mL}$ solution was equivalent to 44.63 ± 1.39 mg/kg/day (Figure 1(c)). These amounts were in fact mostly taken over the 12 h night period, period during which mice usually drink.

Body weights of mice treated chronically with different doses of pregabalin or vehicle were also assessed throughout the experiment. Cuff animals showed a difference in weight gain in the days following the surgery

compared to Sham animals. This difference persisted in Cuff mice treated with vehicle or pregabalin at doses of 5 and 50 $\mu\text{g}/\text{mL}$. Pregabalin treatment at doses of 100 and 300 $\mu\text{g}/\text{mL}$, which relieved neuropathic allodynia, reversed this deficit in weight gain (Figure 1(d); group \times time interaction, $ATS_{(11,2)} = 6.2$, $p < 0.001$; multiple comparisons: “Cuff Vehicle, Pregabalin 5 $\mu\text{g}/\text{mL}$ and Pregabalin 50 $\mu\text{g}/\text{mL}$ ” $<$ “Sham Vehicle” at $p < 0.05$ on postsurgery days 7–40, “Cuff Pregabalin 100 $\mu\text{g}/\text{mL}$ and Pregabalin 300 $\mu\text{g}/\text{mL}$ ” $<$ “Sham Vehicle” at $p < 0.01$ on postsurgery days 7–19 and “Cuff Vehicle” $<$ “Cuff Pregabalin 100 $\mu\text{g}/\text{mL}$ and Pregabalin 300 $\mu\text{g}/\text{mL}$ ” at $p < 0.01$ on postsurgery days 25–40).

Response to pregabalin: Male/female comparison in wild-type mice

Mechanical sensitivity thresholds of female mice were significantly lower than in males (baseline threshold values of paws are equal to $4.67 \text{ g} \pm 0.19$ for males and $3.28 \text{ g} \pm 0.13$ for females, male vs. female: $W = 79.5$, $p < 0.001$). Both male and female mice developed mechanical allodynia after cuff implantation and pregabalin treatment suppressed the cuff-induced allodynia in both sexes (Figure 2(a); Male mice: group \times time interaction, $ATS_{(6,1)} = 7.5$, $p < 0.001$; multiple comparisons: “Cuff Vehicle” $<$ “Sham Vehicle” at $p < 0.05$ on treatment days 0–12 and “Cuff Vehicle” $<$ “Cuff Pregabalin 300 $\mu\text{g}/\text{mL}$ ” at $p < 0.05$ on treatment days 9–12; Female mice: group \times time interaction, $ATS_{(5,9)} = 5.1$, $p < 0.001$; multiple comparisons: “Cuff Vehicle” $<$ “Sham Vehicle” at $p < 0.05$ on treatment days 0–12 and “Cuff Vehicle” $<$ “Cuff Pregabalin 300 $\mu\text{g}/\text{mL}$ ” at $p < 0.05$ on treatment days 9–12).

Chronic oral pregabalin treatment in opioid receptor deficient mice

The MOP, DOP, or KOP receptors-deficient mice displayed baselines for mechanical sensitivity that were similar to the wild-type littermates (Figure 2(b)). We controlled in our facilities that morphine has no more action in MOP-deficient mice.³⁶ Two weeks after surgery, we started the oral treatment with either pregabalin (300 $\mu\text{g}/\text{mL}$) or vehicle (0.02% saccharin) solutions. Pregabalin treatment alleviated cuff-induced allodynia in wild-type mice (Figure 2(b); group \times time interaction, $ATS_{(6,9)} = 13.1$, $p < 0.001$; multiple comparisons: “Cuff Vehicle” $<$ “Cuff Pregabalin” at $p < 0.05$ on treatment days 9–12). The same antiallodynic effect was also present in MOP receptors (Figure 2(c); group \times time interaction, $ATS_{(5,2)} = 10.4$, $p < 0.001$; multiple comparisons: “Cuff Vehicle” $<$ “Cuff Pregabalin” at $p < 0.05$ on treatment days 9–12), DOP receptors (Figure 2(c); group \times time interaction, $ATS_{(7,1)} = 8.8$, $p < 0.001$;

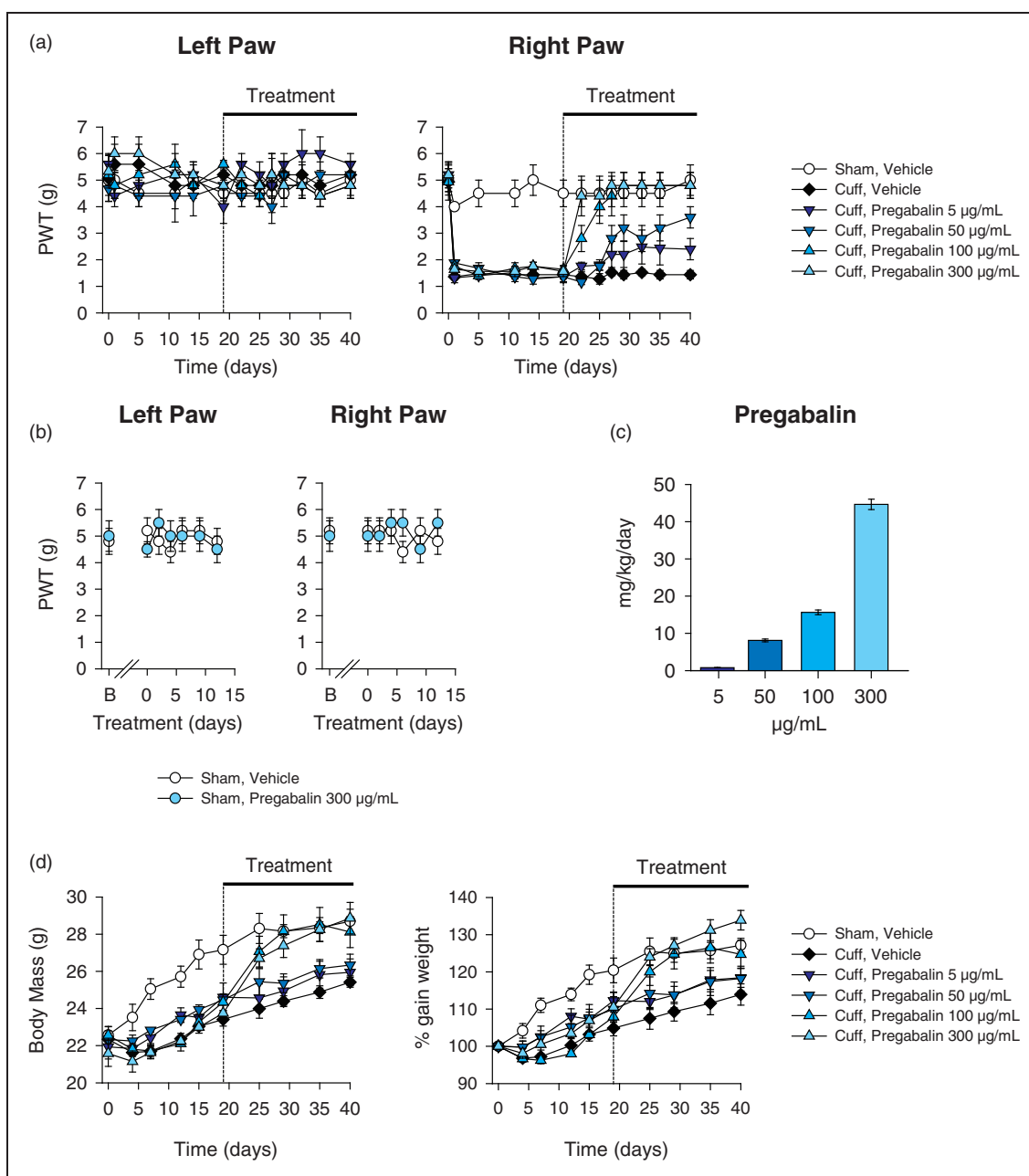

Figure 1. Chronic pregabalin treatment. (a) Two weeks after unilateral cuff insertion around the right sciatic nerve, chronic oral treatment with pregabalin started and lasted three weeks. The animals ($n = 5$ per each group) freely drink pregabalin (5, 50, 100, or 300 µg/mL) with 0.02% saccharin, or vehicle composed of 0.02% saccharin in water, as sole source of fluid. Mechanical PWT were evaluated at indicated time points using von Frey filaments. Vehicle treatment did not affect mechanical sensitivity of either Sham or Cuff mice. Pregabalin treatment was ineffective at dose 5 µg/mL, partially effective at dose 50 µg/mL, and reversed the cuff-induced allodynia at doses 100 and 300 µg/mL. (b) Pregabalin treatment at dose 300 µg/mL had no effect *per se* on sham-operated mice. (c) Histogram showing the equivalence between µg/mL and mg/kg/day of the different doses. (d) Time course of changes in the body weight of the animals throughout the experiment. Data are expressed as mean \pm SEM.

multiple comparisons: “Cuff Vehicle” < “Cuff Pregabalin” at $p < 0.05$ on treatment days 9–12), and KOP receptors-deficient mice (Figure 2(c); group \times time interaction, $ATS_{(5,5)} = 8.4$, $p < 0.001$; multiple

comparisons: “Cuff Vehicle” < “Cuff Pregabalin” at $p < 0.05$ on treatment days 9–12). Thus, pregabalin suppressed cuff-induced allodynia independently of the presence or no of the opioid receptors.

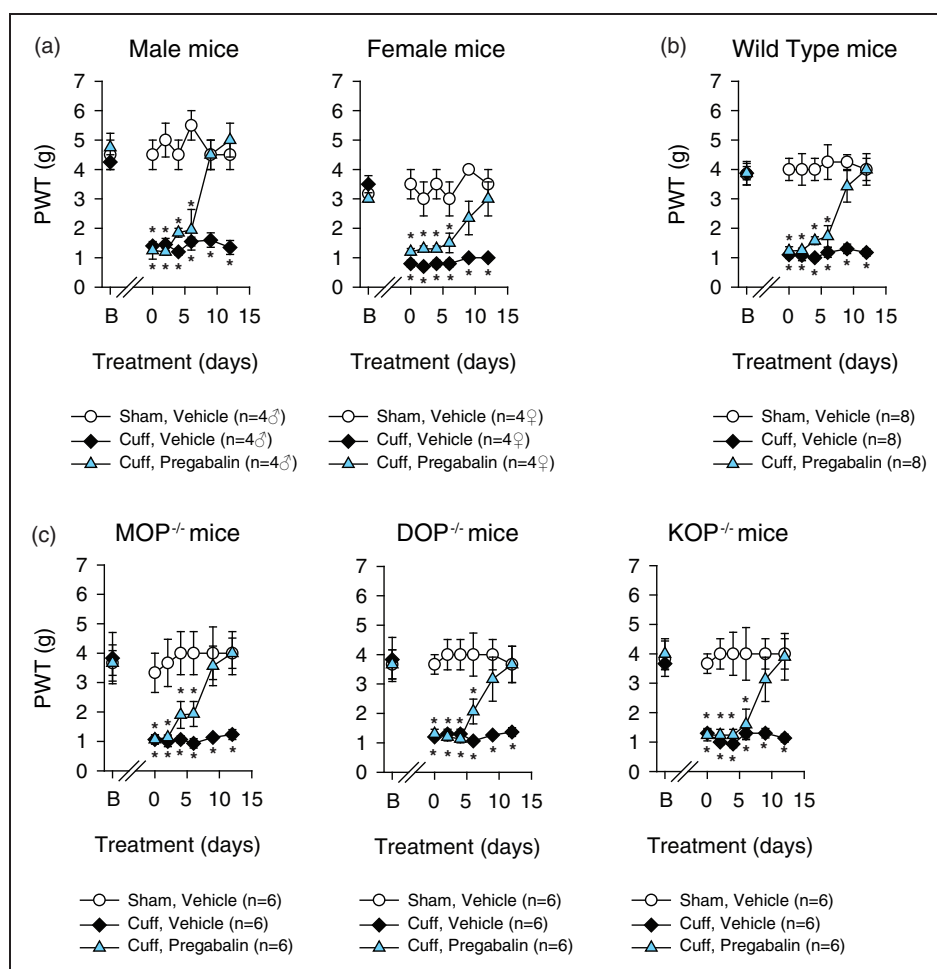

Figure 2. Effect of chronic oral pregabalin in opioid receptor deficient mice. Pregabalin treatment (300 $\mu\text{g}/\text{mL}$ i.e. 44.63 $\text{mg}/\text{kg}/\text{day}$ in the drinking water, with 0.02% saccharin) or control treatment (0.02% saccharin) started two weeks following surgery and lasted 12 days. Mechanical allodynia was tested using von Frey hairs. (a) The mechanical sensitivity threshold (PWT) of female mice is lower than that of male mice. However, both sexes developed mechanical allodynia similarly and pregabalin was effective in reversing the cuff-induced allodynia in both male and female mice. Males and females were then pooled in each experimental group. (b) Chronic pregabalin treatment abolishes the ipsilateral cuff-induced allodynia in wild type mice, as well as in MOP, DOP, or KOP receptors-deficient mice (c). (Data are pooled from three independent experiments, each final group includes the same number of male and female mice, $*p < 0.05$ as compared with Sham-operated control group drinking vehicle). Data are expressed as mean \pm SEM.

Naloxone effect on long lasting pregabalin treatment

We tested the consequence of an acute injection of the opioid receptor antagonist naloxone (1 mg/kg , s.c.) on the antiallodynic action of pregabalin in C57BL/6 J male mice. After 10 days of oral treatment with pregabalin or vehicle (Figure 3(a); group \times time interaction, $\text{ATS}_{(11,1)} = 9.3$, $p < 0.001$; multiple comparisons: “Cuff Vehicle” $<$ “Cuff Pregabalin” at $p < 0.005$ on postsurgery days 19 to 24 and “Cuff Pregabalin” = (“Sham Pregabalin” or “Sham Vehicle”) at $p = 1.0$ on postsurgery days 22 and 24), acute injection of naloxone did not suppress the antiallodynic effect of chronic pregabalin treatment (Figure 3(c)). We also observed that naloxone

per se had no effect in mice with Sham surgery or in mice that received vehicle alone (Figure 3(b)).

Transitory relief of neuropathic allodynia by acute pregabalin

In wild-type mice, an acute injection of pregabalin at a high dose (30 mg/kg , i.p.) had a transitory antiallodynic effect in Cuff mice, without affecting Sham animals (Figure 4; group \times time interaction, $\text{ATS}_{(2,7)} = 12.3$, $p < 0.001$; multiple comparisons: “Cuff Pregabalin” = “Sham Pregabalin” at $p > 0.7$ on post-administration time 60 min and “Cuff Pregabalin” $<$ “Sham Pregabalin” at $p < 0.001$ on post-administration time

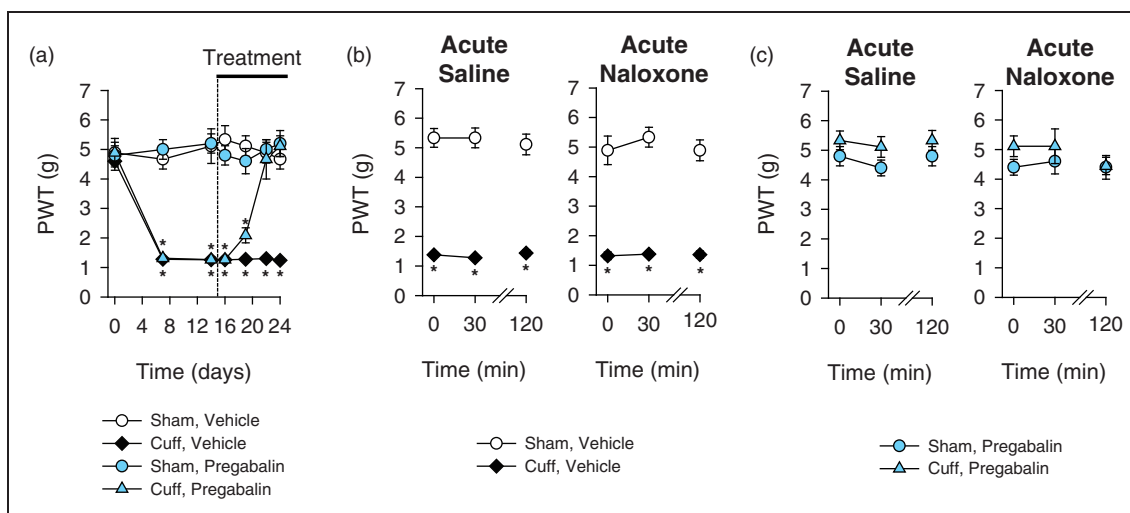

Figure 3. Acute opioid receptor antagonist in chronic pregabalin treatment. (a) Two weeks after unilateral cuff insertion, the oral treatment with pregabalin, or vehicle control started. Mechanical threshold of hindpaw withdrawal (PWT) was evaluated using von Frey filaments. Pregabalin treatment suppressed the cuff-induced allodynia. (b, c) After at least 10 days of pregabalin (300 µg/mL i.e 44.63 mg/kg/day, 0.02% saccharin) or vehicle treatment, the animals received an injection of the opioid receptor antagonist naloxone (1 mg/kg, s.c.) or the control saline solution. Mechanical threshold for hindpaw withdrawal was measured before 30 and 120 minutes after injection. No effect of naloxone or saline was seen in Sham mice or in pregabalin-treated neuropathic animals ($n = 9-10$, $*p < 0.005$ compared to the Sham-operated control group). Data are expressed as mean \pm SEM.

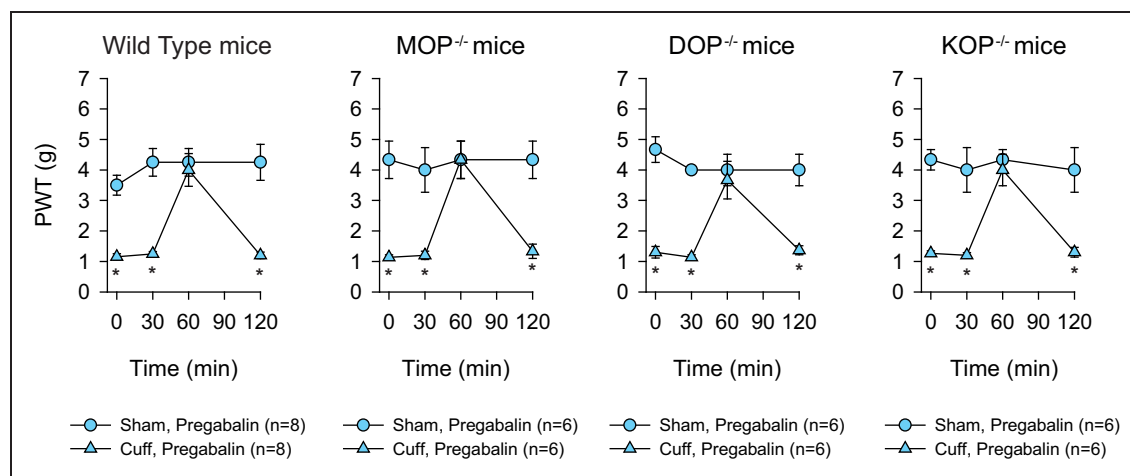

Figure 4. Effect of acute pregabalin in opioid receptor-deficient mice. Two weeks after cuff implantation, the animals received an acute injection of saline (i.p.) or of pregabalin (30 mg/kg, i.p.). Nociceptive mechanical threshold (PWT) was tested before (0 min) 30, 60, and 120 min after these acute injections. Acute pregabalin had a transitory antiallodynic effect in wild type Cuff mice without affecting Sham animals. Similar results were obtained in MOP, DOP, and KOP receptors-deficient mice. (Number of animals are given between brackets, data are pooled from three independent experiments, each final group includes the same number of male and female mice, $*p < 0.005$ compared to Sham-operated controls receiving pregabalin.) Data are expressed as mean \pm SEM.

0, 30, and 120 min). The same transitory effect was also present in MOP receptors (Figure 4; group \times time interaction, $ATS_{(1..6)} = 11.1$, $p < 0.001$; multiple comparisons: “Cuff Pregabalin” = “Sham Pregabalin” at $p = 1.0$ on post-administration time 60 min and “Cuff Pregabalin” < “Sham Pregabalin” at $p < 0.01$ on post-administration

time 0, 30, and 120 min), DOP receptors (Figure 4; group \times time interaction, $ATS_{(2..2)} = 12.7$, $p < 0.001$; multiple comparisons: “Cuff Pregabalin” = “Sham Pregabalin” at $p > 0.7$ on post-administration time 60 min and “Cuff Pregabalin” < “Sham Pregabalin” at $p < 0.01$ on post-administration time 0, 30, and 120 min),

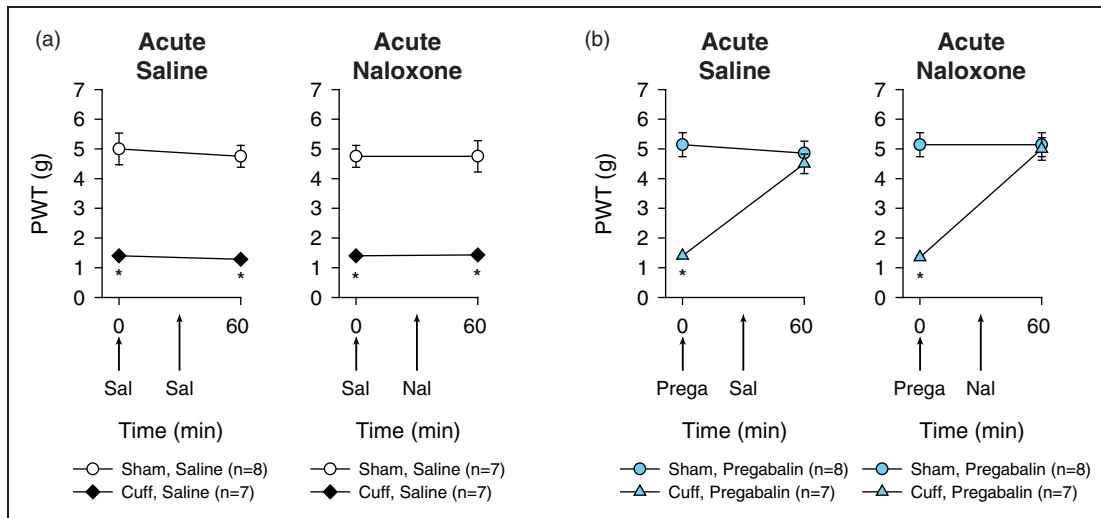

Figure 5. Acute opioid receptor antagonist in acute pregabalin treatment. Two weeks after unilateral cuff surgery, mice received an injection of pregabalin (30 mg/kg, i.p.) or saline control; 30 min later, they received an injection of the opioid receptor antagonist naloxone (1 mg/kg, s.c.) or control saline solution. Mechanical threshold for the right hindpaw (PWT) was measured before the first injection and 30 min after the second injection. (a) Naloxone and saline had no effect in Sham mice and in Cuff mice that received control treatment ($n = 7-8$, $*p < 0.005$ compared to the Sham-operated control group). (b) Naloxone and saline had no effect in Sham mice and in Cuff mice that received pregabalin treatment (30 mg/kg, i.p.) ($n = 7-8$, $*p < 0.005$ compared to the Sham-operated control group). Data are expressed as mean \pm SEM.

and KOP receptors-deficient mice (Figure 4; group \times time interaction, $ATS_{(2,3)} = 10.5$, $p < 0.001$; multiple comparisons: “Cuff Pregabalin” = “Sham Pregabalin” at $p > 0.6$ on post-administration time 60 min and “Cuff Pregabalin” $<$ “Sham Pregabalin” at $p < 0.01$ on post-administration time 0, 30, and 120 min). These transitory antiallodynic effects disappeared 120 min after injection of pregabalin.

Naloxone effect on acute pregabalin treatment

Naloxone (1 mg/kg) did not suppress the transitory anti-allodynic action of acute pregabalin administration (Figure 5(a); group interaction, $ATS_{(1,0)} = 181.7$, $p < 0.001$; multiple comparisons: “Cuff Saline” $<$ “Sham Saline” at $p < 0.001$ for acute saline administration and at $p < 0.005$ for acute naloxone administration) (Figure 5(b), acute saline; group \times time interaction, $ATS_{(1,0)} = 12.7$, $p < 0.001$; multiple comparisons: “Cuff Pregabalin” $<$ “Sham Pregabalin” at $p < 0.001$ preinjection and “Cuff Pregabalin” = “Sham Pregabalin” at $p > 0.5$ post-injection; Acute Naloxone; group \times time interaction, $ATS_{(1,0)} = 13.7$, $p < 0.001$; multiple comparisons: “Cuff Pregabalin” $<$ “Sham Pregabalin” at $p < 0.001$ preinjection and “Cuff Pregabalin” = “Sham Pregabalin” at $p > 0.8$ postinjection).

Long-term pregabalin has an anti-TNF- α action

Using Western blot, we observed increased levels of the membrane-bound form of TNF- α (mTNF- α) in the

lumbar DRG of C57BL/6J Cuff mice at four weeks post-injury. The long-term treatment with pregabalin reversed this increase in mTNF- α . (Figure 6; $H_{(2,0)} = 16.2$, $p < 0.001$; multiple comparisons: “Cuff Vehicle” $>$ (“Cuff Pregabalin” or “Sham Vehicle”) at $p < 0.005$).

Discussion

In the present work, we studied the role of opioid receptors in both the long-term and the acute transitory anti-allodynic action of systemic pregabalin in a model of neuropathic pain. In both cases, we show that the endogenous opioid system is not necessary for this action. We also show that a long-term pregabalin treatment suppresses the DRG TNF- α overexpression that accompanies neuropathic pain.

Clinically, first line pharmacological treatments to relieve neuropathic pain include anticonvulsants and antidepressants. Gabapentinoid anticonvulsants, which target the VDCCs $\alpha 2\delta$ -1 subunit, have proved to be effective in a number of neuropathic pain conditions.^{3,39} Similarly to many reports in various animal models,^{6,20,40,41} we showed that pregabalin has a short-term transitory antiallodynic action after an acute administration; however, this effect cannot be considered as representative of the main clinical therapeutic effect since the mechanical allodynia reappears within 2 h following the injection. Interestingly, the benefit of pregabalin treatment is sustained after three days of oral administration, which is in agreement with other results

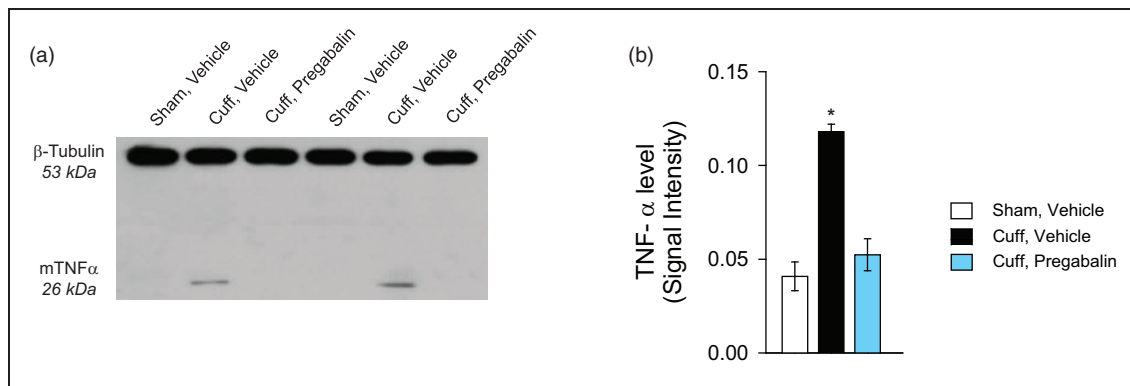

Figure 6. Long-term pregabalin displays an anti-TNF- α action on lumbar dorsal root ganglia of neuropathic mice. (a) Representative picture of Western blot illustrating the increased TNF- α levels in DRG of Cuff mice four to five weeks after induction of the neuropathy, and the anti-TNF- α action of the long-term pregabalin treatment (300 μ g/mL i.e. 44.63 mg/kg/day). (b) Histogram presenting the Western blot analysis ($n = 8$ per group, $*p < 0.005$ vs. Sham-vehicle). Data are expressed as mean \pm SEM.

obtained with systemic delivery of another gabapentinoid, gabapentin,^{20,42} or in other neuropathic pain models.^{24,43} This sustained action may more likely be representative of the clinical use and action of gabapentinoids in neuropathic pain.^{44,45}

Critical aspects of mechanism(s) by which gabapentinoids alleviate neuropathic pain is (are) now well described. Gabapentinoids inhibit calcium currents through direct interaction with the $\alpha 2\delta$ -1 subunit, thus decreasing excitatory transmitter release and spinal sensitization.^{8,46} This target subunit is upregulated in the dorsal horn of the spinal cord and in DRG neurons in several models of neuropathic pain and this increase in $\alpha 2\delta$ -1 correlates with the onset of allodynia.⁴⁷ Furthermore, experiments performed in transgenic mice overexpressing the $\alpha 2\delta$ -1 subunit showed enhanced calcium currents recorded in DRG neurons, as well as nociceptive behavior characterized by hyperalgesia in the absence of nerve damage.⁴⁸ In contrast, $\alpha 2\delta$ -1 deficient mice display reduced DRG calcium currents, have lower baseline mechanical sensitivity, and show delayed mechanical hypersensitivity after partial sciatic nerve ligation.⁴⁹ In DRG neurons, $\alpha 2\delta$ -1 upregulation recruits mitochondrial Ca^{2+} to prolong intracellular Ca^{2+} signals evoked by depolarization.⁵⁰ This mechanism may contribute to the aberrant neurotransmission observed in neuropathic pain. Pregabalin antiallodynic effect is associated with decreased trafficking of the $\alpha 2\delta$ -1 subunit to presynaptic terminals of DRG neurons;^{8,46} and within the dorsal horn, gabapentinoids also decrease the amplitude of excitatory postsynaptic currents.⁵¹

In addition to these actions, two studies suggested that gabapentinoids may also recruit the endogenous opioid system,^{18,19} which is well known for playing a crucial role in the control of nociception and pain.^{10,11,52} Indeed, the opioid antagonist naloxone

reversed the acute antinociceptive activity of a high dose of pregabalin in naive mice.¹⁸ Another study also showed an effect of naltrexone on the acute action of gabapentin in a model of orofacial inflammatory pain.¹⁹ These recent data differ from previous studies on gabapentinoid drugs, which mostly reported naloxone to be ineffective in blocking gabapentinoid-induced analgesia in different pain models.^{20–22} However, most of these studies were not done in models of neuropathic pain, which is the clinical pain condition for which gabapentinoids have legal authorization for prescription in various countries. Beside pharmacological approach, the present study used genetic deletion of opioid receptors for the first time, which further clarifies the involvement of the opioid system in both acute and chronic antiallodynic action of pregabalin in neuropathic pain. We demonstrate that neither acute nor long-term antiallodynic effect of pregabalin requires the presence of opioid receptors. Both our results and previous studies^{20–22} refute the involvement of the opioid system in the antiallodynic action of pregabalin in neuropathic pain, which does not exclude a possible involvement of these receptors in gabapentinoid action on other types of pain.

The opioid system via MOP, DOP, and KOP receptors plays a crucial role in the inhibitory controls of pain^{10,52,53} and also participates in the therapeutic action of various pain killers. Thus, MOP receptors are the primary molecular target for the analgesic action of opioids such as morphine, codeine, fentanyl, or tramadol.^{10,54,55} Indirectly, the opioid system is also necessary for the antiallodynic action of tricyclic antidepressant drugs, which requires DOP receptors, but not MOP or KOP receptors.^{11,36,56} Our results strengthen the idea that antidepressant and anticonvulsant treatments alleviate neuropathic pain through independent mechanisms.

These mechanistic differences may be in favor of combination pharmacotherapy for the management of neuropathic pain using both gabapentinoids and antidepressants,^{57,58} although the benefit of such a combination is still controversial,^{3,59} or using both gabapentinoids and opioid drugs.^{14–17}

In the last decade, there has been an increasing number of studies which now provide compelling evidence that neuropathic pain pathogenesis is not simply confined to changes in the activity of neuronal systems, but that it also involves interactions between neurons, immune cells, and glial cells, including the involvement of inflammatory cytokines and chemokines.^{25,60} Indeed, peripheral nerve injury recruits the immune system at various anatomical locations, including the lesion site, DRG, spinal cord, and supraspinal sites associated with pain pathways.²⁵ Pro-inflammatory cytokines produced after nerve injury could participate to the initiation and maintenance of neuropathic pain. Among these cytokines, TNF- α has the ability to also favor production of other cytokines.²⁸ The direct anti-TNF- α drugs infliximab and etanercept are clinically used to treat autoimmune diseases,⁶¹ and these drugs have been shown to have some action on neuropathic pain symptoms both in animal models and in humans.^{26,30,62–64} In particular, infliximab and etanercept can relieve neuropathic allodynia in the model of neuropathic pain used for the present study.²⁶ Our results show that pregabalin can display an indirect anti-TNF- α action, as seen on DRG from mice with neuropathic pain. This result is in agreement with previous reports on gabapentin suggesting an indirect action of this drug on cytokines.^{16,24} Thus, it has been proposed that gabapentin could upregulate the expression of the anti-inflammatory cytokine IL-10 in the spinal cord, leading to the inhibition of the expression of pro-inflammatory cytokines, TNF- α , but also IL-1 β and IL-6.^{16,24}

Conclusions

This study demonstrates that none of the three opioid receptors is necessary for the antiallodynic action of acute or chronic pregabalin in a neuropathic pain context. Moreover, long-term pregabalin treatment decreases TNF- α in DRG. Further studies will be needed to elucidate the mechanism by which the direct action of pregabalin on the neuronal VDCCs $\alpha 2\delta$ -1 subunit may downregulate DRG TNF- α expression, which is mostly produced by non-neuronal cells. While the direct action of pregabalin on its target provides an explanation for acute pregabalin action at high dose, the sustained effect of prolonged treatment suggests the involvement of other downstream mechanisms the elucidation of which may provide new candidates for pharmacological targeting.

Acknowledgments

The authors thank Dr Jean-Luc Rodeau for his help concerning statistical tests, and Stéphane Doridot for animal care and genotyping. They are grateful to Pr Brigitte Kieffer (McGill University, Canada) and Pr Claire Gavériaux-Ruff (IGBMC, France) for providing MOP, DOP, and KOP receptors-deficient mouse breeders.

Authors Contributions

ES and MB equally participated to this work. MK and IY did all surgeries. RAH and RAC performed dose responses. MK, LN, and XW performed behavioral tests on chronically treated opioid-receptor deficient mice. MK performed behavioral tests concerning naloxone and acute pregabalin. MK and DD performed the Western blot experiment. MB, MK, IY, and ES codesigned and supervised all experiments. MK collected and analyzed all data. MK and MB drafted the article. All authors revised the article prior to submission.

Declaration of Conflicting Interests

The author(s) declared no potential conflicts of interest with respect to the research, authorship, and/or publication of this article: The authors declare that they have no competing interests.

Funding

The author(s) disclosed receipt of the following financial support for the research, authorship, and/or publication of this article: This work was supported by the Centre National de la Recherche Scientifique (CNRS, contract UPR3212) and the Université de Strasbourg (UPR3212), by a CNRS disability PhD fellowship (to MK), by Fondation d'Entreprise Banque Populaire (to MK), and by FédécH-Hewlett-Packard (to MK).

References

1. Jensen TS, Baron R, Haanpaa M, et al. A new definition of neuropathic pain. *Pain* 2011; 152: 2204–2205.
2. von Hehn CA, Baron R and Woolf CJ. Deconstructing the neuropathic pain phenotype to reveal neural mechanisms. *Neuron* 2012; 73: 638–652.
3. Finnerup NB, Attal N, Haroutounian S, et al. Pharmacotherapy for neuropathic pain in adults: a systematic review and meta-analysis. *Lancet Neurol* 2015; 14: 162–173.
4. Lanneau C, Green A, Hirst WD, et al. Gabapentin is not a GABAB receptor agonist. *Neuropharmacology* 2001; 41: 965–975.
5. Mico JA and Prieto R. Elucidating the mechanism of action of pregabalin: alpha(2)delta as a therapeutic target in anxiety. *CNS Drugs* 2012; 26: 637–648.
6. Field MJ, Cox PJ, Stott E, et al. Identification of the alpha2-delta-1 subunit of voltage-dependent calcium channels as a molecular target for pain mediating the analgesic actions of pregabalin. *Proc Natl Acad Sci USA* 2006; 103: 17537–17542.
7. Gee NS, Brown JP, Dissanayake VU, et al. The novel anti-convulsant drug, gabapentin (Neurontin), binds to the

- alpha2delta subunit of a calcium channel. *J Biol Chem* 1996; 271: 5768–5776.
8. Bauer CS, Nieto-Rostro M, Rahman W, et al. The increased trafficking of the calcium channel subunit alpha2delta-1 to presynaptic terminals in neuropathic pain is inhibited by the alpha2delta ligand pregabalin. *J Neurosci* 2009; 29: 4076–4088.
 9. Eroglu C, Allen NJ, Susman MW, et al. The gabapentin receptor alpha2delta-1 is the neuronal thrombospondin receptor responsible for excitatory CNS synaptogenesis. *Cell* 2009; 139: 380–392.
 10. Gaveriaux-Ruff C and Kieffer BL. Opioid receptor genes inactivated in mice: the highlights. *Neuropeptides* 2002; 36: 62–71.
 11. Benbouzid M, Gaveriaux-Ruff C, Yalcin I, et al. Delta-opioid receptors are critical for tricyclic antidepressant treatment of neuropathic allodynia. *Biol Psychiatry* 2008; 63: 633–636.
 12. Mico JA, Ardid D, Berrocoso E, et al. Antidepressants and pain. *Trends Pharmacol Sci* 2006; 27: 348–354.
 13. Marchand F, Ardid D, Chapuy E, et al. Evidence for an involvement of supraspinal delta- and spinal mu-opioid receptors in the antihyperalgesic effect of chronically administered clomipramine in mononeuropathic rats. *J Pharmacol Exp Ther* 2003; 307: 268–274.
 14. Dou Z, Jiang Z and Zhong J. Efficacy and safety of pregabalin in patients with neuropathic cancer pain undergoing morphine therapy. *Asia Pac J Clin Oncol* 2014; 10: 12311–12319.
 15. Chaparro LE, Wiffen PJ, Moore RA, et al. Combination pharmacotherapy for the treatment of neuropathic pain in adults. *Cochrane Database Syst Rev* 2012; 7: CD008943.
 16. Bao YH, Zhou QH, Chen R, et al. Gabapentin enhances the morphine anti-nociceptive effect in neuropathic pain via the interleukin-10-heme oxygenase-1 signalling pathway in rats. *J Mol Neurosci* 2014; 54: 137–146.
 17. De la OAM, Diaz-Reval MI, Cortes-Arroyo AR, et al. Anti-nociceptive synergism of morphine and gabapentin in neuropathic pain induced by chronic constriction injury. *Pharmacol Biochem Behav* 2009; 92: 457–464.
 18. Kaygisiz B, Kilic FS, Senguleroglu N, et al. The antinociceptive effect and mechanisms of action of pregabalin in mice. *Pharmacol Rep* 2015; 67: 129–133.
 19. Miranda HF, Sierralta F, Lux S, et al. Involvement of nitridergic and opioidergic pathways in the antinociception of gabapentin in the orofacial formalin test in mice. *Pharmacol Rep* 2015; 67: 399–403.
 20. Benbouzid M, Choucair-Jaafar N, Yalcin I, et al. Chronic, but not acute, tricyclic antidepressant treatment alleviates neuropathic allodynia after sciatic nerve cuffing in mice. *Eur J Pain* 2008; 12: 1008–1017.
 21. Eutamene H, Coelho AM, Theodorou V, et al. Antinociceptive effect of pregabalin in septic shock-induced rectal hypersensitivity in rats. *J Pharmacol Exp Ther* 2000; 295: 162–167.
 22. Field MJ, Oles RJ, Lewis AS, et al. Gabapentin (neurontin) and S-(+)-3-isobutylgaba represent a novel class of selective antihyperalgesic agents. *Br J Pharmacol* 1997; 121: 1513–1522.
 23. Dias JM, de Brito TV, de Aguiar Magalhaes D, et al. Gabapentin, a synthetic analogue of gamma aminobutyric acid, reverses systemic acute inflammation and oxidative stress in mice. *Inflammation* 2014; 37: 1826–1836.
 24. Lee BS, Jun IG, Kim SH, et al. Intrathecal gabapentin increases interleukin-10 expression and inhibits pro-inflammatory cytokine in a rat model of neuropathic pain. *J Korean Med Sci* 2013; 28: 308–314.
 25. Austin PJ and Moalem-Taylor G. The neuro-immune balance in neuropathic pain: involvement of inflammatory immune cells, immune-like glial cells and cytokines. *J Neuroimmunol* 2010; 229: 26–50.
 26. Bohren Y, Tessier LH, Megat S, et al. Antidepressants suppress neuropathic pain by a peripheral beta2-adrenoceptor mediated anti-TNFalpha mechanism. *Neurobiol Dis* 2013; 60: 39–50.
 27. Uceyler N, Rogausch JP, Toyka KV, et al. Differential expression of cytokines in painful and painless neuropathies. *Neurology* 2007; 69: 42–49.
 28. Leung L and Cahill CM. TNF-alpha and neuropathic pain – a review. *J Neuroinflammation* 2010; 7: 27.
 29. Empl M, Renaud S, Erne B, et al. TNF-alpha expression in painful and nonpainful neuropathies. *Neurology* 2001; 56: 1371–1377.
 30. Sommer C, Lindenlaub T, Teuteberg P, et al. Anti-TNF-neutralizing antibodies reduce pain-related behavior in two different mouse models of painful mononeuropathy. *Brain Res* 2001; 913: 86–89.
 31. Filliol D, Ghozland S, Chluba J, et al. Mice deficient for delta- and mu-opioid receptors exhibit opposing alterations of emotional responses. *Nat Genet* 2000; 25: 195–200.
 32. Matthes HW, Maldonado R, Simonin F, et al. Loss of morphine-induced analgesia, reward effect and withdrawal symptoms in mice lacking the mu-opioid-receptor gene. *Nature* 1996; 383: 819–823.
 33. Simonin F, Valverde O, Smadja C, et al. Disruption of the kappa-opioid receptor gene in mice enhances sensitivity to chemical visceral pain, impairs pharmacological actions of the selective kappa-agonist U-50,488H and attenuates morphine withdrawal. *EMBO J* 1998; 17: 886–897.
 34. Benbouzid M, Pallage V, Rajalu M, et al. Sciatic nerve cuffing in mice: a model of sustained neuropathic pain. *Eur J Pain* 2008; 12: 591–599.
 35. Yalcin I, Megat S, Barthas F, et al. The sciatic nerve cuffing model of neuropathic pain in mice. *J Vis Exp* 2014; 89: 51608.
 36. Bohren Y, Karavelic D, Tessier LH, et al. Mu-opioid receptors are not necessary for nortriptyline treatment of neuropathic allodynia. *Eur J Pain* 2010; 14: 700–704.
 37. Barrot M. Tests and models of nociception and pain in rodents. *Neuroscience* 2012; 211: 39–50.
 38. Noguchi K, Gel YR, Brunner E, et al. nparLD: an R software package for the nonparametric analysis of longitudinal data in factorial experiments. *J Stat Softw* 2012; 50: 1–23.
 39. Gilron I. Gabapentin and pregabalin for chronic neuropathic and early postsurgical pain: current evidence and future directions. *Curr Opin Anaesthesiol* 2007; 20: 456–472.

40. Wallin J, Cui JG, Yakhnitsa V, et al. Gabapentin and pregabalin suppress tactile allodynia and potentiate spinal cord stimulation in a model of neuropathy. *Eur J Pain* 2002; 6: 261–272.
41. Field MJ, McCleary S, Hughes J, et al. Gabapentin and pregabalin, but not morphine and amitriptyline, block both static and dynamic components of mechanical allodynia induced by streptozocin in the rat. *Pain* 1999; 80: 391–398.
42. Yalcin I, Tessier LH, Petit-Demouliere N, et al. Beta2-adrenoceptors are essential for desipramine, venlafaxine or reboxetine action in neuropathic pain. *Neurobiol Dis* 2009; 33: 386–394.
43. Coderre TJ, Kumar N, Lefebvre CD, et al. Evidence that gabapentin reduces neuropathic pain by inhibiting the spinal release of glutamate. *J Neurochem* 2005; 94: 1131–1139.
44. Cheshire WP. Defining the role for gabapentin in the treatment of trigeminal neuralgia: a retrospective study. *J Pain* 2002; 3: 137–142.
45. Sharma U, Griesing T, Emir B, et al. Time to onset of neuropathic pain reduction: A retrospective analysis of data from nine controlled trials of pregabalin for painful diabetic peripheral neuropathy and postherpetic neuralgia. *Am J Ther* 2010; 17: 577–585.
46. Hendrich J, Bauer CS and Dolphin AC. Chronic pregabalin inhibits synaptic transmission between rat dorsal root ganglion and dorsal horn neurons in culture. *Channels (Austin)* 2012; 6: 124–132.
47. Bauer CS, Rahman W, Tran-van-Minh A, et al. The anti-allodynic alpha(2)delta ligand pregabalin inhibits the trafficking of the calcium channel alpha(2)delta-1 subunit to presynaptic terminals in vivo. *Biochem Soc Trans* 2010; 38: 525–528.
48. Li CY, Zhang XL, Matthews EA, et al. Calcium channel alpha2delta1 subunit mediates spinal hyperexcitability in pain modulation. *Pain* 2006; 125: 20–34.
49. Patel R, Bauer CS, Nieto-Rostro M, et al. alpha2delta-1 gene deletion affects somatosensory neuron function and delays mechanical hypersensitivity in response to peripheral nerve damage. *J Neurosci* 2013; 33: 16412–16426.
50. D'Arco M, Margas W, Cassidy JS, et al. The upregulation of alpha2delta-1 subunit modulates activity-dependent Ca²⁺ signals in sensory neurons. *J Neurosci* 2015; 35: 5891–5903.
51. Biggs JE, Boakye PA, Ganesan N, et al. Analysis of the long-term actions of gabapentin and pregabalin in dorsal root ganglia and substantia gelatinosa. *J Neurophysiol* 2014; 112: 2398–2412.
52. Dierich A and Kieffer BL. Knockout mouse models in pain research. *Methods Mol Med* 2004; 99: 269–299.
53. Mogil JS, Yu L and Basbaum AI. Pain genes?: natural variation and transgenic mutants. *Annu Rev Neurosci* 2000; 23: 777–811.
54. Gibson TP. Pharmacokinetics, efficacy, and safety of analgesia with a focus on tramadol HCl. *Am J Med* 1996; 101: 47S–53S.
55. Pasternak GW and Pan YX. Mu opioids and their receptors: evolution of a concept. *Pharmacol Rev* 2013; 65: 1257–1317.
56. Megat S, Bohren Y, Doridot S, et al. kappa-Opioid receptors are not necessary for the antidepressant treatment of neuropathic pain. *Br J Pharmacol* 2015; 172: 1034–1044.
57. Gilron I, Bailey JM, Tu D, et al. Nortriptyline and gabapentin, alone and in combination for neuropathic pain: a double-blind, randomised controlled crossover trial. *Lancet* 2009; 374: 1252–1261.
58. Tesfaye S, Wilhelm S, Lledo A, et al. Duloxetine and pregabalin: high-dose monotherapy or their combination? The “COMBO-DN study” – a multinational, randomized, double-blind, parallel-group study in patients with diabetic peripheral neuropathic pain. *Pain* 2013; 154: 2616–2625.
59. Gilron I, Jensen TS and Dickenson AH. Combination pharmacotherapy for management of chronic pain: from bench to bedside. *Lancet Neurol* 2013; 12: 1084–1095.
60. Vallejo R, Tilley DM, Vogel L, et al. The role of glia and the immune system in the development and maintenance of neuropathic pain. *Pain Pract* 2010; 10: 167–184.
61. Sfikakis PP. The first decade of biologic TNF antagonists in clinical practice: lessons learned, unresolved issues and future directions. *Curr Dir Autoimmun* 2010; 11: 180–210.
62. Korhonen T, Karppinen J, Paimela L, et al. The treatment of disc herniation-induced sciatica with infliximab: results of a randomized, controlled, 3-month follow-up study. *Spine (Phila Pa 1976)* 2005; 30: 2724–2728.
63. Tobinick E and Davoodifar S. Efficacy of etanercept delivered by perispinal administration for chronic back and/or neck disc-related pain: a study of clinical observations in 143 patients. *Curr Med Res Opin* 2004; 20: 1075–1085.
64. Watanabe K, Yabuki S, Sekiguchi M, et al. Etanercept attenuates pain-related behavior following compression of the dorsal root ganglion in the rat. *Eur Spine J* 2011; 20: 1877–1884.

6. Chapter Four: Colon sensitivity in opioid receptor knock-out mice

Ceredig et al. (Submitted article)

1. Introduction

The endogenous opioid system is involved in the modulation of multiple physiological functions which include pain and reward processing, emotional responses, memory, and autonomous functions such as immunity, ventilation and digestion (Akil et al., 1997; Bodnar, 2014; Lalley, 2008). Of interest, opioid receptors are expressed throughout the nervous system, particularly in areas involved in pain processing (Erbs et al., 2015), and activation of these receptors by endogenous opioid peptides reduces pain perception. In digestive tissues, the modulatory activity of the endogenous opioid system reduces gastrointestinal motility and secretion; however the involvement of endogenous pain control in the modulation of visceral perception is not yet fully described.

Inflammatory Bowel Diseases (IBD) are complex disorders with intermittent and unspecific symptoms, which render diagnosis and treatment highly challenging (Loftus Jr., 2004; Sartor, 2006). Multiple genetic, environmental and immune contributors are presumed to be involved (Cho, 2008; Sartor, 2008), research is currently investigating therapeutic approaches which target these components. One of the most unbearable symptoms in IBD is the intense visceral pain (Al-chaer and Traub, 2002; Docherty et al., 2011), which, in the long term, can lead to mood disorders such as anxiety and depression (Bernstein et al., 2010; Mackner et al., 2011). In IBD, inflammatory cytokines recruit immune cells, which are known to release opioid peptides *in situ* (Boué et al., 2014) and endogenous pain control by opioid peptide release has been shown to be more potent in inflamed tissue (Stein et al., 2003; Stein and Machelska, 2011)

Using genetic approaches, we sought to unravel the role of modulatory activity of central and peripheral opioid receptors on colon sensitivity in basal conditions and in a mouse model of IBD. We demonstrate colonic hypersensitivity in naïve MOP or DOP receptor knock-out animals (but not peripheral conditional knock-out animals), which bring evidence of endogenous opioid activity regulating visceral pain perception. However, this opioidergic tone was unable to reduce pain in inflammatory conditions, as all mouse strains had similar colonic sensitivities.

Abstract

Background

Opiates act through opioid receptors to diminish pain. Here, we investigated whether mu (MOR) and delta (DOR) receptor endogenous activity assessed in the whole mouse body or in particular at peripheral receptors on primary nociceptive neurons, control colonic pain.

Methods

We compared global MOR and DOR receptor knockout (KO) mice, Nav1.8-peripheral conditional KO (cKO) mice, and control floxed mice of both genders for visceral sensitivity. Visceromotor responses to colorectal distension (CRD) and macroscopic colon scores were recorded on naïve mice and mice with acute colitis induced by 3% dextran sodium sulfate (DSS) for 5 days. Transcript expression for opioid genes and cytokines was measured by quantitative RT-PCR.

Results

Naïve MOR and DOR global KO mice show increased visceral sensitivity that was not observed in cKO mice. MOR and Penk were the most expressed opioid genes in colon. MOR KO mice had augmented KOR and TNF- α and diminished Penk transcript levels while DOR, Pdyn and IL-1 β were unchanged. Global MOR KO females had a thicker colon than floxed females. No alteration was detected in DOR mutant animals. A 5-day DSS treatment led to comparable hypersensitivity in the different mouse lines.

Conclusion

Our results suggest that mu and delta opioid receptor global endogenous activity but not activity at the peripheral Nav1.8 neurons contribute to visceral sensitivity in naïve mice, and that endogenous MOR and DOR tones were insufficient to elicit analgesia after 5-day DSS-induced colitis.

1) Title: Mu and delta opioid receptor knockout mice show increased colonic sensitivity

2) Running head: Colon sensitivity in opioid receptor knockout mice

3) R.A. Ceredig^{1,2,3,4,5,*}, D. Reiss^{1,2,3,4,*}, J. Boué^{6,7}, G. Dietrich^{6,7} and C. Gavériaux-Ruff^{1,2,3,4,8}

* Equal contributors

4) ¹Institut de Génétique et de Biologie Moléculaire et Cellulaire, Illkirch, France; ²Université de Strasbourg, Illkirch, France; ³Centre National de la Recherche Scientifique, UMR7104, Illkirch, France; ⁴Institut National de la Santé et de la Recherche Médicale, U964, Illkirch, France

⁵Institut des Neurosciences Cellulaires et Intégratives INCI, UPR3212, Strasbourg, France

⁶INSERM UMR 1220, Institut de Recherche en Santé Digestive IRSD, Toulouse, France

⁷Université Paul Sabatier UPS, Toulouse, France

⁸Ecole Supérieure de Biotechnologie de Strasbourg, Université de Strasbourg, France

5) Author responsible for correspondence:

Pr. Claire Gaveriaux-Ruff

Institut de Génétique et de Biologie Moléculaire et Cellulaire, Translational Medicine and Neurogenetics Department, 1 Rue Laurent Fries, 67404 Illkirch, France

Tel 33 3 88 65 56 94; fax 33 388 65 32 01; e-mail: gaveriau@igbmc.fr

6) Category of manuscript: original article

7) Funding sources : Research was funded by the French Agence Nationale de la Recherche (ANR) grant LYMPHOPIOID (G.D. and C. G.-R.) and by Université de Strasbourg (C. G.-

R.); research was supported Frame program Investissements d'Avenir ANR-10-IDEX-0002-02 ANR-10-LABX-0030-INRT (R.A.C.; D.R.; C. G.-R.); Ministère de l'Education Nationale, de la Recherche et de la Technologie (R.A.C.).

8) The authors declare no conflict of interest.

9) What does this study add?

Knockout mice for mu and delta opioid receptor have augmented colon sensitivity in the ColoRectal Distension (CRD) assay.

It shows endogenous mu and delta opioid analgesia that may be explored as potential targets for alleviating chronic intestinal pain.

Abstract

Background

Opiates act through opioid receptors to diminish pain. Here, we investigated whether mu (MOR) and delta (DOR) receptor endogenous activity assessed in the whole mouse body or in particular at peripheral receptors on primary nociceptive neurons, control colonic pain.

Methods

We compared global MOR and DOR receptor knockout (KO) mice, Nav1.8-peripheral conditional KO (cKO) mice, and control floxed mice of both genders for visceral sensitivity. Visceromotor responses to colorectal distension (CRD) and macroscopic colon scores were recorded on naïve mice and mice with acute colitis induced by 3% dextran sodium sulfate (DSS) for 5 days. Transcript expression for opioid genes and cytokines was measured by quantitative RT-PCR.

Results

Naïve MOR and DOR global KO mice show increased visceral sensitivity that was not observed in cKO mice. MOR and Penk were the most expressed opioid genes in colon. MOR KO mice had augmented KOR and TNF- α and diminished Penk transcript levels while DOR, Pdyn and IL-1 β were unchanged. Global MOR KO females had a thicker colon than floxed females. No alteration was detected in DOR mutant animals. A 5-day DSS treatment led to comparable hypersensitivity in the different mouse lines.

Conclusion

Our results suggest that mu and delta opioid receptor global endogenous activity but not activity at the peripheral Nav1.8 neurons contribute to visceral sensitivity in naïve mice, and that endogenous MOR and DOR tones were insufficient to elicit analgesia after 5-day DSS-induced colitis.

1. Introduction

Chronic visceral pain management represents an unmet medical challenge. Identification of new approaches and potential targets for therapeutic pain relief entails combining genetic, molecular and behavioral approaches in an effort to further medical understanding and development of novel treatments. The opioid system comprises three types of opioid receptors, mu (MOR), delta (DOR) and kappa (KOR), activated by endogenous opioids including endorphins, enkephalins, dynorphins, endomorphins and endogenous morphine (Laux-Biehlmann et al., 2013; Bodnar, 2015). All three opioid receptors are expressed in myenteric and submucosal plexi of the enteric nervous system, and regulate gut motility and secretory functions of the gastro-intestinal tract. Expression of all three opioid receptors was detected in both vagal and spinal afferents responsible for visceral nociception (Sternini et al., 2004; Wood & Galligan, 2004; Belvisi & Hele, 2009; Mosinska et al., 2016). Endogenous analgesic tones at opioid receptors have been demonstrated in several preclinical models, mostly for somatic pain (Nadal et al., 2013). Although the role of T cell-derived opioids in the endogenous regulation of inflammation-induced visceral sensitivity has been reported (Verma-Gandhu et al., 2006; Verma-Gandhu et al., 2007; Valdez-Morales et al., 2013; Basso et al., 2014; Boue et al., 2014), the influence of each opioid receptor activity on visceral nociceptive sensitivity has only been assessed in writhing responses to chemical irritants (Nadal et al., 2013). Murine colitis models are classically used to study etiology of Inflammatory Bowel Disease (IBD, which includes Crohn's disease and Ulcerative Colitis), and identify processes underlying chronic visceral pain. Colitis models induced by either 2,4,6-trinitrobenzene sulfonic acid (TNBS), adoptive transfer of CD4⁺CD45RB^{high}T lymphocytes or dextran sodium sulfate (DSS) have shown that endogenous mu opioid activity dampened inflammation (Philippe et al., 2003; Goldsmith et al., 2011; Sobczak et al., 2014; Anselmi et al., 2015) but the contribution of endogenous MOR and DOR activities on

visceromotor responses to colon distension under basal (naïve) and acute inflammatory conditions are still unknown.

Here, we investigated the role of MOR and DOR in the endogenous regulation of colon sensitivity in normal conditions and acute DSS-induced colitis. Visceral sensitivity was evaluated by measuring abdominal muscle contractions in response to colorectal distension (Cenac et al., 2007). Opioid receptors expressed by peripheral nociceptive neurons have been shown to play important roles in pain control and analgesia (Stein & Machelska, 2011) and retrograde tracing from the colon labels DRG neurons. Therefore, we compared mice in which MOR or DOR were either deleted in the whole body or specifically in Nav1.8-expressing primary nociceptive neurons (Gaveriaux-Ruff et al., 2011; Weibel et al., 2013). As pro-inflammatory cytokines, and in particular TNF- α , are known to play a major role in inflammatory bowel disease (Neurath, 2014) and inflammation-induced pain (Basso et al., 2015), IL-1 β , TNF- α and IL-10 transcripts were quantified. Both female and male mice were included here as gender is a well-known disease modifier (Klein et al., 2015) and an important factor in pain control (Mogil, 2012).

We show colon hypersensitivities in MOR or DOR KO naïve mice, indicating analgesia mediated by endogenous MOR and DOR activities.

2. Methods

2.1. Animals

The MOR-floxed (Oprm1fl/fl) and DOR-floxed (Oprd1fl/fl) mouse lines were crossed with CMV-Cre mice to produce global knockout (global KO)(CMV-CrexOprm1fl/fl or MOR KO; CMV-CrexOprd1fl/fl or DOR KO), and interbred with Nav1.8-Cre mice to produce conditional knockout (cKO) in primary nociceptive neurons (Nav-CrexOprm1fl/fl or MOR

cKO; Nav-CrexOprd1fl/fl or DOR cKO), as described previously (Gaveriaux-Ruff et al., 2011; Weibel et al., 2013). All mice were on a mixed genetic background (50% C57BL6/J – 50% SV129Pas). Animals were produced in the Institut Clinique de la Souris (ICS) breeding facility and transferred to the behavior area two weeks before experiments for acclimation. Experiments were performed on animals aged between 12 and 18 weeks weighing 20-34g for females and 25-38g for males. Mice were housed 2-4 per cage under standard laboratory conditions (12h dark/light cycle) in temperature (21 ± 1 °C) and humidity ($55 \pm 10\%$) controlled rooms, with cage bedding from Anibed (Pontvallain, France; reference AB3). Food (SAFE, Augy, France; reference D03) and water (autoclaved tap water) were available ad libitum. In total 412 mice were experimented in the study, allocated to one of the experimental groups according to gender (male or female), genotype (MOR floxed; MOR global KO; MOR cKO; DOR floxed; DOR global KO; DOR cKO) and treatment (drinking water or DSS 3%). The numbers of animals per group were designed in accordance with previous similar studies (Cenac et al., 2007; Boue et al., 2014), with experimenters blind to mouse genotypes. Mice were familiarized to the experimental environment and handled for one week before performing experiments.

2.2. Ethics

Experiments were performed in accordance with the European Communities Council Directive of 22 September 2010 (directive 2010/63/UE), under the guidelines of the Committee for Research and Ethical issues of IASP published in PAIN, 1983; 16:109-110 and were approved by the local ethical committee (Com'Eth, Comité d'Ethique pour l'Expérimentation Animale IGBMC-ICS, licence N° 17) with the agreement number 2012-038. Studies are reported in accordance with the ARRIVE guidelines for reporting experiments involving animals (McGrath et al., 2010).

2.3. Colorectal distension (CRD) and electromyographic recording

The procedures were performed from 9 AM to 1 PM, and according to previous studies (Cenac et al., 2007; Boue et al., 2014). Three days before recording, two electrodes were implanted in the abdominal external oblique musculature of mice anesthetized with xylazine and ketamine (100/10mg/kg intraperitoneal route, ketamine; Virbac, Carros, France; xylazine, Rompun, Bayer Healthcare, Puteaux, France). These anesthetic doses and route of administration are classically used in CRD studies on mice. Electrodes were exteriorized at the back of the neck and protected by a plastic tube attached to the skin. Electrodes were connected to a Bio Amp connected to an electromyogram acquisition system (ADInstruments Inc, Colorado Springs, CO). A 10.5-mm-diameter balloon catheter was gently inserted into the colon at 5mm proximal to the rectum. The balloon was inflated in a stepwise fashion. Ten-second distensions were performed at pressures of 15, 30, 45 and 60 mm Hg with 5-min rest intervals. Electromyographic activity of the abdominal muscles was recorded and visceromotor responses were calculated using Chart-5 software (Cenac et al., 2007). After recording, mice were euthanized by cervical dislocation and colon was dissected out.

2.4. Induction of colitis with dextran sulfate sodium

Colitis was induced by adding 3% (weight/volume) dextran sulfate sodium (DSS, 36000-50000MW, 0216011080, MP Biomedicals, Illkirch, France) to the drinking water for 5 days. Control naïve animals received water alone.

2.5. Macroscopic score and colon length and thickness

Macroscopic colonic tissue damage was evaluated from 1 PM to 5 PM and scaled on the following parameters: erythema (0, absent; 1, length of the area <1 cm; 2, length of the

area >1 cm), edema (0, absent; 1, mild; 2, severe), strictures (0, absent; 1, one; 2, two; 3, more than two), ulceration (0, absent; 1, present), fecal blood (0, absent; 1, present), adhesion (0, absent; 1, moderate; 2, severe), feces (0, normal; 1, soft ; diarrhea, 2) and body deshydration (0, absent; 1, moderate; 2, severe). Colon length was determined from caecum to anus, and colon wall thickness with a caliper, from 1 PM to 5 PM.

2.6. Quantitative RT-PCR

Quantitative RT-PCR (RT-qPCR) was performed as described (Weibel et al., 2013) on colon biopsies from individual mice collected from 1 PM to 5 PM. Briefly, total RNA was extracted using TRIzol (Invitrogen, Cergy Pontoise, France). RNA were evaluated using a ND-1000 Nanodrop spectrophotometer, and total RNA (4 µg) was reverse-transcribed with SuperScript II in a 20 µl final volume. Real-time PCR was performed on cDNA in triplicate on a Light-Cycler-480 (Roche). Forward and reverse primer sequences were

GGTCCTTTTCACCAGCAAGCT;	TGACACTGGTAAAACAATGCA	(Hprt);
GAGCCACAGCCTGTGCCCT;	CGTGCTAGTGGCTAAGGCATC	(Oprm1);
GCTCGTCATGTTTGGCATC;	AAGTACTTGGCGCTCTGGAA	(Oprd1);
CCTGGCATCATCTGTTGGTA;	GGAAACTGCAAGGAGCATTC	(Oprk1);
AGCCAGGACTGCGCTAAAT;	AGGCAGCTGTCCTTCACATT	(Penk);
ATGATGAGACGCCATCCTTC;	TTAATGAGGGCTGTGGGAAC	(Pdyn),
ATGCCGAGATTCTGCTACAGT;	TCCAGCGAGAGGTCGAGTTT	(Pomc);
CGCAGCAGCACATCAACAAGAGC;	TGTCCTCATCCTGGAAGGTCCACG	(IL-1β),
GCTCCTAGAGCTGCGGACT;	TGTTGTCCAGCTGGTCCTTT	(IL-10),
CCGATGGGTTGTACCTTGTCT;	GTGGGTGAG GAGCACGTAGT	(TNF-α).

Relative expression ratios (opioid genes vs HPRT) were calculated with HPRT as reference gene, and

the $2^{-\Delta\Delta C_t}$ method was used to evaluate differences in expression levels between control and mutant mice.

2.7. Statistical analysis

All data are presented as means \pm SEM. Statistical analyses were performed with the GraphPad Prism 6.0 software. Data from each group was tested for normality. Comparisons between mouse genotypes for responses to CRD were done with two-way ANOVA followed by Tukey's analysis between floxed and mutant mice. Comparisons between mouse genotypes for colon parameters data were performed using one-way ANOVA followed by Tukey's analysis between floxed and mutant mice. Comparisons between mouse genotypes for RT-qPCR data were performed using one-way ANOVA followed by Dunnett's analysis between floxed mice as the reference and mutant mice.

3. Results

3.1. Mu opioid receptor global knockout mice show increased visceromotor response to CRD

Basal visceral sensitivity of control MOR and DOR floxed mice was overall similar between females and males with a tendency to higher sensitivity in males (gender: $F_{1,43} = 3.054$, $p=0.088$) (Fig. 1).

In order to investigate the impact of endogenous mu opioid activity on the sensitivity to CRD in normal conditions, we compared naïve global and conditional MOR KO mice to control floxed mice. For females, Fig. 2A shows that global MOR KO mice displayed a higher sensitivity to CRD while cKO mice had similar responses as compared to the floxed gender controls (genotype: $F_{2,35} = 21.63$, $p<0.001$; pressure: $F_{3,105} = 21.30$, $p<0.001$). Similarly, global MOR KO males were more sensitive to CRD, contrasting to the lack of phenotype in the cKOs as shown in Fig. 2B (genotype: $F_{2,37} = 6.27$, $p<0.01$; pressure: $F_{3,111} = 31.61$). The highest difference between global KO and floxed mice were found for 60 mm Hg. Altogether, the data indicate that visceral nociception is augmented by global MOR deletion but not by MOR deletion in peripheral Nav1.8 neurons.

3.2. Delta opioid receptor global knockout mice show increased visceromotor response to CRD

Global naïve DOR KO males and females were more sensitive to CRD than the floxed naïve gender controls, contrasting with unchanged visceral sensitivity in DOR cKO animals, as shown in Fig 2C,D (females: genotype: $F_{2,38} = 3.578$, $p=0.038$; pressure: $F_{3,114} = 37.53$, $p<0.001$; males: genotype: $F_{2,39} = 14.97$, $p<0.001$; pressure: $F_{3,117} = 29.06$, $p<0.001$). Stronger difference between global KO and floxed controls were measured for male mice at

30, 45 and 60 mmHg (Fig. 2D). Thus, as described for mu receptors, the complete deletion of DOR alters the basal visceral sensitivity, while the specific deletion DOR on sensory neurons has no effect.

3.3. The global deletion of mu but not delta receptors alters colon parameters in basal conditions

MOR and DOR mutants were also investigated for length and thickness of the colon (Fig. 3). Length and thickness of the colons from DOR global KO and cKO mice were similar to those of DOR floxed mice (length males, genotype vs floxed: $F_{2,40} = 1.194$, $p=0.313$; length females genotype: $F_{2,41} = 2.219$, $p=0.122$; thickness females: genotype: $F_{2,41} = 0.354$, $p=0.704$; thickness males: genotype: $F_{2,40} = 1.353$, $p=0.270$). Colon length and thickness was similar between MOR global KO, cKO and floxed males (length, genotype: $F_{2,39} = 3.112$, $p=0.158$; thickness, genotype: $F_{2,37} = 0.557$, $p=0.578$) (Fig. 4B). By contrast, in females, colons were thicker in global MOR KO than in cKO and floxed (genotype: $F_{2, 34} = 4.797$, $p=0.015$) (Fig. 3B). The length was unchanged (MOR: genotype: $F_{2,36} = 0.1847$, $p=0.185$) (Fig. 3A). Altogether the data indicate that the absence of mu receptor throughout the body is associated with a higher colon thickness only in female animals.

3.4. The global deletion of mu but not delta receptors alters opioid gene expression in colon

Basal expression levels of transcripts for mu, delta and kappa opioid receptors as well as for the endogenous opioid peptide precursors Penk, Pdyn and POMC were first assessed in flox mice (Fig. 4A). Among the receptors, MOR was the most expressed, followed by DOR and kappa receptor. Penk transcripts were 20.3 fold more abundant than Pdyn transcripts whereas POMC mRNA was undetectable.

Transcript levels of opioid genes in the colon of MOR cKO, global KO and flox animals were then compared (Fig. 4B). Mice harboring MOR-Nav1.8 cKO had an increased MOR expression as compared to flox animals, whereas as expected, MOR transcripts were undetectable in the global MOR KO animals (genotype: $F_{2,27} = 125.8$, $p < 0.001$). Noticeably, both MOR global KO and cKO animals showed augmented KOR (genotype: $F_{2,27} = 9.242$, $p < 0.001$) and diminished Penk (genotype: $F_{2,27} = 12.16$, $p < 0.001$) mRNA levels while DOR and Pdyn were unchanged (genotype: DOR, $F_{2,27} = 0.6735$, $p = 0.513$; Pdyn, $F_{2,27} = 1.636$, $p = 0.213$). By contrast, DOR mutant animals showed no difference in opioid gene expression as compared to controls, except for DOR transcripts that were undetectable in global DOR KO animals, as expected (Fig. 4B) (genotype. MOR: $F_{2,25} = 3.179$, $p = 0.0589$; DOR: $F_{2,25} = 32.03$, $p < 0.001$; KOR: $F_{2,23} = 3.161$, $p = 0.0613$; Penk: $F_{2,25} = 1.600$, $p = 0.222$; Pdyn: $F_{2,26} = 1.731$, $p = 0.197$).

3.5. Increased TNF- α mRNA levels in colon of global mu receptor mutant mice

Transcript levels of the inflammatory cytokines IL-1 β , TNF- α as well as of the anti-inflammatory cytokine IL-10 were determined in the colon of mutant and control mice in basal conditions. The expression of cytokine genes in colons of global DOR KO, DOR cKO and floxed control mice was similar (genotype. IL-1 β : $F_{2,25} = 0.759$, $p = 0.479$; TNF- α : $F_{2,23} = 2.793$, $p = 0.082$; IL-10: $F_{2,23} = 0.5104$, $p = 0.607$) (Fig. 4C). Noticeably, TNF- α transcript expression was higher in global MOR KO mice than in control mice while IL-1 β was similar (genotype, IL-1 β : $F_{2,25} = 0.759$, $p = 0.479$; TNF- α : $F_{2,25} = 5.899$, $p = 0.0080$). IL-10 transcript levels were also lower in MOR cKO and tended to be reduced in global KO animals than in control mice ($F_{2,24} = 5.506$, $p = 0.0108$).

3.6. Mu and delta receptor knockout show no change in acute DSS-induced hyperalgesia

The impact of mu and delta endogenous activities on colitis-induced hypersensitivity was investigated by comparing opioid receptor mutants and controls in the DSS-induced colitis model. Following a 5-day DSS treatment, floxed female and male mice developed hypersensitivity to colon distension (Fig. 5A, D; females DSS vs water: $F_{1,42} = 17.67$, $p < 0.001$; pressure: $F_{3,126} = 20.11$ $p < 0.001$; males DSS vs water: $F_{1,45} = 27.22$, $p < 0.001$; pressure: $F_{3,135} = 5,487$ $p < 0.001$). No gender difference was observed ($F_{1,42} = 0.9735$, $p = 0.329$). Therefore, DSS increased colonic sensitivity in both male and female control floxed mice in the CRD assay.

We then assessed the effects of MOR and DOR deletion on DSS-induced hypersensitivity. Global MOR KO as well as peripheral MOR cKO mice of both genders showed a hypersensitivity similar to their floxed counterparts (Fig. 5B, females, genotype: $F_{2,28} = 0.499$, $p = 0.612$; pressure: $F_{3,84} = 18,54$ $p < 0.001$; Fig. 5E, males, genotype: $F_{2,25} = 1.513$, $p = 0.240$; pressure: $F_{3,75} = 25,18$ $p < 0.001$). Also, global DOR KO as well DOR Nav1.8-cKO mice displayed a similar DSS-induced hypersensitivity as compared to the floxed gender controls (Fig. 5C, females, genotype: $F_{2,33} = 1.672$, $p = 0.203$; pressure: $F_{3,99} = 16.58$, $p < 0.001$; Fig. 5F, males, genotype: $F_{2,30} = 0.357$, $p = 0.703$; pressure: $F_{3,90} = 17,21$ $p < 0.001$). Altogether, the results show that the lack of MOR or DOR, in the whole body or selectively in peripheral Nav1.8 did not aggravate DSS-induced colon hypersensitivity to CRD.

3.7. Colitis-induced alterations of colon parameters in mu and delta receptor mutants

We evaluated colonic damage induced by DSS in MOR and DOR mutant animals to correlate colitis severity with the CRD responses. Oral DSS treatment acts by disrupting the integrity of the gut epithelium. Damage to epithelial cell lining increases intestinal permeability to bacterial flora, thereby leading to inflammatory processes (Perse & Cerar,

2012). As shown in Fig. 3, DSS-induced colitis was characterized in males and females of all genotypes by macroscopic colonic tissue damage, an increase in colon wall thickness which reflects edema and a decrease in colon length caused by the retraction of the mucosa following the specific epithelial damage caused by DSS. No difference in colon length, thickness or macroscopic scores was observed between global and cKO MOR or DOR mutants and the respective floxed control animals (MOR females, length, genotype: F2,34 = 2.926, p=0.354; thickness, genotype F2,33 = 1.087, p=0.661; macroscopic score, genotype F2,34 = 1.679, p=0.202; MOR males, length, genotype: F2,31 = 2.783, p=0.077; thickness genotype F2,30 = 0.888, p=0.422; macroscopic score, genotype F2,31 = 1.061, p=0.358 ; DOR females, length, genotype: F2,40 = 0.419, p=0.661; thickness, genotype F2,42 = 1.121, p=0.355; macroscopic score, genotype F2,42 = 0.361, p=0.699; DOR males, length, genotype: F2,36 = 2.558, p=0.091; thickness, genotype F2,36 = 1.271, p=0.293; macroscopic score, genotype F2,36 = 0.1573, p=0.855) (Fig. 3A-C). Thus, endogenous MOR and DOR opioid endogenous activities do not play a major role in the regulation of acute (5-day) DSS-induced colon pathology.

4. Discussion

4.1. MOR and DOR global knockout mice show increased colon sensitivity in normal conditions

Here, we have shown an increase in visceromotor response to CRD in naïve MOR and DOR global KO mice, indicating that global activity at these two opioid receptors regulates basal visceral pain. A previous study has found a normal sensitivity to CRD in kappa opioid receptor KO mice (Larsson et al., 2008), and altogether this suggests that global MOR and DOR activities have major influences on the response to colon distension. In assays of visceral chemical nociception to intraperitoneal acetic acid, MOR KO mice showed diminished or normal writhing response (Sora et al., 1999; Weibel et al., 2013), DOR KO showed no phenotype (Filliol et al., 2000) and KOR KO mutants were more sensitive than wild-type mice (Simonin et al., 1998). Therefore, the three opioid receptor KO mouse lines have differential phenotypes depending on visceral pain assays (*i.e.* DSS and acetic acid), implying different processes. Furthermore, although MOR and DOR deletions enhanced colonic sensitivity in the CRD paradigm, the mechanisms underlying these endogenous tones may differ between mu and delta, as indicated by changes in the colon (more TNF- α , less Penk and IL-10 expression, increased colon thickness) of MOR KO but not DOR KO animals.

In gut tissue, enkephalins and dynorphins were reported as the only endogenous opioid peptides present, and MOR has the highest expression level, pointing out a key role of this receptor in colon function (Sternini et al., 2004). Our results show transcripts encoding MOR to be the most expressed in colon, followed by those encoding DOR and KOR. Also Penk mRNA expression levels were very high and higher than Pdyn. The present findings are in

accordance with previous expression data on rodent and human colonic tissues (Jimenez et al., 2006; Kimball et al., 2007; Poole et al., 2011; Wade et al., 2012; Boue et al., 2014). Given that Penk-derived peptides are known to target MOR and DOR while those derived from Pdyn target KOR (Kieffer & Gaveriaux-Ruff, 2002; Nadal et al., 2013), our results strengthen the pivotal role of MOR and DOR and their ligands in colon physiology. Transcripts for POMC were undetectable in the colon, whereas previous studies reported positive immunolabelling for beta-endorphin in human or mouse colonic tissue (Verma-Gandhu et al., 2006; Hughes et al., 2013). This may be caused by differences in experimental conditions including mouse strain and the use of immunohistochemistry rather than RT-PCR.

Whereas global MOR and DOR KO mice were more sensitive to CRD than floxed mice in basal conditions, no genotype difference was observed upon acute DSS-induced colitis. Beneficial effects of MOR agonists on colitis induced by 5-7 day DSS have been reported (Goldsmith et al., 2011; Anselmi et al., 2015). Morphine was more effective on the CRD response in naïve than TNBS-treated rats (Sengupta et al., 1999). Similarly to morphine, the delta opioid agonist DPDPE also reduced visceral sensitivity in naïve rats (Harada et al., 1995). Our results of enhanced colon sensitivity in naïve MOR KO mice are consistent with previous studies reporting that MOR KO mice were more susceptible to TNBS-induced colitis than controls (Philippe et al., 2003). The expression of MOR (Pol et al., 2005) and DOR (Pol et al., 2003) is known to increase during intestinal inflammation (croton oil in CD1 mice) but all MOR and DOR KO, cKO and floxed control mice exhibited similar hyperalgesia on day 5 of the DSS-induced colitis. Thus, the global opioid endogenous tone, strong enough to dampen CRD pain in normal conditions, remains insufficient to counteract visceral hypersensitivity associated with acute DSS-induced colitis. Our results are in line with previous studies showing that the inhibition of DSS-induced hypersensitivity occurs only ten

days after DSS treatment when adaptive T cell response takes place and the amounts of enkephalins locally produced by mucosal effector CD4⁺ T lymphocytes are widely increased (Boue et al., 2011; Boue et al., 2012; Boue et al., 2014).

4.2. Augmented TNF- α mRNA levels in colon of mu receptor mutant mice

In agreement with our previous findings (Philippe et al., 2003), TNF- α expression was increased in the colon of global MOR KO animals. Our past and present findings have been performed on mice with different genetic background, and therefore, in combination, strengthen the notion that the absence of MOR activity leads to an increase of TNF- α mRNA levels that may underlie higher visceral sensitivity. Accordingly, MOR agonists diminished colonic TNF α mRNA in mice and rats (Azuma & Ohura, 2002; Philippe et al., 2003; Goldsmith et al., 2011) as well as in organ cultures of human colonic biopsies (Philippe et al., 2006). Also, Penk transcript levels are decreased in the colon of MOR KO and cKO mice. As Penk activity has been shown to produce analgesia in somatic nociception assays (Noble et al., 2008), the lower Penk expression in MOR mutant mice may contribute to colon hypersensitivity. In addition, MOR KO animals displayed lower IL-10 transcript levels, linking the increased visceral response found here to the findings that anti-inflammatory molecules including IL-10 are altered in mouse models of persistent colorectal hypersensitivity in a condition-specific manner (La & Gebhart, 2014). Altogether, the pro-inflammatory shift found in colon of MOR mutant mice suggests that MOR endogenous tone would protect against colon hypersensitivity by mechanisms involving anti-inflammatory regulations.

4.3. Peripheral receptors vs global KO

The peripheral opioid receptors expressed on nociceptive Nav1.8⁺ neurons did not influence visceral nociception in basal conditions and did not protect from 5-day acute DSS-

induced hypersensitivity. Of interest, a recent study took advantage of the conditional expression of a fluorescent protein TdTomato in afferents expressing Nav1.8 to map visceral afferents in the mouse vagal and spinal nervous systems which express this particular sodium channel (Gautron et al., 2011). Strong fluorescence in afferent fibres and terminals enabled the observation of substantial innervations of the digestive tract by Nav1.8 expressing nociceptive neurons, and vagal terminal specializations were also described. These findings support the rich innervations of intestinal mucosa by Nav1.8-expressing afferents reported by others (Cervero, 1994). Interestingly, in the myenteric plexus, intraganglionic laminar endings that are mucosal terminals of vagal afferents known to be involved in tension detection have been clearly identified as expressing substantial fluorescence reflecting Nav1.8 expression. On the other hand, the similar acute colon response found here in Nav1.8-DOR and floxed controls is in accordance with the lack of DOR-eGFP signal on CGRP-immunoreactive fibers innervating colon mucosa of naïve DOR-eGFP mice (Poole et al., 2011), indicating that DOR on other terminals may be important for acute colon sensitivity in naïve animals. Our present results on cKO animals also fit with earlier findings on DOR and MOR Nav1.8 cKO mice, which showed that under basal conditions, peripheral receptors expressed by these neurons do not control nociception in a series of behavioral assays (Gaveriaux-Ruff et al., 2011; Weibel et al., 2013). Somatic inflammatory pain induced in the paw was aggravated in DOR cKO but not in MOR cKO mice. Compared to the present results, this suggests that the endogenous activity at DOR was high enough in the paw inflammation model to be detected, but not sufficient in the CRD model for naïve or 5-day DSS condition. Previous studies reported that supernatants from colon recovered at the later phase of DSS-induced colitis reduced excitability of isolated DRG neurons (Valdez-Morales et al., 2013), and that treatment with the peripheral opioid antagonist naloxone methiodide increased colon sensitivity (Boue et al., 2014), evidencing the presence of endogenous analgesic molecules. The difference between

present and former results may be due to several factors including lower levels of endogenous opioids at the colon site in our 5-day DSS or naïve mice, together with few CD4⁺ T lymphocytes producing opioids surrounding the peripheral endings of primary nociceptive neurons in naïve or 5-day DSS mice in the present study.

In conclusion, our present work with global KO mice for MOR and DOR shows that endogenous MOR and DOR general activity control basal colon sensitivity as assessed by visceromotor response to colorectal distension. By contrast, the same measures on cKO mice for MOR and DOR in Nav1.8 neurons show no major modulation by the receptors expressed in these sensory neurons, suggesting that other central or peripheral receptors including receptors on immune cells may also contribute to regulate basal colonic sensitivity (Sikandar et al., 2012; Meng et al., 2013; Sengupta et al., 2014; Jain et al., 2015; Meng et al., 2015).

Acknowledgements

We thank Hervé Maurin and Brigitte L Kieffer for discussions. We also thank Elise Le Marchand, Gilles Duval and Djemo Memedov at Mouse Clinic Institute (ICS) and IGBMC animal facilities for mouse care.

Author contributions

All authors discussed the results and commented on the manuscript. R.A.C. contributed to acquisition, analysis and interpretation of data, revising the article critically for important intellectual content and final approval of the version to be published. D.R. contributed to acquisition, analysis and interpretation of data, revising the article critically for important intellectual content and final approval of the version to be published. J.B. contributed to acquisition, analysis and interpretation of data, revising the article critically for important intellectual content and final approval of the version to be published. G.D. contributed to the study conception and design, analysis and interpretation of data, drafting and revising the article critically for important intellectual content and final approval of the version to be published. C.G.R. contributed to the study conception and design, analysis and interpretation of data, drafting and revising the article critically for important intellectual content and final approval of the version to be published

References

- Anselmi, L., Huynh, J., Duraffourd, C., Jaramillo, I., Vegezzi, G., Saccani, F., Boschetti, E., Brecha, N.C., De Giorgio, R. & Sternini, C. (2015) Activation of mu opioid receptors modulates inflammation in acute experimental colitis. *Neurogastroenterol Motil*, **27**, 509-523.
- Azuma, Y. & Ohura, K. (2002) Endomorphins 1 and 2 inhibit IL-10 and IL-12 production and innate immune functions, and potentiate NF-kappaB DNA binding in THP-1 differentiated to macrophage-like cells. *Scand J Immunol*, **56**, 260-269.
- Basso, L., Boue, J., Bourreille, A. & Dietrich, G. (2014) Endogenous regulation of inflammatory pain by T-cell-derived opioids: when friend turns to foe. *Inflamm Bowel Dis*, **20**, 1870-1877.
- Basso, L., Bourreille, A. & Dietrich, G. (2015) Intestinal inflammation and pain management. *Curr Opin Pharmacol* **25**, 50-55.
- Belvisi, M.G. & Hele, D.J. (2009) Cough sensors. III. Opioid and cannabinoid receptors on vagal sensory nerves. *Handb Exp Pharmacol*, 63-76.
- Bodnar, R.J. (2015) Endogenous opiates and behavior: 2014. *Peptides*, **75**, 18-70.
- Boue, J., Basso, L., Cenac, N., Blanpied, C., Rolli-Derkinderen, M., Neunlist, M., Vergnolle, N. & Dietrich, G. (2014) Endogenous regulation of visceral pain via production of opioids by colitogenic CD4(+) T cells in mice. *Gastroenterology*, **146**, 166-175.
- Boue, J., Blanpied, C., Brousset, P., Vergnolle, N. & Dietrich, G. (2011) Endogenous opioid-mediated analgesia is dependent on adaptive T cell response in mice. *J Immunol*, **186**, 5078-5084.
- Boue, J., Blanpied, C., Djata-Cabral, M., Pelletier, L., Vergnolle, N. & Dietrich, G. (2012) Immune conditions associated with CD4+ T effector-induced opioid release and analgesia. *Pain*, **153**, 485-493.
- Cenac, N., Andrews, C.N., Holzhausen, M., Chapman, K., Cottrell, G., Andrade-Gordon, P., Steinhoff, M., Barbara, G., Beck, P., Bunnett, N.W., Sharkey, K.A., Ferraz, J.G., Shaffer, E. & Vergnolle, N. (2007) Role for protease activity in visceral pain in irritable bowel syndrome. *J Clin Invest*, **117**, 636-647.
- Cervero, F. (1994) Sensory innervation of the viscera: peripheral basis of visceral pain. *Physiol Rev*, **74**, 95-138.
- Filliol, D., Ghozland, S., Chluba, J., Martin, M., Matthes, H.W., Simonin, F., Befort, K., Gaveriaux-Ruff, C., Dierich, A., LeMeur, M., Valverde, O., Maldonado, R. & Kieffer, B.L. (2000) Mice deficient for delta- and mu-opioid receptors exhibit opposing alterations of emotional responses. *Nat Genet*, **25**, 195-200.
- Gautron, L., Sakata, I., Udit, S., Zigman, J.M., Wood, J.N. & Elmquist, J.K. (2011) Genetic tracing of Nav1.8-expressing vagal afferents in the mouse. *J Comp Neurol*, **519**, 3085-3101.
- Gaveriaux-Ruff, C., Nozaki, C., Nadal, X., Hever, X.C., Weibel, R., Matifas, A., Reiss, D., Filliol, D., Nassar, M.A., Wood, J.N., Maldonado, R. & Kieffer, B.L. (2011) Genetic ablation of delta opioid receptors in nociceptive sensory neurons increases chronic pain and abolishes opioid analgesia. *Pain*, **152**, 1238-1248.
- Goldsmith, J.R., Uronis, J.M. & Jobin, C. (2011) Mu opioid signaling protects against acute murine

- intestinal injury in a manner involving Stat3 signaling. *Am J Pathol*, **179**, 673-683.
- Harada, Y., Nishioka, K., Kitahata, L.M., Nakatani, K. & Collins, J.G. (1995) Contrasting actions of intrathecal U50,488H, morphine, or [D-Pen2, D-Pen5] enkephalin or intravenous U50,488H on the visceromotor response to colorectal distension in the rat. *Anesthesiology*, **83**, 336-343.
- Hughes, P.A., Harrington, A.M., Castro, J., Liebrechts, T., Adam, B., Grasby, D.J., Isaacs, N.J., Maldeniya, L., Martin, C.M., Persson, J., Andrews, J.M., Holtmann, G., Blackshaw, L.A. & Brierley, S.M. (2013) Sensory neuro-immune interactions differ between irritable bowel syndrome subtypes. *Gut*, **62**, 1456-1465.
- Jain, P., Hassan, A.M., Koyani, C.N., Mayerhofer, R., Reichmann, F., Farzi, A., Schuligoi, R., Malle, E. & Holzer, P. (2015) Behavioral and molecular processing of visceral pain in the brain of mice: impact of colitis and psychological stress. *Front Behav Neurosci*, **9**, 177.
- Jimenez, N., Puig, M.M. & Pol, O. (2006) Antiexudative effects of opioids and expression of kappa- and delta-opioid receptors during intestinal inflammation in mice: involvement of nitric oxide. *J Pharmacol Exp Ther*, **316**, 261-270.
- Kieffer, B.L. & Gaveriaux-Ruff, C. (2002) Exploring the opioid system by gene knockout. *Prog Neurobiol*, **66**, 285-306.
- Kimball, E.S., Prouty, S.P., Pavlick, K.P., Wallace, N.H., Schneider, C.R. & Hornby, P.J. (2007) Stimulation of neuronal receptors, neuropeptides and cytokines during experimental oil of mustard colitis. *Neurogastroenterol Motil*, **19**, 390-400.
- Klein, S.L., Schiebinger, L., Stefanick, M.L., Cahill, L., Danska, J., de Vries, G.J., Kibbe, M.R., McCarthy, M.M., Mogil, J.S., Woodruff, T.K. & Zucker, I. (2015) Opinion: Sex inclusion in basic research drives discovery. *Proc Natl Acad Sci U S A*, **112**, 5257-5258.
- La, J.H. & Gebhart, G.F. (2014) Condition-specific role of colonic inflammatory molecules in persistent functional colorectal hypersensitivity in the mouse. *Neurogastroenterol Motil*, **26**, 1730-1742.
- Larsson, M.H., Bayati, A., Lindstrom, E. & Larsson, H. (2008) Involvement of kappa-opioid receptors in visceral nociception in mice. *Neurogastroenterol Motil*, **20**, 1157-1164.
- Laux-Biehlmann, A., Mouheiche, J., Veriepe, J. & Goumon, Y. (2013) Endogenous morphine and its metabolites in mammals: history, synthesis, localization and perspectives. *Neuroscience*, **233**, 95-117.
- McGrath, J.C., Drummond, G.B., McLachlan, E.M., Kilkeny, C. & Wainwright, C.L. (2010) Guidelines for reporting experiments involving animals: the ARRIVE guidelines. *Br J Pharmacol*, **160**, 1573-1576.
- Meng, J., Banerjee, S., Li, D., Sindberg, G.M., Wang, F., Ma, J. & Roy, S. (2015) Opioid Exacerbation of Gram-positive sepsis, induced by Gut Microbial Modulation, is Rescued by IL-17A Neutralization. *Sci Rep*, **5**, 10918.
- Meng, J., Yu, H., Ma, J., Wang, J., Banerjee, S., Charboneau, R., Barke, R.A. & Roy, S. (2013) Morphine induces bacterial translocation in mice by compromising intestinal barrier function in a TLR-dependent manner. *PLoS One*, **8**, e54040.
- Mogil, J.S. (2012) Sex differences in pain and pain inhibition: multiple explanations of a controversial phenomenon. *Nat Rev Neurosci*, **13**, 859-866.

- Mosinska, P., Zielinska, M. & Fichna, J. (2016) Expression and physiology of opioid receptors in the gastrointestinal tract. *Curr Opin Endocrinol Diabetes Obes*, **23**, 3-10.
- Nadal, X., La Porta, C., Andreea Bura, S. & Maldonado, R. (2013) Involvement of the opioid and cannabinoid systems in pain control: new insights from knockout studies. *Eur J Pharmacol*, **716**, 142-157.
- Neurath, M.F. (2014) Cytokines in inflammatory bowel disease. *Nat Rev Immunol*, **14**, 329-342.
- Noble, F., Benturquia, N., Bilkei-Gorzo, A., Zimmer, A. & Roques, B.P. (2008) Use of preproenkephalin knockout mice and selective inhibitors of enkephalinases to investigate the role of enkephalins in various behaviours. *Psychopharmacology (Berl)*, **196**, 327-335.
- Perse, M. & Cerar, A. (2012) Dextran sodium sulphate colitis mouse model: traps and tricks. *J Biomed Biotechnol*, **2012**, 718617.
- Philippe, D., Chakass, D., Thuru, X., Zerbib, P., Tsicopoulos, A., Geboes, K., Bulois, P., Bresse, M., Vorng, H., Gay, J., Colombel, J.F., Desreumaux, P. & Chamailard, M. (2006) Mu opioid receptor expression is increased in inflammatory bowel diseases: implications for homeostatic intestinal inflammation. *Gut*, **55**, 815-823.
- Philippe, D., Dubuquoy, L., Groux, H., Brun, V., Chuoi-Mariot, M.T., Gaveriaux-Ruff, C., Colombel, J.F., Kieffer, B.L. & Desreumaux, P. (2003) Anti-inflammatory properties of the mu opioid receptor support its use in the treatment of colon inflammation. *J Clin Invest*, **111**, 1329-1338.
- Pol, O., Palacio, J.R. & Puig, M.M. (2003) The expression of delta- and kappa-opioid receptor is enhanced during intestinal inflammation in mice. *J Pharmacol Exp Ther*, **306**, 455-462.
- Pol, O., Sasaki, M., Jimenez, N., Dawson, V.L., Dawson, T.M. & Puig, M.M. (2005) The involvement of nitric oxide in the enhanced expression of mu-opioid receptors during intestinal inflammation in mice. *Br J Pharmacol*, **145**, 758-766.
- Poole, D.P., Pelayo, J.C., Scherrer, G., Evans, C.J., Kieffer, B.L. & Bunnett, N.W. (2011) Localization and regulation of fluorescently labeled delta opioid receptor, expressed in enteric neurons of mice. *Gastroenterology*, **141**, 982-991 e981-988.
- Sengupta, J.N., Mickle, A., Kannampalli, P., Spruell, R., McRorie, J., Shaker, R. & Miranda, A. (2014) Visceral analgesic effect of 5-HT(4) receptor agonist in rats involves the rostroventral medulla (RVM). *Neuropharmacology*, **79**, 345-358.
- Sengupta, J.N., Snider, A., Su, X. & Gebhart, G.F. (1999) Effects of kappa opioids in the inflamed rat colon. *Pain*, **79**, 175-185.
- Sikandar, S., Bannister, K. & Dickenson, A.H. (2012) Brainstem facilitations and descending serotonergic controls contribute to visceral nociception but not pregabalin analgesia in rats. *Neurosci Lett*, **519**, 31-36.
- Simonin, F., Valverde, O., Smadja, C., Slowe, S., Kitchen, I., Dierich, A., Le Meur, M., Roques, B.P., Maldonado, R. & Kieffer, B.L. (1998) Disruption of the kappa-opioid receptor gene in mice enhances sensitivity to chemical visceral pain, impairs pharmacological actions of the selective kappa-agonist U-50,488H and attenuates morphine withdrawal. *EMBO J*, **17**, 886-897.
- Sobczak, M., Salaga, M., Storr, M.A. & Fichna, J. (2014) Physiology, signaling, and pharmacology of

- opioid receptors and their ligands in the gastrointestinal tract: current concepts and future perspectives. *J Gastroenterol*, **49**, 24-45.
- Sora, I., Li, X.F., Funada, M., Kinsey, S. & Uhl, G.R. (1999) Visceral chemical nociception in mice lacking mu-opioid receptors: effects of morphine, SNC80 and U-50,488. *Eur J Pharmacol*, **366**, R3-5.
- Stein, C. & Machelska, H. (2011) Modulation of peripheral sensory neurons by the immune system: implications for pain therapy. *Pharmacol Rev*, **63**, 860-881.
- Sternini, C., Patierno, S., Selmer, I.S. & Kirchgessner, A. (2004) The opioid system in the gastrointestinal tract. *Neurogastroenterol Motil*, **16 Suppl 2**, 3-16.
- Valdez-Morales, E., Guerrero-Alba, R., Ochoa-Cortes, F., Benson, J., Spreadbury, I., Hurlbut, D., Miranda-Morales, M., Lomax, A.E. & Vanner, S. (2013) Release of endogenous opioids during a chronic IBD model suppresses the excitability of colonic DRG neurons. *Neurogastroenterol Motil*, **25**, 39-46 e34.
- Verma-Gandhu, M., Bercik, P., Motomura, Y., Verdu, E.F., Khan, W.I., Blennerhassett, P.A., Wang, L., El-Sharkawy, R.T. & Collins, S.M. (2006) CD4+ T-cell modulation of visceral nociception in mice. *Gastroenterology*, **130**, 1721-1728.
- Verma-Gandhu, M., Verdu, E.F., Bercik, P., Blennerhassett, P.A., Al-Mutawaly, N., Ghia, J.E. & Collins, S.M. (2007) Visceral pain perception is determined by the duration of colitis and associated neuropeptide expression in the mouse. *Gut*, **56**, 358-364.
- Wade, P.R., Palmer, J.M., McKenney, S., Kenigs, V., Chevalier, K., Moore, B.A., Mabus, J.R., Saunders, P.R., Wallace, N.H., Schneider, C.R., Kimball, E.S., Breslin, H.J., He, W. & Hornby, P.J. (2012) Modulation of gastrointestinal function by MuDelta, a mixed micro opioid receptor agonist/ micro opioid receptor antagonist. *Br J Pharmacol*, **167**, 1111-1125.
- Weibel, R., Reiss, D., Karchewski, L., Gardon, O., Matifas, A., Filliol, D., Becker, J.A., Wood, J.N., Kieffer, B.L. & Gaveriaux-Ruff, C. (2013) Mu opioid receptors on primary afferent nav1.8 neurons contribute to opiate-induced analgesia: insight from conditional knockout mice. *PLoS One*, **8**, e74706.
- Wood, J.D. & Galligan, J.J. (2004) Function of opioids in the enteric nervous system. *Neurogastroenterol Motil*, **16 Suppl 2**, 17-28.

Figure legends

Figure 1. Female and male MOR and DOR floxed naïve mice show similar nociceptive responses to CRD. Colonic sensitivity was measured in floxed female (n=21) and floxed male (n=24) mice. Abdominal muscle contraction was recorded in response to incremental distention pressures of 15, 30 45 and 60 mmHg. Data is expressed as individual

measurements and mean values per group (black bars). Statistical analysis was performed using a two-way ANOVA.

Figure 2. Global MOR and DOR KO mice are more sensitive to CRD than cKO or floxed mice in normal conditions. Colonic sensitivity was measured in MOR and DOR global KO, cKO and floxed naïve mice. Recordings were attributed to experimental groups according to gender and genotype. Visceromotor responses (VMR) were recorded in response to incremental pressure application (15, 30, 45 and 60mmHg) in (A) MOR female mice, (B) MOR male mice, (C) DOR female and (D) DOR male mice. Data are expressed as mean +/- SEM, n=8-13/genotype/gender. Statistical analysis was performed using a two-way ANOVA followed by Tukey's post-hoc analysis when appropriate. ★ $P < 0.05$, ★★ $P < 0.01$, ★★★ $P < 0.001$ mutant vs floxed.

Figure 3. Colon macroscopic scores, length and wall thickness in naïve and 5-day DSS opioid receptor mutant mice. MOR and DOR floxed, global KO and cKO mice were killed after colorectal distention and colonic tissue damage was assessed by measuring colon length (A) wall thickness (B) and macroscopic scoring of tissue damage (C). Experimental groups were constituted according to gender, genotype and treatment. Baseline scores for naïve animals (left columns) are compared to the corresponding group treated with 5 days of DSS administration (right groups) side by side. Data are expressed as mean values +/- SEM. n=9-18 /genotype/gender/treatment. Statistical analysis was performed using one-way ANOVA with Tukey's correction when appropriate. ☆ $P < 0.05$, ☆☆ $P < 0.01$, ☆☆☆ $P < 0.001$ DSS vs water, ★ $P < 0.05$, mutant vs floxed.

Figure 4. Opioid and cytokine transcript expression in colon of naïve mutant and control

mice. Basal expression levels of transcripts for MOR, DOR and KOR as well as for the endogenous opioid peptide precursors Penk, Pdyn and POMC; and cytokines IL-1 β , TNF- α and IL10 were assessed in colon tissue of floxed mice by quantitative RT-PCR and are expressed relative to the expression of HPRTx10³ in colon tissue of floxed mice (A). Gene transcript levels in the colon of MOR and DOR cKO, global KO and floxed animals (B and C respectively) were measured by RT-qPCR; for opioid gene mRNA transcripts (B, left panel for Mu mice; C, left panel for Delta mice) and inflammatory cytokine gene mRNA transcripts (B, right panel for Mu mice; C, right panel for Delta mice). Data are represented as fold expression relative to levels in naïve floxed animals, n=8-10 /genotype. Statistical analysis was performed using one-way ANOVA followed by Dunnett's test. ★ $P < 0.05$, ★★ $P < 0.01$, ★★★ $P < 0.001$ mutant vs floxed; # $P = 0.075$ mutant vs floxed.

Figure 5. Five-day DSS treated MOR and DOR global KO, cKO and floxed mice show no difference in the CRD assay. Animals were administered 3% DSS in drinking water for 5 days and colonic sensitivity was measured in floxed, cKO and global KO mice for each receptor. Visceromotor muscle response (VMR) was recorded in response to incremental distention pressure application (15, 30, 45 and 60mmHg). VMR is represented in (A) for floxed female mice and in (D) floxed male mice. Colonic sensitivities of global MOR KO and peripheral cKO female (B) and male (E) mice were recorded and compared to floxed counterparts. As for MOR, colonic sensitivities in global DOR KO, cKO female and male mice were compared to the floxed gender controls after 5 days of DSS administration for both females and males (C and F respectively). Data presented as mean values of visceromotor response +/- SEM, n=23 floxed females, 23 floxed males and 8-14/genotype/sex for cKO and global KO animals. Statistical analysis was performed using two-way ANOVA followed by Tukey's post-hoc when needed. ★★ $P < 0.01$, ★★★ $P < 0.001$, DSS vs water.

Figure 1

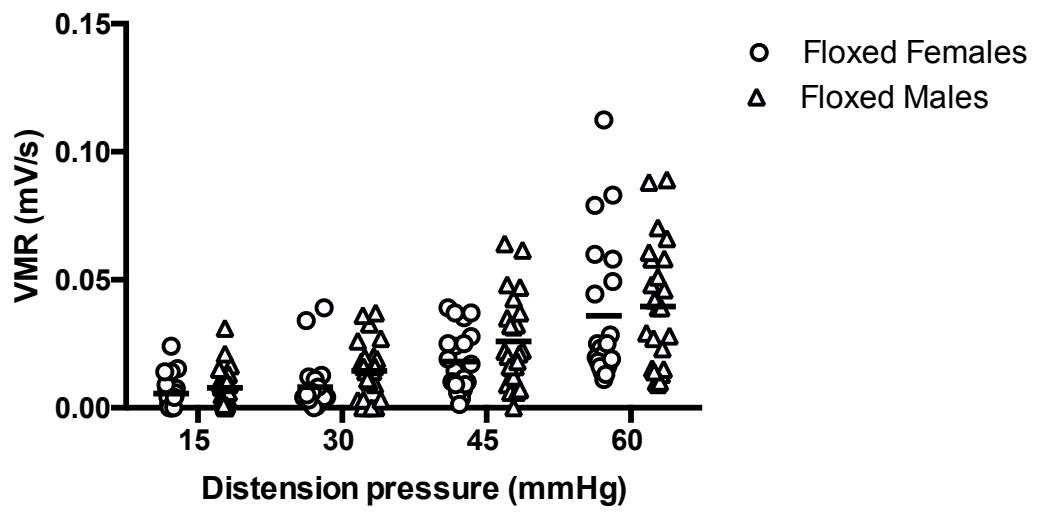

Figure 1

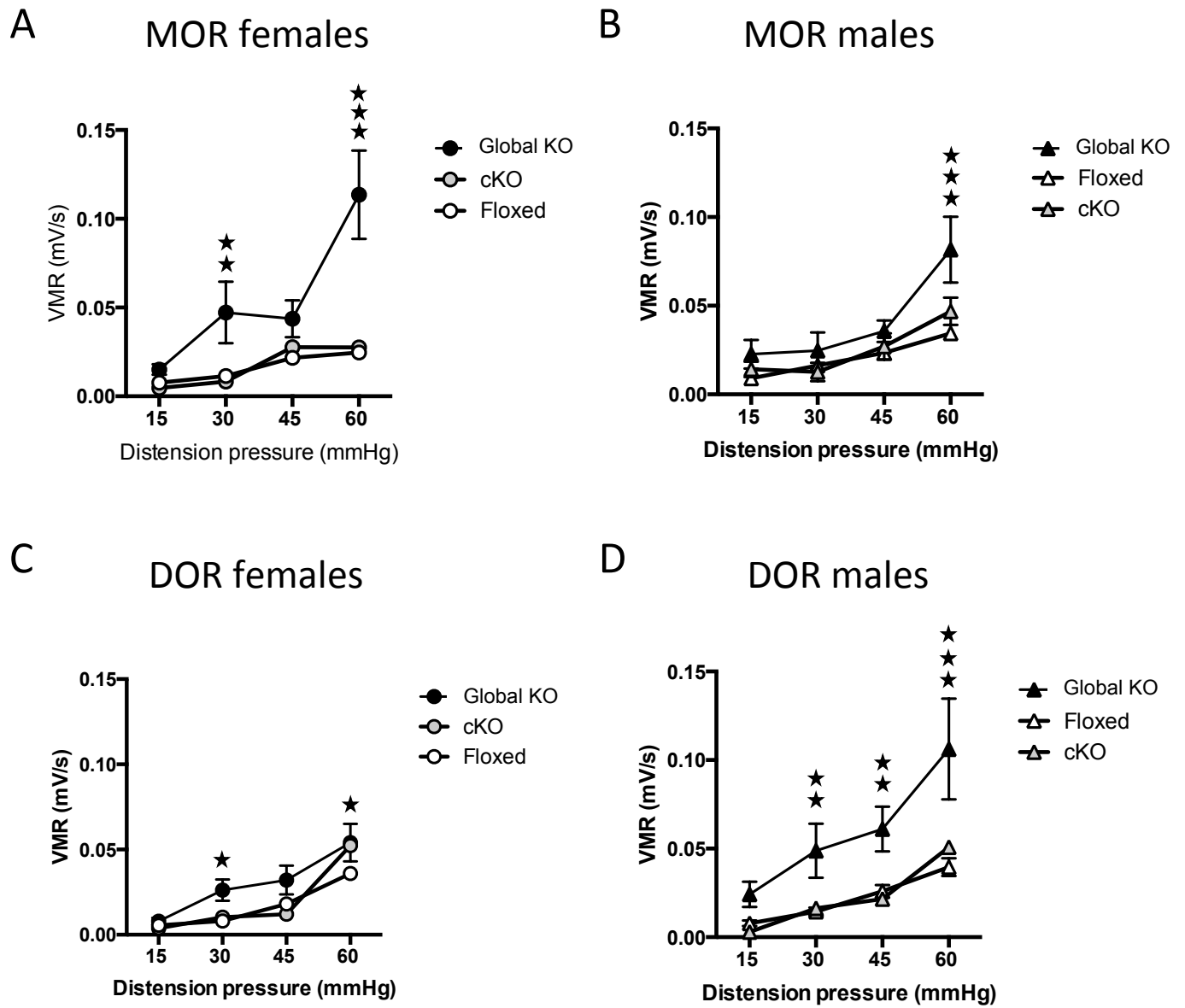

Figure 2

Figure 3

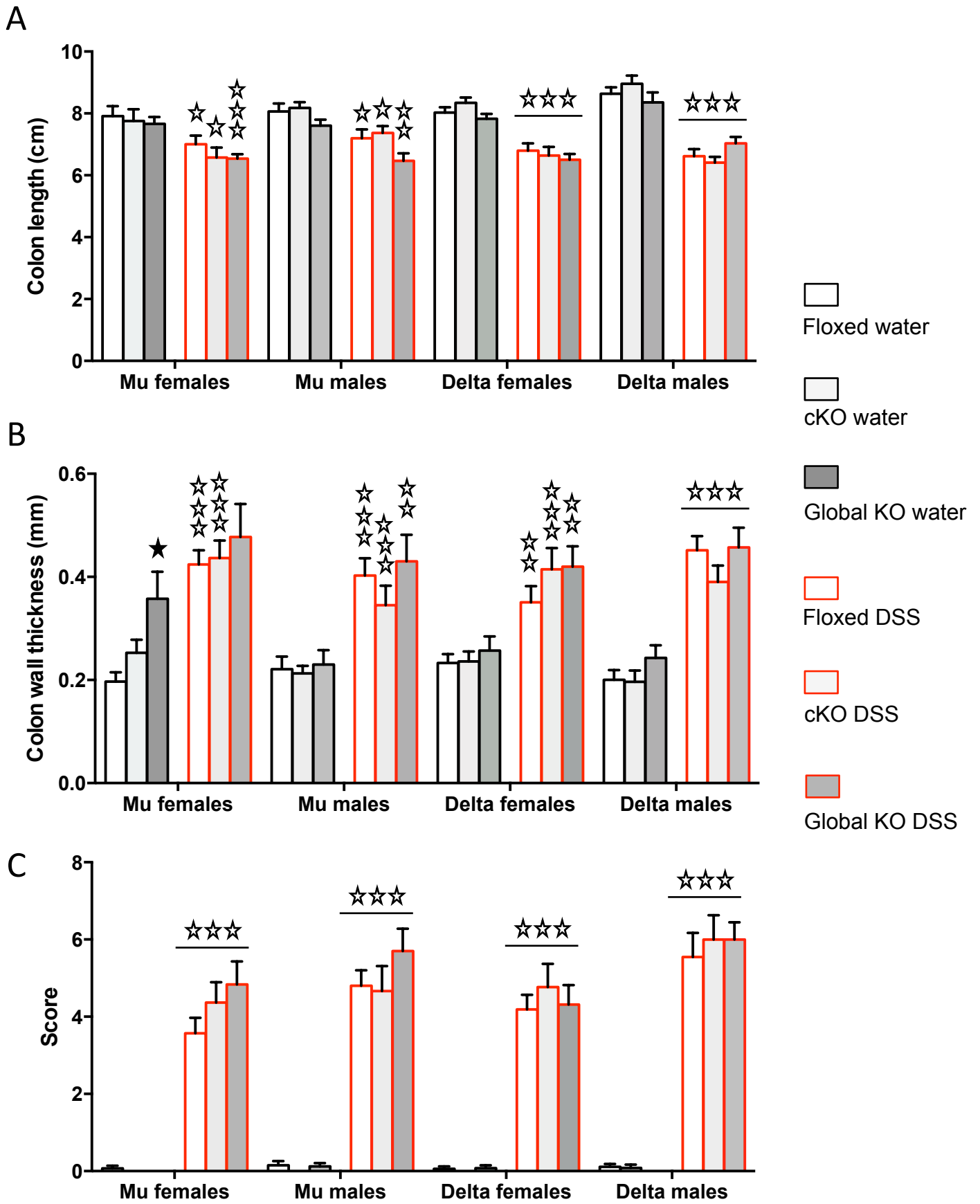

Figure 3

Figure 4

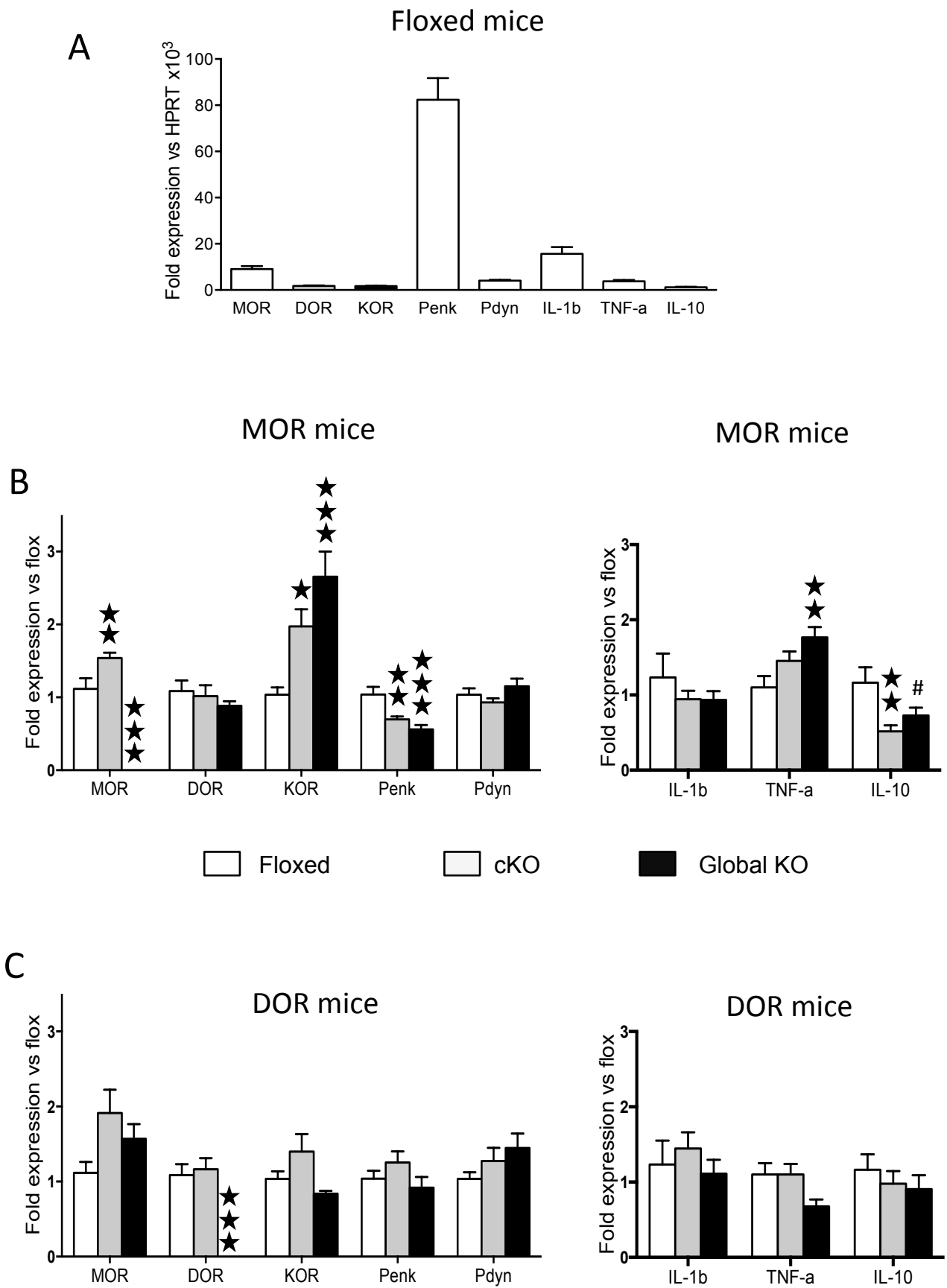

Figure 4

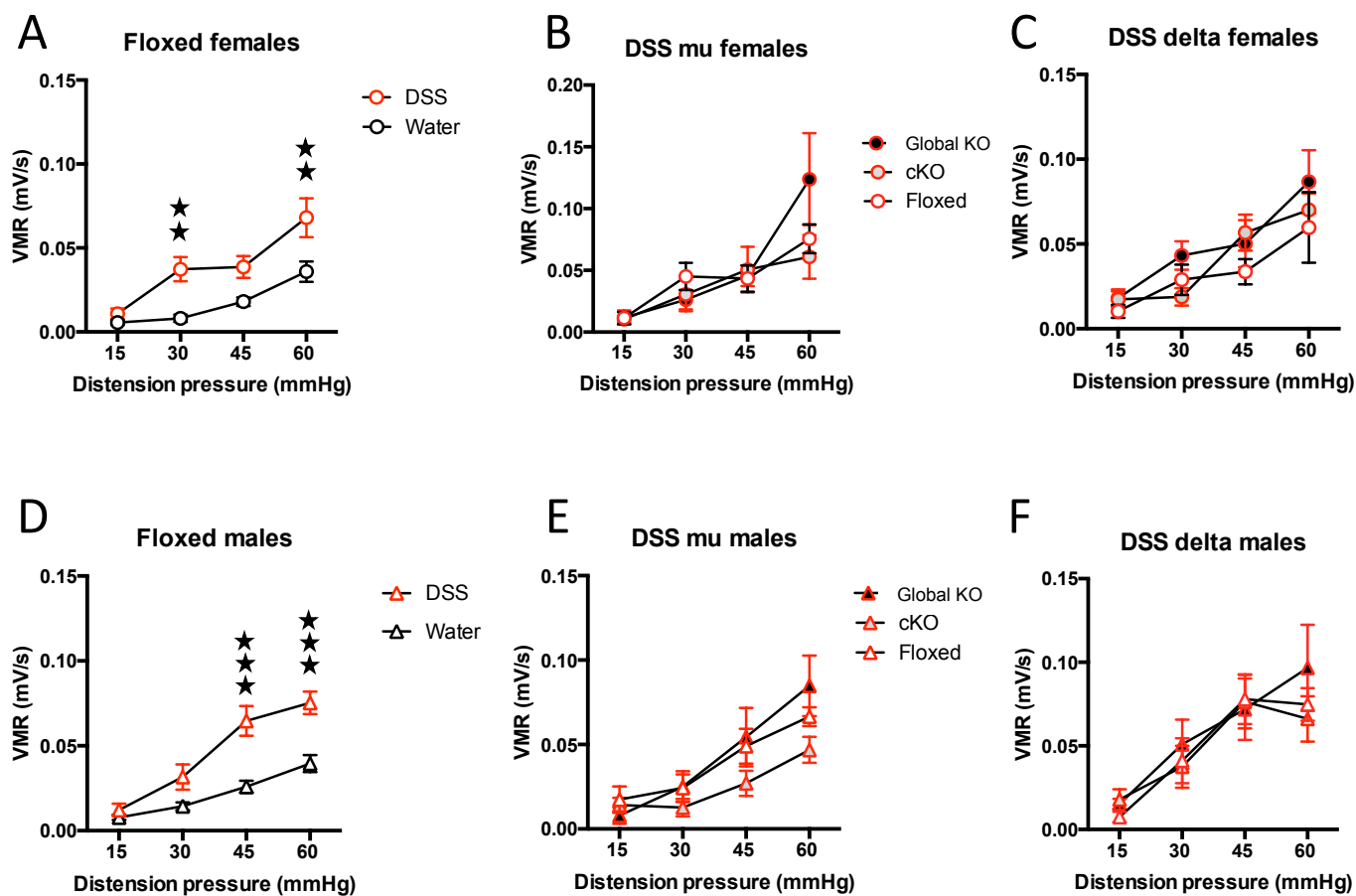

Figure 5

7. Chapter Five: Impact of Chronic Morphine on Delta Opioid Receptor-expressing Neurons in the Mouse

Hippocampus Erbs et al. (Published Article)

1. Introduction

Mapping of delta opioid receptor has been facilitated by the availability of knock-in DOPeGFP mice, which express functional delta opioid receptors in fusion with a green fluorescent protein (Scherrer et al., 2006), thus providing a valuable tool for studying delta opioid receptor localization and function in the central nervous system (Erbs et al., 2015; Faget et al., 2012; Rezai et al., 2013). Delta opioid receptor distribution in the brain has recently gathered interest, on account of the numerous physiological functions this receptor regulates, such as chronic pain, memory and emotional responses, as well as the large number of pathological processes which involve the DOP receptor, with special interest concerning DOP involvement in drug-context association (Le Merrer et al., 2009; Faget et al., 2012). Several studies have demonstrated that in the hippocampus under basal conditions, DOP receptor is expressed in GABAergic neurons (Erbs et al., 2012; Rezai et al., 2012).

In order to gain insight regarding the role of DOP receptors in drug-paired context association, we sought to further describe the changes in DOP receptor expression across hippocampal GABAergic neurons in detail, using the fluorescent knock-in DOPeGFP mice. We report that chronic morphine decreased the number of DOPeGFP expressing cells regardless of GABAergic subtype, and expression remained low in most populations of hippocampal neurons after four weeks of abstinence. Chronic morphine also induced subcellular redistribution of DOPeGFP receptor pools; with increased membrane translocation in hippocampal inhibitory interneurons. Functional consequences of cellular and subcellular changes in DOPeGFP expression in the hippocampus may include modifications of

hippocampal rhythmic activity following morphine exposure. These findings highlight the role of DOP receptors in modulation of hippocampal functions in drug-context associations.

IMPACT OF CHRONIC MORPHINE ON DELTA OPIOID RECEPTOR-EXPRESSING NEURONS IN THE MOUSE HIPPOCAMPUS

E. ERBS,^a L. FAGET,^{a†} R. A. CEREDIG,^b A. MATIFAS,^a
J.-L. VONESCH,^c B. L. KIEFFER^{a,d} AND
D. MASSOTTE^{a,b*}

^a Institut de Génétique et de Biologie Moléculaire et Cellulaire (IGBMC), CNRS/INSERM/UdS, 1 Rue Laurent Fries, F-67404 Illkirch-Graffenstaden, France

^b Institut des Neurosciences Cellulaires et Intégratives, UPR 3212, 5 Rue Blaise Pascal, F-67084 Strasbourg, France

^c Imaging Center IGBMC, CNRS/INSERM/UdS, 1 Rue Laurent Fries, F-67404 Illkirch-Graffenstaden, France

^d Douglas Hospital Research Center, Department of Psychiatry, McGill University, 6875, Boulevard LaSalle, Montreal (Quebec) H4H 1R3, Canada

Abstract—Delta opioid (DOP) receptors participate to the control of chronic pain and emotional responses. Recent data also identified their implication in spatial memory and drug-context associations pointing to a critical role of hippocampal delta receptors. To better appreciate the impact of repeated drug exposure on their modulatory activity, we used fluorescent knock-in mice that express a functional delta receptor fused at its carboxy-terminus with the green fluorescent protein in place of the native receptor. We then tested the impact of chronic morphine treatment on the density and distribution of delta receptor-expressing cells in the hippocampus. A decrease in delta receptor-positive cell density was observed in the CA1, CA3 and dentate gyrus without alteration of the distribution across the different GABAergic populations that mainly express delta receptors. This effect partly persisted after four weeks of morphine abstinence. In addition, we observed increased DOP receptor expression at the cell surface compared to saline-treated animals. In the hippocampus, chronic morphine administration thus induces DOP receptor cellular redistribution and durably decreases delta receptor-expressing cell density. Such modifications are likely to alter hippocampal physiology, and to contribute to long-term cognitive deficits. © 2015 IBRO. Published by Elsevier Ltd. All rights reserved.

Key words: G protein-coupled receptor, chronic morphine, delta opioid receptor, hippocampus, abstinence.

*Correspondence to: D. Massotte, Institut des Neurosciences Cellulaires et Intégratives, INCI UPR 3212, 5 Rue Blaise Pascal, F-67084 Strasbourg Cedex 03, France. Tel: +33-3-88-45-66-52.

E-mail address: d.massotte@unistra.fr (D. Massotte).

† Present address: Department of Neurosciences, UCSD, 9500 Gilman Drive, La Jolla, CA 92093, USA.

Abbreviations: DG, dentate gyrus; DOP, delta opioid; DOP-eGFP, DOP receptor in fusion with the enhanced green fluorescent protein; MOP, mu opioid.

<http://dx.doi.org/10.1016/j.neuroscience.2015.10.022>

0306-4522/© 2015 IBRO. Published by Elsevier Ltd. All rights reserved.

INTRODUCTION

Delta opioid (DOP) receptors are known to play a critical role in the control of emotional responses, including anxiety-like levels and depressive-like behaviors (Filliol et al., 2000). Only recently, their implication in spatial memory (Robles et al., 2003), drug-context associations using pavlovian place conditioning (Shippenberg et al., 2009; Le Merrer et al., 2011), context-induced reinstatement of drug seeking in rats trained to self-administer alcohol (Ciccocioppo et al., 2002; Marinelli et al., 2009) or context-induced withdrawal (Faget et al., 2012) has been recognized. Mu opioid (MOP) receptors on the other hand are extensively studied since they are the molecular targets of exogenous opiate alkaloids such as heroin or morphine that constitute a major class of drugs of abuse (Charbogne et al., 2014).

In previous studies, we mapped DOP receptors in the hippocampus using fluorescent knock-in mice expressing the DOP receptor in fusion with the enhanced green fluorescent protein (DOP-eGFP) (Erbs et al., 2012; Rezaei et al., 2012). These studies revealed that DOP receptors are mainly expressed in GABAergic interneurons with no functional receptors present in pyramidal cells.

Because of a growing interest for DOP receptor implication in drug-context association, the question arises whether chronic opiate administration affects DOP receptor expression in the hippocampus and whether changes elicited at the protein level persist after protracted abstinence. Using the fluorescent knock-in DOP-eGFP mice, we therefore examined the impact of chronic morphine treatment on the density and distribution across GABAergic populations of DOP receptor-expressing neurons in the dorsal hippocampus. We also examined the persistence of the changes following 4 weeks of abstinence, a time point where both behavioral and transcriptional long-term modifications are detectable (Goeldner et al., 2011; Le Merrer et al., 2012a).

EXPERIMENTAL PROCEDURES

Animals

DOP-eGFP knock-in mice expressing the DOP receptor fused to a green fluorescent protein were generated by homologous recombination. In these mice, the eGFP cDNA preceded by a five amino acid linker (G-S-I-A-T) was introduced into exon 3 of the DOP receptor gene,

in frame and 5' from the stop codon as described previously (Scherrer et al., 2006). The genetic background of all mice was C57/BL6J;129svPas (50:50%). Mice were housed in a temperature- and humidity-controlled animal facility ($21 \pm 2^\circ\text{C}$, $45 \pm 5\%$ humidity) on a 12-h dark-light cycle with food and water *ad libitum*. Male and female mice aged 8–12 weeks were used in all protocols. All experiments were performed in accordance with the European Communities Council Directive of 26 May 2010 and approved by the local ethics committee (Com'Eth 2010-003).

Drugs

Escalating doses of morphine (Francopia, Paris, France) ranging from 20 to 100 mg/kg were injected twice daily (i.p.) during 5 days. Control animals were injected twice daily with a saline solution.

Physical dependence to morphine was verified in a parallel group of mice ($n = 8$ per group). For this purpose, withdrawal syndrome was precipitated by a naloxone (Sigma, St Louis, MO, USA) injection (1 mg/kg, s.c.) 2 h after the last morphine injection (100 mg/kg) on day 6. A global withdrawal score was calculated as previously described (Berrendero et al., 2003). Following chronic morphine administration, abstinent animals were housed for 4 weeks in their home cages.

Antibody characterization

Mouse monoclonal antibodies raised against calbindin D-28K (Cat. Nr 300, Swant, Bellinzona, Switzerland, dilution 1:1000), parvalbumin (Cat. Nr 235, Swant, Bellinzona, Switzerland, dilution 1:1000), rat monoclonal antibodies raised against somatostatin (Cat. Nr MAB 354, Millipore, Billerica, MA, USA, dilution 1:100), rabbit polyclonal antibodies raised against eGFP (Cat. Nr A-6455, Molecular Probes, Paisley, UK, dilution 1:1000) and GAD65/67 (Cat. Nr G5163, Sigma, St Louis, MO, USA, dilution 1:2000) were used.

The following AlexaFluor conjugated secondary antibodies (Molecular Probes, Paisley, UK) were used: goat anti rabbit AlexaFluor 488 conjugate (Cat. Nr A-11034, dilution 1:2000), goat anti mouse IgG AlexaFluor 594 conjugate (Cat. Nr A-11005, dilution 1:500), goat anti rabbit IgG AlexaFluor 594 conjugate (Cat. Nr A-11012, dilution 1:2000), goat anti rat IgG AlexaFluor 594 conjugate (Cat. Nr 1-11007, dilution 1:500). Absence of cross-reactivity (rabbit/mouse, rabbit/rat) was systematically checked in control experiments for each antibody. Immunohistochemistry was also performed without primary antibodies to verify the absence of non-specific staining by the secondary antibody alone.

Tissue preparation and immunohistochemistry

Mice were anaesthetized with ketamine (Virbac, Carros, France)/xylazine (Rompun, Kiel, Germany) (100/10 mg/kg, i.p.) and perfused intracardially with 10 ml of 9.25% sucrose in PB 0.1 M pH 7.4 (Sigma, St Louis, MO, USA) followed by 50 ml of 4% paraformaldehyde (Sigma, St Louis, MO, USA) (at $2\text{--}4^\circ\text{C}$) in PB 0.1 M pH

7.4. Brains were post-fixed for 24 h at 4°C in the 4% PFA solution, cryoprotected at 4°C in a 30% sucrose (Sigma, St Louis, MO, USA), PB 0.1 M pH 7.4 solution and finally embedded in OCT (Optimal Cutting Temperature medium, Thermo Scientific) frozen and kept at -80°C . Brain sections ($30\ \mu\text{m}$ thick) were cut with a cryostat (CM3050, Leica) and kept floating in PB 0.1 M pH 7.4.

Immunohistochemistry was performed according to standard protocols. Briefly, $30\text{-}\mu\text{m}$ -thick sections were incubated in blocking solution (PB 0.1 M pH 7.4, 0.5% Triton X100 (Sigma, St Louis, MO, USA), 5% normal goat serum (Invitrogen, Paisley, UK) for 1 h at room temperature (RT). Sections were incubated overnight at 4°C in the blocking solution with appropriate primary antibodies. Sections were washed three times with PB 0.1 M pH 7.4, 0.5% Triton X100, incubated for 2 h at RT with appropriate AlexaFluor conjugated secondary antibodies. Sections were washed three times and mounted on SuperfrostTM glass (Menzel-Glaser) with Mowiol (Calbiochem, Darmstadt, Germany) and 4',6-diamidino-2-phenylindole (DAPI) (Roche Diagnostic, Mannheim, Germany) ($0.5\ \mu\text{g}/\text{ml}$). Double labeling was performed to co-localize DOR-eGFP with the chosen neuronal marker. For each neuronal marker, sections used for immunohistochemistry were distant by $150\ \mu\text{m}$. DOR-eGFP fluorescence was enhanced by detection with an anti-GFP antibody and a secondary antibody coupled to the AlexaFluor 488. Antibodies specific for the neuronal markers were detected with a secondary antibody coupled to the AlexaFluor 594. For co-localization with GAD65/67, single immunofluorescence labeling was performed using a secondary antibody coupled to the AlexaFluor 594 with no amplification of the eGFP fluorescence.

Image acquisition and analysis

Image acquisition was performed with the slide scanner NanoZoomer 2 HT and fluorescence module L11600-21 (Hamamatsu Photonics, Japan). The light source LX2000 (Hamamatsu Photonics, Japan) consisted in an ultra high-pressure mercury lamp coupled to an optical fiber. Single RGB acquisition was made in the epifluorescence mode with the 3-chip TDI camera equipped with a filter-set optimized for DAPI, fluorescein and tetramethylrhodamine detection. The scanner was equipped with a time delay integration camera and performed line scanning that offered fast acquisition at high resolution of the fluorescent signal. The acquisition was performed using a dry $20\times$ objective (NA: 0.75). The $40\times$ resolution was achieved with a lens converter. The latter mode used the full capacity of the camera (resolution: $0.23\ \mu\text{m}/\text{pixel}$).

Neurons expressing a given fluorescent marker were counted manually and blindly (3–4 sections par animal) on screen using the NDP viewer system with an integrated high-resolution zoom and equipped with a counter to simultaneously number two different objects. The NDP viewer also enables separation of the different fluorescent components. Neurons were considered as

immunopositive for a given neuronal marker when the red fluorescence was filling objects with a mean diameter of 12 μm that showed a DAPI-labeled nucleus. No threshold was applied to fluorescence detection. The counting three-dimensional box was delineated by the surface of the hippocampus ($2.035 \pm 0.025 \text{ mm}^2$) and the thickness of the slice ($27.5 \pm 0.3 \mu\text{m}$). The actual value of the latter was determined with a confocal microscope (SP2RS, Leica) using a $63\times$ oil objective (NA: 1.4) on nine randomly chosen sections with three independent measurements per section. Identification of each neuron according to its labeling (AlexaFluor 488 or AlexaFluor 594) was performed with the NDP counter which both prevented overcounting and overing. Colocalization between the green fluorescence associated with DOP expression and the red fluorescence associated with expression of the neuronal markers was determined manually for each stratum.

Counting was performed in the three well-described areas of the dorsal hippocampus (Bregma: -1.58 mm to -1.94 mm): the dentate gyrus (DG), the Ammon's horn 3 (CA3) and the Ammon's horn 1 (CA1) regions using the mouse Paxinos atlas as anatomical reference (Paxinos and Franklin, 2004, 2nd edition). Boundaries between internal hippocampal layers, as annotated in Fig. 2A, were manually defined with the NDP viewer accordingly to (Lister et al., 2005). Briefly, the hilus of the DG was defined as the entire polymorphic cellular layer enclosed between the two densely packed layers of dentate granule cells, but excluded the dense CA3 pyramidal cells that often extend into the hilus. Because of the small size of the CA2 subfield, it was grouped with the CA3 pyramidal layer. The border between CA3 and CA1 areas was identified where the large dense neurons of the CA3 give way to the smaller, more densely packed neurons of the CA1 pyramidal layer. Also, due to its small size, the prosubicular transition zone at the distal end of the CA1 pyramidal cells was included as part of the CA1 area. Surface areas of the different regions were systematically measured with the NDP viewer. Cell density values correspond to the total number of immunoreactive cells counted in the region of interest divided by the volume of the analyzed region.

Some samples were also observed with a confocal microscope (SP2RS, Leica) using $40\times$ (NA: 1.25) and $63\times$ (NA: 1.4) oil objectives and images were acquired with the LCS (Leica) software. Confocal acquisitions in the sequential mode (single excitation beams: 405, 488 and 568 nm) to avoid potential crosstalk between the different fluorescence emissions were also used to validate colocalizations. In addition, we checked for the penetration of each antibody by confocal microscopy. For each marker, two sections were randomly selected and stacks of 20 serial optical sections ($1.5 \mu\text{m}$ apart) were acquired. We did not detect any significant variation in the number of labeled cells with depth.

DOP-eGFP subcellular distribution

DOP-eGFP subcellular distribution was expressed as a ratio of membrane associated versus cytoplasmic fluorescence densities determined as described in

(Scherrer et al., 2006). Briefly, quantification of internalization was performed using the IMAGE J software on 8-bit raw confocal images from neurons randomly sampled in the CA1 and CA3 areas. Nuclear fluorescence was used to define the background level (no threshold was applied). Cytosolic fluorescence intensity was subtracted from whole-cell fluorescence intensity to obtain surface fluorescence intensity. Fluorescence intensity values were divided per surface unit (pixel) to obtain densities. Ratio of surface (Df surf) versus cytoplasmic (Df cyto) fluorescence densities was calculated to normalize data across neurons examined. A value of 1.0 results from equal densities of DOP-EGFP at the cell surface and in the cytoplasm.

Statistical analysis

Statistical analysis was performed with Graph-Pad Prism v4 (GraphPad, San Diego, CA, USA) or Statistica v10 (StatSoft, France). Two-way ANOVA (treatment \times region) analysis was performed to compare the impact of chronic morphine treatment and morphine abstinence across regions or layers followed by a one-way ANOVA with multiple comparisons using Tukey's test for post hoc analysis to compare changes between saline, chronic morphine and morphine-abstinent animals in each area or layer independently. Student's *t* test was used for behavioral analysis and for comparison of DOP-eGFP subcellular distribution between saline and chronic morphine conditions.

RESULTS

Chronic morphine administration induces physical dependence

Chronic administration of escalating doses of morphine is a robust treatment that induces drug dependence in mice (Matthes et al., 1996). We first verified that chronic

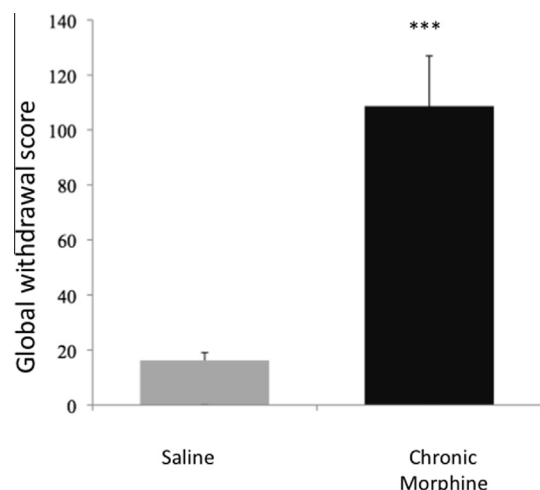

Fig. 1. Chronic morphine treatment induces a drug-dependent state in mice. Global score of pharmacological withdrawal precipitated by naloxone (1 mg/kg, s.c.) in mice treated with escalating doses of morphine (20, 40, 60, 80, 100 mg/kg) or in saline-treated controls ($n = 8$ per group). *** $p < 0.001$, Student's *t* test.

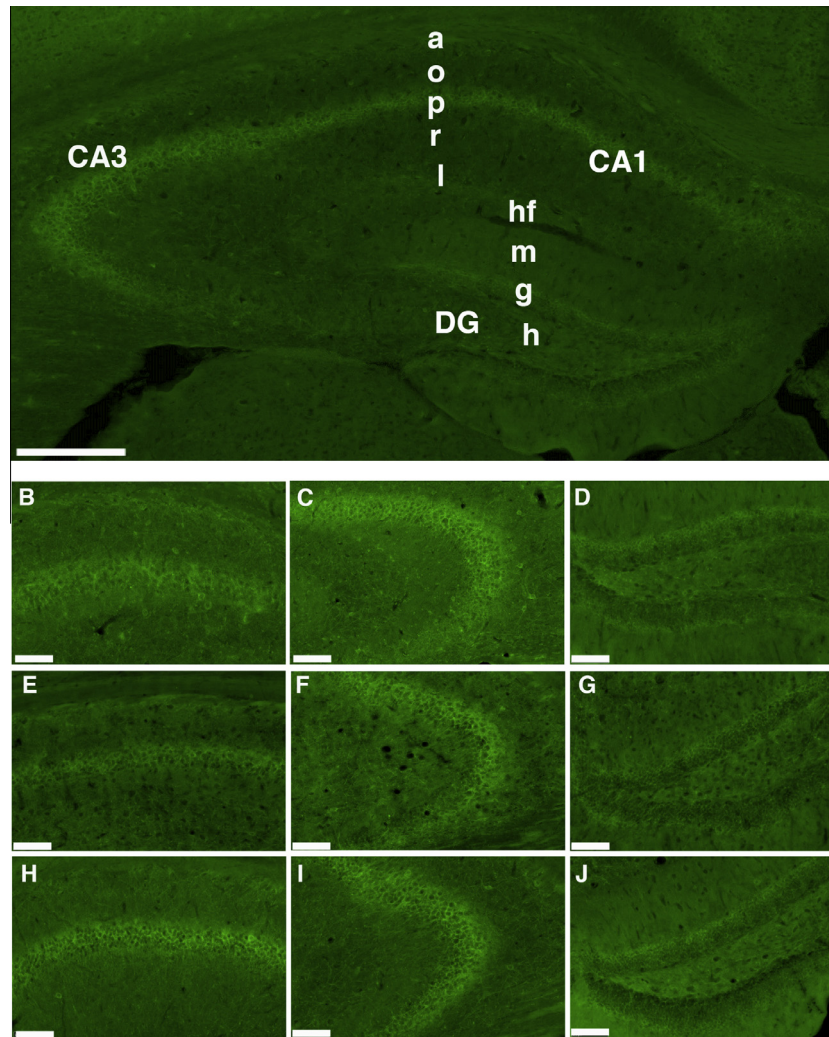

Fig. 2. Expression of DOP-eGFP neurons in naive, morphine-dependent and -abstinent mice. (A) General view of the dorsal hippocampus. DOP-eGFP fluorescence is amplified by immunohistochemistry using an anti-eGFP antibody revealed by a secondary AlexaFluor 488 conjugated antibody. Ammon's horn regions (CA1, CA3), alveus (a), stratum oriens (o), stratum pyramidale (p), stratum radiatum (r), stratum lacunosum moleculare (l) and hippocampal fissure (h.f.), dentate gyrus (DG), hilus (h), stratum granulosum (g), stratum moleculare (m). Scale bar = 250 μ m. (B–J) Enlargements in the CA1 (B, E, H), CA3 (C, F, I) and DG (D, G, J) of naïve (B–D), morphine-dependent (E–G) and morphine-abstinent (H–J) mice. Scale bar = 100 μ m.

morphine treatment indeed elicited physical dependence under our conditions. A group of mice chronically treated with escalating doses was subjected to naloxone-precipitated withdrawal. Somatic and vegetative signs (horizontal activity, paw and body tremors, head shakes and wet dog shakes, sniffing, jumps, ptosis, teeth chattering, piloerection and diarrhea) were scored. As expected, morphine-treated mice exhibited higher global withdrawal score compared to saline-treated animals (Fig. 1). Chronic morphine-treated animals therefore exhibited physical dependence.

Chronic morphine administration durably decreases the density of DOP-eGFP receptor-expressing neurons in the dorsal hippocampus

To address the impact of chronic morphine administration on DOP receptor expression and distribution in the

hippocampus, we explored changes in the density of DOP-eGFP-expressing neurons that took place in the different layers of the dorsal hippocampus after treatment with escalating doses of morphine (Fig. 2). DOP-eGFP was detected in the three regions of the hippocampus with no statistical difference between male and female mice. We first estimated the impact of chronic morphine and the persistence of the effect in the CA1, CA3 and DG. We observed a significant impact of the treatment (two-way ANOVA effect of treatment $F_{(4,78)} = 8.92$, $p < 0.001$, effect of region $F_{(2,78)} = 145.51$, $p < 0.0001$; interaction between treatment and region $F_{(4,78)} = 1.53$, $p = 0.2$). Statistically significant decrease in the density of DOP-eGFP-expressing neurons was identified in the CA1, CA3 and DG areas compared to saline-treated animals (Table 1).

We then focused on the persistence of the changes induced by escalating doses of morphine after 4 weeks

Table 1. DOR-eGFP distribution in saline, chronic morphine-treated and -abstinent mice

DOR-eGFP-expressing neurons (ND/mm ³)	Saline	Chronic morphine	Abstinent	Statistical analysis
Hippocampus	1554 ± 108	1167 ± 58*	1202 ± 69*	$F_{2,26} = 5.74, p = 0.0086$
CA1	1862 ± 126	1279 ± 61**	1394 ± 66*	$F_{2,26} = 9.23, p = 0.0009$
S. oriens	2493 ± 142	1998 ± 115*	2676 ± 132	$F_{2,26} = 5.64, p = 0.0092$
S. pyramidale	5034 ± 195	4101 ± 217*	3845 ± 358**	$F_{2,26} = 7.15, p = 0.0033$
S. radiatum	401 ± 52	330 ± 42	486 ± 53	$F_{2,26} = 1.86, p = 0.1766$
S. lacunosum moleculare	230 ± 44	290 ± 72	393 ± 71	$F_{2,26} = 1.67, p = 0.2079$
CA3	2490 ± 176	1925 ± 117*	1910 ± 92*	$F_{2,26} = 5.14, p = 0.0135$
S. oriens	1976 ± 135	2422 ± 246	2488 ± 345	$F_{2,26} = 1.75, p = 0.1945$
S. pyramidale	2897 ± 134	2325 ± 120*	2522 ± 133	$F_{2,26} = 5.27, p = 0.0120$
S. radiatum	995 ± 90	1137 ± 72	1103 ± 97	$F_{2,26} = 0.77, p = 0.4735$
DG	468 ± 38	346 ± 26*	376 ± 35	$F_{2,26} = 3.63, p = 0.0412$
Hilus	1619 ± 98	1192 ± 101*	1101 ± 106**	$F_{2,26} = 7.75, p = 0.0024$
S. granulare	511 ± 68	396 ± 47*	462 ± 123	$F_{2,26} = 0.64, p = 0.5356$
S. moleculare	147 ± 33	46 ± 18*	38 ± 15*	$F_{2,26} = 5.05, p = 0.0140$

Data are presented as mean ± SEM from 13 (saline), nine (chronic morphine) and seven (abstinent) animals respectively. One-way ANOVA was performed on each region or layer with Tukey's posthoc analysis. * $p < 0.05$, ** $p < 0.01$, significantly different from saline mice.

of protracted abstinence in DOP-eGFP mice (Fig. 2). This time frame was chosen since previous work indicated major modifications in emotional-like responses after such a period of abstinence, whereas signs of physical dependence are attenuated during protracted abstinence (Goeldner et al., 2011). Statistically significant decrease in DOP-eGFP-positive neurons persisted after 4 weeks of abstinence in the CA1 and CA3 areas as well as in the whole dorsal hippocampus (Table 1).

We also analyzed in more detail changes in DOP-eGFP expression across layers in the different hippocampal areas (Table 1). Chronic morphine decreased the density of DOP-eGFP-expressing neurons in the oriens and pyramidal layers of the CA1 area, the pyramidal layer of the CA3 area and in the hilus and molecular layer of the DG. After four weeks abstinence, changes persisted in the CA1 pyramidal layer and in the hilus and stratum moleculare of the DG (Table 1).

On the other hand, the density in GABAergic neurons, measured by GAD65/67 positive immunoreactivity, remained unaffected by chronic morphine treatment or morphine abstinence (two-way ANOVA, effect of treatment $F_{(2,72)} = 0.85, p = .43$; effect of region $F_{(2,72)} = 22.83, p < 0.0001$; interaction treatment × region $F_{(2,72)} = 1.34, p = 0.265$) (Fig. 3). No statistical significant changes were observed in the CA1 (2880 ± 231, 2442 ± 309 and 2678 ± 283 ND/mm³ for saline, chronic morphine and morphine-abstinent animals respectively, $F_{(2,24)} = 0.72, p = 0.499$), the CA3 (3698 ± 269, 3243 ± 394 and 3542 ± 363 ND/mm³ for saline, chronic morphine and morphine-abstinent animals respectively, $F_{(2,24)} = 0.46, p = 0.639$), the DG (1660 ± 181, 1791 ± 203 and 1791 ± 203 ND/mm³ for saline, chronic morphine and morphine-abstinent animals respectively, $F_{(2,24)} = 0.17, p = 0.842$) and globally in the hippocampus (2733 ± 205, 2460 ± 263 and 2635 ± 240 ND/mm³ for saline, chronic morphine and morphine-abstinent animals respectively, $F_{(2,24)} = 0.36, p = 0.699$) which suggests a specific loss in DOP receptor-expressing neurons.

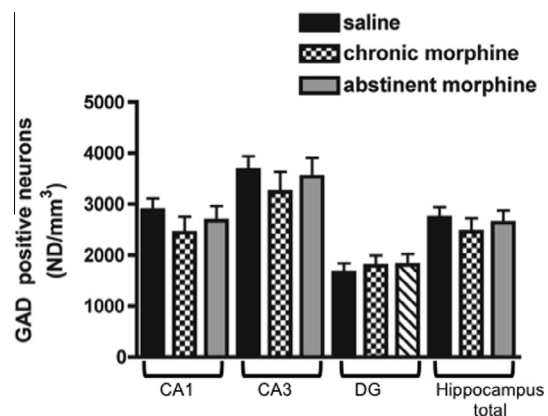

Fig. 3. Chronic morphine treatment does not affect the density of GAD 65/67-expressing neurons. The density of GAD 65/67-expressing neurons was similar in saline-treated mice ($n = 13$), mice chronically treated with morphine ($n = 8$) and mice after 4 weeks of morphine abstinence ($n = 6$) in the different regions of the hippocampus. Data are presented as mean ± SEM.

Altogether, data indicate that chronic morphine administration durably decreases DOP-eGFP expression throughout the dorsal hippocampus.

Chronic morphine administration does not modify the distribution of DOP-eGFP receptor-expressing neurons across GABAergic populations in the dorsal hippocampus

We then investigated whether chronic morphine specifically decreased the density of DOP-eGFP-expressing neurons among the different GABAergic populations previously identified in saline animals (Erbs et al., 2012). We compared the extent of co-localization between DOP-eGFP and parvalbumin, DOP-eGFP and calbindin or DOP-eGFP and somatostatin.

A global analysis showed no difference in the extent of co-localization with parvalbumin-positive neurons across hippocampal regions (effect of treatment $F_{(2,72)} = 1.52, p = 0.226$, effect of region $F_{(2,72)} = 2.26, p = 0.112$). In

the CA1, CA3 and DG of saline, chronic morphine and abstinent morphine mice, the percentage of DOP-eGFP-positive neurons expressing parvalbumin did not statistically differ (Fig. 4A; Table 2).

Similarly, no difference was observed in the extent of co-localization with calbindin-positive neurons across hippocampal regions (effect of treatment $F_{(2,60)} = 0.369$, $p = 0.693$, effect of region $F_{(2,60)} = 17.97$, $p < 0.001$).

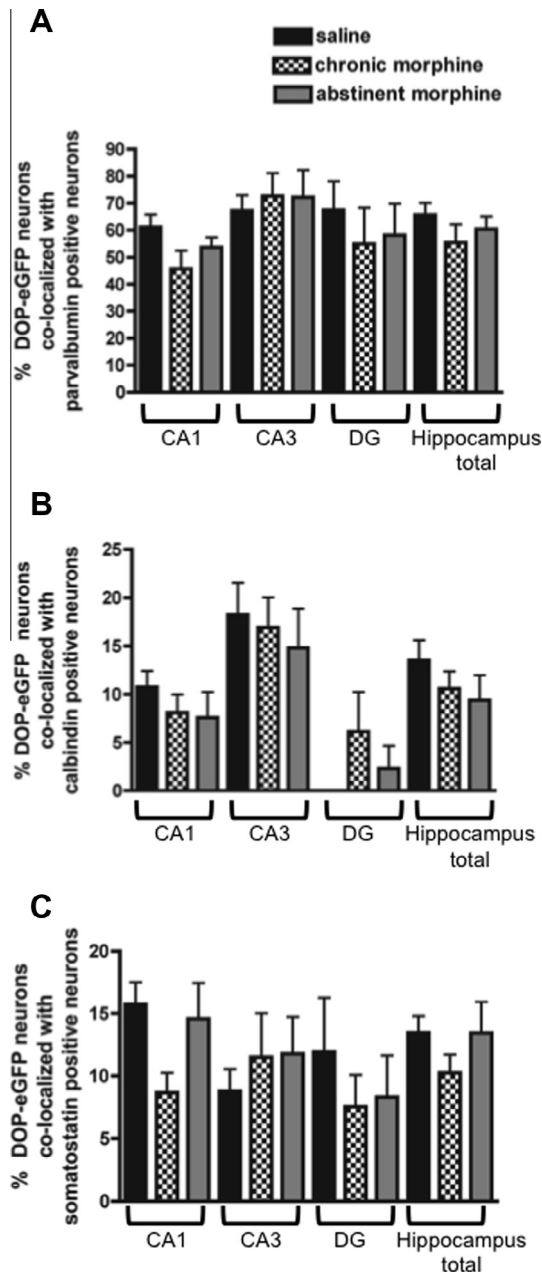

Fig. 4. Distribution of DOP-eGFP-expressing neurons in GABAergic populations in saline, morphine-dependent and morphine-abstinent mice. No change was observed in the extent of co-localization of DOP-eGFP-expressing neurons with parvalbumin (A), calbindin (B) or somatostatin (C)-positive populations in the different regions of the hippocampus. Co-localization with parvalbumin or somatostatin ($n = 13$ saline, $n = 8$ chronic morphine, $n = 6$ morphine abstinent). Co-localization with calbindin ($n = 12$ saline, $n = 7$ chronic morphine, $n = 5$ morphine abstinent). Data are presented as mean \pm SEM.

In the CA1 and CA3 of saline, chronic morphine and abstinent morphine mice, the percentage of DOP-eGFP-positive neurons expressing calbindin did not statistically differ whereas only rare colocalization between DOP-eGFP and calbindin was detected in the DG (Fig. 4B; Table 2).

A global analysis also showed no difference in the extent of co-localization with somatostatin-positive neurons across hippocampal regions (effect of treatment $F_{(2,72)} = 0.19$, $p = 0.822$, effect of region $F_{(2,72)} = 1.21$, $p = 0.306$). In the CA1, the percentage of DOP-eGFP-positive neurons expressing somatostatin decreased upon chronic morphine administration but without reaching statistical significance. No statistically significant change was observed in the CA3, and the DG (Fig. 4C; Table 2).

Detailed analysis of DOP-eGFP distribution in the CA1 and CA3 oriens and pyramidal layers or hilus of the DG revealed no statistically significant change after chronic morphine administration or in morphine-abstinent mice in the percentage of DOP-eGFP-positive neurons co-localized with parvalbumin (Fig. 5A; Table 2), calbindin (Fig. 5B; Table 2) or somatostatin-positive neurons (Fig. 5C; Table 2). Noteworthy, a decrease in the extent of co-localization with somatostatin was observed in the CA1 pyramidal layer after chronic morphine though not reaching statistical significance (Fig. 5C; Table 2).

Altogether, data indicate no change in DOP-eGFP distribution across the different GABAergic populations in chronic morphine and morphine-abstinent groups compared to the saline control.

Chronic morphine induces DOP-eGFP subcellular redistribution

We also investigated whether chronic morphine administration induced subcellular redistribution of DOP-eGFP by quantifying the fluorescence respectively associated with the membrane and cytoplasm (Fig. 6). The ratio of fluorescence associated with the cell surface compared to the fluorescence associated with the intracellular compartments was significantly increased after chronic morphine treatment (1.32 ± 0.04 versus 1.17 ± 0.03 in saline animals, Student's t test $p = 0.0033$) (Fig. 6C), which strongly suggests DOP-eGFP recruitment at the plasma membrane following chronic morphine administration compared to basal conditions.

DISCUSSION

In this study, we used DOP-eGFP knock-in mice to evaluate the impact of chronic morphine administration on DOP receptor distribution in the dorsal hippocampus as well as the persistence of changes after four weeks of morphine abstinence.

Impact of chronic morphine treatment

Chronic morphine significantly decreased DOP-eGFP expression in all areas of the dorsal hippocampus. On

Table 2. Distribution of DOP-eGFP-expressing neurons across GABAergic populations

Extent of co-localization with	Saline	Chronic morphine	Abstinent	Statistical analysis
Parvalbumin-positive neurons	%	%	%	
Hippocampus	66 ± 4	55 ± 7	60 ± 5	$F_{(2,24)} = 0.99, p = 0.385$
CA1	61 ± 5	46 ± 7	54 ± 4	$F_{(2,24)} = 2.27, p = 0.125$
S. oriens	55 ± 7	48 ± 11	56 ± 6	$F_{(2,24)} = 0.26, p = 0.776$
S. pyramidale	94 ± 8	91 ± 17	89 ± 12	$F_{(2,24)} = 0.041, p = 0.960$
CA3	67 ± 6	73 ± 8	72 ± 10	$F_{(2,24)} = 0.18, p = 0.836$
S. oriens	44 ± 5	57 ± 10	48 ± 11	$F_{(2,24)} = 0.85, p = 0.438$
S. pyramidale	94 ± 8	97 ± 15	97 ± 21	$F_{(2,24)} = 0.018, p = 0.982$
DG	68 ± 11	55 ± 13	58 ± 12	$F_{(2,24)} = 0.34, p = 0.715$
Hilus	79 ± 13	77 ± 14	73 ± 23	$F_{(2,24)} = 0.037, p = 0.964$
Calbindin-positive neurons				
Hippocampus	14 ± 2	11 ± 2	9 ± 3	$F_{(2,20)} = 0.97, p = 0.396$
CA1	11 ± 2	8 ± 2	8 ± 3	$F_{(2,20)} = 0.79, p = 0.466$
S. oriens	11 ± 2	12 ± 3	7 ± 3	$F_{(2,24)} = 0.70, p = 0.507$
S. pyramidale	1.5 ± 0.6	2.7 ± 1.4	5.7 ± 2.6	$F_{(2,24)} = 2.35, p = 0.120$
CA3	18 ± 3	17 ± 3	15 ± 4	$F_{(2,20)} = 0.214, p = 0.810$
S. oriens	18 ± 4	22 ± 6	26 ± 5	$F_{(2,24)} = 0.70, p = 0.507$
S. pyramidale	3.6 ± 1.9	1.7 ± 1.7	0 ± 0	$F_{(2,24)} = 0.84, p = 0.448$
DG	nd	nd	nd	
Somatostatin-positive neurons				
Hippocampus	14 ± 1	10 ± 2	14 ± 3	$F_{(2,24)} = 1.15, p = 0.333$
CA1	16 ± 2	9 ± 2	15 ± 3	$F_{(2,24)} = 3.12, p = 0.064$
S. oriens	31 ± 4	20 ± 4	33 ± 8	$F_{(2,24)} = 1.50, p = 0.243$
S. pyramidale	5.3 ± 1.8	0 ± 0	3.0 ± 1.4	$F_{(2,24)} = 2.98, p = 0.069$
CA3	9 ± 2	12 ± 4	12 ± 3	$F_{(2,24)} = 0.50, p = 0.616$
S. oriens	27 ± 5	22 ± 4	21 ± 7	$F_{(2,24)} = 0.49, p = 0.620$
S. pyramidale	6.7 ± 2.8	1.5 ± 1.5	3.5 ± 2.2	$F_{(2,24)} = 1.17, p = 0.329$
DG	12 ± 4	8 ± 3	8 ± 3	$F_{(2,24)} = 0.38, p = 0.688$
Hilus	24 ± 7	14 ± 6	22 ± 9	$F_{(2,24)} = 0.44, p = 0.649$

Data are presented as mean ± SEM from 13 (saline), eight (chronic morphine) and six (abstinent) animals respectively for colocalization with parvalbumin or somatostatin and from 12 (saline), seven (chronic morphine) and five (abstinent) animals respectively for colocalization with calbindin. One-way ANOVA was performed on each region or layer with Tukey's posthoc analysis.

the other hand, we observed no statistically significant decrease in the density of GABAergic neurons. Since DOP-GFP neurons represent at most one third of the GABAergic population (Erbs et al., 2012), this result is consistent with chronic morphine specifically affecting DOP-eGFP-expressing neurons rather than a general pro-apoptotic effect induced by chronic exposure to the drug (Atici et al., 2004; Liu et al., 2013). Interestingly, similar results were observed whether animals were injected daily with escalating doses (20–100 mg/kg) or at 30 mg/kg s.c. (data not shown), another protocol known to induce physical dependence (Faget et al., 2012). This is in agreement with a previous report in which similar impairment of the hippocampal function, in particular long-term potentiation and spatial memory, was observed after administration of escalating doses (20–100 mg/kg) or equal daily doses (20 mg/kg) of morphine that both induced physical dependence (Lu et al., 2010).

Importantly, the distribution of DOP-eGFP neurons across the different GABAergic populations remained unchanged after chronic morphine suggesting that the treatment does not target any particular population of

DOP-expressing neurons. In the CA1, DOP receptors are expressed in parvalbumin-, calbindin, and/or somatostatin-positive neurons that correspond to basket, chandelier and O-LM cells (Erbs et al., 2012). These neurons modulate and synchronize the firing frequency of principal cells. They are involved in the modulation of theta oscillations and scale excitatory input when pyramidal cells are most active (Somogyi and Klausberger, 2005; Klausberger, 2009). A decrease in the density of these neuronal populations would therefore result in reduced inhibition of the firing activity of the hippocampus. This is in line with the strong increase in theta rhythm observed in mice chronically treated with morphine (Liu et al., 2010). Theta oscillations occur during spatial navigation, learning and memory formation (Jinno and Kosaka, 2002; Somogyi and Klausberger, 2005; Klausberger and Somogyi, 2008; Klausberger, 2009) and previous reports indicated spatial memory impairment in heroin abusers (Ornstein et al., 2000) as well as in morphine-dependent rats (Zhang et al., 2005; Marinelli et al., 2007; Hu et al., 2010; Taubenfeld et al., 2010) and mice (Lu et al., 2010). It also supports a role

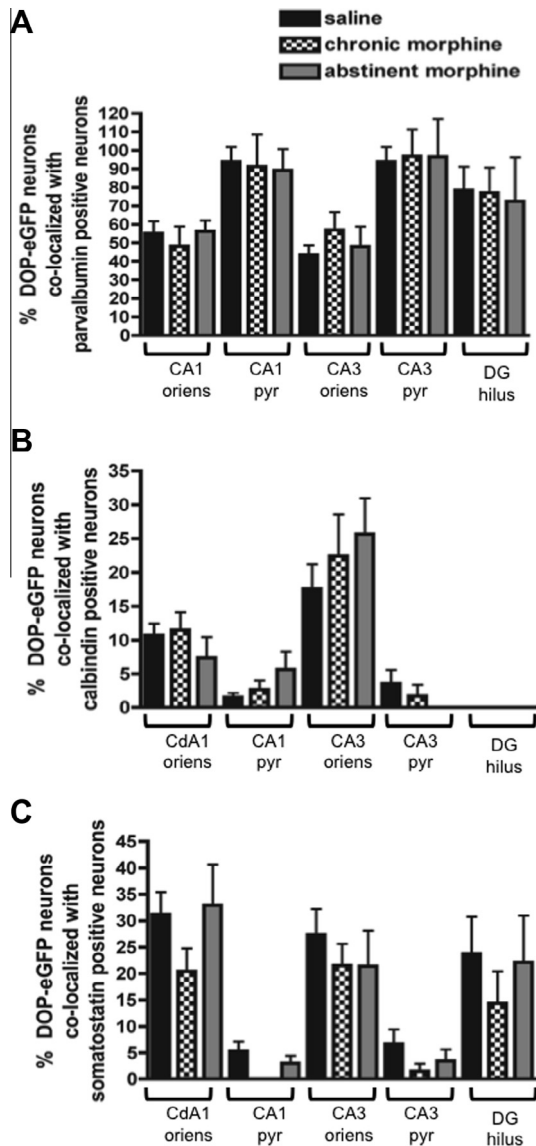

Fig. 5. Distribution of DOP-eGFP-expressing neurons in GABAergic populations across layers in saline, morphine-dependent and morphine-abstinent mice. No change was observed in the extent of co-localization of DOP-eGFP-expressing neurons with parvalbumin (A), calbindin (B) or somatostatin (C)-positive populations in the oris and pyramidal layers of the CA1 and CA3 areas or in hilus of the dentate gyrus from saline ($n = 13$), morphine-dependent ($n = 8$) and morphine-abstinent ($n = 6$) mice. Data are presented as mean \pm SEM.

for DOP receptors in drug-context associations (Ciccocioppo et al., 2002; Marinelli et al., 2009; Le Merrer et al., 2011, 2012b; Faget et al., 2012).

Chronic morphine treatment also increased DOP-eGFP expression at the neuronal surface. This result is in agreement with previous reports showing that chronic but not short-term morphine treatment induces translocation of DOP receptors from intracellular compartments to the plasma membrane in cortical neurons or *in vivo* in the spinal cord, basal ganglia and dorsal root ganglia (Cahill et al., 2001; Morinville et al., 2003; Lucido et al., 2005; Gendron et al., 2006), also recently reviewed in (Gendron et al., 2015). Importantly,

we observed increased receptor expression at the plasma membrane in neurons with significant DOP-eGFP expression under basal conditions indicating that the presence of the fused C-terminal fluorescent protein does not significantly impact on DOP receptor trafficking as already suggested by previous studies on DOP-eGFP internalization (Scherrer et al., 2006; Pradhan et al., 2009). Increased expression of DOP receptors at the surface of the neuron following chronic morphine treatment has been associated with increased receptor function. Electrophysiological recordings revealed that DOP receptors inhibited synaptic GABA release in neurons of the periaqueductal gray matter of mice chronically treated with morphine, an effect that was not detected in naive animals (Hack et al., 2005). In the brainstem, DOP receptor stimulation induced thermal analgesia in rats chronically treated with morphine that was not present in saline-treated animals (Ma et al., 2006). In the hippocampus, increased DOP receptor localization at the surface of the GABAergic interneurons would contribute to a decrease in the inhibitory control on the pyramidal cell firing leading to increased power of theta rhythm (Liu et al., 2010). Next to the decrease in density of DOP-eGFP-positive interneurons, this represents an additional mechanism to modulate/inhibit the activity of principal glutamatergic cells.

Increased export of DOP receptors to the neuronal surface following chronic morphine administration is mediated by MOP receptors (Morinville et al., 2004), also recently reviewed in (Gendron et al., 2015), the primary molecular target of morphine as established using MOP receptor-deficient mice (recently reviewed in (Charbogne et al., 2014)). Interestingly, DOP and MOP receptors co-localize in parvalbumin, calbindin and somatostatin-positive neurons where they can associate to form heteromers under basal conditions, as established by co-immunoprecipitation experiments (Erbs et al., 2014). MOP-DOP heteromerization has already been proposed as a possible mechanism to explain DOP receptor recruitment at the neuronal surface (Xie et al., 2009). Using antibodies specific for MOP-DOP heteromers, L.A. Devi's group showed that chronic morphine treatment increased MOP-DOP heteromers in the hippocampus (Gupta et al., 2010). Abundant co-expression is also detected in double fluorescent knock-in mice for DOP and MOP receptors after chronic morphine treatment (our own unpublished observations). Since increased DOP receptor activity may also contribute to the development of morphine tolerance, possible involvement of MOP-DOP heteromerization in the regulation of DOP receptor subcellular distribution now deserves in-depth investigation.

Persistence of changes after protracted abstinence

Neuronal adaptations in response to chronic morphine administration were evidenced not only at the behavioral level but also in gene expression (Ribeiro Do Couto et al., 2005; McClung, 2006; Befort et al., 2008; McClung and Nestler, 2008). However, long-term consequences of chronic morphine treatment remain poorly investigated (Goeldner et al., 2011; Le Merrer et al.,

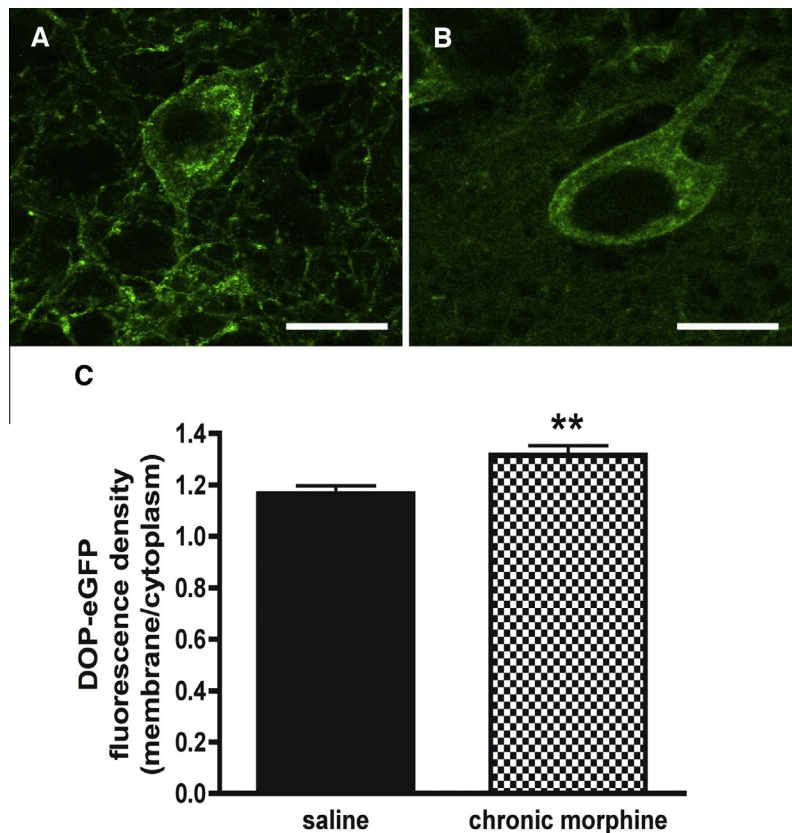

Fig. 6. Chronic morphine administration induces DOP-eGFP subcellular redistribution. Representative fluorescence micrographs of a DOP-eGFP-expressing neuron in saline (A) or chronic morphine-treated (B) animal. Scale bar = 10 μ m. (C) DOP-eGFP subcellular redistribution expressed as a ratio of membrane-associated versus intracellular fluorescence densities is increased after chronic morphine administration. Data are presented as mean \pm SEM ($n = 25$). ** $p < 0.01$ compared to saline.

2012a). Modifications in dendrites and dendritic spine density induced by chronic opiates were reported in different brain regions, including the hippocampal formation, and persisted for at least one month in rats (Robinson et al., 2002; Robinson and Kolb, 2004).

Here, we provide evidence that the impact of chronic morphine administration on DOP receptor expression persists after four weeks of abstinence. Indeed, changes in DOP-eGFP expression were maintained in the CA3 and CA1 areas, in particular in the CA1 pyramidal layer as well as in the hilus and molecular layer of the DG. The long-lasting decrease in the CA1 principal layer indicates persistent alteration in the modulatory control exerted on glutamatergic cell activity in abstinent animals that likely contributes to long-term perturbations of memory processes and needs to be further explored.

CONCLUSION

We have shown that chronic morphine treatment decreases the density of DOP-expressing neurons in the dorsal hippocampus and that this effect persists after four weeks of abstinence. Chronic morphine treatment also promotes DOP receptor recruitment at the plasma membrane. Both alterations likely alter the

rhythmic activity of the hippocampus and, hence, may underlie long-standing alterations of specific cognitive functions in abstinent individuals.

Acknowledgments—We thank Dr K. Befort for critical reading and Dr A. Pereira-de Vasconcelos for help with the statistical analysis. We are grateful to Hamamatsu Photonics for allowing access to the NanoZoomer 2HT acquisition and NDP viewer systems. This work was supported by NIDA Center for Opioid Receptors and Drugs of Abuse (#DA 005010), ANR, CNRS, Inserm and University Strasbourg. LF was a recipient of a region Alsace PhD fellowship.

REFERENCES

- Atici S, Cinel L, Cinel I, Doruk N, Aktekin M, Akca A, Camdeviren H, Oral U (2004) Opioid neurotoxicity: comparison of morphine and tramadol in an experimental rat model. *Int J Neurosci* 114:1001–1011.
- Befort K, Filliol D, Ghate A, Darcq E, Matifas A, Muller J, Lardenois A, Thibault C, Dembele D, Le Merrer J, Becker JA, Poch O, Kieffer BL (2008) Mu-opioid receptor activation induces transcriptional plasticity in the central extended amygdala. *Eur J Neurosci* 27:2973–2984.
- Berrendero F, Castane A, Ledent C, Parmentier M, Maldonado R, Valverde O (2003) Increase of morphine withdrawal in mice lacking A2a receptors and no changes in CB1/A2a double knockout mice. *Eur J Neurosci* 17:315–324.

- Cahill CM, Morinville A, Lee MC, Vincent JP, Collier B, Beaudet A (2001) Prolonged morphine treatment targets delta opioid receptors to neuronal plasma membranes and enhances delta-mediated antinociception. *J Neurosci* 21:7598–7607.
- Charbogne P, Kieffer BL, Befort K (2014) 15 years of genetic approaches in vivo for addiction research: opioid receptor and peptide gene knockout in mouse models of drug abuse. *Neuropharmacology* 76(Pt B):204–217.
- Ciccocioppo R, Martin-Fardon R, Weiss F (2002) Effect of selective blockade of mu(1) or delta opioid receptors on reinstatement of alcohol-seeking behavior by drug-associated stimuli in rats. *Neuropsychopharmacology* 27:391–399.
- Erbs E, Faget L, Scherrer G, Kessler P, Hentsch D, Vonesch JL, Matifas A, Kieffer BL, Massotte D (2012) Distribution of delta opioid receptor-expressing neurons in the mouse hippocampus. *Neuroscience* 221:203–213.
- Erbs E, Faget L, Scherrer G, Matifas A, Filliol D, Vonesch J-L, Koch M, Kessler P, Hentsch D, Birling M-C, Koutsourakis M, Vasseur L, Veinante P, Kieffer BL, Massotte D (2014) A mu-delta opioid receptor brain atlas reveals neuronal co-occurrence in subcortical networks. *Brain Struct Funct*. <http://dx.doi.org/10.1007/s00429-014-0717-9>.
- Faget L, Erbs E, Le Merrer J, Scherrer G, Matifas A, Benturquia N, Noble F, Decossas M, Koch M, Kessler P, Vonesch JL, Schwab Y, Kieffer BL, Massotte D (2012) In vivo visualization of delta opioid receptors upon physiological activation uncovers a distinct internalization profile. *J Neurosci* 32:7301–7310.
- Filliol D, Ghozland S, Chluba J, Martin M, Matthes HW, Simonin F, Befort K, Gaveriaux-Ruff C, Dierich A, LeMeur M, Valverde O, Maldonado R, Kieffer BL (2000) Mice deficient for delta- and mu-opioid receptors exhibit opposing alterations of emotional responses. *Nat Genet* 25:195–200.
- Gendron L, Lucido AL, Mennicken F, O'Donnell D, Vincent JP, Stroh T, Beaudet A (2006) Morphine and pain-related stimuli enhance cell surface availability of somatic delta-opioid receptors in rat dorsal root ganglia. *J Neurosci* 26:953–962.
- Gendron L, Mittal N, Beaudry H, Walwyn W (2015) Recent advances on the delta opioid receptor: from trafficking to function. *Br J Pharmacol* 172:403–419.
- Goeldner C, Lutz PE, Darcq E, Halter T, Clesse D, Ouagazzal AM, Kieffer BL (2011) Impaired emotional-like behavior and serotonergic function during protracted abstinence from chronic morphine. *Biol Psychiatry* 69:236–244.
- Gupta A, Mulder J, Gomes I, Rozenfeld R, Bushlin I, Ong E, Lim M, Maillet E, Junek M, Cahill CM, Harkany T, Devi LA (2010) Increased abundance of opioid receptor heteromers after chronic morphine administration. *Sci Signal* 3:ra54.
- Hack SP, Bagley EE, Chieng BC, Christie MJ (2005) Induction of delta-opioid receptor function in the midbrain after chronic morphine treatment. *J Neurosci* 25:3192–3198.
- Hu Y, Liu P, Guo DH, Rahman K, Wang DX, Xie TT (2010) Antidepressant effects of the extract YZ-50 from *Polygala tenuifolia* in chronic mild stress treated rats and its possible mechanisms. *Pharm Biol* 48:794–800.
- Jinno S, Kosaka T (2002) Immunocytochemical characterization of hippocamposeptal projecting GABAergic nonprincipal neurons in the mouse brain: a retrograde labeling study. *Brain Res* 945:219–231.
- Klausberger T (2009) GABAergic interneurons targeting dendrites of pyramidal cells in the CA1 area of the hippocampus. *Eur J Neurosci* 30:947–957.
- Klausberger T, Somogyi P (2008) Neuronal diversity and temporal dynamics: the unity of hippocampal circuit operations. *Science* 321:53–57.
- Le Merrer J, Befort K, Gardon O, Filliol D, Darcq E, Dembele D, Becker JA, Kieffer BL (2012a) Protracted abstinence from distinct drugs of abuse shows regulation of a common gene network. *Addict Biol* 17:1–12.
- Le Merrer J, Faget L, Matifas A, Kieffer BL (2012b) Cues predicting drug or food reward restore morphine-induced place conditioning in mice lacking delta opioid receptors. *Psychopharmacology* 223:99–106.
- Le Merrer J, Plaza-Zabala A, Del Boca C, Matifas A, Maldonado R, Kieffer BL (2011) Deletion of the delta opioid receptor gene impairs place conditioning but preserves morphine reinforcement. *Biol Psychiatry* 69:700–703.
- Lister JP, Blatt GJ, DeBassio WA, Kemper TL, Tonkiss J, Galler JR, Rosene DL (2005) Effect of prenatal protein malnutrition on numbers of neurons in the principal cell layers of the adult rat hippocampal formation. *Hippocampus* 15:393–403.
- Liu F, Jiang H, Zhong W, Wu X, Luo J (2010) Changes in ensemble activity of hippocampus CA1 neurons induced by chronic morphine administration in freely behaving mice. *Neuroscience* 171:747–759.
- Liu LW, Lu J, Wang XH, Fu SK, Li Q, Lin FQ (2013) Neuronal apoptosis in morphine addiction and its molecular mechanism. *Int J Clin Exp Med* 6:540–545.
- Lu G, Zhou QX, Kang S, Li QL, Zhao LC, Chen JD, Sun JF, Cao J, Wang YJ, Chen J, Chen XY, Zhong DF, Chi ZQ, Xu L, Liu JG (2010) Chronic morphine treatment impaired hippocampal long-term potentiation and spatial memory via accumulation of extracellular adenosine acting on adenosine A1 receptors. *J Neurosci* 30:5058–5070.
- Lucido AL, Morinville A, Gendron L, Stroh T, Beaudet A (2005) Prolonged morphine treatment selectively increases membrane recruitment of delta-opioid receptors in mouse basal ganglia. *J Mol Neurosci* 25:207–214.
- Ma J, Zhang Y, Kalyuzhny AE, Pan ZZ (2006) Emergence of functional delta-opioid receptors induced by long-term treatment with morphine. *Mol Pharmacol* 69:1137–1145.
- Marinelli PW, Funk D, Harding S, Li Z, Juzytsch W, Le AD (2009) Roles of opioid receptor subtypes in mediating alcohol-seeking induced by discrete cues and context. *Eur J Neurosci* 30:671–678.
- Marinelli PW, Funk D, Juzytsch W, Li Z, Le AD (2007) Effects of opioid receptor blockade on the renewal of alcohol seeking induced by context: relationship to c-fos mRNA expression. *Eur J Neurosci* 26:2815–2823.
- Matthes HWD, Maldonado R, Simonin F, Valverde O, Slowe S, Kitchen I, Befort K, Dierich A, Le Meur M, Dollé P, Tzavara E, Hanoune J, Roques B, Kieffer BL (1996) Loss of morphine-induced analgesia, reward effect and withdrawal symptoms in mice lacking the μ -opioid-receptor gene. *Nature* 383:819–823.
- McClung CA (2006) The molecular mechanisms of morphine addiction. *Rev Neurosci* 17:393–402.
- McClung CA, Nestler EJ (2008) Neuroplasticity mediated by altered gene expression. *Neuropsychopharmacology* 33:3–17.
- Morinville A, Cahill CM, Esdaile MJ, Aibak H, Collier B, Kieffer BL, Beaudet A (2003) Regulation of delta-opioid receptor trafficking via mu-opioid receptor stimulation: evidence from mu-opioid receptor knock-out mice. *J Neurosci* 23:4888–4898.
- Morinville A, Cahill CM, Kieffer B, Collier B, Beaudet A (2004) Mu-opioid receptor knockout prevents changes in delta-opioid receptor trafficking induced by chronic inflammatory pain. *Pain* 109:266–273.
- Ornstein TJ, Iddon JL, Baldacchino AM, Sahakian BJ, London M, Everitt BJ, Robbins TW (2000) Profiles of cognitive dysfunction in chronic amphetamine and heroin abusers. *Neuropsychopharmacology* 23:113–126.
- Paxinos G, Franklin KBJ (2004) The mouse brain in stereotaxic coordinates. 2nd ed. Academic Press.
- Pradhan AA, Becker JA, Scherrer G, Tryoen-Toth P, Filliol D, Matifas A, Massotte D, Gaveriaux-Ruff C, Kieffer BL (2009) In vivo delta opioid receptor internalization controls behavioral effects of agonists. *PLoS One* 4:e5425.
- Rezai X, Faget L, Bednarek E, Schwab Y, Kieffer BL, Massotte D (2012) Mouse delta opioid receptors are located on presynaptic afferents to hippocampal pyramidal cells. *Cell Mol Neurobiol* 32:509–516.

- Ribeiro Do Couto B, Aguilar MA, Rodriguez-Arias M, Minarro J (2005) Long-lasting rewarding effects of morphine induced by drug primings. *Brain Res* 1050:53–63.
- Robinson TE, Gorny G, Savage VR, Kolb B (2002) Widespread but regionally specific effects of experimenter- versus self-administered morphine on dendritic spines in the nucleus accumbens, hippocampus, and neocortex of adult rats. *Synapse* 46:271–279.
- Robinson TE, Kolb B (2004) Structural plasticity associated with exposure to drugs of abuse. *Neuropharmacology* 47(Suppl 1): 33–46.
- Robles Y, Vivas-Mejia PE, Ortiz-Zuazaga HG, Felix J, Ramos X, Pena de Ortiz S (2003) Hippocampal gene expression profiling in spatial discrimination learning. *Neurobiol Learn Mem* 80:80–95.
- Scherrer G, Tryoen-Toth P, Filliol D, Matifas A, Laubirot D, Cao YQ, Basbaum AI, Dierich A, Vonesh JL, Gaveriaux-Ruff C, Kieffer BL (2006) Knockin mice expressing fluorescent delta-opioid receptors uncover G protein-coupled receptor dynamics in vivo. *Proc Natl Acad Sci U S A* 103:9691–9696.
- Shippenberg TS, Chefer VI, Thompson AC (2009) Delta-opioid receptor antagonists prevent sensitization to the conditioned rewarding effects of morphine. *Biol Psychiatry* 65:169–174.
- Somogyi P, Klausberger T (2005) Defined types of cortical interneurone structure space and spike timing in the hippocampus. *J Physiol* 562:9–26.
- Taubenfeld SM, Muravieva EV, Garcia-Osta A, Alberini CM (2010) Disrupting the memory of places induced by drugs of abuse weakens motivational withdrawal in a context-dependent manner. *Proc Natl Acad Sci U S A* 107:12345–12350.
- Xie WY, He Y, Yang YR, Li YF, Kang K, Xing BM, Wang Y (2009) Disruption of Cdk5-associated phosphorylation of residue threonine-161 of the delta-opioid receptor: impaired receptor function and attenuated morphine antinociceptive tolerance. *J Neurosci* 29:3551–3564.
- Zhang WP, Guzowski JF, Thomas SA (2005) Mapping neuronal activation and the influence of adrenergic signaling during contextual memory retrieval. *Learn Mem* 12:239–247.

(Accepted 12 October 2015)
(Available online 19 October 2015)

8. General Conclusions and Perspectives

A. General conclusions of the thesis projects

Chronic pain and opiate use are pathological states often associated with MOP receptor activity, however DOP receptors are emerging as potential targets for pharmacotherapy in pain control (Nozaki et al., 2014; Gaveriaux-Ruff et al., 2011) and DOP receptor involvement in processes underlying addiction has brought attention to their role in chronic opiate states (Shippenberg et al., 2009; Gendron et al., 2014). The aim of my thesis work was to investigate the possible role of DOP receptors in the physiopathological mechanisms of several chronic disorders involving the opioid system. We studied the contribution of DOP receptors to the modulation of visceral pain and to antiallodynic activity of treatments for neuropathy, and in particular the contribution of peripheral DOP receptors expressed in Nav1.8-positive primary afferents by using conditional Nav1.8 DOP receptor knock-out animals (DOPcKO) (Gaveriaux-Ruff et al., 2011; Nozaki et al., 2012). We also sought to describe changes in DOP receptor distribution patterns in situations of chronic opiate administration or neuropathy, at the central and/or peripheral levels of the nervous system. To do so, we used DOPeGFP knock-in animals and double fluorescent knock-in animals expressing DOPeGFP and MOPmcherry (Erbs et al., 2015), as we also aimed to explore whether chronic neuropathic pain conditions could alter DOP and MOP receptor co-expression in peripheral afferents and brain areas involved in pain processing and emotional responses.

Our findings bring three comprehensive observations concerning the DOP receptor distribution changes and contributions to the conditions we have investigated.

Firstly, chronic pathological conditions decreased DOP receptor expression in the overall neuronal populations, compared to the basal state. In addition, DOP receptors underwent subcellular distribution alterations in conditions of both chronic pain and morphine administration as DOPeGFP translocation to the plasma membrane was increased, in DRG and hippocampus alike.

Secondly, peripheral DOP receptor populations are mandatory for the antiallodynic treatments in neuropathy, but not for visceral nociception. Hence, we provide evidence that indicates crucial involvement of the peripheral DOP population in treatment mechanisms of both Duloxetine and Formoterol in neuropathic pain. In contrast,

these peripheral receptors appear to have little engagement in the modulation of visceral inflammatory pain processes. These observations highlight the therapeutic potential of strategies designed to target peripheral DOP receptors for relief from neuropathic pain.

Finally, the opioid system, although essential to mediate the antiallodynic effects of antidepressant and $\beta 2$ mimetic molecules, is not necessary for pain relief by gabapentinoids such as pregabalin in the context of neuropathy. Therefore, despite the pivotal role of DOP receptors in some treatments, they do not constitute a universal target for pain relief, as not all effective treatments involve them.

A. Perspectives

In the short term, several aspects we examined require consolidation, in order to give a more complete overview of the role of DOP receptors in the various conditions we investigated; therefore we will focus on the two main projects which are still ongoing: DOPeGFP distribution in DRG neuronal populations and changes in DOP and MOP receptor co-localization at the peripheral and supraspinal levels, following chronic neuropathic pain and/or associated mood disorders. Long term perspectives aim to further explore firstly functional and mechanistic aspects of DOP receptor contribution to the antiallodynic actions of chronic treatments in the context of the cuff model; and the existence of opioid receptor functional interactions in supraspinal structures to evaluate whether MOP/DOP heteromers may be potential drug targets in therapeutic management of chronic pain and comorbid mood disorders.

1. DRG neuronal distribution changes and antiallodynic treatments

a) *Short term and immediate perspectives*

First of all, we should complete our cohort of DOPcKO mice (lacking peripheral DOP receptors in Nav1.8-expressing primary afferents) in order to unambiguously demonstrate the crucial role for peripheral DOP receptors in the antiallodynic effects of Duloxetine and Formoterol treatments. Alleviation of mechanical allodynia by chronic antidepressant and $\beta 2$ mimetic treatments had already been shown to require DOP receptor activity (Benbouzid et al., 2008b; Choucair-Jaafar et al., 2014). Also, when the antidepressant-treated cuff animals had recovered, s.c administration of DOP antagonist naltrindole hydrochloride to these mice induced

acute reinstatement of mechanical allodynia (Benbouzid et al., 2008a). If our first observations are confirmed, and DOPcKO mice fail to respond to antiallodynic chronic administration, our findings suggest that activity of this peripheral DOP receptor population is mandatory for the effective treatment with antidepressants and β 2 mimetics.

Then, our next task will be to accurately describe the distribution changes of MOPmcherry expression in DRG neurons for double KI mice treated with antidepressant or β 2 mimetic molecules, and compare the distribution profiles with our findings in Sham and Cuff animals. This will enable us to assess whether, like DOP receptors, MOP expression and DOPeGFP/MOPmcherry colocalization patterns across DRG neuronal populations is modified by chronic antiallodynic treatments or not.

Concerning the neuroanatomical changes we observed in DRG overall population induced by the cuff model, and more specifically the neuronal loss we described, we must examine whether or not the neuronal loss occurs within the first 4 weeks. This aims to assess whether at treatment initiation, the irreversible loss of DRG neurons has already taken place. If this is not the case, we should then examine whether or not either Duloxetine or Formoterol treatment prevents neuronal loss.

Most importantly, to complete our analysis of the neuroanatomical changes which occur following cuff-induced neuropathy, we plan to ascertain whether, in light of the reduced nerve density innervating the plantar glabrous skin of neuropathic animals, the cuff model may also recapitulate small fibre neuropathy (SFN). SFN can be painful or painless and is characterized by peripheral nerve degeneration in the epidermis. Patients with SFN present varying degrees of sensory and/or autonomous deficits, usually in distal limbs, which generally develop symmetrically and according to nerve length (Karlsson et al., 2015). However, in patients, diagnosis of such pathologies should entail structural assessment (skin and nerve biopsies) and functional tests including quantitative sensory testing (assess small fibre function and determine sensory deficits using in all modalities), assessment of pilomotor and sudomotor nerve fibre activity (altered sweat and piloerection) and conduction velocity of small fibres in response to contact heat-induced potentials and/or laser-evoked potentials. In addition, large fibre involvement should be ruled out by testing for muscle weakness and normal conduction

velocities in response to innocuous stimulation (Karlsson 2014). Patients suffering from SFN display negative symptoms (which can include thermal sensory loss, loss of pinprick sensation and numbness) and defective regeneration of intraepidermal nerve endings after depletion by topical application of capsaicin; fibres regenerate slower in patients suffering from diabetic neuropathy (that also features decreased intraepidermal nerve fibre density) (Hoeijmakers et al., 2012). Therefore, our cuff-induced model should verify one or more of the above criteria in addition to decreased intraepidermal nerve fibre density to be considered as a potential model of SFN. We could investigate whether Cuff animals have decreased innervation of sweat glands or hair follicles by immunohistochemistry. Assessment of intraepidermal nerve fibre regeneration after depletion by topical application of capsaicin on both ipsi- and contralateral hindpaws may be a simple and accessible means of investigating whether the cuff model reproduces this pathological feature. Functional assessment may be more challenging; however it would be interesting to investigate whether mice have mechanical or thermal sensory deficits following cuff implantation using pin-prick testing. If Cuff animals present symptoms which reconstitute small fibre neuropathy, new translational perspectives may arise.

b) Medium and long term complementary investigations

The changes of DOPeGFP distribution following injury and treatment administration, especially increased DOP receptor membrane translocation, beg the question as to what activates the DOP receptor and as a subsidiary, how do expression changes occur in the cuff model and what is the impact of endogenous DOP receptor tone in the neuropathic pain context? In order to investigate possible opioid peptide release in peripheral tissues, we should address the following points: is there an increase in opioid peptides at the site of nerve injury; which cells release them, and do they have an impact on the antiallodynic effects of chronic treatments in our model?

Evidence from the literature indicates that there are three possible sources of endogenous opioids acting on primary afferent neurons: local release of opioidergic neurons (at terminals in the dorsal spinal cord) (Fukushima et al., 2011; for review Mason, 2005); circulating opioid-containing leukocytes (Labuz et al., 2009) which can move freely in and out of DRGs (Ohara et al., 2009) and are present at the site of nerve injury

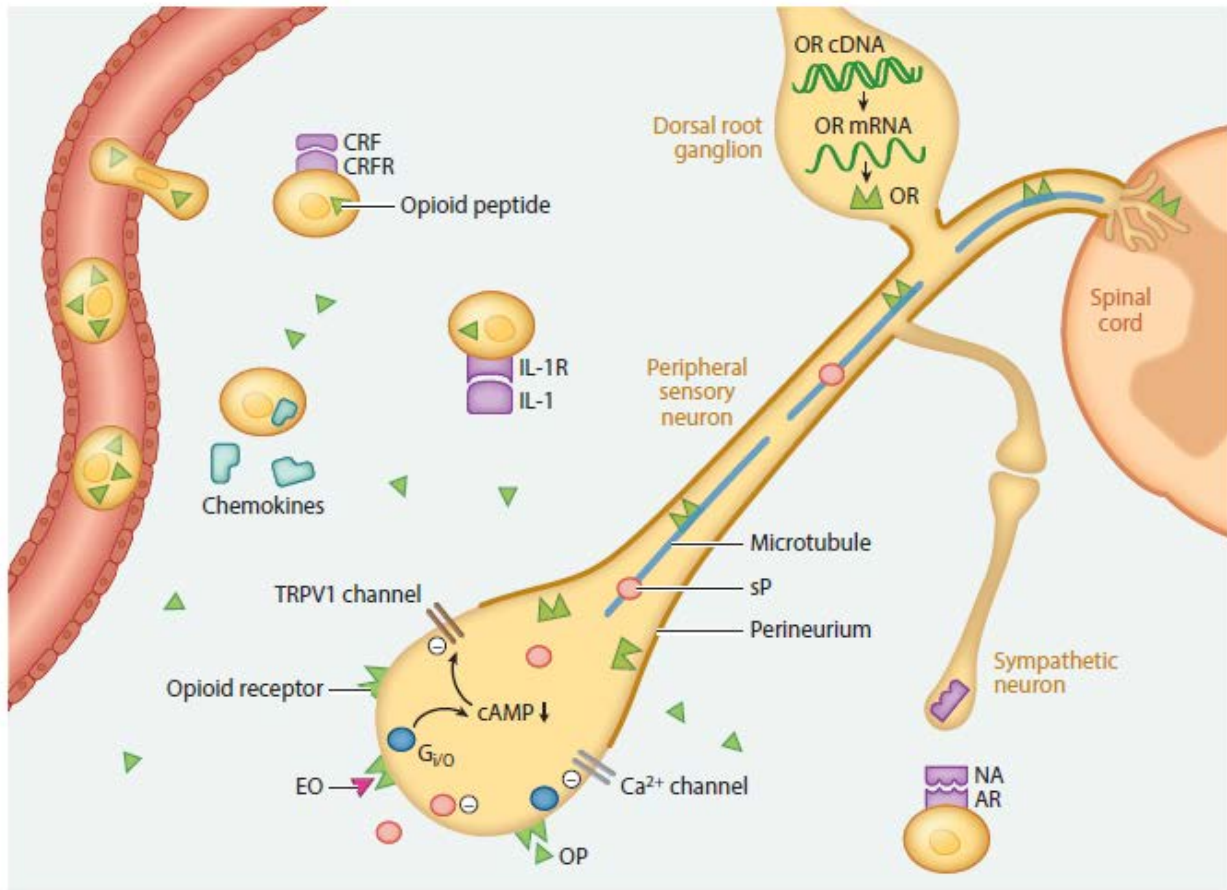

Figure 24: Endogenous antinociceptive mechanisms within peripheral injured tissue

Opioid peptide-containing circulating leukocytes extravasate upon activation of adhesion molecules and chemotaxis by chemokines. Stress or releasing agents, such as corticotropin-releasing factor (CRF), interleukin-1 β (IL-1) and noradrenalin (NA, released from postganglionic sympathetic neurons) stimulate leukocytes to release opioid peptides by activating their respective receptors (CRFR, IL-1R, AR) which are expressed by leukocytes. Exogenous opioids (EO) or endogenous opioid peptides (Ops, green triangles) bind to opioid receptors (ORs) that are synthesized in dorsal root ganglia and transported along intraaxonal microtubules to peripheral and central terminals of sensory neurons. OR activation ultimately leads to subsequent inhibition of ion channels (TRPV1 or calcium channels for example) and of Substance P (sP) release.

From (Stein, 2013)

(Labuz et al., 2009), and lastly opioid peptide-producing cells in the skin (Slominski et al., 2011). The latter source of endogenous opioid peptides has a predominantly neuroendocrine function, and relatively scarcely documented analgesic action. However, we and others showed DOPeGFP expression in sensory endings in the skin (Bardoni et al., 2014), which may support endogenous pain control occurring at these terminals (Stein and Lang, 2009). Opioid peptide release by immune cells at nerve injury sites provides endogenous pain control in the periphery (Labuz et al., 2009; reviewed in Machelska and Stein, 2006; Lesniak and Lipkowski, 2011). More precisely, T cells produce opioid peptides which bind peripheral DOP receptors in the context of inflammatory injury and produce analgesia (Boué et al., 2012). DOP and MOP receptor ligands injected into the hindpaw individually relieved neuropathic allodynia (Gaveriaux-Ruff et al., 2011). Therefore peripheral activation of opioid receptors on primary afferents by endogenous ligands may provide endogenous opioid tone, and can modulate pain processing in a neuropathic pain context. One interesting possibility is therefore that Duloxetine and Formoterol treatments restore or increase endogenous opioid tone. This could be achieved by stimulating the release of opioid peptides by leukocytes following the activation of β 2AR on these immune cells by the NA (Stein, 2013; Ninković and Roy, 2013) that is locally enhanced by either molecule, as peripheral β 2AR are responsible for the antiallodynic activity of antidepressants (Bohren et al., 2010) (see Figures 24 and 25).

In order to test this hypothesis, we might consider investigating the presence of leukocytes and their release of opioid peptides by immune cells recruited to the site of nerve injury, by immunohistochemistry in sciatic nerve tissue and/or the draining lymph nodes of the hindlimb. In the context of neuropathic pain, leukocyte infiltration is increased a few days after nerve injury, and decreases over time; previous studies investigated the presence of immune cells at the site of injury 2 weeks after injury, and in their CCI model, mice recovered from neuropathy as of the third week (Labuz et al., 2009). Kinetics and dynamics of immune cell recruitment may differ according to the injury model, however this is an important aspect. In addition, we could, as done by others, inhibit leukocyte extravasation to the site of injury by injections of anti ICAM1 antibodies (Labuz et al., 2009), and assess how the decreased infiltration of injured tissue by leukocytes may affect treatment response. *Ex vivo* cultures of lymphocytes for analyzing the effect of Duloxetine and Formoterol on opioid peptide release could bring clues as to the role of peripheral endogenous analgesia.

In parallel, we may choose to investigate whether endogenous opioid peptides are responsible for the antiallodynic effects of treatments. This may be done by injecting antibodies against opioid peptides and/or by enhancing endogenous opioid peptide action (by peripheral inhibition of the opioid-peptide degrading peptidases using tiorphan, bestatin and/or NH₂-CH-Ph-P(O)(OH)CH₂-CH-CH₂Ph(p-Ph)-CONH-CH-CH₃-COOH P8B) at the site of nerve injury in treated animals (Labuz et al., 2009; Schreiter et al., 2012). Alternatively, clues as to the involvement of endogenous opioid peptides may also be brought by using *penk* knockout mice (König et al., 1996) in the model of sciatic nerve cuffing, and assessing whether these animals respond to antiallodynic treatments or not.

Nav1.8 is a voltage gated sodium channel, involved in propagation of action potentials in nociceptive primary afferents (mainly but not exclusively). DOP receptors expressed in these cells would, when activated, dampen excitation signals evoked by painful stimuli and DOP receptor absence from these afferents would therefore result in increased pain, or pain resistant to endogenous control by opioid peptides. Recently, optogenetic approaches in mice have demonstrated that silencing the activity of Nav1.8 primary afferents reduces mechanical and thermal inflammatory and neuropathic pain (Daou et al., 2016). Using DRG cell cultures, *in vitro* electrophysiological approaches may be implemented to dissect the mechanisms by which NA and DOP receptor agonists modulate Nav1.8 channel properties.

Previous experiments in the lab support the mechanism by which antiallodynic treatments (antidepressant and β 2mimetics) recruit peripheral β 2ARs situated on satellite glial cells and mediate anti-inflammatory processes resulting in decreased TNF α membrane expression, lowering the inflammatory tone in DRGs and reducing nociceptive transmission in Cuff animals (Bohren et al., 2010). In addition, β 2AR mRNA is also expressed by DRG neurons (qPCR) (Bohren et al., 2013). There is a need to study the impact of β 2AR activation in neurons to determine direct or indirect potential impact on DOP receptor expression and function. First, we should confirm which cells express the receptor, using labelled β 2 agonists such as fluorescent derivatives of propranolol (Daly and McGrath, 2011). *In vitro* knockdown of the *Adb2* gene (which encodes β 2ARs) in leukocytes (that express the receptor (for review see Ninković and Roy, 2013), followed by adoptive transfer of these leukocytes in leukocyte-depleted Cuff animals (Boué et al., 2011) could be an approach aiming to

investigate whether increased NA following antidepressant or $\beta 2$ agonist administration acts on $\beta 2$ AR situated on immune cells, to induce release of opioid peptides (see Figure 25).

2. Anxio-depressive consequences of neuropathic pain

a) *Immediate complementary experiments*

We wish to complete and refine the behavioral assessment of emotional consequences of chronic cuff-induced neuropathy using additional tests, similar to the studies already carried out in male C57Bl6/J mice (Benbouzid et al., 2008c; Yalcin et al., 2011a), and including females and treatment groups. To this end, we have planned experiments of marble burying, novelty suppressed feeding and forced swim test in addition to the splash test. The effects of the pharmacological treatments we used to alleviate anxio-depressive behaviours have not been described before in pathological pain settings, and this is the first report of how these antidepressant and $\beta 2$ mimetic molecules may reverse the anxio-depressive consequences of chronic neuropathic pain, making our study novel, in this respect. These experiments may also bring us additional indication as to the surprising result we observed for the Duloxetine treated group in the splash test. The analgesic properties of antidepressants are independent from their mood-stabilizing activities, occur sooner and generally require lower doses (Mico et al., 2006). Extended treatment administration (6 or 8 weeks instead of 4) or increased dose of Duloxetine may enable to clarify whether the onset of anxiolytic and/or antidepressive properties of Duloxetine is delayed, or whether this effect cannot be observed and/or is gender-sensitive in the splash behavioral paradigm. Noteworthy, however, 3 weeks of oral administration of Duloxetine (two daily 10mg/kg gavage protocol) were sufficient to bring about robust reduction of anxiety-like behaviours in female mice using the zero-maze (Troelsen et al., 2005).

More importantly, we plan to confirm the qualitative changes in neuronal colocalization of DOPeGFP and MOPmcherry signals in supraspinal structures involved in pain processing.

b) *Perspective in the medium and long term*

In the longer term, we should also seek to quantify the changes in colocalized MOPmcherry and DOPeGFP signals, and investigate whether the two opioid receptors are in close physical proximity, by using a co-immunoprecipitation approach in selected areas of interest (such as the brain stem). In parallel, primary

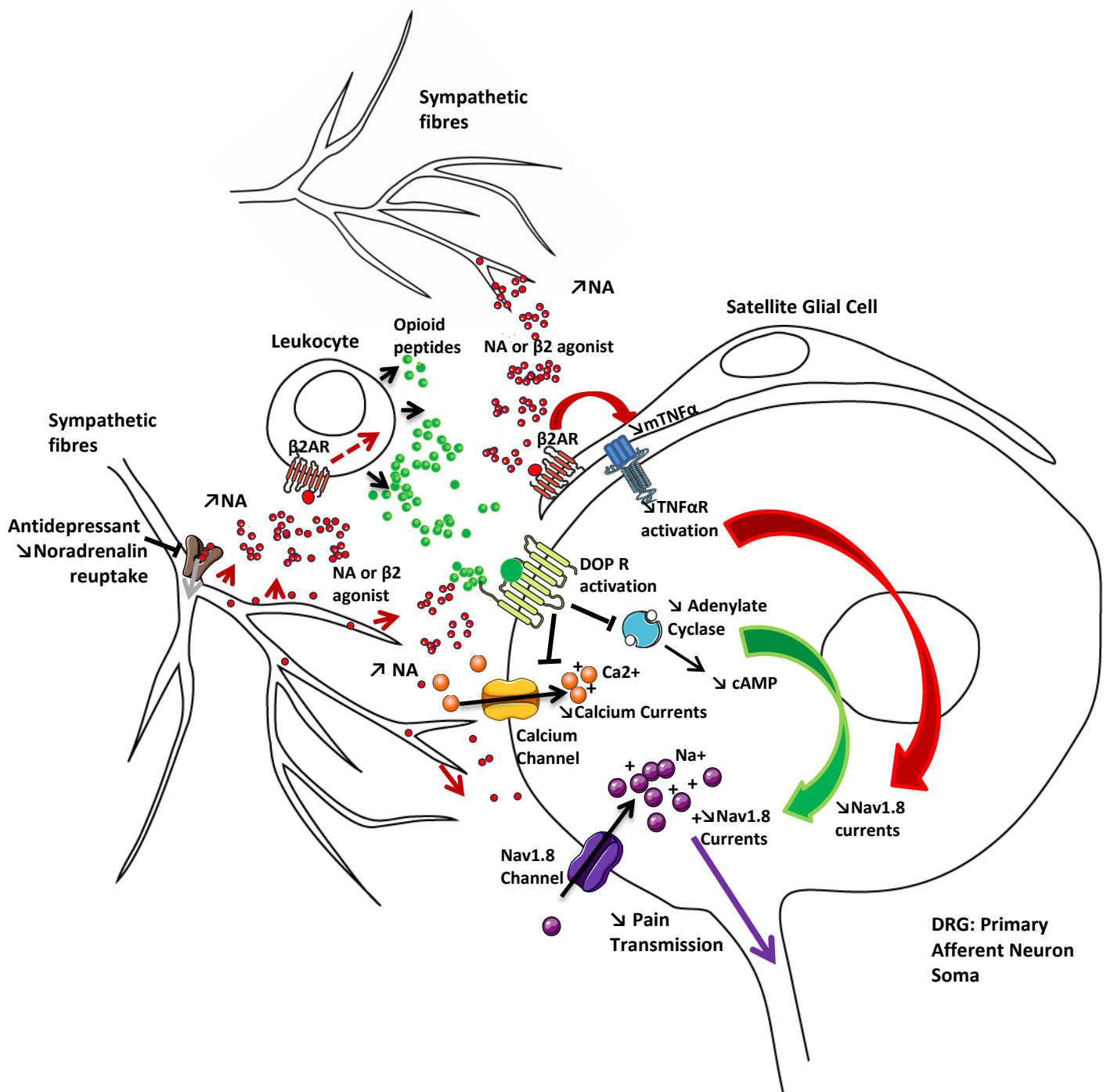

Figure 25: Schematic representation of DOP receptor involvement in antidepressant and $\beta 2$ mimetic treatment effects

Nerve injury promotes sympathetic nerve sprouting in dorsal root ganglia (DRG) near the injury site. Antidepressant molecules inhibit Noradrenalin (NA) reuptake by sympathetic fibres, and increased NA availability *in situ*. Leukocytes are recruited to the site of injury and infiltrate DRGs following inflammatory mediator release in the context of nerve injury. NA and $\beta 2$ agonists activate $\beta 2$ Adrenoceptors ($\beta 2$ AR) on leukocytes which release endogenous opioid peptides and pro-/anti-inflammatory molecules.; NA and $\beta 2$ agonists also activate $\beta 2$ AR on glial cells leading to decreased membrane-bound Tumor Necrosis Factor α (TNF α). Reduced stimulation of TNF α receptors (TNF α R) expressed by DRG neurons, and this reduces sodium currents of voltage-gated Sodium channels (Nav1.8), and ultimately decreases pain transmission.

Opioid peptides bind to Delta Opioid Receptors (DOP) expressed by primary afferent neurons, which inhibits intracellular effectors (Adenylate Cyclase inhibition that then decreases cAMP levels and inhibition of calcium currents) and may recruit effectors which lead to lower Nav1.8 currents, which in fine reduce pain transmission.

neuronal culture would enable the assessment of functional interactions between MOP and DOP receptors, indicating a physiological role for heteromer complexes as opposed to mere cellular co-expression. This information may support the existence of opioid receptor heteromers *in vivo*; that may represent future targets for drug development (Massotte, 2015). The fact that during chronic neuropathic pain, MOP and DOP receptor colocalization increases in brain areas involved in pain processing could lead to therapeutic approaches aiming to enhance endogenous pain control via activation of opioid receptor heteromers, or to reduce anxio-depressive-like behaviours in the context of chronic pain. Indeed, such studies have been engaged by others. CYM51010, a MOP/DOP receptor heteromer-biased agonist, was shown to produce antinociception in mice. This compound is of particular interest as chronic administration of CYM51010 induced lower tolerance to antinociceptive properties and had reduced rewarding effects compared to morphine (Gomes et al., 2013). This compound was not used in chronic pain conditions, which could be an interesting pharmacological investigation we could initiate with our cuff model. In another study, activation of opioid receptor heteromers in the Nucleus accumbens by i.c.v. administration of (H-Dmt-Tic-NH-CH(CH₂-COOH)-Bid UFP-512, a delta agonist which possesses high affinity for MOP/DOP heteromers (Kabli et al., 2010), reduced anxiety- and depressive-like behaviors in rats using forced swim, hyponeophagia and elevated plus maze paradigms and these effects were reversed by physically disrupting heteromers by i.c.v. infusion of a fusion TAT-DOP-Cterm interfering peptide (Kabli et al., 2014). Although the activity was not assessed in depressed rats, this approach suggests that MOP/DOP heteromers are attractive targets for treating depressive-like states. In the long term, we may consider comparing co-localization expression profiles in brain areas of interest across anxio-depressive mouse models, such as chronic mild stress induced anxiety or learned helplessness paradigms, which would further our understanding of opioid receptor changes in the CNS under pathological mood disorder conditions.

9. References

- Ahlgren, S. C., and Levine, J. D. (1993). Mechanical hyperalgesia in streptozotocin-diabetic rats is not sympathetically maintained. *Brain Res.* 616, 171–5.
- Aicher, S. A., Punnoose, A., and Goldberg, A. (2000). μ -Opioid receptors often colocalize with the substance P receptor (NK1) in the trigeminal dorsal horn. *J. Neurosci.* 20, 4345–54.
- Akil, H., Meng, F., Devine, D. P., and Watson, S. J. (1997). Molecular and Neuroanatomical Properties of the Endogenous Opioid System: Implications for Treatment of Opiate Addiction. *Semin. Neurosci.* 9, 70–83. doi:10.1006/smns.1997.0108.
- Akil, H., Owens, C., Gutstein, H., Taylor, L., Curran, E., and Watson, S. (1998). Endogenous opioids : overview and current issues. *Drug Alcohol Depend.* 51, 127–140.
- Al-chaer, E. D., and Traub, R. J. (2002). Biological basis of visceral pain : recent developments. *Pain* 96, 221–225.
- Allouche, S., Noble, F., and Marie, N. (2014). Opioid receptor desensitization: mechanisms and its link to tolerance. *Front. Pharmacol.* 5, 280. doi:10.3389/fphar.2014.00280.
- Almarestani, L., Waters, S. M., Krause, J. E., Bennett, G. J., and Ribeiro-da-Silva, A. (2007). Morphological characterization of spinal cord dorsal horn lamina I neurons projecting to the parabrachial nucleus in the rat. *J. Comp. Neurol.* 504, 287–97. doi:10.1002/cne.21410.
- Ambrósio, A. F., Silva, A. P., Malva, J. O., Soares-da-Silva, P., Carvalho, A. P., and Carvalho, C. M. (1999). Carbamazepine inhibits L-type Ca^{2+} channels in cultured rat hippocampal neurons stimulated with glutamate receptor agonists. *Neuropharmacology* 38, 1349–59.
- Amir, R., Michaelis, M., and Devor, M. (1999). Membrane potential oscillations in dorsal root ganglion neurons: role in normal electrogenesis and neuropathic pain. *J. Neurosci.* 19, 8589–96.
- Antal, M., Polgár, E., Chalmers, J., Minson, J. B., Llewellyn-Smith, I., Heizmann, C. W., and Somogyi, P. (1991). Different populations of parvalbumin- and calbindin-D28k-immunoreactive neurons contain GABA and accumulate 3H-D-aspartate in the dorsal horn of the rat spinal cord. *J. Comp. Neurol.* 314, 114–24. doi:10.1002/cne.903140111.
- Arnold, S. J., Facer, P., Yiangou, Y., Chen, M. X., Plumpton, C., Tate, S. N., Bountra, C., Chan, C. L. H., Williams, N. S., and Anand, P. (2003). Decreased potassium channel IK1 and its regulator neurotrophin-3 (NT-3) in inflamed human bowel. *Neuroreport* 14, 191–5. doi:10.1097/01.wnr.0000053759.76853.85.
- Arnou, B. A., Blasey, C. M., Constantino, M. J., Robinson, R., Hunkeler, E., Lee, J., Fireman, B., Khaylis, A., Feiner, L., and Hayward, C. (2011). Catastrophizing, depression and pain-related disability. *Gen. Hosp. Psychiatry* 33, 150–6. doi:10.1016/j.genhosppsy.2010.12.008.
- Arttamangkul, S., and Quillinan, N. (2008). Differential activation and trafficking of μ -opioid receptors in brain slices. *Mol. Pharmacol.* 74, 972–979. doi:10.1124/mol.108.048512.thought.
- Asai, T. (1998). Effects of morphine, nalbuphine and pentazocine on gastric emptying of indigestible solids. *Arzneimittelforschung.* 48, 802–5.
- Attal, N., Cruccu, G., Baron, R., Haanpää, M., Hansson, P., Jensen, T. S., and Nurmikko, T. (2010). EFNS guidelines on the pharmacological treatment of neuropathic pain: 2010 revision. *Eur. J. Neurol.* 17, 1113–e88. doi:10.1111/j.1468-1331.2010.02999.x.
- Attal, N., Cruccu, G., Haanpää, M., Hansson, P., Jensen, T. S., Nurmikko, T., Sampaio, C., Sindrup, S., and Wiffen, P. (2006). EFNS guidelines on pharmacological treatment of neuropathic pain. *Eur. J. Neurol.* 13, 1153–69. doi:10.1111/j.1468-1331.2006.01511.x.
- Attal, N., Fermanian, C., Fermanian, J., Lanteri-Minet, M., Alchaar, H., and Bouhassira, D. (2008). Neuropathic pain: are there distinct subtypes depending on the aetiology or anatomical lesion? *Pain* 138, 343–53. doi:10.1016/j.pain.2008.01.006.
- Attal, N., Lanteri-Minet, M., Laurent, B., Fermanian, J., and Bouhassira, D. (2011). The specific disease burden of neuropathic pain: results of a French nationwide survey. *Pain* 152, 2836–43. doi:10.1016/j.pain.2011.09.014.
- Atweh, S. F., Murrin, L. C., and Kuhar, M. J. (1978). Presynaptic localization of opiate receptors in the vagal and accessory optic systems: an autoradiographic study. *Neuropharmacology* 17, 65–71.

- Baamonde, A., Daugé, V., Ruiz-Gayo, M., Fulga, I. G., Turcaud, S., Fournié-Zaluski, M. C., and Roques, B. P. (1992). Antidepressant-type effects of endogenous enkephalins protected by systemic RB 101 are mediated by opioid delta and dopamine D1 receptor stimulation. *Eur. J. Pharmacol.* 216, 157–66.
- Bagnol, D., Mansour, A., Akil, H., and Watson, S. J. (1997). Cellular localization and distribution of the cloned mu and kappa opioid receptors in rat gastrointestinal tract. *Neuroscience* 81, 579–91.
- Bair, M. J., Robinson, R. L., Katon, W., and Kroenke, K. (2003). Depression and pain comorbidity: a literature review. *Arch. Intern. Med.* 163, 2433–45. doi:10.1001/archinte.163.20.2433.
- Bardoni, R., Tawfik, V. L., Wang, D., François, A., Solorzano, C., Shuster, S. a, et al. (2014). Delta opioid receptors presynaptically regulate cutaneous mechanosensory neuron input to the spinal cord dorsal horn. *Neuron* 81, 1312–27. doi:10.1016/j.neuron.2014.01.044.
- Baron, R., Binder, A., and Wasner, G. (2010). Neuropathic pain: diagnosis, pathophysiological mechanisms, and treatment. *Lancet. Neurol.* 9, 807–19. doi:10.1016/S1474-4422(10)70143-5.
- Barrot, M. (2012). Tests and models of nociception and pain in rodents. *Neuroscience* 211, 39–50. doi:10.1016/j.neuroscience.2011.12.041.
- Basbaum, A. I. (1999). Distinct neurochemical features of acute and persistent pain. *Proc. Natl. Acad. Sci. U. S. A.* 96, 7739–7743. doi:10.1073/pnas.96.14.7739.
- Basbaum, A. I., Bautista, D. M., Scherrer, G., and Julius, D. (2009). Cellular and molecular mechanisms of pain. *Cell* 139, 267–84. doi:10.1016/j.cell.2009.09.028.
- Bauer, C. S., Nieto-Rostro, M., Rahman, W., Tran-Van-Minh, A., Ferron, L., Douglas, L., et al. (2009). The increased trafficking of the calcium channel subunit alpha2delta-1 to presynaptic terminals in neuropathic pain is inhibited by the alpha2delta ligand pregabalin. *J. Neurosci.* 29, 4076–88. doi:10.1523/JNEUROSCI.0356-09.2009.
- Bautista, D. M., Jordt, S.-E., Nikai, T., Tsuruda, P. R., Read, A. J., Poblete, J., Yamoah, E. N., Basbaum, A. I., and Julius, D. (2006). TRPA1 mediates the inflammatory actions of environmental irritants and proalgesic agents. *Cell* 124, 1269–82. doi:10.1016/j.cell.2006.02.023.
- Befort, K., Tabbara, L., Bausch, S., Chavkin, C., Evans, C., and Kieffer, B. (1996). The conserved aspartate residue in the third putative transmembrane domain of the delta-opioid receptor is not the anionic counterpart for cationic opiate binding but is a constituent of the receptor binding site. *Mol. Pharmacol.* 49, 216–23.
- Beggs, S., and Salter, M. W. (2010). Microglia-neuronal signalling in neuropathic pain hypersensitivity 2.0. *Curr. Opin. Neurobiol.* 20, 474–80. doi:10.1016/j.conb.2010.08.005.
- Belvisi, M. G., and Hele, D. J. (2009). Cough sensors. III. Opioid and cannabinoid receptors on vagal sensory nerves. *Handb. Exp. Pharmacol.*, 63–76. doi:10.1007/978-3-540-79842-2_4.
- Benbouzid, M., Choucair-Jaafar, N., Yalcin, I., Waltisperger, E., Muller, A., Freund-Mercier, M. J., and Barrot, M. (2008a). Chronic, but not acute, tricyclic antidepressant treatment alleviates neuropathic allodynia after sciatic nerve cuffing in mice. *Eur. J. Pain* 12, 1008–17. doi:10.1016/j.ejpain.2008.01.010.
- Benbouzid, M., Gavériaux-Ruff, C., Yalcin, I., Waltisperger, E., Tessier, L.-H., Muller, A., Kieffer, B. L., Freund-Mercier, M. J., and Barrot, M. (2008b). Delta-opioid receptors are critical for tricyclic antidepressant treatment of neuropathic allodynia. *Biol. Psychiatry* 63, 633–6. doi:10.1016/j.biopsych.2007.06.016.
- Benbouzid, M., Pallage, V., Rajalu, M., Waltisperger, E., Doridot, S., Poisbeau, P., Freund-Mercier, M. J., and Barrot, M. (2008c). Sciatic nerve cuffing in mice: a model of sustained neuropathic pain. *Eur. J. Pain* 12, 591–9. doi:10.1016/j.ejpain.2007.10.002.
- Bennett, G. J., and Xie, Y. K. (1988). A peripheral mononeuropathy in rat that produces disorders of pain sensation like those seen in man. *Pain* 33, 87–107.
- Bernstein, C. N., Singh, S., Graff, L. A., Walker, J. R., Miller, N., and Cheang, M. (2010). A prospective population-based study of triggers of symptomatic flares in IBD. *Am. J. Gastroenterol.* 105, 1994–2002. doi:10.1038/ajg.2010.140.
- Bertran-Gonzalez, J., Laurent, V., Chieng, B. C., Christie, M. J., and Balleine, B. W. (2013). Learning-related translocation of δ -opioid receptors on ventral striatal cholinergic interneurons mediates choice between goal-directed actions. *J. Neurosci.* 33, 16060–71. doi:10.1523/JNEUROSCI.1927-13.2013.
- Besson, J. (1999). The neurobiology of pain. *Lancet* 353, 1610–1615. doi:10.1016/S0140-6736(99)01313-6.

- Bester, H., Chapman, V., Besson, J. M., and Bernard, J. F. (2000). Physiological properties of the lamina I spinoparabrachial neurons in the rat. *J. Neurophysiol.* 83, 2239–59.
- Bian, F., Li, Z., Offord, J., Davis, M. D., McCormick, J., Taylor, C. P., and Walker, L. C. (2006). Calcium channel alpha2-delta type 1 subunit is the major binding protein for pregabalin in neocortex, hippocampus, amygdala, and spinal cord: an ex vivo autoradiographic study in alpha2-delta type 1 genetically modified mice. *Brain Res.* 1075, 68–80. doi:10.1016/j.brainres.2005.12.084.
- Bidlack, J. M., Khimich, M., Parkhill, A. L., Sumagin, S., Sun, B., and Tipton, C. M. (2006). Opioid receptors and signaling on cells from the immune system. *J. Neuroimmune Pharmacol.* 1, 260–269. doi:10.1007/s11481-006-9026-2.
- Biel, M., Wahl-Schott, C., Michalakis, S., and Zong, X. (2009). Hyperpolarization-activated cation channels: from genes to function. *Physiol. Rev.* 89, 847–85. doi:10.1152/physrev.00029.2008.
- Bilecki, W., Wawrzczak-Bargiela, A., and Przewlocki, R. (2004). Activation of AP-1 and CRE-dependent gene expression via mu-opioid receptor. *J. Neurochem.* 90, 874–82. doi:10.1111/j.1471-4159.2004.02524.x.
- Birdsall, N. J. M. (2010). Class A GPCR heterodimers: evidence from binding studies. *Trends Pharmacol. Sci.* 31, 499–508. doi:10.1016/j.tips.2010.08.003.
- Boadas-Vaello, P., Castany, S., Homs, J., Álvarez-Pérez, B., Deulofeu, M., and Verdú, E. (2016). Neuroplasticity of ascending and descending pathways after somatosensory system injury: reviewing knowledge to identify neuropathic pain therapeutic targets. *Spinal Cord*, 1–11. doi:10.1038/sc.2015.225.
- Bodnar, R. J. (2014). Endogenous opiates and behavior: 2013. *Peptides* 62, 67–136. doi:10.1016/j.peptides.2014.09.013.
- Bohren, Y., Karavelic, D., Tessier, L.-H., Yalcin, I., Gavériaux-Ruff, C., Kieffer, B. L., Freund-Mercier, M.-J., and Barrot, M. (2010). Mu-opioid receptors are not necessary for nortriptyline treatment of neuropathic allodynia. *Eur. J. Pain* 14, 700–4. doi:10.1016/j.ejpain.2009.11.014.
- Bohren, Y., Tessier, L.-H., Megat, S., Petitjean, H., Hugel, S., Daniel, D., et al. (2013). Antidepressants suppress neuropathic pain by a peripheral β 2-adrenoceptor mediated anti-TNF α mechanism. *Neurobiol. Dis.* 60, 39–50. doi:10.1016/j.nbd.2013.08.012.
- Boivie, J. (1989). On central pain and central pain mechanisms. *Pain* 38, 121–2.
- Boué, J., Basso, L., Cenac, N., Blanpied, C., Rolli-Derkinderen, M., Neunlist, M., Vergnolle, N., and Dietrich, G. (2014). Endogenous regulation of visceral pain via production of opioids by colitogenic CD4(+) T cells in mice. *Gastroenterology* 146, 166–75. doi:10.1053/j.gastro.2013.09.020.
- Boué, J., Blanpied, C., Brousset, P., Vergnolle, N., and Dietrich, G. (2011). Endogenous opioid-mediated analgesia is dependent on adaptive T cell response in mice. *J. Immunol.* 186, 5078–84. doi:10.4049/jimmunol.1003335.
- Boué, J., Blanpied, C., Djata-Cabral, M., Pelletier, L., Vergnolle, N., and Dietrich, G. (2012). Immune conditions associated with CD4+ T effector-induced opioid release and analgesia. *Pain* 153, 485–93. doi:10.1016/j.pain.2011.11.013.
- Bouhassira, D., Attal, N., Alchaar, H., Boureau, F., Brochet, B., Bruxelle, J., et al. (2005). Comparison of pain syndromes associated with nervous or somatic lesions and development of a new neuropathic pain diagnostic questionnaire (DN4). *Pain* 114, 29–36. doi:10.1016/j.pain.2004.12.010.
- Bouhassira, D., Lantéri-Minet, M., Attal, N., Laurent, B., and Touboul, C. (2008). Prevalence of chronic pain with neuropathic characteristics in the general population. *Pain* 136, 380–7. doi:10.1016/j.pain.2007.08.013.
- Bradley, S. J., Riaz, S. A., and Tobin, A. B. (2014). Employing novel animal models in the design of clinically efficacious GPCR ligands. *Curr. Opin. Cell Biol.* 27, 117–25. doi:10.1016/j.ceb.2013.12.002.
- Bräu, M. E., Dreimann, M., Olschewski, A., Vogel, W., and Hempelmann, G. (2001). Effect of drugs used for neuropathic pain management on tetrodotoxin-resistant Na(+) currents in rat sensory neurons. *Anesthesiology* 94, 137–44.
- Bráz, J. M., and Basbaum, A. I. (2009). Triggering genetically-expressed transneuronal tracers by peripheral axotomy reveals convergent and segregated sensory neuron-spinal cord connectivity. *Neuroscience* 163, 1220–32. doi:10.1016/j.neuroscience.2009.07.051.
- Braz, J. M., Nassar, M. a, Wood, J. N., and Basbaum, A. I. (2005). Parallel “pain” pathways arise from subpopulations of primary afferent nociceptor. *Neuron* 47, 787–93. doi:10.1016/j.neuron.2005.08.015.

- Bráz, J. M., Sharif-Naeini, R., Vogt, D., Kriegstein, A., Alvarez-Buylla, A., Rubenstein, J. L., and Basbaum, A. I. (2012). Forebrain GABAergic neuron precursors integrate into adult spinal cord and reduce injury-induced neuropathic pain. *Neuron* 74, 663–75. doi:10.1016/j.neuron.2012.02.033.
- Breivik, H. (2005). Opioids in chronic non-cancer pain, indications and controversies. *Eur. J. Pain* 9, 127–30. doi:10.1016/j.ejpain.2004.05.013.
- Brown, D. R., Poonyachoti, S., Osinski, M. A., Kowalski, T. R., Pampusch, M. S., Elde, R. P., and Murtaugh, M. P. (1998). Delta-opioid receptor mRNA expression and immunohistochemical localization in porcine ileum. *Dig. Dis. Sci.* 43, 1402–10.
- Brush, D. E. (2012). Complications of long-term opioid therapy for management of chronic pain: the paradox of opioid-induced hyperalgesia. *J. Med. Toxicol.* 8, 387–92. doi:10.1007/s13181-012-0260-0.
- Burgess, M., Mullaney, I., McNeill, M., Dunn, M., and Rang, P. (1989). Second Messengers Involved in the Mechanism Bradykinin in Sensory Neurons in Culture of Action of. *J. Neurosci.* 9, 3314–3325.
- Busch-Dienstfertig, M., and Stein, C. (2010). Opioid receptors and opioid peptide-producing leukocytes in inflammatory pain--basic and therapeutic aspects. *Brain. Behav. Immun.* 24, 683–94. doi:10.1016/j.bbi.2009.10.013.
- Bushnell, M. C., Ceko, M., and Low, L. A. (2013). Cognitive and emotional control of pain and its disruption in chronic pain. *Nat. Rev. Neurosci.* 14, 502–11. doi:10.1038/nrn3516.
- Cabot, P. J. (2001). Immune-derived opioids and peripheral antinociception. *Clin. Exp. Pharmacol. Physiol.* 28, 230–2.
- Cahill, C. M., Holdridge, S. V, and Morinville, A. (2007). Trafficking of delta-opioid receptors and other G-protein-coupled receptors: implications for pain and analgesia. *Trends Pharmacol. Sci.* 28, 23–31. doi:10.1016/j.tips.2006.11.003.
- Cahill, C. M., Morinville, A., Lee, M., Vincent, J., Collier, B., and Beaudet, A. (2001). Prolonged Morphine Treatment Targets Delta Opioid Receptors to Neuronal Plasma Membranes and Enhances Delta -Mediated Antinociception. *J. Neurosci.* 21, 7598–7607.
- Camilleri, M. (2008). Novel pharmacology: asimadoline, a kappa-opioid agonist, and visceral sensation. *Neurogastroenterol. Motil.* 20, 971–9. doi:10.1111/j.1365-2982.2008.01183.x.
- Campbell, J. N., and Meyer, R. a (2006). Mechanisms of neuropathic pain. *Neuron* 52, 77–92. doi:10.1016/j.neuron.2006.09.021.
- Carr, D. B. (1999). Acute pain. *Pain* 353, 2051–2058.
- Carr, P. a., and Nagy, J. I. (1993). Emerging relationships between cytochemical properties and sensory modality transmission in primary sensory neurons. *Brain Res. Bull.* 30, 209–219. doi:10.1016/0361-9230(93)90246-8.
- Caterina, M. J., Leffler, A., Malmberg, A. B., Martin, W. J., Trafton, J., Petersen-Zeitz, K. R., Koltzenburg, M., Basbaum, A. I., and Julius, D. (2000). Impaired nociception and pain sensation in mice lacking the capsaicin receptor. *Science* 288, 306–13.
- Cavanaugh, D. J., Lee, H., Lo, L., Shields, S. D., Zylka, M. J., Basbaum, Allan I, and Anderson, D. J. (2009). Distinct subsets of unmyelinated primary sensory fibers mediate behavioral responses to noxious thermal and mechanical stimuli. *Proc. Natl. Acad. Sci.* 106, 11424–11424. doi:10.1073/pnas.0906213106.
- Cervero, F., and Laird, J. M. a (2004). Understanding the signaling and transmission of visceral nociceptive events. *J. Neurobiol.* 61, 45–54. doi:10.1002/neu.20084.
- Chaplan, S. R., Guo, H.-Q., Lee, D. H., Luo, L., Liu, C., Kuei, C., Velumian, A. A., Butler, M. P., Brown, S. M., and Dubin, A. E. (2003). Neuronal hyperpolarization-activated pacemaker channels drive neuropathic pain. *J. Neurosci.* 23, 1169–78.
- Chen, W., McRoberts, J. A., and Marvizón, J. C. G. (2014). μ -Opioid receptor inhibition of substance P release from primary afferents disappears in neuropathic pain but not inflammatory pain. *Neuroscience* 267, 67–82. doi:10.1016/j.neuroscience.2014.02.023.
- Cherubini, E., Morita, K., and North, R. A. (1985). Opioid inhibition of synaptic transmission in the guinea-pig myenteric plexus. *Br. J. Pharmacol.* 85, 805–17.
- Cho, J. H. (2008). The genetics and immunopathogenesis of inflammatory bowel disease. *Nat. Rev. Immunol.* 8, 458–66. doi:10.1038/nri2340.

- Choucair-Jaafar, N., Salvat, E., Freund-Mercier, M.-J., and Barrot, M. (2014). The antiallodynic action of nortriptyline and terbutaline is mediated by $\beta(2)$ adrenoceptors and δ opioid receptors in the ob/ob model of diabetic polyneuropathy. *Brain Res.* 1546, 18–26. doi:10.1016/j.brainres.2013.12.016.
- Choucair-Jaafar, N., Yalcin, I., Rodeau, J.-L., Waltisperger, E., Freund-Mercier, M.-J., and Barrot, M. (2009). Beta2-adrenoceptor agonists alleviate neuropathic allodynia in mice after chronic treatment. *Br. J. Pharmacol.* 158, 1683–94. doi:10.1111/j.1476-5381.2009.00510.x.
- Chu Sin Chung, P., and Kieffer, B. L. (2013). Delta opioid receptors in brain function and diseases. *Pharmacol. Ther.* 140, 112–20. doi:10.1016/j.pharmthera.2013.06.003.
- Chuang, T. K., Killam, K. F., Chuang, L. F., Kung, H. F., Sheng, W. S., Chao, C. C., Yu, L., and Chuang, R. Y. (1995). Mu opioid receptor gene expression in immune cells. *Biochem. Biophys. Res. Commun.* 216, 922–30. doi:10.1006/bbrc.1995.2709.
- Cinque, C., Pondiki, S., Oddi, D., Di Certo, M. G., Marinelli, S., Troisi, A., Moles, A., and D'Amato, F. R. (2012). Modeling socially anhedonic syndromes: genetic and pharmacological manipulation of opioid neurotransmission in mice. *Transl. Psychiatry* 2, e155. doi:10.1038/tp.2012.83.
- Coelho, J. C., Senninger, N., Runkel, N., Herfarth, C., and Messmer, K. (1986). Effect of analgesic drugs on the electromyographic activity of the gastrointestinal tract and sphincter of Oddi and on biliary pressure. *Ann. Surg.* 204, 53–8.
- Cohen, S. P., and Mao, J. (2014). Neuropathic pain: mechanisms and their clinical implications. *BMJ* 348, f7656.
- Colleoni, M., and Sacerdote, P. (2010). Murine models of human neuropathic pain. *Biochim. Biophys. Acta* 1802, 924–33. doi:10.1016/j.bbadis.2009.10.012.
- Contet, C., Gavériaux-Ruff, C., Matifas, A., Caradec, C., Champy, M.-F., and Kieffer, B. L. (2006). Dissociation of analgesic and hormonal responses to forced swim stress using opioid receptor knockout mice. *Neuropsychopharmacology* 31, 1733–44. doi:10.1038/sj.npp.1300934.
- Contet, C., Kieffer, B. L., and Befort, K. (2004). Mu opioid receptor: a gateway to drug addiction. *Curr. Opin. Neurobiol.* 14, 370–8. doi:10.1016/j.conb.2004.05.005.
- Coste, B., Mathur, J., Schmidt, M., Earley, T. J., Ranade, S., Petrus, M. J., Dubin, A. E., and Patapoutian, A. (2010). Piezo1 and Piezo2 are essential components of distinct mechanically activated cation channels. *Science* 330, 55–60. doi:10.1126/science.1193270.
- Costigan, M., Scholz, J., and Woolf, C. J. (2009). Neuropathic pain: a maladaptive response of the nervous system to damage. *Annu. Rev. Neurosci.* 32, 1–32. doi:10.1146/annurev.neuro.051508.135531.
- Coull, J. A. M., Beggs, S., Boudreau, D., Boivin, D., Tsuda, M., Inoue, K., Gravel, C., Salter, M. W., and De Koninck, Y. (2005). BDNF from microglia causes the shift in neuronal anion gradient underlying neuropathic pain. *Nature* 438, 1017–21. doi:10.1038/nature04223.
- Coull, J. A. M., Boudreau, D., Bachand, K., Prescott, S. A., Nault, F., Sfik, A., De Koninck, P., and De Koninck, Y. (2003). Trans-synaptic shift in anion gradient in spinal lamina I neurons as a mechanism of neuropathic pain. *Nature* 424, 938–42. doi:10.1038/nature01868.
- Courteix, C., Eschalier, A., and Lavarenne, J. (1993). Streptozocin-induced diabetic rats: behavioural evidence for a model of chronic pain. *Pain* 53, 81–8.
- Craig, A. D. (1991). Spinal distribution of ascending lamina I axons anterogradely labeled with Phaseolus vulgaris leucoagglutinin (PHA-L) in the cat. *J. Comp. Neurol.* 313, 377–93. doi:10.1002/cne.903130212.
- Cunningham, M. O., Woodhall, G. L., Thompson, S. E., Dooley, D. J., and Jones, R. S. G. (2004). Dual effects of gabapentin and pregabalin on glutamate release at rat entorhinal synapses in vitro. *Eur. J. Neurosci.* 20, 1566–76. doi:10.1111/j.1460-9568.2004.03625.x.
- Czeschik, J. C., Hagenacker, T., Schäfers, M., and Büsselberg, D. (2008). TNF-alpha differentially modulates ion channels of nociceptive neurons. *Neurosci. Lett.* 434, 293–8. doi:10.1016/j.neulet.2008.01.070.
- Daly, C. J., and McGrath, J. C. (2011). Previously unsuspected widespread cellular and tissue distribution of β -adrenoceptors and its relevance to drug action. *Trends Pharmacol. Sci.* 32, 219–26. doi:10.1016/j.tips.2011.02.008.
- Daniels, D. J., Lenard, N. R., Etienne, C. L., Law, P.-Y., Roerig, S. C., and Portoghese, P. S. (2005). Opioid-induced tolerance and dependence in mice is modulated by the distance between pharmacophores in a bivalent ligand series.

Proc. Natl. Acad. Sci. U. S. A. 102, 19208–13. doi:10.1073/pnas.0506627102.

- Daou, I., Beaudry, H., Ase, A. R., Wieskopf, J. S., Ribeiro-da-silva, A., Mogil, J. S., and Séguéla, P. (2016). Optogenetic Silencing of Na^v1.8-Positive Afferents Alleviates Inflammatory and Neuropathic Pain. *eNeuro* 3, 1–12.
- Davis, M. P. (2012). Drug management of visceral pain: concepts from basic research. *Pain Res. Treat.* 2012, 265605. doi:10.1155/2012/265605.
- Decosterd, I., and Woolf, C. J. (2000). Spared nerve injury: an animal model of persistent peripheral neuropathic pain. *Pain* 87, 149–58.
- Delmas, P., Hao, J., and Rodat-Despoix, L. (2011). Molecular mechanisms of mechanotransduction in mammalian sensory neurons. *Nat. Rev. Neurosci.* 12, 139–53. doi:10.1038/nrn2993.
- Devor, M. (1991). Sensory basis of autotomy in rats. *Pain* 45, 109–10.
- Devor, M. (2006). Sodium channels and mechanisms of neuropathic pain. *J. Pain* 7, S3–S12. doi:10.1016/j.jpain.2005.09.006.
- Devor, M. (1999). Unexplained peculiarities of the dorsal root ganglion. *Pain* 82, S27–S35. doi:10.1016/S0304-3959(99)00135-9.
- Dib-Hajj, S. D., Cummins, T. R., Black, J. A., and Waxman, S. G. (2010). Sodium channels in normal and pathological pain. *Annu. Rev. Neurosci.* 33, 325–47. doi:10.1146/annurev-neuro-060909-153234.
- Dieleman, J. P., Kerklaan, J., Huygen, F. J. P. M., Bouma, P. A. D., and Sturkenboom, M. C. J. M. (2008). Incidence rates and treatment of neuropathic pain conditions in the general population. *Pain* 137, 681–8. doi:10.1016/j.pain.2008.03.002.
- Djoughri, L. (2016). A δ -fiber low threshold mechanoreceptors innervating mammalian hairy skin: A review of their receptive, electrophysiological and cytochemical properties in relation to A δ -fiber high threshold mechanoreceptors. *Neurosci. Biobehav. Rev.* 61, 225–38. doi:10.1016/j.neubiorev.2015.12.009.
- Djoughri, L., Koutsikou, S., Fang, X., McMullan, S., and Lawson, S. N. (2006). Spontaneous pain, both neuropathic and inflammatory, is related to frequency of spontaneous firing in intact C-fiber nociceptors. *J. Neurosci.* 26, 1281–92. doi:10.1523/JNEUROSCI.3388-05.2006.
- Docherty, M. J., Iii, R. C. W. J., and Wallace, M. S. (2011). Managing Pain in Inflammatory Bowel Disease. *Gastroenterol. Hepatol. (N. Y.)* 7, 592–601.
- Dogrul, A., Gul, H., Yesilyurt, O., Ulas, U. H., and Yildiz, O. (2011). Systemic and spinal administration of etanercept, a tumor necrosis factor alpha inhibitor, blocks tactile allodynia in diabetic mice. *Acta Diabetol.* 48, 135–42. doi:10.1007/s00592-010-0237-x.
- Drew, L. J., Rohrer, D. K., Price, M. P., Blaver, K. E., Cockayne, D. A., Cesare, P., and Wood, J. N. (2004). Acid-sensing ion channels ASIC2 and ASIC3 do not contribute to mechanically activated currents in mammalian sensory neurones. *J. Physiol.* 556, 691–710. doi:10.1113/jphysiol.2003.058693.
- Drolet, G., Dumont, E. C., Gosselin, I., Kinkead, R., Laforest, S., and Trotter, J. F. (2001). Role of endogenous opioid system in the regulation of the stress response. *Prog. Neuropsychopharmacol. Biol. Psychiatry* 25, 729–41.
- Duan, B., Cheng, L., Bourane, S., Britz, O., Padilla, C., Garcia-Campmany, L., et al. (2014). Identification of spinal circuits transmitting and gating mechanical pain. *Cell* 159, 1417–32. doi:10.1016/j.cell.2014.11.003.
- Duman, R. S. (2002). Pathophysiology of depression: the concept of synaptic plasticity. *Eur. Psychiatry* 17 Suppl 3, 306–10.
- Duncan, K., Ketz, N., and Davachi, L. (2012). Evidence for area CA1 as a match/mismatch detector: A high-resolution fMRI study of the human hippocampus. *Hippocampus* 22, 389–398. doi:10.1002/hipo.20933.Evidence.
- Dunham, J. H., and Hall, R. A. (2009). Enhancement of the surface expression of G protein-coupled receptors. *Trends Biotechnol.* 27, 541–5. doi:10.1016/j.tibtech.2009.06.005.
- Dworkin, R. H., O'Connor, A. B., Backonja, M., Farrar, J. T., Finnerup, N. B., Jensen, T. S., et al. (2007). Pharmacologic management of neuropathic pain: evidence-based recommendations. *Pain* 132, 237–51. doi:10.1016/j.pain.2007.08.033.
- Erbs, E., Faget, L., Ceredig, R. A., Matifas, A., Vonesch, J.-L., Kieffer, B. L., and Massotte, D. (2016). Impact of chronic morphine on delta opioid receptor-expressing neurons in the mouse hippocampus. *Neuroscience* 313, 46–56.

doi:10.1016/j.neuroscience.2015.10.022.

- Erbs, E., Faget, L., Scherrer, G., and Kessler, P. (2012). Distribution of delta opioid receptor-expressing neurons in the mouse hippocampus. *Neuroscience* 221, 203–213. doi:10.1016/j.neuroscience.2012.06.023.
- Erbs, E., Faget, L., Scherrer, G., Matifas, A., Filliol, D., Vonesch, J.-L., et al. (2015). A mu-delta opioid receptor brain atlas reveals neuronal co-occurrence in subcortical networks. *Brain Struct. Funct.* doi:10.1007/s00429-014-0717-9.
- Faget, L., Erbs, E., LeMerrer, J., Scherrer, G., Matifas, A., Benturquia, N., et al. (2012). In vivo visualization of delta opioid receptors upon physiological activation uncovers a distinct internalization profile. *J. Neurosci.* 32, 7301–10. doi:10.1523/JNEUROSCI.0185-12.2012.
- Ferguson, S. S. G., Ill, W. E. D., Colapietro, A., Barak, L. S., Menard, L., and Caron, M. G. (1996). Role of beta-arrestin in mediating agonist-promoted G protein-coupled receptor internalization. *Science (80-.)*. 271, 363–366.
- Filliol, D., Ghodzland, S., Chluba, J., Martin, M., Matthes, H. W., Simonin, F., et al. (2000). Mice deficient for delta- and mu-opioid receptors exhibit opposing alterations of emotional responses. *Nat. Genet.* 25, 195–200. doi:10.1038/76061.
- Finnerup, N. B., Attal, N., Haroutounian, S., McNicol, E., Baron, R., Dworkin, R. H., et al. (2015). Pharmacotherapy for neuropathic pain in adults: a systematic review and meta-analysis. *Lancet Neurol.* 14, 162–173. doi:10.1016/S1474-4422(14)70251-0.
- Finnerup, N. B., and Jensen, T. S. (2007). Clinical use of pregabalin in the management of central neuropathic pain. *Neuropsychiatr. Dis. Treat.* 3, 885–91.
- Fisher, K., Fundytus, M. E., Cahill, C. M., and Coderre, T. J. (1998). Intrathecal administration of the mGluR compound, (S)-4CPG, attenuates hyperalgesia and allodynia associated with sciatic nerve constriction injury in rats. *Pain* 77, 59–66.
- Flatters, S. J. L., and Bennett, G. J. (2004). Ethosuximide reverses paclitaxel- and vincristine-induced painful peripheral neuropathy. *Pain* 109, 150–61. doi:10.1016/j.pain.2004.01.029.
- Freeman, R., Raskin, P., Hewitt, D. J., Vorsanger, G. J., Jordan, D. M., Xiang, J., and Rosenthal, N. R. (2007). Randomized study of tramadol/acetaminophen versus placebo in painful diabetic peripheral neuropathy. *Curr. Med. Res. Opin.* 23, 147–61. doi:10.1185/030079906X162674.
- Fuchs, E., and Flügge, G. (2006). Experimental animal models for the simulation of depression and anxiety. *Dialogues Clin. Neurosci.* 8, 323–333.
- Fujita, W., Gomes, I., and Devi, L. a (2014). Heteromers of μ - δ opioid receptors: new pharmacology and novel therapeutic possibilities. *Br. J. Pharmacol.*, 1–13. doi:10.1111/bph.12663.
- Fukuoka, T., Kobayashi, K., Yamanaka, H., Obata, K., Dai, Y., and Noguchi, K. (2008). Comparative study of the distribution of the alpha-subunits of voltage-gated sodium channels in normal and axotomized rat dorsal root ganglion neurons. *J. Comp. Neurol.* 510, 188–206. doi:10.1002/cne.21786.
- Fukushima, T., Tsuda, M., Kofuji, T., and Hori, Y. (2011). Physiological properties of enkephalin-containing neurons in the spinal dorsal horn visualized by expression of green fluorescent protein in BAC transgenic mice. *BMC Neurosci.* 12, 36. doi:10.1186/1471-2202-12-36.
- Fundytus, M. E., Fisher, K., Dray, A., Henry, J. L., and Coderre, T. J. (1998). In vivo antinociceptive activity of anti-rat mGluR1 and mGluR5 antibodies in rats. *Neuroreport* 9, 731–5.
- Furness, J. B., Costa, M., and Miller, R. J. (1983). Distribution and projections of nerves with enkephalin-like immunoreactivity in the guinea-pig small intestine. *Neuroscience* 8, 653–64.
- Gadient, R. A., and Otten, U. (1996). Postnatal expression of interleukin-6 (IL-6) and IL-6 receptor (IL-6R) mRNAs in rat sympathetic and sensory ganglia. *Brain Res.* 724, 41–6.
- Galligan, J. J., and Akbarali, H. I. (2014). Molecular Physiology of Enteric Opioid Receptors. *Am. J. Gastroenterol.* 2, 17–21. doi:10.1038/ajgsup.2014.5.
- Galligan, J. J., and Burks, T. F. (1983). Centrally mediated inhibition of small intestinal transit and motility by morphine in the rat. *J. Pharmacol. Exp. Ther.* 226, 356–61.
- Gassner, M., Ruscheweyh, R., and Sandkühler, J. (2009). Direct excitation of spinal GABAergic interneurons by noradrenaline. *Pain* 145, 204–10. doi:10.1016/j.pain.2009.06.021.

- Gaudet, A. D., Popovich, P. G., and Ramer, M. S. (2011). Wallerian degeneration: gaining perspective on inflammatory events after peripheral nerve injury. *J. Neuroinflammation* 8, 110. doi:10.1186/1742-2094-8-110.
- Gauriau, C., and Bernard, J. (2002). Nociceptors as Homeostatic Afferents : Central Processing Pain pathways and parabrachial circuits in the rat. *Exp. Physiol.*
- Gauriau, C., and Bernard, J.-F. (2004). Posterior triangular thalamic neurons convey nociceptive messages to the secondary somatosensory and insular cortices in the rat. *J. Neurosci.* 24, 752–61. doi:10.1523/JNEUROSCI.3272-03.2004.
- Gaveriaux, C., Peluso, J., Simonin, F., Laforet, J., and Kieffer, B. (1995). Identification of kappa- and delta-opioid receptor transcripts in immune cells. *FEBS Lett* 369, 272–276. doi:0014-5793(95)00766-3 [pii].
- Gavériaux-Ruff, C., Karchewski, L. a, Hever, X., Matifas, A., and Kieffer, B. L. (2008). Inflammatory pain is enhanced in delta opioid receptor-knockout mice. *Eur. J. Neurosci.* 27, 2558–67. doi:10.1111/j.1460-9568.2008.06223.x.
- Gavériaux-Ruff, C., and Kieffer, B. L. (2011). Delta opioid receptor analgesia: recent contributions from pharmacology and molecular approaches. *Behav. Pharmacol.* 22, 405–14. doi:10.1097/FBP.0b013e32834a1f2c.
- Gavériaux-Ruff, C., and Kieffer, B. L. (2002). Opioid receptor genes inactivated in mice: the highlights. *Neuropeptides* 36, 62–71. doi:10.1054/npep.2002.0900.
- Gavériaux-Ruff, C., Nozaki, C., Nadal, X., Hever, X. C., Weibel, R., Matifas, A., et al. (2011). Genetic ablation of delta opioid receptors in nociceptive sensory neurons increases chronic pain and abolishes opioid analgesia. *Pain* 152, 1238–48. doi:10.1016/j.pain.2010.12.031.
- Gebhart, G. F., Su, X., Joshi, S., Ozaki, N., and Sengupta, J. N. (2000). Peripheral opioid modulation of visceral pain. *Ann. N. Y. Acad. Sci.* 909, 41–50.
- Geboes, K., Ziekenhuis, U., and Rafae, S. (1998). Structural abnormalities of the nervous system in Crohn ' s disease and ulcerative colitis. *Neurogastroenterol. Motil.*
- Gendron, L., Lucido, A. L., Mennicken, F., O'Donnell, D., Vincent, J.-P., Stroh, T., and Beaudet, A. (2006). Morphine and pain-related stimuli enhance cell surface availability of somatic delta-opioid receptors in rat dorsal root ganglia. *J. Neurosci.* 26, 953–62. doi:10.1523/JNEUROSCI.3598-05.2006.
- Gendron, L., Mittal, N., Beaudry, H., and Walwyn, W. (2015). Recent advances on the δ opioid receptor: from trafficking to function. *Br. J. Pharmacol.* 172, 403–19. doi:10.1111/bph.12706.
- Gendron, L., Mittal, N., Beaudry, H., and Walwyn, W. (2014). Recent advances on the δ opioid receptor: from trafficking to function. *Br. J. Pharmacol.* doi:10.1111/bph.12706.
- Giguere, P. M., Kroeze, W. K., and Roth, B. L. (2014). Tuning up the right signal: chemical and genetic approaches to study GPCR functions. *Curr. Opin. Cell Biol.* 27, 51–5. doi:10.1016/j.ceb.2013.11.006.
- Gimbel, J. S., Richards, P., and Portenoy, R. K. (2003). Controlled-release oxycodone for pain in diabetic neuropathy: a randomized controlled trial. *Neurology* 60, 927–34.
- Goldstein, D. J., Lu, Y., Detke, M. J., Lee, T. C., and Iyengar, S. (2005). Duloxetine vs. placebo in patients with painful diabetic neuropathy. *Pain* 116, 109–18. doi:10.1016/j.pain.2005.03.029.
- Gomes, I., Fujita, W., Gupta, A., Saldanha, S. A., Negri, A., Pinello, C. E., et al. (2013). Identification of a mu-delta opioid receptor heteromer-biased agonist with antinociceptive activity. *Proc. Natl. Acad. Sci.* 110, 17162–17160. doi:10.1073/pnas.1317701110.
- Gomes, I., Gupta, A., Filipovska, J., Szeto, H. H., Pintar, J. E., and Devi, L. A. (2004). A role for heterodimerization of μ and δ opiate receptors in enhancing morphine analgesia. *Proc. Natl. Acad. Sci. U. S. A.* 101, 5135–5139. doi:10.1073/pnas.0307601101.
- Goode, T., Connell, J. O., Anton, P., Wong, H., Reeve, J., Sullivan, G. C. O., Collins, J. K., Charles, E., and S, Y. D. (2000). Neurokinin-1 receptor expression in inflammatory bowel disease : molecular quantitation and localisation. *Gut*, 387–396.
- Granier, S., Manglik, A., Kruse, A. C., Kobilka, T. S., Thian, F. S., Weis, W. I., and Kobilka, B. K. (2012). Structure of the δ -opioid receptor bound to naltrindole. *Nature* 485, 400–4. doi:10.1038/nature11111.
- Gray, A. C., Coupar, I. M., and White, P. J. (2006). Comparison of opioid receptor distributions in the rat central nervous system. *Life Sci.* 79, 674–85. doi:10.1016/j.lfs.2006.02.021.
- Greffrath, W., Binzen, U., Schwarz, S. T., Saaler-Reinhardt, S., and Treede, R.-D. (2003). Co-expression of heat sensitive

- vanilloid receptor subtypes in rat dorsal root ganglion neurons. *Neuroreport* 14, 2251–5. doi:10.1097/01.wnr.0000095711.83808.1e.
- Guan, J.-S., Xu, Z.-Z., Gao, H., He, S.-Q., Ma, G.-Q., Sun, T., et al. (2005). Interaction with vesicle luminal protachykinin regulates surface expression of delta-opioid receptors and opioid analgesia. *Cell* 122, 619–31. doi:10.1016/j.cell.2005.06.010.
- Gupta, A., Mulder, J., Gomes, I., Rozenfeld, R., Bushlin, I., Ong, E., et al. (2010). Increased abundance of opioid receptor heteromers after chronic morphine administration. *Sci. Signal.* 3, ra54. doi:10.1126/scisignal.2000807.
- Gupta, A., Mulder, J., Gomes, I., Rozenfeld, R., Bushlin, I., Ong, E., et al. (2011). Increased Abundance of Opioid Receptor Heteromers Following Chronic Morphine Administration. *Sci Signal.* 3. doi:10.1126/scisignal.2000807.Increased.
- Gutiérrez-Cuesta, J., Burokas, A., Mancino, S., Kummer, S., Martín-García, E., and Maldonado, R. (2014). Effects of genetic deletion of endogenous opioid system components on the reinstatement of cocaine-seeking behavior in mice. *Neuropsychopharmacology* 39, 2974–88. doi:10.1038/npp.2014.149.
- Haberstock-Debic, H., Kim, K.-A., Yu, Y. J., and von Zastrow, M. (2005). Morphine promotes rapid, arrestin-dependent endocytosis of mu-opioid receptors in striatal neurons. *J. Neurosci.* 25, 7847–57. doi:10.1523/JNEUROSCI.5045-04.2005.
- Han, Z. S., Zhang, E. T., and Craig, A. D. (1998). Nociceptive and thermoreceptive lamina I neurons are anatomically distinct. *Nat. Neurosci.* 1, 218–25. doi:10.1038/665.
- Hanani, M. (2005). Satellite glial cells in sensory ganglia: from form to function. *Brain Res. Brain Res. Rev.* 48, 457–76. doi:10.1016/j.brainresrev.2004.09.001.
- Harati, Y., Gooch, C., Swenson, M., Edelman, S., Greene, D., Raskin, P., et al. (1998). Double-blind randomized trial of tramadol for the treatment of the pain of diabetic neuropathy. *Neurology* 50, 1842–6.
- Harvey, R. J., Depner, U. B., Wässle, H., Ahmadi, S., Heindl, C., Reinold, H., et al. (2004). GlyR alpha3: an essential target for spinal PGE2-mediated inflammatory pain sensitization. *Science* 304, 884–7. doi:10.1126/science.1094925.
- Hathway, G. J., Vega-Avelaira, D., Moss, A., Ingram, R., and Fitzgerald, M. (2009). Brief, low frequency stimulation of rat peripheral C-fibres evokes prolonged microglial-induced central sensitization in adults but not in neonates. *Pain* 144, 110–8. doi:10.1016/j.pain.2009.03.022.
- He, S. Q., Zhang, Z. N., Guan, J. S., Liu, H. R., Zhao, B., Wang, H. B., et al. (2011). Facilitation of Mu-Opioid Receptor Activity by Preventing Delta-Opioid Receptor-Mediated Codegradation. *Neuron* 69, 120–131. doi:10.1016/j.neuron.2010.12.001.
- van Hecke, O., Austin, S. K., Khan, R. A., Smith, B. H., and Torrance, N. (2014). Neuropathic pain in the general population: a systematic review of epidemiological studies. *Pain* 155, 654–62. doi:10.1016/j.pain.2013.11.013.
- von Hehn, C. A., Baron, R., and Woolf, C. J. (2012). Deconstructing the neuropathic pain phenotype to reveal neural mechanisms. *Neuron* 73, 638–52. doi:10.1016/j.neuron.2012.02.008.
- Hendrich, J., Van Minh, A. T., Hebllich, F., Nieto-Rostro, M., Watschinger, K., Striessnig, J., Wratten, J., Davies, A., and Dolphin, A. C. (2008). Pharmacological disruption of calcium channel trafficking by the alpha2delta ligand gabapentin. *Proc. Natl. Acad. Sci. U. S. A.* 105, 3628–33. doi:10.1073/pnas.0708930105.
- Heng, B. C., Aubel, D., and Fussenegger, M. (2013). An overview of the diverse roles of G-protein coupled receptors (GPCRs) in the pathophysiology of various human diseases. *Biotechnol. Adv.* 31, 1676–94. doi:10.1016/j.biotechadv.2013.08.017.
- Hervera, A., Negrete, R., Lea, S., and Pol, O. (2010). The Role of Nitric Oxide in the Local Antiallodynic and Antihyperalgesic Effects and Expression of δ -Opioid and Cannabinoid-2 Receptors during Neuropathic Pain in Mice. *J. Pharmacol. Exp. Ther.* 334, 887–896. doi:10.1124/jpet.110.167585.Neuropathic.
- Hill, K., and Schaefer, M. (2007). TRPA1 is differentially modulated by the amphipathic molecules trinitrophenol and chlorpromazine. *J. Biol. Chem.* 282, 7145–53. doi:10.1074/jbc.M609600200.
- Hoeijmakers, J. G., Faber, C. G., Lauria, G., Merkies, I. S., and Waxman, S. G. (2012). Small-fibre neuropathies--advances in diagnosis, pathophysiology and management. *Nat. Rev. Neurol.* 8, 369–79. doi:10.1038/nrneurol.2012.97.
- Hollingshead, J., Dühmke, R. M., and Cornblath, D. R. (2006). Tramadol for neuropathic pain. *Cochrane database Syst. Rev.*, CD003726. doi:10.1002/14651858.CD003726.pub3.

- Hong, S., and Wiley, J. W. (2005). Early painful diabetic neuropathy is associated with differential changes in the expression and function of vanilloid receptor 1. *J. Biol. Chem.* 280, 618–27. doi:10.1074/jbc.M408500200.
- Hu, P., and McLachlan, E. M. (2002). Macrophage and lymphocyte invasion of dorsal root ganglia after peripheral nerve lesions in the rat. *Neuroscience* 112, 23–38.
- Hua, S., and Cabot, P. J. (2010). Mechanisms of peripheral immune-cell-mediated analgesia in inflammation: clinical and therapeutic implications. *Trends Pharmacol. Sci.* 31, 427–33. doi:10.1016/j.tips.2010.05.008.
- Hucho, T. B., Dina, O. A., and Levine, J. D. (2005). Epac mediates a cAMP-to-PKC signaling in inflammatory pain: an isolectin B4(+) neuron-specific mechanism. *J. Neurosci.* 25, 6119–26. doi:10.1523/JNEUROSCI.0285-05.2005.
- Hudson, L. J., Bevan, S., Wotherspoon, G., Gentry, C., Fox, A., and Winter, J. (2001). VR1 protein expression increases in undamaged DRG neurons after partial nerve injury. *Eur. J. Neurosci.* 13, 2105–14.
- Hunt, S. P., and Mantyh, P. W. (2001). The Molecular Dynamics of Pain Control. *Nat. Rev. Neurosci.* 2.
- Jaggi, A. S., Jain, V., and Singh, N. (2011). Animal models of neuropathic pain. *Fundam. Clin. Pharmacol.* 25, 1–28. doi:10.1111/j.1472-8206.2009.00801.x.
- Jensen, T. S., Baron, R., Haanpää, M., Kalso, E., Loeser, J. D., Rice, A. S. C., and Treede, R.-D. (2011). A new definition of neuropathic pain. *Pain* 152, 2204–5. doi:10.1016/j.pain.2011.06.017.
- Ji, R.-R., Samad, T. A., Jin, S.-X., Schmoll, R., and Woolf, C. J. (2002). p38 MAPK activation by NGF in primary sensory neurons after inflammation increases TRPV1 levels and maintains heat hyperalgesia. *Neuron* 36, 57–68.
- Jin, X., and Gereau, R. W. (2006). Acute p38-mediated modulation of tetrodotoxin-resistant sodium channels in mouse sensory neurons by tumor necrosis factor- α . *J. Neurosci.* 26, 246–55. doi:10.1523/JNEUROSCI.3858-05.2006.
- Julius, D., and Basbaum, A. (2001a). Molecular mechanisms of nociception. *Nature* 413, 203–210. doi:10.1038/35093019.
- Julius, D., and Basbaum, A. I. (2001b). Molecular mechanisms of nociception. *Nature* 413, 203–10. doi:10.1038/35093019.
- Kabli, N., and Cahill, C. M. (2007). Anti-allodynic effects of peripheral delta opioid receptors in neuropathic pain. *Pain* 127, 84–93. doi:10.1016/j.pain.2006.08.003.
- Kabli, N., Martin, N., Fan, T., Nguyen, T., Hasbi, a, Balboni, G., O’Dowd, B. F., and George, S. R. (2010). Agonists at the δ -opioid receptor modify the binding of μ -receptor agonists to the μ - δ receptor hetero-oligomer. *Br. J. Pharmacol.* 161, 1122–36. doi:10.1111/j.1476-5381.2010.00944.x.
- Kabli, N., Nguyen, T., Balboni, G., O’Dowd, B. F., and George, S. R. (2014). Antidepressant-like and anxiolytic-like effects following activation of the μ - δ opioid receptor heteromer in the nucleus accumbens. *Mol. Psychiatry* 19, 986–94. doi:10.1038/mp.2013.115.
- Kahle, and Frotscher (2006). “Atlas d’Anatomie 3.Système nerveux et organes des sens, chapitre Système nerveux végétatif,” in *Atlas d’Anatomie 3.Système nerveux et organes des sens*, 296 – 305.
- Kallal, L., and Benovic, J. L. (2000). Using green fluorescent proteins to study G-protein-coupled receptor localization and trafficking. *Trends Pharmacol. Sci.* 21, 175–80.
- Karlsson, P., Nyengaard, J. R., Polydefkis, M., and Jensen, T. S. (2015). Structural and functional assessment of skin nerve fibres in small-fibre pathology. *Eur. J. Pain* 19, 1059–70. doi:10.1002/ejp.645.
- Kato, G., Yasaka, T., Katafuchi, T., Furue, H., Mizuno, M., Iwamoto, Y., and Yoshimura, M. (2006). Direct GABAergic and glycinergic inhibition of the substantia gelatinosa from the rostral ventromedial medulla revealed by in vivo patch-clamp analysis in rats. *J. Neurosci.* 26, 1787–94. doi:10.1523/JNEUROSCI.4856-05.2006.
- Kawasaki, Y., Kumamoto, E., Furue, H., and Yoshimura, M. (2003). Alpha 2 adrenoceptor-mediated presynaptic inhibition of primary afferent glutamatergic transmission in rat substantia gelatinosa neurons. *Anesthesiology* 98, 682–9.
- Keïta, H., Kayser, V., and Guilbaud, G. (1995). Antinociceptive effect of a kappa-opioid receptor agonist that minimally crosses the blood-brain barrier (ICI 204448) in a rat model of mononeuropathy. *Eur. J. Pharmacol.* 277, 275–80.
- Kenakin, T. (2014). What is pharmacological “affinity”? Relevance to biased agonism and antagonism. *Trends Pharmacol. Sci.* 35, 434–441. doi:10.1016/j.tips.2014.06.003.
- Kerr, N., Holmes, F. E., Hobson, S.-A., Vanderplank, P., Leard, A., Balthasar, N., and Wynick, D. (2015). The generation of knock-in mice expressing fluorescently tagged galanin receptors 1 and 2. *Mol. Cell. Neurosci.* 68, 258–71. doi:10.1016/j.mcn.2015.08.006.

- Kestell, G. R., Anderson, R. L., Clarke, J. N., Haberberger, R. V, and Gibbins, I. L. (2015). Primary afferent neurons containing calcitonin gene-related peptide but not substance P in forepaw skin, dorsal root ganglia, and spinal cord of mice. *J. Comp. Neurol.* 523, 2555–69. doi:10.1002/cne.23804.
- Kidd, B. L., and Urban, L. A. (2001). Mechanisms of inflammatory pain. *Br. J. Anaesth.* 87, 3–11.
- Kieffer, B. L. (1995). Recent advances in molecular recognition and signal transduction of active peptides: receptors for opioid peptides. *Cell. Mol. Neurobiol.* 15, 615–35.
- Kieffer, B. L., and Gavériaux-Ruff, C. (2002). Exploring the opioid system by gene knockout. *Prog. Neurobiol.* 66, 285–306.
- Kim, C. H., Oh, Y., Chung, J. M., and Chung, K. (2002a). Changes in three subtypes of tetrodotoxin sensitive sodium channel expression in the axotomized dorsal root ganglion in the rat. *Neurosci. Lett.* 323, 125–8.
- Kim, D. S., Choi, J. O., Rim, H. D., and Cho, H. J. (2002b). Downregulation of voltage-gated potassium channel alpha gene expression in dorsal root ganglia following chronic constriction injury of the rat sciatic nerve. *Brain Res. Mol. Brain Res.* 105, 146–52.
- Kim, S. H., and Chung, J. M. (1992). An experimental model for peripheral neuropathy produced by segmental spinal nerve ligation in the rat. *Pain* 50, 355–63.
- Kivell, B., and Prisinzano, T. E. (2010). Kappa opioids and the modulation of pain. *Psychopharmacology (Berl)*. 210, 109–19. doi:10.1007/s00213-010-1819-6.
- Knoll, A. T., and Carlezon, W. A. (2010). Dynorphin, stress, and depression. *Brain Res.* 1314, 56–73. doi:10.1016/j.brainres.2009.09.074.
- Kobayashi, K., Yamanaka, H., and Noguchi, K. (2013). Expression of ATP receptors in the rat dorsal root ganglion and spinal cord. *Anat. Sci. Int.* 88, 10–6. doi:10.1007/s12565-012-0163-9.
- Kondo, I., Marvizon, J. C. G., Song, B., Salgado, F., Codeluppi, S., Hua, X.-Y., and Yaksh, T. L. (2005). Inhibition by spinal mu- and delta-opioid agonists of afferent-evoked substance P release. *J. Neurosci.* 25, 3651–60. doi:10.1523/JNEUROSCI.0252-05.2005.
- Kong, V. K. F., and Irwin, M. G. (2007). Gabapentin: a multimodal perioperative drug? *Br. J. Anaesth.* 99, 775–86. doi:10.1093/bja/aem316.
- König, M., Zimmer, A. M., Steiner, H., Holmes, P. V, Crawley, J. N., Brownstein, M. J., and Zimmer, A. (1996). Pain responses, anxiety and aggression in mice deficient in pre-proenkephalin. *Nature* 383, 535–8. doi:10.1038/383535a0.
- Koob, G. F., and Volkow, N. D. (2010). Neurocircuitry of addiction. *Neuropsychopharmacology* 35, 217–38. doi:10.1038/npp.2009.110.
- Krames, E. S. (2015). The Dorsal Root Ganglion in Chronic Pain and as a Target for Neuromodulation: A Review. *Neuromodulation Technol. Neural Interface* 18, 24–32. doi:10.1111/ner.12247.
- Krames, E. S. (2014). The Role of the Dorsal Root Ganglion in the Development of Neuropathic Pain. *Pain Med.* 15, 1669–1685. doi:10.1111/pme.12413.
- Kremer, M., Yalcin, I., Nexon, L., Wurtz, X., Ceredig, R. A., Daniel, D., Hawkes, R. A., Salvat, E., and Barrot, M. (2016). The antiallodynic action of pregabalin in neuropathic pain is independent from the opioid system. *Mol. Pain* 12. doi:10.1177/1744806916633477.
- Kusuda, R., Ravanelli, M. I., Cadetti, F., Franciosi, A., Previdelli, K., Zanon, S., and Lucas, G. (2013). Long-term antidepressant treatment inhibits neuropathic pain-induced CREB and PLC γ -1 phosphorylation in the mouse spinal cord dorsal horn. *J. Pain* 14, 1162–72. doi:10.1016/j.jpain.2013.04.015.
- Kwan, K. Y., Allchorne, A. J., Vollrath, M. A., Christensen, A. P., Zhang, D.-S., Woolf, C. J., and Corey, D. P. (2006). TRPA1 contributes to cold, mechanical, and chemical nociception but is not essential for hair-cell transduction. *Neuron* 50, 277–89. doi:10.1016/j.neuron.2006.03.042.
- LaBuda, C. J., Sora, I., Uhl, G. R., and Fuchs, P. N. (2000). Stress-induced analgesia in mu-opioid receptor knockout mice reveals normal function of the delta-opioid receptor system. *Brain Res.* 869, 1–5.
- Labuz, D., Berger, S., Mousa, S. A., Zöllner, C., Rittner, H. L., Shaqura, M. A., Segovia-Silvestre, T., Przewlocka, B., Stein, C., and Machelska, H. (2006). Peripheral antinociceptive effects of exogenous and immune cell-derived endomorphins in prolonged inflammatory pain. *J. Neurosci.* 26, 4350–8. doi:10.1523/JNEUROSCI.4349-05.2006.

- Labuz, D., Schmidt, Y., Schreiter, A., Rittner, H. L., Mousa, S. A., and Machelska, H. (2009). Immune cell-derived opioids protect against neuropathic pain in mice. *J. Clin. Invest.* 119, 278–286. doi:10.1172/JCI36246.
- Lagerström, M. C., and Schiöth, H. B. (2008). Structural diversity of G protein-coupled receptors and significance for drug discovery. *Nat. Rev. Drug Discov.* 7, 339–57. doi:10.1038/nrd2518.
- Lakhan, S. E., and Kirchgessner, A. (2010). Neuroinflammation in inflammatory bowel disease. *J. Neuroinflammation* 7, 37.
- Lalley, P. M. (2008). Opioidergic and dopaminergic modulation of respiration. *Respir. Physiol. Neurobiol.* 164, 160–7. doi:10.1016/j.resp.2008.02.004.
- Lanneau, C., Green, A., Hirst, W. D., Wise, A., Brown, J. T., Donnier, E., Charles, K. J., Wood, M., Davies, C. H., and Pangalos, M. N. (2001). Gabapentin is not a GABAB receptor agonist. *Neuropharmacology* 41, 965–75.
- Latremoliere, A., and Woolf, C. J. (2009). Central sensitization: a generator of pain hypersensitivity by central neural plasticity. *J. Pain* 10, 895–926. doi:10.1016/j.jpain.2009.06.012.
- Laurent, V., Wong, F. L., and Balleine, B. W. (2014). δ -Opioid receptors in the accumbens shell mediate the influence of both excitatory and inhibitory predictions on choice. *Br. J. Pharmacol.*, 1–9. doi:10.1111/bph.12731.
- Lawson, S. N. (2002). Phenotype and function of somatic primary afferent nociceptive neurones with C-, Adelta- or Aalpha/beta-fibres. *Exp. Physiol.* 87, 239–44.
- Ledda, M., De Palo, S., and Pannese, E. (2004). Ratios between number of neuroglial cells and number and volume of nerve cells in the spinal ganglia of two species of reptiles and three species of mammals. *Tissue Cell* 36, 55–62. doi:10.1016/j.tice.2003.09.001.
- Lee, D. H., Chang, L., Sorkin, L. S., and Chaplan, S. R. (2005). Hyperpolarization-activated, cation-nonspecific, cyclic nucleotide-modulated channel blockade alleviates mechanical allodynia and suppresses ectopic discharge in spinal nerve ligated rats. *J. Pain* 6, 417–24. doi:10.1016/j.jpain.2005.02.002.
- Lee, M., Cahill, C., Vincent, J., and Beaudet, A. (2002). Internalization and trafficking of opioid receptor ligands in rat cortical neurons. *Synapse* 111, 102–111.
- Leffler, A., Linte, R. M., Nau, C., Reeh, P., and Babes, A. (2007). A high-threshold heat-activated channel in cultured rat dorsal root ganglion neurons resembles TRPV2 and is blocked by gadolinium. *Eur. J. Neurosci.* 26, 12–22. doi:10.1111/j.1460-9568.2007.05643.x.
- Lesniak, A., and Lipkowski, A. W. (2011). Opioid peptides in peripheral pain control. *Acta Neurobiol. Exp. (Wars)*. 71, 129–138.
- Leung, L., and Cahill, C. M. (2010). TNF-alpha and neuropathic pain--a review. *J. Neuroinflammation* 7, 27. doi:10.1186/1742-2094-7-27.
- Li, C.-Y., Song, Y.-H., Higuera, E. S., and Luo, Z. D. (2004). Spinal dorsal horn calcium channel alpha2delta-1 subunit upregulation contributes to peripheral nerve injury-induced tactile allodynia. *J. Neurosci.* 24, 8494–9. doi:10.1523/JNEUROSCI.2982-04.2004.
- Li, C.-Y., Zhang, X.-L., Matthews, E. A., Li, K.-W., Kurwa, A., Boroujerdi, A., et al. (2006). Calcium channel alpha2delta1 subunit mediates spinal hyperexcitability in pain modulation. *Pain* 125, 20–34. doi:10.1016/j.pain.2006.04.022.
- Linden, D. R. (2012). Enhanced excitability of guinea pig inferior mesenteric ganglion neurons during and following recovery from chemical colitis. *Am. J. Physiol. Gastrointest. Liver Physiol.* 303, G1067–75. doi:10.1152/ajpgi.00226.2012.
- Liu, M., and Wood, J. N. (2011). The Roles of Sodium Channels in Nociception : Implications for Mechanisms of Neuropathic Pain. *Pain Med.* 12, 93–99. doi:10.1111/j.1526-4637.2011.01158.x.
- Liu, Q., Vrontou, S., Rice, F. L., Zylka, M. J., Dong, X., and Anderson, D. J. (2007). Molecular genetic visualization of a rare subset of unmyelinated sensory neurons that may detect gentle touch. *Nat. Neurosci.* 10, 946–8. doi:10.1038/nn1937.
- Loftus Jr., E. V (2004). Clinical epidemiology of inflammatory bowel disease: Incidence, prevalence, and environmental influences. *Gastroenterology* 126, 1504–1517.
- Lutz, P.-E., and Kieffer, B. L. (2013a). Opioid receptors: distinct roles in mood disorders. *Trends Neurosci.* 36, 195–206.

doi:10.1016/j.tins.2012.11.002.

- Lutz, P.-E., and Kieffer, B. L. (2013b). The multiple facets of opioid receptor function: implications for addiction. *Curr. Opin. Neurobiol.*, 1–7. doi:10.1016/j.conb.2013.02.005.
- Machelska, H., and Stein, C. (2006). Leukocyte-derived opioid peptides and inhibition of pain. *J. Neuroimmune Pharmacol.* 1, 90–7. doi:10.1007/s11481-005-9002-2.
- Mackner, L. M., Clough-Paabo, E., Pajer, K., Lourie, A., and Crandall, W. V. (2011). Psychoneuroimmunologic factors in inflammatory bowel disease. *Inflamm. Bowel Dis.* 17, 849–57. doi:10.1002/ibd.21430.
- Madziva, M. T., and Edwardson, J. M. (2001). Trafficking of green fluorescent protein-tagged muscarinic M4 receptors in NG108-15 cells. *Eur. J. Pharmacol.* 428, 9–18.
- Maletic, V., and Raison, C. L. (2009). Neurobiology of depression, fibromyalgia and neuropathic pain. *Front. Biosci. (Landmark Ed.)* 14, 5291–338.
- Malik-Hall, M., Dina, O. A., and Levine, J. D. (2005). Primary afferent nociceptor mechanisms mediating NGF-induced mechanical hyperalgesia. *Eur. J. Neurosci.* 21, 3387–94. doi:10.1111/j.1460-9568.2005.04173.x.
- Manglik, A., Kruse, A. C., Kobilka, T. S., Thian, F. S., Mathiesen, J. M., Sunahara, R. K., Pardo, L., Weis, W. I., Kobilka, B. K., and Granier, S. (2012). Crystal structure of the μ -opioid receptor bound to a morphinan antagonist. *Nature* 485, 321–6. doi:10.1038/nature10954.
- Mannion, R. J., Costigan, M., Decosterd, I., Amaya, F., Ma, Q. P., Holstege, J. C., et al. (1999). Neurotrophins: peripherally and centrally acting modulators of tactile stimulus-induced inflammatory pain hypersensitivity. *Proc. Natl. Acad. Sci. U. S. A.* 96, 9385–90.
- Mantyh, P. W., Koltzenburg, M., Mendell, L. M., Tive, L., and Shelton, D. L. (2011). Antagonism of nerve growth factor-TrkA signaling and the relief of pain. *Anesthesiology* 115, 189–204. doi:10.1097/ALN.0b013e31821b1ac5.
- Marchand, F., Perretti, M., and McMahon, S. B. (2005). Role of the immune system in chronic pain. *Nat. Rev. Neurosci.* 6, 521–32. doi:10.1038/nrn1700.
- Martin, M., Matifas, A., Maldonado, R., and Kieffer, B. L. (2003). Acute antinociceptive responses in single and combinatorial opioid receptor knockout mice: distinct mu, delta and kappa tones. *Eur. J. Neurosci.* 17, 701–708. doi:10.1046/j.1460-9568.2003.02482.x.
- Martin-Kleiner, I., Balog, T., and Gabrilovac, J. (2006). Signal transduction induced by opioids in immune cells: a review. *Neuroimmunomodulation* 13, 1–7. doi:10.1159/000092107.
- Marvizón, J. C. G., Chen, W., and Murphy, N. (2009). Enkephalins, dynorphins, and beta-endorphin in the rat dorsal horn: an immunofluorescence colocalization study. *J. Comp. Neurol.* 517, 51–68. doi:10.1002/cne.22130.
- Mason, P. (2005). Deconstructing endogenous pain modulations. *J. Neurophysiol.* 94, 1659–63. doi:10.1152/jn.00249.2005.
- Massotte, D. (2015). In vivo opioid receptor heteromerization: where do we stand? *Br. J. Pharmacol.* 172, 420–34. doi:10.1111/bph.12702.
- Matthes, H. W., Smadja, C., Valverde, O., Vonesch, J. L., Foutz, A. S., Boudinot, E., et al. (1998). Activity of the delta-opioid receptor is partially reduced, whereas activity of the kappa-receptor is maintained in mice lacking the mu-receptor. *J. Neurosci.* 18, 7285–95.
- Mattia, C., Paoletti, F., Coluzzi, F., and Boanelli, A. (2002). New antidepressants in the treatment of neuropathic pain. A review. *Minerva Anestesiol.* 68, 105–14.
- Mauborgne, A., Lutz, O., Legrand, J. C., Hamon, M., and Cesselin, F. (1987). Opposite effects of delta and mu opioid receptor agonists on the in vitro release of substance P-like material from the rat spinal cord. *J. Neurochem.* 48, 529–37.
- Maves, T. J., Pechman, P. S., Gebhart, G. F., and Meller, S. T. (1993). Possible chemical contribution from chronic gut sutures produces disorders of pain sensation like those seen in man. *Pain* 54, 57–69.
- Max, M. B., Culnane, M., Schafer, S. C., Gracely, R. H., Walther, D. J., Smoller, B., and Dubner, R. (1987). Amitriptyline relieves diabetic neuropathy pain in patients with normal or depressed mood. *Neurology* 37, 589–96.
- McDonald, N. A., Henstridge, C. M., Connolly, C. N., and Irving, A. J. (2007). Generation and functional characterization of fluorescent, N-terminally tagged CB1 receptor chimeras for live-cell imaging. *Mol. Cell. Neurosci.* 35, 237–48.

doi:10.1016/j.mcn.2007.02.016.

- McLean, A. J., and Milligan, G. (2000). Ligand regulation of green fluorescent protein-tagged forms of the human beta(1)- and beta(2)-adrenoceptors; comparisons with the unmodified receptors. *Br. J. Pharmacol.* 130, 1825–32. doi:10.1038/sj.bjp.0703506.
- McMahon, S. B., Dmitrieva, N., and Koltzenburg, M. (1995). Visceral pain. *Br. J. Anaesth.*, 132–144.
- Megat, S., Bohren, Y., Doridot, S., Gaveriaux-Ruff, C., Kieffer, B. L., Freund-Mercier, M.-J., Yalcin, I., and Barrot, M. (2015). κ -Opioid receptors are not necessary for the antidepressant treatment of neuropathic pain. *Br. J. Pharmacol.* 172, 1034–44. doi:10.1111/bph.12963.
- Mehendale, S. R., and Yuan, C.-S. (2006). Opioid-induced gastrointestinal dysfunction. *Dig. Dis.* 24, 105–12. doi:10.1159/000090314.
- Mennicken, F., Zhang, J., Hoffert, C., Ahmad, S., Beaudet, A., and O'Donnell, D. (2003). Phylogenetic changes in the expression of delta opioid receptors in spinal cord and dorsal root ganglia. *J. Comp. Neurol.* 465, 349–60. doi:10.1002/cne.10839.
- Le Merrer, J., Becker, J. A. J., Befort, K., and Kieffer, B. L. (2009). Reward processing by the opioid system in the brain. *Physiol. Rev.* 89, 1379–412. doi:10.1152/physrev.00005.2009.
- Mesnage, B., Gaillard, S., Godin, A. G., Rodeau, J.-L., Hammer, M., Von Engelhardt, J., Wiseman, P. W., De Koninck, Y., Schlichter, R., and Cordero-Erausquin, M. (2011). Morphological and functional characterization of cholinergic interneurons in the dorsal horn of the mouse spinal cord. *J. Comp. Neurol.* 519, 3139–58. doi:10.1002/cne.22668.
- Meyer-Rosberg, K., Kvarnström, A., Kinnman, E., Gordh, T., Nordfors, L. O., and Kristofferson, A. (2001). Peripheral neuropathic pain—a multidimensional burden for patients. *Eur. J. Pain* 5, 379–89. doi:10.1053/eujp.2001.0259.
- Mickle, A. D., Shepherd, A. J., and Mohapatra, D. P. (2015). Sensory TRP channels: the key transducers of nociception and pain. *Prog. Mol. Biol. Transl. Sci.* 131, 73–118. doi:10.1016/bs.pmbts.2015.01.002.
- Mico, J., Ardid, D., Berrocoso, E., and Eschalier, a (2006). Antidepressants and pain. *Trends Pharmacol. Sci.* 27, 348–354. doi:10.1016/j.tips.2006.05.004.
- Mika, J., Przewłocki, R., and Przewłocka, B. (2001). The role of delta-opioid receptor subtypes in neuropathic pain. *Eur. J. Pharmacol.* 415, 31–7.
- Miletic, G., and Miletic, V. (2008). Loose ligation of the sciatic nerve is associated with TrkB receptor-dependent decreases in KCC2 protein levels in the ipsilateral spinal dorsal horn. *Pain* 137, 532–9. doi:10.1016/j.pain.2007.10.016.
- Minami, M., Maekawa, K., Yabuuchi, K., and Satoh, M. (1995). Double in situ hybridization study on coexistence of mu-, delta- and kappa-opioid receptor mRNAs with preprotachykinin A mRNA in the rat dorsal root ganglia. *Brain Res. Mol. Brain Res.* 30, 203–10.
- Minnis, J. G., Patierno, S., Kohlmeier, S. E., Brecha, N. C., Tonini, M., and Sternini, C. (2003). Ligand-induced μ opioid receptor endocytosis and recycling in enteric neurons. *Neuroscience* 119, 33–42. doi:10.1016/S0306-4522(03)00135-0.
- Mizumura, K., Sugiura, T., Katanosaka, K., Banik, R. K., and Kozaki, Y. (2009). Excitation and sensitization of nociceptors by bradykinin: What do we know? *Exp. Brain Res.* 196, 53–65. doi:10.1007/s00221-009-1814-5.
- Moore, K. A., Kohno, T., Karchewski, L. A., Scholz, J., Baba, H., and Woolf, C. J. (2002). Partial peripheral nerve injury promotes a selective loss of GABAergic inhibition in the superficial dorsal horn of the spinal cord. *J. Neurosci.* 22, 6724–31. doi:20026611.
- Moreira, I. S. (2014). Structural features of the G-protein/GPCR interactions. *Biochim. Biophys. Acta* 1840, 16–33. doi:10.1016/j.bbagen.2013.08.027.
- Morinville, A., Cahill, C. M., Kieffer, B., Collier, B., and Beaudet, A. (2004). Mu-opioid receptor knockout prevents changes in delta-opioid receptor trafficking induced by chronic inflammatory pain. *Pain* 109, 266–73. doi:10.1016/j.pain.2004.01.011.
- Mosconi, T., and Kruger, L. (1996). Fixed-diameter polyethylene cuffs applied to the rat sciatic nerve induce a painful neuropathy: ultrastructural morphometric analysis of axonal alterations. *Pain* 64, 37–57.
- Mousa, S. A., Shakibaei, M., Sitte, N., Schäfer, M., and Stein, C. (2004). Subcellular pathways of beta-endorphin synthesis,

- processing, and release from immunocytes in inflammatory pain. *Endocrinology* 145, 1331–41. doi:10.1210/en.2003-1287.
- Mousa, S. A., Zhang, Q., Sitte, N., Ji, R., and Stein, C. (2001). beta-Endorphin-containing memory-cells and mu-opioid receptors undergo transport to peripheral inflamed tissue. *J. Neuroimmunol.* 115, 71–8.
- Nadal, X., Baños, J.-E., Kieffer, B. L., and Maldonado, R. (2006). Neuropathic pain is enhanced in delta-opioid receptor knockout mice. *Eur. J. Neurosci.* 23, 830–4. doi:10.1111/j.1460-9568.2006.04569.x.
- Nagase, H., Nemoto, T., Matsubara, A., Saito, M., Yamamoto, N., Osa, Y., et al. (2010). Design and synthesis of KNT-127, a δ -opioid receptor agonist effective by systemic administration. *Bioorganic Med. Chem. Lett.* 20, 6302–6305. doi:10.1016/j.bmcl.2010.08.083.
- Nagy, I., and Rang, H. (1999). Noxious heat activates all capsaicin-sensitive and also a sub-population of capsaicin-insensitive dorsal root ganglion neurons. *Neuroscience* 88, 995–997. doi:10.1016/S0306-4522(98)00535-1.
- Naim, M., Spike, R. C., Watt, C., Shehab, S. A., and Todd, A. J. (1997). Cells in laminae III and IV of the rat spinal cord that possess the neurokinin-1 receptor and have dorsally directed dendrites receive a major synaptic input from tachykinin-containing primary afferents. *J. Neurosci.* 17, 5536–48.
- Nassar, M. A., Baker, M. D., Levato, A., Ingram, R., Mallucci, G., McMahon, S. B., and Wood, J. N. (2006). Nerve injury induces robust allodynia and ectopic discharges in Nav1.3 null mutant mice. *Mol. Pain* 2, 33. doi:10.1186/1744-8069-2-33.
- Nassar, M. A., Levato, A., Stirling, L. C., and Wood, J. N. (2005). Neuropathic pain develops normally in mice lacking both Na(v)1.7 and Na(v)1.8. *Mol. Pain* 1, 24. doi:10.1186/1744-8069-1-24.
- Nassar, M. A., Stirling, L. C., Forlani, G., Baker, M. D., Matthews, E. A., Dickenson, A. H., and Wood, J. N. (2004). Nociceptor-specific gene deletion reveals a major role for Nav1.7 (PN1) in acute and inflammatory pain. *Proc. Natl. Acad. Sci. U. S. A.* 101, 12706–11. doi:10.1073/pnas.0404915101.
- Nestler, E. J., Barrot, M., DiLeone, R. J., Eisch, A. J., Gold, S. J., and Monteggia, L. M. (2002). Neurobiology of depression. *Neuron* 34, 13–25.
- Neunlist, M., Aubert, P., Toquet, C., Oreshkova, T., Barouk, J., Lehur, P. A., Schemann, M., and Galmiche, J. P. (2003). Changes in chemical coding of myenteric neurones in ulcerative colitis. *Gut* 52, 84–90.
- Nieto, M. M., Guen, S. L. E., Kieffer, B. L., Roques, B. P., and Noble, F. (2005). Physiological control of emotion-related behaviors by endogenous enkephalins involves essentially the delta opioid receptors. *Neuroscience* 135, 305–13. doi:10.1016/j.neuroscience.2005.06.025.
- Ninković, J., and Roy, S. (2013). Role of the mu-opioid receptor in opioid modulation of immune function. *Amino Acids* 45, 9–24. doi:10.1007/s00726-011-1163-0.
- Noël, J., Zimmermann, K., Busserolles, J., Deval, E., Alloui, A., Diochot, S., et al. (2009). The mechano-activated K⁺ channels TRAAK and TREK-1 control both warm and cold perception. *EMBO J.* 28, 1308–18. doi:10.1038/emboj.2009.57.
- Norrbrink, C., and Lundeberg, T. Tramadol in neuropathic pain after spinal cord injury: a randomized, double-blind, placebo-controlled trial. *Clin. J. Pain* 25, 177–84. doi:10.1097/AJP.0b013e31818a744d.
- North, R. A., and Karras, P. J. (1978). Opiate tolerance and dependence induced in vitro in single myenteric neurones. *Nature* 272, 73–5.
- Novakovic, S. D., Tzoumaka, E., McGivern, J. G., Haraguchi, M., Sangameswaran, L., Gogas, K. R., Eglén, R. M., and Hunter, J. C. (1998). Distribution of the tetrodotoxin-resistant sodium channel PN3 in rat sensory neurons in normal and neuropathic conditions. *J. Neurosci.* 18, 2174–87.
- Nozaki, C., Le Bourdonnec, B., Reiss, D., Windh, R. T., Little, P. J., Dolle, R. E., Kieffer, B. L., and Gavériaux-Ruff, C. (2012). δ -Opioid mechanisms for ADL5747 and ADL5859 effects in mice: analgesia, locomotion, and receptor internalization. *J. Pharmacol. Exp. Ther.* 342, 799–807. doi:10.1124/jpet.111.188987.
- Nozaki, C., Nagase, H., Nemoto, T., Matifas, a, Kieffer, B. L., and Gaveriaux-Ruff, C. (2014). In vivo properties of KNT-127, a novel δ opioid receptor agonist: receptor internalization, antihyperalgesia and antidepressant effects in mice. *Br. J. Pharmacol.* 171, 5376–86. doi:10.1111/bph.12852.
- Obara, I., Parkitna, J. R., Korostynski, M., Makuch, W., Kaminska, D., Przewlocka, B., and Przewlocki, R. (2009). Local peripheral opioid effects and expression of opioid genes in the spinal cord and dorsal root ganglia in neuropathic and

- inflammatory pain. *Pain* 141, 283–91. doi:10.1016/j.pain.2008.12.006.
- Ohara, P. T., Vit, J.-P., Bhargava, A., Romero, M., Sundberg, C., Charles, A. C., and Jasmin, L. (2009). Gliopathic pain: when satellite glial cells go bad. *Neuroscientist* 15, 450–63. doi:10.1177/1073858409336094.
- Old, E. A., Clark, A. K., and Malcangio, M. (2015). The Role of Glia in the Spinal Cord in Neuropathic and Inflammatory Pain Elizabeth. *Handb. Exp. Pharmacol.* 227, 145–170. doi:10.1007/978-3-662-46450-2.
- Ong, E. C. (2008). Controlled-release oxycodone in the treatment of neuropathic pain of nonmalignant and malignant causes. *Oncology* 74 Suppl 1, 72–5. doi:10.1159/000143223.
- Ong, E. W., Xue, L., Olmstead, M. C., and Cahill, C. M. (2015). Prolonged morphine treatment alters δ opioid receptor post-internalization trafficking. *Br. J. Pharmacol.* 172, 615–29. doi:10.1111/bph.12761.
- Osmakov, D. I., Andreev, Y. a., and Kozlov, S. a. (2015). Acid-sensing ion channels and their modulators. *Biochem.* 79, 1528–1545. doi:10.1134/S0006297914130069.
- Ostrom, R. S., and Insel, P. A. (2004). The evolving role of lipid rafts and caveolae in G protein-coupled receptor signaling: implications for molecular pharmacology. *Br. J. Pharmacol.* 143, 235–45. doi:10.1038/sj.bjp.0705930.
- Pacheco, D. F., Reis, G. M. L., Francischi, J. N., Castro, M. S. A., Perez, A. C., and Duarte, I. D. G. (2005). delta-Opioid receptor agonist SNC80 elicits peripheral antinociception via delta(1) and delta(2) receptors and activation of the l-arginine/nitric oxide/cyclic GMP pathway. *Life Sci.* 78, 54–60. doi:10.1016/j.lfs.2005.04.032.
- Pannese, E., Ledda, M., Cherkas, P. S., Huang, T. Y., and Hanani, M. (2003). Satellite cell reactions to axon injury of sensory ganglion neurons: increase in number of gap junctions and formation of bridges connecting previously separate perineuronal sheaths. *Anat. Embryol. (Berl)*. 206, 337–47. doi:10.1007/s00429-002-0301-6.
- Patapoutian, A., Peier, A. M., Story, G. M., and Viswanath, V. (2003). ThermoTRP channels and beyond: mechanisms of temperature sensation. *Nat. Rev. Neurosci.* 4, 529–39. doi:10.1038/nrn1141.
- Peckys, D., and Landwehrmeyer, G. B. (1999). Expression of mu, kappa, and delta opioid receptor messenger RNA in the human CNS: a 33P in situ hybridization study. *Neuroscience* 88, 1093–135.
- Peier, A. M., Moqrich, A., Hergarden, A. C., Reeve, A. J., Andersson, D. A., Story, G. M., et al. (2002). A TRP channel that senses cold stimuli and menthol. *Cell* 108, 705–15.
- Peirs, C., Williams, S. P. G., Zhao, X., Walsh, C. E., Gedeon, J. Y., Cagle, N. E., et al. (2015). Dorsal Horn Circuits for Persistent Mechanical Pain. *Neuron* 87, 797–812. doi:10.1016/j.neuron.2015.07.029.
- Percie du Sert, N., and Rice, a S. C. (2014). Improving the translation of analgesic drugs to the clinic: animal models of neuropathic pain. *Br. J. Pharmacol.* 171, 2951–63. doi:10.1111/bph.12645.
- Perry, M. J., and Lawson, S. N. (1998). Differences in expression of oligosaccharides, neuropeptides, carbonic anhydrase and neurofilament in rat primary afferent neurons retrogradely labelled via skin, muscle or visceral nerves. *Neuroscience* 85, 293–310.
- Petitjean, H., Hugel, S., Barthas, F., Bohren, Y., Barrot, M., Yalcin, I., and Schlichter, R. (2014). Activation of transient receptor potential vanilloid 2-expressing primary afferents stimulates synaptic transmission in the deep dorsal horn of the rat spinal cord and elicits mechanical hyperalgesia. *Eur. J. Neurosci.* 40, 3189–201. doi:10.1111/ejn.12688.
- Petitjean, H., Rodeau, J.-L., and Schlichter, R. (2012). Interactions between superficial and deep dorsal horn spinal cord neurons in the processing of nociceptive information. *Eur. J. Neurosci.* 36, 3500–8. doi:10.1111/j.1460-9568.2012.08273.x.
- Petrus, M., Peier, A. M., Bandell, M., Hwang, S. W., Huynh, T., Olney, N., Jegla, T., and Patapoutian, A. (2007). A role of TRPA1 in mechanical hyperalgesia is revealed by pharmacological inhibition. *Mol. Pain* 3, 40. doi:10.1186/1744-8069-3-40.
- Pitcher, G. M., Ritchie, J., and Henry, J. L. (1999). Nerve constriction in the rat: model of neuropathic, surgical and central pain. *Pain* 83, 37–46.
- Pohl, M., Ballet, S., Collin, E., Mauborgne, a., Bourgoign, S., Benoliel, J. J., Hamon, M., and Cesselin, F. (1997). Enkephalinergic and dynorphinergic neurons in the spinal cord and dorsal root ganglia of the polyarthritic rat — in vivo release and cDNA hybridization studies. *Brain Res.* 749, 18–28. doi:10.1016/S0006-8993(96)01161-4.
- van den Pol, A. N. (2012). Neuropeptide transmission in brain circuits. *Neuron* 76, 98–115. doi:10.1016/j.neuron.2012.09.014.

- Pol, O., Alameda, F., and Puig, M. M. (2001). Inflammation enhances mu-opioid receptor transcription and expression in mice intestine. *Mol. Pharmacol.* 60, 894–9.
- Pol, O., Murtra, P., Caracuel, L., Valverde, O., Puig, M. M., and Maldonado, R. (2006). Expression of opioid receptors and c-fos in CB1 knockout mice exposed to neuropathic pain. *Neuropharmacology* 50, 123–32. doi:10.1016/j.neuropharm.2005.11.002.
- Pol, O., Palacio, J. R., and Puig, M. M. (2003). The expression of delta- and kappa-opioid receptor is enhanced during intestinal inflammation in mice. *J. Pharmacol. Exp. Ther.* 306, 455–62. doi:10.1124/jpet.103.049346.
- Polgár, E., Furuta, T., Kaneko, T., and Todd, A. (2006). Characterization of neurons that express preprotachykinin B in the dorsal horn of the rat spinal cord. *Neuroscience* 139, 687–97. doi:10.1016/j.neuroscience.2005.12.021.
- Poole, D. P., Pelayo, J.-C., Scherrer, G., Evans, C. J., Kieffer, B. L., and Bunnett, N. W. (2011). Localization and regulation of fluorescently labeled delta opioid receptor, expressed in enteric neurons of mice. *Gastroenterology* 141, 982–991.e1–8. doi:10.1053/j.gastro.2011.05.042.
- Poonyachoti, S., Kulkarni-Narla, A., and Brown, D. R. (2002). Chemical coding of neurons expressing delta- and kappa-opioid receptor and type I vanilloid receptor immunoreactivities in the porcine ileum. *Cell Tissue Res.* 307, 23–33. doi:10.1007/s00441-001-0480-0.
- Porreca, F., and Burks, T. F. (1983). The spinal cord as a site of opioid effects on gastrointestinal transit in the mouse. *J. Pharmacol. Exp. Ther.* 227, 22–7.
- Pradhan, A. A. A., Becker, J. A. J., Scherrer, G., Tryoen-Toth, P., Filliol, D., Matifas, A., Massotte, D., Gavériaux-Ruff, C., and Kieffer, B. L. (2009). In vivo delta opioid receptor internalization controls behavioral effects of agonists. *PLoS One* 4, e5425. doi:10.1371/journal.pone.0005425.
- Pradhan, A. A. A., Walwyn, W., Nozaki, C., Filliol, D., Erbs, E., Matifas, A., Evans, C., and Kieffer, B. L. (2010). Ligand-directed trafficking of the δ -opioid receptor in vivo: two paths toward analgesic tolerance. *J. Neurosci.* 30, 16459–68. doi:10.1523/JNEUROSCI.3748-10.2010.
- Pradhan, A. A., Befort, K., Nozaki, C., Gavériaux-Ruff, C., and Kieffer, B. L. (2011). The delta opioid receptor: an evolving target for the treatment of brain disorders. *Trends Pharmacol. Sci.* 32, 581–90. doi:10.1016/j.tips.2011.06.008.
- Pradhan, A. A., Smith, M. L., Zyuzin, J., and Charles, A. (2014). δ -Opioid receptor agonists inhibit migraine-related hyperalgesia, aversive state and cortical spreading depression in mice. *Br. J. Pharmacol.* 171, 2375–2384. doi:10.1111/bph.12591.
- Prescott, S. A. (2015). *Molecular and Cell Biology of Pain*. 1st ed. Elsevier doi:10.1016/bs.pmbts.2014.11.008.
- Price, T. J., and Flores, C. M. (2007). Critical Evaluation of the Colocalization Between Calcitonin Gene-Related Peptide, Substance P, Transient Receptor Potential Vanilloid Subfamily Type 1 Immunoreactivities, and Isolectin B4 Binding in Primary Afferent Neurons of the Rat and Mouse. *J. Pain* 8, 263–272. doi:10.1016/j.jpain.2006.09.005.
- Price, T. J., and Inyang, K. E. (2015). *Commonalities between pain and memory mechanisms and their meaning for understanding chronic pain*. 1st ed. Elsevier Inc. doi:10.1016/bs.pmbts.2014.11.010.
- Przewłocki, R., and Przewłocka, B. (2001). Opioids in chronic pain. *Eur. J. Pharmacol.* 429, 79–91. doi:10.1016/S0014-2999(01)01308-5.
- Puehler, W., Zöllner, C., Brack, A., Shaqura, M. a, Krause, H., Schäfer, M., and Stein, C. (2004). Rapid upregulation of mu opioid receptor mRNA in dorsal root ganglia in response to peripheral inflammation depends on neuronal conduction. *Neuroscience* 129, 473–9. doi:10.1016/j.neuroscience.2004.06.086.
- Puig, M. M., and Pol, O. (1998). Peripheral effects of opioids in a model of chronic intestinal inflammation in mice. *J. Pharmacol. Exp. Ther.* 287, 1068–75.
- Qin, X. (2012). Etiology of inflammatory bowel disease: A unified hypothesis. *World J. Gastroenterol.* 18, 1708. doi:10.3748/wjg.v18.i15.1708.
- Qiu, C., Sora, I., Ren, K., Uhl, G., and Dubner, R. (2000). Enhanced delta-opioid receptor-mediated antinociception in mu-opioid receptor-deficient mice. *Eur. J. Pharmacol.* 387, 163–9.
- Raboisson, P., Dallel, R., Bernard, J. F., Le Bars, D., and Villanueva, L. (1996). Organization of efferent projections from the spinal cervical enlargement to the medullary subnucleus reticularis dorsalis and the adjacent cuneate nucleus: a PHA-L study in the rat. *J. Comp. Neurol.* 367, 503–17. doi:10.1002/(SICI)1096-9861(19960415)367:4<503::AID-

CNE3>3.0.CO;2-8.

- Radat, F., Margot-Duclot, A., and Attal, N. (2013). Psychiatric co-morbidities in patients with chronic peripheral neuropathic pain: a multicentre cohort study. *Eur. J. Pain* 17, 1547–57. doi:10.1002/j.1532-2149.2013.00334.x.
- Ragnauth, A., Schuller, A., Morgan, M., Chan, J., Ogawa, S., Pintar, J., Bodnar, R. J., and Pfaff, D. W. (2001). Female preproenkephalin-knockout mice display altered emotional responses. *Proc. Natl. Acad. Sci. U. S. A.* 98, 1958–63. doi:10.1073/pnas.041598498.
- Rainville, P. (2002). Brain mechanisms of pain affect and pain modulation. *Curr. Opin. Neurobiol.* 12, 195–204. doi:10.1016/S0959-4388(02)00313-6.
- Ramsey, I. S., Delling, M., and Clapham, D. E. (2006). An introduction to TRP channels. *Annu. Rev. Physiol.* 68, 619–47. doi:10.1146/annurev.physiol.68.040204.100431.
- Rantamäki, T., Hendolin, P., Kankaanpää, A., Mijatovic, J., Piepponen, P., Domenici, E., Chao, M. V., Männistö, P. T., and Castrén, E. (2007). Pharmacologically diverse antidepressants rapidly activate brain-derived neurotrophic factor receptor TrkB and induce phospholipase-Cgamma signaling pathways in mouse brain. *Neuropsychopharmacology* 32, 2152–62. doi:10.1038/sj.npp.1301345.
- Rawls, S. M., Hewson, J. M., Inan, S., and Cowan, A. (2005). Brain delta2 opioid receptors mediate SNC-80-evoked hypothermia in rats. *Brain Res.* 1049, 61–9. doi:10.1016/j.brainres.2005.04.074.
- Raza, A., Yousaf, W., Giannella, R., and Shata, M. T. (2012). Th17 cells: interactions with predisposing factors in the immunopathogenesis of inflammatory bowel disease. *Expert Rev. Clin. Immunol.* 8, 161–8. doi:10.1586/eci.11.96.
- Reichling, D. B., and Levine, J. D. (2009). Critical role of nociceptor plasticity in chronic pain. *Trends Neurosci.* 32, 611–8. doi:10.1016/j.tins.2009.07.007.
- Rezai, X., Faget, L., Bednarek, E., Schwab, Y., Kieffer, B. L., and Massotte, D. (2012). Mouse δ opioid receptors are located on presynaptic afferents to hippocampal pyramidal cells. *Cell. Mol. Neurobiol.* 32, 509–16. doi:10.1007/s10571-011-9791-1.
- Rezai, X., Kieffer, B. L., Roux, M. J., and Massotte, D. (2013). Delta opioid receptors regulate temporoammonic-activated feedforward inhibition to the mouse CA1 hippocampus. *PLoS One* 8, e79081. doi:10.1371/journal.pone.0079081.
- Ribeiro-da-Silva, A., and Coimbra, A. (1982). Two types of synaptic glomeruli and their distribution in laminae I-III of the rat spinal cord. *J. Comp. Neurol.* 209, 176–86. doi:10.1002/cne.902090205.
- Ribeiro-da-Silva, A., Tagari, P., and Cuello, A. C. (1989). Morphological characterization of substance P-like immunoreactive glomeruli in the superficial dorsal horn of the rat spinal cord and trigeminal subnucleus caudalis: a quantitative study. *J. Comp. Neurol.* 281, 497–15. doi:10.1002/cne.902810402.
- van Rijn, R. M., Whistler, J. L., and Waldhoer, M. (2010). Opioid-receptor-heteromer-specific trafficking and pharmacology. *Curr. Opin. Pharmacol.* 10, 73–9. doi:10.1016/j.coph.2009.09.007.
- Rittner, H. L., Hackel, D., Yamdeu, R.-S., Mousa, S. A., Stein, C., Schäfer, M., and Brack, A. (2009). Antinociception by neutrophil-derived opioid peptides in noninflamed tissue—role of hypertonicity and the perineurium. *Brain. Behav. Immun.* 23, 548–57. doi:10.1016/j.bbi.2009.02.007.
- Rivière, P. J.-M. (2004). Peripheral kappa-opioid agonists for visceral pain. *Br. J. Pharmacol.* 141, 1331–4. doi:10.1038/sj.bjp.0705763.
- Roberts, A. J., Gold, L. H., Polis, I., McDonald, J. S., Filliol, D., Kieffer, B. L., and Koob, G. F. (2001). Increased ethanol self-administration in delta-opioid receptor knockout mice. *Alcohol. Clin. Exp. Res.* 25, 1249–56.
- Roques, B. P. (1991). [New approach in the research of analgesics and antihypertensive agents]. *Ann. Pharm. Fr.* 49, 317–26.
- Rose, K., Ooi, L., Dalle, C., Robertson, B., Wood, I. C., and Gamper, N. (2011). Transcriptional repression of the M channel subunit Kv7.2 in chronic nerve injury. *Pain* 152, 742–54. doi:10.1016/j.pain.2010.12.028.
- Ross, R. A. (2003). Anandamide and vanilloid TRPV1 receptors. *Br. J. Pharmacol.* 140, 790–801. doi:10.1038/sj.bjp.0705467.
- Roy, S., Rached, M., and Gallo-Payet, N. (2007). Differential regulation of the human adrenocorticotropin receptor [melanocortin-2 receptor (MC2R)] by human MC2R accessory protein isoforms alpha and beta in isogenic human embryonic kidney 293 cells. *Mol. Endocrinol.* 21, 1656–69. doi:10.1210/me.2007-0041.

- Rozenfeld, R., Bushlin, I., Gomes, I., Tzavaras, N., Gupta, A., Neves, S., et al. (2012). Receptor heteromerization expands the repertoire of cannabinoid signaling in rodent neurons. *PLoS One* 7, e29239. doi:10.1371/journal.pone.0029239.
- Ruscheweyh, R., Forsthuber, L., Schoffinger, D., and Sandkuhler, J. (2007). Modification of Classical Neurochemical Markers in Identified Primary Afferent Neurons With AB-, AD-, and C-Fibers After Chronic Constriction Injury in Mice. *J. Comp. Neurol.* 504, 287–297. doi:10.1002/cne.
- Sadosky, A., McDermott, A. M., Brandenburg, N. A., and Strauss, M. A review of the epidemiology of painful diabetic peripheral neuropathy, postherpetic neuralgia, and less commonly studied neuropathic pain conditions. *Pain Pract.* 8, 45–56. doi:10.1111/j.1533-2500.2007.00164.x.
- Saitoh, A., Kimura, Y., Suzuki, T., Kawai, K., Nagase, H., and Kamei, J. (2004). Potential anxiolytic and antidepressant-like activities of SNC80, a selective delta-opioid agonist, in behavioral models in rodents. *J. Pharmacol. Sci.* 95, 374–80.
- Sartor, R. B. (2006). Mechanisms of disease: pathogenesis of Crohn's disease and ulcerative colitis. *Nat. Clin. Pract. Gastroenterol. Hepatol.* 3, 390–407. doi:10.1038/ncpgasthep0528.
- Sartor, R. B. (2008). Microbial influences in inflammatory bowel diseases. *Gastroenterology* 134, 577–94. doi:10.1053/j.gastro.2007.11.059.
- Sauriyal, D. S., Jaggi, A. S., and Singh, N. (2011). Extending pharmacological spectrum of opioids beyond analgesia: multifunctional aspects in different pathophysiological states. *Neuropeptides* 45, 175–188. doi:10.1016/j.npep.2010.12.004.
- Scammell, T. E., Arrighi, E., Thompson, M. A., Ronan, P. J., Saper, C. B., and Greene, R. W. (2003). Focal Deletion of the Adenosine A1 Receptor in Adult Mice Using an Adeno-Associated Viral Vector. *J. Neurosci.* 23, 5762–5770.
- Scherrer, G., Imamachi, N., Cao, Y. Q., Contet, C., Mennicken, F., O'Donnell, D., Kieffer, B. L., and Basbaum, A. I. (2009). Dissociation of the opioid receptor mechanisms that control mechanical and heat pain. *Cell* 137, 1148–1159. doi:10.1016/j.cell.2009.04.019.
- Scherrer, G., Tryoen-to, P., Filliol, D., Matifas, A., Laustriat, D., Cao, Y. Q., Vonesh, J., Gaveriaux, C., Kieffer, B. L., and Basbaum, A. I. (2006). Knockin mice expressing fluorescent delta -opioid receptors uncover G protein-coupled receptor dynamics in vivo. *PNAS* 103.
- Schmader, K. E. Epidemiology and impact on quality of life of postherpetic neuralgia and painful diabetic neuropathy. *Clin. J. Pain* 18, 350–4.
- Scholz, J., Broom, D. C., Youn, D.-H., Mills, C. D., Kohno, T., Suter, M. R., Moore, K. A., Decosterd, I., Coggeshall, R. E., and Woolf, C. J. (2005). Blocking caspase activity prevents transsynaptic neuronal apoptosis and the loss of inhibition in lamina II of the dorsal horn after peripheral nerve injury. *J. Neurosci.* 25, 7317–23. doi:10.1523/JNEUROSCI.1526-05.2005.
- Schreiter, A., Gore, C., Labuz, D., Fournie-Zaluski, M.-C., Roques, B. P., Stein, C., and Machelska, H. (2012). Pain inhibition by blocking leukocytic and neuronal opioid peptidases in peripheral inflamed tissue. *FASEB J.* 26, 5161–71. doi:10.1096/fj.12-208678.
- Seal, R. P., Wang, X., Guan, Y., Raja, S. N., Woodbury, C. J., Basbaum, A. I., and Edwards, R. H. (2009). Injury-induced mechanical hypersensitivity requires C-low threshold mechanoreceptors. *Nature* 462, 651–5. doi:10.1038/nature08505.
- Seibt, F., and Schlichter, R. (2015). Noradrenaline-mediated facilitation of inhibitory synaptic transmission in the dorsal horn of the rat spinal cord involves interlaminar communications. *Eur. J. Neurosci.* 42, 2654–2665. doi:10.1111/ejn.13077.
- Seltzer, Z., Dubner, R., and Shir, Y. (1990). A novel behavioral model of neuropathic pain disorders produced in rats by partial sciatic nerve injury. *Pain* 43, 205–18.
- Sengupta, J. N., Su, X., and Gebhart, G. F. (1996). Kappa, but not mu or delta, opioids attenuate responses to distention of afferent fibers innervating the rat colon. *Gastroenterology* 111, 968–80.
- Sharif-Naeini, R. (2015). *Molecular and Cell Biology of Pain*. Elsevier doi:10.1016/bs.pmbts.2014.11.011.
- Sharp, B. M. (2006). Multiple opioid receptors on immune cells modulate intracellular signaling. *Brain. Behav. Immun.* 20, 9–14. doi:10.1016/j.bbi.2005.02.002.
- Shields, S. D., Ahn, H.-S., Yang, Y., Han, C., Seal, R. P., Wood, J. N., Waxman, S. G., and Dib-Hajj, S. D. (2012). Nav1.8

- expression is not restricted to nociceptors in mouse peripheral nervous system. *Pain* 153, 2017–30. doi:10.1016/j.pain.2012.04.022.
- Shippenberg, T. S., Chefer, V. I., and Thompson, A. C. (2009). Delta-opioid receptor antagonists prevent sensitization to the conditioned rewarding effects of morphine. *Biol. Psychiatry* 65, 169–74. doi:10.1016/j.biopsych.2008.09.009.
- Shoda, T., Fukuda, K., Uga, H., Mima, H., and Morikawa, H. (2001). Activation of mu-opioid receptor induces expression of c-fos and junB via mitogen-activated protein kinase cascade. *Anesthesiology* 95, 983–9.
- Sikandar, S., and Dickenson, A. H. (2012). Visceral Pain – the Ins and Outs , the Ups and Downs. *Curr. Opin. Support. Palliat. Care* 6, 17–26. doi:10.1097/SPC.0b013e32834f6ec9.Visceral.
- Simonin, F., Valverde, O., Smadja, C., Slowe, S., Kitchen, I., Dierich, A., Le Meur, M., Roques, B. P., Maldonado, R., and Kieffer, B. L. (1998). Disruption of the kappa-opioid receptor gene in mice enhances sensitivity to chemical visceral pain, impairs pharmacological actions of the selective kappa-agonist U-50,488H and attenuates morphine withdrawal. *EMBO J.* 17, 886–97. doi:10.1093/emboj/17.4.886.
- Sindrup, S. H., Otto, M., Finnerup, N. B., and Jensen, T. S. (2005). Antidepressants in the treatment of neuropathic pain. *Basic Clin. Pharmacol. Toxicol.* 96, 399–409. doi:10.1111/j.1742-7843.2005.pto_96696601.x.
- Slominski, A. T., Zmijewski, M. a, Zbytek, B., Brozyna, A. a, Granese, J., Pisarchik, A., Szczesniewski, A., and Tobin, D. J. (2011). Regulated proenkephalin expression in human skin and cultured skin cells. *J. Invest. Dermatol.* 131, 613–22. doi:10.1038/jid.2010.376.
- Smith, H. S. (2012). Opioids and neuropathic pain. *Pain Physician* 15, ES93–110.
- Snider, W. D., and McMahon, S. B. (1998). Tackling pain at the source: new ideas about nociceptors. *Neuron* 20, 629–32.
- Sora, I., Li, X. F., Funada, M., Kinsey, S., and Uhl, G. R. (1999). Visceral chemical nociception in mice lacking mu-opioid receptors: effects of morphine, SNC80 and U-50,488. *Eur. J. Pharmacol.* 366, R3–5.
- Sora, I., Takahashi, N., Funada, M., Ujike, H., Revay, R. S., Donovan, D. M., Miner, L. L., and Uhl, G. R. (1997). Opiate receptor knockout mice define mu receptor roles in endogenous nociceptive responses and morphine-induced analgesia. *Proc. Natl. Acad. Sci. U. S. A.* 94, 1544–9.
- Sorkin, L. S., and Yaksh, T. L. (2009). Behavioral Models of Pain States Evoked by Physical Injury to the Peripheral Nerve. *Neurotherapeutics* 6, 609–619. doi:10.1016/j.nurt.2009.07.007.
- Speight, R. A., and Mansfield, J. C. (2013). Drug advances in inflammatory bowel disease. *Clin. Med.* 13, 378–82. doi:10.7861/clinmedicine.13-4-378.
- Starowicz, K., and Przewlocka, B. (2012). Modulation of neuropathic-pain-related behaviour by the spinal endocannabinoid/endovanilloid system. *Philos. Trans. R. Soc. Lond. B. Biol. Sci.* 367, 3286–99. doi:10.1098/rstb.2011.0392.
- Stein, C. (2013). Opioids, sensory systems and chronic pain. *Eur. J. Pharmacol.* 716, 179–87. doi:10.1016/j.ejphar.2013.01.076.
- Stein, C., Hassan, A. H., Przewlocki, R., Gramsch, C., Peter, K., and Herz, A. (1990). Opioids from immunocytes interact with receptors on sensory nerves to inhibit nociception in inflammation. *Proc. Natl. Acad. Sci. U. S. A.* 87, 5935–9.
- Stein, C., and Lang, L. J. (2009). Peripheral mechanisms of opioid analgesia. *Curr. Opin. Pharmacol.* 9, 3–8. doi:10.1016/j.coph.2008.12.009.
- Stein, C., and Machelska, H. (2011). Modulation of Peripheral Sensory Neurons by the Immune System: Implications for Pain Therapy. *Pharmacol. Rev.* 63, 860–881. doi:10.1124/pr.110.003145.860.
- Stein, C., Machelska, H., and Schäfer, M. (2001). Peripheral analgesic and antiinflammatory effects of opioids. *Z. Rheumatol.* 60, 416–24.
- Stein, C., Schäfer, M., and Machelska, H. (2003). Attacking pain at its source: new perspectives on opioids. *Nat. Med.* 9, 1003–8. doi:10.1038/nm908.
- Sternini, C., Patierno, S., Selmer, I.-S., and Kirchgessner, A. (2004). The opioid system in the gastrointestinal tract. *Neurogastroenterol. Motil.* 16 Suppl 2, 3–16. doi:10.1111/j.1743-3150.2004.00553.x.
- Stockton, S. D., and Devi, L. A. (2012). Functional relevance of μ - δ opioid receptor heteromerization: a role in novel signaling and implications for the treatment of addiction disorders: from a symposium on new concepts in mu-opioid pharmacology. *Drug Alcohol Depend.* 121, 167–72. doi:10.1016/j.drugalcdep.2011.10.025.

- Stumm, R. K., Zhou, C., Schulz, S., and Höllt, V. (2004). Neuronal types expressing mu- and delta-opioid receptor mRNA in the rat hippocampal formation. *J. Comp. Neurol.* 469, 107–18. doi:10.1002/cne.10997.
- Sullivan, M. J. L., Lynch, M. E., and Clark, A. J. (2005). Dimensions of catastrophic thinking associated with pain experience and disability in patients with neuropathic pain conditions. *Pain* 113, 310–315. doi:10.1016/j.pain.2004.11.003.
- Suter, M. R., Berta, T., Gao, Y.-J., Decosterd, I., and Ji, R.-R. (2009). Large A-fiber activity is required for microglial proliferation and p38 MAPK activation in the spinal cord: different effects of resiniferatoxin and bupivacaine on spinal microglial changes after spared nerve injury. *Mol. Pain* 5, 53. doi:10.1186/1744-8069-5-53.
- Takasusuki, T., and Yaksh, T. L. (2011). The effects of intrathecal and systemic gabapentin on spinal substance P release. *Anesth. Analg.* 112, 971–6. doi:10.1213/ANE.0b013e31820f2a16.
- Tejedor-Real, P., Micó, J. A., Smadja, C., Maldonado, R., Roques, B. P., and Gilbert-Rahola, J. (1998). Involvement of delta-opioid receptors in the effects induced by endogenous enkephalins on learned helplessness model. *Eur. J. Pharmacol.* 354, 1–7.
- Thakor, D. K., Lin, A., Matsuka, Y., Meyer, E. M., Ruangsri, S., Nishimura, I., and Spigelman, I. (2009). Increased peripheral nerve excitability and local NaV1.8 mRNA up-regulation in painful neuropathy. *Mol. Pain* 5, 14. doi:10.1186/1744-8069-5-14.
- Thévenot, E., Côté, F., Colin, P., He, Y., Leblois, H., Perricaudet, M., Mallet, J., and Vodjdani, G. (2003). Targeting conditional gene modification into the serotonin neurons of the dorsal raphe nucleus by viral delivery of the Cre recombinase. *Mol. Cell. Neurosci.* 24, 139–147. doi:10.1016/S1044-7431(03)00131-3.
- Thörn, S. E., Wattwil, M., Lindberg, G., and Säwe, J. (1996). Systemic and central effects of morphine on gastroduodenal motility. *Acta Anaesthesiol. Scand.* 40, 177–86.
- Todd, A. J. (1996). GABA and glycine in synaptic glomeruli of the rat spinal dorsal horn. *Eur. J. Neurosci.* 8, 2492–8.
- Todd, A. J. (2010). Neuronal circuitry for pain processing in the dorsal horn. *Nat. Rev. Neurosci.* 11, 823–36. doi:10.1038/nrn2947.
- Todd, A. J., Puskar, Z., Spike, R. C., Hughes, C., Watt, C., and Forrest, L. (2002). Projection neurons in lamina I of rat spinal cord with the neurokinin 1 receptor are selectively innervated by substance p-containing afferents and respond to noxious stimulation. *J. Neurosci.* 22, 4103–13. doi:20026261.
- Todd, A. J., and Spike, R. C. (1993). The localization of classical transmitters and neuropeptides within neurons in laminae I-III of the mammalian spinal dorsal horn. *Prog. Neurobiol.* 41, 609–645. doi:10.1016/0301-0082(93)90045-T.
- Todorovic, S. M., and Lingle, C. J. (1998). Pharmacological properties of T-type Ca²⁺ current in adult rat sensory neurons: effects of anticonvulsant and anesthetic agents. *J. Neurophysiol.* 79, 240–52.
- Tominaga, M., Caterina, M. J., Malmberg, A. B., Rosen, T. A., Gilbert, H., Skinner, K., Raumann, B. E., Basbaum, A. I., and Julius, D. (1998). The cloned capsaicin receptor integrates multiple pain-producing stimuli. *Neuron* 21, 531–43.
- Torregrossa, M. M., Jutkiewicz, E. M., Mosberg, H. I., Balboni, G., Watson, S. J., and Woods, J. H. (2006). Peptidic delta opioid receptor agonists produce antidepressant-like effects in the forced swim test and regulate BDNF mRNA expression in rats. *Brain Res.* 1069, 172–81. doi:10.1016/j.brainres.2005.11.005.
- Torsney, C., and MacDermott, A. B. (2006). Disinhibition opens the gate to pathological pain signaling in superficial neurokinin 1 receptor-expressing neurons in rat spinal cord. *J. Neurosci.* 26, 1833–43. doi:10.1523/JNEUROSCI.4584-05.2006.
- Trafton, J. A., Abbadie, C., Marek, K., and Basbaum, A. I. (2000). Postsynaptic Signaling via the mu -Opioid Receptor : Responses of Dorsal Horn Neurons to Exogenous Opioids and Noxious Stimulation. *J. Neurosci.* 20, 8578–8584.
- Trang, T., Al-Hasani, R., Salvemini, D., Salter, M. W., Gutstein, H., and Cahill, C. M. (2015). Pain and Poppies: The Good, the Bad, and the Ugly of Opioid Analgesics. *J. Neurosci.* 35, 13879–13888. doi:10.1523/JNEUROSCI.2711-15.2015.
- Treede, R.-D., Jensen, T. S., Campbell, J. N., Cruccu, G., Dostrovsky, J. O., Griffin, J. W., Hansson, P., Hughes, R., Nurmikko, T., and Serra, J. (2008). Neuropathic pain: redefinition and a grading system for clinical and research purposes. *Neurology* 70, 1630–5. doi:10.1212/01.wnl.0000282763.29778.59.
- Troelsen, K. B., Nielsen, E. Ø., and Mirza, N. R. (2005). Chronic treatment with duloxetine is necessary for an anxiolytic-like response in the mouse zero maze: the role of the serotonin transporter. *Psychopharmacology (Berl)*. 181, 741–50.

doi:10.1007/s00213-005-0032-5.

- Tsuda, M., Masuda, T., Kitano, J., Shimoyama, H., Tozaki-Saitoh, H., and Inoue, K. (2009). IFN-gamma receptor signaling mediates spinal microglia activation driving neuropathic pain. *Proc. Natl. Acad. Sci. U. S. A.* 106, 8032–7. doi:10.1073/pnas.0810420106.
- Tulleuda, A., Cokic, B., Callejo, G., Saiani, B., Serra, J., and Gasull, X. (2011). TRESK channel contribution to nociceptive sensory neurons excitability: modulation by nerve injury. *Mol. Pain* 7, 30. doi:10.1186/1744-8069-7-30.
- Uta, D., Furue, H., Pickering, A. E., Rashid, M. H., Mizuguchi-Takase, H., Katafuchi, T., Imoto, K., and Yoshimura, M. (2010). TRPA1-expressing primary afferents synapse with a morphologically identified subclass of substantia gelatinosa neurons in the adult rat spinal cord. *Eur. J. Neurosci.* 31, 1960–73. doi:10.1111/j.1460-9568.2010.07255.x.
- Vanderah, T. W. (2010). Delta and kappa opioid receptors as suitable drug targets for pain. *Clin. J. Pain* 26 Suppl 1, S10–5. doi:10.1097/AJP.0b013e3181c49e3a.
- Vasina, V., Barbara, G., Talamonti, L., Stanghellini, V., Corinaldesi, R., Tonini, M., De Ponti, F., and De Giorgio, R. (2006). Enteric neuroplasticity evoked by inflammation. *Auton. Neurosci.* 126-127, 264–72. doi:10.1016/j.autneu.2006.02.025.
- Verma-Gandhu, M., Verdu, E. F., Bercik, P., Blennerhassett, P. A., Al-Mutawaly, N., Ghia, J.-E., and Collins, S. M. (2007). Visceral pain perception is determined by the duration of colitis and associated neuropeptide expression in the mouse. *Gut* 56, 358–64. doi:10.1136/gut.2006.100016.
- Veves, A., Backonja, M., and Malik, R. a. (2008). Painful Diabetic Neuropathy: Epidemiology, Natural History, Early Diagnosis, and Treatment Options. *Pain Med.* 9, 660–674. doi:10.1111/j.1526-4637.2007.00347.x.
- Villanueva, L., Bernard, J. F., and Le Bars, D. (1995). Distribution of spinal cord projections from the medullary subnucleus reticularis dorsalis and the adjacent cuneate nucleus: a Phaseolus vulgaris-leucoagglutinin study in the rat. *J. Comp. Neurol.* 352, 11–32. doi:10.1002/cne.903520103.
- Voets, T., Droogmans, G., Wissenbach, U., Janssens, A., Flockerzi, V., and Nilius, B. (2004). The principle of temperature-dependent gating in cold- and heat-sensitive TRP channels. *Nature* 430, 748–54. doi:10.1038/nature02732.
- Volkers, L., Mechioukhi, Y., and Coste, B. (2014). Piezo channels: from structure to function. *Pflügers Arch. - Eur. J. Physiol.* 467, 95–99. doi:10.1007/s00424-014-1578-z.
- Walczak, J., Pichette, V., and Beaulieu, P. (2006). Characterization of Chronic Constriction of the Saphenous Nerve , a Model of Neuropathic Pain in Mice Showing Rapid Molecular and Electrophysiological Changes. *J. Neurosci. Res.* 1322, 1310–1322. doi:10.1002/jnr.
- Waldhoer, M., Bartlett, S. E., and Whistler, J. L. (2004). Opioid receptors. *Annu. Rev. Biochem.* 73, 953–90. doi:10.1146/annurev.biochem.73.011303.073940.
- Walther, C., and Ferguson, S. S. G. (2013). “Arrestins: role in the desensitization, sequestration, and vesicular trafficking of G protein-coupled receptors.,” in *Progress in molecular biology and translational science* (Elsevier Inc.), 93–113. doi:10.1016/B978-0-12-394440-5.00004-8.
- Walwyn, W., John, S., Maga, M., Evans, C. J., and Hales, T. G. (2009). Delta receptors are required for full inhibitory coupling of mu-receptors to voltage-dependent Ca(2+) channels in dorsal root ganglion neurons. *Mol. Pharmacol.* 76, 134–43. doi:10.1124/mol.109.055913.
- Walwyn, W. M., Wei, W., Xie, C.-W., Chiu, K., Kieffer, B. L., Evans, C. J., and Maidment, N. T. (2006). Mu opioid receptor-effector coupling and trafficking in dorsal root ganglia neurons. *Neuroscience* 142, 493–503. doi:10.1016/j.neuroscience.2006.06.021.
- Wang, C.-M., Chang, Y.-Y., Kuo, J.-S., and Sun, S. H. (2002). Activation of P2X(7) receptors induced [(3)H]GABA release from the RBA-2 type-2 astrocyte cell line through a Cl(-)/HCO(3)(-)-dependent mechanism. *Glia* 37, 8–18.
- Wang, G. K., Russell, C., and Wang, S.-Y. (2004). State-dependent block of voltage-gated Na+ channels by amitriptyline via the local anesthetic receptor and its implication for neuropathic pain. *Pain* 110, 166–74. doi:10.1016/j.pain.2004.03.018.
- Wang, H.-B., Zhao, B., Zhong, Y.-Q., Li, K.-C., Li, Z.-Y., Wang, Q., et al. (2010a). Coexpression of delta- and mu-opioid receptors in nociceptive sensory neurons. *Proc. Natl. Acad. Sci. U. S. A.* 107, 13117–22. doi:10.1073/pnas.1008382107.
- Wang, R., Guo, W., Ossipov, M. H., Vanderah, T. W., Porreca, F., and Lai, J. (2003). Glial cell line-derived neurotrophic

- factor normalizes neurochemical changes in injured dorsal root ganglion neurons and prevents the expression of experimental neuropathic pain. *Neuroscience* 121, 815–24.
- Wang, Y., Sun, J., Tao, Y., Chi, Z., and Liu, J. (2010b). The role of kappa-opioid receptor activation in mediating antinociception and addiction. *Acta Pharmacol. Sin.* 31, 1065–70. doi:10.1038/aps.2010.138.
- Wang, Z., Gardell, L. R., Ossipov, M. H., Vanderah, T. W., Brennan, M. B., Hochgeschwender, U., Hruby, V. J., Malan, T. P., Lai, J., and Porreca, F. (2001). Pronociceptive actions of dynorphin maintain chronic neuropathic pain. *J. Neurosci.* 21, 1779–86.
- Watson, A. H. D., Hughes, D. I., and Bazzaz, A. A. (2002). Synaptic relationships between hair follicle afferents and neurones expressing GABA and glycine-like immunoreactivity in the spinal cord of the rat. *J. Comp. Neurol.* 452, 367–80. doi:10.1002/cne.10410.
- Watson, C. P., and Babul, N. (1998). Efficacy of oxycodone in neuropathic pain: a randomized trial in postherpetic neuralgia. *Neurology* 50, 1837–41.
- Watson, C. P. N., and Oaklander, A. L. (2002). Postherpetic neuralgia. *Pain Pract.* 2, 295–307. doi:10.1046/j.1533-2500.2002.02039.x.
- Wee, S., and Koob, G. F. (2010). The role of the dynorphin-kappa opioid system in the reinforcing effects of drugs of abuse. *Psychopharmacology (Berl)*. 210, 121–35. doi:10.1007/s00213-010-1825-8.
- Weibel, R., Reiss, D., Karchewski, L., Gardon, O., Matifas, A., Filliol, D., Becker, J. a J., Wood, J. N., Kieffer, B. L., and Gaveriaux-Ruff, C. (2013). Mu opioid receptors on primary afferent nav1.8 neurons contribute to opiate-induced analgesia: insight from conditional knockout mice. *PLoS One* 8, e74706. doi:10.1371/journal.pone.0074706.
- Weihe, E. (1992). Neurochemical anatomy of the mammalian spinal cord: functional implications. *Ann. Anat.* 174, 89–118.
- Wendelsdorf, K., Bassaganya-riera, J., Hontecillas, R., and Eubank, S. (2010). Model of colonic inflammation : Immune modulatory mechanisms in inflammatory bowel disease. *J. Theor. Biol.* 264, 1225–1239. doi:10.1016/j.jtbi.2010.03.027.
- Wiffen, P., Collins, S., McQuay, H., Carroll, D., Jadad, A., and Moore, A. (2005). Anticonvulsant drugs for acute and chronic pain. *Cochrane database Syst. Rev.*, CD001133. doi:10.1002/14651858.CD001133.pub2.
- Williams, J. T., Christie, M. J., and Manzoni, O. (2001). Cellular and synaptic adaptations mediating opioid dependence. *Physiol Rev* 81, 299–343.
- Windebank, A. J., and Grisold, W. (2008). Chemotherapy-induced neuropathy. *J. Peripher. Nerv. Syst.* 13, 27–46. doi:10.1111/j.1529-8027.2008.00156.x.
- Wodarski, R., Clark, A. K., Grist, J., Marchand, F., and Malcangio, M. (2009). Gabapentin reverses microglial activation in the spinal cord of streptozotocin-induced diabetic rats. *Eur. J. Pain* 13, 807–11. doi:10.1016/j.ejpain.2008.09.010.
- Wolfe, G. I., and Trivedi, J. R. (2004). Painful peripheral neuropathy and its nonsurgical treatment. *Muscle Nerve* 30, 3–19. doi:10.1002/mus.20057.
- Woo, S.-H., Ranade, S., Weyer, A. D., Dubin, A. E., Baba, Y., Qiu, Z., et al. (2014). Piezo2 is required for Merkel-cell mechanotransduction. *Nature* 509, 622–6. doi:10.1038/nature13251.
- Wood, J. D., and Galligan, J. J. (2004). Function of opioids in the enteric nervous system. *Neurogastroenterol. Motil.* 16 Suppl 2, 17–28. doi:10.1111/j.1743-3150.2004.00554.x.
- Woolf, C. J., and Ma, Q. (2007). Nociceptors--noxious stimulus detectors. *Neuron* 55, 353–64. doi:10.1016/j.neuron.2007.07.016.
- Wu, H., Wacker, D., Mileni, M., Katritch, V., Han, G. W., Vardy, E., et al. (2012). Structure of the human κ -opioid receptor in complex with JD1c. *Nature* 485, 327–32. doi:10.1038/nature10939.
- Wu, Z. C., Kisslinger, S. D., and Gaginella, T. S. (1982). Functional evidence for the presence of cholinergic nerve endings in the colonic mucosa of the rat. *J. Pharmacol. Exp. Ther.* 221, 664–9.
- Xie, W.-Y., He, Y., Yang, Y.-R., Li, Y.-F., Kang, K., Xing, B.-M., and Wang, Y. (2009). Disruption of Cdk5-associated phosphorylation of residue threonine-161 of the delta-opioid receptor: impaired receptor function and attenuated morphine antinociceptive tolerance. *J. Neurosci.* 29, 3551–64. doi:10.1523/JNEUROSCI.0415-09.2009.
- Xu, J.-T., Xin, W.-J., Zang, Y., Wu, C.-Y., and Liu, X.-G. (2006). The role of tumor necrosis factor-alpha in the neuropathic pain induced by Lumbar 5 ventral root transection in rat. *Pain* 123, 306–21.

doi:10.1016/j.pain.2006.03.011.

- Xu, M., Petraschka, M., McLaughlin, J. P., Westenbroek, R. E., Caron, M. G., Lefkowitz, R. J., Czyzyk, T. A., Pintar, J. E., Terman, G. W., and Chavkin, C. (2004). Neuropathic pain activates the endogenous kappa opioid system in mouse spinal cord and induces opioid receptor tolerance. *J. Neurosci.* 24, 4576–84. doi:10.1523/JNEUROSCI.5552-03.2004.
- Xu, Z.-Z., Kim, Y. H., Bang, S., Zhang, Y., Berta, T., Wang, F., Oh, S. B., and Ji, R.-R. (2015). Inhibition of mechanical allodynia in neuropathic pain by TLR5-mediated A-fiber blockade. *Nat. Med.* 21, 1326–31. doi:10.1038/nm.3978.
- Yaksh, T. L., Jessell, T. M., Gamse, R., Mudge, A. W., and Leeman, S. E. (1980). Intrathecal morphine inhibits substance P release from mammalian spinal cord in vivo. *Nature* 286, 155–7.
- Yalcin, I., Bohren, Y., Waltisperger, E., Sage-Ciocca, D., Yin, J. C., Freund-Mercier, M.-J., and Barrot, M. (2011a). A time-dependent history of mood disorders in a murine model of neuropathic pain. *Biol. Psychiatry* 70, 946–53. doi:10.1016/j.biopsych.2011.07.017.
- Yalcin, I., Charlet, A., Cordero-Erausquin, M., Tessier, L.-H., Picciotto, M. R., Schlichter, R., Poisbeau, P., Freund-Mercier, M.-J., and Barrot, M. (2011b). Nociceptive thresholds are controlled through spinal β 2-subunit-containing nicotinic acetylcholine receptors. *Pain* 152, 2131–7. doi:10.1016/j.pain.2011.05.022.
- Yalcin, I., Choucair-Jaafar, N., Benbouzid, M., Tessier, L.-H., Muller, A., Hein, L., Freund-Mercier, M.-J., and Barrot, M. (2009a). Beta(2)-Adrenoceptors Are Critical for Antidepressant Treatment of Neuropathic Pain. *Ann. Neurol.* 65, 218–25. doi:10.1002/ana.21542.
- Yalcin, I., Megat, S., Barthas, F., Waltisperger, E., Kremer, M., Salvat, E., and Barrot, M. (2014). The Sciatic Nerve Cuffing Model of Neuropathic Pain in Mice. *J. Vis. Exp.*, 1–7. doi:10.3791/51608.
- Yalcin, I., Tessier, L.-H., Petit-Demoulière, N., Doridot, S., Hein, L., Freund-Mercier, M.-J., and Barrot, M. (2009b). Beta2-adrenoceptors are essential for desipramine, venlafaxine or reboxetine action in neuropathic pain. *Neurobiol. Dis.* 33, 386–94. doi:10.1016/j.nbd.2008.11.003.
- Yalcin, I., Tessier, L.-H., Petit-Demoulière, N., Waltisperger, E., Hein, L., Freund-Mercier, M.-J., and Barrot, M. (2010). Chronic treatment with agonists of beta(2)-adrenergic receptors in neuropathic pain. *Exp. Neurol.* 221, 115–21. doi:10.1016/j.expneurol.2009.10.008.
- Yasaka, T., Tiong, S. Y. X., Hughes, D. I., Riddell, J. S., and Todd, A. J. (2010). Populations of inhibitory and excitatory interneurons in lamina II of the adult rat spinal dorsal horn revealed by a combined electrophysiological and anatomical approach. *Pain* 151, 475–88. doi:10.1016/j.pain.2010.08.008.
- Yau, W. M., Dorsett, J. A., and Youther, M. L. (1990). Modulation of submucosal cholinergic neurons by 5-hydroxytryptamine and neuropeptides. *Am. J. Physiol.* 259, G1019–24.
- Yiangou, Y., Facer, P., Smith, J. A., Sangameswaran, L., Eglén, R., Birch, R., Knowles, C., Williams, N., and Anand, P. (2001). Increased acid-sensing ion channel ASIC-3 in inflamed human intestine. *Eur. J. Gastroenterol. Hepatol.* 13, 891–6.
- Zadina, J. E., Hackler, L., Ge, L. J., and Kastin, A. J. (1997). A potent and selective endogenous agonist for the mu-opiate receptor. *Nature* 386, 499–502. doi:10.1038/386499a0.
- von Zastrow, M., and Williams, J. T. (2012). Modulating neuromodulation by receptor membrane traffic in the endocytic pathway. *Neuron* 76, 22–32. doi:10.1016/j.neuron.2012.09.022.
- Zhang, G., Chen, W., and Marvizón, J. C. G. (2010). Src family kinases mediate the inhibition of substance P release in the rat spinal cord by μ -opioid receptors and GABA(B) receptors, but not α 2 adrenergic receptors. *Eur. J. Neurosci.* 32, 963–73. doi:10.1111/j.1460-9568.2010.07335.x.
- Zhang, X., Honda, C. N., and Giesler, G. J. (2000). Position of spinothalamic tract axons in upper cervical spinal cord of monkeys. *J. Neurophysiol.* 84, 1180–5.
- Zhang, X., Huang, J., and McNaughton, P. A. (2005). NGF rapidly increases membrane expression of TRPV1 heat-gated ion channels. *EMBO J.* 24, 4211–23. doi:10.1038/sj.emboj.7600893.
- Zhang, Y. H., Kays, J., Hodgdon, K. E., Sacktor, T. C., and Nicol, G. D. (2012). Nerve growth factor enhances the excitability of rat sensory neurons through activation of the atypical protein kinase C isoform, PKM ζ . *J. Neurophysiol.* 107, 315–35. doi:10.1152/jn.00030.2011.
- Zimmermann, K., Leffler, A., Babes, A., Cendan, C. M., Carr, R. W., Kobayashi, J., Nau, C., Wood, J. N., and Reeh, P. W.

(2007). Sensory neuron sodium channel Nav1.8 is essential for pain at low temperatures. *Nature* 447, 855–8. doi:10.1038/nature05880.

Zoli, M., Jansson, A., Syková, E., Agnati, L. F., and Fuxe, K. (1999). Volume transmission in the CNS and its relevance for neuropsychopharmacology. *Trends Pharmacol. Sci.* 20, 142–50.

Zöllner, C., and Schäfer, M. (2008). Opioids in anesthesia. *Anaesthesist* 57, 729–40; quiz 741–2. doi:10.1007/s00101-008-1408-9.

Zygmunt, P. M., Petersson, J., Andersson, D. A., Chuang, H., Sjørgård, M., Di Marzo, V., Julius, D., and Högestätt, E. D. (1999). Vanilloid receptors on sensory nerves mediate the vasodilator action of anandamide. *Nature* 400, 452–7. doi:10.1038/22761.

10. Annex 1: Published Review

Fluorescent knock-in mice to decipher the physiopathological role of G protein-coupled receptors

Ceredig and Massotte, 2015. *Frontiers in Pharmacology*.

1. Introduction

G protein coupled receptors represent the largest family of mammalian metabotropic receptors, and are involved in functional neuronal circuits which regulate diverse physiological processes (Lagerström and Schiöth, 2008). Many GPCRs are involved in neuromodulatory systems, and their activity impacts neurological functions (van den Pol, 2012). When dysfunctions of these pathways develop, occurrence of disorders such as anxiety and depression, chronic pain, substance abuse, neuroendocrine and neuroinflammatory diseases can be facilitated (Heng et al., 2013). Understanding the roles and selectively targeting individual GPCR populations within the CNS is therefore highly desirable.

The investigation of the physiological roles of GPCRs and their implication in disease mechanisms requires the use of tools which enable precise mapping of specific expression patterns and the observation of trafficking or regulatory events in response to physiological stimulation or drug administration. Such aims can be achieved by the use of knock-in mice expressing fluorescent protein under the control of an endogenous GPCR promoter or a fluorescent version of the GPCR of interest.

In this review, we provide an extensive critical examination of the fluorescent GPCR toolbox, and summarize the findings each knock-in mouse line has contributed to the understanding of specific GPCR localization and function in physiology and disease, paying special attention to CNS disorders.



Fluorescent knock-in mice to decipher the physiopathological role of G protein-coupled receptors

Rhian A. Ceredig and Dominique Massotte*

CNRS, Institut des Neurosciences Cellulaires et Intégratives, UPR 3212, Strasbourg, France

Edited by:

Marianthi Papakosta, Pfizer, USA

Reviewed by:

Enrico Sanna, University of Cagliari, Italy

Ioannis N. Charalampopoulos, University of Crete, Greece

*Correspondence:

Dominique Massotte, CNRS, Institut des Neurosciences Cellulaires et Intégratives, UPR 3212, 5 rue Blaise Pascal, 67084 Strasbourg Cedex 03, France

e-mail: d.massotte@unistra.fr

G protein-coupled receptors (GPCRs) modulate most physiological functions but are also critically involved in numerous pathological states. Approximately a third of marketed drugs target GPCRs, which places this family of receptors in the main arena of pharmacological pre-clinical and clinical research. The complexity of GPCR function demands comprehensive appraisal in native environment to collect in-depth knowledge of receptor physiopathological roles and assess the potential of therapeutic molecules. Identifying neurons expressing endogenous GPCRs is therefore essential to locate them within functional circuits whereas GPCR visualization with subcellular resolution is required to get insight into agonist-induced trafficking. Both remain frequently poorly investigated because direct visualization of endogenous receptors is often hampered by the lack of appropriate tools. Also, monitoring intracellular trafficking requires real-time visualization to gather in-depth knowledge. In this context, knock-in mice expressing a fluorescent protein or a fluorescent version of a GPCR under the control of the endogenous promoter not only help to decipher neuroanatomical circuits but also enable real-time monitoring with subcellular resolution thus providing invaluable information on their trafficking in response to a physiological or a pharmacological challenge. This review will present the animal models and discuss their contribution to the understanding of the physiopathological role of GPCRs. We will also address the drawbacks associated with this methodological approach and browse future directions.

Keywords: G protein-coupled receptors, fluorescent protein, knock-in, mouse model, drug design, biased agonism, receptor trafficking

INTRODUCTION

G protein-coupled-receptors (GPCRs) are proteins composed of seven transmembrane alpha helices with an extracellular N-terminus and an intracellular C-terminus (Rosenbaum et al., 2009). They represent one of the largest gene families in mammals and humans (Lagerström and Schiöth, 2008, and references therein). GPCRs can respond to various stimuli such as photons, ions, lipids, peptides, odorants, nucleotides, hormones, or neurotransmitters (Congreve et al., 2014). There are five human GPCR families: Rhodopsin, Secretin, Adhesion, Glutamate, and Frizzled/Taste2 with the rhodopsin receptor family being the largest. More than half of the 800 human GPCRs are classified as chemosensory taste or olfactory receptors (Lagerström and Schiöth, 2008; Heng et al., 2013). The remaining human GPCRs -roughly 370- may be involved in pathophysiological processes and are therefore potentially drugable targets. Indeed, metabolic, inflammatory, infectious or neurodegenerative diseases as well as cancer all involve a plethora of GPCRs (Heng et al., 2013). As many GPCRs belong to neuromodulatory systems (van den Pol, 2012), a large number of them are targeted by drugs in the context of nervous system disorders such as pain, drug addiction, anxiety, depression, sleep disorders, and neuroendocrine deregulation (Heng et al., 2013). Altogether, GPCRs represent the targets of about one third of marketed drugs (Overington et al., 2006).

Understanding the roles of GPCRs requires both in depth small scale investigation and overview. Indeed, GPCR expression,

function, modulation, and trafficking properties remain difficult to fathom and reflect the complex, highly regulated pathways in which they are involved. The study of GPCRs in physiology and disease therefore requires integrative and functional systems. This is especially true when considering the central nervous system (CNS) where neuronal networks are complex and intermingled. It is therefore of utmost importance to identify and delineate cells that express the GPCR of interest. In the majority of studies, mapping GPCR expression was overcast by poor antibody specificity. The measure of this limitation was only fully appreciated when genetically modified mice which were deficient for the GPCR of interest became available, emphasizing the insufficient specificity of the commonly used antibodies, thereby prompting the search for new technologies to monitor receptor trafficking, decipher activated intracellular signaling cascades or investigate functional outcomes of GPCR activation in integrated systems, and particularly in neuronal networks (Marder, 2012). Among the options which were being explored, fluorescent proteins (FPs) isolated from natural organisms attracted special interest as they appeared to be very promising tools to achieve these goals. There are many advantages to using fluorescent molecular tags; the inherent fluorescence is directly visible, chemically resistant to fixation and can be used in time-course studies in living cells for tracking receptor trafficking events (Kallal and Benovic, 2000).

The Green FP (GFP) was the first FP used in biology. This protein is composed of 238 amino acids (roughly 27 kDa) and was

isolated from the jellyfish *Aequorea victoria* (Shimomura et al., 1962, for review see Tsien, 1998). A mutant form of GFP called enhanced GFP (eGFP) was later generated, with improved quantum yield efficiency and higher solubility, making eGFP a popular reporter molecule (Cormack et al., 1997). The additional mutants that were created offer a large palette of fluorescence, ranging from violet to far red, thus opening new perspectives, including the possibility of co-expressing two or more FP in the same cell, whereby protein interactions could be investigated (Heim and Tsien, 1996). Likewise, this can be achieved by simultaneously expressing eGFP and mcherry, a stable monomeric mutant derived from the red fluorescent protein (RFP) DsRed, the latter was isolated from the coral *Discosoma sp.* (Campbell et al., 2002; Shaner et al., 2004). Additional variants derived from the GFP or DsRed were also generated and possess fast maturation, improved pH stability and photostability (reviewed in Shaner et al., 2007; Subach et al., 2009). The development of these FPs has been paralleled by technological advances in the field of live cell imaging that have brought high quality approaches for analysis of biological processes in a time- and space-dependent manner (Nienhaus and Nienhaus, 2014).

Validation of drug targets and pharmacological mechanisms cannot be achieved without *in vivo* preclinical studies for which mouse models provide a mammalian background and genetic tools of great value (Doyle et al., 2012; Bradley et al., 2014). In order to address GPCR function *in vivo*, tracking endogenous receptors with FPs therefore represents indisputable added value. In the following sections, we will review and comment on the use of FPs that has helped to shed light on endogenous GPCR function *in vivo*.

IN VIVO EXPRESSION OF FP UNDER GPCR PROMOTER FROM TRANSGENIC TO KNOCK-IN MOUSE LINES

Transgenic mouse lines expressing FPs under the control of promoters for a GPCR or an endogenous peptide were created. A number of reporter mice generated using bacterial artificial chromosomes (BACs) were part of a project called gene expression nervous system atlas (GENSAT) <http://www.gensat.org/index.html> (Gong et al., 2003) that produced an important set of data relative to gene expression which could be used for deciphering the developmental implications and network dynamics of selected genes of interest. On the account that specific CNS genes are most often expressed in a particular cell population or anatomically defined structure, tandem dimer Tomato (td-Tomato), a RFP, or eGFP-labeling of these cells renders analysis of the anatomical, physiological and biomolecular properties of a chosen subtype of neurons accessible. Overall, transgenic reporter mouse lines have proven to be extremely useful for the precise mapping of GPCR and endogenous ligands expression in the nervous system, and are suitable for analysis of cell populations (Heintz, 2001).

The shortcomings of the transgenic mouse models are, however, manifold (Haruyama et al., 2009). (1) Transgenic expression results in overexpression compared to wild type animals. (2) Low efficiency of transmission to offspring may be caused by mosaic expression of the transgene in founder animals. Indeed, high copy number insertion of transgenes is more vulnerable

to epigenetic silencing, which reduces the transgene expression level in successive generations. (3) Expression in unexpected tissues or timeframes may result from transgene insertion in genomic regions containing an endogenous promoter or enhancer. (4) Silencing or ectopic expression can be caused by positional effects. Transgene insertion can take place into transcriptionally inactive regions of the genome, or can be affected by neighboring repressor sites. Transgene insertion being, in essence, random, the possibility of disrupting the normal genome is very high. As a consequence, the erratic nature of the transgene insertion may result in unpredicted and/or detrimental phenotypes and off-target effects. As an example, many groups used BAC transgenic mice expressing eGFP driven by the promoter for either D₁ or D₂ receptors, the dopamine receptor 1 or 2, respectively (Lee et al., 2006; Bertran-Gonzalez et al., 2008; Valjent et al., 2009; Tian et al., 2010; Kramer et al., 2011; Chan et al., 2012). Mainly, work published using these two BAC transgenic mice successfully identified neurons expressing dopamine receptors and delineated dopaminergic connectivity in the CNS. However, Kramer et al. (2011) brought evidence of molecular and behavioral alterations in Drd2-eGFP BAC transgenic mice comprising novel environment hyperactivity, reduced locomotor response to cocaine, and D₂ receptor agonist hypersensitivity. These effects were presumably due to unfortunate insertion of the BAC, which caused receptor overexpression (Kramer et al., 2011).

KNOCK-IN MICE: TOWARD MORE SPECIFIC MODELS

To overcome the limitations associated with the use of transgenic mice, efforts were made to generate knock-in animals in which a FP is introduced at the locus of interest by homologous

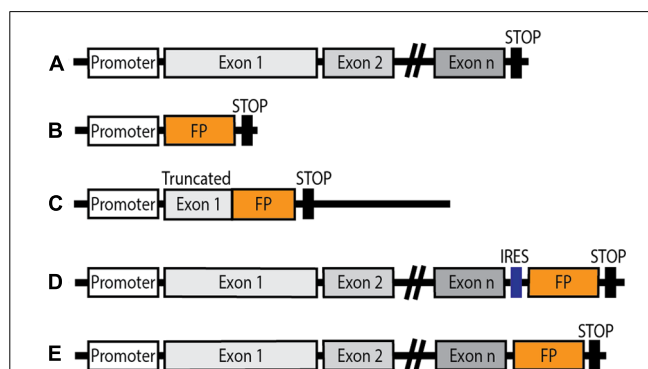

FIGURE 1 | Schematic diagram of genetic constructions of knock-in mice expressing a fluorescent protein (FP) under the control of an endogenous GPCR promoter. (A) Endogenous GPCR gene layout. **(B)** Knock-in FP expressed under the control of the endogenous GPCR promoter: the endogenous GPCR gene is replaced by the FP coding sequence. **(C)** The FP coding sequence is knocked into the truncated gene coding for the native GPCR, resulting in genetic invalidation of the receptor. **(D)** Insertion of an internal ribosomal entry site (IRES) downstream of the endogenous GPCR gene, ahead of the FP coding sequence. Native GPCR expression is maintained, and the FP is also expressed under the control of the endogenous GPCR promoter. **(E)** The FP sequence is inserted in frame in place of the stop codon in the endogenous GPCR gene giving rise to a fluorescent fusion protein in which the FP is fused to the C-terminus of the functional GPCR in conditions of native expression.

recombination. Several strategies are used (see **Figure 1**). Models in which an FP is expressed either under the control of an endogenous GPCR promoter are valuable and reliable tools for localization and characterization of cell population which express the GPCR of interest. However, such strategies present a significant drawback since the GPCR is non-functional following partial or total replacement of its coding sequence by the FP coding one. The FP is thus expressed in appropriate cells, but the precise subcellular localization and function of the receptor cannot be examined and the final outcome, in the case of homozygous animals, is the absence of the functional GPCR, equivalent to a knock-out phenotype. This limitation can be circumvented by the introduction of an internal ribosomal entry site (IRES) sequence, whereby expression of the endogenous GPCR is maintained and the chosen FP is expressed under control of the endogenous promoter.

Chemokine receptors

Jung et al. (2000) published the first knock-in mouse in which an FP was expressed under a GPCR promoter. The aim was to track cells which expressed the Fractalkin (CX₃C) chemokine receptor CX₃CR1, using a GFP knock-in strategy by replacing the first 390 bp of exon 2 of the *CX3CR1* gene that encodes the receptor N-terminus by a eGFP-coding sequence, enabling direct identification of peripheral blood cells and brain microglia expressing CX₃CR1 (see **Table 1**). In heterozygous animals, CX₃CR1 expression remained detectable because these CX₃CR1^{+ / GFP} heterozygous animals possess one allele for fluorescence visualization of cells expressing the GPCR of interest and one allele for expression of the functional receptor. Since CX₃CR1 and its ligand Fractalkin play a role in immunological and inflammatory processes, this model was used to investigate microglia proliferation during early embryonic spinal cord invasion (Rigato et al., 2012) neuron-glia interactions in the context of nerve injury or neuroinflammation (Garcia et al., 2013) and in neurodegenerative diseases such as Alzheimer's disease (Fuhrmann et al., 2010), or Parkinson's disease (Virgone-Carlotta et al., 2013).

A follow-up to this knock-in mouse was published in 2010. In their paper, Saederup et al. (2010) designed a mouse with another single FP, RFP (a DsRed variant) replacing the first 279 base pairs of the open reading frame coding for the chemokine receptor type 2 (CCR2), and crossed the heterozygous CCR2^{+ / RFP} and homozygous CCR2^{RFP / RFP} knock-in animals with the previously published CX₃CR1^{GFP / GFP} homozygous animals, in order to obtain heterozygous double knock-in animals CX₃CR1^{+ / GFP}CCR2^{+ / RFP}. The two chemokine receptors are expressed by distinct monocyte populations, therefore the red and green FPs constitute an elegant "two-colored" mouse model which was ideally suited for immunological studies (see **Table 1**). Indeed, because the immune system is constituted of cells that circulate in blood and lymph vessels, mature cells do not constitute a solid organ and are not restricted by connective tissue, therefore immune cell tracking is essential. Both the double heterozygous knock-in animals and the first mouse line (CX₃CR1^{+ / GFP} knock-in), were used to study and adequately quantify macrophage and monocyte population dynamics

in a model of autoimmune tissue inflammation (experimental autoimmune encephalomyelitis), which recapitulates an animal model of multiple sclerosis (MS). In a subsequent study, the same group unveiled myeloid lineage and microglial chemokine receptor changes at embryonic stages 8.5–13.5, monitored CNS colonization by cells of interest, during development and in an MS model using adult mice (Mizutani et al., 2012). The knock-in models thus yielded exciting and fundamental results relative to the identification of cells expressing the designated GPCRs, and a fine description of cellular population changes in various disease paradigms.

Oxytocin receptors

Yoshida et al. (2009) engineered a mouse line in which a 5' fragment of exon 3 of the oxytocin receptor (*OTR*) gene was replaced by a sequence coding for Venus FP, a yellow FP variant (Nagai et al., 2002). The recombined allele did not encode functional OTR but heterozygous animals retained radiolabelled oxytocin binding patterns through the intact allele, while enabling direct visualization of Venus in oxytocin expressing cells (Yoshida et al., 2009). Immunohistochemical analysis of brain sections from these animals revealed that there was a high expression of Venus (hence OTR) in monoaminergic areas of the brain in agreement with *in situ* hybridization (ISH) studies (Vaccari et al., 1998). However, the approach provided more sensitive detection of OTR expression by identifying additional areas and cells expressing Venus fluorescence among which serotonergic ones. This study was the first to show evidence for interaction between oxytonergic and serotonergic systems in a pathway, which modulates anxiety. In a following study, these knock-in mice were used to map OTR expression in the spinal cord; shedding light on the modulatory role of oxytocinergic networks involved in spinal cord functions, such as nociception (Wrobel et al., 2011).

Taste receptors

Sensing of the chemical categories which are responsible for sweet, sour or umami taste is specifically encoded by GPCRs expressed on primary taste neurons (Liman et al., 2014). The taste receptor family 1 (Tas1r) belongs to class C GPCRs and function as obligatory heteromers, meaning that two GPCRs of different subtypes are associated and interact to form a functional entity. The taste receptor family 2 (Tas2r), on the other hand, are currently classified among class A GPCRs (Alexander, 2013).

In order to study the distribution of taste receptors in the mouse gustatory tissue, Voigt and collaborators engineered two knock-in mouse lines which they subsequently crossed in order to obtain double knock-in animals in which the open reading frame encoding the receptor was replaced by the sequence coding for the mcherry or humanized Renilla (hr)GFP under the control of Tas1r1 (umami taste receptor) or Tas2r131 (bitter taste receptor) promoters, respectively (Voigt et al., 2012). This approach permitted identification of cells expressing mcherry under the control of the Tas1r1 promoter in the lingual papillae, soft palate, fungiform and foliate papillae, confirming previous findings (Hoon et al., 1999; Stone et al., 2007) but also in extra-gustatory tissues (lung epithelium, testis, thymus) which had not been investigated

Table 1 | Knock-in mice expressing fluorescent proteins under the control of G protein-coupled receptor (GPCR) endogenous promoters.

Targeted GPCR	Fluorescent protein	Identified cell type	Model	Therapeutic potential	Reference
Insertion of FP sequence at the GPCR gene locus					
Chemokine CX ₃ CR1	eGFP	Immune cells	Peritonitis Nerve injury	Neuroinflammation Neurodegenerative diseases	Jung et al. (2000)
		Microglia		Population dynamics in embryonic development	Rigato et al. (2012)
		Microglia	Neurodegeneration	Alzheimer	Fuhrmann et al. (2010)
		Microglia	Neuroinflammation	Parkinson	Virgone-Carlotta et al. (2013)
Chemokine CCR2	RFP	Immune cells	Experimental autoimmune encephalomyelitis	Neuroinflammation Neurodegenerative diseases	Saederup et al. (2010)
Chemokine CX ₃ CR1	eGFP	Immune cells	Experimental autoimmune encephalomyelitis	Neuroinflammation Neurodegenerative diseases	Saederup et al. (2010)
x Chemokine CCR2	RFP	Myeloid cells Microglia	Experimental autoimmune encephalomyelitis	Population dynamics in embryonic development	Mizutani et al. (2012)
Oxytocin	Venus	Brain distribution Spinal cord distribution	Anxiety related	Psychiatric disorders Nociception/pain	Yoshimura et al. (2001) Wrobel et al. (2011)
Mrgprd	eGFPf	Sensory projections to epidermis Sensory projections to tooth pulp		Nociception/pain Nociception/dental pain	Zylka et al. (2005) Chung et al. (2012)
Taste TasR1	mcherry	Taste cells in taste buds and peripheral tissue		–	Voigt et al. (2012)
Taste Tas2R131	hrGFP	Taste cells in taste buds and peripheral tissue		–	Voigt et al. (2012)
Taste TasR1	mcherry	Taste cells in taste buds and peripheral tissue		–	Voigt et al. (2012)
x Taste Tas2R131	hrGFP				
GPCR-IRES-FP expression					
Mas-related Mrgprd	eGFPf	Sensory projections to epidermis		Nociception/pain	Zylka et al. (2005)
Cannabinoid CB1	Td-Tomato	Neurons	Chronic cocaine injection	Drug addiction	Winters et al. (2012)

before (Voigt et al., 2012). Expression of hrGFP under the control of Tas2r131 promoter was in accordance with previously findings describing taste receptor distributions (Behrens et al., 2007), showing abundant hrGFP expression in taste buds of the posterior tongue, vallate palate and foliate palate. In addition, it uncovered, for the first time, expression restricted to only half of the bitter sensor cells (Voigt et al., 2012). Double knock-in animals lacked both taste receptors, but expressed FPs in the targeted cells [verified by reverse transcription polymerase chain reaction (RT-PCR), ISH and immunohistochemistry]. This genetic labeling technique served for population distribution studies, which

was until then unachievable, given the fact that Tasr expression is sparse in cells, and that the available antibodies lack specificity. The double knock-in animals yielded a valuable and detailed cartography of taste receptors in the mouse, and revealed that distinct chemosensory cell populations mediate specific and non-overlapping taste qualities.

Mas-related-G-protein coupled receptors

Mas-related-G-protein coupled receptor member D (Mrgprd) belongs to a GPCR family of approximately 50 members, related to *Mas1* (oncogene-like MAS), called Mrgs. Mrgs are suspected to

be involved in development, regulation and function of nociceptive neurons or nociceptors (Dong et al., 2001) and are expressed in a subset of nociceptors, which are small diameter primary sensory neurons in dorsal root ganglia (DRG) directly involved in processing nociceptive stimuli, especially itch (Liu et al., 2012).

Zylka et al. (2005) observed similar expression patterns of the eGFPf (a farnesylated form that anchors the FP to the cytoplasmic leaflet of the lipid bilayer) in nociceptors, and projections of the sensory neurons to the epidermis using knock-in mice in which the open reading frame coding for Mrgprd is replaced by the sequence encoding the eGFPf or knock-in animals in which the eGFPf sequence is inserted behind an IRES element downstream of the mouse Mrgprd gene (Zylka et al., 2005). This demonstrates that both strategies can be equally used for cellular mapping. In addition, similar projection profiles in the epidermis validated the eGFPf knock-in mouse for axonal tracing by comparison with the widely used human placental alkaline phosphatase tethered to the extracellular surface of the plasma membrane by a glycosylphosphatidylinositol linkage.

In a later study, the knock-in mouse model expressing eGFPf at the Mrgprd locus was used to identify non-peptidic nociceptive neurons of trigeminal ganglia innervating tooth pulp (Chung et al., 2012). This opens future application of this model to study the role and function of the targeted GPCR in dental pain.

Cannabinoid receptors

The endocannabinoid system plays roles in memory, appetite, stress and immune processes, as well as motivation and emotional responses and modulates the effects of some drugs of abuse (Pertwee, 2006; Tan et al., 2014). In the nucleus accumbens (NAc), a brain structure which has a crucial role in reward processing and a decisive influence on emotional and motivational responses, cannabinoid receptor 1 (CB1) expression is limited but nevertheless essential for cocaine-induced reward in mice (Marsicano and Lutz, 1999). In order to further identify and delineate the cellular and electrophysiological properties of CB1 receptor expressing cells in the NAc, Winters et al. (2012) designed a knock-in mouse line in which an IRES element ensures expression of both CB1 receptors and td-Tomato under the control of the CB1 promoter. Importantly, this mouse line still expressed functional CB1 receptors. Neurons expressing CB1 receptors were readily visualized in the NAc and their distribution was in accordance with previous data on CB1 receptor localization using ISH or immunohistochemistry (Mailleux and Vanderhaeghen, 1992; Tsou et al., 1997). This mouse line enabled to identify of cells and to explicitly demonstrate biochemical and signaling properties of a particular neuronal population of fast-spiking interneurons in the NAc which impacts on the NAc projections and connectivity. Results also revealed functional impact of cocaine on these neurons (Winters et al., 2012).

GPCR-FP FUSION FOR *IN VIVO* FUNCTIONAL AND MAPPING STUDIES

INITIAL VALIDATION OF GPCR-FP FUSIONS IN HETEROLOGOUS SYSTEMS

Fusions between a GPCR and an FP as tools to monitor the GPCR subcellular localization and trafficking were first studied

in heterologous systems. Two fusion options were considered: either the FP at the *N*-terminus or at the *C*-terminus. A vast majority of GPCRs do not have cleavable *N*-terminus signal sequences that target them to the plasma membrane. Introduction of a foreign sequence ahead of their *N*-terminus has been shown to disrupt surface addressing, and correct membrane targeting and insertion therefore requires introduction of an additional foreign signal sequence in front of the fusion construct (McDonald et al., 2007). If proper cell surface expression is indeed restored, introduction of such a signal sequence nonetheless strongly impacts on the relative ratio between surface expression and intracellular distribution by substantially increasing the amount of protein at the cell surface (Dunham and Hall, 2009, and references therein). Hence, such fusion proteins are not well suited to mimic the responses of endogenous GPCRs to agonist stimulation and were not used for *in vivo* studies.

Concerns have also been raised regarding in frame insertion of the FP at the *C*-terminus of the GPCR by substitution of the stop codon. The presence of a 27 kDa beta barrel at the intracellular extremity of the GPCR could indeed interfere with intracellular scaffold partners and modify signaling or internalization processes thus defeating the object when studying GPCR signaling properties. However, many studies performed in mammalian cells on a large number of GPCRs strongly suggest that addition of GFP at the *C*-terminus does not significantly affect subcellular distribution in the basal/unstimulated state, ligand binding or agonist-induced receptor phosphorylation and internalization, (for review Kallal and Benovic, 2000). McLean and Milligan (2000) expressed β_1 - and β_2 -adrenergic receptors fused to a *C*-terminal eGFP mutant in human embryonic kidney (HEK 293) cells. These authors concluded that the presence of the eGFP did not influence ligand binding but decreased the agonist-induced internalization kinetics without affecting the intracellular fate of the receptor. Trafficking of the fusion protein was qualitatively maintained, but was quantitatively slightly modified compared to native proteins. This study therefore supports the use of such fusions to monitor endogenous receptor subcellular localization. Similarly, the genetic construction encoding the delta opioid (DOP) receptor fused with eGFP protein at the *C*-terminus was expressed in transfected HEK 293 cells, and the fusion did not alter opioid ligand binding affinity or signaling (Scherrer et al., 2006). This construct was later successfully used to express a functional DOP-eGFP fusion in mice by knocking the modified sequence into the endogenous DOP receptor locus (Scherrer et al., 2006, see below).

In some cases, however, FP fusion at the GPCR *C*-terminus had deleterious effects. Defective targeting to the cell surface was reported for the melanocortin 2 receptor fused to the GFP in HEK 293 cells (Roy et al., 2007) and no recycling was observed for the muscarinic M4 receptor fused to a *C*-terminal red variant of GFP in neuroblastoma/glioma hybrid cells (NG108-15 cells; Madziva and Edwardson, 2001). In both cases, impairment was more likely to be due to gross overexpression rather than fusion of the FP to the *C*-terminus. High levels of expression of a GPCR in a non-native environment can indeed artificially elicit properties and interactions that would not occur *in vivo*. Moreover, cell lines

used for heterologous expression may provide different intracellular machinery for complex protein folding or post-translational modifications compared to naturally producing cells. This represents an additional limitation to the study of GPCR functions and prompted to develop *in vivo* approaches.

FROM TRANSGENIC TO KNOCK-IN MOUSE LINES

Papay et al. (2004) reported a transgenic mouse model of a fluorescently tagged GPCR. The construct they described was composed of a 3.4 kb fragment of the mouse endogenous $\alpha 1B$ adrenoceptor promoter, the human $\alpha 1B$ adrenoceptor coding sequence with C-terminal fusion eGFP sequence. The resulting founder lines were characterized, and high expression levels were observed in all tissues that naturally express $\alpha 1B$ adrenoceptors by fluorescence microscopy. Binding affinities and internalization profiles were similar to those of endogenous receptors. With this study, Papay et al. (2004) reported the first mouse model expressing a GPCR tagged with eGFP as a transgenic approach for *in vivo* GPCR localization studies. The generation of knock-in animals represented a further improvement by enabling for the first time to track down endogenous receptors, which has opened a new era for pharmacological research.

KNOCK-IN HUMANIZED RHODOPSIN FUSED WITH A FLUORESCENT PROTEIN (hRho-eGFP)

Chan et al. (2004) mouse lines expressing human rhodopsin-eGFP were engineered using different knock-in strategies. All mouse lines showed decreased expression levels of the fusion protein relative to the endogenous mouse rhodopsin. Comparing the different homozygote mouse lines enabled to correlate the decrease in human rhodopsin-eGFP expression to the increased rate of retinal degeneration, providing a model of human diseases. More recently, using a human mutant rhodopsin allele [proline-to-histidine change at codon 23 (P23H) rhodopsin] which induces mislocalization and degradation of the human protein, the research group generated a knock-in mouse line which modeled a common cause of autosomal dominant retinitis pigmentosa (Price et al., 2011). In humans, mutation Q344X is responsible for a severe early onset form of retinitis pigmentosa. The Q344X mutation introduces a premature stop codon that prevents GFP expression in the human rhodopsin-eGFP construct. Knock-in animals expressing this mutant construct were used to monitor eGFP fluorescence recovery as an index of the frequency and timing of somatic mutations in the rhodopsin gene (Sandoval et al., 2014). These mouse lines provided substantial and valuable data concerning rhodopsin distribution in the retina (for references, also see **Table 2**), and were advantageously implemented for non-invasive measurement by illuminating the mouse retina in live animals with blue light (Wensel et al., 2005). They will provide a means to assess the impact of future gene-targeting treatment strategies for retinal degeneration (Gross et al., 2006; Sandoval et al., 2014).

OPIOID RECEPTORS

The opioid system modulates a wide range of physiological states, of which nociception, reward, mood, stress, neuroendocrine physiology, immunity, autonomic functions such as gastro-intestinal

transit (Kieffer and Evans, 2009; Walwyn et al., 2010; Chu Sin Chung and Kieffer, 2013; Lutz and Kieffer, 2013). Opioid receptors are members of the class A GPCR family, mu (MOP), delta (DOP) and kappa (KOP) opioid receptors couple to inhibitory heterotrimeric inhibitory G protein, and have high sequence homology (Akil et al., 1998).

Mapping of receptor expression with neuronal resolution

Scherrer et al. (2006) generated a DOP-eGFP knock-in mouse line by homologous recombination in which the coding sequence for the DOP receptor fused to its C-terminus to the eGFP was inserted at the *Oprd1* locus.

Delta opioid-eGFP knock-in mice proved very helpful to map DOP receptors in the nervous system and remedy the lack of highly specific antibodies (see **Table 2**). In the peripheral nervous system, DOP-eGFP receptors were detected in cell bodies of specific peripheral sensory neuronal populations which process sensory stimuli, namely mostly in large diameter myelinated (Neurofilament 200 positive), and in small diameter unmyelinated non-peptidergic (Isolectin B4 positive) neurons (Scherrer et al., 2009; Bardoni et al., 2014). The expression pattern of DOP-eGFP receptors was also reported in mechanosensory organs in the skin (Bardoni et al., 2014). Another study focused on the distribution of DOP-eGFP in enteric neurons with DOP-eGFP expression mainly in secretomotor neurons of the submucosal plexus of the digestive tract (Poole et al., 2011). The observed distribution reflects functional roles of DOP receptors in inhibition of intestinal motility and absorption.

In the CNS, DOP-eGFP mapping was performed in the brain and spinal cord (Erbs et al., 2014). Detailed DOP-eGFP expression was also reported in the hippocampus, where functional DOP-eGFP was found to be mainly expressed in GABAergic interneurons, mostly parvalbumin-positive ones (Erbs et al., 2012; Rezai et al., 2013). The DOP-eGFP knock-in mice also enabled to resolve the debate concerning the presence of DOP receptors in principal cells. The absence of colocalization with calbindin (Erbs et al., 2012) and presynaptic expression restricted to afferents to glutamatergic principal cells established that no functional DOP receptors are expressed under basal conditions in those cells (Rezai et al., 2012). These results are consistent with a modulation of principal cell activity in the hippocampus by DOP receptors, and therefore an impact of the receptors in learning and memory.

More recently, a knock-in mouse line expressing a MOP receptor fused with a RFP at the C-terminus, MOP-mcherry, was generated by Erbs et al. (2014). At the *Oprm1* locus, mcherry cDNA was introduced into exon 4 of the MOP gene in frame and 5' from the stop codon. This FP is monomeric and highly photostable, and the strong red signal of MOP-mcherry fusion protein enabled direct identification of neurons expressing MOP in the nervous system (Erbs et al., 2014). The authors compiled the DOP-eGFP and MOP-mcherry distributions in a neuroanatomical atlas available at <http://mordor.ics-mci.fr>

Several studies in heterologous systems or cell culture had suggested that MOP and DOP receptors may interact to form heteromers (van Rijn et al., 2010; Rozenfeld et al., 2012; Stockton and Devi, 2012) but their existence *in vivo* remains debated. Co-immunoprecipitation studies performed on tissue from spinal

Table 2 | Knock-in mice expressing GPCR-fluorescent protein fusions.

Fusion construct	Biological readout	Reference
hRhodopsin-eGFP	Retinal degeneration kinetics (model of recessive retinitis pigmentosa)	Chan et al. (2004)
	Distribution, membrane structure, and trafficking of rhodopsin (model of retinitis pigmentosa)	Gross et al. (2006)
P23H-hRhodopsin-eGFP	Degeneration and degradation kinetics of rhodopsin (model of common cause of autosomal dominant retinitis pigmentosa)	Price et al. (2011)
Q344X-hRhodopsin-eGFP	DNA repair in photoreceptors cells during retinogenesis (degeneration and degradation kinetics in a model of severe early-onset of retinitis pigmentosa)	Sandoval et al. (2014)
DOP-eGFP	Receptor distribution: <ul style="list-style-type: none"> – central nervous system – hippocampus – dorsal root ganglia – mechanosensors in the skin – myenteric plexus 	Scherrer et al. (2006, 2009), Erbs et al. (2014) Erbs et al. (2012), Rezai et al. (2012, 2013) Scherrer et al. (2009), Bardoni et al. (2014) Bardoni et al. (2014) Poole et al. (2011)
	Correlation between behavioral desensitization and receptor internalization	Scherrer et al. (2006), Pradhan et al. (2009, 2010)
	Biased agonism at the receptor <ul style="list-style-type: none"> – pharmacological drugs – endogenous opioid peptides 	Pradhan et al. (2009, 2010) Faget et al. (2012)
	Behaviorally controlled receptor subcellular distribution	Faget et al. (2012), Bertran-Gonzalez et al. (2013), Laurent et al. (2014)
MOP-mcherry	Receptor distribution in the central and peripheral nervous systems	Erbs et al. (2014)
MOP-mcherry x DOP-eGFP	MOP-DOP neuronal co-expression in the brain	Erbs et al. (2014)

cord or DRGs also hinted at close physical proximity between the two receptors in these areas (Gomes et al., 2004; Xie et al., 2009). In addition, MOP-DOP heteromers had been detected in some brain areas using specific antibodies (Gupta et al., 2010). Recently, extensive mapping of MOP-DOP neuronal colocalization using double knock-in mice co-expressing DOP-eGFP and MOP-mcherry provided sound data to investigate MOP-DOP physical proximity and functional interactions. In the hippocampus, a brain area where the two receptors are highly co-expressed, co-immunoprecipitation experiments using antibodies raised against the FPs indeed confirmed physical proximity (Erbs et al., 2014). These animals will now be useful to address MOP-DOP specificities in ligand binding, signaling and trafficking as well as functional output and to investigate the potential of MOP-DOP heteromers as a novel therapeutic target.

In vivo trafficking, desensitization and behavioral output

The DOP-eGFP mouse line is the first example of the use of a knock-in line to study GPCR functions *in vivo* (Scherrer et al., 2006). DOP agonist-induced internalization

was observed *in vivo* upon activation by the alkaloid [(+)-4-[(alphaR)-alpha-((2S,5R)-4-allyl-2,5-dimethyl-1-piperazinyl)-3-methoxybenzyl]-N,N-diethylbenzamide] (SNC-80) and the endogenous peptide Met-enkephalin (Scherrer et al., 2006). The two agonists induce receptor internalization in heterologous systems with receptor phosphorylation as the first step of a cascade of events leading to termination of G protein dependent signaling, receptor removal from the cell membrane and trafficking to intracellular compartments (Ferguson et al., 1996; von Zastrow and Williams, 2012; Walther and Ferguson, 2013). DOP-eGFP mice revealed that these agonists also induce receptor phosphorylation, internalization via clathrin coated pits *in vivo* and degradation in the lysosomal compartment in the brain (Scherrer et al., 2006; Pradhan et al., 2009; Faget et al., 2012) and peripheral nervous system in the myenteric plexus (Poole et al., 2011) and DRGs (Scherrer et al., 2009). Moreover, these animals prove to be instrumental to decipher molecular mechanisms underlying receptor desensitization leading to a loss of responsiveness of the receptor upon stimulation by an agonist. Scherrer et al. (2006) were indeed able, for the first time, to establish the correlation between receptor

trafficking *in vivo* and the behavioral response: namely that the receptor internalization induced by acute administration of the agonist SNC-80 was responsible for the observed locomotor desensitization. This paper was followed by additional studies exploring the consequences of receptor pharmacological stimulation in more detail, in particular the concept of biased agonism.

G protein-coupled receptors have a flexible and highly dynamic nature (Moreira, 2014) which enables a given ligand to show functional selectivity, that is, preferential activation of signal transduction pathways, otherwise termed biased agonism (Ostrom and Insel, 2004; Giguere et al., 2014; Kenakin, 2014). DOP-eGFP mice offer the possibility of addressing this concept *in vivo* and to link it to a functional response. DOP-eGFP mice were used to analyze the properties of two DOP receptor agonists possessing similar signaling potencies and efficacies but with different internalization profiles (Pradhan et al., 2009). SNC-80 and *N,N*-diethyl-4-(phenyl-piperidin-4-ylidenemethyl)-benzamide (AR-M100390), with high and low internalization properties respectively, were systemically administered to mice, and receptor trafficking was correlated to induced anti-allodynic effect in the context of inflammatory pain (Pradhan et al., 2009). As expected, acute SNC-80 administration resulted in receptor phosphorylation, decreased G protein coupling and receptor degradation in the lysosomal compartment, leading to desensitization with loss of anti-allodynic properties. On the other hand, acute injection of AR-M100390 did not result in receptor phosphorylation, did not reduce G protein coupling, did not induce receptor internalization or desensitization but retained analgesic properties. This study demonstrated that DOP receptor localization determines its function *in vivo* and highlights the importance of receptor tracking in order to extricate behavioral and cellular correlates of specific agonist properties (Pradhan et al., 2009).

In a following study, DOP-eGFP mice were used to assess the physiological impact of distinct signaling pathway recruitment and/or adaptive responses upon chronic administration of two DOP receptor agonists (Pradhan et al., 2010). Chronic administration of SNC-80, which has high internalization properties, led to marked receptor downregulation and degradation in SNC-80-tolerant animals. Receptor internalization prevented any additional activation through physical disappearance from the cell surface leading to general desensitization, as assessed by thermal and mechanical analgesia, locomotor activity and anxiety-related behavior. On the other hand, chronic administration of AR-M100390, with weak internalization properties, did not cause changes in DOP-eGFP localization and induced tolerance restricted to analgesia, with no effect on locomotor activity or anxiolytic responses. These data show that a selective internalization-independent tolerance was elicited and suggest the occurrence of adaptative mechanisms that are network dependent. These findings reinforce the importance of understanding agonist specific signaling underlying biased agonism and tolerance. Considering that drug design has focused on offering orthosteric or allosteric modulators of GPCRs (Bradley et al., 2014), research groups need to explore the downstream signaling cascades of these drugs in more detail in order to understand and target the molecular events which underlie their efficacy. This is an essential progress

for the understanding of drug action and opens new possibilities for drug design.

Direct visualization of the receptor also permitted to decipher the functional role of delta receptors in neuronal networks and to understand the complex relation between behavior and receptor subcellular distribution. Of particular interest is the observation that DOP subcellular distribution is modified in two brain areas involved in the processing of information associated with emotional value or predicted outcome. The CA1 area of the hippocampus is known to operate as a coincidence detector that reflects association of the context with strong emotional stimuli of positive or aversive value (Duncan et al., 2012). Accordingly, increased c-Fos immunoreactivity revealed activation of this region in a drug-context association paradigm, and DOP-eGFP internalization in this area therefore suggested a modulatory role of the receptor in behavioral responses linked to context-induced withdrawal (Faget et al., 2012). Along the same line, persistent increase of DOP-eGFP expression at the cell surface of cholinergic interneurons was induced by conditioned training in the NAc shell, which is involved in decision making and predictive reward evaluation upon pavlovian conditioning (Bertran-Gonzalez et al., 2013; Laurent et al., 2014).

Finally, the knock-in strategy revealed that the DOP-eGFP internalization profile in response to endogenous opioid release is distinct from what is observed upon pharmacological stimulation (Faget et al., 2012). Indeed, only part of the receptor population present at the cell surface underwent internalization under physiological conditions. This observation further highlights the need to take into account the extent of changes that drug administration induces in receptor cellular distribution.

Methodological improvements

Interestingly, DOP-eGFP knock in mice also bring useful technical insight. During the process of acute brain slice preparation for electrophysiological recordings, DOP-eGFP revealed spontaneous receptor internalization (Rezai et al., 2013). This event was likely due to high glutamatergic activity in the hippocampus upon slicing that leads to excitotoxicity. Direct visualization of the receptor therefore revealed a bias associated with previously unrecognized receptor trafficking that can now be addressed by initiating optimization of slice preparation conditions for electrophysiological recording (Rezai et al., 2013). This observation may be of particular relevance when addressing cellular responses elicited by drug application.

CONCERNS ABOUT THE USE *IN VIVO* OF GPCR-FP FUSIONS FOR FUNCTIONAL STUDIES

Despite the undeniably wide advances which have been and will be brought by genetically engineered mice encoding fluorescent endogenous GPCRs, concerns were raised regarding the inherent consequences of genetic manipulation. The possibility that the observed localization does not entirely reflect the wild type receptor distribution appears irrelevant since both MOP-mcherry and DOP-eGFP receptor distributions in the brain are in full agreement with reports in mice and rats based on ligand binding (Kitchen et al., 1997; Slowe et al., 1999; Goody et al., 2002; Lesscher et al., 2003), GTP γ S incorporation (Tempel and Zukin, 1987; Pradhan

and Clarke, 2005) or mRNA detection [George et al., 1994; Mansour et al., 1995; Cahill et al., 2001; for a review see (LeMerrer et al., 2009)]. Also, in a more detailed study, DOP-eGFP expression in the hippocampus, mainly in parvalbumin-positive GABAergic interneurons (Erbs et al., 2012), was corroborated by ISH studies on DOP receptors (Stumm et al., 2004).

In the peripheral nervous system, despite previous reports suggesting SP-dependent trafficking of DOP receptors to the cell membrane (Guan et al., 2005), Scherrer et al. (2009) reported that DOP-eGFP almost never co-localized with substance P (SP) in peripheral sensory neurons (Scherrer et al., 2009), a finding that was debated by others (Wang et al., 2010). A more recent study addressed this discrepancy by comparing DOP-eGFP cellular distribution to that of the native DOP receptor using an ultrasensitive and specific ISH technique, which can detect single mRNA molecules (Bardoni et al., 2014). Patterns of DOP-eGFP distribution and *Oprd1* mRNA expression were found to be very similar and detectable in the same neuronal populations, namely mostly in large diameter myelinated cells (Neurofilament 200 positive), and in small diameter unmyelinated non-peptidergic neurons (isolectin B4 positive; Bardoni et al., 2014). These data unambiguously confirm that the expression profile of the fluorescent constructs mimics the endogenous one and that fluorescent knock-in mice can be reliably used for mapping receptors in the central and peripheral nervous system.

Regarding functional aspects, there has been no evidence so far of any overt phenotypical or behavioral differences between the DOP receptor knock-in strain and wild type animals (Scherrer et al., 2006; Pradhan et al., 2009, 2010; Rezai et al., 2013), despite a twofold increase in mRNA and protein levels as well as increased G protein activation compared to wild type animals (Scherrer et al., 2006). However, the possibility that the subcellular distribution of the fluorescent fusion does not recapitulate that of the native untagged receptor is still debated. Indeed, high surface expression of DOP-eGFP is observed under basal conditions in several brain regions, particularly in the hippocampus (Scherrer et al., 2009; Erbs et al., 2012, 2014; Faget et al., 2012). This does not correlate with previous studies on wild type receptors using electron microscopy or fluorescent ligands that indicated a predominant intracellular localization under basal conditions and surface recruitment upon chronic morphine or chronic pain condition (Cahill et al., 2001; Morinville et al., 2004; Gendron et al., 2006; for review see Cahill et al., 2007; Gendron et al., 2014). Surface expression of DOP-eGFP, however, varies across CNS regions and neuronal type whereas high fluorescence is always visible within the cytoplasm (Erbs et al., 2014). Accordingly, high surface expression appears to be restricted to some neuronal types such as GABAergic interneurons in the hippocampus or large proprioceptors in DRGs (Scherrer et al., 2006; Erbs et al., 2014). In many areas where DOP receptors are highly expressed such as the striatum, the basal ganglia, the amygdala or the spinal cord, DOP-eGFP is not readily detected at the cell surface (Erbs et al., 2014) suggesting that DOP-eGFP intracellular localization is predominant in those neurons. Importantly, surface expression of DOP-eGFP can be augmented under physiological stimulation (Bertran-Gonzalez

et al., 2013; Laurent et al., 2014; see above) or increased upon chronic morphine treatment as previously reported for wild type receptors (Erbs et al., unpublished data), strongly supporting that the fused FP does not impact on the native subcellular distribution of the receptor and that the latter can be modulated according to the physiological state or modified upon pharmacological treatment.

In the case of MOP-mcherry knock-in mice, the red fluorescent signal is stronger inside the cell than at the plasma membrane (Erbs et al., 2014). This distribution reflects actual receptor intracellular distribution, as evidenced by comparison with MOP-specific immunohistochemistry in heterozygous mice, which confirms that the fusion protein does not cause defective receptor localization or surface trafficking (Erbs et al., 2014). Importantly, MOP-mcherry retained unchanged receptor density as well as [D-Ala², N-MePhe⁴, Gly-ol]-enkephalin (DAMGO) binding and efficacy and agonist-induced internalization compared to MOP. Moreover, behavioral effects of morphine in knock-in mice were similar to wild type animals: acute and chronic thermal analgesia, physical dependence, sensitization and rewarding properties revealed no significant differences with wild type animals (Erbs et al., 2014). These data suggest that predominant intracellular localization of MOP-mcherry receptors with low expression at the cell surface indeed reflect endogenous wild type receptor subcellular distribution under basal conditions, as observed in enteric neurons (Poole et al., 2011). In addition, internalization kinetics of MOP-mcherry upon activation by the agonist DAMGO in hippocampal primary neuronal cultures (Erbs et al., 2014) were similar to those reported for DAMGO promoted internalization of endogenous wild type receptors in the rat spinal cord (Trafton et al., 2000) and in organotypic cultures of guinea pig ileum (Minnis et al., 2003) or to Fluoro-dermorphin-induced sequestration in rat cortical primary neurons (Lee et al., 2002). This supports once again the use of fluorescent knock-in mice to study endogenous receptor trafficking. Of note, DAMGO promotes Flag-MOP receptor internalization with similar kinetics in transfected striatal primary neurons (Haberstock-Debic et al., 2005), in adenovirus infected primary cultures from DRG (Walwyn et al., 2006) or in neurons of the locus coeruleus in brain slices from transgenic FLAG-MOP receptor mice (Arttamangkul and Quillinan, 2008).

CONCLUSIONS AND IMPACT FOR DRUG DESIGN

Fluorescent knock-in mice represent a substantial technical improvement in basic science. Precise identification and localization of the neurons expressing the GPCR of interest and reliable monitoring of receptor subcellular localization are both essential in understanding the physiopathological roles of endogenous GPCRs. This was greatly anticipated, given the difficulties encountered by many on the grounds of poor specificity of the available antibodies for GPCR targeting. The main surprising finding is maybe that the presence of the FP at the C-terminus of the GPCR does not significantly alter the behavioral output: this observation fully validates the technology. However, fluorescent knock-in animals available to date target a handful of class A GPCRs only. The potency of the model being now clearly established, one would expect rapid expansion to

other receptors, in particular those with critical roles in human pathologies. Forefront candidates include class C GABA_B and metabotropic glutamate receptors, both of which are involved in a wide range of neurological disorders such as schizophrenia, neuropathic pain, cerebral ischemia, mood disorders and substance abuse (Benes and Berretta, 2001; Delille et al., 2013; Kumar et al., 2013). Fluorescent knock-in animals would enable to revisit heterodimerization mechanisms, membrane targeting and cellular distribution patterns of these obligatory heterodimers *in vivo*. Furthermore, the relation between multimer scaffold composition, in particular GABA_B auxiliary subunits, and neuronal or synaptic functions could also be readily examined to refine our current understanding of the variations in pharmacological and functional responses mediated by native receptors (Gassmann and Bettler, 2012).

The knock-in mice bearing GPCR-FP fusions already contributed to understanding the fundamental concepts of distinct signaling or regulatory responses recruited by different agonists of the same GPCR. These essential aspects of biased agonism are a growing central concern in drug discovery in the hope of developing strategies that ally high efficacy with low or no side effects. In addition, GPCR-FP fusions could bring considerable knowledge regarding functional aspects of receptor activity and internalization to evaluate the therapeutic potency of allosteric modulators. This very active field of research is mainly targeting class C GPCRs with well identified allosteric and orthosteric binding sites such as metabotropic glutamate or GABA_B receptors but relevance for class A GPCRs is attracting increasing attention (Nickols and Conn, 2014). Direct visualization of the neurons of interest, either by FP under the control of a GPCR promoter or by expression of the GPCR fluorescent construct, also represents a significant breakthrough by making subsequent targeted investigations available. This includes electrophysiological recordings on previously identified cell, cell isolation by fluorescence-activated cell sorting for further biochemical (Western Blotting) and molecular (RT-PCR) downstream analysis or highly specific and efficient immunoprecipitation of the interacting partners. The presence of the FP also gives access to imaging techniques with which receptor population tracking within membranes can be achieved, by fluorescence recovery after photobleaching or fluorescence resonance energy transfer. The latter also opens ways to identify heteromer formation between GPCRs or between a GPCR and a ligand-gated channel and to investigate *in vivo* their intracellular fate and impact on signaling cascades. All these technological developments will undeniably contribute to deepening our current knowledge of GPCR controlled molecular and cellular processes and ultimately will benefit to drug design and screening.

ACKNOWLEDGMENTS

The authors acknowledge the support of CNRS, the FRM grant (DPA20140629804).

REFERENCES

- Akil, H., Owens, C., Gutstein, H., Taylor, L., Curran, E., and Watson, S. (1998). Endogenous opioids: overview and current issues. *Drug Alcohol Depend.* 51, 127–140. doi: 10.1016/S0376-8716(98)00071-4
- Alexander, S. P. (2013). The concise guide to pharmacology 2013/14: G protein coupled receptors. *Br. J. Pharmacol.* 170, 1459–1581. doi: 10.1111/bph.12445
- Arttamangkul, S., and Quillinan, N. (2008). Differential activation and trafficking of μ -opioid receptors in brain slices. *Mol. Pharmacol.* 74, 972–979. doi: 10.1124/mol.108.048512
- Bardoni, R., Tawfik, V. L., Wang, D., François, A., Solorzano, C., Shuster, S. A., et al. (2014). Delta opioid receptors presynaptically regulate cutaneous mechanosensory neuron input to the spinal cord dorsal horn. *Neuron* 81, 1312–1327. doi: 10.1016/j.neuron.2014.01.044
- Behrens, M., Foerster, S., Staehler, F., Raguse, J.-D., and Meyerhof, W. (2007). Gustatory expression pattern of the human TAS2R bitter receptor gene family reveals a heterogeneous population of bitter responsive taste receptor cells. *J. Neurosci.* 27, 12630–12640. doi: 10.1523/JNEUROSCI.1168-07.2007
- Benes, F., and Berretta, S. (2001). GABAergic interneurons: implications for understanding schizophrenia and bipolar disorder. *Neuropsychopharmacology* 25, 1–27. doi: 10.1016/S0893-133X(01)00225-1
- Bertran-Gonzalez, J., Bosch, C., Maroteaux, M., Matamalas, M., Hervé, D., Valjent, E., et al. (2008). Opposing patterns of signaling activation in dopamine D1 and D2 receptor-expressing striatal neurons in response to cocaine and haloperidol. *J. Neurosci.* 28, 5671–5685. doi: 10.1523/JNEUROSCI.1039-08.2008
- Bertran-Gonzalez, J., Laurent, V., Chieng, B. C., Christie, M. J., and Balleine, B. W. (2013). Learning-related translocation of δ -opioid receptors on ventral striatal cholinergic interneurons mediates choice between goal-directed actions. *J. Neurosci.* 33, 16060–16071. doi: 10.1523/JNEUROSCI.1927-13.2013
- Bradley, S. J., Riaz, S. A., and Tobin, A. B. (2014). Employing novel animal models in the design of clinically efficacious GPCR ligands. *Curr. Opin. Cell Biol.* 27, 117–125. doi: 10.1016/j.ceb.2013.12.002
- Cahill, C. M., Holdridge, S. V., and Morinville, A. (2007). Trafficking of delta-opioid receptors and other G-protein-coupled receptors: implications for pain and analgesia. *Trends Pharmacol. Sci.* 28, 23–31. doi: 10.1016/j.tips.2006.11.003
- Cahill, C. M., Morinville, A., Lee, M., Vincent, J., Collier, B., and Beaudet, A. (2001). Prolonged morphine treatment targets delta opioid receptors to neuronal plasma membranes and enhances delta-mediated antinociception. *J. Neurosci.* 21, 7598–7607.
- Campbell, R. E., Tour, O., Palmer, A. E., Steinbach, P. A., Baird, G. S., Zacharias, D. A., et al. (2002). A monomeric red fluorescent protein. *Proc. Natl. Acad. Sci. U.S.A.* 99, 7877–7882. doi: 10.1073/pnas.082243699
- Chan, C. S., Peterson, J. D., Gertler, T. S., Glajch, K. E., Quintana, R. E., Cui, Q., et al. (2012). Strain-specific regulation of striatal phenotype in Drd2-eGFP BAC transgenic mice. *J. Neurosci.* 32, 9124–9132. doi: 10.1523/JNEUROSCI.0229-12.2012
- Chan, F., Bradley, A., Wensel, T. G., and Wilson, J. H. (2004). Knock-in human rhodopsin-GFP fusions as mouse models for human disease and targets for gene therapy. *Proc. Natl. Acad. Sci. U.S.A.* 101, 9109–9114. doi: 10.1073/pnas.0403149101
- Chu Sin Chung, P., and Kieffer, B. L. (2013). Delta opioid receptors in brain function and diseases. *Pharmacol. Ther.* 140, 112–120. doi: 10.1016/j.pharmthera.2013.06.003
- Chung, M.-K., Jue, S. S., and Dong, X. (2012). Projection of non-peptidergic afferents to mouse tooth pulp. *J. Dent. Res.* 91, 777–782. doi: 10.1177/0022034512450298
- Congreve, M., Dias, J. M., and Marshall, F. H. (2014). Structure-based drug design for G protein-coupled receptors. *Prog. Med. Chem.* 53, 1–63 doi: 10.1016/B978-0-444-63380-4.00001-9
- Cormack, B. P., Bertram, G., Egerton, M., Gow, N. A. R., Falkow, S., and Brown, A. J. P. (1997). Yeast-enhanced green fluorescent protein (yEGFP): a reporter of gene expression in *Candida albicans*. *Microbiology* 143, 303–311. doi: 10.1099/00221287-143-2-303
- Delille, H. K., Mezler, M., and Marek, G. J. (2013). The two faces of the pharmacological interaction of mGlu2 and 5-HT_{2A} – relevance of receptor heterocomplexes and interaction through functional brain pathways. *Neuropharmacology* 70, 296–305. doi: 10.1016/j.neuropharm.2013.02.005
- Dong, X., Han, S., Zylka, M. J., Simon, M. I., and Anderson, D. J. (2001). A diverse family of GPCRs expressed in specific subsets of nociceptive sensory neurons. *Cell* 106, 619–632. doi: 10.1016/S0092-8674(01)00483-4
- Doyle, A., McGarry, M. P., Lee, N. A., and Lee, J. J. (2012). The construction of transgenic and gene knockout/knockin mouse models of human disease. *Transgenic Res.* 21, 327–349. doi: 10.1007/s11248-011-9537-3
- Duncan, K., Ketz, N., and Davachi, L. (2012). Evidence for area CA1 as a match/mismatch detector: a high-resolution fMRI study of the human hippocampus. *Hippocampus* 22, 389–398. doi: 10.1002/hipo.20933

- Dunham, J. H., and Hall, R. A. (2009). Enhancement of the surface expression of G protein-coupled receptors. *Trends Biotechnol.* 27, 541–545. doi: 10.1016/j.tibtech.2009.06.005
- Erbs, E., Faget, L., Scherrer, G., and Kessler, P. (2012). Distribution of delta opioid receptor-expressing neurons in the mouse hippocampus. *Neuroscience* 221, 203–213. doi: 10.1016/j.neuroscience.2012.06.023
- Erbs, E., Faget, L., Scherrer, G., Matifas, A., Filliol, D., Vonesch, J.-L., et al. (2014). A mu-delta opioid receptor brain atlas reveals neuronal co-occurrence in subcortical networks. *Brain Struct. Funct.* doi: 10.1007/s00429-014-0717-9 [Epub ahead of print].
- Faget, L., Erbs, E., LeMerrer, J., Scherrer, G., Matifas, A., Benturquia, N., et al. (2012). In vivo visualization of delta opioid receptors upon physiological activation uncovers a distinct internalization profile. *J. Neurosci.* 32, 7301–7310. doi: 10.1523/JNEUROSCI.0185-12.2012
- Ferguson, S. S. G., Ill, W. E. D., Colapietro, A., Barak, L. S., Menard, L., and Caron, M. G. (1996). Role of beta-arrestin in mediating agonist-promoted G protein-coupled receptor internalization. *Science* 271, 363–366. doi: 10.1126/science.271.5247.363
- Fuhrmann, M., Bittner, T., Jung, C. K. E., Burgold, S., Page, R. M., Mitteregger, G., et al. (2010). Microglial Cx3cr1 knockout prevents neuron loss in a mouse model of Alzheimer's disease. *Nat. Neurosci.* 13, 411–413. doi: 10.1038/nn.2511
- García, J., Cardona, S., and Cardona, A. (2013). Analyses of microglia effector function using CX3CR1-GFP knock-in mice. *Microglia* 1041, 307–317. doi: 10.1007/978-1-62703-520-0_27
- Gassmann, M., and Bettler, B. (2012). Regulation of neuronal GABA(B) receptor functions by subunit composition. *Nat. Rev. Neurosci.* 13, 380–394. doi: 10.1038/nrn3249
- Gendron, L., Lucido, A. L., Mennicken, F., O'Donnell, D., Vincent, J.-P., Stroh, T., et al. (2006). Morphine and pain-related stimuli enhance cell surface availability of somatic delta-opioid receptors in rat dorsal root ganglia. *J. Neurosci.* 26, 953–962. doi: 10.1523/JNEUROSCI.3598-05.2006
- Gendron, L., Mittal, N., Beaudry, H., and Walwyn, W. (2014). Recent advances on the δ opioid receptor: from trafficking to function. *Br. J. Pharmacol.* doi: 10.1111/bph.12706 [Epub ahead of print].
- George, S., Zastawny, R., Brionesurbina, R., Cheng, R., Nguyen, T., Heiber, M., et al. (1994). Distinct distributions of mu, delta and kappa opioid receptor mRNA in rat brain. *Biochem. Biophys. Res. Commun.* 205, 1438–1444. doi: 10.1006/bbrc.1994.2826
- Giguere, P. M., Kroeze, W. K., and Roth, B. L. (2014). Tuning up the right signal: chemical and genetic approaches to study GPCR functions. *Curr. Opin. Cell Biol.* 27, 51–55. doi: 10.1016/jceb.2013.11.006
- Gomes, I., Gupta, A., Filipovska, J., Szeto, H. H., Pintar, J. E., and Devi, L. A. (2004). A role for heterodimerization of mu and delta opiate receptors in enhancing morphine analgesia. *Proc. Natl. Acad. Sci. U.S.A.* 101, 5135–5139. doi: 10.1073/pnas.0307601101
- Gong, S., Zheng, C., Doughty, M. L., Losos, K., Didkovsky, N., Schambra, U. B., et al. (2003). A gene expression atlas of the central nervous system based on bacterial artificial chromosomes. *Nature* 425, 917–925. doi: 10.1038/nature02033
- Goody, R. J., Oakley, S. M., Filliol, D., Kieffer, B. L., and Kitchen, I. (2002). Q quantitative autoradiographic mapping of opioid receptors in the brain of δ -opioid receptor gene knockout mice. *Brain Res.* 945, 9–19. doi: 10.1016/S0006-8993(02)02452-6
- Gross, A. K., Decker, G., Chan, F., Sandoval, I. M., Wilson, J. H., and Wensel, T. G. (2006). Defective development of photoreceptor membranes in a mouse model of recessive retinal degeneration. *Vision Res.* 46, 4510–4518. doi: 10.1016/j.visres.2006.07.012
- Guan, J.-S., Xu, Z.-Z., Gao, H., He, S.-Q., Ma, G.-Q., Sun, T., et al. (2005). Interaction with vesicle luminal protachykinin regulates surface expression of delta-opioid receptors and opioid analgesia. *Cell* 122, 619–631. doi: 10.1016/j.cell.2005.06.010
- Gupta, A., Mulder, J., and Gomes, I. (2010). Increased abundance of opioid receptor heteromers after chronic morphine administration. *Sci. Signal.* 3:ra54. doi: 10.1126/scisignal.2000807
- Haberstock-Debic, H., Kim, K.-A., Yu, Y. J., and von Zastrow, M. (2005). Morphine promotes rapid, arrestin-dependent endocytosis of mu-opioid receptors in striatal neurons. *J. Neurosci.* 25, 7847–7857. doi: 10.1523/JNEUROSCI.5045-04.2005
- Haruyama, N., Cho, A., and Kulkarni, A. (2009). Overview: engineering transgenic constructs and mice. *Curr. Protoc. Cell Biol.* Unit 19.10(Suppl. 42), 1–12. doi: 10.1002/0471143030.cb1910s42
- Heim, R., and Tsien, R. Y. (1996). Engineering green fluorescent protein for improved brightness, longer wavelengths and fluorescence resonance energy transfer. *Curr. Biol.* 6, 178–182. doi: 10.1016/S0960-9822(02)00450-5
- Heintz, N. (2001). BAC to the future: the use of BAC transgenic mice. *Nat. Rev. Neurosci.* 2, 1–10. doi: 10.1038/35104049
- Heng, B. C., Aubel, D., and Fussenegger, M. (2013). An overview of the diverse roles of G-protein coupled receptors (GPCRs) in the pathophysiology of various human diseases. *Biotechnol. Adv.* 31, 1676–1694. doi: 10.1016/j.biotechadv.2013.08.017
- Hoon, M., Adler, E., Lindemeier, J., and Battey, J. (1999). Putative mammalian taste receptors: a class of taste-specific GPCRs with distinct topographic selectivity. *Cell* 96, 541–551. doi: 10.1016/S0092-8674(00)80658-3
- Jung, S., Aliberti, J., Graemmel, P., Sunshine, M. J., Kreutzberg, G. W., Sher, A., et al. (2000). Analysis of fractalkine receptor CX(3)CR1 function by targeted deletion and green fluorescent protein reporter gene insertion. *Mol. Cell. Biol.* 20, 4106–4114. doi: 10.1128/MCB.20.11.4106-4114.2000
- Kallal, L., and Benovic, J. L. (2000). Using green fluorescent proteins to study G-protein-coupled receptor localization and trafficking. *Trends Pharmacol. Sci.* 21, 175–180. doi: 10.1016/S0165-6147(00)01477-2
- Kenakin, T. (2014). What is pharmacological “affinity?” Relevance to biased agonism and antagonism. *Trends Pharmacol. Sci.* 35, 434–441. doi: 10.1016/j.tips.2014.06.003
- Kieffer, B. L., and Evans, C. J. (2009). Opioid receptors: from binding sites to visible molecules in vivo. *Neuropharmacology* 56(Suppl. 1), 205–212. doi: 10.1016/j.neuropharm.2008.07.033
- Kitchen, I., Slowe, S. J., Matthes, H. W. D., and Kieffer, B. L. (1997). Quantitative autoradiographic mapping of m-, d- and k-opioid receptors in knockout mice lacking the m-opioid receptor gene. *Brain Res.* 778, 73–88. doi: 10.1016/S0006-8993(97)00988-8
- Kramer, P. E., Christensen, C. H., Hazelwood, L., Dobi, A., Bock, R., Sibley, D. R., et al. (2011). Dopamine D2 receptor overexpression alters behavior and physiology in Drd2-EGFP mice. *J. Neurosci.* 31, 126–132. doi: 10.1523/JNEUROSCI.4287-10.2011
- Kumar, K., Sharma, S., Kumar, P., and Deshmukh, R. (2013). Therapeutic potential of GABA(B) receptor ligands in drug addiction, anxiety, depression and other CNS disorders. *Pharmacol. Biochem. Behav.* 110, 174–184. doi: 10.1016/j.pbb.2013.07.003
- Lagerström, M. C., and Schiöth, H. B. (2008). Structural diversity of G protein-coupled receptors and significance for drug discovery. *Nat. Rev. Drug Discov.* 7, 339–357. doi: 10.1038/nrd2518
- Laurent, V., Wong, E. L., and Balleine, B. W. (2014). δ -Opioid receptors in the accumbens shell mediate the influence of both excitatory and inhibitory predictions on choice. *Br. J. Pharmacol.* doi: 10.1111/bph.12731 [Epub ahead of print].
- Lee, K.-W., Kim, Y., Kim, A. M., Helmin, K., Nairn, A. C., and Greengard, P. (2006). Cocaine-induced dendritic spine formation in D1 and D2 dopamine receptor-containing medium spiny neurons in nucleus accumbens. *Proc. Natl. Acad. Sci. U.S.A.* 103, 3399–3404. doi: 10.1073/pnas.0511244103
- Lee, M., Cahill, C., Vincent, J., and Beaudet, A. (2002). Internalization and trafficking of opioid receptor ligands in rat cortical neurons. *Synapse* 111, 102–111. doi: 10.1002/syn.10014
- LeMerrer, J., Becker, J. A. J., Befort, K., and Kieffer, B. L. (2009). Reward processing by the opioid system in the brain. *Physiol. Rev.* 89, 1379–1412. doi: 10.1152/physrev.00005.2009
- Lesscher, H. M. B., Bailey, A., Burbach, J. P. H., van Ree, J. M., Kitchen, I., and Gerrits, M. A. F. M. (2003). Receptor-selective changes in μ -, δ - and κ -opioid receptors after chronic naltrexone treatment in mice. *Eur. J. Neurosci.* 17, 1006–1012. doi: 10.1046/j.1460-9568.2003.02502.x
- Liman, E. R., Zhang, Y. V., and Montell, C. (2014). Peripheral coding of taste. *Neuron* 81, 984–1000. doi: 10.1016/j.neuron.2014.02.022
- Liu, Q., Sikand, P., Ma, C., Tang, Z., Han, L., Li, Z., et al. (2012). Mechanisms of itch evoked by β -alanine. *J. Neurosci.* 32, 14532–14537. doi: 10.1523/JNEUROSCI.3509-12.2012
- Lutz, P.-E., and Kieffer, B. L. (2013). The multiple facets of opioid receptor function: implications for addiction. *Curr. Opin. Neurobiol.* 23, 473–479. doi: 10.1016/j.conb.2013.02.005

- Madziva, M. T., and Edwardson, J. M. (2001). Trafficking of green fluorescent protein-tagged muscarinic M4 receptors in NG108-15 cells. *Eur. J. Pharmacol.* 428, 9–18. doi: 10.1016/S0014-2999(01)01266-3
- Mailleux, P., and Vanderhaeghen, J. J. (1992). Distribution of neuronal cannabinoid receptor in the adult rat brain: a comparative receptor binding radioautography and in situ hybridization histochemistry. *Neuroscience* 48, 655–668. doi: 10.1016/0306-4522(92)90409-U
- Mansour, A., Fox, C. A., Akil, H., and Watson, S. J. (1995). Opioid-receptor mRNA expression in the rat CNS: anatomical and functional implications. *Trends Neurosci.* 18, 22–29. doi: 10.1016/0166-2236(95)93946-U
- Marder, E. (2012). Neuromodulation of neuronal circuits: back to the future. *Neuron* 76, 1–11. doi: 10.1016/j.neuron.2012.09.010
- Marsicano, G., and Lutz, B. (1999). Expression of the cannabinoid receptor CB1 in distinct neuronal subpopulations in the adult mouse forebrain. *Eur. J. Neurosci.* 11, 4213–4225. doi: 10.1046/j.1460-9568.1999.00847.x
- McDonald, N. A., Henstridge, C. M., Connolly, C. N., and Irving, A. J. (2007). Generation and functional characterization of fluorescent, N-terminally tagged CB1 receptor chimeras for live-cell imaging. *Mol. Cell. Neurosci.* 35, 237–248. doi: 10.1016/j.mcn.2007.02.016
- McLean, A. J., and Milligan, G. (2000). Ligand regulation of green fluorescent protein-tagged forms of the human beta(1)- and beta(2)-adrenoceptors; comparisons with the unmodified receptors. *Br. J. Pharmacol.* 130, 1825–1832. doi: 10.1038/sj.bjp.0703506
- Minnis, J. G., Patierno, S., Kohlmeier, S. E., Brecha, N. C., Tonini, M., and Sternini, C. (2003). Ligand-induced μ opioid receptor endocytosis and recycling in enteric neurons. *Neuroscience* 119, 33–42. doi: 10.1016/S0306-4522(03)00135-0
- Mizutani, M., Pino, P. A., Saederup, N., Charo, I. F., Ransohoff, R. M., and Cardona, A. E. (2012). The fractalkine receptor but not CCR2 is present on microglia from embryonic development throughout adulthood. *J. Immunol.* 188, 29–36. doi: 10.4049/jimmunol.1100421
- Moreira, I. S. (2014). Structural features of the G-protein/GPCR interactions. *Biochim. Biophys. Acta* 1840, 16–33. doi: 10.1016/j.bbagen.2013.08.027
- Morinville, A., Cahill, C. M., Kieffer, B., Collier, B., and Beaudet, A. (2004). μ -opioid receptor knock-out prevents changes in delta-opioid receptor trafficking induced by chronic inflammatory pain. *Pain* 109, 266–273. doi: 10.1016/j.pain.2004.01.011
- Nagai, T., Ibata, K., Park, E. S., Kubota, M., Mikoshiba, K., and Miyawaki, A. (2002). A variant of yellow fluorescent protein with fast and efficient maturation for cell-biological applications. *Nat. Biotechnol.* 20, 87–90. doi: 10.1038/nbt0102-87
- Nickols, H. H., and Conn, P. J. (2014). Development of allosteric modulators of GPCRs for treatment of CNS disorders. *Neurobiol. Dis.* 61, 55–71. doi: 10.1016/j.nbd.2013.09.013
- Nienhaus, K., and Nienhaus, G. U. (2014). Fluorescent proteins for live-cell imaging with super-resolution. *Chem. Soc. Rev.* 43, 1088–1106. doi: 10.1039/c3cs60171d
- Ostrom, R. S., and Insel, P. A. (2004). The evolving role of lipid rafts and caveolae in G protein-coupled receptor signaling: implications for molecular pharmacology. *Br. J. Pharmacol.* 143, 235–245. doi: 10.1038/sj.bjp.0705930
- Overington, J. P., Al-Lazikani, B., and Hopkins, A. L. (2006). How many drug targets are there? *Nat. Rev. Drug Discov.* 5, 993–996. doi: 10.1038/nrd2199
- Papay, R., Gaivin, R., McCune, D. F., Rorabaugh, B. R., Macklin, W. B., McGrath, J. C., et al. (2004). Mouse alpha1B-adrenergic receptor is expressed in neurons and NG2 oligodendrocytes. *J. Comp. Neurol.* 478, 1–10. doi: 10.1002/cne.20215
- Pertwee, R. G. (2006). The pharmacology of cannabinoid receptors and their ligands: an overview. *Int. J. Obes. (Lond.)* 30(Suppl. 1), S13–8. doi: 10.1038/sj.ijo.0803272
- Poole, D. P., Pelayo, J.-C., Scherrer, G., Evans, C. J., Kieffer, B. L., and Bunnett, N. W. (2011). Localization and regulation of fluorescently labeled delta opioid receptor, expressed in enteric neurons of mice. *Gastroenterology* 141, 982–991.e1–8. doi: 10.1053/j.gastro.2011.05.042
- Pradhan, A. A. A., Becker, J. A. J., Scherrer, G., Tryoen-Toth, P., Filliol, D., Matifas, A., et al. (2009). In vivo delta opioid receptor internalization controls behavioral effects of agonists. *PLoS ONE* 4:e5425. doi: 10.1371/journal.pone.0005425
- Pradhan, A. A. A., and Clarke, P. B. S. (2005). Comparison between delta-opioid receptor functional response and autoradiographic labeling in rat brain and spinal cord. *J. Comp. Neurol.* 481, 416–426. doi: 10.1002/cne.20378
- Pradhan, A. A. A., Walwyn, W., Nozaki, C., Filliol, D., Erbs, E., Matifas, A., et al. (2010). Ligand-directed trafficking of the δ -opioid receptor in vivo: two paths toward analgesic tolerance. *J. Neurosci.* 30, 16459–16468. doi: 10.1523/JNEUROSCI.3748-10.2010
- Price, B. A., Sandoval, I. M., Chan, F., Simons, D. L., Wu, S. M., Wensel, T. G., et al. (2011). Mislocalization and degradation of human P23H-rhodopsin-GFP in a knockin mouse model of retinitis pigmentosa. *Invest. Ophthalmol. Vis. Sci.* 52, 9728–9736. doi: 10.1167/iovs.11-8654
- Rezaei, X., Faget, L., Bednarek, E., Schwab, Y., Kieffer, B. L., and Massotte, D. (2012). Mouse δ opioid receptors are located on presynaptic afferents to hippocampal pyramidal cells. *Cell. Mol. Neurobiol.* 32, 509–516. doi: 10.1007/s10571-011-9791-1
- Rezaei, X., Kieffer, B. L., Roux, M. J., and Massotte, D. (2013). Delta opioid receptors regulate temporoammonic-activated feedforward inhibition to the mouse CA1 hippocampus. *PLoS ONE* 8:e79081. doi: 10.1371/journal.pone.0079081
- Rigato, C., Swinnen, N., Buckinx, R., Couillien, I., Mangin, J.-M., Rigo, J.-M., et al. (2012). Microglia proliferation is controlled by P2X7 receptors in a Pannexin-1-independent manner during early embryonic spinal cord invasion. *J. Neurosci.* 32, 11559–11573. doi: 10.1523/JNEUROSCI.1042-12.2012
- Rosenbaum, D. M., Rasmussen, S. G. F., and Kobilka, B. K. (2009). The structure and function of G-protein-coupled receptors. *Nature* 459, 356–363. doi: 10.1038/nature08144
- Roy, S., Rached, M., and Gallo-Payet, N. (2007). Differential regulation of the human adrenocorticotropin receptor [melanocortin-2 receptor (MC2R)] by human MC2R accessory protein isoforms alpha and beta in isogenic human embryonic kidney 293 cells. *Mol. Endocrinol.* 21, 1656–1669. doi: 10.1210/me.2007-0041
- Rozenfeld, R., Bushlin, I., Gomes, I., Tzavaras, N., Gupta, A., Neves, S., et al. (2012). Receptor heteromerization expands the repertoire of cannabinoid signaling in rodent neurons. *PLoS ONE* 7:e29239. doi: 10.1371/journal.pone.0029239
- Saederup, N., Cardona, A. E., Croft, K., Mizutani, M., Coteleur, A. C., Tsou, C.-L., et al. (2010). Selective chemokine receptor usage by central nervous system myeloid cells in CCR2-red fluorescent protein knock-in mice. *PLoS ONE* 5:e13693. doi: 10.1371/journal.pone.0013693
- Sandoval, I. M., Price, B. A., Gross, A. K., Chan, F., Sammons, J. D., Wilson, J. H., et al. (2014). Abrupt onset of mutations in a developmentally regulated gene during terminal differentiation of post-mitotic photoreceptor neurons in mice. *PLoS ONE* 9:e108135. doi: 10.1371/journal.pone.0108135
- Scherrer, G., Imachi, N., Cao, Y.-Q., Contet, C., Mennicken, F., O'Donnell, D., et al. (2009). Dissociation of the opioid receptor mechanisms that control mechanical and heat pain. *Cell* 137, 1148–1159. doi: 10.1016/j.cell.2009.04.019
- Scherrer, G., Tryoen-to, P., Filliol, D., Matifas, A., Laustriat, D., Cao, Y. Q., et al. (2006). Knockin mice expressing fluorescent delta-opioid receptors uncover G protein-coupled receptor dynamics in vivo. *Proc. Natl. Acad. Sci. U.S.A.* 103, 9691–9696. doi: 10.1073/pnas.0603359103
- Shaner, N. C., Campbell, R. E., Steinbach, P. A., Giepmans, B. N. G., Palmer, A. E., and Tsien, R. Y. (2004). Improved monomeric red, orange and yellow fluorescent proteins derived from *Discosoma* sp. red fluorescent protein. *Nat. Biotechnol.* 22, 1567–1572. doi: 10.1038/nbt1037
- Shaner, N. C., Patterson, G. H., and Davidson, M. W. (2007). Advances in fluorescent protein technology. *J. Cell Sci.* 120, 4247–4260. doi: 10.1042/jcs.005801
- Shimomura, O., Johnson, F., and Saiga, Y. (1962). Extraction, purification and properties of aequorin, a bioluminescent protein from the luminous hydromedusa, *Aequorea*. *J. Cell. Comp. Physiol.* 59, 223–239. doi: 10.1002/jcp.1030590302
- Slowe, S. J., Simonin, F., Kieffer, B. L., and Kitchen, I. (1999). Quantitative autoradiography of mu, delta and kappa opioid receptors in kappa-opioid receptor knockout mice. *Brain Res.* 818, 335–345. doi: 10.1016/S0006-8993(98)01201-3
- Stockton, S. D., and Devi, L. A. (2012). Functional relevance of μ - δ opioid receptor heteromerization: a role in novel signaling and implications for the treatment of addiction disorders: from a symposium on new concepts in mu-opioid pharmacology. *Drug Alcohol Depend.* 121, 167–172. doi: 10.1016/j.drugalcdep.2011.10.025
- Stone, L. M., Barrows, J., Finger, T. E., and Kinnamon, S. C. (2007). Expression of T1Rs and gustducin in palatal taste buds of mice. *Chem. Senses* 32, 255–262. doi: 10.1093/chemse/bjl053
- Stumm, R. K., Zhou, C., Schulz, S., and Höllt, V. (2004). Neuronal types expressing mu- and delta-opioid receptor mRNA in the rat hippocampal formation. *J. Comp. Neurol.* 469, 107–118. doi: 10.1002/cne.10997
- Subach, F. V., Patterson, G. H., Manley, S., Gillette, J. M., Lippincott-Schwartz, J., and Verkhusha, V. V. (2009). Photoactivatable mCherry for high-resolution two-color fluorescence microscopy. *Nat. Methods* 6, 153–159. doi: 10.1038/nmeth.1298

- Tan, H., Ahmad, T., Loureiro, M., Zunder, J., and Laviolette, S. R. (2014). The role of cannabinoid transmission in emotional memory formation: implications for addiction and schizophrenia. *Front. Psychiatry* 5:73. doi: 10.3389/fpsy.2014.00073
- Tempel, A., and Zukin, R. (1987). Neuroanatomical patterns of the mu, delta, and kappa opioid receptors of rat brain as determined by quantitative in vitro autoradiography. *Proc. Natl. Acad. Sci. U.S.A.* 84, 4308–4312. doi: 10.1073/pnas.84.12.4308
- Tian, X., Kai, L., Hockberger, P. E., Wokosin, D. L., and Surmeier, D. J. (2010). MEF-2 regulates activity-dependent spine loss in striatopallidal medium spiny neurons. *Mol. Cell. Neurosci.* 44, 94–108. doi: 10.1016/j.mcn.2010.01.012
- Trafton, J. A., Abbadie, C., Marek, K., and Basbaum, A. I. (2000). Postsynaptic signaling via the mu-opioid receptor: responses of dorsal horn neurons to exogenous opioids and noxious stimulation. *J. Neurosci.* 20, 8578–8584.
- Tsien, R. (1998). The green fluorescent protein. *Annu. Rev. Biochem.* 67, 509–544. doi: 10.1146/annurev.biochem.67.1.509
- Tsou, K., Brown, S., and Sanudo-Pena, M. (1997). Immunohistochemical distribution of cannabinoid CB1 receptors in the rat central nervous system. *Neuroscience* 83, 393–411. doi: 10.1016/S0306-4522(97)00436-3
- Vaccari, C., Lolait, S. J., and Ostrowski, N. L. (1998). Comparative distribution of vasopressin V1b and oxytocin receptor messenger ribonucleic acids in brain. *Endocrinology* 139, 5015–5033. doi: 10.1210/endo.139.12.6382
- Valjent, E., Bertran-Gonzalez, J., Hervé, D., Fisone, G., and Girault, J.-A. (2009). Looking BAC at striatal signaling: cell-specific analysis in new transgenic mice. *Trends Neurosci.* 32, 538–547. doi: 10.1016/j.tins.2009.06.005
- van den Pol, A. N. (2012). Neuropeptide transmission in brain circuits. *Neuron* 76, 98–115. doi: 10.1016/j.neuron.2012.09.014
- van Rijn, R. M., Whistler, J. L., and Waldhoer, M. (2010). Opioid-receptor-heteromer-specific trafficking and pharmacology. *Curr. Opin. Pharmacol.* 10, 73–79. doi: 10.1016/j.coph.2009.09.007
- Virgone-Carlotta, A., Uhrlich, J., Akram, M. N., Ressenkoff, D., Chrétien, F., Domenget, C., et al. (2013). Mapping and kinetics of microglia/neuron cell-to-cell contacts in the 6-OHDA murine model of Parkinson's disease. *Glia* 61, 1645–1658. doi: 10.1002/glia.22546
- Voigt, A., Hübner, S., Lossow, K., Hermans-Borgmeyer, I., Boehm, U., and Meyerhof, W. (2012). Genetic labeling of Tas1r1 and Tas2r131 taste receptor cells in mice. *Chem. Senses* 37, 897–911. doi: 10.1093/chemse/bjs082
- von Zastrow, M., and Williams, J. T. (2012). Modulating neuromodulation by receptor membrane traffic in the endocytic pathway. *Neuron* 76, 22–32. doi: 10.1016/j.neuron.2012.09.022
- Walther, C., and Ferguson, S. S. G. (2013). Arrestins: role in the desensitization, sequestration, and vesicular trafficking of G protein-coupled receptors. *Prog. Mol. Biol. Transl. Sci.* 118, 93–113. doi: 10.1016/B978-0-12-394440-5.00004-8
- Walwyn, W. M., Miotto, K. A., and Evans, C. J. (2010). Opioid pharmaceuticals and addiction: the issues, and research directions seeking solutions. *Drug Alcohol Depend.* 108, 156–165. doi: 10.1016/j.drugalcdep.2010.01.001
- Walwyn, W. M., Wei, W., Xie, C.-W., Chiu, K., Kieffer, B. L., Evans, C. J., et al. (2006). Mu opioid receptor-effector coupling and trafficking in dorsal root ganglia neurons. *Neuroscience* 142, 493–503. doi: 10.1016/j.neuroscience.2006.06.021
- Wang, H.-B., Zhao, B., Zhong, Y.-Q., Li, K.-C., Li, Z.-Y., Wang, Q., et al. (2010). Coexpression of delta- and mu-opioid receptors in nociceptive sensory neurons. *Proc. Natl. Acad. Sci. U.S.A.* 107, 13117–13122. doi: 10.1073/pnas.1008382107
- Wensel, T. G., Gross, A. K., Chan, F., Sykoudis, K., and Wilson, J. H. (2005). Rhodopsin-EGFP knock-ins for imaging quantal gene alterations. *Vision Res.* 45, 3445–3453. doi: 10.1016/j.visres.2005.07.016
- Winters, B. D., Krüger, J. M., Huang, X., Gallaher, Z. R., Ishikawa, M., Czaja, K., et al. (2012). Cannabinoid receptor 1-expressing neurons in the nucleus accumbens. *Proc. Natl. Acad. Sci. U.S.A.* 109, E2717–E2725. doi: 10.1073/pnas.1206303109
- Wrobel, L., Schorscher-Petcu, A., Dupré, A., Yoshida, M., Nishimori, K., and Tribollet, E. (2011). Distribution and identity of neurons expressing the oxytocin receptor in the mouse spinal cord. *Neurosci. Lett.* 495, 49–54. doi: 10.1016/j.neulet.2011.03.033
- Xie, W.-Y., He, Y., Yang, Y.-R., Li, Y.-F., Kang, K., Xing, B.-M., et al. (2009). Disruption of Cdk5-associated phosphorylation of residue threonine-161 of the delta-opioid receptor: impaired receptor function and attenuated morphine antinociceptive tolerance. *J. Neurosci.* 29, 3551–3564. doi: 10.1523/JNEUROSCI.0415-09.2009
- Yoshida, M., Takayanagi, Y., Inoue, K., Kimura, T., Young, L. J., Onaka, T., et al. (2009). Evidence that oxytocin exerts anxiolytic effects via oxytocin receptor expressed in serotonergic neurons in mice. *J. Neurosci.* 29, 2259–2271. doi: 10.1523/JNEUROSCI.5593-08.2009
- Yoshimura, N., Seki, S., Novakovic, S. D., Tzoumaka, E., Erickson, V. L., Erickson, K. A., et al. (2001). The involvement of the tetrodotoxin-resistant sodium channel Na(v)1.8 (PN3/SNS) in a rat model of visceral pain. *J. Neurosci.* 21, 8690–8696.
- Zylka, M. J., Rice, F. L., and Anderson, D. J. (2005). Topographically distinct epidermal nociceptive circuits revealed by axonal tracers targeted to Mrgprd. *Neuron* 45, 17–25. doi: 10.1016/j.neuron.2004.12.015

Conflict of Interest Statement: The authors declare that the research was conducted in the absence of any commercial or financial relationships that could be construed as a potential conflict of interest.

Received: 03 November 2014; accepted: 12 December 2014; published online: 06 January 2015.

Citation: Ceredig RA and Massotte D (2015) Fluorescent knock-in mice to decipher the physiopathological role of G protein-coupled receptors. *Front. Pharmacol.* 5:289. doi: 10.3389/fphar.2014.00289

This article was submitted to *Neuropharmacology*, a section of the journal *Frontiers in Pharmacology*.

Copyright © 2015 Ceredig and Massotte. This is an open-access article distributed under the terms of the Creative Commons Attribution License (CC BY). The use, distribution or reproduction in other forums is permitted, provided the original author(s) or licensor are credited and that the original publication in this journal is cited, in accordance with accepted academic practice. No use, distribution or reproduction is permitted which does not comply with these terms.

11. Annex 2: Le Nouveau Chapitre de la Thèse (en français).

Short lay-man summary and personal experience of the PhD project (in French).

During my thesis, I enrolled in several courses from the Doctoral School, to help me determine what my future career path could be. As a PhD student and a pharmacist, I decided to explore what possibilities were open to candidates with a background in life science and pharmacy, outside academia. During a few months, I was mentored by a retired Human Resources Director of an international Pharmaceutical Company, and wrote a short, lay-man summary of my main work during my PhD, presented my work as if it were a project report in a business, and made an assessment of the main “soft skills” this experience had allowed me to develop. This short summary also helped me to have a clearer idea about what my main interests were and the career options I had and build my career path, once I defend. We were also trained for interviews with professionals.

« Valorisation des compétences, Le Nouveau Chapitre de la Thèse : NCT » ®

Rhian Alice CEREDIG, Doctorante en Neurosciences

Ecole Doctorale des Sciences de la Vie et de la Santé ED 414, Université de Strasbourg

Unité de Recherche CNRS UPR 3212, Laboratoire : Institut des Neurosciences Cellulaires et Intégratives

Equipe Douleur chronique : approche anatomo-fonctionnelle et traitement

Mentor : Bernard Jund

Traitement de la douleur neuropathique et des conséquences émotionnelles

Présentation orale du NCT le jeudi 4 juin 2015

Titre académique de la thèse :

Expression du Récepteur aux Opiïdes Delta dans différents Modèles de Pathologies Chroniques.

Directeur de thèse Dr Dominique MASSOTTE

Date probable de soutenance de thèse : juin 2016.

I Cadre général et enjeux des recherches

1) Présentation succincte

La douleur d'origine nerveuse ou neuropathique se manifeste suite à une atteinte ou une lésion du système nerveux somatosensoriel. Elle est chronique, et se caractérise par des douleurs spontanées, une hypersensibilité aux stimuli douloureux et/ou un abaissement des seuils de perception de douleur.

La douleur chronique d'origine nerveuse ou neuropathique représente un fardeau pour les patients, et un coût en soins important pour la société en termes de dépenses de santé et un manque à gagner dû aux arrêts de travail. Les patients souffrant de douleur neuropathique sont insuffisamment soulagés par les traitements médicamenteux actuels, ceci est en partie dû aux phénomènes de tolérance et de dépendance. La tolérance est définie par la perte d'efficacité progressive d'une molécule lors de son usage répété, et d'un besoin d'augmenter les doses afin d'obtenir le même effet du traitement, menant à l'augmentation des effets indésirables graves chez ces patients. La dépendance est un état psychologique et physique traduisant le besoin irrépressible de consommation de la substance, de manière incontrôlée. L'usage de la morphine, prescrite pour traiter la douleur et qui agit sur les récepteurs opioïdes, mène au développement de la tolérance et la dépendance très rapidement. La douleur neuropathique chronique affecte l'état émotionnel des patients qui en souffrent, ce qui les rend plus vulnérables à des états d'anxiété et de dépression.

Nous cherchons donc à développer une nouvelle approche thérapeutique pour traiter la douleur neuropathique chronique. Nous nous servons d'un modèle animal pour étudier une nouvelle molécule, qui cible une nouvelle entité pharmacologique. Dans un premier temps, nous visons à identifier la cible de l'action de la molécule de manière précise. Puis, cette nouvelle substance sera évaluée selon plusieurs critères : elle devra soulager la douleur, ne pas entraîner de dépendance, et rester efficace lors de son usage répété.

Le modèle animal de constriction du nerf sciatique (par un manchon ou « cuff ») chez la souris, a été développé par notre équipe, et permet de reproduire les symptômes sensoriels et les conséquences émotionnelles de la douleur neuropathique. Le récepteur opioïde delta situé dans le système nerveux périphérique est essentiel pour l'efficacité des traitements par les antidépresseurs dans ce modèle.

Les récepteurs opioïdes modulent la perception de stimuli douloureux, les processus de récompense, régulent les états émotionnels et sont impliqués dans les processus physiopathologiques des maladies psychiatriques ou de la douleur chronique.

L'unité fonctionnelle des récepteurs couplés aux protéines G de classe A, auxquels appartiennent les récepteurs opioïdes, est le monomère mais deux récepteurs différents pourraient s'associer pour former un hétéromère aux propriétés fonctionnelles modifiées. La formation d'hétéromères est un mécanisme moléculaire qui pourrait être impliqué dans diverses pathologies et les hétéromères représentent ainsi les nouvelles cibles thérapeutiques de notre approche.

Les souris knock-in sont des animaux génétiquement modifiés qui expriment un gène avec des fonctions particulières, dans notre cas, ces souris exprimant une version fluorescente du récepteur delta. Elles ont servi à caractériser la distribution neuronale de ce récepteur dans le système nerveux périphérique dans des conditions basales. Récemment, des souris double knock-in fluorescentes exprimant les récepteurs opioïdes delta et mu fonctionnels, respectivement en fusion avec une protéine fluorescente verte et une protéine fluorescente rouge, ont permis de cartographier les neurones co-exprimant ces deux récepteurs dans le système nerveux central à l'état basal, et de mettre en évidence la proximité physique entre ces récepteurs.

2) Résumé succinct de la thèse

Le premier but de ce projet est d'identifier les changements dans la distribution des récepteurs opioïdes mu et delta périphériques induits par la douleur neuropathique, et la réversion éventuelle des changements par le traitement de référence (avec des molécules déjà utilisées dans le cadre de traitement de la douleur neuropathique chez la souris, et qui ont déjà fait l'objet d'études cliniques chez l'homme).

Dans un deuxième temps, nous nous intéresserons à la co-expression neuronale des récepteurs mu et delta dans les processus nociceptifs et la pertinence d'une nouvelle stratégie thérapeutique ciblant sélectivement les hétéromères mu-delta. La perspective du projet sera d'évaluer le potentiel d'une nouvelle thérapie permettant de soulager la douleur avec un nouveau composé efficace ayant des caractéristiques de tolérance et de dépendance faibles. Cette approche ciblera les hétéromères des récepteurs opioïdes, qui sont des entités pharmacologiques dont les caractéristiques et l'expression ne sont que partiellement décrites.

Dans un troisième aspect, nous évaluerons l'efficacité de quatre nouveaux composés par rapport au traitement de référence par voie orale, dans notre modèle de douleur neuropathique. Quatre molécules, synthétisées par un laboratoire, nous seront fournies, et nous testerons deux doses pour chaque molécule. Ce mini-projet pilote permettra de préparer de futures collaborations en vue de l'évaluation préclinique de nouvelles molécules concurrentes du traitement de référence.

Pour atteindre ces objectifs, nous utiliserons un modèle animal de douleur chez des souris comportant des récepteurs opioïdes mu et delta fluorescents rouges et verts respectivement, afin d'établir une cartographie précise des récepteurs cibles dans le contexte de douleur chronique.

3) La thèse dans son contexte

Le laboratoire de recherche auquel appartient l'équipe d'accueil s'appelle l'Institut de Neurosciences Cellulaires et Intégratives (INCI), et fait partie des laboratoires CNRS de Strasbourg. Notre équipe Douleur Chronique : Anatomopathologie et Traitement est une des trois équipes qui constituent le département Nociception et Douleur.

L'Université de Strasbourg établit les contrats doctoraux pour les étudiants en thèse qui ont obtenu la bourse ministérielle par concours. Dans un premier temps, les sujets de thèse approuvés par le Ministère de la recherche et de l'enseignement supérieur sont définis en accord avec les équipes de recherche et l'école doctorale, puis les étudiant sélectionnés peuvent présenter le concours afin d'obtenir une bourse de thèse, qui représente un salaire et des financements pour les expériences pour une durée totale et non extensible de trois ans.

Les laboratoires qui dépendent des institutions publiques telles que le CNRS, sont composés du directeur, puis des chefs d'équipe, qui développent les sujets de recherche spécialisés avec des chercheurs chargés ou directeurs de projets sur les thématiques spécialisées. Ces chercheurs peuvent encadrer des étudiants en thèse lorsqu'ils obtiennent l'habilitation de diriger les recherches : ce sont les directeurs de thèse. Les étudiants en thèse sont nombreux dans notre équipe, nous sommes sept.

Historiquement, notre équipe développe deux thématiques qui sont liées : la neuroanatomie et les traitements de la douleur neuropathique. Notre chef de laboratoire est reconnu dans le milieu de la neuroanatomie pour ses

travaux sur une structure importante dans les circuits de la douleur et de la récompense ; notre équipe se spécialise dans les approches de traçage et neuroanatomie, l'électrophysiologie et le comportement animal ainsi que l'imagerie. En particulier, cette équipe représente un milieu spécialisé dans lequel nous, les étudiants, sommes encouragés à collaborer, apprendre et discuter librement, ce qui permet d'atteindre un niveau de compétence excellent.

Voici un schéma de l'organisation de notre équipe :

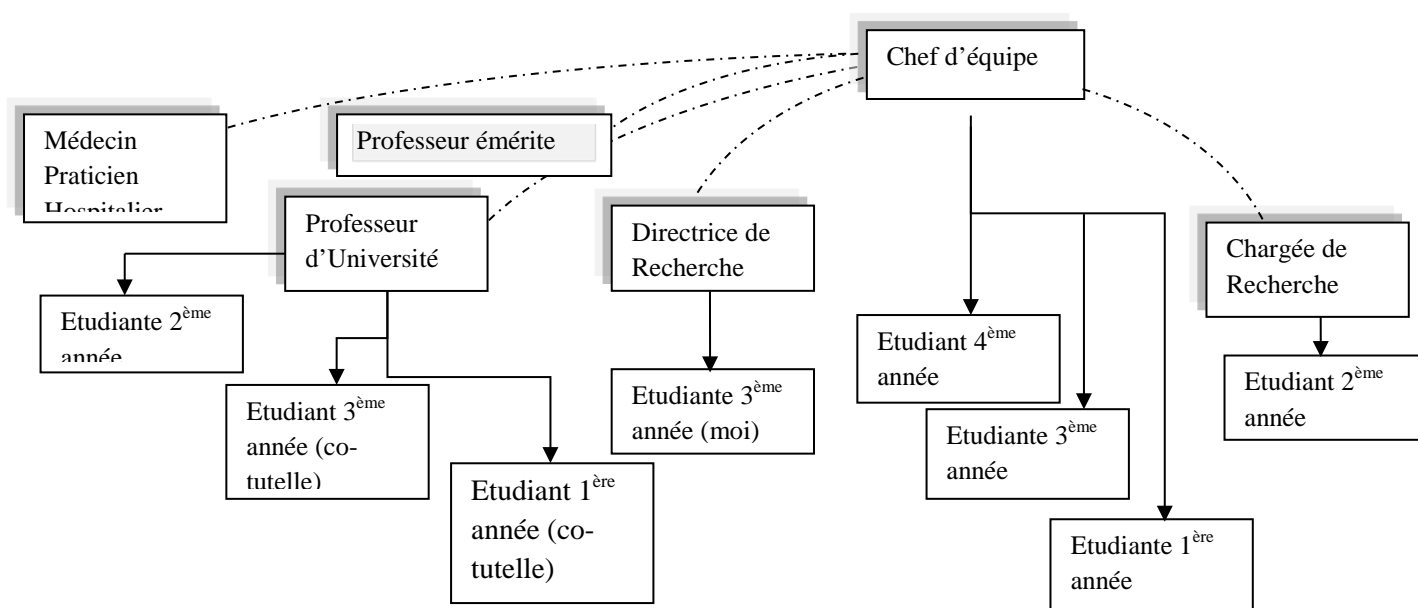

4) Ma place dans ce contexte

Depuis le début de mes études secondaires, j'ai cultivé une curiosité et un goût certain pour les sciences de la vie. Cela m'a conduit à choisir des études de Pharmacie, qui allient chimie et physiologie. Cette filière m'a donné des bases scientifiques solides dans de nombreux domaines de la santé, et j'ai rapidement préféré les aspects précliniques et la recherche et développement de nouvelles molécules. J'ai suivi la filière Industrie et Recherche pour continuer dans la voie qui me plaisait le plus, avec une préférence pour l'immunologie dans un premier temps. Bénéficiant de contacts dans ce domaine, j'ai effectué deux stages volontaires de trois mois au cours de mes études (à Londres et à Sydney) dans des équipes de recherche. Au cours de ces deux expériences, j'ai acquis une rigueur et développé mes compétences pratiques.

Puis, mon cursus théorique en quatrième année de Pharmacie m'a fait découvrir la neurologie et les neurosciences, qui ont vite remplacé l'immunologie comme domaine d'intérêt. Les maladies psychiatriques et la douleur représentent des affections répandues et diverses dont la prise en charge est si complexe que cela m'a marquée, et ces maladies continuent de me passionner encore à ce jour. Afin de me spécialiser et me permettre de prétendre à une bourse de thèse en sciences dans le domaine des neurosciences, j'ai complété un master en neurosciences à la faculté de Strasbourg, et décroché une bourse du Ministère de l'Enseignement Supérieur et de la Recherche pour entamer une thèse de recherche, tout en complétant mon doctorat en Pharmacie.

Le laboratoire dans lequel j'ai effectué mon stage de master pouvait m'accueillir pour la thèse, et m'a proposé un sujet proche de mes aspirations. Pour moi, la recherche et spécifiquement la thèse, permettent de développer une rigueur, des connaissances et des compétences diverses, qui sont une véritable valeur ajoutée pour un Pharmacien.

II Déroulement, gestion et coût du projet

1) Préparation et cadrage du projet

a) Evaluation des facteurs de succès et des facteurs de risque

➤ Facteurs de risque, à priori :

De par le sujet et le contexte scientifique de la thèse, l'utilisation de souris knock-in, génétiquement modifiée pour exprimer un gène en particulier, est indispensable, ce qui pose la question de l'approvisionnement en animaux d'expérience. L'hébergement et le service de reproduction des souris génétiquement modifiées connaît des difficultés néanmoins bien connues et théoriquement maîtrisables. Certaines souches de souris génétiquement modifiées, dont les deux dont l'usage est requis pour notre projet, sont plus sensibles à des variations de conditions d'hébergement, ce qui les rend plus susceptibles de ne pas se reproduire et ainsi être moins nombreuses. Nous connaissons le problème, et pouvons anticiper les périodes difficiles et optimiser les nombres d'animaux nécessaires à nos expériences.

La cible pharmacologique d'intérêt pour nous est constituée des deux récepteurs opioïdes mu et delta en association, qui est nommée hétéromère (par opposition aux monomères individuels des récepteurs lorsqu'ils sont séparés). Un groupe de recherche avec lequel nous collaborons a découvert une molécule qui se lie aux hétéromères mu-delta préférentiellement. Nous ne disposons que de quantités limitées de ce composé, ce qui représente un facteur de risque important, néanmoins nous avons optimisé et prévu les expériences avec soin, ce qui permet de réduire considérablement l'impact de ce facteur.

➤ Facteurs de réussite, à priori :

De par l'expérience du stage de master, mes connaissances théoriques et pratiques étaient en adéquation avec le projet, et je connaissais ma directrice de thèse ainsi que ses étudiants précédents. Les conditions de réalisation du projet semblaient bonnes, d'un point de vue technique, humain mais aussi financièrement, par l'obtention de ma bourse ministérielle.

Le laboratoire d'accueil disposait de toute la ressource matérielle et technique nécessaire aux travaux de ma thèse, et le sujet que j'avais moi-même rédigé en accord avec ma directrice avait été accepté à l'école doctorale.

L'équipe Douleur chronique : approche anatomo-fonctionnelle et traitement fait partie du réseau national de la recherche sur la douleur, ce qui permet de tisser des liens forts avec les communautés médicales et précliniques proches de nos thématiques.

b) Choix des partenaires

Nous avons collaboré avec une équipe basée à Heidelberg pour compléter une étude de microscopie électronique sur nos échantillons. Cette équipe, avec laquelle une collaboration avait déjà été menée avec succès à laquelle ma directrice avait déjà fait appel par le passé, connaît parfaitement les conditions d'analyse spécifique à la protéine de fusion entre le récepteur opioïde delta et la protéine fluorescente verte, ce qui représentait un gain de temps considérable.

Nous avons également collaboré avec une équipe du Laboratoire de Neurosciences Comportementales et Adaptatives à Strasbourg pour des expériences moléculaires, avec des personnes qui faisaient partie de l'ancienne équipe de recherche à l'Institut de Génétique et de Biologie Moléculaire et Cellulaire (IGBMC Illkirch), familières avec les animaux knock-in et disposant des techniques requises. Ainsi, les collaborations avec des personnes qui connaissaient déjà très bien ma directrice de thèse et les approches ainsi que les constructions génétiques utilisées ont été un grand avantage.

2) Conduite du projet

En Août 2013, nous avons rédigé le sujet de thèse et déposé celui-ci auprès de l'école doctorale. Nous avons identifié les objectifs et les approches, définissant deux axes principaux à développer, pour répondre aux questions concernant la localisation des récepteurs opioïdes, en nous servant des souris knock-in fluorescentes qui permettent de visualiser les récepteurs d'intérêt. Nous avons estimé que nos moyens étaient en adéquation avec le but fixé : la faisabilité étant bonne, puisque le nombre d'animaux d'expérience fut optimisé, le matériel ainsi que les produits chimiques et d'analyse étaient déjà utilisés en routine, et que les tests comportementaux de douleur, la manipulation des souris ainsi que les techniques d'immunohistochimie sur coupes de cerveau étaient déjà maîtrisées.

➤ Mise en place du modèle

Dans un premier temps, notre travail a été de mettre en place le modèle d'étude de la douleur neuropathique chez les animaux knock-in fluorescents. J'ai pu m'entraîner aux techniques de chirurgie et de dissection, ainsi qu'apprendre à pratiquer les tests comportementaux pour l'évaluation des troubles anxio-dépressifs, grâce aux membres de l'équipe.

Dans notre modèle, suite à la pose du manchon pour créer une constriction du nerf sciatique par chirurgie, les animaux développent une sensibilité mécanique, qui peut être traitée par l'administration de traitements par voie orale. Nous avons également recherché des signes de troubles anxio-dépressifs chez les animaux douloureux, et vérifié que les animaux traités ne manifestaient pas ces troubles. Nous avons donc montré la validité du modèle chez nos animaux, avec le décours temporel des symptômes sensitifs et émotionnels correspondant aux données de la littérature, et qui sont traités par les molécules déjà utilisées.

- **AXE 1 : Caractérisation des neurones des ganglions rachidiens exprimant le récepteur opioïde**

 **delta dans les différentes conditions**

Questions :

- Quelles cellules des ganglions rachidiens expriment le récepteur delta ?
- Y a-t-il des changements de distribution suite à la douleur neuropathique ? Suite aux traitement par les deux molécules choisies?

La première question à laquelle nous avons voulu répondre est dans quelles cellules du système nerveux périphérique se trouve le récepteur delta ?

Pour ce faire, nous avons prélevé les ganglions rachidiens correspondants aux niveaux anatomiques de constriction du nerf sciatique et procédé à la caractérisation cellulaire des neurones exprimant le récepteur delta en vert. Nous avons comparé les différents groupes de traitements.

A cette étape, nous avons rencontré un problème technique lié à la très petite taille des échantillons de ganglion rachidien. En effet, la taille des tissus est incompatible avec le matériel classiquement utilisé pour immunohistochimie sur des tranches de cerveau ou de moelle épinière, ce qui retarde l'analyse. Nous avons

utilisé différents matériaux et équipements, pour finalement réussir à obtenir des résultats reproductibles de qualité optimale, avec une quantité minimale d'anticorps, qui sont très coûteux. Classiquement, toutes les équipes qui travaillent sur les ganglions rachidiens en immunohistochimie procèdent directement sur lame, et nous sommes, apparemment, les seuls à utiliser cette approche qui permet d'obtenir des images de très grande qualité.

Nous avons envoyé des échantillons de ganglions rachidiens à l'équipe à Heidelberg pour analyse dans le but de déterminer la localisation cellulaire du récepteur delta (neuronale ou gliale).

Les résultats seront affinés par l'analyse de la distribution des récepteurs mu que nous ferons avec les ganglions rachidiens de souris doubles neuropathiques traitée ou non.

Idéalement, nous publierons l'étude comportementale et de distribution delta dans un papier en 2015.

- **AXE 2 : Les hétéromères mu-delta comme cible thérapeutique dans le modèle de douleur neuropathique**



Question :

- Y a-t-il des changements de distribution des récepteurs opioïdes dans des aires du cerveau de souris neuropathiques présentant des signes de troubles anxio-dépressifs ?

En comparant la cartographie qualitative de la co-expression des récepteurs opioïdes dans le cerveau de souris neuropathiques dépressives avec la distribution basale des récepteurs, nous avons pu identifier des aires comportant des changements d'expression des récepteurs opioïdes fluorescents. Nous avons donc décidé qu'il serait intéressant de comparer les cartographies des récepteurs fluorescents dans les différentes conditions pour nos animaux double knock-in.

Cette étude nous donnerait une indication des aires du cerveau où la co-expression neuronale des récepteurs opioïdes a lieu dans notre modèle de douleur neuropathique.

Au cours de cette année 2013/2014, j'ai pu discuter et présenter mes résultats aux réunions hebdomadaires de notre équipe. Ceci m'a permis d'avoir un suivi et des conseils précieux. J'ai également présenté les résultats obtenus au cours de mon séminaire de mi-thèse, ce qui a été utile car cela m'a permis de faire le bilan de l'avancement des travaux, discuter de mes résultats avec les membres du jury département et de dégager de nouvelles questions à explorer par la suite.

En tant que pharmacienne, le développement préclinique de molécules présentant un intérêt en clinique chez l'homme me tient particulièrement à cœur. Aussi, puisque les aspects comportementaux sont plus attrayants pour moi, j'ai souhaité construire un axe pharmacologique et comportemental pour la suite du projet. Ainsi, puisqu'il existe une molécule qui est particulièrement intéressante (un agoniste biaisé qui agit préférentiellement sur les hétéromères mu-delta) j'ai planifié des expériences pour étudier ce composé dans le cadre de la douleur neuropathique chez la souris.



Question :

- La co-expression neuronale dans les aires du cerveau identifiées correspond-t-elle à l'expression d'hétéromères mu-delta ?

Nous envisageons de procéder à des analyses biochimiques pour démontrer la proximité physique entre les deux récepteurs mu et delta. Nous prélèverons des aires du cerveaux qui ont été identifiées comme comportant un co-expression importante des deux récepteurs opioïdes.

Ensuite, nous étudierons les fonctionnalités d'activation des hétéromères par différentes molécules. Nous testerons l'effet de l'agoniste biaisé des hétéromères (la nouvelle molécule d'intérêt). Ceci nous donnera des informations importantes concernant les mécanismes et les caractéristiques d'activation des hétéromères. Ce travail sera réalisé en collaboration avec une équipe du LNCA que nous connaissons déjà, avec laquelle nous avons travaillé à de nombreuses reprises. J'ai souhaité participer activement à ces travaux, afin de perfectionner mon expertise biochimique et pharmacologique avec eux.



Questions :

- Les nouvelles molécules, concurrentes du traitement de référence, soulagent-elles la douleur neuropathique dans notre modèle ?

Dans un premier temps, nous déterminerons la dose efficace qui soulage l'allodynie mécanique qui se développe dans notre modèle de douleur neuropathique.

L'approche comportementale vise à établir le potentiel anti-douleur des nouvelles molécules. Ceci nous permettra d'évaluer la pertinence du développement pré-clinique de l'administration de ces composés dans le traitement de la douleur neuropathique.

En septembre 2015, j'ai prévu de réunir l'équipe et les membres de mon jury de mi-thèse pour présenter les résultats obtenus. J'espère que cette discussion me permettra de faire le point sur les expériences à réaliser en priorité dans l'optique des publications et de la soutenance.

Malgré les difficultés rencontrées, nous avons planifié des expériences ciblées qui nous permettront d'optimiser le travail en vue de résultats définis avec précision. Cette expérience de thèse m'a permis d'acquérir des compétences de gestions du temps et de prise de décision dans le cadre de la conduite d'un projet.

Montants en Euros TTC

Coûts totaux en euros

Nature de la dépense		Détails		Nombre d'unités	Coût unitaire moyen	Quote-part utilisation	Total
1	Ressources Humaines	Salaire Brut	Charges				
1.1	Doctorant	1600	800	48	2400		115200
1.2	Encadrant 1	1800	900	48	2700		129600
	Sous-total Ressources Humaines						244800
2	Consommables						
2.1	Fournitures expérimentales				Prix unitaire		
	souris	C57 6semaines		40	25		1000
	souris	transgénique	4sem repro	14 sem	2.68 la semaine		3376.8
	gants			11250	0.1		1125
	Boites culture			45	232 les 75boites		139.2
	Tubes Falcon		50mL	100	184 les 500 unités		36.8
	Cell Strainer			20	146.70 pour 50		58.68
	Parafilm			0.5	10cmx38m	23.5 les 38m	11.75
	Instruments chirurgie			368 €			368
	lames			690	5.35 les 50		187.25
	lamelles			690	129.2 les 1000		90.44
	pointes		10µL	6000	48 les 1000		288
			200µL	6000	45.3 les 1000		271.8
			1000µL	6000	45.3 les 1001		271.8
	Produits chimiques						
	PFA 32%			17.5	44		770
	SNC80			10mg	195 les 10mg		195
	Formoterol			30mg	545 les 50mg		327
	Duloxétine			1.6 g	119 les 120mg		1586.67

PBS 10X		1.5L	77.30 les 6L		19.33
PB		10L			20
CYM51010		150mg	387.5 les 25mg		2325
NaCl		9g	0.01		0.09
ketamine		10mL			10
xylazine		5mL			30
ocrygel		1/2 tube	10.05 le tube de 10g		5.025
Anticorps					
NF200		30µL	330.5 les .2mL		82.625
IB4		0.5mg	489 par mg		244.5
CGRP		30µL	415 les 100µL		207.5
NPY		10µL	400 les 50µL		80
eGFP Rabbit		2mL	407 les 100µL		8140
eGFP Chicken		200µL	435 les 100µL		870
GAM Alexa 633		50µL	218 les 500µL		21.8
GAM Alexa 594		100µL	179 les 250µL		71.6
GAM Alexa 350		10µL	169 les 500µL		3.38
GAR Alexa 488		500µL	240 les 500µL		240
GAR Alexa 594		100µL	199 les 500		39.8
DAS Alexa 594		100µL	218 les 500µL		43.6
Streptavidin Alexa 594		150µL	264 les 1mg		396
Streptavidin Alexa 350		20µL	264 les 1mg		396
GAC Alexa 488		100µL	119 les 500µL		23.8
GAM Alexa 647		250µL	264 les 250µL		168.96
DAS Alexa 647		500µL	218 les 500µL		43.6
Streptavidin Alexa 647		150µL	264 les 1mg		396
mowiol		6g	26.8 les 50g		3.216

	dapi			5mg	95 pour 250mg		1.9
	glycerol			24g	42.3 les 100mL		21.15
	cryomatrix			500mL	18 les 100mL		90
2.2	Fournitures de bureau					Forfait	
	Cahiers spirale			3			
	Cahiers Laboratoire			2			
	Feutres permanents						
		fin		4			
		épais		4			
	Divers						
		crayons		10			
		bics		20			
		post-its		5			150
2.3	Autres achats						
	posters	A0		2	13		26
	Sous-total Consommables						23275.06
3	Infrastructures				nombre d'utilisateurs	Coût par an	
	Entretien, gardiennage, secrétariat				150	55000	1466.67
	Loyer des locaux						
	Electricité, eau, chauffage				150	330000	8800
	autres						
4	Matériel informatique						
	Expérimentation, logiciels spécialisés		SP5 confocal	200h	30€/h		6000
	ordinateur de bureau		582 75.00%				436.5

	logiciels de bureau		Forfait	
	autre			
5	Déplacements			
	Missions en France			
	GDR Montpellier	gratuit		
	Transports			300
	Hôtel			150
6	Formations		100€/h	10000
	Formations	100h		
	Doctoriales d'Alsace			100
	NCT			
	Expérimentation animale et chirurgie			
	Autres formations		Ressources personnelles	
	Inscriptions			1800
	Sécurité sociale étudiante assurance responsabilité civile			100
	Sous-total autres dépenses			30053.17

TOTAL (€)	298128.22
------------------	------------------

Estimation du coût consolidé de la thèse

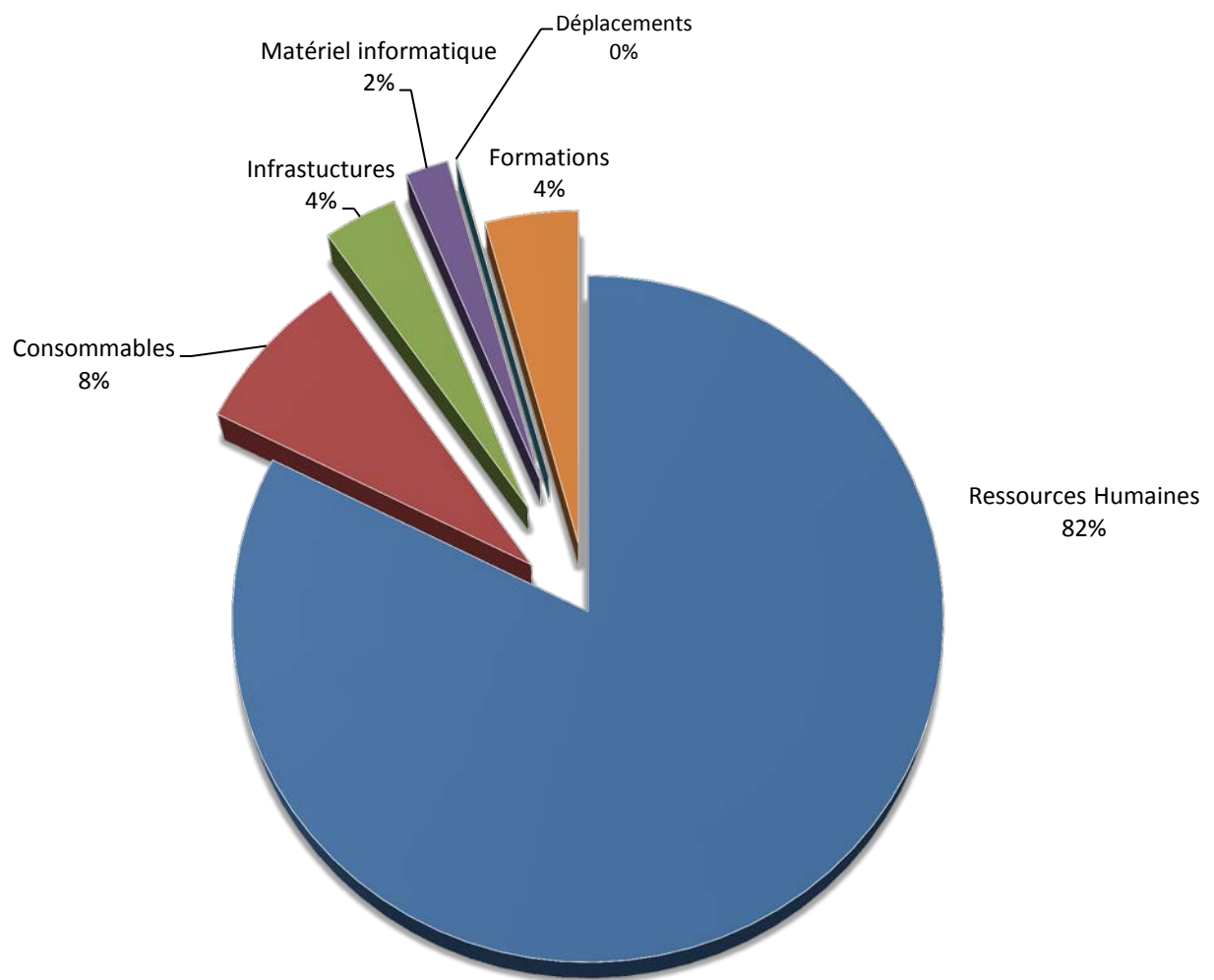

Feuille de Route de la Thèse

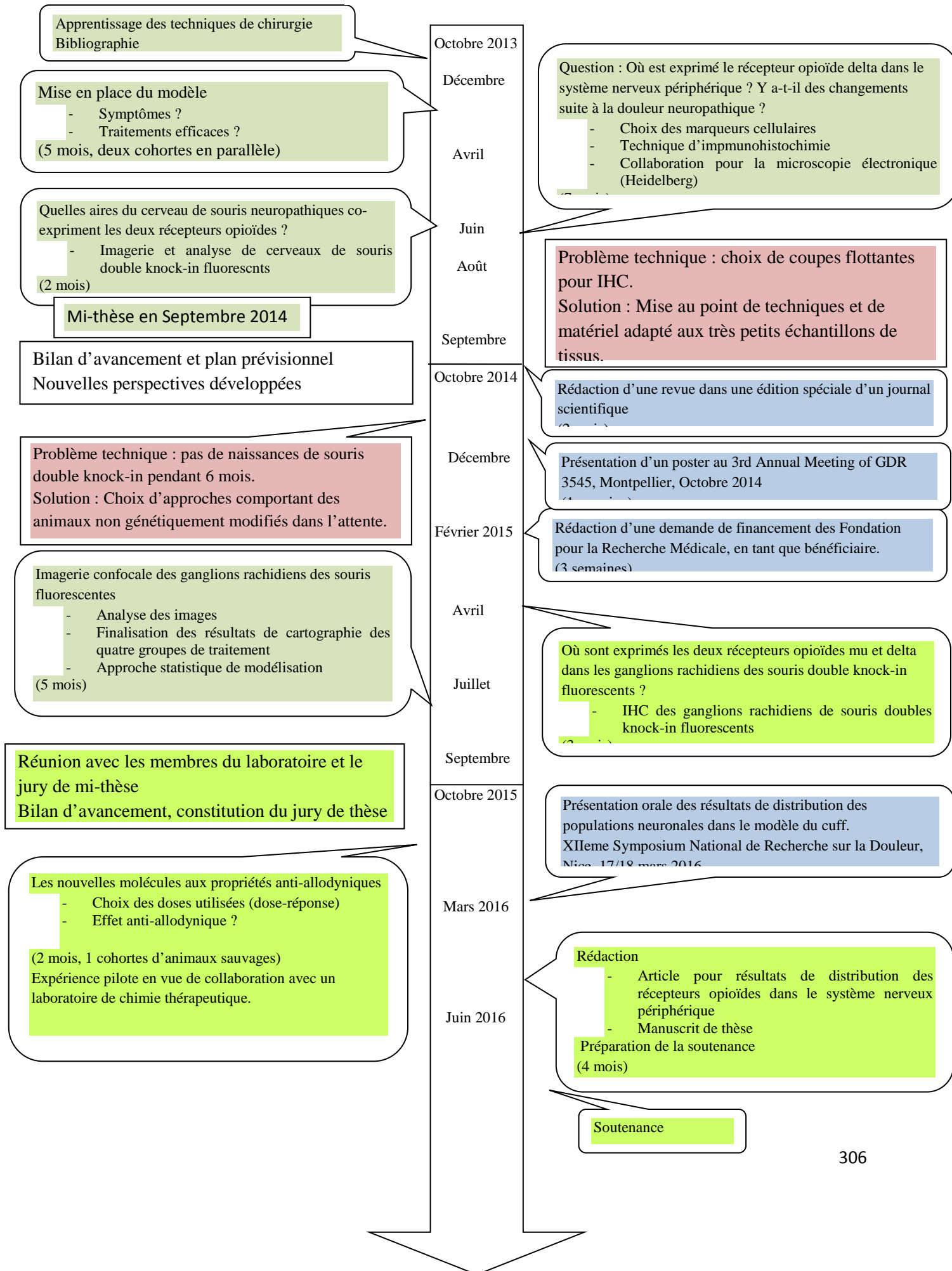

III Compétences, savoir-faire, qualités professionnelles et personnelles illustrées par des exemples

Ma première année de thèse s'est déroulée avec une autre directrice de thèse, dans un laboratoire qui étudiait la douleur chronique. J'ai mis en place un nouveau modèle d'étude de la douleur vicérale, que personne ne pratiquait au laboratoire. Les difficultés d'ordre éthique et technique que les expériences m'ont posées s'ajoutèrent à des problèmes de communication et d'entente entre ma directrice de thèse et moi. De nature très réfléchie et persévérante, j'ai continué et accepté les difficultés de cette première année, qui m'a mise dans le doute à de nombreuses reprises. Au bout de huit mois, j'avais atteint et dépassé la limite de ce que je pouvais supporter d'infliger à des souris, et nous avons décidé d'un commun accord d'interrompre la thèse. J'ai trouvé un nouveau projet, une nouvelle équipe et un nouveau directeur de thèse ; avec ma volonté de continuer un projet de recherche intacte. Cette période m'a permis de me remettre en question et de mettre en perspective mes ambitions. J'ai ainsi découvert que je possédais une forte volonté de m'engager dans la recherche, et j'ai aussi compris beaucoup de choses au sujet des interactions dans le monde du travail avec collègues et supérieurs, et que j'avais consolidé des capacités personnelles pour gérer les situations difficiles et conflictuelles. Je me suis sortie grandie de cette première expérience que je vivais à l'époque comme un échec, mais cela m'a poussée à être plus diplomate et m'a appris l'importance d'une bonne communication entre collègues notamment. J'ai ainsi également acquis de l'expérience en gestion de conflits et de travail dans des conditions de relation difficile. Mon nouveau projet, que j'ai pu écrire avec la supervision de ma directrice actuelle, me permet de développer des approches qui sont plus en adéquation avec mes envies, et qui me passionnent.

Au cours de ma thèse, j'ai développé des compétences purement techniques et scientifiques dans les domaines de l'étude comportementale chez la souris, plus spécifiquement les troubles anxio-dépressifs et la douleur. J'ai également acquis de l'autonomie pour l'analyse in vitro (immunohistochimie sur coupes de cerveau) ainsi que la prise en main de microscopes et de logiciels pour l'analyse des images.

Ma participation aux symposiums et congrès nationaux et internationaux m'ont permis d'élargir ma culture scientifique dans le domaine des neurosciences, autant dans la science fondamentale, appliquée, et la recherche clinique. Ainsi, j'ai participé à un congrès à Montpellier en octobre 2014, auquel j'ai élargi mes connaissances

fondamentales sur les récepteurs couplés aux protéines G. Le symposium national sur la douleur, tenu à Strasbourg, m'a sensibilisée aux aspects cliniques de la recherche dans le domaine de la douleur.

Mon implication dans les réunions régulières de l'équipe et du département m'ont appris à maîtriser la communication orale, et m'a apporté des perspectives variées et enrichissantes qui ont consolidé mes aptitudes à comprendre et gérer la résolution de problèmes complexes ainsi que l'approche des questions scientifiques prioritaires dans la conduite d'un projet.

Au cours de ma première année de thèse, j'ai eu l'opportunité d'encadrer des travaux dirigés et des travaux pratiques des étudiants de deuxième année de licence en biologie. Ceci m'a permis d'avoir une expérience dans l'enseignement, ainsi j'ai développé des compétences de communication et d'encadrement, ainsi que l'expérience de travail en groupe avec des enseignants chercheurs et d'autres étudiants en thèse.

La structure du projet de thèse, qui n'était pas unidirectionnelle et linéaire, m'a poussée à mieux maîtriser la gestion de mon temps, et de travailler en équipe. Aussi, j'ai pu, par le fait que je suis toujours volontaire pour assister mes collègues et/ou encadrer des étudiants stagiaires, participer à de nombreux projets, et travailler dans de différentes conditions, développant ainsi mes capacités d'adaptation et de délégation de tâches. J'ai pu encadrer deux étudiants stagiaires master, un étudiant BTS, je les ai menés vers une autonomie progressivement, en leur montrant les tâches à accomplir, puis les superviser, pour finalement leur fixer des objectifs, tout en restant disponible. J'ai également pu assister et conseiller les autres étudiants en thèse (aide techniques et logistiques). J'ai participé aux projets d'une autre étudiante en thèse pour les traitements et les études comportementales de souris dans le cadre du modèle de douleur neuropathique. Ma directrice de thèse m'a donné la chance de participer à l'envoi d'échantillons pour analyse dans le cadre de quatre collaborations distinctes, me permettant d'apprendre de nouvelles techniques, et de participer à des projets scientifiques enrichissants.

De nature consciencieuse et rigoureuse, j'ai pu consolider mes qualités d'organisation et de gestion administratives grâce au fait que ma directrice de thèse m'a fortement responsabilisée dès le début de ma thèse. Ainsi, elle m'a encouragée à prendre des décisions pour l'achat de matériel et l'utilisation des outils d'analyse.

Progressivement, elle m'a amenée à devenir autonome, et à réfléchir moi-même pour trouver des solutions à des questions scientifiques et tactiques concernant mon champ scientifique.

J'ai bénéficié d'une liberté quant à la gestion de mon temps et mon travail. Ainsi, je présentais régulièrement ma planification d'expérience et de répartition du travail ou de moyens, que je pouvais ajuster, dans un premier temps en demandant des conseils à ma directrice de thèse, puis son encadrement m'a progressivement menée à être capable de gérer mon temps seule, assez rapidement. Il n'était pas rare que je m'organise pour effectuer deux expériences en décalé, du comportement le matin pendant une incubation puis reprise de l'expérience d'immunohistochimie l'après-midi, séance au microscope confocale pendant une autre étape de réaction, ce qui m'a entraînée à gérer des tâches multiples et variées pour être efficace et tenir les délais fixés par le programme établi pour la semaine. Lorsqu'un contretemps ou un problème avait lieu, je pouvais rapidement réorganiser mes objectifs et m'adapter pour tenir des horaires raisonnables et garder une motivation optimale, car lorsqu'une expérience ne fonctionne pas, avoir au moins une chose qui marche permet de garder une attitude positive, essentielle pendant la thèse.

La grande disponibilité de ma directrice m'a permis d'aller discuter avec elle dès que je rencontrais des contretemps, des problèmes, et ainsi la gestion des problèmes techniques a été optimale, notamment en rapport avec les imprévus expérimentaux. Ces méthodes de travail nous ont permis d'atteindre des conditions proches des principes de processus qualité, dans lesquels la communication et la dynamique d'équipe fait avancer le projet de manière très efficace.

J'ai aussi pu participer aux formations proposées par l'école doctorale sans restriction aucune, comme les Doctoriales ® d'Alsace, et prendre des congés lorsque j'en éprouvais le besoin. L'excellente communication et notre bonne entente a permis de développer une complicité et une relation dont mon travail et ma motivation ont grandement bénéficié. Ainsi, notre dynamisme et notre motivation ont créé une synergie permettant d'atteindre nos objectifs de recherche dans les meilleures conditions.

Par ma qualité de bilingue, j'ai eu une place privilégiée pour la relecture et la correction d'articles scientifiques de l'équipe. J'ai corrigé et contribué à deux publications au cours de mes deux dernières années de thèse. J'ai pu

développer mes compétences de communication écrite lors de la rédaction d'une revue en premier auteur parue début 2015. Lors de ce travail, j'ai effectué une revue approfondie de la littérature, qui m'a permis de renforcer mon esprit synthétique et mes qualités rédactionnelles. Le résultat est une source de satisfaction pour moi, et j'ai découvert que ce travail de rédaction m'a passionné, et m'a préparée à la rédaction du manuscrit de la thèse. La veille bibliographique, effectuée régulièrement, a renforcé mon esprit de synthèse, essentiel aux travaux scientifiques et permettant une qualité optimale de communication orale et écrite.

Au cours de la conduite de mon projet de thèse, j'ai développé de fortes capacités organisationnelles et interpersonnelles qui me seront utiles et précieuses, car elles sont recherchées et valorisables dans de nombreux domaines en dehors du cadre purement scientifique dans lequel s'inscrit ma thèse. J'ai, depuis le début de ma thèse, un attrait fort pour les aspects relationnels de l'encadrement et de la gestion. Je possède des aptitudes interpersonnelles excellentes et un goût pour la compréhension des dynamiques de groupe. En plus de mes capacités de communication, d'adaptation et de prise de décision, ce goût et la compréhension des relations humaines m'orientent logiquement vers des professions de gestion et de direction de groupes.

IV Résultats, Impact des Recherches

Les objectifs du projet que nous menons est d'une part de mieux connaître l'implication du récepteur opioïde delta dans la douleur neuropathique et les conséquences émotionnelles liées à la douleur chronique, et d'établir le potentiel thérapeutique d'une approche ciblant les hétéromères des récepteurs opioïdes mu et delta pour traiter la douleur et les conséquences émotionnelles de la douleur chronique. Ces objectifs s'inscrivent dans un but plus long terme qui vise à améliorer la prise en charge des patients qui souffrent de douleur chronique, pour soulager la douleur neuropathique de manière efficace, en entraînant une dépendance et une tolérance faible lors de traitements prolongés.

Nous avons établi la distribution et les changements d'expression du récepteur delta dans les neurones des ganglions rachidiens dans les différentes conditions de douleur et de traitements. Une fois que la distribution du récepteur mu sera aussi finalisée dans les différentes conditions, nous aurons des éléments forts pour publier une description complète des changements d'expression des récepteurs opioïdes dans un modèle de douleur chronique, ce qui étayera le rôle du système opioïde dans la douleur neuropathique.

Nous avons aussi décrit une tendance des changements dans la distribution des récepteurs opioïdes dans certaines zones du cerveau de souris qui présentent des traits comportementaux anxieux ou dépressifs suite à la douleur chronique. Avec la quantification des changements d'expression qui sera achevée et la mise en évidence de la présence d'hétéromères mu-delta, notre analyse permettra de décrire précisément les changements au niveau central entraînés par la douleur chronique et de caractériser pharmacologiquement les hétéromères..

Ces deux axes de recherche permettront à notre équipe de publier ces travaux individuellement, ce qui pourra d'une part d'établir encore plus solidement l'implication du récepteur opioïde delta dans processus périphériques de la douleur neuropathique, et aussi de lier l'expression des hétéromères mu-delta aux conséquences émotionnelles de la douleur chronique. Ces deux aspects du projet constituent la base de la mise en place d'un traitement ciblant les hétéromères, qui sera aussi évalué par nos expériences, et donc nous aurons achevé un tableau complet dans lequel les cibles sont décrites et leur potentiel thérapeutique sera établi. Ceci

permettra également de placer les projets de l'équipe en avant dans le domaine des approches thérapeutiques nouvelles.

Nous pourrions mettre en avant nos travaux dans des communications orales et écrites, pour exposer le raisonnement scientifique pour soutenir le développement d'une stratégie thérapeutique ciblant les hétéromères mu-delta dans le traitement de la douleur neuropathique chronique et des conséquences émotionnelles de la douleur chronique. Nous aurons décrit l'efficacité du traitement, et vérifié que celui-ci remplit les critères de faible tolérance et de dépendance dans le modèle animal. Ceci sera la première étape vers une mise en place d'essais pré-cliniques en vue d'une thérapie chez l'homme.

D'un point de vue personnel, mener ce projet m'a permis d'acquérir de l'expérience en gestion du temps et du travail. Malgré les difficultés, j'ai pu m'adapter et mener de front plusieurs tâches en parallèle pour atteindre les objectifs fixés. Dans un premier temps, la stratégie et la portée des résultats m'échappaient, puis j'ai peu à peu apprivoisé et maîtrisé les aspects logiques et théoriques qui sont essentiels à la compréhension et la mise en œuvre de ce projet. Cela procure une meilleure confiance, à la fois pour l'esprit scientifique, mais également pour l'estime de soi en tant que chercheur accompli comme entité d'une équipe. Le fait d'avoir bénéficié d'un milieu riche et d'un projet porteur m'ont permis de m'épanouir et d'envisager ma carrière sereinement.

Identification de pistes professionnelles

Au cours de ma thèse, j'ai développé et renforcé plusieurs qualités transversales importantes ; qui me seront utiles pour la poursuite de ma carrière. J'ai amélioré mes capacités en matière de communication orale et écrite, qui vont de pair avec l'esprit de synthèse. J'ai également optimisé la gestion du temps et des moyens pour mener mon projet de thèse. Et finalement, j'ai découvert que le contexte du laboratoire et l'expérience professionnelle que représente sollicitaient mes compétences d'analyse des interactions et une compréhension des dynamiques des relations interpersonnelles. Ces capacités, en plus de l'expertise technique et théorique que j'ai acquise au cours des quatre ans du projet de thèse, m'ont poussée à envisager une carrière qui ne serait pas purement scientifique.

De plus, mes études de Pharmacie m'ont sensibilisée à l'importance du développement pré-clinique et clinique ; et j'ai également acquis des connaissances relatives au fonctionnement du domaine de l'industrie pharmaceutique. C'est donc vers ce secteur que je souhaitais orienter mes recherches de poste. Lors d'une discussion à un forum Strasbourgeois en 2013, j'ai rencontré une personne qui travaille dans une Clinical Research Organisation, un type d'entreprise spécialisée dans la mise en place et la conduite de projets de recherche clinique, que les grandes boîtes pharmaceutiques sous-traitent. Ce type d'activité m'a semblé correspondre avec mes goûts pour la gestion et la recherche.

Au cours des derniers dix mois, j'ai commencé à consulter les offres en ligne, puis je me suis rendue compte que la plupart du temps, les personnes qui avaient une double formation pharmaceutique et scientifique occupent des postes à responsabilité élevée, telle que les Directeurs des Affaires Médicales, Chargés de Projet de Recherche Clinique et les Medical Science Liaison. Ainsi, je vise ce type de poste, forte de mes compétences scientifiques et managériales, je souhaite atteindre un poste qui me permettra de mettre en œuvre toutes mes compétences scientifique, relationnelles et décisionnelles pour mener et superviser les projets de recherche clinique.

Atteindre ce but consistera en plusieurs étapes, car l'expérience dans le domaine de la recherche clinique est incontournable. Plusieurs options sont possibles, pour débiter dans l'industrie pharmaceutique ou de

cosmétique. Les bases pour la préparation de ma future carrière comme directeur d'affaires médicales commencera par une ou plusieurs des pistes suivantes :

1. Par la recherche d'un stage comme assistante de projet dans une entreprise pharmaceutique (Actelion, à Bâle) ou cosmétique comme L'Oréal (Paris) sont envisageables. Ce sont des postes temporaires mais qui me permettront de suivre des formations en management au sein de l'entreprise et de connaître le réseau de ces entreprises, et surtout je pourrais ainsi acquérir de l'expérience.
2. Par la formation d'Assistante de Recherche Clinique (ARC) à Paris, qui offre une formation rigoureuse et indispensable pour postuler à des emplois dans le domaine de la recherche clinique. Plusieurs Curriculum Vitae que j'ai pu consulter et les offres d'emploi font apparaître cette formation comme quasi(incontournable. ARC est accessible au niveau Bac+2, mais pour moi, qui aurai deux diplômes universitaires (Bac+6 et Bac+8) je profiterai d'une évolution rapide après avoir complété cette formation et travaillé plusieurs années dans le domaine de la recherche clinique. Je pourrai ensuite envisager des fonctions de responsable du développement clinique.
3. Par la voie d'un master spécialisé dans le management de projets innovants, ce qui me donnera une formation en management intense et d'un réseau professionnel solide. Les responsables de cette formation bénéficient d'excellentes relations avec les entreprises start-ups de la région, en biotechnologie notamment. Par l'obtention de ce master (4 mois de cours puis un stage), je pourrais envisager des postes de manager de projet dans de nombreux domaines, dont l'industrie du médicament et de la cosmétique.

Ainsi, alliant l'expérience de la thèse, mes connaissances et mes contacts dans l'industrie pharmaceutique à une formation complémentaire, je serai parée pour postuler aux fonctions que je convoite, et évoluer vers un poste à responsabilité dans le domaine de la recherche clinique. Ce type de poste me permettra d'exercer mes capacités de gestion de projet et de ressources humaines, de proposition et de supervision d'axes de développement thérapeutiques innovantes.

Résumé

Les travaux présentés ici visent à déterminer l'implication du récepteur aux opioïdes delta dans des modèles de pathologies chroniques telles que la douleur chronique et l'administration d'opiacés.

Nous avons mis en œuvre des approches génétiques, d'imagerie et comportementales afin de décrire précisément les changements de distribution neuronale du récepteur aux opioïdes delta dans un modèle de douleur neuropathique et dans l'administration chronique de morphine, dans les tissus du système nerveux central et périphérique. Nous avons étudié l'implication des récepteurs aux opioïdes delta périphériques dans l'effet thérapeutique de traitements antiallodyniques dans un modèle de douleur neuropathique, et examiné le rôle des récepteurs aux opioïdes delta dans la sensibilité viscérale et dans les effets thérapeutiques de la Prégabaline.

Nos travaux ont permis de décrire précisément les changements et l'implication du récepteur aux opioïdes delta dans plusieurs modèles de pathologies chroniques, dans le but de dégager des pistes thérapeutiques futures.

Mots clé : récepteur aux opioïdes delta, douleur chronique, douleur neuropathique, souris knock-in fluorescentes.

Résumé en anglais

In this work, we used genetic, imaging and behavioral approaches to describe the changes which the distribution of the delta opioid receptor underwent in models of clinical conditions such as neuropathic pain and chronic opioid exposure, at the peripheral and supraspinal levels. We investigated the role of peripheral delta opioid receptor populations in the antiallodynic effect of chronic treatment by antidepressant and $\beta 2$ agonist molecules in a model of neuropathic pain. We also described the implication of delta opioid receptors in visceral sensitivity, and their involvement in the pain-relieving effects of Pregabalin in a model of neuropathic pain.

Thus, we have brought insight as to the role of delta opioid receptors in these various clinical conditions, and thoroughly described the distribution changes; which may lead the way to therapeutic strategies to treat chronic pain or drug addiction.

Key words: delta opioid receptor, chronic pain, neuropathic pain, fluorescent knock-in mice.