



**HAL**  
open science

# Structure et dynamique des communautés de poissons : vers une compréhension écologique du système d'inondation pulsé en Asie tropicale

Ratha Chea

## ► To cite this version:

Ratha Chea. Structure et dynamique des communautés de poissons : vers une compréhension écologique du système d'inondation pulsé en Asie tropicale. Biodiversité et Ecologie. Université Paul Sabatier - Toulouse III, 2016. Français. NNT : 2016TOU30083 . tel-01513559

**HAL Id: tel-01513559**

**<https://theses.hal.science/tel-01513559>**

Submitted on 25 Apr 2017

**HAL** is a multi-disciplinary open access archive for the deposit and dissemination of scientific research documents, whether they are published or not. The documents may come from teaching and research institutions in France or abroad, or from public or private research centers.

L'archive ouverte pluridisciplinaire **HAL**, est destinée au dépôt et à la diffusion de documents scientifiques de niveau recherche, publiés ou non, émanant des établissements d'enseignement et de recherche français ou étrangers, des laboratoires publics ou privés.



Université  
de Toulouse

# THÈSE

En vue de l'obtention du

## DOCTORAT DE L'UNIVERSITÉ DE TOULOUSE

Délivré par :

Université Toulouse 3 Paul Sabatier (UT3 Paul Sabatier)

---

**Présentée et soutenue par :**

**Ratha CHEA**

Le jeudi 21 juillet 2016

**Titre :**

Structure et dynamique des communautés de poissons : vers une  
compréhension écologique du système d'inondation pulsé en Asie tropicale

---

ED SEVAB : Écologie, biodiversité et évolution

**Unité de recherche :**

Évolution et Diversité Biologique

**Directeur(s) de Thèse :**

Gaël GRENOUILLET (Maître de conférences, Université Paul Sabatier, Toulouse)

**Rapporteurs :**

Christine ARGILLIER (Directrice de recherche, IRSTEA, Aix-en-Provence)

Marc POUILLY (Chargé de recherche, Institut de Recherche pour le Développement, Paris)

**Autre(s) membre(s) du jury :**

Sovan LEK (Professeur, Université Paul Sabatier, Toulouse)

Pablo TEDESCO (Chargé de recherche, Institut de Recherche pour le Développement,  
Toulouse)

Hervé CAPRA (Chargé de Recherche, IRSTEA, Lyon)



## REMERCIEMENTS

Cette thèse n'aurait pas pu être réalisée sans l'aide précieuse de nombreuses personnes. Je voudrais tout particulièrement remercier :

Gaël Grenouillet et Sovan Lek qui ont codirigé efficacement cette thèse tant au niveau écologique qu'au niveau théorique. Je les remercie au profond de mon cœur pour leur entière confiance qu'ils m'ont accordée tout au long de ce travail, pour la liberté de travail qu'ils m'ont donnée, pour les modèles stats « casse-tête » pour lesquels ils m'ont guidé, pour nos discussions dynamiques et constructives, ainsi que les expériences et connaissances scientifiques précieuses qu'ils m'ont fournies toujours au cours de mon travail avec eux. Cela me permet de découvrir le monde de la recherche et m'entraîner vers un chercheur indépendant dans ma future carrière.

Les collaborateurs qui m'ont assisté au cours de la réalisation de mes articles et le travail de terrain : Kirk Winemiller, Chuanbo Guo, Mathieu Chevalier, Loïc Tudesque, Phen Chheng, Phanara Thach, Ngor Pengbun, Thomas Pool, Vittoria Elliott. Grand merci à Loïc et Mathieu pour leur gentillesse et soutien lors de mon travail de terrain au Cambodge.

Christine Argillier, Marc Pouilly, Hervé Capra, Nam So, Pablo Tedesco qui ont consacré de leur temps et leur d'énergie d'analyse de ce travail.

Belmont Forum et le projet Erasmus Mundus TECHNO qui ont financé mon travail de recherche au Cambodge et mon séjour à Toulouse. Également, merci à mon université de Battambang (UBB) et à ma Présidente pour sa compréhension et coordination de mon projet d'études.

Commission du Mékong (MRC) pour les données précieuses des poissons et de la qualité de l'eau dans le Mékong, et Inland Fisheries Research and Development Institute (IFReDI) pour le soutien technique et la collecte des données sur le terrain.

Mon laboratoire d'accueil, particulièrement mon équipe AQUAECO et tous ceux qui m'ont soutenu pendant cette période : mes amis asiatiques à Toulouse Ratha Sor, Ratha Seng,

Heng Kong, Chan Bunyeth, Lin Mingli, Joyita Mukherjee, Sopheak Sam. Merci à Sébastien Brosse, mon chef d'équipe et l'équipe d'administration du labo Nicole Hommet, Florence Peborde, Linda Jalabert qui facilitent toutes les procédures administratives au cours de mon séjour.

Enfin, je remercie du profond de mon cœur mes parents, mes beaux-parents, Madame Lek, Monsieur et Madame Lay, en particulier *my beloved wife* « *Solida Chea* » pour leurs soutiens et la confiance qu'ils m'ont toujours accordés.

អ្នកក្នុងខ្លួននេះ កូនសូមគោរពថ្លែងអំណរគុណដល់ លោកអ្នកមានគុណទាំងពីរ ព្រមទាំង លោកខ្ចីពុក អ្នកម្តាយក្មេក ដែលតែងតែផ្តល់កំលាំងចិត្ត និងស្ថិតិជិតរូបកូនជាដីច្នៃប្រឌិតអរគុណជាពិសេសដល់ លោកគ្រូ ឡេក ឡេក សុវណ្ណ និងអ្នកគ្រូ ឡេក ស៊ីថាន លោកអ៊ុំ ឡាយ សុវណ្ណ និងអ៊ុំស្រី ឡាយ តូរី ដែលយកចិត្តទុកដាក់មែលថែ ខ្ញុំ និងឥរិយាដូចកូនបង្កើត ប្រអុណជាពិសេសលោកគ្រូ សុវណ្ណ ស្តីទៅនឹងចិត្តដែលលោកគ្រូមានសំរាប់ខ្ញុំ និងអ្វីៗដែលលោកគ្រូបង្ហាត់បង្ហាញតាំងពីដើម រហូតមកដល់ថ្ងៃនេះ ប្រអុណជាពិសេស ឥរិយាជាទីស្រឡាញ់ ស្តីអ្វីគ្រប់យ៉ាងដែលផ្តល់សំរាប់បងៗជាចុងក្រោយ សូមគោរពជូនពរលោក អ្នកមានគុណ ទាំងអស់ ប្រកបដោយ សុខភាពល្អ បរិប្រសើរជាដាច់ខាត។

## AVANT - PROPOS

Ce manuscrit regroupe mes principaux travaux effectués au sein du Laboratoire Évolution et Diversité Biologique (EDB-UMR 5174) pendant 3 ans dans le cadre du projet TLSCC (Tonle Sap Climate Change) financé par Belmont Forum. Ces études ont donné lieu à trois articles publiés dans les revues internationales à comité de lecture. Un quatrième article est en cours de préparation. Le manuscrit est composé de deux principales parties : la synthèse des articles et les publications. La synthèse présente une introduction générale et le matériel utilisé pour réaliser ce travail, ainsi que les principaux résultats résumés en 3 chapitres autour d'une thématique scientifique commune « structure et dynamique des communautés de poisson » dans les hydrosystèmes tropicaux en Asie du sud-est. Différents sujets relatifs à la dynamique spatiale et temporelle de la structure des communautés de poisson et au fonctionnement de l'écosystème sont abordés :

- Structure spatiale de la physicochimie et des poissons à large échelle
- Structure temporelle des communautés de poissons
- Réseau trophique et état écologique de l'écosystème

Les zones d'études concernées sont celles du bassin du Mékong en aval et la zone humide Tonlé Sap au Cambodge, des systèmes gouvernés par les crues saisonnières. L'introduction générale fait la synthèse des contextes et problématiques des études abordées, ainsi que l'état de l'art des connaissances écologiques des plaines inondables riveraines en Asie tropicale. Le manuscrit se termine par une conclusion générale constituant une synthèse des implications des résultats et des perspectives pour de prochaines études. Les résultats de ces études contribuent non seulement au développement durable du bassin du Mékong, mais aussi à une amélioration de la compréhension écologique et biologique des écosystèmes des plaines inondables du monde entier.

# PARTIE I : SYNTHÈSE

## SOMMAIRE

INTRODUCTION.....	1
1. Écologie du système d'inondation pulsé (Flood pulse system).....	1
2. Dynamique et structure des communautés de poissons.....	3
3. État de l'art des connaissances écologiques et biologiques en Asie tropicale.....	5
4. Défis et enjeux de la biodiversité en Asie tropicale .....	8
5. Problématique de l'étude .....	10
6. Objectifs spécifiques.....	11
MATÉRIELS ET MÉTHODES .....	13
1. Zones d'études .....	13
2. Données .....	14
3. Approches de modélisation .....	19
4. Ecopath with Ecosim (EwE).....	23
CHAPITRE I : STRUCTURE SPATIALE DE LA PHYSICO-CHIMIE ET DES POISSONS À LARGE ÉCHELLE.....	25
1. Variations spatiales des caractéristiques physicochimiques des eaux.....	27
2. Patron spatial de diversité et structure d'assemblage de poisson .....	30
3. Déterminants environnementaux des assemblages de poisson.....	35
CHAPITRE II : STRUCTURE TEMPORELLE DES COMMUNAUTÉS DE POISSONS ..	39
1. Évolution temporelle des communautés de poissons .....	41
2. Synchronie spatiale de la variation temporelle des communautés .....	45
3. Réponse des communautés de poisson au régime hydrologique.....	45
CHAPITRE III : RÉSEAU TROPHIQUE ET ETAT ÉCOLOGIQUE DE L'ÉCOSYSTÈME .....	49
1. Réseau trophique et flux d'énergie .....	51
2. État écologique de l'écosystème.....	55
CONCLUSIONS GENERALES ET PERSPECTIVES .....	59
1. Conclusions générales .....	59
2. Implications .....	62
3. Perspectives .....	63
BIBLIOGRAPHIE .....	67
APPENDICE I.....	79
APPENDICE II .....	81

## PARTIE II : PUBLICATIONS

A1). Evidence of water quality degradation in Lower Mekong Basin revealed by Self-Organizing Map.

R. Chea, G. Grenouillet, S. Lek 2016.

*PLoS ONE 11(1):e0145527*

A2). Large-scale patterns of fish diversity and assemblage structure in the longest tropical river in Asia.

R. Chea, S. Lek, P. Ngor, G. Grenouillet 2016.

*Ecology of Freshwater Fish (in press)*

A3). Temporal dynamics of fish community structure in a flood pulsed, tropical lake ecosystem.

R. Chea, S. Lek, M. Chevalier, P. Ngor, K.O. Winemiller, G. Grenouillet.

*En préparation*

A4). Toward an ecological understanding of a flood-pulse system lake in a tropical ecosystem: Food web structure and ecosystem health.

R. Chea, C. Guo, G. Grenouillet, S. Lek 2016.

*Ecological Modelling 323:1-11.*





# **PARTIE I : SYNTHÈSE**



## **INTRODUCTION**

Les grands fleuves tropicaux sont toujours associés à de vastes plaines inondables et zones humides qui fournissent des services écosystémiques multiples et d'une importance cruciale pour l'humanité et la biodiversité qu'elles soutiennent (Welcomme 1988; Coates 2001). Au-delà, la plupart des systèmes d'eau douce tropicaux soutiennent les pêches extraordinaires qui assurent la sécurité alimentaire et les revenus pour des millions de personnes dans le monde entier, souvent dans les pays pauvres (Coates *et al.* 2003). Évidemment, les pêcheries tropicales sont souvent composées d'assemblages d'espèces très divers en comparaison des pêcheries tempérées, et également caractérisées par un large éventail de pratiques de pêches, e.g. de l'échelle commerciale à celle familiale. Ce large éventail de tactiques de pêche produit une pêche dite "non discriminée" (indiscriminate fisheries) ; contrairement à la pêche ciblée ou sélective, où toutes sortes de tailles et d'espèces sont récoltées (McCann *et al.* 2015). Cette approche possède probablement des implications inconsidérées pour la durabilité et le maintien des productions alimentaires dans ces écosystèmes très divers. Par ailleurs, la plupart des écosystèmes tropicaux les plus productifs sont les lacs et les fleuves d'inondation occasionnée par les crues (flood pulse lakes and rivers) qui dépendent de l'hydrologie du système pour déclencher les processus biologiques et alimenter la productivité (Junk, Bayley & Sparks 1989; Junk & Wantzen 2004).

### **1. Écologie du système d'inondation pulsé (Flood pulse system)**

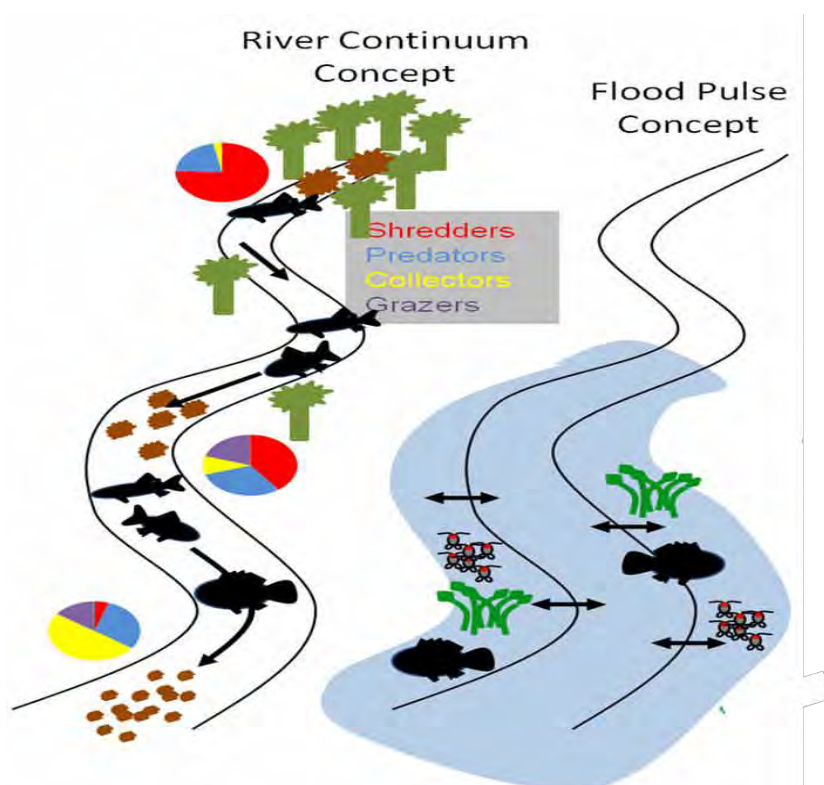
De nombreux fleuves, lacs et plaines inondables tropicaux sont gouvernés fortement par le cycle hydrologique (e.g. le Mékong et Tonlé Sap). Ces plaines inondables riveraines et zones humides, par leur nature, sont des écosystèmes fortement saisonniers avec des cycles hydrologiques qui modifient souvent la taille des lacs et des plaines inondables d'une manière considérable au cours de l'année (Bayley 1995; Allan & Castillo 2007). Lorsque ces systèmes sont dans des conditions d'inondation, les réseaux hydrologiques des lacs et fleuves

augmentent et connectent avec les autres habitats terrestres. Ce processus crée de nouveaux refuges pour les proies, et alimente l'écosystème avec des proies terrestres et des nutriments qui sont critiques pour les recrutements larvaires (souvent appelé le concept d'inondation pulsé ou « Flood Pulse Concept ») (Junk & Wantzen 2004). Par conséquent, ces écosystèmes sont des modèles parfaits pour étudier comment les écosystèmes répondent ou s'adaptent aux fluctuations des facteurs environnementaux (i.e., cycle hydrologique, climatique, physicochimique).

À partir de la théorie existante sur le concept d'inondation pulsé (FPC), il est prédit que tous les processus écologiques et la productivité au sein du système sont contrôlés par les dynamiques des crues saisonnières (Junk *et al.* 1989; Junk & Wantzen 2004). A la différence du concept de continuum fluvial (River Continuum Concept) (Vannote *et al.* 1980) où la productivité et les nutriments sont contrôlés par les processus en amont, le FPC se concentre sur l'échange latéral de l'eau, des nutriments, et des organismes entre les fleuves/lacs et leurs plaines inondables adjacentes, en d'autre terme, la production autochtone (Fig. 1) (Tockner, Malard & Ward 2000; Fang 2010).

Les écologistes ont depuis longtemps reconnu que la variabilité temporelle peut être responsable du maintien de la diversité et de la productivité. Plus récemment, les écologistes ont commencé à envisager la possibilité que la variabilité dans le temps peut jouer aussi un rôle important dans la persistance des réseaux alimentaires complexes du système d'inondation pulsé (Holt 1996; Dudgeon 2000; Straile 2005; McCann *et al.* 2015). Effectivement, dans les systèmes où cette variation a existé pendant de longues périodes (e.g. les plaines inondables), les espèces se sont probablement adaptées à ces différentes conditions afin de sélectionner des niches qui favorisent leur coexistence (Bayley 1995; Ward, Tockner & Schiemer 1999). Il est donc essentiel de comprendre comment le cycle hydrologique affecte le maintien de la diversité, la stabilité et le fonctionnement de ces écosystèmes. De plus, il est accepté que le régime hydrologique et la dynamique des crues sont les principaux

facteurs environnementaux influençant la structure des communautés (i.e. histoire de vie, alimentation et position trophique des espèces), le recrutement des poissons, la productivité dans le système (Junk & Wantzen 2004; Zeug & Winemiller 2008; Simões *et al.* 2013). Par conséquent, les barrages et le changement climatique menacent et affaiblissent l'intensité du cycle hydrologique qui pourrait modifier rapidement l'entièreté de ces écosystèmes.



**Fig. 1 :** Concept de continuum fluvial vs le concept d'inondation pulsé (modifié d'après Vannote *et al.* 1980; Junk *et al.* 1989)

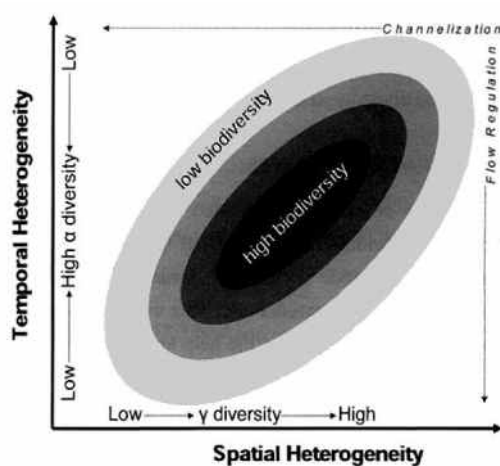
## 2. Dynamique et structure des communautés de poissons

Malgré les recherches intensives sur la structure des communautés de poissons et le fonctionnement des écosystèmes, notre capacité à expliquer comment la composition des espèces influence la communauté, ainsi que de quantifier la relation complexe entre la structure taxonomique, les traits biologiques et la diversité trophique, reste insuffisante (di Castri & Younes 1989; Olden *et al.* 2010). Comment les communautés des organismes changent à travers l'espace et le temps ? Quelle est l'importance relative des facteurs environnementaux structurant la communauté des organismes et la biodiversité ? Est-ce que

les compositions ou caractères fonctionnels de la communauté convergent le long de gradients environnementaux (e.g. les régimes de l'écoulement) ? Toutes ces questions demeurent d'actualité, malgré de nombreuses études des patrons spatio-temporels à travers le globe (Berra 2001; Lévêque *et al.* 2007). Effectivement, il est largement reconnu que la structure des communautés est caractérisée par la variabilité spatiale de l'habitat, de la variabilité environnementale et des interactions entre les organismes (Olden *et al.* 2010; Albert & Reis 2011; Lujan *et al.* 2013; Zhao *et al.* 2015). Par exemple, certains auteurs ont révélé les rôles dominants des facteurs physico-chimiques dans la structuration des communautés de poissons (Tejerina-garro, Fortin & Rodríguez 1998; Pires *et al.* 2010), tandis que d'autres ont signalé les effets importants des facteurs climatiques (Buisson, Blanc & Grenouillet 2008; Guo *et al.* 2015). Pourtant, malgré le nombre d'études sur ces facteurs, leur importance relative dans la distribution des communautés de poissons reste douteuse et discutable pour les écologistes des communautés (Murdoch 1994). De plus en plus, les écologistes sont convaincus que leurs connaissances dans la dynamique temporelle de la structure des communautés sont encore limitées, ce qui entraîne la mise en place de nombreux programmes de surveillance de la biodiversité à long terme dans les différents biomes (Magurran *et al.* 2010).

La structure des communautés résulte de l'action combinée d'un ensemble de facteurs environnementaux et des interactions écologiques influençant des espèces qui coexistent (Fig. 2) (Junk 1997; Likens 2010). Effectivement, l'interaction entre les facteurs biotiques et abiotiques est complexe et un certain nombre de cadres théoriques visent à expliquer ce qui contrôle la diversité et la composition des communautés (Junk *et al.* 1989; Bayley 1995; Grossman *et al.* 1998; Guégan, Lek & Oberdorff 1998; Arrington & Winemiller 2004). Par ailleurs, à grande échelle spatiale, les études des communautés de poissons rencontrent toujours beaucoup de difficultés, à savoir le manque de variables environnementales à l'échelle locale, la rareté de grandes bases de données sur les compositions des espèces au lieu d'utiliser la richesse spécifique ou les données de présence-absence, la limitation de la

modélisation des relations non-linéaires entre les facteurs biotiques et abiotiques, en particulier pour les grands fleuves transfrontaliers (e.g. le Mékong) (Oberdorff, Guegan & Hugueny 1995; Amarasinghe & Welcomme 2002). Dans les écosystèmes des plaines inondables, il est prédit que les communautés de poissons sont structurées par des processus stochastiques et déterministiques dont l'amplitude varie saisonnièrement (Grossman, Moyle & Whitaker 1982; Winemiller 1996; Arrington 2002). Par conséquent, une meilleure compréhension écologique est nécessaire pour gérer et préserver efficacement la diversité biologique dans les écosystèmes des plaines inondables tropicales.



**Fig. 2.** Un modèle conceptuel illustrant l'importance de l'hétérogénéité spatio-temporelle dans le maintien de la biodiversité dans les écosystèmes des plaines inondables. Des modifications anthropogéniques telles que la canalisation et la régulation de l'écoulement devraient modifier cette hétérogénéité, et leur impact sur la biodiversité est indiqué par les lignes en pointillés (modifiée de Arrington & Winemiller, 2004).

### 3. État de l'art des connaissances écologiques et biologiques en Asie tropicale

Les fleuves tropicaux asiatiques soutiennent un riche biotope mais incomplètement connu, y compris un grand nombre de poissons, un large éventail d'invertébrés benthiques et un assemblage de mammifères adaptés aux zones humides riveraines (Dudgeon 2000). Effectivement, l'écologie du système est dominée par les crues saisonnières imposées par les pluies de mousson ayant des conséquences profondes sur les communautés aquatiques.



Néanmoins, une attention grandissante a été portée à l'étude de la biodiversité dans les zones tempérées et néotropicales, alors qu'il y a étonnamment très peu d'information et d'études sur la dynamique des communautés aquatiques en Asie tropicale; bien que cette région ait été classée comme hotspot de la biodiversité (Dudgeon 2000, 2003; Mittermeier *et al.* 2011). Par exemple, beaucoup d'efforts de recherche ont été mobilisés, de l'Europe en Amérique, pour étudier et comprendre la dynamique des communautés faunistiques par rapport aux structures taxonomiques, traits fonctionnels, histoires de vie des espèces et au changement du régime hydrologique des zones humides riveraines tempérées et néotropicales (Winemiller 1989; Merigoux & Ponton 1999; Agostinho *et al.* 2000; Merigoux, Doledec & Statzner 2001; Blanck, Tedesco & Lamouroux 2007; Tedesco *et al.* 2008; Pease *et al.* 2012, 2015).

En Asie tropicale, et particulièrement dans le bassin du Mékong, les connaissances des impacts des barrages hydroélectriques sur la biodiversité et la production des poissons sont augmentées de jour en jour; pourtant la compréhension écologique et biologique des structures spatiales et temporelles des communautés de poissons dans la région est encore mal décrite, ni étudiée (Dudgeon 2000, 2003; Dugan *et al.* 2010; Ziv *et al.* 2012). Au cours des dernières années, avec les efforts de la Commission du Mékong (MRC) en collaboration avec les entités nationales, les connaissances bioécologiques du système ont été beaucoup approfondies, surtout sur les espèces de poisson commerciales. Pour le moment, trois guildes écologiques des poissons, i.e. blanc, gris, noir, ont été établies selon la réponse écologique des espèces aux variations de l'environnement (Coates *et al.* 2003; Baran *et al.* 2006, 2007; Baran, So & Leng 2008; Valbo-Jorgensen, Coates & Hortle 2009). Également, à l'aide du programme de surveillance et des enquêtes auprès des pêcheurs, trois routes potentielles de migrations ont été identifiées au long du Mékong et le patron de migration est fortement lié au régime hydrologique du bassin (Fig. 3) (Poulsen *et al.* 2002, 2004; van Zalinge *et al.* 2004; Baran 2006; Baran *et al.* 2013). Effectivement, la migration est essentielle pour les poissons du Mékong pour compléter leurs cycles de vie, i.e. reproduction, fraie, alimentation, car la

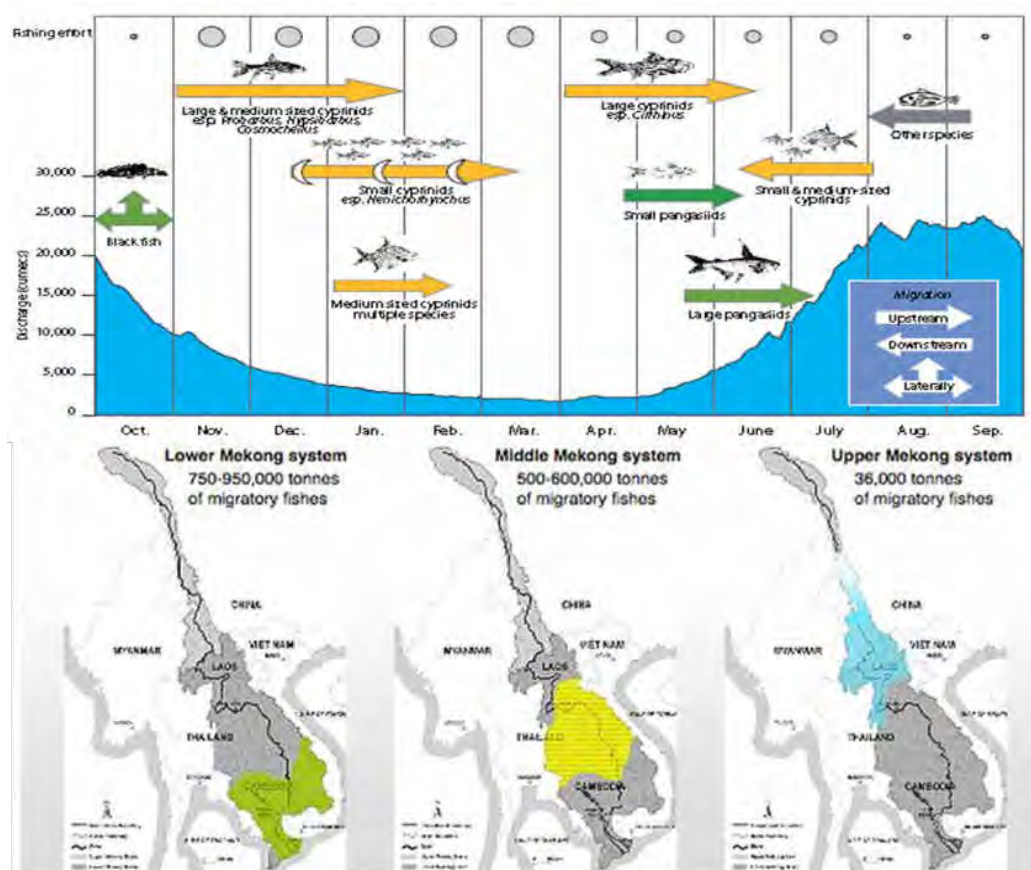
plupart de ces espèces sont des migrants de courte à longue distance « poissons gris et blancs » (Baran 2006; Baran *et al.* 2008). Cependant, ce statut migratoire est connu seulement pour 24% des espèces de poissons (Valbo-Jorgensen *et al.* 2009).

Par ailleurs, sous le programme de MRC pour le suivi de la qualité de l'eau dans le bassin au cours de 20 ans, la qualité de l'eau a été évaluée régulièrement et signalée aux agences nationales des pays riverains (MRC 2007a, 2008, 2010b). Parallèlement, des études de transports sédimentaires ont été menées il y a des années pour quantifier le flux de sédiments dans le Mékong et ses affluents tels que le lac Tonlé Sap. Il apparaît que les sédiments ont été réduits de presque 50% après la construction des barrages en Chine et les sédiments dans le Mékong sont beaucoup plus élevés que ses affluents surtout au cours des événements pluvieux (Campbell *et al.* 2006; Lu & Siew 2006; Wang, Lu & Kummu 2011; Lu, Kummu & Oeurng 2014a; Lu *et al.* 2014b). Au-delà, il a été estimé que 85% des sédiments du Mékong sont déposés dans le lac Tonlé Sap, que 15% contribuent au delta, et que ces sédiments sont un des moteurs de la productivité du lac (Campbell *et al.* 2006; Lu *et al.* 2014a). Néanmoins, à ce jour, le patron spatial des caractéristiques de l'eau à l'échelle du bassin, ainsi que les déterminants physicochimiques des différents compartiments du bassin restent en question (Hart, Jones & Pistone 2001; Campbell 2007; Abebe *et al.* 2010).

À ce jour, très peu d'études ont abordé le statut écologique de l'écosystème, e.g. Tonlé Sap, surtout concernant les relations trophiques, les flux d'énergie et la stabilité de l'écosystème, du fait que les interactions biotiques dans un écosystème sont très complexes (Van Zalinge, Nao & Sam 2001; Baran *et al.* 2007; Baran & Myschowoda 2008). Par exemple, dans le lac Tonlé Sap, plusieurs indicateurs importants ont montré que le système abritait précédemment de nombreux poisson-chat géants, des barbillons géants et pastenagues, et est maintenant dominée par des espèces petites et à basse valeur commerciale (Enomoto *et al.* 2011; Cooperman *et al.* 2012), remettant en question la durabilité de la pêche dans le lac. Effectivement, la surpêche peut influencer de manière significative la structure du réseau

trophique et modifier l'abondance des prédateurs affectant les abondances des proies qui induisent des cascades trophiques dans l'écosystème (Sala, Boudouresque & Harmelin-Vivien 1998).

Ainsi, malgré les études existantes, nos connaissances écologiques et biologiques du système du Mékong restent extrêmement limitées (Dudgeon 2000). Robert (1993) disait « l'ensemble du domaine de la bioécologie du Mékong, y compris la reproduction, migration, le temps et le lieu pour le fraie, l'adaptation physiologique sous les conditions naturelles sont largement intactes ».



**Fig. 3.** Relation entre la migration et le régime hydrologique (en haut) et en bas les trois routes de migrations identifiées dans le bassin du Mékong.

#### 4. Défis et enjeux de la biodiversité en Asie tropicale

Il est amplement prouvé que les écosystèmes d'eau douce dans le monde entier souffrent de la surexploitation, pollution, diminution de biodiversité, ainsi que de la dégradation et des pertes

des habitats (Fang *et al.* 2006; de Kerckhove, Minns & Chu 2015). La gestion des ressources naturelles et l'évaluation de la qualité de l'écosystème aquatique sont actuellement des enjeux et défis pour la communauté scientifique et les gestionnaires de l'environnement. Compte tenu de ces faits, il est largement reconnu que les approches écosystémiques sont cruciales pour la gestion durable des ressources naturelles et le maintien du bon état écologique des écosystèmes (FAO 1995; Li *et al.* 2009).

À l'ère de l'anthropocène, la croissance rapide de la population, particulièrement en Asie, (60% de la population mondiale), les besoins en nourriture et la croissance économique sont des défis pour la conservation de la biodiversité ; par conséquent, les pertes de diversité sont inévitables (Dudgeon 2003, 2011). Spécifiquement dans le bassin du Mékong au cours des 30 dernières années, avec la croissance rapide de la population (doublement), l'intensification agricole et le développement des barrages hydroélectriques, il a été signalé que le bassin est confronté maintenant à une dégradation environnementale (pollution de l'eau, eutrophication, déforestation) qui affecte négativement la biodiversité dans toute la région (Dudgeon 2003, 2011; Vörösmarty *et al.* 2010). Par ailleurs, les ressources de pêches jouent un rôle crucial pour la sécurité alimentaire et représentent pour certains pays (Cambodge, Laos, Vietman) près de 60% des protéines animales pour la consommation humaine (Hortle 2007). Ainsi, des efforts de gestion de la biodiversité et de conservation sont nécessaires pour atténuer les pertes, mais ceux-ci ont besoin d'une compréhension complète de la dynamique des communautés et des forces motrices sous-jacentes de la structure spatiale et temporelle des communautés aquatiques (Olden *et al.* 2010; Pool *et al.* 2010).

Le Mékong est le plus grand fleuve tropical en Asie et biologiquement très productif, classé 3<sup>ème</sup> au niveau mondial en terme de diversité de poissons juste après l'Amazon et le Congo (Froese & Pauly 2015). Chaque année, le Mékong fournit 2.3 millions de tonnes de poissons d'eau douce constituant la plus grande pêcherie du monde entier et permettant l'alimentation de millions de personnes dans la région (MRC 2015). Cependant, que savons-

nous sur les interactions écologiques de l'écosystème du Mékong ? Comment pouvons-nous optimiser la gestion des ressources naturelles et maintenir l'état écologique de ce type d'écosystème? Pour répondre à ces questions, une compréhension holistique et écologique est fondamentale, contribuant à équilibrer la productivité et maintenir un bon état écologique du système aux besoins actuels. La dynamique de la structure des communautés, les réseaux trophiques, les flux d'énergies sont les éléments clés et interconnectés pour le fonctionnement de l'écosystème (Ings *et al.* 2009). Au-delà, la structure des réseaux trophiques joue un rôle décisif dans la détermination de la dynamique d'un écosystème, et est l'objet de nombreuses études écologiques (Kitchell *et al.* 2000; Worm & Duffy 2003). Ces connaissances contribuent non seulement à maintenir la stabilité et la durabilité du fonctionnement de l'écosystème, mais aussi à la conservation et à la gestion de l'écosystème pour répondre aux besoins actuels et dans le futur.

## **5. Problématique de l'étude**

Le manque d'information sur la nature et le rôle des facteurs abiotiques qui structurent naturellement les communautés de poisson en milieu tropical en Asie pose un problème majeur pour le développement durable du bassin, ainsi que pour mesurer et prédire de manière fiable les impacts liés aux actions anthropiques (e.g. construction des barrages, intensification agricole). Les modifications de la fréquence et de l'amplitude ou de la durée des inondations sont susceptibles de changer les structures physiques et chimiques dans les systèmes lotiques et lentiques (Allan & Castillo 2007). Même si les poissons sont en général bien adaptés aux variations physiques ou chimiques naturelles, ces modifications anthropiques peuvent affecter les communautés de poissons et avoir donc des conséquences non négligeables à long terme sur la biodiversité dans la région (Lowe-McConnell 1987; Welcomme 1995; Matthews 1998). Cependant, la plupart des recherches portant sur les impacts du changement climatique, des modifications de l'hydrologie, ou de la fragmentation des cours d'eau sur la pêche ou la biodiversité se concentre sur les zones tempérées et

néotropicales. Des recherches en zones tropicales sont aujourd'hui primordiales pour comprendre ces impacts sur la durabilité des pêches en eaux douces tropicales, qui diffèrent de manière importante des systèmes étudiés auparavant.

## **6. Objectifs spécifiques**

La dynamique spatiale et temporelle de la structure des communautés de poissons est limitée par les conditions et ressources du milieu, particulièrement dans les systèmes qui dépendent fortement des crues saisonnières. Les objectifs spécifiques de la thèse ont été donc développés afin de décrire les patrons spatio-temporels des communautés et l'ensemble du fonctionnement de l'écosystème d'inondation pulsé (Fig. 4). Quatre objectifs spécifiques, regroupés en trois parties dans cette synthèse, ont été abordés durant la thèse :

### **PARTIE 1**

- Étudier les caractéristiques physicochimiques du milieu d'étude (le bassin du Mékong en aval) en décrivant le patron spatial de la qualité de l'eau et des caractéristiques physicochimiques associées.
- Décrire le patron de diversité et la structure des communautés de poissons en déterminant les facteurs environnementaux qui contrôlent la structuration des communautés.

### **PARTIE 2**

- Investiguer la dynamique temporelle des communautés de poisson en examinant les relations entre la variabilité temporelle des poissons (structure fonctionnelle et traits fonctionnels) et régime hydrologique du système.

### **PARTIE 3**

- Établir le modèle de base du réseau trophique du système en évaluant les propriétés et l'état écologique de l'écosystème d'inondation pulsé par l'approche Ecopath with Ecosim.

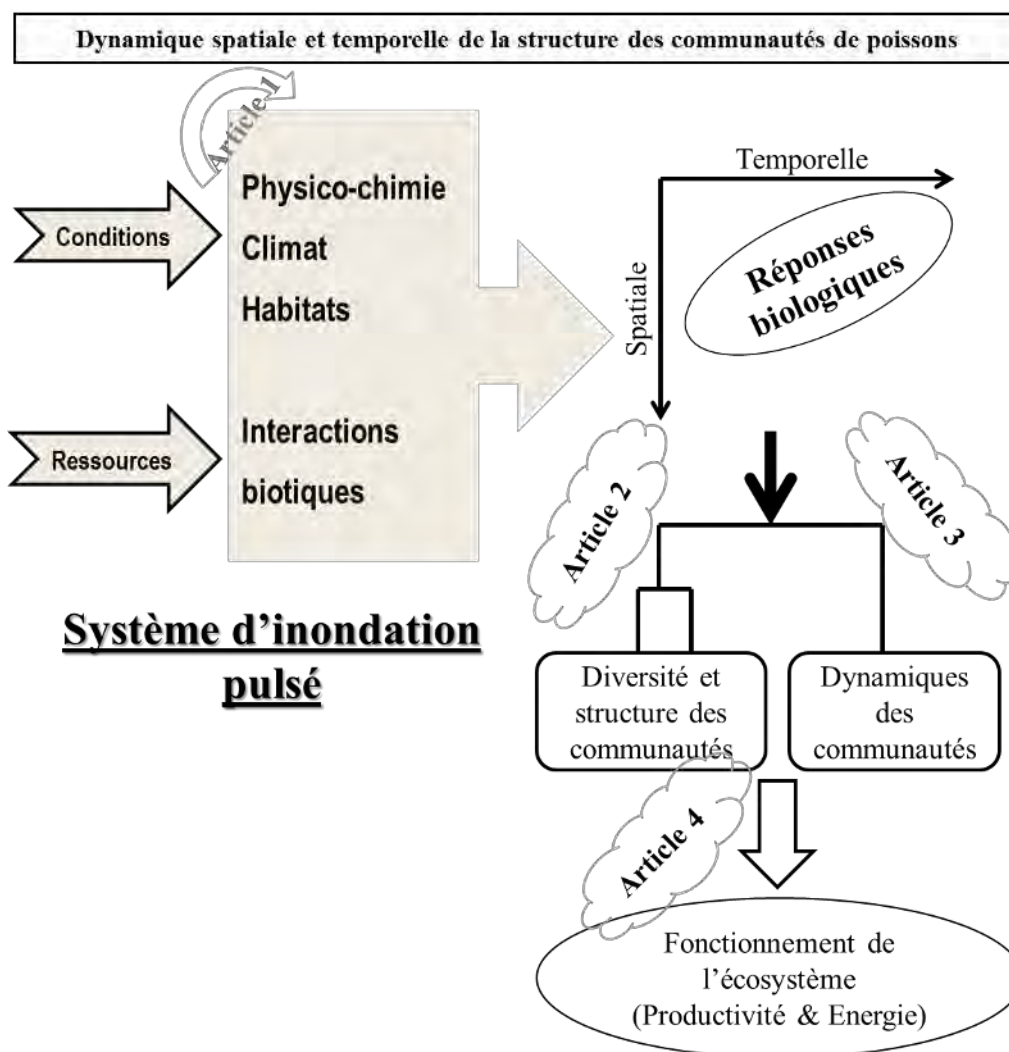


Fig. 4. Représentation schématique de la structure de thèse.

## MATÉRIELS ET MÉTHODES

### 1. Zones d'études

Les zones d'études se concentrent sur le fleuve Mékong en aval et le plus grand lac d'eau douce en Asie du sud-est « le grand lac Tonlé Sap » au Cambodge. Le Mékong, plus grand fleuve tropical en Asie, prend sa source sur le plateau tibétain en Chine et s'écoule sur 4 350 km en passant par la Chine, le Myanmar, le Laos, le Cambodge et le Vietnam à la mer de Chine méridionale, où il décharge chaque année en moyenne 475 000 million de m<sup>3</sup> (Lu & Siew 2006). Le bassin du Mékong couvre une superficie de 795 000 km<sup>2</sup> et est fonctionnellement divisé en 2 parties : le bassin du Mékong en amont (UMB) et le bassin du Mékong en aval (LMB) (Lu & Siew 2006). La partie amont du fleuve, située en Chine, est appelé Lancang Jiang et caractérisée par des gorges étroites, profondes et une forte pente. Après avoir chuté à environ 360 m, il passe la région nommée le Triangle d'Or, où les frontières du Laos, du Myanmar et de la Thaïlande se rencontrent. Ceci est le début du bassin du Mékong en aval (LMB), le fleuve Mékong en aval (LMR) s'écoule sur 2500 km jusqu'à la mer (Fig. 5).

#### *Fleuve Mékong en aval (LMR)*

Le LMB se compose de 4 pays riverains, i.e. le Laos, la Thaïlande, le Cambodge et le Vietnam, et couvre 77% de la superficie totale du bassin du Mékong avec 60 millions d'habitants. Géographiquement, le LMR forme un tronçon rectiligne d'environ 900 km qui marque la frontière entre le Laos et la Thaïlande. Le fleuve forme un delta d'eau douce à la frontière Lao-cambodgienne connu sous le nom de la chute de Khone (21 m de hauteur) (Fig.5) (Robert & Baird 1995). Puis, à Phnom Penh, à environ 330 km de la mer, le Mékong connecte avec le grand lac Tonlé Sap au Cambodge par le fleuve Tonlé Sap (120 km de longueur). Là, le fleuve se divise en 2 branches, i.e. le Mékong propre et le Bassac, et forme un large delta estuarien avant de se jeter dans la mer. Sous l'influence de la mousson



tropicale, le climat du LMB est fondamentalement divisé en 2 saisons, i.e. la saison sèche (décembre-mai) et humide (juin-novembre), chacune durant 6 mois (MRC 2005).

### ***Le grand lac Tonlé Sap (TLS)***

Fortement lié au fleuve Mékong, le lac Tonlé Sap est une des plus grandes pêcheries non-discriminées et probablement l'écosystème le plus productif du monde (Fig. 5). Le lac fournit chaque année entre 289 000 et 431 000 tonnes de poissons représentant plus de 60% des captures totales au Cambodge. De plus, le lac est caractérisé par un système d'inondation pulsé extraordinaire, qui souligne saisonnièrement le phénomène hydrologique unique au Mékong, i.e. l'écoulement inverse du lac. En tant que cœur du Mékong, le lac présente une hydrologie caractérisée par la mousson qui divise le climat en deux saisons. Chaque année, le niveau de l'eau dans le lac varie de 1 m à 9 m, conduisant à une expansion de sa surface de 3 000 km<sup>2</sup> à 15 000 km<sup>2</sup> et créant une vaste plaine inondable autour du lac. Par ailleurs, le flux d'eau inverse du TLS est un phénomène hydrologique crucial pour le Mékong car il sert d'une part à élever le niveau de l'eau dans le Mékong et d'autre part à protéger le delta de l'intrusion saline (Matsui 2005; Kummu & Sarkkula 2008; MRC 2010a). Le TLS draine 85 065 km<sup>2</sup> (11.3% de la superficie totale du bassin du Mékong) et la précipitation annuelle moyenne va de 1300 mm à 1900 mm avec une température moyenne de 29°C. L'hydrologie du lac est fortement dépendante du Mékong étant donné que plus de 60% de l'eau du TLS proviennent du Mékong, le reste provenant des sous-bassins versants autour du lac.

## **2. Données**

### ***Physico-chimie***

Les données physicochimiques ont été fournies par la MRC et 117 sites de surveillance ont été sélectionnés pour étudier la variation spatiale des caractéristiques physicochimiques des eaux du LMB (Fig. 5), parmi lesquels 22 sites étaient situés au Cambodge, 25 au Laos, 20 en Thaïlande et 50 au Vietnam (MRC 2008). Seize variables physicochimiques (Tableau 1) ont

été choisies sur la base de (1) l'importance physicochimique des variables pour expliquer la qualité écologique de l'eau et (2) la disponibilité des données (i.e. variables mesurées sur tous les sites, avec moins de 30% de valeurs manquantes). Dans l'ensemble, les données physicochimiques de cette étude comprenaient 24 383 échantillons de 1985 à 2010 sur 117 sites à l'échelle mensuelle.

**Tableau 1.** Liste des paramètres physicochimiques des eaux et leurs unités.

Paramètres	Unités	Paramètres	Unités
Température de l'eau (T)	°C	Magnésium ( $Mg^{2+}$ )	$mgL^{-1}$
Conductivité (EC)	$\mu S cm^{-1}$	Chlore ( $Cl^{-}$ )	$mgL^{-1}$
Matières en suspension (TSS)	$mgL^{-1}$	Sulfate ( $SO_4^{2-}$ )	$mgL^{-1}$
pH	SU	Alcalinité en $HCO_3^{-}$	$mgL^{-1}$
Oxygène dissous (DO)	$mgL^{-1}$	Nitrate ( $NO_3^{-}$ )	$mgL^{-1}$
Sodium ( $Na^{+}$ )	$mgL^{-1}$	Phosphore total (TP)	$mgL^{-1}$
Potassium ( $K^{+}$ )	$mgL^{-1}$	Demande chimique en oxygène ( $COD_{mn}$ )	$mgL^{-1}$
Calcium ( $Ca^{2+}$ )	$mgL^{-1}$	Ammoniac total ( $NH_3^{-} + NH_4^{+}$ )	$mgL^{-1}$

### *Poissons*

Toutes les données piscicoles utilisées dans ce travail ont été dérivées du programme de surveillance à long terme des poissons de la MRC dans le lac Tonlé Sap et le Mékong en aval (Poulsen *et al.* 2002; Ngor 2012). Dans le Mékong, la surveillance journalière a été effectuée uniquement le long du cours d'eau principal de décembre 2000 à novembre 2001 sur les 38 sites, parmi lesquels 8 sites étaient situés au Laos, 7 en Thaïlande, 12 au Cambodge et 11 au Vietnam (Fig. 5). En principe, sur chaque site, les pêcheurs enregistraient quotidiennement leurs captures dans les logbooks, i.e. la composition des espèces, les nombres d'individus, les tailles et poids des espèces capturées. En plus, les pêcheurs notaient les engins de pêche utilisés, ainsi que les conditions météorologiques de la journée de pêche. Au total, environ 14 368 observations ont été enregistrées au cours de la période d'enquête et 5 principaux types d'engins de pêches ont été recensés, i.e. les filets maillants (47%), longue lignes et crochets (23%), pièges (10%), sennes (8%) and filets à lancer (7%) (Sinthavong 2006). Afin de minimiser l'effet des différents efforts de pêches qui pourraient se produire au cours de l'enquête, les données piscicoles du Mékong ont été converties et exprimées en abondance

relative. Ensuite, les moyennes annuelles de l'abondance relative ont été calculées pour résumer l'ensemble des données. Finalement, le tableau destiné aux analyses multivariées était composé de 38 lignes (sites) et 182 colonnes (taxons).

Dans le lac Tonlé Sap, le programme de surveillance a porté sur cinq endroits dans les 5 provinces autour du lac. i.e. Kampong Chhnang, Pursat, Battambang, Siem Reap and Kampong Thom (Fig. 5), de janvier 2012 à octobre 2015. De la même façon, dans chaque site, 3 pêcheurs enregistraient tous les jours leurs captures dans les logbooks. Effectivement, cette méthode a été appliquée dans tout le bassin du Mékong en aval, surtout pour les programmes de surveillance de la MRC (FEVM 2007). Au préalable, tous les pêcheurs ont été entraînés pour les techniques d'échantillonnages et de sous-échantillonnages appliquées au cours des grosses captures pendant les saisons de pointe, l'identification des poissons, ainsi que la mesure des tailles et poids des espèces capturées. Pour assurer la qualité des enquêtes, toutes les données ont été vérifiées pour les erreurs et nettoyées chaque trimestre par les spécialistes de MRC. Dans cette base de données, seules les captures par filets (98% des données) ainsi que les espèces présentes dans plus de 5% des observations totales (i.e. plus de 60 fois sur 1172 jours) ont été prises en compte. Ensuite, pour minimiser les bruits et le biais dans la distribution, les abondances de poissons des 3 pêcheurs ont été moyennées pour chaque site et transformée en  $\ln(X+1)$ . Finalement, le tableau multivarié du lac était composé de 5 tableaux constitués de 1172 lignes (jours) et 53 colonnes (taxon).

### ***Climat***

Dix-neuf variables bioclimatiques ont été extraites de la base de données de WorldClim (Hijmans et al. 2005), disponible à <http://www.worldclim.org>, décrivant les conditions moyennes du climat pour la période 1950 à 2000 avec une résolution spatiale 1 km<sup>2</sup> (Tableau 2).

**Tableau 2.** Liste des variables bioclimatiques.

<b>Code</b>	<b>Unités</b>	<b>Type de variable</b>
-------------	---------------	-------------------------

bio1	(°C)	Température moyenne annuelle
bio2	(°C)	Range diurne moyenne (Moyenne de chaque mois (max temp - min temp))
bio3	%	Isothermalité (bio2/bio7) (* 100)
bio4	(°C*100)	Température saisonnière (écart-type*100)
bio5	(°C)	Température max pour les mois les plus chauds
bio6	(°C)	Température min pour les mois les plus froids
bio7	(°C)	Range annuelle de température (bio5-bio6)
bio8	(°C)	Température moyenne des trimestres les plus humides
bio9	(°C)	Température moyenne des trimestres les plus secs
bio10	(°C)	Température moyenne des trimestres les plus chauds
bio11	(°C)	Température moyenne des trimestres les plus froids
bio12	mm	Précipitation annuelle
bio13	mm	Précipitation du mois le plus humide
bio14	mm	Précipitation du mois le plus sec
bio15	-	Précipitation saisonnière (Coefficient de variation)
bio16	mm	Précipitation du trimestre le plus humide
bio17	mm	Précipitation du trimestre le plus sec
bio18	mm	Précipitation du trimestre le plus chaud
bio19	mm	Précipitation du trimestre le plus froid

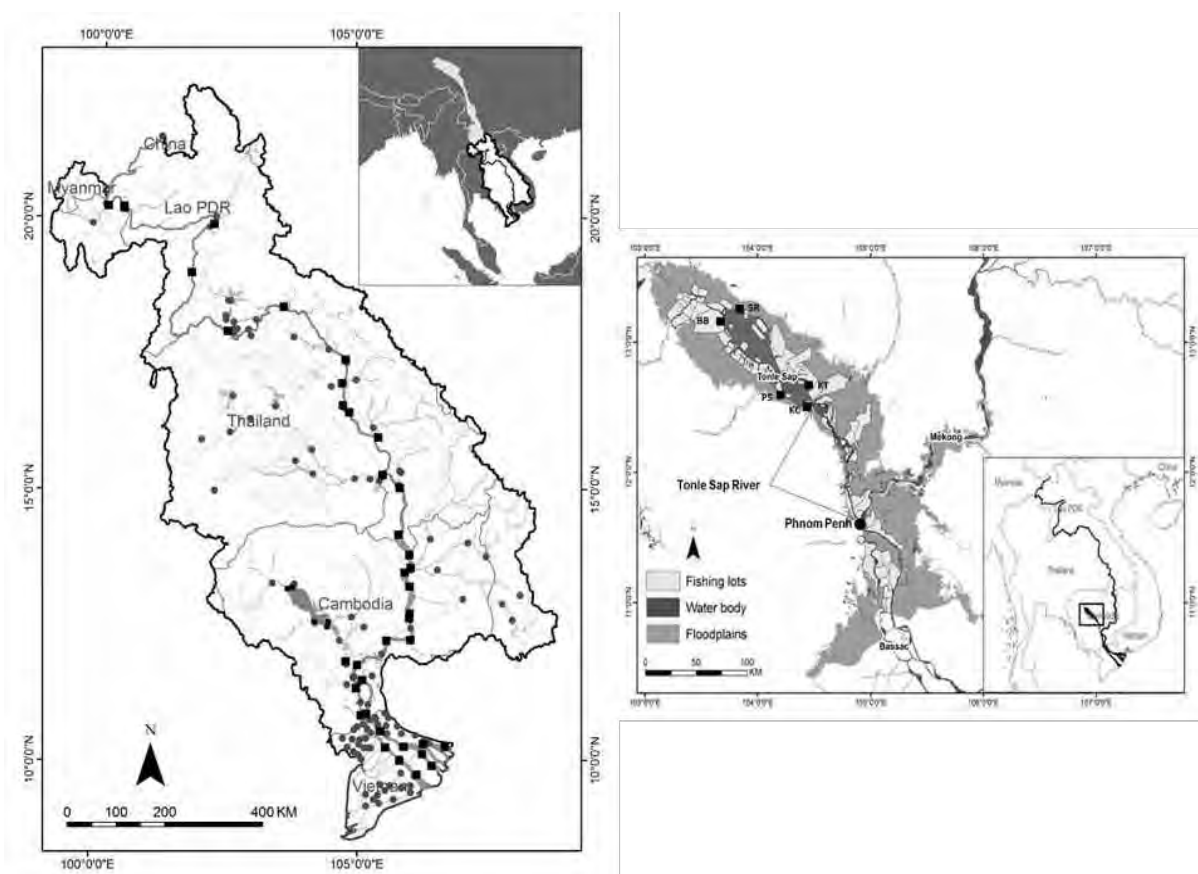
### ***Hydrologie***

Les données journalières des niveaux de l'eau du lac ont été récupérées pour la période (2012 à 2015) de surveillance des poissons autour du lac, à partir de la station hydrologique de MRC située à Kampong Loung (PS, Fig. 5).

### ***Traits fonctionnels***

Neuf traits biologiques (taille, niveau trophique, habitat, habitat d'alimentation, habitat de fraie, guildes écologiques, position dans la colonne d'eau et présence de respiration accessoire) ont été utilisés pour examiner les relations entre la variabilité temporelle des communautés de poissons et les caractères fonctionnels (Appendice II). La taille maximale des poissons (cm), les niveaux trophiques et les habitats ont été récupérés à partir de FishBase (Froese & Pauly 2015) et Lim *et al.* (1999); tandis que les stratégies de vie ont été modifiées suivant les modèles d'histoire de vie des poissons proposés par Winemiller & Rose (1992) qui ont classifié l'histoire de vie des poissons en 3 catégories, i.e. équilibre (EQU), périodique (PER) et opportuniste (OPP), sur la base du taux de survie des juvéniles, la fécondité et l'âge de

reproduction (Winemiller & Rose 1992; Winemiller 2005). Ensuite, les guildes écologiques de poissons ont été récupérées à partir de l'étude bioécologique de l'IFReDI (Inland Fisheries Research and Development Institute) et de la MRC, qui visaient à classer les espèces de poissons du Tonlé Sap et Mékong en 3 principales guildes différentes, i.e. noir, gris et blanc, suivant une liste de descripteurs, e.g. la migration, l'habitat, l'oxygénation (Poulsen *et al.* 2002; Baran *et al.* 2007). Enfin, les autres traits tels que les habitats de fraies, habitats d'alimentation, la position du poisson dans la colonne d'eau et la présence de respiration accessoire des taxons ont été collectés et modifiés à partir des études de Winemiller & Rose (1992); Lim *et al.* (1999); Poulsen *et al.* (2004).

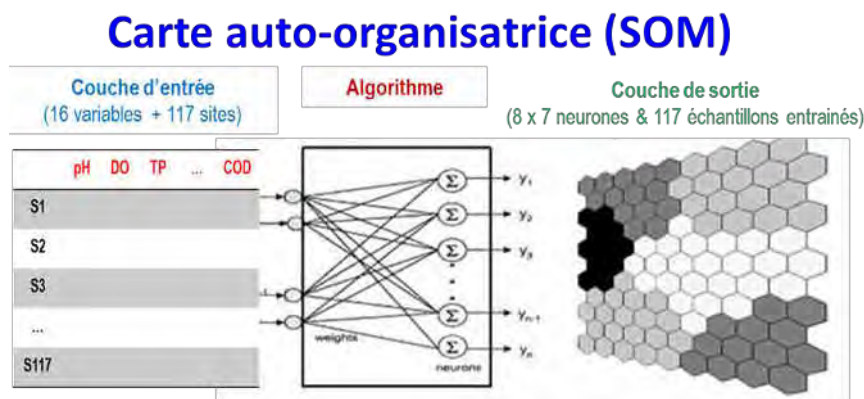


**Fig. 5.** Carte du bassin du Mékong en aval (à gauche) et du grand lac Tonlé Sap (à droite). A gauche, les points circulaires représentent les sites d'échantillonnage pour la physico-chimie et les rectangles les sites d'échantillonnage pour les poissons. A droite, les rectangles représentent les sites de surveillance des poissons autour du lac et les lots de pêches sont indiqués par les parcelles pointillées.

### 3. Approches de modélisation

#### *Carte auto-organisatrice (Self-Organizing Map)*

La variation spatiale des caractéristiques physicochimiques des eaux a été quantifiée à l'aide de l'approche des réseaux de neurones artificiels, appelée carte auto-organisatrice (SOM). La SOM est un réseau neuronal artificiel non-supervisé qui est formé au moyen d'un processus d'apprentissage compétitif pour produire une représentation en deux dimensions des échantillons entraînés, appelé une carte (Lek & Guégan 1999). En général, la SOM est composée de 2 couches : couche d'entrée et couche de sortie (Fig. 6). Dans cette étude, la couche d'entrée contenait 16 neurones connectés à 117 échantillons entraînés, qui sont respectivement les variables physicochimiques et les sites étudiés. La couche sortie est représentée par la grille rectangulaire ou le plan avec  $l$  lignes et  $m$  colonnes, arrangées dans un réseau hexagonal (Fig. 6). Au cours de l'apprentissage (la couche cachée), le niveau d'activation correspondant à la distance euclidienne entre les vecteurs d'entrée (les échantillons entraînés) et les poids des vecteurs associés aux neurones dans la SOM ont été calculés par la formule (Lek & Guégan 1999):  $\|w^j - x\| = \sqrt{\sum_{i=1}^n (w_i^j - x_i)^2}$ ; où  $x$  est la valeur du vecteur d'entrée décrit par des variables physicochimiques,  $i$  varie de 1 à 117,  $j$  est le numéro de neurone et  $w^j$  est le poids du vecteur associé au neurone  $j$  de la carte. Normalement, la classification est faite par le niveau d'activation entre l'espace d'entrée et de sortie pour trouver les neurones gagnants ou les meilleures unités de correspondance (Best Matching Units). Enfin, une classification hiérarchique des vecteurs de poids associés aux neurones a été effectuée pour définir les clusters possibles dans la carte SOM et le test Kruskal-Wallis a été utilisé pour tester la différence entre les clusters identifiés. Le modèle a été exécuté par le package de SOM dans le programme Matlab.



**Fig. 6.** Procédure d'apprentissage de la carte auto-organisatrice (SOM) utilisée dans cette étude.

### *Approches multivariées*

Afin de décrire la structure spatiale des communautés de poissons, la classification hiérarchique des sites étudiés a été effectuée selon leurs similarités en composition des espèces (Fig. 7) (Murtagh & Legendre 2014). Ensuite, la richesse spécifique, l'indice de diversité et les espèces indicatrices ont été déterminés et testés pour décrire les communautés identifiées (De Caceres, Legendre & Moretti 2010). Cette procédure a été lancée simultanément pour les bases de données saisonnières (sèche et humide). Par ailleurs, pour quantifier les relations entre les assemblages de poissons et les variables environnementales, les ordinations classiques ont été effectuées. L'analyse des correspondances détendancées (DCA) a été effectuée pour sélectionner les méthodes d'ordination appropriées aux études (i.e. l'analyse de redondance (RDA) vs l'analyse canonique des correspondances (ACC)) (Legendre & Legendre 2012). ACC est décrit comme la méthode la plus appropriée lorsque le gradient d'ordination calculé de DCA est  $> 3$  car elle révèle des réponses unimodales des poissons aux facteurs environnementaux, c'est le cas de cette étude (Ter Braak & Prentice 1988). L'importance des variables environnementales a été testée par le test de permutation de Monte Carlo avec 999 permutations (Legendre & Legendre 2012). Enfin, pour examiner l'effet relatif des facteurs environnementaux (climatiques, physicochimiques) et spatiaux

contribuant à la variation des communautés, une partition de variance a été effectuée et présentée sous forme d'un diagramme de Venn (Borcard, Legendre & Drapeau 1992; Legendre & Legendre 2012). Seules les variables environnementales significatives ont été sélectionnées pour les analyses et toutes ces analyses statistiques ont été réalisées dans R.3.2.2 (R Core Team 2015).

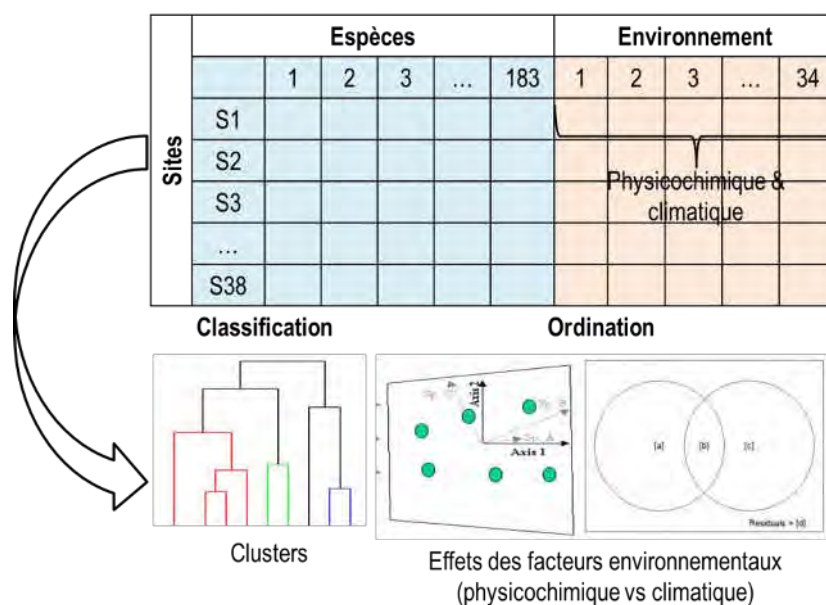


Fig. 7. Illustration schématique des procédures multivariées.

### *Analyse de co-inertie multiple (ACOM)*

La variabilité temporelle des communautés de poissons a été quantifiée à l'aide de l'analyse de co-inertie multiple (ACOM), qui est une des techniques de couplage entre tableaux permettant d'étudier la variation spatiotemporelle des communautés faunistiques basée sur le critère d'optimisation de la covariance entre les tableaux individuels et un tableau de référence (Chessel & Hanafi 1996; Bady *et al.* 2004). Dans cette étude, l'ACOM a été effectuée sur 5 tableaux individuels, i.e. cinq sites de surveillance, et la structure de référence peut être considérée comme la structure temporelle des communautés à l'échelle du lac (Fig. 8). En effet, la variation temporelle des communautés a été résumée et représentée sous forme des scores synthétiques des 3 premiers d'axes d'ACOM. Ensuite, les coefficients RV (i.e. coefficient de corrélation entre l'évolution temporelle des tableaux individuels et la structure de référence temporelle) ont été calculés pour quantifier les relations entre chaque tableau



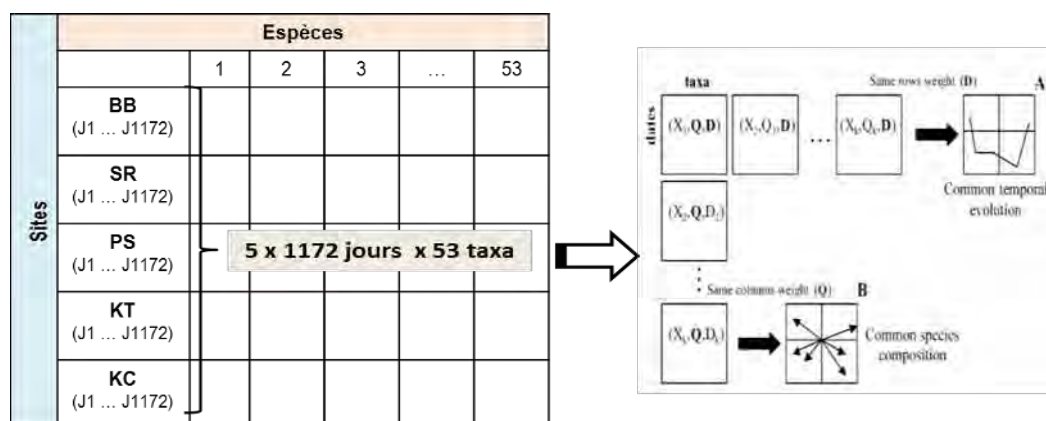
individuel et la structure commune (Robert & Escoufier 1976). Le coefficient RV est compris entre 0 et 1, une faible valeur indiquant un faible niveau de synchronie entre la structure temporelle du tableau individuel et celle de référence. Afin d'examiner les relations entre la variabilité temporelle des structures de communautés et les traits fonctionnels, les traits quantitatifs ont été régressés en utilisant des modèles linéaires, alors que ceux qualitatifs ont été testés à l'aide du test non-paramétrique Kruskal-Wallis ( $p < 0,05$ ). Ensuite, la variation temporelle de la structure taxonomique a été testée pour les 5 familles des poissons les plus grandes (Cyprinidae, Bagridae, Siluridae, Pangasiidae et Osphronemidae) de la zone d'étude.

Par ailleurs, pour estimer la synchronie spatiale dans les variations temporelles des communautés à travers les cinq sites, une distribution normale multivariée a été utilisée :  $Y_{ij} \sim MVN(\mu_j, \Sigma_{ij})$ ; où  $Y_{ij}$  sont les projections du site  $j$  et au jour  $i$  sur les axes de l'ACOM,  $\mu_j$  sont les moyennes des sites spécifiques et  $\Sigma_{ij}$  est la matrice de variance-covariance sous

forme:  $\Sigma_{ij} = \begin{pmatrix} \sigma_1^2 & \cdots & \rho_{15}\sigma_1\sigma_5 \\ \vdots & \ddots & \vdots \\ \rho_{15}\sigma_1\sigma_5 & \cdots & \sigma_5^2 \end{pmatrix}$ ; où les éléments en diagonal représentent la variance

au sein de chaque site et hors diagonal la covariance entre les sites.  $\rho$  est le coefficient de corrélation temporelle entre chaque site et constitue la synchronie temporelle de la structure des communautés (Santin-Janin *et al.* 2014).

Enfin, le lien entre le changement des communautés et le régime hydrologique du lac a été quantifié par la fonction de corrélation croisée (CCF), qui permet d'examiner la relation entre deux séries temporelles ( $x_t$  et  $y_t$ ) en fonction du temps de décalage ( $h$ ) entre deux séries, i.e. les corrélations entre les séries  $x_{t+h}$  et  $y_t$  (Venables & Ripley 2002). Dans ce cas,  $x_t$  et  $y_t$  étaient respectivement les scores synthétiques d'ACOM et les niveaux de l'eau. Le temps de décalage ( $h$ , jours), indiquant la réponse des communautés au changement du régime hydrologique, a été estimé à partir de la valeur maximale des coefficients de CCF. Toutes les analyses de données ont été effectuées dans R.3.2.2.



**Fig. 8.** Représentation schématique de la procédure de l'analyse de co-inertie multiple (ACOM).

#### 4. Ecopath with Ecosim (EwE)

Au cours des dernières années, EwE a été largement utilisé partout dans le monde pour décrire les relations trophiques et les propriétés quantitatives des écosystèmes (Christensen, Walters & Pauly 2005). De nombreuses applications ont été recensées sur les écosystèmes aquatiques, terrestres et marins (e.g., lac Malawi, lac Tanganyika, estuaire de la Gironde, la mer Méditerranée) (<http://www.ecopath.org/models>). De plus, EwE est une approche très appropriée pour étudier le fonctionnement écologique de grands écosystèmes avec une source d'information limitée tels que le lac Tonlé Sap (Coll, Bundy & Shannon 2009). Effectivement, le modèle EwE fournit une représentation quantitative des flux d'énergie dans le réseau alimentaire de l'écosystème étudié. L'écosystème est représenté par différentes catégories ou groupes fonctionnels qui sont définis par les propriétés fonctionnelles des taxons inscrits dans chaque catégorie pouvant être composée d'une ou de plusieurs espèces écologiquement similaires. Dans le cas du TLS, 21 groupes fonctionnels ont été définis pour construire le modèle : 12 groupes fonctionnels de poissons, les crabes, les crevettes, les mollusques, les autres zoobenthos, les macrozooplanctons, les microzooplanctons, les phytoplanctons, les macrophytes et les détritiques (Appendice I). L'agrégation des groupes fonctionnels a été basée sur la composition du régime alimentaire, les traits, les guildes écologiques, et la valeur économique des espèces.

L'algorithme d'EwE est basé sur la paramétrisation de l'équation suivante :

$$B_i \cdot \left(\frac{P}{B}\right)_i \cdot EE_i - \sum_{j=1}^i B_j \cdot \left(\frac{Q}{B}\right)_j \cdot DC_{ji} - EX_i = 0; \text{ où } B_i \text{ est la biomasse du groupe } i; (P/B)_i \text{ le ratio}$$

de la production et la biomasse du groupe  $i$ , qui est égal au coefficient de la mortalité totale ( $Z$ ) sous la condition d'état stable;  $EE_i$  est l'efficacité écotrophique du groupe  $i$ ;  $B_j$  est la biomasse du groupe prédateur  $j$ ;  $(Q/B)_j$  est le ratio de la consommation et la biomasse des prédateurs  $j$ ;  $EX_i$  est l'exportation du groupe  $i$ ;  $DC$  est la composition des aliments;  $i$  et  $j$  sont respectivement les nombres de groupes de proies et de prédateurs.

$B$ ,  $P/B$ ,  $Q/B$ ,  $EE$  et  $DC$  sont les principaux paramètres du modèle Ecopath. Afin de pouvoir lancer le modèle,  $DC$  et au moins trois des quatre paramètres ( $B$ ,  $P/B$ ,  $Q/B$ ,  $EE$ ) pour chaque groupe fonctionnel sont nécessaires (un seul paramètre inconnu peut être estimé par le modèle Ecopath au cours de la paramétrisation). La description détaillée des sources des données pour les groupes fonctionnels et des calculs des paramètres du modèle sont décrits dans l'article 4.

### ***Calibration et l'incertitude du modèle***

Le modèle Ecopath a été calibré par le lancement de la première estimation de base dans la paramétrisation du modèle afin d'obtenir les valeurs d'EEs ( $EE < 1$ ) et  $P/Q$  (0,05 – 0,3) pour tous les groupes fonctionnels. En pratique, une modification manuelle sur les données d'entrée a été utilisée pour calibrer le modèle en se basant sur les connaissances écologiques plutôt que de compter entièrement sur des algorithmes informatiques, i.e. la composition des aliments de certains groupes ont été fréquemment modifiée pour calibrer le modèle (Christensen et al., 2005). Enfin, le Pedigree a été utilisé pour évaluer la certitude du modèle et décrire la qualité des données d'entrée en désignant la classe de confiance basée sur leurs origines. La valeur de pedigree ( $P$ ) varie de 0 (faible) à 1 (élevé) indiquant la qualité du modèle étudié (Morissette, Hammill & Savenkoff 2006).

## **CHAPITRE I**

# **STRUCTURE SPATIALE DE LA PHYSICO-CHEMIE ET DES POISSONS À LARGE ÉCHELLE**



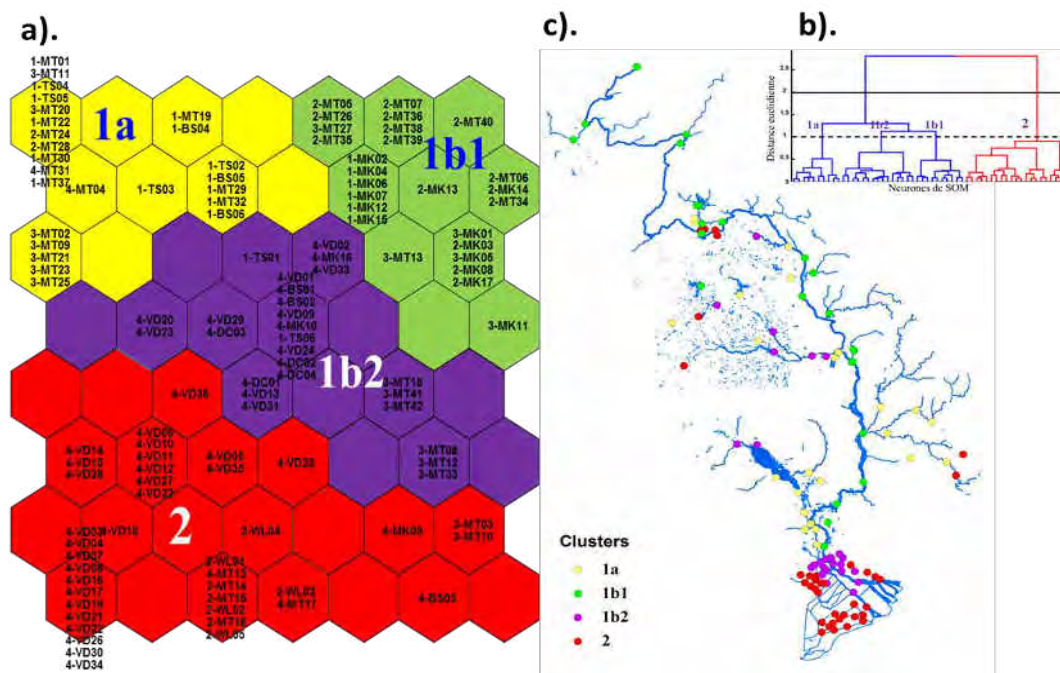
## 1. Variations spatiales des caractéristiques physicochimiques des eaux

À l'échelle du bassin du Mékong en aval, la similarité des neurones m'a permis de diviser la carte SOM en 4 clusters (Fig. 9): 2 clusters principaux 1 & 2 avec les sous-groupes (1a, 1b1, 1b2). Ce patron spatial a révélé le gradient longitudinal du système LMB, partie amont (cluster 1) et son delta (cluster 2). Plus précisément, la majorité des sites en amont (Laos et Thaïlande) et au milieu (Cambodge) du bassin LMB ont été regroupés en deux clusters (1a et 1b1) caractérisés par de faibles niveaux de nutriments (TP,  $\text{NO}_3^-$ ,  $\text{NH}_3^- + \text{NH}_4^+$ ) et une valeur élevée de DO (Fig. 9, 10). Les deux autres clusters (1b2 et 2) ont été principalement composés de sites dans le delta au Vietnam et quelques sites des affluents au nord-ouest Thaïlandais, au nord du Tonlé Sap, et à la tourbière près de Vientiane. Ces derniers étaient associés aux fortes teneurs en nutriments et en éléments solides dissous ( $\text{Ca}^{2+}$ ,  $\text{Mg}^{2+}$ ,  $\text{Na}^+$ ,  $\text{Cl}^-$ ,  $\text{K}^+$  and  $\text{SO}_4^{2-}$ ) (Fig. 9, 10). Globalement, ce patron spatial était cohérent entre les saisons sèches et pluviales et aucune différence significative n'a été observée entre les deux saisons (Kruskal-Wallis test,  $p > 0,05$ ).

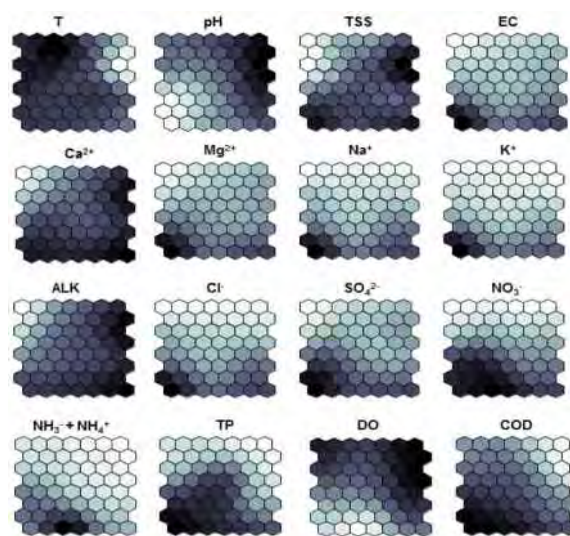
Le gradient physicochimique de l'eau dans le bassin variait significativement entre l'amont du LMB et son delta. DO diminue graduellement de l'amont vers l'aval, alors que la concentration de phosphore (TP) augmente forcément dans le delta (Fig. 10). De plus, la forte concentration de l'ammoniac total a été révélée sur presque tout le bassin, en particulier pour les sites situés près de Vientiane et dans le delta. La variation des caractéristiques de l'eau dans les clusters 1 et 2 pourrait révéler les changements de qualité de l'eau le long du bassin, une baisse importante étant observée dans le delta du Mékong. Apparemment, la forte baisse de la qualité de l'eau dans le delta et ses affluents, en particulier DO et TP, est principalement associée aux activités humaines plutôt que des processus naturels. Cette conclusion a été marquée par le changement brutal des caractéristiques physicochimiques au long du système et soulignée par plusieurs auteurs (Ozaki *et al.* 2014; Wilbers *et al.* 2014; Chau *et al.* 2015; Phung *et al.* 2015). Par conséquent, la croissance rapide de la production d'algues due à

l'augmentation des éléments nutritifs et la pollution chimique provenant du ruissellement agricole et des pesticides, conduisait à une eutrophication dans la région, surtout dans le delta, le lac Tonlé Sap et ses affluents au nord-est Thaïlandais (Fedra, Winkelbauer & Pantulu 2004; Snidvong & Teng 2006). En outre, l'augmentation excessive du chlorure dans le delta est expliquée d'une part par l'effet naturel (l'intrusion saline) et d'autre part par la perturbation humaine (agriculture, aquaculture) (Ozaki *et al.* 2014; Phong *et al.* 2014). La croissance de la salinité due aux activités agricoles dans le plateau de Khorat Thaïlandais et au nord du Tonlé Sap constitue une préoccupation (Fig. 9, 10).

Néanmoins, par rapport à d'autres fleuves asiatiques (e.g., Yangtze, Jaune, Ganges), le Mékong a été considéré comme un fleuve vierge (Dudgeon 2011). Globalement, j'ai constaté que l'eau dans le cours principal était moins polluée que ses affluents ; l'eutrophication et la salinité pourraient être des facteurs clés qui affectent la biodiversité dans le LMB, en particulier les poissons. De plus, la variation saisonnière des caractéristiques physicochimiques de l'eau semble moins marquée que la variation spatiale se produisant au long du gradient longitudinal du Mékong. La dégradation importante a été principalement liée aux perturbations humaines, et particulièrement dans le delta, où la croissance de la population et le développement agricole sont intensifs.



**Fig. 9.** Résultats de SOM. a). Classification des sites en fonction de leurs similarités physicochimiques. b). Classification hiérarchique selon la similarité des neurones de SOM. c). Carte représentant le regroupement géographique des sites dans le bassin Mékong en aval (LMB).



**Fig. 10.** Carte des composants de SOM montrant la contribution des 16 variables dans le modèle de SOM. Les grilles sombres représentent les valeurs élevées des variables d'entrée.



## **2. Patron spatial de diversité et structure d'assemblage de poisson**

Au total, 182 espèces appartenant à 110 genres, 42 familles et 13 ordres ont été enregistrées par les pêcheurs pour les 38 sites de surveillance du Mékong en aval. Les Cypriniformes (54 espèces), Siluriformes (53 espèces) et Perciformes (39 espèces) étaient les trois principaux ordres représentant 80% du nombre total d'espèces, tandis que les Anguilliformes, Batrachoidiformes, Beloniformes, Clupeiformes, Mugiliformes, Osteoglossiformes, Pleuronectiformes, Rajiformes, Synbranchiformes and Tetraodontiformes représentaient moins de 20% des espèces de poissons au total.

La complexité et l'hétérogénéité du système LMR, i.e. partie amont, milieu et delta, reflète la différenciation longitudinale de la diversité et des structures d'assemblage du Mékong (van Zalinge *et al.* 2004). Dans le cadre de mon travail, 4 différents assemblages (Ia, Ib, IIa, et IIb) ont été identifiés en fonction de la composition annuelle en espèces (Fig. 11a). Deux principaux assemblages de poisson ont été définis à la première division (cluster I et II), révélant les caractéristiques longitudinales du Mékong entre la partie amont du LMR et son delta. Ensuite, les deux groupes principaux ont été sous-divisés en 4 clusters différents considérés comme les quatre assemblages de poissons (Ia, Ib, IIa, and IIb) dans le LMR (Fig. 11a).

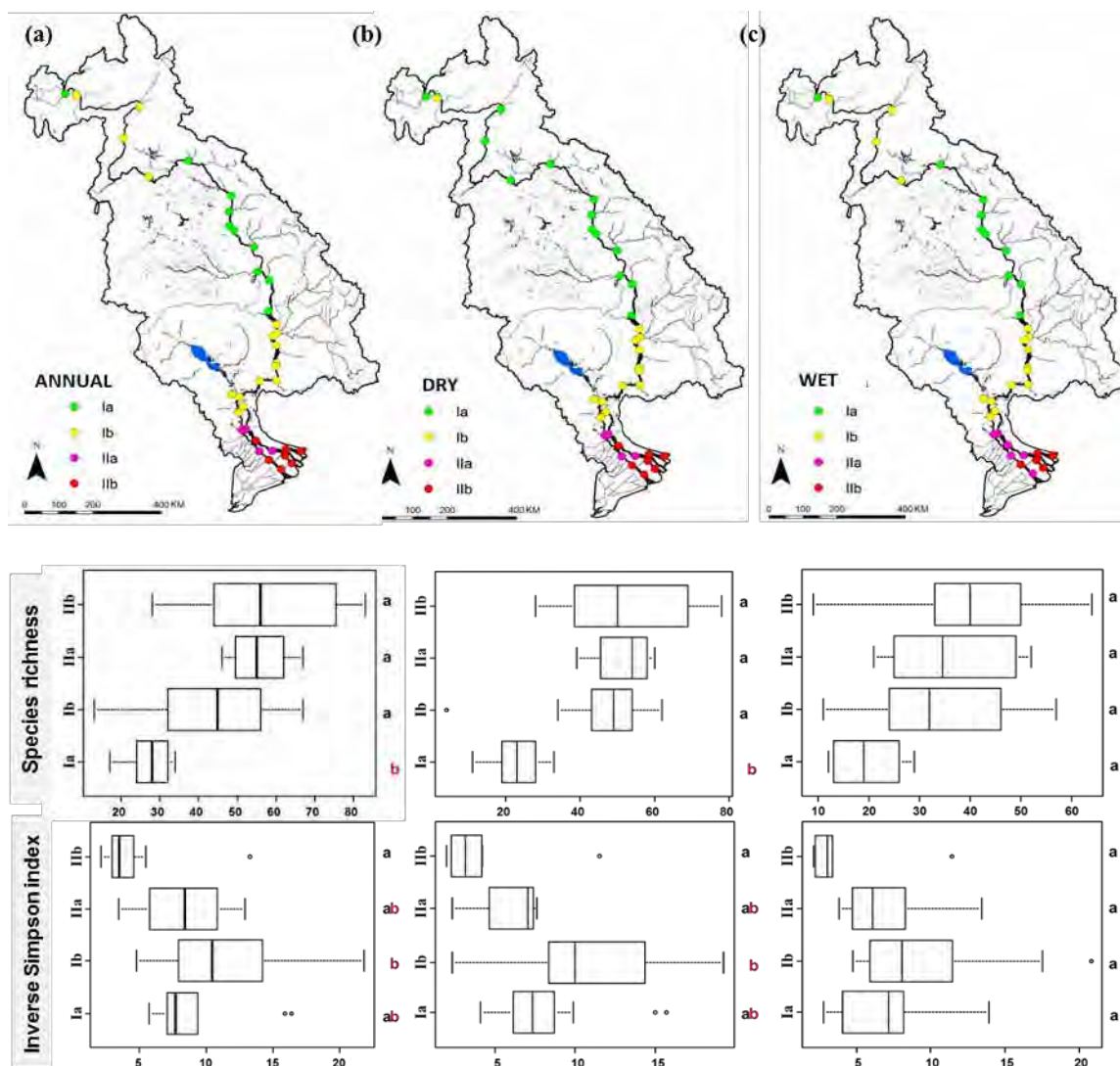
En termes de diversité, la richesse spécifique variait de 17 espèces en tête à 82 espèces à l'exutoire du LMR (Fig. 11a) et la plus élevée a été trouvée dans IIb (médiane : 56 espèces), suivie par IIa (55 espèces), puis Ib (45 espèces) et enfin Ia contenait la richesse spécifique la plus basse (28 espèces). Par conséquent, la partie amont du LMR présentait la plus faible richesse spécifique, alors que la plus grande a été observée dans le delta, avec des espèces d'eau douce, saumâtres et marines. Effectivement, les changements longitudinaux de la richesse spécifique le long des gradients physiques et chimiques, i.e. amont-aval, sont bien connus dans les patrons spatiaux des assemblages de poissons. De nombreuses discussions et explications sur les mécanismes responsables de ces patrons ont mis au point le concept

d'« addition » d'espèces conduisant à l'augmentation de la richesse spécifique en aval des cours d'eau (Matthews 1998; Coates *et al.* 2003; Valbo-Jorgensen *et al.* 2009). Contrairement à la richesse spécifique, le plus faible indice de diversité a été présenté au Iib (médiane : 3.5) dans le delta, alors que la valeur plus élevée était observée dans Ib (médiane : 10.5) au Cambodge (Fig. 11d). Ce patron de diversité pourrait refléter le concept de continuum fluvial (RCC) où la richesse spécifique est élevée à l'exutoire du système et la plus grande diversité est observée au milieu du cours d'eau (Vannote *et al.* 1980; Statzner & Higler 1985). Pourtant, le RCC est développé dans la zone tempérée et est plus applicable aux petites-moyennes rivières. Une autre raison de la grande diversité au Cambodge pourrait être liée à la condition géographique du cours d'eau, étant donné que le Mékong au Cambodge est caractérisé par une faible topographie et l'absence de barrières (Fig. 5), permettant aux espèces de se déplacer aisément (Baran *et al.* 2008; Valbo-Jorgensen *et al.* 2009).

Entre saisons, la composition des communautés diffère un peu entre les sites des saisons sèche et humide, surtout dans la partie amont du LMR et au delta (Fig. 11b et Fig. 11c). Le patron spatial des communautés au cours de la saison humide était similaire au patron annuel ; cependant pas de différences significatives de la richesse spécifique et de la diversité ont été observées parmi les assemblages identifiés. En saison sèche, les assemblages possédaient une richesse spécifique plus grande qu'en saison humide et la différence de la diversité entre les assemblages était également significative ce qui était observé dans le patron annuel (Fig. 11b). Ce dernier est due au fait que les poissons peuvent être concentrés dans les fosses profondes, microhabitats ou au cours principal ; alors qu'en saison humide, les poissons seraient probablement plus dispersés, sachant que le cours d'eau principal s'étend en connectant des plaines inondables conduisant à l'accroissement de la diversité des habitats (Junk *et al.* 1989; Ferreira & Stohlgren 1999; Silvano, Benedito & Oyakawa 2000). Par conséquent, cette concentration permettait aux pêcheurs de capturer facilement les poissons avec une plus grande variété d'espèces par rapport à la saison humide. De plus, le patron

différent dans la composition des communautés entre les deux saisons pourrait être lié au mouvement migratoire des poissons dans le bassin (Baran 2006). Ainsi, le turnover saisonnier des communautés peut être attribué à la différence de capturabilité, diversité des habitats et migration des poissons dans le bassin. Cette conclusion a été révélée également par les précédentes études des communautés de poissons dans les fleuves amazoniens (Winemiller 1996; Matthews 1998; Albert & Reis 2011).

Différentes structures d'assemblage ont été observées entre la partie amont du LMR et son delta. Par conséquent, 80 espèces indicatrices ont été identifiées à partir des 4 assemblages annuels (Tableau 3). Plus précisément, les assemblages en amont (Ia et Ib) ont été caractérisés par les cyprinidés (Cypriniformes) et les poisson-chat (Siluriformes), connus comme étant des espèces potamodromes qui naissent dans les habitats d'eau douce en amont du Mékong, puis se déplacent en tant que juvéniles vers l'aval (en restant dans l'eau douce) où ils deviennent adultes avant de migrer vers l'amont pour frayer, i.e., *C. harmandi*, *L. chrysophekadion*, *H. waandersii*, *B. yarelli*, *Bangana behri*, (Lucas *et al.* 2001). Au delta du Mékong, les assemblages de poissons (IIa et IIb) ont été marqués par une forte décroissance de l'abondance des cyprinidés et poisson-chat, qui sont sténohalines (Valbo-Jorgensen *et al.* 2009). En revanche, les Perciformes et les clupéidés (Clupeiformes) étaient les espèces les plus présentes ; ces groupes de poissons sont plus tolérants à la salinité et à la turbidité, i.e. *C. aesarnensis*, *Mastacembelus spp.*, *G. giuris*, *Acanthopsis sp.*, *Cynoglossus microlepis*. Globalement, cette structuration était cohérente entre la saison sèche et humide. Effectivement, la structure spatiale des communautés de poissons pourrait être influencée par les schémas des migrations le long du LMR, où il a été estimé que près de 40% des espèces du Mékong sont des migrants à longue distance ou des poissons blancs (Poulsen *et al.* 2002, 2004; van Zalinge *et al.* 2004; Baran 2006; Baran *et al.* 2013).



**Fig. 11.** Patron spatial annuel (a), en saison sèche (b) et humide (c) de diversité et des assemblages de poissons dans le fleuve Mékong en aval (LMR). La richesse spécifique et l'indice inverse de Simpson de chaque cluster (Ia, Ib, IIa, IIb) sont illustrés en bas des cartes du regroupement. Les valeurs moyennes des clusters partageant les lettres communes ne sont pas significativement différentes au seuil  $p=0,05$  (Tests de Tukey-HSD).

**Tableau 3.** Liste des espèces indicatrices de chaque cluster du fleuve Mékong en aval (LMR).

Assemblage Ia : 11 espèces		Annuel		Sèche		Humide	
Scientific names	Code	IndVal	Niv. Sign	IndVal	Niv. Sign	IndVal	Niv. Sign
<i>Cosmochilus harmandi</i>	coha	0.922	***	-	-	0.905	***
<i>Bangana behri</i>	babe	0.885	***	0.752	**	0.845	**
<i>Helicophagus waandersii</i>	hewa	0.877	***	-	-	0.839	*
<i>Labeo chrysophekadion</i>	moch	0.86	***	0.826	***	0.899	***
<i>Bagarius yarrelli</i>	baya	0.854	***	0.92	***	0.769	**

Chapitre I: Structure spatiale de la physico-chimie et des poissons à large échelle

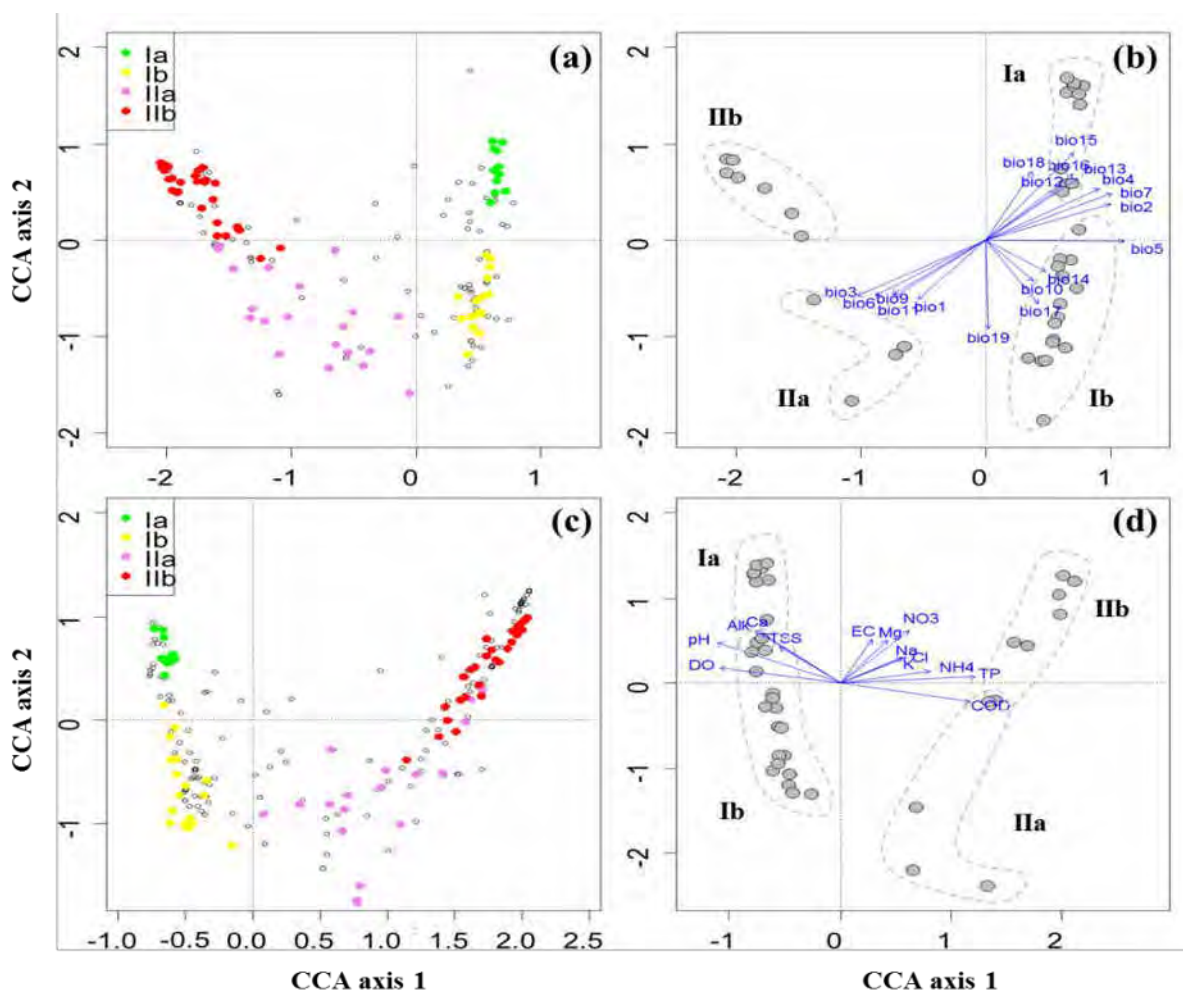
<i>Mekongina erythrospila</i>	meer	0.844	**	0.814	*	0.747	**
<i>Labeo erythropterus</i>	laer	0.788	**	0.783	*	-	-
<i>Phalacrotonotus apogon</i>	phap	0.787	**	0.818	***	-	-
<i>Pangasius conchophilus</i>	paco	0.769	*	-	-	0.785	**
<i>Tenualosa thibaudeaui</i>	teth	0.767	*	0.79	*	-	-
<i>Syncrossus helodes</i>	syhe	0.748	*	-	-	0.673	*
<b>Assemblage Ib: 17 espèces</b>							
<i>Henicorhynchus spp.</i>	hecr	0.933	***	0.859	**	0.945	***
<i>Thynnichthys thynnoides</i>	thth	0.865	**	-	-	0.859	**
<i>Wallago attu</i>	waat	0.849	**	0.891	**	0.785	**
<i>Belodontichthys dinema</i>	bedi	0.843	**	0.961	***	0.804	**
<i>Puntioplites falcifer</i>	pufa	0.838	**	0.955	***	0.84	**
<i>Micronema bleekeri</i>	mibl	0.828	***	0.844	***	0.817	**
<i>Labiobarbus lineata</i>	lali	0.817	**	0.909	**	0.744	*
<i>Osteochilus melanopleura</i>	osme	0.813	**	0.927	***	0.75	**
<i>Gyrinocheilus pennocki</i>	gype	0.802	*	0.873	**	0.642	*
<i>Cyclocheilichthys furcatus</i>	cyfu	0.798	**	0.912	***	0.804	**
<i>Pangasianodon hypophthalmus</i>	pahy	0.78	*	0.863	**	0.708	*
<i>Hemibagrus nemurus</i>	hene	0.768	***	0.669	*	0.787	***
<i>Paralaubuca typus</i>	paty	0.768	*	-	-	0.784	*
<i>Hemibagrus wyckioides</i>	hewyd	0.736	*	0.775	*	-	-
<i>Leptobarbus hoevenii</i>	leho	0.728	*	-	-	-	-
<i>Brachirus harmandi</i>	brha	0.686	*	0.784	*	-	-
<i>Bagrichthys macropterus</i>	bama	0.64	*	0.679	*	-	-
<b>Assemblage IIa: 21 espèces</b>							
<i>Macragnathus siamensis</i>	masi	1	***	0.997	***	0.816	***
<i>Acanthopsis sp.</i>	acsp	0.995	***	0.861	**	0.816	**
<i>Puntioplites proctozysron</i>	pupr1	0.954	***	0.948	***	0.951	***
<i>Mastacembelus armatus</i>	maar	0.954	***	0.95	***	0.643	*
<i>Cynoglossus microlepis</i>	cymi	0.894	**	0.909	**	0.927	***
<i>Hampala macrolepidota</i>	hama	0.889	***	0.721	*	0.811	**
<i>Plotosus canius</i>	plca	0.877	**	0.713	*	0.869	**
<i>Mystus singaringan</i>	mysi	0.854	**	0.908	**	0.718	*
<i>Mystus mysticetus</i>	mymy	0.843	***	0.735	*	0.755	**
<i>Osteochilus vittatus</i>	osvi	0.822	**	-	-	0.794	**
<i>Notopterus notopterus</i>	nono	0.825	**	0.861	**	-	-
<i>Cyclocheilichthys armatus</i>	cyar	0.806	**	0.809	**	-	-
<i>Glossogobius giuris</i>	glgi	0.787	***	0.863	***	0.652	*
<i>Brachirus orientalis</i>	bror	0.787	**	0.855	**	0.728	**
<i>Boesemania microlepis</i>	bomi	0.775	*	-	-	-	-
<i>Oxyeleotris marmorata</i>	oxma	0.748	**	0.862	**	-	-
<i>Bagrichthys obscurus</i>	baob	0.707	**	0.707	**	-	-
<i>Hypsibarbus vernayi</i>	hyve	0.707	**	0.707	**	-	-
<i>Pseudomystus siamensis</i>	pssi	0.707	**	-	-	0.577	*

<i>Puntioplites</i> sp.	pupr2	0.707	**	0.707	**	-	-
<i>Akisis</i> sp.	aksp	0.693	*	0.686	*	-	-
<b>Assemblage IIb: 31 espèces</b>							
<i>Clupeichthys aesarnensis</i>	clae	0.954	***	0.946	***	0.987	***
<i>Rasbora trilineata</i>	ratr	0.927	***	0.926	**	0.977	***
<i>Trichogaster trichopterus</i>	trtr	0.821	**	-	-	0.766	**
<i>Rasbora</i> sp.	rasp	0.8	**	0.849	**	-	-
<i>Scomberomorus sinensis</i>	scsp	0.755	***	0.756	**	-	-
<i>Toxotes chatareus</i>	toch	0.755	**	0.756	***	0.775	***
<i>Toxotes</i> spp.	tosp	0.755	**	0.756	***	-	-
<i>Arius stormi</i>	arst	0.753	*	0.681	*	-	-
<i>Liza</i> spp.	lisp	0.751	**	0.752	**	0.629	*
<i>Parambassis wolffi</i>	pabwo	0.725	*	0.749	*	-	-
<i>Anabas testudineus</i>	ante	0.7	*	0.782	*	-	-
<i>Hemilurus mekongensis</i>	heme	0.686	*	0.789	**	-	-
<i>Polynemus dubius</i>	podu	0.681	*	0.69	*	0.727	**
<i>Lates calcarifer</i>	laca	0.674	*	0.827	**	-	-
<i>Eleutheronema tetradactylum</i>	elte	0.656	*	0.655	*	-	-
<i>Pangasius juvernile</i>	paju	0.656	*	0.535	*	0.775	***
<i>Scatophagus argus</i>	scar	0.656	*	0.655	*	-	-
<i>Zenarchopterus ectuntio</i>	zesp	0.656	*	0.655	*	-	-
<i>Ellochelon vaigiensis</i>	liva	0.656	*	0.534	*	-	-
<i>Coilia magrognathos</i>	cosp2	0.636	*	-	-	0.624	*
<i>Pseudapocryptes elongatus</i>	psel	0.631	*	0.596	*	-	-
<i>Acentrogobius</i> sp.	acens	0.539	*	-	-	0.632	*
<i>Allenbatrachus grunniens</i>	algr	0.539	*	0.535	*	-	-
<i>Arius</i> spp.	arsp	0.539	*	0.535	*	-	-
<i>Arius thalassinus</i>	arth	0.539	*	0.535	*	-	-
<i>Boleophthalmus boddarti</i>	bobo	0.539	*	-	-	-	-
<i>Butis butis</i>	bubu	0.539	*	0.535	*	-	-
<i>Hyporhamphus limbatus</i>	hyli	0.539	*	-	-	-	-
<i>Taenioides</i> sp.	tasp	0.539	*	-	-	0.632	**
<i>Trichogaster pectoralis</i>	trpe	0.539	*	-	-	-	-
<i>Xenentodon cancila</i>	xeca	0.539	*	0.535	*	-	-

### 3. Déterminants environnementaux des assemblages de poisson

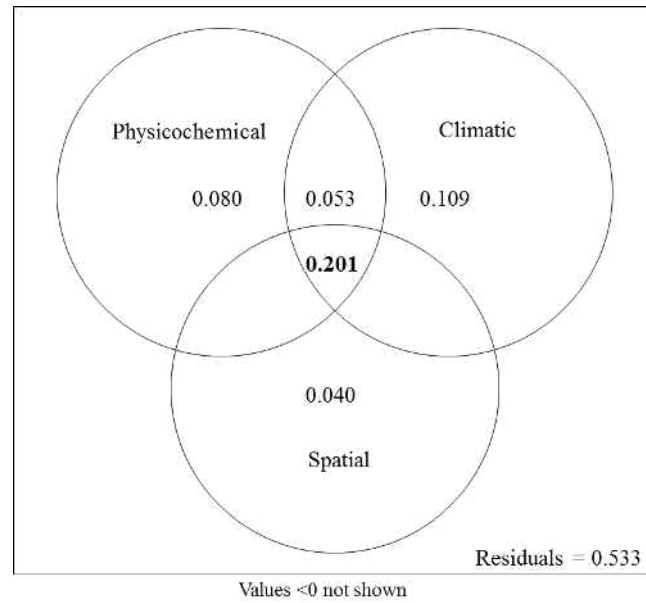
Les deux modèles d'ACC testant l'association entre les assemblages de poissons annuels et les variables climatiques et physicochimiques étaient significatifs ( $p=0,001$ ). Par conséquent, la structure spatiale des communautés changeait significativement le long des gradients physicochimiques et climatiques. Cependant, on admet qu'il y aurait d'autres facteurs (e.g. régime hydrologique, géomorphologie du fleuve, interactions biotiques) qui influencent

probablement la structure des assemblages. Effectivement, la variation saisonnière des précipitations (bio15), la précipitation du mois le plus humide (bio16), la température maximale du mois le plus chaud (bio5), la précipitation du trimestre le plus froid (bio19), ainsi que l'isothermalité (bio3), la température minimale du mois le plus froid (bio6), et la température moyenne des trimestres les plus secs (bio9) étaient les facteurs climatiques clés expliquant les changements dans la structure des assemblages des poissons. Alternativement, les TP, DO, COD et pH ont été identifiés comme les facteurs physicochimiques clés influençant la structure spatiale des assemblages de poisson (Fig. 12). Plus précisément, les différences entre les assemblages en amont (Ia et Ib) et au delta (IIa et IIb) ont été expliquées par la température, les teneurs en nutriments et la salinité causée par l'intrusion saline. Par conséquent, les espèces en amont étaient celles adaptées aux conditions montagneuses ou en haute altitude, à basse température, forte précipitation, et valeur élevée de DO et pH ; tandis que les espèces du delta étaient celles adaptées aux niveaux élevés de nutriment, et pouvaient tolérer une température et salinité élevées. Ces conclusions sont compatibles avec les études antérieures (Valbo-Jorgensen *et al.* 2009). Finalement, j'ai pu montrer que les facteurs physicochimiques et climatiques ont contribué à part égale à l'explication du patron spatial des assemblages de poissons du LMR (Fig. 13). Malgré tout, les études précédentes sur les déterminants environnementaux de la structure des assemblages de poissons ont signalé dans d'autres systèmes la principale contribution des facteurs physicochimiques (Braaten & Guy 1999; Trujillo-Jiménez *et al.* 2009; Pires *et al.* 2010), alors que d'autres ont révélé un rôle prépondérant des facteurs climatiques dans la structuration spatial des poissons (Reash & Pigg 1990; Buisson *et al.* 2008; Zhao *et al.* 2015; Guo *et al.* 2015). Cependant, j'ai conclu que la combinaison des facteurs environnementaux (physicochimiques, climatiques) et spatiaux fournissait une meilleure explication de la variation des assemblages de poissons, alors que les facteurs physicochimiques ou climatiques seuls ne seraient pas optimaux pour expliquer la distribution des poissons (Lujan *et al.* 2013).



**Fig. 12.** Analyses canoniques des correspondances (ACC) reliant les abondances relatives des poissons aux (a, b) variables climatiques et (c, d) variables physicochimiques. Les différents points de couleur à gauche représentent les espèces indicatrices dans chaque assemblage de poisson ; alors que les points gris sur le côté droit indiquent les sites d'échantillonnage. Les flèches bleues représentent les vecteurs des variables environnementales (i.e., climatiques et physicochimiques) et seules les variables significatives ( $p < 0,05$ ) sont représentées.





**Fig. 13.** Diagramme de Venn montrant les effets relatifs des variables physicochimiques, climatiques, et spatiales seules et en combinaison sur la variation des assemblages de poisson. Les chiffres représentent le pourcentage de variation expliquée par chaque facteur.

## **CHAPITRE II**

# **STRUCTURE TEMPORELLE DES COMMUNAUTÉS DE POISSONS**



## 1. Évolution temporelle des communautés de poissons

La structure temporelle des communautés de poissons a été résumée et représentée sous forme des scores synthétiques d'ACOM de chaque site et ceux de référence. Ici, je n'ai présenté que la variabilité temporelle de référence des communautés de poissons (Fig. 14a), tandis que l'évolution temporelle de chaque site individuel a été illustrée par la variation des valeurs de coefficient RV. Les trois premiers axes d'ACOM, expliquant 53% de la variance totale, ont été gardés et les scores factoriels moyens des espèces ont été calculés pour chaque axe et représentés (Fig. 14a, b). Des scores élevés indiquent la contribution importante de l'espèce à la structure des communautés.

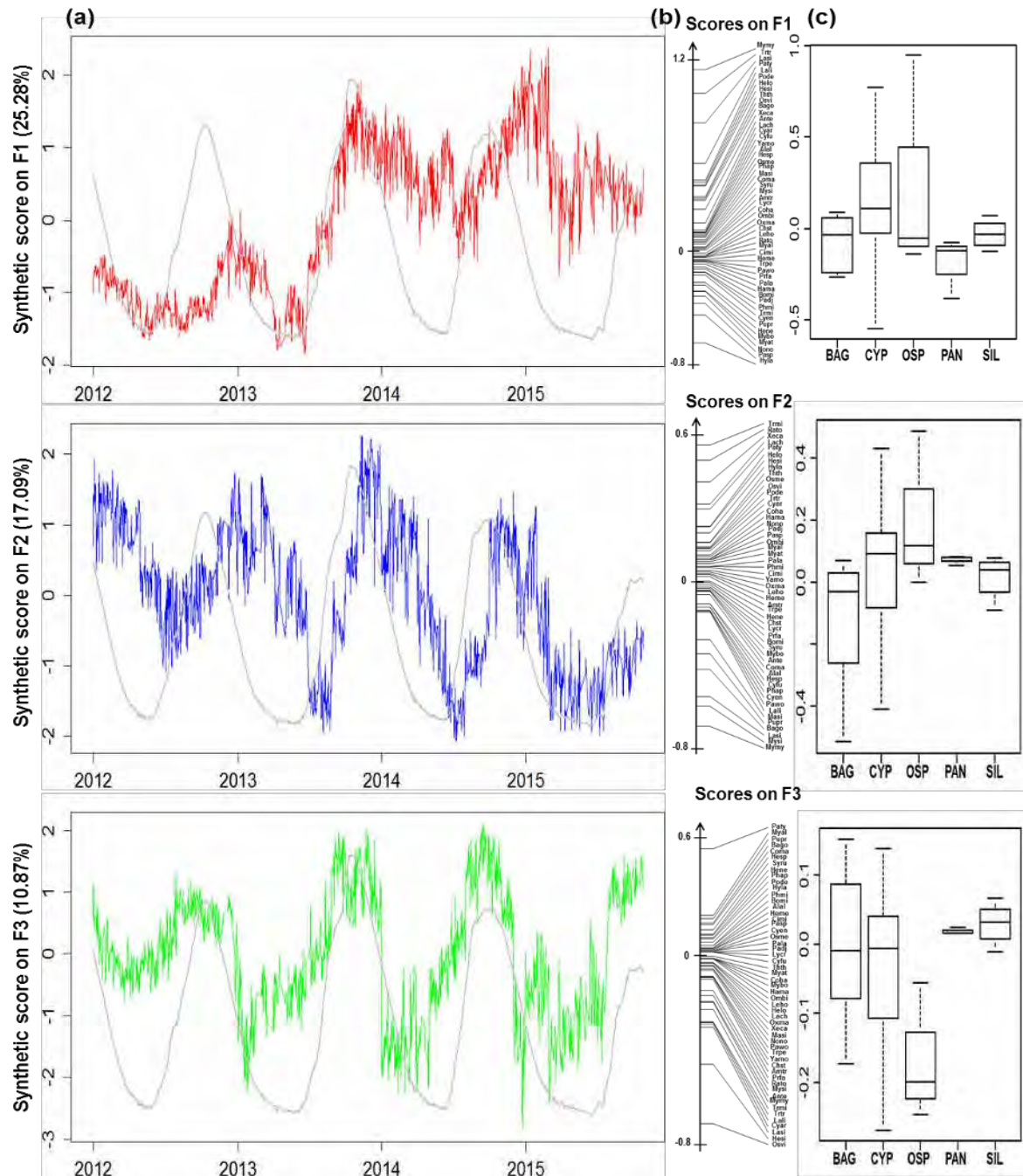
L'évolution temporelle des communautés de poissons dans le lac était plutôt associée aux traits fonctionnels que la structure taxonomique et cette variabilité était fortement liée à la variation hydrologique dans le lac (Tableau 4). Six des neuf traits étudiés étaient significativement associés à la variation temporelle des communautés de poisson dans le lac et les relations ont été observées principalement sur les axes F1 et F3 de l'ACOM (Fig. 15, Tableau 4). Effectivement, de nombreux auteurs ont également mis en évidence ce type de patron temporel dans les divers écosystèmes (eau douce, estuariens, marins) (Winemiller 1989; Sale 2004; Agostinho *et al.* 2005; Edna *et al.* 2007; Tedesco *et al.* 2008). Ici, la communauté a été caractérisée par des gros poissons avec des niveaux trophiques élevés pendant la période de basse eau, progressivement remplacée par des poissons de petite taille avec des niveaux trophiques bas lorsque l'eau dans le lac monte (Fig. 14, 15). De manière similaire, de nombreuses études ont révélé la corrélation positive entre les tailles des poissons et leurs niveaux trophiques, et que la taille est également un des paramètres biologiques importants et fortement corrélée aux autres traits (Winemiller 1989; Romanuk, Hayward & Hutchings 2011). Pourtant, à Orinoco, il a été montré qu'il n'y avait pas de corrélation entre la taille du poisson et sa position trophique dans le système où le réseau trophique est divers et productif (Layman *et al.* 2005). D'ailleurs, selon une étude récente des structures des

communautés de poissons dans la zone humide Pantanal en Amazonie, une étude a montré un changement significatif du recrutement des prédateurs et spécialistes entre les saisons humides et sèches (Wantzen *et al.* 2002). Cette remarque était cohérente avec ce qu'on a trouvé à TLS où plus de recrutement des gros poissons prédateurs, e.g. *Hysibarbus* sp., *Pangasius* spp., *Nototerus notopterus*, *Hemibarbus nemurus*, a été observé au cours de la période d'étéage.

De plus, la variation temporelle des communautés était liée également à la stratégie de vie, aux guildes écologiques, aux habitats d'alimentation et à la présence de respiration accessoire. Par conséquent, les poissons noirs avec la stratégie d'équilibre (*Trichogaster* spp.) dominaient la communauté au cours de la période d'étéage, alors que les poissons blancs avec la stratégie opportuniste (*Paralaubuca* spp., *Henicorhynchus* spp.) caractérisaient la communauté pendant la période de hautes eaux (avant et après les pics des pulses) (Fig. 14, 15). Le turn-over au cours de la période transitoire était caractérisé par les poissons gris et blanc avec la stratégie périodique (*Mystus* spp., *Puntioplites proctozystron*). Apparemment, il a été montré que les espèces opportunistes et périodiques sont plus adaptées aux environnements variables (e.g. régime hydrologique turbulent) que les équilibres (Winemiller 1989). Les autres traits tels que la présence de respiration accessoire et les habitats d'alimentation sont connus pour être fortement corrélés aux stratégies de vie et guildes écologiques des poissons. Par exemple, la plupart des poissons noirs, i.e. les perches (*Ananbas testudineus*), poisson chats (*Claria* spp.), snakeheads (*Channa* spp.), gourami (*Trochopodus* spp.), ont été décrits comme tolérants à l'hypoxie car ils sont équipés de respiration accessoire leur permettant de respirer dans l'air (Lamberts 2001; Baran *et al.* 2006). Néanmoins, les habitats, les habitats de fraies et la position dans la colonne d'eau n'expliquaient pas l'évolution temporelle de la communauté (Tableau 4).

À l'échelle régionale, la variabilité temporelle des communautés pourrait être liée aux migrations dans le Mékong, étant donné que 1/3 des espèces du Mékong sont des migrants à

longue distance, en particulier les cyprinidés (*Hypsibarbus* sp., *Puntioplites* sp., *Cyclocheilichthys* sp.), les bagrids (*Hemibagrus* sp.) et les poisson-chats (*Pangasius* sp.) (Baran 2006; MRC 2007b).

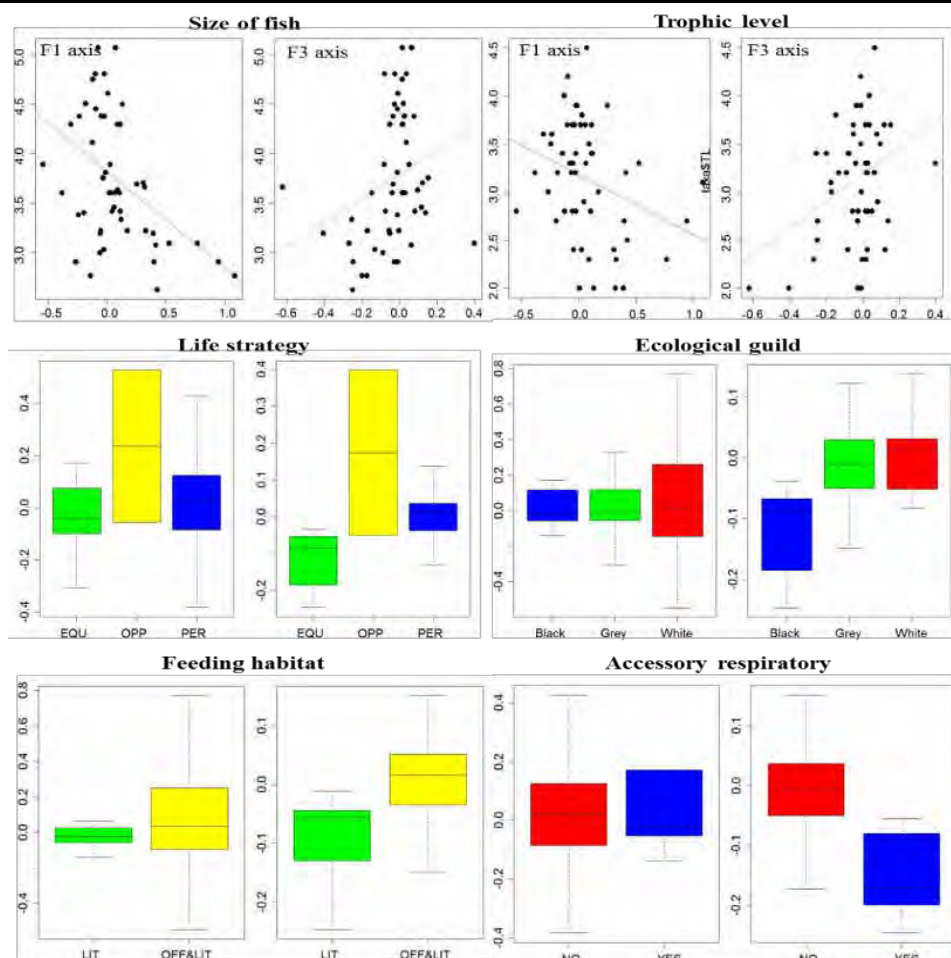


**Fig. 14.** Variabilité temporelle de référence de la structure des communautés de poisson dans le lac Toulé Sap. (a) Séries temporelles des scores synthétiques d'ACOM sur les 3 premiers axes du tableau de référence. Les courbes grises représentent le régime hydrologique du lac. (b) Scores factoriels des 53 taxons sur les 3 premiers axes d'ACOM. (c) Boxplots des scores

des espèces sur les axes en fonction des 5 principales familles de poissons (CYN: Cyprinidae, BAG: Bagridae, OSP: Osphrinemidae, PAN: Pangasiidae, SIL: Siluridae).

**Tableau 4.** Relations entre la structure taxonomique, les traits fonctionnels et les scores factoriels des espèces de poissons sur les 3 premiers axes d'ACOM.  $R^2$  et P sont respectivement le pourcentage des variables expliquées et leurs valeurs-p associées, alors que ns désigne la relation non-significative (Kruskal-Wallis,  $p < 0,05$ ).

	F1 Axis		F2 Axis		F3 Axis	
	$R^2$	P	$R^2$	P	$R^2$	P
Family	-	ns	-	ns	-	ns
Size of fish	0.19	0.001	0	ns	0.08	0.02
Trophic Level	0.09	0.02	0	ns	0.12	0.01
Habitats	-	ns	-	ns	-	ns
Life strategy	-	ns	-	ns	-	0.017
Ecological guild	-	ns	-	ns	-	0.003
Spawning habitat	-	ns	-	ns	-	ns
Feeding habitat	-	ns	-	ns	-	0.003
Water column position	-	ns	-	ns	-	ns
Accessory respiratory	-	ns	-	ns	-	0.01



**Fig. 15.** Relations entre les traits fonctionnels et les scores factoriels des espèces de poissons dans le lac Tonlé Sap sur les axes F1 et F3 de l'ACOM. Seules les relations significatives ont été présentées (Kruskal-Wallis,  $p < 0.05$ , Tableau 4). La taille des poissons est montrée en échelle logarithmique (axe-y) et les noms complets des acronymes sont fournis dans l'appendice II.

## 2. Synchronie spatiale de la variation temporelle des communautés

À l'échelle du lac, les valeurs des corrélations temporelles moyennes  $\rho$  variaient de 0.43 à 0.66 et la variation temporelle de BB et KT était moins synchronisée par rapport à SR, PS et KC (Fig. 5). Par conséquent, aucune relation n'a été observée entre le niveau de synchronie et la distance géographique des sites comme attendu. Effectivement, des études précédentes sur la synchronie spatiale (intra et interspécifique) en Afrique et en Europe ont aussi montré une relation non-significative entre le niveau du synchronisme et la distance des sites étudiés (Grenouillet *et al.* 2001; Tedesco *et al.* 2004). Par ailleurs, en regardant les valeurs des coefficients RV, ils allaient de 0.52 (BB) à 0.75 (SR) et la variation temporelle des communautés à SR, PS (0.65) et KC (0.71) était corrélée à la variabilité temporelle de référence du lac, sauf BB et KT (0.56). Les sites situés à proximité les uns des autres (Fig. 5), i.e. BB et SR, présentaient une faible valeur de corrélation temporelle ( $\rho$ ). En outre, le patron temporel de BB et KT semblait moins corrélé à la structure de référence ( $RV \sim 0.5$ ), ce qui suggère l'effet de facteurs spécifiques liés aux caractéristiques des sites (e.g. hétérogénéité des habitats) (Daufresne, Bady & Fruget 2007).

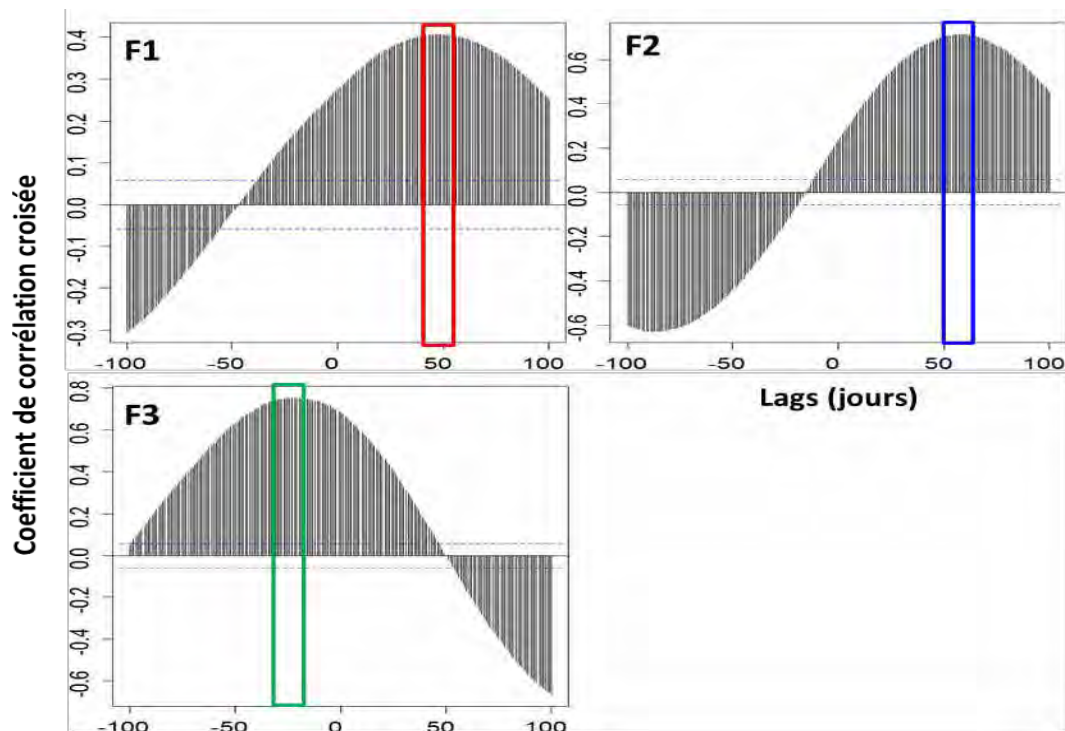
## 3. Réponse des communautés de poissons au régime hydrologique

Le modèle a révélé une forte influence de la variation du régime hydrologique sur l'évolution temporelle de la composition des communautés et des traits fonctionnels (Fig. 16). En effet, la réponse des communautés des poissons au régime hydrologique semble décalée et le décalage était estimé entre +38 à +58 jours sur F1 ( $r^2 = 0.40$ ), de +50 à +60 jours sur F2 ( $r^2 = 0.71$ ), et



de -20 à -30 jours ( $r^2 = 0.75$ ) sur F3. Approximativement, le mouvement des poissons dans le lac s'est fait 1 à 2 mois avant ou après l'arrivée des crues.

L'état de l'art du décalage de la réponse des communautés de poisson au régime hydrologique est très limité, surtout dans les écosystèmes d'inondation pulsés. À partir des études dans le néotropique, e.g. le fleuve Parana, le décalage de la réponse de la chlorophylle-a et phytoplancton aux changements hydrologiques dans les plaines inondables a été quantifié à 6 jours et 14 jours respectivement (Agostinho *et al.* 2000). En Guyane, Merigoux & Ponton (1999) a montré que l'évolution temporelle des communautés de juvéniles était fortement corrélée avec la condition hydrologique pendant 30 jours. En tenant compte la surface du lac, la durée de l'inondation, le décalage observé de 1.5 à 2 mois semblait raisonnable. Pour l'instant, la période d'inondation de la zone humide en Amazonie Centrale a été estimée entre 50 jours à 270 jours (Ferreira & Stohlgren 1999).



**Fig. 16.** Corrélacion croisée entre les séries temporelles des scores synthétiques d'ACOM et des niveaux de l'eau dans le lac Tonlé Sap. Les lignes pointillées en bleue indiquent les

## *Chapitre II : Structure temporelle des communautés de poissons*

niveaux significatifs avec 95% d'intervalle de confiance. Les rectangles de différentes couleurs indiquent le temps de décalage pour les 3 axes d'ACOM.



## **CHAPITRE III**

# **RÉSEAU TROPHIQUE ET ETAT ÉCOLOGIQUE DE L'ÉCOSYSTÈME**



### **1. Réseau trophique et flux d'énergie**

Le réseau trophique et les flux d'énergie sont des éléments clés qui déterminent le fonctionnement et l'état écologique de l'écosystème. Dans le lac Tonlé Sap, les niveaux trophiques (FTL) variaient de 1 (macrophytes, phytoplancton et détritus) à 3,17 (snakehead) (Tableau 5). Le snakehead s'est trouvé au plus haut niveau trophique avec la biomasse de 4,480 t km<sup>-2</sup> an<sup>-1</sup>, suivi par plusieurs groupes de poissons carnivores, tels que le poisson-chat (2,98), les autres carnivores (2,96), la barbe de rivière (2,77) et la perche (2,74). Le schéma plus concis du réseau trophique a été également représenté pour indiquer les flux d'énergie dans le réseau trophique du lac (Fig. 17). Les impacts trophiques mixtes (MTI) présentaient des effets positifs et négatifs des groupes fonctionnels l'un sur l'autre (Fig. 18). Par conséquent, seuls les macrophytes, phytoplanctons et détritus ont eu un impact positif sur la plupart des autres groupes fonctionnels, ce qui pourrait expliquer les effets « bottom-up » du point de vue de l'écosystème, tandis que les autres compartiments ont montré des interactions directes prédateur-proies, des effets en cascade (cascading effect) et de la compétition.

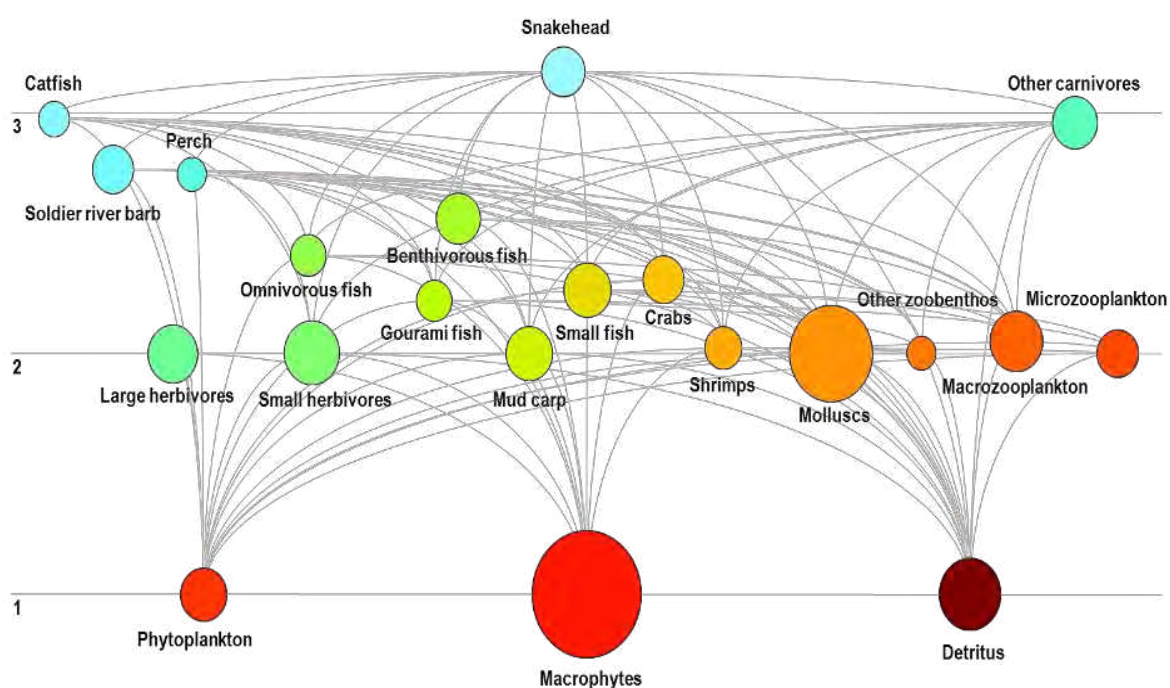
De plus, Les effets négatifs entre groupes des poissons nous montraient principalement les impacts négatifs dus à leur compétition trophique. Par exemple, le snakehead a montré des effets négatifs importants sur le poisson-chat, la perche et les autres carnivores, surtout parce qu'ils ont des sources alimentaires similaires. Également, les pêches ont eu des effets négatifs sur tous les poissons commerciaux et les crustacés, mais étaient bénéfiques pour les poissons omnivores, les crabes et les autres ressources fourragères.

Une des particularités du réseau trophique du TLS était observée à partir de la variation des valeurs d'EE dans les groupes fonctionnels établis. Globalement, les valeurs de l'EE de tous les groupes fonctionnels sont inférieures à 1, et la plupart des valeurs P/Q sont comprises entre 0,05 et ~0,3, répondant au critère du modèle équilibré. Par conséquent, les valeurs de l'EE ont été estimées à plus de 0,5 pour presque tous les groupes fonctionnels, sauf pour les mollusques et macrophytes (Tableau 5). Ces derniers ont illustré la pression sur les ressources

subies par les activités de pêches, ainsi que la pression de prédation pour les groupes de poissons fourragers (i.e., les mud carpes, petits herbivores, et petits poissons). Cette remarque est compatible avec celle des études antérieures sur la production de la pêche du lac qui ont souligné la préoccupation que représente la surexploitation des ressources de pêches dans le lac (Lamberts 2001; Enomoto *et al.* 2011). En revanche, les valeurs d'EE estimées pour les mollusques et macrophytes étaient très faibles, cela signifiait qu'ils n'étaient pas bien utilisés dans l'écosystème. Certes, les macrophytes ne sont pas facilement utilisables dans l'écosystème quand ils sont vivants (Christensen *et al.* 2005). Parallèlement, entant que la source d'énergie de l'écosystème, j'ai trouvé que les valeurs de l'EE des phytoplanctons et détritiques approchaient 1, et étaient relativement plus élevés que ceux observés dans d'autres grands lacs africains (e.g., Lac Victoria, Tanganyika, Malawi), malgré parfois des biomasses similaires de phytoplanctons, macrophytes et zooplanctons (e.g. Lac Tchad, Christensen & Pauly 1993).

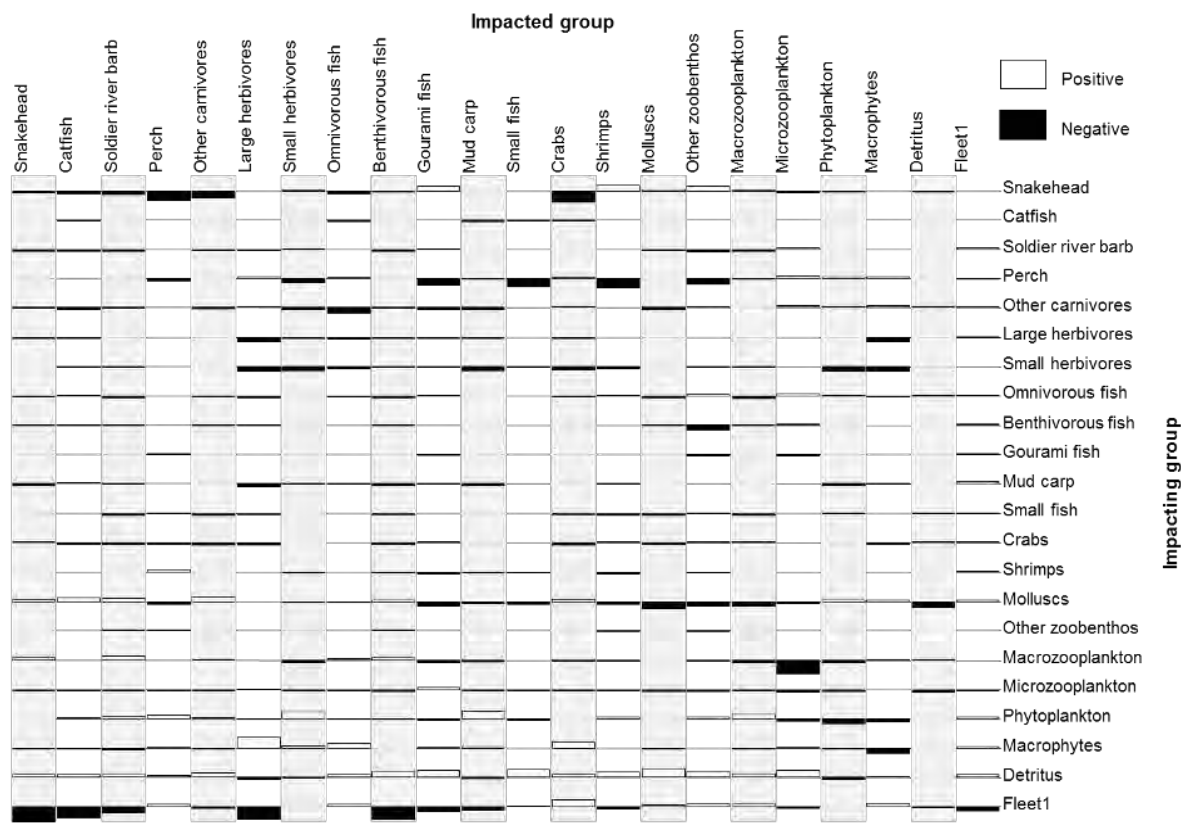
Deux chaînes alimentaires principales ont été trouvées dans le système TLS, une chaîne alimentaire à base de détritiques et une chaîne alimentaire à base de la production primaire (grazing food chain) (Fig. 19). Cependant, environ 77,9% de l'ensemble de l'énergie circule à travers la chaîne alimentaire à base de détritiques, alors que seulement 22,1% circule dans celle de la production primaire, malgré la biomasse très élevée de ces producteurs primaires ( $1494 \text{ t km}^{-2} \text{ an}^{-1}$ ) (Fig. 19). Par conséquent, la chaîne alimentaire semble essentiellement basée sur la chaîne alimentaire détritique et l'efficacité moyenne du transfert trophique (TEs) des deux chaînes alimentaires du lac était de 8,27%. En regardant le TE global dans les deux chaînes alimentaires, un faible TE a été trouvé à la base des chaînes alimentaires (de TL II à III), alors que le TE augmentait significativement de TL III à TL supérieur (Fig. 19). Ce dernier était en contraste avec les TEs des autres grands lacs africains (i.e., Lac Victoria, Tanganyika, Malawi), où les TEs diminuent de façon dramatique de TL III à TL plus élevé (Christensen & Pauly 1993). Ce contraste m'a permis de souligner une meilleure exploitation des ressources

de pêche dans le lac pour la consommation humaine et la prédation que celle des lacs africains. Néanmoins, la surexploitation des ressources de pêche dans le TLS affectait principalement le bas de la chaîne alimentaire (fishing down the food chain). Par conséquent, le lac est maintenant dominé par les petits poissons (van Zalinge, Nao & Touch 1998); alors qu'une grande partie de la production primaire (macrophytes) n'est pas pleinement utilisée dans l'écosystème.

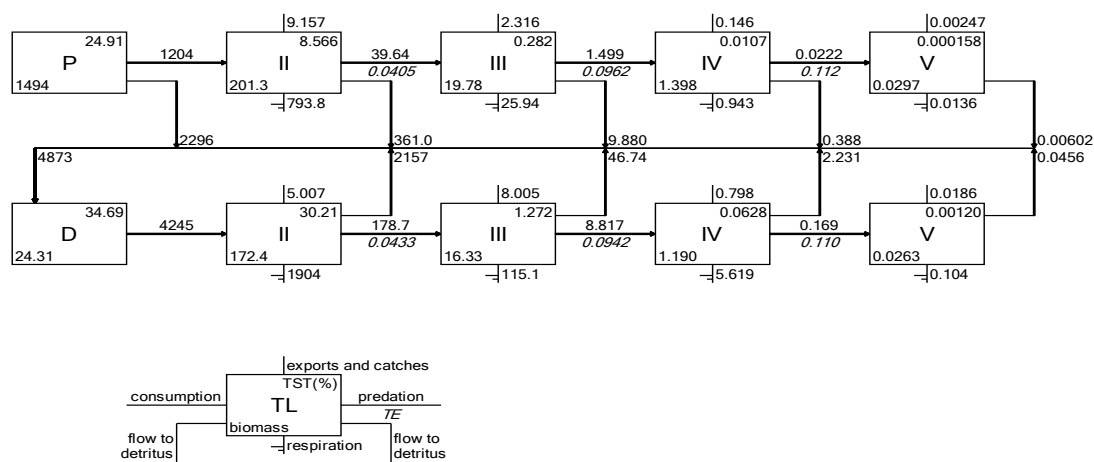


**Fig. 17.** Schéma du flux d'énergie représentant la structure du réseau alimentaire dans l'écosystème Tonlé Sap. Les lignes grises désignent les niveaux trophiques 1, 2, et 3 respectivement ; alors que les différentes tailles des cercles indiquent les différentes biomasses ( $t\ km^{-2}$ ) des groupes fonctionnels.





**Fig. 18.** Impacts trophiques mixtes (MTI) de l'écosystème Tonle Sap. Les barres noires pointant vers le bas montrent l'impact négatif sur les groupes fonctionnels, alors que les barres blanches pointant vers le haut indiquent l'impact positif. Les hauteurs des barres sont proportionnelles au niveau de l'impact et ses valeurs varient de -1 à +1.



**Fig. 19.** Graphe de Lindeman spine du Tonlé Sap. P et D représentent la production primaire et les détritiques, respectivement.

**Tableau 5.** Entrée de base et paramètres estimés (*italique*) pour les 21 groupes fonctionnels du lac Tonlé Sap

Group number	Group name	TL	B(t km <sup>-2</sup> )	P/B(year <sup>-1</sup> )	Q/B (year <sup>-1</sup> )	EE	P/Q
1	Snakehead	<i>3.17</i>	4.48	1.22	6.20	<i>0.598</i>	<i>0.196</i>
2	Catfish	<i>2.98</i>	1.38	0.92	3.70	<i>0.897</i>	<i>0.249</i>
3	Soldier river barb	<i>2.77</i>	3.64	0.94	5.50	<i>0.936</i>	<i>0.171</i>
4	Perch	<i>2.74</i>	1.13	2.85	33.40	<i>0.565</i>	<i>0.085</i>
5	Other carnivores	<i>2.96</i>	5.23	0.96	7.20	<i>0.898</i>	<i>0.134</i>
6	Large herbivores	<i>2.00</i>	7.96	0.38	12.00	<i>0.600</i>	<i>0.031</i>
7	Small herbivores	<i>2.00</i>	13.09	0.68	38.70	<i>0.952</i>	<i>0.018</i>
8	Omnivorous fish	<i>2.41</i>	2.23	2.73	22.90	<i>0.994</i>	<i>0.119</i>
9	Benthivorous fish	<i>2.56</i>	4.89	0.35	5.00	<i>0.934</i>	<i>0.070</i>
10	Gourami fish	<i>2.22</i>	2.26	1.21	10.40	<i>0.933</i>	<i>0.116</i>
11	Mud carp	<i>2.00</i>	5.99	1.53	26.40	<i>0.938</i>	<i>0.058</i>
12	Small fish	<i>2.26</i>	6.07	1.38	18.20	<i>0.944</i>	<i>0.076</i>
13	Crabs	<i>2.31</i>	3.76	2.12	8.48	<i>0.721</i>	0.250
14	Shrimps	<i>2.02</i>	2.36	4.50	24.40	<i>0.936</i>	<i>0.184</i>
15	Molluscs	<i>2.00</i>	143.10	4.30	<i>17.20</i>	<i>0.146</i>	0.250
16	Other zoobenthos	<i>2.00</i>	1.19	5.00	<i>25.00</i>	<i>0.843</i>	0.200
17	Macrozooplankton	<i>2.05</i>	9.98	<i>4.29</i>	85.87	0.900	0.050
18	Microzooplankton	<i>2.00</i>	3.74	<i>15.26</i>	305.23	0.950	0.050
19	Phytoplankton	<i>1.00</i>	5.48	185.00		<i>0.936</i>	
20	Macrophytes	<i>1.00</i>	1488.62	1.67		<i>0.102</i>	
21	Detritus	<i>1.00</i>	24.31			<i>0.871</i>	

## 2. État écologique de l'écosystème

Le fonctionnement et l'état écologique du Tonlé Sap ont été quantitativement évalués en utilisant les attributs et les indicateurs écologiques obtenus par le modèle Ecopath. Également, Xu *et al.* (2001) ont fourni certains indicateurs qui pourraient être utilisés pour évaluer l'état écologique de l'écosystème (i.e., la biomasse du phytoplancton, la biomasse du zooplancton, la richesse spécifique, le ratio de P/R, le ratio de P/B et la capacité de tampon). Généralement, un écosystème en bonne qualité écologique est caractérisé par une faible biomasse de phytoplancton, une biomasse élevée de zooplancton et macrozooplancton, une grande diversité d'espèces et des ratios de P/B et P/R qui approchent 1 (Xu *et al.* 2001). De plus, selon la théorie de Odum (1969), les ratios de TPP/TR et TPP/TB sont deux indicateurs

importants pour mesurer la maturité de l'écosystème, un écosystème mature possédant une valeur TPP/TR proche de 1 et une faible valeur de TPP/TB.

Dans le système de TLS, le débit total d'énergie du système a atteint  $14\,050,330\text{ t km}^{-2}\text{ an}^{-1}$ , dont 40,4% provient de la consommation, 4,65% de l'exportation, 20,3% de la respiration et le reste (34,68%) s'écoule dans les détritiques (Tableau 6). Le ratio TPP/TR était de 1,23, beaucoup plus bas que la plupart des lacs dans le monde entier, tels que le lac Taihu (3,85), Qiandaohu (3,725), mais plus élevé que le lac Hayq en Éthiopie (1,05). Parallèlement, le ratio TPP/TB était de 2,482, soit une valeur entre l'écosystème immature Taihu (11,6) et l'écosystème mature Gehu (1,76), et beaucoup plus faible que le lac Awassa (5,834) ou le lac Malawi (66) (Fetahi & Mengistou 2007; Liu *et al.* 2007; Darwall *et al.* 2010; Li *et al.* 2010; Fetahi *et al.* 2011; Jia *et al.* 2012). Dans l'ensemble, les valeurs des indices de flux d'énergie, i.e. CI et SOI, ont été estimées à 0,253 et 0,075, respectivement. Ces valeurs de CI et SOI sont les indices importants pour décrire les caractéristiques de la chaîne alimentaire, i.e. linéaire ou web-like. Par conséquent, la valeur CI de TLS était presque identique à celle théorique (0,252) calculée par l'équation de régression empirique (Christensen & Pauly 1993). Comparativement, les valeurs de CI et SOI de TLS étaient beaucoup plus faibles que celles observées pour le lac Ayame en Côte d'Ivoire (0,386, 0,193), le lac Annecy en France (0,258, 0,107) et légèrement supérieures à celles des lacs chinois: Taihu (0,206, 0,042) et Bao'an (0,205, 0,058) (Traore *et al.* 2008; Janjua & Gerdeaux 2009; Li *et al.* 2009; Guo *et al.* 2013). Globalement, suivant les valeurs de ces indicateurs (TPP/TR, TPP/TB, CI et SOI) et que la chaîne alimentaire était à base détritique, j'ai conclu que l'écosystème du TLS atteint un certain stade de maturité avec une structure du réseau trophique vulnérable due à l'absence de complexité dans la structure des chaînes alimentaires exprimée par les faibles valeurs de CI et de SOI. Également, en vérifiant les indices de l'état écologique du TLS avec ceux théoriques, le modèle a suggéré que l'écosystème pourrait être considéré comme un écosystème en bonne

qualité écologique, mais souffrant de perturbations humaines (e.g. la surpêche) (Odum 1969; Xu *et al.* 2001).

**Tableau 6.** Liste des indicateurs pour l'évaluation de l'état écologique du lac Tonlé Sap

<b>Parameters</b>	<b>Value</b>	<b>Units</b>
<b>Ecosystem properties</b>		
Sum of all consumption (TC)	5677.091	t km <sup>-2</sup> y <sup>-1</sup>
Sum of all exports (TE)	654.194	t km <sup>-2</sup> y <sup>-1</sup>
Sum of all respiratory flows (TR)	2845.601	t km <sup>-2</sup> y <sup>-1</sup>
Sum of all flows into detritus (TD)	4873.439	t km <sup>-2</sup> y <sup>-1</sup>
Total system throughput (TST)	14050.330	t km <sup>-2</sup> y <sup>-1</sup>
Sum of all production (TP)	4297.950	t km <sup>-2</sup> y <sup>-1</sup>
Mean trophic level of the catch (TLc)	2.482	-
Gross efficiency (catch/net p.p.)	0.007	-
Calculated total net primary production (TNPP)	3499.795	t km <sup>-2</sup> y <sup>-1</sup>
Net system production (NSP)	654.194	t km <sup>-2</sup> y <sup>-1</sup>
Total biomass (excluding detritus) (TB)	1716.580	t km <sup>-2</sup> y <sup>-1</sup>
<b>Ecosystem maturity</b>		
Total primary production/total respiration (TPP/TR)	1.230	-
Total primary production/total biomass (TPP/TB)	2.039	-
Total biomass/total throughput (TB/TST)	0.122	-
<b>Food web structure</b>		
Connectance Index (CI)	0.253	-
System Omnivory Index (SOI)	0.075	-
Finn's cycling index (FCI)	23.62	% of total throughput
Finn's mean path length (FML)	4.015	-
Ascendancy (A)	0.274	-
System overhead (O)	0.726	-
<b>Model reliability</b>		
Ecopath pedigree index	0.511	-
Measure of fit ( t*)	2.523	-



## **CONCLUSIONS GENERALES ET PERSPECTIVES**

### **1. Conclusions générales**

La question de la dynamique spatiotemporelle des communautés de poissons comprend une synthèse de tous les facteurs climatiques, physicochimiques et les interactions biotiques qui influencent la distribution et la coexistence des espèces, particulièrement dans le système fortement gouverné par les crues saisonnières. À l'échelle du bassin du Mékong en aval (LMB), les caractéristiques physicochimiques de l'eau variaient d'une manière significative au long du gradient longitudinal du fleuve Mékong et 4 clusters associés aux différentes caractéristiques ont été identifiés. Visiblement, une dégradation de la qualité écologique a été observée de l'amont vers l'aval et plus marquée dans le delta du Mékong où la densité de la population et le développement agricole sont intensifs. Par conséquent, 4 assemblages de poissons ont été déterminés au long du gradient amont-aval de LMR selon la similarité en composition des espèces. Apparemment, les assemblages en amont étaient composés des espèces adaptées aux conditions montagneuses, à basse température, forte précipitation et une valeur élevée de DO; alors que les assemblages au delta étaient les espèces tolérantes aux niveaux élevés de nutriments et de salinité. À partir du patron spatial de la qualité de l'eau dans le bassin, les caractéristiques physicochimiques du cours d'eau principal (LMR) ne changeaient pas beaucoup, sauf dans le delta. Donc, les variables climatiques pourraient être responsables à la structuration des assemblages de poisson du LMR. Cependant, on voit que la combinaison des facteurs environnementaux (physicochimiques, climatiques) et spatiaux fournissait une meilleure explication de la variation des poissons du LMR, malgré plusieurs études dans d'autres systèmes qui ont révélé la contribution principale des facteurs climatiques ou physicochimiques.

Dans le LMR, la richesse spécifique augmentait de l'amont vers son delta ; pourtant la plus grande diversité s'est trouvée au milieu du cours d'eau au Cambodge, ce qui pourrait

refléter le concept de continuum fluvial (RCC) (Vannote et al. 1980). Pourtant, ce concept est plus applicable aux petites-moyennes rivières des zones tempérées ; probablement ce n'est pas le cas du Mékong. Une meilleure explication de ce patron de diversité pourrait être liée à la condition géographique du fleuve, e.g. faible topographie et absence de barrière, et la connectivité cruciale entre le lac Tonlé Sap et le Mékong au Cambodge, reliant tous les habitats essentiels au cycle de vie des poissons en favorisant leur coexistence.

Ainsi, le lac joue un rôle indispensable pour le maintien de la diversité du système car il fournit d'une part des habitats d'alimentation et d'autre part des habitats de fraie pour des centaines d'espèces de poissons du Mékong. Par conséquent, la structure temporelle des communautés de poissons du lac est fortement influencée par le mouvement des poissons dans le LMB et son régime hydrologique. Le recrutement des grands poissons de haut niveau trophique était plus important au cours de l'étiage, tandis que les petits poissons de bas niveau trophique dominaient au cours des hautes eaux. Également, les poissons noirs de stratégie d'équilibre caractérisaient la communauté pendant les basses eaux et progressivement la communauté a été remplacée par les poissons blancs de stratégies d'opportunistes et périodiques, quand le niveau de l'eau dans le lac monte. Globalement, la structure temporelle des communautés de poissons dans le lac était associée plutôt aux caractères fonctionnels que taxonomiques et cette variation était fortement conditionnée par la dynamique des crues du Mékong. Effectivement, dans le système où la variation a existé pendant une longue période, les espèces de poissons se sont probablement adaptées à ces différentes conditions afin de sélectionner les niches qui favorisent leur coexistence. Par conséquent, la réponse des communautés au changement du régime hydrologique pourrait être décalée entre 1 à 2 mois avant ou après les pics des pulses, c'est le cas du lac Tonlé Sap. Ce temps de décalage devait être lié à plusieurs facteurs parmi lesquels le mouvement des poissons dans le Mékong déclenché par la première pluie au début de la saison humide pourrait être un des facteurs clés

induisant une migration en masse des poissons vers le lac, e.g. les cyprinidés et poissons-chats.

Au delà, dans le système d'inondation pulsé, la variabilité temporelle imposée par les crues saisonnière pourrait être responsable du maintien de la productivité et de la persistance du réseau trophique complexe dans le système. Concrètement, dans le lac Tonlé Sap, malgré une exploitation intensive des ressources de pêches depuis des années, on voit que l'état écologique du système restait en bonne santé et que l'écosystème atteignait un certain stade de maturité avec une structure des chaînes alimentaires vulnérables. Par ailleurs, la méthode d'exploitation ancienne des ressources de pêche dans le lac « lôt de pêche » pourrait avoir des implications inconsidérées concernant la durabilité et la productivité du système. Effectivement, cette pratique de pêche était caractérisée par un large éventail des engins de pêche en produisant une pêche véritablement non-discriminée qui favorise la coexistence des prédateurs et de leurs proies.

Néanmoins, plusieurs auteurs ont signalé également la dégradation des ressources de pêches dans le lac et que le lac est maintenant dominé par les petites espèces opportunistes de basse valeur économique. Évidemment, cette conclusion doit être suivie par une étude à long terme des structures temporelles des communautés de poissons car les événements extrêmes, e.g. inondations ou sécheresse, pourrait bouleverser la structure des communautés et induire plus de recrutements des petits poissons étant mieux adaptés aux conditions variables du milieu. Cela prend du temps pour que l'écosystème revienne à la condition normale, surtout dans les grands systèmes comme le Tonlé Sap. Ainsi, l'amélioration de notre compréhension sur la façon donc les traits fonctionnels des espèces répondent au changement du régime hydrologique pourrait améliorer énormément notre capacité à expliquer et prédire comment les communautés aquatiques du système répondent aux changements globaux.



## **2. Implications**

Avec les défis de la croissance démographique, l'urbanisation, la nécessité de nourrir la population, ainsi que l'exportation, des impacts sur la biodiversité dans le bassin LMB sont attendus. En combinaison avec cela, la construction des barrages et la vulnérabilité au changement climatique sont les préoccupations majeurs conduisant à la dégradation des ressources de pêches dans le bassin (Vörösmarty *et al.* 2010; Grumbine, Dore & Xu 2012; Arias *et al.* 2014). Dans ce contexte, des plans de gestion et de conservation stratégiques concrets des ressources de pêches sont indispensables pour atténuer les impacts et assurer un développement durable du bassin du Mékong dans son entier.

La zone de conservation prioritaire devrait être la partie intermédiaire du LMR, où la plus grande diversité a été révélée. Cette conservation doit également tenir compte de la partie amont du LMR, entre la chute de Khone et Vientiane, où des niveaux élevés d'endémisme ont été décrits (Coates 2001). De plus, le maintien de la connectivité entre le lac Tonlé Sap et le Mékong est crucial pour la plupart des espèces du Mékong ; donc j'appuie fermement les préoccupations des pertes de biodiversité due à la construction des barrages à travers le long du cours d'eau principal (Hortle 2009; Valbo-Jorgensen *et al.* 2009; Ziv *et al.* 2012). Dans le delta du Mékong, la surveillance et l'amélioration de la qualité de l'eau doivent être abordées rigoureusement (MRC 2008; Dudgeon 2011; Chea, Grenouillet & Lek 2016). Par exemple, la diminution des diversités de poisson au delta pourrait refléter les effets de la pollution de l'eau sur la communauté des poissons. Par conséquent, les cyprinidés et les poisson-chats de type *Pangasius*, qui sont les principales sources de protéines dans la région (Hortle 2007), seraient fortement affectés car ils sont incapables de résister au changement brutal de la condition des eaux. Cependant, l'étude a montré que la combinaison des deux facteurs physico-chimiques et climatiques contribue significativement à la structuration des communautés le long du LMR. Prendre en compte simultanément ces facteurs apparaît donc

crucial si nous voulons initier des stratégies de gestion pour assurer l'utilisation durable et la conservation des ressources dans le fleuve Mékong.

L'évolution temporelle des communautés de poissons a été associée principalement aux traits fonctionnels et la structure des communautés était fortement liée à la dynamique de l'inondation pulsée. Donc toute modification hydrologique induite par les perturbations humaines, e.g. les barrages ou le changement climatique, pourrait modifier fortement la structure des communautés de poissons. En outre, j'ai constaté que les réponses des communautés de poissons aux changements du régime hydrologique étaient décalées entre 1 à 2 mois. Par conséquent, prendre en compte ce temps de décalage serait bénéfique pour les pratiques de conservation et la gestion des pêches dans le système lentique tropical.

La surexploitation des ressources aquatiques est fréquente dans les pêcheries d'aujourd'hui du monde entier (Mchich *et al.* 2006). Pour répondre à la surexploitation et renforcer la structure des chaînes alimentaires du système, les piscivores et omnivores tels que le poisson-chat, snakehead, et les autres omnivores devraient être privilégiés pour le stockage, car ces espèces sont connues pour renforcer le fonctionnement de l'écosystème et la structure des chaînes alimentaires, ainsi que pour améliorer l'efficacité des transferts de l'énergie (Petchey *et al.* 2004; Bruno & O'Connor 2005; Carey & Wahl 2011). De plus, plus d'attention devrait également être accordée à l'utilisation de la production primaire et des détritiques, non seulement pour améliorer l'écoulement de l'énergie dans l'écosystème, mais aussi pour améliorer la qualité de l'eau, surtout pendant la saison sèche où la dégradation de la qualité de l'eau est sévère due à l'excès de la production algale et de la végétation terrestre submergée.

### **3. Perspectives**

Les études de la réponse des communautés face aux perturbations anthropiques et au changement climatique pourraient être essentielles pour la prédiction de la stabilité de l'écosystème en état actuel et dans le futur (Fig. 20). Effectivement, le fonctionnement et

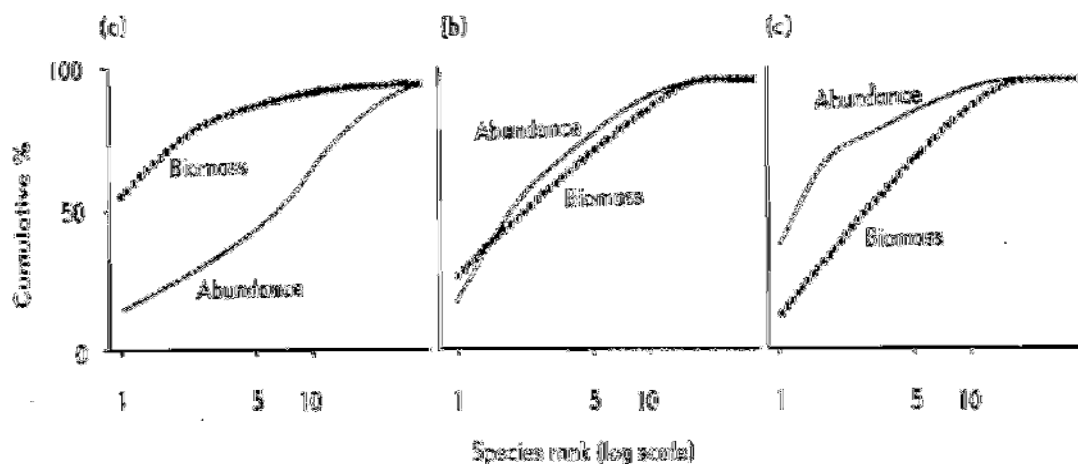
l'état écologique de l'écosystème sont fortement liés à la stabilité des chaînes alimentaires. Cette stabilité est décrite par la résilience et la résistance du réseau trophique face aux perturbations. Tandis que le modèle d'Ecopath décrit tout simplement l'état statique de l'écosystème, le modèle ECOSIM pourrait être utilisé pour quantifier la dynamique des réseaux trophiques du système, et donc pouvoir évaluer la stabilité de l'écosystème sous différents scénarios. Par exemple, qu'est ce qui se passe avec la modification des biomasses des prédateurs de 10% à 20% dans un contexte de surexploitation ou de stockage ? Parallèlement, dans un contexte de constructions de barrages et de pollution trophique, comment répond l'écosystème à une modification des producteurs primaires ? Un scénario intéressant du modèle pourrait porter sur la politique de pêche du gouvernement cambodgien pour évaluer si la suppression des lôts de pêches autour du lac Tonlé Sap est avantageuse.

En Asie du Sud-est, l'agriculture est le moteur de l'économie nationale. L'augmentation des éléments nutritifs dans les cours d'eau apparaît presque partout dans le bassin. Dans le Mékong, la concentration de N est moins importante que celle de P. Donc, l'étude du comportement des communautés face à des phénomènes d'eutrophication est importante pour atténuer les impacts dans le futur. Par exemple, comment est la réponse des communautés aux environnements *N-limités* (e.g. Tonle Sap) et *P-limités* (e.g. le delta du Mékong) ? Cette réponse est-elle conditionnée également par les autres facteurs hydrologiques tels que l'intensité des pulses, la durée et la fréquence de l'inondation ? Et si oui, dans quelle mesure ?

Pour répondre à ces questions, l'évolution temporelle et spatiale des formes des courbes ABC nous permettrait de décrire le comportement des communautés face à des perturbations (Fig. 20) (Warwick 1986; Magurran 2004). Afin d'illustrer les milieux N ou P limités, le lac Tonlé Sap (*N-limité*) et le fleuve Mékong (*P-limité*) sont de bons modèles pour tester ces questions. Effectivement, la forme des courbes ABC est synthétisée par un indice, appelé

l'indice de Warwick (Warwick 1986; Clarke 1990) :  $W = \frac{\sum_{i=1}^S (B_i - A_i)}{50(S-1)}$  Où  $B_i$  est la biomasse

de l'espèce  $i$ ,  $A_i$  est l'abondance relative de l'espèce  $i$  et  $S$  est le nombre des espèces. Donc, l'évolution spatiotemporelle de cet indice en fonction des conditions des milieux pourrait nous aider à montrer la stabilité des communautés à travers le temps et l'espace. Par conséquent, avec ces études, nous pourrions établir un plan stratégique plus concret et robuste pour compenser la dégradation des ressources de pêche.



**Fig. 20.** Diagramme conceptuel des courbes ABC (*Abundance-Biomass-Curve*) montrant les conditions non-perturbées (a), modérément perturbées (b), et fortement perturbées des milieux (Warwick 1986).



**BIBLIOGRAPHIE**

- Abebe B.A., Haq S.M.A., Chien V.Q. & Arafat B. (2010) The Challenges of Integrated Management of Mekong River Basin in Terms of People's Livelihood. *Journal of Water Resource and Protection* **02**, 61–68.
- Agostinho A.A., Gomes L.C., Veri S. & Okada E.K. (2005) Flood regime , dam regulation and fish in the Upper Parana: effect on assemblage attributes , reproduction and recruitment. *Reviews in Fish Biology and Fisheries*, 11–19.
- Agostinho A.A., Thomas S.M., Minte-Vera C.V. & Winemiller K.O. (2000) Biodiversity in the high Parana River floodplains. In: *Biodiversity in wetlands: assessment, function and conservation*. (Eds B. Gopal, W.J. Junk & J.A. Davis), pp. 90–118. Backhuys.
- Agostinho A.A. & Zalewski M. (1995) The dependence of fish community structure and dynamics on floodplain and riparian ecotone zone in Parana River , Brazil. *Hydrobiologia* **303**, 141–148.
- Albert S.J. & Reis E.R. (2011) Introduction to Neotropical Freshwaters. In: *Historical Biogeography of Neotropical Freshwater Fishes*. Berkeley Los Angeles: University of California Press.
- Allan J.D. & Castillo M.M. (2007) *Stream Ecology: Structure and function of running waters*. Springer.
- Amarasinghe U.S. & Welcomme R.L. (2002) An analysis of fish species richness in natural lakes. 327–339.
- Arias M.E., Cochrane T. a., Kumm M., Lauri H., Holtgrieve G.W., Koponen J., *et al.* (2014) Impacts of hydropower and climate change on drivers of ecological productivity of Southeast Asia's most important wetland. *Ecological Modelling* **272**, 252–263.
- Arrington D.A. (2002) *Evaluation of the relationship between habitat structure, community structure, and community assembly in a neotropical blackwater river*. exas A&M University, Texas, College Station. Station. (Doctoral dissertation).
- Arrington D.A. & Winemiller K.O. (2004) Organization and Maintenance of Fish Diversity in Shallow Water of Tropical Floodplain Rivers. In: *Proceedings of the Second International Symposium on the Management of Large Rivers for Fisheries*. (Eds R. Welcomme & T. Petr), pp. 25–36. RAP Publication 2004/16, Regional Office for Asia and the Pacific, Bangkok, Thailand.
- Bady P., Dolédec S., Dumont B. & Fruget J.-F. (2004) Multiple co-inertia analysis: a tool for assessing synchrony in the temporal variability of aquatic communities. *Comptes Rendus Biologies* **327**, 29–36.
- Baran E. (2006) *Fish migration triggers in the Lower Mekong Basin and other tropical freshwater systems*. MRC Technical Paper No. 14. Mekong River Commission. 70pp.
- Baran E. & Myschowoda C. (2008) Have Fish Catches Been Declining in the Mekong River Basin ? *Water & Development Publication - Helsinki University of Technology*, 55–64.
- Baran E., Penh P., Degen P., River M. & Cas Z. (2013) Updated information on fish and fisheries in Updated information on fish and fisheries in the Mekong Basin. *Catch and Culture*.
- Baran E., So N., Arthur R., Leng S.V. & Kura Y. (2006) *Bioecology of 296 fish species of the Tonle Sap Great Lake (Cambodia)*. Technical Assistance to the Kingdom of Cambodia for the Study of the Influence of Built Structures on the Fisheries of the Tonle Sap. 166pp.

- Baran E., So N. & Leng S.V. (2008) *Integrating fish resources to Agro-Ecosystem Analyses*. Phnom Penh, Cambodia.
- Baran E., So N., Leng S.V., Arthur R. & Kura Y. (2007) *Relationships between bioecology and hydrology among Tonle Sap fish species*.
- Bayley P.B. (1995) Understanding Large River-Floodplain Ecosystems stability would result from restoration of impaired systems. *BioScience* **45**, 153–158.
- Berra T. (2001) *Freshwater fish distribution*. Press, San Diego, CA.
- Blanck A., Tedesco P. a. & Lamouroux N. (2007) Relationships between life-history strategies of European freshwater fish species and their habitat preferences. *Freshwater Biology* **52**, 843–859.
- Borcard D., Legendre P. & Drapeau P. (1992) Partialling out the Spatial Component of Ecological Variation. *Ecology* **73**, 1045–1055.
- Ter Braak C.J.. & Prentice I.C. (1988) A Theory of Gradient Analysis. *Advances in Ecological Research* **34**, 271–317.
- Braaten P.J. & Guy C.S. (1999) Relations between Physicochemical Factors and Abundance of Fishes in Tributary Confluences of the Lower Channelized Missouri River. *Transactions of the American Fisheries Society* **128**, 1–6.
- Bruno J.F. & O'Connor M.I. (2005) Cascading effects of predator diversity and omnivory in a marine food web. *Ecology Letters* **8**, 1048–1056.
- Buisson L., Blanc L. & Grenouillet G. (2008) Modelling stream fish species distribution in a river network: The relative effects of temperature versus physical factors. *Ecology of Freshwater Fish* **17**, 244–257.
- De Caceres M., Legendre P. & Moretti M. (2010) De-Caceres\_2010. *Oikos* **119**, 1674–1684.
- Campbell I.C. (2007) Perceptions, data, and river management: Lessons from the Mekong River. *Water Resources Research* **43**, 1–13.
- Campbell I.C., Poole C., Giesen W. & Valbo-Jorgensen J. (2006) Species diversity and ecology of Tonle Sap Great Lake, Cambodia. *Aquatic Sciences* **68**, 355–373.
- Carey M.P. & Wahl D.H. (2011) Fish diversity as a determinant of ecosystem properties across multiple trophic levels. *Oikos* **120**, 84–94.
- di Castri F. & Younes T. (1989) Ecosystem Function of Biological Diversity. *Biology International*, 1–19.
- Chau N., Sebesvari Z., Amelung W. & Renaud F. (2015) Pesticide pollution of multiple drinking sources in the Mekong Delta, Vietnam: evidence from two provinces. *Environmental Science and Pollution Research* **22**, 9042–9058.
- Chea R., Grenouillet G. & Lek S. (2016a) Evidence of water quality degradation in Lower Mekong Basin revealed by Self Organizing Map. *Plos One* **11**.
- Chea R., Guo C., Grenouillet G. & Lek S. (2016b) Toward an ecological understanding of a flood-pulse system lake in a tropical ecosystem: Food web structure and ecosystem health. *Ecological Modelling* **323**, 1–11.
- Chessel D. & Hanafi M. (1996) Analyses de la co-inertie de K nuages de points. *Revue Statistique Appliquée* **44**, 35–60.
- Christensen V. & Pauly D. (1993) Trophic models of aquatic ecosystem. In: *ICLARM Conf. Pro.* 29. p. 390pp. Manila, Philippines.
- Christensen V., Walters C.J. & Pauly D. (2005) *Ecopath with Ecosim: A user's guide*.

- Clarke K.R. (1990) Comparisons of dominance curves. *Journal of Experimental Marine Biology and Ecology* **138**, 143–157.
- Coates D. (2001) *Biodiversity and Fisheries Management Opportunities in the Mekong River Basin*. Fisheries Programme, Mekong River Commission, Vientiane Lao PDR.
- Coates D., Ouch P., Suntornratana U., Nguyen T.T. & Sinthavong V. (2003) *Biodiversity and Fisheries in the Lower Mekong Basin*. Mekong Development Series No.2. Mekong River Commission, Phnom Penh, 30pp.
- Coll M., Bundy A. & Shannon L.J. (2009) Ecosystem Modelling Using the Ecopath with Ecosim Approach. In: *Computers in Fisheries Research*. pp. 145–190.
- Cooperman M.S., So N., Arias M., Cochran T. a, Hand T., Hannah L., *et al.* (2012) A watershed moment for the Mekong: newly announced community use and conservation areas for the Tonle Sap Lake may boost sustainability of the world's largest inland fishery. *Cambodian Journal of Natural History*, 101–106.
- Darwall W.R.T., Allison E.H., Turner G.F. & Irvine K. (2010) Lake of flies, or lake of fish? A trophic model of Lake Malawi. *Ecological Modelling* **221**, 713–727.
- Daufresne M., Bady P. & Fruget J.-F. (2007) Impacts of global changes and extreme hydroclimatic events on macroinvertebrate community structures in the French Rhône River. *Oecologia* **151**, 544–59.
- Daufresne M., Lengfellner K. & Sommer U. (2009) Global warming benefits the small. *Proceedings of the National Academy of Sciences of the United States of America* **106**.
- Dray S., Dufour A.B. & Chessel D. (2007) The ade4 package-II: Two-table and K-table methods. *R News* **7**, 47–52.
- Dudgeon D. (2011) Asian river fishes in the Anthropocene: threats and conservation challenges in an era of rapid environmental change. *Journal of fish biology* **79**, 1487–524.
- Dudgeon D. (2003) The contribution of scientific information to the conservation and management of freshwater biodiversity in tropical Asia. *Hydrobiologia* **500**, 295–314.
- Dudgeon D. (2000) The Ecology of Tropical Asian Rivers and Streams in Relation to Biodiversity Conservation. *Annual Review of Ecology and Systematics* **31**, 239–263.
- Dugan P.J., Barlow C., Agostinho A. a., Baran E., Cada G.F., Chen D., *et al.* (2010) Fish Migration, Dams, and Loss of Ecosystem Services in the Mekong Basin. *Ambio* **39**, 344–348.
- Edna F., Cunha D.A., Monteiro-neto C., Nottingham M.C. & Fluminense U.F. (2007) Temporal and spatial variations in tidepool fish assemblages of the northeast coast of Brazil. *Biota Neotropica* **7**, 111–119.
- Enomoto K., Ishikawa S., Hori M., Sitha H., Song S.L., Thuok N., *et al.* (2011) Data mining and stock assessment of fisheries resources in Tonle Sap Lake, Cambodia. *Fisheries Science* **77**, 713–722.
- Fang J., Wang Z., Zhao S., Li Y., Tang Z., Yu D., *et al.* (2006) Biodiversity changes in the lakes of the Central Yangtze. *Front Ecol Environ* **4**, 369–377.
- Fang W. (2010) River-Continuum and Flood-Pulse: Exploring Ecological and Hydrologic Concepts in Riparian-wetland. *National Taiwan Museum*, 101–111.
- FAO (1995) *Code of Conduct for Responsible Fisheries*. United Nations of Food and Agriculture Organization. Rome, Italy.
- Fedra K., Winkelbauer L. & Pantulu V.R. (2004) *Environmental problems of water resources*



- development in the Lower Mekong Basin*. International Institute for Applied Systems Analysis, A- 2361, Laxenburg, Austria. Retrieved September, 2004.
- Ferreira L.V. & Stohlgren T.J. (1999) Effects of river level fluctuation on plant species richness, diversity, and distribution in a floodplain forest in Central Amazonia. *Oecologia* **120**, 582–587.
- Fetahi T. & Mengistou S. (2007) Trophic analysis of Lake Awassa (Ethiopia) using mass-balance Ecopath model. *Ecological Modelling* **201**, 398–408.
- Fetahi T., Schagerl M., Mengistou S. & Libralato S. (2011) Food web structure and trophic interactions of the tropical highland lake Hayq, Ethiopia. *Ecological Modelling* **222**, 804–813.
- FEVM (2007) *Monitoring Fish Abundance and Diversity in the Lower Mekong Basin : Methodological Guidelines*. Mekong River Commission. Phnom Penh, Cambodia. 12pp.
- Froese R. & Pauly D. (2015) FishBase. *World Wide Web electronic publication*.
- Grenouillet G., Hugueny B., Carrel G.A., Olivier J.M. & Pont D. (2001) Large-scale synchrony and inter-annual variability in roach recruitment in the Rhone River: the relative role of climatic factors and density-dependent processes. *Freshwater Biology* **46**, 11–26.
- Grossman G.D., Moyle P.B. & Whitaker J.O. (1982) Stochasticity in Structural and Functional Characteristics of an Indiana Stream Fish Assemblage: A Test of Community Theory. *The American Naturalist* **117**, 423–454.
- Grossman G.D., Ratajczak R.E., Crawford M. & Freeman M.C. (1998) Assemblage organization in stream fishes: Effect of environmental variation and interspecific interactions. *Ecological Monographs* **68**, 395–420.
- Grumbine R.E., Dore J. & Xu J. (2012) Mekong hydropower: drivers of change and governance challenges. *Front Ecol Envir* **5**, 91–98.
- Guégan J.F., Lek S. & Oberdorff T. (1998) Energy availability and habitat heterogeneity predict global riverine fish diversity. *Nature* **391**, 382–384.
- Guo C., Lek S., Ye S., Li W., Liu J., Chen Y., *et al.* (2015) Predicting fish species richness and assemblages with climatic, geographic and morphometric factors: A broad-scale study in Chinese lakes. *Limnologia - Ecology and Management of Inland Waters* **54**, 66–74.
- Guo C., Ye S., Lek S., Liu J., Zhang T., Yuan J., *et al.* (2013) The need for improved fishery management in a shallow macrophytic lake in the Yangtze River basin: Evidence from the food web structure and ecosystem analysis. *Ecological Modelling* **267**, 138–147.
- Hart B.T., Jones M.J. & Pistone G. (2001) *Transboundary Water Quality Issues in the Mekong River Basin* *Transboundary Water Quality Issues in the*.
- Holt D.R. (1996) Temporal and Saptatial Aspects of Food Web Structure and Dynamics. In: *Food Webs: Integration of Patterns and Dynamics*. (Eds G.A. Polis & K.O. Winemiller), Springer-Science & Business Media, B.V.
- Hortle K.G. (2007) Consumption and the yield of fish and other aquatic animals from the Lower Mekong Basin. 87.
- Hortle K.G. (2009) Fisheries of the Mekong River Basin. In: *The Mekong Biophysical environment of an international river basin*. (Ed. I.C. Campbell), pp. 197–249. Academic, Amsterdam.
- Ings T.C., Montoya J.M., Bascompte J., Blüthgen N., Brown L., Dormann C.F., *et al.* (2009)

- Ecological networks - Beyond food webs. *Journal of Animal Ecology* **78**, 253–269.
- Janjua M.Y. & Gerdeaux D. (2009) Preliminary trophic network analysis of subalpine Lake Annecy (France) using an Ecopath model. *Knowledge and Management of Aquatic Ecosystems*, 02.
- Jia P., Hu M., Hu Z., Liu Q. & Wu Z. (2012) Modeling trophic structure and energy flows in a typical macrophyte dominated shallow lake using the mass balanced model. *Ecological Modelling* **233**, 26–30.
- Junk W.J. (1997) *The Central Amazon Floodplain: Ecology of a Pulsing System*. Springer-Verlag Berlin Heidelberg.
- Junk W.J., Bayley P.B. & Sparks R.E. (1989) The Flood Pulse Concept in River-Floodplain Systems. In: *International Large River Symposium*. (Ed. D.P. Dodge), pp. p. 110–127. Can. Spec. Publ. Fish. Aquat. Sci. 106.
- Junk W.J. & Wantzen K.M. (2004) The Flood Pulse Concept: New aspect, approaches and application-An update. In: *Second International Symposium on the Management of Large River*. pp. 117–132.
- de Kerckhove D.T., Minns C.K. & Chu C. (2015) Estimating Fish Exploitation and Aquatic Habitat Loss across Diffuse Inland Recreational Fisheries. *Plos One* **10**, e0121895.
- Kitchell J.F., Cox S.P., Harvey C.J., Johnson T.B., Mason D.M., Schoen K.K., *et al.* (2000) Sustainability of the Lake Superior fish community: Interactions in a food web context. *Ecosystems* **3**, 545–560.
- Kummu M. & Sarkkula J. (2008) Impact of the Mekong River Flow Alteration on the Tonle Sap Flood Pulse. *Ambio*, 185–192.
- Lamberts D. (2001) *Tonle Sap fisheries: a case study on floodplain gillnet fisheries*. Asia-Pacific Fishery Commission, Food and Agriculture Organization, Bangkok, Thailand.
- Layman C.A., Winemiller K.O., Arrington D.A. & Jepsen D.B. (2005) Body size and trophic position in a diverse tropical food web. *Ecology* **86**, 2530–2535.
- Legendre P. & Legendre L. (2012) Canonical analysis. In: *Numerical Ecology*, 3rd Editio. Elsevier.
- Lek S. & Guégan J.F. (1999) Artificial neural networks as a tool in ecological modelling, an introduction. *Ecological Modelling* **120**, 65–73.
- Lévêque C., Oberdorff T., Paugy D., Stiassny M.L.J. & Tedesco P. a. (2007) Global diversity of fish (Pisces) in freshwater. *Hydrobiologia* **595**, 545–567.
- Li Y., Chen Y., Song B., Olson D. & Yu N. (2009) Ecosystem structure and functioning of Lake Taihu (China) and the impacts of fishing. *Fisheries Research* **95**, 309–324.
- Li Y., Song B., Chen Y., Chen L., Yu N. & Olson D. (2010) Changes in the trophic interactions and the community structure of Lake Taihu (China) ecosystem from the 1960s to 1990s. *Aquatic Ecology* **44**, 337–348.
- Liebhold A., Koenig W.D. & Bjørnstad O.N. (2004) Spatial Synchrony in Population Dynamics\*. *Annual Review of Ecology, Evolution, and Systematics* **35**, 467–490.
- Likens G.E. (2010) Introduction to river ecosystem ecology. In: *River Ecosystem Ecology: A global perspective*. pp. 11–12. Elsevier.
- Lim P., Lek S., Touch S.T., Mao O.S. & Chhouk B. (1999) Diversity and spatial distribution of freshwater fish in Great Lake and Tonle Sap river. *Aquat. Living Resour.* **12**, 379–386.
- Liu Q.G., Chen Y., Li J. Le & Chen L.Q. (2007) The food web structure and ecosystem

- properties of a filter-feeding carps dominated deep reservoir ecosystem. *Ecological Modelling* **203**, 279–289.
- Lowe-McConnell R.H. (1987) *Ecological Studies in the Tropical Fish Community*. Cambridge University Press, Cambridge.
- Lu X.X., Kummu M. & Oeurng C. (2014a) Reappraisal of sediment dynamics in the Lower Mekong River, Cambodia. *Earth Surface Processes and Landforms* **39**, 1855–1865.
- Lu X.X., Li S., Kummu M., Padawangi R. & Wang J.J. (2014b) Observed changes in the water flow at Chiang Saen in the lower Mekong: Impacts of Chinese dams? *Quaternary International* **336**, 145–157.
- Lu X.X. & Siew R.Y. (2006) Water discharge and sediment flux changes over the past decades in the Lower Mekong River: possible impacts of the Chinese dams. *Hydrology and Earth System Sciences* **10**, 181–195.
- Lucas M.C., Baras E., Thom T.J., Duncan A. & Slavik O. (2001) Migration and Spatial Behaviour. In: *Migration of Freshwater Fishes*. pp. 1–12. Osney Mead, Oxford OX2 0EL: Blackwell Science Ltd.
- Lujan N.K., Roach K. a., Jacobsen D., Winemiller K.O., Vargas V.M., Ching V.R., *et al.* (2013) Aquatic community structure across an Andes-to-Amazon fluvial gradient. *Journal of Biogeography* **40**, 1715–1728.
- Magurran A.E. (2004) Comparative studies of diversity. In: *Measuring Biological Diversity*. pp. 131–160. Blackwell Science Ltd.
- Magurran A.E., Baillie S.R., Buckland S.T., Dick J.M., Elston D. a, Scott E.M., *et al.* (2010) Long-term datasets in biodiversity research and monitoring: assessing change in ecological communities through time. *Trends in ecology & evolution* **25**, 574–82.
- Matsui S. (2005) *Tonle Sap Experience and Lessons Learned Brief*.
- Matthews W.J. (1986) Linked references are available on JSTOR for this article : Fish Faunal Structure in an Ozark Stream : Stability , Persistence and a Catastrophic Flood. *Copeia* **2**, 388–397.
- Matthews W.J. (1998) *Patterns in Freshwater Fish Ecology*. Springer Science & Business Media.
- McCann K.S., Gellner G., McMeans B.C., Deenik T., Holtgrieve G., Rooney N., *et al.* (2015) Food webs and the sustainability of indiscriminate fisheries. *Canadian Journal of Fisheries and Aquatic Sciences* **73**, 656–665.
- Mchich R., Charouki N., Auger P., Raïssi N. & Ettahiri O. (2006) Optimal spatial distribution of the fishing effort in a multi fishing zone model. *Ecological Modelling* **197**, 274–280.
- Merigoux S., Doledec S. & Statzner B. (2001) Species traits in relation to habitat variability and state : neotropical juvenile fish in floodplain creeks. *Freshwater Biology* **46**, 1251–1267.
- Merigoux S. & Ponton D. (1999) Spatio-temporal distribution of young fish in tributaries of natural and flow-regulated sections of a neotropical river in French Guiana. *Freshwater Biology* **42**, 177–198.
- Mittermeier R., Turner W., Larsen F., Brooks T. & Gascon C. (2011) Global biodiversity conservation: the critical role of hotspots. In: *Biodiversity hotspots: distribution and protection of conservation priority areas*. (Eds F. Zachos & J. Habel), Springer, Heidelberg.
- Morissette L., Hammill M.O. & Savenkoff C. (2006) The Trophic Role of Marine Mammals

- in the Northern Gulf of St. Lawrence. *Marine Mammal Science* **22**, 74–103.
- MRC (2008) *An assessment of water quality in the Lower Mekong Basin*. MRC Technical Paper No.19. (Eds E. Ongley & T.J. Burnhill), Mekong River Commission, Vientiane. 70pp.
- MRC (2010a) *Assessment of basin-wide development scenarios: Impacts on the Tonle Sap Ecosystem*. Mekong River Commission. Vientiane, Lao PDR. 45 pp.
- MRC (2007a) *Diagnostic study of water quality in the Lower Mekong Basin*. MRC Technical Paper No.15. Mekong River Commission, Vientiane. 57pp.
- MRC (2007b) *Fish migration triggers the Lower Mekong*. Mekong Fisheries Management Recommendation No 6. Mekong River Commission. Vientian Lao PDR. 8pp.
- MRC (2015) Fisheries Research and Development in the Mekong Region. *Catch and Culture* **21**.
- MRC (2005) *Overview of the Hydrology of the Mekong Basin*. MRC Technical Paper, Mekong River Commission, Vientian.
- MRC (2010b) *The Mekong River Report on Water Quality*. Mekong River Commission, Vientiane, 16pp.
- Murdoch W.W. (1994) Population regulation in theory and practice. *Ecology* **75**, 271–287.
- Murtagh F. & Legendre P. (2014) Ward 's Hierarchical Agglomerative Clustering Method : Which Algorithms Implement Ward 's Criterion? *Journal of Classification* **31**, 274–295.
- Ngor P.B. (2012) Monitoring fish abundance and diversity around the Tonle Sap Lake. *Catch and Culture* **20**, 20–27.
- Oberdorff T., Guegan J.-F. & Hugueny B. (1995) Global scale patterns of fish species richness in rivers. *Ecography* **18**, 345–352.
- OCHA (2013) Cambodia: Hundreds of thousands affected by floods. *United Nations Office for the Coordinations of Humanitarian Affairs*, Bangkok, Thailand.
- Odum E.P. (1969) The strategy of ecosystem development. *Science (New York, N.Y.)* **164**, 262–270.
- Olden J.D., Kennard M.J., Leprieur F., Tedesco P. a., Winemiller K.O. & García-Berthou E. (2010) Conservation biogeography of freshwater fishes: recent progress and future challenges. *Diversity and Distributions* **16**, 496–513.
- Ozaki H., Co T.K., Le A.K., Pham V.N., Nguyen V.B., Tarao M., *et al.* (2014) Human factors and tidal influences on water quality of an urban river in Can Tho, a major city of the Mekong Delta, Vietnam. *Environmental Monitoring and Assessment* **186**, 845–858.
- Pease A.A., González-Díaz A.A., Rodiles-Hernández R. & Winemiller K.O. (2012) Functional diversity and trait-environment relationships of stream fish assemblages in a large tropical catchment. *Freshwater Biology* **57**, 1060–1075.
- Pease A.A., Taylor J.M., Winemiller K.O. & King R.S. (2015) Ecoregional, catchment, and reach-scale environmental factors shape functional-trait structure of stream fish assemblages. *Hydrobiologia* **753**, 265–283.
- Petchey O.L., Gaston K.J., Downing A.L., Mittelbach G.G., Persson L., Steiner C.F., *et al.* (2004) Species loss and the structure and functioning of multitrophic aquatic systems. *Oikos* **104**, 467–478.
- Phong N.D., Hoanh C.T., Tuong T.P. & Malano H. (2014) Effective management for acidic

- pollution in the canal network of the Mekong Delta of Vietnam: A modeling approach. *Journal of environmental management* **140**, 14–25.
- Phung D., Huang C., Rutherford S., Dwirahmadi F., Chu C., Wang X., *et al.* (2015) Temporal and spatial assessment of river surface water quality using multivariate statistical techniques: a study in Can Tho City, a Mekong Delta area, Vietnam. *Environmental Monitoring and Assessment* **187**.
- Pires D.F., Pires A.M., Collares-Pereira M.J. & Magalhães M.F. (2010) Variation in fish assemblages across dry-season pools in a Mediterranean stream: effects of pool morphology, physicochemical factors and spatial context. *Ecology of Freshwater Fish* **19**, 74–86.
- Poff N.L. & Allan J.D. (1995) Functional Organization of Stream Fish Assemblages in Relation to Hydrological Variability. *Ecology* **76**, 606–627.
- Pool T.K., Olden J.D., Whittier J.B. & Paukert C.P. (2010) Environmental drivers of fish functional diversity and composition in the Lower Colorado River Basin. *Canadian Journal of Fisheries and Aquatic Sciences* **67**, 1791–1807.
- Poulsen A.F., Hortle K.G., Valbo-Jorgensen J., Chan S., Chhuon C.K., Viravong S., *et al.* (2004) Distribution and Ecology of Some Important Riverine Fish Species of the Mekong River Basin. *MRC Technical Paper No. 10. ISSN: 1683-1489*, 1–116.
- Poulsen A.F., Poeu O., Viravong S., Suntornratana U. & Tung N.T. (2002) Fish migrations of the Lower Mekong River Basin: implications for development, planning and environmental management. *MRC Technical Paper No. 8, Mekong River Commission, Phnom Penh. 62 pp. ISSN: 1683-1489*, 62.
- R Core Team (2015a) R: A Language and Environment for Statistical Computing.
- R Core Team (2015b) R: A language and environment for statistical computing. R Foundation for Statistical Computing, Vienna, Au.
- Ranta E., Kaitala V. & Lundberg P. (1997) The Spatial Dimension in Population Fluctuations. *Science* **278**, 1621–1624.
- Reash J.R. & Pigg J. (1990) Physicochemical Factors Affecting the Abundance and Species Richness of Fishes in the Cimarron River. *Proc Okla Acad Sci* **28**, 23–28.
- Robert P. & Escoufier Y. (1976) A Unifying Tool for Linear Multivariate Statistical Methods: The RV- Coefficient. *Journal of the Royal Statistical Society: Series C (Applied Statistics)* **25**, 257–265.
- Robert R.T. (1993) Artisanal fisheries and fish ecology below the great waterfalls in the Mekong River in Southern Laos. *Nat. Hist. Bull. Siam. Soc.* **41**, 31–62.
- Robert T.R. & Baird I.G. (1995) Traditional Fisheries and Fish Ecology on the Mekong River at the Khone Waterfalls in Southern Laos. *Nat. Hist. Bull. Siam. Soc* **43**, 219–262.
- Romanuk T.N., Hayward A. & Hutchings J. a. (2011) Trophic level scales positively with body size in fishes. *Global Ecology and Biogeography* **20**, 231–240.
- Sala E., Boudouresque C.F. & Harmelin-Vivien M. (1998) Fishing, trophic cascades, and the structure of algal assemblages: evaluation of an old but untested paradigm. *Oikos* **82**, 425–439.
- Sale P.F. (2004) Connectivity , Recruitment Variation , and the Structure of Reef Fish Communities 1. *Integrative and Comparative Biology* **44**, 390–399.
- Santin-Janin H., Hugueny B., Aubry P., Fouchet D., Gimenez O. & Pontier D. (2014) Accounting for sampling error when inferring population synchrony from time-series

- data: a Bayesian state-space modelling approach with applications. *PloS one* **9**, e87084.
- Shumway H.R. & Stoffer S.D. (2015) Time Series Characteristics. In: *Time Series Analysis and Its Applications*, EZ Edition. pp. 1–25. Department of Statistics, University of Pittsburgh.
- Silvano R.A., Benedito D. & Oyakawa O.T. (2000) Spatial and temporal patterns of diversity and distribution of the Upper Jurua River fish community ( Brazilian Amazon ). *Environmental Biology of Fishes* **57**, 25–35.
- Simões N.R., Dias J.D., Leal C.M., de Souza Magalhães Braghin L., Lansac-Tôha F.A. & Bonecker C.C. (2013) Floods control the influence of environmental gradients on the diversity of zooplankton communities in a neotropical floodplain. *Aquatic Sciences* **75**, 607–617.
- Sinthavong V. (2006) *Observations of the fisheries of the Mekong with notes on the life history strategies of four fish species ( Botia Henicorhynchus waandersii Probarbus jullieni ) being a Thesis submitted for the Degree of Doctor of Philosophy in the University of Hull*. Doctor of Philosophy: The University of Hull.
- Snidvong A. & Teng S.K. (2006) *Global Internation Water Assessment: GIWA Regional assessment 55 Mekong River*. UNEP, University of Kalmar, Kalmar, Sweden.
- Statzner B. & Higler B. (1985) Questions and Comments on the River Continuum Concept. *Canadian Journal of Fisheries and Aquatic Sciences* **42**.
- Straile D. (2005) Food webs in lakes - seasonal dynamics and the impact of climate variability. In: *Aquatic Food Webs: an ecosystem approach*. (Eds A. Belgrano, U.M. Scharler, J. Dunne & R.E. Ulanowicz), pp. 41–51. Oxford University Press.
- Tedesco P.A., Hugueny B., Oberdorff T., Dürr H.H., Mérigoux S. & de Mérona B. (2008) River hydrological seasonality influences life history strategies of tropical riverine fishes. *Oecologia* **156**, 691–702.
- Tedesco P.A., Hugueny B., Paugy D. & Fermon Y. (2004) Spatial synchrony in population dynamics of West African fishes : a demonstration of an intraspecific and interspecific Moran effect. *Journal of Animal Ecology* **73**, 693–705.
- Tejerina-garro F.L., Fortin R. & Rodríguez M.A. (1998) Fish community structure in relation to environmental variation in floodplain lakes of the Araguaia River , Amazon Basin. *Environmental Biology of Fishes* **51**, 399–410.
- Tockner K., Malard F. & Ward J. V (2000) An extension of the food pulse concept. *Hydrological Processes* **2883**, 2861–2883.
- Traore A., Ouattara A., Doumbia L., Moreau J. & Gourène G. (2008) First record of the western tubenose goby *Proterorhinus semilunaris* (Heckel, 1837) in France. *Knowledge and Management of Aquatic Ecosystems* **389**, 1–5.
- Trujillo-Jiménez P., López-López E., Díaz-Pardo E. & Camargo J. a. (2009) Patterns in the distribution of fish assemblages in Río Amacuzac, Mexico: influence of abiotic factors and biotic factors. *Reviews in Fish Biology and Fisheries* **20**, 457–469.
- Valbo-Jorgensen J., Coates D. & Hortle K. (2009) Fish Diversity in the Mekong River Basin. In: *The Mekong biophysical environment of an international river basin*. Elsevier Academic Press.
- Vannote R.L., Minshall G.W., Cummins K.W., Sedell J.R. & Cushing C.E. (1980) The River Continuum Concept. *Canadian Journal of Fisheries and Aquatic Sciences* **37**, 130–137.
- Venables W.N. & Ripley B.D. (2002) Time Series Analysis. In: *Modern Applied Statistics with S*, Fourth edi. pp. 387–414. Springer-Verlag.

- Vörösmarty C.J., McIntyre P.B., Gessner M.O., Dudgeon D., Prusevich A., Green P., *et al.* (2010) Global threats to human water security and river biodiversity. *Nature* **467**, 555–561.
- Wang J., Lu X.X. & Kumm M. (2011) Sediment Load Estimates and Variations in the Lower Mekong River. *River. Res. Applic.* **7**, 189.
- Wantzen K.M., Machado F.D.A., Voss M., Boriss H. & Junk W.J. (2002) Seasonal isotopic shifts in fish of the Pantanal wetland , Brazil. **64**, 239–251.
- Ward J., Tockner K. & Schiemer F. (1999) Biodiversity of Floodplain River Ecosystems : Ecotones and Connectivity. *River Research and Application*.
- Warwick R.M. (1986) A new method for detecting pollution effects on marine macrobenthic communities. *Marine Biology* **92**, 557–562.
- Welcomme R.L. (1988) Concluding Remarks I: On the Nature of Large Tropical Rivers, Floodplains, and Future Research Directions. *J. N. Am. Benthol. Soc.* **7**, 525–526.
- Welcomme R.L. (1995) Relationship between fisheries and the integrity of river system. *Regulated Rivers: Research and Management* **11**, 121–136.
- Wilbers G.-J., Becker M., Nga L.T., Sebesvari Z. & Renaud F.G. (2014) Spatial and temporal variability of surface water pollution in the Mekong Delta, Vietnam. *The Science of the total environment* **485-486**, 653–65.
- Winemiller K.O. (1996) Dynamic diversity in fish assemblages of tropical rivers. In: *Long-term studies of vertebrates communities*. (Ed. M.L. Cody), pp. 99–134. Academic Press, London.
- Winemiller K.O. (2005) Life history strategies , population regulation , and implications for fisheries management. *Canadian Journal of Fisheries and Aquatic Sciences* **62**, 872–885.
- Winemiller K.O. (1989) Patterns of variation in life history among South American fishes in seasonal environments. **241**, 225–241.
- Winemiller K.O. & Rose K.A. (1992) Implications for Population Regulation. *Canadian Journal of Fisheries and Aquatic Sciences* **49**, 2196–2218.
- Worm B. & Duffy J.E. (2003) Biodiversity, productivity and stability in real food webs. *Trends in Ecology and Evolution* **18**, 628–632.
- Xu F.L., Tao S., Dawson R.W., Li P.G. & Cao J. (2001) Lake ecosystem health assessment: indicators and methods. *Water research* **35**, 3157–3167.
- van Zalinge N., Degen P., Pongsri C., Nuov S., Jensen J.G., Nguyen V.H., *et al.* (2004) The Mekong River System. In: *Proceedings of the Second International Symposium on the Management of Large Rivers for Fisheries*. pp. 1–21.
- Van Zalinge N., Nao T. & Sam N. (2001) Status of the Cambodian inland capture fisheries sector with special reference to the Tonle Sap Great Lake. Pp. 10-16 in van Zalinge, Sam Nuov, R. Ounsted, Lieng Sopha. pp. 1–8. Crossing Boundaries, the Seventh Biennial Conference of the Interna.
- van Zalinge N., Nao T. & Touch S.T. (1998) Where There is Water, There is Fish? Fisheries Issues in the Lower Mekong Basin from a Cambodian Perspective. In: *Crossing Boundaries, the Seventh Biennial Conference of the International Association for the Study of Common Property*. Vancouver, British Columbia, Canada.
- Zeug S.C. & Winemiller K.O. (2008) Relationships between ydrology, spatial heterogeneity, and fish recruitment dynamics in a temperate floodplain river. *River. Res. Applic.* **102**,

90–102.

Zhao T., Grenouillet G., Pool T., Tudesque L. & Cucherousset J. (2015) Environmental determinants of fish community structure in gravel pit lakes. *Ecology of Freshwater Fish*, n/a–n/a.

Ziv G., Baran E., Nam S., Rodríguez-Iturbe I. & Levin S. a (2012) Trading-off fish biodiversity, food security, and hydropower in the Mekong River Basin. *Proceedings of the National Academy of Sciences of the United States of America* **109**, 5609–14.





## APPENDICE I

Composition des espèces principales dans chaque catégorie de l'écosystème Tonle Sap

No	Nom de catégorie	Composition des espèces principales
1	Snakehead	<i>Channa micropeltes</i> , <i>Channa striata</i> , <i>Channa gachua</i> , <i>Channa lucius</i>
2	Catfish	<i>Pangasius</i> sp. ( <i>hypophthalmus</i> , <i>conchophilus</i> ), <i>Pangasius larnaudii</i>
3	Soldier river barb	<i>Cyclocheilichthys enoplos</i>
4	Perch	<i>Anabas testudineus</i> , <i>Pristolepis fasciata</i> , <i>Parambassis wolffii</i>
5	Other carnivores	<i>Hampala</i> sp., <i>Boesemania microlepis</i> , <i>Oxyeleotris marmorata</i> , <i>Wallago attu</i> , <i>Lycotrissa crocodilus</i> , <i>Notopterus notopterus</i> , <i>Chitala ornata</i> , <i>Kryptopterus cheveyi</i> , <i>Ompok siluroides</i> , <i>Cephalocassis borneensis</i> , <i>Mastacembelus armatus</i> , <i>Phalacrotonus apagon</i> , <i>Belodontichthys truncatus</i> , <i>Colia lindmani</i>
6	Large herbivores	<i>Labeo chrysophekadion</i> , <i>Cirrhinus microlepis</i> , <i>Osteochilus melanopleara</i> , <i>Catlocarpio siamensis</i> , <i>Cosmochilus harmandi</i> , <i>Tenuulosa thibaudeaui</i> , <i>Barbichtys laevis</i>
7	Small herbivores	<i>Thynnichthys hynnoides</i> , <i>Labiobarbus leptocheilus</i> , <i>Amblyrhynchichthys micracanthus</i> , <i>Gyrinocheilus pennocki</i> , <i>Labiobarbus siamensis</i>
8	Omnivorous fish	<i>Hypsibarbus malcolmi</i> , <i>Osteochilus vittatus</i> , <i>Puntioplites proctozysron</i> , <i>Barbonymus altus</i> , <i>Puntioplites bulu</i> , <i>Systemus orphoides</i> , <i>Albulichthys albuloides</i>
9	Benthivorous fish	<i>Hemibagrus spilopterus</i> , <i>Leptobarbus rubripinna</i> , <i>Clarias</i> sp., <i>Hemibagrus filamentus</i> , <i>Macrognathus siamensis</i> , <i>Cynoglossus cynoglossus</i> , <i>Yasuhikotakia modesta</i> , <i>Cyclocheilichthys apogon</i> , <i>Pangasius macronema</i> , <i>Toxotes</i> sp., <i>Hyporhamphus limbatus</i> , <i>Thryssocypris tonlesapensis</i> , <i>Macrochirichthys smacrochirus</i> , <i>Bagarius bagarius</i> , <i>Probarbus labeamajor</i>
10	Gourami fish	<i>Trichopodus</i> sp., <i>Trichopodus pectoralis</i>
11	Mud carp	<i>Henicorhynchus</i> sp.
12	Small fish	<i>Paralaubuca typus</i> , <i>Rasbora tornieri</i> , <i>Rasbora dusonensis</i> , <i>Parambassis apogonoides</i> , <i>Corica laciniata</i> , <i>Puntius brevis</i> , <i>Parachela siamensis</i> , <i>Mystus</i> sp. ( <i>atrifasciatus</i> , <i>albolineatus</i> )
13	Crabs	<i>Sommaniathelaphusa lacuvita</i>
14	Shrimps	<i>Macrobrachium lanchesteri</i>
15	Molluscs	<i>Corbicula</i> sp., <i>limnoperna</i> sp.
16	Other zoobenthos	Oligochaeta, Insecta (chironomidae), others

17	Macrozoopankton	Copepoda, Cladocera
18	Microzooplankton	Protozoa, Rotifera
19	Phytoplankton	Chlorophyta, Cyanobacteria, Bacillariophyta, Euglenophyta
20	Macrophytes	<i>Barringtonia acutangula</i> , <i>Eichhornia crassipes</i>
21	Detritus	-

---

## APPENDICE II

Liste des espèces de poissons étudiées et leurs traits fonctionnels associés du lac Tonlé Sap

Order, Family and Species	Code	Habitat <sup>1</sup>	Size <sup>2</sup> (cm)	Trophic level	Ecological guilds	Life history <sup>3</sup>	Feeding habitat <sup>4</sup>	Spawning habitat <sup>5</sup>	Water column position <sup>6</sup>	Accessory respiratory
<b>Beloniformes</b>										
Belonidae										
<i>Xenentodon cancila</i>	Xeca	PELN	40	3.9	Grey	PER	OFF&LIT	RIV	M-S	No
<b>Clupeiformes</b>										
Engraulidae										
<i>Coilia macrognathos</i>	Coma	PEL	31.7	3.7	Estuarine	PER	OFF&LIT	RIV	M-S	No
<i>Lycotrissa crocodilus</i>	Lycr	PEL	36.6	3.7	NA	PER	OFF&LIT	RIV	M-S	No
<b>Cypriniformes</b>										
Cyprinidae										
<i>Albulichthys albuloides</i>	Alal	BEN	36.6	2.8	Grey	PER	OFF&LIT	FLP	B-M	No
<i>Amblyrhynchichthys truncatus</i>	Amtr	BEN	48.8	2.4	White	PER	OFF&LIT	FLP	B-M	No
<i>Barbonymus gonionotus</i>	Bago	BEN	40.5	2.4	Grey	PER	OFF&LIT	RIV	B-M	No
<i>Cirrhinus microlepis</i>	Cimi	BEN	79.3	2.4	White	PER	OFF&LIT	FLP	B-M	No
<i>Cosmochilus harmandi</i>	Coha	BEN	100	2	White	PER	OFF&LIT	FLP	B-M	No
<i>Cyclocheilichthys armatus</i>	Cyar	BEN	28.1	3.4	Grey	PER	OFF&LIT	FLP	B-M	No
<i>Cyclocheilichthys enoplus</i>	Cyen	BEN	90.3	3.2	White	PER	OFF&LIT	RIV	B-M	No
<i>Cyclocheilichthys furcatus</i>	Cyfu	BEN	73.2	3.7	White	PER	OFF&LIT	FLP	B-M	No
<i>Hampala macrolepidota</i>	Hama	BEN	85.4	4.2	Grey	PER	OFF&LIT	RIV	M-S	No
<i>Henicorhynchus lobatus</i>	Helo	BEN	18.3	2.7	White	PER	OFF&LIT	RIV	B-M	No
<i>Henicorhynchus siamensis</i>	Hesi	BEN	24.4	2	White	PER	OFF&LIT	RIV	B-M	No
<i>Hypsibarbus lagleri</i>	Hyla	BEN	48.8	2.8	White	PER	OFF&LIT	FLP	B-M	No
<i>Labeo chrysophekadion</i>	Lach	BEN	90	2	White	PER	OFF&LIT	RIV	B-M	No
<i>Labiobarbus lineatus</i>	Lali	BEN	13.8	2.5	Grey	PER	OFF&LIT	RIV	B-M	No
<i>Labiobarbus siamensis</i>	Lasi	BEN	22	2.3	White	PER	OFF&LIT	RIV	B-M	No
<i>Leptobarbus hoevenii</i>	Leho	PEL	122	2.8	Grey	PER	OFF&LIT	FLP	M-S	No
<i>Osteochilus melanopleurus</i>	Osme	BEN	73.2	2.3	Grey	PER	OFF&LIT	RIV	B-M	No
<i>Osteochilus vittatus</i>	Osvi	BEN	39	2	Grey	PER	OFF&LIT	FLP	B-M	No
<i>Paralaubuca typus</i>	Paty	BEN	22	3.3	White	OPP	OFF&LIT	RIV	M-S	No

<i>Poropuntius normani</i>	Pode	BEN	21.6	3.2	NA	PER	OFF&LIT	FLP	B-M	No
<i>Puntioplites proctozystron</i>	Pupr	BEN	30	2.7	White	PER	OFF&LIT	RIV	B-M	No
<i>Rasbora tornieri</i>	Rato	BEN	20.7	3.2	Grey	PER	OFF&LIT	FLP	M-S	No
<i>Systemus rubripinnis</i>	Syru	BEN	30.5	2.9	NA	PER	OFF&LIT	FLP	M-S	No
<i>Thynnichthys thynnoides</i>	Thth	BEN	25	2.3	Grey	PER	OFF&LIT	RIV	M-S	No
Cobitidae										
<i>Yasuhikotakia modesta</i>	Yamo	DEM	30.5	3.4	White	PER	OFF&LIT	RIV	B-M	No
<b>Osteoglossiformes</b>										
Notopteridae										
<i>Notopterus notopterus</i>	Nono	DEM	73.2	3.6	Grey	EQU	LIT	FLP	M-S	No
<b>Perciformes</b>										
Anabantidae										
<i>Anabas testudineus</i>	Ante	DEM	25	3	Black	EQU	LIT	FLP	B-M	Yes
Sciaenidae										
<i>Boesemania microlepis</i>	Bomi	BEN	122	3.7	White	PER	OFF&LIT	RIV	B-M	No
Channidae										
<i>Channa striata</i>	Chst	BEN	122	3.4	Black	EQU	LIT	FLP	M-S	Yes
Eleotridae										
<i>Oxyeleotris marmorata</i>	Oxma	DEM	79.3	3.9	Grey	EQU	LIT	FLP	B-M	No
Ambassidae										
<i>Parambassis wolffii</i>	Pawo	DEM	24.4	3.7	Grey	OPP	LIT	FLP	M-S	No
Pristolepididae										
<i>Pristolepis fasciata</i>	Prfa	DEM	20	3.2	Black	EQU	LIT	FLP	B-M	No
Osphronemidae										
<i>Trichogaster microlepis</i>	Trmi	DEM	15.9	3.4	Black	EQU	LIT	FLP	M-S	Yes
<i>Trichopodus pectoralis</i>	Trpe	BEN	25	2.8	Black	EQU	LIT	FLP	M-S	Yes
<i>Trichopodus trichopterus</i>	Trtr	BEN	18.3	2.7	Black	EQU	LIT	FLP	M-S	Yes
<b>Siluriformes</b>										
Siluridae										
<i>Hemisilurus mekongensis</i>	Heme	DEM	80	3.3	Grey	PER	OFF&LIT	FLP	M-S	No
<i>Ompok bimaculatus</i>	Ombi	DEM	45	3.9	Grey	PER	LIT	FLP	B-M	No
<i>Phalacrotonotus apogon</i>	Phap	BEN	158.6	4.5	Grey	PER	OFF&LIT	FLP	M-S	No
<i>Phalacrotonotus micronemus</i>	Phmi	BEN	61	4	Grey	PER	OFF&LIT	FLP	M-S	No
Bagridae										

<i>Hemibagrus nemurus</i>	Hene	BEN	79.3	3.6	Grey	PER	OFF&LIT	FLP	B-M	No
<i>Hemibagrus spilopterus</i>	Hesp	DEM	37.7	3.5	Grey	PER	OFF&LIT	RIV	B-M	No
<i>Mystus albolineatus</i>	Myal	DEM	42.7	3.7	Grey	PER	OFF&LIT	RIV	B-M	No
<i>Mystus atrifasciatus</i>	Myat	DEM	18.3	3	Grey	PER	OFF&LIT	FLP	B-M	No
<i>Mystus bocourti</i>	Mybo	DEM	29.3	3.5	Grey	PER	OFF&LIT	RIV	B-M	No
<i>Mystus mysticetus</i>	Mymy	DEM	15.9	3.1	Grey	PER	OFF&LIT	RIV	B-M	No
<i>Mystus singaringan</i>	Mysi	DEM	36.6	3.8	Grey	PER	OFF&LIT	FLP	B-M	No
Pangasiidae										
<i>Pangasius bocourti</i>	Padj	BEN	115.2	2.8	Na	PER	OFF&LIT	FLP	B-M	No
<i>Pangasius larnaudii</i>	Pala	BEN	158.6	3.3	White	PER	OFF&LIT	RIV	B-M	No
<i>Pangasius macronema</i>	Pasp	BEN	36.6	3.2	White	PER	OFF&LIT	RIV	M-S	No
Mastacembelidae										
<i>Macrogathus siamensis</i>	Masi	BEN	36.6	3.3	Black	PER	LIT	FLP	B-M	No



## **PARTIE II : PUBLICATIONS**





## ARTICLE 1

### **Evidence of water quality degradation in Lower Mekong Basin revealed by Self-Organizing Map.**

**R. Chea, G. Grenouillet and S. Lek (2016).**

*PLoS ONE 11(1):e0145527*



RESEARCH ARTICLE

# Evidence of Water Quality Degradation in Lower Mekong Basin Revealed by Self-Organizing Map

Ratha Chea<sup>1,2\*</sup>, Gaël Grenouillet<sup>1</sup>, Sovan Lek<sup>1</sup>

**1** CNRS, Université Toulouse III Paul Sabatier, ENFA, UMR5174 EDB (Laboratoire Évolution & Diversité Biologique), 118 route de Narbonne, F-31062 Toulouse, France, **2** Faculty of Agriculture and Food Processing, University of Battambang, Road 5, Battambang City, Cambodia

\* [chearatha@rocketmail.com](mailto:chearatha@rocketmail.com)



**OPEN ACCESS**

**Citation:** Chea R, Grenouillet G, Lek S (2016) Evidence of Water Quality Degradation in Lower Mekong Basin Revealed by Self-Organizing Map. PLoS ONE 11(1): e0145527. doi:10.1371/journal.pone.0145527

**Editor:** Chon-Lin Lee, NSYSU, TAIWAN

**Received:** August 13, 2015

**Accepted:** December 4, 2015

**Published:** January 5, 2016

**Copyright:** © 2016 Chea et al. This is an open access article distributed under the terms of the [Creative Commons Attribution License](https://creativecommons.org/licenses/by/4.0/), which permits unrestricted use, distribution, and reproduction in any medium, provided the original author and source are credited.

**Data Availability Statement:** Data are available on the Dryad website: <http://dx.doi.org/10.5061/dryad.51021>.

**Funding:** The authors are grateful to the Erasmus Mundus TECHNO Program and the Belmont Forum for providing funds to support the studies, which were a part of the Tonle Sap Climate Change (TLSCC) project (ANR-13-JCL-0003-01). EDB lab was supported by "Investissement d'Avenir" grants (CEBA, ref. ANR-10-LABX-0025; TULIP, ref. ANR-10-LABX-41). SL was supported by grant number ANR-13-JCL-0003-01 from the National Research Agency France (<http://www.agence-nationale-recherche.fr>). The funders had no role in study design, data

## Abstract

To reach a better understanding of the spatial variability of water quality in the Lower Mekong Basin (LMB), the Self-Organizing Map (SOM) was used to classify 117 monitoring sites and hotspots of pollution within the basin identified according to water quality indicators and US-EPA guidelines. Four different clusters were identified based on their similar physicochemical characteristics. The majority of sites in upper (Laos and Thailand) and middle part (Cambodia) of the basin were grouped in two clusters, considered as good quality water with high DO and low nutrient levels. The other two clusters were mostly composed of sites in Mekong delta (Vietnam) and few sites in upstream tributaries (i.e., north-western Thailand, Tonle Sap Lake, and swamps close to Vientiane), known for moderate to poor quality of water and characterized by high nutrient and dissolved solid levels. Overall, we found that the water in the mainstream was less polluted than its tributaries; eutrophication and salinity could be key factors affecting water quality in LMB. Moreover, the seasonal variation of water quality seemed to be less marked than spatial variation occurring along the longitudinal gradient of Mekong River. Significant degradations were mainly associated with human disturbance and particularly apparent in sites distributed along the man-made canals in Vietnam delta where population growth and agricultural development are intensive.

## Introduction

Globally, water resources are significantly threatened by various anthropogenic activities, including climate change which is particularly intense in tropical regions, and notably Asia [1,2]. As a result, many rivers in the region are grossly polluted and huge portions of their drainage basins and floodplains have been deforested or otherwise degraded [3].

The Lower Mekong Basin (LMB) water resources are extremely important for the four riparian countries downstream of China and Myanmar, i.e. Thailand, Laos, Cambodia, and Vietnam. Today, the basin serves for a variety of water-related activities—watershed

collection and analysis, decision to publish, or preparation of the manuscript.

**Competing Interests:** The authors have declared that no competing interests exist.

management, agriculture, fisheries, navigation and transport, hydropower development, tourism and recreation, which support the livelihood of more than 60 million people living in the basin [4]. Apparently, among the largest great rivers around the world, the Mekong River is probably the largest river to feed vast numbers of people relying on it for nutritional needs (e.g. fish and other aquatic organisms) [5]. However, over the last 30 years, the Mekong River has been faced with environmental degradation due to the multiple sources of pressure, i.e. rapid population growth, industrialization, intensive agricultural development. These have left natural resource managers with a number of serious challenges regarding the preservation of biodiversity and ecosystem health. Consequently, water quality is becoming dramatically degraded from upstream to downstream in many part of the basin and evidence indicates that the diversity and productivity of freshwater species and ecosystems is also adversely affected [2,6,7]. This is of serious concern to all riparian countries since their livelihood depend mainly on the environment health and ecosystem services provided by the Mekong river and its tributaries [4]. Thus, water quality is the key factor determining the environmental health and quality of the ecosystem [8].

Recent studies on Mekong mainstream have addressed hydrological issues, sediment fluxes, climate change, and the impact of upstream dams on the Mekong's floodplains [9–11]. However, the global perspectives on water quality patterns across the whole catchment are still questionable. Of course, under the water quality monitoring program of Mekong River Commission (MRC), the annual water quality assessment has been reported for monitoring sites along the main river and tributaries, yet the secondary sites were not well assessed. So far, there is no substantial scientific study to quantify the physicochemical characteristics of water at the whole basin scale, let alone the water quality studies conducted at local scale by each member country.

In the Mekong delta, many studies have shown surface water pollution in the man-made canals and some densely populated cities such as Chau Doc, Can Tho, My Thau, that could threaten human, animal and ecosystem health given the fact that this water source is intensively used for drinking, irrigation and domestic services [12–14]. In Thailand, water quality monitoring by the Pollution Control Department (PCD) revealed that 68% of water bodies were suitable for use by agriculture and for general consumption being of good and moderate quality but no surface water was categorized as being of very good quality [15]. Compared to Thailand, water quality monitoring in Laos, Cambodia and Vietnam is very limited and monitoring complicated, in particular the unclear definition of responsibilities and competences among different ministries and agencies at national and regional levels [16–19]. In Laos, recent studies into water quality have shown high concentrations of nutrients ( $\text{NO}_3$  and P), nitrogenous matter and TSS at Vientiane city and in upstream Mekong located in northern of Laos [20,21]. In Cambodia, some concerns have been raised regarding the degradation of water quality in Tonle Sap lake and the 3S river system (Sesan, Sekong, Sraepork) [22,23]. Although multiple pressures affect the water quality in the LMB; the Mekong River Commission (MRC) reported that water quality in the main channel is still good, except for some local degradation [24–26]. As an example of water quality assessment in 2008, at least 50 monitoring sites in the basin were assessed for human health and aquatic life using dissolved oxygen, ammonium, total phosphorus, chemical oxygen demand, pH and nitrate as pollution indicators. The results indicated that 31% of all samples were rated as B (good), while 38% were rated as C (moderate) and 25% as D (poor); only 6% of samples were categorized as A (high quality) [4,26]. However, these previous studies were limited to describe and to discuss further variation of water quality patterns across the whole basin. Specifically, the parameters that could reflect the physicochemical characteristics in each compartment of the basin (i.e., upper, middle, lower part) were not well addressed, nor informed. Thus, water quality status, as well as ecological health of the

basin were somehow over or underestimated. Besides, most of regular assessments were located in the main channel, while many tributaries were overlooked. Accordingly, with the challenges of population growth, urbanization, waste management and the need to feed, it is expected that the degradation of water quality in both the main channel and the tributaries of the LMB will occur.

In this context, the objective of the present work was to assess the spatial variation of water quality in the LMB based on physicochemical characteristics of the surface water. More specifically we used a Self-Organizing Map to characterize the surface water status and to identify the hotspots of pollution within the 4 riparian countries, generating a whole picture of water quality variation at the basin scale. The water quality status is helpful for defining the environmental situation and detecting the anthropogenic impact on biodiversity. This information is essential not only for people living in the basin and for the governments of the 4 countries to prioritize the management plan and action in order to reduce environmental and human health risks, but also it could help to improve the effectiveness of existing water quality monitoring programs in river basins worldwide.

## Materials and Methods

### Study area: Lower Mekong Basin

The Mekong River is the world's 12<sup>th</sup> longest river and the 7<sup>th</sup> longest in Asia. Its estimated length is 4,350 km and it drains an area of 795,000 km<sup>2</sup>, discharging 457 km<sup>3</sup> of water annually. From the Tibetan Plateau this river runs through China's Yunnan province, Burma (Myanmar), Laos, Thailand, Cambodia and Vietnam. The Mekong river basin is functionally divided into two parts: the Upper Mekong basin (UMB) and the Lower Mekong basin (LMB) [27]. The UMB, located in the temperate and high altitude semi-tropical zone of China (Lancang Jiang), is covered by alpine and mountainous areas with a low population density while the LMB, located in the tropical zone of South-East Asia, drains more than 76% (60 000 km<sup>2</sup>) of the Mekong basin and is characterized by a low, flat topography with a high population density [20]. The LMB is well known for its rich freshwater biodiversity; particularly fish which provides a livelihood for million people [28]. The hydrology of the LMB is characterized by two monsoons, from May to October and from November to March, with the former bringing most of the annual rain. The water level begins rising in May and peaks in September reaching an average flow of 45 000 m<sup>3</sup>/s [27].

In Cambodia, Tonle Sap Lake, which is the largest freshwater lake in Southeast Asia [23], is connected to the Mekong through the Tonle Sap River. This creates an exceptional hydrological cycle; during the rainy seasons the excess water from Mekong river enters the Tonle Sap lake, expanding the area it covers from 2 500 km<sup>2</sup> to 15 000 km<sup>2</sup> and creating an extensive wetland around the entire lake. When the rain ceases and water levels drop in the Mekong, reverse flow drains the lake which flows into the Mekong delta [29]. The Mekong delta is known for its high density of artificial canals which are for domestic and agricultural utilization, connected to Bassac and Mekong rivers [30]. During the wet season, 35–50% of the total surface area of the delta is flooded [31]. Sea-water intrusion dominates the hydrology along the coastal areas with water level fluctuations of more than 3 m due to the tidal regime [14]. The reverse flow from Tonle Sap is very important to balance the Mekong delta in Vietnam during the dry season ensuring freshwater flow into the Mekong delta and protecting against sea water intrusion.

### Monitoring sites

The data used were provided by the Mekong River Commission (MRC), under the Water Quality Monitoring Network Program. The monitoring program has begun in 1985 in Laos-



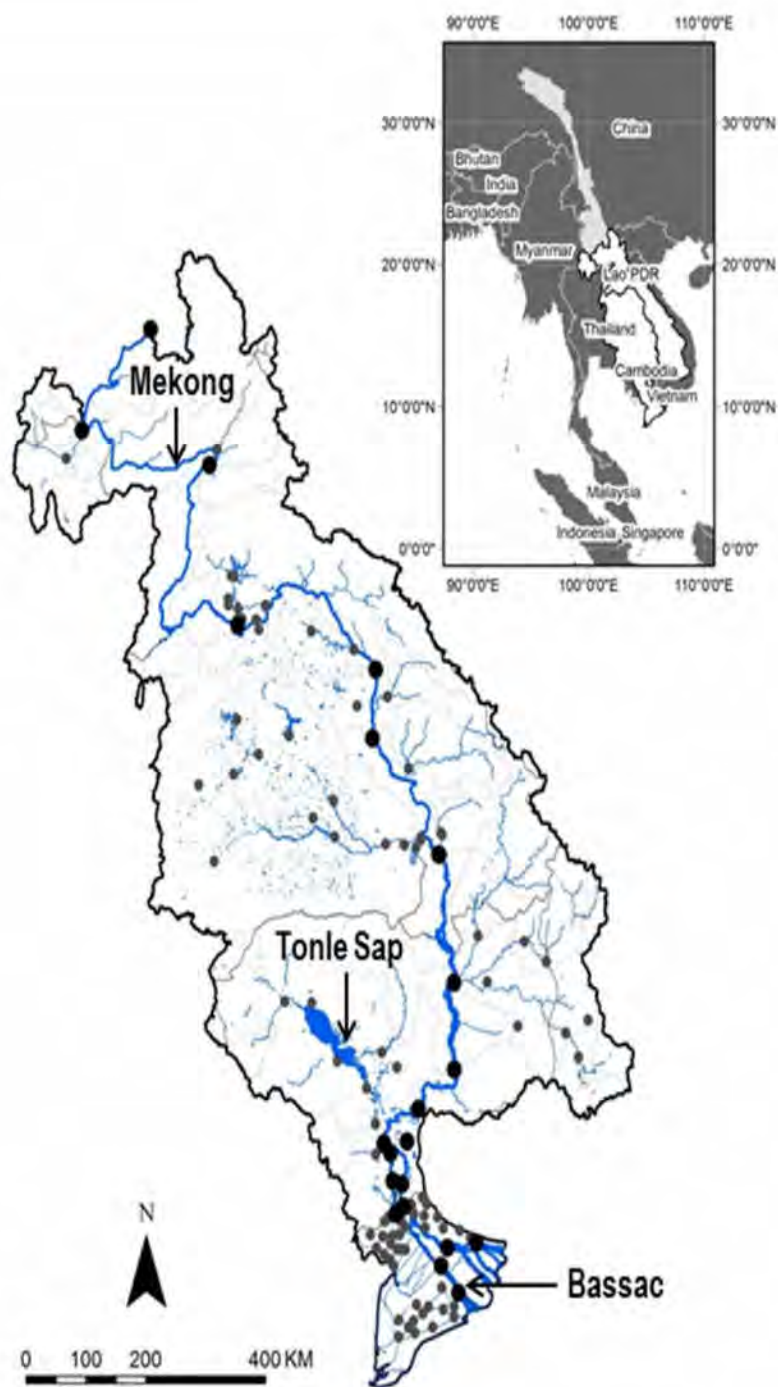
Vietnam-Thailand and in 1995 in Cambodia [4]. So far there are a total of 132 monitoring sites including 33 newer sites established in the 2000s and 99 older sites established before 1995. To study the spatial variation of water quality in the LMB, we focused on 117 monitoring sites (Fig 1), among which 22 were located in Cambodia, 25 in Laos, 20 in Thailand, and 50 in Vietnam. Sixteen physicochemical variables (Table 1) were selected from the 46 variables in the dataset for water quality analysis. The selection was based also on the physicochemical importance of variables in explaining the water quality status and data completeness criteria (i.e. variables measured at all sites, with less than 30% missing values). The water quality data used in this study included 24,383 samples monitored from 1985 to 2010 at 117 sites with a monthly time scale base.

## Data analysis and modelling approach

**Overview.** First, annual averages of each variable were calculated at each site. Then the medians of the annual means were computed to describe the physicochemical characteristics at each site over the study period. Only median values were used for the analysis as they are considered as a robust statistical indicator minimizing the effects of noise in the dataset that can influence analysis [32]. Unsupervised artificial neural networks (Self-Organizing Maps) were then used to classify the monitoring sites into different clusters based on the similarities of samples defined by the 16 physicochemical variables. Last, water quality assessment was compiled to identify pollution hotspots within the basin according to the selected water quality indicators and US-EPA guideline [33].

**Self-Organizing Map (SOM).** The SOM is a non-supervised artificial neural network that is trained using a competitive learning process to produce a two-dimensional representation of the training samples, called a map [34]. The SOM is a powerful method to classify complex data ruled by non-linear relationships. Recent applications of SOM in water quality and aquatic ecology have yielded very good results in patterning and prediction [35–38]. Mostly, the SOM consists of 2 main types of layers: the input layer and the output layer. In the present case, the input layer contained 16 neurons connected to 117 training samples and the output layer is represented by the rectangular grid or map with  $l$  rows and  $m$  columns of neurons, laid out in a hexagonal lattice. During the training process, the activation level, which is the Euclidean distance between the input vectors of the 117 training samples and weight vector of each neuron on the map was calculated as follows [34]:  $\|w^j - x\| = \sqrt{\sum_{i=1}^n (w_i^j - x_i)^2}$ , where  $x$  is the input vector or training samples described by a set of descriptors known as the physicochemical variables,  $i$  is the number of training samples from 1 to 117,  $j$  is the neuron number and  $w^j$  is the weight vector associated to neuron  $j$  on the map. With the different magnitudes of the input vector  $x$ , the activation level was calculated once the logarithmic normalization of median values of each of the 16 physicochemical variables for the studied sites was computed, and the calculation was done for each input pattern and all the neurons presented on the map.

After all sample vectors have been trained, the algorithm automatically classifies the trained samples on the map in what is known as the mapping process. The map consists of several neurons which store the weight vector as mentioned above. Normally, the classification is done through activation levels between the input and output spaces to find the winning neurons or best matching units (BMU). The neuron whose weight vector closely matches the input vector will have a small activation level, while the neuron with a weight vector very different from the input vector will exhibit the large activation level. The neuron with the smallest activation level is considered to be the winner or the BMU for the current input vector. The mapping process is continued until a stopping criterion is met, usually when the BMU is determined with the corresponding neurons of the map after completing a certain number of iterations. The



**Fig 1. Lower Mekong Basin and monitoring site localities (grey dots for tributaries and big black dots for Main River).**

doi:10.1371/journal.pone.0145527.g001

algorithm was run through the SOM package in Matlab program (<http://www.cis.hut.fi/somtoolbox/>).

Different map sizes were tested during the training process based on a formula:  $c = 5\sqrt{n}$  proposed by the Laboratory of Computer and Information Science (CIS)—University of Helsinki, where  $c$  is the number of neurons and  $n$  is the number of training samples, according to



**Table 1. Physicochemical variables and measurement unit of selected variables for water quality analysis.**

Parameters	Units	Parameters	Units
Water temperature (T)	°C	Magnesium (Mg <sup>2+</sup> )	mgL <sup>-1</sup>
Conductivity (EC)	µScm <sup>-1</sup>	Chloride (Cl <sup>-</sup> )	mgL <sup>-1</sup>
Total suspended solids (TSS)	mgL <sup>-1</sup>	Sulphate (SO <sub>4</sub> <sup>2-</sup> )	mgL <sup>-1</sup>
pH	SU	Alkalinity as HCO <sub>3</sub> <sup>-</sup>	mgL <sup>-1</sup>
Dissolved oxygen (DO)	mgL <sup>-1</sup>	Nitrate (NO <sub>3</sub> <sup>-</sup> )	mgL <sup>-1</sup>
Sodium (Na <sup>+</sup> )	mgL <sup>-1</sup>	Total phosphorus (TP)	mgL <sup>-1</sup>
Potassium (K <sup>+</sup> )	mgL <sup>-1</sup>	Chemical oxygen demand (COD <sub>mn</sub> )	mgL <sup>-1</sup>
Calcium (Ca <sup>2+</sup> )	mgL <sup>-1</sup>	Total ammonia (NH <sub>3</sub> + NH <sub>4</sub> <sup>+</sup> )	mgL <sup>-1</sup>

doi:10.1371/journal.pone.0145527.t001

the optimal values of quantization and topographic errors. Therefore, the input layer was composed of 16 neurons connected to 117 training samples and the output layer comprised 56 neurons organized in an array with 8 rows and 7 columns. Moreover, in order to define the boundaries of possible clusters in the SOM map, a hierarchical clustering on the final SOM weight vectors was used to classify SOM neurons according to Ward’s method. Kruskal-Wallis analysis was used to test the significance of the clusters identified.

### Water quality assessment

In the LMB, no specific or standard guidelines have been found in particular besides the guidelines used by MRC [4,26,39]. In 2007, MRC conducted a diagnostic study in LMB by using SEQ-Eau, i.e. Water quality evaluation system for surface water [40], evaluation system to quantify the quality status of water in main sub-basins [26]. SEQ-Eau was developed for European rivers; thus the criteria of certain parameters seem far-reaching the standards of tropical ones. Consequently, most of the evaluated sites were graded to good and very good for many parameters. Subsequently, MRC adopted new water quality guidelines based on the data set from 1985 to 2000 by using 6 indicators to evaluate the impacts of water quality on aquatic life (i.e., DO, pH, total ammonia, conductivity, total nitrate and total phosphorus) and 2 indicators for human impact (i.e., ammonium and COD) [4].

In our study, water quality assessment was undertaken based on the Environmental Protection Agency of United States (US-EPA) guidelines for the impact on aquatic life [33]. These guidelines were developed under the Water Clean Act 1972 and known as the foundation of water quality-based pollution control program to protect the human health and aquatic life. The guidelines consist of many criteria with specific uses (i.e., aquatic life, human, recreation, reuse, irrigation) and are potentially applicable to any kinds of water bodies (e.g., cold, cool and warm water) [41]. On the other hand, the threshold values were matched to MRC’s guidelines for the impact on aquatic life [4]. Dissolved oxygen, total phosphorus, total ammonia and chloride were used as water quality indicators to detect the surface water pollution in the LMB that could affect the river health. Numerous studies have confirmed that DO, TP, nitrates and total ammonia are the primary important parameters revealing the ecological health of the surface water [42]. Low DO can affect aquatic communities, while excessive amounts of TP, nitrates and ammonia are likely to cause significant changes in ecosystem functioning since they are very toxic and have adverse effects on human health and organisms [43]. In neutral pH values most of the ammonia in river water is in the form of NH<sub>4</sub><sup>+</sup> [26]. Additionally, chloride is recommended by US-EPA for salinity assessment instead of conductivity since the diurnal fluctuation of Cl<sup>-</sup> is less significant [44]. Therefore, the four selected indicators could be

optimal to quantify the quality status of water and pollution hotspots in the basin. Accordingly, the assessment was done through these 4 criteria (Table 2), if the assessed site meets all criteria it would get 4 points and would be classified as Very Good water quality, as Good for 3 points, as Fair for 2 points and as Poor for 1 or 0 point.

## Results

### Water quality patterns

**Cluster identification.** The monitoring sites were first classified on the SOM map according to the similarity of their physicochemical characteristics (Fig 2a). Different map sizes were tested and the optimum map size compromised 56 neurons [8 x 7] with the minimum value of quantisation (0.34) and topographic errors (0.009).

The similarity of neurons allowed us to divide the SOM map into 4 clusters (Fig 2b): 2 main clusters 1 & 2 with sub-groups (1a, 1b1, 1b2). This distribution pattern revealed the longitudinal water system of the Mekong in the LMB between upstream LMB (cluster 1) and Mekong delta (cluster 2). Cluster 1a included 25 sites extending through the floodplain of the Mekong River, in the middle part of the LMB between Cambodia and the southern part of Thailand. This group of sites was distributed along the larger Mekong tributaries such as the 3S Rivers (Sraepork, Sesan, Sekong) and Tonle Sap River connecting the Tonle Sap Lake to the Mekong (Fig 2c). Cluster 1b1 was defined by 26 sites mostly in the Mekong main channel from the head in Laos to the delta at the border between Cambodia and Vietnam. Some sites in this group were located in tributaries of the Mekong in Laos (Fig 2c). Cluster 1b2 was determined by 26 sites located in the transitional zone between the Lower Mekong River and its delta. Most of the sites were distributed along the 2 main branches of the Mekong (Mekong and Bassac rivers) closed to the border of Cambodia and Vietnam. Only a few sites of this cluster were found in the delta (i.e., Chau Doc, Can Tho, My Thuan) and upstream of Mun river in Thailand (Fig 2c). Cluster 2 grouped 40 sites, the majority of which were located in the Vietnam delta, along the artificial canals that connect to Bassac and Mekong rivers next to the outlet of the river, known to be brackish zones (Fig 2c). The sites in this group were generally affected by the tides with an average depth of 0.3 to 0.7 m [45]. A few sites in this cluster were found in Laos' swamps and tributaries close to Vientiane and in the upstream part of the 3S rivers located in Vietnam.

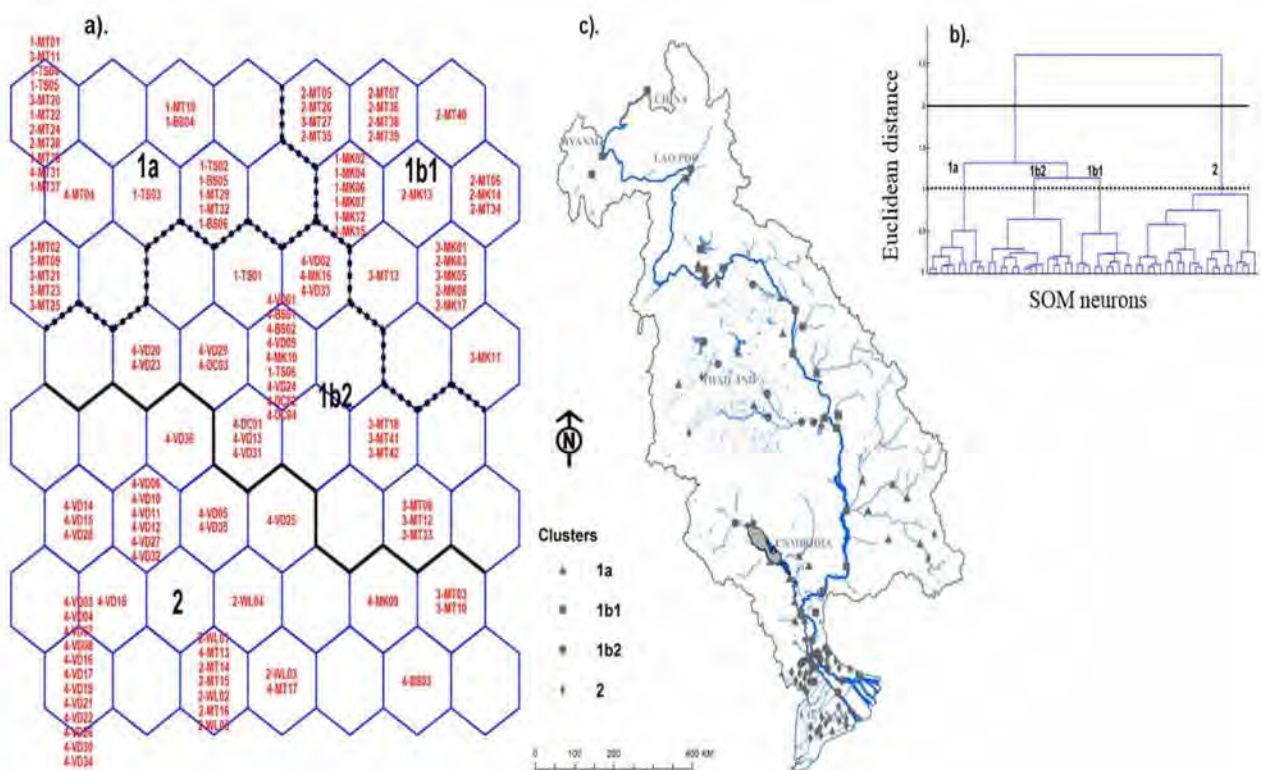
**Cluster interpretation.** The SOM component map was constructed to visualise the contribution of each physicochemical parameter to the map (Fig 3). The weight vectors of the SOM neurons revealed the influence of each physicochemical variable in the characterization of the identified clusters (Fig 4). Cluster 1a was mainly characterized by high water temperature, relatively high dissolved oxygen and pH, comparatively low levels of TSS and all cations and anions (i.e.  $\text{Ca}^{2+}$ ,  $\text{Mg}^{2+}$ ,  $\text{Na}^+$ ,  $\text{Cl}^-$ ,  $\text{K}^+$  and  $\text{SO}_4^{2-}$ ) i.e. dissolved solids in the water. Cluster 1b1 was determined by high levels of oxygen and high pH, followed by low water temperature and TSS values, and high level of alkalinity and calcium. Cluster 1b2 had similar characteristics to cluster

**Table 2. Criteria of water quality indicators used for water quality assessment with threshold values (US-EPA, 1976).**

Parameter	Threshold value
Dissolved oxygen	> 5 mgL <sup>-1</sup>
Total phosphorus	< 50 µgL <sup>-1</sup>
Total ammonia	< 20 µgL <sup>-1</sup>
Chloride	< 250 mgL <sup>-1</sup>

doi:10.1371/journal.pone.0145527.t002





**Fig 2. SOM results.** a). Classification of monitoring sites based on their similarities from physicochemical variables on SOM output layer. b). Hierarchical clustering according to the similarity between SOM neurons. c). Map of the clustering sites in the LMB. The acronyms in the hexagonal neurons represent the monitoring sites. The sample code is composed of 5 characters; the first character is a number from 1 to 4 indicating the country code: 1 for Cambodia, 2 for Laos, 3 for Thailand and 4 for Vietnam. The rest indicates the water body type and number of sites along this water body (i.e. MK-Mekong river, BS: Bassac river, MT: Mekong tributary, VD: Vietnam delta, DC: Delta canal, TS: Tonle Sap lake, WL: Swamp).

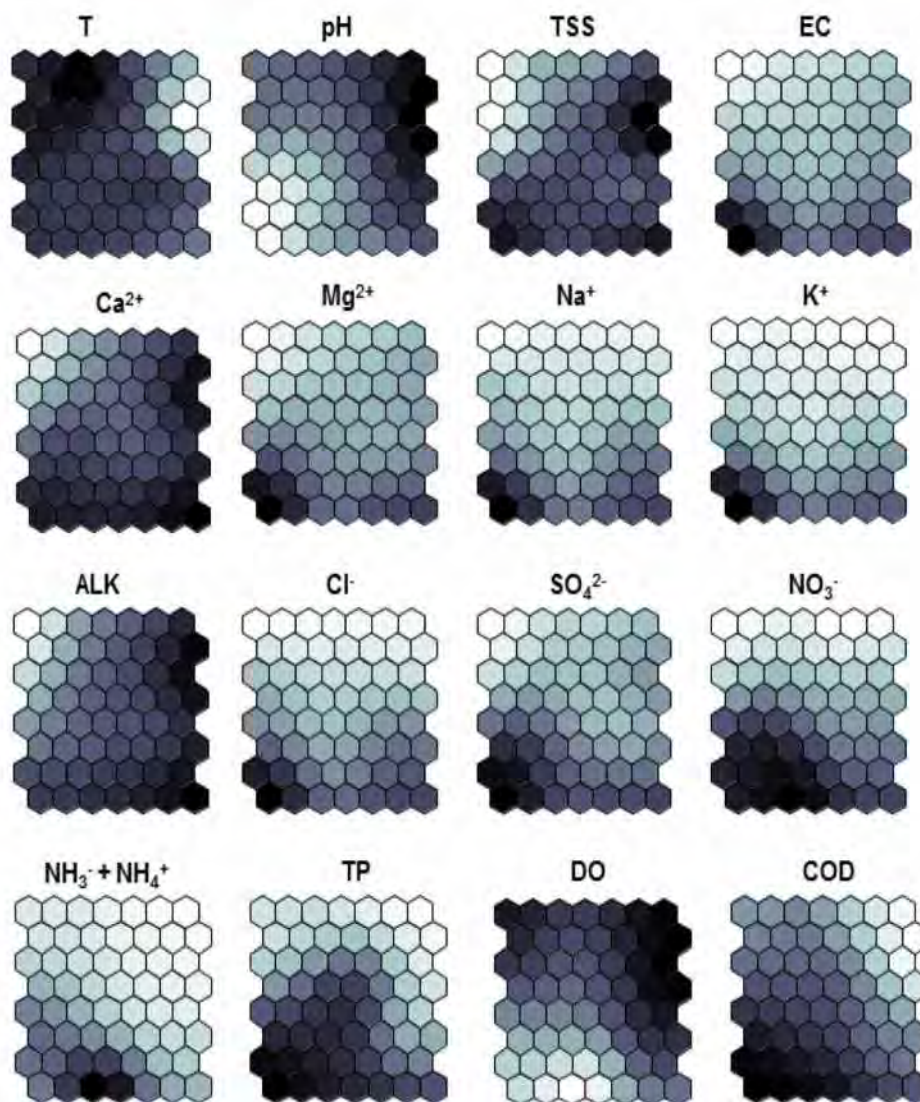
doi:10.1371/journal.pone.0145527.g002

1a, it was categorized by high temperature, slightly reduced oxygen and pH values, and relatively increased TSS, calcium and alkalinity. Completely different from the previous clusters, cluster 2 was primarily determined by high values of nutrients (nitrates, total phosphorus and total ammonia) and all dissolved solids. Moreover, the strong variations were noted in nutrients and ions between the monitoring sites of cluster 2.

### Water quality assessment

In cluster 1a, 13 sites were categorized as being of good quality while 12 were fair (Table 3). Fourteen sites of cluster 1b1 were graded as good quality and the rest were assessed as fair quality. In both, clusters 1a and 1b1 more than half the sites were ordered as good. In cluster 1b2, most of the sites (23 sites) were classified as fair, while 2 sites were good and 1 was poor. The water quality ranged from poor to fair in cluster 2, more than 60% of sites (24 sites) were typed as poor and 16 considered as fair. In the whole basin, 29, 63 and 25 sites were found as good, fair, and poor quality, respectively, while no sites were categorized as very good quality (Table 3).

Spatial patterns in water quality in LMB were observed in the geographic representation of annual concentration variation of the four water quality indicators at each site in the basin (Fig 5). The gradient of water quality was seen to vary significantly between upstream of the LMB and its delta. Indeed, the DO started to decline in the delta while the phosphorus concentration increased. The same patterns of DO and TP were also observed around Tonle Sap Lake in Cambodia. Regarding chloride, high concentrations were found for all coastal sites in the



**Fig 3. SOM component map showing the contribution of 16 variables on the SOM model.** Dark areas represent high values of each input variable.

doi:10.1371/journal.pone.0145527.g003

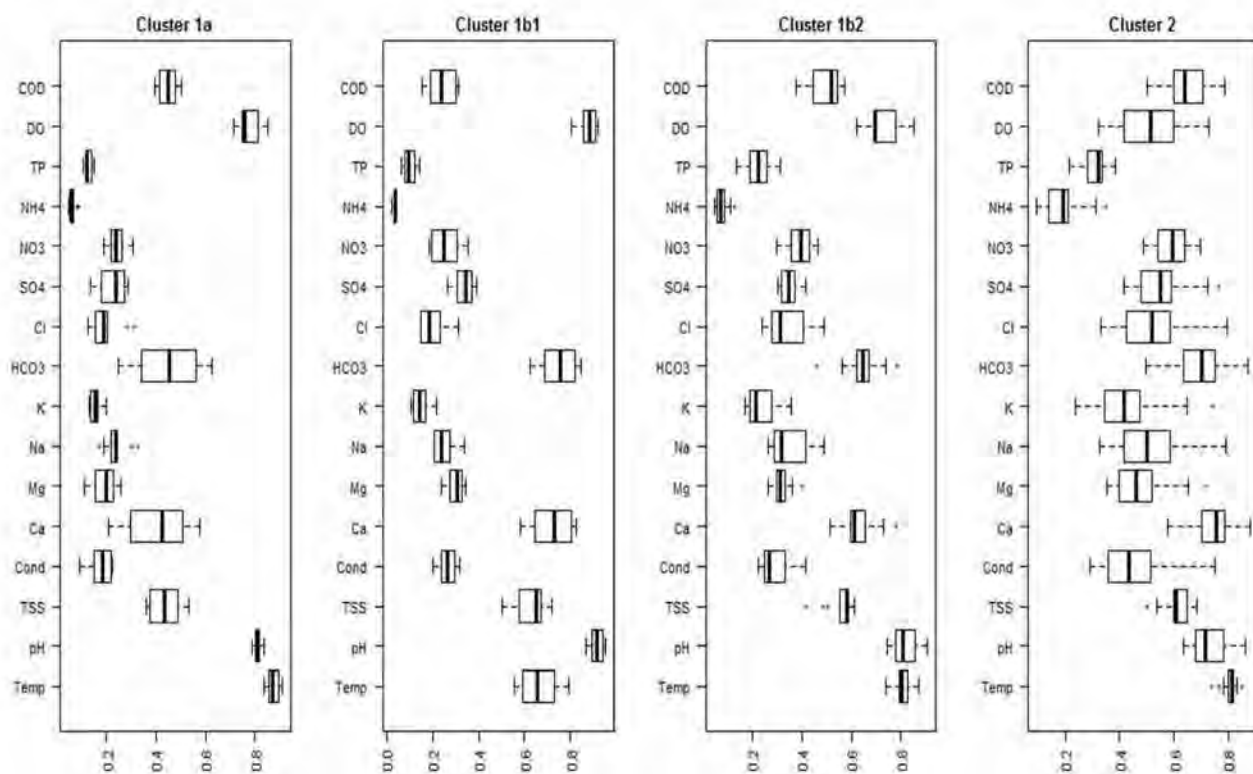
Vietnam delta and moderately high concentrations at the head of Mun river (Khorat plateau) in Thailand. Meanwhile, the high concentration of total ammonia was patterned particularly in swamps located close to Vientiane city in Laos and relatively for many sites close to the Cambodian border and the head of the 3S Rivers in Vietnam. Overall, these spatial patterns were consistent among dry and rainy seasons, since no differences were observed between the two seasons (Kruskal-Wallis test,  $p > 0.05$ ) (Fig 6).

## Discussion

### Spatial patterns in water characteristics in LMB

Variability of water characteristics in LMB was defined by different physical and chemical characteristics in clusters 1a, 1b1, 1b2 and 2. In our study, cluster 2 was completely different from other clusters; it characterized the Mekong delta, which was mainly affected by multiple point and non-point sources of pollutions. Recent studies of water quality in the Mekong delta have shown high levels of pollution in terms of organic pollutants, salts, metals and





**Fig 4. Boxplot of weight vectors (codebook) between SOM neurons.** The boxplots represent 25, 50 (median) and 75 percentiles of Euclidean distance between SOM neurons, while the whiskers indicate 10 and 90 percentiles. Large boxes indicate large variations between neighbourhood neurons of each cluster, while high values for the parameter in each plot denotes its important contribution to all neurons associated to the clusters.

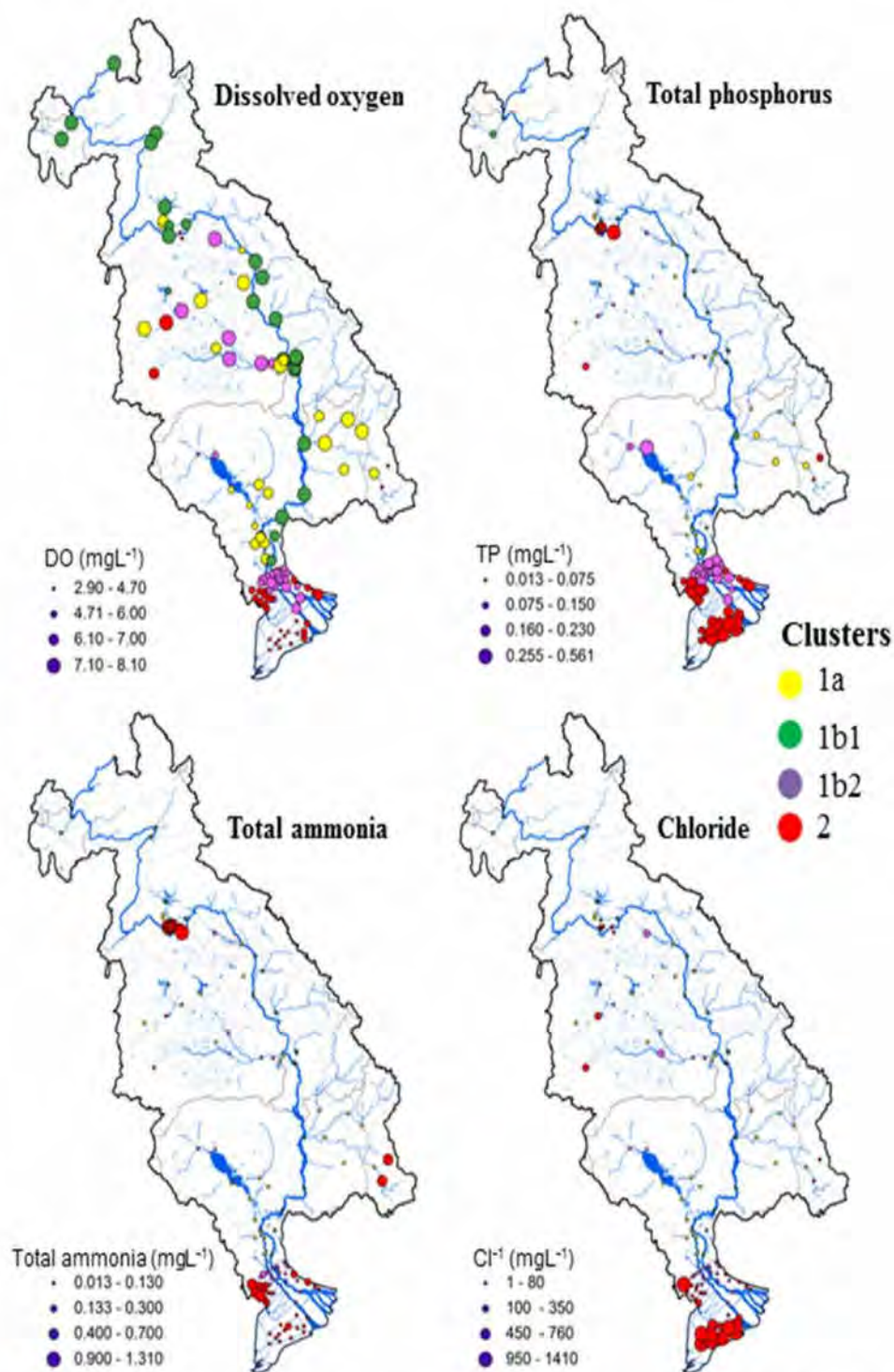
doi:10.1371/journal.pone.0145527.g004

microorganisms that could threaten human, animal and ecosystem health [14,46]. Our study revealed that the nutrient concentration was highest mainly along the delta canals, especially the concentration of TP which ranged from 0.13 mgL<sup>-1</sup> in cluster 1b2 to 0.56 mgL<sup>-1</sup> in cluster 2. Previous studies have concluded that the pollution from Can Tho city could affect human health within the delta [12,47]. Besides, pH and DO were depleted for most of the sites due to the decomposition of organic matter and storm runoff affected by land use in acid sulfate soils [48,49]. Furthermore, the increase of acid in the water could result from the intensive aquaculture in the delta canals and chemical fertilizers from agriculture. Among the adverse effects of shrimp farming are low pH values and acidification due to the release of feed chemical elements [50]. Associated with many chemical reactions in the water (e.g. the relationship between total ammonia and ammonium), acidification could thus be one of main issues in the delta likely to affect biodiversity. In parallel, our study illustrated the degradation of water quality in swamps close to Vientiane city in Laos. Gerrard (2004) reported the effect of Vientiane municipal waste on the swamps (That Luang basin connecting to Mekong) affecting

**Table 3. Water quality assessment based on the 4 indicators.**

	A Very Good	B Good	C Fair	D Poor
Cluster 1a	0	13	12	0
Cluster 1b1	0	14	12	0
Cluster 1b2	0	2	23	1
Cluster 2	0	0	16	24

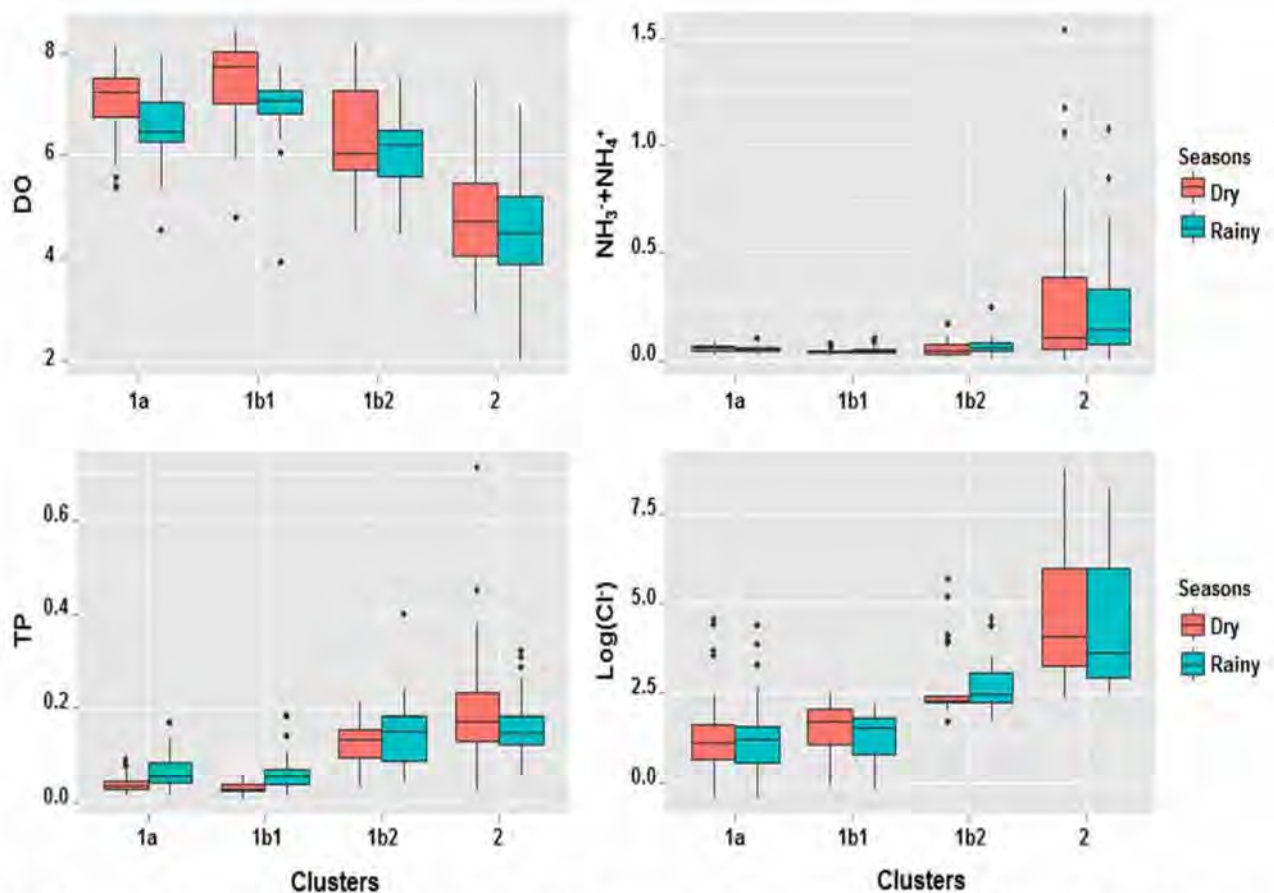
doi:10.1371/journal.pone.0145527.t003



**Fig 5. Geographic representation of annual median concentration of dissolved oxygen, total phosphorus, total ammonia, and chloride in LMB.**

doi:10.1371/journal.pone.0145527.g005

environmental health [51,52]. In Vientiane, direct discharge of municipal waste into the swamps can be one of the reasons leading to excess concentrations of total ammonia. The concentration of total ammonia ranged from  $0.013 \text{ mgL}^{-1}$  to  $1.3 \text{ mgL}^{-1}$ , with maximum values (i.e. greater than  $1 \text{ mgL}^{-1}$ ) for all the sites in the swamps of Laos. In the delta, stream farming and



**Fig 6. Seasonal variations between the dry (in red) and rainy (in blue) seasons for dissolved oxygen (DO), total phosphorus (TP), total ammonia ( $\text{NH}_3+\text{NH}_4^+$ ) and chloride ( $\text{Cl}^-$ ) within the four identified clusters.** Vertical axis indicates the concentration of DO, TP, total ammonia and  $\text{Cl}^-$  in logarithmic scale in  $\text{mgL}^{-1}$ .

doi:10.1371/journal.pone.0145527.g006

catfish aquaculture also contributed to the excess levels of ammonium in the water body [53]. Apart from this, the daily effects of sea water intrusion drive the salinity increase in the delta, especially in the coastal zone of Mekong delta (Bassac river) the concentration of salt at certain sites attaining  $1400 \text{ mgL}^{-1}$  chloride with similar patterns for conductivity ( $22\,000 \mu\text{Scm}^{-1}$ ). Moreover, TSS were found to be high for most of the sites in the delta, and could be accounted for firstly by the accumulated sediments from the upstream Mekong and secondly by erosion within the delta zone due to the intensive agricultural activities. Therefore, domestic waste from the municipalities, agriculture, and seawater intrusion remain the main sources of pollution in the delta.

In freshwater systems, dissolved solids consist of inorganic salts, small amounts of organic matter and other dissolved material [54] are  $\text{CO}_3^-$ ,  $\text{Ca}^{2+}$ ,  $\text{Mg}^{2+}$ ,  $\text{Na}^+$ ,  $\text{Cl}^-$ ,  $\text{K}^+$  and  $\text{SO}_4^{-2}$ . Strong correlations between conductivity and dissolved solids were found for all monitored sites in the LMB. In contrast to cluster 2 and 1b2, alkalinity and concentrations of dissolved solids were found to be low in cluster 1a and 1b1. In the transitional zone between the Mekong and its delta (cluster 1b2), the nutrients started to increase and reached a maximum for certain sites along the delta canals, especially phosphorus which is a toxic element and subject to bioaccumulation. Excess concentrations of TP can cause biological disturbances such as eutrophication. These could result from the direct municipal discharges and urban storm water runoff from the densely populated cities (i.e. Vientiane, Phnom Penh, Can Tho, Chau Doc) and also



agricultural activities (i.e. shrimp farming, catfish farming in Vietnam delta) which are the main source of pollution [55]. On the other hand, the concentration of TP in the main channel was lower than in the swamps and delta canals.

In Mekong mainstream (cluster 1b1), the water temperature increased from 20°C to 30°C from upstream to downstream. The lowest temperature was found in a few high altitude sites located in Laos and Thailand, while high temperatures were observed in the middle of the basin (cluster 1a), particularly around Tonle Sap Lake and along the Bassac river where the mean temperature was about 30°C. Moreover, the sediment load in Mekong mainstream seems to be much greater than in its tributaries and floodplains [4]. As a result, the annual median concentration of TSS in main channel reached maximum for certain upstream sites in Laos and Thailand, from Loung Prahban to Nakhon Phnom, comparatively 10 to 20 times higher than in tributaries and floodplains (e.g., Tonle Sap Lake and 3S rivers). This could be a cause for concern since the sediment has important implications in the river system and is a crucial element in aquatic systems, fisheries, agriculture, water supply and navigation [56]. Recent studies on sediment transport showed that 84% of sediments from the Mekong are retained in the lake and less than 15% contribute to Vietnam delta sediment [57]. This could explain the siltation at the bottom of the lake and in the floodplains. Downstream of Phnom Penh, capitals of Cambodia, oxygen levels started to decline and were found to be limited on arriving in the delta, potentially affected by agricultural, domestic and industrial disposal. This could also result from accumulation of organic matter from discharge from Phnom Penh city and two other big cities in the delta (Chau Doc and Can Tho), excessive algae growth caused by phosphorus and decomposition of submerged plants. In the main channel, total ammonia was found to be less than in its tributaries.

## Water quality degradation

The variation in water characteristics in clusters 1 and 2 could reveal the water quality changes along the basin, a significant decline observed in the Mekong delta and its transitional zone. From Laos to Thailand (cluster 1b1, upstream), the water quality was found to be good except the degradation in some sections of the mainstream such as in Chiang Sean, Vientiane and Nakhon Phanom. After connecting with Mun river in Thailand, the water quality declined to fair, continuously in Khong Chiam, Pakse, Stung Treng. After leaving the Khone falls and before connecting with Tonle Sap river, the water quality was found to be good at Kratie. In Cambodia, the water quality started to decline again, especially below the capital Phnom Penh. The water quality was degraded across the border along the densely populated cities of Vietnam delta Chau Doc, Than Chau, Can Tho, My Tho, and Dai Ngai. In the delta, the water quality became dramatically degraded, particularly in the coastal zone sites.

The spatial trends in water quality degradation can be clearly observed on the maps of water quality indicators in Fig 5. Apparently, the sharp decline of DO and significant increase of TP in delta region, north Tonle Sap and tributaries below Vientiane were associated mainly to anthropogenic activities rather than natural processes, as illustrated in S1 Fig. Upstream (above Vientiane), the trends of DO and TP varied gradually, while significant shifts were noticed for sites below the densely populated cities (i.e., Vientiane, Phnom Penh, Chau Doc, Tan Chau) (S1 Fig). The condition was drastic for tributaries sites below Vientiane, as well as below Phnom Penh city and along the man-made canals in delta, where TP and DO showed rough shifts. The peak of TP and drop of DO indicated clearly significant impacts on water quality due to human activities. According to recent study on nutrient dynamics, 75% of TP in LMB originate from intensive agricultural activities, particularly the uses of fertilizers [24]. Besides, we found very high concentrations of total ammonia in most of the monitoring sites, especially



in the Laos's swamps and delta canals (Fig 5; S1 Fig). Otherwise, the excess concentration of ammonium and the increase of phosphorus in some areas of the basin (e.g., north of Tonle Sap Lake in Cambodia and the Khorat plateau upstream of the Mun river in Thailand) could also be a concern with organic pollution leading to eutrophication and salinity increase. So far, Sdi-vong and Teng (2006) have drawn their concerns on the increase of nutrients in Mekong, as well as the chemical pollution originating from agricultural run-off and pesticides, affecting Mekong delta, Tonle Sap Lake and north-eastern tributaries of Thailand [58]. Fedá et al. (2004) confirmed the rapid growth of algal production leading to eutrophication in these regions, potentially during dry season when the input of TP is excessive [59]. Furthermore, the salinity increase in the basin would be also the concern in LMB. Apparently, chloride seems to be stable in main channel and suddenly increased at delta canals (S1 Fig). In northwestern part of Thailand (Khorat plateau), salinity increase was noticed as well, as reported in MRC (2008) (Fig 5) [4]. Mainly, the effects of salinity in the basin were linked to both natural process (i.e., sea water intrusion in the delta region) and human activities (i.e., agriculture, shrimp farming, fish aquaculture).

Nevertheless, compared to other Asian rivers (e.g., Yangtze, Yellow, Ganges), Mekong was considered as pristine river [60]. According to our assessment, the water quality in the LMB ranged from fair to good, apart from the delta, and Mekong mainstream was considered to be less polluted than its tributaries. Overall, we found good agreement between our assessment and MRC water quality monitoring reports; the differences could result from the water quality indicators and the guidelines used for the assessment [4,15]. According to our understanding, the degradation of water quality in main channel for some sections can be caused by the low quality inputs from tributaries. Consequently, the self-cleaning mechanisms of running water in the mainstream may control cross-border pollution transfer [61].

Under the influence of Monsoon, the significant seasonal changes of flow could induce the variation in water quality. However, according to our result, there was no significant difference of water quality between the 2 seasons at the basin scale (Fig 6). So far, Liljeström et al. (2012) showed that TP slightly increased during rainy season and peak in July-September; while Hart et al. (2001) reported the lowest DO and highest TP values in lower part of the basin during dry season [24,62]. Indeed, the seasonal change reported would mainly reflect the nutrient dynamics within the main channel; while at the basin scale, the seasonal effect seem to be less important than the spatial variation occurring among compartments of the basin (i.e., tributaries, wetland and main river). Consequently, we found that the spatial variations of water quality along the longitudinal gradient of LMB significantly exceeded the seasonal variations. Previous study has also demonstrated the weak negative relationship between water discharge and physicochemical parameters in LMB, except for TSS and conductivity which were positively correlated to river discharge [63]. Such seasonal effects of hydrological regimes could be more apparent for local impacts on water quality in tributaries rather than in mainstream, and could reflect different water quality dynamics between main channel and tributaries.

### Pollution hotspots in LMB

In LMB, nitrates seem to be less harmful than phosphorus, with concentrations below or slightly above the thresholds. Mekong delta, Tonle Sap Lake, the swamps close to Vientiane, Khorat plateau could be considered as pollution hotspots. The sharp degradation of water quality in these regions was associated mainly to agricultural development, urbanization and industrial waste. In the coastal area of the Mekong delta in Vietnam, the water quality was very poor due to the multiple impacts from upstream in combination with the effect of sea water intrusion. Many studies have identified the degradation of water quality in the canals built in the

Mekong delta [13,14,64,65]. Consequently, the pollution will become exacerbated in these areas under the intensive stress of population growth, industrialization, agriculture and tourism, which require food production and economic growth. These would be the major concerns for the riparian countries [6,24,58,66]. Moreover, these impacts could be also associated with the hydropower development in upstream Mekong [67]. Yet, our study was limited to conclude on the impacts of dams on water quality. To date, there is no dam across the main channel in LMB; while 5 of 8 planned dams were operating in upper Mekong basin in China. Previous studies on the impacts of Chinese dams on LMB have raised major issues concerning sediment trapping in dam reservoirs, flow regime regulation, habitat and biodiversity losses and food security in the basin [66,68]. Yet, there is no evidence of these impacts on water quality in LMB, as well as impacts of tributary dams [69]. While the contamination of heavy metals (Zn, Cr, Cu, Pb, As) in upstream basin has been related to the impacts of Chinese dams [70], further studies are clearly needed. In this context, we could expect that in the coming years, the effect of water quality might intensify since Laos, Thailand, and Cambodia propose to construct more dams across the main channel (e.g., 11 planned dams) and across large tributaries for electricity and agriculture purposes [71].

## Conclusion

With the challenges of population growth, urbanization, wastewater management, the need to feed of people, and the need for exports, changes in water quality in the LMB are expected. However, in spite of the multiple pressures from point and non-point sources of pollution, this study showed that the Mekong mainstream was less polluted than its tributaries. Potentially, the degradation of water quality in the mainstream was caused by the low quality of water discharged from tributaries. Eutrophication and salinity increases in many tributaries could represent the main water quality issues in the LMB, particularly in areas identified as pollution hotspots.

To date, few studies have quantified the impact of eutrophication on aquatic life (e.g. fish and fisheries resources) in LMB, although this concern has been evoked. Consistently, we raise the major concern on eutrophication and salinity increase in pollution hotspots, where urgent effective management is needed to mitigate these impacts. Indeed, as in the delta, to feed the population and enable economic growth, agriculture and aquaculture are prioritized for people living there. In the meantime, positive signs can be seen at national and regional levels as water quality monitoring programs and basin management plans have been implemented to improve the water quality and biodiversity. Improving water quality is another challenge for riparian countries; they would have strong support and participation from the people and governments of the four nations living in the basin.

To conclude, our study suggests that the monitoring efforts should be consolidated more for the group of sites in clusters 1b2 and 2, and particularly all pollution hotspot zones. Biological parameters such as Chlorophyll as well as heavy metals should also be monitored regularly. In perspective, the study of temporal dynamics of water quality associated with the influence of dams under different scenarios could be substantial to enhance the effectiveness of the existing monitoring programs and future management plans in the basin.

## Supporting Information

**S1 Fig. Variations in dissolved oxygen (DO), total phosphorus (TP), total ammonia ( $\text{NH}_3 + \text{NH}_4^+$ ) and chloride (Cl) along the longitudinal gradient (i.e., distance from the sea in km) for Mekong River (Circle lines) and its tributaries (dot lines). Vertical axis indicates the annual median values of concentration of DO, TP, total ammonia and Cl in**

logarithmic scale ( $\text{mgL}^{-1}$ ),  
(TIF)

## Acknowledgments

The authors are grateful to the Erasmus Mundus TECHNO Program and the Belmont Forum for providing funds to support our studies, which are a part of the Tonle Sap Climate Change (TLSCC) project. Great thanks to the Mekong River Commission (MRC) for providing the water quality data used in this study. We thank to University of Battambang for the data request and our colleagues at the Laboratory of Evolution and Biological Diversity (EDB) for their support and discussion concerning data preparation and analysis. EDB lab was supported by “Investissement d’Avenir” grants (CEBA, ref. ANR-10-LABX-0025; TULIP, ref. ANR-10-LABX-41).

## Author Contributions

Conceived and designed the experiments: RC GG SL. Performed the experiments: RC. Analyzed the data: RC GG SL. Contributed reagents/materials/analysis tools: RC GG SL. Wrote the paper: RC.

## References

1. Vörösmarty CJ, Green P, Salisbury J, Lammers BR. Global Water Resources: Vulnerability from Climate Change and Population Growth. *Science*. 2000; 289: 284–288. PMID: 10894773
2. Vörösmarty CJ, McIntyre PB, Gessner MO, Dudgeon D, Prusevich A, Green P, et al. Global threats to human water security and river biodiversity. *Nature*. 2010; 467: 555–561. doi: 10.1038/nature09440 PMID: 20882010
3. Dudgeon D. River Rehabilitation for Conservation of Fish Biodiversity in Monsoonal Asia. *Ecol Soc*. 2005; 10. Available: <http://www.ecologyandsociety.org/vol10/iss2/art15/>.
4. MRC. An assessment of water quality in the Lower Mekong Basin. MRC Technical Paper No.19. Mekong River Commission, Vientiane; 2008 p. 70pp. Available: <http://www.mrcmekong.org/assets/Publications/technical/tech-No19-assessment-of-waterquality.pdf>.
5. Resh VH. Multinational, freshwater biomonitoring programs in the developing world: lessons learned from African and Southeast Asian river surveys. *Environ Manage*. 2007; 39: 737–48. doi: 10.1007/s00267-006-0151-8 PMID: 17377729
6. Campbell IC. Perceptions, data, and river management: Lessons from the Mekong River. *Water Resour Res*. 2007; 43: 1–13. doi: 10.1029/2006WR005130
7. Abebe BA, Haq SMA, Chien VQ, Ararat B. The Challenges of Integrated Management of Mekong River Basin in Terms of People's Livelihood. *J Water Resour Prot*. 2010; 02: 61–68.
8. Singh N, Kumar A, Sharma MP. Ecological Health Assessment of Chambal River using Water Quality Parameters. *Integr Sci Technol*. 2014; 2: 52–56. ISSN 2321-4635.
9. Lu XX, Li S, Kummu M, Padawangi R, Wang JJ. Observed changes in the water flow at Chiang Saen in the lower Mekong: Impacts of Chinese dams? *Quat Int*. 2014; 336: 145–157. doi: 10.1016/j.quaint.2014.02.006
10. Johnston R, Smakhtin V. Hydrological Modeling of Large river Basins: How Much is Enough? *Water Resour Manag*. 2014; 28: 2695–2730. doi: 10.1007/s11269-014-0637-8
11. Li S, Lu XX, Bush RT. Chemical weathering and CO<sub>2</sub> consumption in the Lower Mekong River. *Sci Total Environ*. 2014; 472: 162–77. doi: 10.1016/j.scitotenv.2013.11.027 PMID: 24291559
12. Ozaki H, Co TK, Le AK, Pham VN, Nguyen VB, Tarao M, et al. Human factors and tidal influences on water quality of an urban river in Can Tho, a major city of the Mekong Delta, Vietnam. *Environ Monit Assess*. 2014; 186: 845–858. doi: 10.1007/s10661-013-3421-y PMID: 24114277
13. Phong ND, Hoanh CT, Tuong TP, Malano H. Effective management for acidic pollution in the canal network of the Mekong Delta of Vietnam: A modeling approach. *J Environ Manage*. 2014; 140: 14–25. Available: <http://www.sciencedirect.com/science/article/pii/S030147971400084X>. doi: 10.1016/j.jenvman.2013.11.049 PMID: 24726961



14. Wilbers G-J, Becker M, Nga LT, Sebesvari Z, Renaud FG. Spatial and temporal variability of surface water pollution in the Mekong Delta, Vietnam. *Sci Total Environ*. 2014; 485–486: 653–65. doi: [10.1016/j.scitotenv.2014.03.049](https://doi.org/10.1016/j.scitotenv.2014.03.049)
15. Evans AEV, Hanjra MA, Jiang Y, Qadir M, Drechsel P. Water Quality: Assessment of the Current Situation in Asia. *Int J Water Resour Dev*. 2012; 28: 195–216. doi: [10.1080/07900627.2012.669520](https://doi.org/10.1080/07900627.2012.669520)
16. Phet P. The implication of Environmental Legal Tools to Water Environment in Cambodia. The 3rd WEPA International Forum on Water Environmental Governance in Asia. Putrajaya, Malaysia; 2008. Available: <http://www.wepa-db.net/pdf/0810forum/paper21.pdf>.
17. Sengsoulichanh P, Cuny J, Pierret, A, Sengtaheuangoung O, Ribolzi O. Water Quality along a Mekong Tributary in Northern Lao PDR. The 3rd WEPA International Forum on Water Environmental Governance in Asia. Putrajaya, Malaysia; 2008. Available: <http://www.wepa-db.net/pdf/0810forum/paper20.pdf>.
18. Hoang DH, Nguyen TD. The current state of river basin in Vietnam: pollution and solution. The 3rd WEPA International Forum on Water Environmental Governance in Asia. Putrajaya, Malaysia; 2008. Available: <http://www.wepa-db.net/pdf/0810forum/paper16.pdf>.
19. Komany S. Water Quality Monitoring and Management in Lao PDR: The Case Study of Nam Ngum River Basin. The 3rd WEPA International Forum on Water Environmental Governance in Asia. Putrajaya, Malaysia; 2008. Available: <http://www.wepa-db.net/pdf/0810forum/paper18.pdf>.
20. Iida T, Inkamseng S, Yoshida K, Tanji H. Characterization of water quality variation in the Mekong River at Vientiane by frequent observations. *Hydrol Process*. 2011; 25: 3590–3601. doi: [10.1002/hyp.8084](https://doi.org/10.1002/hyp.8084)
21. Ribolzi O, Cuny J, Sengsoulichanh P, Mousquès C, Soullieuth B, Pierret A, et al. Land use and water quality along a mekong tributary in Northern Lao P.D.R. *Environ Manage*. 2011; 47: 291–302. doi: [10.1007/s00267-010-9593-0](https://doi.org/10.1007/s00267-010-9593-0) PMID: 21132547
22. MacQuarrie PR, Welling R, Rammont L, Pangare G. The 3S River Basin. Gland, Switzerland: IUCN; 2013. p. 12pp. Available: [https://cmsdata.iucn.org/downloads/3s\\_river\\_basin.pdf](https://cmsdata.iucn.org/downloads/3s_river_basin.pdf).
23. Sarkkula J, Kiirikki M, Koponen J, Kummu M. Ecosystem processes of the Tonle Sap Lake. first Workshop of Ecotone Phase II. Phnom Penh, Cambodia; 2003. pp. 1–14. Available: <http://citeseeix.ist.psu.edu/viewdoc/download?doi=10.1.1.472.3903&rep=rep1&type=pdf>.
24. Liljeström I, Kummu M, Varis O. Nutrient Balance Assessment in the Mekong Basin: Nitrogen and Phosphorus Dynamics in a Catchment Scale. *Int J Water Resour Dev*. 2012; 28: 373–391. doi: [10.1080/07900627.2012.668649](https://doi.org/10.1080/07900627.2012.668649)
25. MRC. The Mekong River Report on Water Quality. Mekong River Commission, Vientiane; 2010 p. 16pp. Available: <http://www.mrcmekong.org/assets/Publications/repoi-management-develop/Water-Quality-Report-Card-2010.pdf>.
26. MRC. Diagnostic study of water quality in the Lower Mekong Basin. MRC Technical Paper No.15. Mekong River Commission, Vientiane; 2007 p. 57pp. Available: <http://www.mrcmekong.org/assets/Publications/technical/tech-No15-diagnostic-study-of-water-quality.pdf>.
27. Lu XX, Siew RY. Water discharge and sediment flux changes over the past decades in the Lower Mekong River: possible impacts of the Chinese dams. *Hydrol Earth Syst Sci*. 2006; 10: 181–195. Available: <https://hal.archives-ouvertes.fr/hal-00304834>.
28. Campbell IC. A case study of the Mekong River—water, people and fisheries in a politically complex river basin. Proceedings of the International Conference. Environmental Flows for River Systems, incorporating the Fourth International Ecohydraulics Symposium. Cape Town, South Africa; 2003. Available: <https://hal.archives-ouvertes.fr/hal-00304834>.
29. Arias ME, Cochrane T, Caruso B, Killeen T, Kummu M. A landscape approach to assess impacts of hydrological changes to vegetation communities of the Tonle Sap Floodplain. *Eng Aust*. 2011; 3018–3025. ISBN 978-0-85825-868-6.
30. Kummu M, Lu XX, Rasphone A, Sarkkula J, Koponen J. Riverbank changes along the Mekong River. Remote sensing detection in the Vientiane-Nong Khai area. *Quat Int*. 2008; 186: 100–112. doi: [10.1016/j.quaint.2007.10.015](https://doi.org/10.1016/j.quaint.2007.10.015)
31. MRC. Overview of the Hydrology of the Mekong Basin. Mekong River Commission, Vientiane; 2005 p. 73pp. Available: <http://www.mekonginfo.org/assets/midocs/0001968-inland-waters-overview-of-the-hydrology-of-the-mekong-basin.pdf>.
32. Gamble A, Babbar-Sebens M. On the use of multivariate statistical methods for combining in-stream monitoring data and spatial analysis to characterize water quality conditions in the White River Basin. Indiana, USA. *Environ Monit Assess*. 2012; 184: 845–875. doi: [10.1007/s10661-011-2005-y](https://doi.org/10.1007/s10661-011-2005-y) PMID: 21455628



33. US-EPA. Quality Criteria for Water. United States Environmental Protection Agency. Washington, D. C. 20460; 1976, pp. 34–427. Available: [http://water.epa.gov/scitech/swguidance/standards/criteria/current/upload/2009\\_01\\_13\\_criteria\\_redbook.pdf](http://water.epa.gov/scitech/swguidance/standards/criteria/current/upload/2009_01_13_criteria_redbook.pdf).
34. Lek S, Guégan JF. Artificial neural networks as a tool in ecological modelling, an introduction. *Ecol Modell*. 1999; 120: 65–73. pii: S0304-3800(99)00092-7.
35. Olkowska E, Kudlak B, Tsakovski S, Ruman M, Simeonov V, Polkowska Z. Assessment of the water quality of Klodnica River catchment using self-organizing maps. *Sci Total Environ*. 2014; 476–477C: 477–484. Available: <http://www.sciencedirect.com/science/article/pii/S0048969714000539>.
36. Ye C, Li S, Yang Y, Shu X, Zhang J, Zhang Q. Advancing Analysis of Spatio-Temporal Variations of Soil Nutrients in the Water Level Fluctuation Zone of China's Three Gorges Reservoir Using Self-Organizing Map. *PLoS One*. 2015; 10: e0121210. doi: [10.1371/journal.pone.0121210](https://doi.org/10.1371/journal.pone.0121210) PMID: 25789612
37. Qu H, Bae M, Chon T, Song M, Park Y. Comparative Analyses of Community and Biological Indices based on Benthic Macroinvertebrates in Streams using a Self-Organizing Map. *Korean J Limnol*. 2009; 42: 303–316.
38. Tudesque L, Gevrey M, Grenouillet G, Lek S. Long-term changes in water physicochemistry in the Adour-Garonne hydrographic network during the last three decades. *Water Res*. 2008; 42: 732–742. PMID: 18023839
39. Ongley ED. Water Quality Guidelines and Index: Recommendations for Mekong Water Quality Assessment. Vientiane, Lao PDR; 2006.
40. SEQ-Eau. Système d'évaluation de la qualité de l'eau des cours d'eau. Agences de l'eau-Ministère de l'écologie et du développement durable; 2003 p. 40pp.
41. Stephan EC, Mount ID, Hansen JD, Gentile HJ, Chapman AG, Brungs AW. Guidelines for deriving numerical national water quality criteria for the protection of aquatic organisms and their uses. U.S. Environmental Protection Agency, Environmental Research Laboratories, Duluth, Minnesota; 1985. p. 104pp.
42. WWF. National Surface Water Classification Criteria. Freshwater & Toxics Programme, World Wildlife Fund, Pakistan; 2007. p. 33pp. Available: <http://www.mocc.gov.pk/gop/index.php>.
43. Dise NB, Ashmore M, Belyazid S, Bleeker A, Bobbink R, Vries W De, et al. Nitrogen as a threat to European biodiversity, The European Nitrogen Assessment. 2011, pp. 463–494.
44. US-EPA. Conductivity: An Inappropriate Measure of Water Quality. U.S. Environmental Protection Agency, Washington, D.C. 20460; 2010. Available: [http://www.nma.org/pdf/051210\\_conductivity.pdf](http://www.nma.org/pdf/051210_conductivity.pdf).
45. MNRE. Climate Change in the Mekong Delta: Climate scenario's, sea level rise, other effects. Vietnam-Netherlands Mekong Delta Masterplan project. Ministry of Natural Resources and Environment. Ho Chi Minh City; 2010.
46. Minh NH, Minh TB, Kajiwara N, Kunisue T, Iwata H, Viet PH, et al. Pollution sources and occurrences of selected persistent organic pollutants (POPs) in sediments of the Mekong River delta, South Vietnam. *Chemosphere*. 2007; 67: 1794–1801. doi: [10.1016/j.chemosphere.2006.05.144](https://doi.org/10.1016/j.chemosphere.2006.05.144) PMID: 17223174
47. Phung D, Huang C, Rutherford S, Dwirahmadi F, Chu C, Wang X, et al. Temporal and spatial assessment of river surface water quality using multivariate statistical techniques: a study in Can Tho City, a Mekong Delta area, Vietnam. *Environ Monit Assess*. 2015; 187. doi: [10.1007/s10661-015-4474-x](https://doi.org/10.1007/s10661-015-4474-x)
48. Phong ND, Tuong TP, Phu ND, Nang ND, Hoanh CT. Quantifying source and dynamics of acidic pollution in a coastal acid sulphate soil area. *Water Air Soil Pollut*. 2013; 224. doi: [10.1007/s11270-013-1765-0](https://doi.org/10.1007/s11270-013-1765-0)
49. Minh LQ, Tuong TP, VanMensvoort MEF, Bouma J. Contamination of surface water as affected by land use in acid sulfate soils in the Mekong River Delta, Vietnam. *Agric Ecosyst Environ*. 1997; 61: 19–27. pii: S0167-8809(96)01084-5.
50. Lan NTP. Social and ecological challenges of market-oriented shrimp farming in Vietnam. *Springerplus*. 2013; 2: 675. Available: <http://www.springerplus.com/content/2/1/675>. doi: [10.1186/2193-1801-2-675](https://doi.org/10.1186/2193-1801-2-675) PMID: 24386621
51. Claridge GF. An inventory of wetlands of the Lao PDR. IUCN-The World Conservation Union; 1996. p. 317.
52. Gerrard P. Integrating Wetland Ecosystem Values into Urban Planning: The Case of That Luang Marsh, Vientiane, Lao PDR. IUCN – The World Conservation Union Asia Regional Environmental Economics Programme and WWF Lao Country Office, Vientiane; 2004.
53. Alongi DM, Dixon P, Johnston DJ, Van Tien D, Thanh Xuan T. Pelagic processes in extensive shrimp ponds of the Mekong delta, Vietnam. *Aquaculture*. 1999; 175: 121–141. pii: S0044-8486 99 00078–2.
54. Weber-Scannell PK, Duffy LK. Effects of total dissolved solids on aquatic organisms: A review of literature and recommendation for salmonid species. *Am J Environ Sci*. 2007; 3: 1–6.

55. Bui TM, Phan LT, Ingram BA, Nguyen TTT, Gooley GJ, Nguyen HV, et al. Seed production practices of striped catfish, *Pangasianodon hypophthalmus* in the Mekong Delta region, Vietnam. *Aquaculture*. 2010; 306: 92–100.
56. Wang J, Lu XX, Kummu M. Sediment Load Estimates and Variations in the Lower Mekong River. *River Res Applic*. 2011; 7: 189. doi: [10.1002/rra.1337](https://doi.org/10.1002/rra.1337)
57. Lu XX, Kummu M, Oeumg C. Reappraisal of sediment dynamics in the Lower Mekong River, Cambodia. *Earth Surf Process Landforms*. 2014; 39: 1855–1865. doi: [10.1002/esp.3573](https://doi.org/10.1002/esp.3573)
58. Snidvong A, Teng SK. Global International Waters Assessment Mekong River, GIWA Regional assessment 55. In: *Global International Water Assessment*. University of Kalmar, Kalmar, Sweden; 2006. p. 75pp. ISSN: 1651-940x.
59. Fedra K, Winkelbauer L, Pantulu VR. Environmental problems of water resources development in the Lower Mekong Basin. International Institute for Applied Systems Analysis, A-2361, Laxenburg, Austria. 2004. Available: <http://www.ess.co.at/EIA/rr04.html>.
60. Dudgeon D. Asian river fishes in the Anthropocene: threats and conservation challenges in an era of rapid environmental change. *J Fish Biol*. 2011; 79: 1487–524. doi: [10.1111/j.1095-8649.2011.03086.x](https://doi.org/10.1111/j.1095-8649.2011.03086.x) PMID: [22136237](https://pubmed.ncbi.nlm.nih.gov/22136237/)
61. Qin B, Zhu G. The nutrient forms, cycling and exchange flux in the sediment and overlying water system in lakes from the middle and lower reaches of Yangtze River. *Sci China, Ser D Earth Sci*. 2006; 49: 1–13.
62. Hart BT, Jones MJ, Pistone G. *Transboundary Water Quality Issues in the Mekong River Basin*. Water Studies Centre, Monash University, Melbourne, Australia; 2001. Available: <http://www.mekonginfo.org/assets/midocs/0003423-environment-transboundary-water-quality-issues-in-the-lower-mekong-basin.pdf>.
63. Prathumratana L, Sthiannopkao S, Kim KW. The relationship of climatic and hydrological parameters to surface water quality in the lower Mekong River. *Environ Int*. 2008; 34: 860–866. doi: [10.1016/j.envint.2007.10.011](https://doi.org/10.1016/j.envint.2007.10.011) PMID: [18068783](https://pubmed.ncbi.nlm.nih.gov/18068783/)
64. Chau N, Sebesvari Z, Amelung W, Renaud F. Pesticide pollution of multiple drinking sources in the Mekong Delta, Vietnam: evidence from two provinces. *Environ Sci Pollut Res*. 2015; 22: 9042–9058. doi: [10.1007/s11356-014-4034-x](https://doi.org/10.1007/s11356-014-4034-x)
65. Sebesvari Z, Le T, Toan P, Arnold U, Renaud F. Agriculture and water quality in the Vietnamese Mekong Delta. In: *The Mekong Delta system; interdisciplinary analysis of a river delta*. Dordrecht, The Netherlands: Springer Environmental Science and Engineering; 2012. pp. 61–331.
66. Yoshimura C, Zhou M, Kiem AS, Fukami K, Prasantha HH, Ishidaira H, et al. 2020s scenario analysis of nutrient load in the Mekong River Basin using a distributed hydrological model. *Sci Total Environ*. 2009; 407: 5356–5366. doi: [10.1016/j.scitotenv.2009.06.026](https://doi.org/10.1016/j.scitotenv.2009.06.026) PMID: [19625073](https://pubmed.ncbi.nlm.nih.gov/19625073/)
67. Ziegler AD, Petney TN, Grundy-Warr C, Andrews RH, Baird IG, Wasson RJ, et al. Dams and Disease Triggers on the Lower Mekong River. *PLoS Negl Trop Dis*. 2013; 7: 5–8.
68. Ziv G, Baran E, Nam S, Rodríguez-Iturbe I, Levin S. Trading-off fish biodiversity, food security, and hydropower in the Mekong River Basin. *Proc Natl Acad Sci U S A*. 2012; 109: 5609–14. doi: [10.1073/pnas.1201423109](https://doi.org/10.1073/pnas.1201423109) PMID: [22393001](https://pubmed.ncbi.nlm.nih.gov/22393001/)
69. Piman T, Cochrane T, Arias M, Green A, Dat N. Assessment of Flow Changes from Hydropower Development and Operations in Sekong, Sesan, and Srepok Rivers of the Mekong Basin. *J Water Resour Plann Manage*. 2013; 139: 723–732. doi: [10.1061/\(ASCE\)WR.1943-5452.0000286](https://doi.org/10.1061/(ASCE)WR.1943-5452.0000286)
70. Fu K, Su B, He D, Lu X, Song J, Huang J. Pollution assessment of heavy metals along the Mekong River and dam effects. *J Geogr Sci*. 2012; 22: 874–884.
71. Grumbine RE, Dore J, Xu J. Mekong hydropower: drivers of change and governance challenges. *Front Ecol Envir*. 2012; 5: 91–98.



## ARTICLE 2

### **Large-scale patterns of fish diversity and assemblage structure in the longest tropical river in Asia.**

**R. Chea, S. Lek, P. Ngor and G. Grenouillet 2016.**

*Ecology of Freshwater Fish (In press)*





# Large-scale patterns of fish diversity and assemblage structure in the longest tropical river in Asia

Ratha Chea<sup>1,2</sup> | Sovan Lek<sup>1,2</sup> | Pengbun Ngor<sup>3</sup> | Gaël Grenouillet<sup>1,4</sup>

<sup>1</sup>Université de Toulouse, Labo Evolution & Diversité Biologique, UMR5174 EDB CNRS-Université Paul Sabatier-ENFA, Toulouse, France

<sup>2</sup>Faculty of Agriculture and Food Processing, University of Battambang, Battambang City, Cambodia

<sup>3</sup>Fisheries Program, Mekong River Commission, Phnom Penh, Cambodia

<sup>4</sup>Institut Universitaire de France, Paris, France

## Correspondence

R. Chea, Université de Toulouse, Labo Evolution & Diversité Biologique, UMR5174 EDB CNRS- Université Paul Sabatier-ENFA, Toulouse, France.  
Email: chearatha@rocketmail.com

## Abstract

Although the Mekong River is one of the world's 35 biodiversity hot spots, the large-scale patterns of fish diversity and assemblage structure remain poorly addressed. This study aimed to investigate the fish distribution patterns in the Lower Mekong River (LMR) and to identify their environmental determinants. Daily fish catch data (i.e. from December 2000 to November 2001) at 38 sites distributed along the LMR were related to 15 physicochemical and 19 climatic variables. As a result, four different clusters were defined according to the similarity in assemblage composition and 80 indicator species were identified. While fish species richness was highest in the Mekong delta and lowest in the upper part of the LMR, the diversity index was highest in the middle part of the LMR and lowest in the delta. We found that fish assemblages changed along the environmental gradients and that the main drivers affecting the fish assemblage structure were the seasonal variation of temperature, precipitation, dissolved oxygen, pH and total phosphorus. Specifically, upstream assemblages were characterised by cyprinids and *Pangasius* catfish, well suited to low temperature, high dissolved oxygen and high pH. Fish assemblages in the delta were dominated by perch-like fish and clupeids, more tolerant to high temperatures, and high levels of nutrients (nitrates and total phosphorus) and salinity. Overall, the patterns were consistent between seasons. Our study contributes to establishing the first holistic fish community study in the LMR.

## KEYWORDS

distribution patterns, environmental gradient, fish assemblage, fishery, Lower Mekong River

## 1 | INTRODUCTION

Large tropical rivers represent ecosystems of historically immense value for humanity, both in terms of the high biodiversity they support and of the number of people whose livelihoods depend directly upon that biodiversity (Coates, 2001). Mekong River, the largest tropical river in Asia, is known as one of the world's 35 biodiversity hot spots (Mittermeier, Turner, Larsen, Brooks, & Gascon, 2011). It is a biologically diverse and highly productive ecosystem, ranked 3rd in terms of fish diversity (877 species, Ziv, Baran, So, Rodriguez-Iturbe, & Levin, 2012), just after the Amazon River Basin (3,000 species, Rainboth, 1996) and the Congo River Basin (991 species, Froese & Pauly, 2015); yet, on a per unit area basis and fish family diversity Mekong is indeed

the richest. Annually, Mekong harvests 2.3 million tonnes of wild fish supporting the world's largest inland fishery and providing essential livelihoods, nutrition and food security for millions of people within the region (MRC 2015). The economic values of fisheries in Lower Mekong alone were estimated to be worth around 17 billion USD a year generating employments and constituting a safety net for more than 60 million people within the region, especially the poor households in rural communities (MRC 2015). More importantly, in combination with its socio-economic values, the Mekong River Basin accounts for high levels of endemism, for example among the known species, 219 are endemic to the basin (76% are cyprinids and 12% catfishes; Dudgeon, 2011). However, compared to other riverine ecosystems, that is temperate, neotropical and subtropical, still very little effort has



been mobilised to study the ecological and biological compartments of this extremely productive system, for example fish, invertebrates and other primary producers (Coates, 2001; Dudgeon, 2003; Kottelat & Whitten, 1996). While previous studies have focused on the relationship between hydrology and fish production, the impact of dams as well as the migration patterns of certain common species, the spatial structure of the fish community as a whole has not been investigated (Baran, 2006; Dugan et al., 2010; Lucas, Baras, Thom, Duncan, & Slavik, 2001; Poulsen, Ouch, Sinthavong, Ubolratana, & Nguyen, 2002; Ziv et al., 2012) and the relative importance of environmental factors in structuring fish communities along the river remains to be studied. Accordingly, the large-scale distribution patterns of the fish community have neither been described nor documented, except some ecological and biological descriptions of single species (see Rainboth, 1996).

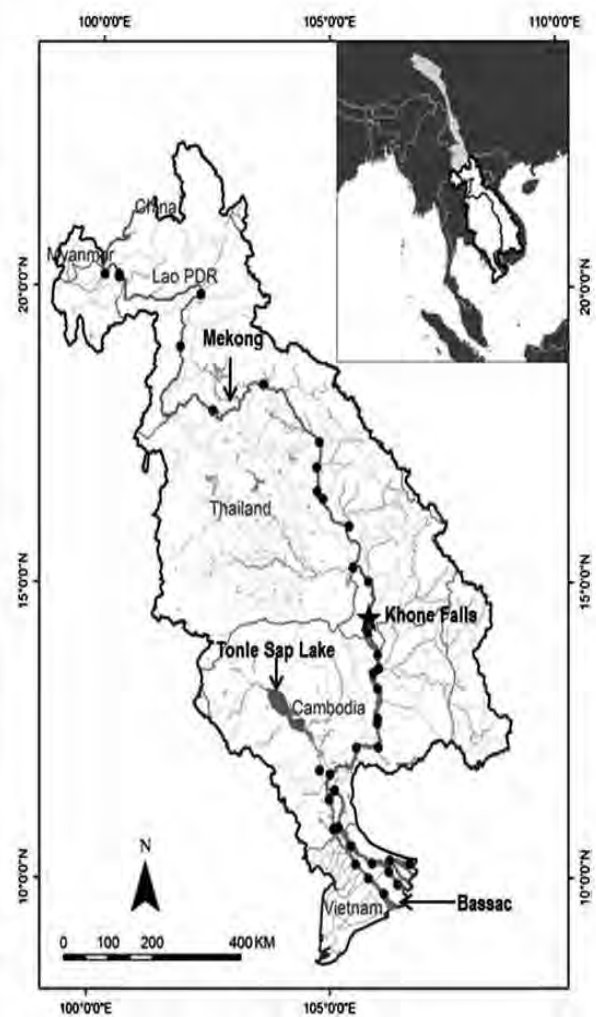
To date, the determination of factors structuring communities remains one of the major objectives in fish ecological studies and it is widely accepted that the structure of communities results from spatial variability of habitat, environmental variability and interactions among the organisms (Albert & Reis, 2011; Lujan et al., 2013; Olden et al., 2010; Zhao, Grenouillet, Pool, Tudesque, & Cucherousset, 2015). For instance, some authors revealed the prevailing roles of physico-chemical factors in structuring fish communities (Pires, Pires, Collares-Pereira, & Magalhães, 2010; Tejerina-Garro, Fortin, & Rodriguez, 1998), while others reported the dominant effects of climatic factors (Buisson, Blanc, & Grenouillet, 2008; Guo et al., 2015). Considering large-scale patterns, the study of fish communities is always challenging, for example lack of environmental variables at the local scale, rarity of large data sets of fish composition, which are much more informative than simple presence-absence data, and limitation of modelling the nonlinear relationship between biotic and abiotic factors, especially for cross-border river basins (e.g. the Mekong; Amarasinghe & Welcomme, 2002; Oberdorff, Guegan, & Hugueny, 1995).

Furthermore, over the last 30 years, with the rapid growth of population, industrialisation, agriculture intensification and hydropower development in the basin, in both Upper and Lower Mekong Basins, it was reported that the basin is now facing increasing environmental degradation, that is water pollution, eutrophication, deforestation, which are adversely affecting the biodiversity within the whole region (Dudgeon, 2003, 2011; Vorosmarty et al., 2010). Therefore, biodiversity management and conservation efforts are needed to mitigate these impacts. Consequently, this requires an understanding of how environmental and anthropogenic factors shape the present biogeography of organisms (Olden et al., 2010; Pool, Olden, Whittier, & Paukert, 2010). In this context, the main objectives of the present work were: (i) to describe the fish diversity and assemblage structure in the Lower Mekong River (LMR) by examining the relative abundance of fish composition and the associated distribution patterns and (ii) to identify the physicochemical and climatic factors driving fish assemblage patterns. More specifically, our study contributes to establishing a baseline holistic fish community study in the LMR and to identifying the drivers controlling the fish assemblage patterns. These findings could have important implications for biodiversity management and conservation in the large river basins worldwide.

## 2 | MATERIALS AND METHODS

### 2.1 | Study area: The Lower Mekong River

The Mekong rises on the Tibetan plateau and runs for 4,350 km through six countries to the South China Sea, where it discharges annually on average 475,000 million m<sup>3</sup> (Lu & Siew, 2006). The Mekong River Basin covers an area of 795,000 km<sup>2</sup> and is functionally divided into two parts: the Upper Mekong Basin (UMB) and the Lower Mekong Basin (LMB; Lu & Siew, 2006). The upper part of the river, in China, is called the Lancang Jiang and is characterised by deep gorges and steep declines. At the Golden Triangle, where the borders of Laos, Myanmar and Thailand meet, the LMB starts, and the river (Lower Mekong River) runs for another 2,500 km to the sea (Fig. 1). The LMB consists of four riparian countries, that is Laos, Thailand, Cambodia and Vietnam and covers 77% of the total basin area with 60 million inhabitants. Geographically, the Lower Mekong River (LMR) forms a stretch of about 900 km, which marks the border between Laos and Thailand, and creates an inland delta at the Lao-Cambodian border known as Khone Falls (21 m high; Fig. 1; Roberts & Baird, 1995). Then, at Phnom Penh, the Mekong



**FIGURE 1** Lower Mekong Basin. Black dots represent the fish monitoring sites along the mainstream Lower Mekong River



**TABLE 1** List of bioclimatic variables used in the study with the average and standard deviation

Variable	Unit	Variable type	Mean	SD
Bio1	(°C)	Annual Mean Temperature	26.76	0.90
Bio2	(°C)	Mean Diurnal Range (Mean of monthly (max temp - min temp))	9.15	1.71
Bio3	%	Isothermality (bio2/bio7)*100	58.54	5.39
Bio4	(°C*100)	Temperature Seasonality (standard deviation *100)	1,569.82	736.45
Bio5	(°C)	Maximum Temperature of Warmest Month	34.23	0.98
Bio6	(°C)	Minimum Temperature of Coldest Month	18.39	3.57
Bio7	(°C)	Temperature Annual Range (bio5-bio6)	15.84	4.20
Bio8	(°C)	Mean Temperature of Wettest Quarter	27.20	0.31
Bio9	(°C)	Mean Temperature of Driest Quarter	24.83	2.19
Bio10	(°C)	Mean Temperature of Warmest Quarter	28.53	0.55
Bio11	(°C)	Mean Temperature of Coldest Quarter	24.50	2.03
Bio12	mm	Annual Precipitation	1,635.26	324.78
Bio13	mm	Precipitation of Wettest Month	329.85	90.95
Bio14	mm	Precipitation of Driest Month	4.18	3.27
Bio15	—	Precipitation Seasonality (Coefficient of Variation)	83.82	10.42
Bio16	mm	Precipitation of Wettest Quarter	869.21	251.89
Bio17	mm	Precipitation of Driest Quarter	25.31	12.84
Bio18	mm	Precipitation of Warmest Quarter	407.79	184.73
Bio19	mm	Precipitation of Coldest Quarter	63.51	46.40

Isothermality (bio3) is defined as the ratio of the diurnal range of temperature to the annual range.

connects with Tonle Sap Lake through Tonle Sap River. There, the river splits into two branches, that is Mekong proper and Bassac River, and forms a large estuarine delta before it empties in the sea. Under the influence of tropical Monsoon, the LMB's climate is basically divided into two seasons, that is dry (December–May) and wet (June–November) seasons, each lasting 6 months (Lu, Li, Kumm, Padawangi, & Wang, 2014). One of the important features of the Mekong's hydrological regime is the flow regulation by the Great Lake in Cambodia, that is the vast lake draining into the Mekong in the dry season and raising the water level in the delta for 5–6 months (Lu et al., 2014).

## 2.2 | Fish catch monitoring

The fish data used in this study were derived from the Mekong River Commission (MRC), under the Assessment of Mekong Fisheries Component of the MRC Fisheries Programme. The daily fish catches were monitored at 38 sites along the Lower Mekong mainstream from November 2000 to December 2001; the project was funded by the government of Denmark through DANIDA (Danish International Development Agency; Poulsen et al., 2002). Indeed, the fish survey was carried out along the main channel and consisted of eight sites located in Laos, seven in Thailand, 12 in Cambodia and 11 in Vietnam. Basically, at each location, fishermen recorded their daily catches in the logbooks, the maximum length of each species in every sample, the type of fishing gears used as well as the weather condition of the fishing day (e.g. high/low water level, rainy/sunny day). The catch monitoring methods were derived from the MRC's regional monitoring programme on Fish abundance and diversity in Lower Mekong Basin (FEVM 2007). Indeed, all fishermen were trained to use logbooks, sampling and subsampling techniques applied for the large catch during the peak seasons, identify the fish species, as well as measure length and weight of fish species. The taxonomic identification was performed to species level and to help with fish identification, the photograph flipcharts of more than 170 fish common species were provided to fishermen. Moreover, to ensure the quality of monitoring, all data were checked for errors and cleaned quarterly within the monitoring period by MRC's specialists. In total, about 14,368 observations have been recorded over the survey period and five main types of fishing gear were recorded, that is gillnets (47%), long lines and hooks (23%), traps (10%), bag nets (8%) and cast nets (7%; Sinthavong, 2006). The fishing efforts ranged from 1 to 24 hr depending on the seasons and type of the gear; nevertheless, the average efforts over the record period were between 6 to 7 hr/day. We used the whole data set for the statistical analyses.

## 2.3 | Climatic variables

Nineteen bioclimatic variables were derived from the WorldClim database (Hijmans, Cameron, Parra, Jones, & Jarvis, 2005), available at <http://www.worldclim.org>, describing the climate conditions for the period 1950–2000 with a spatial resolution of about 1 km<sup>2</sup> (Table 1).

## 2.4 | Physicochemical variables

Fifteen physicochemical variables were obtained from the MRC's water quality monitoring programme (Chea, Grenouillet, & Lek, 2016) and used to examine the link between physicochemical factors and fish assemblages (Table 2). The monitoring programme started in 1985 in Laos–Vietnam–Thailand and 1995 in Cambodia. At the basin scale, 117 sites were monitored monthly. The values of physicochemical variables of each fish site were attributed from the closest water quality monitoring sites (Table S1). In total, 22 of the whole number of monitoring sites were used for the analyses and the values of each parameter were expressed as annual median values (Table S1). The



**TABLE 2** List of physicochemical variables used

Variables	Unit	Mean	SD
pH	—	7.38	0.33
Total suspended solids (TSS)	mg/L	124.47	84.70
Conductivity (EC)	$\mu\text{S}/\text{cm}$	202.19	105.07
Calcium ( $\text{Ca}^{+2}$ )	mg/L	19.30	6.21
Magnesium ( $\text{Mg}^{+2}$ )	mg/L	5.36	2.29
Sodium ( $\text{Na}^{+}$ )	mg/L	12.56	17.22
Potassium ( $\text{K}^{+}$ )	mg/L	1.85	1.01
Alkalinity (Alk)	mg/L	76.07	20.00
Chloride ( $\text{Cl}^{-}$ )	mg/L	15.69	30.00
Sulphate ( $\text{SO}_4^{-2}$ )	mg/L	14.22	5.99
Nitrate ( $\text{NO}_3^{-}$ )	mg/L	0.23	0.07
Ammonium ( $\text{NH}_4^{+}$ )	mg/L	0.05	0.02
Total phosphorus (TP)	mg/L	0.09	0.06
Dissolved oxygen (DO)	mg/L	7.09	0.69
Chemical oxygen demand (COD)	mg/L	2.59	1.13

average distance between fish and physicochemical sites was 27.36 ( $\pm 27.08$  SD) km.

## 2.5 | Statistical analysis

Here, we focused on patterns of community in terms of composition rather than abundance. Therefore, all fish catches were transformed into relative abundance to reduce the effect of varying fishing efforts between sites and averaged to annual mean relative abundance to summarise the data set. Next, we performed Ward hierarchical clustering based on the annual mean relative abundance to classify the fish sites into different groups according to their similarity in species composition (Murtagh & Legendre, 2014). Species richness and diversity index (i.e. inverse Simpson index) were computed to describe the clusters identified, and significant differences ( $p < .05$ ) among clusters were tested using Tukey's HSD (Honest Significant Difference) tests.

Afterwards, the indicator species of each group of sites were determined using the "indicspecies" package to describe the differences in the clusters identified (De Cáceres, Legendre, & Moretti, 2010). For a given cluster, the indicator value of the species is the square root of the product of two quantities called A and B, that is predictive value and sensitivity. Quantity A is the probability of the target group of sites given that an individual species has been found and was defined as the mean abundance of the species in the target site group divided by the sum of the mean abundance value over all groups. Quantity B is the average relative abundance of individuals of the species at a site that belongs to the target site group and was determined as the relative frequency of occurrence of the species inside the target site group (De Cáceres et al., 2010). Hence, species with high indicator values were used as characteristic members of the cluster. The same procedure was performed simultaneously for dry and wet seasons of fish data sets.

To study the relationship between fish assemblages and environmental variables, ordination methods were performed on annual mean fish data. First, detrended correspondence analysis (DCA) was performed to select the appropriate ordination method for our study (i.e. redundancy analysis (RDA) versus canonical correspondence analysis (CCA; Legendre & Legendre, 2012). CCA was described as the most appropriate method as the calculated DCA ordination gradient was  $> 3$  (i.e. 4.22 for our study), revealing that unimodal responses to environmental factors predominated (Ter Braak & Prentice, 1988). CCA is a constraint ordination method which reveals the relationships between community structure, sites and environmental variables (Legendre & Legendre, 2012). In the biplot of CCA, the importance of environmental variables is depicted by the length of the vectors, while the correlation between them is exhibited by the angle between the vectors. We used Monte Carlo permutation tests with 999 permutations to test whether the variables significantly ( $p < .05$ ) explained the fish data (Legendre & Legendre, 2012).

Lastly, to examine the contribution of the two sets of environmental factors in explaining the variation in fish assemblages, variance partitioning was performed to see how the physicochemical and climatic variables contributed to explain fish assemblages (Borcard, Legendre, & Drapeau, 1992; Legendre & Legendre, 2012). Spatial vectors were also included in the variance partitioning to disentangle the influence of environmental and spatial factors on fish distribution. The geographic coordinates of the sites were modelled following the Asymmetric Eigenvectors Map (AEM) procedure proposed by Blanchet, Legendre, and Borcard (2008). Forward selection was performed on AEM vectors, and only significant environmental and AEM variables were kept for the analysis. The partitioning was performed through the "vegan" package and displayed in the form of a Venn diagram (Borcard et al., 1992). All statistical analyses were conducted in R 3.2.2 (R Core Team 2015).

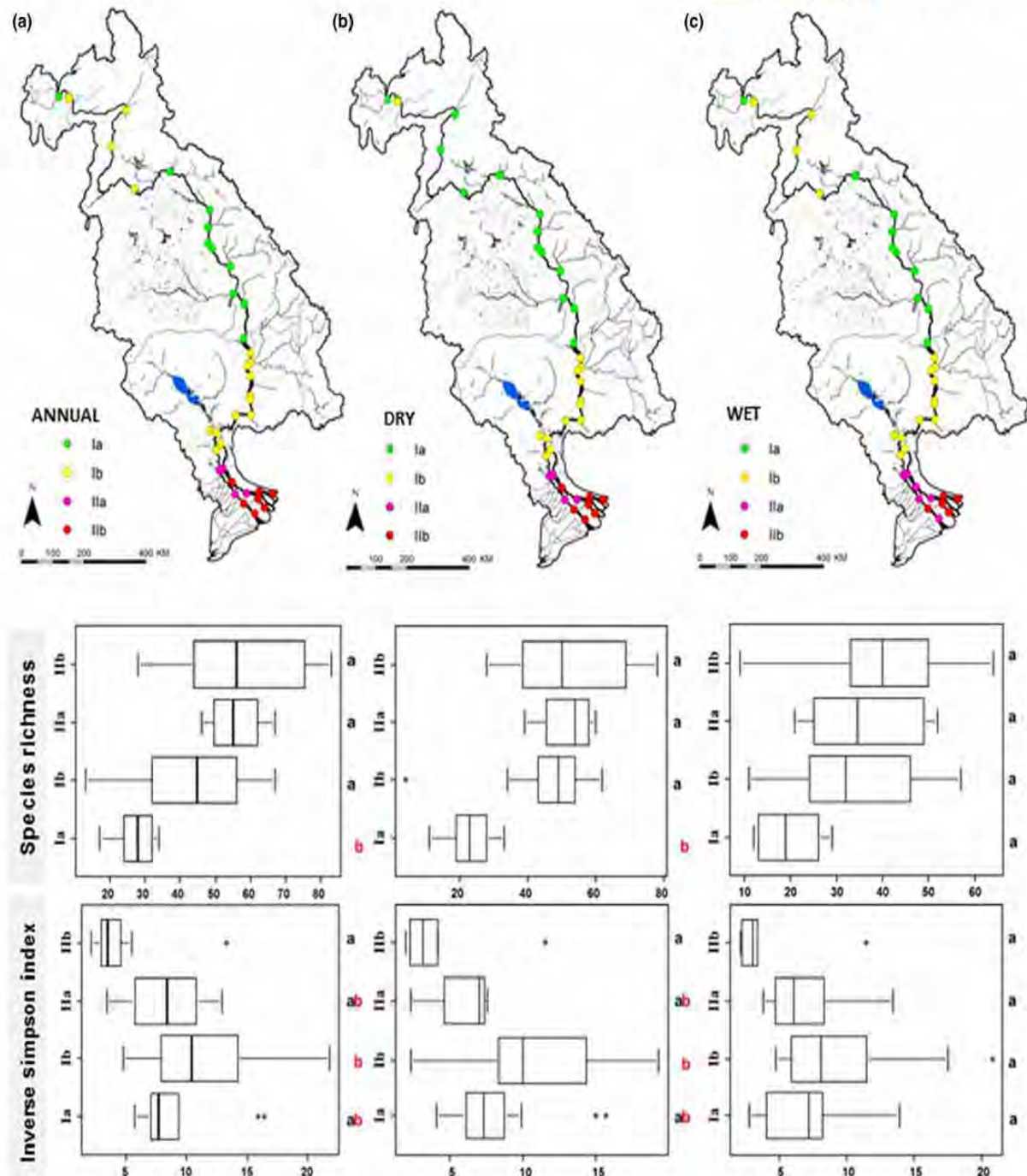
## 3 | RESULTS

### 3.1 | Fish diversity and assemblage structure

A total of 182 species belonging to 110 genera, 42 families and 13 different orders were recorded by the fishermen at 38 monitoring sites. Three main orders accounted for 80% of the total number of species, that is Cypriniformes (54 species), Siluriformes (53 species) and Perciformes (39 species), while Anguilliformes, Batrachoidiformes, Beloniformes, Clupeiformes, Mugiliformes, Osteoglossiformes, Pleuronectiformes, Rajiformes, Synbranchiformes and Tetraodontiformes represented each of them  $< 5\%$  of the total fish species richness.

The 38 monitoring sites were patterned into four different community assemblage clusters based on the similarity of their species composition (Fig. 2a). Two main community clusters were defined at the first split (clusters I and II), revealing the longitudinal characteristics of the Mekong system between the upper LMR and its delta. Subsequently, the main clusters were subdivided into four different groups considered as four different fish assemblages (Ia, Ib, IIa and





**FIGURE 2** Fish distribution and assemblage patterns in Lower Mekong River. Annual (a), dry season (b) and wet season (c) clustering associated with species richness and Inverse Simpson index of each cluster (Ia, Ib, IIa, IIb). For each box plot, the dark line inside the box represents the median value, while the lines below and above indicate the 25 and 75 percentiles respectively. The whisker marks represent the minimum and maximum values. Mean values among clusters with a common letter are not significantly different at  $p = .05$  (Tukey's HSD tests)

IIb) in the LMR (Fig. 2a). Indeed, cluster Ia was composed of 10 sites, stretching down in the upper part of the LMR, along the border between Laos and Thailand. Only one site of this cluster was found at the head of the LMB. Cluster Ib was composed of 17 sites, mainly located in Cambodia and four sites were found in upstream of the LMR, above Vientiane city. The smallest cluster IIa was made up of four sites, that is two sites located at the border of Cambodia and Mekong delta and other two sites in the middle part of the delta. Finally, the cluster IIb was characterised by seven sites in the lower

part of the Mekong delta, known as the brackish zone; only one site of IIb was found in the middle part of the delta. Fish species richness of each assemblage ranged from 17 species at the head of the LMR to 82 at the mouth of the river (Fig. 2a). The highest species richness was found in IIb (median: 56 species), followed by IIa (55 species) and then Ib (45 species), and Ia contained the lowest species richness (28 species; Fig. 2a). Indeed, cluster Ia presented significantly lower species richness than the other three clusters, while no significant differences were observed between clusters Ib, IIa and IIb. Moreover, important



variations in species richness were noticed between clusters Ib and IIb. In contrast, the diversity index was highest (median: 10.5) in Ib and lowest (median: 3.5) in IIb (Fig. 2a). Accordingly, the diversity in Ib was significantly different from IIb, while the others exhibited similar diversity indices (Fig. 2a).

The seasonal patterns were consistent between dry and wet season (Fig. 2b,c). During the dry season, fish assemblages were characterised by higher species richness than in wet season and the patterns of diversity were pronounced, especially between clusters Ib and IIb (Fig. 2b). By contrast, during the wet season, fish assemblage patterns were more similar to the annual patterns; and no significant differences in species richness and diversity were observed between the identified clusters (Fig. 2c).

Furthermore, the relative abundance of fish orders varied greatly along the longitudinal gradient of the LMR system, and this pattern was consistent between seasons for all except one fish order (i.e. Clupeiformes, Fig. 3, Wilcoxon test,  $p < .05$ ). Apart from the Mekong delta, that is particularly in Ia and Ib, Cypriniformes and Siluriformes dominated and occurred almost in every site, while their abundances decline dramatically in the delta. Additionally, Osteoglossiformes and Perciformes were found in some sites of Ib, that is the sites in Cambodia. In the delta (IIa and IIb), the fish composition was diverse and characterised by many species from different orders such as Clupeiformes, Perciformes, Pleuronectiformes, Synbranchiformes, Tetraodontiformes; among those, Perciformes and Clupeiformes were the most abundant (Fig. 3).

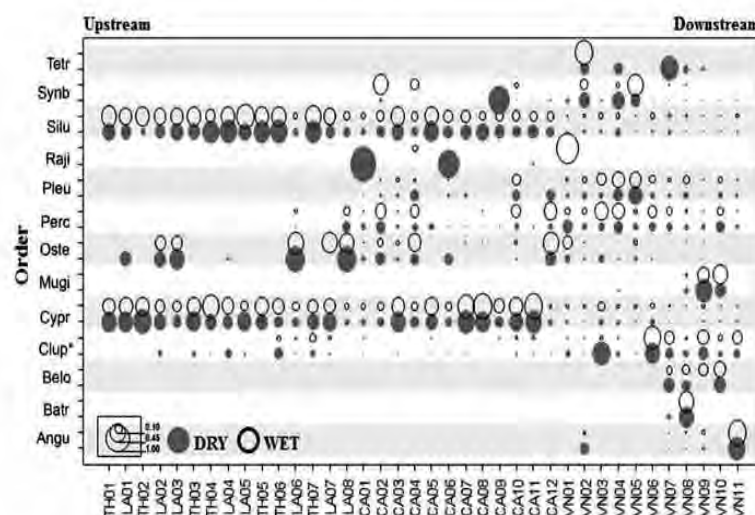
### 3.2 | Indicator species of clusters

A total of 80 indicator species were identified from the four annual clusters (Table S2). The highest number of indicator species was found in IIb (31 species), while the lowest was observed in Ia (11 species).

The clusters in the delta (IIa and IIb) accounted for 66% of the total indicator species. The indicator species in Ia and Ib were mostly species from Cyprinidae, Pangasiidae, Siluridae and Bagridae families, that is *Cosmochilus harmandi*, *Bagnana behri*, *Helicophagus waandersii*, *Labeo chrysophekadion*, *Bagarius yarelli*, *Henicorhynchus* spp., *Micronema bleekeri* and *Hemibagrus nemurus*, which are known as potamodromous fish and indigenous to the LMB. Assemblage IIa contained 21 indicator species. Among them, many are known as freshwater and secondary freshwater fish such as *Glossogobius giurus*, *Macroganathus siamensis*, *Acanthopsis* sp., *Puntioplites proctozysron*, *Mastacembelus armatus* and *Mystus mysticetus*. Similarly, the main indicator species of IIb were mostly characterised by secondary freshwater fish and marine species, known as amphidromous and anadromous fish, that is *Clupeichthys aesarnensis*, *Rasbora trilineata*, *Scomberomorus sinensis*, *Eleotris* spp., *Liza* spp., *Arius stormi*, *Toxotes* spp., *Lates calcarifer*. Most of indicator species during the dry season were also identified as indicator species using annual assemblage compositions. Overall, dry season assemblages contained more indicator species (73 species) compared to wet season assemblages (51 species), while many indicators species from annual IIa and IIb were absent in the wet season (Table S2).

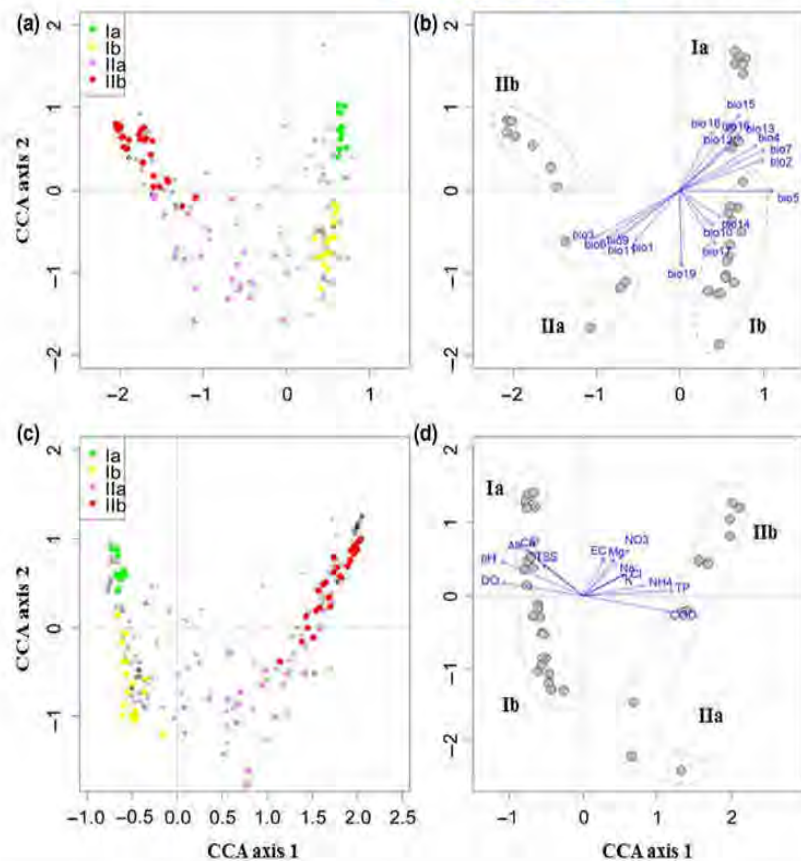
### 3.3 | Environmental determinants of the fish assemblages

The CCA model testing the association between annual fish assemblages and climatic variables was significant ( $F = 1.55$ ,  $p = .001$ ) and the first two axes explained 15.8% and 7.2% of the variation in fish composition respectively. Among the climatic variables tested, 18 had a significant ( $p < .05$ ) effect on fish assemblage (Fig. 4a,b, Tables 1 and 3). Indeed, cluster Ia was mainly characterised by high values of bio15, bio16 and bio13 respectively the seasonal variation of precipitation,



**FIGURE 3** Relative abundances of fish order along the Lower Mekong River. Open and close circles denote the wet and dry season respectively. The acronyms in the vertical axis denote the species order: angu (Anguilliformes), batr (Batrachoidiformes), belo (Beloniformes), clup (Clupeiformes), cypr (Cypriniformes), mugi (Mugiliformes), oste (Osteoglossiformes), perc (Perciformes), pleu (Pleuronectiformes), raji (Rajiformes), silu (Siluriformes), synb (Synbranchiformes), tetr (Tetraodontiformes). The acronyms in the horizontal axis indicate the location of the sites: TH (Thailand), LA (Laos), CA (Cambodia) and VN (Vietnam). \*denotes significant differences in fish relative abundance between seasons (Wilcoxon test,  $N = 313$  and  $p = .04$ )





**FIGURE 4** Canonical correspondence analysis (CCA) relating fish relative abundance to (a, b) climatic variables and (c, d) physicochemical variables. The different colour dots on the left plots represent the indicator species in each fish assemblage; while the grey dots on the right hand side indicate the fish monitoring sites. The blue arrows represent the vectors of environmental variables (i.e. climatic and physicochemical) and only significant variables ( $p < .05$ ) are depicted. Details about the indicator species and environmental variables are given in Tables 1–3 and S2

the precipitation of the wettest month and wettest quarter. Similar climatic patterns were associated to Ib, except that high values of bio5 (maximal temperature of warmest month) and bio19 (precipitation of coldest quarter) were strongly associated with this cluster. In the Mekong delta, clusters IIa and IIb were characterised by high values of the isothermality (bio3), minimal temperature of the coldest month (bio6), the mean temperature of the driest quarter (bio9) and coldest quarter (bio11). Overall, in the upper part of the LMR, the clusters Ia and Ib were associated with high values of precipitation, while the delta clusters (IIa and IIb) were strongly characterised by high values of temperature.

In parallel, the CCA model testing the effect of physicochemical variables on annual fish assemblage composition was significant ( $F = 1.77, p = .001$ ). The first two axes explained 22.5% of the variation in fish assemblage (15.5% and 7.0% respectively). Among the physicochemical variables tested, 14 had a significant effect on the fish assemblages ( $p < .05$ ; Fig. 4c,d, Tables 2 and 3). Clusters Ia and Ib were strongly characterised by high values of DO, pH, Ca, alk and TSS; while the IIa and IIb were positively associated with high values of TP, COD and  $\text{NH}_4^+$ . In addition, cluster IIb was found to be associated with high levels of  $\text{NO}_3^-$  and  $\text{Cl}^-$  as well, especially for the sites close to the sea.

### 3.4 | Effects of environmental and spatial factors on the fish assemblages

Variance partitioning in fish assemblage composition indicated that both environmental (physicochemical and climatic) and spatial variables contributed significantly to explain patterns in fish assemblages

(Fig. 5). The pure physicochemical factors explained 8.0% of variation in fish assemblages, while 10.9% and 4.0% were explained uniquely by climatic and spatial factors respectively. Physicochemical and climatic factors jointly explained 5.3% of the total variance, while the component shared by the three factors (physicochemical, climatic and spatial) explained 20.1% of the variation in fish assemblages. The adjusted  $R^2$  from the model was 46.7%.

## 4 | DISCUSSION

### 4.1 | Fish diversity and assemblage structure

To our knowledge, this study is the first holistic fish community study to investigate the large-scale patterns of fish distribution and their environmental determinants in the lower Mekong river. In terms of fish diversity, the upstream part of the LMR exhibited the lowest species richness, while the highest richness was observed in the delta where fish species were composed of freshwater, brackish and marine species. Indeed, the longitudinal changes of species richness along the physical and chemical gradients, that is upstream-downstream, are well known in large-scale patterns of fish assemblages. Many discussions and explanations of the mechanisms responsible for such patterns have come up with the concept of “addition” leading to the increase in species richness from the headwaters to lower part of the river (see Matthews, 1998).

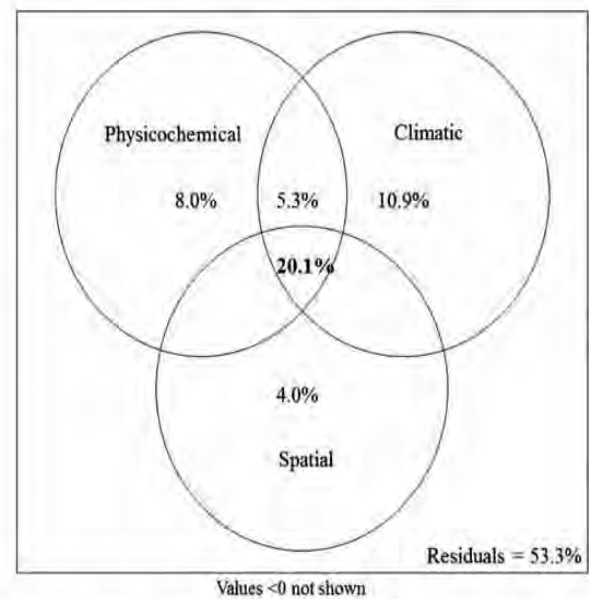
In contrast to species richness, cluster IIb exhibited the lowest diversity index, while the highest value was observed in Ib in Cambodia. Consequently, these patterns of diversity could reflect



**TABLE 3** Canonical correlation coefficients of climatic and physicochemical variables with the first two canonical correspondence analysis axes (CCA1 and CCA2). The correlation of the explanatory variables to the final ordination ( $r^2$ ) determines their importance in explaining fish assemblage composition, with their associated  $p$ -values computed from permutation tests. Variable codes are in Tables 1 and 2

Parameters	CCA1	CCA2	$r^2$	$p$
<b>Climatic variables</b>				
Bio1	-.664	-.748	.393	.001
Bio2	.937	.349	.676	.001
Bio3	-.870	-.493	.820	.001
Bio4	.861	.509	.658	.001
Bio5	1.000	-.010	.727	.001
Bio6	-.838	-.546	.656	.001
Bio7	.901	.434	.743	.001
Bio8	.272	-.962	.013	.756
Bio9	-.803	-.595	.518	.001
Bio10	.658	-.753	.191	.025
Bio11	-.783	-.622	.516	.001
Bio12	.736	.677	.336	.001
Bio13	.750	.662	.561	.001
Bio14	.830	-.557	.197	.020
Bio15	.613	.790	.788	.001
Bio16	.714	.700	.566	.001
Bio17	.538	-.843	.360	.002
Bio18	.463	.886	.382	.001
Bio19	.016	-1.000	.500	.001
<b>Physicochemical variables</b>				
pH	-.918	.397	.721	.001
TSS	-.789	.615	.236	.014
EC	.494	.869	.170	.043
Ca	-.780	.626	.476	.001
Mg	.637	.771	.213	.016
Na	.876	.482	.199	.023
K	.877	.480	.202	.021
Alk	-.768	.640	.415	.001
Cl	.890	.456	.217	.011
SO <sub>4</sub>	-.294	.956	.154	.066
NO <sub>3</sub>	.707	.708	.377	.001
NH <sub>4</sub>	.985	.174	.334	.005
TP	.998	.061	.736	.001
DO	-.987	.161	.600	.001
COD	.984	-.180	.703	.001

the river continuum concept (RCC) where the species richness is high at the lower part of the river and highest diversity is observed in the middle reach (Statzner & Higler, 1985; Vannote, Minshall, Cummins, Sedell, & Cushing, 1980). However, RCC is more applicable to small- to medium-sized rivers, that is probably not the case for the lower Mekong. Another reason for the high diversity in Cambodia could be the geographical conditions of the region, where many species cannot migrate up the Khone Falls (Valbo-Jorgensen, Coates, & Hurtle, 2009). In Cambodia, the river is characterised by low land and no barriers; thus, many species could move easily up and down this part (Baran, So, & Leng, 2008). Besides, the vital connectivity between the Tonle Sap Lake and Mekong provides favourable conditions for many species to complete their life cycle as the lake provides feeding and nursing



**FIGURE 5** Venn diagram of variance partitioning results showing the relative effects of physicochemical, climatic and spatial factors alone and in combination with the variation of the fish assemblages. Numbers represent % variation explained by each factor. All pure factors were statistically significant ( $p$ -value < .05)

grounds, while many deep pools below Khone Falls and at large tributaries (3S river system) are essential for spawning and dry season refuge.

Dry season fish assemblages were characterised by significant changes in species richness and diversity along the LMR, similar to observed annual patterns. It can be due to the fact that fish may be concentrated in deep pools, microhabitats or main river course during the dry season, while fish would probably disperse more as the river expands with increased inundated floodplains and habitat diversity during wet season (Ferreira & Stohlgren, 1999; Junk, Barley, & Sparks, 1989; Silvano, do Amaral, & Oyakawa, 2000). Consequently, this concentration would lead fishermen to catch easily the fish with variety of species compared to wet season. Moreover, different patterns in community composition between seasons could be explained by the migratory fish movement in the basin (Baran, 2006). Therefore, the seasonal turnover may be attributed to the different catchability, habitat diversity and migration of fish within the basin. Similar conclusions have been previously reported from fish community studies in tropical Amazonian rivers (Albert & Reis, 2011; Matthews, 1998; Winemiller, 1996).

At the upper part of LMR, the different patterns in 1a and 1b between dry and wet seasons revealed the association of community structure with migration patterns (Fig. 2a,c). For instance, many wet season indicator species from 1a and 1b, that is *C. harmandi*, *Henicorhynchus* spp., *Pangasianodon hypophthalmus*, *H. nemurus*, are long-distance migrants, and their spawning ground was identified at uppermost parts of LMR (Baran, 2006; Poulsen et al., 2004). Similarly, to many Amazonian fish, some of the Mekong species were reported to migrate upwards for reproduction, while others migrate downwards for feeding and nursing (Poulsen et al., 2004). Accordingly, in the middle part of LMR, most



of the migrants feed in Tonle Sap Lake and spawn below Khone Falls; while at upper part, the river serves both, that is spawning and feeding, for all migrants (Poulsen et al., 2004; Rainboth, 1996). Nevertheless, as a result of fish movement, no significant difference in diversity was observed during the wet season, revealing that diversity patterns were more homogenous compared to dry season and annual patterns.

Clear patterns of the assemblage structure were observed between the upper LMR and its delta. Specifically, assemblages Ia and Ib were characterised by cyprinids and catfish, species known to be potamodromous, which frequently occur in a large-sized river, specifically in the Mekong mainstream, that is *C. harmandi*, *L. chrysophekadion*, *H. waandersii*, *B. yarelli* and *Bangana behri* (Lucas et al., 2001). Below Khone Falls, the cyprinids in Ib were dominated by opportunist species, that is *Henicorhynchus* spp., *Thynnichthys thynnoides* and *Paralabucca typus*; these species are known as fast growing with short lifespan and are reported to do the long-distance migration as well, commonly between Tonle Sap Lake and upstream Cambodian Mekong (Baran et al., 2008).

In the Mekong delta, the fish assemblages changed significantly, with sharp declines in fish abundances observed for cyprinids and catfish, known as stenohaline species with low tolerance to salinity (Valbo-Jorgensen et al., 2009). Obviously, the perch-like fish (Perciformes) and clupeids (Clupeiformes) were common species in IIa and IIb; these groups of fish are tolerant to salinity and turbid water (Albert & Reis, 2011). Nevertheless, in IIa, many species were known as stenohaline species, that is *C. aesarnensis*, *Mastacembelus* spp., *Acanthopsis* sp., which are less tolerant to the brackish conditions of the delta. However, some of them need the marine environment to complete their life cycle, for example *Cynoglossus microlepis*, while others were believed to reside permanently in the estuary, for example *G. giuris* (Froese & Pauly, 2015; Valbo-Jorgensen et al., 2009). In IIb, we found mostly marine species, that is *Liza* spp., *Scomberomorus* sp., *Toxotes* spp., *Allenbatrachus grunniens*, *Boleophthalmus boddarti*, which are well suited to the marine environment with less light penetration (Moyle & Cech, 1988). Of course, these species are known as amphidromous fish and some of them are catadromous fish, for example *Anguilla* sp., *Ellochelon vaigiensis*, *Mugil cephalus*, which inhabit fresh-brackish water and live permanently in the estuary like the small anchovies (*Coilia* sp. and *Tenuulosa toti*; Froese & Pauly, 2015; Motomura, Iwatsuki, Kimura, & Yoshino, 2002).

So far, the difference in fish assemblage patterns could result from the different migration routes of fish within the basin, where it was estimated that about 40% of lower Mekong species are "white fish" that conduct long-distance migrations (Baran, 2006; Poulsen et al., 2004).

#### 4.2 | Relative importance of environmental and spatial factors structuring the fish assemblages

Overall, our study showed that the seasonal variation of precipitation (bio15), the precipitation of the wettest month (bio16), the maximal temperature of warmest month (bio5), the precipitation of coldest quarter (bio19), as well as the isothermality (bio3), the minimal

temperature of the coldest month (bio6) and the mean temperature of the driest quarter (bio9) were the key climatic factors driving the changes in fish assemblage structure. Obviously, the seasonal variations of temperature and precipitation have proved to be important factors affecting the distribution of organisms in ecosystems (Buisson et al., 2008; Cheung et al., 2009). Alternatively, TP, DO, COD and pH significantly influenced the spatial structure of the fish assemblages as well. Indeed, many studies have revealed the link between physicochemical factors, particularly nutrients and DO, and the patterns of fish assemblages along river systems (Fialho, Oliveira, Tejerina-Garro, & de Mérona, 2007; Trujillo-Jiménez, López-López, Díaz-Pardo, & Camargo, 2009).

According to the results of our study, the differences between upstream (Ia and Ib) and delta assemblages (IIa and IIb) were mainly explained by temperature as well as nutrients and the natural effects of seawater intrusion. Consequently, the upstream species were specialised for upstream conditions with high altitude, lower temperature, high rainfall, DO and pH, particularly in cluster Ia. By contrast, the delta species were suited to high levels of nutrients and could tolerate high temperature and salinity. These conclusions were also consistent with previous studies which reported that the upper Mekong fish were dominated by Cyprinidae, Balitoridae, Cobitidae and Sisoridae that all prefer cold, oxygen-rich water bodies (Valbo-Jorgensen et al., 2009), while Gobiidae, Polynemidae, Toxotidae, Eleotridae, Clupeidae and Engraulidae dominated in the delta, with species known to tolerate estuarine conditions, that is low oxygen, high nutrient, eutrophication and salinity.

So far, many studies on the environmental determinants of fish assemblage structure have reported the main contribution of physicochemical factors (Braaten & Guy, 1999; Pires et al., 2010; Trujillo-Jiménez et al., 2009), while others revealed a predominant role of climatic factors in structuring the spatial distribution of fish (Buisson et al., 2008; Guo et al., 2015; Reash & Pigg, 1990; Zhao et al., 2015). However, in our study, the combination of environmental and spatial factors provided a better explanation of the variation in fish assemblages. Thus, the physicochemical or climatic factors alone would not optimally explain the distribution patterns of fish assemblages (Lujan et al., 2013).

#### 4.3 | Fish diversity management and conservation

Our results provide the current baseline information on fish assemblage structure in the LMR system. According to our results, fish conservation zones should be prioritised in the middle part of the LMR, that is mainly cluster Ib, where the highest diversity was exhibited. Moreover, conservation planning should also consider the upstream part of the LMR (Cluster Ia), between Khone Falls and Vientiane city, where high levels of endemism to the LMR system are recorded (Coates, 2001). Accordingly, it was reported that the construction of natural reserves would be an effective approach to protect fish biodiversity (Park, Chang, Lek, & Brosse, 2003). Besides, the conservation strategies should be prioritised to specialist groups of fish as they are endangered and vulnerable to environmental changes (Kang et al.,



2009). Alternatively, conservation practices should be carried out in a networked region rather than in single reserve and different conservation strategies should be proposed according to the different objectives and eco-regions, for example upstream LMR and Mekong delta.

Furthermore, the maintaining of the connectivity between upstream-downstream habitats (including deep pools as dry refuge) and major tributaries (3S river systems, Tonle Sap River, the Great Lake and its floodplains) is essential for many short- and long-distance migrants such as *Pangasianodon gigas* and *Pangasius krempfi* to complete their life cycle. Therefore, we strongly support the concerns of biodiversity losses due to the construction of dams across the main channel (Hortle, 2007; Valbo-Jorgensen et al., 2009; Ziv et al., 2012). Meanwhile, water quality monitoring and improvement need to be addressed rigorously within the region (Chea et al., 2016; Dudgeon, 2011). For instance, our study exhibited the lowest fish diversity in the delta, likely to reflect water pollution effects on the fish community. Thus, the cyprinids and *Pangasius* catfish, which are the main sources of proteins (Hortle, 2007), would be strongly affected as they are unable to withstand significant changes in water condition. Nevertheless, our study revealed that the combination of both environmental and spatial factors contributes significantly in structuring the fish community along the LMR. Taking these factors into account appears therefore crucial if we are to initiate management strategies to ensure the conservation and sustainable use of fisheries resources in the Lower Mekong River.

## ACKNOWLEDGEMENTS

We are grateful to the Erasmus Mundus TECHNO Program and the Belmont Forum (TLSCC project) for funding our study. Great thanks to the Mekong River Commission (MRC) for providing the fish and water quality data sets used in this study. We would like to thank to Dr. Peter Winterton for helping us to correct the English. Thanks to University of Battambang for the data request and our colleagues at the Laboratory of Evolution and Biological Diversity (EDB) for their support and discussion concerning data preparation and analysis. EDB laboratory was supported by "Investissement d'Avenir" grants (CEBA, ref. ANR-10-LABX-0025; TULIP, ref. ANR-10-LABX-41).

## REFERENCES

- Albert, S. J., & Reis, E. R. (2011). Introduction to neotropical freshwaters. In S. J. Albert, & E. R. Reis (Eds.), *Historical biogeography of neotropical freshwater fishes* (pp. 3–16). Berkeley, CA: University of California Press.
- Amarasinghe, U. S., & Welcomme, R. L. (2002). An analysis of fish species richness in natural lakes. *Environmental Biology of Fishes*, *65*, 327–339.
- Baran, E. (2006). *Fish migration triggers in the Lower Mekong Basin and other tropical freshwater systems*. MRC Technical Paper No. 14. Mekong River Commission, Vientiane. 56 pp. Retrieved from <http://agris.fao.org/agris-search/search.do?recordID=QW2016000150>
- Baran, E., So, N., & Leng, S. V. (2008). *Integrating fish resources to agro-ecosystem analyses*. Fisheries Component, CGIAR Challenge Program on Water & Food, Phnom Penh, Cambodia. 65 pp. Retrieved from [http://pubs.iclam.net/resource\\_centre/WF\\_2581.pdf](http://pubs.iclam.net/resource_centre/WF_2581.pdf)
- Blanchet, F. G., Legendre, P., & Borcard, D. (2008). Modelling directional spatial processes in ecological data. *Ecological Modelling*, *215*, 325–336.
- Borcard, D., Legendre, P., & Drapeau, P. (1992). Partialling out the spatial component of ecological variation. *Ecology*, *73*, 1045–1055.
- Braaten, P. J., & Guy, C. S. (1999). Relations between physicochemical factors and abundance of fishes in tributary confluences of the Lower Channelized Missouri River. *Transactions of the American Fisheries Society*, *128*, 1213–1221.
- Buisson, L., Blanc, L., & Grenouillet, G. (2008). Modelling stream fish species distribution in a river network: The relative effects of temperature versus physical factors. *Ecology of Freshwater Fish*, *17*, 244–257.
- Chea, R., Grenouillet, G., & Lek, S. (2016). Evidence of water quality degradation in Lower Mekong Basin revealed by self-organizing map. *PLoS ONE*, *11*, e0145527.
- Cheung, W. W. L., Lam, V. W. Y., Sarmiento, J. L., Kearney, K., Watson, R., & Pauly, D. (2009). Projecting global marine biodiversity impacts under climate change scenarios. *Fish and Fisheries*, *10*, 235–251.
- Coates, D. (2001). *Biodiversity and fisheries management opportunities in the Mekong River Basin*. MRC Technical Paper. Mekong River Commission, Phnom Penh. 40 pp. Retrieved from <https://www.cbd.int/doc/nbsap/fisheries/Coates.pdf>.
- De Cáceres, M., Legendre, P., & Moretti, M. (2010). Improving indicator species analysis by combining groups of sites. *Oikos*, *119*, 1674–1684.
- Dudgeon, D. (2003). The contribution of scientific information to the conservation and management of freshwater biodiversity in tropical Asia. *Hydrobiologia*, *500*, 295–314.
- Dudgeon, D. (2011). Asian river fishes in the anthropocene: Threats and conservation challenges in an era of rapid environmental change. *Journal of Fish Biology*, *79*, 1487–1524.
- Dugan, P. J., Barlow, C., Agostinho, A. A., Baran, E., Cada, G. F., Chen, D., ... Winemiller, K. O. (2010). Fish migration, dams, and loss of ecosystem services in the Mekong Basin. *Ambio*, *39*, 344–348.
- Ferreira, L. V., & Stohlgren, T. J. (1999). Effects of river level fluctuation on plant species richness, diversity, and distribution in a floodplain forest in Central Amazonia. *Oecologia*, *120*, 582–587.
- FEVM. (2007). *Monitoring fish abundance and diversity in the Lower Mekong Basin: Methodological guidelines*. Regional fish abundance and diversity monitoring programme. Phnom Penh, MRCS, 12 pp. Retrieved from <http://www.mremekong.org/assets/Publications/technical/Tech-No33-Integrated-Analysis-of-Data.pdf>
- Fialho, A. P., Oliveira, L. G., Tejerina-Garro, F. L., & de Mèrona, B. (2007). Fish-habitat relationship in a tropical river under anthropogenic influences. *Hydrobiologia*, *598*, 315–324.
- Froese, R., & Pauly, D. (2015). *FishBase*. World wide web electron publication. Retrieved from <http://www.fishbase.org>, version (last accessed 25/11/2015).
- Guo, C., Lek, S., Ye, S., Li, W., Liu, J., Chen, Y., & Li, Z. (2015). Predicting fish species richness and assemblages with climatic, geographic and morphometric factors: A broad-scale study in Chinese lakes. *Limnologia – Ecology and Management of Inland Waters*, *54*, 66–74.
- Hijmans, R. J., Cameron, S. E., Parra, J. L., Jones, P. G., & Jarvis, A. (2005). Very high resolution interpolated climate surfaces for global land areas. *International Journal of Climatology*, *25*, 1965–1978.
- Hortle, K. G. (2007). *Consumption and the yield of fish and other aquatic animals from the Lower Mekong Basin*. MRC Technical Paper No. 16. Mekong River Commission, Vientiane. 87 pp. Retrieved from <http://www.mrcmekong.org/assets/Publications/technical/tech-No16-consumption-n-yield-of-fish.pdf>.
- Junk, W. J., Barley, P. B., & Sparks, R. E. (1989). The flood pulse concept in river-floodplain systems. Proceedings of the International Large River Symposium. *Canadian Journal of Fisheries and Aquatic Sciences*, *106*, 110–127.
- Kang, B., He, D., Perrett, L., Wang, H., Hu, W., Deng, W., & Wu, Y. (2009). Fish and fisheries in the Upper Mekong: Current assessment of the fish community, threats and conservation. *Reviews in Fish Biology and Fisheries*, *19*, 465–480.



- Kottelat, M., & Whitten, J. A. (1996). *Freshwater biodiversity in Asia with special reference to fish*. World Bank Technical Paper 343. The World Bank, Washington, DC, USA. 59 pp.
- Legendre, P., & Legendre, L. (2012). Canonical analysis. In P. Legendre, & L. Legendre (Eds.), *Numerical ecology* (3rd ed., pp. 575–633). Amsterdam: Elsevier.
- Lu, X. X., Li, S., Kumm, M., Padawangi, R., & Wang, J. J. (2014). Observed changes in the water flow at Chiang Saen in the lower Mekong: Impacts of Chinese dams? *Quaternary International*, 336, 145–157.
- Lu, X. X., & Siew, R. Y. (2006). Water discharge and sediment flux changes over the past decades in the Lower Mekong River: Possible impacts of the Chinese dams. *Hydrology and Earth System Sciences Discussions*, 10, 181–195.
- Lucas, M. C., Baras, E., Thom, T. J., Duncan, A., & Slavik, O. (2001). Migration and spatial behaviour. In M. C. Lucas, & E. Baras (Eds.), *Migration of freshwater fishes* (pp. 1–12). Oxford: Blackwell Science Ltd.
- Lujan, N. K., Roach, K. A., Jacobsen, D., Winemiller, K. O., Vargas, V. M., Ching, V. R., & Maestr, J. A. (2013). Aquatic community structure across an Andes-to-Amazon fluvial gradient. *Journal of Biogeography*, 40, 1715–1728.
- Matthews, W. J. (1998). *Patterns in freshwater fish ecology* (pp. 30–85). Dordrecht: Springer Science & Business Media.
- Mittermeier, A. R., Turner, R. W., Larsen, W. F., Brooks, M. T., & Gascon, C. (2011). Global biodiversity conservation: The critical role of hotspots. In F. Zachos, & J. Habel (Eds.), *Biodiversity hotspots: Distribution and protection of conservation priority areas* (pp. 3–7). Heidelberg: Springer.
- Motomura, H., Iwatsuki, Y., Kimura, S., & Yoshino, T. (2002). Revision of the Indo-West Pacific polynemid fish genus *Eleutheronema* (Teleostei: Perciformes). *Ichthyological Research*, 49, 47–61.
- Moyle, P. B., & Cech, J. J. (1988). *Fishes: An introduction to ichthyology* (pp. 193–211). Upper Saddle River, NJ: Prentice Hall.
- MRC (2015). Fisheries research and development in the Mekong region. *Catch and Culture*, 21, 1–56.
- Murtagh, F., & Legendre, P. (2014). Ward's hierarchical agglomerative clustering method: Which algorithms implement Ward's criterion? *Journal of Classification*, 31, 274–295.
- Oberdorff, T., Guegan, J.-F., & Hugueny, B. (1995). Global scale patterns of fish species richness in rivers. *Ecography*, 18, 345–352.
- Olden, J. D., Kennard, M. J., Leprieux, F., Tedesco, P. A., Winemiller, K. O., & Garcia-Berthou, E. (2010). Conservation biogeography of freshwater fishes: Recent progress and future challenges. *Diversity and Distributions*, 16, 496–513.
- Park, Y. S., Chang, J., Lek, S., & Brosse, S. (2003). Conservation strategies for endemic fish species threatened by the Three Gorges Dam. *Conservation Biology*, 17, 1748–1758.
- Pires, D. F., Pires, A. M., Collares-Pereira, M. J., & Magalhães, M. F. (2010). Variation in fish assemblages across dry-season pools in a Mediterranean stream: Effects of pool morphology, physicochemical factors and spatial context. *Ecology of Freshwater Fish*, 19, 74–86.
- Pool, T. K., Olden, J. D., Whittier, J. B., & Paukert, C. P. (2010). Environmental drivers of fish functional diversity and composition in the Lower Colorado River Basin. *Canadian Journal of Fisheries and Aquatic Sciences*, 67, 1791–1807.
- Poulsen, A. F., Hortle, K. G., Valbo-Jorgensen, J., Chan, S., Chhuon, C. K., Sinthavong, V., ... Tran, B. Q. (2004). *Distribution and ecology of some important riverine fish species of the Mekong River Basin*. MRC Technical Paper No. 10. Mekong River Commission, Phnom Penh. 115 pp. Retrieved from <http://www.mrcmekong.org/assets/Publications/technical/tech-No10-distribution-n-ecology-of-important.pdf>.
- Poulsen, A. F., Ouch, P., Sinthavong, V., Ubolratana, S., & Nguyen, T. T. (2002). *Fish migrations of the Lower Mekong River Basin: implications for development, planning and environmental management*. MRC Technical Paper No. 8. Mekong River Commission, Phnom Penh. 62 pp. Retrieved from <http://www.mrcmekong.org/assets/Publications/technical/tech-No8-fish-migration-of-LMB.pdf>.
- R Core Team (2015). *R: A language and environment for statistical computing*. Vienna, Austria: R Foundation for Statistical Computing.
- Rainboth, W. J. (1996). *Fishes of the Cambodian Mekong. FAO species identification field guide for fishery purposes*. FAO, Italy. 265 pp. Retrieved from <http://library.enaca.org/inland/fishes-cambodian-mekong.pdf>.
- Reash, J. R., & Pigg, J. (1990). Physicochemical factors affecting the abundance and species richness of fishes in the Cimarron River. *Proceeding of the Oklahoma Academy of Science*, 70, 23–28.
- Roberts, T. R., & Baird, I. G. (1995). Traditional fisheries and fish ecology on the Mekong River at Khone Waterfall in Southern Laos. *Natural History Bulletin of the Siam Society*, 43, 219–262.
- Silvano, R. A. M., do Amaral, B. D., & Oyakawa, O. T. (2000). Spatial and temporal patterns of diversity and distribution of the Upper Jurua River fish community (Brazilian Amazon). *Environmental Biology of Fishes*, 57, 25–35.
- Sinthavong, V. (2006). Observations of the fisheries of the Mekong with notes on the life history strategies of four fish species (*Botia modesta*, *Henicorhynchus siamensis*, *Helicophagus waandersii* and *Probarbus jullieni*). Doctor of Philosophy: The University of Hull. 216 pp. Retrieved from <http://ad.nafri.org.uk/fulltext/2216-0.pdf>.
- Statzner, B., & Higl, B. (1985). Questions and comments on the river continuum concept. *Canadian Journal of Fisheries and Aquatic Sciences*, 42, 1038–1044.
- Tejerina-Garro, F. L., Fortin, R., & Rodríguez, M. A. (1998). Fish community structure in relation to environmental variation in floodplain lakes of the Araguaia River, Amazon Basin. *Environmental Biology of Fishes*, 51, 399–419.
- Ter Braak, C. J. F., & Prentice, I. C. (1988). A theory of gradient analysis. *Advances in Ecological Research*, 34, 235–282.
- Trujillo-Jiménez, P., López-López, E., Díaz-Pardo, E., & Camargo, J. A. (2009). Patterns in the distribution of fish assemblages in Río Amacuzac, Mexico: Influence of abiotic factors and biotic factors. *Reviews in Fish Biology and Fisheries*, 20, 457–469.
- Valbo-Jorgensen, J., Coates, D., & Hortle, K. G. (2009). Fish diversity in the Mekong River Basin. In C. I. Campbell (Ed.), *The Mekong biophysical environment of an international river basin* (pp. 162–185). Amsterdam: Elsevier Academic Press.
- Vannote, R. L., Minshall, G. W., Cummins, K. W., Sedell, J. R., & Cushing, C. E. (1980). The river continuum concept. *Canadian Journal of Fisheries and Aquatic Sciences*, 37, 130–137.
- Vorosmarty, C. J., McIntyre, P. B., Gessner, M. O., Dudgeon, D., Prusevich, A., Green, P., ... Davies, P. M. (2010). Global threats to human water security and river biodiversity. *Nature*, 467, 555–561.
- Winemiller, K. O. (1996). Dynamic diversity in fish assemblages of tropical rivers. In M. L. Cody, & J. A. Smallwood (Eds.), *Long-term studies of vertebrate communities* (pp. 99–134). Orlando, FL: Academic Press.
- Zhao, T., Grenouillet, G., Pool, T., Tudesque, L., & Cucherousset, J. (2015). Environmental determinants of fish community structure in gravel pit lakes. *Ecology of Freshwater Fish*, 25, 412–421.
- Ziv, G., Baran, E., So, N., Rodríguez-Iturbe, I., & Levin, S. A. (2012). Trading-off fish biodiversity, food security, and hydropower in the Mekong River Basin. *Proceedings of the National Academy of Science of the United States of America*, 109, 5609–5614.

## SUPPORTING INFORMATION

Additional Supporting Information may be found online in the supporting information tab for this article.



## **ARTICLE 3**

**Temporal dynamics of fish community structure in a flood pulsed,  
tropical lake ecosystem.**

**R. Chea, S. Lek, M. Chevalier, P. Ngor, K.O. Winemiller and G.**

**Grenouillet.**

*(In preparation)*



## **Abstract**

1. We investigated the temporal change of fish community in relations to the taxonomic structure, functional traits, and hydrologic regime in a tropical flood pulse lake ecosystem, Tonle Sap Lake in Cambodia, where biological and ecological knowledge are very limited.
2. Daily fish catch and water levels were collected from five locations around the lake between 2012 and 2015. Nine functional traits (size of fish, trophic level, habitats, life history, ecological guild, spawning habitat, feeding habitat, water column position, and accessory respiratory) of the 53 taxa were collected from different sources. Temporal change of fish community were summarized and analysed using multiple co-inertia analysis (MCOA) procedure. Cross-correlation function (CCF) was performed to quantify the response of fish community to hydrological changes.
3. We found that the temporal changes of fish community were associated to functional traits, i.e. size of fish, trophic position, life history strategy, ecological guild, feeding habitat and accessory respiratory, than taxonomic structure. Indeed, the community were characterized by large fish with high trophic level during the low water, while it was gradually replaced by small fish with low trophic position with the arrival of pulses.
4. In parallel, more black fish with equilibrium strategy were observed in the low water period, while the community was dominated by white fish with the opportunistic/periodic strategy when the water level goes up. Besides, the temporal variation of community structure in individual sites were matched to the reference structure; however the spatial synchrony was not related to the geographic distance of sampling locations as expected.
5. Furthermore, the responses of fish community to the hydrological changes were estimated to lag between 1.5 to 2 months. Therefore, taking account for the time lags would be crucial for fisheries management and conservation practice in the lake.

**Key words:** *fish community, dynamics, flood pulse system, functional traits, spatial synchrony*



## Introduction

Despite intensive research on fish community structure and ecosystem functioning for the last decades, our ability to explain how the species composition influences the community, as well as to quantify the complex relationship between taxonomic structure, biological traits and trophic diversity, remains insufficient (di Castri & Younes 1989; Olden *et al.* 2010). Starting with the simple questions, how the community of organisms change through space and time? Do the functional compositions of community converge along the changing environment, e.g. flow regime? If so, that means the fish community response similarly across the different locations within the ecosystem? These questions remained central goals for ecological studies, given that numbers of spatiotemporal patterns of diversity studies across the globe (Berra 2001; Lévêque *et al.* 2007). Increasingly, ecologists are believed their knowledge in temporal dynamics of community structure are still limited, resulting the implementation of many long-term biodiversity monitoring programs in biomes (Magurran *et al.* 2010). Nevertheless, the knowledge and monitoring programs are not well distributed across the different regions, i.e. tropics, sub-tropics, neotropics and temperate zones (Dudgeon 2000). For instance, more research attentions have attempted to study the biodiversity in temperate and neotropical zones, while there is surprisingly very little information and work to assess the dynamics of aquatic community in the Oriental region/Tropical Asia (Dudgeon 2003). Though, this region was classified as hotspot of biodiversity. Obviously, large tropical rivers (e.g. the Mekong) are always associated with huge floodplains and extensive wetlands (e.g. Tonle Sap Lake) which provide multiple ecosystem services representing the immense values for humanity and biodiversity they support (Coates 2001). More importantly, tropical ecosystems are often characterized by an extremely diverse fish community compared to the temperate fisheries and many of them are flood pulse lakes that rely mainly on the hydrology of the system (Junk *et al.* 1989; Junk & Wantzen 2004).

By its nature, the flood pulsed systems are highly productive and strongly governed by the hydrological cycles that are often change the size of the floodplain dramatically over the year, e.g. Tonle Sap Lake. From the existing theory on flood pulsed system – flood pulse concept (FPC), all ecological process and productivity within the systems are predicted to regulate by the seasonal flood pulses (Junk *et al.* 1989; Junk & Wantzen 2004). Different from the early river continuum concept (RCC) (Vannote *et al.* 1980), where the productivity and nutrients were driven from the upstream process, FPC focuses on lateral exchange of water, nutrients and organisms between rivers/lakes and its connected floodplains, in other word, the autochthonous production. Thus, it was believed that the hydrologic regime and flood dynamics are the primary environmental factor influencing the structure of community (i.e. life history, feeding and trophic), fish recruitment and productivity in the system (Junk & Wantzen 2004; Zeug & Winemiller 2008; Simões *et al.* 2013). Therefore, more intensive research work should be allocated to quantify the influence of hydrology, climate changes on the sustainability of tropical freshwater systems which would be quite different in many ways from what we have learned in the temperate ecosystems.

Obviously, many previous studies have been conducted in neotropics, north America and Africa to understand the dynamics of fauna community in relation to the taxonomic structure, functional traits, life history and hydrological shifts (Winemiller 1989; Merigoux & Ponton 1999; Agostinho *et al.* 2000; Merigoux *et al.* 2001; Tedesco *et al.* 2008; Pease *et al.* 2012, 2015). As an example from Pantanal wetland in Central Amazonia, it was showed that the feeding of fish community were shifted from high to low trophic level between dry and wet seasons; thus more specialist recruitments were observed in the dry season (Wantzen *et al.* 2002). In French Guiana, Merigoux & Ponton (1999) reported the spatiotemporal variations of juvenile fish community in river floodplains and quantified its relationship to life history traits of taxa, habitat variability and flow regimes (Merigoux & Ponton 1999; Merigoux *et al.* 2001). Accordingly, Agostinho *et al.* (2005) came up with conclusion that the flood regime is

the most important factor determining the structure of community, i.e. attribute of assemblage, reproduction and recruitment, in Upper Parana River floodplains (Agostinho & Zalewski 1995; Agostinho *et al.* 2000, 2005). In addition, from the river networks in West Africa, Tedesco *et al.* (2008) reported the association of temporal structure of fish community to the life history strategy and hydrological condition. How about the temporal dynamics of fish community structure in flood pulsed lake ecosystem in Tropical Asia? The temporal changes of fish community are also associated to the life history strategy, seasonality gradient of hydrological condition?

In the era of anthropocene, the fast growing of population especially in Asia (60% of world population), the needs for feeding and economic growth are challenging for biodiversity conservation; consequently the loss of diversity is insurmountable (Dudgeon 2003, 2011). Additionally, fisheries play a crucial role in food security and represent nearly 80% of the entire animal proteins for human consumption, especially in the third world countries such as Cambodia, Lao PDR, Vietnam (Hortle 2007). Hence, biodiversity management and conservation is really needed to mitigate and minimize the losses; however these require a full understanding of the community structure and the driving forces underlining the spatial and temporal structure of community (Olden *et al.* 2010; Pool *et al.* 2010). In Oriental region, the knowledge on impact of hydropower dams on biodiversity and fish production are being increased day by day (Dugan *et al.* 2010; Ziv *et al.* 2012). However, the temporal patterns of fish community structure within the region are still poorly described, nor investigated, e.g. Tonle Sap Lake (Dudgeon 2000, 2003).

The present paper aimed at investigating the temporal structure of fish community in a large tropical flood pulse lake ecosystem. First, we constructed the temporal patterns of fish community in the lake using multivariate techniques. Then we tested the association of the variability to the taxonomic structure and functional traits. Last, we examined the link between the temporal changes of fish community to hydrologic regimes. We would like to

address the following question: How the fish community in the lake changes through the time? These temporal variations are associated to the taxonomic structure or functional traits? The fish community evolve synchronously across the different parts of the lake? Is the temporal evolution of fish community linked to the change of hydrologic regime? We anticipated that the temporal structures of fish community are strongly characterized by the period flood pulse, both in taxonomic structure and functional traits. Besides, the spatial synchrony of the fish community would be correlated to the geographical distance of the community as reported from the previous authors that the synchrony between populations decreases with the increase of distance between populations (Ranta, Kaitala & Lundberg 1997; Liebhold, Koenig & Bjørnstad 2004). To the best of our knowledge, this is the first holistic fish community studies to examine the temporal change in taxonomic structure and functional traits of fish community in the flood pulse lake ecosystem within the Oriental Region. Furthermore, the paper was finished with some conclusions and perspectives on the fisheries management and conservation that would contribute to enhance the ecological knowledge on the flood pulse lake ecosystem worldwide.

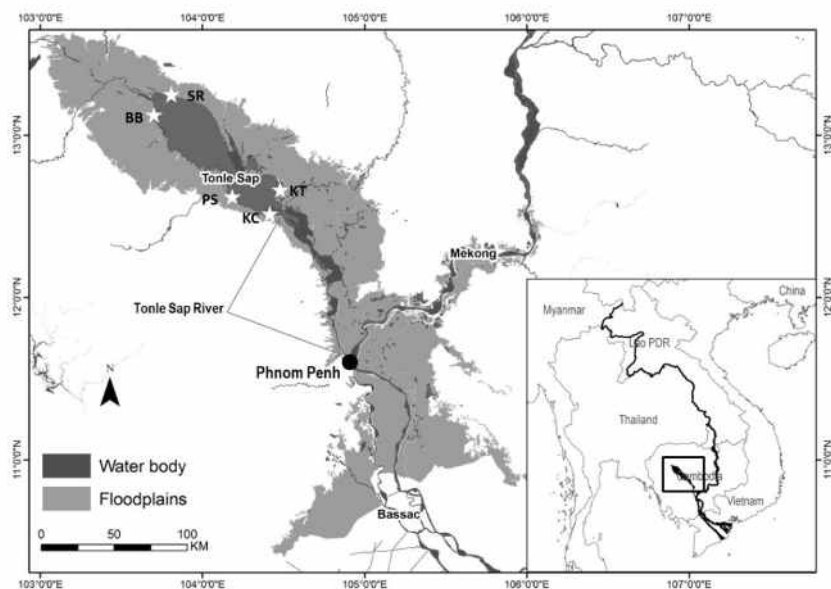
## **Materials and methods**

### ***Study system: Tonle Sap Lake***

One of the largest indiscriminate fisheries in the world, Tonle Sap Lake (TSL) is unique for many ways (Fig. 1). The lake is biologically diverse and also perhaps the most productive lake ecosystem in the world. TSL harvests annually between 289 000 and 431 000 tons of catch representing more than 60% of Cambodian inland fisheries. Strongly connected to the Mekong River through Tonle Sap River (120 KM long) (Fig. 1), the TSL is also known for its extraordinary flood-pulse system which underlines seasonally the unique hydrological features to the Mekong, the reverse flow from the lake. Indeed, under the tropical monsoon climate, the hydrology of the lake is characterized by two seasons, i.e. wet (May-October) and dry (November-April) seasons, and the water level fluctuates from 1 m to 9 m, causing an

expansion of the area of the lake from 3 000 km<sup>2</sup> to 15 000 km<sup>2</sup> and creating an extensive floodplains around the entire lake. Besides, the reverse flow from TLS is a crucial hydrological phenomenon raising the water levels and protecting the Mekong delta from the natural sea water intrusion (Matsui 2005; Kummu & Sarkkula 2008; MRC 2010a).

TSL drains 85 065 km<sup>2</sup>, ca. 11.3% of the total drainage area of the Mekong River Basin (MRB), and the averages annual rainfall ranges from 1 300 mm to 1 900 mm with the average temperature 29 °C (max: 33 °C, min: 25 °C). The hydrology of the lake is strongly dependent to the Mekong since more than 60% of TSL' s water come from the Mekong and the rest is drained from the 12 sub-basins around the lake, among that Stung Sen, Sangke, Pursat, Chinet rivers are the main contributors (Fig. 1). The lake is surrounded by 5 provinces respectively Battambang (BB), Siem Reap (SR), Pursat (PS), Kampong Thmorn (KT), Kampong Chhnang (KC) (Fig. 1) and its floodplains are mainly covered by shrubland, flooded forest, grass land, rice and lotus fields, which are the key habitats for flora and fauna (Lamberts 2001; MRC 2010a).



**Fig. 1.** Tonle Sap Lake and geographic locations of fish monitoring sites (star).

### *Fish data*

The fish data used in this study were derived from the “Fish abundance and diversity monitoring in the Tonle Sap Lake” program of Mekong River Commission (MRC)’s Fisheries programs (Ngor 2012). The monitoring program covered five locations in five provinces surrounded the lake, i.e. Kampong Chhnang, Pursat, Battambang, Siem Reap and Kampong Thom (Fig. 1), from January 2012 to October 2015. Basically, in each location, 3 fishermen were asked to record daily in the Logbooks their catches, maximum length of each species in every sample, type and dimension of fishing gears used. The catch monitoring methods were implied from the MRC’s regional monitoring program on Fish abundance and diversity in Lower Mekong Basin (FEVM 2007). Indeed, all fishermen were trained to use logbooks, sampling and sub-sampling techniques applied for the large catch during the peak seasons, identify the fish species, as well as measure length and weight of caught species. The taxonomic identification was done to species level and to help with fish identification, the photo flipcharts of more than 170 fish common species were provided to fishermen. Moreover, to ensure the quality of monitoring, all data were checked for errors and cleaned quarterly within the monitoring period from MRC’s specialist.

For our study, only fish catches from gillnets were selected for multivariate table. From the records, gillnets represented 98% of the total fishing gears used during the monitoring and the mesh sizes ranged from 2 to 6.5 cm with an average dimension of 850 m in length and 1.5 m in depth. The catch was expressed in total number of individual per species and about 209 species were recorded in the Logbooks during the monitoring program. Only the species present > 5% of the total observation, i.e. 60 times over 1172 days, were kept for the analysis. To minimize the range and skew of distribution, the fish abundances from the 3 fishermen were averaged at each site and  $\ln(X+1)$ -transformed. Finally, our multivariate tables were composed of 5 tables with dimension of 1172 (days) and 53 columns (taxa).

### ***Hydrological data***



Daily water levels were taken for the same period (2012-2015) of fish data from the primary hydrological station of MRC located in Kampong Loung (PS, Fig. 1). The water levels fluctuate seasonally with the lowest levels in April-May and peak in September-October. In September 2013, the MRB was undergone the intense seasonal monsoon induced a catastrophic flood in the lake affecting more than 1.7 million of people around the lake and along the Cambodian Mekong (OCHA 2013).

### ***Functional traits***

Nine functional traits (size, trophic level, habitats, life strategy, ecological guilds, feeding habitats, spawning habitats, water column position and accessory respiratory) of the 53 studied species were used to examine the relationship of the community structure to the traits. All functional traits were collected and modified from different sources as following description (see Table S1). The size, i.e. the total length of fish (cm), the trophic levels and habitats were collected from FishBase (Froese & Pauly 2015) and Lim *et al.* (1999). The size and trophic level of fish range from 13 cm to 158 cm and from 2 to 4.5 respectively, while the habitats were categorized into 3 types, i.e. pelagic (PEL), benthopelagic (BEN) and demarsal (DEM). The life history strategies were modified to follow the life history models suggested by Winemiller & Rose (1992), which attempt to classify the life history of fish into 3 different categories, i.e. equilibrium (EQU), periodic (PER) and opportunistic (OPP), based on the juvenile survivorship, fecundity and the age of reproduction (Winemiller & Rose 1992; Winemiller 2005). Then the ecological guilds of fish were collected from the long-time bio-ecological study of Inland Fisheries Research and Development Institute (IFREDI) and MRC, which aimed at classifying the Tonle Sap and Mekong fish species into 3 main different guilds, i.e. black, grey and white, based on a set of descriptors, e.g. migration, habitat, oxygenation (Poulsen *et al.* 2002; Baran *et al.* 2007). Among the studied species, 3 were unknown and 1 was classified in the estuarine group. Spawning and feeding habitat traits were collected and modified from Poulsen *et al.* (2004) and Lim *et al.* (1999). Indeed, for the

spawning habitats, species were categorized between spawning in floodplains (FLP) and in river channels (RV), while in littoral (LIT) and in offshore and littoral (OFF&LIT) zones for feeding habitats. Last, the water column position and accessory respiratory traits were modified from (Winemiller & Rose 1992). Basically, all studied species were classified to locate between the bottom-middle (B-M) and middle-surface (M-S) of the water column, as well as to equip (YES) or not (NO) the accessory for respiratory.

### ***Statistical analyses***

The multi-time series of fish tables were analysed using multiple co-inertia analysis (MCOA) procedure, which is one of multi-table ordination methods used to assess the ecological patterns in space and time based on the covariance optimisation criterion between the individual table ordinations and reference ordination (Chessel & Hanafi 1996; Bady *et al.* 2004). Indeed, MCOA produces the reference ordination which is the common structure or patterns shared by the individual tables. However, despite its ability to quantify the spatiotemporal patterns of biological community, MCOA was found rarely to be used in ecological studies compared to others ordination methods, e.g. principle component analysis (PCA), redundancy analysis (RDA), canonical correspondence analysis (CCA).

In our study, the MCOA was performed on the 5 individual tables, i.e. five monitoring sites, and the reference structure can be viewed as the temporal patterns of the lake. The temporal change of fish community were summarized and represented as MCOA synthetic scores, which are the optimized covariance from the individual tables. In addition to that, the coefficient RV, which is known as the classical correlation coefficient between the temporal evolution of individual tables and temporal reference structure, was generated to quantify the strength of the relationship between individual table and common structure (Robert & Escoufier 1976). RV coefficient ranges from 0 to 1; low value indicates the low level of synchronism between the temporal patterns of individual table and reference structure. Besides, to estimate spatial synchrony in temporal variations of community structure across

the five sites, we used a multivariate normal distribution:  $Y_{ij} \sim MVN(\mu_j, \Sigma_{ij})$ ; where  $Y_{ij}$  are the coordinates of site  $j$  and time  $i$  along a given MCOA axis,  $\mu_j$  are the site-specific means and  $\Sigma_{ij}$

is a variance-covariance matrix of the form:  $\Sigma_{ij} = \begin{pmatrix} \sigma_1^2 & \cdots & \rho_{15}\sigma_1\sigma_5 \\ \vdots & \ddots & \vdots \\ \rho_{15}\sigma_1\sigma_5 & \cdots & \sigma_5^2 \end{pmatrix}$ ; where diagonal

elements represent the variance within each site and off-diagonal elements represent the covariance between sites.  $\rho$  is the temporal correlation coefficient between each site and represent the temporal synchrony of community structure (Santin-Janin *et al.* 2014).

Apart from that, to examine the relationships between the variability of the community structure and the functional traits, the quantitative traits were regressed using linear model, while the qualitative traits were tested using the non-parametric Kruskal-Wallis test ( $p < 0.05$ ). All the relationships were tested for the three first axes of MCOA. The tests were performed only for the categories containing the comparable numbers of species, while the taxonomic structure was tested only for the five main families of the taxa.

### ***Linking community change to hydrologic regimes***

In order to assess the link between the temporal variability of the fish community and hydrologic regimes of the lake, we performed the cross-correlation function (CCF). CCF is used to quantify the relationship of two time-series ( $x_t$  and  $y_t$ ) as a function of time lag ( $h$ ) between one to another, i.e. the correlation between series  $x_{t+h}$  and  $y_t$  for  $h=0, \pm 1, \pm 2$  and so on (Venables & Ripley 2002). In our case,  $x_t$  and  $y_t$  were respectively the synthetic scores of MCOA and water level and the time lags ( $h$ , days) indicating the response of fish community to the hydrological changes were estimated from the maximum value of CCF coefficients. Indeed, when the time lags  $h$  is negative ( $-h$ ), it shows the correlation between  $x$  at a time before  $t$  and the  $y$  at time  $t$ ; in other word  $x$  leads  $y$ . On the other hand,  $x$  lags  $y$  when time lags  $h$  is positive (Shumway & Stoffer 2015).

All data analyses were conducted in R.3.2.2 using “Base” and “ADE4” packages (Dray, Dufour & Chessel 2007; R Core Team 2015b).

## Results

### *Overview on fish composition*

The studied species belonged to 40 genera, 16 families and 7 orders. Indeed, Cypriniformes, Siluriformes and Perciformes represented 90% of the whole species, while the others, i.e. Clupeiformes, Beloniformes, Osteoglossiformes, Synbranchiformes, accounted for 10% (Table S1). In addition, Cyprinidae was the largest family (45% of the total species), followed by Bagridae (13%), Siluridae (8%), Pangasiidae (6%) and Osphronemidae (6%); while other 11 families represented less than 20% of the whole studied species.

### *Temporal change in fish community structure*

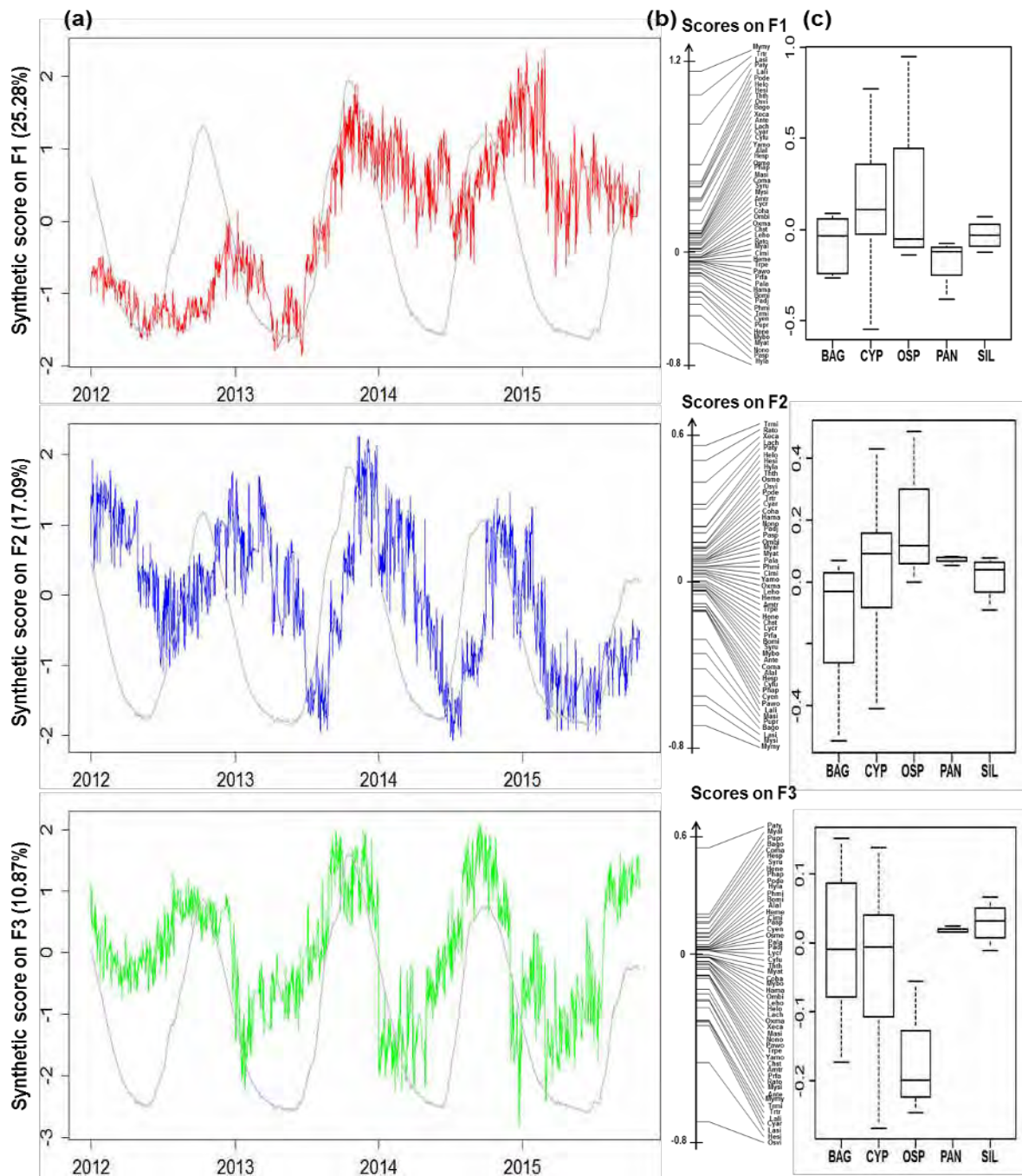
The temporal structure of fish community in the lake were summarized and represented by the time series of multivariate scores at each site and reference. Here, we presented only the reference temporal variability of fish community (Fig. 2a), while the temporal patterns of the individual site were elucidated by the fluctuation of the correlation coefficient RV. As a result, the first three axes of MCOA explained 53% of the total variance from the fish abundance data set (25.28% on F1 axis, 17.09% on F2 axis and 10.87% on F3 axis) (Fig. 2a). The average species factorial scores were calculated from each axis and represented on the arrow bar (Fig. 2b). High scores indicate the important contribution of the species to the community structure, in other words, the species characterized the community. Basically, the values of the species factorial scores were read according to the values of MCAO score curves. For instance, the species with high positive value would expect to dominate the community during the high positive value of MCOA scores, and vice versa (Fig. 2a, b). Additionally, the temporal changes of fish community were observed to follow the fluctuation of hydrology in the lake; though the variability on F1 was less cyclic compared to F2 and F3 (Fig. 2a). Besides, the temporal variation of community on F1 was marked by the rough shift of community structure during the wet season in 2013. The values of RV coefficients ranged

from 0.52 (BB) to 0.75 (SR) and the temporal variation of fish community in SR, PS (0.65) and KC (0.71) were matched to the temporal structure of the lake except in BB and KT (0.56).

Moreover, we found little temporal trends on F2 and F3 for the temporal changes in the taxonomic structures, while no such trend was observed on F1 (Fig. 2c). Indeed, the community seems to change seasonally from bagrids (Bagridae) and cyprinids (Cyprinidae) to gourami fish (Osphronemidae); however, the changes were not significant (Table 1). In terms of functional traits, six out of nine traits were strongly associated to the temporal changes of fish community in the lake and the relationships were observed only the first and third axes of MCOA (Fig. 3, Table 1). On F1, the size of fish was negatively correlated with the temporal changes of community ( $R^2= 19\%$ ,  $p=0.001$ ), while positive correlation was observed on F3 ( $R^2= 8\%$ ,  $p=0.045$ ). The same association were observed on F1 ( $R^2= 9\%$ ,  $p=0.02$ ) and F3 ( $R^2= 12\%$ ,  $p=0.01$ ) for trophic position (Table1, Fig. 3). Therefore, we would expect the community structure changed from the large fish with high trophic level to small fish with low trophic position on F1 and vice versa on F3. Besides, the temporal changes of community structure were related to the life history strategy and ecological guilds of fish (Table 1, Fig. 3). However, these relationships were found only on F3. Indeed, the community were first dominated by the black fish with equilibrium strategy in low water and gradually the community was replaced by grey and white fish with opportunistic strategy when the wet season starts. We found also on F3 the significant relationships between the community structure and feeding habitats, as well as accessory respiratory traits. Accordingly, the community changed from the species feeding on littoral to offshore and littoral. Similarly, more species with the accessory respiratory were found in dry season, while the taxa without equipping accessory were observed during the wet season. Nevertheless, no significant relationships were observed on F2. Apart from the above traits, habitats, spawning habitats, water column position were found to have no influence on the temporal change of community

structure (Table 1). Overall, the temporal changes of community structure were explained by the changes in size and trophic position on F1 and in life history strategies on F3.

The spatial synchrony of community variation between the different monitoring locations across the lake was quantified on the 3 axes of MCOA. As a result, the mean temporal correlation  $\rho$  ranged from 0.43 to 0.66 and the temporal variation of BB and KT were less synchronous compared to SR, PS and KC. Accordingly, no relationships were observed between the level of synchronism and geographical distance of sites as expected.

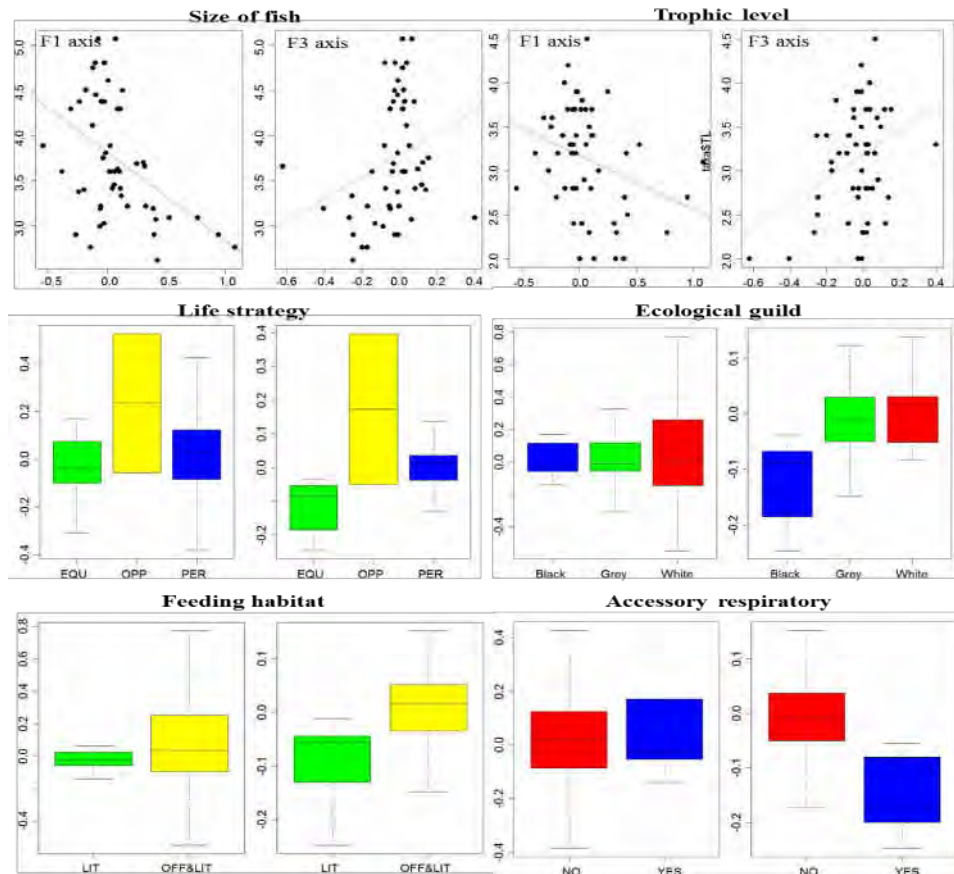




**Fig. 2.** Reference temporal change of fish community structure in Tonle Sap Lake. (a) Time series of MCOA synthetic scores on the first 3 axes from the reference fish abundance table. Grey line represents the daily water level fluctuation in the lake. (b) Mean factorial scores of the 53 taxa on the first 3 axes of MCOA reference structure. (c) Boxplots between MCOA scores and the five main fish families (CYN: Cyprinidae, BAG: Bagridae, OSP: Osphrinemidae, PAN: Pangasiidae, SIL: Siluridae).

**Table 1.** Relationships between the taxonomic structure, functional traits and reference temporal structure of fish community in Tonle Sap Lake.  $R^2$  and P are % of variable explained and associated p-value, while *ns* denotes the non-significant relationship (Kruskal-Wallis,  $p < 0.05$ ).

	F1 Axis		F2 Axis		F3 Axis	
	$R^2$	P	$R^2$	P	$R^2$	P
Family	-	ns	-	ns	-	ns
Size of fish	0.19	0.001	0	ns	0.08	0.02
Trophic Level	0.09	0.02	0	ns	0.12	0.01
Habitats	-	ns	-	ns	-	ns
Life strategy	-	ns	-	ns	-	0.017
Ecological guild	-	ns	-	ns	-	0.003
Spawning habitat	-	ns	-	ns	-	ns
Feeding habitat	-	ns	-	ns	-	0.003
Water column position	-	ns	-	ns	-	ns
Accessory respiratory	-	ns	-	ns	-	0.01



**Fig. 3.** Relationships between functional traits and temporal variability of fish community structure in Tonle Sap Lake on F1 and F3 axes of MCOA. Only significant relationships were presented (Kruskal-Wallis,  $p < 0.05$ , Table 1). The size of fish (y-axis) is showed in log scale and the full names of acronyms were provided in Table S1.

### *Linking the temporal changes of fish community to hydrologic regimes*

The CCF exhibited the significant relationship between the temporal variability of fish community and hydrologic regime (Fig. S1). As a result, the response of fish community seems to lag behind the hydrologic regime except the variability on F3. Thus, the time lags were estimated between 38 to 58 days on F1 ( $r^2 = 0.40$ ), while 50 to 60 days on F2 ( $r^2 = 0.71$ ). On F3, the response of fish community leads the hydrologic regime between 20 to 30 days ( $r^2 = 0.75$ ). Therefore, the fish movement in lake was done 1 to 2 months before or after the arrival of floods.

## **Discussion**

### ***Temporal change in fish community structure***

From the fish table, cyprinids represented about 45% of the studied species, followed by bagrids, silurids, pangasius and gourami fish. Of course, Cyprinidae (39%), Bagridae (8%), Siluridae (7%), Pangasiidae (7%) were the largest families and contained the most common species in the lake (Lim *et al.* 1999; Campbell *et al.* 2006). Besides, similar statistics were reported from the one year daily catch monitoring around the lake (2012-2013), cyprinids (*Henicorhynchus* spp., *Osteochilus* sp.) , gourami fish (*Trichogaster* spp.) , bagrids (*Mystus* spp., *Hemibagrus* spp.), pangasius (*Pangasius* spp.) and featherbreak (*Notopterus* sp.) were the most abundant and accounted more than 90% of abundance in the whole recorded species (Ngor 2012). Therefore, the temporal changes of community structure in the TSL could be mainly influenced by the changes in composition or characteristics of the above assemblages.

According to our results, the temporal changes of fish community structure in TSL were associated to functional traits than to taxonomic structure and this variability was strongly linked to the hydrological variation in the lake. So far, many authors have also come up such temporal patterns from various ecosystems, i.e. freshwater, estuarine and marine. For instance, the community was characterized by the large fish with high trophic levels during the low water and was gradually replaced by the small-sized fish with low trophic level when the water in the lake goes up. Indeed, many studies revealed the positive correlation between body size of fish and its trophic level (Romanuk *et al.* 2011). Besides, the body size of fish is the important trait and strongly correlated with other biological traits of fish (Winemiller 1989). However, from the Orinoco river basin, it was showed that there was no correlation between the body size and trophic position across different taxa in the diverse food web and productive ecosystem (Layman *et al.* 2005). Consistently, recent study on seasonal isotopic shift in fish community of the Pantanal wetland in Brazil has demonstrated the significant change of trophic level from low trophic to high trophic between wet season to dry season, more herbivorous fish in the high water and omnivorous and carnivorous fish during the low

water period (Wantzen *et al.* 2002). Accordingly, more predator and specialist would be expected to dominate the community in TLS during low water and most of them are medium-large fish, e.g. *Hypsibarbus* sp., *Pangasius* spp., *Nototerus notopterus*, *Hemibarbus nemurus*.

Furthermore, we found also the temporal structure of fish community was associated to the life history strategy, ecological guilds, feeding habitats and accessory respiratory. Consequently, the black fish with equilibrium strategy (*Trichogaster* spp.) dominated the community during the low water period, while the white fish with opportunistic strategy (*Paralauca* spp., *Henicorhynchus* spp.) characterized the community during the high water (before and after the peak of pulses). The turn-overs within the transitional periods (dry and wet seasons) were the grey and white fish with periodic strategy (*Mystus* spp., *Puntioplites proctozystron*). Indeed, it was showed that the periodic and opportunistic species are more suited to variable environment, e.g. hydrological fluctuation, than equilibrium species (Winemiller 1989). As an example from South American fish, the community was dominated by the equilibrium in the dry season and gradually changed to opportunist with the beginning of rainy season (Winemiller 1989). Another explanation in accordance to the migration study in Lower Mekong Basin, one third of Mekong species, e.g. cyprinids and river catfish, are known as white fish who conduct the long distant migration between the lake and upstream Cambodian Mekong (Baran 2006; MRC 2007b). It was reported that at the beginning of wet season or late dry season, many of large and medium sized-cyprinid (*Hypsibarbus* sp., *Puntioplites* sp., *Cyclocheilichthys* sp.), catfish (*Pangasius* sp.) and bagrids (*Hemibagrus* sp.) start to migrate from Mekong/tributaries to Tonle Sap for spawning and feeding. Then with the arrival of pulses more small-sized opportunistic cyprinids (*Henicorhynchus* spp., *Labiobarbus* spp., *Paralauca* spp.) were dominant and the catch is peak in December when the water starts to empty from the lake. Indeed, black fish, e.g. *Trochopodus* spp, *Ananbas testudineus*, *Channa* spp., was described to stay permanently in the lake or flood plains and some were reported to conduct the lateral migration between the tributaries, floodplains and

lake (Lamberts 2001; Baran *et al.* 2006). Hence, the temporal structure of fish community could be explained partly by the migration patterns of fish.

Moreover, most of black fish, i.e. climbing perch (*Ananbas testudineus*), walking catfish (*Claria* spp.), snakehead (*Channa* spp.), gourami fish (*Trochopodus* spp.), were described to tolerate the hypoxia environment since they are equipped with accessory respiratory allowing them to breath in the air, and most of them are carnivorous fish (Lamberts 2001; Baran *et al.* 2006). Generally, the food resource is limited during the dry season; thus most of the resident fish, i.e. black and grey fish, feed mostly in littoral zone. With the input of nutrients from Mekong's pulse, the feeding habitats are expanded and more food is available on the offshore. Therefore, we found that the accessory respiratory and feeding habitat traits were strongly correlated to the life history and ecological guild of fish.

One remarkable feature was observed on F1 (Fig. 2a) was the rough shift in community structure. This phenomenon has provoked the changes in the abundance of large/medium-sized cyprinids, bagrids and catfish to small cyprinid and gourami fish. Basically, this rough shift could be explained by the extreme pulse disturbance or hydrological shift in the mid of 2013 due to the intense monsoon within the LMB. Previous study in Parana river on the rough shift of community due to the pulse disturbance has been illustrated the dramatic reduction in biomass of large predators and a significant increase in abundance of the small prey (Agostinho & Zalewski 1995). Moreover, Matthews (1986) has demonstrated that the extreme pulse event could change in rank order abundance of numerically dominant fish and composition of the entire fauna and the response of community to this event would take several years to get back to the original assemblages. Additionally, as mentioned earlier, more environments are variable, more the opportunistic species, e.g. mud carp or gourami fish, are beneficial.

Apart from the community structure, no significant relationships between the level of synchronism and geographical distance of sites were observed as hypothesized. Thus, the

spatial variation of community structure was independent across the lake. Previous studies on spatial synchrony (intra and interspecific) in Africa and Europe have come up as well with no significant relationship between the level of synchronism and geographical distance between the studied sites (Grenouillet *et al.* 2001; Tedesco *et al.* 2004). For instance, the sites located close to each other (Fig.1), i.e. BB and SR, exhibited low value of temporal correlation ( $\rho$ ). Besides, the temporal patterns of BB and KT seem less matched to the reference structure ( $RV \sim 0.5$ ), indicating the influence of site-specific factors on the community dynamics (Daufresne *et al.* 2007). Habitat characteristics of studied sites and influence of the large tributaries, i.e. Stung Sangke and Sen could explain these differences (Fig. S2). Probably, the dynamics of fish community in BB and KT were characterized by the flood pulse dynamics of tributaries. Nevertheless, we acknowledged also that it would derive from the sampling efforts of fishermen.

### ***Linking the temporal structure of fish community to hydrologic regime***

Our results revealed the strong influence of the hydrological variation in the lake to the temporal changes in community composition and functional traits. Indeed, the response of fish community to the changes in hydrologic regime seems to lag within 1.5 months before and after the arrival of pulse (Fig. S1). Very limited literatures on time lags between the fish community and hydrologic regime could be found, particularly in flood pulse lake ecosystem. Our work could probably be the first study to quantify the time lag between fish community and hydrological condition. Previous study in neotropic, e.g. Parana river floodplains, was reported the time lags of chlorophyll-a (6 days) and phytoplankton (14 days) to the change of water levels in the floodplains (Agostinho *et al.* 2000). Thus, we could expect that the lags between water level and fish in TSL would be greater than 2 weeks. From French Guiana river, Merigoux & Ponton (1999) showed that the temporal changes in juvenile fish community were strongly correlated to the past 30 days' hydrological conditions. Therefore, the estimation of time lags between 1.5 to 2 months in TSL could be reasonable. Given that



Tonle Sap floodplains are huge and the seasonal inundations would last longer than river floodplains. For instance, the flooding periods of wetlands in the Central Amazonia were estimated to range from 50 days to 270 days (Ferreira & Stohlgren 1999). Besides, recent study on fish migration in the LMB showed that flow regime and the first rainfall, which takes place about 2 month before the peak season, were the key factors triggered the movement of the fish within the basin such as cyprinids (e.g. *Cyclocheilichthys enoplus*), pangaius (e.g. *Pangasius larnaudii*) and silurids, which are the most sensitive species to the first rainfall (Baran 2006; MRC 2007b).

### ***Conclusions and perspectives***

In summary, we found that the temporal changes of fish community in TLS were associated mainly to the functional traits. Besides, evidence from the rough shift of fish community structure in the mid of 2013 caused by the extreme flood condition, we implied that temporal changes of fish community structure in TLS were strongly related to the flood pulse dynamics. Thus, any hydrological alterations induced by human disturbance, e.g. dam fragmentation in the Mekong, or climate change could modify the whole fish community structure. Moreover, based on the results of our study we suggested that the temporal dynamics of fish community study should link to the functional traits rather than taxonomic groups since it provides more general ecological patterns across different taxa and regions compared to the taxonomic structure (Poff & Allan 1995; Olden *et al.* 2010).

Apart from that, the decreased trend in size of fish could be a concern as we observed more small fish (opportunistic) dominated the community after some flood disturbance. Partly, this mechanism could be linked to fishing pressures and overexploitation of fisheries resources within the lake as illustrated in the previous study on food web structure and ecosystem health assessment in TLS (Chea *et al.* 2016b). Accordingly, in the context of climate change, it was showed that the climate warming benefits the small fish than large fish in aquatic ecosystems (Daufresne *et al.* 2009).

In addition, we found that the responses of fish community to the hydrological changes were lagged between 1.5 to 2 months. Therefore, accounting for these time lags would be beneficial for fisheries conservation and management practices in the lake. Finally, improving our knowledge on how functional traits of fish respond to hydrologic regime will greatly enhance our ability to explain and predict how the local fish assemblages will respond to global changes.

### **Acknowledgement**

The authors are grateful to Erasmus Mundus TECHNO Program and the Belmont Forum for providing the funds to support our study, which are part of the Tonle Sap Climate Change (TLSCC) project. We thank to the Mekong River Commission (MRC) for providing the long time-series data on fish and hydrology of the Tonle Sap Lake. Great thanks to our colleagues and friends, Mr. Phen Chheng Phen, Dr. Nam So, Prof. Les Kaufman, Prof. Lee Hannah for their insightful comments and discussion on our work.

### **References**

- Agostinho A.A., Gomes L.C., Veri S. & Okada E.K. (2005) Flood regime , dam regulation and fish in the Upper Parana: effect on assemblage attributes , reproduction and recruitment. *Reviews in Fish Biology and Fisheries*, 11–19.
- Agostinho A.A., Thomas S.M., Minte-Vera C.V. & Winemiller K.O. (2000) Biodiversity in the high Parana River floodplains. In: *Biodiversity in wetlands: assessment, function and conservation*. (Eds B. Gopal, W.J. Junk & J.A. Davis), pp. 90–118. Backhuys.
- Agostinho A.A. & Zalewski M. (1995) The dependence of fish community structure and dynamics on floodplain and riparian ecotone zone in Parana River , Brazil. *Hydrobiologia* **303**, 141–148.
- Bady P., Dolédec S., Dumont B. & Fruget J.-F. (2004) Multiple co-inertia analysis: a tool for assessing synchrony in the temporal variability of aquatic communities. *Comptes Rendus Biologies* **327**, 29–36.
- Baran E. (2006) *Fish migration triggers in the Lower Mekong Basin and other tropical freshwater systems*. MRC Technical Paper No. 14. Mekong River Commission. 70pp.
- Baran E., So N., Arthur R., Leng S.V. & Kura Y. (2006) *Bioecology of 296 fish species of the Tonle Sap Great Lake (Cambodia)*. Technical Assistance to the Kingdom of Cambodia for the Study of the Influence of Built Structures on the Fisheries of the Tonle Sap. 166pp.

- Baran E., So N., Leng S.V., Arthur R. & Kura Y. (2007) *Relationships between bioecology and hydrology among Tonle Sap fish species*.
- Berra T. (2001) *Freshwater fish distribution*. Press, San Diego, CA.
- Campbell I.C., Poole C., Giesen W. & Valbo-Jorgensen J. (2006) Species diversity and ecology of Tonle Sap Great Lake, Cambodia. *Aquatic Sciences* **68**, 355–373.
- Di Castri F. & Younes T. (1989) Ecosystem Function of Biological Diversity. *Biology International*, 1–19.
- Chea R., Guo C., Grenouillet G. & Lek S. (2016) Toward an ecological understanding of a flood-pulse system lake in a tropical ecosystem: Food web structure and ecosystem health. *Ecological Modelling* **323**, 1–11.
- Chessel D. & Hanafi M. (1996) Analyses de la co-inertie de K nuages de points. *Revue Statistique Appliquée* **44**, 35–60.
- Coates D. (2001) *Biodiversity and Fisheries Management Opportunities in the Mekong River Basin*. Fisheries Programme, Mekong River Commission, Vientiane Lao PDR.
- Daufresne M., Bady P. & Fruget J.-F. (2007) Impacts of global changes and extreme hydroclimatic events on macroinvertebrate community structures in the French Rhône River. *Oecologia* **151**, 544–59.
- Daufresne M., Lengfellner K. & Sommer U. (2009) Global warming benefits the small. *Proceedings of the National Academy of Sciences of the United States of America* **106**.
- Dray S., Dufour A.B. & Chessel D. (2007) The ade4 package-II: Two-table and K-table methods. *R News* **7**, 47–52.
- Dudgeon D. (2011) Asian river fishes in the Anthropocene: threats and conservation challenges in an era of rapid environmental change. *Journal of fish biology* **79**, 1487–524.
- Dudgeon D. (2003) The contribution of scientific information to the conservation and management of freshwater biodiversity in tropical Asia. *Hydrobiologia* **500**, 295–314.
- Dudgeon D. (2000) The Ecology of Tropical Asian Rivers and Streams in Relation to Biodiversity Conservation. *Annual Review of Ecology and Systematics* **31**, 239–263.
- Dugan P.J., Barlow C., Agostinho A. a., Baran E., Cada G.F., Chen D., *et al.* (2010) Fish Migration, Dams, and Loss of Ecosystem Services in the Mekong Basin. *Ambio* **39**, 344–348.
- Edna F., Cunha D.A., Monteiro-neto C., Nottingham M.C. & Fluminense U.F. (2007) Temporal and spatial variations in tidepool fish assemblages of the northeast coast of Brazil. *Biota Neotropica* **7**, 111–119.
- Ferreira L.V. & Stohlgren T.J. (1999) Effects of river level fluctuation on plant species richness, diversity, and distribution in a floodplain forest in Central Amazonia. *Oecologia* **120**, 582–587.

- FEVM (2007) *Monitoring Fish Abundance and Diversity in the Lower Mekong Basin : Methodological Guidelines*. Mekong River Commission. Phnom Penh, Cambodia. 12pp.
- Froese R. & Pauly D. (2015) FishBase. *World Wide Web electronic publication*.
- Grenouillet G., Hugueny B., Carrel G.A., Olivier J.M. & Pont D. (2001) Large-scale synchrony and inter-annual variability in roach recruitment in the Rhone River: the relative role of climatic factors and density-dependent processes. *Freshwater Biology* **46**, 11–26.
- Hortle K.G. (2007) Consumption and the yield of fish and other aquatic animals from the Lower Mekong Basin. 87.
- Junk W.J., Bayley P.B. & Sparks R.E. (1989) The Flood Pulse Concept in River-Floodplain Systems. In: *International Large River Symposium*. (Ed. D.P. Dodge), pp. p. 110–127. Can. Spec. Publ. Fish. Aquat. Sci. 106.
- Junk W.J. & Wantzen K.M. (2004) The Flood Pulse Concept: New aspect, approaches and application-An update. In: *Second International Symposium on the Management of Large River*. pp. 117–132.
- Kummu M. & Sarkkula J. (2008) Impact of the Mekong River Flow Alteration on the Tonle Sap Flood Pulse. *Ambio*, 185–192.
- Lamberts D. (2001) *Tonle Sap fisheries: a case study on floodplain gillnet fisheries*. Asia-Pacific Fishery Commission, Food and Agriculture Organization, Bangkok, Thailand.
- Layman C.A., Winemiller K.O., Arrington D.A. & Jepsen D.B. (2005) Body size and trophic position in a diverse tropical food web. *Ecology* **86**, 2530–2535.
- Lévêque C., Oberdorff T., Paugy D., Stiassny M.L.J. & Tedesco P. a. (2007) Global diversity of fish (Pisces) in freshwater. *Hydrobiologia* **595**, 545–567.
- Liebhold A., Koenig W.D. & Bjørnstad O.N. (2004) Spatial Synchrony in Population Dynamics\*. *Annual Review of Ecology, Evolution, and Systematics* **35**, 467–490.
- Lim P., Lek S., Touch S.T., Mao O.S. & Chhouk B. (1999) Diversity and spatial distribution of freshwater fish in Great Lake and Tonle Sap river. *Aquat. Living Resour.* **12**, 379–386.
- Magurran A.E., Baillie S.R., Buckland S.T., Dick J.M., Elston D. a, Scott E.M., *et al.* (2010) Long-term datasets in biodiversity research and monitoring: assessing change in ecological communities through time. *Trends in ecology & evolution* **25**, 574–82.
- Matsui S. (2005) Tonle Sap Experience and Lessons Learned Brief. *Lake Basin Management Initiative* **1**, 14.
- Matthews W.J. (1986) Linked references are available on JSTOR for this article: Fish Faunal Structure in an Ozark Stream: Stability , Persistence and a Catastrophic Flood. *Copeia* **2**, 388–397.

- Merigoux S., Doledec S. & Statzner B. (2001) Species traits in relation to habitat variability and state: neotropical juvenile fish in floodplain creeks. *Freshwater Biology* **46**, 1251–1267.
- Merigoux S. & Ponton D. (1999) Spatio-temporal distribution of young fish in tributaries of natural and flow-regulated sections of a neotropical river in French Guiana. *Freshwater Biology* **42**, 177–198.
- MRC (2010) *Assessment of basin-wide development scenarios: Impacts on the Tonle Sap Ecosystem*. Mekong River Commission. Vientiane, Lao PDR. 45 pp.
- MRC (2007) *Fish migration triggers the Lower Mekong*. Mekong Fisheries Management Recommendation No 6. Mekong River Commission. Vientian Lao PDR. 8pp.
- Ngor P.B. (2012) Monitoring fish abundance and diversity around the Tonle Sap Lake. *Catch and Culture* **20**, 20–27.
- OCHA (2013) Cambodia: Hundreds of thousands affected by floods. *United Nations Office for the Coordinations of Humanitarian Affairs*, Bangkok, Thailand.
- Olden J.D., Kennard M.J., Leprieur F., Tedesco P. a., Winemiller K.O. & García-Berthou E. (2010a) Conservation biogeography of freshwater fishes: recent progress and future challenges. *Diversity and Distributions* **16**, 496–513.
- Olden J.D., Kennard M.J., Leprieur F., Tedesco P. a., Winemiller K.O. & García-Berthou E. (2010b) Conservation biogeography of freshwater fishes: recent progress and future challenges. *Diversity and Distributions* **16**, 496–513.
- Pease A. a., González-Díaz A. a., Rodiles-Hernández R. & Winemiller K.O. (2012) Functional diversity and trait-environment relationships of stream fish assemblages in a large tropical catchment. *Freshwater Biology* **57**, 1060–1075.
- Pease A. a., Taylor J.M., Winemiller K.O. & King R.S. (2015) Ecoregional, catchment, and reach-scale environmental factors shape functional-trait structure of stream fish assemblages. *Hydrobiologia* **753**, 265–283.
- Poff N.L. & Allan J.D. (1995) Functional Organization of Stream Fish Assemblages in Relation to Hydrological Variability. *Ecology* **76**, 606–627.
- Pool T.K., Olden J.D., Whittier J.B. & Paukert C.P. (2010) Environmental drivers of fish functional diversity and composition in the Lower Colorado River Basin. *Canadian Journal of Fisheries and Aquatic Sciences* **67**, 1791–1807.
- Poulsen A.F., Hortle K.G., Valbo-Jorgensen J., Chan S., Chhuon C.K., Viravong S., *et al.* (2004) Distribution and Ecology of Some Important Riverine Fish Species of the Mekong River Basin. *MRC Technical Paper No. 10. ISSN: 1683-1489*, 1–116.
- Poulsen A.F., Poeu O., Viravong S., Suntornratana U. & Tung N.T. (2002) Fish migrations of the Lower Mekong River Basin: implications for development, planning and environmental management. *MRC Technical Paper No. 8, Mekong River Commission, Phnom Penh. 62 pp. ISSN: 1683-1489*, 62.

- R Core Team (2015) R: A language and environment for statistical computing. R Foundation for Statistical Computing, Vienna, Au.
- Ranta E., Kaitala V. & Lundberg P. (1997) The Spatial Dimension in Population Fluctuations. *Science* **278**, 1621–1624.
- Robert P. & Escoufier Y. (1976) A Unifying Tool for Linear Multivariate Statistical Methods: The RV- Coefficient. *Journal of the Royal Statistical Society:Series C (Applied Statistics)* **25**, 257–265.
- Romanuk T.N., Hayward A. & Hutchings J. a. (2011) Trophic level scales positively with body size in fishes. *Global Ecology and Biogeography* **20**, 231–240.
- Sale P.F. (2004) Connectivity , Recruitment Variation , and the Structure of Reef Fish Communities 1. *Integrative and Comparative Biology* **44**, 390–399.
- Santin-Janin H., Hugueny B., Aubry P., Fouchet D., Gimenez O. & Pontier D. (2014) Accounting for sampling error when inferring population synchrony from time-series data: a Bayesian state-space modelling approach with applications. *PloS one* **9**, e87084.
- Shumway H.R. & Stoffer S.D. (2015) Time Series Characteristics. In: *Time Series Analysis and Its Applications*, EZ Edition. pp. 1–25. Department of Statistics, University of Pittsburgh.
- Simões N.R., Dias J.D., Leal C.M., de Souza Magalhães Braghin L., Lansac-Tôha F.A. & Bonecker C.C. (2013) Floods control the influence of environmental gradients on the diversity of zooplankton communities in a neotropical floodplain. *Aquatic Sciences* **75**, 607–617.
- Tedesco P. a, Hugueny B., Oberdorff T., Dürr H.H., Mérigoux S. & de Mérona B. (2008) River hydrological seasonality influences life history strategies of tropical riverine fishes. *Oecologia* **156**, 691–702.
- Tedesco P.A., Hugueny B., Paugy D. & Fermon Y. (2004) Spatial synchrony in population dynamics of West African fishes: a demonstration of an intraspecific and interspecific Moran effect. *Journal of Animal Ecology* **73**, 693–705.
- Vannote R.L., Minshall G.W., Cummins K.W., Sedell J.R. & Cushing C.E. (1980) The River Continuum Concept. *Canadian Journal of Fisheries and Aquatic Sciences* **37**, 130–137.
- Venables W.N. & Ripley B.D. (2002) Time Series Analysis. In: *Modern Applied Statistics with S*, Fourth edi. pp. 387–414. Springer-Verlag.
- Wantzen K.M., Machado F.D.A., Voss M., Boriss H. & Junk W.J. (2002) Seasonal isotopic shifts in fish of the Pantanal wetland , Brazil. **64**, 239–251.
- Winemiller K.O. (2005) Life history strategies , population regulation , and implications for fisheries management. *Canadian Journal of Fisheries and Aquatic Sciences* **62**, 872–885.

Winemiller K.O. (1989) Patterns of variation in life history among South American fishes in seasonal environments. **241**, 225–241.

Winemiller K.O. & Rose K.A. (1992) Implications for Population Regulation. *Canadian Journal of Fisheries and Aquatic Sciences* **49**, 2196–2218.

Zeug S.C. & Winemiller K.O. (2008) Relationships between hydrology, spatial heterogeneity, and fish recruitment dynamics in a temperate floodplain river. *River. Res. Applic.* **102**, 90–102.

Ziv G., Baran E., Nam S., Rodríguez-Iturbe I. & Levin S. a (2012) Trading-off fish biodiversity, food security, and hydropower in the Mekong River Basin. *Proceedings of the National Academy of Sciences of the United States of America* **109**, 5609–14.



## Appendix

**Table S1.** List of fish taxa, code, and functional traits in Tonle Sap Lake.

Order, Family and Species	Code	Habitat <sup>1</sup>	Size <sup>2</sup> (cm)	Trophic level	Ecological guilds	Life history <sup>3</sup>	Feeding habitat <sup>4</sup>	Spawning habitat <sup>5</sup>	Water column position <sup>6</sup>	Accessory respiratory
<b>Beloniformes</b>										
Belonidae										
<i>Xenentodon cancila</i>	Xeca	PELN	40	3.9	Grey	PER	OFF&LIT	RIV	M-S	No
<b>Clupeiformes</b>										
Engraulidae										
<i>Coilia macrognathos</i>	Coma	PEL	31.7	3.7	Estuarine	PER	OFF&LIT	RIV	M-S	No
<i>Lycotrhissa crocodilus</i>	Lycr	PEL	36.6	3.7	NA	PER	OFF&LIT	RIV	M-S	No
<b>Cypriniformes</b>										
Cyprinidae										
<i>Albulichthys albuloides</i>	Alal	BEN	36.6	2.8	Grey	PER	OFF&LIT	FLP	B-M	No
<i>Amblyrhynchichthys truncatus</i>	Amtr	BEN	48.8	2.4	White	PER	OFF&LIT	FLP	B-M	No
<i>Barbonymus gonionotus</i>	Bago	BEN	40.5	2.4	Grey	PER	OFF&LIT	RIV	B-M	No
<i>Cirrhinus microlepis</i>	Cimi	BEN	79.3	2.4	White	PER	OFF&LIT	FLP	B-M	No
<i>Cosmochilus harmandi</i>	Coha	BEN	100	2	White	PER	OFF&LIT	FLP	B-M	No
<i>Cyclocheilichthys armatus</i>	Cyar	BEN	28.1	3.4	Grey	PER	OFF&LIT	FLP	B-M	No
<i>Cyclocheilichthys enoplus</i>	Cyen	BEN	90.3	3.2	White	PER	OFF&LIT	RIV	B-M	No
<i>Cyclocheilichthys furcatus</i>	Cyfu	BEN	73.2	3.7	White	PER	OFF&LIT	FLP	B-M	No
<i>Hampala macrolepidota</i>	Hama	BEN	85.4	4.2	Grey	PER	OFF&LIT	RIV	M-S	No
<i>Henicorhynchus lobatus</i>	Helo	BEN	18.3	2.7	White	PER	OFF&LIT	RIV	B-M	No
<i>Henicorhynchus siamensis</i>	Hesi	BEN	24.4	2	White	PER	OFF&LIT	RIV	B-M	No
<i>Hypsibarbus lagleri</i>	Hyla	BEN	48.8	2.8	White	PER	OFF&LIT	FLP	B-M	No
<i>Labeo chrysophekadion</i>	Lach	BEN	90	2	White	PER	OFF&LIT	RIV	B-M	No
<i>Labiobarbus lineatus</i>	Lali	BEN	13.8	2.5	Grey	PER	OFF&LIT	RIV	B-M	No
<i>Labiobarbus siamensis</i>	Lasi	BEN	22	2.3	White	PER	OFF&LIT	RIV	B-M	No
<i>Leptobarbus hoevenii</i>	Leho	PEL	122	2.8	Grey	PER	OFF&LIT	FLP	M-S	No
<i>Osteochilus melanopleurus</i>	Osme	BEN	73.2	2.3	Grey	PER	OFF&LIT	RIV	B-M	No

<i>Osteochilus vittatus</i>	Osvi	BEN	39	2	Grey	PER	OFF&LIT	FLP	B-M	No
<i>Paralaubuca typus</i>	Paty	BEN	22	3.3	White	OPP	OFF&LIT	RIV	M-S	No
<i>Poropuntius normani</i>	Pode	BEN	21.6	3.2	NA	PER	OFF&LIT	FLP	B-M	No
<i>Puntioplites proctozystron</i>	Pupr	BEN	30	2.7	White	PER	OFF&LIT	RIV	B-M	No
<i>Rasbora tornieri</i>	Rato	BEN	20.7	3.2	Grey	PER	OFF&LIT	FLP	M-S	No
<i>Systemus rubripinnis</i>	Syru	BEN	30.5	2.9	NA	PER	OFF&LIT	FLP	M-S	No
<i>Thynnichthys thymoides</i>	Thth	BEN	25	2.3	Grey	PER	OFF&LIT	RIV	M-S	No
Cobitidae										
<i>Yasuhikotakia modesta</i>	Yamo	DEM	30.5	3.4	White	PER	OFF&LIT	RIV	B-M	No
<b>Osteoglossiformes</b>										
Notopteridae										
<i>Notopterus notopterus</i>	Nono	DEM	73.2	3.6	Grey	EQU	LIT	FLP	M-S	No
<b>Perciformes</b>										
Anabantidae										
<i>Anabas testudineus</i>	Ante	DEM	25	3	Black	EQU	LIT	FLP	B-M	Yes
Sciaenidae										
<i>Boesemania microlepis</i>	Bomi	BEN	122	3.7	White	PER	OFF&LIT	RIV	B-M	No
Channidae										
<i>Channa striata</i>	Chst	BEN	122	3.4	Black	EQU	LIT	FLP	M-S	Yes
Eleotridae										
<i>Oxyeleotris marmorata</i>	Oxma	DEM	79.3	3.9	Grey	EQU	LIT	FLP	B-M	No
Ambassidae										
<i>Parambassis wolffii</i>	Pawo	DEM	24.4	3.7	Grey	OPP	LIT	FLP	M-S	No
Pristolepididae										
<i>Pristolepis fasciata</i>	Prfa	DEM	20	3.2	Black	EQU	LIT	FLP	B-M	No
Osphronemidae										
<i>Trichogaster microlepis</i>	Trmi	DEM	15.9	3.4	Black	EQU	LIT	FLP	M-S	Yes
<i>Trichopodus pectoralis</i>	Trpe	BEN	25	2.8	Black	EQU	LIT	FLP	M-S	Yes
<i>Trichopodus trichopterus</i>	Trtr	BEN	18.3	2.7	Black	EQU	LIT	FLP	M-S	Yes
<b>Siluriformes</b>										
Siluridae										
<i>Hemisilurus mekongensis</i>	Heme	DEM	80	3.3	Grey	PER	OFF&LIT	FLP	M-S	No

<i>Ompok bimaculatus</i>	Ombi	DEM	45	3.9	Grey	PER	LIT	FLP	B-M	No
<i>Phalacrotonotus apogon</i>	Phap	BEN	158.6	4.5	Grey	PER	OFF&LIT	FLP	M-S	No
<i>Phalacrotonotus micronemus</i>	Phmi	BEN	61	4	Grey	PER	OFF&LIT	FLP	M-S	No
Bagridae										
<i>Hemibagrus nemurus</i>	Hene	BEN	79.3	3.6	Grey	PER	OFF&LIT	FLP	B-M	No
<i>Hemibagrus spilopterus</i>	Hesp	DEM	37.7	3.5	Grey	PER	OFF&LIT	RIV	B-M	No
<i>Mystus albolineatus</i>	Myal	DEM	42.7	3.7	Grey	PER	OFF&LIT	RIV	B-M	No
<i>Mystus atrifasciatus</i>	Myat	DEM	18.3	3	Grey	PER	OFF&LIT	FLP	B-M	No
<i>Mystus bocourti</i>	Mybo	DEM	29.3	3.5	Grey	PER	OFF&LIT	RIV	B-M	No
<i>Mystus mysticetus</i>	Mymy	DEM	15.9	3.1	Grey	PER	OFF&LIT	RIV	B-M	No
<i>Mystus singaringan</i>	Mysi	DEM	36.6	3.8	Grey	PER	OFF&LIT	FLP	B-M	No
Pangasiidae										
<i>Pangasius bocourti</i>	Padj	BEN	115.2	2.8	Na	PER	OFF&LIT	FLP	B-M	No
<i>Pangasius larnaudii</i>	Pala	BEN	158.6	3.3	White	PER	OFF&LIT	RIV	B-M	No
<i>Pangasius macronema</i>	Pasp	BEN	36.6	3.2	White	PER	OFF&LIT	RIV	M-S	No
Mastacembelidae										
<i>Macrognathus siamensis</i>	Masi	BEN	36.6	3.3	Black	PER	LIT	FLP	B-M	No

**Notes:** 1. Habitat : Pelagic (PEL), Demersal (DEM), Benthopelagic (BEN), Pelagic-niritic (PELN) ; 2. Size: Total length of fish in cm ; 3. Life history: Equilibrium (EQU), Periodic (PER), Opportunistic (OPP) ; 4. Feeding habitat: Littoral (LIT), Offshore & littoral (OFF&LIT); 5. Spawning habitat: Floodplains (FLP), River channels (RIV) ; 6. Water column position: Bottom-Middle (B-M), Middle-Surface (M-S).



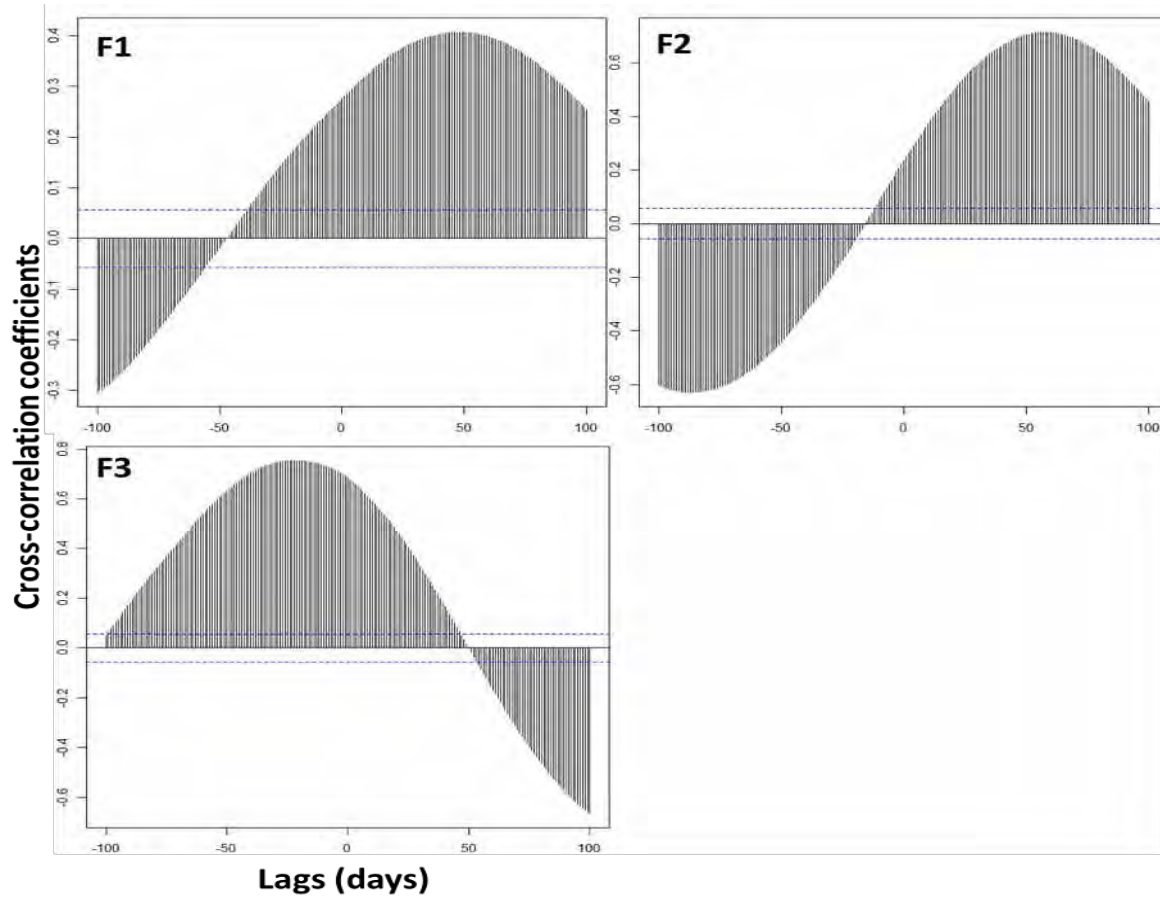


Fig. S1. Cross-correlation between the time series of MCOA synthetic scores and daily water levels in Tonle Sap Lake. The blue dot-lines indicate the significant levels with 95% of confident interval.



## ARTICLE 4

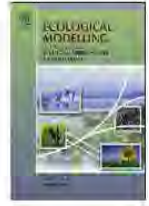
**Toward an ecological understanding of a flood-pulse system lake  
in a tropical ecosystem: Food web structure and ecosystem health.**

**R. Chea, C. Guo, G. Grenouillet and S. Lek (2016)**

*Ecological Modelling 323:1-11.*







## Toward an ecological understanding of a flood-pulse system lake in a tropical ecosystem: Food web structure and ecosystem health



Ratha Chea<sup>a,b</sup>, Chuanbo Guo<sup>a,c,\*</sup>, Gaël Grenouillet<sup>a</sup>, Sovan Lek<sup>a</sup>

<sup>a</sup> Université de Toulouse, Labo Evolution & Diversité Biologique, UMR5174 EDB CNRS – Université Paul Sabatier-ENEA, F-31062 Toulouse, France

<sup>b</sup> Faculty of Agriculture and Food Processing, University of Battambang, Road 5, Battambang city, Cambodia

<sup>c</sup> State Key Laboratory of Freshwater Ecology and Biotechnology, Institute of Hydrobiology, Chinese Academy of Sciences, Wuhan 430072, China

### ARTICLE INFO

#### Article history:

Received 29 August 2015

Received in revised form

24 November 2015

Accepted 25 November 2015

#### Keywords:

Ecological indicators

Ecosystem management

Ecopath with Ecosim

Food web

Trophic interaction

Tonle Sap Great Lake

### ABSTRACT

Tonle Sap Great Lake (TSL) is the largest freshwater lake ecosystem in Southeast Asia and receptacle of impressive biodiversity. However, there is surprisingly little knowledge of its ecosystem structure and functioning. The main objective of the current work was to quantify the food web structure and assess the ecosystem health status of the TSL system by constructing the first holistic food web model using Ecopath with Ecosim (EwE). The results indicate that the ecotrophic efficiency (EE) values were very high for most of functional groups (EE > 0.5) except molluscs (0.146) and macrophytes (0.102). The high EE values together with the MTI (Mixed Trophic Impact) analysis indicated the overexploitation and degradation of fishery resources in the TSL system. The discrete trophic levels varied from 1 (phytoplankton, macrophytes and detritus) to 3.17 (snakehead). The energy transfer in the TSL food web was based mostly on the detrital food chain (77.9%) rather than the grazing food chain (22.1%), with an average transfer efficiency of 8.27%. The ratios of total primary production to respiration (TPP/TR) and to biomass (TPP/TB) were 1.23 and 2.04, respectively, while the Ascendency and Finn cycling index (FCI) of the system were estimated at 27.4% and 23.62%. Nevertheless, the connectance index (CI: 0.253) and system omnivory index (SOI: 0.075) were in-between compared to other lake ecosystems, which indicated that the food web structure was characterized by linear, rather than web-like features. Systematic analysis and indicators suggested that the ecosystem was a relatively healthy ecosystem achieving a certain stage of maturity, albeit with a vulnerable food web structure. Accordingly, some ecosystem-based strategies are presented for the improvement of fishery management and ecosystem conservation in TSL.

© 2015 Elsevier B.V. All rights reserved.

### 1. Introduction

There is ample evidence that freshwater ecosystems globally suffer from overexploitation, environmental pollution, biodiversity decrease and habitat loss and/or degradation (De Kerckhove et al., 2015; Fang et al., 2006). Natural resource management and aquatic ecosystem assessment currently challenge both scientific communities and environmental managers. In view of these facts, it is widely recognized that an ecosystem-based approach is important for managing sustainable natural resources and maintaining ecosystem health in freshwater systems (FAO, 1995; Li et al., 2009).

Tonle Sap Lake (TSL) is acknowledged as being the largest freshwater ecosystem in Southeast Asia and is an ecological hotspot

zoned as biosphere reserve in 1997 by UNESCO (United Nations Educational, Scientific and Cultural Organization) (Lamberts, 2006; UNESCO, 1997). The lake is characterized by the flood-pulse system, interconnected with the Great Mekong River through the Tonle Sap River (120 km long), creating hydrological processes unique worldwide with the reversed flow from the lake into the Mekong in the dry season when water in the Mekong starts to recede (Arias et al., 2013). Moreover, Tonle Sap Lake is one of the largest contributors to freshwater fish which include more than 296 species ranking the 3rd in the world just after 2 African Great Lakes: Malawi (433 species) and Tanganyika (309 species) (Baran et al., 2007). Fishes are the main sources of nutrition representing 80% of Cambodians dietary proteins (Hortle, 2007). Therefore, TSL is not only important due to its large area but it has also played a crucial role in ecological, economic and socio-cultural values to sustain the livelihoods of millions of people for centuries (Lamberts, 2006). Indeed, Tonle Sap fisheries represent more than 60% of Cambodia's inland fisheries captures – estimated between 289,000 and 431,000 tons of catch annually (Van Zalinge et al., 2001). The average annual catch

\* Corresponding author at: State Key Laboratory of Freshwater Ecology and Biotechnology, Institute of Hydrobiology, Chinese Academy of Sciences, Wuhan 430072, China. Tel.: +86 27 68 78 07 17.

E-mail address: [guochuanbo@gmail.com](mailto:guochuanbo@gmail.com) (C. Guo).



from TSL was reported to be between 179,500 and 246,000 tons (Baran and Myschowoda, 2008).

In contrast to its importance, little effort has been focused on understanding its aquatic communities, fishes and fisheries, biological status and primary production, let alone holistic studies as such as that investigating food web and ecosystem properties in TSL system (Lamberts, 2006). It was shown that among the world's largest tropical lakes and floodplains, TSL is the one where hydrology and ecology has been studied the least (Junk et al., 2006a). So far, most of the previous studies in TSL have focused mainly on fishery production and its relationship with hydrological and environmental factors (Baran and Myschowoda, 2008; Baran et al., 2001). For instance, Lake George in Uganda which is 60 times smaller than TSL and supports the livelihood of about 1700 households, has probably received 100 times more research attention (Keizire and Muhwezi, 2006).

Due to the limited studies and related ecosystem approaches, up until now, little is known about the ecosystem status and food web structure of TSL, since the interactions of biodiversity within an ecosystem are very complex (Baran and Myschowoda, 2008; Baran et al., 2007; Van Zalinge et al., 2001). Recent studies have shown that TSL fisheries exert over exploitation. Subsequently, multiple significant indicators have shown that the system, previously home to many giant catfishes, giant barb and stingrays, is now dominated by small and low value species (Cooperman et al., 2012; Enomoto et al., 2011), questioning the sustainability of the fisheries in the lake. As a matter of fact, overfishing can impact the food web structure and change the abundance of predators that can alter the prey abundance leading to a cascade of trophic effects (Sala et al., 1998). It is believed that the more an ecosystem is large and complex, the greater its vulnerability (MacDougall et al., 2013).

Nevertheless, what do we know about the ecological interactions of the TSL ecosystem, how can we optimise management of the natural resources and maintain a healthy ecosystem? To address these issues, a holistic ecological understanding is fundamental contributing to balancing productivity and maintaining the health of ecosystems in response to present needs. The food web is one of the key components in an ecosystem and ecologists have been struggling for centuries to understand the real trophic interactions among its living organisms (Ings et al., 2009). Food web structure and interactions play a decisive role in determining the dynamics of an ecosystem, and are of interest in many ecological studies (Kitchell et al., 2000). This knowledge contributes not only to maintaining the stability and sustainability of ecosystem functioning, but also to the conservation and management of the ecosystem to mitigate the present and future needs for feeding (Van Worm and Duffy, 2003).

In recent years, Ecopath with Ecosim (EwE) has been widely used all over the world to describe the trophic relationship and the quantitative ecosystem properties (Christensen et al., 2005). Many applications have been constructed on the largest and most productive aquatic, terrestrial and coastal ecosystems (i.e., Lake Malawi, lake Tanganyika, Gironde estuary, Mediterranean Sea) (<http://www.ecopath.org/models>). Moreover, EwE is a very suitable approach to study the ecological functioning of the large ecosystem with limited availability of information and data, such as Tonle Sap Lake (Coll et al., 2009).

This study aims to establish the first systematic model of trophic interactions and ecosystem properties for the important, yet poorly studied TSL ecosystem. Our main objectives are to (1) quantify the food web structure and trophic interactions in TSL; (2) assess the TSL ecosystem properties and health status based on the ecological indicators attributed by the model; and (3) propose ecosystem-based strategies for the improvement of fisheries management in TSL. The results are critically important for effective decision making and policy development in terms of conservation and

sustainability of fishery resources and ecosystem health in large freshwater lakes worldwide.

## 2. Materials and methods

### 2.1. Tonle Sap Lake

Tonle Sap Great Lake (Fig. 1) is the most important wetland within the Lower Mekong Basin and characterized by tropical monsoon climate (Atlas et al., 2013). The water level in the lake varies from 0.8 m in the dry season to 9 m in the rainy season causing an expansion of the lake's area from 2500 km<sup>2</sup>–3000 km<sup>2</sup> to reach 10,000 km<sup>2</sup>–16,000 km<sup>2</sup> when full (Matsui et al., 2005). More than 60% of the lake's water originally comes from the Mekong River through the Tonle Sap River (120 km) with just 40% being drained within the TSL lake basin and its tributaries (Matsui et al., 2005). Since the area of the lake varies greatly between the dry and rainy seasons, only 10,500 km<sup>2</sup> were taken in account for our study area by assuming 2500 km<sup>2</sup> of permanent water and 8000 km<sup>2</sup> for the average productive area of the floodplains within 3 months of flooding periods (Koponen et al., 2010). Under the tropical wet and dry monsoon regime, the annual rainfall within the lake area is between 1300 mm and 1900 mm, with the mean water temperature about 30 °C (MRC, 2010). The TSL has been described as a meso to eutrophic lake (Junk et al., 2006a) the average nutrient concentrations of 0.17 mg L<sup>-1</sup> for total nitrogen, and 0.06 mg L<sup>-1</sup> for total phosphorus, with pH remaining almost neutral (Table 1).

### 2.2. Modelling approach

Ecopath with Ecosim (EwE) is free ecological modelling software developed by Christensen and Pauly (1993), which creates a static mass-balanced snapshot of the resources in an ecosystem and their interactions, represented by trophically linked biomass "pools" or ecological guilds (Christensen et al., 2005). In recent years, EwE has been widely used to address ecological questions, evaluate ecosystem properties, study trophic relationships, explore the fisheries management and restoration policies; and evaluate the effect of environmental changes in continental and coastal ecosystems (Coll and Libralato, 2012; Kao et al., 2014; Rogers and Allen, 2012). The algorithm of EwE is based on parameterization of the two master equations known as: (1) Production = catch + predation + net migration + biomass accumulation + other mortality; (2) Consumption = production + respiration + unassimilated food, can be simplified and expressed as follows (Christensen et al., 2005):

$$B_i \cdot \left(\frac{P}{B}\right)_i - EE_i - \sum_{j=1}^i B_j \cdot \left(\frac{Q}{B}\right)_j \cdot DC_{ji} - EX_i = 0 \quad (1)$$

where  $B_i$  is the biomass of group  $i$ ;  $(P/B)_i$  the production biomass ratio of group  $i$ , which is equal to the coefficient of total mortality ( $Z$ ) under the steady state condition;  $EE_i$  is the ecotrophic efficiency of group  $i$ ;  $B_j$  is the biomass of predator group  $j$ ;  $(Q/B)_j$  is the con-

**Table 1**  
Physicochemical parameters of water quality in Tonle Sap Lake during 1995–2010.

Parameters	Unit	Mean ± SD
Water temperature	°C	30 ± 0.45
pH	-	7 ± 0.07
Dissolved oxygen	mg L <sup>-1</sup>	6 ± 0.89
Specific conductivity	µS cm <sup>-1</sup>	68 ± 39
Total suspended solids	mg L <sup>-1</sup>	109 ± 62
Total phosphorus	mg L <sup>-1</sup>	0.06 ± 0.09
Total nitrogen	mg L <sup>-1</sup>	0.17 ± 0.04
Secchi depth	m	1.07 ± 0.26



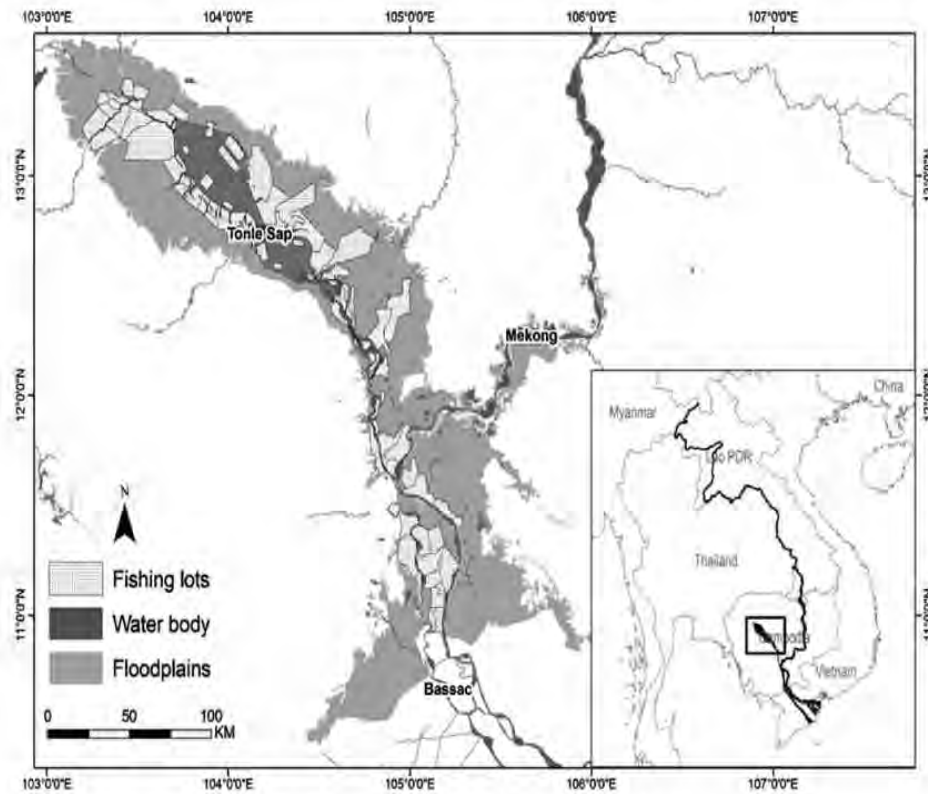


Fig. 1. Geographic location of Tonle Sap Great Lake.

sumption biomass ratio of the predators  $j$ ;  $EX_j$  is the export of group  $i$ ;  $i$  and  $j$  are respectively numbers of prey and predator groups.

Biomass ( $B$ ), production/biomass ratio ( $P/B$ ), consumption/biomass ratio ( $Q/B$ ), ecotrophic efficiency ( $EE$ ) and diet composition ( $DC$ ) are the main parameters of the Ecopath model. To construct the model, the composition of the diet and at least three of the four parameters ( $B$ ,  $P/B$ ,  $EE$ , and  $Q/B$ ) are needed for the basic input of the model for each functional group (detailed in Section 2.2.1). Additionally, the one unknown parameter can be estimated by the model through the Ecopath parameterization algorithm.

### 2.2.1. Functional groups

EwE model provides a quantitative representation of the energy flows in the food web of the ecosystem studied. This ecosystem is represented by different categories, defined by the functional properties of taxa included in each category and considered as functional groups, which can be composed of one or many ecologically similar species (Coll et al., 2009). In TSL, 21 functional groups have been defined to construct the mass balance model in order to study the trophic relationship of this ecosystem (Table 2). There were 12 fish functional groups, crabs, shrimps, molluscs, other zoobenthos, macrozooplankton, microzooplankton, phytoplankton, macrophytes and detritus. The aggregation of the fish functional groups was based mostly on the composition of diet, traits (size), ecological guilds and commercial landing statistics (Poulsen et al., 2004).

### 2.2.2. Data collection and preparation

**2.2.2.1. Fish.** Seventy common fish species with an important economic value were selected for the study and were aggregated into 12 functional groups according to their ecological similarity. The biomass ( $B$ ) and production/biomass ratio ( $P/B$ ) of each fish functional group were calculated by the empirical relationship of Pauly

(1980) and Beverton and Holt (1957) as follows (Christensen et al., 2005):

$$B = \frac{Y}{F}; \quad F = Z - M; \quad Z = \frac{P}{B} = K \frac{L_{\infty} - \bar{L}}{\bar{L} - L'} \quad (2)$$

where  $B$ ,  $Y$ ,  $F$ ,  $Z$  and  $M$  represent the biomass ( $\text{t km}^{-2}$ ), the annual catch yield ( $\text{t km}^{-2} \text{ year}^{-1}$ ), the fishing mortality ( $\text{year}^{-1}$ ), total mortality ( $\text{year}^{-1}$ ), and natural mortality ( $\text{year}^{-1}$ );  $K$ ,  $L_{\infty}$ ,  $\bar{L}$ ,  $L'$  represent the growth rate of VBFB, asymptotic length of fish (cm), mean length of fish (cm), cut off length of fish (cm).  $K$ ,  $L_{\infty}$ ,  $\bar{L}$ ,  $L'$  were derived from the FishBase website ([www.fishbase.org](http://www.fishbase.org)) and previously published studies.

Annual fish yields of TSL were derived from the fish catch statistic survey 1994–1997 of the fishing lots and fishermen in the fishing lot zones around the lakes (Fig. 1) conducted by Mekong River Commission (MRC) under the support of DANIDA (Danish International Development Agency) in collaboration with Fisheries Administration of Cambodia (Ly and van Zalinge, 1998). Fishing lots (Fig. 1) are the commercial fishing zones around the lakes auctioned by Cambodian government to the highest bidder for exclusive exploration, so it is one of the government's main instruments for extracting fisheries resources from the lake (Van Zalinge et al., 1998). There were about 125 fishing lots located around the TSL, its floodplains, and Tonle Sap River. After the fisheries reform in 2012, the fishing lots were completely removed from the lake leaving 65% of the lake open to family fishing activities under the management of community fisheries (CFI) and 35% for conservation purposes (CDRI, 2013). In our study, the average catch of the TSL was assumed to be 235,000 tons per year, and the total fish yield/landing was computed at  $22.38 \text{ t km}^{-2}$  by Van Zalinge et al. (2001) and Ly and van Zalinge (1998).

The consumption biomass ratio ( $Q/B$ ) was estimated from FishBase website ([www.fishbase.org](http://www.fishbase.org)). The diet composition of each fish functional group was based on the literature reviews and report from the previous studies Guo et al. (2013), Jia et al. (2012) and Lim et al. (1999).



**Table 2**  
Main species composition of each category for the Tonle Sap lake ecosystem.

No	Category name	Main species composition
1	Snakehead	<i>Channa micropeltes</i> , <i>Channa striata</i> , <i>Channa gachua</i> , <i>Channa lucius</i>
2	Catfish	<i>Pangasius</i> sp. ( <i>hypophthalmus</i> , <i>conchophilus</i> ), <i>Pangasius lamarudii</i>
3	Soldier river barb	<i>Cylocheilichthys enoplos</i>
4	Perch	<i>Anabas testudineus</i> , <i>Pristolepis fasciata</i> , <i>Parambassis wolffii</i>
5	Other carnivores	<i>Harpala</i> sp., <i>Boesemania microlepis</i> , <i>Oxyeleotris marmorata</i> , <i>Waliago attu</i> , <i>Lycotrisa crocodilus</i> , <i>Notopterus notopterus</i> , <i>Chitala ornata</i> , <i>Kryptopterus cheveyi</i> , <i>Ompok siluroides</i> , <i>Cephalocassis borneensis</i> , <i>Mastacembelus armatus</i> , <i>Phalacrognathus apogon</i> , <i>Belodontichthys truncatus</i> , <i>Colia lindmani</i>
6	Large herbivores	<i>Labeo chrysophekadion</i> , <i>Cirrhinus microlepis</i> , <i>Osteochilus melanopleara</i> , <i>Catlocarpio siamensis</i> , <i>Cosmochilus harmandi</i> , <i>Tenualosa thibaudeaui</i> , <i>Barbichthys laevis</i>
7	Small herbivores	<i>Thynnichthys hynnoides</i> , <i>Labiobarbus leptocheilus</i> , <i>Amblyrhynchichthys micracanthus</i> , <i>Gyrinocheilus pennocki</i> , <i>Labiobarbus siamensis</i>
8	Omnivorous fish	<i>Hypsibarbus malcoini</i> , <i>Osteochilus vittatus</i> , <i>Puntioplites practozyron</i> , <i>Barborynus altus</i> , <i>Puntioplites bulu</i> , <i>Systemus orphoides</i> , <i>Albulichthys albuloides</i>
9	Benthivorous fish	<i>Hemibagrus spllopterus</i> , <i>Leptobarbus rubripinna</i> , <i>Clarias</i> sp., <i>Hemibagrus filamentus</i> , <i>Macrognathus siamensis</i> , <i>Cynoglossus cynoglossus</i> , <i>Yasuhikotakia modesta</i> , <i>Cylocheilichthys apogon</i> , <i>Pangasius macronema</i> , <i>Toxotes</i> sp., <i>Hyporhamphus limbatus</i> , <i>Thryssocypris tonlesapensis</i> , <i>Macrochirochthys smacochirus</i> , <i>Bagarius bagarius</i> , <i>Probarbus labeamajor</i>
10	Gourami fish	<i>Trichopodus</i> sp., <i>Trichopodus pectoralis</i>
11	Mud carp	<i>Henicorhynchus</i> sp.
12	Small fish	<i>Paralabuca typus</i> , <i>Rasbora tomeri</i> , <i>Rasbora dusonensis</i> , <i>Parambassis apogonoides</i> , <i>Corica laciniata</i> , <i>Puntius brevis</i> , <i>Parachela siamensis</i> , <i>Mystus</i> sp. ( <i>atrifasciatus</i> , <i>albolineatus</i> )
13	Crabs	<i>Sommamiatelaphusa lacuvita</i>
14	Shrimps	<i>Macrobrachium lanchesteri</i>
15	Molluscs	<i>Corbicula</i> sp., <i>Limnoperna</i> sp.
16	Other zoobenthos	Oligochaeta, Insecta (chironomidae), others
17	Macrozoopankton	Copepoda, Cladocera
18	Microzooplankton	Protozoa, Rotifera
19	Phytoplankton	Chlorophyta, Cyanobacteria, Bacillariophyta, Euglenophyta
20	Macrophytes	<i>Barringtonia acutangula</i> , <i>Eichhornia crassipes</i>
21	Detritus	-

**2.2.2.2. Crabs and shrimps.** The biomass of crabs and shrimps was estimated from the field survey conducted by MRC in 2008 in the northern part of Tonle Sap (Battambang province). MRC reported that other aquatic animals (OAAs) including crabs, shrimps, snakes, frogs and others represented approximately 24% of the total catch (Hortle et al., 2008). Crabs and shrimps composed of 35.5% and 22.5% of total OAAs' biomass, respectively. The estimated biomass of crabs and shrimps were 3.76 t km<sup>-2</sup> and 2.36 t km<sup>-2</sup> respectively. The value of *P/B* and *Q/B* were modified from Guo et al. (2013) and Jia et al. (2012).

**2.2.2.3. Zooplankton and zoobenthos.** The biomass of zooplankton and zoobenthos were estimated from the field survey in TSL (Ohraka et al., 2010). In our study, the zooplankton communities were divided into 2 functional groups: macrozooplankton (copepoda and cladocera) and microzooplankton (protozoa and rotifers). The mean densities of zooplankton communities were: copepods (347 ind. L<sup>-1</sup>), cladocera (87 ind. L<sup>-1</sup>), protozoa (1040 ind. L<sup>-1</sup>) and rotifers (260 ind. L<sup>-1</sup>). It was noted that more than 70% of zooplankton in TSL were microzooplankton, particularly protozoa.

Zoobenthos communities were categorized into 2 different functional groups: molluscs and other zoobenthos (i.e., oligochaeta, insects including chironomidae). The estimated biomass of molluscs was exceptionally high compared to other zoobenthos, with an average biomass of 143.14 g m<sup>-2</sup> and 1.19 g m<sup>-2</sup>, respectively. The *P/B* and the production to consumption ratio (*P/Q*) of zooplankton and zoobenthos communities were modified from Guénette et al. (2008) and Guo et al. (2013).

**2.2.2.4. Primary producers.** The primary producers were characterized by 2 functional groups: phytoplankton and macrophytes. The biomass of phytoplankton and macrophytes were computed as 5.48 t km<sup>-2</sup> and 1489 t km<sup>-2</sup>, respectively, from the previous primary production model of the lake (Junk, 2006; Koponen et al., 2010). In the TSL system, the phytoplankton was constituted mainly by algal production (i.e., chlorophyta, cyanobacteria, bacillariophyta, euglenophyta) while the rooted and floating macrophytes typed as terrestrial vegetation were dominated

by *Barringtonia acutangula*, *Eichhornia crassipes* (Campbell et al., 2006). Furthermore, the *P/B* values of phytoplankton and macrophytes were estimated at 185 year<sup>-1</sup> and 1.67 year<sup>-1</sup>, respectively, similar to many Chinese and tropical lakes.

**2.2.2.5. Detritus.** The biomass of detritus was calculated using the empirical equation from the primary production and euphotic depth suggested by Christensen and Pauly (1993):

$$\log D = 0.954 \log PP + 0.863 \log E - 2.41 \quad (3)$$

where *D* is the detrital biomass in (g C m<sup>-2</sup>), *PP* is the primary production in (g C m<sup>-2</sup>); *E* is the euphotic depth in meters. The depth of the euphotic zone was calculated as follows:  $E = 2.5 \times SD$  (Secchi depth in meters), the average SD of TSL is 1.07 m and therefore  $E = 2.68$  m.

### 2.2.3. Model balancing and uncertainty

The Ecopath model was balanced by launching the first basic estimation in parameterization to get *EE* values ( $EE < 1$ ) and *P/Q* values (0.05–0.3) for all functional groups. In practice, a manual modification on the input data was employed to balance the model (Christensen et al., 2005). The new version of the Ecopath model was balanced using ecological knowledge rather than entirely relying on computer algorithms, e.g., the diet compositions of some functional groups were slightly modified in order to get the mass-balance model (the modified diet matrix is shown in Table 4).

Pedigree was used to describe the quality of input data by assigning the confidence interval based on their origins. This can be used to evaluate the certainty of the model. With the individual computation of the pedigree index for each functional group, an overall pedigree index (*P*) for the model was estimated as follows:

$$P = \sum_{i=1}^n \sum_{j=1}^n \frac{I_{ij}}{n}$$

where  $I_{ij}$  is the pedigree index for model group *i* and parameter *j*, *n* is the total number of modelled groups (Christensen et al., 2005). The overall model pedigree index (*P*) ranges from 0 (low) to 1 (high)



**Table 3**  
Basic input and estimated parameters (italics) for the 21 functional groups of the Tonle Sap Lake ecosystem.

Group number	Group name	FTL	B (t km <sup>-2</sup> )	P/B (year <sup>-1</sup> )	Q/B (year <sup>-1</sup> )	EE	P/Q
1	Snakehead	3.17	4.48	1.22	6.20	0.598	0.196
2	Catfish	2.98	1.38	0.92	3.70	0.897	0.249
3	Soldier river barb	2.77	3.64	0.94	5.50	0.936	0.171
4	Perch	2.74	1.13	2.85	33.40	0.565	0.085
5	Other carnivores	2.96	5.23	0.96	7.20	0.898	0.134
6	Large herbivores	2.00	7.96	0.38	12.00	0.600	0.031
7	Small herbivores	2.00	13.09	0.68	38.70	0.952	0.018
8	Omnivorous fish	2.41	2.23	2.73	22.90	0.994	0.119
9	Benthivorous fish	2.56	4.89	0.35	5.00	0.934	0.070
10	Gourami fish	2.22	2.26	1.21	10.40	0.933	0.116
11	Mud carp	2.00	5.99	1.53	26.40	0.938	0.058
12	Small fish	2.26	6.07	1.38	18.20	0.944	0.076
13	Crabs	2.31	3.76	2.12	8.48	0.721	0.250
14	Shrimps	2.02	2.36	4.50	24.40	0.936	0.184
15	Molluscs	2.00	143.10	4.30	17.20	0.146	0.250
16	Other zoobenthos	2.00	1.19	5.00	25.00	0.843	0.200
17	Macrozooplankton	2.05	9.98	4.29	85.87	0.900	0.050
18	Microzooplankton	2.00	3.74	15.26	305.23	0.950	0.050
19	Phytoplankton	1.00	5.48	185.00		0.936	
20	Macrophytes	1.00	1488.62	1.67		0.102	
21	Detritus	1.00	24.31			0.871	

Notes: FTL stands for fractional trophic level and B, P/B, Q/B, EE, P/Q respectively for Biomass, Production to Biomass ratio, Consumption to Biomass ratio, Ecotrophic Efficiency, Production to Consumption ratio.

quality of the model studied. Indeed, the pedigree values of over 150 Ecopath models published ranged from 0.164 to 0.675 (Morissette et al., 2006).

#### 2.2.4. Network analysis and ecosystem properties

In Ecopath model, all ecological groups were also assigned discrete trophic levels according to Lindeman (1942) with the approach suggested by Ulanowicz (1995). Then, a modified input–output analysis with the procedure “Mixed Trophic Impacts (MTI)” described by Ulanowicz and Puccia (1990) was implemented in the EwE to describe how any group (including fishing fleets) impacts trophically on all the other groups in an ecosystem. It includes both direct and indirect impacts, i.e., both predatory and competitive interactions (Christensen et al., 2005).

Theoretically, in EwE, the ecosystem properties were quantified by implementing the ecosystem theories proposed by Odum and Barreir (1972), Odum (1969) and Ulanowicz (1987). Accordingly, a set of indicators were used to describe and assess the stability and maturity of the ecosystem (Christensen et al., 2005). Indeed, the flow indices, including the connectance index (CI) and system omnivory index (SOI), were used to describe whether the food web is web-like or linear. Whereas, the connectance index (CI) is a measure of the observed number of food links in a system relative to the number of possible links (Gardner and Ashby, 1970). The value of CI depends on both the size of a system and on diet matrices, while the SOI expresses the variance in the TL of the consumer prey groups. Besides, a routine based on the approach suggested by Ulanowicz (1987) was implemented to describe the numerous cycles and pathways implied by the food web representing an ecosystem. Finn’s cycling index (FCI) is widely used to calculate the flows with respect to cycled fractions in an ecosystem (Finn, 1976). Moreover, the ecosystem information indices, i.e., ascendancy (A) and system overhead (O), were computed from information theory as a measure of the average mutual information in a system (Ulanowicz and Norden, 1990).

### 3. Results

#### 3.1. Basic input and output variables

The balanced Ecopath model with the pedigree index (0.511) and the measure of fit (2.523) indicated that the input parameters

of the model were based on reliable sources and that the model was robust with a high level of confidence (Table 5).

A set of basic input variables and the estimated parameters from the model are listed in Table 3. Generally, the EE values of all functional groups are less than 1, and most of the P/Q values are between 0.05 and ~ 0.3, meeting the requirements of a balanced model. The EE values of all the commercial fishery objectives (e.g., fishes, shrimps and crabs) were much higher than 0.5. For instance, omnivorous fish suffered the highest EE value of 0.994, followed by small herbivores (0.952), small fish (0.944), mud carp (0.938), shrimps (0.936), soldier river barb (0.936), benthivorous fish (0.934), gourami fish (0.933), other carnivores (0.898), catfish (0.897), crabs (0.721), large herbivores (0.600), snakehead (0.598) and perch (0.565). However, the EE of macrophytes and molluscs were extraordinarily lower than other function groups (i.e., 0.102 and 0.146, respectively) (Table 3).

#### 3.2. Food web structure and trophic analysis

##### 3.2.1. Trophic structure

The fractional trophic levels (FTL) varied from 1 (macrophytes, phytoplankton and detritus) to 3.17 (snakehead) (Table 3). The snakehead group occupied the top trophic level with a biomass of 4.480 t km<sup>-2</sup> y<sup>-1</sup>, followed by several carnivorous fish functional groups, such as catfish (2.98), other carnivores (2.96), soldier river barb (2.77) and perch (2.74). All the functional groups consisted of the middle trophic levels of the TSL ecosystem except macrophytes, phytoplankton and detritus. Macrophytes and phytoplankton were the main primary producers in TSL ecosystem. A more concisely web-like figure was also shown in Fig. 2 to indicate the whole interactions and energy flows in the lake food web.

##### 3.2.2. Transfer efficiencies

From the Lindeman spine of the TSL system, two main food chains, a detritus-based food chain and a grazing food chain can be found (Fig. 3). However, around 77.9% of the whole energy and matter (4245 t km<sup>-2</sup> y<sup>-1</sup>) flows through the detritus-based food chain, while only 22.1% (1204 t km<sup>-2</sup> y<sup>-1</sup>) flows in the grazing food chain, despite the high biomass of the primary producers (1494 t km<sup>-2</sup> y<sup>-1</sup>) (Fig. 3).

Five discrete trophic levels (TL from I to V) including all the functional groups of the TSL ecosystem were also pictured according



**Table 4**  
Diet composition matrix of the 21 function groups of the Tonle Sap lake system.

Group	Prey/predator	1	2	3	4	5	6	7	8	9	10	11	12	13	14	15	16	17	18	
1	Snakehead																			
2	Catfish	0.005																		
3	Soldier river barb	0.030																		
4	Perch	0.040																		
5	Other carnivores	0.070																		
6	Large herbivores																			
7	Small herbivores	0.060	0.030		0.080	0.050														
8	Omnivorous fish	0.060	0.110			0.050														
9	Benthivorous fish	0.005																		
10	Gourami fish	0.005	0.001		0.030	0.015														
11	Mud carp	0.040	0.150		0.030	0.050														
12	Small fish	0.080	0.050		0.100	0.010														
13	Crabs	0.130	0.050											0.005						
14	Shrimps	0.015	0.050		0.160	0.025							0.010							
15	Molluscs	0.260	0.415	0.400	0.100	0.565			0.250	0.350			0.150	0.300						
16	Other zoobenthos			0.050	0.050	0.010				0.050	0.020					0.001				
17	Macrozooplankton	0.150	0.045	0.300	0.150	0.150			0.150	0.150			0.050							
18	Microzooplankton										0.200		0.050		0.020				0.050	
19	Phytoplankton		0.049	0.150	0.150		0.200	0.600	0.050		0.100	0.600	0.040	0.090	0.279	0.030	0.200	0.350	0.100	
20	Macrophytes				0.050		0.800	0.200	0.350	0.100	0.080	0.200	0.050	0.400	0.050					
21	Detritus	0.050	0.050	0.100	0.100	0.075		0.200	0.200	0.350	0.600	0.200	0.650	0.205	0.650	0.970	0.800	0.600	0.900	
	Sum	1.000	1.000	1.000	1.000	1.000	1.000	1.000	1.000	1.000	1.000	1.000	1.000	1.000	1.000	1.000	1.000	1.000	1.000	1.000

to Lindeman (1942) (Fig. 3). The transfer efficiencies (TEs) are the ratios between the sum of exports and flows predated by the next level and the throughput on the trophic level. For the grazing food chain of the TSL ecosystem, the TEs from TL III to TL V were 4.05%, 9.62%, 11.2% respectively, with a mean value of 8.29%. In parallel, for the detrital food chain, TEs were 4.33%, 9.42% and 11% with a mean value of 8.25%. The geometric mean of the trophic transfer efficiency for the TSL Lake ecosystem was 8.27%.

### 3.2.3. Mixed trophic impacts

The result of MTI exhibited both positive and negative effects among each other's (Fig. 4). Only macrophytes, phytoplankton

and detritus had positive impact on most other functional groups, this could explain the bottom-up effects from the ecosystem perspective. The other compartments showed direct predator-prey interactions, cascading effects and competition. For instance, perch showed significantly negative effects on some of the fish diet groups like gourami fish, small fish, shrimps and other zoobenthos mostly because of the predator-prey interactions. A simple example can be also seen from the relationships between macrozooplankton and microzooplankton. The fish groups seemed to have more negative effects on each other mainly due to trophic competition, for instance snakehead showed significant negative effects on catfish, perch and other carnivore groups mostly because they have similar food sources. Fishery had relatively strong negative effects on all the commercial fish and shrimps, but was beneficial for omnivorous fish, crabs and some other forage resources. It was observed that most groups had a negative impact on themselves, interpreted here as reflecting increased within-group competition for resources (Christensen et al., 2005).

### 3.3. Ecosystem properties and indicators

The summary statistics and flow indices of the TSL ecosystem are listed in Table 5. The total system throughput of the lake ecosystem reached 14,050.330 t km<sup>-2</sup> y<sup>-1</sup>, of which 40.4% derived from consumption (5677.091 t km<sup>-2</sup> y<sup>-1</sup>), 4.65% from exports (654.194 t km<sup>-2</sup> y<sup>-1</sup>), 20.3% from respiration (2845.601 t km<sup>-2</sup> y<sup>-1</sup>) with 34.68% (4873.439 t km<sup>-2</sup> y<sup>-1</sup>) eventually flowing into detritus. The sum of all production (TP) was 4297.950 t km<sup>-2</sup> y<sup>-1</sup>, and the calculated total net primary production (TNPP) and the net system production (NSP) were 3499.795 t km<sup>-2</sup> y<sup>-1</sup> and 654.194 t km<sup>-2</sup> y<sup>-1</sup>, respectively. Thus, the ratios of total primary production to total respiration (TPP/TR) and total primary production to total biomass (TPP/TB) were 1.230 and 2.039 respectively. The mean trophic level of catch was calculated at 2.482, and the gross efficiency (catch/net primary production) was 0.007 in the TSL ecosystem. Overall, in the TSL ecosystem, the values of flow indices, i.e., CI and SOI, were estimated at 0.253 and 0.075 respectively, while the FCI and Finn's mean path length (FML) calculated by the model were 23.62% and 4.015, respectively (Table 5). Meanwhile, the values of ascendancy and overhead were 27.4% and 72.6% respectively (Table 5).

**Table 5**  
Ecosystem attributes of Tonle Sap Lake.

Parameters	Value	Units
<b>Ecosystem properties</b>		
Sum of all consumption (TC)	5677.091	t km <sup>-2</sup> y <sup>-1</sup>
Sum of all exports (TE)	654.194	t km <sup>-2</sup> y <sup>-1</sup>
Sum of all respiratory flows (TR)	2845.601	t km <sup>-2</sup> y <sup>-1</sup>
Sum of all flows into detritus (TD)	4873.439	t km <sup>-2</sup> y <sup>-1</sup>
Total system throughput (TST)	14050.330	t km <sup>-2</sup> y <sup>-1</sup>
Sum of all production (TP)	4297.950	t km <sup>-2</sup> y <sup>-1</sup>
Mean trophic level of the catch (TLC)	2.482	–
Gross efficiency (catch/net p.p.)	0.007	–
Calculated total net primary production (TNPP)	3499.795	t km <sup>-2</sup> y <sup>-1</sup>
Net system production (NSP)	654.194	t km <sup>-2</sup> y <sup>-1</sup>
Total biomass (excluding detritus) (TB)	1716.580	t km <sup>-2</sup> y <sup>-1</sup>
<b>Ecosystem maturity</b>		
Total primary production/total respiration (TPP/TR)	1.230	–
Total primary production/total biomass (TPP/TB)	2.039	–
Total biomass/total throughput (TB/TST)	0.122	–
<b>Food web structure</b>		
Connectance Index (CI)	0.253	–
System Omnivory Index (SOI)	0.075	–
Finn's cycling index (FCI)	23.62	% of total throughput
Finn's mean path length (FML)	4.015	–
Ascendancy (A)	0.274	–
System overhead (O)	0.726	–
<b>Model reliability</b>		
Ecopath pedigree index	0.511	–
Measure of fit (t*)	2.523	–



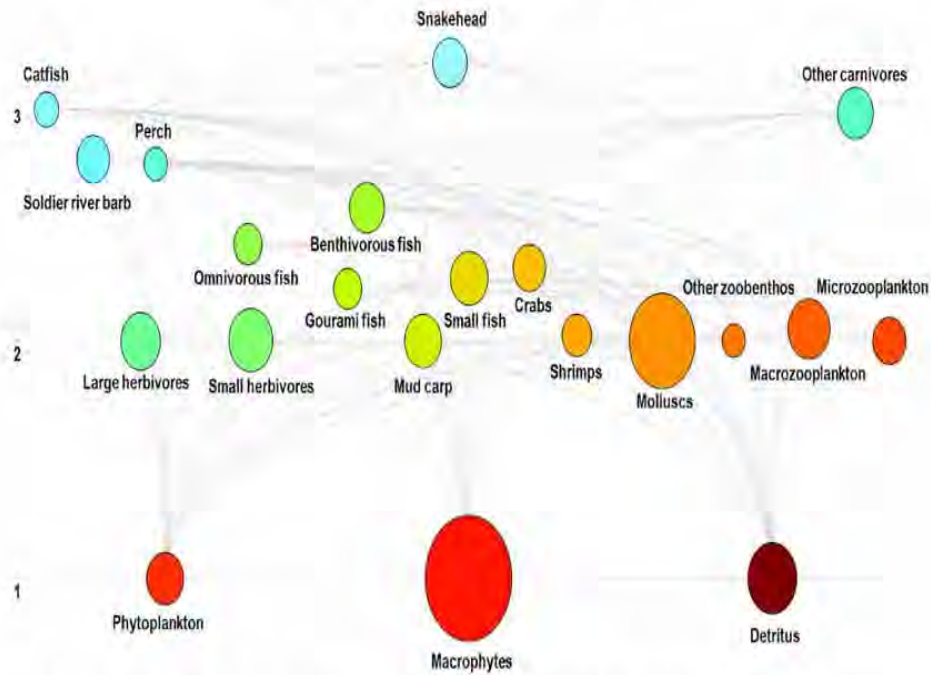


Fig. 2. Schematic diagram of energy flow represented the food web structure of the Tonle Sap ecosystem. The grey lines denote the trophic levels 1, 2 and 3 respectively, while the different sizes of the circles indicate the different biomass ( $t\ km^{-2}$ ) of the function groups.

4. Discussion

4.1. Food web structure in TSL

The current study contributed to constructing the first mass-balance model in the TSL ecosystem where ecological information and understanding were scarce. The model is a useful tool for assessing the ecosystem health and the overall functioning of this large freshwater system. From the basic estimate of the model, the biomass of fish groups in the TSL ecosystem was estimated at  $58\ t\ km^{-2}$  higher than the estimated biomass of fish groups in Lake Victoria ( $43\ t\ km^{-2}$ ) and Lake Tanganyika ( $35\ t\ km^{-2}$ ) (Christensen

and Pauly, 1993). The relatively high biomass of the top predators in TSL could produce a predation pressure on its forage species through the top-down controls in the food web (Du et al., 2015). The catch statistics from the lake showed that snakehead and catfish were found to be abundant in the TSL system since TSL and its floodplains are suitable feeding and spawning grounds for many carnivore species (Van Zalinge et al., 1998). Indeed, according to their ecological guilds, snakehead and climbing perch (i.e., *Anabas testudineus*) were categorized as “Black fish” or resident fish, they stay permanently in the lake, swamp or pond all year round in contrast to many species of catfish and soldier river barb known as “White fish” that migrate between TSL and the Mekong

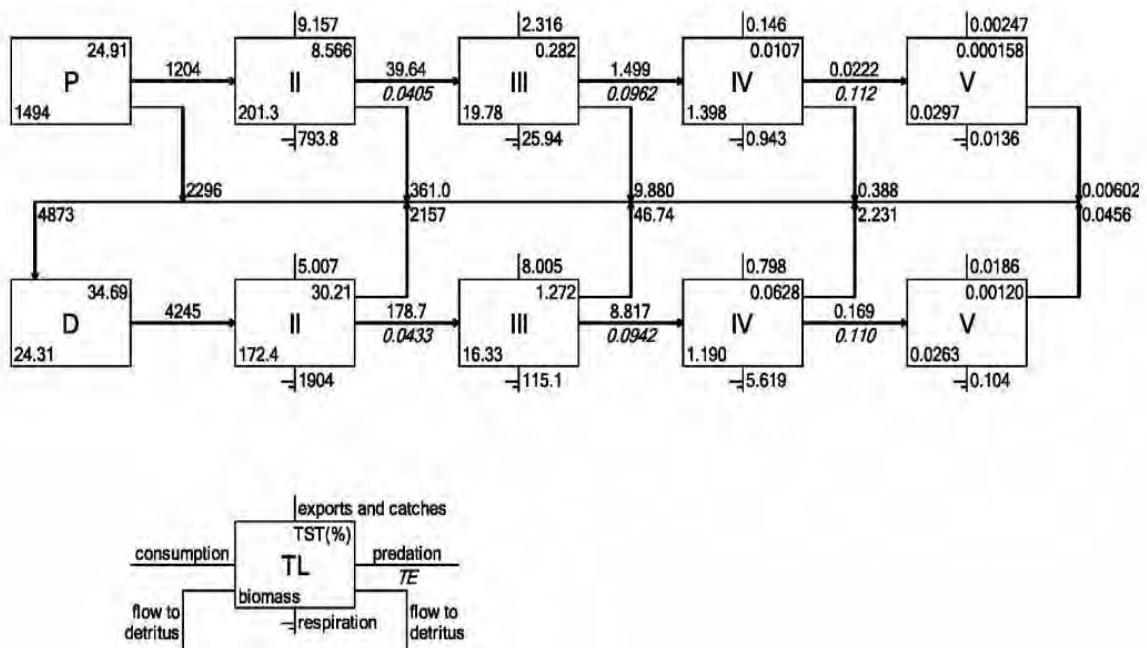


Fig. 3. Lindeman spine of Tonle Sap Lake system. P and D represent the primary production and detritus respectively, while the values in boxes indicate the biomass and percentage of total system throughput (TST) for each trophic level (TL). The values above and below arrows exhibit the efficiency of energy transfer (TE) through each trophic level.



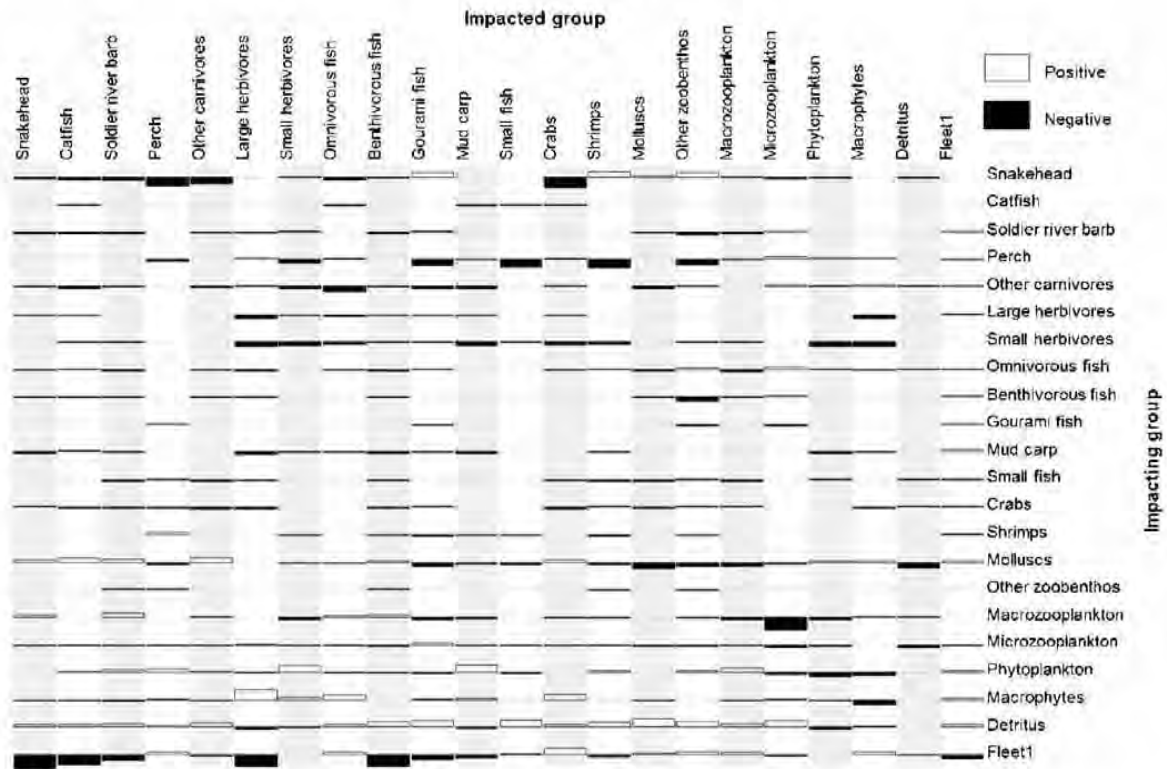


Fig. 4. Mixed trophic impact (MTI) of Tonle Sap lake ecosystem. The black bars pointing downwards show the negative impact on the functional groups, while the white bars pointing upwards indicate the positive impacts. The heights of the bars are proportionate to the degree of the impacts and its values ranges from  $-1$  to  $+1$ .

river. Intermittent between black and white fish, many species of other carnivores (i.e., *Wallago attu*, *Hemibarbus* sp., *Belodontichthys dinema*, *Colia lindmani*, *Kryopterus cheveyi*) were categorized as “Grey fish”; they do the short distance migration and tend to spend the dry season in the lake rather than migrating to the Mekong river like the white fish (MRC, 2010). This could explain the high proportion of top predators in the TSL food web since TSL is crucial for all fish guilds to complete their life cycles.

One of the most prominent features in the TSL food web could be observed from the variation of the estimated EE values in the constructing functional groups. The EE values are defined as the proportion of production that is exported out of the system through fishing activities or consumed by predators within it (Coll et al., 2009). As a result, the EE values were estimated to be greater than 0.5 for almost all functional groups except molluscs and macrophytes. The high EE values of fish groups illustrated the pressure on the resources suffered from fishing activities as well as predation pressure for the forage fish groups (i.e., mud carp, small herbivores and small fish). This result was consistent with many previous studies on the fishery production of the lake that have drawn their concerns on over exploitation of fisheries resources in the lake (Enomoto et al., 2011). In addition, Enomoto et al. (2011) illustrated the fluctuation of CPUE (catch per unit effort) of snakehead (*Channa* sp.) and catfish (*Pangasius* sp.) which tended to decline compared to those of the opportunist species such as mud carp (*Henicorhynchus* sp.), small herbivores (*Labiobarbus* sp.), and gourami fish (*Trichopodus* sp.). In 2008, the catch statistics from the fishing lots in the East part of TSL (Kampong Thom province) illustrated that the CPUE, i.e., the total catch (t) divided by the total length of bamboo fence systems (km), of snakehead and catfish were about  $2 \text{ t km}^{-1}$  lower than mud carp ( $6 \text{ t km}^{-1}$ ) (Enomoto et al., 2011). Moreover, Lamberts (2001) produced length-weight relationships for soldier river barb (*Cyclocheilichthys enoplos*) and showed that this species, which can reach a total length of 90 cm, was found only at lengths of up to or less than 45 cm, which is the most common in the lake.

In contrast, the estimated EE values of molluscs and macrophytes were very low since molluscs and macrophytes were not well utilized in the TSL ecosystem. Normally, macrophyte communities are not easy to be utilized in the ecosystem when they are alive (Christensen et al., 2005). Campbell (2006) reported more than 200 species of terrestrial vegetation are found in TSL. Moreover, the biomass of macrophytes represented more than 80% of the total biomass in the ecosystem, but from an ecological point of view, there are not many fish species that can consume large portions of macrophytes (e.g., in TSL ecosystem, only large herbivores were able to consume large part of macrophytes). Meanwhile, the underlying reason for the extremely high biomass of molluscs in the lake could be due to their low EE. Lamberts (2001) reported that molluscs made up over 85% of zoobenthos communities by weight. Moreover, Ohtaka et al. (2010) mentioned that molluscs were very abundant compared to the other zoobenthos such as oligochaeta and insects; which were found to be scarce in the lake and which could suffer from predation by benthivorous fish in the system. Indeed, the MTI analysis (Fig. 4) also showed the negative impact of benthivorous fish on other zoobenthos communities; this could confirm its predation pressure on other zoobenthos group. As the energy source of the ecosystem, we found the EE values of phytoplankton and detritus approached 1, which were comparatively high as other African great lakes (i.e., L. Victoria, Tanganyika, Malawi); particularly to Great Lake Chad with similar biomass of phytoplankton, macrophytes and zooplankton communities (Christensen and Pauly, 1993).

Another remarkable feature of the TSL food web is the transfer efficiency (TE) within its food chain. In TSL, the food web was more based on the detrital food chain than on the grazing food chain. By looking at the overall TE within the food web, we found low TE from TL II to TL III and then the TE started to increase significantly from TL III to higher TSLs, which is in contrast with the African great lakes (i.e.: L. Victoria, Tanganyika, Malawi), where TEs declined dramatically from TL III to higher TSLs (Christensen and Pauly, 1993).



This contrast drives us to point out the good utilization of fisheries resources in TSL for human consumption and predation instead of lacking exploitation as in the African lakes. Nevertheless, overexploitation of the fishery resources in the TSL was notified to fishing down the food chain, consequently dominated by small-sized fish; whereas a large proportion of primary production (macrophytes) was not well utilized in the ecosystem. This conclusion is consistent with the previous study of van Zalinge et al. (1998).

#### 4.2. Ecosystem health assessment

The ecosystem health of TSL was quantitatively assessed using the ecosystem attributes and ecological indicators given by the Ecopath model. Xu et al. (2001) provided some indicators that could be used to assess the lake ecosystem health (i.e., phytoplankton biomass, zooplankton biomass, species diversity,  $P/R$  ratio,  $P/B$  ratio and buffer capacities). These indicators provided an overall assessment of the lake ecosystem health. Generally, a healthy lake ecosystem is characterized by low biomass of phytoplankton, high zooplankton and macrozooplankton biomass, high species diversity, high  $P/B$  ratio and  $P/R$  ratio approaching 1 (Xu et al., 2001).

With ecosystem development as stated by Odum (1969), the ratio of total primary production to respiration (TPP/TR) and total primary production to biomass (TPP/B) are two important indicators to measure the maturity of an ecosystem. The mature ecosystem tends to have TPP/TR of nearly 1 and a low TPP/B value. In the TSL system, the TPP/TR ratio was 1.23, much lower than most the lakes worldwide, as Lake Taihu (3.85), Lake Qiandaohu (3.725), but higher than lake Hayq in Ethiopia (1.05). Therewith, the TPP/B ratio was 2.482 in between the immature lake ecosystem Taihu (11.6) and mature ecosystem lake Gehu (1.76), much lower than Lake Awassa (5.834) and lake Malawi (66) (Liu et al., 2007; Fetahi and Mengistou, 2007; Darwall et al., 2010; Fetahi et al., 2011; Jia et al., 2012; Li et al., 2010;). According to Ulanowicz and Norden (1990) and Ulanowicz (1987), the ratio of ascendancy to system throughput and overhead could also be the measurement of ecosystem growth and development. The high overhead value indicates the stability of the ecosystem; in TSL the ascendancy was 27.4%, slightly higher than Taihu lake (25.9%); yet much lower than the mature ecosystem of Bao'an lake (38.7%) and Lake Gehu (33.2%), which suggested that the lake achieved some level of stability close to the mature stage.

The Finn cycling index (FCI) represents the fraction of an ecosystem's throughput that is recycled compared to total throughput. Finn (1976) stated that this index strongly correlates with ecosystem maturity, resilience and stability. Indeed, cycling index is assumed to increase as systems mature and become more stable (Odum, 1969). This is because low cycling is highly dependent on energy passing rapidly through and is rather unstable and vulnerable to the changes in nutrient input (Christensen and Pauly, 1993). Moreover, a high cycling flow could also actually be a sign of stress, especially if most of the cycling occurs over short periods near the base of the trophic ladder (Christensen et al., 2005). The value of FCI in TSL was 23.62%, slightly lower than in Taihu lake in the 1960s and 1980s (24.2%, 26.56%) and Quiandaohu lake (24.2%), but higher than other Chinese lakes: Gehu lake (14.76%), Bao'an lake (9.25%). Consequently, the higher the cycling index the more the ecosystem is released from stress (Guo et al., 2013; Jia et al., 2012; Li et al., 2010; Liu et al., 2007).

In addition, CI and SOI are the important indices used to describe the food web feature, which could describe the system maturity since the food chain is expected to change from linear to web-like as the mature ecosystem. Ecosystems with higher values of ascendancy (%) indeed reflect relatively higher levels of maturity. In TSL system, the value of CI and SOI were 0.253 and 0.075,

respectively. Given the fact that the CI value was almost the same as the theoretical value (0.252) calculated using the empirical regression equation (Christensen and Pauly, 1993). Comparatively, the CI and SOI indices were much lower than for Lake Ayame in Ivory Cost (0.386, 0.193), and Lake Anney in France (0.258, 0.107) and slightly higher than Chinese lakes: Taihu (0.206, 0.042) and Bao'an (0.205, 0.058) (Janjua and Gerdeaux, 2009; Traore et al., 2008). High values of CI and SOI could reflect the high diversity of diet composition while low values indicate a linear food web pattern rather than a web-like structure.

According to Odum (1969), the high values of TPP/TR and ascendancy and the low values of TPP/B, and the more detritus dominated food chain, we concluded that the TSL ecosystem achieved a certain stage of maturity with a vulnerable food web structure due to the lack of complexity in the food web structure expressed by the low values of CI and SOI. The systematic results globally suggested that TSL could be considered as a healthy ecosystem (i.e., high biomass of macrozooplankton, low biomass of phytoplankton, TPP/TR value near 1), however still suffering from human disturbance (e.g., overfishing) (Odum, 1969; Xu et al., 2001).

#### 4.3. Ecosystem-based fisheries management

The overexploitation of aquatic living resources is common in today's fisheries worldwide, even freshwater ecosystems are heavily influenced by intense fishing activities (Mchich et al., 2006). In view of these facts, it is widely accepted that an ecosystem-based approach to fisheries management is important for maintaining sustainable fisheries and healthy ecosystems (FAO, 1995; NRC, 1999). Ecosystem models are complementary to single-species fisheries models in that they are potentially able to predict otherwise unforeseen effects of trophic interactions; they are now common in stock assessment and fisheries management (Coll et al., 2006; Fletcher et al., 2005). Ecosystem based fishery management has already been widely employed worldwide, as in the Great Lakes in the USA (Kolding et al., 2008), Qiandaohu Lake (Liu et al., 2007), Bao'an Lake (Guo et al., 2013) and Three Gorges Reservoir (Mao et al., 2014) in China.

In the TSL system, MTI analyses have highlighted the fishing pressure on many fish functional groups, especially the top predators (i.e., snakehead, catfish, other carnivores, river barb, large herbivores and benthivorous fish). Many previous studies on fish production of the lake have confirmed this compounded by the over harvesting of the commercial species from the lake (Cooperman et al., 2012; Enomoto et al., 2011). Overfishing could significantly impact the food web structure of the lake causing the shift from *k-selected* species (large long-lived species) to *r-selected* species (small fast growing species) (Travers et al., 2010). Recent statistics of fish catch from the lake showed that the catch composition was dominated by the opportunist species (mud carp, small herbivores) and small size fish even economically important species, that means most of them were caught at the young age or juvenile stage and hadn't reached maturity (Enomoto et al., 2011; Lieng and Van Zalinge, 2003; Van Zalinge et al., 2001). This could introduce the "fishing down the food web" concept where large predatory fish at the top of the food web are depleted, increasing the numbers of small fish (Pauly et al., 1998).

Globally, fish and fishery resource management should aim to increase predator diversity since numerous studies showed that predator diversity can strengthen ecosystem function and food web structure, and thus improve the transfer efficiency (Carey and Wahl, 2011; Griffin et al., 2008). As a recent example from the food web model of Lake Hayq, the introduction of African perch (*Tilapia*) in the lake contributed to improving the transfer efficiency and maturity of the lake (Fetahi et al., 2011).



Based on ecosystem analysis, to improve fishery management and ecosystem health in TSL, ecosystem-oriented strategies are suggested here:

Fish stocking and fry release could be an effective method for compensating the fishery resources degradation. Additionally, the trophic interactions must be considered in the stock assessment and management program since predation could modulate the population dynamics of the most important fishery resources. Specifically in TSL, piscivores and omnivores such as catfish, snakehead, river barb and other omnivorous fish could be advisable for stocking. Since these are the two most important groups to mediate biodiversity–ecosystem functioning relationships in the food web (Bruno and O'Connor, 2005; Petchey et al., 2004).

More efforts should be taken in fish biodiversity conservation, especially for some native species and endangered species. As an example of Giant barb (*Varicorhinus siamensis*) and Mekong giant catfish (*Pagasianodon gigas*), which are the two giant herbivorous and piscivorous fish in the TSL and Mekong systems. Their populations have decreased dramatically and they are rarely seen in the lake these days due to habitat degradation (i.e., deforestation of flooded forest, which is the key breeding ground for these fish) and pressure from illegal fishing activities. Moreover, restricting the use on fishing gear and the length of the fishing season could be very beneficial to ensure the sustainability of the lake. As a result of the recent stock assessment study in TSL, the reduction of the number of small meshed gill nets (diameter <50 mm) diverting more effort to hook and line has contributed to the improvement of snakehead and river barb production (Yen et al., 2009).

More attention should be also paid to the utilization of primary production and detritus, not only to improve the energy flows in the TSL ecosystem, but also to improve the water quality, especially during the dry season when it shows dramatic degradation due to excess of production algae and submerged terrestrial vegetation. Therefore, stocking with large herbivores and omnivorous fish (e.g., *Labeo chrysophekadion*, *Cirrhinus microlepis*, *Varicorhinus siamensis*, *Hypsibarbus malcolmi*, *Puntioplites proctozysron*) could be very favourable and consistent with the utilization of excess macrophytes.

In combination with the ecological perspective, the construction of hydropower dams along the Mekong mainstream and its tributaries could also be a major challenge leading to the degradation of fisheries resources in the lake since many studies on the impact of dams have concluded that it has a negative impact on the TSL floodplain as well as flood duration, and sediment fluxes, which are the key drivers of the TSL's productivity and sustainability (Arias et al., 2014). Thus, concrete strategic management plans for dam construction are needed to mitigate these issues and ensure fishery resources and the vital roles of this productive ecosystem.

## Acknowledgements

We are grateful to the Erasmus Mundus TECHNO and LOTUS Programs and the Belmont Forum for providing funds to support our studies which are a part of the Tonle Sap Climate Change (TSLCC) project. Thanks to the Mekong River Commission (MRC) for providing the fish dataset used in this study and we thank the University of Battambang (UBB) for the data request. Particular thanks to Mr. Phanara Thach, fish biologist of Fisheries Administration of Cambodia, who assisted in fish data preparation. Last, we highly appreciated our colleagues at Laboratory of Evolution and Biological Diversity (EDB) for the fruitful discussions and comments contributing to the improvement of the results obtained in these studies. EDB lab was supported by 'Investissement d'Avenir' grants (CEBA, ref. ANR-10-LABX-0025; TULIP, ref. ANR-10-LABX-41).

## References

- Arias, M.E., Cochrane, T., Kumm, M., Lauri, H., Holtgrieve, G.W., Koponen, J., Piman, T., 2014. Impacts of hydropower and climate change on drivers of ecological productivity of Southeast Asia's most important wetland. *Ecol. Modell.* 272, 252–263.
- Arias, M.E., Cochrane, T., Norton, D., Killeen, T.J., Khon, P., 2013. The flood pulse as the underlying driver of vegetation in the largest wetland and fishery of the Mekong basin. *Ambio* 42, 864–876.
- Baran, E., Myschowoda, C., 2008. *Have Fish Catches Been Declining in the Mekong River Basin?* Water & Development Publication, Helsinki University of Technology, pp. 55–64.
- Baran, E., So, N., Leng, S.V., Arthur, R., Kura, Y., 2007. Technical Assistance to the Kingdom of Cambodia for the Study of the Influence of Built Structures on the Fisheries of the Tonle Sap. Asian Development Bank TA 4669-CAM.
- Baran, E., van Zalinge, N., Ngor, P.B., 2001. Floods, floodplains and fish production in the Mekong basin: present and past trends. In: Ahyaudin Ali, et al. (Eds.), *Proceedings of the Second Asian Wetlands Symposium*. Penang, Malaysia: Penerbit Universiti Sains Malaysia, Pulau Pinang, Malaysia, 1116 pp.
- Beverton, R.J.H., Holt, S.J., 1957. On the dynamics of exploited fish populations, *Fishery Investigations Series II*, Vol. XIX Ministry of Agriculture, Fisheries and Food 1, 957.
- Bruno, J.F., O'Connor, M.I., 2005. Cascading effects of predator diversity and omnivory in a marine food web. *Ecol. Lett.* 8, 1048–1056.
- Campbell, I.C., Poole, C., Giesen, W., Valbo-Jorgensen, J., 2006. Species diversity and ecology of Tonle Sap Great Lake, Cambodia. *Aquat. Sci.* 68, 355–373.
- Carey, M.P., Wahl, D.H., 2011. Fish diversity as a determinant of ecosystem properties across multiple trophic levels. *Oikos* 120, 84–94.
- CDRI, 2013. *Fishery reform on the Tonle Sap Lake: risks and opportunities for innovation*. *Cambodia Dev. Rev.* 17, 01–24.
- Christensen, V., Pauly, D., 1993. Trophic models of aquatic ecosystem. In: *ICLARM Conf. Pro.* 29, Manila, Philippines, 390 pp.
- Christensen, V., Walters, C.J., Pauly, D., 2005. *Ecopath with Ecosim: A User's Guide* by Fisheries Centre, University of British Columbia, Vancouver, 154 pp.
- Coll, M., Bundy, A., Shannon, L.J., 2009. Ecosystem modelling using the Ecopath with Ecosim approach. In: *Computers in Fisheries Research*. Springer, Netherlands, pp. 145–190.
- Coll, M., Libralato, S., 2012. Contributions of food web modelling to the ecosystem approach to marine resource management in the Mediterranean Sea. *Fish. Fish.* 13, 60–88.
- Coll, M., Palomera, I., Tudela, S., Sardà, F., 2006. Trophic flows, ecosystem structure and fishing impacts in the South Catalan Sea. *Northwestern Mediterranean. J. Mar. Syst.* 59, 63–96.
- Cooperman, M.S., So, N., Arias, M., Cochrane, T., Hand, T., Hannah, L., Holtgrieve, G.W., Kaufman, L., Koning, A.A., Koponen, J., Kum, V., McCann, K.S., McIntyre, P.B., Min, B., Ou, C., Rooney, N., Rose, K.A., Sabo, J.L., Winemiller, K.O., 2012. A watershed moment for the Mekong: newly announced community use and conservation areas for the Tonle Sap Lake may boost sustainability of the world's largest inland fishery. *Cambodian J. Nat. Hist.* 101–106.
- Darwall, W.R.T., Allison, E.H., Turner, G.F., Irvine, K., 2010. Lake of flies, or lake of fish? A trophic model of Lake Malawi. *Ecol. Modell.* 221, 713–727.
- De Kerckhove, D.T., Minns, C.K., Chu, C., 2015. Estimating fish exploitation and aquatic habitat loss across diffuse inland recreational fisheries. *PLOS ONE* 10, e0121895.
- Du, X., Garcia-Berthou, E., Wang, Q., Liu, J., Zhang, T., Li, Z., 2015. Analyzing the importance of top-down and bottom-up controls in food webs of Chinese lakes through structural equation modeling. *Aquat. Ecol.* 49, 199–210.
- Enomoto, K., Ishikawa, S., Hori, M., Sitha, H., Song, S.L., Thuok, N., Kurokura, H., 2011. Data mining and stock assessment of fisheries resources in Tonle Sap Lake, Cambodia. *Fish. Sci.* 77, 713–722.
- Fang, J., Wang, Z., Zhao, S., Li, Y., Tang, Z., Yu, D., Ni, L., Liu, H., Xie, P., Da, L., Li, Z., Zheng, C., 2006. Biodiversity changes in the lakes of the Central Yangtze. *Front. Ecol. Environ.* 4 (7), 369–377.
- FAO, 1995. *Code of Conduct for Responsible Fisheries*. Fisheries and Aquaculture Department, United Nations of Food and Agriculture Organization, Rome.
- Fetahi, T., Mengistou, S., 2007. Trophic analysis of Lake Awassa (Ethiopia) using mass-balance Ecopath model. *Ecol. Modell.* 201, 398–408.
- Fetahi, T., Schagerl, M., Mengistou, S., Libralato, S., 2011. Food web structure and trophic interactions of the tropical highland lake Hayq, Ethiopia. *Ecol. Modell.* 222, 804–813.
- Finn, J.T., 1976. Measures of ecosystem structure and function derived from analysis of flows. *J. Theor. Biol.* 56, 363–380.
- Fletcher, W.J., Chesson, J., Sainsbury, K.J., Hundloe, T.J., Fisher, M., 2005. A flexible and practical framework for reporting on ecologically sustainable development for wild capture fisheries. *Fish. Res.* 71, 175–183.
- Gardner, M.R., Ashby, W.R., 1970. Connectance of large dynamic (cybernetic) systems: critical values for stability. *Nature* 228 (21), 784.
- Griffin, J.N., De La Haye, K.L., Hawkins, S.J., Thompson, R.C., Jenkins, S.R., 2008. Predator diversity and ecosystem functioning: density modifies the effect of resource partitioning. *Ecology* 89, 298–305. <http://dx.doi.org/10.1890/07-1220.1>.
- Guénette, S., Christensen, V., Pauly, D., 2008. Trophic modelling of the Peruvian upwelling ecosystem: towards reconciliation of multiple datasets. *Prog. Oceanogr.* 79, 326–335.
- Guo, C., Ye, S., Lek, S., Liu, J., Zhang, T., Yuan, J., Li, Z., 2013. The need for improved fishery management in a shallow macrophytic lake in the Yangtze River basin:



- evidence from the food web structure and ecosystem analysis. *Ecol. Modell.* 267, 138–147.
- Hortle, K.G., Troeung, R., Lieng, S., 2008. Yield and Value of the Wild Fishery of Rice Fields in Battambang Province Near the Tonle Sap Lake, Cambodia. MRC Technical Paper No. 18. Mekong River Commission, Vientiane, Lao PDR, 62 pp.
- Hortle, K.G., 2007. Consumption and the Yield of Fish and Other Aquatic Animals from the Lower Mekong Basin. MRC Technical Paper No. 16. Mekong River Commission, Vientiane, Lao PDR, 87 pp.
- Ings, T.C., Montoya, J.M., Bascompte, J., Blüthgen, N., Brown, L., Dormann, C.F., Edwards, F., Figueroa, D., Jacob, U., Jones, J.L., Lauridsen, R.B., Ledger, M.E., Lewis, H.M., Olesen, J.M., Van Veen, F.J.F., Warren, P.H., Woodward, G., 2009. Ecological networks – beyond food webs. *J. Anim. Ecol.* 78, 253–269.
- Janjua, M.Y., Gerdeaux, D., 2009. Preliminary trophic network analysis of subalpine Lake Annecy (France) using an Ecopath model. *Knowl. Manag. Aquat. Ecosyst.* 02.
- Jia, P., Hu, M., Hu, Z., Liu, Q., Wu, Z., 2012. Modeling trophic structure and energy flows in a typical macrophyte dominated shallow lake using the mass balanced model. *Ecol. Modell.* 233, 26–30.
- Junk, W.J., Brown, M., Campbell, I.C., Finlayson, M., Gopal, B., Ramberg, L., Warner, B.G., 2006a. The comparative biodiversity of seven globally important wetlands: a synthesis. *Aquat. Sci.* 68, 400–414.
- Junk, W.J., 2006. Estimation of the Fish-Production and Fishery Production of Tonle Sap System. Max-Planck-Institute for Limnology, Tropical Ecology Working Group, Germany.
- Kao, Y.C., Adlerstein, S., Rutherford, E., 2014. The relative impacts of nutrient loads and invasive species on a Great Lakes food web: an Ecopath with Ecosim analysis. *J. Great Lakes Res.* 40, 35–52.
- Keizire, B.B., Muhwezi, W.W., 2006. The Paradox of Poverty Amidst Plenty in the Fish Product Chain in Uganda: The Case of Lake George. ACODE Policy Res. 80 pp.
- Kitchell, J.F., Cox, S.P., Harvey, C.J., Johnson, T.B., Mason, D.M., Schoen, K.K., Aydin, K., Bronte, C., Ebener, M., Hansen, M., Hoff, M., Schram, S., Schreiner, D., Walters, C.J., 2000. Sustainability of the Lake Superior fish community: interactions in a food web context. *Ecosystems* 3, 545–560.
- Kolding, J., Mkumbo, O., Silsbe, G., Hecky, R., 2008. Are the Lake Victoria fisheries threatened by exploitation or eutrophication? Towards an ecosystem based approach to management. In: Bianchi, G., Skjoldal, H.R. (Eds.), *The Ecosystem Approach to Fisheries*. CAB International, pp. 309–354.
- Koponen, J., Lamberts, D., Sarkkula, J., Inkala, A., Junk, W., 2010. Primary and Fish Production Report. Finnish Environment Institute, Helsinki, Finland.
- Lamberts, D., 2006. The Tonle Sap lake as a productive ecosystem. *Int. J. Water Resour. Dev.* 22, 481–495.
- Lamberts, D., 2001. Tonle Sap Fisheries: A Case Study on Floodplain Gillnet Fisheries. Food and Agriculture Organisation of the United Nations Regional Office for Asia and the Pacific, Bangkok, Thailand.
- Li, Y., Chen, Y., Song, B., Olson, D., Yu, N., 2009. Ecosystem structure and functioning of Lake Taihu (China) and the impacts of fishing. *Fish. Res.* 95, 309–324.
- Li, Y., Song, B., Chen, Y., Chen, L., Yu, N., Olson, D., 2010. Changes in the trophic interactions and the community structure of Lake Taihu (China) ecosystem from the 1960 to 1990. *Aquat. Ecol.* 44, 337–348.
- Lieng, S., Van Zalinge, N., 2003. Fish Yield Estimation in the Floodplains of the Tonle Sap Great Lake and River, Cambodia.
- Lim, P., Lek, S., Touch, S.T., Mao, O.S., Chhouk, B., 1999. Diversity and spatial distribution of freshwater fish in Great Lake and Tonle Sap river. *Aquat. Living Resour.* 12, 379–386.
- Lindeman, R.L., 1942. the trophic-dynamic aspect of ecology. *Ecology* 23, 399–417.
- Liu, Q.G., Chen, Y., Li, J., Le Chen, L.Q., 2007. The food web structure and ecosystem properties of a filter-feeding carps dominated deep reservoir ecosystem. *Ecol. Modell.* 203, 279–289.
- Ly, S., van Zalinge, N., 1998. Catch Statistics of the Cambodian Freshwater Fisheries. Fishery Administration, Cambodia.
- MacDougall, S., McCann, K.S., Gellner, G., Turkington, R., 2013. Diversity loss with persistent human disturbance increases vulnerability to ecosystem collapse. *Nature* 494, 86–89.
- Mao, H., Yang, L., Xu, R., Wei, F., Meng, W., Cai, D., Lu, Y., 2014. Research on the countermeasure of water ecological environment protection and fishery proliferation development in the Three Gorges. *Environ. Pollut. Control* 36, 92–96.
- Matsui, S., Marko, K., Pech, S., Masahisa, N., 2005. Tonle Sap: Experience and Lessons Learned Brief. GEF IW:LEARN c/o UNDP Bratislava Regional Centre, Bratislava.
- Mchich, R., Charouki, N., Auger, P., Raïssi, N., Ettahiri, O., 2006. Optimal spatial distribution of the fishing effort in a multi fishing zone model. *Ecol. Modell.* 197, 274–280.
- Morissette, L., Hammill, M.O., Savenkoff, C., 2006. The trophic role of marine mammals in the Northern Gulf of St. Lawrence. *Mar. Mammal Sci.* 22, 74–103.
- MRC, 2010. Assessment of Basin-Wide Development Scenarios: Impacts on the Tonle Sap Ecosystem. MRC Technical Note 10. Mekong River Commission, Vientiane, Lao PDR, 45 pp.
- NRC, 1999. Sustaining Marine Fisheries. National Research Council, National Academy Press, Washington, DC.
- Odum, E.P., 1969. The strategy of ecosystem development. *Science* 164, 262–270.
- Odum, E.P., Barrett, G.W., 1972. *Fundamentals of Ecology*. Sauder, Philadelphia.
- Ohtaka, A., Watanabe, R., Im, S., Chhay, R., Tsukawaki, S., 2010. Spatial and seasonal changes of net plankton and zoobenthos in Lake Tonle Sap, Cambodia. *Limnology* 11, 85–94.
- Pauly, D., 1980. On the interrelationships between natural mortality, growth parameters, and mean environmental temperature in 175 fish stocks. *Journal du Conseil* 39 (2), 175–192.
- Pauly, D., Christensen, V., Dalsgaard, J., Froese, R., Torres, J.F., 1998. Fishing down marine food webs. *Science* 279, 860–863.
- Petchev, O.L., Gaston, K.J., Downing, A.L., Mittelbach, G.G., Persson, L., Steiner, C.F., Warren, P.H., Woodward, G., 2004. Species loss and the structure and functioning of multitrophic aquatic systems. *Oikos* 104, 467–478.
- Poulsen, A.F., Hortle, K.G., Chan, S., Chhuon, C.K., Viravong, S., 2004. Distribution and Ecology of Some Important Riverine Fish Species of the Mekong River Basin. MRC Technical Paper No. 10. Mekong River Commission, Vientiane, Lao PDR, 116 pp.
- Rogers, M.W., Allen, M.S., 2012. An ecosystem model for exploring lake restoration effects on fish communities and fisheries in Florida. *Restor. Ecol.* 20, 612–622.
- Sala, E., Boudouresque, C.F., Harmelin-Vivien, M., 1998. Fishing, trophic cascades, and the structure of algal assemblages: evaluation of an old but untested paradigm. *Oikos* 82, 425–439.
- Traore, A., Ouattara, A., Doumbia, L., Moreau, J., Gourère, G., 2008. First record of the western tubenose goby *Proterorhinus semilunaris* (Heckel, 1837) in France. *Knowl. Manag. Aquat. Ecosyst.* 389, 1–5.
- Travers, M., Watermeyer, K., Shannon, L.J., Shin, Y.J., 2010. Changes in food web structure under scenarios of overfishing in the southern Benguela: comparison of the Ecosim and OSMOSE modelling approaches. *J. Mar. Syst.* 79, 101–111.
- Ulanowicz, R., 1995. Ecosystem trophic foundations: Lindeman exonerata. In: Patten, B.C., Jørgensen, S.E. (Eds.), *Complex Ecology: The Part-Whole Relation in Ecosystems*. Prentice Hall, Englewood Cliffs, pp. 549–560 (Chapter 21).
- Ulanowicz, R.E., 1987. Growth and development: variational principles reconsidered. *Eur. J. Oper. Res.* 30, 173–178.
- Ulanowicz, R.E., Norden, J.S., 1990. Symmetrical overhead in flow networks. *Int. J. Syst. Sci.* 21, 429–437.
- Ulanowicz, R.E., Puccia, C.J., 1990. Mixed trophic impacts in ecosystem. *Coenoses* 5, 7–16.
- UNESCO, 1997. Tonle Sap Biosphere Reserve. Man and the Biosphere Program (MAB). United Nations Educational, Scientific and Cultural Organization, Paris.
- Van Zalinge, N., Nao, T., Sam, N., 2001. Status of the Cambodian inland capture fisheries sector with special reference to the Tonle Sap Great Lake. In: Cambodia Fisheries Technical Paper Series, Volume III, Inland Fisheries Research and Development Institute of Cambodia (IFREDI). Phnom Penh, Cambodia.
- Van Zalinge, N., Nao, T., Touch, S.T., 1998. Where there is water, there is fish? Cambodian fisheries issues in a Mekong River Basin perspective. In: The Seventh Common Property Conference of the International Association for the Study of Common Property, Vancouver, Canada.
- Van Worm, B., Duffy, J.E., 2003. Biodiversity, productivity and stability in real food webs. *Trends Ecol. Evol.* 18, 628–632.
- Xu, F.L., Tao, S., Dawson, R.W., Li, P.G., Cao, J., 2001. Lake ecosystem health assessment: indicators and methods. *Water Res.* 35, 3157–3167.
- Yen, N.T.H., Sunada, K., Oishi, S., Ikejima, K., Iwata, T., 2009. Stock assessment and fishery management of *Hemicorhynchus* spp., *Cydocheilichthys enoplos* and *Channa micropeltes* in Tonle Sap Great Lake, Cambodia. *J. Great Lakes Res.* 35, 169–174.





**AUTEUR:** Ratha Chea

**TITRE:** Structure et dynamiques des communautés de poisson : vers une compréhension écologique d'un système d'inondation pulsé en Asie tropicale.

**DIRECTEUR DE THÈSE :** Gaël Grenouillet

**RÉSUMÉ :**

L'objectif principal de cette thèse était d'étudier la dynamique spatiale et temporelle de la structure des communautés de poissons du fleuve Mékong en aval et du grand lac Tonlé Sap au Cambodge. Les deux systèmes sont fortement liés et caractérisés par les systèmes d'inondation pulsés. À l'aide d'approches multivariées sur des bases de données piscicoles, environnementales et des traits fonctionnels des taxons étudiés, j'ai pu mettre en évidence :

- les gradients longitudinaux des caractéristiques physicochimiques des eaux et l'importance relative des facteurs environnementaux dans la structuration des communautés de poissons à large échelle ;
- la structure temporelle des communautés de poissons qui est fortement liée aux traits fonctionnels des taxons et déclenchée par les crues occasionnées du système
- la structure de base du réseau trophique et l'état écologique du système d'inondation pulsé qui est perturbé par la pression anthropique.

Ces résultats ont démontré leurs valeurs quant à leurs potentiels de transferts vers la compréhension écologique et la gestion durable des ressources de pêches dans le système d'inondation pulsé en Asie tropicale en relevant que :

- la connectivité entre le fleuve Mékong et le lac Tonlé Sap est indispensable pour les poissons pour compléter leurs cycles de vie, et la conservation devrait prioritairement s'effectuer au milieu du Mékong où se trouve la plus forte diversité.
- dans le système d'inondation pulsé, la structure temporelle des communautés dépend des dynamiques des crues, donc l'aménagement des cours d'eau est à éviter au maximum.
- la compréhension bioécologique complète des communautés et leurs relations trophiques sont primordiales pour la mise en place des plans de gestion et de conservation à long terme.

**MOTS CLÉS :** Communautés de poissons ; Système d'inondation pulsé ; Asie tropicale ; Réseau trophique ; Traits fonctionnels ; Ecopath with Ecosim ; État écologique de l'écosystème.

**LABORATOIRE :** Laboratoire Evolution & Diversité Biologique (EDB – UMR 5174), Université Paul Sabatier, 118 route de Narbonne, Bât. 4R1, 31062 Toulouse cédex 9, France.

**AUTHOR:** Ratha Chea

**TITLE:** Structure and dynamic of fish community: toward an ecological understanding of flood pulse system in tropical Asia.

**SUPERVISOR:** Gaël Grenouillet

**ABSTRACT:**

The main objective of the thesis was to study the spatial and temporal dynamics of fish community structure in Lower Mekong river basin and Tonle Sap Great Lake in Cambodia. These two systems are strongly connected to each other and characterised by flood pulse system. By using the multivariate approaches on the fish, environmental and fish functional traits data sets, I am able to highlight:

- the longitudinal gradients of physicochemical characteristics of water and the relative importance of environmental factors in explaining the large scale patterns of fish community;
- the temporal structure of fish community, which is strongly linked to functional traits of fish and triggered by the pulse dynamics of the system;
- the baseline trophic structure model and ecological health assessment of flood pulse system, which is disturbed by anthropogenic pressure

These results have demonstrated their values as well as their potentials to transfers toward an ecological understanding and sustainable fisheries resource management of the flood pulse system in tropical Asia by suggesting:

- the connectivity between Mekong river and Tonle Sap lek is essential for fish to complete their life cycle and also the conservation should be done in the middle part of Lower Mekong river where containing the highest diversity;
- in flood pulse system, the temporal structure of fish community strongly depend on the dynamics of pulses; therefore any river development must be strictly prohibited;
- complete bio-ecological understanding of communities and their trophic relationships are crucial to the establishment of long-term management and conservation plans.

**KEY WORDS :** Fish community; Flood pulse system ; tropical Asia; Trophic network ; Fonctional traits ; Ecopath with Ecosim ; Ecological health assessment.

**LABORATORY :** Laboratoire Evolution & Diversité Biologique (EDB – UMR 5174), Université Paul Sabatier, 118 route de Narbonne, Bât. 4R1, 31062 Toulouse cédex 9, France.