



HAL
open science

Processus écologiques et évolutifs impliqués dans le succès de l'introduction de *Quercus rubra* L. en Europe

Nastasia Merceron

► **To cite this version:**

Nastasia Merceron. Processus écologiques et évolutifs impliqués dans le succès de l'introduction de *Quercus rubra* L. en Europe. Sylviculture, foresterie. Université de Bordeaux; Université de Liège, 2016. Français. NNT: 2016BORD0263 . tel-01526866

HAL Id: tel-01526866

<https://theses.hal.science/tel-01526866v1>

Submitted on 23 May 2017

HAL is a multi-disciplinary open access archive for the deposit and dissemination of scientific research documents, whether they are published or not. The documents may come from teaching and research institutions in France or abroad, or from public or private research centers.

L'archive ouverte pluridisciplinaire **HAL**, est destinée au dépôt et à la diffusion de documents scientifiques de niveau recherche, publiés ou non, émanant des établissements d'enseignement et de recherche français ou étrangers, des laboratoires publics ou privés.

THÈSE EN COTUTELLE PRÉSENTÉE POUR OBTENIR LE GRADE DE

DOCTEUR DE

L'UNIVERSITÉ DE BORDEAUX ET DE L'UNIVERSITÉ DE LIÈGE

ÉCOLE DOCTORALE SCIENCE ET ENVIRONNEMENT

ÉCOLE DOCTORALE EN SCIENCES AGRONOMIQUE ET INGÉNIEURIE
BIOLOGIQUE

Spécialité ECOLOGIE EVOLUTIVE, FONCTIONNELLE ET DES COMMUNAUTÉS

Par Nastasia MERCERON

Processus écologiques et évolutifs impliqués dans le succès de l'introduction de *Quercus rubra* L. en Europe

Sous la direction d'Antoine KREMER,
Annabel PORTÉ et Arnaud MONTY

Soutenue le 28 novembre 2016.

Membres du jury :

M. MAHY, Grégory
M. SITZIA, Tommaso
M. SCOTTI, Ivan
Mme. MUSCH, Brigitte
M. KICHEY, Thomas

Professeur, Université de Liège
Professeur, Université de Padoue
Directeur de Recherche, INRA Avignon
Chargée RDI USC, ONF-INRA Orléans
Maître de conférences, Université de Picardie

Président
Rapporteur
Rapporteur
Examinatrice
Examineur

Avant-propos

Ce travail de doctorat porte avant tout sur l'étude des « processus écologiques et évolutifs impliqués dans le succès de l'introduction de *Quercus rubra* en Europe » dans le contexte des invasions biologiques. Il a été conçu sous la forme de publications scientifiques. Compte tenu de l'espèce modèle étudiée, l'état de l'art a été réalisé principalement à partir d'articles bibliographiques portant sur les plantes invasives terrestres, avec un focus régulier sur les espèces invasives ligneuses. La première partie de la thèse traite notamment de la considération du statut invasif de *Q. rubra* en tentant de déterminer si cette espèce naturalisée en Europe parvient à se répandre au sein des communautés forestières natives et à être dispersée au sol par des animaux terrestres dans son aire d'introduction. La seconde partie identifie s'il y a eu des changements évolutifs et/ou une réduction de la diversité génétique en conséquence à l'introduction de *Q. rubra* en Europe à travers une approche d'écologie évolutive et de génétique moléculaire. En annexe, une publication scientifique rédigée durant ce doctorat et acceptée dans la revue internationale *Ecological Restoration* présente les résultats obtenus sur une méthode de contrôle pour lutter efficacement et éradiquer localement *Acer negundo*, une espèce d'arbre invasif en Europe.

Débuté en octobre 2013, ce doctorat a été financé pour une durée de trois ans par le programme « Doctorat international » de l'Initiative d'Excellence (IdEx) de l'Université de Bordeaux (ANR-10- IDEX-03-02) et par le projet TREEPEACE du Conseil Européen de la Recherche (#FP7-339728). Il a été réalisé dans le cadre d'une cotutelle entre l'Université de Bordeaux et l'Université de Liège (Gembloux Agro-Bio-Tech) en Belgique. Il s'est principalement déroulé à l'Unité Mixte de Recherche 1202 Biodiversité, Gènes et Communautés (BIOGECO) entre l'INRA et l'Université de Bordeaux. Durant cette thèse, deux séjours de quatre (décembre 2014 - mars 2015) et deux mois (février - mars 2016) ont été effectués dans l'Université partenaire de Liège à l'unité Biodiversité et Paysage de Gembloux Agro-Bio-Tech en Belgique.

Remerciements

Je remercie les financeurs de ce projet de thèse : le programme Initiative d'Excellence (ANR-10- IDEX-03-02) de l'Université de Bordeaux pour m'avoir attribué une bourse de thèse et avoir donné une dimension internationale à cette thèse et le programme du Conseil Européen de la Recherche (ERC) Treepeace (#FP7-339728) pour avoir financé les expérimentations durant cette thèse.

Je remercie tous les membres de mon jury : Madame Brigitte Musch, Messieurs Ivan Scotti, Thomas Kichey, Grégory Mahy et Tommaso Sitzia pour avoir accepté d'évaluer ce travail de façon rigoureuse et pour s'être déplacé pour chacune de mes deux soutenances à Gembloux et à Bordeaux.

Je tiens à remercier mes trois directeurs de thèse pour avoir encadrée et suivie mon travail de thèse. Vous avez toujours gardé de très bonnes relations entre vous durant ces trois années et cela a été fortement appréciable pour moi. Merci Arnaud pour tes remarques éclairées et ton esprit critique sur mon travail. Merci Annabel pour ta disponibilité, tes conseils et ton aide précieuse en statistique. Merci Antoine pour m'avoir réconciliée avec la génétique.

Merci Régis pour avoir toujours répondu à mes questions et m'avoir dépannée de divers matériels quand j'en avais besoin !

Merci Paul et Marie de l'OAFS pour votre écoute et votre soutien. Vous formez un super duo de choc !

Merci Thomas C. pour ton dévouement et ta gentillesse, tu t'es souvent sacrifié pour venir me donner un coup de main sur le terrain quand j'étais en galère !

Merci Laurent L. pour ta bonté et ton aide.

Merci Anna-Karine, la meilleure de toutes les stagiaires du monde, pour ta bonne humeur, ton dynamisme et ton efficacité sur le terrain lors des comptages de glands. Tu iras loin avec une telle détermination ! Merci également à Lunel et Hugo pour votre aide lors des comptages de glands !

Merci Raphaël pour ta jovialité constante et pour ta participation aux comptages de glands dans les plantations d'Ibos et de Capvern chaque automne !

Merci à la propriétaire et au cuisinier du restaurant « chez Maurette » à Lannemezan pour nous avoir si bien nourris et fait découvrir de bons plats régionaux après les journées sur le terrain à Capvern !

Merci Patrick R. et Benjamin D. de m'avoir aidée sur le terrain. Merci Alexis D. pour ta collaboration à mes travaux de thèse, ton aide sur le terrain et tes conseils avisés.

Merci Tibo pour ton aide et tes conseils en génétique, ta disponibilité sans faille et ta gentillesse. Tu as bien souvent réussi à me rassurer dans les moments de panique lors de ma dernière année de thèse.

Merci Émilie C. pour m'avoir appris les techniques en génétique moléculaire et pour m'avoir aidée dans l'analyse des données génétiques.

Merci Cyril F. pour ton amitié et toutes ces discussions très intéressantes sur divers sujets.

Merci à mes collègues belges de Gembloux pour m'avoir accueillie si chaleureusement à Gembloux : Mélanie, Carline, Jessica, Marie, Emilie, Julie, Laura, Cynthia, Catherine, Roel, Williams, Maxime, Thalès et Sylvain. Merci particulièrement à William O. et Sylvain pour la folle ambiance dans le bureau que nous partageons, même si je n'ai pas toujours compris vos blagues ! Merci également à William O., Laura, Sylvain et Luivine pour avoir diverti quelques-unes de mes soirées à Gembloux !

Une mention très spéciale pour toi Nadège, nous avons vécu les mêmes (ou presque) galères de thèse mais on a réussi à aller jusqu'au bout ! J'ai été ravie de passer ces trois ans à tes côtés ! Merci pour ta générosité, pour avoir souvent organisé des soirées « burgers » ou chez toi (à la Groloc) pour faire la fête. Merci de m'avoir fait un délicieux gâteau d'anniversaire pour mes 26 ans alors que tu ne pouvais pas accéder à ta cuisine ! Merci d'être venue me voir deux fois dans le « Nord » à Gembloux et à Amsterdam ! Mes plus beaux souvenirs avec toi resteront notre super voyage en Crète : les yaourts aux miels, Gramvoussa la plage idyllique, le B&B chez Stathis et Anastasia et tout le reste ...

Merci Max pour tes conseils avisés et la bonne ambiance dans notre bureau à Biogeco !

Merci également à ma famille et mes amis.

Merci Emeric pour ton aide dans la réalisation des cartes. Et surtout merci pour m'avoir supportée durant ces derniers mois de thèse, je sais que tu as fait de ton mieux pour me soutenir et m'encourager !

Laboratoires d'accueil :

- Université de Bordeaux

INRA - Institut National de la Recherche Agronomique

UMR 1202 – Biodiversité, Gènes et Ecosystèmes

Equipe Ecologie et Génomique Fonctionnelle

Allée Geoffroy Saint-Hilaire 33615 PESSAC - France

- Université de Liège

Gembloux Agro-Bio Tech

Unité Biodiversité et Paysage

Avenue Maréchal Juin, 27 B-5030 GEMBLoux - Belgique

Introduction.....	12
A. Contexte général	12
B. De l'introduction à l'invasion : les étapes-clés et barrières à franchir	16
C. Hypothèses écologiques et évolutives liées au succès des plantes invasives et changements phénotypiques	21
D. Modifications de la diversité génétique et mécanismes évolutifs impliqués lors de l'introduction	28
E. Le chêne rouge d'Amérique : une espèce modèle	33
Problématique et objectifs de la thèse	42
Partie 1	45
Chapitre 1 : Assessing invasiveness of <i>Quercus rubra</i> from its patterns of distribution in European forests	46
Abstract	47
Keywords.....	47
Introduction.....	48
Materials and Methods	50
Results.....	53
Discussion	56
Conclusions	58
Appendix.....	60
References	63
Chapitre 2 : Removal of acorns of the alien oak <i>Quercus rubra</i> on the ground by scatterhoarding animals in Belgian forests	68
Introduction.....	71
Materials and methods	74
Studied species.....	74

Experimental sites and design	74
Monitoring of acorn removal using camera traps	76
Data and statistical analyses.....	76
Results.....	77
Acorn removal.....	77
Identification of animals.....	80
Discussion	82
Acorn removal and feeding behavior of animals	82
Selection between <i>Q. robur</i> and <i>Q. rubra</i> acorns by animals.....	83
Implication for <i>Q. rubra</i> invasion in Europe	84
Acknowledgements	85
References	86
Partie 2	93
Chapitre 3 : Phenotypic differentiation between native and introduced populations of <i>Quercus rubra</i>	99
Abstract	100
Key-words.....	101
Introduction.....	102
Materials and methods	105
Provenance-progeny tests	105
Phenotypic measurements.....	109
Q _{ST} estimation.....	111
Statistical analysis.....	112
Results.....	112
Discussion	120

Acknowledgements	123
References	124
Appendices.....	131
Chapitre 4 : From North America to Europe: deciphering the introduction history of <i>Quercus rubra</i>	142
Abstract	143
Key-words.....	143
Introduction.....	144
Materials and methods	147
Sampling design and DNA extraction	147
SNP marker selection and genotyping.....	148
Genetic data analysis.....	148
Results.....	153
Population structure	153
Population divergence.....	161
Bottleneck in introduced populations	165
Discussion	167
Acknowledgements	171
References	172
Supporting information.....	185
Synthèse et perspectives.....	193
A. Ecologie de la dispersion et de la régénération de <i>Q. rubra</i> en Europe	193
B. Histoire de l'introduction de <i>Q. rubra</i> en Europe.....	199
C. Conclusion générale et perspectives : quel avenir pour le chêne rouge en Europe ?	207
Bibliographie.....	210

Annexe : Killing it Softly: Girdling as an Efficient Eco-friendly Method to Locally Remove the Invasive *Acer negundo* 230

Introduction

A. Contexte général

D'un point de vue scientifique, une espèce introduite dans un nouveau milieu est considérée comme invasive lorsqu'elle parvient à se naturaliser en dehors de son aire de répartition naturelle après franchissement d'une barrière géographique puis à se propager à distance des sources d'introduction en produisant des descendants viables et fertiles en abondance sans l'intervention de l'Homme (Richardson *et al.* 2000; Colautti & MacIsaac 2004; Blackburn *et al.* 2011). Le consensus de la communauté scientifique a décidé que les impacts, positifs ou négatifs, de ces espèces, souvent évalués de façon à orienter les objectifs des différents acteurs sociétaux, n'entraient pas en ligne de compte dans la définition.

Cependant, les invasions biologiques sont considérées comme une menace pour la biodiversité à l'échelle globale, pouvant altérer aussi bien la diversité spécifique que la diversité génétique (Vitousek *et al.* 1996; Sala *et al.* 2000; Chapin *et al.* 2000). Elles peuvent causer des dégâts écologiques et économiques considérables (Pimentel *et al.* 2001; Pimentel, Zuniga & Morrison 2005; Born, Rauschmayer & Bräuer 2005; Olson 2006). Les impacts écologiques négatifs associées aux espèces invasives affectent aussi bien les écosystèmes et les communautés envahies que les espèces locales côtoyées (Mack *et al.* 2000; Levine *et al.* 2003; Pyšek *et al.* 2012b; Vilà *et al.* 2011). Les services écosystémiques se retrouvent également impactés, engendrant des conséquences sur la santé et le bien-être des populations humaines (Pejchar & Mooney 2009; Vilà *et al.* 2010). D'un autre côté, et notamment en ce qui concerne les arbres introduits pour des raisons ornementale ou économique, certaines espèces ont des usages aux impacts positifs pour la société : production de bois (ex. *Quercus rubra*), ornement (ex. *Ailanthus altissima*), stabilisation des talus, production de miel (ex. *Robinia pseudoacacia*). C'est pourquoi, les impacts associés aux invasions biologiques ont été inclus dans la définition d'une espèce invasive, d'un point de vue législatif. En effet, selon le Règlement n° 1143/2014 du Parlement Européen et du Conseil daté du 22 octobre 2014, une espèce est définie

comme invasive si elle représente une menace ou des effets néfastes pour la biodiversité et les services écosystémiques associés (Journal officiel de l'Union Européenne 2014).

En raison des diverses nuisances écologiques et économiques associées aux invasions biologiques, il est donc devenu indispensable de trouver des moyens pour lutter contre la prolifération de ces espèces invasives, souvent indésirables dans certains milieux. Des programmes et organisations à l'échelle régionale et internationale se sont développés pour la prévention et la gestion des espèces invasives (Genovesi & Shine 2004; Shine 2007; De Poorter 2009). En ratifiant la Convention sur la diversité biologique, des Etats membres dans le monde entier se sont engagés à « empêcher l'introduction, contrôler et éradiquer les espèces invasives qui menacent les écosystèmes, les habitats ou les espèces » (De Poorter 2009). Afin de préserver ou rétablir la biodiversité et de restaurer les écosystèmes et leurs fonctions, des mesures ciblées de prévention, de détection précoce et de gestion peuvent être mises en place pour lutter contre les invasions biologiques (Hulme 2006). Cependant, l'efficacité de ces mesures diminuent et les coûts liés à ces mesures augmentent en fonction du temps écoulé depuis l'introduction d'une espèce invasive (Simberloff *et al.* 2013; **Figure 1**). L'Union Européenne a adopté récemment le Règlement n° 1143/2014 du Parlement Européen et du Conseil, entré en vigueur le 1^{er} janvier 2015 (Journal officiel de l'Union Européenne 2014). Celui-ci prévoit notamment l'élaboration d'une liste des espèces invasives préoccupantes à l'échelle de l'Union Européenne et la mise en place de mesures spécifiques de prévention, de détection précoce, d'éradication rapide et de gestion concernant ces espèces. Selon l'article 4 de ce règlement, les espèces invasives doivent satisfaire les critères suivants pour faire partie de la liste : a) être allochtones au territoire de l'Union Européenne ; b) constituer des populations viables et être capable de se disperser ; c) avoir des impacts négatifs avérés sur la biodiversité et les services écosystémiques associés ; d) sur la base de résultats d'une évaluation des risques, nécessiter une action concertée pour prévenir leur introduction, établissement ou propagation ; e) provoquer des effets négatifs qui pourraient être efficacement évités, minimisés et atténués. A l'heure actuelle, 34 espèces ont été listées mais aucune espèce d'arbre exotique invasif n'a été incluse (Journal officiel de l'Union Européenne 2016).

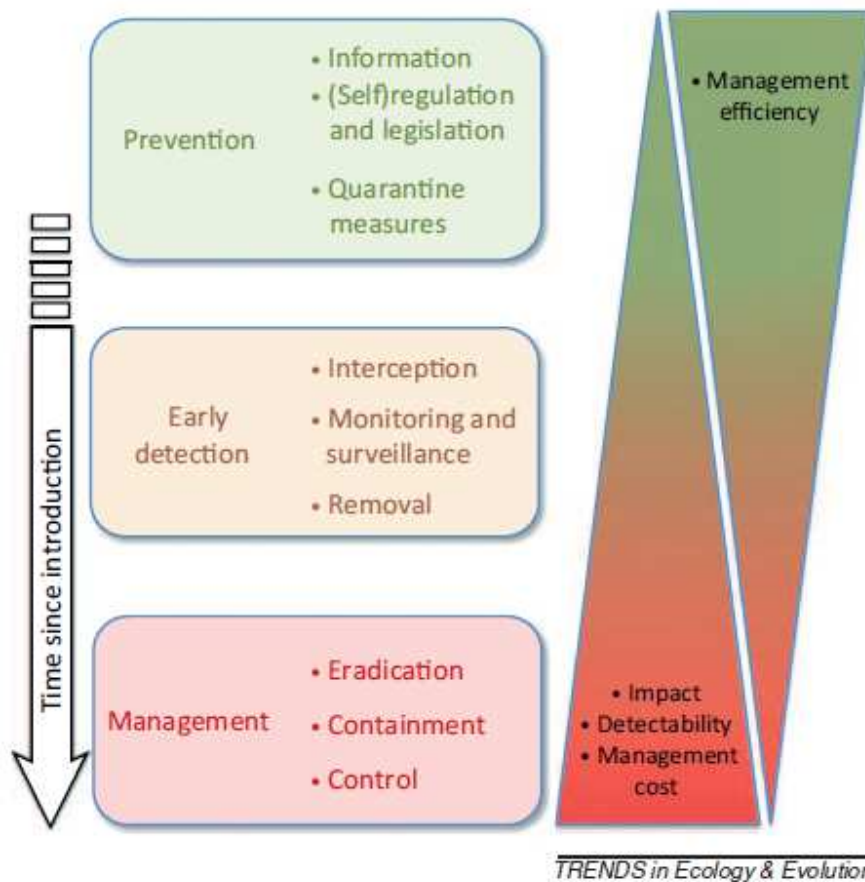

Figure 1. Schéma représentant les stratégies de gestion à l'encontre des espèces invasives (Simberloff *et al.* 2013).

Des cas d'introduction ont été reportés sur l'ensemble des règnes animaux, végétaux, fongiques (Desprez-Loustau *et al.* 2007; DAISIE 2010), et même chez certains virus phytopathogènes ou responsables de zoonoses (Anderson *et al.* 1986; Daszak, Cunningham & Hyatt 2000, 2001; Peeler *et al.* 2011). Il est difficile d'estimer le nombre d'espèces introduites qui parviennent à devenir invasives. Selon Williamson and Fitter (1996), on considère de manière empirique, que seule une espèce introduite sur mille sera invasive. Pourtant, aujourd'hui quasiment tous les continents et tous les écosystèmes sont touchés par des invasions, notamment de plantes (Pyšek 2004; Pyšek & Richardson 2006). Selon le Règlement (UE) n°1143/2014, parmi les 12 000 espèces présentes sur le territoire européen, environ 10 à 15% d'entre elles sont considérées comme invasives (Journal officiel de l'Union Européenne 2014).

Les agents responsables des invasions biologiques sont multiples et généralement en lien avec les activités humaines (Vitousek *et al.* 1997; Mack & Lonsdale 2001; Pyšek *et al.* 2010). Les invasions biologiques sont étroitement liées à l'ouverture de nouvelles voies maritimes et terrestres. Selon Hulme (2009), trois périodes historiques ont contribué au développement des introductions biologiques sur de nouveaux continents. Les premières introductions d'espèces dateraient du XVI^{ème} siècle. Avec l'essor de la navigation et la découverte de nouvelles Terres, les explorateurs et navigateurs ramènent de leurs expéditions des espèces qu'ils trouvent intéressantes. Suite à la Révolution Industrielle, la construction de routes, voies de chemin de fer et canaux facilite l'expansion des espèces invasives. Enfin, ces 25 dernières années, la mondialisation et l'accroissement du commerce international n'ont cessé d'intensifier le transfert et l'introduction d'espèces d'un continent à un autre (Meyerson & Mooney 2007; Banks *et al.* 2015).

Le commerce international et les transports représentent les principales raisons des introductions d'espèces à travers le monde (Mack *et al.* 2000; Banks *et al.* 2015). Bien que de nombreuses espèces invasives aient été transférées dans un nouvel habitat par accident, une grande majorité des invasions biologiques proviennent de l'introduction volontaire d'espèces par l'Homme, notamment pour les arbres (Ewel *et al.* 1999; Mack & Lonsdale 2001). Les modes et raisons d'introductions en lien avec les activités humaines sont multiples (Hodkinson & Thompson 1997; Wilson *et al.* 2009) : l'horticulture, l'aquaculture et la foresterie par exemple (Richardson 1998; Reichard & White 2001; Naylor, Williams & Strong 2001; Dehnen-Schmutz *et al.* 2007). Compte tenu de leur usage mais aussi des nuisances qu'elles peuvent apporter, ces espèces peuvent induire un conflit d'intérêt entre les gestionnaires de milieux envahis et les exploitants intéressés par la valeur commerciale de ces espèces invasives. C'est notamment le cas pour de nombreux arbres ou arbustes utilisés en foresterie pour la production de bois (de Wit, Crookes & van Wilgen 2001; Dickie *et al.* 2014).

D'autre part, les espèces invasives offrent la possibilité d'étudier les phénomènes évolutifs rapides en réponse à des environnements nouveaux ou changeants de par leur introduction récente dans une nouvelle aire géographique (Thompson 1998; Hanfling & Kollmann 2002; Prentis *et al.* 2008). Même pour un arbre invasif, la précocité (à partir de

6 ans pour *Robinia pseudoacacia*, 5 ans pour *Acer negundo*, 20 ans pour *Quercus rubra* ; Cierjacks *et al.* 2013; Medrzycki, 2011; Timbal, Bartoli & Buffet 1994) et l'abondance de reproduction de ces espèces assurent un nombre relativement élevé de générations entre l'introduction et l'expansion, permettant en effet d'envisager la faisabilité d'études évolutives portant sur des intervalles de temps de quelques décennies à quelques siècles seulement.

Dans la suite de cette introduction, l'intérêt sera porté principalement sur les espèces invasives végétales terrestres illustrées avec des exemples sur les arbres ou arbustes, dans la majorité des cas, ou sur les plantes herbacées, le cas échéant.

B. De l'introduction à l'invasion : les étapes-clés et barrières à franchir

Une espèce introduite dans un nouveau milieu est définie comme une espèce invasive à partir du moment où elle a réussi à passer les différentes étapes de l'invasion et à franchir plusieurs barrières (Richardson *et al.* 2000; Blackburn *et al.* 2011). Ce processus d'invasion est illustré étape par étape dans la **Figure 22**. En premier lieu, l'espèce est transportée en dehors de son aire naturelle de répartition pour atteindre une nouvelle zone géographique dans laquelle elle pourra s'établir. Durant cette phase de **transport**, l'espèce outrepassa des barrières géographiques, comme par exemple une chaîne de montagnes ou un océan, qui étaient jusque-là infranchissables sans l'intervention intentionnelle ou accidentelle de l'Homme (B1, B2). Lors de la phase d'**introduction**, l'espèce doit affronter les conditions environnementales du nouveau milieu. Si l'espèce a été importée de manière volontaire pour la culture ou l'ornementation par exemple, les meilleures conditions sont mises en œuvre par l'Homme afin que l'introduction soit réussie. Cependant, dans les cas où l'espèce est directement relâchée ou s'échappe en milieu naturel (B3, C0), elle doit être capable de survivre et se reproduire de façon sexuée et/ou asexuée sans l'intervention de l'Homme pour s'établir et se développer dans l'aire d'introduction (C1, C2, C3). C'est la phase d'**installation**. En franchissant la barrière reproductive, l'espèce est considérée comme une espèce naturalisée. La dernière étape correspond à la phase de **propagation**, l'aire de répartition de l'espèce s'étend au-delà

de la zone d'introduction (D1, D2). L'espèce se disperse dans l'aire d'introduction et ses descendants réussissent s'adapter aux conditions environnementales qu'ils rencontrent en envahissant progressivement de nouveaux milieux (E). Elle est définie comme une espèce invasive.

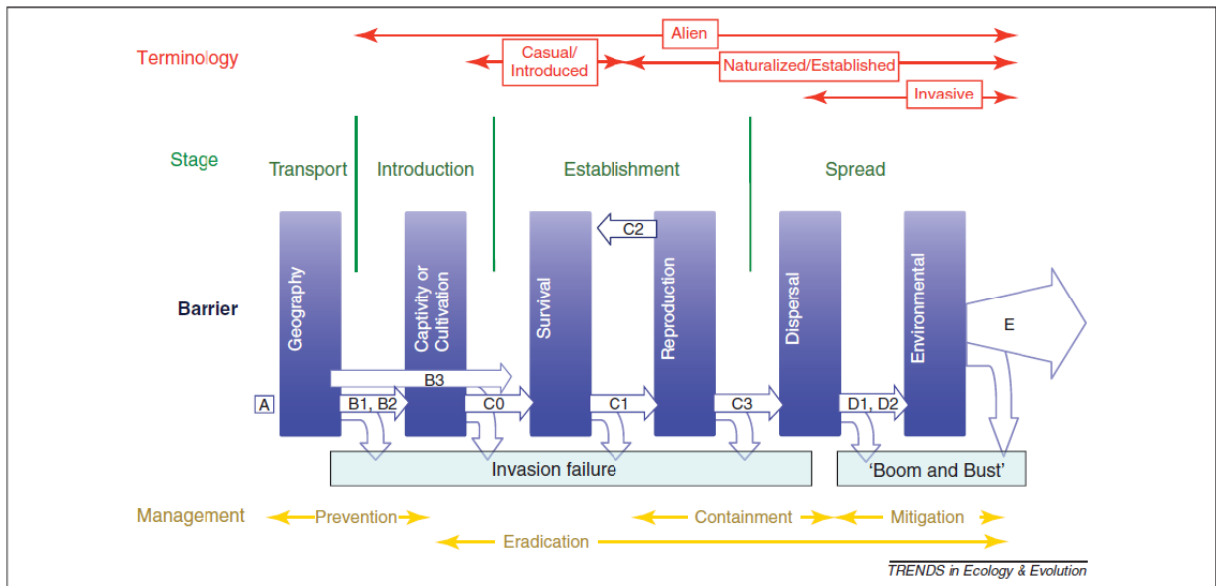

Figure 2. Schéma présentant les différentes étapes et barrières à franchir lors du processus d'invasion : l'espèce n'est pas transportée au-delà des limites de son aire de répartition naturelle (A) ; individus transportés au-delà des limites de leur aire de répartition naturelle accidentellement (B1) ou volontairement (B2) pour être exploités ou directement relâchés dans la nature (B3) ; individus relâchés dans la nature à l'endroit où ils ont été introduits mais incapables de survivre (C0) ; individus survivant dans la nature à l'endroit où ils ont été introduits sans se reproduire (C1) ; individus survivant dans la nature à l'endroit où ils ont été introduits, capables de se reproduire (C2 et C3) ; individus survivant et se reproduisant à une distance suffisamment éloignée de la zone d'introduction (D1 et D2) ; espèce invasive avec des individus se dispersant, survivant et se reproduisant à travers une large gamme de milieux (E) (Blackburn et al. 2011).

Chacune de ces étapes se fait progressivement dans le temps et dans l'espace. Cependant, une espèce introduite et naturalisée depuis un certain temps ne devient généralement pas invasive immédiatement en raison de périodes de décalage (lag phase, Williamson, 1996) qui peuvent se produire entre l'établissement et la propagation de l'espèce (Crooks & Soulé 1999; Crooks 2005). Ces périodes peuvent être plus ou moins longues avec des décalages de seulement 2 ans pour *Clerodendrum macrostegium* et *Ardisia virens* sur l'île d'Hawaï à presque 100 ans recensés pour *Cytisus scoparius* en Nouvelle-Zélande (Daehler 2009; Aikio, Duncan & Hulme 2010). De même, le temps

écoulé depuis l'introduction, qualifié de temps de résidence, permet notamment aux espèces ligneuses allochtones de réussir à se naturaliser en Europe et devenir invasives (Bucharova & van Kleunen 2009; Pyšek, Křivánek & Jarošík 2009). De nombreuses études ont tenté d'identifier les facteurs écologiques responsables de la réussite des plantes lors du continuum introduction-naturalisation-invasion (Williamson 2006; Theoharides & Dukes 2007; Bucharova & van Kleunen 2009; Richardson & Pyšek 2012; Kempel *et al.* 2013). La **pression de propagules**, également appelée effort d'introduction, est un élément majeur dans la réussite ou l'échec des invasions biologiques (Lockwood, Cassey & Blackburn 2005). Elle correspond à la quantité d'individus importés et libérés en dehors de leur aire de répartition naturelle et à la fréquence de ces événements d'importation. Elle est aussi bien impliquée lors de la phase d'introduction de l'espèce que lors de la propagation et colonisation des descendants dans l'aire d'introduction (Lockwood, Cassey & Blackburn 2009; Richardson & Pyšek 2012). Une forte pression de propagules favorise l'installation des individus en diminuant les effets de la stochasticité démographique de la population et les impacts de la stochasticité environnementale (Simberloff 2009; Kempel *et al.* 2013). Chez les espèces ligneuses introduites, l'intensité de plantation augmente la probabilité que des individus s'échappent dans la nature, en dehors des zones de cultures, et facilite leur naturalisation en Europe (Bucharova & van Kleunen 2009; Pyšek *et al.* 2009).

Une fois introduits dans leur nouveau milieu, les individus vont devoir affronter de nouvelles conditions biotiques et abiotiques. Le climat et le sol peuvent être semblables ou différents par rapport à leur aire d'origine. Dans l'aire d'introduction, les individus peuvent être confrontés à un changement ou une conservation de leur niche climatique d'origine (Wiens & Graham 2005; Broennimann *et al.* 2007; Gallagher *et al.* 2010). La **disponibilité des ressources** semble être un critère primordial afin que les individus récemment arrivés puissent s'établir dans l'aire d'introduction (Huenneke *et al.* 1990; Davis, Grime & Thompson 2000). Cependant, les plantes invasives peuvent aussi coloniser des environnements ayant de faibles ressources. Par exemple, Funk and Vitousek (2007) ont mis en évidence une meilleure performance dans l'assimilation du carbone des espèces invasives comparées aux espèces natives locales dans des habitats ayant de faibles ressources en lumière, eau et nutriments.

De même, **des interactions biotiques** sont également impliquées dans le succès ou l'échec des invasions biologiques. Par exemple, la présence de pathogènes et de prédateurs, la compétition avec les espèces locales ou l'absence de mutualismes (pollinisation, symbioses) peuvent compromettre la survie ou la reproduction des plantes introduites lors de la phase d'établissement sans toutefois que ces résistances biotiques empêchent l'invasion (Levine, Adler & Yelenik 2004; Mitchell *et al.* 2006). Parmi toutes les interactions biotiques qui peuvent s'établir lors du processus d'invasion, le mutualisme favorise le succès des invasions végétales (Richardson *et al.* 2000). Trois types d'interactions mutualistes peuvent intervenir favorablement lors des étapes d'établissement, de reproduction et de dispersion des invasions biologiques (Traveset & Richardson 2014; **Figure 3**). Des symbioses racinaires microbiennes ou fongiques aident la plante à s'établir dans le nouveau milieu, la pollinisation par les insectes est indispensable pour assurer la reproduction sexuée chez certaines espèces de plantes allogames et la dispersion des graines par les animaux permet à la plante de se propager dans l'aire d'introduction.

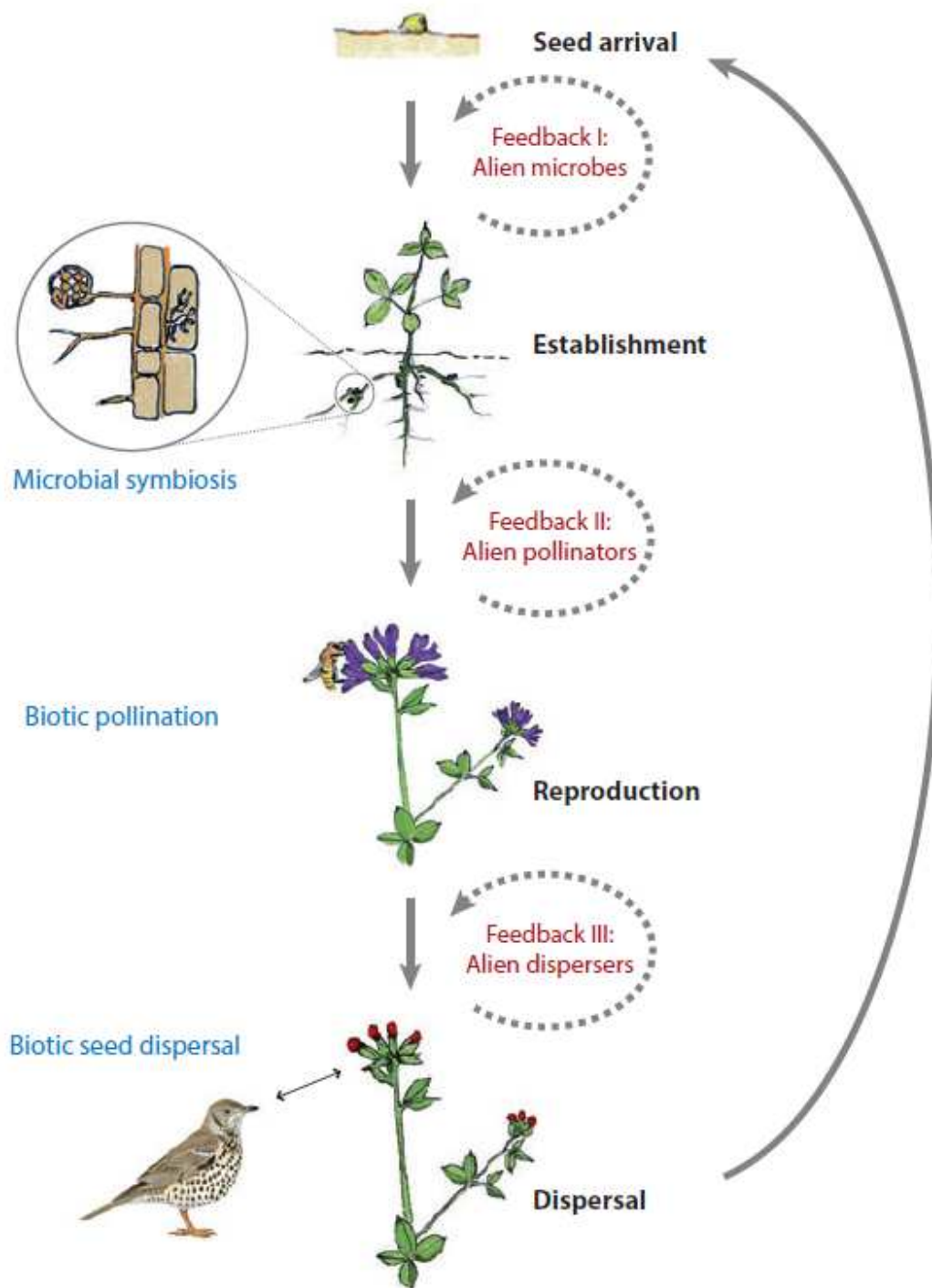

Figure 3. Interactions mutualistes possibles lors du processus d'invasion et pouvant intervenir à chaque stade du cycle de vie d'une plantes (Traveset & Richardson 2014).

Parce qu'une espèce est considérée invasive à partir du moment où elle étend sa répartition à l'intérieur de son aire d'introduction, la capacité de dispersion par le biais de la reproduction sexuée ou asexuée semble être une caractéristique indispensable pour conquérir et envahir de nouveaux habitats (Theoharides & Dukes 2007; Murray & Phillips 2010; Richardson & Pyšek 2012). Il existe trois principaux modes de dispersion des graines : l'anémochorie, l'hydrochorie et la zoochorie ; cette dernière étant très diversifiée et efficace, notamment par le biais des oiseaux capables de disperser sur de longues distances (Vittoz & Engler 2007). Bass *et al.* (2006) ont mis en évidence que deux espèces ligneuses originaire d'Europe et invasives en Australie parvenaient à se disperser rapidement, sur des distances de plusieurs kilomètres pour *Crataegus monogyna* grâce à une espèce d'oiseaux et trois de mammifères, et sur des distances inférieures à 100 mètres pour *Prunus mahaleb* grâce à six espèces d'oiseaux et quatre de mammifères. Les animaux disperseurs favorisent le mouvement des graines vers des sites plus éloignés dont les conditions peuvent être plus avantageuses pour l'accès aux nutriments, la germination et la croissance des plantules. Il a été par exemple démontré en Amérique du Nord qu'une espèce d'oiseaux natifs parvenait à disperser sans difficulté des graines de *Lonicera maackii*, un arbuste invasif, de façon préférentielle vers des sites parfaitement appropriés à cette espèce ligneuse (Bartuszevige & Gorchov 2006). La dispersion longue distance permet aux descendants d'échapper aux effets de la compétition intraspécifique à proximité de l'arbre-mère et de favoriser des flux de gènes entre les populations, contribuant ainsi au développement de populations diversifiées (Cain, Milligan & Strand 2000; Trakhtenbrot *et al.* 2005; Nathan *et al.* 2008). La connaissance du pool de disperseurs d'une espèce exotique contribue à déterminer si l'espèce est capable de se répandre dans l'aire d'introduction. Cela permet également d'évaluer les distances de dispersion et la vitesse de propagation de l'espèce.

C. Hypothèses écologiques et évolutives liées au succès des plantes invasives et changements phénotypiques

Deux concepts fondamentaux sont impliqués dans la réussite des invasions par les plantes : la sensibilité du milieu à être envahi appelée « invasibilité » (« invasibility » en anglais) et la capacité des espèces à envahir de nouveaux milieux appelée « invasivité »

(« invasiveness » en anglais) (Richardson & Pyšek 2006; **Figure 4**). L'invasibilité correspond aux caractéristiques du milieu (écosystème, communauté, habitat) qui aideront les plantes invasives à s'établir et envahir ce milieu, comme par exemple la disponibilité des ressources, les perturbations, l'absence d'ennemis naturels (Burke & Grime 1996; Lonsdale 1999; Davis *et al.* 2000). L'invasivité correspond aux caractéristiques biologiques des plantes qui vont améliorer leurs performances et leur permettre d'envahir de nouveaux milieux et d'étendre leur distribution au sein de l'aire d'introduction (Rejmánek 1996; Goodwin, McAllister & Fahrig 1999).

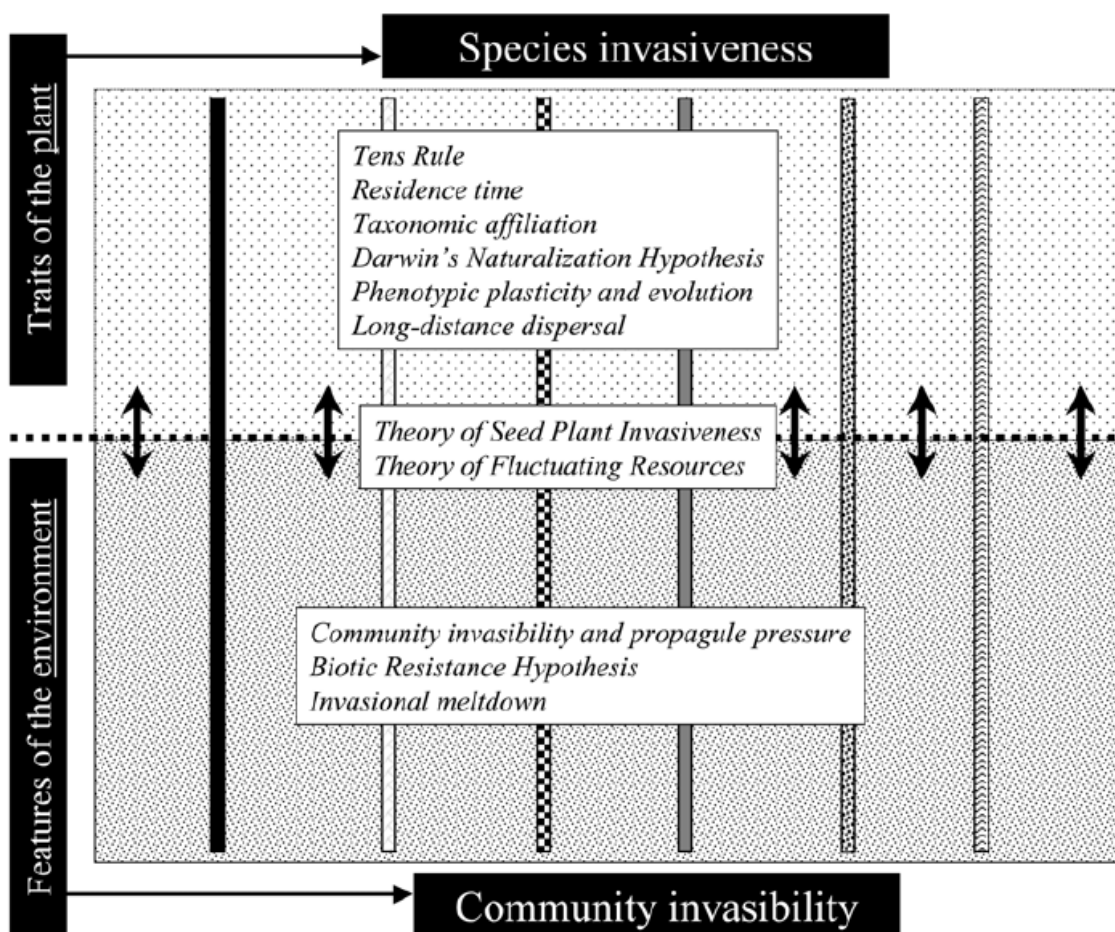

Figure 4. Schéma illustrant les concepts d'invasivité associée aux traits des plantes et d'invasibilité liée aux caractéristiques de l'environnement (Richardson & Pyšek 2006).

Parmi les caractéristiques biologiques qui contribuent au succès des invasions végétales, les traits d'histoires de vie qui améliorent la valeur sélective (« fitness » en anglais) des individus sont généralement impliqués (Gerlach & Rice 2003). Ces traits sont des

caractères mesurables relatifs à la croissance, la phénologie, la survie et la reproduction de l'espèce. De nombreuses études ont tenté d'identifier les traits phénotypiques impliqués dans le succès des invasions biologiques végétales (Rejmánek & Richardson 1996; Reichard & Hamilton 1997; Goodwin *et al.* 1999; Grotkopp, Rejmánek & Rost 2002; Hamilton *et al.* 2005; van Kleunen *et al.* 2010a; Moravcová *et al.* 2015). Les espèces invasives sont généralement plus compétitives que les plantes natives (Bakker & Wilson 2001; Vilà & Weiner 2004). La physiologie, l'allocation pour la croissance végétative, le taux de croissance, la taille, la production quantitative de graines, la fécondité, les caractéristiques des propagules sont des traits qui améliorent la performance et la compétitivité des espèces invasives par rapport aux espèces non-invasives résidentes (Leishman *et al.* 2007; van Kleunen, Weber & Fischer 2010b; Schmidt & Drake 2011; Godoy & Levine 2014; Castro-Díez *et al.* 2014; Moravcová *et al.* 2015). Chez les angiospermes ligneuses notamment, la croissance supérieure des plantules avantage les espèces invasives favorisant leur succès d'invasion (Grotkopp & Rejmánek 2007; Grotkopp, Erskine-Ogden & Rejmánek 2010). Les plantes invasives herbacées et ligneuses sont plus fécondes produisant en moyennes plus de graines que les espèces natives (Mason *et al.* 2008; Jelbert *et al.* 2015). Chez les arbres invasifs, la vitesse de propagation des graines et la taille des graines ont une influence positive sur leur processus de naturalisation (Bucharova & van Kleunen 2009; Pyšek *et al.* 2009). Les graines de grosse taille possèdent généralement davantage de réserves nutritives pour l'embryon et la future plantule, conférant un avantage compétitif aux espèces invasives pour s'établir et survivre dans leur nouvel habitat, même si cela suppose une production de graines en quantité plus faible. Ainsi, chez les plantes invasives favorisant la reproduction sexuée pour envahir de nouveaux milieux, il existe un fort compromis entre la taille et la quantité des graines produites (Pichancourt & van Klinken 2012). D'autre part, malgré quelques exceptions, les plantes invasives ont tendance à avoir une croissance et des capacités reproductives supérieures comparées aux plantes natives ou non invasives (Thébaud & Simberloff 2001; Mason *et al.* 2008; Burns *et al.* 2013; Jelbert *et al.* 2015). Chez plusieurs espèces de plantes invasives, une croissance plus élevée au sein de populations invasives par rapport aux populations natives a été recensée, aussi bien chez les herbacées, comme *Lythrum salicaria*, (Bastlová & Květ 2002; Chun, Kim &

Moloney 2010), que chez les arbustes *Rhododendron ponticum* (Erfmeier & Bruelheide 2004) ou même les arbres tels que *Acer negundo* ou *Sapium sebiferum* (Siemann & Rogers 2001; Lamarque *et al.* 2013).

Plusieurs hypothèses en lien avec l'invasibilité ou l'invasivité ont été émises pour expliquer la réussite des invasions végétales, également chez les arbres invasifs (Lamarque, Delzon & Lortie 2011). Parmi ces huit hypothèses, seulement quatre sont abordées et développées dans la suite. Il s'agit des hypothèses susceptibles d'être impliquées dans le succès de l'introduction de l'espèce étudiée dans cette thèse (les deux hypothèses de la pression de propagule et la disponibilité des ressources ont été précédemment mentionnées dans la partie b).

1/ Il est rare que l'espèce introduite se déplace avec son cortège de pathogènes et de prédateurs. En l'absence d'ennemis naturels, l'espèce invasive bénéficie d'un avantage compétitif pour accroître son expansion et son abondance dans l'aire d'introduction (**Enemy release hypothesis**, Keane and Crawley, 2002). Par exemple, il a été démontré que l'arbuste invasif, *Clidemia hirta*, pousse uniquement en milieu ouvert dans son aire d'origine au Costa-Rica alors qu'il envahit les forêts tropicales d'Hawaï, en l'absence de pathogènes fongiques et insectes prédateurs dans l'aire d'invasion (DeWalt, Denslow & Ickes 2004). Chez les plantes, il existe un compromis entre l'investissement pour des traits relatifs à la croissance ou la reproduction et l'investissement pour des traits de résistance aux prédateurs et pathogènes, conférant soit un avantage compétitif soit un avantage défensif. Les pressions de sélection exercées par les pathogènes et herbivores étant fortement réduites dans le nouveau milieu, les plantes invasives allouent davantage de ressources et d'énergie pour la croissance et/ou la reproduction que pour la défense comparées aux espèces natives locales. Siemann and Rogers (2003a) ont montré que les semis de *Sapium sebiferum*, un arbre invasif en Amérique du Nord, étaient largement moins affectés par les insectes herbivores que les semis de *Celtis laevigata*, un arbre natif aux exigences écologiques semblables. De plus, la suppression de ces insectes engendrait une meilleure survie et croissance des jeunes plants de *S. sebiferum*.

2/ En raison d'une modification des pressions de sélection entre l'aire native et l'aire d'invasion, les plantes invasives peuvent manifester des changements évolutifs pour

augmenter leurs capacités compétitives (**Evolution of increase competitive ability hypothesis**, Blossey and Nötzold, 1995). Par exemple, lorsque des génotypes invasifs américains de *S. sebiferum* sont réintroduits dans leur aire d'origine en Chine, ils sont plus affectés par *Melanoplus angustipennis*, une sauterelle herbivore, mais plus compétitifs que les génotypes natifs. Des différences génétiques sur des traits de croissance et de résistance à l'herbivorie se sont donc créées entre les génotypes natifs et les génotypes invasifs (Siemann & Rogers 2003b). De même, sans compétition avec d'autres plantes, les populations invasives chiliennes de Pavot de Californie (*Eschscholzia californica*) présentent une croissance et une fécondité supérieures par rapport aux populations natives californiennes (Leger & Rice 2003).

Cependant, chez les plantes, il peut aussi arriver que les populations natives soient plus compétitives que les populations invasives (Bossdorf *et al.* 2004). Un changement évolutif d'allocation augmentant la croissance et diminuant les traits relatifs à la défense n'est pas systématiquement observé chez les plantes invasives, comme par exemple chez *Melaleuca quinquenervia*, un arbre originaire d'Australie et invasif en Floride (Franks *et al.* 2008a; b).

3/ Certaines plantes peuvent produire et libérer des substances biochimiques ayant un effet négatif sur les plantes voisines en inhibant leur développement (croissance, germination). Dans l'aire native, les plantes adjacentes se sont généralement adaptées à ces interactions établies depuis longtemps. Au contraire, dans l'aire d'invasion, les substances allélopathiques diminuent la performance des plantes natives voisines et favorisent la compétitivité des plantes invasives. Les interactions allélopathiques constituent de nouvelles armes pour les espèces invasives nouvellement arrivées dans des communautés végétales (**Novel weapons hypothesis**, Callaway and Aschehoug, 2000; Hierro and Callaway, 2003). L'arbuste invasif originaire d'Asie, *Lonicera maackii*, libère, par le biais de ses feuilles et racines, des substances toxiques qui inhibent la germination de plantes herbacées natives (*Impatiens capensis*, *Alliaria petiolata*, *Arabidopsis thaliana*) en Amérique du Nord (Dorning & Cipollini 2006). Bien que généralement les substances allélopathiques aient un effet négatif sur certaines plantes natives, il arrive parfois qu'elles stimulent le développement d'autres espèces. C'est

notamment le cas d'*Ailanthus altissima*, un arbre invasif originaire d'Asie qui empêcherait la croissance de *Quercus rubra* en libérant une substance chimique nocive, l'ailanthone, mais stimulerait le développement d'*Acer rubrum* en augmentant la fertilité du sol en Amérique du Nord (Gómez-Aparicio & Canham 2008). L'allélopathie peut être considérée comme un mécanisme soumis à la sélection naturelle et résultant d'une évolution rapide susceptible d'augmenter les capacités compétitives de l'espèce invasive (Callaway & Ridenour 2004).

4/ La présence de niches écologiques vacantes dans l'aire d'introduction est supposée faciliter la réussite des invasions biologiques, leur permettant d'accéder à des ressources non utilisées par les espèces natives locales (**Empty niches hypothesis**, Hierro *et al.* 2005; Levine and D'Antonio 1999). Les communautés végétales, dont la richesse spécifique est élevée, seront plus résistantes aux invasions biologiques en raison de la faible disponibilité de niches disponibles. Cependant, cette hypothèse a rarement été démontrée pour expliquer le succès des invasions par les espèces ligneuses (Lamarque, Delzon & Lortie 2011). Dans le cas des niches climatiques, il s'agit d'un transfert dans le temps et dans l'espace à travers différents environnements climatiques favorables à l'espèce. Notamment si dans l'aire d'introduction l'espèce invasive se retrouve dans des climats similaires à ceux présents dans son aire native, les niches climatiques de l'espèce sont conservées entre les deux aires (Wiens & Graham 2005; Petitpierre *et al.* 2012). Dans ce cas, les espèces introduites sont capables d'envahir de nouveaux environnements sans changement écologique ou évolutif. Cependant, les espèces invasives peuvent aussi occuper des niches climatiques considérablement distinctes de celles de leur aire d'origine, sans que toutefois ce ne soit un obstacle empêchant leur établissement dans l'aire d'invasion (Gallagher *et al.* 2010). Dans ce cas, des processus écologiques et évolutifs peuvent intervenir pour permettre aux espèces invasives de s'établir dans le nouvel environnement. Broennimann *et al.* (2007) ont démontré que la plante *Centaurea maculosa* avait colonisé et envahi une niche climatique en Amérique du Nord différente de celle qu'elle occupe dans son aire d'origine en Europe. Des changements de niches ont également été constatés chez trois espèces de plante d'*Heracium*, originaires d'Europe et invasive en Australie, Nouvelle-Zélande et Amérique du Nord (Beaumont *et al.* 2009).

Pour déterminer le caractère invasif d'une espèce, on s'intéresse aux traits phénotypiques, également appelés traits d'histoire de vie (Monty & Mahy 2009a), qui peuvent varier d'un individu à l'autre. Les variations de ces traits phénotypiques observées entre les individus natifs et les individus invasifs d'une même espèce résultent d'un déterminisme environnemental, génétique ou d'une interaction entre les deux.

$$\textit{Phénotype} = \textit{Environnement} + \textit{Génotype} + \textit{Génotype} \times \textit{Environnement}$$

Le déterminisme environnemental fait référence à la plasticité phénotypique qui agit sur la variation phénotypique des individus en réponse à des changements environnementaux (Bradshaw 1965; Schlichting 1986). La plasticité phénotypique peut être adaptative dans certains cas (van Kleunen & Fischer 2005) et soumise à des pressions de sélection naturelles ou artificielles (Scheiner 1993). Elle permet aux espèces invasives de maintenir leur valeur sélective à travers divers environnements favorables ou défavorables (Richards *et al.* 2006) et contribue au succès des invasions biologiques.

Le déterminisme génétique correspond à la variation phénotypique héritable entre individus résultant de modifications au niveau du génome. La variabilité génétique peut se détecter à partir d'analyses moléculaires mais aussi par l'analyse des traits phénotypiques en comparant des populations provenant de l'aire native et de l'aire d'invasion et ayant grandi dans les mêmes conditions environnementales, c'est-à-dire en jardin commun (Bossdorf *et al.* 2005). Les différences génétiques adaptatives existant entre les populations natives et invasives peuvent résulter de la création de nouveaux génotypes grâce à des recombinaisons génétiques, de la sélection de génotypes déjà pré-adaptés dans l'aire d'origine (préadaptation) ou de la sélection naturelle dans l'aire d'invasion (évolution post-introduction) (Bossdorf, Lipowsky & Prati 2008; Elst *et al.* 2016).

En réponse aux changements de pressions de sélection exercées par les conditions biotiques et abiotiques entre l'aire native et l'aire d'invasion, les espèces invasives peuvent rapidement évoluer pour s'adapter aux nouvelles conditions locales (Thompson 1998; Lee 2002; Maron *et al.* 2004). Selon Prentis *et al.* (2008), des changements évolutifs rapides peuvent se produire en moins de 20 générations après l'introduction de nouvelles populations dans un nouvel environnement. L'évolution adaptative rapide aux conditions climatiques facilite notamment la naturalisation et la propagation des plantes invasives au

sein de l'aire d'introduction (Colautti & Barrett 2013). En effet, le climat est reconnu pour être un facteur qui conditionne la répartition des populations de plantes et génère de la différenciation génétique au sein des populations en réponse à de l'adaptation locale. Chez les plantes herbacées, les variations phénotypiques provenant de la différenciation génétique entre les populations invasives observées au sein de l'aire d'introduction le long d'un gradient écologique latitudinal (Kollmann & Bañuelos 2004; Colautti, Eckert & Barrett 2010; Hodgins & Rieseberg 2011) ou altitudinal (Monty & Mahy 2009b; Alexander *et al.* 2009) suggèrent que les populations invasives parviennent à s'adapter rapidement à de nouvelles conditions climatiques. Les plantes invasives sont même capables dans l'aire d'invasion, de reconstituer de la différenciation génétique de façon comparable à celle observée au sein des populations natives dans l'aire d'origine. Par exemple, en conditions contrôlées, *Lythrum salicaria* présente des variations phénotypiques pour l'initiation de la floraison et la dimension des individus lors de la floraison au sein des populations nord-américaines invasives issues d'un gradient latitudinal similaires à celles observées parmi les populations de l'aire native en Europe (Montague, Barrett & Eckert 2008). Une même constatation a été faite sur la variation clinale de traits phénotypiques relatifs à la croissance végétative de populations natives et invasives de *Solidago altissima*, issues de gradients latitudinaux similaires dans chacune des aires de distribution, élevées en jardin commun (Etterson *et al.* 2008). Ces changements génétiques par rapport aux conditions environnementales le long de gradients latitudinaux suggèrent une forte capacité d'évolution adaptative des plantes invasives face aux conditions climatiques et topographiques rencontrées dans l'aire d'invasion.

D. Modifications de la diversité génétique et mécanismes évolutifs impliqués lors de l'introduction

L'histoire de l'introduction influence considérablement la structure et la diversité génétique des espèces introduites (Prentis *et al.* 2009). Grâce à une approche de génétique moléculaire, il est possible d'identifier les populations sources des espèces invasives qui ont été introduites afin de retracer l'histoire des introductions d'espèces conduisant à des invasions et de comparer les variations génétiques entre les populations natives et les populations introduites pour comprendre les mécanismes impliqués dans l'adaptation

rapide (Miura 2007). Une large diversité génétique au sein des populations permet à une espèce introduite de réussir à s'adapter rapidement aux nouvelles conditions environnementales du milieu dans lequel elle se trouve (Lavergne & Molofsky 2007; Barrett & Schluter 2008; Crawford & Whitney 2010). Or, des mécanismes évolutifs ou des événements démographiques sont susceptibles d'intervenir lors des différentes phases d'invasion du processus et de modifier la diversité et la structure génétiques des populations introduites (Lee 2002; Dlugosch *et al.* 2015).

Il est généralement attendu que chez les espèces invasives la diversité génétique des populations introduites soit faible. Tout d'abord, il est possible que toute la diversité génétique présente dans l'aire native n'ait pas été introduite dans la nouvelle aire. Les populations introduites peuvent résulter d'un **sous-échantillonnage** des populations et donc de la diversité génétique présente dans l'aire native. L'introduction d'un nombre faible ou insuffisant de populations provenant de l'aire d'origine entraînera une réduction de la diversité génétique dans l'aire d'introduction suite à des **événements d'effet de fondation** et de **goulot d'étranglement**. En raison de l'isolement géographique et génétique, les populations introduites ne peuvent plus échanger de gènes avec les populations d'origine. La diversité génétique devra se reconstituer à partir des populations introduites qui seront considérées comme fondatrices. La **dérive génétique** est également un facteur de diminution de la diversité génétique par fixation d'allèles et son action peut être attendue de façon particulièrement forte lors d'une introduction. En effet, pour les espèces à faible dispersion, seuls les individus au niveau du front d'une vague migratoire contribuent à l'extension de l'aire ce qui conduit à une dérive génétique locale particulièrement rapide, ce processus étant décrit sous le nom de « surf » allélique (« gene surfing » en anglais). En outre, en favorisant certains génotypes par rapport à d'autres, la **sélection artificielle** d'origine anthropique et la **sélection naturelle** peuvent réduire localement la diversité génétique. La sélection naturelle agit comme un filtre en éliminant les individus les moins aptes à survivre et se reproduire et en conservant préférentiellement les individus ayant les meilleures valeurs sélectives. Des introductions peu nombreuses dans un environnement donné peuvent conduire à une forte sélection des individus lors de l'acclimatation dans la nouvelle aire. Une diminution drastique du nombre d'individus contre-sélectionnés induit une perte de diversité au sein des

populations introduites. Dans le cas d'une sélection artificielle d'origine anthropique, l'Homme peut choisir de favoriser préférentiellement les individus ayant des traits phénotypiques avantageux en termes de survie et de productivité, éliminant ainsi une part de la diversité naturelle introduite. Ces processus sélectifs ou démographiques aboutissant à une réduction de la diversité génétique pourraient être responsables de l'échec de naturalisation de certaines espèces exotiques introduites, mais les études à ce sujet sont relativement rares (Zenni & Nuñez 2013).

Cependant, il existe un paradoxe génétique chez les espèces invasives selon lequel des populations introduites parviendraient à devenir invasives malgré une faible ou insuffisante diversité génétique (Frankham 2005; Roman & Darling 2007). Il semblerait qu'une réduction de la diversité génétique, généralement associée à des événements de goulot d'étranglement et d'effet de fondation, n'empêcherait pas la capacité des populations invasives à se naturaliser et se propager au sein de leur nouvelle aire (Uller & Leimu 2011). De nombreuses populations introduites sont parvenues à évoluer et à s'adapter à leur nouvel environnement malgré une faible diversité génétique (Rollins *et al.* 2013). Par exemple, les populations d'un arbuste invasif *Hypericum canariense*, originaire des îles Canaries, présentent de la différenciation génotypique sur des traits phénotypiques relatifs à la floraison alors que la diversité allélique de ces populations est plus faible que dans l'aire native, en raison d'évènements de goulot d'étranglement durant l'introduction (Dlugosch & Parker 2008a). Par conséquent, même les populations introduites en faible quantité ou ayant subi un effet de fondation sont capables de devenir invasives laissant suggérer que de la diversité génétique puisse se reconstituer au sein des populations.

Par ailleurs, une forte variabilité génétique peut se maintenir au sein des populations durant l'introduction grâce à plusieurs mécanismes. Tout d'abord, les **introductions multiples** à partir d'un grand nombre d'individus échantillonnés au hasard dans l'aire native ou issus de plusieurs populations sources différentes favorisent le maintien d'une diversité génétique élevée (**Figure 55**; Miura 2007). Des introductions répétées d'individus de l'aire native vers l'aire d'introduction permettent de conserver un flux de gènes et de maintenir ou augmenter la diversité génétique à long terme (Facon *et al.*

2008; Dlugosch & Parker 2008b). Grâce à l'analyse de marqueurs génétiques, une forte et similaire diversité génétique ou allélique entre les populations natives et invasives a été observée sur de nombreuses espèces de plantes herbacées invasives telles que *Verbascum thapsus*, *Alliaria petiolata*, *Ambrosia artemisiifolia*, *Phalaris arundinacea*, *Brassica nigra* (Durka *et al.* 2005; Genton, Shykoff & Giraud 2005; Lavergne & Molofsky 2007; Dlugosch & Parker 2008b; Oduor *et al.* 2015). Cependant, une récente étude a montré que malgré des introductions multiples en Europe, les populations invasives d'*Impatiens glandulifera* présentaient une diversité génétique inférieure comparée aux populations natives situées en Inde, probablement à cause de la dérive génétique (Hagenblad *et al.* 2015).

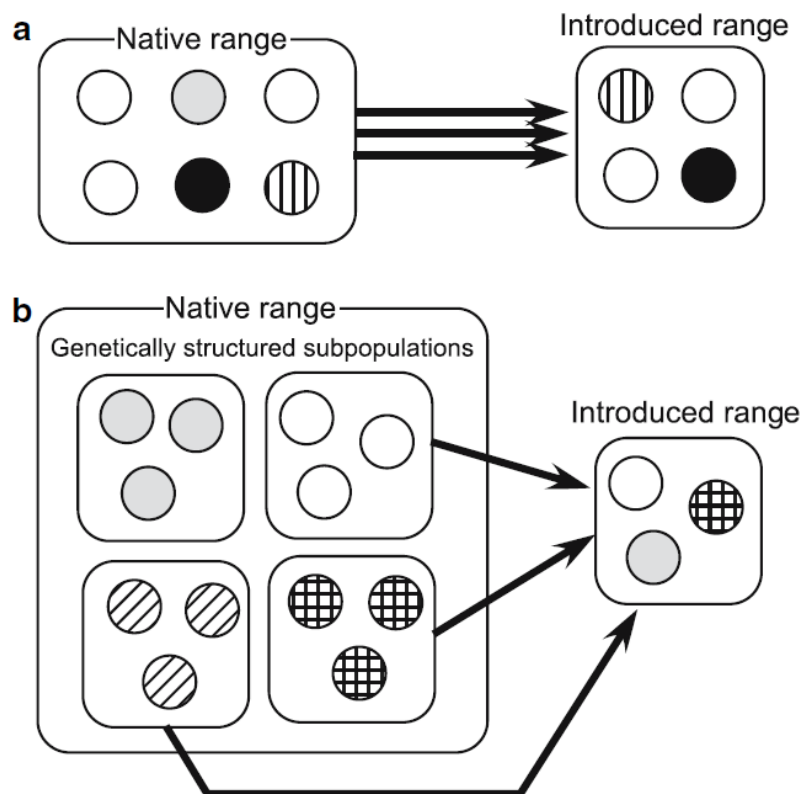

Figure 5. Schémas illustrant le phénomène d'introductions multiples qui contribuent à maintenir de forts niveaux de variation génétique chez les espèces invasives. Les espèces invasives conservent un fort niveau de variation génétique lorsqu'un grand nombre d'individus sont transportés (a) ou lorsqu'ils sont transportés à partir de plusieurs populations sources (b) (Miura 2007).

Suite à l'introduction, la reproduction des populations de l'espèce introduite peuvent conduire à des **mélanges génétiques** (« genetic admixture » en anglais) causés par des

croisements interspécifiques avec une espèce locale phylogénétiquement proche ou des croisements intraspécifiques entre lignées initialement isolées dans l'aire d'origine (Abbott 1992; Ellstrand & Schierenbeck 2000). Bien que souvent considérés comme des processus rendant l'adaptation moins rapide car ils contribuent à l'introduction d'allèles exotiques, les mélanges génétiques peuvent procurer un réel avantage aux espèces invasives récemment introduites. En effet, ils peuvent contribuer à augmenter la variabilité génétique au sein des populations, générer de nouvelles combinaisons génétiques ou purger des mutations délétères afin d'accroître leur potentiel adaptatif face aux conditions environnementales dans l'aire d'introduction (Verhoeven *et al.* 2011). Les mélanges génétiques génèrent des hybrides grâce aux recombinaisons génétiques et surviennent généralement après des événements répétés d'introduction (Dlugosch & Parker 2008b; Dlugosch *et al.* 2015). Ici, l'hybridation est considérée comme le croisement et le flux de gènes entre parents sur plusieurs générations aboutissant à la production de descendants hybrides fertiles (non stériles). L'hybridation interspécifique peut se produire dans l'aire d'invasion aussi bien sur des espèces herbacées, comme par exemple entre deux espèces de Centaurées invasives en Amérique du Nord : *Centaurea stoebe* et *C. diffusa* (Blair & Hufbauer 2010), que sur des espèces ligneuses, comme par exemple entre *Tamarix ramosissima* et *T. chinensis* invasifs aux Etats-Unis (Gaskin & Kazmer 2009). Chez les plantes invasives, l'hybridation intraspécifique résulte généralement de la mise en contact de populations sources géographiquement isolées dans l'aire native ayant fait l'objet d'introductions multiples (Rosenthal, Ramakrishnan & Cruzan 2008). Le croisement entre individus de la même espèce peut avoir des conséquences négatives sur la valeur sélective des descendants (Lynch 1991). Dans un croisement entre individus apparentés, notamment au sein de la même aire géographique, la dépression de consanguinité (« inbreeding depression » en anglais) réduit la valeur sélective des descendants par rapport à celle des parents (van Kleunen, Röckle & Stift 2015). Dans un croisement entre individus issus de deux populations différentes, la dépression d'hybride (« outbreeding depression » en anglais) diminue la valeur sélective des hybrides par rapport à celle des parents (Bailey & McCauley 2006). Cependant, grâce à un phénomène de vigueur hybride ou hétérosis, les populations hybrides peuvent au contraire s'avérer être plus agressives et envahissantes que les populations parentales en exprimant des traits phénotypiques

plus performants (Vilà & D'Antonio 1998). Ainsi, par exemple, la vigueur hybride résultant de croisements entre plusieurs populations de l'aire native a pu créer des individus recombinés de *Silene vulgaris* dont la valeur sélective est supérieure à celle des individus non-recombinés dans l'aire d'introduction (Keller & Taylor 2010). Grâce à leur capacité adaptative et leur valeur sélective supérieure, certains hybrides invasifs peuvent coloniser de nouveaux milieux dans l'aire d'introduction (Rius & Darling 2014). Les individus hybrides présentant un avantage adaptatif peuvent ainsi conquérir de nouveaux habitats contraignants, comme par exemple les trois espèces de tournesols hybrides *Helianthus anomalous*, *H. deserticola*, et *H. paradoxus* qui sont parvenues à coloniser, respectivement, les dunes de sables, le désert et les marais salés (Rieseberg *et al.* 2007). Les divers avantages associés aux mélanges génétiques soulignent l'importance de la reproduction sexuée, génératrice de nouvelles combinaisons génétiques, chez les espèces invasives.

E. Le chêne rouge d'Amérique : une espèce modèle

Étant donné que l'espèce étudiée dans cette thèse est une espèce ligneuse, une brève présentation sur les arbres et arbustes invasifs s'impose avant d'aborder le cas spécifique du chêne rouge d'Amérique. Les espèces invasives ligneuses sont relativement moins étudiées que les plantes invasives herbacées (Lamarque, Delzon & Lortie 2011) en raison de leur temps de génération beaucoup plus long. Néanmoins, en 2013, 751 espèces ligneuses étaient recensées comme invasives à travers le monde dont 434 arbres et 317 arbustes, majoritairement originaires d'Asie, Amérique du Sud, Europe et Australie (Rejmánek & Richardson 2013). Les principales raisons d'introduction d'arbres et arbustes invasifs sont, par ordre d'importance, l'ornementation, pour leurs aspects esthétiques, la foresterie, pour leur croissance rapide, la nourriture et l'agroforesterie ; ils sont souvent sélectionnés préférentiellement à d'autres espèces natives du fait de leur tolérance à une large gamme de conditions environnementales, leur croissance rapide et leur fructification et production de graines précoces et prolifiques (Richardson & Rejmánek 2011). Les espèces ligneuses invasives colonisent des habitats très variés, non seulement les milieux forestiers mais aussi les milieux ouverts, tels que les prairies, les zones riveraines, les milieux humides et les landes (Rundel, Dickie & Richardson

2014). La dispersion des graines d'arbres et arbustes invasifs est majoritairement assurée par les oiseaux, vecteurs efficaces pour transporter les graines sur de longues distances (Nathan 2006). Le vent, les mammifères, l'eau, les fourmis et les ballasts des bateaux sont également des vecteurs de dispersion (Richardson & Rejmánek 2011). Le succès de l'invasion dans la nouvelle aire d'introduction dépend donc souvent de la capacité des animaux à disperser les graines si cette nouvelle espèce introduite est zoochore.

Le chêne rouge d'Amérique (*Quercus rubra* L.) est une espèce ligneuse originaire d'Amérique du Nord. Son aire de répartition naturelle inclut la moitié Est de l'Amérique du Nord : du Sud du Minnesota à l'Est du Nebraska, Oklahoma et Arkansas, du Sud-Est du Canada au Nord de l'Alabama, en Géorgie et Caroline du Nord ; quelques populations isolées se trouvent en Louisiane et au Mississippi (**Figure 6**; Little 1971; Sander 1990). Il est capable de pousser jusqu'à une altitude de 1070 mètres en Virginie-Occidentale et de 1680 mètres dans le sud de Appalaches, ses exigences climatiques varient de 4 à 16 °C de température annuelle moyenne et de 750 à 2030 millimètres de pluviosité annuelle moyenne (Sander 1990). Sensible à l'hydromorphie et calcifuge, il affectionne les sols profonds et bien drainés. Le chêne rouge tolère aisément les perturbations, comme par exemple les feux qui favorisent sa régénération et son expansion en Amérique du Nord (Dey & Guyette 2000; Abrams 2005). Il est considéré comme une espèce de succession primaire à intermédiaire et tolère une gamme d'habitats xériques (secs) à mésiques (moyennement humides) (Crow 1988). Dans son aire d'origine, *Q. rubra* se retrouve en peuplement pur ou en mélange avec des espèces de feuillus ou conifères (Sander 1990). Il pousse principalement en association avec le pin blanc et l'érable rouge dans les forêts des régions septentrionales, et avec des espèces de chênes blancs et noirs et le tulipier de Virginie dans les forêts des régions centrales (Crow 1988). Le chêne rouge entre en compétition avec les espèces sciaphiles et les espèces pionnières à croissance rapide, comme l'érable rouge (*Acer rubrum*) ou le tulipier de Virginie (*Liriodendron tulipifera*). C'est pourquoi, les sylviculteurs américains proposent de modifier artificiellement le couvert des peuplements forestiers pour fournir suffisamment de lumière aux semis et jeunes plants de chêne dans le sous-étage en pratiquant des coupes d'abri. Ils recommandent également la pratique d'une méthode de coupe progressive pour maîtriser la dominance des compétiteurs ligneux et favoriser la régénération naturelle (Weigel &

Johnson 1998, 2000; Dey, Miller & Kabrich 2007). Celle-ci peut se faire à partir des semis s'ils sont suffisamment nombreux ou à partir des souches si les arbres-parents sont âgés et présentent des diamètres importants (Johnson 1994). Les peuplements de chêne rouge peuvent être conduits en futaies ou en taillis mais en ne gardant qu'une seule tige dominante pour maximiser le diamètre des arbres. La productivité des arbres augmentent considérablement lorsque des actions de désherbage de la végétation non-arborescente et de dépressage sont pratiquées dans le peuplement (Schuler & Robison 2006).

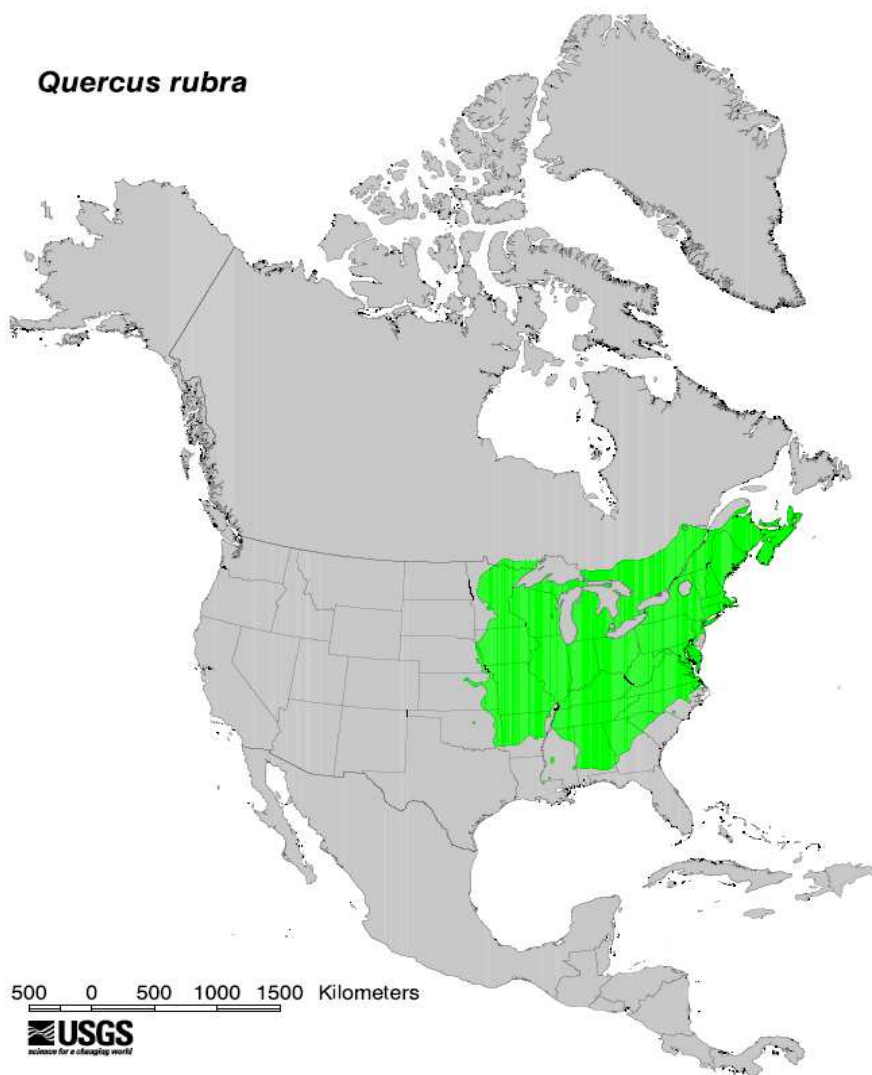

Figure 6. Distribution naturelle de *Q. rubra* représentée en vert clair dans son aire native en Amérique du Nord (Little 1971).

Le chêne rouge a été introduit en Europe à partir de la fin du XVII^{ème} siècle, la première date d'introduction est recensée en 1691 (Goeze 1916; Bauer 1953; Magni Diaz 2004). Tout d'abord importé en Europe pour ses qualités ornementales, le chêne rouge est planté dans les parcs et les jardins car il est très apprécié pour les couleurs rougeoyantes que peut prendre son feuillage à l'automne. A partir de la deuxième moitié du XIX^{ème} siècle, avec l'intensification de la sylviculture, les forestiers se sont intéressés à cette espèce à la croissance juvénile rapide pour la production et la commercialisation de son bois (Vansteenkiste, Boever & Acker 2005; Woziwoda *et al.* 2014b). En France, il a été largement planté comme essence de reboisement en alternative aux résineux à partir des années 1970 (Timbal, Bartoli & Buffet 1994) et a fait l'objet d'un programme de sélection mis en place à partir des années 1980 (Kremer 1986, 1994). De plus, en Europe, il est capable de pousser sur des sols pauvres, xériques ou acides, peu propices à d'autres espèces de feuillus (Miltner & Kupka 2016). De nos jours, le chêne rouge est présent dans de nombreux pays européens du Sud du Portugal jusqu'à la Scandinavie, de la France à la Russie (Delivering Alien Invasive Species Inventories for Europe DAISIE, <http://www.europe-aliens.org/speciesFactsheet.do?speciesId=14881#>). Bien qu'il soit établi dans de nombreux pays européens (**Figure 7**), il est déclaré comme étant une espèce invasive seulement en République Tchèque (Möllerová 2005; Pyšek *et al.* 2012a), en Belgique (Vansteenkiste, Boever & Acker 2005; Verloove 2006), en Pologne (Chmura 2004, 2013; Woziwoda, Kopeć & Witkowski 2014a), en Allemagne (Kowarik 2010; Lauterbach & Nehring 2013) et en Lituanie (Riepšas & Straigyte 2008; Straigyte & Zalkauskas 2012). En France, le chêne rouge n'est pas classé parmi les espèces invasives selon l'Inventaire National du Patrimoine Naturel, très probablement en raison des intérêts économiques liées à l'exploitation et au commerce de son bois et d'un manque de connaissances sur ses caractéristiques relatives aux espèces invasives.



Figure 7. Distribution de *Q. rubra* en Europe (Woziwoda *et al.* 2014b).

Dans son aire d'introduction, il est présent en peuplement pur dans des plantations ou alors en forêt naturelle, associé à *Quercus robur*, *Pinus sylvestris* ou d'autres espèces de feuillus comme *Betula pendula* ou *Populus tremula* (Woziwoda, Kopeć & Witkowski 2014a). En Europe Centrale, les forestiers suggèrent de réaliser des coupes rases sur de petites surfaces ou des coupes progressives pour assurer suffisamment de lumières aux futures générations de chêne rouge (Miltner & Kupka 2016). En France, la sylviculture du chêne rouge est menée majoritairement en futaies, pour favoriser des arbres bien droits, et très rarement en taillis sous futaie (Bartoli & Le Goff 1994). En Belgique et en Allemagne, le chêne rouge est cultivé en futaie pure ou en mélange (Kenk & Borsy 1994; Thill 1994). Il est conseillé de pratiquer des coupes d'éclaircies tous les 6 à 8 ans pour maximiser la production de bois et éliminer les arbres concurrents ou indésirables (CRPF Aquitaine 2005; CRPF Poitou-Charentes 2007; CRPF Limousin 2011; CRPF Rhône-Alpes 2014). Pour corriger artificiellement la forme des chênes rouges qui ont tendance à présenter des fourches ou d'autres défauts, Hubert (1994) conseille de pratiquer une taille de formation sur les jeunes plants et l'élagage des branches basses sur les arbres adultes

dans le but d'obtenir des troncs droits et une production de bois sans nœuds. Son bois peut être utilisé comme bois d'œuvre en menuiserie, ébénisterie, charpente pour l'intérieur et comme bois de chauffage (Vansteenkiste, Boever & Acker 2005, CRPF Rhône-Alpes 2014).

Le chêne rouge d'Amérique est un arbre de grande taille pouvant atteindre jusqu'à 35 mètres de hauteur à l'âge adulte présentant un feuillage très coloré à l'automne (**Figure 8 a et b**). C'est une espèce post-pionnière tolérant modérément l'ombre. Sa croissance au stade juvénile est rapide et la rend très compétitive vis-à-vis des espèces voisines (Sander 1990). Suite à des perturbations d'origine naturelle ou anthropique, le chêne rouge est capable de se régénérer à partir de rejets de souche (Hibbs 1983). Comme la plupart des arbres forestiers, cette espèce est allogame et anémophile ce qui permet une pollinisation par de nombreux individus mâles différents favorisant ainsi l'échange de gènes. Chez les chênes rouges, le cycle de reproduction se déroule sur deux années de végétation. Au printemps de la première année, les fleurs mâles émergent une quinzaine de jours avant les fleurs femelles. Au mois d'avril, les fleurs mâles émettent leur pollen et pollinisent les fleurs femelles. Le pollen transperce le stigmate pour émettre son tube pollinique à travers le style puis celui-ci stoppe sa croissance juste avant de féconder les ovules encore immatures. La fécondation a lieu au printemps de la deuxième année de végétation après maturation définitive des ovules et reprise de la croissance du tube pollinique. Elle a lieu au mois de juin et se poursuit par le développement des glands jusqu'en automne. Une fois mures, les glands chutent au sol entre septembre et novembre (**Figure 8 c**) et rentrent en dormance pour tout l'hiver. Ils ne pourront germer qu'à partir du printemps suivant (Sander 1990). Les arbres commencent à fructifier à partir de l'âge de 20-25 ans et de façon abondante à partir de 50 ans avec de fortes productions de glands tous les 4 ans en moyenne (Sander 1990; Sork, Bramble & Sexton 1993). Les productions de glands présentent des variations interindividuelles et interannuelles (Greenberg 2000). La position de la couronne dans la canopée ainsi que la taille et l'âge des arbres peuvent influencer la quantité de glands produits (Dey 1995). De même, les arbres dominés et de petite taille produisent moins de fruits que les arbres dominant avec une large couronne (Sander 1990). Les conditions météorologiques, notamment le froid et l'humidité, durant la période de reproduction peuvent avoir un impact négatif sur la

dispersion du pollen et compromettre la pollinisation, la fécondation et, par conséquent, la production de glands (Dey 1995; Gribko, Schuler & Ford 2002). De même, des espèces d'oiseaux, de mammifères, d'insectes et autres microorganismes sont susceptibles de consommer ou d'attaquer les glands matures une fois au sol (Sork 1984; Gribko *et al.* 2002; Haas & Heske 2005). En Amérique du Nord, la dispersion des glands est assurée par de nombreuses espèces animales aussi bien par les airs grâce aux oiseaux qu'au sol par des mammifères terrestres (Darley-Hill & Johnson 1981; Sork, Stacey & Averett 1983; Gribko *et al.* 2002; Schnurr, Ostfeld & Canham 2002).



Figure 8. Photos de *Q. rubra* : vue d'ensemble d'un individu adulte (a), feuillage à l'automne (b), gland mature et cupule (c).

Paradoxalement, le chêne rouge présente des difficultés à se régénérer dans son aire d'origine (Crow 1988) alors qu'une forte dynamique de régénération est constatée en Europe (Steiner, Abrams & Bowersox 1993; Major *et al.* 2013). En Amérique du Nord, la régénération du chêne rouge dépend de la fréquence des perturbations telles que les feux d'origine naturelle et anthropique et la coupe de bois. En effet, ces perturbations

permettent à la lumière de pénétrer dans le sous-bois et de réduire la compétition interspécifique entre les jeunes plantules d'arbres (Abrams 1992, 2005). En l'absence de ces perturbations, des espèces ligneuses plus tolérantes à l'ombre, telles que *Acer saccharum* et *A. rubrum* par exemple, peuvent dominer dans le sous-bois et entrer en compétition avec *Q. rubra* en diminuant l'accès à la lumière et limitant sa régénération (Lorimer 1984; Lorimer, Chapman & Lambert 1994; Dey & Parker 1997; Dech, Robinson & Nosko 2008). La croissance et la survie des plantules de *Q. rubra* sont avantagées dans les sites où repoussent des plantes ligneuses et herbacées dont la canopée clairsemée peut filtrer la moitié des rayons lumineux du soleil (Crow 1992). Les gels tardifs au printemps, la prédation des glands à l'automne, de même que le broutage du feuillage durant toute la saison de végétation par les cervidés, notamment par le cerf de Virginie en Amérique du Nord ou le chevreuil en Europe, peuvent altérer le développement des jeunes plantules et limiter la régénération du chêne rouge (Ducousso 1994; Steiner 1995; Buckley, Sharik & Isebrands 1998; Steiner & Joyce 1999). Cependant, les pressions de prédation sur les glands et d'herbivorie sur les jeunes plantules semblent plus faibles en Europe que dans l'aire d'origine expliquant possiblement les facilités de régénération de *Q. rubra* (Steiner *et al.* 1993). De même, l'ombre ne semble pas compromettre l'accroissement des plantules de *Q. rubra*, contrairement à ce qui est observé en Amérique du Nord (Major *et al.* 2013). En Europe, *Q. rubra* est capable de pousser dans des milieux fermés à proximité d'espèces compétitrices vis-à-vis de l'ombre, comme *Q. robur* et *Q. petraea* par exemple (Vansteenkiste, Boever & Acker 2005). En revanche, comme la plupart des espèces de Fagacées, *Q. rubra* peut être affecté par des champignons pathogènes. En France et en Allemagne, il est principalement touché par *Phytophthora cinnamomi*, responsable de la maladie de l'encre, et *Pezizula cinnamomea*, deux espèces de champignons qui parasitent l'écorce et provoquent des chancres sur le tronc (Kehr 1991, 1992; Robin, Desprez-Loustau & Delatour 1992; Robin, Dupuis & Desprez-Loustau 1994; Marçais, Dupuis & Desprez-Loustau 1996). *Quercus rubra* est également vulnérable à la maladie de la pourriture des racines causée par *Collybia fusipes*, un champignon qui provoque des lésions au niveau des racines et de la base du tronc (Marçais & Delatour 1996; Marçais, Caël & Delatour 2000). Plusieurs espèces d'insectes ravageurs peuvent consommer les feuilles, le bois ou les glands de *Q. rubra*,

bien que ces attaques soient moins importantes comparé aux espèces de chênes autochtones (*Q. robur*, *Q. petraea*) (Delplanque & Menassieu 1994).

L'introduction et la propagation de *Q. rubra* en Europe sont associées à plusieurs sortes d'impacts écologiques négatifs. *Quercus rubra* affecte la biodiversité au sein des communautés végétales natives dans lequel il se développe en diminuant la richesse spécifique et l'abondance des arbustes et herbacées natifs, en raison de sa forte compétitivité vis-à-vis de la lumière (Chmura 2013; Woziwoda, Kopeć & Witkowski 2014a). La structure horizontale (recouvrement) de la végétation forestière et la composition spécifique se trouvent modifiées sous des peuplements de *Q. rubra* comparés à ceux de *Q. robur*, notamment les strates arborées secondaires et herbacées (Marozas, Straigyte & Sepetiene 2009). *Quercus rubra* limite la dynamique de régénération d'espèces ligneuses natives sous son couvert (Woziwoda, Kopeć & Witkowski 2014a). Il est capable de pousser dans divers habitats aussi bien sur des sols secs et pauvres que des sols humides et fertiles (Woziwoda *et al.* 2014b), et de modifier les propriétés chimiques et la composition biologique du sol. Sous *Q. rubra*, les sols contiennent moins de micromycètes, de minéraux et de microorganismes, dont les décomposeurs de la litière, comparés aux sols sous *Q. robur* (Riepšas & Straigyte 2008).

Problématique et objectifs de la thèse

Ce travail de doctorat s'inscrit dans la thématique des invasions biologiques dont les conséquences menacent la biodiversité à l'échelle planétaire. Dans le domaine des invasions végétales terrestres, l'intérêt est plus largement porté sur les plantes herbacées que les espèces ligneuses. Les arbres sont considérés comme des espèces ingénieurs au sein des écosystèmes puisqu'ils influencent directement ou indirectement la disponibilité des ressources et modifient, maintiennent ou créent des habitats (Jones, Lawton & Shachak 1994). Il semble donc primordial de s'intéresser aux arbres invasifs dont les impacts peuvent porter atteinte aux écosystèmes natifs dans lesquels ils prolifèrent et aux espèces qui s'y développent. Alors que pour certaines espèces introduites et naturalisées en Europe leur statut d'espèce invasive est clairement établi, pour d'autres leur statut reste ambigu, souvent par un manque de connaissances sur leur dynamique de dispersion dans l'aire d'introduction. Le chêne rouge (*Quercus rubra*) fait partie de ces espèces introduites en Europe dont le statut d'espèce invasive n'est pas clairement déterminé dans tous les pays européens où il se trouve. De plus, les arbres introduits dans une nouvelle aire géographique depuis plusieurs siècles offrent également l'opportunité d'étudier les processus évolutifs qui ont pu se produire durant le processus d'introduction et de naturalisation.

Ainsi, mon travail doctoral contribue à répondre à deux objectifs principaux, présenté en deux parties, la première abordant des notions relatives à l'écologie de l'invasion et la seconde partie des notions relatives à l'écologie évolutive et la génétique des populations.

Le premier objectif de cette thèse a été de déterminer si le chêne rouge pouvait être considéré comme une espèce invasive en Europe de l'Ouest. Les questions relatives à cet objectif sont les suivantes :

- Est-ce que le chêne rouge réussit à se développer spontanément, sans intervention de l'Homme, en dehors des zones de plantation dans les forêts d'Europe ?

Pour répondre à cette question, une analyse détaillée des inventaires forestiers nationaux de l'Espagne, l'Italie, l'Allemagne, la France et la Wallonie a été réalisée

pour identifier si des plantules, jeunes plants et arbres adultes de chêne rouge étaient présents hors de leur zone de plantations, dans des forêts de feuillus ou conifères. Les résultats et conclusions sont présentés dans le chapitre 1.

- Est-ce que les glands de chêne rouge parviennent à être dispersés au sol dans les forêts de Wallonie et quels sont les animaux impliqués dans cette dispersion ?
Pour répondre à ces questions, des expérimentations d'observation du prélèvement des glands de chêne rouge par des animaux au sol ont été installées dans des forêts wallonnes et réalisées pendant deux automnes consécutifs pour identifier les animaux impliqués dans la dispersion du chêne rouge au sol. Les résultats et conclusions sont exposés dans le chapitre 2.

Le second objectif de la thèse est d'analyser la diversité génétique des populations natives et introduites de chêne rouge afin d'évaluer l'existence de différenciations génétiques entre les populations depuis l'introduction en Europe. Les questions associées à cet objectif sont les suivantes :

- Est-ce que les populations natives et introduites de chêne rouge sont génétiquement différenciées ? Si oui, est-ce en conséquence de nouvelles pressions de sélection rencontrées en Europe ou en conséquence d'une sélection artificielle, orientée par la main de l'Homme ?
Pour répondre à ces questions, une comparaison de plusieurs traits phénotypiques relatifs à la valeur sélective des populations introduites et natives de chêne rouge a été effectuée dans trois tests de provenances-descendances installés en France. Les résultats et conclusions sont détaillés dans le chapitre 3.
- D'où proviennent les populations introduites en Europe ? La diversité génétique du chêne rouge présente dans l'aire d'introduction est-elle similaire à celle observée dans l'aire native ? Est-ce qu'il y a eu une réduction de la taille efficace des populations (phénomène de goulot d'étranglement) lors de l'introduction ?
Pour répondre à ces questions, une analyse génétique des populations natives et introduites à l'aide de marqueurs moléculaires (SNP) a permis de comparer

la structuration et la diversité génétique au sein de ces deux groupes de populations et d'identifier les populations sources à l'origine des populations introduites. Différents scénarios évolutifs ont été testés par inférence bayésienne. Les résultats et conclusions sont analysés dans le chapitre 4.

Partie 1

Dans cette première partie, l'objectif a été de déterminer si *Q. rubra* pouvait être reconnu comme une espèce invasive en Europe de l'Ouest. Selon les définitions de Richardson *et al.* (2000) et Blackburn *et al.* (2011), une espèce naturalisée est considérée comme invasive lorsqu'elle a franchi la barrière de dispersion dans l'aire d'introduction. Dans le chapitre 1, nous avons tout d'abord voulu caractériser la distribution de *Q. rubra* dans les forêts d'Espagne, Italie, France, Allemagne et Wallonie à partir des données des inventaires forestiers nationaux. Dans chaque pays ou régions, nous avons comparé la proportion de parcelles inventoriées abritant des individus de *Q. rubra* juvéniles ou adultes dominées par *Q. rubra* ou une autre espèce de feuillus ou conifères.

Dans le chapitre 2, nous avons voulu savoir si les glands de *Q. rubra* pouvaient être prélevés et dispersés par des animaux au sol. Nous avons mis en place une expérimentation en milieu naturel pour comparer le taux de prélèvement des glands de *Q. rubra* par rapport à ceux de *Q. robur* dans plusieurs sites forestiers en Wallonie. Afin d'identifier, au mieux, les animaux prélevant les glands de *Q. rubra*, des pièges photographiques capable de filmer et photographier ces animaux ont été installés en direction des glands de *Q. rubra*. Cette expérimentation a été réalisée consécutivement à l'automne 2013 et à l'automne 2014 par des étudiants de Gembloux Agro-Bio-Tech.

Chapitre 1 : Assessing invasiveness of *Quercus rubra* from its patterns of distribution in European forests

In preparation.

Annabel J. Porté ^{1,*}, Nastasia Merceron ^{1,2}, Anna-Karine Jean ¹ and Arnaud Monty ²

¹ BIOGECO, INRA, Université de Bordeaux, 33615 Pessac, France.

² University of Liege, Gembloux Agro-Bio Tech, Biodiversity and Landscape Unit, 2, Passage des Déportés, B-5030 Gembloux, Belgium.

* Correspondence: annabel.porte@u-bordeaux.fr; Tel.: +33-54000-3664

Abstract

Quercus rubra was introduced in Europe from North America at the end of the 17th century and used as an ornamental and forest tree; since the end of the 20th century, managers question its invasive status. To evaluate its dynamics across European forests, data from five national forest inventories were analyzed with respect to the dominant species of the stand. Plots presenting presence of individuals of *Q. rubra* represented up to 2.7% of the total inventoried plots. In each country, *Q. rubra* saplings/adults were more largely distributed under non-similar species (40 to 89%). In France, Spain and Wallonia, dominant species were mostly native oaks; in Spain and Germany, *Q. rubra* was largely present under coniferous stands. Abundance of regeneration was always higher when the dominant species was *Q. rubra*, but regeneration also occurred under all the other species canopies. In Spain and France, regeneration was largely occurring on plots without any adult *Q. rubra* individual, suggesting the species is capable of distant dispersal. Considering these elements of self-reproduction and spreading at distance of the original human mediated introductions, *Q. rubra* can be defined as an invasive species to European forests. Risk assessment and evaluation of economic and ecological impacts should now be addressed to evaluate if management measures or control legislation should be considered.

Keywords

Distribution patterns; invasiveness; *Quercus rubra*; European national forest inventories; natural regeneration; invasive species

Introduction

During the last decade, ecological and economic concerns associated with invasive species have led to the development of international organizations and regional programs for preventing and managing invasive species (Shine, 2007). In ratifying the Convention on Biological Diversity (CBD), all the member states committed 'to prevent the introduction of, or control or eradicate those alien species which threaten ecosystems, habitats or species' (De Poorter, 2009). In 2014, the European Union Parliament has adopted a regulation on the prevention and management of the introduction and spread of invasive alien species (Regulation E.U., 2014; Genovesi et al., 2015). Experts are now working to determine which exotic species should be registered on the lists of invasive alien species of Union concern (European Commission, 2016). But we are still lacking information on some species making it hazardous for using lists for further regulation (McGeoch et al., 2012).

The first condition for being listed is that the exotic species has to be invasive. Definitions of invasive species are not straightforward: all sociological groups don't always share the same definitions, negative impacts being largely considered as a compulsory criteria out of the scientific community (Catford et al., 2016). Thus scientists debated over it during the last fifteen years (Richardson et al., 2000; Maclsaac & Colautti, 2004; Blackburn et al., 2011; Barney et al., 2013; Catford et al., 2016) and proposed a unified framework. The history of the species, its ranges and dynamics are to be taken into account in the definition: first, the species has to be exotic in the considered range, having been introduced on purpose or accidentally; then it must have demonstrated that it can reproduce enough in the new range to maintain natural populations and to expand through natural dispersal in a variety of sites and environments (see Blackburn et al. (2011) and review by Catford et al. (2016)). This scientific definition does not consider the impacts (positive or negative) of the species; on the contrary impacts should be considered for further risk assessment and decision making regarding regulation and management (Essl et al., 2011; Keller et al., 2011; Larson et al., 2011; Barney et al., 2013).

Contrary to many herbaceous or animal species, most exotic trees were deliberately introduced mostly for horticultural reasons (Richardson & Rejmánek, 2011) and for economic reasons they are still considered for uses in horticulture, landscaping or forestry. Although benefiting of planting and/or breeding programs, some exotic trees are also questioned regarding their invasiveness. This can ultimately lead to conflicts or strongly divergent views (Dickie et al., 2014) to decide whether, where and when tree species should be considered invasive, and whether they could be planted or should be removed. Deliberately introduced from the North America to Europe in the 17th century, probably in 1691 in France and circa 1724-1732 in England (Goeze, 1916; Timbal et al., 1994; Magni Diaz, 2004), northern red oak (*Quercus rubra*) has been used both for ornamental and wood production purposes (Timbal et al., 1994; Woziwoda et al., 2014b). Since then, it has been establishing populations over the entire European continent (Daisie, online resource) with published evidence mostly in central Europe (Riepsas & Straigytė, 2008; Major et al., 2013; Woziwoda et al., 2014a, 2014b). In the 70-80s, it was considered as an interesting species for timber production, when forest managers asked for a tree breeding program to be undertaken in France (Kremer, 1986). Nowadays, the same foresters point out that its regeneration sometimes presents an invasive behavior (CRPF Normandie, 2001; CRPF Lorraine Alsace, 2005) even recommending avoiding its cultivation to prevent competition when local species are preferred. In Central Europe, particularly in Poland, *Q. rubra* high regeneration levels impede local tree species regeneration or negatively affect understory biodiversity (Chmura, 2013; Woziwoda et al., 2014a).

The ability of *Q. rubra* to spread at distance of original populations and establish new populations is still poorly documented in Europe. Acorns dispersal is mostly achieved by gravity and by animals: in the native range, acorns can be dispersed by jays and squirrels (Desmarais, 1998); in Europe, it was recently demonstrated that the spreading barriers can be overcome by native jays (Myczko et al., 2014) and by rodents (Bieberich et al., 2016) (see also Merceron et al. chapter 2). Moreover, the ability of seeds to produce a new forest regeneration of *Q. rubra* showed a major contrast between the native area and Europe. In recent decades, native populations in North America were marked by low regeneration levels (Crow, 1988; Fei et al., 2011) that could result from high competition

from other plant species in forests where fire disturbance was reduced (Nowacki et al., 1990; Buckley et al., 1998). In Europe, on the contrary, introduced populations have sometimes demonstrated high levels of regeneration (Major et al., 2013), even higher than that of native oaks *Quercus robur* or *Quercus petraea* (Vansteenkiste et al., 2005). But these studies were presenting local cases and make it difficult to strongly conclude to the ability of *Q. rubra* to develop distant populations under various forests in Europe.

In this context, we proposed to assess the invasive status of *Q. rubra* at the biogeographic scale of several European countries using data from national forest inventories. We intended to evaluate the current distribution of the species within the various types of forests and assess its ability to spread considering both trees and seedlings, by analyzing its presence relatively to the native species dominating the stands.

Materials and Methods

Data were retrieved from the last German, French, Spanish, Wallonia (Belgium) and Italian forest inventories (see **Table 1** for databases details) selecting all plots presenting the presence of *Q. rubra*. Data correspond to saplings¹ and adult trees (Na, **Table 1**), as forest inventories are focusing on trees with a minimum diameter at breast height (4.5 cm in Italy, INFC online; 7 cm in Germany, Thünen-Institut, online; 7.5 cm in France and Spain, IGN a, TRAGSATEC, online; 6.3 cm in Wallonia, (Rondeux et al., 2010).

¹ Sapling: a usually young tree larger than a seedling but smaller than a pole or mature tree (Helms 1998).

Table 1. List and main characteristics of the European national forest inventories used to perform the analyses. For each country, inventory cycle (NFI) year or period are indicated, total number of plots inventoried (plot nb.), number of plots presenting *Q. rubra* individuals in the sapling/tree layer (Adult N_a), number of plots presenting *Q. rubra* seedlings (N_s) and total number of plots presenting individuals of *Q. rubra* (N_t). N_t does not correspond to the sum of N_a and N_s as *Q. rubra* individuals of each strata are not always present on the plot. Numbers between parentheses indicate the percentage of total plot number. Some databases are provided free of use on the indicated website.

Country	NFI	Year	Plot nb.	N_a	N_s	N_t	Website
Germany	3rd	2011-2012	20514	733 (3.57)	402 (1.96)	758 (3.69)	https://bwi.info/start.aspx
Wallonia	3rd	1994-2008	11080	229 (2.07)	30 (0.27)	229 (2.07)	Data provided on collaboration basis
France	3rd	2005-2014	61844	382* (0.62)	939* (1.52)	940 (1.52)	http://inventaire-forestier.ign.fr/spip/spip.php?article532
Spain	3rd	1997-2007	91742	154* (0.17)	126* (0.14)	217 (0.24)	http://www.magrama.gob.es/es/biodiversidad/servicios/banco-datos-naturaleza/informacion-disponible/ifn3_bbdd_descargas.htm.aspx
Italy	2nd	2005	7188	10 (0.14)	-	10 (0.14)	http://www.inventarioforestale.org/en/node/13

* Due to missing data, fewer plots were used in the distribution analyses: in France, 351 and 824 plots with adults or regeneration of *Q. rubra*; in Spain, 130 and 109 plots, respectively.

Forest regeneration² was monitored in different ways according to the inventory. In France and Wallonia, seedling abundance was quantified per plot providing a percentage of soil coverage, with cover classes following a Braun-Blanquet scale (1 = 0–5%, 2 = 5–25%, 3 = 25–50%, 4 = 50–75% and 5 = 75–100% of soil cover; IGN a, online). In Wallonia, data were provided with a 6 class cover scale: class 0 indicating only presence of the species was added to class 1 to go back to a similar 5 class scale compared to the French inventory. In Spain and Germany, seedlings were counted on a 5 m (78.5 m²) and a 1 or 2 m (3.14 and 12.6 m²) radius plot, respectively. In Spain, data were then provided following a 3 level density scale (1 = scarce, 1-4 seedlings per plot or < 510 ind.ha⁻¹; 2 = regular, 5-15 seedlings per plot or < 1900 ind.ha⁻¹; 3 = abundant, > 15 seedlings per plot or > 1900 ind.ha⁻¹; TRAGSATEC online). Data counts on larger seedlings (H > 1.30 m but DBH < 7.5 cm) were provided but these values were transformed to follow the same classification scale (1-3). In Germany, regeneration data (included seedlings higher than 20 cm of height, and with diameter lower than 7 cm) were provided as count per plot; we transformed these values into density (ind.ha⁻¹) and analyzed them using a 5 class scale. In Italy, data were only provided as total regeneration per plot, making it impossible to separate the species and perform the analyses.

In the Spanish and French inventories, the dominant species of the stand was provided in the databases as the one representing the largest fraction in the canopy cover. In the Wallonia inventory, the dominant species was identified by the one presenting the highest percentage of basal area in the stand. In the Italian inventory, the dominant species was estimated in the same way. In Germany, the dominant species was not provided but the stand type, identified through the main genus in the stand was indicated. To achieve a similar analyses than in other countries, the dominant species was also identified using basal area estimates. Allometric relationships in trees indicate that basal area is proportional to crown leaf area (Davis & Roberts, 2000) and thus canopy cover and basal areas can be considered equivalent proxies to get the stand dominant species.

² Regeneration: seedlings existing in a stand (Helms 1998).

Results

1. *Quercus rubra* distribution reveals its ability to develop in non-identical species stands

Number of plots with *Q. rubra* adult trees (N_a) corresponded to 0.14 to 3.69% of total inventoried plots depending on the national forest inventory (**Table 1**). Adults and saplings were largely present under non identical species canopy stands: stands dominated by *Q. rubra* only represented 11 to 40% of the plots, according to the country (**Figure 1**).

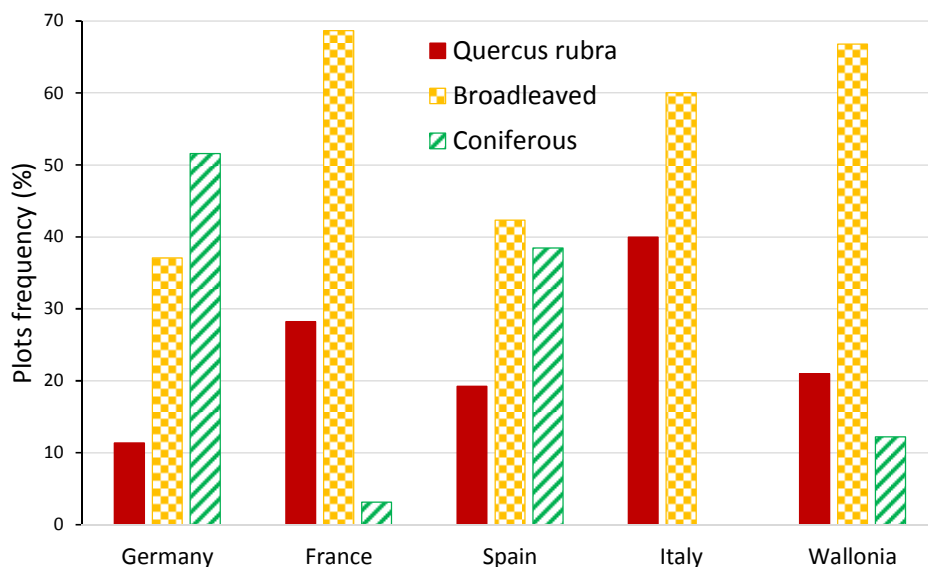

Figure 1. Proportion of plots (N_a / plot nb.) with presence of *Q. rubra* saplings or adults which are dominated by this same species, or any other broadleaved or coniferous species. Data are presented per country.

In Germany, *Q. rubra* was largely present in conifer dominated stands, mostly *Pinus sylvestris* (30%) and *Picea abies* (14%), then in *Fagus sylvatica* stands (14%). It is only moderately present in *Q. rubra* dominated stands (11.3%) and quasi-absent from white oak stands (6% *Quercus robur*, 4% *Quercus petraea*). However, in France, *Q. rubra* was mostly present in white oaks dominated stands (48% *Q. robur* and 16% *Q. petraea*) with only 28.2% of the plots dominated by *Q. rubra*. The same pattern was observed in Wallonia, with native oak forests representing 32% of the plots, then *Q. rubra* dominated stands (21%) and *F. sylvatica* stands (11%). In Spain, it was mostly present in *Pinus*

radiata stands (30%) and *Q. robur* stands (25%), then in *Q. rubra* stands (19.2%). On the contrary, in Italy, when the species was present on the plot, *Q. rubra* was dominant in 40% of the cases, then it was encountered in a variety of stands (*Populus nigra* 20%). A complete list of the plots distribution according to the dominant species of the stands can be found in appendix **Table A1**.

2. *Quercus rubra* regeneration indicates a high dynamics of spread of the species in some countries

In Germany, Spain and Wallonia, the number of plots with regeneration was equivalent or lower to that with saplings or adult trees (**Table 1**). In Wallonia and Germany, all or most plots presenting *Q. rubra* regeneration were also presenting adult trees. On the contrary, in Spain, 50% of the plots presenting regeneration did not present adult *Q. rubra*, as regeneration and adult trees were largely not co-occurring on the same plots. A typical pattern was observed in France: regeneration was present in a much larger number of plots than plots with adult trees: 59% of the plots presenting regeneration were indicated without any adult *Q. rubra* trees.

Overall, the distribution of the plots according to the stand dominant species presented the same pattern for seedlings of *Q. rubra* compared to saplings/ adults, whatever the country (**Table A1**). The only noticeable shift in regeneration corresponded in an increase in the number of plots under the main invaded species in Spain (*P. radiata*) and France (*Q. robur*) with a slight decrease in the *Q. rubra* dominated plots. In Germany, *Q. rubra* regeneration under *F. sylvatica* was lower compared to the presence of adult trees.

Regeneration abundance was analyzed by focusing on the plots of which dominant species represented more than 10% of the plots with *Q. rubra* regeneration, so it corresponded to 3 to 4 stand types, according to the country. In France and Wallonia, the abundance of *Q. rubra* regeneration in the understory was higher when *Q. rubra* was the dominant stand species, with cover reaching more than 50% (classes 4 and 5) on 51 and 59% of the plots, respectively. *Q. rubra* regeneration was lower under white oaks and beech canopies, abundance corresponding mostly up to 25% (classes 1 and 2; **Figure 2 a, b**).

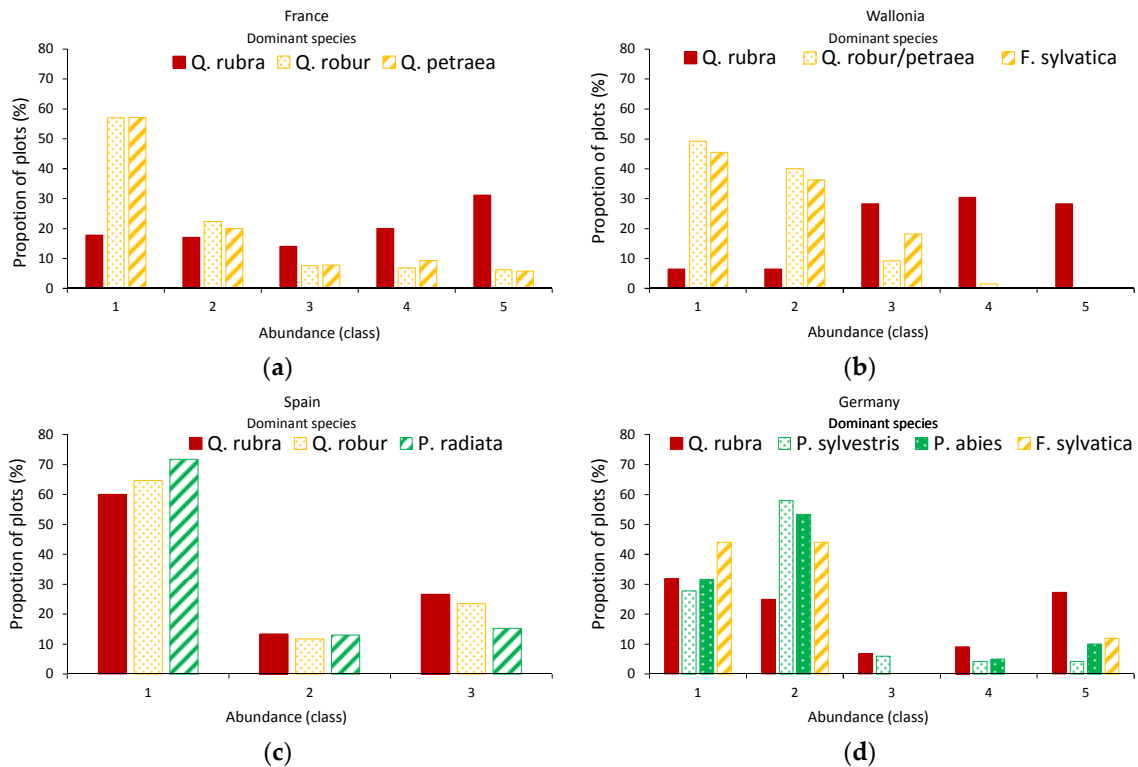

Figure 2. Proportion of *Q. rubra* seedlings per abundance class. For each country, analyses focused on species representing more than 10% of the analysed plots. (a) In France, *Q. robur*, *Q. petraea*, *Q. rubra*. (b) In Wallonia, *Q. robur/petraea*, *Q. rubra*, *F. sylvatica*. The five abundance classes are based on a percentage of soil coverage (1 = 0–5%, 2 = 5–25%, 3 = 25–50%, 4 = 50–75% and 5 = 75–100%). (c) In Spain, *P. radiata*, *Q. robur*, *Q. rubra*. The three classes are based on seedling density (1 < 510 ind.ha⁻¹; 2 < 1900 ind.ha⁻¹; 3 > 1900 ind.ha⁻¹) (d) In Germany, *P. sylvestris*, *P. abies*, *F. sylvatica*, *Q. rubra*. The five classes are based on seedling density (1 < 2000 ind.ha⁻¹; 2 < 4000 ind.ha⁻¹; 3 < 6000 ind.ha⁻¹; 4 < 8000 ind.ha⁻¹; 5 > 8000 ind.ha⁻¹).

In Spain (**Figure 2 c**), no differences in the abundance of the regeneration were observed with the stand dominant species, the levels of regeneration being mainly scarce (class 1). Overall, regeneration was weak compared to that in the temperate countries: this was underlined by the fact that regeneration abundance in most plots from Spain was equivalent to class 1 of Germany (density < 2000 ind.ha⁻¹). Finally in Germany (**Figure 2 d**), the regeneration was generally of the same abundance whatever the dominant species of the stand, with the highest class 5 abundance still mostly observed in *Q. rubra* dominated stands.

Discussion

Using national forest inventories data, we evidenced that in Europe, *Q. rubra* is mainly present in forests of which the canopies are not dominated by *Q. rubra*, mostly oak trees in France and Wallonia and conifers in Spain and Germany. Although *Q. rubra* is sometimes mentioned as an invasive tree species in Europe (Poland (Tokarska-Guzik, 2005; Woziwoda et al., 2014b), Techkia (Pysek et al., 2003), Belgium (Verloove, 2006), Lithuania (Riepsas & Straigytė, 2008; Straigytė & Zalkauskas, 2012), there was no broad evidence of its ability to regenerate at distance from adult populations, a criterion being part of the definition of an invasive species (Richardson et al., 2000; Blackburn et al., 2011). The presence of sapling/adults mostly under non similar canopies (60 to 89% of the plots) and in some countries, the large presence of seedlings under stands presenting no mature *Q. rubra* trees make it clear that the species is able to disperse and develop new populations. According to the scientific definition, this naturalized species is thus invasive in Europe.

The data used in our study does not separate artificial plantations from natural stands. However, indications about forest management practices comfort our analysis. In France, *Q. rubra* was mostly planted or seeded as monospecific even-aged stands (Timbal et al., 1994; CRPF Poitou Charentes, 2007; Woziwoda et al., 2014b). Similarly, in Spain (Galicia) and Italy (Varese), we found indications of mono-specific plantings (Molina Rodriguez et al., available online; Viganò and Zavagno 2009). In Germany, we found two indications, either mono-specific plantations or mixtures with *Fagus sylvatica* (Gauer, 2010; Ruhm, 2013); the admixture was particularly indicated in the North-Rhine Westphalia region (Gauer, 2010). We can thus hypothesized that most of the plantations are such part of the 11% to 40% of the plots whose canopies are dominated by *Q. rubra*, and in Germany a part of the plots dominated by *F. sylvatica*; other stands being issued from natural regeneration and spreading of the species.

The patterns of presence of *Q. rubra* in the European forests are signs of its ability to disperse and establish in European forests. This regeneration certainly resulted from dispersal by animals such as jays and rodents (Merceron et al. chapitre 2, Myczko et al., 2014; Bieberich et al., 2016) with a local dispersal distance evaluated to 300 m (Vor, 2005)

and 500 m (Riepsas & Straigytė, 2008). Moreover, jays can fly back with seeds between territories distant of up to a few kilometers (*Q. ilex* (Gomez, 2003), *Q. petraea* and *Q. robur* (den Ouden et al., 2004)) thus contributing to explain the patterns that we have observed throughout European forests. Locally, the dynamics of *Q. rubra* regeneration was previously evaluated in certain types of stands: in pine and in mixed broadleaved forests in Belgium (Lust et al., 1998; Vansteenkiste et al., 2005), pine or spruce in Germany and Poland (Chmura, 2004; Vor, 2005; Zerbe & Wirth, 2006). In a sampling of 15 Belgium *Pinus sylvestris* stands, the two main species in the forest regeneration were *Prunus serotina* and *Q. rubra*. In Italy, *Q. rubra* was indicated to frequently invade native oak forests in Lombardy and Piedmont, where it impeded their regeneration (Viganò and Zavagno, 2009; Celesti-Grapow et al., 2010); in this country, only a subsample of the forest plots identified on photographs are really inventoried, so the scarcity of forest inventory data could explain we were not able to identify the main species colonized by *Q. rubra*. The identity of the dominant species under which *Q. rubra* could be found in Europe varied between countries, and was largely depending on the proportion of the native species in the national forests. In Germany for instance (Federal Ministry of Food, Agriculture and Consumer Protection, 2011), forests are mainly spruce (28.2%), pines (23.3%) and beech (14.8%) plantations, with only 9.6% of oak forests; this could largely explain that *Q. rubra* was mainly distributed in *P. abies* (14.4 %) , *P. sylvestris* (30.1%) and *F. sylvatica* (14%), with only 10% under native oak forests. In France, forests are mostly broadleaved forests (72%), with *Q. robur* and *Q. petraea* dominated stands constituting the first two species with 13% and 11% of the forested areas (IGN b, available online); however, the pattern of *Q. rubra* is only partly following these proportions, with a much higher proportion of 47.9% and 16%. So in general, our analysis would provide conclusions on the invasiveness of *Q. rubra* and according to the local conditions, it could also help to assess the invasibility of the different forest ecosystems. To be more accurate in evaluating invasiveness of European forests, more information on the local environment (soil, climate) could be necessary. A spatial landscape analysis could also be performed to take into account propagule pressure, through the distance to the planted mono-specific *Q. rubra* stands.

Conclusions

As a first step towards defining actions to be undertaken in Europe regarding the management of the exotic and naturalized tree *Q. rubra*, we demonstrated that it can spread and develop under different forest types. Currently, we would such recommend that the species be listed on watch lists. Regarding EU legislation, actions such as interdiction of planting or control measures will be undertaken if negative impacts are resulting from this behavior (Regulation E.U., 2014). Thus, before proposing the species for consideration or not on the list of invasive alien species of Union concern (European Commission, 2016) further analyses on paired plots with and without *Q. rubra* could be performed to quantify the ecological impacts on understory biodiversity and native tree regeneration.

Acknowledgments: The authors would like to Franz Kroiher from the German National Forest Inventory who helped in extracting the accurate data from the German language databases and website. N.R.M. PhD was financially supported by a grant from the French National Research Agency (ANR) in the frame of the Investments for the future Program (ANR-10- IDEX-03-02). A-K. J. was financially supported by a grant from the European Research Council under the Advanced Grant TREEPEACE (#FP7-339728).

Author Contributions: A.J.P conceived and performed the forest data analyses; A.J.P., N.R.M. and A-K.J. performed the bibliographic research; A.J.P, N.R.M, A-K.J. and A.M. wrote the paper.

Conflicts of Interest: The authors declare no conflict of interest. The founding sponsors had no role in the design of the study; in the collection, analyses, or interpretation of data; in the writing of the manuscript, and in the decision to publish the results.

Appendix

Table A1. Percentage of plots with *Q. rubra* presence organized according to the dominant species of the stand, for each national forest inventory; data from saplings/ adult trees and seedlings (Rege.) were considered separately. Bold characters indicate proportion over 10%.

Species	Germany		France		Spain		Italy	Wallonia	
	Adults	Rege.	Adults	Rege.	Adults	Rege.	Adults	Adults	Rege.
<i>Abies alba</i>	1.3	0.8	-	-	-	-	-	-	-
<i>Abies grandis</i>	0.1	-	-	-	-	-	-	-	-
<i>Acer platanoides</i>	0.8	0.8	-	-	-	-	-	0.4	0.5
<i>Acer pseudoplatanus</i>	1.7	1.2	-	0.1	-	-	-	5.2	4.5
<i>Aesculus hippocastanum</i>	-	-	0.3	0.1	-	-	-	-	-
<i>Alnus glutinosa</i>	1.3	1.0	0.9	0.4	-	-	-	0.9	1.0
<i>Alnus incana</i>	-	-	-	0.1	-	-	-	0.4	0.5
<i>Betula pendula</i>	2.4	3.5	-	1.3	-	-	-	-	-
<i>Betula pubescens</i>	0.4	0.7	-	-	-	-	-	-	-
<i>Betula sp.</i>							-	3.9	4.5
<i>Carpinus betulus</i>	0.9	0.2	0.3	0.7	-	-	-	-	-
<i>Castanea sativa</i>	0.7	0.5	1.7	2.5	1.5	0.9	-	3.5	2.5
<i>Chamaecyparis lawsoniana</i>	-	-	-	-	1.5	1.8	-	-	-
<i>Eucalyptus globulus</i>	-	-	-	-	0.8	2.7	-	-	-

<i>Fagus sylvatica</i>	14.0	6.5	0.6	0.8	10.0	4.6	-	11.4	10.9
<i>Fraxinus angustifolia</i>	-	-	-	-	0.8	-	-	-	-
<i>Fraxinus exelsior</i>	0.9	1.0	0.3	0.8	-	-	10.0	-	-
<i>Fraxinus</i> sp.								3.5	3.5
<i>Larix</i> sp.	2.8	3.0	0.3	0.2	2.3	0.9	-	1.7	1.5
<i>Picea abies</i>	14.4	14.4	0.3	0.1	-	-	-	4.8	4.0
<i>Picea sitchensis</i>	0.1	-	-	0.1	-	-	-	-	-
<i>Pinus</i> sp.	0.1	-	-	-	-	-	-	-	-
<i>Pinus nigra</i>	0.3	0.5	0.6	0.7	1.5	1.8	-	0.9	1.0
<i>Pinus pinaster</i>	-	-	1.4	1.3	1.5	8.3	-	-	-
<i>Pinus radiata</i>	-	-	-	-	30.0	42.2	-	-	-
<i>Pinus sylvestris</i>	30.1	42.0	-	1.0	0.8	-	-	3.1	3.5
<i>Platanus hispanica</i>	-	-	-	-	0.8	0.9	-	-	-
<i>Populus nigra</i>	0.5	0.3	-	-	-	-	20.0	-	-
<i>Populus tremula</i>	0.1	0.5	0.3	0.4	-	-	-	-	0.8
<i>Populus (trichocarpa x maximoviczii x canadensis)</i>	0.3	0.3	-	-	-	-	-	2.2	2.5
<i>Prunus avium</i>	-	-	-	-	-	-	-	0.4	0.5
<i>Prunus serotina</i>	0.3	0.3	-	-	-	-	-	-	-
<i>Pseudotsuga menziesii</i>	2.4	1.5	0.6	1.1	0.8	1.8	-	1.8	2.0

<i>Quercus faginea</i>	-	-	-	-	-	0.9	-	-	-
<i>Quercus ilex</i>	-	-	-	-	0.8	-	-	-	-
<i>Quercus petraea</i>	4.2	3.7	16.0	17.0	-	-	10.0	-	-
<i>Quercus pubescens</i>	-	-	0.3	0.6	-	-	-	-	-
<i>Q pyrenaica</i>	-	-	0.3	0.2	0.8	1.8	-	-	-
<i>Quercus robur</i>	5.8	4.2	47.9	53.1	24.6	15.6	10.0	32.3*	32.2*
<i>Quercus rubra</i>	11.3	10.9	28.2	16.4	19.2	13.8	40.0	21.0	22.8
<i>Riparian species (Salix sp., Ulmus sp.)</i>	0.4	0.7	-	0.2	1.5	0.9	-	0.4	0.5
<i>Robinia pseudoacacia</i>	1.3	0.8	-	0.4	0.8	0.9	10.0	-	-
<i>Sorbus aucuparia</i>	0.1	0.2	-	-	-	-	-	-	-
<i>Tilia sp.</i>	0.9	0.5	-	-	-	-	-	0.4	0.5

*In Wallonia, *Quercus robur* and *Quercus petraea* were not indicated separately. An undefined “various broadleaved” category represented 1.3 and 1.0% of the plots for adults and regeneration respectively.

References

- Barney J.N., Tekiel D.R., Dollete E.S.J., & Tomasek B.J. (2013) What is the “real” impact of invasive plant species? *Frontiers in Ecology and the Environment*, **11**, 322–329.
- Bieberich J., Lauerer M., & Aas G. (2016) Acorns of introduced *Quercus rubra* are neglected by European Jay but spread by mice. *Annals of Forest Research*, **59**, 1–10.
- Blackburn T.M., Pyšek P., Bacher S., Carlton J.T., Duncan R.P., Jarošík V., Wilson J.R.U., & Richardson D.M. (2011) A proposed unified framework for biological invasions. *Trends in Ecology and Evolution*, **26**, 333–339.
- Buckley D., Sharik T., & Isebrands J. (1998) Regeneration of northern red oak: positive and negative effects of competitor removal. *Ecology*, **79**, 65–78.
- Catford J.A., Baumgartner J.B., Vesik P.A., White M., Buckley Y.M., & McCarthy M.A. (2016) Disentangling the four demographic dimensions of species invasiveness. *Journal of Ecology*, doi: 10.1111/1365–2745.12627.
- Celesti-Grapow, L., Pretto, F., Carli, E. & Blasi, C. (2010). Flora vascolare alloctona e invasiva delle regioni d'Italia. Ministero dell' ambiente e de la tutela del territorio e del mare, Università degli Studi di Roma La Sapienza
- Chmura D. (2004) Penetration and naturalisation of invasive alien plant species (neophytes) in woodlands of the slesian upland (southern Poland). *Nature Conservation*, **60**, 3–11.
- Chmura D. (2013) Impact of alien tree species *Quercus rubra* L . on understorey environment and flora : a study of the Silesian Upland (Southern Poland). *Polish Journal of Ecology*, **61**, 431–442.
- Crow T.R. (1988) Reproductive Mode and Mechanisms for of Northern Red Oak (*Quercus rubra*) A Review. *Forest Science*, **34**, 19–40.
- CRPF Lorraine Alsace (2005) Le chêne rouge d'Amérique.
- CRPF Normandie (2001) Bois et forêts de Normandie.
- CRPF Poitou Charentes (2007) Le chêne rouge d 'Amérique.
- Daisie. Species factsheet, *Quercus rubra*. Available online: <http://www.europe-aliens.org/speciesFactsheet.do?speciesId=14881#> (accessed on 8 September 2016).
- Davis F.W. & Roberts D. (2000) Stand structure in terrestrial ecosystems. *Methods in ecosystem science* (ed. by O.E. Sala, R.B. Jackson, H.A. Mooney, and R. Howarth), pp. 7–30. Springer Science and Business Media, New York.
- Desmarais B.K.M. (1998) Northern Red Oak Regeneration : Biology and Silviculture Division of Forests and Lands.

- Dickie I. a., Bennett B.M., Burrows L.E., Nuñez M. a., Peltzer D. a., Porté A., Richardson D.M., Rejmánek M., Rundel P.W., & van Wilgen B.W. (2014) Conflicting values: Ecosystem services and invasive tree management. *Biological Invasions*, **16**, 705–719.
- Essl F., Nehring S., Klingenstein F., Milasowszky N., Nowack C., & Rabitsch W. (2011) Review of risk assessment systems of IAS in Europe and introducing the German – Austrian Black List Information System (GABLIS). *Journal for Nature Conservation*, **19**, 339–350.
- European Commission (2016) Commission implementing regulation (EU) 2016/1141 of 13 July 2016 adopting a list of invasive alien species of union concern pursuant to regulation (EU) No 1143/2014 of the European parliament and of the council. *Official Journal of the European Union* 59:4–8
- Federal Ministry of Food, Agriculture and Consumer Protection (2011) German forestry, nature and economic factor. <http://www.bmel.de/SharedDocs/Downloads/EN/Publications/GermanForests.pdf?blob=publicationFile> (accessed on 14 November 2016)
- Fei S., Kong N., Steiner K.C., Moser W.K., & Steiner E.B. (2011) Change in oak abundance in the eastern United States from 1980 to 2008. *Forest Ecology and Management*, **262**, 1370–1377.
- Gauer, J. (2010) Je wärmer, desto mehr Regen braucht die Roteiche. Available online: <https://www.lw-heute.de/je-waermer-desto-regen-braucht-roteiche> (accessed on 14 November 2016)
- Genovesi P., Carboneras C., Vilà M., & Walton P. (2015) EU adopts innovative legislation on invasive species: a step towards a global response to biological invasions? *Biological Invasions*, **17**, 1307–1311.
- Goeze E. (1916) Liste der seit dem 16. Jahrhundert bis auf die Gegenwart in die Garten und Parks Europas eingeführten Baume und Straucher.
- Gomez J.M. (2003) Spatial patterns in long-distance dispersal of *Quercus ilex* acorns. *Ecography*, **26**, 573–584.
- Helms, J. A. (1998). The dictionary of forestry. Cab International.
- IGN. (a) Résultats d’inventaire forestier, méthodologie, pour bien comprendre les résultats publiés. Available online: <http://inventaire-forestier.ign.fr/ocre-gp/docs/methodologie.pdf> (accessed on 8 September 2016).
- IGN. (b) Résultats d’inventaire forestier. Le palmarès. Les résultats des campagnes d’inventaire 2009 à 2013. Available online : http://inventaire-forestier.ign.fr/spip/IMG/pdf/RS_0913_PALMARES.pdf (accessed on 14 November 2016).

- INFC. Inventario nazionale delle foreste e dei serbatoi forestali di carbonio. Procedure di posizionamento e di rilievo degli attributi di terza fase. Available online: http://www.inventarioforestale.org/sites/default/files/datiinventario/manuale_inf_050_506.pdf (accessed on 8 September 2016).
- Keller R.P., Geist J., Jeschke J.M., & Kühn I. (2011) Invasive species in Europe : ecology, status, and policy. *Environmental Sciences Europe*, **23**, 23.
- Kremer A. (1986) Chêne rouge d'Amérique. *Revue Forestière Française*, **XXXVIII**, 165–167.
- Larson D.L., Phillips-mao L., Quiram G., Sharpe L., Stark R., Sugita S., & Weiler A. (2011) A framework for sustainable invasive species management : Environmental, social, and economic objectives. *Journal of Environmental Management*, **92**, 14–22.
- Lust N., Muys B., & Nachtergale L. (1998) Increase of biodiversity in homogeneous Scots pine stands by an ecologically diversified management. *Biodiversity and Conservation*, **7**, 249–260.
- Maclsaac H.J. & Colautti R.I. (2004) A neutral terminology to define 'invasive' species. *Diversity & Distributions*, **10**, 135–141.
- Magni Diaz C.R. (2004) Reconstitution de l'introduction de *Quercus rubra* L. en Europe et conséquences génétiques dans les populations allochtones. Thèse de doctorat, Ecole Nationale du Génie Rural des Eaux et Forêts, Paris, France.
- Major K.C., Nosko P., Kuehne C., Campbell D., & Bauhus J. (2013) Regeneration dynamics of non-native northern red oak (*Quercus rubra* L.) populations as influenced by environmental factors: A case study in managed hardwood forests of southwestern Germany. *Forest Ecology and Management*, **291**, 144–153.
- McGeoch M.A., Spear D., Kleynhans E.J., & Marais E. (2012) Uncertainty in invasive alien species listing. *Ecological Applications*, **22**, 959–971.
- Molina Rodríguez F., In del Valle F., Fernández de Ana Magán F.J., & Molina Martínez B. (available online) Guía de silvicultura, Producción de madera de alto valor, El roble americano *Quercus rubra* L. http://www.selvicultor.net/redfor/wp-content/uploads/nuevos_docs/guia_Roble_Americano.pdf (accessed on 14 November 2016).
- Myczko Ł., Dylewski Ł., Zduniak P., Sparks T.H., & Tryjanowski P. (2014) Predation and dispersal of acorns by European Jay (*Garrulus glandarius*) differs between a native (Pedunculate Oak *Quercus robur*) and an introduced oak species (Northern Red Oak *Quercus rubra*) in Europe. *Forest Ecology and Management*, **331**, 35–39.
- Nowacki G.J., Abrams M.D., & Lorimer C.G. (1990) Composition, structure, and historical development of northern *Quercus rubra* stands along an edaphic gradient in northcentral Wisconsin. *Forest Science*, **36**, 276–292.

- Den Ouden J., Jansen P.A., & Smit R. (2004) Jays, mice and oaks: predation and dispersion of *Quercus robur* and *Q. petraea* in North-Western Europe. *Seed Fate: Predation, Dispersal and Seedling Establishment* (ed. by P.-M. Forget, J.E. Lambert, and P.E. Hulme), pp. 223–239. CABI, Wallingford, UK.
- Pysek P., Sadlo J., & Mandak B. (2003) Alien flora of the Czech Republic, its composition, structure and history. *Plant invasions: ecological threats and management solutions* (ed. by L.E. Child, J.H. Brock, G. Brundu, K. Prach, P. Pysek, P.M. Wade, and M. Williamson), pp. 113–130. Backhuys publishers, Leiden, the Netherlands.
- Regulation E.U. (2014). Regulation (EU) No 1143/2014 of the European Parliament and of the Council of 22 October 2014 on the prevention and management of the introduction and spread of invasive alien species. *Official Journal of the European Union*, 57(317), 35.
- Richardson D.M., Pysek P., Rejmánek M., Barbour M.G., Panetta F.D., & West C.J. (2000) Naturalization and invasion of alien plants: concepts and definitions. *Diversity and Distributions*, 6, 93–107.
- Richardson D.M. & Rejmánek M. (2011) Trees and shrubs as invasive alien species - a global review. *Diversity and Distributions*, 17, 788–809.
- Riepsas E. & Straigytė L. (2008) Invasiveness and Ecological Effects of Red Oak (*Quercus rubra* L.) in Lithuanian Forests. *Baltic Forestry*, 14, 122–130.
- Rondeux J., Sanchez C., & Latte N. (2010) Belgium (Walloon Region). *National Forest Inventories* (ed. by E. Tomppo, T. Gschwantner, M. Lawrence, and R.E. McRoberts), Springer Netherlands, pp. 73–88.
- Ruhm, W. (2013) Die Roteiche, wüchsig und attraktiv. *Die Landwirtschaft* 5: 32-33
- Shine, C. (2007). Invasive species in an international context: IPPC, CBD, European Strategy on Invasive Alien Species and other legal instruments. *EPPO bulletin*, 37(1), 103-113.
- Straigytė L. & Zalkauskas R. (2012) Effect of climate variability on *Quercus rubra*. *Dendrobiology*, 67, 79–85.
- Timbal J., Kremer A., Le Goff N., & Nepveu G. (1994) *Le chêne rouge d'Amérique*. INRA, Paris, France.
- Tokarska-Guzik B. (2005) *The Establishment and Spread of Alien Plant Species (Kenophytes) in the Flora of Poland*. Wydawnictwo Uniwersytetu Śląskiego, Katowice.
- TRAGSATEC. Tercer inventario forestal nacional. Descripción de los cogidos de la base de datos de campo. Available online: http://www.magrama.gob.es/es/biodiversidad/servicios/banco-datos-naturaleza/Documentador_BDCAMPO_IFN3_tcm7-217971.pdf (accessed on 8 September 2016).

- Thünen-Institut. Aufnahmeanweisung für die dritte Bundeswaldinventur (BWI³) (2011-2012). Available online: https://bwi.info/Download/de/Methodik/Aufnahmeanweisung_BWI3.pdf (accessed on 8 September 2016).
- Vansteenkiste D., Boever L. De, & Acker J. Van (2005) Alternative processing solutions for Red oak (*Quercus rubra*) from converted forests in Flanders , Belgium. 1–15.
- Verloove F. (2006) *Catalogue of neophytes in Belgium*. National Botanic Garden, Meise, Belgium.
- Viganò, A. & Zavagno, F. (2009) La flora esotica Parco del Medio Olona, presenza e distribuzione
http://www.parcomedioolona.it/allegati/download/flora_esotica_parte_1.pdf
(accessed on 14 November 2016)
- Vor T. (2005) Natural regeneration of *Quercus rubra* L. (Red Oak) in Germany. 111–123.
- Woziwoda B., Kopeć D., & Witkowski J. (2014a) The negative impact of intentionally introduced *Quercus rubra* L. on a forest community. *Acta Societatis Botanicorum Poloniae*, **83**, 39–49.
- Woziwoda B., Potocki M., Sagan J., Michal Z., Tomusiak R., & Wilczynski S. (2014b) Commercial forestry as vector of alien tree species - the case of *Quercus rubra* L. introduction in Poland. *Baltic Forestry*, **20**, 131–141.
- Zerbe S. & Wirth P. (2006) Non-indigenous plant species and their ecological range in Central European pine (*Pinus sylvestris* L.) forests. *Annals of Forest Science*, **63**, 189–203.

Chapitre 2 : Removal of acorns of the alien oak *Quercus rubra* on the ground by scatter-hoarding animals in Belgian forests

Short title: Removal of northern red oak acorns by animals

Submitted to: Biotechnologie, Agronomie, Société et Environnement

Nastasia R. Merceron ^{(1, 2)*}, Aurélie De Langhe ⁽²⁾, Héloïse Dubois ⁽²⁾, Olivier Garin ⁽²⁾, Fanny Gerarts ⁽²⁾, Floriane Jacquemin ⁽²⁾, Bruno Balligand ⁽²⁾, Maureen Otjacques ⁽²⁾, Thibaut Sabbe ⁽²⁾, Maud Servranckx ⁽²⁾, Sarah Wautelet ⁽²⁾, Antoine Kremer ⁽¹⁾, Annabel J. Porté ⁽¹⁾, and Arnaud Monty ⁽²⁾

⁽¹⁾ BIOGECO, INRA, Université de Bordeaux, 33615 Pessac, France.

⁽²⁾ University of Liege, Gembloux Agro-Bio Tech, Biodiversity and Landscape Unit, 2, Passage des Déportés, B-5030 Gembloux, Belgium.

*E-mail: nastasia.merceron@u-bordeaux.fr

Description of the subject. The northern red oak (*Quercus rubra* L.) was introduced from North America to Europe where it is now considered an invasive species in several countries. Little is known about its dispersal in the introduced range, notably the movement of fallen acorns by native animals on the ground.

Objectives. We tested the hypothesis that in the introduced range, acorns of *Q. rubra* are moved away by animals after falling to the ground, and we identified the animal species involved in this process.

Method. During two consecutive autumns, the rate of removal of acorns from *Q. rubra* and from a native oak species (*Q. robur*) was assessed weekly in several forest sites in Belgium. We used automated motion detection camera traps to identify the animals that removed acorns from the ground.

Results. *Quercus rubra* acorns were removed by the following vertebrates: wood mice (*Apodemus sylvaticus* L.), red squirrels (*Sciurus vulgaris* L.), rats (*Rattus* sp.), and wild boars (*Sus scrofa* L.). No bird species were observed. Based on their feeding behavior, scatter-hoarding rodents, i.e., wood mice and red squirrels, can be considered potential dispersers, while rats and wild boars are purely consumers. *Quercus robur* acorns were removed at a higher rate than *Q. rubra* acorns.

Conclusion. Dispersal of *Q. rubra* acorns in Western Europe by scatter-hoarding animals may help the species overcome the so-called *dispersal barrier* and increasingly colonize forest ecosystems.

Keywords. *Quercus rubra*; *Quercus robur*; seed removal; scatter-hoarders; rodents; invasive tree species.

Prélèvement au sol des glands d'une espèce de chêne allochtone (*Quercus rubra*) par des animaux accumulateurs-disperseurs dans les forêts belges.

Titre abrégé: Prélèvement de glands de chêne rouge par les animaux

Description du sujet. Le chêne rouge d'Amérique (*Quercus rubra* L.) a été introduit d'Amérique du Nord en Europe où il est considéré comme une espèce invasive dans plusieurs pays. Sa dispersion dans l'aire d'introduction est mal connue, notamment le déplacement de glands tombés au sol par les animaux indigènes.

Objectifs. Nous avons testé l'hypothèse que les glands étaient déplacés par les animaux après être tombés au sol, et identifié les animaux impliqués dans ce processus.

Méthode. Durant deux automnes consécutifs, le taux de prélèvement des glands de *Q. rubra* et d'une espèce de chêne indigène (*Quercus robur*) a été évalué chaque semaine dans différents sites forestiers en Belgique. Grâce à l'utilisation de pièges photographiques, les animaux prélevant des glands au sol ont été identifiés.

Résultats. Au cours de l'expérimentation, les glands de *Q. rubra* ont été prélevés par les vertébrés suivants: mulots sylvestres (*Apodemus sylvaticus* L.), l'écureuil roux (*Sciurus vulgaris* L.), le rat (*Rattus* sp.), et le sanglier (*Sus scrofa* L.). Aucune espèce d'oiseaux n'a été observée. Sur la base de leur comportement alimentaire, les rongeurs accumulateurs-disperseurs, c'est-à-dire le mulot sylvestre et l'écureuil roux, peuvent être considérés comme potentiels disperseurs, tandis que le rat et le sanglier comme des consommateurs exclusifs. Les glands de *Q. robur* ont été prélevés à un taux plus élevé que ceux de *Q. rubra*.

Conclusion. La dispersion des glands de *Q. rubra* en Europe de l'Ouest par les animaux accumulateurs-disperseurs pourrait aider l'espèce à franchir la barrière de dispersion et coloniser progressivement les écosystèmes forestiers.

Mots-clés. *Quercus rubra*; *Quercus robur*; prélèvement de graines; accumulateurs-disperseurs; rongeurs; espèce d'arbre invasive.

Introduction

Horticulture and forestry are the major reasons for the introduction of exotic woody species in forests (Richardson, 1998; Richardson et al., 2011). In particular, the development of commercial silviculture has contributed to large plantations of alien tree species. However, alien species may have negative ecological impacts on the native species, communities, and ecosystems (Hejda et al., 2009; Ehrenfeld, 2010; Vilà et al., 2011), and forests are not spared (Holmes et al., 2009). This situation may result in a conflict of interest between foresters and environmental managers regarding some of these alien tree species (de Wit et al., 2001; Dickie et al., 2014).

To escape from plantation areas, colonize natural or semi-natural habitats, and spread across landscapes, effective propagule dispersal is essential for species to progress from naturalization to invasion (Bucharova et al., 2009; Richardson et al., 2011). According to Richardson et al. (2000), the criterion for a naturalized species to be characterized as an invasive species is that it overcomes the so-called *dispersal barrier*, i.e., disperses and produces reproductive offspring in areas distant from the sites of introduction. The seeds of invasive tree species can be dispersed by animals (e.g., birds and mammals), wind, and water (Richardson et al., 2011). In the case of zoochory, seed dispersal modes and disperser animal communities are likely to differ between the native and introduced ranges. Consequently, a better understanding of seed dispersal modes and disperser animals in the introduced range is required to confirm the potential invasive status of an alien tree species.

The northern red oak (*Q. rubra* L.) is a classic example of a species with potential conflicting interests (Woziwoda, Potocki, et al., 2014). Native to North America (eastern USA and southeastern Canada), it was introduced to Europe between the end of the 17th century and the beginning of the 18th century (Timbal, Bartoli, et al., 1994; Magni Diaz, 2004). Initially, *Q. rubra* was planted as an ornamental species in parks and gardens for its attractive color traits, and then gradually in forests for timber production (Timbal, Bartoli, et al., 1994). Naturalized in Europe, *Q. rubra* can sexually reproduce from the age of 20–25 years and produces abundant acorns from the age of 40–50 years (Steiner et al., 1993; Cecich, 1994; Major et al., 2013). Nevertheless, the invasive status of this species

throughout Europe is not clear. *Quercus rubra* is an alien plant established in numerous European countries (Delivering Alien Invasive Species Inventories for Europe DAISIE) and was declared an invasive species in Lithuania (Riepšas et al., 2008; Marozas et al., 2009; Straigytė et al., 2012), Poland (Chmura, 2004, 2013; Woziwoda, Kopeć, et al., 2014), the Czech Republic (Pyšek et al., 2012), Germany (Reinhardt et al., 2003; Major et al., 2013), and Belgium (Verloove, 2006). Recent studies have highlighted the negative ecological impacts associated with *Q. rubra* introduction: for example, its development impedes the spontaneous regeneration of native tree species in coniferous and broad-leaved forests in Eastern Europe (Woziwoda, Kopeć, et al., 2014), and its presence significantly reduces the number of native plant species, changing the structure and composition of forest communities (Riepšas et al., 2008; Marozas et al., 2009; Chmura, 2013). Moreover, *Q. rubra* modifies the soil microbial community structure and microelement composition (Riepšas et al., 2008). In contrast, little is known regarding the potential dispersal of *Q. rubra* acorns in European forests.

In North America, *Q. rubra* stands currently encounter difficulties to regenerate naturally (Steiner et al., 1993; Magni Diaz, 2004; Major et al., 2013). Overwinter conditions (e.g., frost damage), browsing of seedlings, canopy shade levels, and interspecific competition constrain survival and germination of *Q. rubra* acorns (Crow, 1988; Steiner et al., 1993; Buckley et al., 1998). On the contrary, *Q. rubra* can form dense seedling cohorts close to parent trees when in European forests (Major et al., 2013). Acorns represent a good source of digestible feed with high nutritional content (Vander Wall, 2001; Shimada et al., 2006) that attract several vertebrates. However, some chemical compounds in acorns, e.g. tannins, can repel them when in high concentrations (Steele et al., 1993).

The dispersal of *Q. rubra* acorns in its native range can be performed by birds, mainly blue jays (*Cyanocitta cristata*) and wild turkeys (*Meleagris gallopavo*) (Darley-Hill et al., 1981; Sork et al., 1983; Gribko et al., 2002). On the ground, several mammals have been identified as predators or dispersers (or both) of *Q. rubra* acorns in North America, such as white-footed mice and deer mice (*Peromyscus leucopus* and *P. maniculatus*, respectively), field mice (*Apodemus* spp.), southern red-backed voles (*Clethrionomys gapperi*), fox squirrels and grey squirrels (*Sciurus niger* and *S. carolinensis*, respectively),

eastern chipmunks (*Tamias striatus*), white-tailed deer (*Odocoileus virginianus*), and black bears (*Euarctos americanus*) (Sork et al., 1983; Steiner, 1995; Plucinski et al., 2001; Smallwood et al., 2001; Gribko et al., 2002; Schnurr et al., 2002; Steele et al., 2006). Dispersal is efficient if acorns are transported away from parent trees and escape consumption. If the total consumption of acorns by animals limits efficient seed dispersal, partial consumption of acorns, especially without damaging the embryo, can contribute to natural dispersal of oak species (Perea, San Miguel, et al., 2011). Moreover, some scatter-hoarding animals, such as rodents, can cache acorns by burying and covering them with litter. In this manner, they may protect seeds from predation and desiccation, favoring seed survival and seedling establishment (Jansen et al., 2005). This behavior allows animals to have feeding stocks for later use and creates favorable conditions for *Q. rubra* acorn germination when the hiding places are forgotten (García et al., 2002).

In Europe, the acorns of native oaks are eaten on the ground by numerous animal species. Some are pure consumers, e.g., wild boars (*S. scrofa*) and roe deer (*Capreolus capreolus*), whereas others play a significant role in dispersal: birds, particularly the European jay (*Garrulus glandarius*), and scatter-hoarding rodents, especially wood mice (*A. sylvaticus*) (Ouden et al., 2005; Perea, Miguel, et al., 2011). While the European jay plays a role in the dispersal of *Q. rubra* acorns above the ground (Myczko et al., 2014), little is known about the removal of these acorns fallen on the ground. Therefore, we may hypothesize that some vertebrate species feed on *Q. rubra* acorns in Western European forests and that scatter-hoarding rodents act as potential dispersers on the ground.

Seed removal and seed selection experiments in natural conditions, coupled with animal species identification using camera traps (Jansen et al., 2005), allows the identification of animals involved in seed consumption and/or dispersal. The objective of the present study was to investigate the significance of *Q. rubra* zoochory on the ground by vertebrates in oak forests of its introduced range in Belgium. More specifically, we addressed the following questions: i) are acorns of *Q. rubra* moved away by animals in the introduced range? ii) which animal species are involved in this process and among them, which can be considered scatter hoarders? and iii) are *Q. rubra* acorns preferred over *Q. robur* acorns in the introduced range? Answering these questions will help us better understand

the potential ability of *Q. rubra* acorns to be successfully dispersed on the ground by mammals in European forests.

Materials and methods

Studied species

The alien oak species *Q. rubra* requires two vegetative seasons for fruit maturation: pollination in the spring of the first year, and fertilization and growth of acorns in the following year. Spherical and rounded acorns fall in the autumn of the second year. These acorns are dormant during autumn and winter, and typically germinate in the following spring (Cecich, 1994). The indigenous oak species *Q. robur* L. is widely distributed in Europe: from northern Spain to southern Scandinavia (Ducousso et al., 2004). Fructification occurs in one year. *Quercus robur* acorns are more elongated and narrower than *Q. rubra* acorns. They fall in autumn, and germination begins in winter without a necessary dormancy period.

Experimental sites and design

The study was conducted in Wallonia (southern Belgium) during October and November of 2013 and 2014. Each year, four different experimental sites were selected, and were at least 3 km apart from one another (**Table 1**). All sites were mixed oak stands dominated by adult trees of *Q. robur* and/or *Q. rubra* of reproductive age. In all cases, we ensured that both oak species were present in the vicinity (i.e., within 500 m) of each experimental site.

Table 1. Location of the experimental sites and number of cameras used for identification of animals (N).
Localisation des sites expérimentaux et nombre de pièges photographiques utilisés pour l'identification des animaux.

Year	Sites	Latitude/ Longitude	Latitude/ Longitude	N
2013	Onoz	50°28'58" N	4°40'39" E	4
	Ferooz	50°32'30" N	4°41'38" E	3
	Grand-Leez	50°35'16" N	4°47'16" E	-
	Gembloux	50°33'46" N	4°41'42" E	-
2014	Spy	50°28'46" N	4°40'50" E	2
	Floreffe	50°26'07" N	4°42'37" E	-
	Malonne	50°22'55" N	4°49'42" E	1
	Profondeville	50°22'46" N	4°51'40" E	-

Acorns of *Q. rubra* and *Q. robur* were collected from the ground under fruiting oak trees. Approximately 2000 acorns from each oak species were collected from September 28 to October 27, 2013, in two forest stands in Wallonia. In 2014, approximately 3000 acorns from each species were collected from September 21 to November 16 in three forest stands in Wallonia. For each species, the acorns collected in the different stands were pooled. They were stored at room temperature before being used for the experiment. Acorns with obvious damage or infections were discarded. Throughout the study, acorns were manipulated with latex gloves to prevent impregnation with human odor.

At every site, four identical pairs of 28-cm diameter plastic dishes were randomly placed on the ground at a distance of 10–20 cm from each other. The dishes were drilled to allow rainwater drainage. One dish per pair contained 20 acorns of *Q. robur* and the other contained 20 acorns of *Q. rubra*. Every week, the remaining acorns in each dish were collected and counted to determine the number of acorns removed. Subsequently, the dishes were completely refilled with 20 undamaged acorns. Dishes spilled by animals or humans were replaced in their initial positions, and the data of the considered week were not taken into account. The experiment lasted five weeks in 2013 (from October 4 to November 7) and eight weeks in 2014 (from October 3 to November 28). This duration corresponds to the period during which acorns fall in Western Europe (Bonnet-Masimbert, 1984).

Monitoring of acorn removal using camera traps

During the experiment, automated motion detection cameras (Cuddeback Digital® Attack Model 1156, De Pere, WI, USA) were attached high on the nearest oak trunk and pointed directly at the dish containing *Q. rubra* acorns. These camera traps captured color images in the day, and black and white infrared images at night, as well as short videos. When movement was detected lasting more than 30 seconds, the cameras took pictures every 5 seconds and recorded a video for 10 seconds. Seven and three cameras were available in 2013 and 2014, respectively, but could not be placed at all sites because the risk of theft or destruction was too high in some sites. Each year, cameras were positioned at two sites (**Table 1**). Identification of animals based on the photographs and videos was performed in the laboratory with the help of mammal guide books (Quéré et al., 2011; Aulagnier et al., 2013). The videos allowed us to detect and distinguish between acts of consumption and acts of collecting and scattering. We classified the observed animals as pure consumers or scatter hoarders of *Q. rubra* acorns in agreement with the scientific literature regarding their feeding behavior. In this study, we focused on *Q. rubra* acorn removal on the ground by terrestrial vertebrates and we did not follow acorns after removal.

Data and statistical analyses

Every missing acorn from the dishes was considered removed by animals. For each *Quercus* species, the number of acorns removed from their respective dishes was converted to the proportion of acorns removed during one week and was considered the *acorn removal rate*. For each site, the mean acorn removal rate of the four dishes was calculated according to species and week. An arcsine square root transformation was performed on this mean to improve the normal distribution of data and the homogeneity of variances. A mixed model with repeated measurements (proc. MIXED) was used to analyze the effects of species (*Q. rubra* or *Q. robur*), week, site, and the interaction site × species on the mean acorn removal rate. Species was treated as a fixed factor; week, site, and interaction site × species were treated as random factors. Weeks were considered repetitions in the model. Statistical analyses were conducted separately for

the two years (2013, 2014). The effect of factors was considered significant at $p < 0.05$; all analyses were performed using the SAS software package (SAS, version 9.4; SAS Institute Inc., Cary, NC, USA).

Results

Acorn removal

Acorns from both the native oak and alien oak were removed on the ground by animals in the Belgian forests; *Q. robur* and *Q. rubra* acorns were removed from the dishes during all considered weeks at all experimental sites. Acorn removal differed between the two *Quercus* species depending on the year of the study. There was no significant effect of species on the acorn removal rate in 2013, but in the following year, the effect of species was significant (**Table 2**). In 2014, acorns of *Q. robur* were preferred to acorns of *Q. rubra*: the acorn removal rate was 0.982 (± 0.010) for *Q. robur* and 0.399 (± 0.033) for *Q. rubra*. In both years, no significant effect of interaction site \times species was observed on the acorn removal rate, and no variations between sites was detected in 2014 (**Table 2**). The effect of week, considered a repeated measure in the two years of the experiment, significantly affected the acorn removal rate in 2013 and 2014 (**Table 2**). In 2014, the acorn removal rate for *Q. rubra* increased with time, i.e., from the beginning to the end of the monitoring (**Figure 1**). Almost all *Q. robur* acorns were removed from the dishes that year (**Figure 1**).

Table 2. Summary of ANOVA of the mean of acorn removal rate from dishes in 2013 and 2014. For each variable and year, ANOVA results are presented using d.f. (degrees of freedom), F or Z statistics, and the corresponding *p*-value. *Résumé de l'ANOVA de la moyenne du taux de prélèvement des glands dans les coupelles en 2013 et en 2014. Pour chaque variable et année, les résultats de l'ANOVA ont été représentés par d.f. (les degrés de liberté), les statistiques F ou Z, et la valeur p correspondante.*

Source of variations	Factor	Year	d.f.	F or Z	<i>p</i>-value
Species	Fixed	2013	1, 3	7.52	0.0712
		2014	1, 6	33.94	0.0011
Site	Random	2013	3, 8	0.95	0.3444
		2014	-	-	-
Site × species	Random	2013	3, 46	1.09	0.2772
		2014	7, 74	1.36	0.1728
Week	Random	2013	-	4	<0.0001
		2014	-	5.29	<0.0001

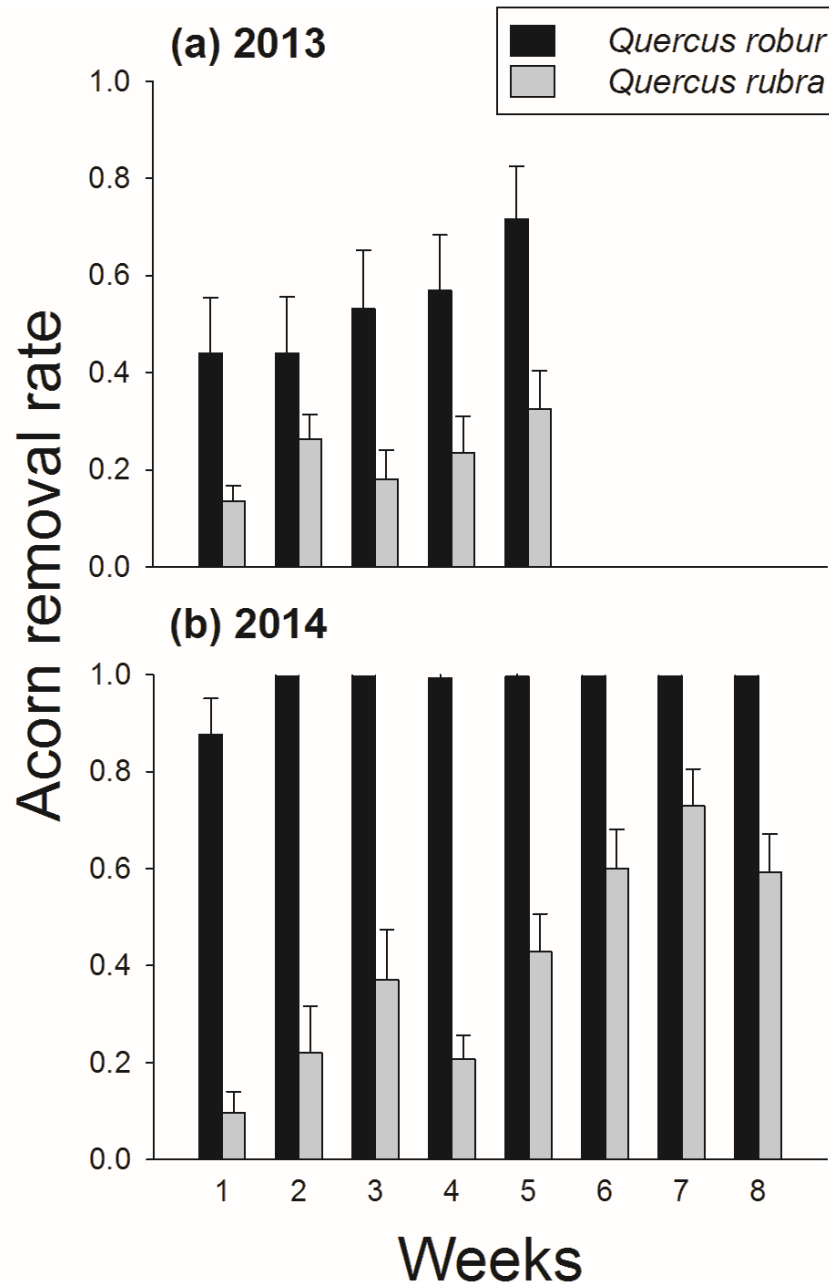

Figure 1. The acorn removal rate of *Q. robur* (black bars) and *Q. rubra* (grey bars) by animals on the ground per week. Monitoring was performed over five weeks from October 4 to November 8, 2013 (a) and over eight weeks from October 3 to November 28, 2014 (b). Values represent the mean of all pairs of experimental dishes at the four sites pooled together for each species and year ($n = 16$). The error bars represent the standard error (SE) of the means. *Taux de prélèvement des glands de Q. robur (barres noires) and Q. rubra (barres grises) par les animaux au sol par semaine. Le suivi a été réalisé durant cinq semaines en 2013 du 4 octobre au 8 novembre (a) et durant huit semaines en 2014 du 3 octobre au 28 novembre (b). Les valeurs représentent la moyenne de toutes les paires de coupelles dans les 4 sites regroupés ensemble pour chaque espèce et chaque année ($n=16$). Les barres d'erreurs représentent l'erreur standard (SE) des moyennes.*

Identification of animals

Based on pictures and videos obtained using the camera traps in 2013 and 2014, we identified four mammals removing *Q. rubra* acorns from the dishes. Wood mice (*A. sylvaticus* L.) and red squirrels (*S. vulgaris* L.) were identified as consumers and scatter hoarders. The pictures and videos distinctly showed that they removed *Q. rubra* acorns before eating them or were removing them from the dishes (see video showing removal by these rodents in **Appendix 1**). Wild boars (*S. scrofa* L.) and rats (*Rattus* sp.) were regarded as pure consumers of *Q. rubra* acorns because they were only seen eating acorns in the dishes, which was in concordance with the scientific literature regarding their feeding behavior. Roe deer (*C. capreolus* L.) were photographed several times near the dishes containing *Q. rubra* acorns but were never seen removing or consuming them; i.e., their participation in the removal of *Q. rubra* acorns was not proven in our study. The camera traps observed no bird species at the dishes. Considering both years combined, the scatter hoarders wood mouse and red squirrel were three times more frequently photographed by the camera traps than the pure consumers: rat and wild boar (**Table 3**).

Table 3. Total number of pictures illustrating the pure consumers and scatter-hoarding species of *Q. rubra* acorns photographed close to the dishes eating or removing *Q. rubra* acorns in 2013, 2014, and both years combined (Total). Seven camera traps were used in 2013 over five weeks and three camera traps were used in 2014 over eight weeks. *Nombre total d'images illustrant les animaux consommateurs et disperseurs de glands de Q. rubra, photographiés à proximité des coupelles mangeant ou emportant des glands de Q. rubra en 2013, en 2014 et les deux années combinées (Total). Sept pièges photographiques ont été utilisés en 2013 durant cinq semaines et trois pièges photographiques en 2014 durant huit semaines.*

Animal species	Category	2013	2014	Total
Wood mouse (<i>Apodemus sylvaticus</i>)	Scatter hoarder	14	4	36
Red squirrel (<i>Sciurus vulgaris</i>)	Scatter hoarder	18	0	
Rat (<i>Rattus</i> sp.)	Pure consumer	0	7	11
Wild boar (<i>Sus scrofa</i>)	Pure consumer	0	4	
Total		32	15	47

Discussion

Acorn removal and feeding behavior of animals

We demonstrated that four mammalian species, both rodents and other mammals, were involved in removing the acorns of the alien oak species *Q. rubra* on the ground in Belgian forests. We distinguished pure consumers and scatter hoarders of *Q. rubra* acorns based on the scientific literature on their feeding behavior and on the pictures and videos from the camera traps. The identified animals are all known to consume *Q. robur* acorns in Europe (Ouden et al., 2005). Wild boars are well-known consumers of acorns (Schley et al., 2003). However, wild boars do not act efficiently as dispersers because they chew and digest whole acorns, thereby destroying the embryos. Rats were observed never removing *Q. rubra* acorns from the dishes, only feeding on them. Although they are rodents, rats do not exhibit scatter-hoarding behavior and have never been described as acorn dispersers in European forests. We considered this species a pure consumer of acorns. In contrast, the scatter-hoarding rodents observed in the present study, i.e., wood mice and red squirrels, are known for caching and burying native acorns (Moller, 1983; Wauters et al., 1996; Ouden et al., 2005) and can therefore be considered potential dispersers of *Q. rubra* acorns. Scatter-hoarding rodents can carry acorns to sites with favorable conditions for seed germination by burying and covering acorns with litter, protecting them from desiccation and consumption by other animals (García et al., 2002). Our results indicate that European scatter-hoarding rodent species in the introduced range play a similar role to American species in the native range.

We observed partially eaten *Q. rubra* acorns close to the experimental dishes, which were probably left over by rodents. Partial consumption of acorns without embryo damage barely affects their germination and consequent successful establishment (Perea, San Miguel, et al., 2011). Nevertheless, if acorn resources on the ground are weak, wild boars can also consume buried acorns by scatter-hoarding rodents, halting the acorn dispersal process (Focardi et al., 2000). Ungulates and rodents can enter into competition for the same food resource, e.g., acorns, and the presence of ungulates can influence the behavior of rodents, which cache fewer acorns, reducing oak recruitment (Muñoz et al.,

2007). Although no bird species was photographed by the camera traps, we cannot exclude their possible contribution to acorn removal at sites without cameras. The consumption of *Q. rubra* acorns 1.5 m above the ground by European jays has been previously demonstrated in western Poland and Germany (Myczko et al., 2014; Bieberich et al., 2016).

Selection between *Q. robur* and *Q. rubra* acorns by animals

Across the 2 years of the experiment, the average acorn removal rate of *Q. robur* was more than twice as high as that of *Q. rubra*. This can be attributed to the habits of the animals, as they are accustomed to feeding on the acorns of native oaks (*Q. robur* and *Q. petraea*) in the northwestern European forests (Ouden et al., 2005). Moreover, several intrinsic factors could be involved in the choice of specific acorns by the animals, as lipid intake is essential for many vertebrates that need to store fat reserves to face winter climatic conditions. Depending on the species, acorns have different concentrations of tannins and nutrients (Ofcarcik et al., 1971; Shimada et al., 2006). *Quercus rubra* acorns contain more fat than *Q. robur* acorns (Shimada et al., 2006). However, tannin concentrations differ, with *Q. robur* acorns having lower levels of tannins than *Q. rubra* acorns (Shimada et al., 2006). As tannins are chemical defense compounds that induce a bitter and astringent taste, the lower tannin concentrations of *Q. robur* acorns probably render them more palatable to animals. In the native range, it has been indicated that the higher levels of tannins render *Q. rubra* acorns less palatable than other oak species and therefore protect the embryos from consumption and subsequent damage (Steele et al., 1993). Moreover, lipids and tannins are barely degraded, and their levels in the acorns remain similar over time, even during storage (Wood, 2005). As a consequence, rodents in North America preferentially cache and hoard acorns of *Q. rubra* in comparison, for example, to a white oak species (*Q. macrocarpa*), because *Q. rubra* acorns can be preserved (Smallwood et al., 2001). *Quercus rubra* acorns require a winter dormancy period before germinating and therefore constitute overwinter food reserves for scatter-hoarding rodents.

Implication for *Q. rubra* invasion in Europe

Major et al. (2013) suggested that the dense regeneration of seedlings beneath red oak trees was related to the short distance of dispersal of *Q. rubra* acorns following barochory and a lack of seed movement on the ground. Nevertheless, Bieberich et al. (2016) and the removal of *Q. rubra* acorns in our experiment showed that a significant proportion of acorns may possibly be dispersed on the ground over greater distances by scatter-hoarding rodents. Generally, scatter-hoarding rodents disperse intact or partially eaten acorns by moving them away over areas ranging from approximately 100 m² (wood mice) to approximately 15 ha (squirrels) (Perea, Miguel, et al., 2011; Quéré et al., 2011). Potential dispersal distances can thus vary from a few meters to hundreds of meters according to the species and number of repeated dispersal actions (Moore et al., 2007; Vander Wall, 2010; Perea, Miguel, et al., 2011). Moreover, *Q. rubra* trees can produce abundant acorns in their introduced range (Steiner et al., 1993; Timbal & Kremer, 1994).

In conclusion, the present study reports that red oak acorns on the ground can be moved away from mother trees by scatter-hoarding rodents even if they are not preferred over native oak acorns. In general, scatter-hoarding rodents are efficient dispersers of acorns, albeit over short distances as compared to long-distance dispersal by birds. Combined with the high reproductive success of red oak in Western Europe, our results all suggest that *Q. rubra* is gradually crossing the natural dispersal barrier even without human intervention (Richardson et al., 2000). Further study regarding the fate of *Q. rubra* acorns after removal in forests should provide more knowledge on the dispersal distances and effective spread of this alien oak species in Europe.

Acknowledgements

The authors would like to thank Thierry Kervyn for access to the Onoz site and Alain Licoppe for loaning the camera equipment. This study was carried out with financial support from the French National Research Agency (ANR) under the Investments for the Future Program (ANR-10-IDEX-03-02) and from the University of Liege under the “Fonds spéciaux pour la recherche”.

References

- Aulagnier S., Haffner P., Mitchell-Jones A.J., Moutou F., Zima J., Chevallier J., Norwood J. & Simo J.V., 2013. *Guide des mammifères d'Europe, d'Afrique du Nord et du Moyen-Orient*, 271.
- Bieberich J., Lauerer M. & Aas G., 2016. Acorns of introduced *Quercus rubra* are neglected by European Jay but spread by mice. *Ann. For. Res.* **59**(1), 1–10.
- Bonnet-Masimbert M., 1984. Biologie florale et cycle de reproduction de quelques arbres forestiers. Douglas, pin sylvestre, chêne. *In*: Pesson, P., Louveaux, J. eds. *Pollinisation et Productions Végétales*. INRA, Paris, 219–242.
- Bucharova A. & Van Kleunen M., 2009. Introduction history and species characteristics partly explain naturalization success of North American woody species in Europe. *J. Ecol.* **97**, 230–238.
- Buckley D.S., Sharik T.L. & Isebrands J.G., 1998. Regeneration of northern red oak: positive and negative effects of competitor removal. *Ecology* **79**(1), 65–78.
- Cecich R.A., 1994. Biologie florale du chêne rouge. *In*: Timbal, J., Kremer, A., Le Goff, N., Nepveu, G. eds. *Le Chêne Rouge d'Amérique*. Institut National de la Recherche Agronomique, Paris, France, 54–60.
- Chmura D., 2004. Penetration and naturalisation of invasive alien plant species (neophytes) in woodlands of the Silesian upland (southern Poland). *Nat. Conserv.* **60**, 3–11.
- Chmura D., 2013. Impact of alien tree species *Quercus rubra* L. on understory environment and flora: A study of the Silesian upland (Southern Poland). *Polish J. Ecol.* **61**(3), 431–442.
- Crow T.R., 1988. Reproductive Mode and Mechanisms for Self-Replacement of Northern Red Oak (*Quercus rubra*) - A Review. *For. Sci.* **34**(1), 19–40.
- Darley-Hill S. & Johnson W.C., 1981. Acorn dispersal by the blue jay (*Cyanocitta cristata*). *Oecologia* **50**(2), 231–232.

de Wit M.P., Crookes D.J. & van Wilgen B.W., 2001. Conflicts of interest in environmental management: estimating the costs and benefits of a tree invasion. *Biol. Invasions* **3**(2), 167–178.

Delivering Alien Invasive Species Inventories for Europe DAISIE, *Quercus rubra* DAISIE - Species Factsheet.

<http://www.europe-aliens.org/speciesFactsheet.do?speciesId=14881#> (25/04/2016)

Dickie I.A., Bennett B.M., Burrows L.E., Nuñez M.A., Peltzer D.A., Porté A., Richardson D.M., Rejmánek M., Rundel P.W. & van Wilgen B.W., 2014. Conflicting values: ecosystem services and invasive tree management. *Biol. Invasions* **16**(3), 705–719.

Ducouso A. & Bordacs S., 2004. Technical Guidelines for genetic conservation and use for pedunculate and sessile oaks (*Quercus robur* and *Q. petraea*). *EUFORGEN Tech. Guidel. Genet. Conservat. Use* 6.

Ehrenfeld J.G., 2010. Ecosystem Consequences of Biological Invasions. *Annu. Rev. Ecol. Evol. Syst.* **41**(1), 59–80.

Focardi S., Capizzi D. & Monetti D., 2000. Competition for acorns among wild boar (*Sus scrofa*) and small mammals in a Mediterranean woodland. *J. Zool.* **250**(3), 329–334.

García D., Bañuelos M.-J. & Houle G., 2002. Differential effects of acorn burial and litter cover on *Quercus rubra* recruitment at the limit of its range in eastern North America. *Can. J. Bot.* **80**(10), 1115–1120.

Gribko L., Schuler T. & Ford W., 2002. Biotic and abiotic mechanisms in the establishment of northern red oak seedlings: a review. *USDA For. Serv.*

Hejda M., Pyšek P. & Jarošík V., 2009. Impact of invasive plants on the species richness, diversity and composition of invaded communities. *J. Ecol.* **97**(3), 393–403.

Holmes T.P., Aukema J.E., Von Holle B., Liebhold A. & Sills E., 2009. Economic Impacts of Invasive Species in Forests. *Ann. N. Y. Acad. Sci.* **1162**(1), 18–38.

Jansen P.A. & den Ouden J., 2005. Observing Seed Removal : Remote Video Monitoring of Seed Selection, Predation and Dispersal. *In: Forget, P.M., Lambert, J.E., Hulme,*

- P.E., Vander Wall, S.B. eds. *Seed Fate: Predation, Dispersal, and Seedling Establishment*. CABI, 363–378.
- Magni Diaz C., 2004. Reconstitution de l'introduction de *Quercus rubra* L. en Europe et conséquences génétiques dans les populations allochtones. Doctoral thesis : University of Bordeaux (France).
- Major K.C., Nosko P., Kuehne C., Campbell D. & Bauhus J., 2013. Regeneration dynamics of non-native northern red oak (*Quercus rubra* L.) populations as influenced by environmental factors: A case study in managed hardwood forests of southwestern Germany. *For. Ecol. Manage.* **291**, 144–153.
- Marozas V., Straigyte L. & Sepetiene J., 2009. Comparative analysis of alien red oak (*Quercus rubra* L.) and native common oak (*Quercus robur* L.) vegetation in Lithuania. *Acta Biol. Univ. Daugavp.* **9**(1), 19–24.
- Moller H., 1983. Foods and foraging behaviour of Red (*Sciurus vulgaris*) and Grey (*Sciurus carolinensis*) squirrels. *Mamm. Rev.* **13**(2-4), 81–98.
- Moore J.E., McEuen A.B., Swihart R.K., Contreras T.A. & Steele M.A., 2007. Determinants of seed removal distance by scatter-hoarding rodents in deciduous forests. *Ecology* **88**(10), 2529–2540.
- Muñoz A. & Bonal R., 2007. Rodents change acorn dispersal behaviour in response to ungulate presence. *Oikos* **116**(10), 1631–1638.
- Myczko Ł., Dylewski Ł., Zduniak P., Sparks T.H. & Tryjanowski P., 2014. Predation and dispersal of acorns by European Jay (*Garrulus glandarius*) differs between a native (Pedunculate Oak *Quercus robur*) and an introduced oak species (Northern Red Oak *Quercus rubra*) in Europe. *For. Ecol. Manage.* **331**, 35–39.
- Ofcarcik R.P. & Burns E.E., 1971. Chemical and physical properties of selected acorns. *J. Food Sci.* **36**(4), 576–578.
- Ouden J. den, Jansen P.A. & Smit R., 2005. Jays, mice and oaks: predation and dispersal of *Quercus robur* and *Q. petraea* in North-western Europe. In: Forget, P.M., Lambert, J.E., Hulme, P.E., Vander Wall, S.B. eds. *Seed Fate: Predation, Dispersal and*

Seedling Establishment. CABI, Wallingford, 223–239.

Perea R., Miguel A.S. & Gil L., 2011. Acorn dispersal by rodents: The importance of re-dispersal and distance to shelter. *Basic Appl. Ecol.* **12**(5), 432–439.

Perea R., San Miguel A. & Gil L., 2011. Leftovers in seed dispersal: ecological implications of partial seed consumption for oak regeneration. *J. Ecol.* **99**(1), 194–201.

Plucinski K.E. & Hunter Jr M.L., 2001. Spatial and temporal patterns of seed predation on three tree species in an oak-pine forest. *Ecography* **24**(3), 309–317.

Pyšek P., Danihelka J., Sádlo J., Chrtěk J., Chytrý M., Jarošík V., Kaplan Z., Krahulec F., Moravcová L., Pergl J., Štajerová K. & Tichý L., 2012. Catalogue of alien plants of the Czech Republic (2nd edition): Checklist update, taxonomic diversity and invasion patterns. *Preslia* **84**(2), 155–255.

Quéré J.P. & Le Louarn H., 2011. *Les rongeurs de France: faunistique et biologie*. Editions Quae ed., Versailles, France, 311.

Reinhardt F., Herle V.M., Bastiansen F. & Steit B., 2003. Economic impact of the spread of alien species in Germany: German Federal Ministry of the Environment, Nature Conservation and Nuclear Safety. Texte 80 (03), 43-47.

Richardson D.M., 1998. Forestry Trees as Invasive Aliens. *Conserv. Biol.* **12**(1), 18–26.

Richardson D.M., Pyšek P., Rejmánek M., Barbour M.G., Panetta F.D. & West C.J., 2000. Naturalization and invasion of alien plants: concepts and definitions. *Divers. Distrib.* **6**(2), 93–107.

Richardson D.M. & Rejmánek M., 2011. Trees and shrubs as invasive alien species - a global review. *Divers. Distrib.* **17**(5), 788–809.

Riepšas E. & Straigyte L., 2008. Invasiveness and Ecological Effects of Red Oak (*Quercus rubra* L.) in Lithuanian Forests. *Balt. For.* **14**(2), 122–130.

Schley L. & Roper T.J., 2003. Diet of wild boar *Sus scrofa* in Western Europe, with particular reference to consumption of agricultural crops. *Mamm. Rev.* **33**(1), 43–56.

Schnurr J.L., Ostfeld R.S. & Canham C.D., 2002. Direct and indirect effects of masting on

- rodent populations and tree seed survival. *Oikos* **96**(3), 402–410.
- Shimada T. & Saitoh T., 2006. Re-evaluation of the relationship between rodent populations and acorn masting: a review from the aspect of nutrients and defensive chemicals in acorns. *Popul. Ecol.* **48**(4), 341–352.
- Smallwood P.D., Steele M. a. & Faeth S.H., 2001. The Ultimate Basis of the Caching Preferences of Rodents, and the Oak-Dispersal Syndrome: Tannins, Insects, and Seed Germination¹. *Am. Zool.* **41**(4), 840–851.
- Sork V.L., Stacey P. & Averett J.E., 1983. Utilization of red oak acorns in non-bumper crop year. *Oecologia* **59**(1), 49–53.
- Steele M.A., Knowles T., Bridle K. & Simms E.L., 1993. Tannins and Partial Consumption of Acorns: Implications for Dispersal of Oaks by Seed Predators. *Am. Midl. Nat.* **130**(2), 229.
- Steele M.A., Manierre S., Genna T., Contreras T.A., Smallwood P.D. & Pereira M.E., 2006. The innate basis of food-hoarding decisions in grey squirrels: evidence for behavioural adaptations to the oaks. *Anim. Behav.* **71**(1), 155–160.
- Steiner K.C., 1995. Autumn predation of northern red oak seed crops. *In*: Gottschalk, K.W., Fosbroke, S.L.C. eds. *10th Central Hardwood Forest Conference. 5–8 March, 1995, Morgantown, West Virginia*, General Technical Report NE-197. U.S. Department of Agriculture, Forest Service, Northeastern Forest Experiment Station, 489–494.
- Steiner K.C., Abrams M.D. & Bowersox T.W., 1993. Advance reproduction and other stand characteristics in Pennsylvania and French stands of Northern Red Oak. *In*: Gillespie A.R., Parker G.R., Pope P.E., Rink G. eds. *9th Central Hardwood Forest Conference. 8–10 March, 1993, West Lafayette, Indiana*, General Technical Report NC-161. U.S. Department of Agriculture, Forest Service, North Central Forest Experiment Station, 473–483.
- Straigytė L. & Zalkauskas R., 2012. Effect of climate variability on *Quercus rubra* phenotype and spread in Lithuanian forests. *Dendrobiology* **67**, 79–85.

- Timbal J., Bartoli M. & Buffet M., 1994. Introduction et utilisation en reboisement du chêne rouge en France. *In*: Timbal, J., Kremer, A., Le Goff, N., Nepveu, G. eds. *Le Chêne Rouge d'Amérique*. Institut National de la Recherche Agronomique, Paris, France, 45–53.
- Timbal J. & Kremer A., 1994. Caractères botaniques, morphologiques, biologiques et chronologiques. *In*: Timbal, J., Kremer, A., Le Goff, N., Nepveu, G. eds. *Le Chêne Rouge d'Amérique*. Institut National de la Recherche Agronomique, Paris, France, 16–24.
- Vander Wall S.B., 2001. The evolutionary ecology of nut dispersal. *Bot. Rev.* **67**(1), 74–117.
- Vander Wall S.B., 2010. How plants manipulate the scatter-hoarding behaviour of seed-dispersing animals. *Philos. Trans. R. Soc. B Biol. Sci.* **365**(1542), 989–997.
- Verloove F., 2006. Catalogue of neophytes in Belgium (1800-2005). *Scr. Bot. Belgica* **39**, 1–89.
- Vilà M., Espinar J.L., Hejda M., Hulme P.E., Jarošík V., Maron J.L., Pergl J., Schaffner U., Sun Y. & Pyšek P., 2011. Ecological impacts of invasive alien plants: a meta-analysis of their effects on species, communities and ecosystems. *Ecol. Lett.* **14**(7), 702–708.
- Wauters L.A. & Casale P., 1996. Long-term scatterhoarding by Eurasian red squirrels (*Sciurus vulgaris*). *J. Zool.* **238**(2), 195–207.
- Wood M.D., 2005. Tannin and Lipid Content of Acorns in Scatterhoards and Larderhoards. *Northeast. Nat.* **12**(4), 463–472.
- Woziwoda B., Kopeć D. & Witkowski J., 2014. The negative impact of intentionally introduced *Quercus rubra* L. on a forest community. *Acta Soc. Bot. Pol.* **83**(1), 39–49.
- Woziwoda B., Potocki M., Sagan J., Michaù Z., Tomusiak R. & Wilczynski S., 2014. Commercial Forestry as a Vector of Alien Tree Species – the Case of *Quercus rubra* L. introduction in Poland. *Balt. For.* **20**(1), 131–141.

Partie 2

Dans une seconde partie, l'objectif de cette thèse a été de comparer la diversité génétique des populations natives et introduites de *Q. rubra* afin d'évaluer l'existence de différenciations génétiques entre ces populations depuis l'introduction en Europe.

Dans le chapitre 3, nous avons comparé plusieurs traits phénotypiques de croissance, phénologie foliaire, survie et fourchaison entre 64 populations natives et 41 populations introduites installées dans 3 tests de provenance-descendance en France. Puis pour chaque caractère phénotypique, nous avons aussi calculé un indice de différenciation génétique (Q_{ST}) au sein des populations de chaque aire. A travers une approche de génétique quantitative, nous avons voulu déterminer s'il existait de la différenciation génétique entre et au sein des populations natives et introduites.

La totalité des populations utilisées dans le chapitre 3 proviennent d'un dispositif expérimental complexe composé de 3 tests de provenances-descendances installées dans le Sud-Ouest, le Centre et le Nord-Est de la France (voir étoiles noires Figure 1b, Chapitre 3).

A partir de la fin des années 1970, un vaste programme d'amélioration et de sélection génétique à long terme du chêne rouge d'Amérique a été mis en place en France (Lanier, Keller & Kremer 1980; Kremer 1986). Les objectifs de ce programme étaient d'étudier la diversité génétique et de sélectionner les meilleurs peuplements porte-graine de chêne rouge qui constituait à l'époque une espèce largement utilisée pour le reboisement. Pour ce faire, des plantations comparatives de provenances-descendances américaines et européennes ont été installées par Alexis Ducouso, Antoine Kremer et leur équipe dans 3 zones géographiques distinctes en France (Sud-Ouest, Centre, Nord-Est). Chacune de ces 3 zones représente un **test de provenance-descendance** soumis à un environnement différent (**Figure 1**).



Figure 1. Photographie illustrant le test de provenance-descendance du Sud-Ouest (ici sur le site de Capvern, avril 2014).

Les **provenances** (ou **populations**) correspondent aux différentes populations natives et introduites, échantillonnées dans plusieurs pays au sein des deux aires géographiques : américaine et européenne. Elles se distinguent par des coordonnées géographiques (latitude et longitude en degrés décimaux) et une altitude différentes. Un code (de 1 à 420) a été attribué à chaque provenance lors de la plantation dans le dispositif expérimental.

Une **descendance** regroupe les différents individus issus d'une même provenance et récoltés sur un même arbre-mère. Il y a entre 1 et 25 descendance par provenance. Chacune porte un code de descendance numéroté de 1 à 43. Les individus de même provenance-descendance sont donc au minimum des demi-frères, ils ont un lien de parenté et partagent la même mère mais pas nécessairement le même père. Lorsque les

individus ont été récoltés au sein d'une provenance sans identification de l'arbre-mère, ils ont été regroupés dans la même descendance codée 0. Ces descendances en mélange (« bulk ») ne possèdent donc pas de lien de parenté connu (les descendances « bulk » sont mentionnées dans la quatrième colonne du Tableau S1, Chapitre 3).

Les **populations natives** installées dans les tests de provenance-descendance ont été échantillonnées sur l'ensemble de l'aire naturelle aux Etats-Unis et au Canada (Figure 1a, Chapitre 3), sans critère de sélection sur le terrain autre que des populations naturelles, à partir de graines récoltées au sol entre 1979 et 1990 (généralement un à deux ans avant le semis) et issues d'une pollinisation libre en forêt. Les **populations introduites** installées dans les tests de provenance-descendance ont été échantillonnées, sans critère de sélection, majoritairement en France et dans six autres pays Européens (Italie, Roumanie, Espagne, Pays-Bas, Belgique et Allemagne) afin de représenter au mieux l'ensemble de l'aire d'introduction sur le continent européen (Figure 1b, Chapitre 3). Pour ces populations, les glands ont été récoltés principalement dans l'arbre entre 1979 et 1990, après pollinisation libre en forêt. L'ensemble des graines ont été semées entre 1980 et 1991 et élevées en pépinières à l'INRA d'Orléans ou de Pierroton dans les mêmes conditions environnementales pendant deux à quatre ans. L'immensité du dispositif et les difficultés de stockage des glands n'ont pas permis une récolte et un semis simultanés de tous les individus, c'est pourquoi, les plantations des arbres ont été traitées par tranches successives entre 1982 et 1993. Au total, le dispositif à la plantation compte 80603 arbres issus de 64 provenances natives et 41 provenances introduites dont les caractéristiques sont détaillées dans le Tableau S1, Chapitre 3. La répartition des populations dans chaque tranche de la pépinière et des 3 tests de provenance-descendance est précisée dans le Tableau S2, Chapitre 3.

Les plantations comparatives de provenances-descendances natives et introduites de *Q. rubra* ont été installées sur 7 **sites**, de surface variable, répartis dans les 3 tests de provenance-descendance en France (Tableau 1, Chapitre 3) : 2 sites dans le Sud-Ouest, 2 dans le Centre, 3 dans le Nord-Est. La construction des dispositifs de test de provenance-descendance est illustrée ci-dessous par la **Figure 2**, qui détaille le test du Sud-Ouest.

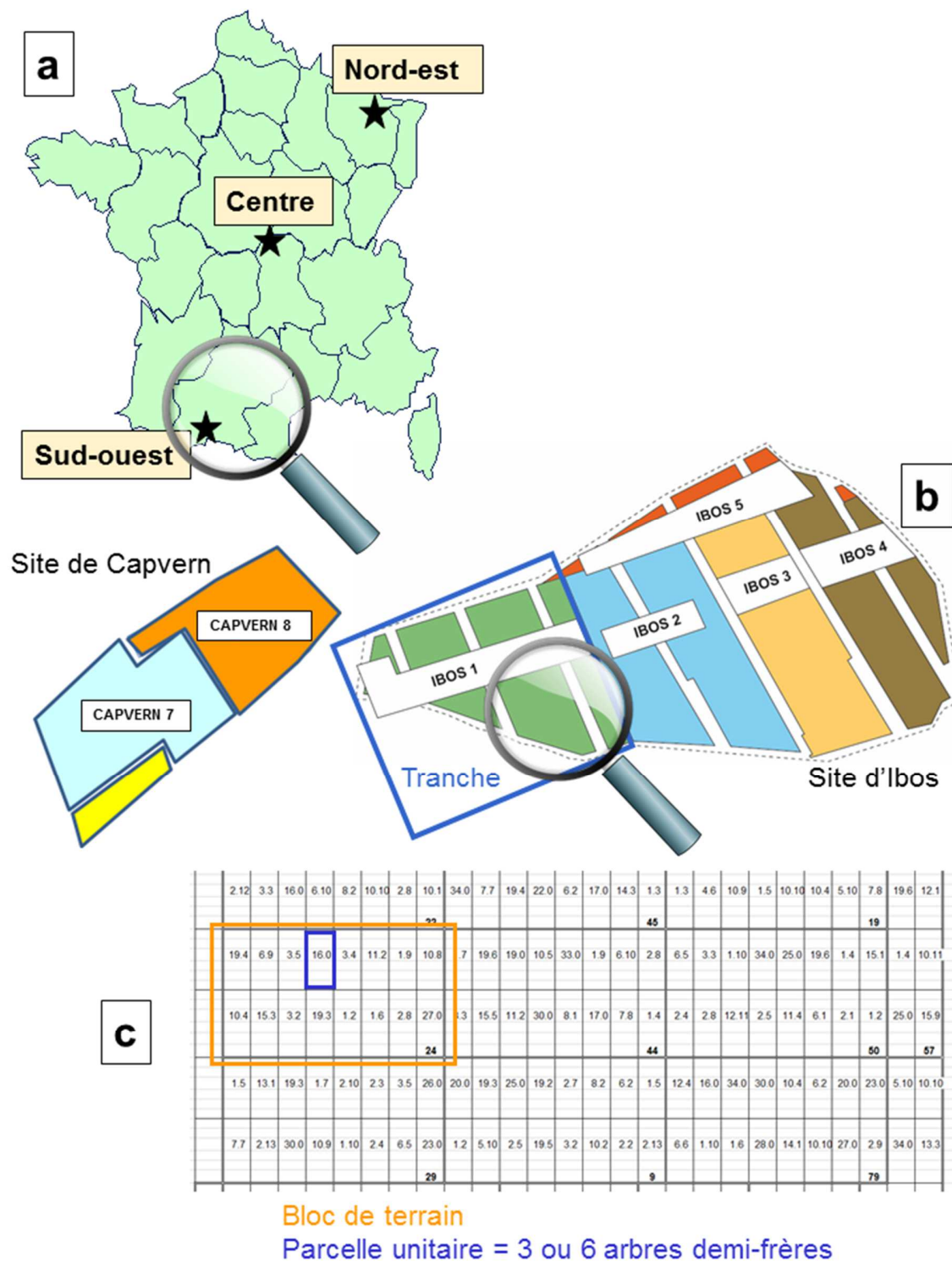

Figure 2. Illustration représentant : les 3 tests de provenance-descendance installés dans le Nord-Est, le Centre et le Sud-Ouest de la France (a) ; les sites du test de provenance-descendance du Sud-Ouest de Capvern, divisé en 2 tranches, et d'Ibos, divisé en 5 tranches (b) ; un détail du plan de la tranche 1 composée de nombreux blocs de terrain (encadré en orange) contenant 16 parcelles unitaires (encadré en bleu) chacun (c) Selon les tranches, les parcelles unitaires contiennent 3 ou 6 arbres de la même provenance et même descendance.

Au sein de chaque site, une **tranche** correspond à une campagne de plantation de *Q. rubra*. Au sein de chaque tranche, les arbres ont été répartis dans des **blocs** de terrain afin de s'affranchir de l'hétérogénéité environnementale existant au sein de la parcelle. Chaque bloc se compose de 16 ou 32 parcelles unitaires selon la tranche. Une **parcelle unitaire** représente, selon la tranche, une série de 3 ou 6 arbres de même provenance et de même descendance. Afin de réduire les niveaux d'emboîtement du dispositif expérimental qui rendent difficile les analyses statistiques, les sites, tranches et blocs de terrain ont été concaténés pour créer des blocs statistiques. Lors des analyses statistiques, ce sont ces blocs statistiques qui ont été utilisés pour tester l'effet du facteur « bloc ».

Toutes les provenances-descendances n'ayant pu être plantées au sein de chaque bloc, elles ont été répétées plusieurs fois de façon aléatoire dans les blocs au sein des tranches. Cependant, des provenances natives et introduites de mêmes coordonnées géographiques et altitude portant le même nom de population, ont été répétées dans l'ensemble du dispositif. Elles se retrouvent dans deux ou trois tests de provenance-descendance. Il s'agit des populations « ponts » (provenances « ponts » soulignées en noir dans le Tableau S1, Chapitre 3). Certaines de ces provenances « ponts » ont été récoltées et plantées la même année dans des tests de provenance-descendance différents et portent le même code de provenance. D'autres ont été récoltées et plantées à plusieurs années d'intervalle dans des tests de provenance-descendance différents et ne possède pas le même code de provenance. Le dispositif expérimental est donc un dispositif en blocs incomplets, toutes les provenances ne sont pas présentes dans chaque tranche, et déséquilibré, il n'y a pas le même nombre de descendances pour chaque provenance.

Au fil des années, certains sites ou certaines tranches du dispositif ont été abandonnés à cause de fortes mortalités au sein des arbres plantés dans des sols trop hydromorphes. Il en résulte donc une absence de certaines mesures dans les sites et tranches abandonnés. Aujourd'hui, seuls les sites de Sorbey (Nord-Ouest), Capvern et Ibos (Sud-Ouest) sont accessibles et en bon état ; Capvern et Ibos constituent des vergers à graines pour le chêne rouge d'Amérique.

Les mesures de croissance, phénologie foliaire (débourrement, coloration), survie et fourchaison ont été réalisées sur l'ensemble des arbres des 3 tests de provenance-descendance par des techniciens de l'INRA.

Dans le chapitre 4, nous avons génotypé 62 populations natives et 38 populations introduites, provenant des tests de provenance-descendances installés en France, et 11 populations natives supplémentaires, provenant directement de populations naturelles récoltées aux États-Unis. À travers une approche de génétique moléculaire, nous avons voulu déterminer l'origine des populations introduites en Europe et savoir si ces populations avaient subi un évènement de goulot d'étranglement lors de l'introduction.

Des échantillons de bourgeons et de feuilles ont été prélevés directement sur les arbres au sein de 62 populations natives et 38 populations introduites présentes dans les tests de provenance-descendance décrits ci-dessus. Les bourgeons correspondent aux échantillons récoltés mais non-utilisés par Carlos Magni Diaz durant sa thèse (Magni Diaz 2004). Ils ont été stockés au congélateur à -80°C pour conserver l'ADN. Afin de compléter l'échantillonnage et d'augmenter le nombre de descendances par provenance, des échantillons de feuilles fraîches ont été prélevés durant l'été 2016 dans les sites encore accessibles : Capvern, Ibos et Sorbey. Pour augmenter le nombre de populations natives, des échantillons de feuilles directement récoltées sur 18 à 39 arbres différents dans 11 populations naturelles aux États-Unis et lyophilisés nous ont été envoyés par des collègues chercheurs à l'Université de Notre-Dame (Indiana). Au total 1061 feuilles ou bourgeons ont été échantillonnés à partir de 73 populations natives, dont 11 proviennent directement de populations naturelles prélevées sur continent nord-américain et 62 proviennent des tests de provenance-descendance installés en France, et 38 populations introduites issues des tests de provenance-descendance (Tableau 1, Chapitre 4). Les caractéristiques détaillées de chacune des populations natives et introduites utilisées dans ce chapitre sont mentionnées dans le Tableau S1, Chapitre 4.

Chapitre 3 : Phenotypic differentiation between native and introduced populations of *Quercus rubra*

In preparation.

Nastasia R. Merceron ^{1,2}, Alexis Ducousso ¹, Arnaud Monty ², Antoine Kremer ¹, Annabel J. Porté ¹

¹ BIOGECO, INRA, Univ. Bordeaux, 33610 Cestas, France

² University of Liège, Gembloux Agro-Bio Tech., Biodiversity and Landscape Unit,
2, Passage des Déportés, B-5030 Gembloux, Belgium.

Abstract

Rapid evolutionary changes can help introduced plants to locally adapt to new environmental conditions and successfully establish in a variety of habitats. This suppose phenotypic differentiation due to genetic variation among introduced populations. In response to new biotic and abiotic conditions in the introduced range, natural selection can favor genotypes with advantageous phenotypic traits related to fitness plant. In the case of species introduced for ornamentation or cultivation, anthropic artificial selection could be involved in phenotypic differentiation observed among natives and introduced plant populations. Native to North America, Northern red oak (*Quercus rubra* L.) was intentionally introduced in Europe from the XVIIth century for ornamentation then forestry. *Quercus rubra* is now widespread in European forests due to plantations and natural regeneration and considered as an invasive species in some countries. Our objectives were to test if introduced populations of *Q. rubra* expressed phenotypic differences in artificial selection-related traits or fitness-related traits compared to native populations and if these differences could result from a local adaptation to new environmental conditions. We used three provenance-progeny tests settled in South-Western, Central and North-Eastern France, composed of 64 American and 41 European populations. Growth in height and circumference, survival, forking, budburst and coloration were measured in native and introduced populations. In each provenance-progeny test and for each trait, Q_{ST} indexes were calculated to evaluate genetic differentiation within both populations. Probably by means of natural selection, introduced populations presenting a higher growth compared to native populations have been favored in Europe. Q_{ST} estimates demonstrated the existence of a high genetic differentiation between native populations for most of the traits. Introduced populations presented a significant lower level of differentiation for leaf budburst. No evidence of artificial selection was detected. Introduced populations of *Q. rubra* are genetically differentiated and seem have managed to adapt to environmental conditions encountered in Europe suggesting a rapid evolution of populations after their introduction.

Key-words

Provenance-progeny tests, phenotypic traits, genetic differentiation, selection, *Quercus rubra*.

Introduction

Population transfer may offer the opportunity to study rapid evolution, usually over a few centuries, following introduction and spread of a species in a new geographical area (Sakai *et al.*, 2001; Lee, 2002; Maron *et al.*, 2004; Prentis *et al.*, 2008; Monty *et al.*, 2013). After introduction, species must cope with new biotic and abiotic conditions and may undergo new selection pressures. In response to these pressures, genetically-based evolutionary changes in phenotypic traits can occur rapidly facilitating the establishment and geographic spread of the populations to their new environment (Sultan *et al.*, 2013; Vandepitte *et al.*, 2014). Recent studies mentioned the importance of rapid evolutionary changes due to local adaptation in contributing to successful plant introductions (Buswell *et al.*, 2011; Novy *et al.*, 2013; Moran & Alexander, 2014; Lamarque *et al.*, 2015), especially local adaptation to new climatic conditions in the introduced range (Becker *et al.*, 2006; Colautti & Barrett, 2013; Hamilton *et al.*, 2015). Natural selection is one of the evolutionary forces which could be responsible for adaptive genetic changes of introduced populations leading to local adaptation (Lee, 2002; Colautti & Barrett, 2010; Colautti & Lau, 2015). Moreover, some species which were deliberately introduced (Ewel *et al.*, 1999; Mack & Lonsdale, 2001), especially plants and trees used for ornamentation or production purposes (Mack, 2000; Reichard & White, 2001; Barney & Ditomaso, 2008), could have benefited from anthropogenic selection. Phenotypic superior seed trees regarding growth and shape may have been selected as source material and thus resulted in a genetic change in introduced populations. Anthropogenic selection can occur at two points. First, in the native range before introduction, human could have been collected and brought back from the native range the most robust and vigorous individuals with a high growth and no visual defect. For instance, cultivar populations of the invasive shrub *Ardisia crenata*, introduced for ornamentation, expressed a greater fecundity and a denser foliage compared to native populations; these traits favored their invasion success, enhancing their regeneration potential and competitive ability (Kitajima *et al.*, 2006). Second, in the new range after introduction, an organized breeding program can have been set-up when managing the introduced species, as for example the European invasive tree *Robinia pseudoacacia* (Keresztesi, 1983) largely used in forestry. For

example, invasive shrubs of *Mahonia* species, introduced from North America to Europe, showed a superior growth compared to native species resulting from hybridization and artificial selection during plant breeding in the introduced range (Ross & Auge, 2008).

Rapid evolutionary changes may be triggered via various demographic or evolutionary processes associated to the introduction of a species such as founding effect, genetic drift, intra- or interspecific hybridization, local adaptation to new environments by natural selection or anthropogenic selection (Allendorf & Lundquist, 2003; Lambrinos, 2004; Ellstrand & Schierenbeck, 2006). These changes will ultimately lead to genetic differentiations between both native and introduced populations. They can be detected by a combined approach of evolutionary ecology and quantitative genetics: firstly, by comparing phenotypic traits between the populations of native and introduced ranges in a similar environment but repeated in multiple common gardens to deal with potential genetic x environment interactions (Bossdorf *et al.*, 2005; Williams *et al.*, 2008); secondly, by measuring quantitative genetic variation of phenotypic traits among populations within either the native or introduced range. The degree of genetic differentiation among populations for quantitative traits can then be estimated using Q_{ST} , which is the ratio of between-population additive genetic variance to total genetic variance (Wright, 1949; Spitze, 1993). Comparing means values for various adaptive traits (growth, reproduction, phenology, survival) assessed in common garden experiments between introduced and native populations is a way to evaluate whether evolutionary change has occurred since introduction. These comparisons may further be enriched by comparing Q_{ST} values estimated within each gene pools (Merilä & Crnokrak, 2001; McKay & Latta, 2002; Whitlock, 2008). Earlier investigation have indeed shown significant divergence between introduced and native population for different phenotypic traits related to fitness as growth, budburst, reproduction and survival in some introduced plants such as *Sapinum sebiferum*, *Ambrosia artemisiifolia*, *Acer negundo* (Siemann & Rogers, 2001; Hodgins & Rieseberg, 2011; Lamarque *et al.*, 2015).

Quercus rubra (northern red oak) is a deciduous tree species native to North America (eastern USA and southeastern Canada, Little, 1971; **Fig. 1a**). It was intentionally introduced to Europe during the 17th century (Goeze, 1916; Magni, 2004) for ornamental

purposes, then planted for hardwood reforestation and timber trade (Lanier *et al.*, 1980; Woziwoda *et al.*, 2014b). *Quercus rubra* benefited from a breeding program in the 1980's in France (Kremer, 1986, 1994). Now well-established in European forests due to large plantations and a significant natural regeneration (Major *et al.*, 2013), it is considered an invasive species in some European countries (Woziwoda *et al.*, 2014a). A previous study comparing 15 European and 18 North American populations of *Q. rubra* in a provenance test showed genetic differentiation in leaf phenology related to the origin of the populations (Daubree & Kremer, 1993). Stem forking is a part of main defects in tree shape and considered as a criterion of selection by European foresters to improve wood quality (Fernandez & Steinmetz, 1994). If anthropic artificial selection occurred on *Q. rubra* introduced populations, we can suspect that they have fewer forks than native populations.

A few studies suggested that introduced trees can exhibit rapid evolution (Siemann & Rogers, 2001; Erfmeier & Bruelheide, 2004; Lamarque *et al.*, 2015). We explore here if genetic divergence has occurred between native and introduced populations of *Q. rubra* by comparing, respectively, 64 and 41 populations of the native and introduced ranges planted in replicated provenance-progeny tests established in the South-West, Center and North-East of France. We included in our investigations various phenotypic traits putatively related to fitness (survival, growth, leaf phenology) or to anthropogenic selection (stem forking). We addressed the following question: 1) Are there genetic differences for anthropogenic selection-related traits suggesting a significant role of man-made selection in the patterns observed? 2) Are there genetic differences between *Q. rubra* populations of the native and introduced ranges for fitness-related traits? 3) Are these differences adaptive, i.e. contributing to higher fitness in introduced populations?

Materials and methods

Provenance-progeny tests

Three provenance-progeny tests were settled in South-West (SW), Center (CT) and North-East (NE) of France in the 80s and 90s (**Fig. 1b**, **Table 1**). Each provenance-progeny test was constituted of 7, 4 and 6 sets, respectively, and the nurseries of 3 sets (**Table 1**). A set corresponds to a homogeneous planting site and at the same planting time period. Each set was split in field blocks made of 16 or 32 unit plots, each unit plot consisting of 3 or 6 trees from the same progeny. Each progeny was randomly repeated 2 to 30 times within each set. Acorns were sampled between 1979 and 1990, sown the year after sampling and grown under the same environmental conditions for one to four years in one of the two French nurseries (Orléans or Cestas-Pierroton) before seedlings were planted in the field between 1982 and 1993.

Table 1. Main characteristics of the three provenance-progeny tests and the nursery: forest name, set code, latitude (Lat., decimal degrees), longitude (Long., decimal degrees), altitude (Alt., m), aspect, set area (Area, ha), distance between trees at planting (m), years of sowing (Sowing) and planting (Planting), total number of populations (N_P), of link populations (N_L) (proportion of link populations relative to the total number of populations), progenies (N_F) and trees (N_T) within each set. The dash indicates the lack of information concerning some characteristic.

Provenance-progeny test	Forest + set code	Lat.	Long.	Alt.	Aspect	Area	Planting distance	Sowing	Planting	N_P	N_L	N_F	N_T
Nursery	Pierroton 1	44.744	-0.784	60	-	-	-	1981	-	33	31 (94%)	105	4170
Nursery	Pierroton 2	44.744	-0.784	60	-	-	-	1982	-	32	27 (84%)	184	5400
Nursery	Pierroton 3	44.744	-0.784	60	-	-	-	1982	-	25	19 (76%)	85	4032
South-West	Ibos 1	43.230	-0.029	340	South-East	4.56	3 x 2	1980	1982	33	31 (94%)	101	7506
South-West	Ibos 2	43.230	-0.029	340	West	5.30	3 x 2	1981	1982	27	25 (93%)	111	5496
South-West	Ibos 3	43.230	-0.029	340	South-West	2.70	3 x 2	1981	1984	10	9 (90%)	63	4506
South-West	Ibos 4	43.230	-0.029	340	South-West	3.11	3 x 2	1981	1985	11	4 (36%)	59	4758
South-West	Ibos 5	43.230	-0.029	340	South-West	1.78	3 x 2	1983	1986	10	6 (60%)	39	3026
South-West	Capvern 7	43.104	0.347	590	North-West	6.04	3 x 2	1989	1991	25	18 (72%)	203	8640
South-West	Capvern 8	43.104	0.347	590	North-West	4.50	3 x 2	1991	1993	13	10 (77%)	103	6474
Center	Vouzeron 1	47.273	2.253	226	South-West	3.97	3 x 2	1980	1982	31	31 (100%)	91	3874
Center	Vouzeron 2	47.273	2.253	226	South-West	2.13	3 x 2	1981	1983	17	16 (94%)	56	3402
Center	Vouzeron 3	47.273	2.253	226	South-West	3.11	3 x 2	1981	1984	10	10 (100%)	65	1350
Center	Vierzon 1	47.416	1.973	165	-	2.32	2.5 x 2.6	1982	1986	9	6 (66%)	44	3840

North-East	Ternes 1	48.383	6.333	320	West	2.15	3 x 3	1980	1982	25	25 (100%)	51	2802
North-East	Ternes 2	48.383	6.333	320	East	1.25	3 x 1.5	1981	1983	16	16 (100%)	44	2723
North-East	Mondon 1	48.55	6.633	250	South-West	1.85	3 x 1.5	1981	1984	17	14 (82%)	47	4128
North-East	Mondon 2	48.55	6.633	250	South-West	0.92	3 x 1.5	1981	1985	4	4 (100%)	28	2063
North-East	Sorbey 7	49.039	6.322	240	South-West	5.21	3 x 1.75	1989	1991	28	18 (64%)	186	7857
North-East	Sorbey 8	49.039	6.322	240	South-West	4.30	3 x 1.75	1991	1993	16	10 (63%)	115	8208

In total, 64 North American populations were sampled throughout all the native range (**Fig. 1a**) and 41 European populations through the introduced range (**Fig. 1b**) with 1 to 25 progenies per population. Individuals from a same progeny were half-siblings originating from open-pollinated acorns sampled on the same mother tree. In 7 North American and 33 European populations, acorns were collected without distinction of the mother tree thus corresponding to a bulk progeny (**Appendix Table S1**). There was a total of 1405 different progenies. Thirty-two American and 37 European populations, so-called the link populations, were planted repeatedly in varying number (from 4 to 31) across the different sets in the three provenance-progeny tests (**Table 1**). The general geographic and climatic characteristics of the sampled populations are detailed in **Appendix Table S1**. The distribution of populations in each set of the nursery and the three provenance-progeny tests is mentioned in **Appendix Table S2**.

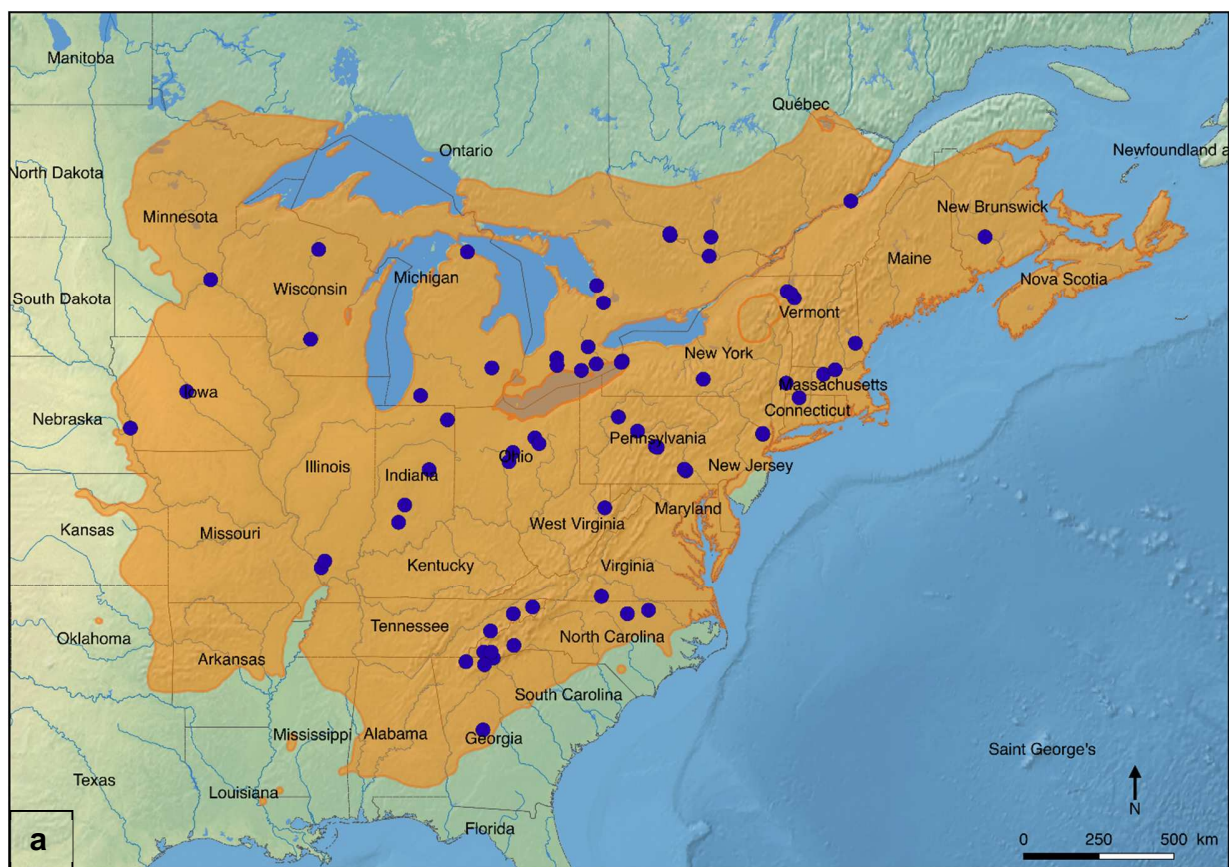



Figure 1. Location of the *Q. rubra* populations sampled in the native range (a, n=64) and in the introduced range (b, n=41). The three provenance-progeny tests (b) are represented using black stars. The native range of the species in North America according to Little (1971) is represented in orange (U.S. Geological Survey, <http://esp.cr.usgs.gov/data/little/> Little, 1971). The raster background maps were provided free of use by Natural Earth website (<http://www.naturalearthdata.com/>) at 1:50m scale.

Phenotypic measurements

From sowing date to 2012, trees were monitored regularly for survival, growth (diameter, height), forking and leaf phenology (budburst, coloration). With time, parts of the provenance-progeny tests have been abandoned due to high mortalities that occurred particularly in hydromorphic soils or due to forest management practices that altered the experimental design (**Appendix Table S3**). To deal with the huge size of the experimental design, phenotypic measurements were made consecutively in the sets of each test, such

as they were performed during different years but when the trees had reached approximately the same age (**Appendix Table S3**).

Survival, growth and forking

Assessment of tree survival (living or dead tree) was done twice in each provenance-progeny test: first, between 4 and 6 years after sowing (survival at age 5) and second, between 10 and 15 years after sowing (survival at age 12). Juvenile growth was assessed twice (between 5 and 15 years after sowing) measuring total tree height (cm) using a graduated pole, from ground level to the terminal bud, at the end of the growing season. When trees grew taller, growth was assessed twice (between 9 and 16 years after sowing) by measuring stem circumference measurements at 1.30 meter height from the ground using a dendrometric tape (cm), at the end of the growing season. Height and circumference annual increments (cm.y^{-1}) were calculated by dividing the difference between two growth values by the time lapse between the two measurements. Finally, assessment of stem forking was done in each provenance-progeny test, between 9 and 15 years after sowing, by recording the absence or presence of forks on the leading stem.

Leaf phenology

Leaf budburst was assessed using a relative scoring system, from score 0 (dormant buds) to score 5 (beginning of stem elongation) that was first developed in the INRA by A. Ducouso, J.-M. Louvet and G. Roussel (**Appendix Fig. S1**) from previous measurements on native oak trees. Scoring of bud development was performed in the provenance-progeny tests once during the juvenile period (between 2 and 4 years after sowing) for spring time when at least half of the trees presented open buds.

Leaf coloration was assessed using a scoring system, from score 0 (green leaves) to score 4 (red-colored leaves). Scoring was performed one year after sowing only in the nursery of Cestas-Pierroton, in fall when at least half of the trees presented colored leaves. Dates of budburst and leaf coloration are highly sensitive to environmental conditions especially winter and spring temperatures (Fu *et al.*, 2012; Clark *et al.*, 2014). Therefore, to allow an overall analysis of the experimental design, field scores of budburst and coloration were standardized per set to obtain a relative score. The relative score of

each individual was calculated as its field score dividing by the average field score of all individuals of the link populations of the set.

Q_{ST} estimation

A quantification of the genetic differentiation among populations (Q_{ST}) was estimated for each phenotypic trait within each provenance-progeny test, considering separately the native or introduced populations. Q_{ST} is defined as the ratio between the genetic variance among populations (inter-population σ_{pop}^2) and the total genetic variance (σ_{tot}^2); the total genetic variance is calculated knowing the genetic variance among populations and the additive variance (σ_A^2) (Wright, 1949; Spitze, 1993; Falconer & Mackay, 1996):

$$Q_{ST} = \frac{\sigma_{pop}^2}{\sigma_{tot}^2} = \frac{\sigma_{pop}^2}{(\sigma_{pop}^2 + 2 * \sigma_A^2)} \quad [1]$$

Additive variance (σ_A^2) can be estimated from the within-population variance. Assuming that the open pollinated progenies were half sibs, the additive genetic variance corresponds to four times the genetic variance among progenies within populations (intra-population σ_F^2) (Falconer & Mackay, 1996; Lynch & Walsh, 1998) can be estimated as follows :

$$\sigma_A^2 = 4 \times \sigma_F^2 \quad [2]$$

Bulk progenies were ruled out for the calculation of σ_A^2 .

A 95% confidence interval of Q_{ST} value was calculated using the Delta method (see Appendix 1 in Lynch & Walsh, (1998)) following the procedure used for heritability by Isik (2009) by taking the square root of the Q_{ST} variance to have error standard of the confidence interval. The Q_{ST} variance was obtained from the ratio of variance and covariance of genetic variance among populations (σ_{pop}^2) and genetic variance among progenies within populations (σ_F^2):

$$var(Q_{ST}) = Q_{ST}^2 * \left[\frac{var(\sigma_{pop}^2)}{(\sigma_{pop}^2)^2} + \frac{var(\sigma_{pop}^2)+64*cov(\sigma_{pop}^2,\sigma_F^2)+16*var(\sigma_F^2)}{(\sigma_{pop}^2+8*\sigma_F^2)^2} - \frac{\frac{2}{\sigma_{pop}^2}}{(\sigma_{pop}^2+8*\sigma_F^2)*(var(\sigma_{pop}^2)+8*var(\sigma_F^2))} \right] \quad [3]$$

Statistical analysis

Complete block designs were used in the nursery and unbalanced incomplete block designs in the provenance-progeny tests. To reduce the levels of nesting within the experimental design and still take into account spatial and temporal effects on trait variance, statistical blocks were created from the concatenation of sets and field blocks (n= 76 to 421 according to the provenance-progeny test). For each provenance-progeny test, leaf budburst relative score, leaf coloration relative score, circumference and height annual increments were analyzed using a linear mixed model (procedure MIXED, REML method, SAS, version 9.4, SAS Institute Inc., Cary, NC, USA); survival and forking binary data were analysed using a generalized linear mixed model (procedure GLIMMIX) with a binary distribution and a logit link. For all analyses, range (native vs introduced) was considered as a fixed effect; block, the interaction range x block, population nested within range and progeny nested within population were considered as random effects. Effects were considered significantly different at $p < 0.05$. The genetic variance inter-population (σ_{pop}^2) was estimated from variance of populations nested within range considering all populations, and the genetic variance intra-population (σ_F^2) from variance of progenies nested within populations without bulk progenies.

Results

Height growth of introduced populations was significantly higher in comparison to native populations. Circumference annual increment was significantly different between ranges in the South-West progeny test (**Table 2, Fig. 2a&b**). There was no significant difference in leaf phenology between ranges in all progeny tests, although introduced populations tended to present earlier budburst compared to native populations (**Table 2, Fig. 2d**). The differences in forking between ranges were not significant in the South-West

and North-East provenance-progeny tests but forking was significantly more frequent in trees from the native range compared to the introduced range in the Center provenance-progeny test (**Table 3, Fig. 2c**). No significant differences were observed between native and introduced populations for both survival assessments across all progeny tests (**Table 3, Fig. 2e&f**).

Within each range and for all progeny tests, there was a significant population effect for survival at ages 5 and 12, circumference increment, leaf budburst (**Table 2, Table 3**) and leaf coloration (**Table 4**). Significant population effects were also evidenced for height increment within each range in the South-West test. In all three progeny tests, there was no significant differences in forking due to populations within neither ranges (**Table 3**). Overall, whatever the test and the phenotypic trait, there was a significant effect of progenies within populations (except for survival at age 12 in the Center test, **Table 2, Table 3, Table 4**).

Table 2. Results of the linear mixed model analyses for circumference and height increment and leaf budburst standardized score in each provenance-progeny test (South-West, Center, North-East). The lack of circumference data in the Central provenance-progeny test was represented by dashes. *F* value is given for fixed effect: range, and *Z* values for random effects: block, block and range interaction, population nested within range, and progeny nested within population. *df* represents degree of freedom. ns $p > 0.05$; * $p < 0.05$; ** $p < 0.01$; *** $p < 0.0001$.

Provenance-progeny test	Source of variation	Circumference		Height		Leaf budburst	
		<i>df</i>	increment <i>F</i> or <i>Z</i>	<i>df</i>	increment <i>F</i> or <i>Z</i>	<i>df</i>	score <i>F</i> or <i>Z</i>
South-West							
	Range	1	21.46***	1	17.33***	1	0.51(ns)
	Block	376	10.93***	418	12.68***	420	9.10***
	Range x block	753	0.89(ns)	837	5.61***	841	3.85***
	Population (range)	85	4.41***	87	3.87***	87	5.40***
	Progeny (population)	40	8.27***	40	9.54***	40	13.82***
Center							
	Range	-	-	1	11.92**	1	0.49(ns)
	Block	-	-	138	5.83***	79	5.05***
	Range x block	-	-	277	2.28*	159	2.16*
	Population (range)	-	-	52	0.00(ns)	44	3.78***
	Progeny (population)	-	-	29	6.05***	13	5.06***
North-East							
	Range	1	2.36(ns)	1	20.22***	1	1.13(ns)
	Block	204	3.44**	404	8.30***	286	7.60***
	Range x block	409	1.02(ns)	809	2.50**	573	3.60**
	Population (range)	28	2.75**	75	0.00(ns)	43	3.92***
	Progeny (population)	24	3.97***	36	3.23**	36	8.74***

Table 3. Results of the generalized linear mixed model analyses with a binary response distribution and a logit link for survival at age 5 and at age 12 and forking in each provenance-progeny test (South-West, Center, North-East). *F* value is given for fixed effect: range, and *ChiSq* values for random effects: block, block and range interaction, population nested within range, and progeny nested within population. *df* represents degree of freedom. ns $p > 0.05$; * $p < 0.05$; ** $p < 0.01$; *** $p < 0.0001$.

Provenance-progeny test	Source of variation	Survival at age 5		Survival at age 12		Forking	
		<i>df</i>	<i>F</i> or <i>ChiSq</i>	<i>df</i>	<i>F</i> or <i>ChiSq</i>	<i>df</i>	<i>F</i> or <i>ChiSq</i>
South-West							
	Range	1	1.19(ns)	1	0.11(ns)	1	0.00(ns)
	Block	420	65.48***	370	160.39***	372	75.07***
	Block x range	841	65.48***	741	160.39***	746	75.07***
	Population (range)	87	22.77***	85	35.73***	86	2.19(ns)
	Progeny (population)	40	269.99***	40	43.27***	40	49.68***
Center							
	Range	1	1.66(ns)	1	0.66(ns)	1	4.30*
	Block	138	51.2***	98	41.66***	75	5.36*
	Block x range	277	51.2***	197	41.66***	151	5.36*
	Population (range)	52	9.09**	50	49.36***	50	0.00(ns)
	Progeny (population)	29	3.18*	28	0.99(ns)	28	6.98**
North-East							
	Range	1	3.37(ns)	1	0.20(ns)	1	1.24(ns)
	Block	346	163.77***	117	31.25***	192	4.38*
	Block x range	693	163.77***	235	31.25***	385	4.38*
	Population (range)	62	6.72**	37	3.58*	49	0.01(ns)
	Progeny (population)	36	24.86***	13	9.61**	19	113.88***

Table 4. Results of the linear mixed model analyses for leaf coloration standardized score in the nursery. *F* value is given for fixed effect: range, and *Z* values for random effects: block, block and range interaction, population nested within range, and progeny nested within population. *df* represents degree of freedom. ns $p > 0.05$; * $p < 0.05$; ** $p < 0.01$; *** $p < 0.0001$.

Source of variation	<i>df</i>	Coloration <i>F- or Z-value</i>
Range	1	4.29(ns)
Block	11	2.04*
Block x range	23	0.68(ns)
Population (range)	68	3.77***
Progeny (population)	30	9.77***

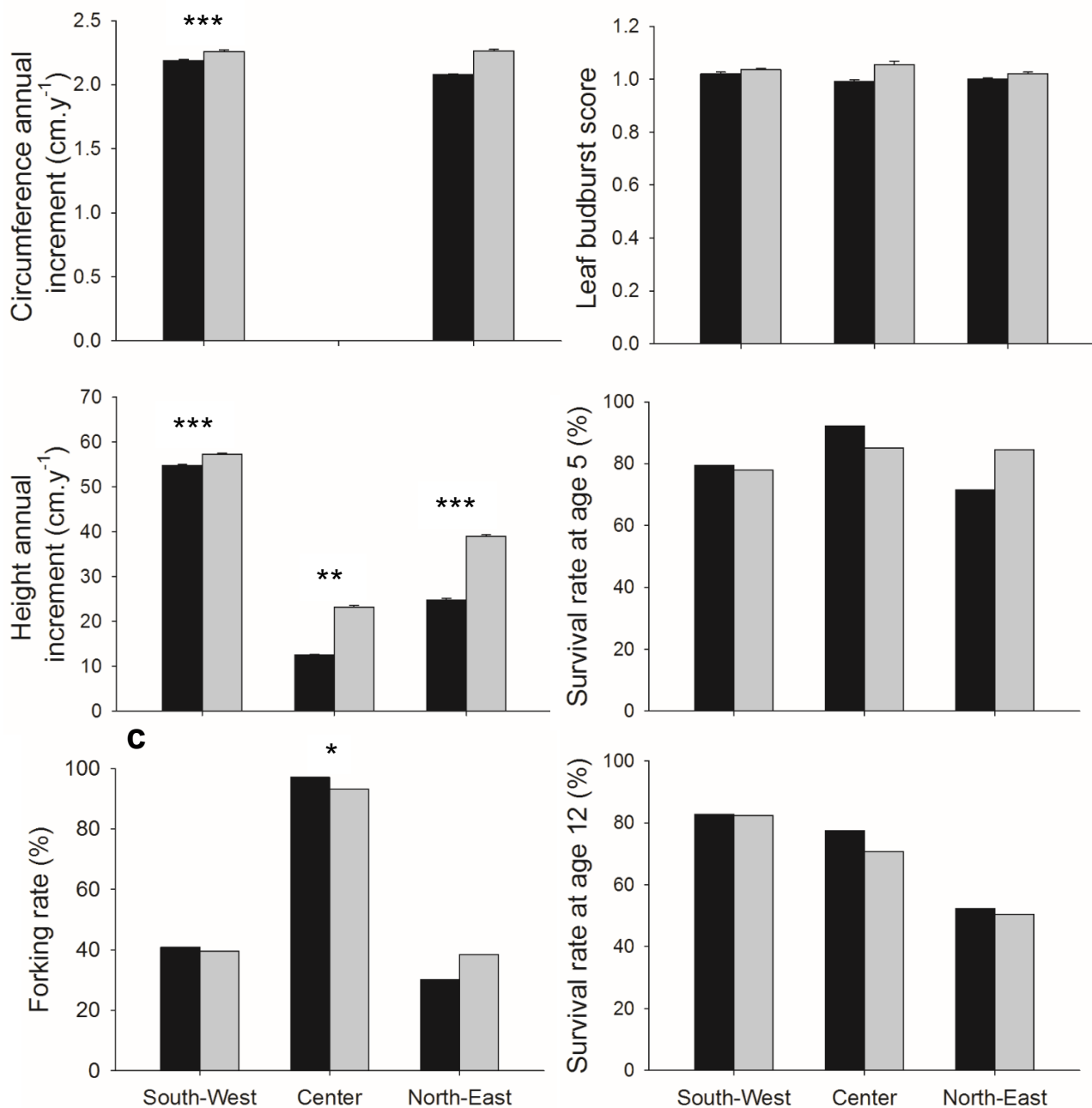

Figure 2. Mean of circumference annual increment (a), height annual increment (b), forking rate (c), leaf budburst standardized score (d), survival rates at age 5 (e) and at age 12 (f) for native (black bars) and introduced (grey bars) populations of *Q. rubra* in each of the three provenance-progeny tests (South-West, Center and North-East). Due to a partial destruction of the Central provenance-progeny test, it was abandoned 10 to 14 years after planting according the set and no circumference measurements were performed. For convenience and ease of representation, survival and forking data which were analyzed at binary data are presented here as a percentage. Values represent mean \pm SE for native and introduced populations. * p < 0.05, ** p < 0.01, *** p < 0.0001.

Overall, whatever the trait and the provenance-progeny test, genetic differentiation among populations (Q_{ST} values) indicated that native populations were more differentiated than introduced populations; Q_{ST} values varied respectfully from 0.028 to 0.686 for native populations and from 0 to 0.347 for introduced populations (**Table 5**). For height increment, forking and leaf coloration, no significant genetic differentiation was found among introduced populations whereas native populations were significantly differentiated with high Q_{ST} values. For survival, circumference increment and budburst, Q_{ST} values between native populations were also high, while differentiation was weak between introduced populations. There was some of variation of genetic differentiation among the provenance-progeny tests. For survival at age 5, differentiation was significant in two out of the three tests; for radial growth significant differentiation was only detected in the North-East test. For leaf budburst, low but significant Q_{ST} values were observed both in the North-East and South-West tests (in the Center test, there was only bulk populations, not allowing to calculate Q_{ST} indexes).

Table 5. Q_{ST} indexes and confidence interval estimated using a mixed model and delta method for each phenotypic trait: circumference annual increment, height annual increment, leaf budburst standardized score, leaf coloration standardized score, survival at age 5 and at age 12 and forking. Bold characters indicates significant Q_{ST} values with confidence interval not including zero. Dashes were used when Q_{ST} could not be calculated (only bulk progenies in introduced populations into some sets and provenance-progeny tests).

Phenotypic trait	Provenance-progeny test	Q_{ST} Introduced	Q_{ST} Native
<i>Circumference annual increment</i>	South-West	0.007 [-0.006; 0.021]	0.492 [0.368; 0.616]
	North-East	0.092 [0.039; 0.144]	0.576 [0.316; 0.836]
<i>Height annual increment</i>	South-West	0.013 [-0.001; 0.028]	0.596 [0.475; 0.717]
	Center	0.000†	0.381 [0.165; 0.597]
	North-East	0.347 [-0.031; 0.726] ‡	0.520 [0.259; 0.782]
<i>Leaf budburst standardized score</i>	South-West	0.016 [0.009; 0.023]	0.229 [0.150; 0.309]
	Center	-	0.351 [0.195; 0.507]
	North-East	0.033 [0.008; 0.059]	0.471 [0.307; 0.635]
<i>Leaf coloration standardized score</i>	Nursery	0.005 [-0.003; 0.014]	0.190 [0.098; 0.282]
<i>Survival at age 5</i>	South-West	0.012 [0.008; 0.015]	0.661 [0.537; 0.785]
	Center	0.000†	0.195 [0.075; 0.314]
	North-East	0.024 [0.004; 0.044]	0.686 [0.541; 0.831]
<i>Survival at age 12</i>	South-West	0.003 [-0.007; 0.001]	0.254 [0.159; 0.348]
	Center	0.000†	0.028 [-0.007; 0.063]
	North-East	-	0.295 [0.071; 0.520]
<i>Forking</i>	South-West	0.043 [-0.017; 0.104]	0.616 [0.452; 0.779]
	Center	0.000†	0.259 [0.092; 0.427]
	North-East	0.227 [0.094; 0.360]	0.666 [0.416; 0.915]

The symbol † indicates a null estimate of Q_{ST} without confidence interval as a result of no genetic variance between populations. The symbol ‡ indicates a high variability between introduced populations in this provenance-progeny test probably due to stressful or no favorable conditions to grow.

Discussion

Using three provenance-progeny tests and measuring traits related to survival, growth and phenology, our study provided evidence of genetic differentiation between European introduced and North American native populations of *Q. rubra* as well as among populations within each range. Genetically based phenotypic differences between and within both ranges could result from different demographic or evolutionary processes associated to the introduction of a species. Here, we focused on natural or artificial selection that could be involved in local adaptation of introduced populations.

In forestry, we can hypothesize that since *Q. rubra* is a tree species used for timber production, artificial selection of the most robust and vigorous individuals could have occur as a result of breeding program in the introduced range favoring trees with a superiority in growth and showing no visual defect presenting a good wood quality. Sustaining this hypothesis, anthropic artificial selection contributed to the observed genetic differentiation between introduced and native populations of ornamental invasive shrubs, *Ardisia crenata* and *Mahonia* species (Kitajima *et al.*, 2006; Ross & Auge, 2008). In our study, we analyzed changes of stem forking as a sign of potential anthropogenic selection, since such a defect of tree shape could have been progressively eliminated by forest managers in the introduced range to improve wood quality (Fernandez & Steinmetz, 1994). No evidence of anthropogenic selection in forking was detected between native and introduced populations of *Q. rubra* in our data. Nevertheless, analysis of more phenotypic traits related to anthropogenic selection, as the number of bayonets or forks or a rating of tree shape, could help to confirm the lack of an artificial selection by human.

Introduced populations of *Q. rubra* in Europe showed on average a greater growth than native populations from North America. Higher growth rates were often observed in introduced populations compared to native populations in herbaceous species (Leger & Rice, 2003; Jakobs *et al.*, 2004; Blumenthal & Hufbauer, 2007; Hodgins & Rieseberg, 2011) as well as in woody species (Siemann & Rogers, 2001; Erfmeier & Bruelheide, 2004; Zou *et al.*, 2009; Lamarque *et al.*, 2015). According to the EICA (Evolution of Increased Competitive Ability) hypothesis, invasive plants display a higher growth and

reproduction further to a post-introduction adaptation due to changes in selective pressures, in particular the absence or reduction of natural enemies in the new range (Blossey & Nötzold, 1995; Keane & Crawley, 2002; Bossdorf, 2013). This trade-off in carbon use strategies with a shift towards growth and reproduction instead of allocating resources to the development of costly defense traits has been recently demonstrated in woody invasive species (Siemann & Rogers, 2001; Ebeling *et al.*, 2007). Furthermore, changes in competitive pressure from other plants may also induce shifts in carbon allocation in introduced species to outcompete local species, and thus result in a natural selection of the fastest and highest growing individuals in the introduced range (Lamarque *et al.*, 2013; Sheppard & Burns, 2014). One hypothesis is thus that introduced populations of *Q. rubra* have been naturally selected over generations for better growth in response to the biotic or abiotic selection pressures encountered in Europe, conferring them an adaptive and competitive advantage. Since genetic differences were evidenced for higher growth but not better wood quality, this could suggest that observed differences between native and introduced populations of *Q. rubra* would result from the action of natural processes favoring more competitive individuals.

Local adaptation by mean of rapid evolution is commonly involved to explain successful plant introductions (Maron *et al.*, 2004; Leger & Rice, 2007; Colautti & Barrett, 2013). In our study, native populations of *Q. rubra* exhibited significant Q_{ST} values for almost all the phenotypic traits and the provenance-progeny tests demonstrating a genetic differentiation among populations. Genetic differentiation among native *Q. rubra* populations was previously found for coloration, budburst, height and diameter growth in several North American provenance tests: budburst variations were correlated with longitude and coloration variations with latitude of the population sources (Deneke, 1975; Kriebel *et al.*, 1976; Schlarbaum & Bagley, 1981). A latitudinal trend was observed for diameter growth but not for height growth which is highest for populations located in a North-Central zone between 43 and 46 °N from East to West (Deneke, 1975; Schlarbaum & Bagley, 1981; Kriebel, 1993). For growth, variation within populations seems higher than among populations (Kriebel *et al.*, 1976).

In our study, genetic differentiation among introduced populations were also evidenced mostly for growth and leaf budburst, as indicated by significant Q_{ST} values or significant range effect. Being lower than in the native range, it could suggest a re-differentiation in progress of *Q. rubra* populations since the introduction in Europe. Particularly, leaf phenology is recognized to be a phenotypic trait extremely sensitive to climatic conditions and able to evolve quickly, even in forest tree species (Vitasse *et al.*, 2009). Comparing budburst and coloration between 15 introduced and 18 native populations of *Q. rubra* in a nursery, Daubree & Kremer (1993) found a small genetic variation between introduced populations suggesting that natural selection would have acted on phenology to escaping early frosts in Europe. Introduced species can be able to rapidly evolve recreating genetic differentiation among populations to adapt to new environmental conditions encountered in their new range (Leger & Rice, 2007; Etterson *et al.*, 2008; Montague *et al.*, 2008; Urbanski *et al.*, 2012). Rapid adaptive evolution to local conditions into the introduced range was recently detected in a common garden experiment on phenotypic traits of flowering phenology in *Lythrum salicaria* and *Microstegium vimineum* along a latitudinal cline (Colautti & Barrett, 2013; Novy *et al.*, 2013). Adaptive evolution of traits related to fitness from Q_{ST} values was already observed for introduced plants. Lavergne & Molofsky (2007) showed a superior genetic differentiation in phenotypic traits of growth for native populations beside introduced populations of *Phalaris arundinacea*. Significant Q_{ST} values were close, i.e. around 0.2 for introduced populations and 0.3 for native populations, suggesting an ability for the introduced populations of this species to rapidly evolve and adapt to new climatic conditions. In another study regarding only genetic differentiation among invasive populations of *Ambrosia artemisiifolia* for five phenotypic traits of growth and reproduction, Chun *et al.* (2011) found Q_{ST} values superior to 0.3 for traits of reproductive allocation supposed a rapid adaptive evolution due to abiotic conditions toward a best reproductive ability of introduced plants. Although our Q_{ST} values are not as high as those previously mentioned, they suggest that a genetic differentiation among introduced populations is producing within European *Q. rubra* populations for budburst trait. We hypothesized that introduced populations of *Q. rubra* are subject to an ongoing rapid evolution of fitness-related traits to locally adapt to biotic and abiotic conditions occurring in Europe.

To confirm a potential rapid adaptive evolution in introduced species, an analysis of molecular markers highlighting genetic changes in allele frequencies over time is required (Vandepitte *et al.*, 2014). A further study using neutral molecular loci would allow comparing genetic differentiation in quantitative traits (Q_{ST}) to neutral markers (F_{ST}) (Merilä & Crnokrak, 2001; McKay & Latta, 2002; Whitlock, 2008; Leinonen *et al.*, 2013) in order to identify the evolutionary scenario being responsible for the among-population differentiation that we evidenced in populations of *Q. rubra*.

Nevertheless, others demographic or evolutionary processes associated to the introduction of a species such as source and quantity of populations introduced in Europe, founder effects, hybridization from multiple introductions could also explain genetic differences and should be investigated to know if there is enough genetic diversity into the European populations of *Q. rubra*.

Acknowledgements

We thank M. Bertocchi, J. Boireau, J. Brach, N. Cheval, J. Daugey, J-L. Denou, F. Duverger, F. Lagane, A. Lardit, J-M. Louvet, C. Gauvrit, B. Issenhuth, P. Pastuska, R. J. Petit, L. Puzos, G. Roussel, the ONF managers and the technicians from INRA experimental units of Cestas-Pierroton, Orleans and Lorraine for field measurements in the provenance-progeny tests.

This study was carried out with financial support from the Groupement Interêt Scientifique Variétés Forestières, Améliorées, the Ministère de l'Agriculture de l' Alimention et de la Forêt, the French National Research Agency in the frame of the Investments for the future Program (ANR-10- IDEX-03-02) and from the European Research Council under the European Union's Seventh Framework Program (FP/2007-2013; ERC Grant Agreement n. 33972).

References

- Allendorf, F. & Lundquist, L. 2003. Introduction: population biology, evolution, and control of invasive species. *Conserv. Biol.* **17**: 24–30.
- Barney, J.N. & Ditomaso, J.M. 2008. Nonnative Species and Bioenergy: Are We Cultivating the Next Invader? *Bioscience* **58**: 64.
- Becker, U., Colling, G., Dostal, P., Jakobsson, A. & Matthies, D. 2006. Local adaptation in the monocarpic perennial *Carlina vulgaris* at different spatial scales across Europe. *Oecologia* **150**: 506–518.
- Blossey, B. & Nötzold, R. 1995. Evolution of increased competitive ability in invasive nonindigenous plants: a hypothesis. *J. Ecol.* **83**: 887–889.
- Blumenthal, D.M. & Hufbauer, R.A. 2007. Increased plant size in exotic populations: A common-garden test with 14 invasive species. *Ecology* **88**: 2758–2765.
- Bossdorf, O. 2013. Enemy release and evolution of increased competitive ability: At last, a smoking gun! *New Phytol.* **198**: 638–640.
- Bossdorf, O., Auge, H., Lafuma, L., Rogers, W.E., Siemann, E. & Prati, D. 2005. Phenotypic and genetic differentiation between native and introduced plant populations. *Oecologia* **144**: 1–11.
- Buswell, J.M., Moles, A.T. & Hartley, S. 2011. Is rapid evolution common in introduced plant species? *J. Ecol.* **99**: 214–224.
- Chun, Y.J., Le Corre, V. & Bretagnolle, F. 2011. Adaptive divergence for a fitness-related trait among invasive *Ambrosia artemisiifolia* populations in France. *Mol. Ecol.* **20**: 1378–1388.
- Clark, J.S., Salk, C., Melillo, J. & Mohan, J. 2014. Tree phenology responses to winter chilling, spring warming, at north and south range limits. *Funct. Ecol.* **28**: 1344–1355.
- Colautti, R.I. & Barrett, S.C.H. 2010. Natural Selection and Genetic Constraints on Flowering Phenology in an Invasive Plant. *Int. J. Plant Sci.* **171**: 960–971.

- Colautti, R.I. & Barrett, S.C.H. 2013. Rapid adaptation to climate facilitates range expansion of an invasive plant. *Science* **342**: 364–6.
- Colautti, R.I. & Lau, J.A. 2015. Contemporary evolution during invasion: evidence for differentiation, natural selection, and local adaptation. *Mol. Ecol.* **24**: 1999–2017.
- Daubree, J. & Kremer, A. 1993. Genetic and phenological differentiation between introduced and natural populations of *Quercus rubra* L. *Ann. des Sci. For.* **50**: 271–280.
- Deneke, F.J. 1975. A red oak provenance trial in Kansas. *Trans. Kansas Acad. Sci.* **77**: 195–199.
- Ebeling, S.K., Hensen, I. & Auge, H. 2007. The invasive shrub *Buddleja davidii* performs better in its introduced range. *Divers. Distrib.* **14**: 225–233.
- Ellstrand, N.C. & Schierenbeck, K.A. 2006. Hybridization as a stimulus for the evolution of invasiveness in plants? *Euphytica* **148**: 35–46.
- Erfmeier, A. & Bruelheide, H. 2004. Comparison of native and invasive *Rhododendron ponticum* populations: Growth, reproduction and morphology under field conditions. *Flora - Morphol. Distrib. Funct. Ecol. Plants* **199**: 120–133.
- Etterson, J.R., Delf, D.E., Craig, T.P., Ando, Y. & Ohgushi, T. 2008. Parallel patterns of clinal variation in *Solidago altissima* in its native range in central USA and its invasive range in Japan. *Botany* **86**: 91–97.
- Ewel, J.J., O'Dowd, D.J., Bergelson, J., Daehler, C.C., D'Antonio, C.M., Gómez, L.D., et al. 1999. Deliberate Introductions of Species: Research Needs. *Bioscience* **49**: 619.
- Falconer, D.S. & Mackay, T.F.C. 1996. *Introduction to quantitative genetics*, Fourth Edition (Longman, ed). New York, NY.
- Fernandez, R. & Steinmetz, G. 1994. Peuplements porte-graines et production de graines. In: *Le chêne rouge d'Amérique* (J. Timbal et al., eds), pp. 179–184. INRA, Paris.
- Fu, Y.H., Campioli, M., Deckmyn, G. & Janssens, I.A. 2012. The Impact of Winter and

- Spring Temperatures on Temperate Tree Budburst Dates: Results from an Experimental Climate Manipulation. *PLoS One* **7**.
- Goeze. 1916. *Liste der seit dem 16. Jahrhundert bis auf die Gegenwart in die Gärten und Parks Europas eingeführten Bäume und Stäucher. Mitteilungen der Deutschen Dendrologischen Gesellschaft.*
- Hamilton, J.A., Okada, M., Korves, T. & Schmitt, J. 2015. The role of climate adaptation in colonization success in *Arabidopsis thaliana*. *Mol. Ecol.* **24**: 2253–2263.
- Hodgins, K. a. & Rieseberg, L. 2011. Genetic differentiation in life-history traits of introduced and native common ragweed (*Ambrosia artemisiifolia*) populations. *J. Evol. Biol.* **24**: 2731–2749.
- Isik, F. 2009. Analysis of Half-sib Progeny Tests in Forestry. pp. 1–45. <http://www4.ncsu.edu/~fisik/Analysis%20of%20Half-sib%20Progeny%20Test%20Data%20in%20Forestry.pdf>
- Jakobs, G., Weber, E. & Edwards, P.J. 2004. Introduced plants of the invasive *Solidago gigantea* (Asteraceae) are larger and grow denser than conspecifics in the native range. *Divers. Distrib.* **10**: 11–19.
- Keane, R.M. & Crawley, M.J. 2002. Exotic plant invasions and the enemy release hypothesis. *Trends Ecol. Evol.* **17**: 164–170.
- Keresztesi, B. 1983. Breeding and cultivation of black locust, *Robinia pseudoacacia*, in Hungary. *For. Ecol. Manage.* **6**: 217–244.
- Kitajima, K., Fox, A.M., Sato, T. & Nagamatsu, D. 2006. Cultivar selection prior to introduction may increase invasiveness: Evidence from *Ardisia crenata*. *Biol. Invasions* **8**: 1471–1482.
- Kremer, A. 1986. Chêne rouge d'Amérique : Amélioration génétique des arbres forestiers. *Rev. For. Française* numéro spécial: 165–167.
- Kremer, A. 1994. Programme d'amélioration génétique du chêne rouge en France. In: *Le chêne rouge d'Amérique* (J. Timbal et al., eds), pp. 425–443. INRA, Paris.

- Kriebel, H. 1993. Intraspecific variation of growth and adaptive traits in North American oak species. *Ann. des Sci. For.* **50**: 153s–165s.
- Kriebel, H.B., Bagley, W.T., Deneke, F.J., Funsch, R.W., Roth, P., Jokela, J.J., *et al.* 1976. Geographic variation in *Quercus rubra* in north central United States plantations. *Sylvae Genet.* **25**: 118–122.
- Lamarque, L.J., Lortie, C.J., Porté, A.J. & Delzon, S. 2015. Genetic differentiation and phenotypic plasticity in life-history traits between native and introduced populations of invasive maple trees. *Biol. Invasions* **17**: 1109–1122.
- Lamarque, L.J., Porté, A.J., Eymeric, C., Lasnier, J.-B., Lortie, C.J. & Delzon, S. 2013. A Test for Pre-Adapted Phenotypic Plasticity in the Invasive Tree *Acer negundo* L. *PLoS One* **8**: 1–10.
- Lambrinos, J. 2004. How interactions between ecology and evolution influence contemporary invasion dynamics. *Ecology* **85**: 2061–2070.
- Lanier, L., Keller, R. & Kremer, A. 1980. Le Chêne rouge (*Quercus rubra* L.) en France. *Rev. For. Française* **32**: 419.
- Lavergne, S. & Molofsky, J. 2007. Increased genetic variation and evolutionary potential drive the success of an invasive grass. *Proc. Natl. Acad. Sci. U. S. A.* **104**: 3883–8.
- Lee, C.E. 2002. Evolutionary genetics of invasive species. *Trends Ecol. Evol.* **17**: 386–391.
- Leger, E.A. & Rice, K.J. 2003. Invasive California poppies (*Eschscholzia californica* Cham.) grow larger than native individuals under reduced competition. *Ecol. Lett.* **6**: 257–264.
- Leger, E. a. & Rice, K.J. 2007. Assessing the speed and predictability of local adaptation in invasive California poppies (*Eschscholzia californica*). *J. Evol. Biol.* **20**: 1090–1103.
- Leinonen, T., McCairns, R.J.S., O'Hara, R.B. & Merilä, J. 2013. Q_{ST} - F_{ST} comparisons: evolutionary and ecological insights from genomic heterogeneity. *Nat. Rev. Genet.* **14**: 179–90. Nature Publishing Group.

- Little, E.L.J. 1971. *Atlas of United States trees, volume 1, conifers and important hardwoods* (U.S. Department of Agriculture Miscellaneous Publication, ed). U.S. Department of Agriculture Miscellaneous Publication.
- Lynch, M.. & Walsh, B.. 1998. *Genetics and Analysis of Quantitative Traits*. Sinauer Associates, Inc., Sunderland, Massachusetts, U.S.A.
- Mack, R.N. 2000. Cultivation fosters plant naturalization by reducing environmental stochasticity. *Biol. Invasions* **2**: 111–122.
- Mack, R.N. & Lonsdale, W.M. 2001. Humans as Global Plant Dispersers : Getting More Than We Bargained For. *Bioscience* **51**: 95–102.
- Magni Diaz, C.R. 2004. Reconstitution de l'introduction de *Quercus rubra* L. en Europe et conséquences génétiques dans les populations allochtones. Thèse de doctorat, Ecole Nationale du Génie Rural des Eaux et Forêts, Paris, FRANCE.
- Major, K.C., Nosko, P., Kuehne, C., Campbell, D. & Bauhus, J. 2013. Regeneration dynamics of non-native northern red oak (*Quercus rubra* L.) populations as influenced by environmental factors: A case study in managed hardwood forests of southwestern Germany. *For. Ecol. Manage.* **291**: 144–153.
- Maron, J.L., Vilà, M., Bommarco, R., Elmendorf, S. & Beardsley, P. 2004. Rapid evolution of an invasive plant. *Ecol. Monogr.* **74**: 261–280.
- McKay, J.K. & Latta, R.G. 2002. Adaptive population divergence: markers, QTL and traits. *Trends Ecol. Evol.* **17**: 285–291.
- Merilä, J. & Crnokrak, P. 2001. Comparison of genetic differentiation at marker loci and quantitative traits. *J. Evol. Biol.* **14**: 892–903.
- Montague, J.L., Barrett, S.C.H. & Eckert, C.G. 2008. Re-establishment of clinal variation in flowering time among introduced populations of purple loosestrife (*Lythrum salicaria*, Lythraceae). *J. Evol. Biol.* **21**: 234-245
- Monty, A., Bizoux, J.P., Escarré, J. & Mahy, G. 2013. Rapid Plant Invasion in Distinct Climates Involves Different Sources of Phenotypic Variation. *PLoS One* **8**.

- Moran, E. V & Alexander, J.M. 2014. Evolutionary responses to global change: lessons from invasive species. *Ecol. Lett.* **17**: 637–49.
- Novy, A., Flory, S.L. & Hartman, J.M. 2013. Evidence for rapid evolution of phenology in an invasive grass. *J. Evol. Biol.* **26**: 443–450.
- Prentis, P.J., Wilson, J.R.U., Dormontt, E.E., Richardson, D.M. & Lowe, A.J. 2008. Adaptive evolution in invasive species. *Trends Plant Sci.* **13**: 288–294.
- Reichard, S.H. & White, P. 2001. Horticulture as pathways of plant introductions in the United States. *Am. Inst. Biol. Sci.* **51**: 103–113.
- Ross, C.A. & Auge, H. 2008. Invasive *Mahonia* plants outgrow their native relatives. *Plant Ecol.* **199**: 21–31.
- Sakai, A., Allendorf, F. & Holt, J. 2001. The population biology of invasive species. *Annu. Rev. Ecol. Syst.* **32**: 305–332.
- Schlarbaum, S.E. & Bagley, W.T. 1981. Intraspecific Genetic Variation of *Quercus rubra* L., Northern Red Oak. *Sylvae Genet.* **30**: 50–56.
- Sheppard, C.S. & Burns, B.R. 2014. Effects of interspecific alien versus intraspecific native competition on growth of native woody plants. *Plant Ecol.* **215**: 1527–1538.
- Siemann, E. & Rogers, W.E. 2001. Genetic differences in growth of an invasive tree species. *Ecol. Lett.* **4**: 514–518.
- Spitze, K. 1993. Population Structure in *Daphnia obtusa*: Quantitative Genetic and Allozymic Variation. *Genetics* **135**: 367–374.
- Sultan, S.E., Horgan-Kobelski, T., Nichols, L.M., Riggs, C.E. & Waples, R.K. 2013. A resurrection study reveals rapid adaptive evolution within populations of an invasive plant. *Evol. Appl.* **6**: 266–278.
- Urbanski, J., Mogi, M., O'Donnell, D., DeCotiis, M., Toma, T. & Armbruster, P. 2012. Rapid Adaptive Evolution of Photoperiodic Response during Invasion and Range Expansion across a Climatic Gradient. *Am. Nat.* **179**: 490–500.
- Vandepitte, K., de Meyer, T., Helsen, K., van Acker, K., Roldán-Ruiz, I., Mergeay, J., et

- al.* 2014. Rapid genetic adaptation precedes the spread of an exotic plant species. *Mol. Ecol.* **23**: 2157–64.
- Vitasse, Y., Delzon, S., Dufrêne, E., Pontailleur, J.Y., Louvet, J.M., Kremer, A., *et al.* 2009. Leaf phenology sensitivity to temperature in European trees: Do within-species populations exhibit similar responses? *Agric. For. Meteorol.* **149**: 735–744.
- Whitlock, M.C. 2008. Evolutionary inference from Q_{ST} . *Mol. Ecol.* **17**: 1885–1896.
- Williams, J.L., Auge, H. & Maron, J.L. 2008. Different gardens, different results: Native and introduced populations exhibit contrasting phenotypes across common gardens. *Oecologia* **157**: 239–248.
- Woziwoda, B., Kopeć, D. & Witkowski, J. 2014a. The negative impact of intentionally introduced *Quercus rubra* L. on a forest community. *Acta Soc. Bot. Pol.* **83**: 39–49.
- Woziwoda, B., Potocki, M., Sagan, J., Michaù, Z., Tomusiak, R. & Wilczynski, S. 2014b. Commercial Forestry as a Vector of Alien Tree Species – the Case of *Quercus rubra* L. Introduction in Poland. *Balt. For.* **20**: 131–141.
- Wright, S. 1949. The genetical structure of populations. *Ann. Eugen.* **15**: 323–354.
- Zou, J., Rogers, W.E. & Siemann, E. 2009. Plasticity of *Sapium sebiferum* seedling growth to light and water resources: Inter- and intraspecific comparisons. *Basic Appl. Ecol.* **10**: 79–88.

Appendices

Appendix Table S1. Main characteristics of the populations used in the provenance-progeny tests: range, name and code of the population, notation of bulking of progenies within the population (Bulk), country of origin, latitude (Lat., decimal degrees), longitude (Long., decimal degrees), altitude (Alt, m), annual mean temperature (T, °C) and annual mean precipitation (P, mm) at the population location. The climatic data were provided by WorldClim (<http://www.worldclim.org/>) and were interpolated from observed data recorded between 1960 and 1990. Populations whose names are underlined are the link populations (see Materials and Methods for more details).

Range	Name	Code	Bulk	Country	Lat.	Long.	Alt	T	P
Introduced	<u>AINHOA</u>	68	no	France	43.2849	-1.4712	200	13.0	1293
Introduced	<u>AINHOA</u>	311	no	France	43.2849	-1.4712	200	13.0	1293
Introduced	ALLI_LECUMBERRI	115	yes	Spain	42.4310	-8.6600	13	14.8	1316
Introduced	<u>AVERON_BERGELLE</u>	21	yes	France	43.7365	0.0574	150	12.3	843
Introduced	<u>AZEREIX</u>	51	no	France	43.2078	-0.0370	400	11.3	845
Introduced	<u>AZEREIX</u>	310	no	France	43.2078	-0.0370	400	11.3	845
Introduced	<u>BASSOUES</u>	70	no	France	43.5956	0.2242	215	12.1	833
Introduced	<u>BASSOUES</u>	308	no	France	43.5956	0.2242	215	12.1	833
Introduced	BIDASOA_BERROARAN	116	yes	Spain	43.2663	-1.7447	50	14.4	1347
Introduced	<u>BOEKEL_VENHORST</u>	30	yes	Netherlands	52.2000	6.8120	29	9.2	774
Introduced	<u>BOISSEROUX</u>	32	yes	Belgium	50.6833	4.2500	67	10.2	795
Introduced	<u>BRIDE</u>	301	no	France	48.8752	6.6697	300	9.2	764
Introduced	<u>BRIDE</u>	416	no	France	48.8752	6.6697	300	9.2	764
Introduced	<u>CHAUX (EST)</u>	319	no	France	47.0516	5.7603	250	10.6	947
Introduced	<u>CHAUX_1_COLONNE</u>	23	yes	France	47.0520	5.5469	230	10.7	892
Introduced	<u>CHAUX_1_COLONNE</u>	65	no	France	47.0520	5.5469	230	10.7	892
Introduced	<u>CHAUX_1_COLONNE</u>	109	no	France	47.0520	5.5469	230	10.7	892

Introduced	<u>CHAUX LA ROYALE</u>	24	yes	France	47.0598	5.6736	245	10.6	926
Introduced	<u>CHAUX LA ROYALE</u>	64	no	France	47.0598	5.6736	245	10.6	926
Introduced	<u>CHAUX LA ROYALE</u>	108	no	France	47.0598	5.6736	245	10.6	926
Introduced	<u>DOAT EAUZE</u>	20	yes	France	43.8625	0.0760	125	12.4	860
Introduced	<u>DOAT EAUZE</u>	55	no	France	43.9092	0.0760	125	12.4	860
Introduced	<u>DOAT EAUZE</u>	105	yes	France	43.9092	0.0760	125	12.4	860
Introduced	<u>DOAT EAUZE</u>	313	no	France	43.9092	0.0760	125	12.4	860
Introduced	<u>DOAT EAUZE</u>	419	no	France	43.9092	0.0760	125	12.4	860
Introduced	<u>DRESDNER HEIDE</u>	48	yes	Germany	51.0960	13.8227	150	8.9	644
Introduced	<u>ELSENDORF GEMERT</u>	31	yes	Netherlands	51.5482	5.7782	23	9.7	777
Introduced	<u>HARDT NORD</u>	54	yes	France	47.7837	7.4389	232	10.1	669
Introduced	<u>HARDT NORD</u>	317	no	France	47.7837	7.4389	232	10.1	669
Introduced	<u>HARDT SUD</u>	53	yes	France	47.6843	7.4920	247	10.2	712
Introduced	<u>HARDT SUD</u>	303	no	France	47.6843	7.4920	247	10.2	712
Introduced	<u>HERPEN BERGEN</u>	29	yes	Netherlands	51.7550	5.6167	18	9.3	775
Introduced	<u>HOHE DUBRAU</u>	49	yes	Germany	51.3333	14.5833	220	8.3	587
Introduced	HOUILLES	73	no	France	44.1562	0.0250	148	12.1	887
Introduced	<u>IBOS</u>	93	no	France	43.2688	-0.0051	380	11.4	867
Introduced	<u>IBOS</u>	315	no	France	43.2688	-0.0051	380	11.4	867
Introduced	<u>JUNGHOLTZ</u>	33	yes	France	47.8926	7.1678	600	8.1	912
Introduced	LA_DOLOMETA	118	yes	Spain	43.1575	-2.6693	340	12.9	1121
Introduced	<u>LA HOUVE</u>	22	yes	France	49.1970	6.6669	250	9.4	757
Introduced	<u>LA HOUVE</u>	110	yes	France	49.1970	6.6669	250	9.4	757
Introduced	<u>LA HOUVE</u>	304	no	France	49.1970	6.6669	250	9.4	757

Introduced	<u>LA_VERNEE</u>	58	yes	France	46.1703	5.1722	250	10.9	839
Introduced	<u>LA_VERNEE</u>	300	no	France	46.1703	5.1722	250	10.9	839
Introduced	<u>LAMOTTE_CLEDOU</u>	66	yes	France	45.5309	0.0408	160	11.8	890
Introduced	<u>LAMPERTHEIM</u>	28	yes	Germany	49.5974	8.5371	90	10.1	637
Introduced	<u>MIXE_BIDACHE</u>	69	no	France	43.4680	-1.1554	100	13.1	1204
Introduced	<u>MIXE_BIDACHE</u>	312	no	France	43.4680	-1.1554	100	13.1	1204
Introduced	<u>MORITZBURG</u>	47	yes	Germany	51.1755	13.6554	140	9.0	625
Introduced	<u>OFFENBURG</u>	27	yes	Germany	48.4711	7.9135	150	10.4	706
Introduced	<u>PARC_NEUDORF</u>	61	yes	Romania	46.0599	21.6172	137	10.8	606
Introduced	<u>PARDIES</u>	72	no	France	43.3596	-0.5907	113	12.9	945
Introduced	<u>PARDIES</u>	305	no	France	43.3596	-0.5907	113	12.9	945
Introduced	<u>PRECHACQ_JOSBAIG</u>	71	no	France	43.2560	-0.7439	140	12.9	974
Introduced	<u>PRECHACQ_JOSBAIG</u>	306	no	France	43.2560	-0.7439	140	12.9	974
Introduced	<u>SCHOPPERTEN</u>	25	yes	France	48.9512	7.0595	235	9.4	729
Introduced	<u>SCHOPPERTEN</u>	63	yes	France	48.9512	7.0595	235	9.4	729
Introduced	<u>SCHOPPERTEN</u>	102	yes	France	48.9512	7.0595	235	9.4	729
Introduced	<u>SCHOPPERTEN</u>	316	no	France	48.9512	7.0595	235	9.4	729
Introduced	<u>SCHOPPERTEN</u>	415	no	France	48.9512	7.0595	235	9.4	729
Introduced	<u>SERENAC</u>	26	yes	France	43.9777	2.3194	360	12.3	767
Introduced	<u>SERENAC</u>	96	no	France	43.9777	2.3194	360	12.3	767
Introduced	<u>SERENAC</u>	307	no	France	43.9777	2.3194	360	12.3	767
Introduced	<u>SERENAC</u>	417	no	France	43.9777	2.3194	360	12.3	767
Introduced	<u>TURNHOUT</u>	50	yes	Belgium	51.3196	4.9469	90	9.2	800
Introduced	<u>VARESE</u>	56	yes	Italy	45.8200	8.8300	411	10.8	1262

Introduced	<u>VIC EN BIGORRE</u>	19	yes	France	43.3947	0.0057	250	12.0	842
Introduced	<u>VIC EN BIGORRE</u>	57	no	France	43.3947	0.0057	250	12.0	842
Introduced	<u>VIC EN BIGORRE</u>	309	no	France	43.3947	0.0057	250	12.0	842
Introduced	<u>VIC EN BIGORRE</u>	418	no	France	43.3947	0.0057	250	12.0	842
Introduced	<u>VOUZERON</u>	52	no	France	47.2825	2.2087	172	10.9	706
Introduced	<u>VOUZERON</u>	98	yes	France	47.2825	2.2087	172	10.9	706
Introduced	<u>VOUZERON</u>	314	no	France	47.2825	2.2087	172	10.9	706
Introduced	<u>WERDAU</u>	46	yes	Germany	50.8495	13.0512	350	7.6	634
Introduced	<u>WISSEMBOURG</u>	62	yes	France	49.0084	7.9870	152	10.0	685
Introduced	<u>WISSEMBOURG</u>	67	yes	France	49.0084	7.9870	152	10.0	685
Introduced	<u>WISSEMBOURG</u>	318	no	France	49.0084	7.9870	152	10.0	685
Introduced	<u>WISSEMBOURG</u>	414	no	France	49.0084	7.9870	152	10.0	685
Native	<u>AMSLER SPRING</u>	13	no	USA	41.4661	-79.1971	427	7.9	1138
Native	BARDEN_TREE_FARM	405	no	USA	43.3307	-71.0819	230	6.8	1159
Native	<u>BARRIE</u>	38	no	Canada	44.3382	-79.7077	75	7.5	870
Native	BEEBE_HILL_STATE_FOREST	407	no	USA	42.3294	-73.4508	500	6.4	1121
Native	BLOOMINGTON	91	no	USA	39.1699	-86.5147	250	11.5	1109
Native	BOLINGBROKE	88	no	USA	32.9333	-83.8333	150	17.5	1214
Native	<u>BURLINGTON</u>	17	yes	USA	44.4509	-73.1718	91	7.0	878
Native	<u>CLAY</u>	327	no	USA	35.1361	-83.5541	1450	8.8	1953
Native	COLCHESTER_BOG	401	no	USA	44.5660	-73.2832	30	7.1	816
Native	<u>CONGRESS</u>	3	no	USA	40.9254	-82.0573	366	9.0	957
Native	DE_KALB	331	no	USA	41.3931	-85.0519	260	9.3	904
Native	<u>DEVIL'S LAKE</u>	4	no	USA	43.4296	-89.7381	366	6.8	820

Native	ELGIN	338	no	Canada	42.7750	-81.2980	75	8.5	946
Native	<u>FANNIN</u>	321	no	USA	34.8667	-84.4167	671	12.4	1582
Native	FONTENELLE	18	yes	USA	41.1806	-95.9079	305	10.3	770
Native	<u>FREDERICTON</u>	1	no	Canada	45.9443	-66.6428	250	4.0	1102
Native	GATINEAU	332	no	Canada	45.9399	-76.0283	170	4.5	915
Native	GIFFORD_PINCHOT	412	no	USA	40.0707	-76.8879	152	11.2	1016
Native	<u>GREENE</u>	74	no	USA	36.2000	-82.8000	520	12.7	1124
Native	HAMMOND_HILL_STATE_FOREST	408	no	USA	42.4288	-76.2917	580	6.5	1010
Native	HARRISBURG	413	no	USA	40.1129	-76.9416	300	10.3	1042
Native	<u>HARSHAW_FARM</u>	2	no	USA	45.6428	-89.4630	488	4.4	786
Native	HARVARD_FOREST	402	no	USA	42.5500	-72.1773	400	6.5	1160
Native	<u>HILL_FOREST</u>	41	no	USA	36.2009	-78.8888	137	14.6	1137
Native	HOLST_FOREST	40	no	USA	42.1167	-93.9825	335	8.6	835
Native	JACKSON	90	no	USA	37.6667	-89.2500	170	12.9	1159
Native	JONESBORO_UNION	42	no	USA	37.4844	-89.3744	122	13.6	1181
Native	<u>KILBOURNE</u>	9	no	USA	40.3104	-82.9464	280	10.0	965
Native	<u>LANSING</u>	97	no	USA	42.7127	-83.5329	250	8.9	782
Native	<u>LONDON</u>	37	no	Canada	42.9551	-81.3093	250	7.6	960
Native	MADISON	330	no	USA	40.1012	-85.6814	280	10.3	992
Native	<u>MONT_GILHEAD</u>	8	no	USA	40.5507	-82.8121	350	9.4	985
Native	<u>MORGANTOWN</u>	10	no	USA	36.6799	-79.7787	732	10.2	1136
Native	<u>MOSHANNON</u>	400	no	USA	41.1017	-78.5441	730	6.5	1124
Native	<u>NRD</u>	15	no	USA	35.1353	-83.8073	1300	9.3	1842
Native	OTTAWA_CARLETON	323	no	Canada	45.4823	-76.0880	70	5.6	828

Native	<u>PARSONS</u>	36	no	USA	39.0933	-79.6647	549	9.8	1209
Native	PENETANGUISHENE	39	no	Canada	44.7681	-79.9410	225	5.9	930
Native	<u>PEOPLES STATE FOREST</u>	406	no	USA	41.9575	-73.0081	330	7.7	1246
Native	<u>PETAWAWA</u>	16	yes	Canada	45.9770	-77.4247	250	4.3	842
Native	<u>PINE GROVE MILLS</u>	35	no	USA	40.7083	-77.9333	427	9.1	1025
Native	PNFI	325	no	Canada	46.0222	-77.4360	130	5.0	839
Native	POINT ABINO	335	no	Canada	42.8501	-79.0993	185	8.4	967
Native	<u>QUEBEC</u>	7	no	Canada	46.7890	-71.2384	5	5.1	1123
Native	RABUN	320	no	USA	34.9700	-83.4833	976	11.4	1907
Native	RAMAPO_FOREST	410	no	USA	41.0421	-74.2557	244	9.5	1281
Native	RIDGWAY	334	no	Canada	42.8844	-79.0633	190	8.4	966
Native	<u>ROTHROCK FOREST</u>	409	no	USA	40.6804	-77.8664	550	8.3	1001
Native	<u>RUSS FOREST</u>	107	no	USA	42.0120	-85.9725	160	9.6	958
Native	<u>SAULT_SAINTE_MARIE</u>	5	no	Canada	45.5833	-84.3702	180	6.1	770
Native	<u>SELKIRK</u>	6	no	Canada	42.8135	-79.9566	180	8.2	935
Native	SHOALS	92	no	USA	38.7079	-86.7252	225	12.0	1164
Native	SMOKY_MOUNTAINS	14	no	USA	35.7228	-83.5757	1000	9.9	1424
Native	ST_GEORGES	337	no	Canada	43.2414	-80.2365	220	7.6	896
Native	ST_WILLIAMS	336	no	Canada	42.6500	-80.4667	200	8.2	968
Native	SULLIVAN	326	no	USA	36.3867	-82.1378	610	12.1	1157
Native	<u>TRANSYLVANIA</u>	328	no	USA	35.3227	-82.7760	1200	10.0	1716
Native	UNION	322	no	USA	34.7833	-83.7833	620	13.0	1699
Native	UNIVERSITY	89	no	USA	44.9144	-93.1616	290	7.1	750
Native	<u>VALCOUR</u>	11	no	USA	44.6222	-73.4175	30	7.0	781

Native	<u>WARRENTON</u>	12	no	USA	36.3000	-78.1667	114	14.4	1131
Native	<u>WILLARD_BROOK</u>	403	no	USA	42.6664	-71.7757	300	7.1	1150
Native	<u>WOOSTER</u>	45	no	USA	40.7797	-81.9158	305	9.6	952
Native	<u>YAWPAW_BERGEN</u>	404	no	USA	41.0213	-74.2543	240	9.4	1226

Appendix Table S2. Detailed list of populations present in each set and forest in the nursery and the three provenance-progeny tests.

Provenance-progeny test	Forest + set code	Codes of populations
Nursery	Pierroton 1	1, 2, 3, 4, 5, 6, 7, 8, 9, 10, 11, 12, 13, 14, 15, 16, 17, 18, 19, 20, 21, 22, 23, 24, 25, 26, 27, 28, 29, 30, 31, 32, 33
Nursery	Pierroton 2	19, 20, 22, 25, 35, 36, 37, 38, 39, 40, 41, 42, 45, 46, 47, 48, 49, 50, 51, 52, 54, 55, 56, 57, 58, 60, 61, 62, 63, 64, 65, 66
Nursery	Pierroton 3	16, 19, 20, 22, 25, 44, 51, 53, 54, 55, 57, 58, 59, 60, 63, 66, 67, 68, 69, 70, 71, 72, 73, 74, 75
South-West	Ibos 1	1, 2, 3, 4, 5, 6, 7, 8, 9, 10, 11, 12, 13, 14, 15, 16, 17, 18, 19, 20, 21, 22, 23, 24, 25, 26, 27, 28, 29, 30, 31, 32, 33
South-West	Ibos 2	19, 20, 22, 25, 35, 36, 37, 38, 40, 41, 42, 45, 46, 47, 48, 49, 50, 51, 52, 54, 55, 56, 57, 58, 61, 62, 63
South-West	Ibos 3	19, 20, 22, 68, 69, 70, 71, 72, 73, 74
South-West	Ibos 4	54, 55, 62, 63, 64, 65, 88, 89, 90, 91, 92
South-West	Ibos 5	93, 96, 97, 102, 105, 107, 110, 115, 116, 118
South-West	Capvern 7	300, 301, 303, 305, 306, 307, 308, 309, 310, 311, 312, 313, 314, 315, 316, 317, 318, 319, 320, 321, 322, 326, 327, 328, 330
South-West	Capvern 8	400, 401, 403, 404, 406, 407, 409, 414, 415, 416, 417, 418, 419
Center	Vouzeron 1	1, 2, 3, 4, 5, 6, 7, 8, 9, 10, 11, 12, 13, 15, 16, 17, 19, 20, 21, 22, 23, 24, 25, 26, 27, 28, 29, 30, 31, 32, 33
Center	Vouzeron 2	19, 20, 22, 35, 36, 37, 38, 39, 41, 45, 46, 47, 48, 49, 50, 56, 61
Center	Vouzeron 3	19, 20, 22, 51, 52, 55, 68, 70, 72, 74
Center	Vierzon 1	96, 97, 98, 102, 105, 107, 108, 109, 110
North-East	Ternes 1	1, 2, 3, 4, 5, 6, 10, 11, 12, 15, 16, 17, 19, 20, 21, 22, 23, 24, 25, 26, 27, 28, 30, 32, 33
North-East	Ternes 2	19, 20, 22, 35, 36, 37, 38, 41, 45, 46, 47, 48, 49, 50, 56, 61

North-East	Mondon 1	16, 19, 22, 51, 52, 53, 55, 57, 58, 63, 66, 67, 68, 69, 70, 71, 74
North-East	Mondon 2	54, 55, 62, 63
North-East	Sorbey 7	300, 301, 303, 304, 305, 307, 308, 310, 311, 313, 314, 315, 316, 317, 318, 319, 321, 323, 325, 327, 328, 331, 332, 334, 335, 336, 337, 338
North-East	Sorbey 8	400, 402, 404, 405, 406, 408, 409, 410, 412, 413, 414, 415, 416, 417, 418, 419

Appendix Table S3. Synthetic chronology of the set up and phenotypic monitoring in the three provenance-progeny tests. Year is indicated per set for each event: sowing, planting, first and second circumference measurements (Circ 1 & 2), first and second height measurements (Height 1 & 2), leaf budburst score (Bb), survival assessment at age 5 (Surv 5) and 12 (Surv 12) and forking measurement (Fork). The dash indicates the lack of measurement for the phenotypic trait concerned in some set of the provenance-progeny tests.

Provenance-progeny test	Forest	Set code	Sowing	Planting	Circ 1	Circ 2	Height 1	Height 2	Bb	Surv 5	Surv 12	Fork
South-West	Ibos	1	1980	1982	1990	2004	1985	1990	1984	1984	1990	1990
South-West	Ibos	2	1981	1982	1992	2005	1986	1992	1985	1985	1992	1992
South-West	Ibos	3	1981	1984	-	-	-	-	1987	1987	-	-
South-West	Ibos	4	1981	1985	1997	2009	1988	1996	1987	1987	1996	1996
South-West	Ibos	5	1983	1986	1998	2009	1991	1997	1988	1988	1997	1998
South-West	Capvern	7	1989	1991	2001	2011	1995	2001	1995	1995	2001	2001
South-West	Capvern	8	1991	1993	2002	2011	1996	2002	1995	1995	2002	2002
Center	Vouzeron	1	1980	1982	-	-	1985	1987	1984	1984	1990	1990
Center	Vouzeron	2	1981	1983	-	-	1986	1988	1985	1985	1991	1991
Center	Vouzeron	3	1981	1984	-	-	1987	1989	-	1987	1995	1995
Center	Vierzon	1	1982	1986	-	-	-	-	-	1988	-	-
North-East	Mondon	1	1981	1984	1997	2002	1987	1989	1986	1986	-	-
North-East	Mondon	2	1981	1985	1997	2002	1987	1989	1987	1987	-	-
North-East	Ternes	1	1980	1982	-	-	1985	1987	-	1985	1995	1992
North-East	Ternes	2	1981	1983	-	-	-	-	-	-	1992	1995
North-East	Sorbey	7	1989	1991	-	-	-	-	1994	1994	-	-
North-East	Sorbey	8	1991	1993	2000	2012	-	-	1995	1995	-	2000

Appendix Figure S1. Illustrations of the six phenological stages considered to describe leaf budburst scores of *Q. rubra* in spring (a) score 0: dormant bud, (b) score 1: bud elongation, (c) score 2: bud opening, (d) score 3: beginning of leaf expansion, (e) score 4: at least one leaf completely out of the bud, (f) score 5: beginning of internode elongation. Photos by A. Ducouso, J.-M. Louvet, G. Roussel and N. R. Merceron.

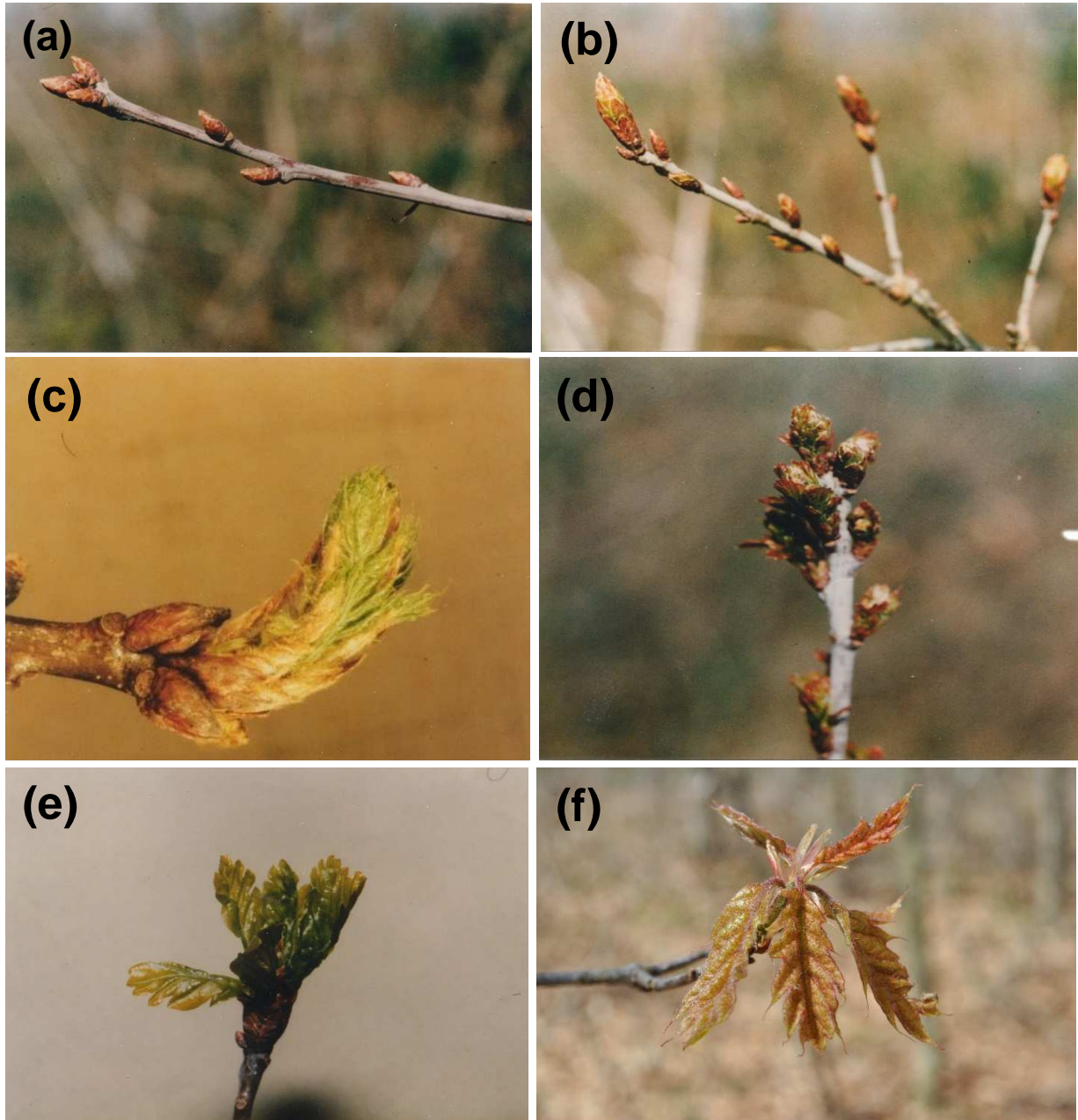

Chapitre 4 : From North America to Europe: deciphering the introduction history of *Quercus rubra*

Submitted to: Genome, special issue “The Evolution of Tree Diversity”

Nastasia R. Merceron^{1,2}, Thibault Leroy¹, Emilie Chancerel¹, Jeanne Romero-Severson³,
Daniel Borkowski³, Alexis Ducousso¹, Arnaud Monty², Annabel J. Porté¹, Antoine Kremer¹

¹ BIOGECO, INRA, Univ. Bordeaux, 33610 Cestas, France

² University of Liège, Gembloux Agro-Bio Tech., Biodiversity and Landscape Unit,
2, Passage des Déportés, B-5030 Gembloux, Belgium

³ University of Notre Dame, Department of Biological Sciences, 100 Galvin Life
Sciences Center Notre Dame 46556. Indiana, USA

Corresponding authors: antoine.kremer@pierroton.inra.fr and
nastasia.merceron@gmail.com

Abstract

Northern red oak (*Quercus rubra*) has been introduced in Europe since the end of the seventeenth century. It is widely distributed today across this continent and considered as invasive in some European countries.

Here, we investigated the population structure of both native and introduced populations of *Q. rubra* to track major historical and demographic events. A large sampling of 883 individuals from 73 native and 38 European locations were genotyped at 69 SNPs. Using a Bayesian clustering method, we found support for three genetic clusters distributed along geographic gradients in the natural range. Two of them extended from the Northeast to the Southeast whereas a third cluster is preferentially spread between the Northcentral and Northwestern part of the range. In the introduced gene pool, trees were mostly assigned to only two clusters of the native range: the Northeastern and the Northcentral/Northwestern clusters. These results are consistent with historical records concerning main sea routes between North America and Europe at the beginning of the eighteenth century. Our Approximate Bayesian Computation (ABC) inferences found support for a unique and extensive event of secondary contacts (SC) between these three gene pools which occurred prior to the introduction in Europe, but did not found support for bottleneck effects occurring during this introduction.

Key-words

Quercus rubra, spatial genetic structure, genetic divergence, secondary contact, Approximate Bayesian Computation

Introduction

Since the sixteenth century, the development of international trade by terrestrial and maritime routes has favored deliberate and accidental introductions of species by humans, far from their native habitats and contributed to inter-continental scale expansions (Hulme 2009, Pyšek et al. 2010). During last decades, multiple examples of human-mediated introductions have been reported in animals (Clout and Russell 2008, Leprieur et al. 2008, Bigsby et al. 2011), plants (Reichard and White 2001, Richardson et al. 2011), fungi (Desprez-Loustau et al. 2007, Vellinga et al. 2009) and viruses (Tatem et al. 2006, Jones 2009). In some instances biological introductions can lead to invasions and strong disturbances in natural ecosystems (Ehrenfeld 2010) or had concrete deleterious effects for plants, animals and human health (Pejchar and Mooney 2009, Pyšek and Richardson 2010, Vilà et al. 2011).

Two key features required for a successful plant introduction are the residence time, and propagule pressure (Pyšek and Jarošík 2005, Simberloff 2009, Blackburn et al. 2015). Long-standing introductions and planting densities may trigger the shift from cultivation to naturalization of woody species (Pyšek et al. 2009). Unfortunately, historical writings of the inter-continental movement of species are often scarce and partial, which makes it difficult to accurately reconstruct the introduction history of a species. One of the most promising options to retrace introduction routes – and more broadly to decipher the evolutionary history of the introduced species – is to use analytical methods of population genetics (Cristescu 2015). Firstly, the analysis of genetic structure and diversity of native and introduced populations can identify sources and pathways from the native to the introduced range using a handful of DNA markers (Bossdorf et al. 2005, Miura 2007). Secondly, inferences drawn from an Approximate Bayesian Computation (ABC) framework may help to test and understand the demographic history of introduction (Estoup and Guillemaud 2010, Csilléry et al. 2010, Roux et al. 2011, Leroy et al. 2014).

Demographic processes are of utmost importance to understand the success and spread of species recently introduced in new environments (Allendorf and Lundquist 2003, Facon et al. 2006, Sax et al. 2007). To adapt to novel environments, introduced species

can rapidly evolve displaying phenotypic and genetic divergence with their source populations (Bossdorf et al. 2005). Rapid adaptive evolution is quite often advocated to explain successful invasions (Maron et al. 2004, Lavergne and Molofsky 2007, Buswell et al. 2011).

Generally speaking, high genetic diversity is a prerequisite for rapid adaptation of introduced populations to new environments and ultimately for invasion success (Lavergne and Molofsky 2007). However, in the newly colonized areas, founder events and drift on the expanding front of colonization may reduce substantially genetic diversity and may hamper further adaptation. Indeed bottlenecks are not unlikely, given the introduction scenarios, and may generate foundation effects during the early steps of introduction (Dlugosch and Parker 2008). As a result, loss of diversity will constrain adaptation of the newly introduced populations. Quite paradoxically, many empirical studies report demographic successes even in case of strong founder effects or population bottleneck, e.g. in *Phyla canescens* (Xu et al. 2015), suggesting that adaptation may still occur under such circumstances (Tsutsui et al. 2000, Rollins et al. 2013, Stapley et al. 2015). There are at least three interpretations, not mutually exclusive, to this apparent paradox. First, there might be a strong publication bias because the tracking of these events is laborious and remains elusive. Thus only few instances of failed introductions were reported. Second, several allopatric populations from different gene pools in the native range could have been sampled and introduced. Simultaneous or repeated multiple introductions from different sources populations in the native range can restore substantial genetic diversity, as it has been observed in different case studies e.g. *Alliaria petiolata*, *Ambrosia artemissifolia* and *Phalaris arundinacea* (Durka et al. 2005, Genton et al. 2005, Lavergne and Molofsky 2007). Thus, even if single populations were subjected to bottlenecks during their introduction, the introduced gene pool is a “melting pot”, restoring diversity by the later interbreeding of different sources of material. Third, genetic admixture and introgression between multiple populations may further enhance adaptation to local conditions (Keller and Taylor 2010, Rius and Darling 2014). Finally, surfing of advantageous mutations can also be expected during population expansion of an introduced species and contribute to rapid adaptation (Miller 2010, Lehe et al. 2012).

Native to North America, *Quercus rubra* L. (Northern red oak) was introduced in Europe at the end of seventeenth and the beginning of the eighteenth centuries. First historical records date back to 1691, suggesting that *Q. rubra* has been present for more than ten generations in Europe (Goeze 1916, Bauer 1953, Magni Diaz 2004). Firstly planted in parks and gardens as an ornamental, its use gradually increased in the second half of the nineteenth century for reforestation and timber production, making *Q. rubra* an important forest resource since the 1970s (Timbal et al. 1994). *Quercus rubra* is now planted across large areas in Europe (Magni Diaz 2004). In some European countries, *Q. rubra* is considered an invasive alien tree species due to its regeneration potential and its large acorn production in Europe (Major et al. 2013, Woziwoda et al. 2014). The species is wind-pollinated, monoecious and allogamous. Within the native range, intraspecific gene flow maintains high genetic diversity (Sork et al. 1993). Reproductive barriers and differences in acorn maturation periods prevent interspecific hybridization between *Q. rubra* (*Quercus* section *Lobatae*) and European white oaks (*Quercus* section *Quercus*) (Lanier et al. 1980).

Comparative studies of native and introduced populations showed genetically based phenotypic differences for some life-history traits such as leaf phenology and growth (Daubree and Kremer 1993). Introduced populations are assumed to undergo selection for adaptation to new local conditions encountered in Europe. Magni Diaz (2004) found similar genetic levels of genetic diversity between native and introduced populations by using chloroplast DNA markers, suggesting that multiple sources of introductions have likely prevented a strong founder effect. Surprisingly, no spatial genetic structure was detected in 66 North American populations sampled throughout the natural range of *Q. rubra* suggesting that American populations of *Q. rubra* form a single and large panmictic group (Magni et al. 2005, Birchenko et al. 2009). Nevertheless, these results were based on cpDNA diversity, which may show different structure and distribution than nuclear diversity, given the maternal inheritance of chloroplast in oaks (Kremer et al. 2002).

In this study, we analyzed the spatial and geographic genetic structure of 73 native and 38 introduced populations of *Q. rubra* by using 69 nuclear DNA markers. By comparing the genetic structure between both native and introduced populations, our aim

was to draw inferences on demographic processes that may have been associated to the introduction of *Q. rubra* in Europe. We particularly addressed the following leading questions: (1) What is the genetic structure of *Q. rubra* populations within the native range? (2) If any, is genetic divergence between native populations recent? (3) What were the likely sources of origin of populations introduced in Europe? (4) Did the introduction of *Q. rubra* in Europe lead to severe founder effects?

Materials and methods

Sampling design and DNA extraction

All nuclear DNA samples were extracted from buds or leaves collected from the native and introduced populations (**Table 1**).

Table 1. Description of samples used for DNA extraction and genotyping: kind of samples, number of samples (N_{SAMPLES}), year of sampling, sampling location, number of native (N_{NATIVE}) and introduced ($N_{\text{INTRODUCED}}$) populations sampled.

Samples	N_{SAMPLES}	Year	Sampling location	N_{NATIVE}	$N_{\text{INTRODUCED}}$
Buds	394	2003	Progeny tests in France	62	38
Leaves	331	2015	Progeny tests in France		
Leaves	336	2015	Natural population in USA	11	-
Total	1061	-	-	73	38

Fresh buds and leaves were harvested in a common garden experiment (combined provenance and progeny tests) comprising populations from the native and introduced ranges by Magni Diaz (2004) in 2003 and by ourselves in the summer and fall 2015. Sixty-two native populations and 38 introduced populations were sampled. Each population is composed of one to 19 open pollinated progenies. Buds were preserved at -20°C until DNA extraction. This collection was completed by a second sampling campaign in North America composed of 11 additional native populations. Samples were collected in naturally regenerated stands. For each population buds or leaves were harvested on 18

to 39 individual trees. In total, 73 native populations and 38 introduced populations were used in this study (see detailed information about populations in **Appendix Table S1**).

Nuclear DNA was isolated from 1050 bud or leaf samples using the Invisorb® DNA plant HTS 96 kit (STRATEC Molecular GmbH, Berlin, Germany). DNA yield and quality were evaluated using a NanoDrop spectrophotometer (NanoDrop Technologies, Inc., Wilmington, USA). To assess the genotyping reproducibility, 77 individuals were extracted and genotyped twice.

SNP marker selection and genotyping

Based on the availability of 2,394 *RAD-Seq*-derived SNPs (Restriction-site Associated DNA sequencing) for red oak, 1,410 bi-allelic SNPs randomly distributed along the genome and satisfying Sequenom® selection criteria (primer design constraints) were selected (Konar et al. submitted). Three Sequenom® assays (W1 40 SNPs, W2 40 SNPs and W3 35 SNPs: total 115 SNPs) were designed with the MassARRAY® Assay design 3.1 software (Sequenom®, San Diego, USA). Genotyping was performed using a MassARRAY® System (Agena Bioscience™) and iPLEX® chemistry, according to manufacturer's specifications. Cluster plots were *visually inspected* to ensure accurate genotyping calls *and* the data analysis was performed using MassARRAY® TYPER 4.0 genotyping software. After excluding monomorphic and unamplified loci, data analysis was performed for 80 SNPs. Individuals with more than 10 missing genotypes were excluded and loci with more than 10% of missing data were excluded as well from the analysis. The remaining dataset contains 883 individuals genotyped on 69 SNP loci. High reproducibility of the genotyping method (assessed on 77 replicate individuals) was found (100%).

Genetic data analysis

Bayesian Clustering

TESS version 2.3, a spatially-explicit Bayesian clustering program (François et al. 2006, Chen et al. 2007), was used to determine genetic structure of populations within the native and introduced ranges. A first analysis including populations from the native range

(624 individuals from 73 different geographic locations) was made to estimate the number of genetic clusters (K) in North America. A second analysis based on populations from native and introduced ranges (883 individuals from 111 locations) was carried out to identify the putative source of introductions. For both analysis, assignment of individuals to different genetic clusters (K from 2 to 8) was simulated 100 times using an admixture model (Durand et al. 2009), with 5000 sweeps of Markov Chain Monte Carlo (MCMC) and 1000 burn-in of sweeps of MCMC. The Deviance Information Criterion (DIC), a statistical measure of the model prediction capabilities, was computed by TESS program for each simulation. A comparison of the best simulations based on DIC values per K allowed to determine the most likely number of genetic clusters for each analysis. The proportion of ancestry represented by Q-values matrices of the 10% best simulations per K were summarized using the Clumpak package to obtain the average individual membership coefficients (Kopelman et al. 2015) and create graphical representations (Rosenberg 2004, Jakobsson and Rosenberg 2007).

Multivariate analysis, population differentiation and diversity

Using the whole data set, we performed a Correspondence Analysis (CA) with Genetix program version 4.05 (Belkhir et al. 2004). Pairwise population differentiation (F_{ST}) between native and introduced populations and between genetic clusters was calculated using Genetix according to Weir and Cockerham (1984). Only individuals with Q-values > 0.80 ($n=283$) were selected and used for this analysis. Statistical significance of F_{ST} values was evaluated by permuting genotypes among clusters (1000 permutations). The genetic diversity, estimated through expected heterozygosity (H_e), and the analysis of molecular variance (AMOVA, Excoffier *et al.* 1992), testing for the subdivision of genetic variation among and within populations in both North America and Europe, were obtained using GenAlEx program version 6.5 (Peakall and Smouse 2012). The statistical significance of H_e between native and introduced populations was evaluated with the R package (Hs.test, adegenet package, Jombart 2008; Jombart and Ahmed 2011) using 1000 permutations.

Approximate Bayesian Computations

Models of divergence

Approximate Bayesian Computation framework (ABC; Beaumont et al. 2000) was used to investigate the demographic history of *Q. rubra*. For all pair of clusters, we evaluated six scenarios of divergence allowing gene flow at different timescales. All scenarios assumed a split of an ancestral population into two daughter populations (A and B) at time T_{SPLIT} and that these 3 diploid populations could have different sizes (N_{ANC} , N_A and N_B , N_{ANC} being the size of the ancestral population) but remained constant over time (except for sub-scenarios with bottlenecks, see below). Among these 6 scenarios (**Fig. 1**), five assumed periods of gene flow since T_{SPLIT} : ancient migration (AM), periodic ancient migration (PAM), continuous migration (IM), secondary contacts (SC) and periodic secondary contacts (PSC). The sixth model was a strict isolation model (SI) assuming no migration between clusters. In the AM model, migration occurred after T_{SPLIT} but stopped at time T_{AM} . In the PAM model, a derivative of the previous AM model, two periods of ancient migration are assumed stopping at time T_{AM1} and T_{AM2} . In the IM model, migration is assumed to occur continuously since T_{SPLIT} . In the SC model, divergence without gene flow is assumed to occur first but at time T_{SC} , the two populations started to exchange secondary gene flow. In its derivative model (PSC), two different cycles of isolation and gene flow were assumed, with gene flow starting at time T_{SC1} and restarting at time T_{SC2} (i.e. no gene flow between $T_{\text{SPLIT}}-T_{\text{SC1}}$ and $T_{\text{SC1}}-T_{\text{SC2}}$).

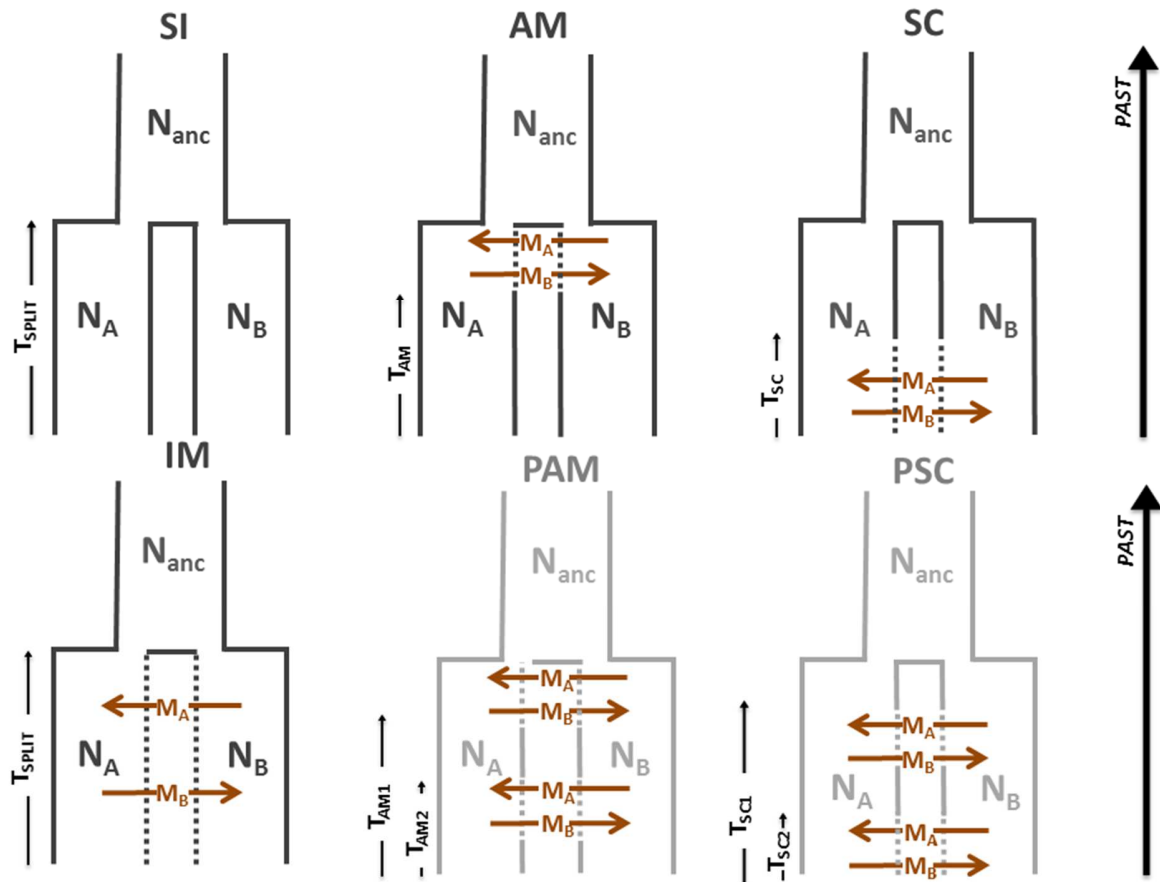

Figure 1. Alternative model of divergence tested using our ABC framework: SI: strict isolation, AM: ancient migration, IM: isolation migration, SC: secondary contact, PAM: periodic ancient migration; PSC: periodic secondary contact. N_A and N_B are the size of populations (Pop A and Pop B) for each cluster tested in twos, N_{ANC} is the size of ancestral population before the division into two populations (Pop A and Pop B). M_A and M_B are, respectively, migration rates from population B to population A and from population A to population B. T_{SPLIT} is the number of generations since the divergence time and T_{SC} the number of generations since the secondary contact between both populations. T_{AM} is the number of generations since the ancient migration between both populations.

For all scenarios, four million data sets were simulated under the six different scenarios using a pipeline composed of *msnsam*, *priorgen* and *mscal*. *Msnsam* is a modified version of the *ms* allowing variations of sample sizes between loci (Hudson 2002, Ross-Ibarra et al. 2008). *Priorgen* is a generator of random prior previously developed by Ross-Ibarra et al. (2008) and then modified by Roux et al. (2011, 2013) and Leroy et al. (submitted) to take into account both more complex scenarios of divergence and variations in both effective population sizes and migration rates among loci, two key genomic features known to bias demographic inferences (Charlesworth et al. 1997,

Castric et al. 2008, Charlesworth 2009, Roux et al. 2013, Cruickshank and Hahn 2014). For this study, we made further improvements to allow priorgen to generate random prior draws for more complex demographic scenarios such as bottlenecks and divergence with two-cycles of gene flow (PAM and PSC scenarios). Prior parameters were drawn from a large uniform distribution for times and effective population sizes as following: T_{SPLIT} [0; 100]; N_{ANC} , N_{A} and N_{B} [0; 10,000,000]. The relevance of prior-model combinations was pre-evaluated using principal component analysis to check if these combinations can produce simulated data sets close enough to the observed data set. For the five models assuming gene flow, locus-specific effective migration rates M_{A} and M_{B} were drawn from a Beta distribution shaped by parameters a and b (see Roux et al. (2013) for details). Parameters a and b were randomly drawn in a uniform distribution: [0; 100] and [0; 500] respectively. We used a feed forward neural network to estimate the posterior probability of the six models (SI, AM, PAM, IM, SC, PSC). This network was performed under the R package “abc” (Csilléry et al. 2012) and used a nonlinear multivariate regression by considering the model itself as an additional parameter to be inferred under the ABC framework. We retained the 0.125 % simulated values closest to the observed values for the summary statistics which were weighted by an Epanechnikov kernel. ABC analyses were performed 20 times using for each 20 trained neural networks and 8 hidden layers in the regression.

Parameter estimation was performed using the “abc” package (Csilléry et al. 2012) for the best inferred model and were based on the 10,000 best replicated simulations (0.25% closest simulations) providing the smallest Euclidian distance. Computations were performed using 25 trained neural networks and 10 hidden layers in the regression. To check the robustness of our inferences, we computed 1000 pseudo-observed data sets (PODs) for each scenario with priors drawn in the same distribution, as previously described. We used the same model selection procedure to obtain posterior probabilities of each six scenarios for each POD and then estimated robustness by using distributions of these posterior probabilities over all PODS (**Appendix Fig. S2**).

Sub-scenarios assuming bottlenecks

For the best inferred model, we tested several sub-scenarios assuming different recent bottleneck in comparison to no bottleneck event. Three sub-scenarios assumed an instantaneous reduction of population size more or less intensive ($\alpha=2, 4$ or 8 , where α is a parameter to scale the level of bottleneck) in population A (α_A) with $N_{\text{bottleA}}=N_A/\alpha_A$ or/and in population B (α_B) with $N_{\text{bottleB}}=N_B/\alpha_B$ that occurred in coalescent times between present and the most recent event (T_{SPLIT} for SI and IM, T_{AM} for AM and T_{SC} for SC scenarios, T_{AM1} for PAM and T_{SC1} for PSC scenarios). A constant population size in both population A and B ($\alpha=1$) were considered to test a scenario without bottleneck event. Population sizes before bottleneck events (N_A and N_B) and further to these bottleneck events (N_{bottleA} and N_{bottleB}) were drawn from a large uniform distribution [0; 10,000,000]. In all tested sub-scenarios, bottlenecks could occur in either one or two different sister populations. We used the same model selection procedure than previously described to detect the best sub-scenarios.

All datasets and programs used in this article are available from the GitHub repository:

<https://github.com/ThibaultLeroyFr/RedOakABC/>.

Results

Population structure

Overall subdivision of genetic diversity

The genetic diversity calculated for native and introduced populations was similar in both gene pools. Expected heterozygosity values were not significantly different: $H_e=0.330$ (± 0.019 SE) for the native populations and $H_e=0.327$ (± 0.019 SE) for the introduced populations ($p=0.299$). The results of the AMOVA analyses indicated that the subdivision of genetic diversity among gene pools and among populations was significant, albeit low. Most of the genetic diversity was found among individuals within populations (**Table 2**).

Table 2. Results of Analyses of Molecular Variance (AMOVA) within North America and Europe and between both gene pools of *Q. rubra*. *df* represents the degree of freedom.

Source of variation	<i>df.</i>	Sum of squares	Variance components	Percent variation	<i>p</i> -value
North America					
Among populations	45	1740.4	0.838	3	0.001
Within populations	512	14645.7	28.605	97	0.001
Europe					
Among populations	21	791	0.847	3	0.001
Within populations	220	6253.4	28.424	97	0.001
All two gene pools					
Among gene pools	1	138.4	0.291	1	0.001
Among populations	66	2531.4	0.840	3	0.001
Within populations	732	20899	28.551	96	0.001

In both North American and European areas, only 3% of the total variation was among populations, suggesting a quite low genetic differentiation between *Q. rubra* populations into both gene pools. Similarly, genetic differentiation between Europe and North America, albeit significant, was weak among both gene pools (1%) and populations (3%). Ninety-six per cent of total molecular variance was explained by within-population variation (**Table 2**).

Structure in native populations

The average Deviance Information Criterion (DIC) criteria was used to estimate the number of *K* genetic clusters that best fit the data. In our case, DIC values continuously decreased without reaching a plateau (see **Appendix Table S2**), which made it impossible to identify the optimal *K* value using this criteria. Consequently, instead of using the DIC criteria, we checked the assignment of individuals to different genetic clusters and determined *K* value by identifying the number of meaningful groups of individuals (lower admixture proportions, fitting to geographical coordinates). At *K*=2, the Bayesian clustering analysis revealed that individuals from the Northeastern and Southeastern areas were mainly assigned to two different clusters (**Fig. 2**, see also

Appendix Fig. S1). At $K=3$, clustering analysis indicated a second level of structure and suggested one more cluster (G3 purple) that is preferential present in the Northcentral to Northwestern part of the distribution, although its distribution is more ubiquitous than for the other two clusters. This third cluster contained a large group of individuals originating from Missouri (populations MO_2, see **Appendix Table S1**) and from Northwestern Michigan (populations OT_2 and MTU, see **Appendix Table S1**) suggesting a genetic split from Northeastern (G1 orange) and Southeastern (G2 yellow) populations (**Fig. 2 and 3**, see also **Appendix Fig. S1**). At $K=4$ and beyond, most individuals were admixed and clustering appeared to be independent of geography, reinforcing the idea that the best partitioning is observed for $K=3$ (**Fig. 2**, see also **Appendix Fig. S1**). Correspondence analysis (CA) confirmed the Bayesian clustering analysis emphasizing the distinction of three genetic clusters previously found by TESS. Projections of individual values along the main axis were rather continuous with extreme values corresponding to the three clusters previously identified by the Bayesian clustering analysis (**Fig. 4**).

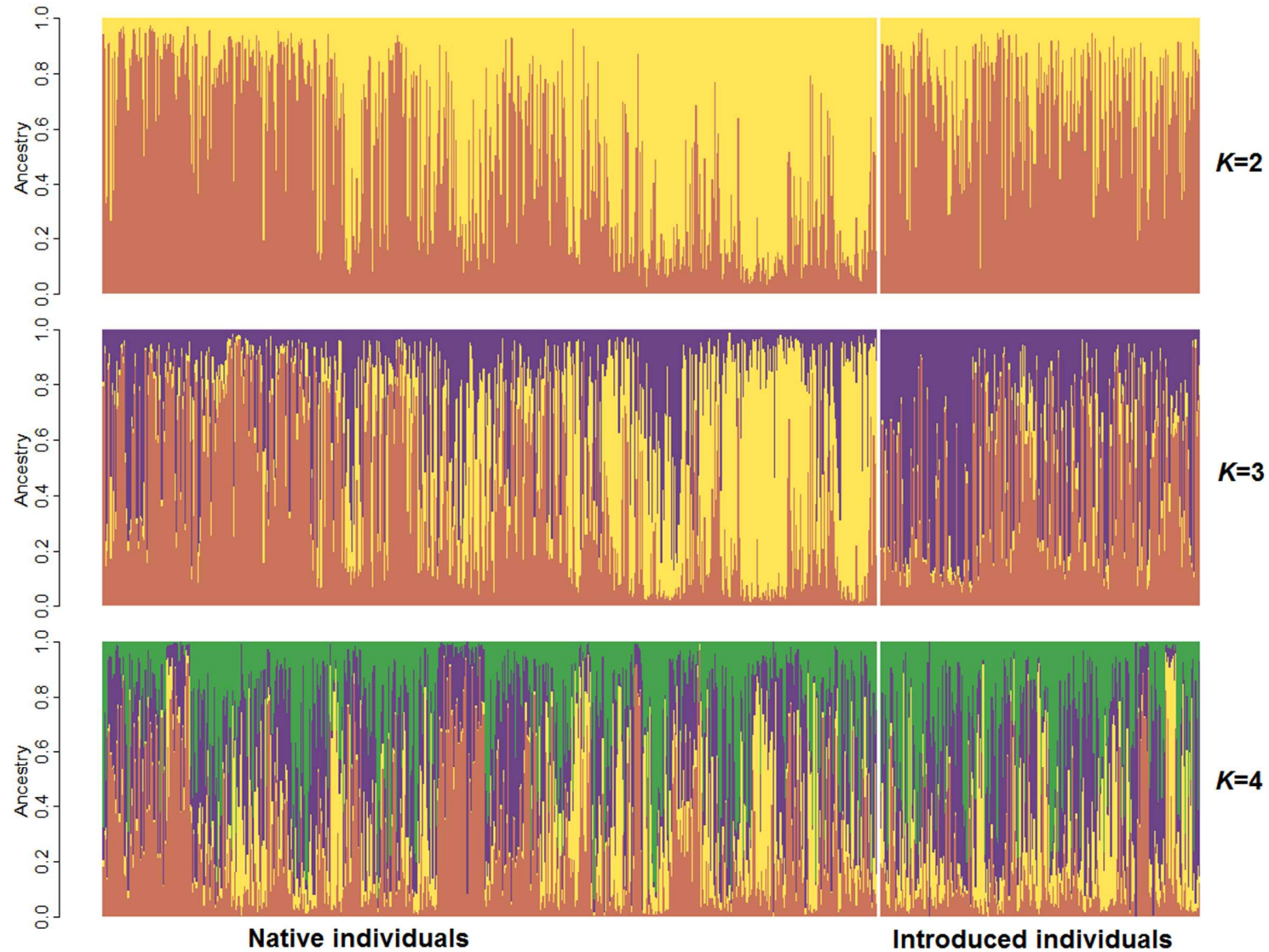

Figure 2. Posterior estimates of cluster membership for native and introduced individuals (respectively $n=624$ and $n=259$) at selected values of K (from 2 to 4), obtained with TESS software. Genetic cluster of G1 is represented in orange, G2 in yellow, G3 in purple and G4 in green. Native individuals are arranged according to their latitudinal coordinates from North to South (from right to left).

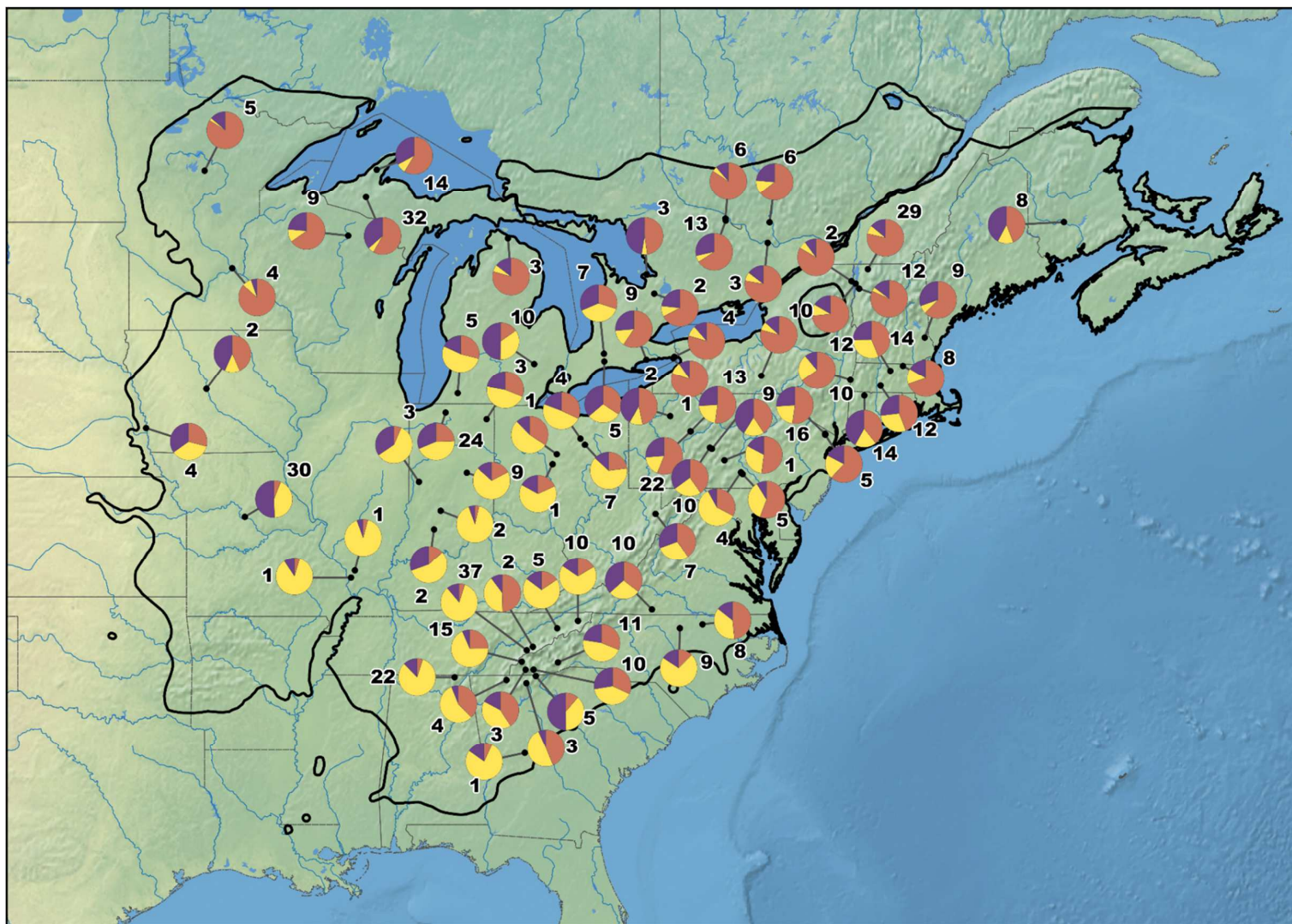

Figure 3. Geographic distribution of the 3 genetic clusters (K) detected in North America. Pie diagrams represent the mean assignment of every native population to each genetic cluster and the nearby number indicates the amount of individuals contributing to the population. G1 individuals, Northeastern populations, are indicated in orange, G2, Southeastern populations, in yellow and G3, Northcentral/Northwestern populations, in purple (see main text). The black thick line delimits the natural area of *Q. rubra* in North America. The raster maps data are free of use and come from Natural Earth website (<http://www.naturalearthdata.com/>) at 1:50m scale.

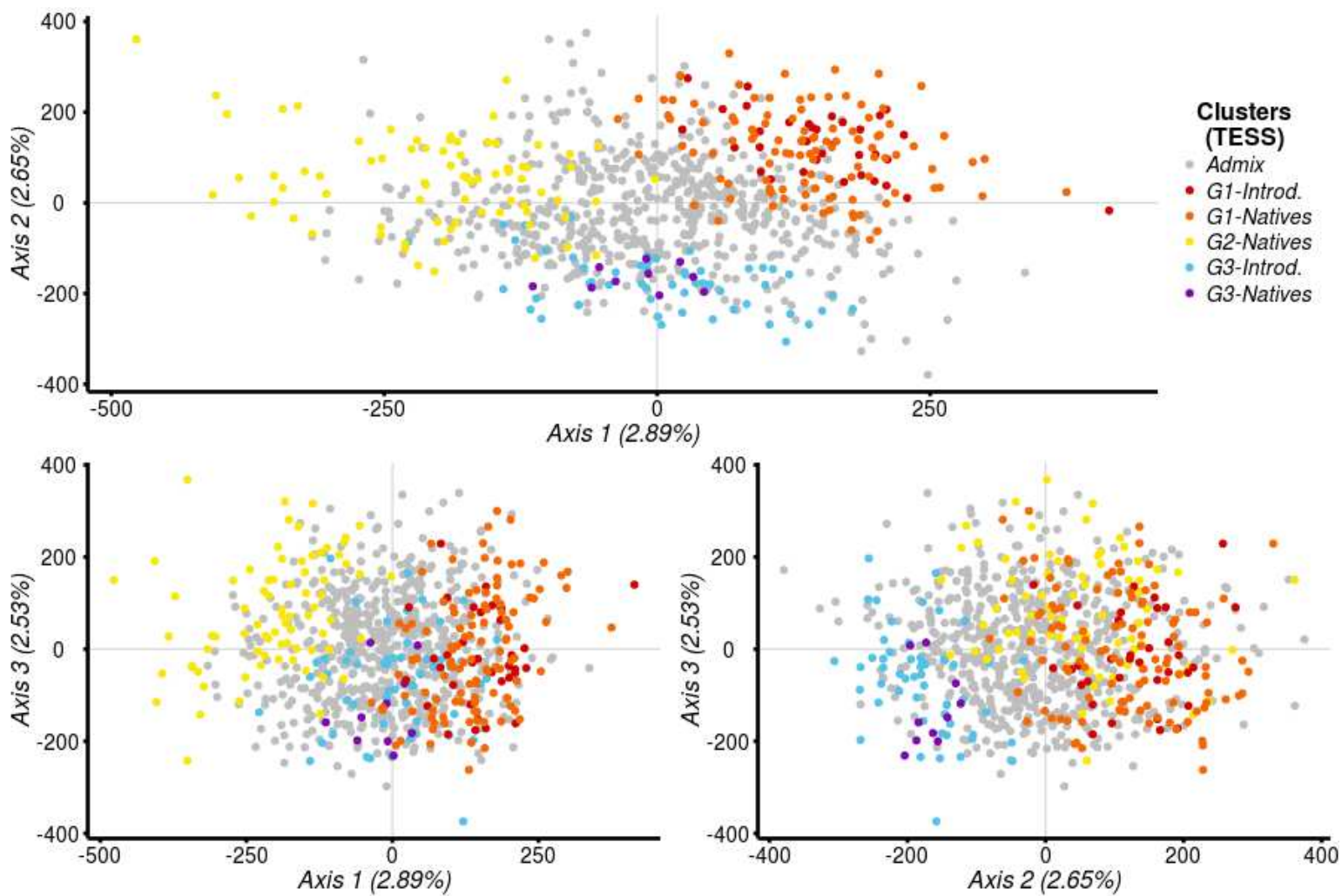

Figure 4. Correspondence Analysis (CA) of all North American and European individuals. The first three axes were represented in pairs. Admix individuals (*Hybrid*, $n=600$) were represented in grey and individuals with a high membership to one of the three cluster (Q-values > 0.80) are shown by different colors: *G1-Introd.* in red, *G1-Natives* in orange, *G2-Natives* in yellow, *G3-Introd.* in blue and *G3-Natives* in purple.

Structure in introduced populations

Given both the recent introduction of *Q. rubra* in Europe (first introduction circa 1691) and our considerable sampling effort in North America, we assumed that all introduced individuals originated from the three source populations detected in the native range and thus set the K value to 2 or 3. At $K=2$, most individuals were mainly assigned to the genetic cluster of Northeastern native populations (G1, orange). Fifty-nine percent of samples ($n=153$) were assigned to the cluster G1 and only 5% ($n=12$) to the cluster G2. The remaining (36%, $n=94$) exhibited Q-values below 0.8 and were considered as being admixed. At $K=3$, individuals were near-exclusively assigned to two of the three native clusters: Northeastern and Northcentral/Northwestern native clusters (G1, orange and G3, purple; **Fig. 2**). In this case, only 21% ($n=53$) were mostly assigned to the cluster G1, 13% ($n=34$) to the cluster G3 and only 1% ($n=2$) to the cluster G2. Sixty-five per cent of individuals have Q-values lower than 0.8 at $K=3$. No geographical structure across Europe was observed (**Fig. 5**). Considering the genetic structure in the native range at $K=3$, we mostly detected in introduced populations trees belonging to two of the three genetic clusters of the native range of *Q. rubra*. For all subsequent analyses, only native and introduced individuals with Q-values > 0.8 ($n=283$) were taken into consideration. The remaining 600 individuals were considered as admixed.

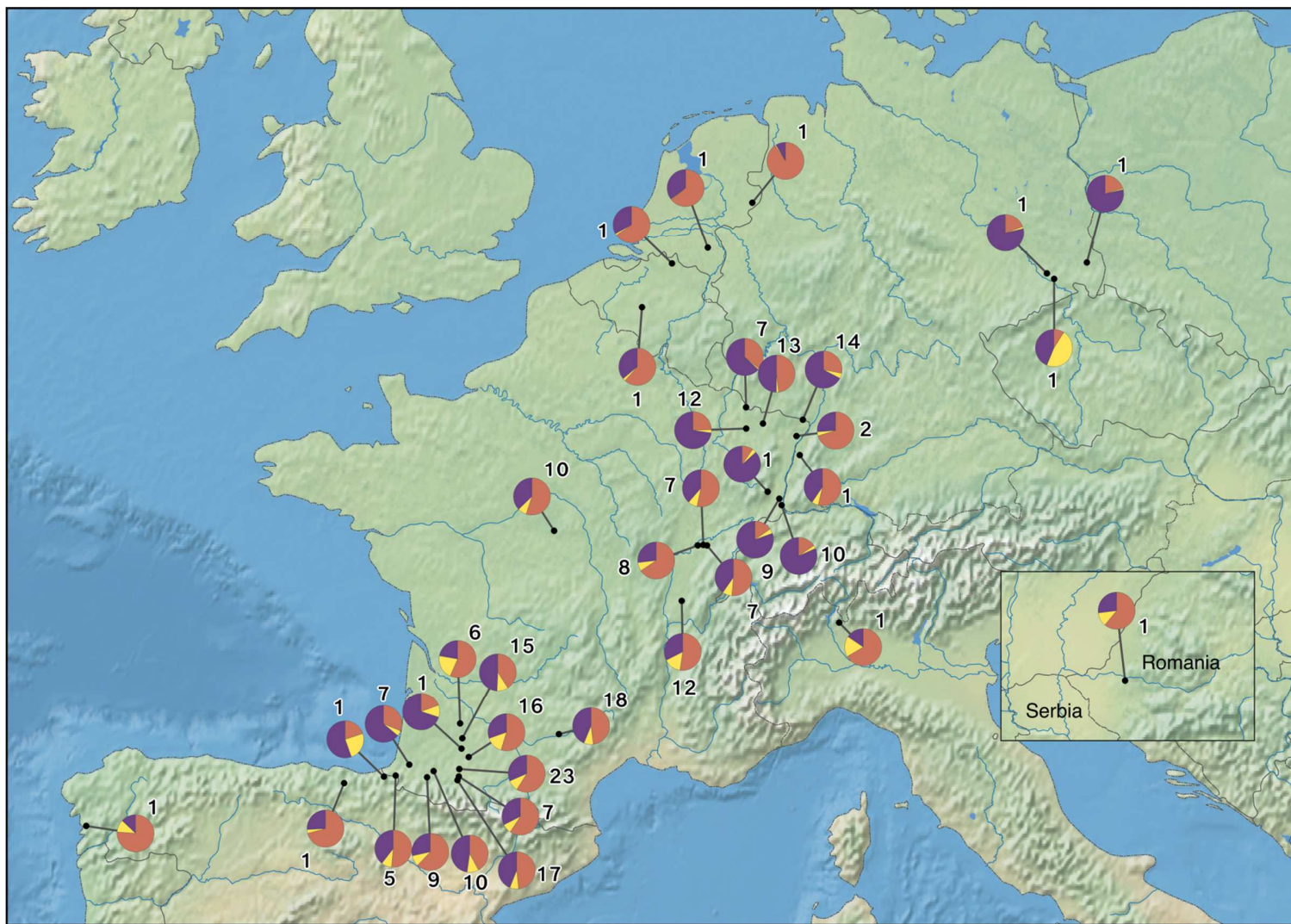

Figure 5. Geographic distribution of the 3 genetic clusters (K) found in Europe. Pie diagrams represent the mean assignment of every introduced population to each genetic cluster and the nearby number indicates the amount of individuals contributing to population. G1 individuals, Northeastern populations, are indicated in orange, G2, Southeastern populations, in yellow and G3, Northcentral/Northwestern populations, in purple. The raster maps data are free of use and come from Natural Earth website (<http://www.naturalearthdata.com/>) at 1:50m scale.

Pairwise genetic differentiation (F_{ST}) were calculated between all genetic clusters in both native and introduced ranges (**Table 3**). All pairwise genetic differentiation values (F_{ST}) between clusters were significant, ranging from 0.059 to 0.086. A low and non-significant level of genetic differentiation (<0.01) was observed between native and introduced populations belonging to the same genetic cluster.

Table 3. Pairwise estimates of genetic differentiation (F_{ST}) for all major genetic clusters (G) detected in the native range (Natives) and introduced range (Introd.). The star (*) is the significance level of F statistics ($p < 0.05$).

	G1-Natives	G2-Natives	G3-Introd.	G3-Natives
G1-Introd.	0.005	0.059*	0.076*	0.068*
G1-Natives	-	0.062*	0.086*	0.067*
G2-Natives	-	-	0.074*	0.068*
G3-Introd.	-	-	-	0.004

Population divergence

We used an Approximate Bayesian Computation (ABC) framework to try to reconstruct the demographic history of *Q. rubra*. These methods allow explicit tests of primary vs secondary differentiation hypotheses. Here, six demographic models of divergence were tested by pair of populations in both native and introduced ranges (see Materials and methods). We considered each genetic cluster previously identified by the Bayesian clustering analysis as a population and chose to perform our tests on four pairs of clusters: G1-G2, G2-G3, G1-G3 of the native range and G1-G3 of the introduced range. The ABC model-choice procedure leads to the identification of the simulated model with the highest relative posterior probability. For the four pairs of clusters, the ABC analysis provided the strongest support for models with at least one event of secondary contact, with posterior probabilities ranging from 0.6976 to 0.8319 (**Table 4**). Models with a single secondary contact (SC) clearly outperformed models assuming two cycles of secondary contacts (**Table 4**). This holds true for comparisons taking into account individuals from native and introduced ranges.

For each pair of clusters, demographic parameters were estimated under the best-fitting model SC (**Table 5**). Posterior distributions of parameters were built from 10,000 best simulations. Among all parameters, the ancestral population sizes (N_{ANC}), migration rates (M_A and M_B) and divergence times (T_{SPLIT}) were found to be poorly differentiated from their prior distributions. Conversely, the timing of secondary contact (T_{SC}) was quite well estimated and suggests that secondary gene flow occurred recently, in the last 2.1% of the divergence time between G1 and G3 (median=0.33%), and the last 5.7% of the divergence time between G2 and G3 (median= 0.41%). Posterior distribution of the divergence time between G1 and G2 is larger, suggesting that secondary contact occurred in the last 65.5% of the divergence time (median = 9.32%) (**Table 5**). Using leave-one-out cross validations based on 1,000 pseudo-observed datasets (PODS) for each model, we estimated a robustness of 1 in support of secondary contact for all pairwise comparisons (**Appendix Fig. S2**).

Table 4. Average posterior probabilities for each of the six models simulated (SI: strict isolation, AM: ancient migration, IM: isolation migration, SC: secondary contact, PAM: periodic ancient migration; PSC: periodic secondary contact) and each pair of clusters in the native and introduced range. Standard deviation is given in square bracket Best models are indicated in bold.

Range	Clusters						
	(Pop A vs Pop B)	SI	AM	IM	SC	PAM	PSC
Native	G1_vs_G2	0.0000 [±0.0001]	0.0637 [±0.0230]	0.0631 [±0.0111]	0.6976 [±0.0359]	0.0334 [±0.0128]	0.1420 [±0.0188]
Native	G1_vs_G3	0.0000 [±0.0000]	0.0004 [±0.0002]	0.0033 [±0.0017]	0.8180 [±0.0132]	0.0006 [±0.0002]	0.1777 [±0.0125]
Native	G2_vs_G3	0.0001 [±0.0000]	0.0012 [±0.0002]	0.0058 [±0.0020]	0.8053 [±0.0145]	0.0008 [±0.0002]	0.1868 [±0.0137]
Introduced	G1_vs_G3	0.0000 [±0.0000]	0.0002 [±0.0002]	0.0035 [±0.0073]	0.8319 [±0.0190]	0.0014 [±0.0052]	0.1630 [±0.0180]

Table 5. Prior and posterior parameters estimated from the best model scenario (SC: secondary contact) for each pair of genetic clusters in the native and introduced range. Minimum and maximum values are given in square bracket for prior parameters, median value and confidence interval at 95% in square bracket for posterior parameters. N_{PopA} and N_{PopB} are the size of populations (Pop A and Pop B) for each pair of cluster, N_{ANC} is the size of ancestral population before the division into two populations (Pop A and Pop B). Values of population size must be multiply by 10^5 . M_A and M_B are, respectively, migration rates from population B to population A and from population A to population B. T_{SPLIT} is the number of generations since the divergence time and T_{SC} the number of generations since the secondary contact between both populations. T_{SC}/T_{SPLIT} is the ratio of number of generations between the last secondary contact and divergence time.

Parameters	Priors	Native			Introduced
		Pop A: G1 Pop B: G2	Pop A: G1 Pop B: G3	Pop A: G2 Pop B: G3	Pop A: G1 Pop B: G3
N_{PopA}	[0; 100]	15.88 [0.61; 93.86]	34.22 [3.15; 94.42]	19.64 [1.72; 87.77]	39.66 [2.50; 95.84]
N_{PopB}	[0; 100]	26.90 [1.64; 95.03]	32.83 [3.76; 91.56]	14.51 [1.33; 82.78]	37.67 [3.00; 95.27]
N_{ANC}	[0; 100]	57.61 [4.60; 97.45]	59.46 [3.81; 98.23]	60.54 [4.39; 98.14]	51.60 [2.89; 97.68]
M_A	[0; 50]	3.895 [2.00; 96.15]	43.92 [2.93; 94.20]	38.89 [2.29; 94.78]	36.53 [1.07; 95.99]
M_B	[0; 50]	48.68 [3.10; 97.70]	39.69 [2.32; 94.85]	36.40 [2.91; 92.67]	40.01 [1.37; 96.70]
T_{SPLIT}	[0; 100]	53.97 [2.51; 97.07]	47.14 [1.29; 97.41]	43.77 [0.89; 96.53]	35.91 [1.50; 95.30]
T_{SC}	[0; 100]	2.94 [0.07; 51.39]	0.11 [0.01; 0.69]	0.12 [0.02; 0.75]	0.12 [0.00; 2.24]
T_{SC}/T_{SPLIT}	[0; 1]	0.0932 [0.0023; 0.6548]	0.0033 [0.0003; 0.0208]	0.0041 [0.0006; 0.0570]	0.0046 [0.0001; 0.0329]

Bottleneck in introduced populations

We analyzed several sub-scenarios of the best inferred model, secondary contact SC, assuming instantaneous changes in population sizes to mimic a recent founder effect occurring between T_{SC} and present. These sub-scenarios assuming recent bottlenecks were simulated on introduced populations as well as on native populations, used here as controls (**Table 6**). All sub-scenarios assuming bottlenecks slightly outperformed SC sub-scenarios assuming constant population sizes (0.63-0.78 vs. 0.22-0.37), except for the G2_vs_G3 pair where both models perform quite similarly (0.51 vs. 0.49). This observation held true for introduced populations but also for native populations, suggesting that bottlenecks could have occurred prior to the introduction of *Q. rubra* in Europe. In addition, we compared several combinations of parameters to test for different bottleneck intensities, scaled by the α parameter (**Table 7**). Models assuming low values of α_A or α_B perform slightly better than models assuming higher values for α_A or α_B . We found a slight advantage of models with a moderate bottleneck in a single population rather than no bottleneck at all.

Table 6. Average posterior probabilities over 20 ABC analyses of two secondary contacts (SC) sub-scenarios assuming constant size (SC-no bottleneck) or bottlenecks in each branch since T_{SC} (SC-bottleneck) for each pair of clusters in the native and introduced range. Standard deviations are given in square brackets. Best models are indicated in bold.

Range	Clusters	SC-no bottleneck	SC-bottleneck
Native	G1_vs_G2	0.2208 [±0.0316]	0.7792 [±0.0316]
Native	G1_vs_G3	0.3093 [±0.0415]	0.6907 [±0.0415]
Native	G2_vs_G3	0.4880 [±0.0321]	0.5120 [±0.0321]
Introduced	G1_vs_G3	0.3735 [±0.0619]	0.6265 [±0.0619]

Table 7. Average posterior probabilities over 20 ABC analyses of ten secondary contacts (SC) sub-scenarios simulated for each pair of clusters in the native and introduced range. Models assume instantaneous size change since T_{SC} . Standard deviations are given in square brackets. Best models are indicated in bold.

Range	Clusters	no bottleneck	bottleneck occurring in cluster A			bottleneck occurring in cluster B			bottlenecks occurring in cluster A & B		
		$\alpha_A=1; \alpha_B=1$	$\alpha_A=2$	$\alpha_A=4$	$\alpha_A=8$	$\alpha_B=2$	$\alpha_B=4$	$\alpha_B=8$	$\alpha_A=2; \alpha_B=2$	$\alpha_A=4; \alpha_B=4$	$\alpha_A=8; \alpha_B=8$
Native	G1_vs_G2	0.0161 [±0.0018]	0.1610 [±0.0039]	0.1267 [±0.0028]	0.0969 [±0.0027]	0.1286 [±0.0035]	0.0847 [±0.0029]	0.0596 [±0.0029]	0.1357 [±0.0020]	0.1099 [±0.0011]	0.0807 [±0.0038]
Native	G1_vs_G3	0.0019 [±0.0013]	0.1405 [±0.0031]	0.1124 [±0.0020]	0.0824 [±0.0025]	0.1561 [±0.0034]	0.1189 [±0.0027]	0.0812 [±0.0026]	0.1341 [±0.0019]	0.1011 [±0.0015]	0.0714 [±0.0037]
Native	G2_vs_G3	0.0127 [±0.0016]	0.1530 [±0.0032]	0.1240 [±0.0036]	0.0904 [±0.0030]	0.1371 [±0.0039]	0.0987 [±0.0024]	0.0667 [±0.0026]	0.1464 [±0.0020]	0.1086 [±0.0008]	0.0624 [±0.0036]
Introduced	G1_vs_G3	0.0214 [±0.0103]	0.1520 [±0.0159]	0.1523 [±0.0215]	0.0659 [±0.0076]	0.1283 [±0.0102]	0.1203 [±0.0137]	0.0551 [±0.0072]	0.1974 [±0.0253]	0.0674 [±0.0083]	0.0399 [±0.0084]

Discussion

In this study, our main goal was to retrace historical and demographic events that would have been associated to the introduction of *Q. rubra* in Europe. We proceeded stepwise by first deciphering the existing genetic structure in the natural distribution only. We then compared the structure in the introduced range with the extant structure in the native range, and inferred putative original sources of the introduced gene pools. Finally, we tested whether introduced populations have undergone genetic bottlenecks resulting from founder effects. Overall our efforts and expectations were hampered by the low differentiation of *Q. rubra* in its natural range. We found low F_{ST} among populations. There have been few range-wide explorations of gene diversity in *Q. rubra*. Earlier reports mentioned contrasting levels of differentiation ($F_{ST} = 0.092$ in allozymes Sork et al. 1993; $G_{ST} = 0.018$ in allozymes, Daubree and Kremer 1993; $F_{ST} = 0.043$ in microsatellites, Borkowski et al. submitted), likely due to quite different sampling strategies. Other genetic surveys conducted on continental-wide distributed oak species report similar levels to what we found here ($G_{ST} = 0.025$ in *Quercus petraea*, Zanetto and Kremer 1995; $G_{ST} = 0.020$ in *Quercus robur*, Mariette et al. 2002). Finally differentiation between the introduced and native gene pool was even lower, about 1%. Despite the low differentiation within and between the two gene pools, we found a continuous trend of genetic variation across the natural distribution extending from the Northeast to the Southeast and thus identified two genetic clusters by using Bayesian Clustering methods. Additionally this method allowed also to identify a more ubiquitous group, preferentially located in the Northcentral to the Northwestern part of the natural distribution.

These findings contrast with a previous study using chloroplast DNA markers reporting no genetic structure in North America (Magni et al. 2005). Although chloroplast DNA markers usually exhibit very high genetic differentiation in oaks due to limited seed dispersal (Petit et al. 2002a, 2002b, 2002c), these markers are inappropriate for the detection of population structure at the nuclear level due to their different mode of inheritance and different evolutionary drivers. Indeed chloroplast genome capture and swamping occurring during colonization dynamics may blur and hide the background nuclear genetic structure (Kremer et al. 2002; Leroy et al. submitted). Alternatively, high

nuclear genetic structure may be present with very low or absent chloroplast population structure (Hoban et al. 2010, Laricchia et al. 2015).

Whether the structure of diversity we found in the natural range is a signature of historical demographic events, divergent selection remains an open debate. A recent range wide genetic survey based on microsatellites also detected a latitudinal trend of variation but detected a higher divergence at the Northwestern part of the range (Borkowski et al. submitted). Apart from genetic marker data, comparison of phenotypic traits among populations in provenance-progeny tests detected genetic trends across the entire native range. Phenological traits as the timing of leaf budburst and leaf coloration, exhibited strong differentiation among provenances from different geographic origins (Kriebel 1993). Timing of budburst was correlated with longitude whereas senescence showed North-South variations (Deneke 1974, Kriebel et al. 1976, Schlarbaum and Bagley 1981). No latitudinal or longitudinal trend was observed for growth but populations coming from the central part of the range (between latitudes 43 and 46° N) grew faster than other provenances (Schlarbaum and Bagley 1981, Kriebel et al. 1988). Populations located to the west of the range limits, in Iowa, Kansas and Missouri for example, were more drought resistant and had higher survival compared to other populations of the natural range (Deneke 1974). Overall there are some congruent patterns observed between genetic surveys conducted on DNA markers or sequences (our results and Borkowski et al. submitted) and previous investigations conducted in common garden experiments suggesting potential common causes as divergent selection across large environmental gradients. However these gradients overlap also with historical pathways of colonization (Schlarbaum et al. 1982) and may generate similar signatures than demographic processes. Further investigations are needed to disentangle these sources of variation.

One question we addressed is to know whether divergence between these three different genetic clusters is ancient. Indeed, divergence can be the result of a recent process of isolation (“primary divergence”) or more ancient as expected under secondary contact (SC) scenarios. For all pairs of clusters, our ABC analyses found support for models assuming at least an event of secondary contact, with higher support for models

assuming a single period of SC. In addition, our inferences suggested that secondary contact is very recent as compared with the period of strict isolation. More broadly, the compilation of all our ABC analyses suggests that these three different genetic groups have been separated in at least three different regions during a long part of their history, or were somehow isolated. One explanation for this apparent allopatric isolation is different climatic refuges, as already suspected between four species of the European white oak complex (Leroy et al. submitted). In the continental United States the advances and retreats of Pleistocene glaciations for the last 800,000 years occurred over four major cycles, with complex patterns of retreats and advances (Balco and Rovey 2010). Long established regional populations of *Q. rubra* could have come into secondary contact during the migrations that must have occurred during these climate shifts.

To investigate the origin of the current *Q. rubra* populations in Europe, we performed a second Bayesian clustering analysis based on both native and introduced populations. In Europe, all other individuals are mostly assigned to only two of the three genetic clusters: Northeastern and Northcentral-Northwestern populations. This result is quite consistent with historical documents reporting numerous introductions of *Q. rubra* individuals in Europe from Northeastern of North America during the eighteenth century, probably due to the shortest maritime route between Northern states and the ports of Western Europe, as suggested by Bauer (1954), who first raised the issue of the origin of introduced populations in Europe. Nevertheless, there are also a few records about trade exchanges with southern states occurring at the beginning nineteenth century (United States. Bureau of the Census 1975). Whether acorns of red oak were introduced during that period is unknown. If it ever had been the case, then our results suggest that southern origins have been largely extirpated since introduction either through natural selection or human interferences. Probably, Northeastern and Northcentral/Northwestern populations could have managed better to adapt to environmental conditions encountered in Europe. As mentioned by Colautti and Barrett (2013) and Hamilton et al. (2015), rapid adaptation to local climatic conditions favors survival and spread of introduced populations in new habitats. It is worthwhile mentioning at this point that the extant species *Q. rubra* was earlier named *Quercus borealis* Michx f. and that botanists and foresters recognized within the species a variety called *Quercus borealis* var *maxima* (Marsh) Ashe. which exhibited

some acorn shape differences and was supposedly more frequent in New England (Palmer 1942). This distinction was still used in the 1950s by European foresters (Bauer 1953, Göhre and Wagenknecht 1955), and it might well be a clue for understanding the preferential seed sourcing in Northeastern states where the pure type *Q. borealis* was supposedly more frequent. Finally, we cannot exclude the possibility that southern native populations were never introduced in Europe. Further investigations are needed to be based on additional markers and phenotypic traits assessed in common garden experiments including populations of both origins.

Given the lower likelihood of local adaptation in small populations, bottleneck events inducing a loss of genetic diversity are generally expected to reduce fitness and evolutionary potential. We tested different sub-scenarios considering instantaneous reductions in population size. The results of our ABC analysis suggest that *Q. rubra* populations have possibly undergone a bottleneck effect. However this event is unlikely associated with the introduction to Europe. Indeed, moderate bottlenecks have been detected using both the native and introduced pairs of populations, revealing that this bottleneck occurred prior to the introduction of *Q. rubra* in Europe. A reduction of population size may have occurred during the allopatric isolation in North America. However our results suggest that a moderate to strong founder effect associated to the introduction is an unlikely hypothesis. There was earlier tiny support to the lack of bottleneck effects based on the comparison of allozyme allele frequencies of rare alleles in introduced and native populations (Daubree and Kremer 1993). Alleles that were rare in native populations were in most cases maintained at low frequencies in introduced populations, but these investigations were limited to only four loci. Previous studies comparing genetic diversity and differentiation between American and European populations of *Q. rubra* suggested multiple or repeated introductions for forest plantation from the late of nineteenth century in Europe to explain maintaining of genetic diversity between both ranges (Magni Diaz 2004). While our investigations did not find support for the occurrence of bottlenecks, they could not tackle the likelihood of interbreeding between first introduced materials. Further research is needed along this avenue. Overall our results suggest that the recruitment success of *Q. rubra* largely used in forestry across Europe (Timbal et al. 1994) is likely the result of steady adaptation, facilitated by the

absence of acorn predators (Steiner et al. 1993, Steiner 1995) and has not been profoundly impacted by demographic bottlenecks.

Acknowledgements

We thank C. Firmat, B. Dencausse, R. Ségura, F. Bonne, T. Paul and V. Rousselet for helping during sampling collection in the field in France, R. Robichaud and T. McCleary for sampling in North America, P. Leger for helping during DNA extraction and the team of the Genome-Transcriptome platform for helping during genotyping. T. L. wants to thank C. Roux and Q. Rougemont for a long-term collaboration on demographic inferences and Approximate Bayesian Computations. We are grateful to the genotoul bioinformatics platform Toulouse Midi-Pyrenees (Bioinfo Genotoul) for providing computing resources. Part of the experiments (genotyping) were performed at the Genomic and Transcriptomic Facility of Bordeaux (grants from the Conseil Regional d'Aquitaine 20030304002FA and 20040305003FA and from the European Union, FEDER 2003227 and from Investissements d'avenir, Convention attributive d'aide N°ANR-10-EQPX-16-01). This study was carried out with financial support from the French National Research Agency (ANR) in the frame of the Investments for the future Program (ANR-10- IDEX-03-02) and from the European Research Council under the Advanced Grant TREEPEACE (#FP7-339728).

References

- Allendorf, F.W., and Lundquist, L.L. 2003. Introduction: Population Biology, Evolution, and Control of Invasive Species. *Conserv. Biol.* **17**(1): 24–30. doi:10.1046/j.1523-1739.2003.02365.x.
- Balco, G., and Rovey, C.W. 2010. Absolute chronology for major Pleistocene advances of the laurentide ice Sheet. *Geology* **38**(9): 795–798. doi:10.1130/G30946.1.
- Bauer, F. 1953. Die Roteiche. *Edited by Sauerländer's Verlag*. Frankfurt Am Main.
- Bauer, F. 1954. Zur Rassenfrage der Roteiche. *Allg. Forstzeitschrift* **9**: 470–474.
- Beaumont, M.A., Zhang, W., and Balding, D.J. 2002. Approximate Bayesian Computation in Population Genetics. *Genetics* **162**(4): 2025–2035. Available from <http://www.genetics.org/content/162/4/2025.abstract>.
- Belkhir, K., Borsa, P., Chikhi, L., Raufaste, N., and Bonhomme, F. 2004. GENETIX 4.05, logiciel sous Windows TM pour la génétique des populations. Laboratoire Génome, Populations, Interactions, CNRS UMR 5000, Université de Montpellier II, Montpellier (France).
- Biggsby, K.M., Tobin, P.C., and Sills, E.O. 2011. Anthropogenic drivers of gypsy moth spread. *Biol. Invasions* **13**(9): 2077–2090. doi:10.1007/s10530-011-0027-6.
- Birchenko, I., Feng, Y., and Romero-Severson, J. 2009. Biogeographical Distribution of Chloroplast Diversity in Northern Red Oak (*Quercus rubra* L.). *Am. Midl. Nat.* **161**(1): 134–145. doi:10.1674/0003-0031-161.1.134.
- Blackburn, T.M., Lockwood, J.L., and Cassey, P. 2015. The influence of numbers on invasion success. *Mol. Ecol.* **24**(9): 1942–1953. doi:10.1111/mec.13075.
- Borkowski, D.S., Hoban, S.M., Chatwin, W.B., and Romero-Severson, J. 2016. Response to rangewide disturbances influences values of population differentiation in *Quercus*

rubra L. [submitted].

- Bossdorf, O., Auge, H., Lafuma, L., Rogers, W.E., Siemann, E., and Prati, D. 2005. Phenotypic and genetic differentiation between native and introduced plant populations. *Oecologia* **144**(1): 1–11. doi:10.1007/s00442-005-0070-z.
- Buswell, J.M., Moles, A.T., and Hartley, S. 2011. Is rapid evolution common in introduced plant species? *J. Ecol.* **99**(1): 214–224. doi:10.1111/j.1365-2745.2010.01759.x.
- Castric, V., Bechsgaard, J., Schierup, M.H., and Vekemans, X. 2008. Repeated Adaptive Introgression at a Gene under Multiallelic Balancing Selection. *PLoS Genet.* **4**(8): e1000168. doi:10.1371/journal.pgen.1000168.
- Charlesworth, B. 2009. Fundamental concepts in genetics: Effective population size and patterns of molecular evolution and variation. *Nat. Rev. Genet.* **10**(3): 195–205. doi:10.1038/nrg2526.
- Charlesworth, B., Nordborg, M., and Charlesworth, D. 1997. The effects of local selection, balanced polymorphism and background selection on equilibrium patterns of genetic diversity in subdivided populations. *Genet. Res.* **70**(2): 155–174.
- Chen, C., Durand, E., Forbes, F., and François, O. 2007. Bayesian clustering algorithms ascertaining spatial population structure : a new computer program and a comparison study. *Mol. Ecol.* **7**: 747–756. doi:10.1111/j.1471-8286.2007.01769.x.
- Clout, M.N., and Russell, J.C. 2008. The invasion ecology of mammals: A global perspective. *Wildl. Res.* **35**(3): 180–184. doi:10.1071/WR07091.
- Colautti, R.I., and Barrett, S.C.H. 2013. Rapid adaptation to climate facilitates range expansion of an invasive plant. *Science.* **342**(6156): 364–6. doi:10.1126/science.1242121.
- Cristescu, M.E. 2015. Genetic reconstructions of invasion history. *Mol. Ecol.* **24**(9): 2212–2225. doi:10.1111/mec.13117.

- Cruickshank, T.E., and Hahn, M.W. 2014. Reanalysis suggests that genomic islands of speciation are due to reduced diversity, not reduced gene flow. *Mol. Ecol.* **23**(13): 3133–3157. doi:10.1111/mec.12796.
- Csilléry, K., Blum, M.G.B., Gaggiotti, O.E., and François, O. 2010. Approximate Bayesian Computation (ABC) in practice. *Trends Ecol. Evol.* **25**(7): 410–418. doi:10.1016/j.tree.2010.04.001.
- Csilléry, K., François, O., and Blum, M.G.B. 2012. abc: an R package for approximate Bayesian computation (ABC). *Methods Ecol. Evol.* **3**(3): 475–479. doi:10.1111/j.2041-210X.2011.00179.x.
- Daubree, J., and Kremer, A. 1993. Genetic and phenological differentiation between introduced and natural populations of *Quercus rubra* L. *Ann. des Sci. For.* **50**(Suppl 1): 271s–280s. doi:10.1051/forest:19930727.
- Deneke, F.J. 1974. A Red Oak Provenance Trial in Kansas. *Trans. Kansas Acad. Sci.* **77**(3): 195. doi:10.2307/3627319.
- Desprez-Loustau, M.-L., Robin, C., Buée, M., Courtecuisse, R., Garbaye, J., Suffert, F., Sache, I., and Rizzo, D.M. 2007. The fungal dimension of biological invasions. *Trends Ecol. Evol.* **22**(9): 472–480. doi:10.1016/j.tree.2007.04.005.
- Dlugosch, K.M., and Parker, I.M. 2008. Founding events in species invasions: genetic variation, adaptive evolution, and the role of multiple introductions. *Mol. Ecol.* **17**(1): 431–49. doi:10.1111/j.1365-294X.2007.03538.x.
- Durand, E., Jay, F., Gaggiotti, O.E., and Francois, O. 2009. Spatial Inference of Admixture Proportions and Secondary Contact Zones. *Mol. Biol. Evol.* **26**(9): 1963–1973. doi:10.1093/molbev/msp106.
- Durka, W., Bossdorf, O., Prati, D., and Auge, H. 2005. Molecular evidence for multiple introductions of garlic mustard (*Alliaria petiolata*, Brassicaceae) to North America. *Mol. Ecol.* **14**(6): 1697–1706. doi:10.1111/j.1365-294X.2005.02521.x.

- Ehrenfeld, J.G. 2010. Ecosystem Consequences of Biological Invasions. *Annu. Rev. Ecol. Evol. Syst.* **41**(1): 59–80. doi:10.1146/annurev-ecolsys-102209-144650.
- Estoup, A., and Guillemaud, T. 2010. Reconstructing routes of invasion using genetic data: Why, how and so what? *Mol. Ecol.* **19**(19): 4113–4130. doi:10.1111/j.1365-294X.2010.04773.x.
- Excoffier, L., Smouse, P.E., and Quattro, J.M. 1992. Analysis of molecular variance inferred from metric distances among DNA haplotypes: application to human mitochondrial DNA restriction data. *Genetics* **131**: 479–491. Available from <http://link.springer.com/10.1007/s00424-009-0730-7>.
- Facon, B., Genton, B.J., Shykoff, J., Jarne, P., Estoup, A., and David, P. 2006. A general eco-evolutionary framework for understanding bioinvasions. *Trends Ecol. Evol.* **21**(3): 130–135. doi:10.1016/j.tree.2005.10.012.
- François, O., Ancelet, S., and Guillot, G. 2006. Bayesian clustering using hidden Markov random fields in spatial population genetics. *Genetics* **174**(2): 805–16. doi:10.1534/genetics.106.059923.
- Genton, B.J., Shykoff, J.A., and Giraud, T. 2005. High genetic diversity in French invasive populations of common ragweed, *Ambrosia artemisiifolia*, as a result of multiple sources of introduction. *Mol. Ecol.* **14**(14): 4275–4285. doi:10.1111/j.1365-294X.2005.02750.x.
- Goeze. 1916. Liste der seit dem 16. Jahrhundert bis auf die Gegenwart in die Gärten uns Parks Europas eingeführten Bäume und Stäucher. *Mitteilungen der Deutschen Dendrologischen Gesellschaft*.
- Göhre, K., and Wagenknecht, E. 1955. Die Roteiche und ihr Holz. *Edited by Deutscher Bauernverlag*. Berlin.
- Hamilton, J.A., Okada, M., Korves, T., and Schmitt, J. 2015. The role of climate adaptation in colonization success in *Arabidopsis thaliana*. *Mol. Ecol.* **24**(9): 2253–2263. doi:10.1111/mec.13099.

- Hoban, S.M., Borkowski, D.S., Brosi, S.L., McCleary, T.S., Thompson, L.M., McLachlan, J.S., Pereira, M.A., Schlarbaum, S.E., and Romero-Severson, J. 2010. Range-wide distribution of genetic diversity in the North American tree *Juglans cinerea*: a product of range shifts, not ecological marginality or recent population decline. *Mol. Ecol.* **19**(22): 4876–4891. doi:10.1111/j.1365-294X.2010.04834.x.
- Hudson, R.R. 2002. Generating samples under a Wright-Fisher neutral model of genetic variation. *Bioinformatics* **18**(2): 337–338. doi:10.1093/bioinformatics/18.2.337.
- Hulme, P.E. 2009. Trade, transport and trouble: Managing invasive species pathways in an era of globalization. *J. Appl. Ecol.* **46**(1): 10–18. doi:10.1111/j.1365-2664.2008.01600.x.
- Jakobsson, M., and Rosenberg, N.A. 2007. CLUMPP: A cluster matching and permutation program for dealing with label switching and multimodality in analysis of population structure. *Bioinformatics* **23**(14): 1801–1806. doi:10.1093/bioinformatics/btm233.
- Jombart, T. 2008. adegenet: a R package for the multivariate analysis of genetic markers. *Bioinformatics* **24**(11): 1403–1405. doi:10.1093/bioinformatics/btn129.
- Jombart, T., and Ahmed, I. 2011. adegenet 1.3-1: new tools for the analysis of genome-wide SNP data. *Bioinformatics* **27**(21): 3070–3071. doi:10.1093/bioinformatics/btr521.
- Jones, R.A.C. 2009. Plant virus emergence and evolution: Origins, new encounter scenarios, factors driving emergence, effects of changing world conditions, and prospects for control. *Virus Res.* **141**(2): 113–130. doi:10.1016/j.virusres.2008.07.028.
- Keller, S.R., and Taylor, D.R. 2010. Genomic admixture increases fitness during a biological invasion. *J. Evol. Biol.* **23**(8): 1720–1731. doi:10.1111/j.1420-9101.2010.02037.x.
- Konar, A., Choudhury, O., Bullis, R., Fiedle, L., Kruser, J.M., Stephens, M.T., Gailing, O., Schlarbaum, S.E., Coggeshall, M. V., Staton, M.E., Carlson, J.E., Emrich, S., and

- Romero-Severson, J. 2016. The promise and performance of ddRADseq for constructing a dense genetic linkage map in the non-model tree *Quercus rubra*. [submitted].
- Kopelman, N.M., Mayzel, J., Jakobsson, M., Rosenberg, N.A., and Mayrose, I. 2015. Clumpak: A program for identifying clustering modes and packaging population structure inferences across K. *Mol. Ecol. Resour.*: 1179–1191. doi:10.1111/1755-0998.12387.
- Kremer, A., Kleinschmit, J., Cottrell, J., Cundall, E.P., Deans, J.D., Ducousso, A., König, A.O., Lowe, A.J., Munro, R.C., Petit, R.J., and Stephan, B.R. 2002. Is there a correlation between chloroplastic and nuclear divergence, or what are the roles of history and selection on genetic diversity in European oaks? *For. Ecol. Manage.* **156**(1–3): 75–87. doi:10.1016/S0378-1127(01)00635-1.
- Kriebel, H. 1993. Intraspecific variation of growth and adaptive traits in North American oak species. *Ann. des Sci. For.* **50**: 153s–165s. doi:10.1051/forest:19930715.
- Kriebel, H.B., Bagley, W.T., Deneke, F.J., Funsch, R.W., Roth, P., Jokela, J.J., Merritt, C., Wright, J.W., and Williams, R.D. 1976. Geographic variation in *Quercus rubra* in north central United States plantations. *Sylvae Genet.* **25**(3–4): 118–122. Available from http://www.silvaegenetica.de/fileadmin/content/dokument/archiv/silvaegenetica/25_1976/25-3-4-118.pdf \n<http://www.cabdirect.org.ezproxy.bibl.ulaval.ca/abstracts/19771654165.html>.
- Kriebel, H.B., Merritt, C., and Stadt, T. 1988. Genetics of Growth Rate in *Quercus rubra*: Provenance and Family Effects by the Early Third Decade in the North Central USA. *Sylvae Genet.* **37**: 193–198.
- Lanier, L., Keller, R., and Kremer, A. 1980. Le Chêne rouge (*Quercus rubra* L.) en France. *Rev. For. Française* **32**(5): 419. doi:10.4267/2042/21428.
- Laricchia, K.M., McCleary, T.S., Hoban, S.M., Borkowski, D., and Romero-Severson, J.

2015. Chloroplast haplotypes suggest preglacial differentiation and separate postglacial migration paths for the threatened North American forest tree *Juglans cinerea* L. *Tree Genet. Genomes* **11**(2): 30. doi:10.1007/s11295-015-0852-3.
- Lavergne, S., and Molofsky, J. 2007. Increased genetic variation and evolutionary potential drive the success of an invasive grass. *Proc. Natl. Acad. Sci. U. S. A.* **104**(10): 3883–8. doi:10.1073/pnas.0607324104.
- Lehe, R., Hallatschek, O., and Peliti, L. 2012. The Rate of Beneficial Mutations Surfing on the Wave of a Range Expansion. *PLoS Comput. Biol.* **8**(3): e1002447. doi:10.1371/journal.pcbi.1002447.
- Leprieur, F., Beauchard, O., Blanchet, S., Oberdorff, T., and Brosse, S. 2008. Fish Invasions in the World's River Systems: When Natural Processes Are Blurred by Human Activities. *PLoS Biol.* **6**(2): e28. doi:10.1371/journal.pbio.0060028.
- Leroy, T., Le Cam, B., and Lemaire, C. 2014. When virulence originates from non-agricultural hosts: New insights into plant breeding. *Infect. Genet. Evol.* **27**: 521–529. doi:10.1016/j.meegid.2013.12.022.
- Leroy, T., Roux, C., Villate, L., Bodénès, C., Romiguier, J., Paiva, J.A., Dossat, C., Aury, J.-M., Plomion, C., and Kremer, A. 2016. Extensive recent secondary contacts between four European white oak species. [submitted].
- Magni, C.R., Ducouso, A., Caron, H., Petit, R.J., and Kremer, A. 2005. Chloroplast DNA variation of *Quercus rubra* L. in North America and comparison with other Fagaceae. *Mol. Ecol.* **14**(2): 513–524. doi:10.1111/j.1365-294X.2005.02400.x.
- Magni Diaz, C.R. 2004. Reconstitution de l'introduction de *Quercus rubra* L. en Europe et conséquences génétiques dans les populations allochtones. Thèse de doctorat, Ecole Nationale du Génie Rural des Eaux et Forêts, Paris, FRANCE.
- Major, K.C., Nosko, P., Kuehne, C., Campbell, D., and Bauhus, J. 2013. Regeneration dynamics of non-native northern red oak (*Quercus rubra* L.) populations as influenced by environmental factors: A case study in managed hardwood forests of

- southwestern Germany. *For. Ecol. Manage.* **291**: 144–153. doi:10.1016/j.foreco.2012.12.006.
- Mariette, S., Cottrell, J., Csaikl, U.M., Goikoechea, P., König, A., Lowe, A.J., Van Dam, B.C., Barreneche, T., Bodénès, C., Streiff, R., Burg, K., Groppe, K., Munro, R.C., Tabbener, H., and Kremer, A. 2002. Comparison of levels of genetic diversity detected with AFLP and microsatellite markers within and among mixed *Q. petraea* (MATT.) LIEBL. and *Q. robur* L. stands. *Silvae Genet.* **51**(2–3): 72–79.
- Maron, J.L., Vilà, M., Bommarco, R., Elmendorf, S., and Beardsley, P. 2004. Rapid evolution of an invasive plant. *Ecol. Monogr.* **74**(2): 261–280. doi:10.1890/03-4027.
- Miller, J.R. 2010. Survival of mutations arising during invasions. *Evol. Appl.* **3**(2): 109–121. doi:10.1111/j.1752-4571.2010.00120.x.
- Miura, O. 2007. Molecular genetic approaches to elucidate the ecological and evolutionary issues associated with biological invasions. *Ecol. Res.* **22**(6): 876–883. doi:10.1007/s11284-007-0389-5.
- Palmer, E.J. 1942. The Red Oak Complex in the United States. *Am. Midl. Nat.* **27**(3): 732–740. doi:10.2307/2420922.
- Peakall, R., and Smouse, P.E. 2012. GenAEx 6.5: genetic analysis in Excel. Population genetic software for teaching and research - an update. *Bioinformatics* **28**(19): 2537–2539. doi:10.1093/bioinformatics/bts460.
- Pejchar, L., and Mooney, H.A. 2009. Invasive species, ecosystem services and human well-being. *Trends Ecol. Evol.* **24**(9): 497–504. doi:10.1016/j.tree.2009.03.016.
- Petit, R.J., Brewer, S., Bordács, S., Burg, K., Cheddadi, R., Coart, E., Cottrell, J., Csaikl, U.M., van Dam, B., Deans, J.D., Espinel, S., Fineschi, S., Finkeldey, R., Glaz, I., Goicoechea, P.G., Jensen, J.S., König, A.O., Lowe, A.J., Madsen, S.F., Mátyás, G., Munro, R.C., Popescu, F., Slade, D., Tabbener, H., de Vries, S.G., Ziegenhagen, B., de Beaulieu, J.-L., and Kremer, A. 2002a. Identification of refugia and post-glacial colonisation routes of European white oaks based on chloroplast DNA and fossil

- pollen evidence. *For. Ecol. Manage.* **156**(1–3): 49–74. doi:10.1016/S0378-1127(01)00634-X.
- Petit, R.J., Csaikl, U.M., Bordács, S., Burg, K., Coart, E., Cottrell, J., van Dam, B., Deans, J.D., Dumolin-Lapègue, S., Fineschi, S., Finkeldey, R., Gillies, A., Glaz, I., Goicoechea, P.G., Jensen, J.S., König, A.O., Lowe, A.J., Madsen, S.F., Mátyás, G., Munro, R.C., Olalde, M., Pemonge, M.-H., Popescu, F., Slade, D., Tabbener, H., Turchini, D., de Vries, S.G.M., Ziegenhagen, B., and Kremer, A. 2002b. Chloroplast DNA variation in European white oaks Phylogeography and patterns of diversity based on data from over 2600 populations. *For. Ecol. Manage.* **156**: 5–26. doi:10.1016/S0378-1127(01)00645-4.
- Petit, R.J., Latouche-Hallé, C., Pemonge, M.-H., and Kremer, A. 2002c. Chloroplast DNA variation of oaks in France and the influence of forest fragmentation on genetic diversity. *For. Ecol. Manage.* **156**(1–3): 115–129. doi:10.1016/S0378-1127(01)00638-7.
- Pyšek, P., and Jarošík, V. 2005. Residence time determines the distribution of alien plants. *In Invasive Plants: Ecological and Agricultural Aspects*. Birkhäuser-Verlag, Basel. pp. 77–96. doi:10.1007/3-7643-7380-6_5.
- Pyšek, P., Jarosik, V., Hulme, P.E., Kühn, I., Wild, J., Arianoutsou, M., Bacher, S., Chiron, F., Didziulis, V., Essl, F., Genovesi, P., Gherardi, F., Hejda, M., Kark, S., Lambdon, P.W., Desprez-Loustau, M.-L., Nentwig, W., Pergl, J., Pobljsaj, K., Rabitsch, W., Roques, A., Roy, D.B., Shirley, S., Solarz, W., Vilà, M., and Winter, M. 2010. Disentangling the role of environmental and human pressures on biological invasions across Europe. *Proc. Natl. Acad. Sci.* **107**(27): 12157–12162. doi:10.1073/pnas.1002314107.
- Pyšek, P., Křivánek, M., and Jarošík, V. 2009. Planting intensity, residence time, and species traits determine invasion success of alien woody species. *Ecology* **90**(10): 2734–2744. doi:10.1890/08-0857.1.
- Pyšek, P., and Richardson, D.M. 2010. Invasive species, environmental change, and

- health. *Annu. Rev. Environ. Resour.* **35**: 25–55. doi:10.1146/annurev-environ-033009-095548.
- Reichard, S.H., and White, P. 2001. Horticulture as a Pathway of Invasive Plant Introductions in the United States. *Bioscience* **51**(2): 103. doi:10.1641/0006-3568(2001)051[0103:HAAPOI]2.0.CO;2.
- Richardson, D.M., Carruthers, J., Hui, C., Impson, F.A.C., Miller, J.T., Robertson, M.P., Rouget, M., Le Roux, J.J., and Wilson, J.R.U. 2011. Human-mediated introductions of Australian acacias - a global experiment in biogeography. *Divers. Distrib.* **17**(5): 771–787. doi:10.1111/j.1472-4642.2011.00824.x.
- Rius, M., and Darling, J.A. 2014. How important is intraspecific genetic admixture to the success of colonising populations? *Trends Ecol. Evol.* **29**(4): 233–242. doi:10.1016/j.tree.2014.02.003.
- Rollins, L.A., Moles, A.T., Lam, S., Buitenwerf, R., Buswell, J.M., Brandenburger, C.R., Flores-Moreno, H., Nielsen, K.B., Couchman, E., Brown, G.S., Thomson, F.J., Hemmings, F., Frankham, R., and Sherwin, W.B. 2013. High genetic diversity is not essential for successful introduction. *Ecol. Evol.* **3**(13): 4501–4517. doi:10.1002/ece3.824.
- Rosenberg, N.A. 2004. DISTRUCT: A program for the graphical display of population structure. *Mol. Ecol. Notes* **4**(1): 137–138. doi:10.1046/j.1471-8286.2003.00566.x.
- Ross-Ibarra, J., Wright, S.I., Foxe, J.P., Kawabe, A., DeRose-Wilson, L., Gos, G., Charlesworth, D., and Gaut, B.S. 2008. Patterns of Polymorphism and Demographic History in Natural Populations of *Arabidopsis lyrata*. *PLoS One* **3**(6): e2411. doi:10.1371/journal.pone.0002411.
- Roux, C., Castric, V., Pauwels, M., Wright, S.I., Saumitou-Laprade, P., and Vekemans, X. 2011. Does Speciation between *Arabidopsis halleri* and *Arabidopsis lyrata* Coincide with Major Changes in a Molecular Target of Adaptation? *PLoS One* **6**(11): e26872. doi:10.1371/journal.pone.0026872.

- Roux, C., Tsagkogeorga, G., Bierne, N., and Galtier, N. 2013. Crossing the Species Barrier: Genomic Hotspots of Introgression between Two Highly Divergent *Ciona intestinalis* Species. *Mol. Biol. Evol.* **30**(7): 1574–1587. doi:10.1093/molbev/mst066.
- Sax, D.F., Stachowicz, J.J., Brown, J.H., Bruno, J.F., Dawson, M.N., Gaines, S.D., Grosberg, R.K., Hastings, A., Holt, R.D., Mayfield, M.M., O'Connor, M.I., and Rice, W.R. 2007. Ecological and evolutionary insights from species invasions. *Trends Ecol. Evol.* **22**(9): 465–71. doi:10.1016/j.tree.2007.06.009.
- Schlarbaum, S.E., Adams, R.P., Bagley, W.T., and Wayne, W.J. 1982. Postglacial migration pathways of *Quercus rubra* L., northern red oak, as indicated by regional genetic variation patterns. *Sylvae Genet.* **31**: 150–158.
- Schlarbaum, S.E., and Bagley, W.T. 1981. Intraspecific Genetic Variation of *Quercus rubra* L., Northern Red Oak. *Sylvae Genet.* **30**(2–3): 50–56.
- Simberloff, D. 2009. The role of propagule pressure in biological invasions. *Annu. Rev. Ecol. Evol. Syst.* **40**(1): 81–102. doi:10.1146/annurev.ecolsys.110308.120304.
- Sork, V., Huang, S., and Wiener, E. 1993. Macrogeographic and fine-scale genetic structure in a North American oak species, *Quercus rubra* L. *Ann. des Sci. For.* **50**(1): 261s–270s. doi:10.1051/forest:19930726.
- Stapley, J., Santure, A.W., and Dennis, S.R. 2015. Transposable elements as agents of rapid adaptation may explain the genetic paradox of invasive species. *Mol. Ecol.* **24**(9): 2241–2252. doi:10.1111/mec.13089.
- Steiner, K.C. 1995. Autumn predation of northern red oak seed crops. *In* 10th Central Hardwood Forest Conference. *Edited by* K.W. Gottschalk and S.L.C. Fosbroke. Morgantown, West Virginia. pp. 489–494. Available from http://nrs.fs.fed.us/pubs/gtr/gtr_ne197/gtr_ne197_489.pdf.
- Steiner, K.C., Abrams, M.D., and Bowersox, T.W. 1993. Advance reproduction and other stand characteristics in Pennsylvania and French stands of Northern Red Oak. *In* 9th Central Hardwood Forest Conference. *Edited by* A.R. Gillespie, G.R. Parker, P.E.

- Pope, and G. Rink. West Lafayette, Indiana. pp. 473–483.
- Tatem, A.J., Hay, S.I., and Rogers, D.J. 2006. Global traffic and disease vector dispersal. *Proc. Natl. Acad. Sci.* **103**(16): 6242–6247. doi:10.1073/pnas.0508391103.
- Timbal, J., Kremer, A., Goff, N. Le, and Nepveu, G. 1994. *Le chêne rouge d'Amérique*. Institut National de la Recherche Agronomique, Paris.
- Tsutsui, N.D., Suarez, A. V, Holway, D.A., and Case, T.J. 2000. Reduced genetic variation and the success of an invasive species. *Proc. Natl. Acad. Sci. U. S. A.* **97**(11): 5948–53. doi:10.1073/pnas.100110397.
- United States. Bureau of the Census. 1975. Water transportation. *In Historical Statistics of the United States : Colonial Times to 1970 : Volume 2*. pp. 742–766. Available from https://fraser.stlouisfed.org/scribd/?item_id=5808&filepath=/docs/publications/histstatus/hstat1970_cen_1975_v2.pdf.
- Vellinga, E.C., Wolfe, B.E., and Pringle, A. 2009. Global patterns of ectomycorrhizal introductions. *New Phytol.* **181**(4): 960–973. doi:10.1111/j.1469-8137.2008.02728.x.
- Vilà, M., Espinar, J.L., Hejda, M., Hulme, P.E., Jarošík, V., Maron, J.L., Pergl, J., Schaffner, U., Sun, Y., and Pyšek, P. 2011. Ecological impacts of invasive alien plants: a meta-analysis of their effects on species, communities and ecosystems. *Ecol. Lett.* **14**(7): 702–708. doi:10.1111/j.1461-0248.2011.01628.x.
- Weir, B.S., and Cockerham, C.C. 1984. Estimating F-Statistics for the Analysis of Population Structure. *Evolution (N. Y.)*. **38**(6): 1358–1370. doi:10.2307/2408641.
- Woziwoda, B., Kopeć, D., and Witkowski, J. 2014. The negative impact of intentionally introduced *Quercus rubra* L. on a forest community. *Acta Soc. Bot. Pol.* **83**(1): 39–49. doi:10.5586/asbp.2013.035.
- Xu, C.-Y., Tang, S., Fatemi, M., Gross, C.L., Julien, M.H., Curtis, C., and van Klinken, R.D. 2015. Population structure and genetic diversity of invasive *Phyla canescens*: implications for the evolutionary potential. *Ecosphere* **6**(9): 1–21. doi:10.1890/ES14-

00374.1.

Zanetto, A., and Kremer, A. 1995. Geographical structure of gene diversity in *Quercus petraea* (Matt.) Liebl. I. Monolocus patterns of variation. *Heredity* (Edinb). **75**(5): 506–517. doi:10.1038/hdy.1995.167.

Supporting information

Appendix Fig. S1 Posterior estimates of cluster membership for native individuals (n=624) at distinct values of K , obtained with TESS software. Native individuals are arranged from North to South (from right to left).

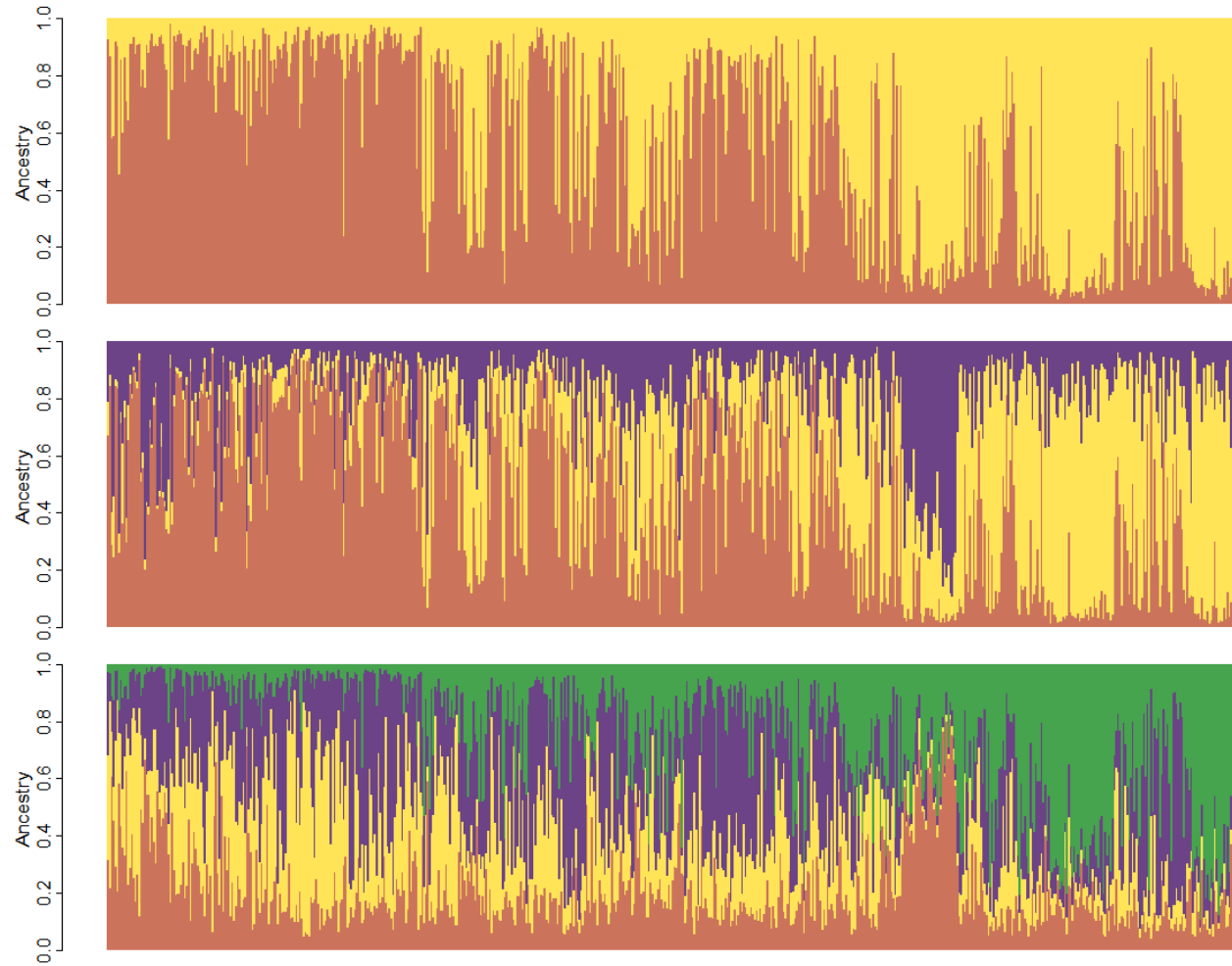

Appendix Fig. S2 Distributions of the posterior probabilities of each model across 20,000 PODS, as the true scenario $P(M|M)$, to check the ability of the method to correctly retrieve the six different models (A) and distributions of probabilities for the SC scenario $P(SC|M)$ when SI, IM, AM, PAM, SC and PSC are simulated (B).

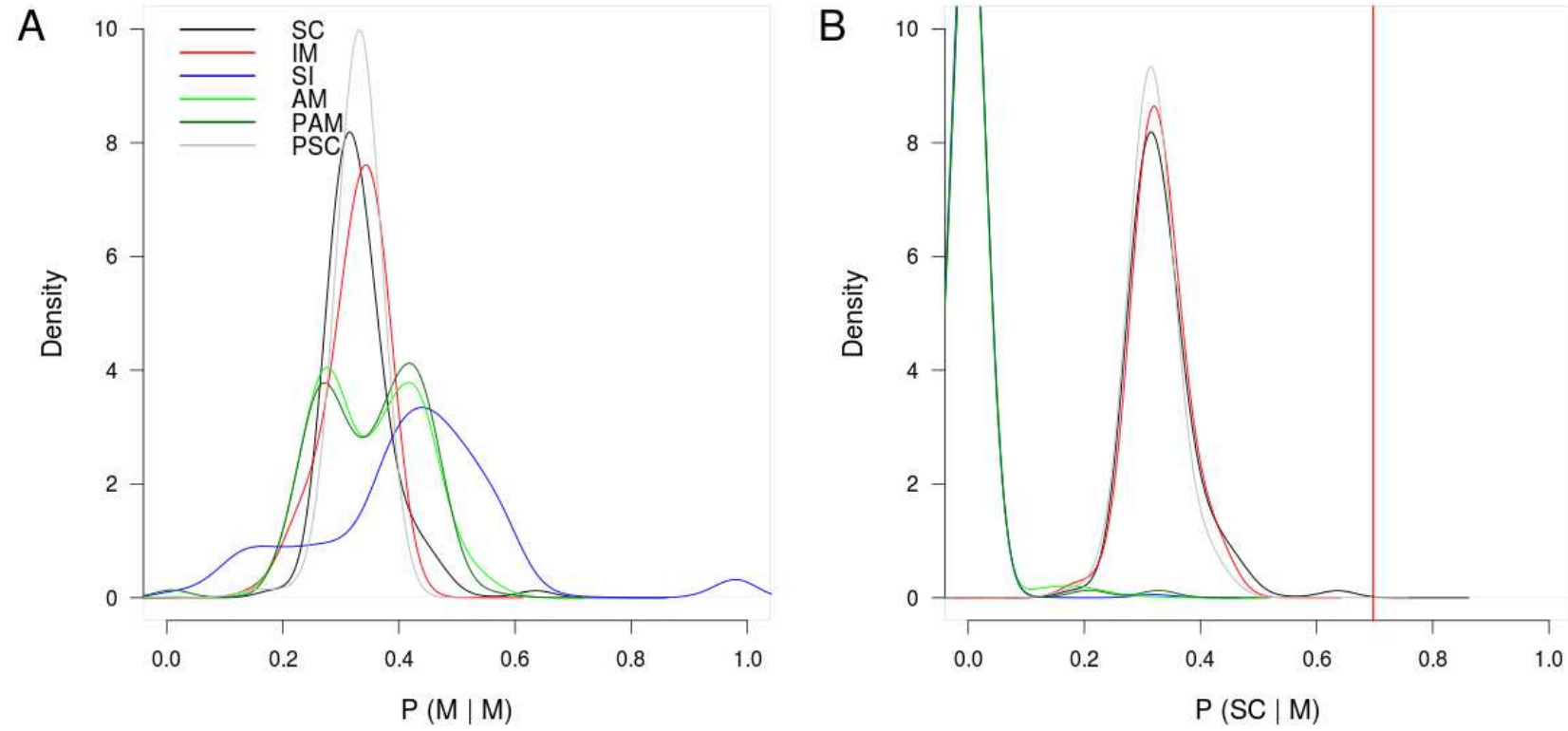

Appendix Table S1 Main characteristics of the populations genotyped: range, code and name of the population, region and country source, latitude (Lat, decimal degrees), longitude (Long, decimal degrees), altitude (Alt, m) at the population location and number of samples per population.

Range	Code	Name of population	Region	Country	Lat.	Long.	Alt.	Ns
Native	1	FREDERICTON	NEW-BRUNSWICK	Canada	45.9443	-66.6428	250	10
Native	2	HARSHAW_FARM	WISCONSIN	USA	45.6428	-89.463	488	16
Native	3	CONGRESS	OHIO	USA	40.9254	-82.0573	366	4
Native	5	SAULT_SAINTE_MARIE	ONTARIO	Canada	45.5833	-84.3702	180	5
Native	6	SELKIRK	ONTARIO	Canada	42.8135	-79.9566	180	9
Native	8	MONT_GILHEAD	OHIO	USA	40.5507	-82.8121	350	3
Native	9	KILBOURNE	OHIO	USA	40.3104	-82.9464	280	1
Native	10	MORGANTOWN	WEST-VIRGINIA	USA	36.6799	-79.7787	732	10
Native	11	VALCOUR	NEW-YORK	USA	44.6222	-73.4175	30	2
Native	12	WARRENTON	NORTH-CAROLINA	USA	36.3	-78.1666	114	10
Native	13	AMSLER_SPRING	PENNSYLVANIA	USA	41.4661	-79.1971	427	4
Native	14	SMOKY_MOUNTAINS	TENNESSEE	USA	35.7228	-83.5757	1000	2
Native	15	NRD	NORTH-CAROLINA	USA	35.1353	-83.8073	1300	5
Native	16	PETAWAWA	ONTARIO	Canada	45.977	-77.4247	250	16
Native	17	BURLINGTON	VERMONT	USA	44.4509	-73.1718	91	12
Native	18	FONTENELLE	NEBRASKA	USA	41.1806	-95.9079	305	6
Native	35	PINE_GROVE_MILLS	PENNSYLVANIA	USA	40.7083	-77.9333	427	11
Native	36	PARSONS	WEST-VIRGINIA	USA	39.0933	-79.6647	549	8
Native	37	LONDON	ONTARIO	Canada	42.9551	-81.3093	250	10
Native	38	BARRIE	ONTARIO	Canada	44.3382	-79.7077	75	4
Native	39	PENETANGUISHENE	ONTARIO	Canada	44.7681	-79.941	225	4
Native	40	HOLST_FOREST	IOWA	USA	42.1167	-93.9825	335	4

Native	41	HILL_FOREST	NORTH-CAROLINA	USA	36.2009	-78.8888	137	11
Native	42	JONESBORO_UNION	ILLINOIS	USA	37.4844	-89.3744	122	1
Native	45	WOOSTER	OHIO	USA	40.7797	-81.9158	305	7
Native	74	GREENE	TENNESSEE	USA	36.2	-82.8	520	5
Native	88	BOLINGBROKE	GEORGIA	USA	32.9333	-83.8333	150	4
Native	89	UNIVERSITY	MINNESOTA	USA	44.9144	-93.1616	290	5
Native	90	JACKSON	ILLINOIS	USA	37.6666	-89.25	170	1
Native	91	BLOOMINGTON	INDIANA	USA	39.1699	-86.5147	250	2
Native	92	SHOALS	INDIANA	USA	38.7079	-86.7252	225	2
Native	97	LANSING	MICHIGAN	USA	42.7127	-83.5329	250	10
Native	107	RUSS_FOREST	MICHIGAN	USA	42.012	-85.9725	160	7
Native	320	RABUN	GEORGIA	USA	34.97	-83.4833	976	5
Native	321	FANNIN	GEORGIA	USA	34.8666	-84.4166	671	4
Native	322	UNION	GEORGIA	USA	34.7833	-83.7833	620	4
Native	323	OTTAWA_CARLETON	ONTARIO	Canada	45.4823	-76.088	70	3
Native	325	PNFI	ONTARIO	Canada	46.0222	-77.436	130	6
Native	326	SULLIVAN	TENNESSEE	USA	36.3867	-82.1378	610	10
Native	327	CLAY	NORTH-CAROLINA	USA	35.1361	-83.5541	1450	11
Native	328	TRANSYLVANIA	NORTH-CAROLINA	USA	35.3227	-82.776	1200	11
Native	330	MADISON	INDIANA	USA	40.1012	-85.6814	280	10
Native	331	DE_KALB	INDIANA	USA	41.3931	-85.0519	260	4
Native	332	GATINEAU	QUEBEC	Canada	45.9399	-76.0283	170	7
Native	334	RIDGWAY	ONTARIO	Canada	42.8844	-79.0633	190	4
Native	335	POINT_ABINO	ONTARIO	Canada	42.8501	-79.0993	185	1
Native	338	ELGIN	ONTARIO	Canada	42.775	-81.298	75	5

Native	400	MOSHANNON	PENNSYLVANIA	USA	41.1017	-78.5441	730	14
Native	401	COLCHESTER_BOG	VERMONT	USA	44.566	-73.2832	30	13
Native	402	HARVARD_FOREST	MASSACHUSETTS	USA	42.55	-72.1773	400	14
Native	403	WILLARD_BROOK	MASSACHUSETTS	USA	42.6664	-71.7757	300	9
Native	404	YAWPAW_BERGEN	NEW-JERSEY	USA	41.0213	-74.2543	240	16
Native	405	BARDEN_TREE_FARM	NEW-HAMPSHIRE	USA	43.3307	-71.0819	230	9
Native	406	PEOPLES_STATE_FOREST	CONNECTICUT	USA	41.9575	-73.0081	330	13
Native	407	BEEBE_HILL_STATE_FOREST	NEW-YORK	USA	42.3294	-73.4508	500	11
Native	408	HAMMOND_HILL_STATE_FOREST	NEW-YORK	USA	42.4288	-76.2917	580	12
Native	409	ROTHROCK_FOREST	PENNSYLVANIA	USA	40.6804	-77.8664	550	11
Native	410	RAMAPO_FOREST	NEW-JERSEY	USA	41.0421	-74.2557	244	4
Native	411	HICKORY_RIDGE	PENNSYLVANIA	USA	40.4042	-77.4682	427	2
Native	412	GIFFORD_PINCHOT	PENNSYLVANIA	USA	40.0707	-76.8879	152	5
Native	413	HARRISBURG	PENNSYLVANIA	USA	40.1129	-76.9416	300	4
Native	420	CHIPPEWA	MINNESOTA	USA	47.084	-94.0422	412	5
Native	500	AL_2	ALABAMA	USA	34.938	-86.071	532	33
Native	501	NC_2	NORTH-CAROLINA	USA	35.342	-83.928	775	26
Native	502	TN	TENNESSEE	USA	35.637	-83.77	533	39
Native	503	MO_2	MISSOURI	USA	39.02	-92.759	199	30
Native	504	TR	INDIANA	USA	39.879	-87.207	202	29
Native	505	PA_2	PENNSYLVANIA	USA	41.102	-78.552	669	30
Native	506	PC	INDIANA	USA	41.55	-86.357	232	31
Native	507	MA_2	MASSACHUSETTS	USA	42.192	-72.489	110	32
Native	508	VT_3	VERMONT	USA	44.892	-72.896	147	32
Native	509	OT_2	MICHIGAN	USA	46.498	-88.896	374	36

Native	510	MTU	MICHIGAN	USA	47.105	-88.553	280	18
Introduced	19	VIC_EN_BIGORRE	HAUTES-PYRENEES	France	43.3947	0.0057	250	15
Introduced	21	AVERON_BERGELLE	GERS	France	43.7365	0.0574	150	1
Introduced	22	LA_HOUVE	MOSELLE	France	49.197	6.6669	250	10
Introduced	27	OFFENBURG	BADE-WURTEMBERG	Germany	48.4711	7.9135	150	1
Introduced	30	BOEKEL_VENHORST	BRABANT-SEPTENTRIONAL	Netherlands	52.2	6.812	29	1
Introduced	31	ELSENDORF_GEMERT	BRABANT-NORD	Netherlands	51.5482	5.7782	23	1
Introduced	32	BOISSEROUX	WALLONIE	Belgium	50.6833	4.25	67	1
Introduced	33	JUNGHOLTZ	HAUT-RHIN	France	47.8926	7.1678	600	1
Introduced	47	MORITZBURG	DRESDEN	Germany	51.1755	13.6554	140	1
Introduced	48	DRESDNER_HEIDE	DRESDEN	Germany	51.096	13.8227	150	1
Introduced	49	HOHE_DUBRAU	NIESKY	Germany	51.3333	14.5833	220	1
Introduced	50	TURNHOUT	CAMPINE	Belgium	51.3196	4.9469	90	1
Introduced	51	AZEREIX	PYRENEES-ATLANTIQUES	France	43.2078	-0.037	400	19
Introduced	52	VOUZERON	CHER	France	47.2825	2.2087	172	11
Introduced	53	HARDT_SUD	HAUT-RHIN	France	47.6843	7.492	247	10
Introduced	54	HARDT_NORD	HAUT-RHIN	France	47.7837	7.4389	232	10
Introduced	55	DOAT_EAUZE	GERS	France	43.9092	0.076	125	14
Introduced	56	VARESE	LOMBARDIE	Italy	45.82	8.83	411	1
Introduced	60	GRIES	BAS-RHIN	France	48.7612	7.8382	135	5
Introduced	61	PARC_NEUDORF	ARAD	Romania	46.0599	21.6172	137	1
Introduced	62	WISSEMBOURG	BAS-RHIN	France	49.0084	7.987	152	16
Introduced	63	SCHOPPERTEN	BAS-RHIN	France	48.9512	7.0595	235	15
Introduced	64	CHAUX_LA_ROYALE	JURA	France	47.0598	5.6736	245	7
Introduced	65	CHAUX_1_COLONNE	JURA	France	47.052	5.5469	230	11

Introduced	68	AINHOA	PYRENEES-ATLANTIQUES	France	43.2849	-1.4712	200	11
Introduced	69	MIXE_BIDACHE	PYRENEES-ATLANTIQUES	France	43.468	-1.1554	100	10
Introduced	70	BASSOUES	GERS	France	43.5956	0.2242	215	13
Introduced	71	PRECHACQ_JOSBAIG	PYRENEES-ATLANTIQUES	France	43.256	-0.7439	140	10
Introduced	72	PARDIES	PYRENEES-ATLANTIQUES	France	43.3596	-0.5907	113	10
Introduced	73	HOUILLES	LOT-ET-GARONNE	France	44.1562	0.025	148	6
Introduced	93	IBOS	HAUTES-PYRENEES	France	43.2688	-0.0051	380	9
Introduced	96	SERENAC	TARN	France	43.9777	2.3194	360	15
Introduced	115	ALLI_LECUMBERRI	GALICIA	Spain	42.431	-8.66	13	1
Introduced	116	BIDASOA_BERROARAN	SANTESTEBAN	Spain	43.2663	-1.7447	50	1
Introduced	118	LA_DOLOMETA	BISCAYE	Spain	43.1575	-2.6693	340	1
Introduced	300	LA_VERNEE	AIN	France	46.1703	5.1722	250	13
Introduced	301	BRIDE	MOSELLE	France	48.8752	6.6697	300	14
Introduced	319	CHAUX_(EST)	JURA	France	47.0516	5.7603	250	7

Appendix Table S2 Mean value of the lowest Deviance Information Criterion (DIC) and standard deviation (SD) for 10 runs of each *K* value from 2 to 8.

<i>K</i> value	Mean DIC (Total)	SD (Total)	Mean DIC (Native)	SD (Native)
2	116630.4	103.3	82264.2	36.3
3	115215.4	85.1	81370.9	39.9
4	113973.0	100.6	80151.9	91.0
5	113186.0	148.6	79267.7	71.3
6	112631.2	123.7	78669.1	102.7
7	112007.1	183.7	78027.9	179.3
8	111787.6	136.3	77611.6	100.3

Synthèse et perspectives

A. Ecologie de la dispersion et de la régénération de *Q. rubra* en Europe

En Europe, le statut invasif du chêne rouge est encore discuté. Selon les définitions de Richardson *et al.* (2000) et Blackburn *et al.* (2011), une espèce est considérée comme invasive si, après introduction et naturalisation dans une nouvelle aire, elle franchit la barrière de dispersion pour se répandre dans sa nouvelle aire et y maintenir des populations, sans l'intervention de l'Homme. Ce travail de thèse a permis de déterminer que *Q. rubra* parvenait à se régénérer naturellement et à se disperser aisément dans les forêts européennes où il a été délibérément implanté, afin de mieux renseigner son caractère invasif dans son aire d'introduction.

L'analyse des inventaires nationaux forestiers de cinq pays ou régions en Europe, réalisée dans le chapitre 1, nous a permis de montrer que des individus de *Q. rubra* sont présents en dehors des peuplements dominés par *Q. rubra*. Cette espèce se retrouve dans des peuplements d'espèces de feuillus et conifères natifs des forêts européennes, notamment *Q. robur*, *Q. petraea*, *Fagus sylvatica*, *Populus nigra*, *Pinus sylvestris*, *Picea abies*, *Pinus radiata*. De plus, le pourcentage de parcelles contenant des semis de *Q. rubra* dans les sous-bois d'espèces forestières locales telles que *Q. robur* en France, *P. radiata* en Espagne ou *P. sylvestris* en Allemagne est supérieur à celui dans les peuplements de chêne rouge. Le couvert des espèces locales d'arbres natifs ne semble pas compromettre la germination et le développement de *Q. rubra*, qui tolère mieux l'ombre en Europe que dans son aire d'origine. *Quercus rubra* parvient donc à se régénérer naturellement et sans difficultés dans certaines forêts de feuillus et de conifères en Europe. Dans une étude récente, Major *et al.* (2013) ont également démontré que les densités de régénération de *Q. rubra* étaient largement supérieures à celles des autres espèces dans six forêts mélangées de feuillus principalement dominées par *Q. robur* et *Carpinus betulus* dont la canopée est très fermée. N'ayant observé aucun semis au-delà de 15 mètres des arbres-mères de *Q. rubra*, les auteurs en ont déduit que la dispersion des glands était limitée

laissant supposer que le pool de disperseurs de cette espèce zoochore était éventuellement absent en Europe.

Cependant, grâce à l'étude comparative de prélèvement et de sélection entre des glands de *Q. robur* et de *Q. rubra* en forêts wallonnes présentée dans le chapitre 2, nous avons mis en évidence que des animaux au sol notamment des rongeurs, tels que l'écureuil et le mulot (*Sciurus vulgaris* et *Apodemus sylvaticus*), étaient capables de prélever et d'emporter avec eux des glands de chêne rouge. Dans une étude comparable, Bieberich *et al.* (2016) ont également démontré que des espèces de souris (*Apodemus sylvaticus* ou *A. flavicollis*) étaient impliquées dans la collecte et l'éventuelle dispersion de glands de chêne rouge à l'échelle locale. En effet, ces animaux sont susceptibles de transporter les glands de chêne rouge sur des distances de quelques mètres à plusieurs centaines de mètres et, par conséquent, de participer à la dispersion de cette espèce dans les forêts européennes. D'autre part, Myczko *et al.* (2014) ont constaté que le geai des chênes (*Garrulus glandarius*) était capable de prélever et disperser des glands de *Q. rubra*. Le geai de chêne est une espèce d'oiseau reconnue pour être impliquée dans la dispersion des glands de chênes européens (Bossema 1979; Pons & Pausas 2007a) à longue-distance, jusqu'à un kilomètre du lieu de prélèvement (Gómez 2003; Ouden, Jansen & Smit 2005). Une dispersion éloignée des peuplements sources a été documentée dans les forêts lituaniennes, des individus de *Q. rubra* peuvent se retrouver jusqu'à une distance de 500 mètres de leur peuplement (Riepšas & Straigyte 2008). Mais aucun réel suivi de dispersion n'a été réalisé à notre connaissance dans d'autres forêts européennes. Il serait donc intéressant d'estimer les capacités de dispersion de *Q. rubra* en évaluant plus précisément les distances de dispersion des glands par le biais des disperseurs aérien, les geais des chênes, et terrestres, les rongeurs, en lien avec le franchissement de la barrière de dispersion selon Richardson *et al.* (2000). Par exemple, des méthodes de suivis des glands par télémétrie ont déjà été testées sur plusieurs espèces de chênes, dont *Q. rubra* en Amérique du Nord, pour quantifier les distances de dispersion parcourues et la proportion de glands qui échappent à la consommation (Sork 1984; Pons & Pausas 2007b). La télémétrie permet de retrouver en forêts des glands préalablement marqués à une distance de quelques dizaines à plusieurs centaines de mètres.

Connus pour leur comportement fouisseur-disperseur, les rongeurs peuvent cacher ou enterrer des glands en les plaçant dans des conditions favorables à la germination des graines et au développement des semis. De même, le geai des chênes a l'habitude de stocker des provisions de nourriture qu'il cache sous terre. Une partie des glands cachés ou enterrés n'est pas retrouvée par les animaux, cela permet de contribuer à la régénération du chêne rouge (García, Bañuelos & Houle 2002). De plus, ces glands cachés ou enterrés réussissent à échapper à la prédation par les sangliers (*Sus scrofa*) qui se nourrissent de glands à l'automne (Schley & Roper 2003), dont ceux du chêne rouge comme nous l'avons observé dans notre expérimentation comparative. La dispersion au sol sur de courtes distances par les rongeurs influence la régénération de l'espèce à l'échelle locale tandis que la dispersion à longue distance par les oiseaux favorise la colonisation et la répartition de l'espèce (Vander Wall 2001; Gómez 2003). En étant ainsi transportés à distance des arbres-mères grâce aux animaux disperseurs, les glands de chêne rouge peuvent être soustraits à la compétition intraspécifique et constituer de nouvelles populations dans l'aire d'introduction.

Les espèces invasives sont souvent associées à des impacts écologiques négatifs notamment une réduction de la diversité locale au sein des espèces natives (Hejda, Pyšek & Jarošík 2009; Vilà *et al.* 2011). Woziwoda, Kopec & Witkowski (2014a) ont observé que le couvert de *Q. rubra* diminuait la richesse et l'abondance des espèces natives dans les strates herbacée et arbustive et limitait la régénération naturelle des arbres natifs. Dans le chapitre 2, nous avons également montré que les animaux au sol prélevaient dans les coupelles majoritairement les glands de *Q. robur* comparés à ceux de *Q. rubra*. Le geai des chênes sélectionne préférentiellement les glands de *Q. robur* qu'il arrive à distinguer visuellement des glands de *Q. rubra* grâce à leurs différentes caractéristiques morphologiques (Pons & Pausas 2007a; Bieberich *et al.* 2016). D'autre part, la concentration en tannins est plus élevée dans les glands de *Q. rubra* que dans ceux de *Q. robur* (Shimada & Saitoh 2006). Il est donc possible que les glands de *Q. robur*, probablement plus appétant, soient préférentiellement consommés par les prédateurs épargnant d'avantage les glands de *Q. rubra*. Une diminution de la pression de prédation des glands de *Q. rubra* par rapport à *Q. robur* pourrait favoriser la dispersion et la prolifération de l'espèce introduite dans les forêts européennes au détriment de l'espèce

native locale. Il serait donc intéressant de quantifier l'impact de la présence et de la régénération de *Q. rubra* sur les principales espèces d'arbres natifs de nos forêts européennes et d'évaluer quelles en seraient les conséquences écologiques en Europe. Une telle étude des impacts écologiques pourrait être réalisée à l'aide des inventaires forestiers nationaux présentant des données de régénération, comme ceux que nous avons utilisés. De plus, les bases de données des inventaires forestiers peuvent contenir des informations relatives aux données écologiques des placettes inventoriées sur le territoire, comme par exemple des données édaphiques stationnelles telles que le type d'humus, le type de roche-mère, le type de sol ou encore l'hydromorphie. La comparaison des données de régénération du chêne rouge en fonction des caractéristiques édaphiques des placettes dans lesquelles il se trouve permettrait d'avoir une meilleure connaissance sur ses préférences et exigences écologiques en Europe et de mieux caractériser les milieux susceptibles d'être envahis.

La reproduction sexuée maintient la pérennité d'une espèce et peut conférer un avantage démographique aux espèces invasives par rapport aux espèces natives locales (Burns *et al.* 2013). En effet, une forte production de descendants permet d'augmenter les chances de dispersion et de colonisation vers de nouveaux milieux au sein de l'aire d'introduction, contribuant ainsi au succès des plantes invasives. En effet, en l'absence d'ennemis naturels dans l'aire d'introduction, les populations de plantes invasives peuvent allouer davantage à la reproduction et à la croissance comparées aux populations de l'aire native (Keane & Crawley 2002; Hawkes 2007). De façon générale, les traits en lien avec la reproduction (fécondité, floraison, fructification) améliorent la valeur sélective des individus et contribuent au caractère invasif des populations d'espèces introduites (Pyšek & Richardson 2007; Moravcová *et al.* 2015; Jelbert *et al.* 2015). Contrairement à ce qui est observé dans l'aire d'origine en Amérique du Nord (Crow 1988), *Q. rubra* ne semble présenter aucune difficulté à se régénérer et à disperser dans les forêts européennes. La forte régénération naturelle du chêne rouge en Europe peut résulter de capacités reproductives supérieures des populations introduites par rapport aux populations natives. Nous avons donc voulu savoir s'il existait une différence de fructification entre les populations américaines et européennes de *Q. rubra*. Pour ce faire, nous avons comparé la quantité de glands produits par les populations natives et introduites de *Q. rubra* dans

le test de descendance du Sud-Ouest (sites d'Ibos et Capvern). Des comptages de glands ont été réalisés à l'automne (octobre-novembre) après leur chute au sol, dans un cerceau de 0,2 m², représentant un sous-échantillonnage de la projection au sol du houppier de l'arbre, durant deux années successives à Capvern (2014-2015) et une année à Ibos (2015). Étant donné la proximité des arbres dans ces plantations, nous avons choisi d'évaluer la production de glands sous l'arbre central de la parcelle unitaire. Les glands viables et les glands avortés ont été différenciés et comptés séparément ; les glands des années précédentes, de couleur noirâtre et très friables, ont été exclus des comptages. Compte tenu de la variabilité interannuelle de la production des glands (Sork *et al.* 1993; Liebhold, Sork & Peltonen 2004) et de la maturation sur 2 ans des glands de chêne rouge (Cecich 1994), les comptages se poursuivent encore actuellement et les résultats présentés ici sont donc exploratoires. En effet, la production de glands de *Q. rubra* présente une forte variation interannuelle en raison de fortes pressions climatiques ou biotiques (Sork *et al.* 1993). Les conditions météorologiques annuelles peuvent compromettre la pollinisation, la fécondation ou la maturation des glands tandis que des prédateurs et pathogènes sont susceptibles d'attaquer les glands (Dey 1995; Gribko *et al.* 2002). Dans l'ensemble, nous avons constaté que les populations introduites de *Q. rubra* produisent en moyenne plus de glands que les populations natives (**Figure 1**). Ce résultat s'observe aussi bien à Capvern qu'à Ibos et pour les glands viables et avortés, les différences étant significatives à Ibos. À Capvern, les populations introduites et natives produisent majoritairement des glands avortés, contrairement à Ibos où les populations introduites produisent davantage de glands viables (**Figure 1**). Cette différence de fructification entre les deux sites peut s'expliquer par leur différence d'âge : les individus présents à Capvern, semés en 1989 et 1991, sont plus jeunes que ceux d'Ibos, semés entre 1980 et 1983. Sachant que *Q. rubra* atteint sa maturité sexuelle vers l'âge de 20 ans, les individus à Capvern commencent seulement à être en âge de fructifier, tandis qu'à Ibos la fructification des arbres est initiée depuis une dizaine d'années maintenant.

Capvern - 2014

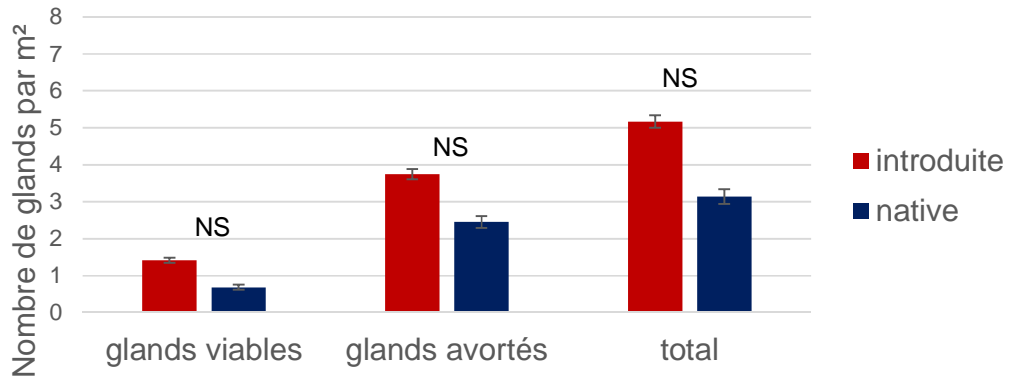

Capvern - 2015

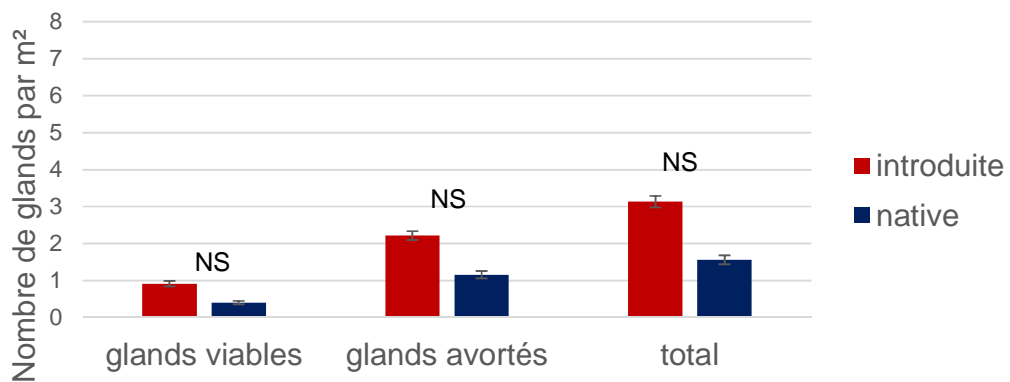

Ibos - 2015

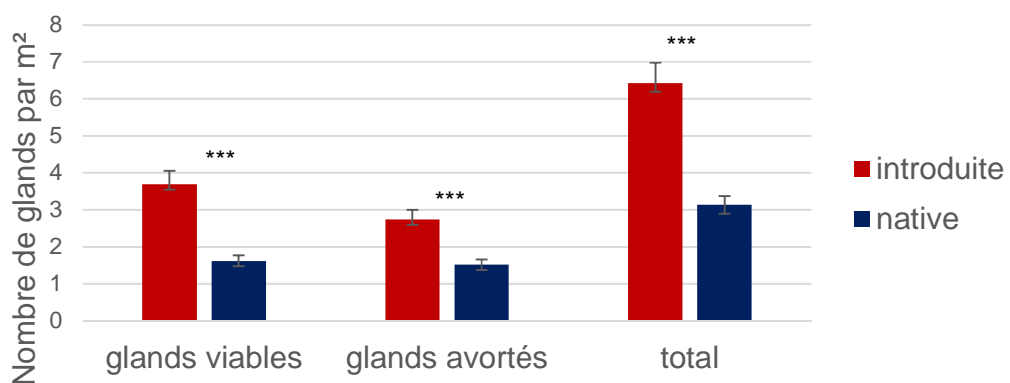

Figure 1. Nombre (moyenne et écart-type) de glands viables, avortés et total par mètre carré produits par les populations introduites (en rouge) et natives (en bleu). La significativité des résultats est représentée par : NS non-significatif ($p > 0.05$) et *** hautement significatif ($p < 0.0001$) au seuil $\alpha = 0.05$.

Ces observations tendent à montrer que les populations introduites de *Q. rubra* présentent des capacités reproductives supérieures par rapport aux populations natives. Dans l'aire d'invasion, la fécondité et la production de graines sont des traits phénotypiques souvent corrélées au caractère invasif (Mason *et al.* 2008; Moravcová *et al.* 2010; Burns *et al.* 2013). Une forte production de graines offre l'opportunité aux espèces de coloniser de nouveaux milieux (Westoby *et al.* 2002). Ainsi, les capacités reproductives supérieures des populations introduites peuvent favoriser la dispersion de *Q. rubra* dans les forêts en Europe. Ces comptages seront poursuivis pendant encore plusieurs années afin de confirmer la tendance que nous avons observée.

B. Histoire de l'introduction de *Q. rubra* en Europe

La comparaison des populations introduites et natives d'une espèce invasive au niveau phénotypique et génotypique permet de détecter si les populations invasives présentent des différenciations génétiques qui peuvent être liées à leur histoire démographique et évolutive, pendant et depuis leur introduction (Bossdorf *et al.* 2005). Dans une seconde partie, ce travail de thèse a permis de mettre en évidence que les populations introduites de *Q. rubra* présentaient des différenciations génétiques comparées aux populations natives et d'identifier les populations sources introduites en Europe. Au niveau phénotypique, des éléments semblent indiquer que les populations introduites ont évolué face aux nouvelles conditions environnementales rencontrées en Europe. Au niveau moléculaire, nous avons retrouvé seulement deux des trois groupes génétiques présents en Amérique du Nord au sein des populations européennes.

Dans l'aire d'introduction, de nouvelles pressions de sélection biotiques et abiotiques s'exercent sur les populations introduites. Les plantes invasives peuvent présenter des différenciations génétiques entre les populations natives et introduites résultant d'une adaptation locale à leur nouvel environnement (Hodgins & Rieseberg 2011; Colautti & Barrett 2013; Lamarque *et al.* 2015). Dans le cas des plantes introduites pour l'ornementation ou la culture, une sélection artificielle d'origine anthropique peut également induire des différenciations génétiques en favorisant les individus les plus vigoureux, robustes, productifs ou sans imperfections (Conner 2003; Kitajima *et al.* 2006). Dans le chapitre 3, nous avons comparé des traits phénotypiques en relation avec la

valeur sélective (croissance en hauteur et en circonférence, survie, débourrement et coloration foliaire) et avec la sélection artificielle (fourchaison) de 64 populations natives et 41 populations introduites de *Q. rubra* installées dans trois tests de provenance-descendance en France. Nous avons pu démontrer que les populations introduites étaient génétiquement différenciées des populations natives pour les traits de croissance. En Europe, les populations introduites poussent mieux que les populations natives. Ce résultat peut s'expliquer par deux hypothèses. D'une part, les pressions de sélection naturelle dans l'aire d'introduction peuvent être différentes par rapport à celles dans l'aire native, comme par exemple l'absence ou la réduction des pressions biotiques exercées par les prédateurs, herbivores ou pathogènes (« Enemy release hypothesis », Keane and Crawley, 2002). D'autre part, la sélection naturelle peut favoriser les individus présentant de meilleures capacités compétitives suite à une adaptation post-introduction des populations dans l'aire d'invasion (« Evolution of increase competitive ability hypothesis », Blossey and Nötzold, 1995). La croissance est reconnue comme un trait phénotypique caractérisant l'invasivité des arbres qui peut permettre d'identifier les espèces envahissantes potentielles (Lamarque *et al.* 2011). Nous supposons que les populations introduites de *Q. rubra* ayant une croissance supérieure, leur conférant un avantage compétitif, ont été naturellement sélectionnées au cours des générations en réponse aux changements de pressions de sélection biotiques ou abiotiques rencontrées en Europe. Par ailleurs, nous n'avons observé aucune différence significative au niveau de la fourchaison entre les populations laissant suggérer que les populations introduites n'ont probablement pas subi de sélection artificielle d'origine anthropique. Cependant, une analyse plus détaillée avec d'autres caractères phénotypiques relatifs aux défauts et qualités du bois, tels que le nombre de fourches ou de baïonnettes, la rectitude du tronc, la branchaison, permettrait de mieux évaluer le rôle de la sélection artificielle sur la différenciation des populations introduites de *Q. rubra*. Au travers de l'analyse des Q_{ST} , nous avons observé de la différenciation génétique pour le trait de débourrement foliaire entre les populations au sein de l'aire native et au sein de l'aire d'introduction. De façon exploratoire, nous avons mis en évidence l'existence d'un gradient latitudinal du débourrement foliaire des populations introduites et natives, à partir des trois tests de descendance (**Figure 2**). Ces résultats montrent que, dans l'aire native, les populations

les plus au Sud sont plus tardives que les populations les plus au Nord tandis que, dans l'aire d'introduction, le gradient est inversé, et les populations les plus au Sud débourrent plus tôt que les populations les plus au Nord (**Figure 2**). De même, le débourrement des populations natives et introduites semblent montrer une corrélation forte avec la température moyenne annuelle des sites d'origine des populations, mais de sens opposé au sein de chaque aire (**Figure 3**). En Amérique du Nord, une variation adaptative en fonction de l'origine géographique des populations était déjà connue pour ce caractère (Kriebel 1993). Dans une étude préliminaire portant sur la phénologie des populations natives et introduites de *Q. rubra* en Europe, Daubree and Kremer (1993) ont constaté une forte variation du score de débourrement au sein des populations de l'aire native en fonction de leur provenance ainsi qu'une variation plus faible au sein des populations de l'aire d'introduction. Le débourrement foliaire est un trait phénotypique extrêmement sensible aux variations de températures (Vitasse *et al.* 2009b; Fu *et al.* 2012) qui pourraient exercer une pression de sélection. Cependant, ces oppositions de gradients nous laissent supposer que les populations natives et les populations introduites montrent une réponse phénotypique différente probablement en raison de différences de pressions de sélection naturelle existant entre les deux continents. Plus particulièrement, il faudrait tester si d'autres variables climatiques ont exercé des pressions de sélection sur les différences de débourrement foliaire observées parmi les populations au sein de l'aire d'introduction et de l'aire native. Par exemple, les températures hivernales et printanières, le nombre de jour de gel ou la date moyenne du dernier jour de gel peuvent faire varier le score de débourrement au sein des populations (Cannell 1997; Vitasse *et al.* 2009a). Le rôle de la photopériode est également à tester (Basler & Körner 2012), car de façon générale les latitudes des populations d'origine en Europe sont beaucoup plus hautes que celles en Amérique. Ces pistes devront être explorées pour déterminer si les populations ont évolué depuis l'introduction notamment par une adaptation locale des traits phénotypiques liés à la phénologie foliaire.

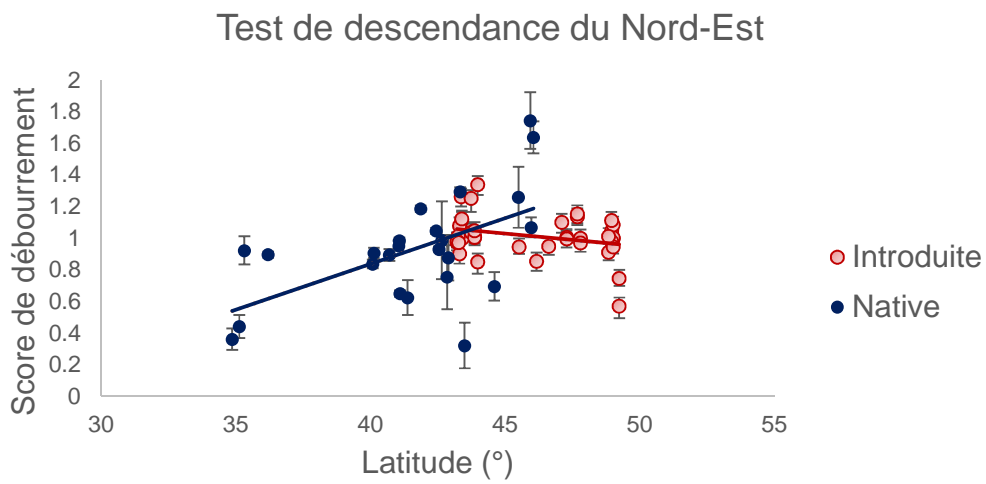
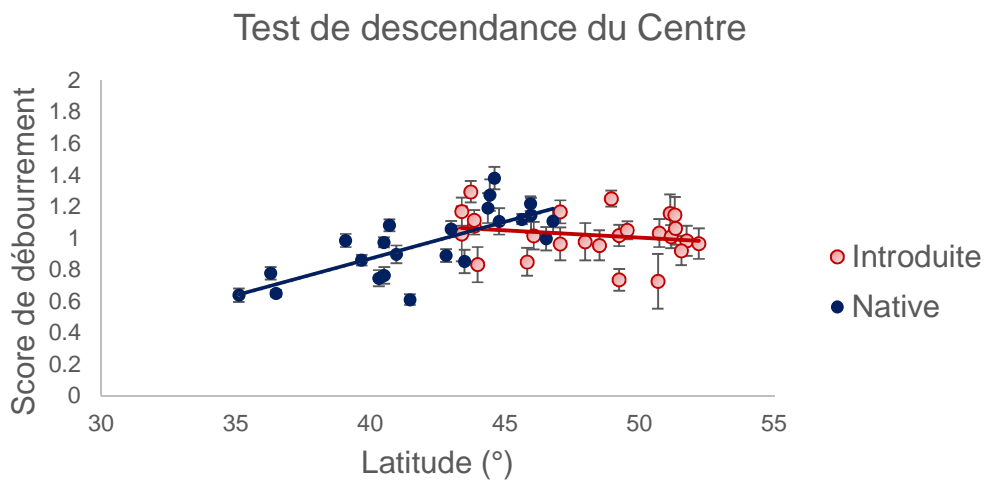
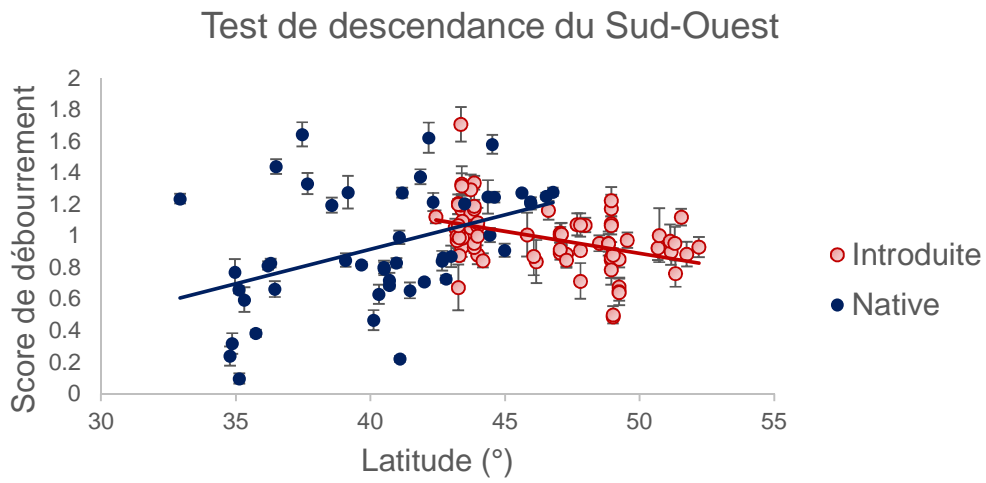

Figure 2. Score de débourement moyen pour chaque population introduite (en rouge) et native (en bleu) en fonction de leur latitude d'origine.

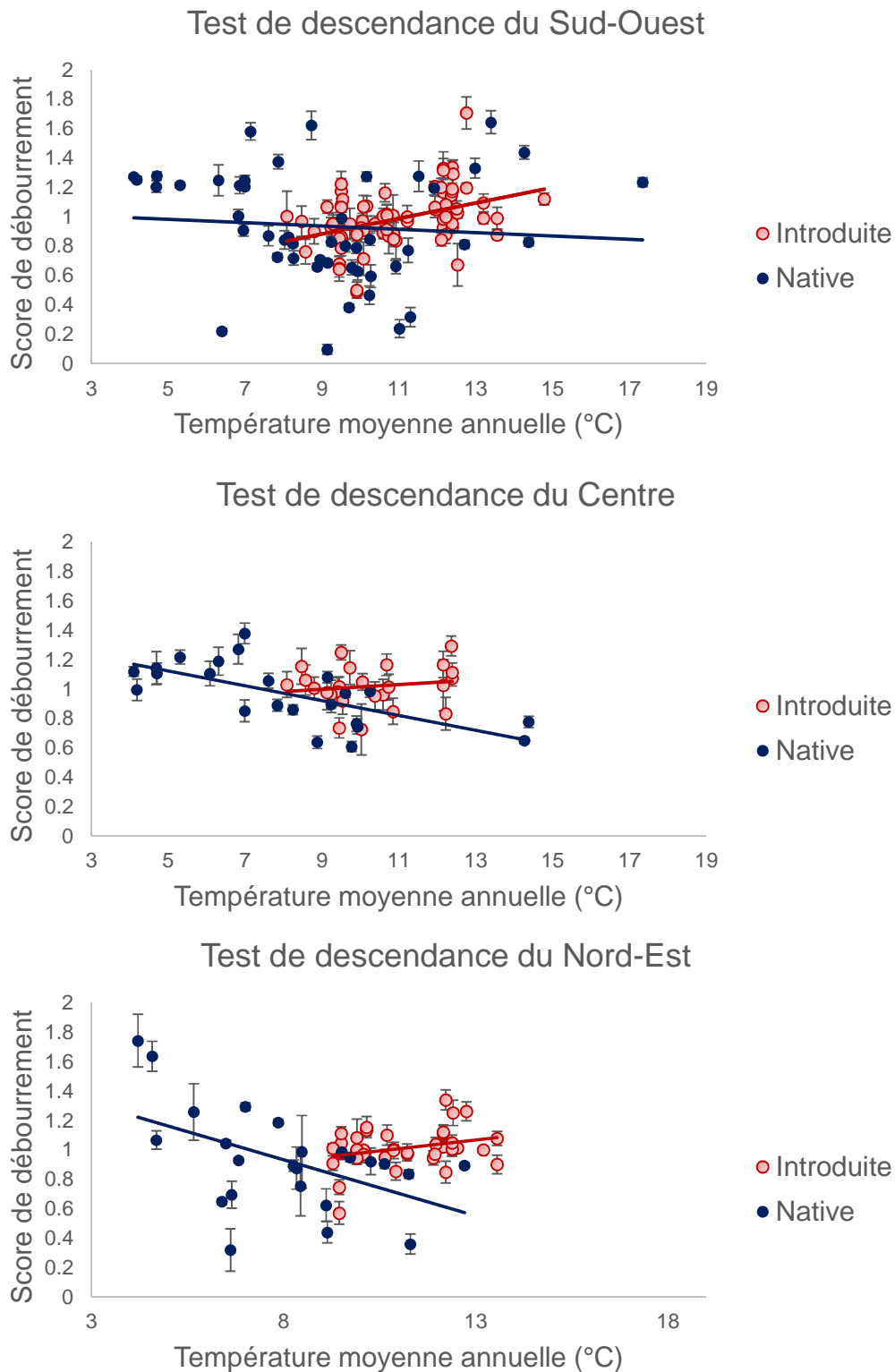

Figure 3. Score de débournement moyen pour chaque population introduite (en rouge) et native (en bleu) en fonction de leur température moyenne annuelle d'origine (données extraites de la base de données WordClim : <http://www.worldclim.org/current>).

Une forte diversité génétique facilite l'adaptation locale des populations invasives aux nouvelles conditions biotiques et abiotiques dans l'aire d'introduction (Lavergne & Molofsky 2007). Grâce à l'analyse génétique des populations au sein des deux aires de distribution, il est possible d'identifier la composition génétique et la source des populations introduites (Miura 2007). Dans le chapitre 4, nous avons analysé et comparé la structure génétique de populations nord-américaines et européennes de *Q. rubra*. À l'aide de 69 marqueurs moléculaires nucléaires de type SNP (Single-Nucleotide Polymorphism), nous avons pu mettre en évidence que les populations du continent nord-américain sont structurées en trois groupes génétiques : les populations du Nord-Est de l'aire native se distinguent des populations du Sud-Est et un troisième groupe génétique est constitué des populations du Nord-Ouest et du Nord-Centre. À l'aide d'une méthode de Calcul Bayésien Approché, nous avons pu déterminer que, dans le passé, ces trois groupes étaient strictement isolés les uns des autres sans échanger de gènes ; récemment, grâce à un évènement de contact secondaire unique le flux de gènes a été rétabli entre les groupes génétiques. Nos résultats suggèrent également que les populations détectées aux extrémités de l'aire native sont des reliquats ancestraux des trois groupes génétiques avant contact secondaire. Ces populations ont vraisemblablement moins subi l'évènement de contact secondaire et moins échangé de gènes comparées à celles du centre de l'aire de répartition originelle.

En Europe, les individus sont majoritairement assignés aux populations provenant des deux groupes génétiques du Nord (Est et Centre/Ouest) de l'aire d'origine. Trois hypothèses peuvent expliquer l'absence du groupe génétique du Sud-Est de l'aire native en Europe. (1) Tout d'abord, il est envisageable que ce groupe génétique n'ait pas été introduit en Europe si l'on suppose que les échanges commerciaux lors des premières introductions, au cours du XVIII^{ème} siècle, s'opéraient préférentiellement avec les ports des États du Nord de l'aire native. D'après les différentes archives historiques recensées par Magni Diaz (2004), de nombreuses introductions à cette époque sont inventoriées en provenance de l'Est du Canada (Québec, Nouvelle Angleterre, Nouvelle Ecosse) et du Nord-Est des États-Unis ; cependant, il est aussi mentionné que Jean-François Gaultier (1708-1756) en poste en Nouvelle France (Canada et Nord-Est des États-Unis) avait envoyé en Europe des plantes de sources distantes, après transit par la Nouvelle France.

(2) D'autre part, certaines plantes invasives ont besoin de retrouver dans l'aire d'introduction une niche climatique similaire à celle qu'elles occupaient dans l'aire native (Wiens & Graham 2005; Petitpierre *et al.* 2012). L'absence de niche adéquate dans l'aire d'introduction pourrait éventuellement avoir compromis l'acclimatation des populations du Sud-Est de l'aire native en Europe. En effet, Camenen *et al.* (2016) ont montré que la niche climatique de *Q. rubra* en Europe est en partie similaire à celle de son aire native : 6% de la niche climatique européenne est nouvelle par rapport à celle d'Amérique du Nord tandis que 41% de la niche climatique de l'aire native présente en Europe n'est pas retrouvée dans la niche climatique actuelle de l'aire d'introduction. Il serait intéressant de tester si cette partie de la niche climatique native non présente en Europe correspond éventuellement à celle des populations appartenant au groupe génétique du Sud-Est de l'aire native. En testant cette hypothèse, nous pourrions déterminer si ces populations n'ont pas été introduites. (3) Enfin, il est possible que des individus issus de ce groupe génétique du Sud-Est de l'aire d'origine aient été importés en Europe mais qu'ils aient été contre-sélectionnés. Si les individus provenant de ce groupe génétique sont moins compétitifs et n'ont pas réussi à s'acclimater dans le nouvel environnement et face aux nouvelles pressions de sélection en Europe, ils ont pu avoir disparu suite à de fortes mortalités. Pour tester cette hypothèse, il faudrait comparer les performances et la compétitivité des populations en fonction de leur appartenance aux trois groupes génétiques pour déceler d'éventuelles différences phénotypiques entre les groupes de populations.

Au début du processus d'invasion, un effet de fondation peut se produire si le nombre d'individus introduits est faible et engendrer une diminution de la diversité génétique dans les populations introduites pouvant compromettre l'adaptation locale (Dlugosch & Parker 2008b). Cependant, malgré une faible diversité génétique, certaines espèces invasives parviennent à s'adapter à leur nouvel environnement (Rollins *et al.* 2013). A l'inverse, suite à des introductions multiples dans le temps et dans l'espace, la diversité génétique peut se maintenir ou être restaurée au sein des populations introduites (Facon *et al.* 2008). Les méthodes de Calcul Bayésien Approché (ABC) offrent l'opportunité de faire des inférences sur les scénarios évolutifs complexes, comme ceux qui peuvent intervenir lors des invasions biologiques (Estoup & Guillemaud 2010). Dans le chapitre 4, nous

avons testé si chacun des deux groupes génétiques introduits séparément ou simultanément avaient subi un phénomène de goulot d'étranglement de plus ou moins forte intensité. Les résultats que nous avons obtenus tendent à suggérer que s'il y a eu une réduction de la diversité au sein des populations de *Q. rubra* durant leur introduction en Europe, celle-ci a probablement été de faible intensité. Cependant, nos résultats sont relativement peu tranchés entre les différents scénarios de perte de diversité testés et laissent supposer que nous arrivons en limite des capacités d'inférence de notre jeu de données. Une meilleure estimation de la diversité génétique à l'intérieur des populations Nord-américaines et européennes, en utilisant davantage de marqueurs de type SNP, pourrait nous permettre de mieux renseigner sur l'intensité de cet éventuel effet de fondation. N'ayant pas observé une forte réduction de la diversité génétique, nous pouvons donc supposer que des introductions multiples ont maintenu une diversité génétique suffisante dans les populations introduites de *Q. rubra* en Europe. Dans une précédente étude utilisant des marqueurs moléculaires cytoplasmiques, Magni Diaz (2004) a observé que les peuplements introduits présentaient une richesse allélique semblable à celle des peuplements d'origine, suggérant que la diversité entre les deux aires était quasiment inchangée. A travers une étude détaillée de quelques récits historiques disponibles, il a supposé que la multiplicité des lieux de récolte et des dates d'introduction de *Q. rubra* en Europe avait conduit à des introductions multiples de matériel végétal. Des phénomènes de mélanges génétiques intra-spécifiques peuvent survenir suite à des introductions multiples (Dlugosch & Parker 2008b; Dlugosch *et al.* 2015). Ainsi, nous avons constaté une forte proportion d'individus hybrides entre les deux groupes génétiques au sein des populations introduites de *Q. rubra*, bien qu'elle soit comparable à celle que nous avons observée dans les populations natives. Ces individus hybrides en Europe peuvent provenir d'une forte introduction d'individus déjà hybrides dans l'aire native ou résulter de phénomènes de mélanges génétiques intra-spécifiques entre les groupes génétiques depuis leur introduction.

C. Conclusion générale et perspectives : quel avenir pour le chêne rouge en Europe ?

En Amérique du Nord, la structure génétique de *Q. rubra* est répartie géographiquement selon trois groupes avec un découpage entre les populations du Nord-Est et celles du Sud-Est et un troisième groupe, plus ubiquiste, constitué des populations du Nord-Centre et du Nord-Ouest. Historiquement, ces trois groupes étaient éloignés les uns des autres et ne pouvaient échanger que peu ou pas de gènes. Récemment, un évènement de contact secondaire unique a rétabli le flux de gènes entre les groupes, créant ainsi de nombreux individus hybrides à la jonction entre les groupes. Lors de l'introduction de *Q. rubra*, il semblerait qu'il n'y ait pas eu un fort effet de fondation sur les groupes génétiques introduits, susceptible d'induire une perte de diversité génétique remarquable dans ces populations. Seuls les individus des deux groupes génétiques du Nord de l'aire d'origine ont été observés dans la structure génétique actuelle des populations européennes de *Q. rubra*. Cependant, il semblerait que l'absence du groupe génétique du Sud-Est n'ait pas empêché les populations introduites de s'adapter aux nouvelles conditions environnementales en Europe. Les populations européennes de *Q. rubra* présentent notamment de la différenciation génétique pour le trait de débourrement foliaire. La sélection anthropique ne semble pas être le moteur de ces différenciations, aussi la sélection naturelle a probablement favorisé en Europe les individus les plus compétitifs en termes de croissance, phénologie et reproduction. D'autre part, la large distribution de *Q. rubra* dans les peuplements de feuillus et de conifères des forêts européennes révèle sa forte capacité de régénération naturelle et résulte sans doute en grande partie d'une dispersion efficace. En effet, le chêne rouge est le plus souvent mené en plantations mono-spécifiques par les forestiers européens, alors qu'il est finalement majoritairement présent sous le couvert d'autres espèces forestières. L'analyse de l'identité de ces espèces dans les peuplements envahis par *Q. rubra* montre une grande variabilité, reflétant en partie les essences dominantes dans chaque pays. Cependant, les niveaux d'invasibilité sont différents en fonction de l'espèce dominante du peuplement, il existe par exemple un fort risque dans les chênaies natives, notamment en France. Cette analyse mériterait d'être approfondie par une évaluation des milieux forestiers envahis et

par une évaluation spatiale de la dynamique d'invasion par rapport à la proximité des plantations mono-spécifiques de chêne rouge. De plus, parmi les animaux impliqués dans le prélèvement des glands de chêne rouge au sol, l'écureuil roux et le mulot sylvestre présentent un comportement fouisseur-disperseur, contribuant ainsi à lever la barrière de dispersion de cet arbre en Europe et pouvant expliquer en partie cette dispersion efficace. À partir de ces nouvelles connaissances sur les processus écologiques de dispersion et de régénération de *Q. rubra*, nous pouvons conclure que cette espèce peut être considérée comme invasive, au sens scientifique du terme, en Europe Centrale et de l'Ouest.

Actuellement, 42% de la surface de l'Europe est occupée par des forêts (Eurostat Press Office 2008) et celles-ci abritent des espèces ligneuses invasives, notamment en raison de l'utilisation de ces espèces pour la production et commercialisation de leur bois. En effet, la sylviculture est une des principales raisons de l'introduction et de la propagation d'arbres exotiques invasifs à travers le monde (Richardson & Rejmánek 2011). Dans une publication récente, Sitzia (2014) met en garde contre les effets des pratiques sylvicoles d'espèces ligneuses invasives sur les changements de composition et structure des peuplements forestiers, notamment concernant le risque d'invasion dans des peuplements adjacents ou des milieux naturels ou semi-naturels non-boisés. Mais les sylviculteurs peuvent également jouer un rôle important dans la gestion et la lutte contre les espèces invasives en milieu boisé grâce à des pratiques sylvicoles susceptibles de freiner les invasions biologiques. Parmi ces pratiques, il est recommandé d'éviter les coupes rases, les trouées et les taillis chez les espèces exotiques susceptibles de rejeter à partir de souches ou de racines, de favoriser l'utilisation d'espèces natives et de maintenir une canopée dense et fermée, et d'éliminer les nouvelles générations non désirées d'espèces invasives (Sitzia *et al.* 2016). Pour être efficace, ces pratiques doivent cependant être appliquées systématiquement et coordonnées entre les sylviculteurs des différents pays de l'Union Européenne.

Bien que *Q. rubra* soit déclaré comme une espèce invasive dans de nombreux pays d'Europe Centrale et de l'Ouest, cette espèce ligneuse ne figure pas dans la liste des espèces invasives préoccupantes à l'échelle de l'Union Européenne (Journal officiel de

l'Union Européenne 2016). Pourtant, le chêne rouge remplit de nombreux critères pour figurer dans cette liste, notamment au regard des résultats de cette thèse qui mettent en évidence la capacité de cet arbre à se développer dans des peuplements dominés par des espèces ligneuses natives et à être disperser par des animaux. Des impacts négatifs de cette espèce sur la biodiversité locale ont été recensés en Pologne et en Lituanie (Riepšas & Straigyte 2008; Chmura 2013; Woziwoda, Kopec & Witkowski 2014a). Pour définir son statut invasif ou non d'un point de vue législatif, les impacts du chêne rouge seront à caractériser plus largement en Europe. Il sera nécessaire, à l'avenir, d'évaluer ses impacts écologiques et économiques – positifs et négatifs – et d'estimer les risques à différentes échelles du territoire où il se développe afin de pouvoir établir la pertinence d'une législation concernant son utilisation dans les plantations forestières et les mesures de gestion à envisager dans les forêts européennes. Toutefois, dans les pays européens où *Q. rubra* est déjà considéré comme une espèce invasive et présente des impacts négatifs avérés, cette espèce peut être incluse dans une liste nationale des espèces invasives préoccupantes pour un État membre (articles 10 et 12, Journal officiel de l'Union Européenne 2014).

En attendant que des mesures de gestion et une législation soient prises à l'échelle des pays ou du territoire de l'Union Européenne, nous recommandons aux forestiers de limiter les plantations mono-spécifiques ou en mélange de *Q. rubra* et de favoriser de préférence l'utilisation d'essences forestières locales pour le reboisement.

Bibliographie

- Abbott, R.J. (1992) Plant invasions, interspecific hybridization and the evolution of new plant taxa. *Trends in Ecology & Evolution*, **7**, 401–405.
- Abrams, M.D. (1992) Fire and the Development of Oak Forests. *BioScience*, **42**, 346–353.
- Abrams, M.D. (2005) Prescribing fire in eastern oak forests: Is time running out? *Northern Journal of Applied Forestry*, **22**, 190–196.
- Aikio, S., Duncan, R.P. & Hulme, P.E. (2010) Lag-phases in alien plant invasions: separating the facts from the artefacts. *Oikos*, **119**, 370–378.
- Alexander, J.M., Naylor, B., Poll, M., Edwards, P.J. & Dietz, H. (2009) Plant invasions along mountain roads: the altitudinal amplitude of alien Asteraceae forbs in their native and introduced ranges. *Ecography*, **32**, 334–344.
- Anderson, R.M., May, R.M., Joysey, K., Mollison, D., Conway, G.R., Cartwell, R., Thompson, H. V. & Dixon, B. (1986) The Invasion, Persistence and Spread of Infectious Diseases within Animal and Plant Communities [and Discussion]. *Philosophical Transactions of the Royal Society B: Biological Sciences*, **314**, 533–570.
- Bailey, M.F. & McCauley, D.E. (2006) The effects of inbreeding, outbreeding and long-distance gene flow on survivorship in North American populations of *Silene vulgaris*. *Journal of Ecology*, **94**, 98–109.
- Bakker, J. & Wilson, S. (2001) Competitive abilities of introduced and native grasses. *Plant Ecology*, **157**, 117–125.
- Banks, N.C., Paini, D.R., Bayliss, K.L. & Hodda, M. (2015) The role of global trade and transport network topology in the human-mediated dispersal of alien species. *Ecology Letters*, **18**, 188–199.
- Barrett, R.D.H. & Schluter, D. (2008) Adaptation from standing genetic variation. *Trends in Ecology & Evolution*, **23**, 38–44.
- Bartoli, M. & Le Goff, N. (1994) La conduite des peuplements en France. *Le chêne rouge d'Amérique* (eds J. Timbal, A. Kremer, N. Le Goff & G. Nepveu), pp. 237–246. Institut National de la Recherche Agronomique, Paris, France.
- Bartuszevige, A.M. & Gorchov, D.L. (2006) Avian Seed Dispersal of an Invasive Shrub. *Biological Invasions*, **8**, 1013–1022.
- Basler, D. & Körner, C. (2012) Photoperiod sensitivity of bud burst in 14 temperate forest tree species. *Agricultural and Forest Meteorology*, **165**, 73–81.
- Bass, D.A., Crossman, N.D., Lawrie, S.L. & Lethbridge, M.R. (2006) The importance of population growth, seed dispersal and habitat suitability in determining plant invasiveness. *Euphytica*, **148**, 97–109.
- Bastlová, D. & Květ, J. a. n. (2002) Differences in dry weight partitioning and flowering

- phenology between native and non-native plants of purple loosestrife (*Lythrum salicaria* L.). *Flora - Morphology, Distribution, Functional Ecology of Plants*, **197**, 332–340.
- Bauer, F. (1953) *Die Roteiche* (ed Sauerländer's Verlag). Frankfurt Am Main.
- Beaumont, L.J., Gallagher, R. V., Thuiller, W., Downey, P.O., Leishman, M.R. & Hughes, L. (2009) Different climatic envelopes among invasive populations may lead to underestimations of current and future biological invasions. *Diversity and Distributions*, **15**, 409–420.
- Bieberich, J., Lauerer, M. & Aas, G. (2016) Acorns of introduced *Quercus rubra* are neglected by European Jay but spread by mice. *Annals of Forest Research*, **59**, 1–10.
- Blackburn, T.M., Pyšek, P., Bacher, S., Carlton, J.T., Duncan, R.P., Jarošík, V., Wilson, J.R.U. & Richardson, D.M. (2011) A proposed unified framework for biological invasions. *Trends in Ecology & Evolution*, **26**, 333–339.
- Blair, A.C. & Hufbauer, R.A. (2010) Hybridization and invasion: One of North America's most devastating invasive plants shows evidence for a history of interspecific hybridization. *Evolutionary Applications*, **3**, 40–51.
- Blossey, B. & Nötzold, R. (1995) Evolution of increased competitive ability in invasive nonindigenous plants: a hypothesis. *Journal of Ecology*, **83**, 887–889.
- Born, W., Rauschmayer, F. & Bräuer, I. (2005) Economic evaluation of biological invasions—a survey. *Ecological Economics*, **55**, 321–336.
- Bossdorf, O., Auge, H., Lafuma, L., Rogers, W.E., Siemann, E. & Prati, D. (2005) Phenotypic and genetic differentiation between native and introduced plant populations. *Oecologia*, **144**, 1–11.
- Bossdorf, O., Lipowsky, A. & Prati, D. (2008) Selection of preadapted populations allowed *Senecio inaequidens* to invade Central Europe. *Diversity and Distributions*, **14**, 676–685.
- Bossdorf, O., Prati, D., Auge, H. & Schmid, B. (2004) Reduced competitive ability in an invasive plant. *Ecology Letters*, **7**, 346–353.
- Bossema, I. (1979) Jays and Oaks: an Eco-Ethological Study of a Symbiosis. *Behaviour*, **70**, 1–116.
- Bradshaw, A.D. (1965) Evolutionary Significance of Phenotypic Plasticity in Plants., pp. 115–155.
- Broennimann, O., Treier, U. A, Müller-Schärer, H., Thuiller, W., Peterson, A. T. & Guisan, A. (2007) Evidence of climatic niche shift during biological invasion. *Ecology Letters*, **10**, 701–709.
- Bucharova, A. & van Kleunen, M. (2009) Introduction history and species characteristics partly explain naturalization success of North American woody species in Europe. *Journal of Ecology*, **97**, 230–238.
- Buckley, D.S., Sharik, T.L. & Isebrands, J.G. (1998) Regeneration of northern red oak:

- positive and negative effects of competitor removal. *Ecology*, **79**, 65–78.
- Burke, M.J.W. & Grime, J.P. (1996) An Experimental Study of Plant Community Invasibility. *Ecology*, **77**, 776–790.
- Burns, J.H., Pardini, E.A., Schutzenhofer, M.R., Chung, Y.A., Seidler, K.J. & Knight, T.M. (2013) Greater sexual reproduction contributes to differences in demography of invasive plants and their noninvasive relatives. *Ecology*, **94**, 995–1004.
- Cain, M.L., Milligan, B.G. & Strand, A.E. (2000) Long-distance dispersal in plant populations. *American Journal of Botany*, **87**, 1217–1227.
- Callaway, R.M. & Aschehoug, E.T. (2000) Invasive Plants Versus Their New and Old Neighbors: A Mechanism for Exotic Invasion. *Science*, **290**, 521–523.
- Callaway, R.M. & Ridenour, W.M. (2004) Novel weapons: Invasive success and the evolution of increased competitive ability. *Frontiers in Ecology and the Environment*, **2**, 436–443.
- Camenen, E., Porté, A.J. & Benito Garzón, M. (2016) American trees shift their niches when invading Western Europe: evaluating invasion risks in a changing climate. *Ecology and Evolution*.
- Cannell, M.G.R. (1997) Spring phenology of trees and frost avoidance. *Weather*, **52**, 46–52.
- Castro-Díez, P., Valle, G., González-Muñoz, N. & Alonso, Á. (2014) Can the Life-History Strategy Explain the Success of the Exotic Trees *Ailanthus altissima* and *Robinia pseudoacacia* in Iberian Floodplain Forests? (ed SR Roiloa). *PLoS ONE*, **9**, 1–12.
- Cecich, R.A. (1994) Biologie florale du chêne rouge. *Le chêne rouge d'Amérique* (eds J. Timbal, A. Kremer, N. Le Goff & G. Nepveu), pp. 54–60. Institut National de la Recherche Agronomique, Paris, France.
- Centre Régional de la Propriété Forestière (CRPF) Aquitaine. (2005) Essences Forestières Aquitaine.
- Centre Régional de la Propriété Forestière (CRPF) Limousin. (2011) Le Chêne Rouge.
- Centre Régional de la Propriété Forestière (CRPF) Poitou-Charentes. (2007) Le Chêne Rouge d'Amérique.
- Centre Régional de la Propriété Forestière (CRPF) Rhône-Alpes. (2014) Le Chêne Rouge d'Amérique un chêne à croissance rapide.
- Chapin, F.S., Zavaleta, E.S., Eviner, V.T., Naylor, R.L., Vitousek, P.M., Reynolds, H.L., Hooper, D.U., Lavorel, S., Sala, O.E., Hobbie, S.E., Mack, M.C. & Díaz, S. (2000) Consequences of changing biodiversity. *Nature*, **405**, 234–242.
- Chmura, D. (2004) Penetration and naturalisation of invasive alien plant species (neophytes) in woodlands of the slesian upland (southern Poland). *Nature Conservation*, **60**, 3–11.
- Chmura, D. (2013) Impact of alien tree species *Quercus rubra* L. on understorey environment and flora: A study of the Silesian upland (Southern Poland). *Polish Journal of Ecology*, **61**, 431–442.

- Chun, Y.J., Kim, C.G. & Moloney, K.A. (2010) Comparison of life history traits between invasive and native populations of purple loosestrife (*Lythrum salicaria*) using nonlinear mixed effects model. *Aquatic Botany*, **93**, 221–226.
- Cierjacks, A., Kowarik, I., Joshi, J., Hempel, S., Ristow, M., von der Lippe, M. & Weber, E. (2013) Biological Flora of the British Isles: *Robinia pseudoacacia*. *Journal of Ecology*, **101**, 1623–1640.
- Colautti, R.I. & Barrett, S.C.H. (2013) Rapid Adaptation to Climate Facilitates Range Expansion of an Invasive Plant. *Science*, **342**, 364–366.
- Colautti, R.I., Eckert, C.G. & Barrett, S.C.H. (2010) Evolutionary constraints on adaptive evolution during range expansion in an invasive plant. *Proceedings of the Royal Society B: Biological Sciences*, **277**, 1799–1806.
- Colautti, R.I. & MacIsaac, H.J. (2004) A neutral terminology to define “invasive” species. *Diversity and Distributions*, **10**, 135–141.
- Conner, J.K. (2003) Artificial Selection: A Powerful Tool for Ecologists. *Ecology*, **84**, 1650–1660.
- Crawford, K.M. & Whitney, K.D. (2010) Population genetic diversity influences colonization success. *Molecular Ecology*, **19**, 1253–1263.
- Crooks, J.A. (2005) Lag times and exotic species: The ecology and management of biological invasions in slow-motion. *Ecoscience*, **12**, 316–329.
- Crooks, J.A. & Soulé, M.E. (1999) Lag times in population explosions of invasive species: causes and implications. *Invasive Species and Biodiversity Management* (eds O.T. Sandlund, P.J. Schei & A. Viken), Kluwer Academic Publishers.
- Crow, T.R. (1988) Reproductive Mode and Mechanisms for Self-Replacement of Northern Red Oak (*Quercus rubra*) - A Review. *Forest science*, **34**, 19–40.
- Crow, T. (1992) Population dynamics and growth patterns for a cohort of northern red oak (*Quercus rubra*) seedlings. *Oecologia*, **91**, 192–200.
- Daehler, C.C. (2009) Short Lag Times for Invasive Tropical Plants: Evidence from Experimental Plantings in Hawai'i (ed DM Hansen). *PLoS ONE*, **4**, e4462.
- DAISIE. (2010) European invasive alien species gateway. URL <http://www.europe-alien.org> [accessed 16 August 2016]
- Darley-Hill, S. & Johnson, W.C. (1981) Acorn dispersal by the blue jay (*Cyanocitta cristata*). *Oecologia*, **50**, 231–232.
- Daszak, P., Cunningham, A.A. & Hyatt, A.D. (2000) Emerging Infectious Diseases of Wildlife - Threats to Biodiversity and Human Health. *Science*, **287**, 443–449.
- Daszak, P., Cunningham, A.A. & Hyatt, A.D. (2001) Anthropogenic environmental change and the emergence of infectious diseases in wildlife. *Acta Tropica*, **78**, 103–116.
- Daubree, J. & Kremer, A. (1993) Genetic and phenological differentiation between introduced and natural populations of *Quercus rubra* L. *Annales des sciences forestières*, **50**, 271–280.

- Davis, M.A., Grime, J.P. & Thompson, K. (2000) Fluctuating resources in plant communities: a general theory of invasibility. *Journal of Ecology*, **88**, 528–534.
- Dech, J.P., Robinson, L.M. & Nosko, P. (2008) Understorey plant community characteristics and natural hardwood regeneration under three partial harvest treatments applied in a northern red oak (*Quercus rubra* L.) stand in the Great Lakes-St. Lawrence forest region of Canada. *Forest Ecology and Management*, **256**, 760–773.
- Dehnen-Schmutz, K., Touza, J., Perrings, C. & Williamson, M. (2007) The horticultural trade and ornamental plant invasions in Britain. *Conservation Biology*, **21**, 224–231.
- Delplanque, A. & Menassieu, P. (1994) Les insectes déprédateurs du chêne rouge en France. *Le chêne rouge d'Amérique* (eds J. Timbal, A. Kremer, N. Le Goff & G. Nepveu), pp. 374–386. Institut National de la Recherche Agronomique, Paris, France.
- Delivering Alien Invasive Species Inventories for Europe DAISIE. *Quercus rubra* - DAISIE - Species Factsheet. URL <http://www.europe-aliens.org/speciesFactsheet.do?speciesId=14881#> [accessed 16 August 2016]
- Desprez-Loustau, M.-L., Robin, C., Buée, M., Courtecuisse, R., Garbaye, J., Suffert, F., Sache, I. & Rizzo, D.M. (2007) The fungal dimension of biological invasions. *Trends in Ecology & Evolution*, **22**, 472–480.
- DeWalt, S.J., Denslow, J.S. & Ickes, K. (2004) Natural-enemy release facilitates habitat expansion of the invasive tropical shrub *Clidemia hirta*. *Ecology*, **85**, 471–483.
- Dey, D.C. (1995) *Acorn Production in Red Oak*. Forest Research Information Paper No. 127. Ontario Forest Research Institute.
- Dey, D.C. & Parker, W.C. (1997) Overstorey density affects field performance of underplanted red oak (*Quercus rubra* L.) in Ontario. *Northern Journal of Applied Forestry*, **14**, 120–125.
- Dey, D.C. & Guyette, R.P. (2000) Anthropogenic fire history and red oak forests in south-central Ontario. *The Forestry Chronicle*, **76**, 339–347.
- Dey, D.C., Miller, G.W. & Kabrich, J.M. (2007) Sustaining northern red oak forests: Managing oak from regeneration to canopy dominance in mature stands. Integrated Restoration of Forested Ecosystems to Achieve Multi-Resource Benefits: Proceedings of the 2007 National Silviculture Workshop, pp. 91–105.
- Dickie, I.A., Bennett, B.M., Burrows, L.E., Nuñez, M.A., Peltzer, D.A., Porté, A., Richardson, D.M., Rejmánek, M., Rundel, P.W. & van Wilgen, B.W. (2014) Conflicting values: ecosystem services and invasive tree management. *Biological Invasions*, **16**, 705–719.
- Dlugosch, K.M., Anderson, S.R., Braasch, J., Cang, F.A. & Gillette, H.D. (2015) The devil is in the details: Genetic variation in introduced populations and its contributions to invasion. *Molecular Ecology*, **24**, 2095–2111.
- Dlugosch, K.M. & Parker, I.M. (2008a) Invading populations of an ornamental shrub show rapid life history evolution despite genetic bottlenecks. *Ecology Letters*, **11**, 701–709.

- Dlugosch, K.M. & Parker, I.M. (2008b) Founding events in species invasions: genetic variation, adaptive evolution, and the role of multiple introductions. *Molecular ecology*, **17**, 431–49.
- Dorning, M. & Cipollini, D. (2006) Leaf and root extracts of the invasive shrub, *Lonicera maackii*, inhibit seed germination of three herbs with no autotoxic effects. *Plant Ecology*, **184**, 287–296.
- Ducousso, A. (1994) L'attractivité du chêne rouge pour le chevreuil. *Le chêne rouge d'Amérique* (eds J. Timbal, A. Kremer, N. Le Goff & G. Nepveu), pp. 399–408. Institut National de la Recherche Agronomique, Paris, France.
- Durka, W., Bossdorf, O., Prati, D. & Auge, H. (2005) Molecular evidence for multiple introductions of garlic mustard (*Alliaria petiolata*, Brassicaceae) to North America. *Molecular Ecology*, **14**, 1697–1706.
- Ellstrand, N.C. & Schierenbeck, K.A. (2000) Hybridization as a stimulus for the evolution of invasiveness in plants? *Proceedings of the National Academy of Sciences*, **97**, 7043–7050.
- Elst, E.M., Acharya, K.P., Dar, P.A., Reshi, Z.A., Tufto, J., Nijs, I. & Graae, B.J. (2016) Pre-adaptation or genetic shift after introduction in the invasive species *Impatiens glandulifera*? *Acta Oecologica*, **70**, 60–66.
- Erfmeier, A. & Bruelheide, H. (2004) Comparison of native and invasive *Rhododendron ponticum* populations: Growth, reproduction and morphology under field conditions. *Flora - Morphology, Distribution, Functional Ecology of Plants*, **199**, 120–133.
- Estoup, A. & Guillemaud, T. (2010) Reconstructing routes of invasion using genetic data: Why, how and so what? *Molecular Ecology*, **19**, 4113–4130.
- Etterson, J.R., Delf, D.E., Craig, T.P., Ando, Y. & Ohgushi, T. (2008) Parallel patterns of clinal variation in *Solidago altissima* in its native range in central USA and its invasive range in Japan. *Botany*, **86**, 91–97.
- Eurostat Press Office. (2008) Forest covers 42% of the EU27 land area. URL <http://ec.europa.eu/eurostat/web/products-press-releases/-/1-20102008-BP> [accessed 9 November 2016]
- Ewel, J.J., O'Dowd, D.J., Bergelson, J., Daehler, C.C., D'Antonio, C.M., Gómez, L.D., Gordon, D.R., Hobbs, R.J., Holt, A., Hopper, K.R., Hughes, C.E., LaHart, M., Leakey, R.R.B., Lee, W.G., Loope, L.L., Lorence, D.H., Louda, S.M., Lugo, A.E., McEvoy, P.B., Richardson, D.M., Vitousek, P.M. & Gomez, L.D. (1999) Deliberate Introductions of Species: Research Needs. *BioScience*, **49**, 619.
- Facon, B., Pointier, J.P., Jarne, P., Sarda, V. & David, P. (2008) High Genetic Variance in Life-History Strategies within Invasive Populations by Way of Multiple Introductions. *Current Biology*, **18**, 363–367.
- Frankham, R. (2005) Resolving the genetic paradox in invasive species. *Heredity*, **94**, 385–385.
- Franks, S.J., Pratt, P.D., Allen Dray, F. & Simms, E.L. (2008a) No evolution of increased competitive ability or decreased allocation to defense in *Melaleuca quinquenervia*

- since release from natural enemies. *Biological Invasions*, **10**, 455–466.
- Franks, S.J., Pratt, P.D., Allen Dray, F. & Simms, E.L. (2008b) Selection on herbivory resistance and growth rate in an invasive plant. *American Naturalist*, **171**, 678–691.
- Fu, Y.H., Campioli, M., Deckmyn, G. & Janssens, I.A. (2012) The Impact of Winter and Spring Temperatures on Temperate Tree Budburst Dates: Results from an Experimental Climate Manipulation. *PLoS ONE*, **7**.
- Funk, J.L. & Vitousek, P.M. (2007) Resource-use efficiency and plant invasion in low-resource systems. *Nature*, **446**, 1079–1081.
- Gallagher, R. V., Beaumont, L.J., Hughes, L. & Leishman, M.R. (2010) Evidence for climatic niche and biome shifts between native and novel ranges in plant species introduced to Australia. *Journal of Ecology*, **98**, 790–799.
- García, D., Bañuelos, M.-J. & Houle, G. (2002) Differential effects of acorn burial and litter cover on *Quercus rubra* recruitment at the limit of its range in eastern North America. *Canadian Journal of Botany*, **80**, 1115–1120.
- Gaskin, J.F. & Kazmer, D.J. (2009) Introgression between invasive saltcedars (*Tamarix chinensis* and *T. ramosissima*) in the USA. *Biological Invasions*, **11**, 1121–1130.
- Genovesi, P. & Shine, C. (2004) European Strategy on Invasive Alien Species. Convention on the Conservation of European Wildlife and Habitats (Bern Convention). Council of Europe Publishing. *Nature and environment*, No. 137.
- Genton, B.J., Shykoff, J.A. & Giraud, T. (2005) High genetic diversity in French invasive populations of common ragweed, *Ambrosia artemisiifolia*, as a result of multiple sources of introduction. *Molecular Ecology*, **14**, 4275–4285.
- Gerlach, J.D. & Rice, K.J. (2003) Testing life history correlates of invasiveness using congeneric plant species. *Ecological Applications*, **13**, 167–179.
- Godoy, O. & Levine, J.M. (2014) Phenology effects on invasion success: insights from coupling field experiments to coexistence theory. *Ecology*, **95**, 726–736.
- Goeze, E. (1916) *Liste Der Seit Dem 16. Jahrhundert Bis Auf Die Gegenwart in Die Gärten Uns Parks Europas Eingeführten Bäume Und Stäucher. Mitteilungen Der Deutschen Dendrologischen Gesellschaft.*
- Gómez, J.M. (2003) Spatial patterns in long-distance dispersal of *Quercus ilex* acorns by jays in a heterogeneous landscape. *Ecography*, **26**, 573–584.
- Gómez-Aparicio, L. & Canham, C.D. (2008) Neighbourhood analyses of the allelopathic effects of the invasive tree *Ailanthus altissima* in temperate forests. *Journal of Ecology*, **96**, 447–458.
- Goodwin, B.J., McAllister, A.J. & Fahrig, L. (1999) Predicting invasiveness of plant species based on biological information. *Conservation Biology*, **13**, 422–426.
- Greenberg, C. (2000) Individual variation in acorn production by five species of southern Appalachian oaks. *Forest Ecology and Management*, **132**, 199–210.
- Gribko, L., Schuler, T. & Ford, W. (2002) Biotic and abiotic mechanisms in the establishment of northern red oak seedlings: a review. *USDA Forest Service.*

- Grotkopp, E., Erskine-Ogden, J. & Rejmánek, M. (2010) Assessing potential invasiveness of woody horticultural plant species using seedling growth rate traits. *Journal of Applied Ecology*, **47**, 1320–1328.
- Grotkopp, E. & Rejmánek, M. (2007) High seedling relative growth rate and specific leaf area are traits of invasive species: Phylogenetically independent contrasts of woody angiosperms. *American Journal of Botany*, **94**, 526–532.
- Grotkopp, E., Rejmánek, M. & Rost, T.L. (2002) Toward a Causal Explanation of Plant Invasiveness: Seedling Growth and Life-History Strategies of 29 Pine (*Pinus*) Species. *The American Naturalist*, **159**, 396–419.
- Haas, J.P. & Heske, E.J. (2005) Experimental Study of the Effects of Mammalian Acorn Predators on Red Oak Acorn Survival and Germination. *Journal of Mammalogy*, **86**, 1015–1021.
- Hagenblad, J., Hülskötter, J., Acharya, K.P., Brunet, J., Chabrierie, O., Cousins, S. a. O., Dar, P. a., Diekmann, M., De Frenne, P., Hermy, M., Jamoneau, A., Kolb, A., Lemke, I., Plue, J., Reshi, Z. a. & Graae, B.J. (2015) Low genetic diversity despite multiple introductions of the invasive plant species *Impatiens glandulifera* in Europe. *BMC Genetics*, **16**, 103.
- Hamilton, M.A., Murray, B.R., Cadotte, M.W., Hose, G.C., Baker, A.C., Harris, C.J. & Licari, D. (2005) Life-history correlates of plant invasiveness at regional and continental scales. *Ecology Letters*, **8**, 1066–1074.
- Hanfling, B. & Kollmann, J. (2002) An evolutionary perspective of biological invasions. *Trends in Ecology & Evolution*, **17**, 545–546.
- Hawkes, C. V. (2007) Are invaders moving targets? The generality and persistence of advantages in size, reproduction, and enemy release in invasive plant species with time since introduction. *The American naturalist*, **170**, 832–843.
- Hejda, M., Pyšek, P. & Jarošík, V. (2009) Impact of invasive plants on the species richness, diversity and composition of invaded communities. *Journal of Ecology*, **97**, 393–403.
- Hibbs, D. (1983) Forty Years of Forest Succession in Central New England. *Ecology*, **64**, 1394–1401.
- Hierro, J.L. & Callaway, R.M. (2003) Allelopathy and exotic plant invasion. *Plant and Soil*, **256**, 29–39.
- Hierro, J.L., Maron, J.L. & Callaway, R.M. (2005) A biogeographical approach to plant invasions: The importance of studying exotics in their introduced and native range. *Journal of Ecology*, **93**, 5–15.
- Hodgins, K.A. & Rieseberg, L. (2011) Genetic differentiation in life-history traits of introduced and native common ragweed (*Ambrosia artemisiifolia*) populations. *Journal of Evolutionary Biology*, **24**, 2731–2749.
- Hodkinson, D.J. & Thompson, K. (1997) Plant Dispersal: The Role of Man. *The Journal of Applied Ecology*, **34**, 1484.
- Hubert, M. (1994) Tailles de formation et élagages. *Le chêne rouge d'Amérique* (eds J.

- Timbal, A. Kremer, N. Le Goff & G. Nepveu), pp. 247–253. Institut National de la Recherche Agronomique, Paris, France.
- Huenneke, L.F., Hamburg, S.P., Koide, R., Mooney, H.A. & Vitousek, P.M. (1990) Effects of Soil Resources on Plant Invasion and Community Structure in Californian Serpentine Grassland. *Ecology*, **71**, 478–491.
- Hulme, P.E. (2006) Beyond control: wider implications for the management of biological invasions. *Journal of Applied Ecology*, **43**, 835–847.
- Hulme, P.E. (2009) Trade, transport and trouble: Managing invasive species pathways in an era of globalization. *Journal of Applied Ecology*, **46**, 10–18.
- Jelbert, K., Stott, I., McDonald, R.A. & Hodgson, D. (2015) Invasiveness of plants is predicted by size and fecundity in the native range. *Ecology and Evolution*, **5**, 1933–1943.
- Johnson, P.S. (1994) La sylviculture du chêne rouge aux USA. *Le chêne rouge d'Amérique* (eds J. Timbal, A. Kremer, N. Le Goff & G. Nepveu), pp. 272–283. Institut National de la Recherche Agronomique, Paris, France.
- Jones, C.G., Lawton, J.H. & Shachak, M. (1994) Organisms as Ecosystem Engineers. *Ecosystem Management*, pp. 130–147. Springer New York, NY.
- Journal officiel de l'Union Européenne. (2014) Règlement (UE) N° 1143/2014 du Parlement Européen et du Conseil du 22 Octobre 2014 relatif à la prévention et à la gestion de l'introduction et de la propagation des espèces exotiques envahissantes. URL <http://data.europa.eu/eli/reg/2014/1143/oj> [accessed 9 November 2016]
- Journal officiel de l'Union Européenne. (2016) Règlement d'exécution (UE) 2016/1141 de la commission du 13 Juillet 2016 adoptant une liste des espèces exotiques envahissantes préoccupantes pour l'Union conformément au règlement (UE) N° 1143/2014 du Parlement Européen et du Conseil. URL http://data.europa.eu/eli/reg_impl/2016/1141/oj [accessed 9 November 2016]
- Keane, R.M. & Crawley, M.J. (2002) Exotic plant invasions and the enemy release hypothesis. *Trends in Ecology & Evolution*, **17**, 164–170.
- Kehr, R.D. (1991) Pezicula canker of *Quercus rubra* L., caused by *Pezicula cinnamomea* (DC.) Sacc. I. Symptoms and pathogenesis. *European journal of forest pathology*, **21**, 218–233.
- Kehr, R.D. (1992) Pezicula canker of *Quercus rubra* L., caused by *Pezicula cinnamomea* (DC.) Sacc. II. Morphology and biology of the causal agent. *European journal of forest pathology*, **22**, 29–40.
- Keller, S.R. & Taylor, D.R. (2010) Genomic admixture increases fitness during a biological invasion. *Journal of Evolutionary Biology*, **23**, 1720–1731.
- Kempel, A., Chrobock, T., Fischer, M., Rohr, R.P. & van Kleunen, M. (2013) Determinants of plant establishment success in a multispecies introduction experiment with native and alien species. *Proceedings of the National Academy of Sciences*, **110**, 12727–12732.
- Kenk, G. & Borsy, P. (1994) Le chêne rouge (*Quercus borealis* Michx.) en Allemagne. *Le*

- chêne rouge d'Amérique* (eds J. Timbal, A. Kremer, N. Le Goff & G. Nepveu), pp. 265–271. Institut National de la Recherche Agronomique, Paris, France.
- Kitajima, K., Fox, A.M., Sato, T. & Nagamatsu, D. (2006) Cultivar selection prior to introduction may increase invasiveness: Evidence from *Ardisia crenata*. *Biological Invasions*, **8**, 1471–1482.
- van Kleunen, M., Dawson, W., Schlaepfer, D., Jeschke, J.M. & Fischer, M. (2010a) Are invaders different? A conceptual framework of comparative approaches for assessing determinants of invasiveness. *Ecology Letters*, **13**, 947–958.
- van Kleunen, M. & Fischer, M. (2005) Constraints on the evolution of adaptive phenotypic plasticity in plants. *The New phytologist*, **166**, 49–60.
- van Kleunen, M., Röckle, M. & Stift, M. (2015) Admixture between native and invasive populations may increase invasiveness of *Mimulus guttatus*. *Proceedings of the Royal Society B: Biological Sciences*, **282**, 20151487.
- van Kleunen, M., Weber, E. & Fischer, M. (2010b) A meta-analysis of trait differences between invasive and non-invasive plant species. *Ecology Letters*, **13**, 235–245.
- Kollmann, J. & Bañuelos, M.J. (2004) Latitudinal trends in growth and phenology of the invasive alien plant *Impatiens glandulifera* (Balsaminaceae). *Diversity and Distributions*, **10**, 377–385.
- Kowarik, I. (2010) Biologische Invasionen. *Neophyten Und Neozoen in Mitteleuropa*, Second edition (ed Verlag Eugen Ulmer). Ulmer, Stuttgart, Germany
- Kremer, A. (1986) Chêne rouge d'Amérique. *Revue Forestière Française*, **38**, 165–167.
- Kremer, A. (1994) Programme d'amélioration génétique du chêne rouge en France. *Le chêne rouge d'Amérique* (eds J. Timbal, A. Kremer, N. Le Goff & G. Nepveu), pp. 425–443.
- Kriebel, H. (1993) Intraspecific variation of growth and adaptive traits in North American oak species. *Annales des sciences forestières*, **50**, 153s–165s.
- Lanier, L., Keller, R. & Kremer, A. (1980) Le Chêne rouge (*Quercus rubra* L.) en France. *Revue Forestière Française*, **32**, 419–451.
- Lamarque, L.J., Delzon, S. & Lortie, C.J. (2011) Tree invasions: a comparative test of the dominant hypotheses and functional traits. *Biological Invasions*, **13**, 1969–1989.
- Lamarque, L.J., Lortie, C.J., Porté, A.J. & Delzon, S. (2015) Genetic differentiation and phenotypic plasticity in life-history traits between native and introduced populations of invasive maple trees. *Biological Invasions*, **17**, 1109–1122.
- Lamarque, L.J., Porté, A.J., Eymeric, C., Lasnier, J.-B., Lortie, C.J. & Delzon, S. (2013) A Test for Pre-Adapted Phenotypic Plasticity in the Invasive Tree *Acer negundo* L. (ed G Sorci). *PLoS ONE*, **8**, 1–10.
- Lauterbach, D. & Nehring, S. (2013) Naturschutzfachliche Invasivitätsbewertung. *Quercus Rubra – Rot-Eiche*.
- Lavergne, S. & Molofsky, J. (2007) Increased genetic variation and evolutionary potential drive the success of an invasive grass. *Proceedings of the National Academy of*

Sciences of the United States of America, **104**, 3883–8.

- Lee, C.E. (2002) Evolutionary genetics of invasive species. *Trends in Ecology & Evolution*, **17**, 386–391.
- Leger, E.A. & Rice, K.J. (2003) Invasive California poppies (*Eschscholzia californica* Cham.) grow larger than native individuals under reduced competition. *Ecology Letters*, **6**, 257–264.
- Leishman, M.R., Haslehurst, T., Ares, A. & Baruch, Z. (2007) Leaf trait relationships of native and invasive plants: Community- and global-scale comparisons. *New Phytologist*, **176**, 635–643.
- Levine, J.M., Adler, P.B. & Yelenik, S.G. (2004) A meta-analysis of biotic resistance to exotic plant invasions. *Ecology Letters*, **7**, 975–989.
- Levine, J.M. & D'Antonio, C.M. (1999) Elton Revisited: A Review of Evidence Linking Diversity and Invasibility. *Oikos*, **87**, 15.
- Levine, J.M., Vilà, M., Antonio, C.M.D., Dukes, J.S., Grigulis, K. & Lavorel, S. (2003) Mechanisms underlying the impacts of exotic plant invasions. *Proceedings of the Royal Society B: Biological Sciences*, **270**, 775–781.
- Liebhold, A., Sork, V. & Peltonen, M. (2004) Within-population spatial synchrony in mast seeding of North American oaks. *Oikos*, **104**, 156–164.
- Little, E.L.J. (1971) *Atlas of United States Trees, Volume 1, Conifers and Important Hardwoods* (ed U.S. Department of Agriculture Miscellaneous Publication). U.S. Department of Agriculture Miscellaneous Publication.
- Lockwood, J.L., Cassey, P. & Blackburn, T. (2005) The role of propagule pressure in explaining species invasions. *Trends in Ecology & Evolution*, **20**, 223–228.
- Lockwood, J.L., Cassey, P. & Blackburn, T.M. (2009) The more you introduce the more you get: the role of colonization pressure and propagule pressure in invasion ecology. *Diversity and Distributions*, **15**, 904–910.
- Lonsdale, W. (1999) Global patterns of plant invasions and the concept of invasibility. *Ecology*.
- Lorimer, C.G. (1984) Development of the red maple understorey in northeastern oak forests. *Forest Science*, **30**, 3–22.
- Lorimer, C.G., Chapman, J.W. & Lambert, W.D. (1994) Tall Understorey Vegetation as a Factor in the Poor Development of Oak Seedlings Beneath Mature Stands. *Journal of Ecology*, **82**, 227–237.
- Lynch, M. (1991) The Genetic Interpretation of Inbreeding Depression and Outbreeding Depression. *Evolution*, **45**, 622–629.
- Mack, R.N. & Lonsdale, W.M. (2001) Humans as Global Plant Dispersers : Getting More Than We Bargained For. *BioScience*, **51**, 95–102.
- Mack, R.N., Simberloff, D., Lonsdale, W.M., Evans, H., Clout, M. & Bazzaz, F.A. (2000) Biotic invasion: causes, epidemiology, global consequences and control. *Ecological Applications*, **10**, 689–710.

- Magni Diaz, C.R. (2004) *Reconstitution de l'introduction de Quercus Rubra L. en Europe et conséquences génétiques dans les populations allochtones*. Thèse de doctorat, Ecole Nationale du Génie Rural des Eaux et Forêts, Paris, France.
- Major, K.C., Nosko, P., Kuehne, C., Campbell, D. & Bauhus, J. (2013) Regeneration dynamics of non-native northern red oak (*Quercus rubra* L.) populations as influenced by environmental factors: A case study in managed hardwood forests of southwestern Germany. *Forest Ecology and Management*, **291**, 144–153.
- Marçais, B., Caël, O. & Delatour, C. (2000) Relationship between presence of basidiomes, above-ground symptoms and root infection by *Collybia fusipes* in oaks. *European Journal of Forest Pathology*, **30**, 7–17.
- Marçais, B. & Delatour, C. (1996) Inoculation of Oak (*Quercus robur* and *Q. rubra*) with *Collybia fusipes*. *Plant Disease*, **80**, 1391–1394.
- Marçais, B., Dupuis, F. & Desprez-Loustau, M. (1996) Susceptibility of the *Quercus rubra* root system to *Phytophthora cinnamomi*; comparison with chestnut and other oak species. *European Journal of Forest Research*, **26**, 133–143.
- Maron, J.L., Vilà, M., Bommarco, R., Elmendorf, S. & Beardsley, P. (2004) Rapid evolution of an invasive plant. *Ecological Monographs*, **74**, 261–280.
- Marozas, V., Straigyte, L. & Sepetiene, J. (2009) Comparative analysis of alien red oak (*Quercus rubra* L.) and native common oak (*Quercus robur* L.) vegetation in Lithuania. *Acta Biologica Universitatis Daugavpiliensis*, **9**, 19–24.
- Mason, R.A.B., Cooke, J., Moles, A.T. & Leishman, M.R. (2008) Reproductive output of invasive versus native plants. *Global Ecology and Biogeography*, **17**, 633–640.
- Medrzycki, P. (2011) NOBANIS - Invasive Alien Species Fact Sheet - *Acer negundo*. URL <http://www.nobanis.org/> [accessed 22 July 2014]
- Meyerson, L.A. & Mooney, H.A. (2007) Invasive alien species in an era of globalization. *Ecological Society of America*, **5**, 199–208.
- Miltner, S. & Kupka, I. (2016) Silvicultural potential of northern red oak and its regeneration - Review. *Journal of Forest Science*, **62**, 145–152.
- Mitchell, C.E., Agrawal, A.A., Bever, J.D., Gilbert, G.S., Hufbauer, R.A., Klironomos, J.N., Maron, J.L., Morris, W.F., Parker, I.M., Power, A.G., Seabloom, E.W., Torchin, M.E. & Vazquez, D.P. (2006) Biotic interactions and plant invasions. *Ecology Letters*, **9**, 726–740.
- Miura, O. (2007) Molecular genetic approaches to elucidate the ecological and evolutionary issues associated with biological invasions. *Ecological Research*, **22**, 876–883.
- Möllerová, J. (2005) Notes on invasive and expansive trees and shrubs. *Journal of Forest Science*, **51**, 19–23.
- Montague, J.L., Barrett, S.C.H. & Eckert, C.G. (2008) Re-establishment of clinal variation in flowering time among introduced populations of purple loosestrife (*Lythrum salicaria*, Lythraceae). *Journal of Evolutionary Biology*, **21**, 234–245.

- Monty, A. & Mahy, G. (2009a) Évolution des traits d'histoire de vie lors des invasions végétales. *Biotechnologie, Agronomie, Société et Environnement*, **13**, 449–458.
- Monty, A. & Mahy, G. (2009b) Clinal differentiation during invasion: *Senecio inaequidens* (Asteraceae) along altitudinal gradients in Europe. *Oecologia*, **159**, 305–315.
- Moravcová, L., Pyšek, P., Jarošík, V., Havlíčková, V. & Zákrevský, P. (2010) Reproductive characteristics of neophytes in the Czech Republic: Traits of invasive and non-invasive species. *Preslia*, **82**, 365–390.
- Moravcová, L., Pyšek, P., Jarošík, V. & Pergl, J. (2015) Getting the Right Traits: Reproductive and Dispersal Characteristics Predict the Invasiveness of Herbaceous Plant Species (ed B Li). *PLOS ONE*, **10**, 1–16.
- Murray, B.R. & Phillips, M.L. (2010) Investment in seed dispersal structures is linked to invasiveness in exotic plant species of south-eastern Australia. *Biological Invasions*, **12**, 2265–2275.
- Myczko, Ł., Dylewski, Ł., Zduniak, P., Sparks, T.H. & Tryjanowski, P. (2014) Predation and dispersal of acorns by European Jay (*Garrulus glandarius*) differs between a native (Pedunculate Oak *Quercus robur*) and an introduced oak species (Northern Red Oak *Quercus rubra*) in Europe. *Forest Ecology and Management*, **331**, 35–39.
- Nathan, R. (2006) Long-distance dispersal of plants. *Science*, **313**, 786–788.
- Nathan, R., Schurr, F.M., Spiegel, O., Steinitz, O., Trakhtenbrot, A. & Tsoar, A. (2008) Mechanisms of long-distance seed dispersal. *Trends in Ecology & Evolution*, **23**, 638–647.
- Naylor, R.L., Williams, S.L. & Strong, D.R. (2001) Aquaculture -A Gateway for Exotic Species. *Science*, **294**, 1655–1656.
- Oduor, A.M.O., Gómez, J.M., Herrador, M.B. & Perfectti, F. (2015) Invasion of *Brassica nigra* in north america: Distributions and origins of chloroplast dna haplotypes suggest multiple introductions. *Biological Invasions*, **17**, 2447–2459.
- Olson, L.J. (2006) The economics of terrestrial invasive species: a review of the literature. *Agricultural and Resource Economics Review*, **35**, 178–194.
- Ouden, J. den, Jansen, P.A. & Smit, R. (2005) Jays, mice and oaks: predation and dispersal of *Quercus robur* and *Q. petraea* in North-western Europe. *Seed fate: predation, dispersal and seedling establishment* (eds P.M. Forget, J.E. Lambert, P.E. Hulme & S.B. Vander Wall), pp. 223–239. CABI, Wallingford.
- Peeler, E.J., Oidtmann, B.C., Midtlyng, P.J., Miossec, L. & Gozlan, R.E. (2011) Non-native aquatic animals introductions have driven disease emergence in Europe. *Biological Invasions*, **13**, 1291–1303.
- Pejchar, L. & Mooney, H.A. (2009) Invasive species, ecosystem services and human well-being. *Trends in Ecology & Evolution*, **24**, 497–504.
- Petitpierre, B., Kueffer, C., Broennimann, O., Randin, C., Daehler, C. & Guisan, A. (2012) Climatic Niche Shifts Are Rare Among Terrestrial Plant Invaders. *Science*, **335**, 1344–1348.

- Pichancourt, J.B. & van Klinken, R.D. (2012) Phenotypic plasticity influences the size, shape and dynamics of the geographic distribution of an invasive plant. *PLoS ONE*, **7**.
- Pimentel, D., McNair, S., Janecka, J., Wightman, J., Simmonds, C., O'Connell, C., Wong, E., Russel, L., Zern, J., Aquino, T. & Tsomondo, T. (2001) Economic and environmental threats of alien plant, animal, and microbe invasions. *Agriculture, Ecosystems & Environment*, **84**, 1–20.
- Pimentel, D., Zuniga, R. & Morrison, D. (2005) Update on the environmental and economic costs associated with alien-invasive species in the United States. *Ecological Economics*, **52**, 273–288.
- Pons, J. & Pausas, J.G. (2007a) Not only size matters: Acorn selection by the European jay (*Garrulus glandarius*). *Acta Oecologica*, **31**, 353–360.
- Pons, J. & Pausas, J.G. (2007b) Acorn dispersal estimated by radio-tracking. *Oecologia*, **153**, 903–911.
- de Poorter, M. (2009) International legal instruments and frameworks for invasive species. *Invasive Species Management A Handbook of Principles and Techniques* (eds M.N. Clout & P.A. Williams), pp. 108–125. Oxford University Press.
- Prentis, P.J., Sigg, D.P., Raghu, S., Dhileepan, K., Pavasovic, A. & Lowe, A.J. (2009) Understanding invasion history: Genetic structure and diversity of two globally invasive plants and implications for their management. *Diversity and Distributions*, **15**, 822–830.
- Prentis, P.J., Wilson, J.R.U., Dormontt, E.E., Richardson, D.M. & Lowe, A.J. (2008) Adaptive evolution in invasive species. *Trends in Plant Science*, **13**, 288–294.
- Pyšek, P. (2004) The most complete global overview of invasive species in natural areas. *Diversity and Distributions*, **10**, 505–506.
- Pyšek, P., Danihelka, J., Sádlo, J., Chrtek, J., Chytrý, M., Jarošík, V., Kaplan, Z., Krahulec, F., Moravcová, L., Pergl, J., Štajerová, K. & Tichý, L. (2012a) Catalogue of alien plants of the Czech Republic (2nd edition): Checklist update, taxonomic diversity and invasion patterns. *Preslia*, **84**, 155–255.
- Pyšek, P., Jarošík, V., Hulme, P.E., Pergl, J., Hejda, M., Schaffner, U. & Vilà, M. (2012b) A global assessment of invasive plant impacts on resident species, communities and ecosystems: The interaction of impact measures, invading species' traits and environment. *Global Change Biology*, **18**, 1725–1737.
- Pyšek, P., Jarosik, V., Hulme, P.E., Kühn, I., Wild, J., Arianoutsou, M., Bacher, S., Chiron, F., Didziulis, V., Essl, F., Genovesi, P., Gherardi, F., Hejda, M., Kark, S., Lambdon, P.W., Desprez-Loustau, M.-L., Nentwig, W., Pergl, J., Paboljsaj, K., Rabitsch, W., Roques, A., Roy, D.B., Shirley, S., Solarz, W., Vilà, M. & Winter, M. (2010) Disentangling the role of environmental and human pressures on biological invasions across Europe. *Proceedings of the National Academy of Sciences*, **107**, 12157–12162.
- Pyšek, P., Křivánek, M. & Jarošík, V. (2009) Planting intensity, residence time, and

- species traits determine invasion success of alien woody species. *Ecology*, **90**, 2734–2744.
- Pyšek, P. & Richardson, D.M. (2006) The biogeography of naturalization in alien plants. *Journal of Biogeography*, **33**, 2040–2050.
- Pyšek, P. & Richardson, D.M. (2007) Traits Associated with Invasiveness in Alien Plants: Where Do we Stand? *Biological Invasions* (ed W. Nentwig), pp. 97–125. Springer Berlin Heidelberg, Berlin, Heidelberg.
- Pyšek, P., Sádlo, J. & Mandák, B. (2003) Alien flora of the Czech Republic, its composition, structure and history. *Plant invasions: ecological threats and management solutions* (eds L.E. Child, J.H. Brock, G. Brundu, K. Prach, P. Pyšek, P.M. Wade & M. Williamson), pp. 113–130. Backhuys publishers, Leiden, the Netherlands.
- Reichard, S.H. & Hamilton, C.W. (1997) Predicting Invasions of Woody Plants Introduced into North America. *Conservation Biology*, **11**, 193–203.
- Reichard, S.H. & White, P. (2001) Horticulture as pathways of plant introductions in the United States. *American Institute of Biological Sciences*, **51**, 103–113.
- Rejmánek, M. (1996) A theory of seed plant invasiveness: The first sketch. *Biological Conservation*, **78**, 171–181.
- Rejmánek, M. & Richardson, D.M. (1996) What attributes make some plant species more invasive? *Ecology*, **77**, 1655–1661.
- Rejmánek, M. & Richardson, D.M. (2013) Trees and shrubs as invasive alien species—2013 update of the global database. *Diversity and Distributions*, **19**, 1093–1094.
- Richards, C.L., Bossdorf, O., Muth, N.Z., Gurevitch, J. & Pigliucci, M. (2006) Jack of all trades, master of some? On the role of phenotypic plasticity in plant invasions. *Ecology Letters*, **9**, 981–993.
- Richardson, D.M. (1998) Forestry Trees as Invasive Aliens. *Conservation Biology*, **12**, 18–26.
- Richardson, D.M., Allsopp, N., D'Antonio, C.M., Milton, S.J. & Rejmánek, M. (2000a) Plant invasions - the role of mutualisms. *Biological Reviews*, **75**, 65–93.
- Richardson, D.M. & Pyšek, P. (2006) Plant invasions: merging the concepts of species invasiveness and community invasibility. *Progress in Physical Geography*, **30**, 409–431.
- Richardson, D.M. & Pyšek, P. (2012) Naturalization of introduced plants: ecological drivers of biogeographical patterns. *New Phytologist*, **196**, 383–396.
- Richardson D.M., Pyšek, P., Rejmánek, M., Barbour, M.G., Panetta, F.D. & West, C.J. (2000) Naturalization and invasion of alien plants: concepts and definitions. *Diversity and Distributions*, **6**, 93–107.
- Richardson, D.M. & Rejmánek, M. (2011) Trees and shrubs as invasive alien species - a global review. *Diversity and Distributions*, **17**, 788–809.
- Riepšas, E. & Straigyte, L. (2008) Invasiveness and Ecological Effects of Red Oak

- (*Quercus rubra* L.) in Lithuanian Forests. *Baltic Forestry*, **14**, 122–130.
- Rieseberg, L.H., Kim, S.-C., Randell, R.A., Whitney, K.D., Gross, B.L., Lexer, C. & Clay, K. (2007) Hybridization and the colonization of novel habitats by annual sunflowers. *Genetica*, **129**, 149–165.
- Rius, M. & Darling, J.A. (2014) How important is intraspecific genetic admixture to the success of colonising populations? *Trends in Ecology & Evolution*, **29**, 233–242.
- Robin, C., Desprez-Loustau, M.-L. & Delatour, C. (1992) Spatial and Temporal Enlargement of Trunk Cankers of *Phytophthora Cinnamomi* in Red Oak. *Canadian Journal of Forest Research*, **22**, 157–165.
- Robin, C., Dupuis, F. & Desprez-Loustau, M.L. (1994) Seasonal changes in northern red oak susceptibility to *Phytophthora cinnamomi*. *Plant Disease*, **78**, 369–374.
- Rollins, L.A., Moles, A.T., Lam, S., Buitenwerf, R., Buswell, J.M., Brandenburger, C.R., Flores-Moreno, H., Nielsen, K.B., Couchman, E., Brown, G.S., Thomson, F.J., Hemmings, F., Frankham, R. & Sherwin, W.B. (2013) High genetic diversity is not essential for successful introduction. *Ecology and Evolution*, **3**, 4501–4517.
- Roman, J. & Darling, J. (2007) Paradox lost: genetic diversity and the success of aquatic invasions. *Trends in Ecology & Evolution*, **22**, 454–464.
- Rosenthal, D.M., Ramakrishnan, A.P. & Cruzan, M.B. (2008) Evidence for multiple sources of invasion and intraspecific hybridization in *Brachypodium sylvaticum* (Hudson) Beauv. in North America. *Molecular Ecology*, **17**, 4657–4669.
- Rundel, P.W., Dickie, I.A. & Richardson, D.M. (2014) Tree invasions into treeless areas: Mechanisms and ecosystem processes. *Biological Invasions*, **16**, 663–675.
- Sala, O.E., Chapin III, F.S., Armesto, J.J., Berlow, E., Bloomfield, J., Dirzo, R., Huber-Sanwald, H., Huenneke, L.F., Jackson, R.B., Kinzig, A., Leemans, R., Lodge, D.M., Mooney, H.A., Oesterheld, M., LeRoy Poff, N., Sykes, M.T., Walker, B.H., Walker, M. & Wall, D.H. (2000) Global Biodiversity Scenarios for the Year 2100. *Science*, **287**, 1770–1774.
- Sander, I.L. (1990) *Quercus rubra* L. Northern Red Oak. *Silvics of North America - Volume 2, Hardwoods* (eds R.M. Burns & B.H. Honkala), pp. 148–152.
- Scheiner, S.M. (1993) Genetics and Evolution of Phenotypic Plasticity. *Annual Review of Ecology and Systematics*, **24**, 35–68.
- Schley, L. & Roper, T.J. (2003) Diet of wild boar *Sus scrofa* in Western Europe, with particular reference to consumption of agricultural crops. *Mammal Review*, **33**, 43–56.
- Schlichting, C.D. (1986) The Evolution of Phenotypic Plasticity in Plants. *Annual Review of Ecology and Systematics*, **17**, 667–693.
- Schmidt, J.P. & Drake, J.M. (2011) Time since introduction, seed mass, and genome size predict successful invaders among the cultivated vascular plants of Hawaii. *PLoS ONE*, **6**.
- Schnurr, J.L., Ostfeld, R.S. & Canham, C.D. (2002) Direct and indirect effects of masting

- on rodent populations and tree seed survival. *Oikos*, **96**, 402–410.
- Schuler, J.L. & Robison, D.J. (2006) Stand development and growth responses of 1- and 3-year-old natural upland hardwoods to silvicultural treatments. *Forest Ecology and Management*, **232**, 124–134.
- Shimada, T. & Saitoh, T. (2006) Re-evaluation of the relationship between rodent populations and acorn masting: a review from the aspect of nutrients and defensive chemicals in acorns. *Population Ecology*, **48**, 341–352.
- Shine, C. (2007) Invasive species in an international context: IPPC, CBD, European Strategy on Invasive Alien Species and other legal instruments. *EPPO Bulletin*, **37**, 103–113.
- Siemann, E. & Rogers, W.E. (2001) Genetic differences in growth of an invasive tree species. *Ecology Letters*, **4**, 514–518.
- Siemann, E. & Rogers, W.E. (2003a) Herbivory, disease, recruitment limitation and success of alien and native tree species. *Ecology*, **84**, 1489–1505.
- Siemann, E. & Rogers, W.E. (2003b) Reduced resistance of invasive varieties of the alien tree *Sapinum sebiferum* to a generalist herbivore. *Oecologia*, **135**, 451–457.
- Simberloff, D. (2009) The role of propagule pressure in biological invasions. *Annual Review of Ecology, Evolution, and Systematics*, **40**, 81–102.
- Simberloff, D., Martin, J.L., Genovesi, P., Maris, V., Wardle, D.A., Aronson, J., Courchamp, F., Galil, B., García-Berthou, E., Pascal, M., Pyšek, P., Sousa, R., Tabacchi, E. & Vilà, M. (2013) Impacts of biological invasions: What's what and the way forward. *Trends in Ecology and Evolution*, **28**, 58–66.
- Sitzia, T. (2014) A call to silviculturists for a new field of science: The forestry of invasive alien species. *The Forestry Chronicle*, **90**, 486–488.
- Sitzia, T., Campagnaro, T., Kowarik, I. & Trentanovi, G. (2016) Using forest management to control invasive alien species: helping implement the new European regulation on invasive alien species. *Biological Invasions*, **18**, 1–7.
- Sork, V.L. (1984) Examination of Seed Dispersal and Survival in Red Oak, *Quercus Rubra* (Fagaceae), Using Metal-Tagged Acorns. *Ecology*, **65**, 1020–1022.
- Sork, V.L., Bramble, J. & Sexton, O. (1993) Ecology of mast fruiting in three species of North America deciduous oaks. *Ecology*, **74**, 528–541.
- Sork, V.L., Stacey, P. & Averett, J.E. (1983) Utilization of red oak acorns in non-bumper crop year. *Oecologia*, **59**, 49–53.
- Steiner, K.C. (1995) Autumn predation of northern red oak seed crops. *10th Central Hardwood Forest Conference* (eds K.W. Gottschalk & S.L.C. Fosbroke), pp. 489–494. Morgantown, West Virginia.
- Steiner, K.C., Abrams, M.D. & Bowersox, T.W. (1993) Advance reproduction and other stand characteristics in Pennsylvania and French stands of Northern Red Oak. *9th Central Hardwood Forest Conference* (eds A.R. Gillespie, G.R. Parker, P.E. Pope & G. Rink), pp. 473–483. West Lafayette, Indiana.

- Steiner, K.C. & Joyce, B.J. (1999) Survival and growth of a *Quercus rubra* regeneration cohort during five years following masting. *12th Central Hardwood Forest Conference* (ed Jeffrey W. Stringer and David L. Loftis), pp. 255–257. Lexington, Kentucky.
- Straigytė, L. & Zalkauskas, R. (2012) Effect of climate variability on *Quercus rubra* phenotype and spread in Lithuanian forests. *Dendrobiology*, **67**, 79–85.
- Thébaud, C. & Simberloff, D. (2001) Are Plants Really Larger in Their Introduced Ranges? *The American Naturalist*, **157**, 231–236.
- Theoharides, K.A. & Dukes, J.S. (2007) Plant invasion across space and time: factors affecting nonindigenous species success during four stage of invasion. *New Phytologist*, **176**, 256–273.
- Thill, A. (1994) La sylviculture du chêne rouge d'Amérique en Belgique. *Le chêne rouge d'Amérique* (eds J. Timbal, A. Kremer, N. Le Goff & G. Nepveu), pp. 254–264. Institut National de la Recherche Agronomique, Paris, France.
- Thompson, J.N. (1998) Rapid evolution as an ecological process. *Trends in Ecology & Evolution*, **13**, 329–32.
- Timbal, J., Bartoli, M. & Buffet, M. (1994) Introduction et utilisation en reboisement du chêne rouge en France. *Le chêne rouge d'Amérique* (eds J. Timbal, A. Kremer, N. Le Goff & G. Nepveu), pp. 425–443.
- Trakhtenbrot, A., Nathan, R., Perry, G. & Richardson, D.M. (2005) The importance of long-distance dispersal in biodiversity conservation. *Diversity and Distributions*, **11**, 173–181.
- Traveset, A. & Richardson, D.M. (2014) Mutualistic Interactions and Biological Invasions. *Annual Review of Ecology, Evolution, and Systematics*, **45**, 89–113.
- Uller, T. & Leimu, R. (2011) Founder events predict changes in genetic diversity during human-mediated range expansions. *Global Change Biology*, **17**, 3478–3485.
- Vansteenkiste, D., De Boever, L. & Van Acker, J. (2005) Alternative processing solutions for Red oak (*Quercus rubra*) from converted forests in Flanders, Belgium. *Cost Action E44 Conference in Vienna on broad spectrum utilisation of wood*.
- Verhoeven, K.J.F., Macel, M., Wolfe, L.M. & Biere, A. (2011) Population admixture, biological invasions and the balance between local adaptation and inbreeding depression. *Proceedings. Biological sciences / The Royal Society*, **278**, 2–8.
- Verloove, F. (2006) Catalogue of neophytes in Belgium (1800-2005). *Scripta Botanica Belgica*, **39**, 1–89.
- Vilà, M., Basnou, C., Pyšek, P., Josefsson, M., Genovesi, P., Gollasch, S., Nentwig, W., Olenin, S., Roques, A., Roy, D. & Hulme, P.E. (2010) How well do we understand the impacts of alien species on ecosystem services? A pan-European, cross-taxa assessment. *Frontiers in Ecology and the Environment*, **8**, 135–144.
- Vilà, M. & D'Antonio, C.M. (1998) Hybrid Vigor for Clonal Growth in *Carpobrotus* (Aizoaceae) in Coastal California. *Ecological Applications*, **8**, 1196–1205.
- Vilà, M., Espinar, J.L., Hejda, M., Hulme, P.E., Jarošík, V., Maron, J.L., Pergl, J.,

- Schaffner, U., Sun, Y. & Pyšek, P. (2011) Ecological impacts of invasive alien plants: a meta-analysis of their effects on species, communities and ecosystems. *Ecology Letters*, **14**, 702–708.
- Vilà, M. & Weiner, J. (2004) Are invasive plant species better competitors than native plant species? - evidence from pair-wise experiments. *Oikos*, **105**, 229–238.
- Vitasse, Y., Delzon, S., Bresson, C.C., Michalet, R. & Kremer, A. (2009a) Altitudinal differentiation in growth and phenology among populations of temperate-zone tree species growing in a common garden. *Canadian Journal of Forest Research*, **39**, 1259–1269.
- Vitasse, Y., Delzon, S., Dufrêne, E., Pontaillet, J.Y., Louvet, J.M., Kremer, A. & Michalet, R. (2009b) Leaf phenology sensitivity to temperature in European trees: Do within-species populations exhibit similar responses? *Agricultural and Forest Meteorology*, **149**, 735–744.
- Vitousek, P.M., D'Antonio, C.M., Loope, L.L., Rejmánek, M. & Westbrooks, R. (1997) Introduced species: a significant component of human-caused global change. *New Zealand Journal of Ecology*, **21**, 1–16.
- Vitousek, P.M., D'Antonio, C.M., Loope, L.L., & Westbrooks, R. (1996) Biological Invasions as Global Environmental Change. *American Naturalist*, **84**, 468–478.
- Vittoz, P. & Engler, R. (2007) Seed dispersal distances: a typology based on dispersal modes and plant traits. *Botanica Helvetica*, **117**, 109–124.
- Vander Wall, S.B. (2001) The evolutionary ecology of nut dispersal. *The Botanical Review*, **67**, 74–117.
- Weigel, D.R. & Johnson, P.S. (1998) Planting Northern Red Oak in the Ozark Highlands: A Shelterwood Prescription.
- Weigel, D.R. & Johnson, P.S. (2000) Planting Red Oak Under Oak/ Yellow-Poplar Shelterwoods : A Provisional Prescription.
- Westoby, M., Falster, D.S., Moles, A.T., Vesk, P.A. & Wright, I.J. (2002) Plant ecological strategies: Some Leading Dimensions of Variation Between Species. *Annual Review of Ecology and Systematics*, **33**, 125–159.
- Wiens, J.J. & Graham, C.H. (2005) Niche Conservatism: Integrating Evolution, Ecology, and Conservation Biology. *Annual Review of Ecology, Evolution, and Systematics*, **36**, 519–539.
- Williamson, M. (1996) Biological Invasions (ed New York: Chapman & Hall). Springer Science and Business Media.
- Williamson, M. (2006) Explaining and predicting the success of invading species at different stages of invasion. *Biological Invasions*, **8**, 1561–1568.
- Williamson, M. & Fitter, A. (1996) The Varying Success of Invaders. *Ecology*, **77**, 1661–1666.
- Wilson, J.R.U., Dormontt, E.E., Prentis, P.J., Lowe, A.J. & Richardson, D.M. (2009) Something in the way you move: dispersal pathways affect invasion success. *Trends*

- in Ecology & Evolution*, **24**, 136–144.
- de Wit, M.P., Crookes, D.J. & van Wilgen, B.W. (2001) Conflicts of interest in environmental management: estimating the costs and benefits of a tree invasion. *Biological Invasions*, **3**, 167–178.
- Woziwoda, B., Kopec, D. & Witkowski, J. (2014a) The negative impact of intentionally introduced *Quercus rubra* L. on a forest community. *Acta Societatis Botanicorum Poloniae*, **83**, 39–49.
- Woziwoda, B., Potocki, M., Sagan, J., Michaù, Z., Tomusiak, R. & Wilczynski, S. (2014b) Commercial Forestry as a Vector of Alien Tree Species - the Case of *Quercus rubra* L. Introduction in Poland. *Baltic Forestry*, **20**, 131–141.
- Zenni, R.D. & Nuñez, M.A. (2013) The elephant in the room: the role of failed invasions in understanding invasion biology. *Oikos*, **122**, 801–815.

**Annexe : Killing it Softly: Girdling as an
Efficient Eco-friendly Method to Locally
Remove the Invasive *Acer negundo***

Published in: Ecological Restoration

Killing it Softly: Girdling as an Efficient Eco-friendly Method to Locally Remove Invasive *Acer negundo*

Nastasia R. Merceron, Laurent J. Lamarque, Sylvain Delzon and Annabel J. Porté

ABSTRACT

Acer negundo (boxelder maple) is a North American native tree species that currently invades riparian and disturbed areas in Europe, affecting both bank stability and ecosystem biodiversity. As a response to managers' requests, we aimed at finding an eco-friendly method which would locally remove this species and help habitat restoration. Four control methods were tested on *A. negundo* adults and saplings from stands located in three experimental sites along different watercourses in Southwestern France: girdling, low cutting, high cutting, and cutting followed by the application of juglone (a natural allelopathic substance from walnut tree leaves). Mortality and resprout production on the treated *A. negundo* individuals were assessed during two years following the application of the control methods. Girdling was the most efficient method as it significantly induced higher mortality rates compared to the others (65 vs 15% of dead *A. negundo* two years after treatment administration). When healing emerged on trunks, yearly repeated girdling was required to reach full success. None of the control methods significantly reduced resprout production; not even the application of juglone. Girdling is the most recommended method to kill and remove *A. negundo* at a local scale in invaded natural habitats. Considering that *A. negundo* benefits from increases in light availability to outcompete native species, we further recommend removing seedlings from understories when applying girdling on adult and sapling individuals in order to optimize restoration conditions in natural stands and improve native species re-establishment.

Keywords: control methods, habitat restoration, management practices, tree invasion

Restoration Recap

- Girdling is an efficient eco-friendly control method to locally remove individual adults and saplings of *Acer negundo*, a resprouting tree invading European riparian forests and wetlands.
- Repeated girdling is necessary over two or three years to kill *A. negundo* individuals when stem healing is observed and to remove resprouts from the stems during spring time after leaf development.
- Timing of treatment application should be synchronized with tree cuttings or tree falls to impede release of *A. negundo* understory trees in light gap conditions.
- Seedlings should also be removed from the managing sites during at least two years after girdling of adult trees and saplings in order to control regeneration and allow native tree species to re-establishment.

Invasive plants significantly decrease native species diversity and modify ecosystem processes within invaded

communities (Vilà et al. 2011) resulting in large investments to manage and restore these ecosystems (Pimentel et al. 2005). Riparian ecosystems are highly subjected to invasions given that (i) rivers are efficient dispersal corridors for propagules over long distances (Säumel and Kowarik 2010), and (ii) frequent disturbances increase nutrient and light availability (Hood and Naiman 2000). Because they act as critical buffer zones along water courses (Correll 1996), traditional practices of invasive plant removal, inducing soil disturbance or chemical pollution, should be avoided. In France, chemical pesticides are forbidden in wetlands

 Color version of this article is available through online subscription at: <http://er.uwpress.org>

 This open access article is distributed under the terms of the CC-BY-NC-ND license (<http://creativecommons.org/licenses/by-nc-nd/3.0>) and is freely available online at: <http://er.uwpress.org>

Ecological Restoration Vol. 34, No. 4, 2016

ISSN 1522-4740 E-ISSN 1543-4079

©2016 by the Board of Regents of the University of Wisconsin System.

and forests (Journal Officiel de la République Française 2006). One challenge is therefore to develop efficient and eco-friendly methods to constrain plant invasions and restore invaded habitats.

Chemical, biological, and mechanical methods largely used by managers to control invasive herbaceous plants (Holt 2009) have also been tested on invasive woody species (van Wilgen et al. 2001). To date, broad-spectrum herbicide applications, i.e., Trycoplyr (Patch et al. 1998, Burch and Zedaker 2003) and Glyphosate (Walter et al. 2004, Itou et al. 2015), are the most efficient methods to kill invasive resprouting tree species. However, these practices can have substantial ecological consequences on non-target species if sprayed or by contaminating soil and water. Infections by pathogen fungi such as *Chondrostereum purpureum* (De Jong 2000, Becker et al. 2005) and *Fusarium* spp. (Ding et al. 2006) were also used with success but no homologation of these pathogens exist in Europe. Moreover, these generalist pathogens present a risk regarding native species and testing introduced ones would risk introducing a new virulent invasive species (Simberloff and Stiling 1996). In weed management, allelopathic compounds have also been used (Macías et al. 2007) but to our knowledge, allelopathic substances produced by native species were never tested to control invasive plants. Finally, mechanical methods (mowing, mulching, cutting, burning, uprooting, or girdling) are also largely used to eliminate invasive trees (Sabo 2000, Meloche and Murphy 2006, Loh and Daehler 2007, Tanaka et al. 2010). Although it is often time consuming, methods such as girdling or cutting can be applied on targeted individuals thus avoiding environmental impacts. Girdling is a common practice in forestry (MacKinney and Korstian 1932, Noel 1970) and is advised to locally eliminate invasive woody species in natural areas (Loh and Daehler 2007). However, partial girdling is a poorly efficient method to kill the resprouting invasive species *Robinia pseudoacacia* (black locust) and *Ailanthus altissima* (tree of heaven) (Kowarik and Säumel 2007, Cierjacks et al. 2013), therefore such methods has to be evaluated on more invasive tree species.

Native to North America, *A. negundo* (boxelder maple) is an alien species in Europe that has heavily invaded wetlands and riparian forests. The species' high resprouting ability leads to unsuccessful control by natural area managers using repeated cutting. Here, we aim to test ecologically-friendly methods to kill *A. negundo* to offer tools to managers involved in restoration. Cutting was used to mimic their current practices and we hypothesized that the use of an allelopathic substance (juglone) or stem girdling would prove more efficient due to their impacts on plant physiology. Efficiency was assessed during two years following treatment application and management recommendations are proposed.

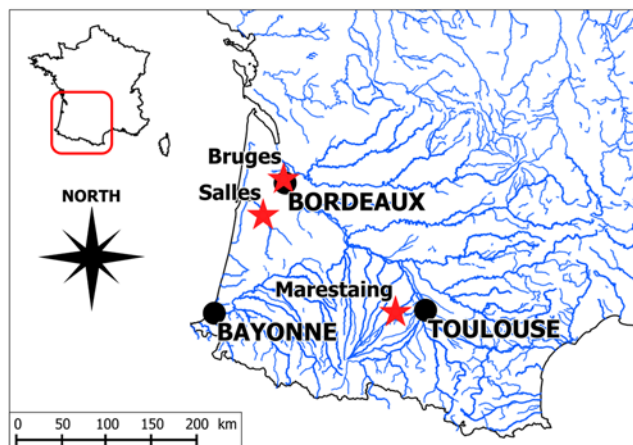

Figure 1. Map of the study area, including experimental sites (red stars), main cities (black dots), and the river network which favors the proliferation of *Acer negundo* in Southwestern France. The blank base map was provided free of charge and use by Daniel Dalet (Académie Aix-Marseille, www.pedagogie.ac-aix-marseille.fr/jcms/c_51055/fr/cartotheque-compacte).

Methods

Target Species

Acer negundo is a medium size, dioecious tree native to North America and intentionally introduced in Europe during the seventeenth century (Kowarik 2003), for horticulture and landscaping purposes. It has escaped from urban areas and colonized river banks and wetlands, becoming invasive throughout Southern and Eastern Europe and considered as one of the most invasive plant species in these habitats (DAISIE 2010). A female individual can produce high quantities of seeds (Schopmeyer 1974), about 100,000–500,000 samaras, dispersed by wind and water (Medrzycki 2011). Moreover, individuals have the ability to produce new vegetative sprouts following human cuttings or natural disturbances. Locally, this species may form monospecific stands (Lamarque et al. 2012), reducing both native species richness and abundance by decreasing light availability (Saccone et al. 2010, Bottollier-Curtet et al. 2012). In France, *A. negundo* invasion leads to replacement of economically important trees such as *Salix alba* (white willow) (Bottollier-Curtet et al. 2012) and *Populus* spp., to river bank collapses and reduces bird nesting (L. Degrave, Parc Naturel Régional des Landes de Gascogne and S. Buyle, Réserve Naturelle des Marais de Bruges, pers. comm.).

Experimental Design

Three riparian stands, Bruges, Marestaing, and Salles, were selected in Southwestern France because of their high densities of *A. negundo* (Figure 1). Bruges is a swampy forest which dominated by even-sized *A. negundo* and large *Fraxinus excelsior* (European ash) trees. Marestaing,

Table 1. Stands characteristics of three invaded forest stands in southwestern France. For each forest stand, density (tree/ha), relative density (%), mean diameter at breast height (dbh, cm \pm SD) and basal area (m²/ha) of adult trees are presented per species and for the whole plot (All). The geographic coordinates (degree, minutes and seconds) of each site are indicated below the stand name. The asterisks denote the species which were represented by only one tree in the experimental plots, thus explaining the absence of SD values.

Forest stand	Species	Density (tree/ha)	Relative density (%)	Mean dbh (cm \pm SD)	Mean basal area (m ² /ha)
Bruges (44°54'27.11"N 0°36'18.66"W)	<i>Acer negundo</i>	1,772	68.4	8.0 \pm 6.8	15.2
	<i>Alnus glutinosa</i>	33	1.3	10.9 \pm 13.6	0.7
	<i>Fraxinus excelsior</i>	417	16.1	17.4 \pm 9.7	12.9
	<i>Platanus sp.*</i>	8	0.3	20.4	0.3
	<i>Quercus robur</i>	73	2.8	11.3 \pm 15.3	1.9
	<i>Ulmus procera</i>	286	11.1	3.0 \pm 2.8	0.4
	All	2,589	100	—	31.4
Marestaing (43°34'31.56"N, 1°01'39.68"E)	<i>Acer negundo</i>	1,655	72.0	10.2 \pm 6.8	19.7
	<i>Alnus glutinosa</i>	29	1.3	10.6 \pm 2.6	0.3
	<i>Fraxinus excelsior</i>	97	4.3	10.6 \pm 12.1	1.9
	<i>Populus alba*</i>	10	0.4	43.2	1.4
	<i>Salix alba*</i>	10	0.4	52.0	2.1
	<i>Ulmus procera</i>	497	21.6	5.0 \pm 4.5	1.7
	All	2,298	100	-	27.1
Salles (44°32'54.13"N, 0°52'18.05"W)	<i>Acer negundo</i>	4,788	90.6	4.9 \pm 3.6	13.7
	<i>Alnus glutinosa</i>	57	1.1	6.9 \pm 3.2	0.2
	<i>Carpinus betulus</i>	19	0.4	8.5 \pm 0.3	0.1
	<i>Populus nigra*</i>	10	0.2	2.7	< 0.01
	<i>Populus sp.</i>	372	7.0	19.4 \pm 8.7	13.2
	<i>Quercus robur*</i>	10	0.2	5.6	0.02
	<i>Ulmus procera</i>	29	0.5	7.8 \pm 3.6	0.2
All	5,284	100	-	27.4	

located along the Save river, is a riparian forest mainly composed of small *Ulmus minor* (field elm) and numerous medium-sized *A. negundo* individuals. Salles, located along the L'Eyre River, is a riparian *Populus sp.* plantation largely invaded by abundant and small *A. negundo* trees (Table 1).

Each stand was divided into four plots, and each of the four control methods were randomly assigned to one plot (average area 220 \pm 21 m²). Control methods were specifically applied to *A. negundo* saplings (0.5 m < height < 3 m) and adult trees (height > 3 m) (Table 2) in May–June 2009, after sap rise and when leaves were fully developed. A unique code indicating the number of the tree and the control method applied was grafted to the base of the tree to follow successive analyses. The native species remained untouched. Saplings and adult trees were counted to assess tree density per species and diameter at breast height (dbh, cm) was measured using a dendrometric tape (\pm 0.1 cm).

All *A. negundo* seedlings (height < 0.5 m) were counted and removed out of the plots as were cutting residues. Four treatments were tested: 1) stem girdling, 2) high stem cutting, 3) low stem cutting, and 4) juglone application on cut trees. Stem girdling (Figure 2A, B) was performed at 1.30 m from the ground, using an axe or a machete to remove the bark, phloem, and cambium over a 30 cm long segment around the whole circumference. This approach allowed undamaged xylem tissues to keep supplying water and nutrients (raw sap) to the crown while removing phloem tissues prevented the distribution of sugars (elaborated sap) towards the stump and the root system. The purpose was to exhaust the tree to death as below-ground organs would die first and to avoid recurring resprouting. High stem cutting (Figure 2C) and low stem cutting (Figure 2F) were applied using a chainsaw at 1.30 m and 20 cm from the ground, respectively. These two methods aimed at

Table 2. Number of *Acer negundo* saplings and adults treated with each of the four control methods (stem girdling, high stem cutting, low stem cutting, juglone application) in each forest stand (Bruges, Marestaing, Salles).

Forest stand	Girdling		Low cutting		High cutting		Cutting + Juglone		Total
	Saplings	Adults	Saplings	Adults	Saplings	Adults	Saplings	Adults	
Bruges	0	14	6	41	3	53	5	65	187
Marestaing	0	46	0	38	3	20	0	41	148
Salles	2	60	16	131	10	129	9	124	481

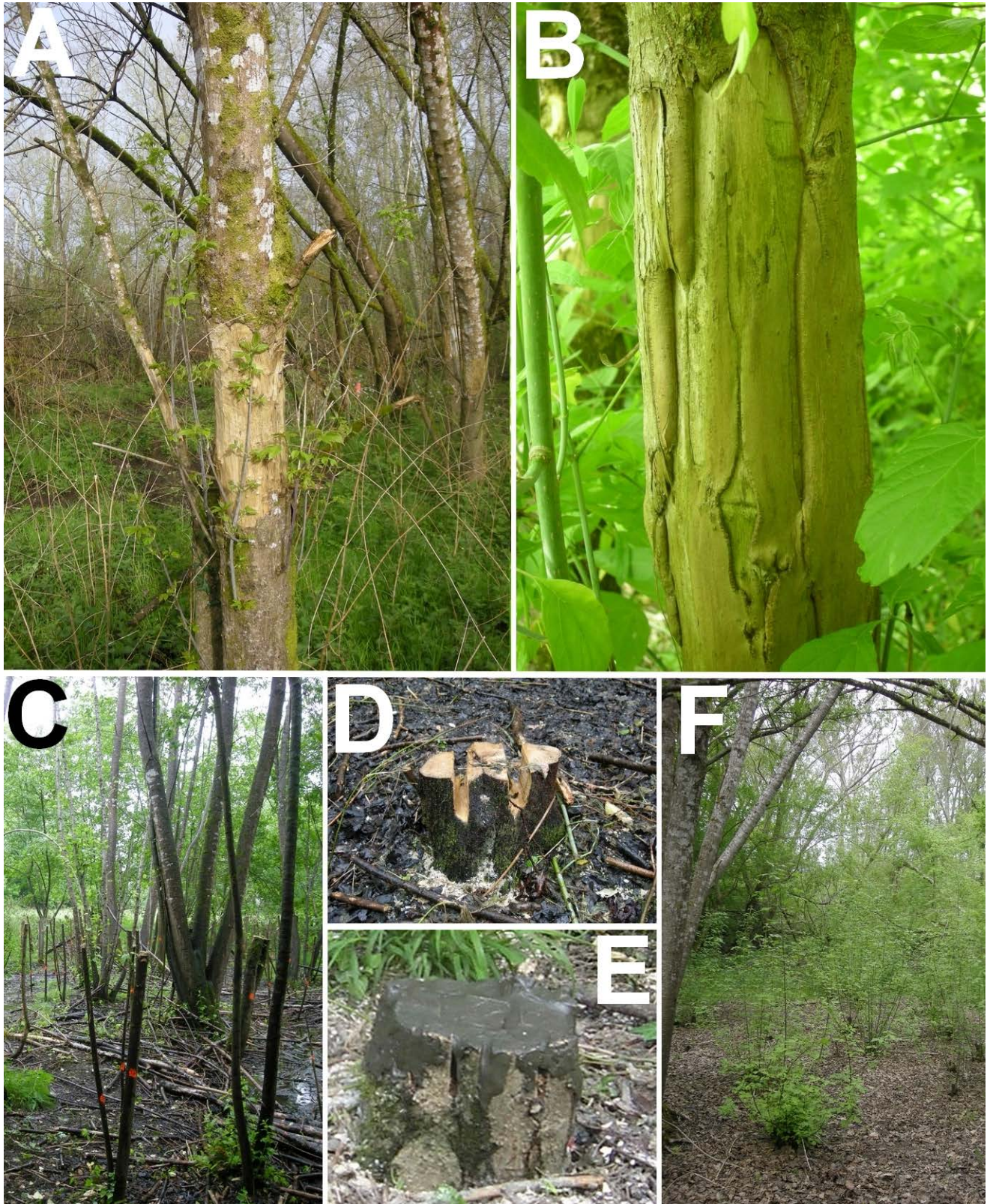

Figure 2. Illustration of the four control methods tested to kill individuals of *Acer negundo*: A) stem girdling presenting some small resprouts one year after treatment application (Salles, March 2010); B) close view of the girdled zone presenting stem healing (Marestaing, May 2010); C) general view of a plot after first treatment with the high stem cutting method (Salles, May 2009); D) close view of a stem cut which received application of the juglone-based mixture (Salles, May 2009) and E) once covered with healing balm to prevent leaks (Salles, May 2009); and F) low cuttings mimicking managers' current practices with numerous resprouts one year after first application of the treatment (Salles, April 2010). Photo Credit: A.J. Porté

mimicking common tree removal management practices in forestry. Juglone was applied as a mixture inside the stump after cutting at the tree base (Figure 2D, E). The Juglone mixture was made of crushed walnut leaves (3000 g, Côme and Verbena SARL, Aubenas, France), a binding substance (500 g, acacia gum powder, Fisher Scientific G/1050/53) and water (9l). A healing balm (Lac Balsam, Scotts France SAS, Medan SA Eysines, France) was applied on treated stumps to avoid any leakage. Walnut tree (*Juglans* sp.) leaves naturally contain significant amounts of juglone, an active allelopathic substance with herbicide properties (Rietveld 1983). Because juglone acts on plant growth by reducing photosynthesis, respiration, and blocking cell development (Neave and Dawson 1989, Jose and Gillespie 1998, Ercisli et al. 2005), we expect it to limit resprouting. Walnut leaves were preferred for juglone extract for cost reasons that would have prevented the actual use of the method by managers.

Evaluating Method Efficiency

Control method efficiency was evaluated on treated trees, encompassing both adults and saplings, in May during two years following first treatment application (Y + 1 – 2010, Y + 2 – 2011). Mortality of *A. negundo* was assessed by a visual survey of the absence of leaves in the crown and resprouts on the trunk. The total number of resprouts per tree was counted and the diameters (mm) of the five biggest resprouts per tree were measured using an electronic caliper. The mortality rate per treatment (%) was calculated as the ratio of the number of dead trees to the total number of treated trees. A final assessment of mortality was performed during a third year on the Salles and Marestaing sites on the cut and girdled plots only (Y + 3 – 2012). All resprouts were cut and removed from the plot. When healing had occurred on the stem of a girdled trees (Figure 2B), girdling was applied again.

Statistical Analyses

Analyses were conducted separately for each year of the experiment in order to provide information on the efficiency of the treatment at different time steps. Mortality of *A. negundo* individuals was analyzed using a generalized linear mixed model with a binary distribution and logit link function (procedure GLIMMIX in SAS, v. 9.4, SAS Institute, Cary, NC). Number of resprouts and mean diameter of the five biggest resprouts were analyzed using a linear mixed model (procedure MIXED in SAS, v. 9.4, SAS Institute, Cary, NC). The method was declared as a fixed effect, site and site x method interaction as random effects. The site effect was removed from the analysis when it did not present enough variation to get a proper estimate of the variance (Kiernan et al. 2012). Tree diameter was used to test for a possible covariance effect.

Results

One year after treatment application, there was no significant effect of the treatments on the mortality of *A. negundo* (Y + 1, Table 3). However, mortality increased in all treatments after two years. There was no significant effect of tree diameter on tree mortality for any tested method (data not shown), so all saplings and adults were pooled together for analyses. The second year after the experimental setting, there was a significant effect of the treatment methods (Y + 2, Table 3): girdling was the most efficient method (Figure 3) with a 65% average mortality rate. A large variability among sites was observed with 32.6% of mortality in Marestaing and 100% in Bruges. Three years after the first treatment application (Y + 3 – 2012), mortality rates after girdling reached 78% and 75%, in Marestaing and Salles, respectively. High cutting was the least efficient treatment across all sites; it even failed to kill a single tree in Bruges (Figure 3). Overall, juglone application was no more efficient than the high and low cutting methods.

Table 3. Results from mixed model analyses testing for the response of *Acer negundo* individuals in terms of mortality, number of resprouts, and mean diameter of the five biggest resprouts per individual. Analyses were performed independently for each monitoring year that followed method application (Y + 1, Y + 2). Method was treated as a fixed effect (F test values for fixed effects). Site and site x method interaction were treated as random effects (ChiSq in proc glimmix, Z in proc mixed), but site was removed from the analysis when presenting not enough variation to get a proper estimate of the variance. df = degrees of freedom. Asterisks (*) indicate statistically significant values ($p < 0.05$).

	Year	df	Method		Site		Site x method	
			F	p	χ^2 / Z	p	χ^2 / Z	p
Mortality	Y + 1	3	1.66	0.27	0.7	0.20	1.7	0.10
	Y + 2	3	4.09	0.04*	—	—	29.68	< 0.0001*
Number of resprouts	Y + 1	3	7.15	0.02*	0.88	0.19	1.47	0.07
	Y + 2	3	3.66	0.10	0.71	0.24	1.38	0.09
Mean diameter (mm)	Y + 1	3	6.51	0.02*	0.84	0.20	1.65	0.05
	Y + 2	3	5.30	0.05	0.60	0.27	1.40	0.08

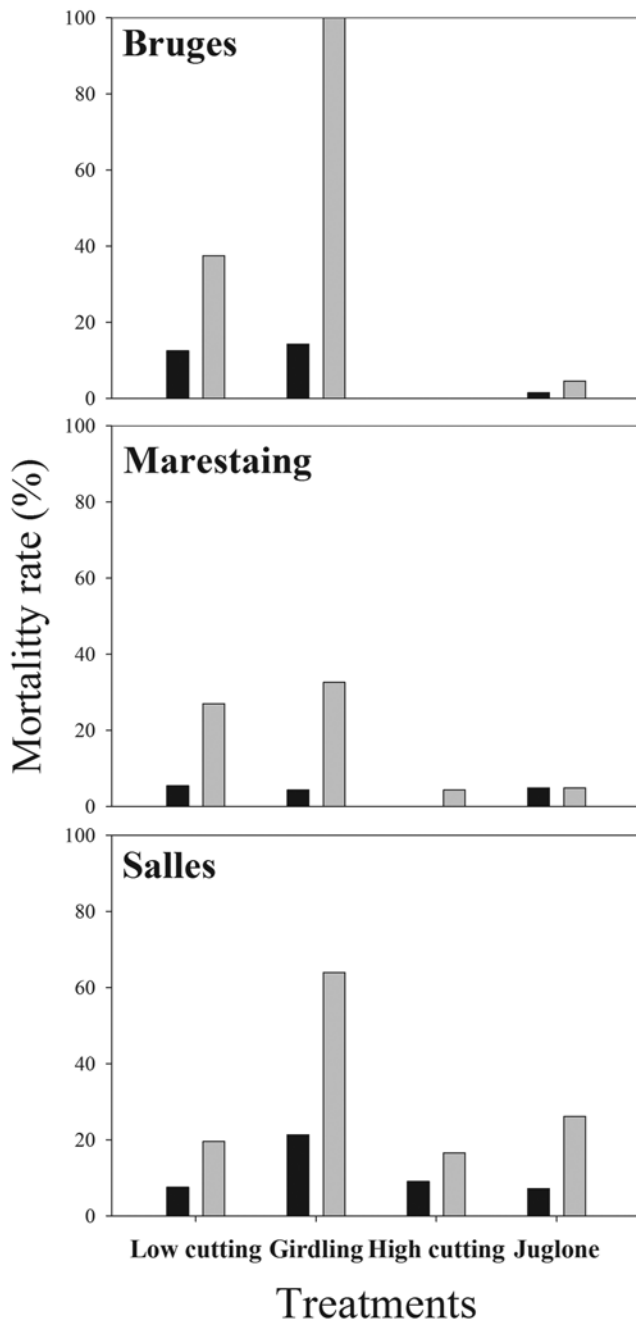

Figure 3. Mortality rate (%) of *Acer negundo* individuals per treatment method and experimental site after one (Y + 1, black bars) and two (Y + 2, grey bars) years of experiment.

During the first year following treatment application, resprouts were significantly affected by the treatments: resprouts were more numerous on trees treated with the high cutting method, and they were smaller on the girdled trees (Table 3, Table 4). Two years after treatment, the same tendency was observed although non-significant due to large variability among trees ($p = 0.05$, Table 3). Juglone application did not result in any reduction in resprouting ability, and resprouts were overall as numerous or large

than those observed on trees from low and high cutting methods (Table 4).

Discussion

An Ecologically-friendly Method to Kill the Invasive A. negundo

Tree girdling proved to be the most efficient method to kill individuals of *A. negundo* within invaded habitats and thus facilitate restoration process. Cutting methods currently used by managers proved to be the less efficient. Girdling has already proven to be efficient in killing individual resprouting trees (Negreros-Castillo and Hall 1994, Loh and Daehler 2007) but its efficiency was species-dependent. It had relatively low efficiency on *R. pseudoacacia* and *A. altissima* (Kowarik and Säumel 2007, Cierjacks et al. 2013), but was highly successful on *Falcataria moluccana* (Moluccan albizia) which reached death six to twelve months after girdling (Hughes et al. 2011). In our experiment, the high mortality of girdled *A. negundo* trees did not depend on tree size but instead could be due to the general character of this species that has a small root/shoot ratio (Porté et al. 2011). This could reflect little below-ground reserves and explain the efficiency of girdling in exhausting the tree to death. The major cause of girdled *A. negundo* survival was related to the healing that could occur after girdling (Figure 2B); this process probably reconstructed the phloem continuum from leaves to roots and compromised the exhaustion of the underground reserves. Healing was greatest on the Marestaing site, which could explain the between-site variability of treatment efficiency. The third year follow-up assessment of mortality by girdling on *A. negundo* indeed confirmed that a longer repeated treatment reduced the between-site variability. Although the removal of trees by girdling takes time and requires several applications, girdling avoids chemical pollution in natural areas (Noel 1970, Negreros-Castillo and Hall 1994) and should therefore be favored in wetlands. Moreover, dead standing trees can afterwards promote biodiversity by providing shelter or food (Müller and Bütler 2010).

Juglone application did not lead to significant results in our study contrary to previous tests on herbaceous plants or young seedlings (Rietveld 1983, Jose and Gillespie 1998, Ercisli et al. 2005, Tomilov et al. 2006, Terzi 2008). For example, Juglone has been found to limit germination and growth of *Alnus glutinosa* (black alder) seedlings (Neave and Dawson 1989). Adult trees such as the ones treated here were probably less sensitive than young seedlings. Moreover, we tested crushed walnut leaves opposite to the pure juglone extract used in the aforementioned studies. Further tests using other substances with higher allelopathic power (e.g., ailanthone) as potential inhibitors of *A. negundo* development could still be conducted.

Table 4. Mean values (\pm SE) of the number of resprouts per treated individual and of the diameter of the five biggest resprouts for each of the four control methods tested on *Acer negundo* adults and saplings. Analyses were performed independently for both monitoring years that followed method application (Y + 1, Y + 2). Means with the same letter are not considered statistically different ($p > 0.05$).

	Year	Control methods			
		Girdling	Low cutting	High cutting	Cutting + Juglone
Number of resprouts	Y + 1	26.3 \pm 6.2 A	9.2 \pm 6.0 A	30.5 \pm 6.0 B	14.7 \pm 6.0 A
	Y + 2	27.6 \pm 11.3 a	14.9 \pm 9.4 a	47.9 \pm 9.4 a	23.5 \pm 9.3 a
Mean diameter (mm)	Y + 1	4.7 \pm 2.2 A	9.2 \pm 2.2 B	13.1 \pm 2.1 B	11.2 \pm 2.1 B
	Y + 2	4.1 \pm 1.3 a	5.8 \pm 1.1 a	9.5 \pm 1.1 a	7.6 \pm 1.1 a

Management Implications

Girdling is an efficient eco-friendly control method to achieve local removal of *A. negundo*, a resprouting tree invading European riparian forests and wetlands. Although this control method has been demonstrated in wet and nutrient-rich ecosystems, it can be applied on *A. negundo* invading dry and resource-poor environments corresponding to its secondary invasive habitats (Erfmeier et al. 2011). When healing development is observed, it only requires repeated girdling for a few years to lead to exhaustion of *A. negundo* below-ground systems and to tree death. Whereas girdling is efficient on *A. negundo*, partial or total girdling resulted in the spread of *A. altissima* invasions by inducing root-sucker production (Kowarik and Säuml 2007). Thus any transfer to another species should be tested prior to its use as a restoration practice.

To impede the development of *A. negundo* saplings and understory trees into dominant trees of the upper layer of the riparian forest and avoid the formation of mono-specific maple stands, we recommend to particularly consider the timing of canopy opening. *Acer negundo* presents high growth plasticity in response to increasing light under nutrient-rich conditions, which allows it to outcompete co-occurring native tree species (Porté et al. 2011). Girdling treatment should be applied three years before any cutting of native species (e.g., *Populus nigra* for pulp or *S. alba* for fuel biomass) to prevent the expression of *A. negundo* plasticity. Similarly, girdling should be applied in emergencies after a natural disturbance (wind, storm, flooding) resulting in large canopy openings to limit its competition over local species.

Apart from removing adult trees, land managers should also consider the temporal dynamics and potential reestablishment through seeds (Simberloff 2009). We therefore suggest adapting South Africa's management recommendations for restoring riparian ecosystems (Holmes et al. 2008): (i) minimizing regeneration of *A. negundo* by removing all seedlings and juvenile individuals during two years (optimum seed life span, Möllerová 2005) after the removal of adult trees; and (ii) facilitating the restoration of native tree species using artificial seed-rains.

In 2013 and 2014, this protocol was successfully performed on *A. negundo* stands by local managers along the

Charente River in France (S. Fonteny, Conseil Général de Charente-Maritime, pers. comm.) inducing 75% mortality after two years thus avoiding establishment of large invasive populations. Our findings proved that girdling is an efficient eco-friendly method for land managers to achieve local removal of *A. negundo*, a resprouting tree invading riparian forests and wetlands across Europe. Precautions should however be considered when applying this method: (i) treatment needs to be repeated several years until exhaustion and death of *A. negundo* individuals when healing development is observed; (ii) an appropriate timing relatively to canopy opening must be considered for treatment application to avoid the plastic response of *A. negundo* to light availability and to limit its competitive advantage; and (iii) the removal of seedlings is advised during at least two years to control propagule pressure and to allow native vegetation to recover.

Acknowledgements

The authors would like to thank technicians and students from University of Bordeaux, INRA Bordeaux, Parc Naturel Régional des Landes de Gascogne, Réserve Naturelle des Marais de Bruges, Syndicat Intercommunal de Gestion et de Valorisation de la Save Gersoise who participated in the field work: S. Brogniez, Y. Ducournau, S. Buyle, L. Degrave, J. Roudie, O. Felis, A. Moreau, P. Vernin, and Y. Guengant. Authors would like to thank Maximilien Larter for English editing. The experiment was funded thanks to the Conseil général du Gers and Conseil général de la Gironde. This study has been carried out with financial support from the French National Research Agency (ANR) in the frame of the Investments for the future Program (ANR-10-IDEX-03-02).

References

- Becker, E., S.F. Shamoun and W.E. Hintz. 2005. Efficacy and environmental fate of *Chondrostereum purpureum* used as a biological control for red alder (*Alnus rubra*). *Biological Control* 33:269–277.
- Bottollier-Curtet, M., J-Y. Charcosset, F. Poly, A-M. Planty-Tabacchi and E. Tabacchi. 2012. Light interception principally drives the understory response to boxelder invasion in riparian forests. *Biological Invasions* 14:1445–1458.
- Burch, P.L. and S.M. Zedaker. 2003. Removing the invasive tree *Ailanthus altissima* and restoring natural cover. *Journal of Arboriculture* 29:18–24.

- Cierjacks, A., I. Kowarik, J. Joshi, S. Hempel, M. Ristow, M. von der Lippe and E. Weber. 2013. Biological Flora of the British Isles: *Robinia pseudoacacia*. *Journal of Ecology* 101:1623–1640.
- Correll, D.L. 1996. Buffer Zones and water quality protection: general principles. Pages 7–20 in N. Haycock, T. Burt, K. Goulding and G. Pinay (eds.) *Buffer Zones: Their Processes and Potential in Water Protection. The Proceedings of the International Conference on Buffer Zones*. Quest Environmental, Harpenden, Hertfordshire, UK.
- Delivering Alien Invasive Species Inventories for Europe (DAISIE). 2010. European invasive alien species gateway. www.europe-alien.org.
- De Jong, M.D. 2000. The BioChon story: Deployment of *Chondrostereum purpureum* to suppress stump sprouting in hardwoods. *Mycologist* 14:58–62.
- Ding, J.Q., Y. Wu, H. Zheng, W. Fu, R. Reardon and M. Liu. 2006. Assessing potential biological control of the invasive plant, tree-of-heaven, *Ailanthus altissima*. *Biocontrol Science and Technology* 16:547–566.
- Ercisli, S., A. Esitken, C. Turkkal and E. Orhan. 2005. The allelopathic effects of juglone and walnut leaf extracts on yield, growth, chemical and PNE compositions of strawberry cv. Fern. *Plant, Soil and Environment* 51:283–287.
- Erfmeier, A., M. Böhnke and H. Bruelheide. 2011. Secondary invasion of *Acer negundo*: The role of phenotypic responses versus local adaptation. *Biological Invasions* 13:1599–1614.
- Holmes, P.M., K.J. Esler, D.M. Richardson and E.T.F. Witkowski. 2008. Guidelines for improved management of riparian zones invaded by alien plants in South Africa. *South African Journal of Botany* 74:538–552.
- Holt, J. 2009. Management of invasive terrestrial plants. Pages 126–140 in M.N. Clout and P.A. Williams (eds.) *Invasive Species Management: A Handbook of Principles and Techniques*. New York, NY: Oxford University Press.
- Hood, W.G. and R.J. Naiman. 2000. Vulnerability of riparian zones to invasion by exotic vascular plants. *Plant Ecology* 148:105–114.
- Hughes, R.F., M.T. Johnson and A. Uowolo. 2011. The invasive alien tree *Falcataria moluccana*: its impacts and management. Pages 218–223 in Y. Wu, T. Johnson, S. Sing, S. Raghu, G. Wheeler, P. Pratt, K. Warner, T. Center, J. Goolsby and R. Reardon (eds.) *Proceedings of the XIII International Symposium on Biological Control of Weeds*. U.S. Department of Agriculture, Forest Service, Forest Health Technology Enterprise Team, 2012–07.
- Itou, T., K. Hayama, A. Sakai, H. Tanouchi, S. Okuda, H. Kushima and T. Kajimoto. 2015. Developing an effective glyphosate application technique to control *Bischofia javanica* Blume, an invasive alien tree species in the Ogasawara Islands. *Journal of Forest Research* 20:248–253.
- Jose, S. and A.R. Gillespie. 1998. Allelopathy in black walnut (*Juglans nigra* L.) alley cropping. II. Effects of juglone on hydroponically grown corn (*Zea mays* L.) and soybean (*Glycine max* L. Merr.) growth and physiology. *Plant and Soil* 203:199–205.
- Journal Officiel de la République Française. 2006. Arrêté du 12 septembre 2006 relatif à la mise sur le marché et à l'utilisation des produits visés à l'article L. 253–1 du code rural et de la pêche.
- Kiernan, K., J. Tao and P. Gibbs. 2012. Tips and strategies for mixed modeling with SAS/STAT Procedures. (Paper 332–2012). In SAS Forum.
- Kowarik, I. 2003. *Biologische Invasionen—Neophyten und Neozoen in Mitteleuropa*. Stuttgart, Germany: Eugen Ulmer Verlag.
- Kowarik, I. and I. Säumel. 2007. Biological flora of Central Europe: *Ailanthus altissima* (Mill.) Swingle. *Perspectives in Plant Ecology, Evolution and Systematics* 8:207–237.
- Lamarque, L.J., S. Delzon, M.H. Sloan and C.J. Lortie. 2012. Biogeographical contrasts to assess local and regional patterns of invasion: A case study with two reciprocally introduced exotic maple trees. *Ecography* 35:803–810.
- Loh, R.K. and C.C. Daehler. 2007. Influence of invasive tree kill rates on native and invasive plant establishment in a Hawaiian forest. *Restoration Ecology* 15:199–211.
- Macias, F., J. Molinillo, R. Varela and J. Galindo. 2007. Allelopathy—A natural alternative for weed control. *Pest Management Science* 63:327–348.
- MacKinney, A.L. and C.F. Korstian. 1932. Felling, Girdling, and Poisoning Undesirable Trees in Forest Stands. *Journal of Forestry* 30:169–177.
- Medrzycki, P. 2011. NOBANIS—Invasive alien species fact sheet—*Acer negundo*. Online Database of the European Network on Invasive Alien Species—NOBANIS. www.nobanis.org/globalassets/speciesinfo/a/acer-negundo/acer_negundo.pdf.
- Meloche, C. and S.D. Murphy. 2006. Managing tree-of-heaven (*Ailanthus altissima*) in parks and protected areas: A case study of Rondeau Provincial Park (Ontario, Canada). *Environmental Management* 37:764–772.
- Möllerová, J. 2005. Notes on invasive and expansive trees and shrubs. *Journal of Forest Science* 51:19–23.
- Müller, J. and R. Büttler. 2010. A review of habitat thresholds for dead wood: A baseline for management recommendations in European forests. *European Journal of Forest Research* 129:981–992.
- Neave, I.A. and J.O. Dawson. 1989. Juglone reduces growth, nitrogenase activity, and root respiration of actinorhizal black alder seedlings. *Journal of Chemical Ecology* 15:1823–1836.
- Negreros-Castillo, P. and R.B. Hall. 1994. Four methods for partial overstory removal in tropical forests in Mexico. *Journal of Environmental Management* 41:237–243.
- Noel, A.R.A. 1970. The girdled tree. *The Botanical Review* 36:162–195.
- Patch, N.L., D. Geesing and P. Felker. 1998. Suppression of resprouting in pruned mesquite (*Prosopis glandulosa* var *glandulosa*) saplings with chemical or physical barrier treatments. *Forest Ecology and Management* 112:23–29.
- Pimentel, D., R. Zuniga and D. Morrison. 2005. Update on the environmental and economic costs associated with alien-invasive species in the United States. *Ecological Economics* 52:273–288.
- Porté, A.J., L.J. Lamarque, C.J. Lortie, R. Michalet and S. Delzon. 2011. Invasive *Acer negundo* outperforms native species in non-limiting resource environments due to its higher phenotypic plasticity. *BMC Ecology* 11:28.
- Rietveld, W.J. 1983. Allelopathic effects of juglone on germination and growth of several herbaceous and woody species. *Journal of Chemical Ecology* 9:295–308.
- Sabo, A. 2000. *Robinia pseudoacacia* invasions and control in North America and Europe. *Restoration and Reclamation Review* 6:1–9.
- Saccone, P., J.-P. Pagès, J. Girel, J.-J. Brun and R. Michalet. 2010. *Acer negundo* invasion along a successional gradient: Early direct facilitation by native pioneers and late indirect facilitation by conspecifics. *The New Phytologist* 187:831–842.
- Säumel, I. and I. Kowarik. 2010. Urban rivers as dispersal corridors for primarily wind-dispersed invasive tree species. *Landscape and Urban Planning* 94:244–249.
- Schopmeyer, C. 1974. *Seeds of Woody Plants in the United States*. Agriculture Handbook, United State Department of Agriculture, Forest Service, Government Printing Office, Washington, DC.

- Simberloff, D. and P. Stiling. 1996. Risks of species introduced for biological control. *Biological Conservation* 78:185–192.
- Simberloff, D. 2009. The role of propagule pressure in biological invasions. *Annual Review of Ecology, Evolution, and Systematics* 40:81–102.
- Tanaka, N., K. Fukasawa, K. Otsu, E. Noguchi and F. Koike. 2010. Eradication of the invasive tree species *Bischofia javanica* and restoration of native forests on the Ogasawara Islands. Pages 167–171 in I. Okochi and K. Kawakami (eds.) *Restoring the Oceanic Island Ecosystem: Impact and Management of Invasive Alien Species in the Bonin Islands*. Tokyo, Japan: Springer.
- Terzi, I. 2008. Allelopathic effects of juglone and decomposed walnut leaf juice on muskmelon and cucumber seed germination and seedling growth. *African Journal of Biotechnology* 7:1870–1874.
- Tomilov, A., N. Tomilova, D.H. Shin, D. Jamison, M. Torres, R. Reagan, H. McGray, T. Horning, R. Truong, A. Nava, A. Nava and J.I. Yoder. 2006. Chemical signaling between plants. Pages 55–69 in M. Dicke and W. Takken (eds.) *Chemical Ecology: From Gene to Ecosystem*. The Netherlands: Springer.
- van Wilgen, B., D. Richardson and S. Higgins. 2001. Integrated control of invasive alien plants in terrestrial ecosystems. *Land Use and Water Resources Research* 1:1–6.
- Vilà, M., J.L. Espinar, M. Hejda, P.E. Hulme, V. Jarošík, J.L. Maron, J. Pergl, U. Schaffner, Y. Sun and P. Pyšek. 2011. Ecological impacts of invasive alien plants: A meta-analysis of their effects on species, communities and ecosystems. *Ecology Letters* 14: 702–708.
- Walter, W., H.E. Garrett and L.D. Godsey. 2004. Use of herbicide to reduce stump-sprouting following thinning of an eastern black walnut agroforestry planting. Pages 106–109 in C.H. Michler, P.M. Pijut, J.W. Van Sambeek, M.V. Coggeshall, J. Seifert, K. Woeste, R. Overton and F. Ponder (eds.), *Proceedings of the 6th Walnut Council Research Symposium. General Technical Report. NC-243*. St. Paul, MN: U.S. Department of Agriculture, Forest Service, North Central Research Station.

Nastasia R. Merceron (corresponding author) BIOGECO, INRA, Univ. Bordeaux, 33615 Pessac, France, nastasia.merceron@u-bordeaux.fr.

Laurent J. Lamarque, BIOGECO, INRA, Univ. Bordeaux, 33615 Pessac, France.

Sylvain Delzon, BIOGECO, INRA, Univ. Bordeaux, 33615 Pessac, France.

Annabel J. Porté, BIOGECO, INRA, Univ. Bordeaux, 33615 Pessac, France. annabel.porte@pierroton.inra.fr.



Acer negundo. USDA-NRCS PLANTS Database. USDA NRCS. *Wetland flora: Field office illustrated guide to plant species*. USDA Natural Resources Conservation Service.

Titre : Processus écologiques et évolutifs impliqués dans le succès de l'introduction de *Quercus rubra* L. en Europe

Résumé : Le chêne rouge d'Amérique (*Quercus rubra* L.) est un arbre originaire d'Amérique du Nord et introduit en Europe à partir de la fin du XVII^{ème} siècle pour l'ornementation et le commerce du bois. Le but de cette thèse est de comprendre les mécanismes écologiques et évolutifs qui contribuent à la dynamique et au succès de l'introduction de *Q. rubra* en Europe. Nous avons montré que cette espèce naturalisée et plantée dans certains pays européens parvient aisément à se développer de façon naturelle dans les forêts de feuillus et de conifères. La dispersion de ses glands est notamment rendue possible par des animaux fousseurs-disperseurs, tels que les écureuils et les mulots, qui cependant préfèrent les glands du chêne natif *Q. robur*. Lors de l'introduction d'une espèce dans un nouvel environnement, des processus évolutifs sont susceptibles de se produire et d'engendrer des modifications phénotypiques et génétiques au sein des populations introduites. Une analyse comparative de la structure et de la diversité génétique des populations natives et introduites de *Q. rubra* a démontré que seulement deux des trois groupes génétiques de l'aire américaine sont actuellement présents en Europe. Aucun goulot d'étranglement fort n'a été détecté lors de l'introduction des populations en Europe laissant supposer que des introductions multiples ont pu maintenir la diversité génétique dans les populations introduites. Une analyse comparative des traits phénotypiques a permis de montrer que les populations introduites de *Q. rubra* présentent une croissance supérieure par rapport aux populations natives. Une différenciation génétique au sein des populations introduites est en cours pour le trait de débourrement foliaire suggérant une possible évolution adaptative rapide depuis l'introduction.

Mots-clés : *Quercus rubra*, régénération naturelle, dispersion des glands, différenciation génétique, structure des populations, invasion biologique.

Title: Ecological and evolutionary processes involved in the success of *Quercus rubra* L. introduction in Europe

Abstract: Northern Red Oak (*Quercus rubra* L.) is a tree native to North America and introduced in Europe at the end of the 17th century as an ornamental and forestry species. The aim of this dissertation is to understand the ecological and evolutionary mechanisms contributing to its dynamics and success in Europe. We demonstrated that this species naturalized and planted in some European countries can easily naturally grow in deciduous and conifer forests. Acorn dispersal away from mother-trees was made possible by scatter-hoarding animals such as squirrels and mice that take away acorns, although the animals still preferred acorns of the native oak *Q. robur*. During species introduction in a new environment, evolutionary processes can occur and lead to phenotypic and genetic changes. A comparative analysis of the genetic structure and diversity of *Q. rubra* populations from the native and introduced ranges demonstrated that only two of the three genetic clusters encountered in North America are currently present in Europe. No strong bottleneck event was detected during the introduction of *Q. rubra* populations in Europe suggesting that multiple introductions could have maintained genetic diversity in introduced populations. A comparative analysis of phenotypic traits showed that introduced populations of *Q. rubra* present a higher growth compared to that of native populations. A genetic differentiation within European populations is ongoing regarding phenology of leaf budburst suggesting a possible rapid adaptive evolution since introduction.

Keywords: *Quercus rubra*, natural regeneration, acorn dispersal, genetic differentiation, population structure, biological invasion.