



HAL
open science

Role of lysine acetyltransferase (KAT) activation in spatial memory : a new therapeutic approach for memory related disorders such as Alzheimer's disease

Snehajyoti Chatterjee

► To cite this version:

Snehajyoti Chatterjee. Role of lysine acetyltransferase (KAT) activation in spatial memory : a new therapeutic approach for memory related disorders such as Alzheimer's disease. Neurobiology. Université de Strasbourg, 2015. English. NNT : 2015STRAJ092 . tel-01536343v1

HAL Id: tel-01536343

<https://theses.hal.science/tel-01536343v1>

Submitted on 11 Jun 2017 (v1), last revised 12 Jun 2017 (v2)

HAL is a multi-disciplinary open access archive for the deposit and dissemination of scientific research documents, whether they are published or not. The documents may come from teaching and research institutions in France or abroad, or from public or private research centers.

L'archive ouverte pluridisciplinaire **HAL**, est destinée au dépôt et à la diffusion de documents scientifiques de niveau recherche, publiés ou non, émanant des établissements d'enseignement et de recherche français ou étrangers, des laboratoires publics ou privés.



UNIVERSITÉ DE STRASBOURG



ÉCOLE DOCTORALE DES SCIENCES DE LA VIE DE LA SANTE (ED414)

Laboires de Neurosciences Cognitives et Adaptatives

THÈSE présentée par :
Snehajyoti Chatterjee

soutenu le : **11 December, 2015**

pour obtenir le grade de : **Docteur de l'université de Strasbourg**

Discipline/ Spécialité : **Neurosciences**

Role of Lysine Acetyltransferase (KAT) Activation in Spatial Memory: A New Therapeutic Approach for Memory Related Disorders such as Alzheimer's Disease

THÈSE dirigée par :

Dr BOUTILLIER Anne-Laurence

Directeur de Recherche CNRS, University of Strasbourg

RAPPORTEURS :

Dr García-Osta Ana

Research Scientist, University of Navarra

Dr Sergeant Nicolas

Directeur de Recherche INSERM, University Lille

AUTRES MEMBRES DU JURY :

Dr Barco Angel

CSIC Research Investigator, Universitat Miguel Hernandez de Elche (UMH)

Dr Rouaux Caroline

Chargé de Recherches CNRS, University Strasbourg

To Ma, Baba and Tania

Acknowledgements

I would like to thank my PhD mentor Dr Anne-Laurence Boutillier for guidance, mentorship and providing all the important training that helped to improve my scientific knowledge and growth. It was a wonderful experience to work with you. Thanks for discussing with me about the project and science for those countless hours. During the most difficult times while writing the thesis, you have given me the moral support, freedom and strong intellectual inputs that I needed the most. The amount of support that I received from you cannot be expressed in words.

Thank you to all the members of LNCA for accepting me when I first arrived in Strasbourg and lending your helping hands whenever I needed.

Thank you Dr. Jean-Christophe Cassel, the director of LNCA, your dynamic personality, limitless motivation and passion for neuroscience always motivates me. Thanks Dr. Christian Kelche, Dean of the Faculty of Psychology for always encouraging me.

I also wish to thank the Committee for the Scrutiny of my thesis, Dr Ana García-Osta, Dr Nicolas Sergeant, Dr Angel Barco, Dr Caroline Rouaux.

I acknowledge my funding agency CEFIPRA/IFCPAR for funding my PhD scholarship.

Thanks a lot to Dr Tapas K Kundu, under whom I have first started my journey in research. The training that I received while working with you has laid the foundation for me to do science. You have always inspired and motivated me and your contribution in my research carrier is immense.

Thanks to my collaborators: Dr Ted Abel, Philadelphia, USA, Dr Luc BUEE and Dr David BLUM, Lille, France, Dr. Patrick DUTAR, Paris, France and Dr. Claire Rampon, Toulouse, France for always being so helpful and supportive.

Thanks to Catherine for the administrative assistances. Also thanks for significantly contributing to improve my stamp collection diary.

Thanks to the past and present members of Boutillier's team: Anne Anthony, Amelie Gressier, Raphaëlle Cassel, Romain Neidl and Olivier Bousiges for being so friendly, discussing about ideas and providing valuable suggestions. Thanks Olivier Bousiges for giving important inputs for my thesis introduction chapters.

Thanks Celine and Julien for all the helpful discussions and for those trips around Alsace that helped me to get rid of all the stress.

Thanks Jean Bastian, Jean Baptiste, and Marco for the helpful discussions and hang-outs together.

Thanks Romain Goutagny, Karine Merienne, Anne Pereira, Pascal, Lucas, Alexandra, Monique, Aline, Katia, Dominique, Herrade and Chantal for being so nice and kind to me and sharing your knowledge with me. Talking to you is always a pleasure.

Thank you Karine Herbeaux, Carole, Aurelia and Aurelie. Thank you for all the good times spent working with you. It's lucky to have you and to benefit from your expertise. Thanks to Fanny, Valentine and Victor for always being so helpful.

Brigitte, special thanks goes to you. Your help throughout my PhD was a great support.

Thank you Olivier, Georges and Daniel for providing excellent care to our dear animals.

Thanks to all the members of LNCA.

I also like to thank all my friends and well-wishers from Strasbourg: Anamika bhabi, Ananya di, Arghyashree, Atish da, Chinmoy, Jan, Ming, Nadia, Natarajan, Nicholas, Niraj, Pavan, Prem Ji, Satish, Shankari di, Sonali bhabi, Soumya da and Souvick, and my friends from India: Amit, Babhru, Bappa, Rahul Khasnabish, Rahul Modak for your constant support and encouragement.

I will like to take this opportunity to thank my parents. Thank you for trusting me since the beginning and for supporting and motivating me on every step throughout these studies. Its because of you that I could come this far in my academic career. Thanks to my in-laws for trusting me and always being so encouraging. Thanks to all members of my family for all the support that I got from you.

I thank my better half, Tania. Thank you for accompanying and supporting me for the last 10 years for my adventures in life. Thank you also for listening to all my complaints, being my companion throughout this journey and most importantly your patience. You deserve a lot of credit for my PhD to go so smoothly. Thank you for everything.

Contents

Principal Abbreviations	8
<i>General Introduction and Objectives of the Thesis</i>	13
<i>SECTION I: General Introduction</i>	17
<i>CHAPTER 1: Learning and Memory</i>	18
<i>CHAPTER 1: Learning and Memory</i>	19
1. Introduction to Learning and memory	19
1.1. Brief history	19
1.2. Different forms of Memory.....	20
2. Role of Hippocampus in the consolidation of Spatial memory	28
2.1. Hippocampus: Anatomy and Nomenclature	28
2.2. The standard connectional view.....	28
2.3. Different cell types present in hippocampus	29
2.4. Glutamatergic Neurotransmission in the Hippocampus	31
2.5. Theories of hippocampal function	34
3. Memory consolidation: Synaptic and Systemic.....	35
3.1. Synaptic consolidation	35
3.2. Systems consolidation.....	41
4. Adult Neurogenesis and Memory consolidation.....	45
4.1. Neurogenesis process in the Dentate gyrus.....	45
4.2. Systemic regulation of adult neurogenesis.....	47
4.3. Functions of immature adult born neurons	48
4.4. Adult hippocampal neurogenesis and cognition	48
<i>CHAPTER 2: Molecular Mechanism of Memory</i>	52
1. Introduction to molecular events during memory consolidation	52
2. Growth factors involved in synaptic plasticity and memory	53
Brain-derived neurotrophic factor (BDNF)	54
3. Signaling cascades involved during memory formation	59
MAPK signaling cascade in synaptic plasticity and memory consolidation.....	59
4. Implications of transcription factors in synaptic plasticity and memory	62
CREB	62
5. Neuronal activity-regulated gene expression during memory formation.....	65
Immediate early genes (IEGs) in memory	65
<i>CHAPTER 3: Epigenetics and Memory</i>	73

1.	Basic introduction to Epigenetics	74
1.1.	Definition and introduction.....	74
1.2.	Different Histone Post translational modifications	75
1.3.	Writers and Erasers of acetylation	79
3.	Histone acetylation and transcription regulation in memory formation	85
3.1.	Histone acetylation and gene expression	85
3.2.	Histone acetylation and neuronal activity	86
3.3.	Histone acetylation and synaptic plasticity	87
3.4.	Histone acetylation and memory formation	88
4.	Role of lysine acetyltransferases (HATs/KATs) in cognitive function	89
	CREB binding protein (CBP)	89
	p300.....	91
	p300/CBP-associated factor (PCAF)	91
	Gcn512.....	92
	Tip60.....	92
5.	Histone Deacetylases (HDACs) in Cognitive Processes	93
6.	Role of other PTMs in learning and memory.....	96
6.1.	Histone Phosphorylation in Memory	96
6.2.	Histone Methylation and Memory	96
<i>CHAPTER 4: Alzheimer's Disease: Possible Therapeutics using Epigenetic Drugs</i>		98
1.	Basic introduction to Alzheimer's disease (AD)	99
1.1.	History.....	99
1.2.	Epidemiology of Alzheimer's disease	100
1.3.	Symptoms	101
1.4.	Therapies of AD.....	103
2.	Important players associated with pathophysiology of Alzheimer's disease (AD)	104
2.1.	Amyloid Precursor Protein (APP).....	104
2.2.	ApoE4	106
2.3.	Tau	108
3.	Tau as a model system to study Alzheimer's disease and other tauopathies: THY-Tau22	113
	Hippocampal synaptic plasticity	113
	Behavioral abnormalities	114
4.	Histone modifications and AD: Implications of small molecule modulators of HATs as a therapeutic possibility	115

4.1. Non-histone protein acetylation and AD.....	115
4.2. Histone acetylation and AD	117
4.3. Histone deacetylases in AD	117
4.4. Small molecule modulators of acetylation in the treatment of AD.....	118
<i>SECTION II</i>	121
<i>Experimental Contributions</i>	121
PUBLICATION 1.	122
A Novel Activator of CBP/p300 Acetyltransferases Promotes Neurogenesis and Extends Memory Duration in Adult Mice	122
PUBLICATION 2.	147
CREB-dependent CBP regulations of plasticity-related genes is required for long-term spatial memory formation	147
PUBLICATION 3	188
Chronic treatment of a Tau mouse model with a HAT activator increases maturation of newly generated neurons and improves hippocampus-dependent memory	188
<i>Supporting Results</i>	232
Supporting Results, SR1	233
Supporting Results SR2	234
Supporting Results SR3A	235
Supporting Results SR3B	239
Supporting Results SR4	244
<i>SECTION III</i>	245
<i>General Discussion and Future Perspectives</i>	245
<i>Annexe</i>	258
PUBLICATION 4.	259
Acetyltransferases (HATs) as Targets for Neurological Therapeutics	259
PUBLICATION 5.	281
Multifunctional chromatin organizing protein, PC4 is critical for brain plasticity	281
<i>References</i>	282

Principal Abbreviations

Ac	acetylation
AD	Alzheimer's disease
AMPA	α -amino-3-hydroxy-5-methyl-4-isoxazolepropionic acid
APP	Amyloid Precursor Protein
ARC	Activity regulated cytoskeleton-associated protein
BDNF	Brain-derived neurotrophic factor
C/EBP	CCAAT enhancer-binding protein
CA	cornu ammonis
CAM	Cell adhesion molecules
CaMKII	Calcium/calmodulin-dependent protein kinase II
CBP	CREB binding protein
CNS	Central nervous system
CRE	cyclic AMP-responsive element
CREB	cAMP-response element binding protein
DG	Dentate gyrus
DGC	Dentate granule cells
EC	Entorhinal cortex
EGR	Early growth response protein
ERK	Endoplasmic reticulum kinase
GABA	γ -aminobutyric acid
GF	Growth factors
HAT	Histone acetyltransferase
HD	Huntington's disease
HDAC	Histone deacetylase
IEG	Immediate early gene
KIX	Kinase-inducible domain interacting
LTD	Long-term depression
LTM	Long-term memory
LTP	Long-term potentiation
MAPK	Mitogen-activated protein kinase
Me	Methylation

MTL	Medial temporal lobes
MTT	Multiple trace theory
MWM	Morris water maze
NF-κB	Nuclear factor-k light-chain enhancer of activated B cells
NFTs	Neurofibrillary Tangles
NGF	Nerve growth factor
NMDA	N-methyl-D-aspartate
NR	Nuclear receptor
P	Phosphorylation
PCAF	p300/CBP-associated factor
PKC	Protein kinase C
PSD95	Postsynaptic density protein 95
PTM	Post-translational modification
RSTS	Rubinstein-Taybi Syndrome
SARE	Synaptic activity-responsive element
SRF	Serum response factor
STM	Short-term memory
SVZ	Subventricular zone
TF	Transcription factors
TGRA	Temporally-graded retrograde amnesia

Research Communications Related to the Thesis

Major publications from the thesis

1. **Chatterjee S^Ψ**, Mizar P^Ψ, Cassel R^Ψ, Neidl R, Selvi BR, Mohankrishna DV, Vedamurthy BM, Schneider A, Bousiges O, Mathis C, Cassel JC, Eswaramoorthy M, Kundu TK and Boutillier AL (2013) Pharmacological activation of CBP/p300 acetyltransferases promotes neurogenesis and extends memory duration in adult mice. *J Neurosci.* **33**(26):10698-712
2. **Chatterjee S**, Schneider-Anthony A, Abel T, Cassel JC and Boutillier AL. CREB-dependent CBP regulation of plasticity-related genes is required for long-term spatial memory formation. *Manuscript under preparation.*
3. **Chatterjee S**, Sendid-Chouala M, Kumar M, Cassel R, Cosquer B, Halder Sinha S, Chaturderby P, Eswaramoorthy M, Cassel JC, Buée L, Blum D, Kundu TK and Boutillier AL. Chronic treatment of a Tau mouse model with a HAT activator increases maturation of newly generated neurons and improves hippocampus-dependent memory. *Manuscript under preparation*
4. Schneider-Anthony A^Ψ, Cassel R^Ψ, **Chatterjee S^Ψ**, Bousiges O, Kumar M, Petsophonsakul P, Halder Sinha S, Chaturderby PK, Le Gras S, Keime C, Blanc F, Buée L, Eswaramoorthy M, Rampon C, Dutar P, Merienne K, Cassel JC, Blum D, Kundu TK and Boutillier AL. Epigenomic correction of defective excitability and plasticity in a mouse model of tauopathy. *Manuscript under preparation.*

Other publications related to the thesis

1. Schneider A, **Chatterjee S**, Bousiges O, Selvi BR, Swaminathan A, Cassel R, Blanc F, Kundu TK, Boutillier AL (2013) Acetyltransferases (HATs) as Targets for Neurological Therapeutics. *Neurotherapeutics.* **10**(4):568-88 (Review article)
2. Selvi RB^Ψ, **Chatterjee S^Ψ**, Jagadeesan D^Ψ, Chaturbady P, Suma BS, Eswaramoorthy M, Kundu TK (2012) ATP driven clathrin dependent entry of carbon nanospheres prefer cells with glucose receptors. *J Nanobiotechnology.* **10**:35
3. Swaminathan A , Delage H , **Chatterjee S**, Belgarbi-Dutron L, Cassel R, Martinez N, Cosquer B, Kumari S, Mongelard F, Lannes B, Cassel JC, Boutillier AL, Bouvet P and Kundu TK. Multifunctional chromatin organizing protein, PC4 is critical for brain plasticity. Manuscript submitted to: *Cerebral cortex*

^Ψ Equal contributors

Patents:

Title of the Invention: Histone Acetyltransferase (HAT) Activator Composition and Process Thereof.

Inventors: Kundu T. K., Boutillier A.L., **Chatterjee S.**, Eswaramoorthy M., Mizar P., Mathis C., Cassel J. C., Neidl R., D. V. Mohankrishna., Vedamurthy B. M.

Indian Provisional Patent Application No. 4646/CHE/2011

International PCT Application No. PCT/IB2013/053343

Talks delivered or posters presented in conferences/ meetings

1. Epinantes 2013- Held at Institut de Recherche en Santé de l'Université de Nantes Centre de Recherche en Cancérologie Nantes/Angers, Nantes Cedex

Oral presentation title: A novel activator of CBP/p300 acetyltransferases (HATs) promotes neurogenesis and extends memory duration in adult mice: An alternative of HDAC inhibitors? (**Received best short talk award**)

Authors: **Snehajyoti Chatterjee**, P. Mizar, R Cassel, R. Neidl, B.R. Selvi, D.V. Mohankrishna, B.M. Vedamurthy, A. Schneider, O. Bousiges , C. Mathis, JC. Cassel, M Eswaramoorthy, T.K. Kundu and AL. Boutillier

2. Neurex meeting on "From neuronal dynamics to behavior"- Held at Hörsaal, PharmaZentrum, Klingelbergstrasse, Basel, Switzerland on 10th June, 2013

Poster Title: A novel activator of CBP/p300 acetyltransferases (HATs) promotes neurogenesis and extends memory duration in adult mice: An alternative of HDAC inhibitors?

Authors: **Snehajyoti Chatterjee**, P. Mizar, R Cassel, R. Neidl, B.R. Selvi, D.V. Mohankrishna, B.M. Vedamurthy, A. Schneider, O. Bousiges , C. Mathis, JC. Cassel, M Eswaramoorthy, T.K. Kundu and AL. Boutillier

3. Journée des Doctorants ED414 – Held at the College Doctoral European, Strasbourg, France on 19th February, 2014.

Poster title: A novel activator of CBP/p300 acetyltransferases (HATs) promotes neurogenesis and extends memory duration in adult mice: An alternative of HDAC inhibitors?

Authors: **Snehajyoti Chatterjee**, P. Mizar, R Cassel, R. Neidl, B.R. Selvi, D.V. Mohankrishna, B.M. Vedamurthy, A. Schneider, O. Bousiges , C. Mathis, JC. Cassel, M Eswaramoorthy, T.K. Kundu and AL. Boutillier

4. 5th Meeting of the Asian Forum of Chromosome and Chromatin Biology- Held at JNCASR, Bangalore, India on January 15th – 18th, 2015

Poster title: Chronic treatment of CBP/p300 acetyltransferase activator CSP-TTK21 restores hippocampal dependent memory in a Tau mouse model (**Received best poster presentation award**)

Snehajyoti Chatterjee, Brigitte Cosquer, Aurelia Ces, Manoj Kumar, Sarmistha Haldar Sinha, Piyush Kumar Chaturbedy, Chantal Mathis, Luc Buee, David Blum, Muthusamy Eswaramoorthy, Jean-Christophe Cassel, TapasK Kundu, Anne-Laurence Boutillier

General Introduction and Objectives of the Thesis

General Introduction and Objectives of the Thesis

General framework of the thesis

The most fascinating feature of the brain is its ability to form long-term memories and store them for durations ranging from days to weeks to a whole lifetime. Long-term memory formation is a complex process associated with long-lasting structural modifications in the brain. Long-term memory formation does not occur immediately following learning, as memory is initially in a fragile state. It then undergoes process of stabilization known as memory consolidation through which memory becomes less susceptible to disruption. Mechanistically, *de novo* gene expression is a critical event during memory consolidation, which is fundamental to cellular or molecular consolidation. Gene expression during memory consolidation requires several overlapping mechanisms, including recruitment of transcription factors, transcriptional co-activators and regulators. One of the principal mechanisms of gene expression regulation is by chromatin remodelling, through histone-tail modifications, of which histone acetylation is an important player. The enzymes that catalyze the transfer of acetyl- group to the lysine residues of histone or non-histone proteins are histone/lysine acetyltransferases (HATs/KATs). The reverse reaction is catalyzed by histone deacetylases (HDACs). Recently, histone acetylation has been on prime focus to modulate memory related processes. In particular, histone acetylation participates in the processes involved during synaptic plasticity, learning and long-term memory formation. CBP is one such HAT which has shown important features in the formation of long-term memory. CBP functions as acetyltransferase and transcriptional co-activator. Both the acetyltransferase activity and the transcriptional co-activator function are critical for long-term memory formation. Lastly, CBP dysregulation has been observed in neurodegenerative conditions like in Alzheimer's disease and Huntington's disease. Therefore, targeting CBP function in pathological conditions could provide beneficial outcomes.

Objectives of the Thesis

The role of CBP in spatial memory is a topic of debate because various mutant models of CBP have provided different outcomes in spatial memory. Studies from different mutant mice models of CBP proves its importance in memory formation but results from specific

tasks that were not always comparable (reviewed in Valor et al., 2013). While most of the mutant mice models were impaired in objects recognition tasks, results from spatial memory were mostly variable. Mice lacking only one allele of *cbp* show not deficit in spatial memory formation nor recent retention (Alarcon et al., 2004), whereas these *cbp*^{+/-} mice were found impaired in environmental enrichment (EE)-mediated enhancement of spatial memory (Lopez-Atalaya et al., 2011). Mice with CBP mutation in the HAT domain were impaired in long-term spatial memory retention whereas short-term memory was sparse (Korzus et al., 2004). Notably, the deficiency in recent long-term memory could be reversed upon intense training (Korzus et al., 2004). Yet, conditional knock-out (cKO) of CBP in the excitatory neurons of the postnatal forebrain of mice developed in J. Shen's laboratory resulted in complete impairment in short- and long-term spatial memory (Chen et al., 2010), while deletion of CBP in forebrain principal neurons of mice developed in A. Barco's laboratory displayed intact spatial memory (Valor et al., 2011).

Thus, research groups have rather produced transgenic mice bearing mutated acetyltransferases, than look at the dynamic aspect of acetyltransferase regulation. Data obtained in the laboratory before my PhD studies, bring a very interesting angle to this debate, as Bousiges et al. (2010) showed that the expression of several acetyltransferases (including CBP, but also EP300 and PCAF) was increased during consolidation of spatial memory. As CBP levels are present in limited concentrations in the cells (Vo and Goodman, 2001), competition for recruitment of CBP might provide a potential mechanism for cross-talk between different neuronal functions during memory formation. Such production of higher CBP levels - and eventually other HATs - might serve to implement the consolidation phase of memory formation either by increasing the robustness of the response within time, or by participating in the signal transduction through CBP's multiple other functions (coactivator, bridging, or recruitment of RNA polymerase II at enhancers; Kim et al., 2010). In addition, acetylation of H2B, the level of which is dramatically altered in the hippocampus of CBP mutant mice (Alarcon et al. 2004; Chen et al., 2010; Valor et al., 2011) and thus appears to be an *in vivo* CBP-target, is increased in hippocampal neurons while a spatial memory is being formed both at bulk chromatin levels and at the promoters of several memory- and plasticity-related genes (Bousiges et al., 2010; Bousiges et al., 2013). H2B acetylation was also associated with neuronal activity as observed in depolarized hippocampal slices (Sharma et al., 2010). Thus, the induction of an acetylated-H2B / CBP-dependent genetic program could contribute to hippocampus-dependent memory formation.

Altogether, these studies and the laboratory's recent data clearly establish that acetyltransferases (presence and activity) are a critical component of memory formation.

Therefore, my aim for the thesis was to 1/ better define the function of CBP in spatial memory using two different strategies: pharmacological (small molecule mediated activation of CBP HAT in brain; collaboration with Prof. Tapas KUNDU, Bangalore, India) and transgenic model (mice model with mutation of CBP in the KIX domain, so that CBP cannot bind with phospho-CREB; collaboration with Dr. Ted ABEL, Philadelphia, USA) and 2/ examine the relevance of using a HAT activator molecule as new therapeutic option for memory-related diseases such as Alzheimer's in a Tau mouse model (collaboration with Drs. Luc BUEE and David BLUM, Lille, France).

HDAC inhibitors increases histone acetylation and have shown promising consequences to improve memory related processes. Our aim was to increase histone acetylation in a more direct approach by activating the acetyltransferase enzymes itself. We used chemical biology approach to develop a small molecule activator of HAT CBP/p300 (CSP-TTK21) that induces histone acetylation in dorsal hippocampus and frontal cortex of mice brain. We investigated the implications of CBP/p300 activation in two important hippocampal functions: adult neurogenesis and long-term spatial memory. The next objective was to study the KIX domain-dependent transcriptional co-activator function of CBP in spatial memory formation and retention, as well as in the regulation of CBP target gene expression (i.e. Memory and plasticity relevant genes) during spatial learning in the dorsal hippocampus and frontal cortex by using CBP^{KIX/KIX} mice. Lastly, we explored the therapeutic implications of pharmacological activation of CBP in a mice model of Alzheimer's disease (THY-Tau22 mice). Prior evidences from our lab suggest CBP dysregulation in hippocampus of THY-Tau22 mice and also from human patients of Alzheimer's disease. Therefore, our hypothesis was to treat THY-Tau22 mice with the HAT activator CSP-TTK21 from an early time point (as early as 3 months of age), so that we might be able not only to improve memory functions, but also improve adult neurogenesis and may be delay the onset of the disease pathology.

Structure of the thesis

The “**General Introduction**” introduces the basic fundamental scientific concepts that laid the foundation of my thesis. I started with basic understanding of learning and memory where, I introduce the different forms of memory. Later I focussed on hippocampus and explained important functions of hippocampus in memory related processes. In the next chapter, I explained briefly the different molecular pathways involved during memory formation starting from the growth factors to the transcription factors and immediate early gene expression. I have cited examples of one principal component associated in each layers of the signalling cascade. In the next chapter, I introduced epigenetic mechanisms especially focussing on acetylation involvement in memory related processes. In the last chapter, I described the pathological condition of Alzheimer’s disease and briefly described the important factors involved in the pathology. Then, I emphasized on implications of histone acetylation modulation as a possible therapeutic approach for treatment of Alzheimer’s disease.

“**Experimental contribution**” is divided into **three chapters** based on the publications and thesis objectives:

In *Publication 1*, the implications of pharmacological activation of CBP/p300 HAT with CSP-TTK21 have been shown for two important hippocampal functions: adult neurogenesis and spatial memory formation. It laid the basis of a collaborative patent (WO2013//160885) between UNISTRA (Strasbourg, France) and JNCASR (Bangalore, India). *Publication 2* shows the importance of CBP KIX domain in the storage of long-term spatial memory. In *Publication 3*, we have showed the beneficial effects of chronic treatment with HAT activator CSP-TTK21 in THY-Tau22 mice to rescue spatial memory deficits.

“**Supporting results**” presents the results from collaborative works performed with other members of my lab and colleagues to identify the molecular mechanisms associated with CBP/p300 activation by CSP-TTK21 in THY-Tau22 mice (description of the THY-Tau22 mouse strain, effect of CSP-TTK21 on LTD (electrophysiology measurements in collaboration with Dr. Patrick DUTAR, Paris, France) and transcriptomic studies (in collaboration with the BIOPUCE Platform of IGBMC, Illkirch, France).

In the “**General Discussion and Perspective**” section, I have demonstrated what we learned about CBP function in spatial memory and have suggested the implications of the thesis work in the development of epigenetic drug for the treatment of memory impairment diseases like Alzheimer’s disease, and probably other neurodegenerative diseases.

SECTION I: General Introduction

CHAPTER 1: Learning and Memory

CHAPTER 1: Learning and Memory

1. Introduction to Learning and memory

1.1. Brief history

Learning an experience and storing it as memory is the building block for our mental growth and intellectual development. Learning is the act of acquiring new or modifying existing knowledge, behaviours, skills, values, preferences or understanding. Memory is a process by which information is encoded, stored, and retrieves. Encoding is associated with receiving, processing and combining all the received information. Then the encoded information gets stored as a record. Finally, in response to some specific cues, the stored memory gets retrieved or recalled. Presently it is the challenge of the scientific community to unravel the mystery behind the mammalian memory processes.

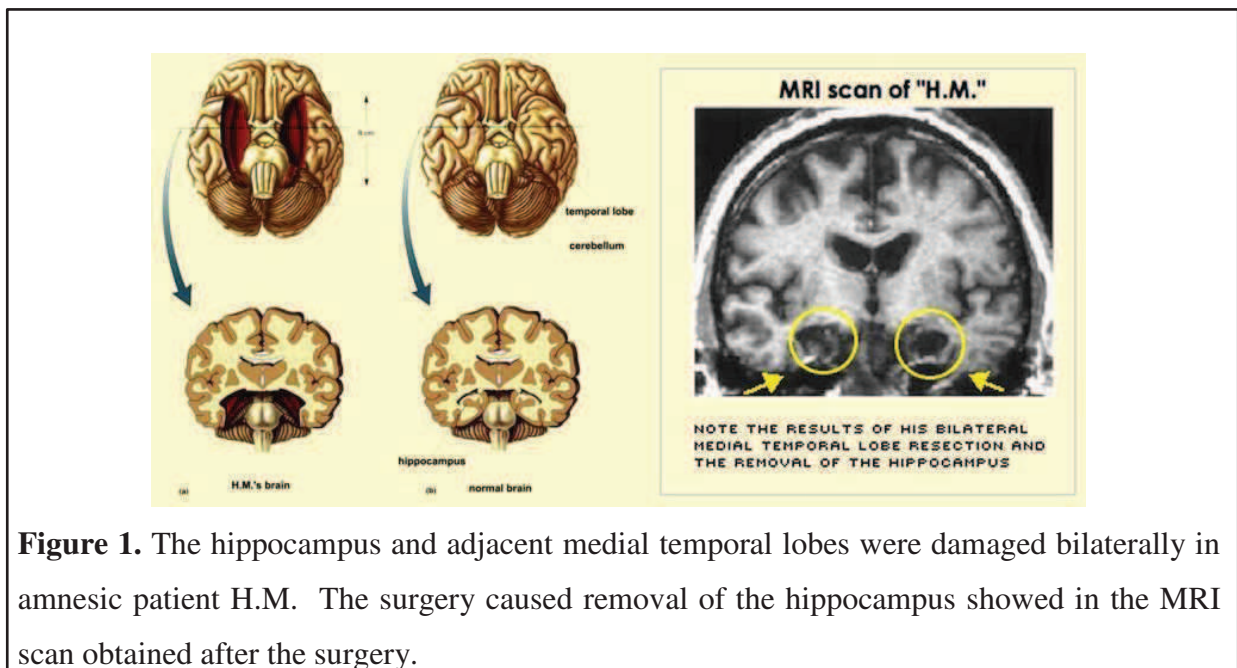

Figure 1. The hippocampus and adjacent medial temporal lobes were damaged bilaterally in amnesic patient H.M. The surgery caused removal of the hippocampus showed in the MRI scan obtained after the surgery.

The region of brain that is important for memory formation is the most intriguing question in neuroscience. Karl Lashley in 1920s tried to understand the site of memory storage by carefully damaging the cortical neurons of rats after memory acquisition through a simple maze. As he failed to obtain any single critical “memory area”, he concluded that memory is delocalised in the brain. Later, neurosurgeon Wilder Penfield discovered that electrical stimulation of certain brain regions like temporal cortex (preceding brain surgery) often

triggered memory-like experiences in awake patients. Thus Penfield concluded that certain memories are stored in individual brain regions. The discrepancy between the two above mentioned findings were solved by Donald Hebb. He referred the combination of neurons that can be grouped as one processing unit as “cell-assemblies”. He postulated that thoughts and memories were supported by cell-assemblies or network of neurons where learning or experiences could modulate their connections (Hebb and Konzett 1949). Thus the Hebbian hypothesis laid the cornerstone towards our understanding towards synaptic plasticity and cognition. The role of involvement of one region of the brain, the hippocampus was evidenced from one of the most famous patients of neuroscience, late Henry Gustav Molaison, popularly known as H.M. He was a patient of severe epilepsy for which he had to undergo brain surgery. His left and right medial temporal lobes (MTLs) were removed during the surgery (Figure 1). However, the surgery exhibited severe anterograde amnesia which can be characterised by the inability to form lasting memories and loss of cognitive ability (Scoville and Milner 1957). Interestingly, H.M. could still recall his childhood memory whereas he failed to recall the events that were relatively close to the surgery. H.M.’s ability to learn new motor skills was not impaired. The inability to create new long term memory after the surgery suggests that encoding and retrieval of long-term memory are processes that are dealt by distinct systems. H.M., case provided substantial evidence for the involvement of a specific brain region such as hippocampus in memory formation.

1.2. Different forms of Memory

1.2.1. Sensory Memory

Sensory memory holds information for less than a second after the stimulus. The sensory receptors possess the potential to hold huge amount of information but whatever these receptors can hold lasts for a fraction of a second. Sensory memory can be further divided into echoic and iconic memory.

1.2.2. Short term Memory

Short term Memory (STM) is the ability to hold small amount of information for a short time and its duration is believed to be in order of seconds. Short term memory is considered to be a critical component of cognition. Hardly any task could be completed without the involvement of Short term memory (Reviewed in Jonides et al. 2008). Several factors can

affect STM like Alzheimer’s disease, Aphasia, Schizophrenia, ageing and Post Traumatic stress disorder. In neurodegenerative conditions like in Alzheimer’s disease, shrinkage in the cerebral cortex disables the patient’s ability to think and recall memories.

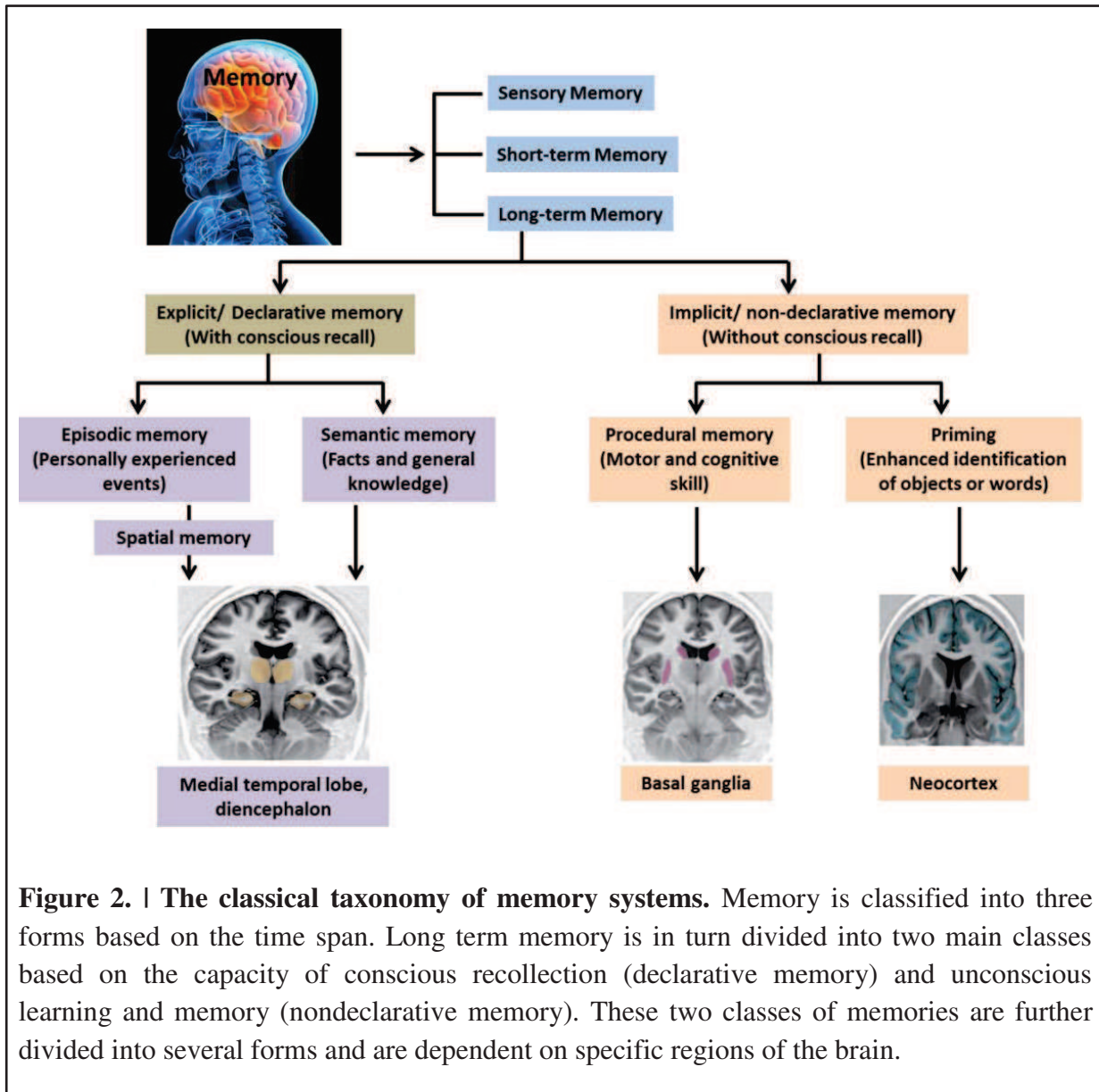

Figure 2. | The classical taxonomy of memory systems. Memory is classified into three forms based on the time span. Long term memory is in turn divided into two main classes based on the capacity of conscious recollection (declarative memory) and unconscious learning and memory (nondeclarative memory). These two classes of memories are further divided into several forms and are dependent on specific regions of the brain.

1.2.3. Long term Memory

In Long term memory, information can be stored for a very long period of time which can last for lifetime. Scientists have explored the LTM in a variety of behavioural paradigm using the rodents as a model system. LTM consolidation requires protein synthesis (Helmstetter, Parsons, and Gafford 2008; Johansen et al. 2011), various pharmacological and genetic

approaches has implicated the regulation at the transcription and translation level in different brain regions could affect LTM formation (Jarome and Helmstetter 2014). The protein synthesis requirement for LTM has a specific time window that starts during and minutes after learning which is called the consolidation phase. Blockage of protein synthesis during consolidation phase impairs long term memory (R. Bourtchouladze et al. 1998); Meiri and Rosenblum 1998). Physiologically, LTM establishment requires changes in the structure of neuron in the brain. These brain structure changes are called long-term potentiation and involve stable changes in the neural connections throughout the brain. The hippocampus is one of the most important structure in the persistence of LTM. It acts as a temporary transit point for LTM and does not store information by itself. Hippocampus is involved in the consolidation process to convert information from short term to LTM. Several different forms of LTM have been distinguished (Figure 2):

Declarative (Explicit) memory

Declarative memory involves memory associated with facts and events that can be consciously recalled. This form of memory is also referred as explicit memory as the informations are explicitly stored and retrieved. Declarative memory is further sub-divided into episodic memory and semantic memory.

a. Episodic memory

Episodic memory also referred as memory of autobiographical events represents the experience and specific events in sequential form that can be reconstructed to form memory of actual events that had happened at some point of our lives.

b. Semantic memory

Semantic memory refers to all kinds of general world knowledge that includes words or concepts, facts or beliefs. The common factors among these knowledge is that the knowledge is built up independently from specific experiences and can be retrieved without any reference from specific circumstances in which it was originally acquired. For example, knowledge of colour and shape of an apple can be considered to be part of semantic memory, whereas the knowledge about the last time where we have seen or tasted an apple is considered to be episodic memory.

Both episodic and semantic memory involves similar encoding process. Formation of semantic memory activates the frontal and temporal cortexes, whereas hippocampus is the major structure required for episodic memory activity. An interesting question that arises is that children who develop amnesia due to bilateral hippocampal damage in early childhood, can they acquire semantic knowledge? Interestingly, amnesic children can still acquire semantic knowledge despite impairment in their episodic memory (Bindschaedler et al. 2011; Gardiner et al. 2008; Vargha-Khadem et al. 1997). Furthermore, the case study of the famous amnesic patient H.M. have also revealed that he could still acquire some semantic knowledge after the surgery that caused his amnesia (Gabrieli, Cohen, and Corkin 1988 ;O’Kane, Kensinger, and Corkin 2004). However, acquisition of semantic knowledge in amnesic patients is not normal i.e., it is very slow and laborious. Thus, it can be concluded that acquisition of semantic memory requires involvement of episodic memory but can bypass it rather in a less efficient manner when the episodic system is damaged.

Non-Declarative memory

Procedural memory (Implicit)

Procedural (Implicit) memory is the unconscious memory of skills (motor skills, perceptual skills, and cognitive skills) or habits where use of a particular object or movement of a body part is involved. This form of memory is acquired after series of repetition and practice. The information is formed from automatic sensorimotor behaviours and are so deeply embedded that we remain no longer aware of them. This skill based habits or learning can be acquired by amnesic patients that include motor skills (Brooks and Baddeley 1976), perceptuomotor skills (Nissen and Bullemer 1987), perceptual skills (N. J. Cohen and Squire 1980), and cognitive skills. Also monkeys with large medial temporal lobe lesions who fail in the object recognition tasks can still perform skill based learning (Zola-Morgan and Squire 1984).

Priming is the effect of the influence of a stimulus for a subsequent effect. It is the processing or detecting an object based on recent experience (Shimamura 1986; Tulving and Schacter 1990). **Familiarity** is also referred to be a form of memory which is closely related to priming as both these forms of memory are automatic, fast-acting, sensitive to the study–test interval and depends on repetition-induced processing fluency (Reviewed in Henke 2010). Also cortical activity directly influences both priming and familiarity even though

they do not depend on the same neural circuitry. Familiarity is restricted to perirhinal cortex whereas priming is associated with different brain areas.

1.3. Spatial memory

Spatial memory or spatial cognition defines the answer to the question, Where? and 'where' can be anything ranging from: Where am I? Where is my house? Where are my glasses? Spatial cognition is formed from exploratory behaviour. This form of behaviour is instinctive and is considered to be an expression of natural curiosity or is required to acquire new information when exposed to a new environment or stimulus. Thus Spatial memory can be defined as the part of memory responsible for recognizing, codifying, storing and recovering information about one's environment which includes arrangement of objects or specific routes (Kessels et al. 2001). 'Space' consists of two dimensions- a) personal corporal space (location of corporal stimuli), and b) external space. These two sources contribute the information to organize and used by two kinds of processes: egocentric and allocentric strategies (Figure 3).

Egocentric strategy

It is independent of spatial cues and utilises information contributed by the bodily cues. The subject utilises this strategy considering its own central point as reference. Thus position of any object will be defined using its own position in the space. Egocentric strategy depends more on small or local landmarks and personal directions (left/right) to navigate through a path. This involves activation in the right parietal lobe and prefrontal regions of the brain.

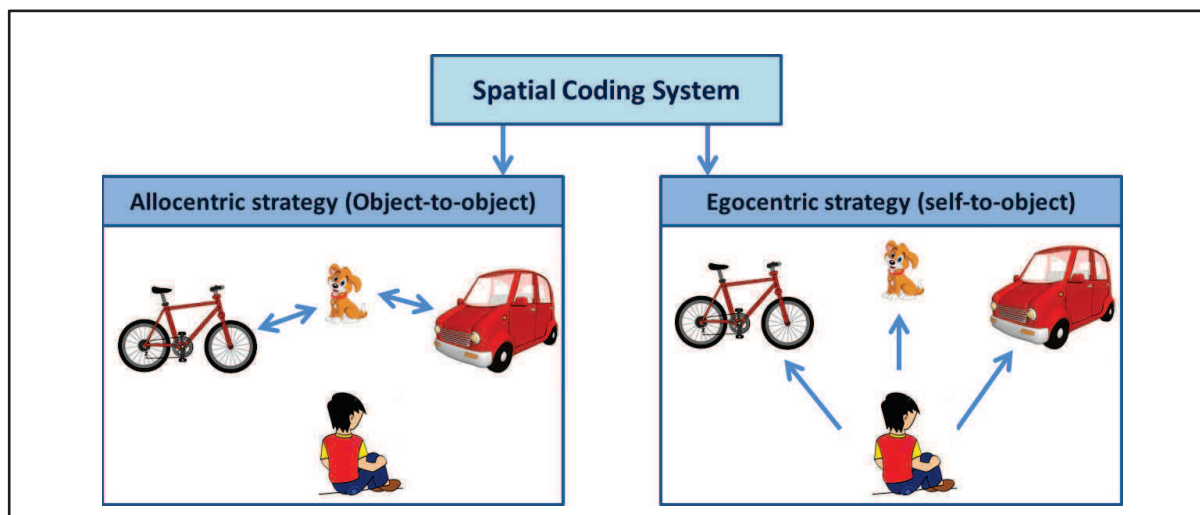

Figure 3. Spatial coding system. *Allocentric strategy:* Information about the location of objects is encoded with respect to other objects. *Egocentric strategy:* Information about the location of objects in space is represented relative to the body axes of subject (example; Left-right or front-back)

Allocentric strategy

This strategy depends on spatial cues. Using this strategy, the subject identifies the target destination using the environment reference landmarks. Furthermore, requirement for short routes or whole pathways involves different memory processes. The *spatial working memory* allows storage of limited amount of spatial information that can be accessed immediately. On the contrary, *spatial reference memory* system involves obtaining the spatial information through multiple trials. Spatial memory is considered as a sub-type of episodic memory as it stores information within a spatial–temporal frame (Reviewed in Paul, Magda, and Abel 2009).

Morris Water Maze (MWM): A tool to study spatial memory in rodents

Invented by Richard G.M. Morris in 1981, MWM is a vastly used behavioural task to evaluate spatial learning and memory in rodents. It was designed to evaluate the role of specific visual cues as reference for spatial memory (Morris 1984).

Design and general procedure

The MWM design (Figure 4) includes a round pool which will be filled with opaque water. The opacity could be achieved by adding different substances: powder milk, white paint, titanium dioxide or others. An escape platform will be placed slightly hidden below the water (around 2-3 cm). Simple reference spatial memory could be measured by dividing the pool into four equal quadrants. As water acts as an aversive stimulant, the first day training starts with period of habituation where the mice or rats will be allowed to swim in the pool without the platform. The learning protocol starts when the platform is placed in a fixed position in one of the quadrants and the animal will be allowed to search for the hidden trial using the spatial cues present in the room. The acquisition or learning protocol ranges for multiple days with multiple trials per day. Each trial starts by placing the animal in a different starting point. For each trial, the time taken by the animal to reach the platform is recorded (escape

latency). After the acquisition trials, after a defined time point the platform will be removed and the animal will be allowed to swim in the pool. The time spent by the animal in the target quadrant (the quadrant where the platform was originally placed) will be measured. The time in target quadrant or the distance travelled in the target quadrant reflects the spatial memory consolidation.

Methodological variables

Multiple variables can affect the performance of an animal in the MWM:

- a) Diameter of the pool.
- b) Presence or absence of previous habituation in the maze.
- c) Number of starting positions and their position in the maze
- d) Measures of various parameters

Factors influencing performance in the Morris water maze

Body weight, physical condition and age have been demonstrated to influence the swim velocity (D'Hooge and De Deyn 2001). Other reports suggests that males performs better compared to the females possibly because of physical strength and differences in spatial navigation abilities (Brandeis, Brandys, and Yehuda 1989; Sherry and Hampson 1997). These differences disappears by using mice older than 6 months age suggesting differential gender based maturation in younger animals (Bucci, Chiba, and Gallagher 1995). Also low levels of estrogen significantly improve spatial performance, thus hormonal cycle during which females are tested is also a contributing factor for the differential performance between genders. The age of the animal is also an essential factor. It is already an accepted fact that learning capacity declines with age. Stress also plays important role in the spatial performance in MWM as this test involves an aversive stimulus. Hyperactive animals that are sensitive to stress performs poorly in MWM. Thus additional learning tasks and measuring the blood corticosterone to determine the amount of stress needs to be considered to conclude that the deficits observed in the MWM is due to the alterations in learning and memory (Paul, Magda, and Abel 2009).

Disadvantages

- *Aversive behavioural stimulus (aquatic immersion)*. Habituation in the maze prior to the training can significantly reduce the stress levels in the animals.

- If not maintained properly, water itself could create complications. If the optimal condition is not maintained, respiratory, ophthalmic and other infections could arise
- Animals quite often use a directional strategy, when it runs up from starting point.
- The requirements for video-recording systems and software for the complete analysis makes it difficult for some research groups to acquire.

Advantages

- Learning is faster compared to other mazes (radial maze, circular maze).
- Reference memory, spatial working memory and learning can be measured more accurately and the data is generally reproducible.
- No previous preparation like food or water deprivation is required.
- Animals cannot use aromatic cues due to the presence of water.

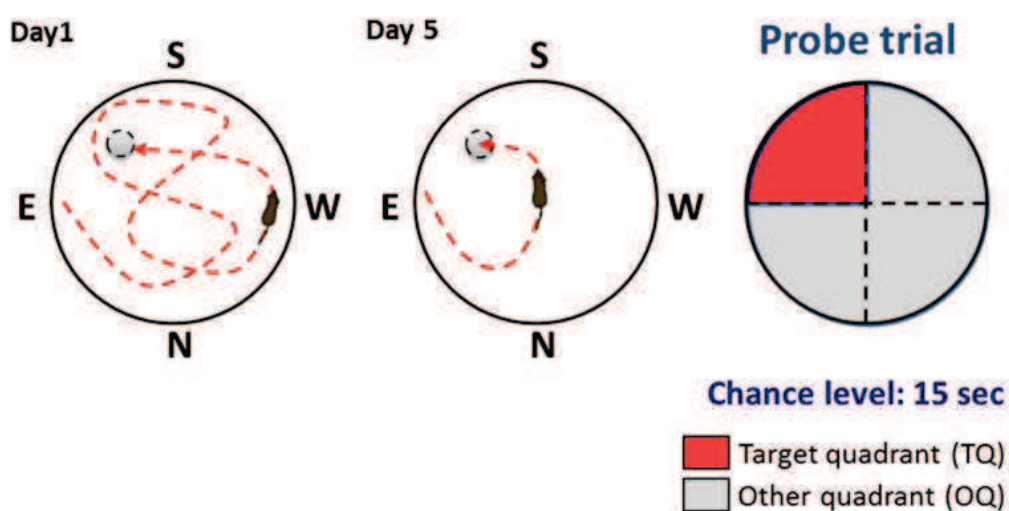
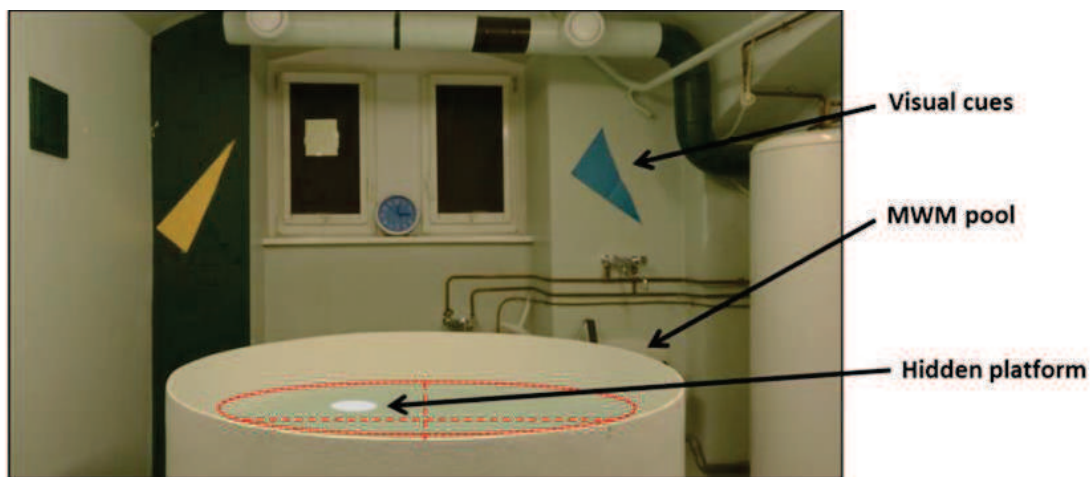
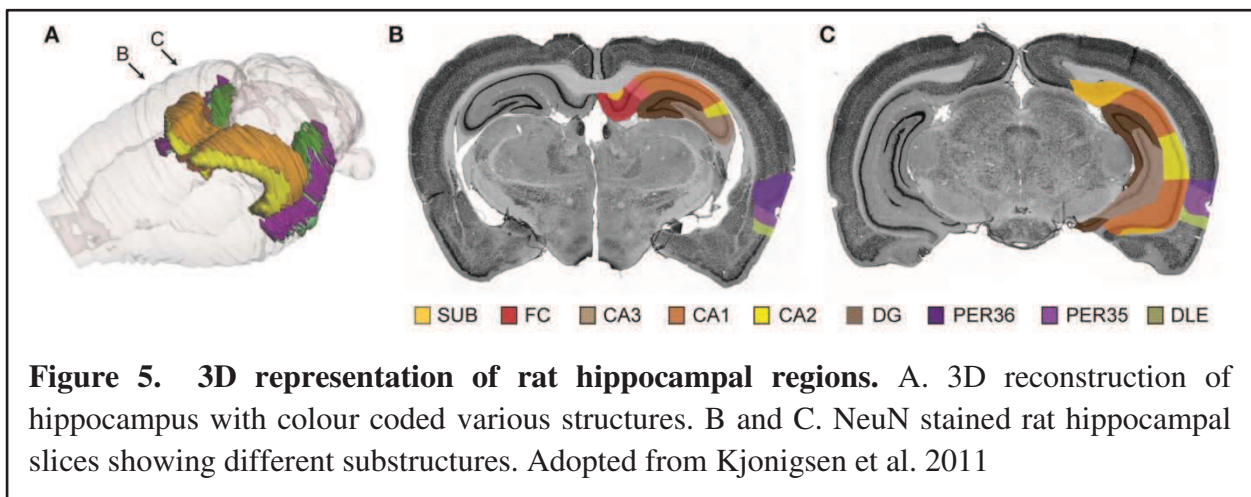

Figure 4. Picture of a typical Morris Water Maze experimental room.

2. Role of Hippocampus in the consolidation of Spatial memory

2.1. Hippocampus: Anatomy and Nomenclature

Hippocampus is present deep in the medial temporal lobes is one of the most studied neuronal systems in the brain. In rodents, it occupies a large portion of the forebrain. It can be divided into two regions, a dorsal portion that lies behind the septum, and ventral portion lying in the temporal part of the brain. Based on the cell morphology and fiber projection, hippocampus can be divided into multiple sub fields: dentate gyrus and the cornu ammonis (also referred as CA) (Figure 5). The dentate gyrus (DG) consists of the fascia dentata and the hilus, while cornu ammonis (CA) is further differentiated into CA1, CA2, CA3, and CA4.



2.2. The standard connectional view

The standard view suggests that the neocortical projections at the para hippocampal region provide the main source of input to the hippocampal formation through the entorhinal cortex (EC) (Figure 6). Parahippocampal region is the site for two parallel projection streams: the perirhinal cortex (PER) mediated projections towards lateral entorhinal cortex (LEC) and the postrhinal cortex (POR) projection towards the medial entorhinal cortex (MEC). The principal component of the performant pathway is EC who projects to all hippocampal sub-regions including the reciprocation of the connections from the PER and POR. DG and CA3 receives projections from Entorhinal layer II, while CA1 and Sub received from Entorhinal layer III. According to the polysynaptic pathway, a unidirectional route exists that connects all the hippocampal formation sub-regions sequentially.

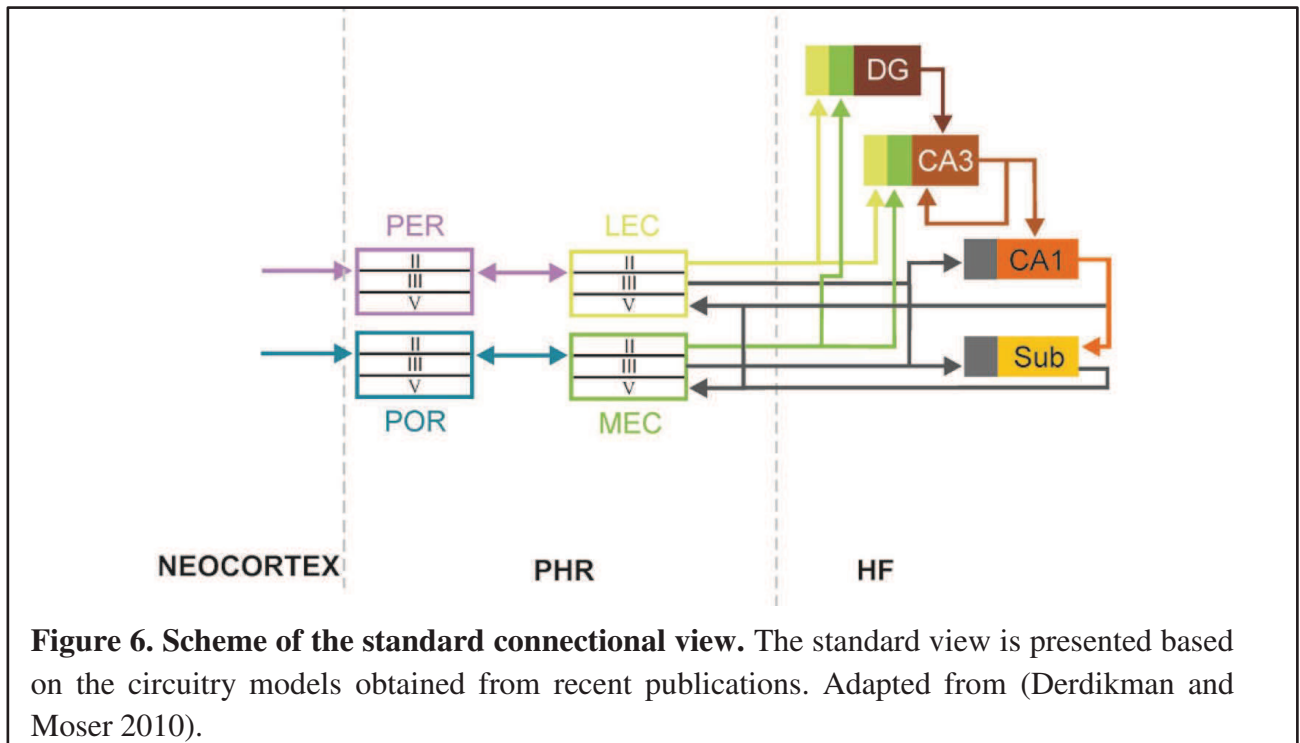

2.3. Different cell types present in hippocampus

Principal cells

Hippocampal principal cells include pyramidal cells of the CA areas, granular cells of the DG and the mossy cells of the hilus.

Pyramidal neurons of CA

One of the best studied hippocampal neurons are the *pyramidal cells of CA1*. The major characteristics of these types of neurons are its pyramidal or ovoid shaped soma, long apical dendrites and small basal dendrites. CA1 pyramidal cells are densely covered with spines that significantly contribute to the total volume of the neuron (Figure 7). Spines act as post synaptic targets mostly for glutamatergic terminals. Thus, more number of spines would mean more excitatory synaptic input to the neurons. Notably, a single CA1 pyramidal neuron shows ~30,600 terminals converge to form putative excitatory synapses through dendritic spines (Megías et al. 2001).

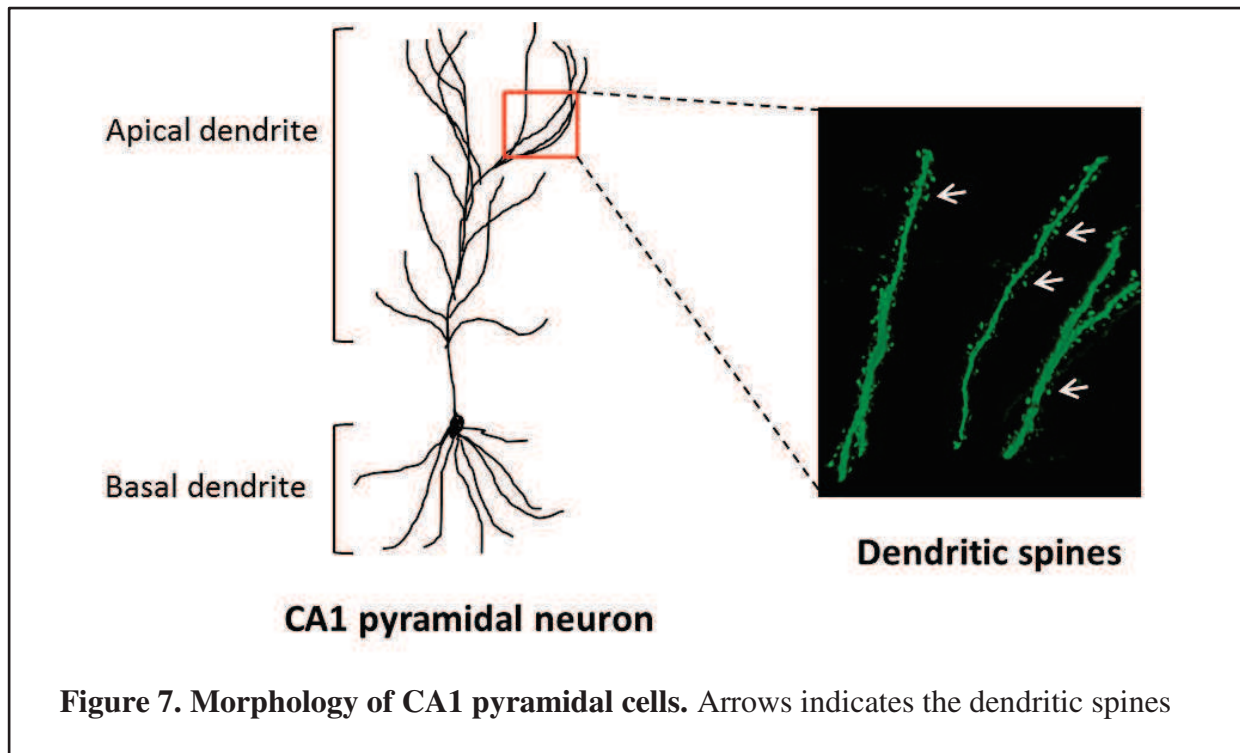

Morphologically, *CA3 pyramidal neurons* show many similarities to their CA1 counterparts. One of the notable differences between the two is that the CA3 pyramidal neurons have larger cell bodies with around two to four times higher surface area. The proximal dendrites shows large complex thorny spines that are post synaptic targets of mossy fiber boutons (Chicurel and Harris 1992). The morphological feature of CA2 pyramidal neurons lies in between the pyramidal cells from CA1 and CA3. The neurons have large cell bodies, but lacks complex spines. Their dendritic arborisation pattern is also similar to the CA1 pyramids. CA2 pyramidal cells shows highest total dendritic length compared to the CA1 and CA3 pyramids (Ishizuka, Cowan, and Amaral 1995).

Granular cells of DG

GCs are one of the important hippocampal cell types, characterised by spiny dendrites which originates from the upper pole of the soma and an axon that emerges from the base (Seress and Pokorny 1981; Schmidt-Hieber, Jonas, and Bischofberger 2007). Dendrites ranging from one to four originate from the soma and bifurcate three to six times to form a dendritic tuft in the molecular layer. Similar to the CA pyramidal cells, GCs from DG are also densely covered with spines. Mossy fibers, axons of the GC are the source of major output of the DG to the CA3. 10–18 sparsely spaced mossy fiber boutons forms synaptic contacts with

complex spines of CA3 pyramidal in the str. lucidum and mossy cells in the hilus (Rollenhagen et al. 2007).

Mossy cells of the hilus

Morphologically mossy cells of hilus share several similarities with the CA3 pyramidal cells. The dendrites originating from the hilus rarely invades the granule cell layer in rats (Rollenhagen et al. 2007). Soma and the dendrites are covered by complex spines that receive inputs from GC (Acsády, Arabadzisz, and Freund 1996). Furthermore, mossy cells are also involved in synaptic contacts with distal, simple dendritic spines (Frotscher et al. 1991).

2.4. Glutamatergic Neurotransmission in the Hippocampus

Glutamate is the main excitatory transmitter in the hippocampus. Ionotropic and metabotropic receptors form the two main classes of glutamate receptors (Table 1).

	Groups	Subunits	Conducting ions/ Signalling pathway
Ionotropic receptors	AMPA	GluR1, GluR2, GluR3, GluR4	Na ⁺ , Ca ²⁺
	NMDA	NR1, NR2A, NR2B, NR2C, NR2D, NR3A	Na ⁺ , Ca ²⁺
	Kainate	GluR5, GluR6, GluR7, KA1, KA2	Na ⁺ , Ca ²⁺
Metabotropic receptors	Group I	mGluR1, mGluR5	Phospholipase C
	Group II	mGluR2, mGluR3	Adenylyl cyclase
	Group III	mGluR4, mGluR6, mGluR7, mGluR8	Adenylyl cyclase

Table 1. Different classes of Glutamate receptors in hippocampus

2.4.1. Ionotropic glutamate receptors

These are ligand-gated ion channels that participate in most of the fast excitatory neurotransmission in the CNS. Glutamate binding in these receptors causes opening of the channels that result in predominant Na⁺ influx leading to membrane depolarization.

Ionotropic glutamate receptors are further classified into three main classes based on their pharmacology and selective agonists:

- AMPA (α -amino-3-hydroxy-5-methyl-4-isoxazolepropionic acid)
- NMDA (N-methyl-D-aspartate)
- Kainate receptors

AMPA receptors have four major subunits: GluR1, GluR2, GluR3, and GluR4 (or GluR A–D) (Dingledine et al. 1999). These AMPA receptor subunits exist in different combinations. Interestingly, these subunits undergoes post-transcriptional RNA editing at the “Q/R site” which results into low conductance, Ca^{2+} -impermeable channels. Principal neurons of the hippocampus express high levels of GluR2 that show Ca^{2+} -impermeable AMPA receptors.

NMDA receptors of hippocampus consist of heteromultimers of NR1 and NR2A–D subunits. NMDA receptors shows slow dissociation rate of glutamate suggesting very slow kinetics compared to AMPA or kainite receptors. Glycine and glutamate are the two agonists that activate NMDA receptors. Sequential binding of glycine followed by glutamate opens the channel to enable Na^{+} and Ca^{2+} to enter the cell. This can only happen when Mg^{2+} block is removed from NMDA receptors. Ca^{2+} influx via NMDA receptors plays crucial role in the synaptic plasticity.

Kainate receptors are also heteromultimers that are formed in combination of GluR5,6,7 and KA1,2 subunits. Similar to the GluR2 of AMPA receptors, GluR5 and -6 subunits also undergoes alternative splicing at the Q/R site.

2.4.2. Metabotropic glutamate receptors

Metabotropic glutamate receptors consist of seven transmembrane domains and their actions are guided by G-proteins.

Group I metabotropic glutamate receptors are mostly localised postsynaptically and their activation leads to increased cell excitability. **Group II and III receptors** are mostly localised presynaptically where they are involved in the control of neurotransmitter release.

2.4.3. The perforant pathway

Perforant pathway or path is one of the major connective routes in the brain through which the entorhinal cortex provides inputs to the hippocampus (Figure 8). The origin of this pathway is the entorhinal cortex layer II and III through which it sends direct inputs to the dentate gyrus, all fields of CA and the subiculum. Layer II provides direct inputs to the granule cells of dentate gyrus (DG) through the perforant pathway (Witter 1993). The CA3 cells receive projections from the granule cells of DG via mossy fibers (mf). Layer III of entorhinal cortex axons sends inputs to the distal dendrites of CA1 and the subiculum via the temporoammonic pathway. Perforant pathway contributes significantly in the consolidation of spatial memory especially the temporoammonic pathway (TA-CA1) (Witter et al. 2000).

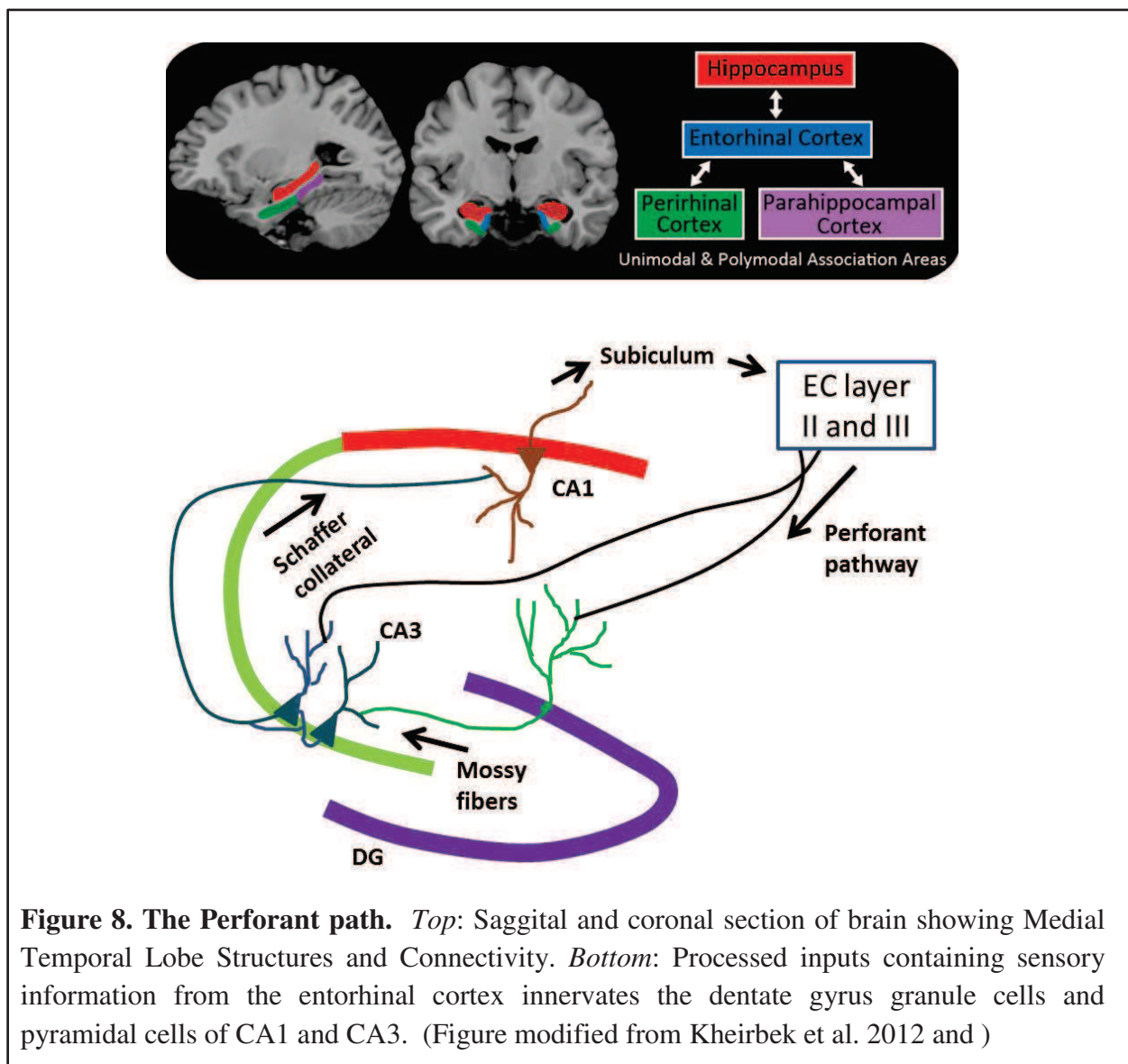

Figure 8. The Perforant path. *Top:* Sagittal and coronal section of brain showing Medial Temporal Lobe Structures and Connectivity. *Bottom:* Processed inputs containing sensory information from the entorhinal cortex innervates the dentate gyrus granule cells and pyramidal cells of CA1 and CA3. (Figure modified from Kheirbek et al. 2012 and)

2.5. Theories of hippocampal function

Over the years of research on hippocampus fetched multiples theories on its role in memory formation. All the theories proposes its role in episodic memory but the differences lies in the concept that whether hippocampus is involved in a time limited role (reviewed in Bird and Burgess 2008).

Declarative Theory

Hippocampus in association with other regions of the temporal lobe participates in the formation of episodic and semantic memory in a time limited period. Finally all these memory forms are consolidated to neocortical sites which are then unaffected by damage on temporal lobe.

Multiple-Trace Theory

Hippocampus in concert with other medial temporal lobe regions is important for the acquisition of episodic and semantic memories. Hippocampus remains crucial for the recollection of the episodic memory throughout the life-time, whereas semantic memory is stored in other brain regions for which it becomes independent of the hippocampus.

Dual-Process Theory

Hippocampus plays valuable role in the retrieval of episodic memory for the contextual details of an event.

Relational Theory

Hippocampus helps to associate information to the cortical modules which otherwise could not communicate. Hippocampus processes various sequences of events in our daily life.

Cognitive-Map Theory

One of the most important roles of hippocampus is to construct and store allocentric information in the environment to help in navigation.

3. Memory consolidation: Synaptic and Systemic

New memories are gradually formed from a labile state which is prone to disruption to a more permanent state. The process of stabilisation of memory after a new experience is termed as consolidation. The consolidation process can be distinguished into two forms: synaptic (fast) and systemic (slow). Synaptic consolidation involves morphological changes at the synapse level whereas systemic consolidation requires reorganisation of brain regions that supports memory.

3.1. Synaptic consolidation

Selected memories are stored in the brain for long period of time by a process called memory consolidation. Memories are thought to be stored in the neuronal connections called synapses. The strength of the synapse varies with learning. Acquisition of new memories can alter the strength of the existing synapse and thus disrupt it. It is thus difficult to imagine how some memories last for a life time. One possible explanation is that memories are stored in the synapses but some important memories are transferred to different parts of the brain to protect it from changes occurring due to new memory acquisition. During consolidation, memories are stored in the hippocampus and then it is transferred to the cortical areas during resting or sleeping (Kirwan et al. 2008; Smith and Squire 2009; Wilson and McNaughton 1994; Diba and Buzsáki 2007). The strength of a synapse can vary making it plastic in nature. Synaptic plasticity can be defined as the experience or learning induced change in the strength or connectivity of neurons.

3.1.1 Hippocampal Synaptic Plasticity

The hippocampal anatomy is critical for memory formation and makes it a good target for electrophysiological studies. The hippocampus is involved with three synaptic pathways: perforant, mossy fiber, and Schaffer collateral pathways. Stimulating these pathways alters the synaptic efficacy. A persistent strengthening of synapses is known as Long-term potentiation (LTP), whereas activity dependent reduction of neuronal synapse efficacy is termed as Long-term depression (LTD). High frequency stimulation provides synaptic strengthening commonly known as long-term potentiation (LTP), whereas low-frequency

stimulation results in synaptic weakening, called long-term depression (LTD). Spike timing–dependent plasticity can also generate LTP or LTD, where the timing of the pre- and post-synaptic spikes changes synaptic strength. Hippocampal synaptic plasticity can be studied both *in vivo* and *ex vivo*. Electrodes implanted on living animals can provide valuable information about the hippocampal pathways whereas slices from hippocampus can also be used for electrophysiological measurements (Figure 19).

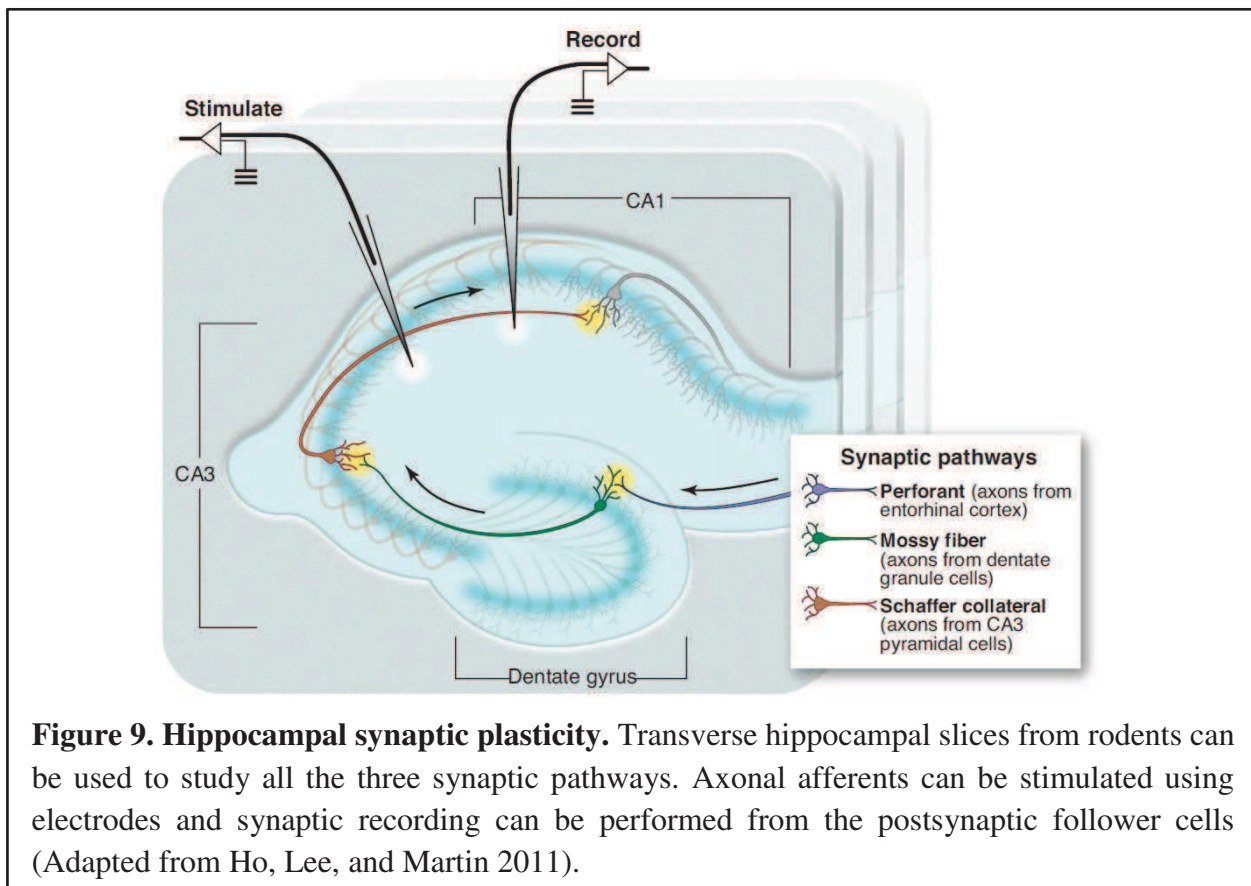

Figure 9. Hippocampal synaptic plasticity. Transverse hippocampal slices from rodents can be used to study all the three synaptic pathways. Axonal afferents can be stimulated using electrodes and synaptic recording can be performed from the postsynaptic follower cells (Adapted from Ho, Lee, and Martin 2011).

3.1.2. Presynaptic Mechanisms of Plasticity

Releases of neurotransmitters from the pre synaptic terminal followed by binding to the postsynaptic receptors are essential components for communication at the chemical synapses (Ho, Lee, and Martin 2011). The active zone of the presynaptic terminal consists of synaptic vesicles (Figure 10). Synaptic vesicles are rich with neurotransmitter, scaffolding proteins and a dense matrix of cytoskeleton. Synaptic strength during neuronal plasticity has direct correlation with the amount of neurotransmitter released. The synaptic vesicles exist in three different states in the presynaptic terminal: pool of readily releasable vesicles present at the active zone, pool of recyclable vesicles that is release upon mild or moderate stimulation; and

the reserve pool which is release upon strong stimulation. The synaptic vesicles then undergo docking or priming to be competent for fusion.

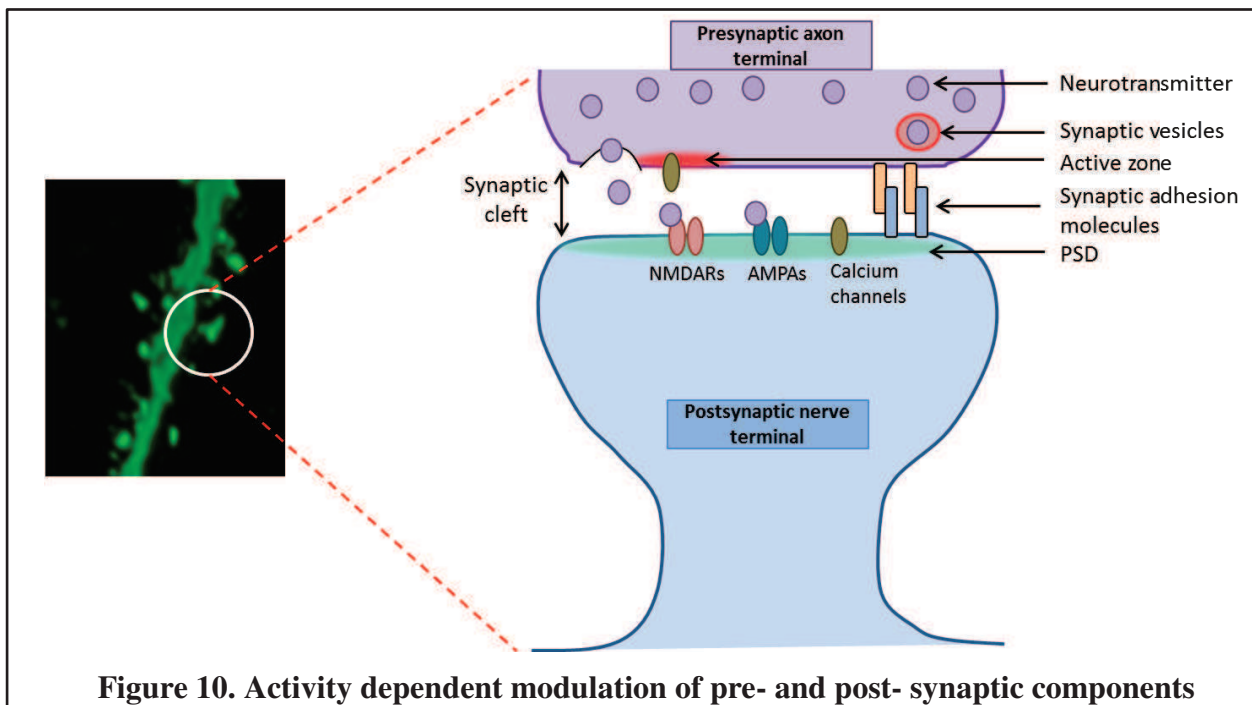

Figure 10. Activity dependent modulation of pre- and post- synaptic components

3.1.3. Postsynaptic Mechanisms of Plasticity

The principal neurons in the brain are mostly fabricated with the post synaptic compartments; dendritic spines. Spines bear a bulbous head and thinner neck which connects the spine with dendritic shaft. The size and volume of a spine correlates its synaptic strength; large spine possesses greater synaptic strength due to its large pool of neurotransmitter receptors. Interestingly, the number and shape of spine alters during synaptic plasticity. Post synaptic increase in intracellular calcium level modulates induction of LTP and LTD. LTP requires increased amounts of calcium concentration whereas LTD depends on less calcium increases. Increased calcium concentration leads to activation of multiple downstream signalling enzymes consisting of kinases calcium/calmodulin-dependent protein kinase II (CaMKII) and protein kinase C (PKC). CaMKII activity is crucial in CA1 during LTP and directly affects spatial learning (Malenka et al. 1989, Malinow, Schulman, and Tsien 1989, Silva et al. 1992, Hierholzer 1977). Increased Ca^{2+} -bound calmodulin activates kinase activity of CAMKII by autophosphorylation. Neuronal activity mediates translocation of CAMKII to PSD. Activated CAMKII phosphorylates multiple PSD proteins. Autophosphorylation of CAMKII is an important event for induction of LTP (Lisman, Schulman, and Cline 2002). Another

important component of the post synaptic plasticity in the brain is glutamate which activates several post synaptic receptors. Both AMPA and NMDA-type glutamate receptors are ligand-gated ion channels that play key roles in hippocampal synaptic plasticity. NMDARs are calcium permeable and allow influx of calcium required for LTP, whereas AMPARs are essential for expression and maintenance of LTP.

3.1.4. Trans-Synaptic Signalling; the Synaptic Cleft

The ~20-nm junction between the pre- and post-synaptic compartments is known as synaptic cleft. The neurotransmitters diffuse through the synaptic cleft to bind to the post synaptic receptors and the cell adhesion molecules (CAMs). The CAMs keeps the synapse in close association to each other. The important members of CAMs are cadherin, integrin, and immunoglobulin containing CAMs, as well as neuroligins and neuroligins.

3.1.5. The Tripartite Synapse: Glia and Synaptic Plasticity

Glial cells are now recognised to be another important factor involved in synaptic plasticity and transmission, synapse formation. Astrocytes localised near the synapse forms a “tripartite synapse” (Figure 11). The glial cells involved with the pre- and post-synaptic compartments release neuroactive molecules that contribute towards the communication among the neurons. One such example is the glial cell mediated release of D-serine (a coactivator of the NMDA receptor) is essential for LTP of hippocampal Schaffer collateral synapses (Henneberger et al. 2010, Agulhon, Fiacco, and McCarthy 2010).

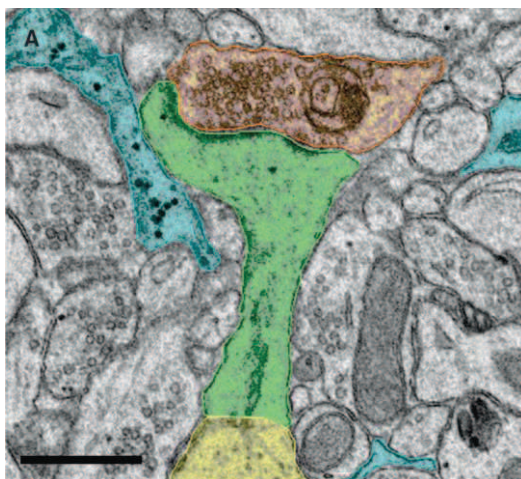
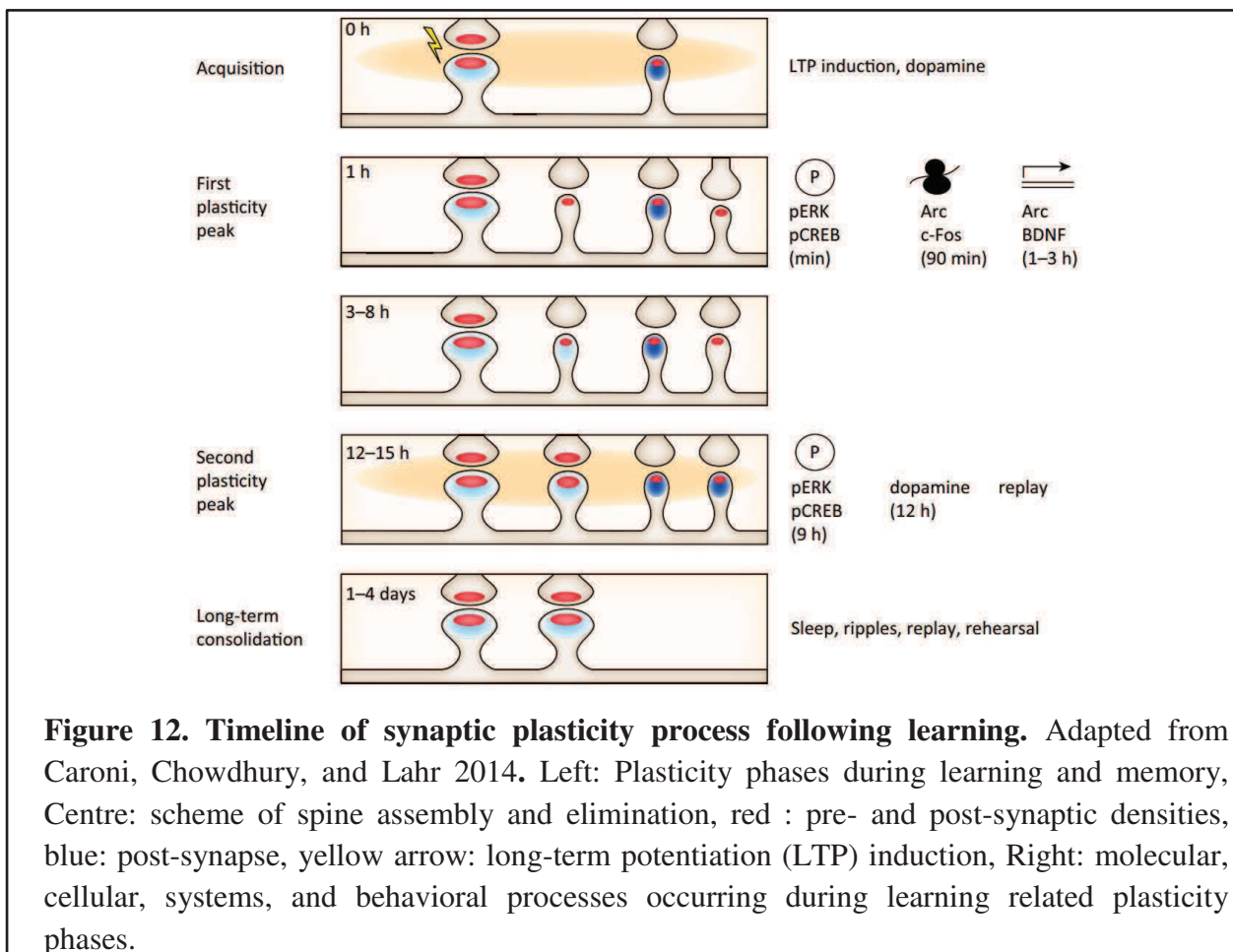

Figure 11. Electron microscopic image of a typical tripartite Synapse from CA1 region in adult rat hippocampus. The presynaptic terminal is coloured in orange, the spine neck of the post synaptic terminal in green, the dendritic shaft in yellow and the astroglial processes in blue. Scale bar represents 0.5 μm . Picture adapted from Ho, Lee, and Martin 2011.

3.1.6. Time-line of synaptic rearrangement upon learning

The first series of molecular and cellular events triggered by enhanced plasticity after acquisition includes 1) post translational modification like protein phosphorylation of protein kinase RNA-like endoplasmic reticulum kinase (pERK) and phosphorylated cAMP-response element binding protein (pCREB) within minutes, 2) protein synthesis of pre-existing mRNAs of plasticity related genes (e.g., c-Fos and Arc) within minutes and peak at 90 minutes, 3) growth of new immature synapse within one hour, 4) transcription of memory and plasticity related genes like BDNF and Arc within 1–3 hours (Figure 12) (Caroni, Chowdhury, and Lahr 2014). The second wave of molecular and cellular events includes protein phosphorylation (e.g., pERK and pCREB) peak at 9 hours followed by structural–functional maturation of new synapses within 12-15 hours. New memory consolidation process continues for several days with synapse elimination (most of the new synapses are eliminated within the first 1.5 days) and long-term retention of few synapses. The mechanistic details underlying long term memory consolidation is not very well described, but several factors like sleep, replay and rehearsal are thought to be involved this process.



3.1.7. Essential factors involved in synaptic plasticity and memory consolidation

Transcription is pivotal for persistence of long-lasting forms of synaptic plasticity underlying long term memory (Kandel 2001, Cristina M. Alberini and Kandel 2015). One of the most important gene expression pathway required for long term plasticity and memory consolidation across different species and memory types is the cAMP response element-binding proteins (CREB) dependent pathway (Alberini 2009; Kandel 2012). In a mammalian brain CREB dependent pathway is essential for long-term memory formation and long-term synaptic plasticity (Benito and Barco 2010; Barco and Marie 2011). CREB regulates transcription of multiple sets of genes during memory formation, one such example in the context of learning or long-term plasticity is the CCAAT enhancer-binding protein (C/EBP). C/EBP is an immediate early gene (IEG) which has direct influence on long-term synaptic plasticity and long-term memory consolidation. Thus CREB controls a transcriptional cascade via C/EBP (C. M. Alberini et al. 1994). c-Fos and the zinc-finger protein Zif268 (also known as early growth response protein [EGR]-1) are IEGs that are regulated by CREB. Gene expression of both c-fos and Zif268 are upregulated following learning and acts as important step during memory consolidation (John F. Guzowski 2002). The IEG overexpression following learning has provided excellent platform for modern biologists to explore the field of neuroscience to understand the basic mechanisms behind memory formation. Recently, several groups have developed transgenic mice by manipulating the regulatory elements (e.g., promoter regions) of IEGs to obtain activity-dependent response readouts (Garner et al. 2012).

Apart from the IEGs, several classes of transcription factors also plays essential roles in memory formation like nuclear factor-k light-chain enhancer of activated B cells (NF-kB), members of the families nuclear receptor 4a (NR4a), serum response factor (SRF), and neuronal Per-Arnt-Sim (PAS) homology factor 4 (NPAS4). LTP and learning tasks induces expression of NF-kB in both neurons and glia. NF-kB is implicated in memory-related synaptic plasticity. Knockout of NF-kB impairs memory formation (Crampton and O'Keefe 2013; Snow et al. 2014). NF-kB has a dual role in long-term memory depending on its synaptic localisation; it acts as a signalling molecule at the synapse and upon translocation into nucleus it acts as a transcriptional regulator (Romano et al. 2006).

Ligand-activated transcription factors belonging to the nuclear receptor (NR) superfamily is also linked to memory formation. Immediately after learning, expression of members of

NR4a family of orphan receptors increases in the hippocampus. The increased expression of these genes is crucial for hippocampus-dependent memory formation especially contextual fear and object recognition memory as well as the transcriptional-dependent LTP (Bridi and Abel 2013).

Several lines of evidences suggest that brain derived neurotrophic factor, bdnf triggers synaptic consolidation (Bramham 2007). Bdnf enhances synaptic consolidation at adult excitatory medial perforant path-granule cell synapses through its receptor tyrosine kinase (TrkB) present on pre- and postsynaptic elements of glutamatergic synapses (Drake, Milner, and Patterson 1999). One important characteristics of bdnf is that it regulates transcription and translation through post-transcriptional mechanisms, and can also stimulate its own release (Santi et al. 2006).

Arc is another factor that mediates synaptic consolidation. Within the first hour after induction of LTP, Arc mRNA gets transported to the distal dendrites of the granule cells (Won and Hogan 1995; Lyford et al. 1995). Increased protein levels of Arc are obtained in dendritic spines following LTP induction (Rodríguez et al. 2005). Behavioural training dynamically induces expression of Arc in principal neurons of many cortical and limbic structures which is crucial for long term memory (J. F. Guzowski et al. 1999; Vazdarjanova et al. 2006).

3.2. Systems consolidation

Unlike synaptic consolidation, systems consolidation is another level of memory consolidation. Memory consolidation at the systems levels is a slow process that requires reorganisation of the brain. Consolidation at the systems levels is associated with both declarative (Scoville and Milner 1957) and non-declarative memory (Shadmehr and Holcomb 1997). The first demonstration of systems consolidation was suggested by French psychologist Ribot where he proposed that memories possibly reorganise over time. He pointed out that the recent memories are more vulnerable to disruption after brain insult than the remote memories. Behavioural examinations from patients with temporally-graded retrograde amnesia (TGRA) showed that the role of hippocampus in the storage and retrieval of memory is time limited. Thus it could be suggested that hippocampus temporally stores new information but the permanent storage depends on broadly distributed cortical network (Reviewed in Frankland and Bontempi 2005).

3.2.1. Models of memory consolidation

Standard consolidation model

The first model for system consolidation was accounted by Marr (Marr 1970). He postulated that the hippocampus stores the new memories and subsequently transfers to the cortex for subsequent reorganization and reclassification. The transfer process depends on the neural activity during sleep. Based on these facts, contemporary models were formulated. The standard consolidation model states that new information is encoded between the hippocampus and cortical networks (Figure 13). Subsequent reactivation across hippocampal–cortical networks strengthens the cortico-cortical connections which further enables the new memories to be independent of hippocampus. According to this model memory in the hippocampus is more vulnerable to decay than in the cortex. One of the important features of this model is that changes in hippocampal and different cortical connection strength are rapid and transient whereas connection changes between cortical areas are slow.

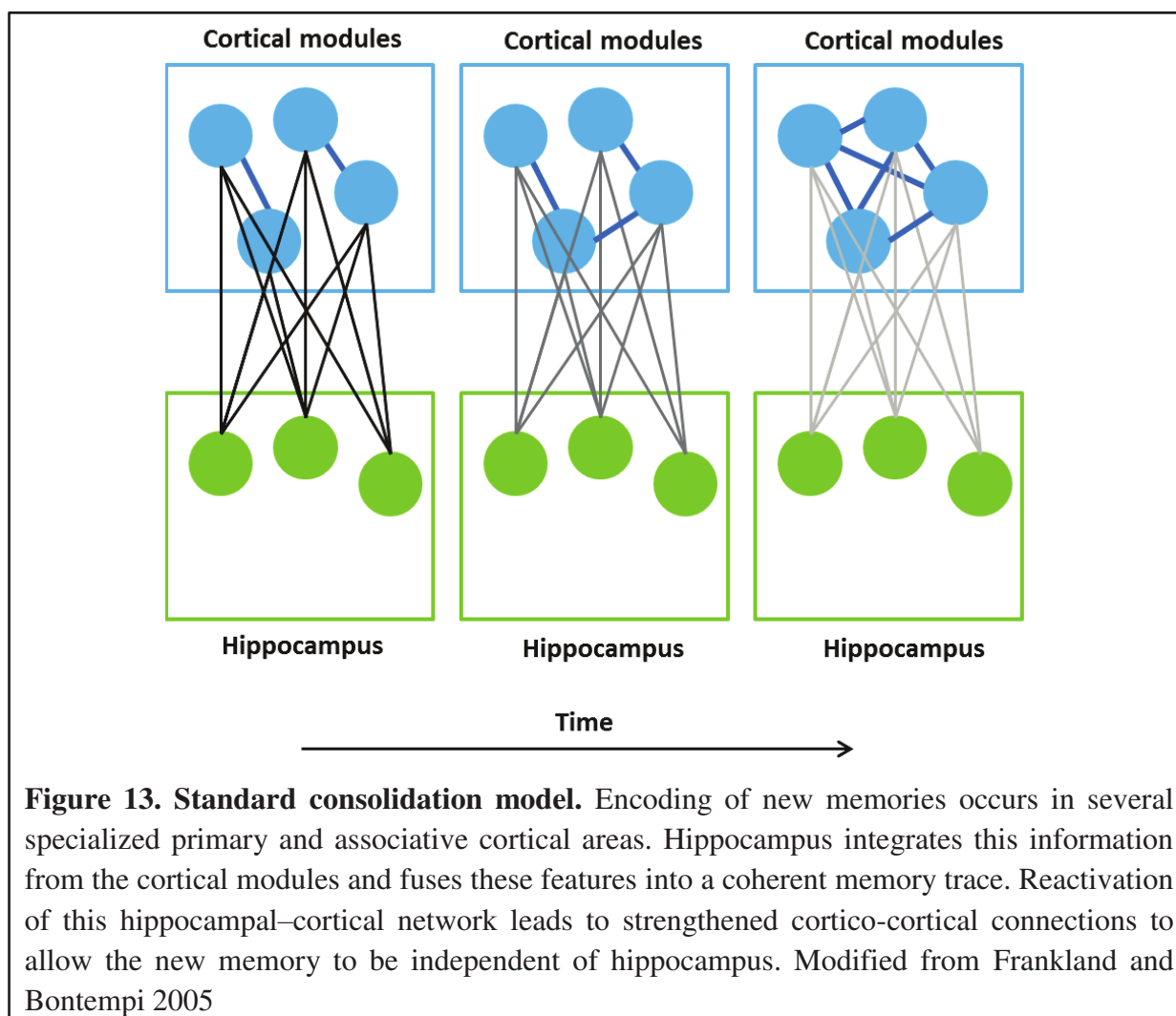
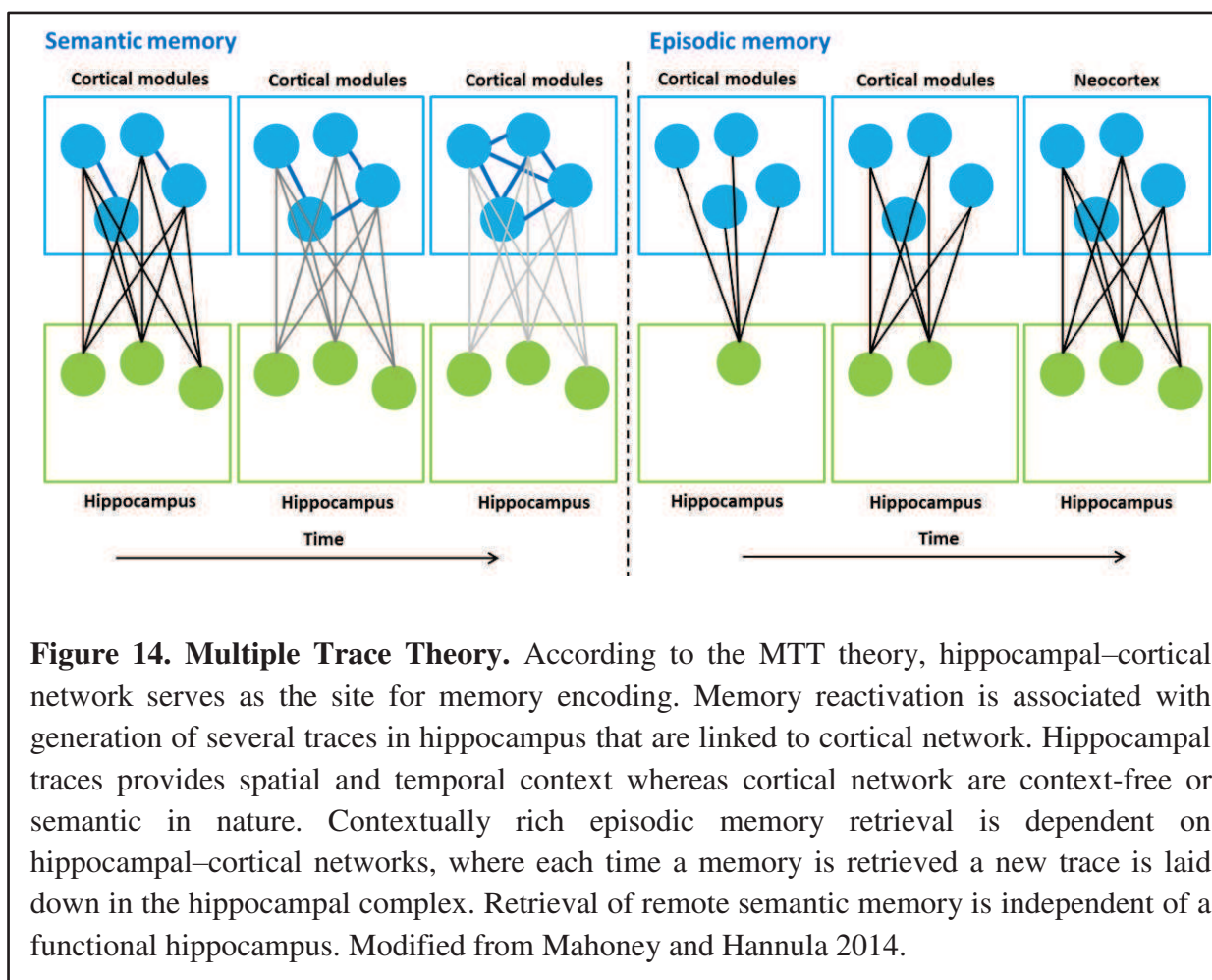

Figure 13. Standard consolidation model. Encoding of new memories occurs in several specialized primary and associative cortical areas. Hippocampus integrates this information from the cortical modules and fuses these features into a coherent memory trace. Reactivation of this hippocampal–cortical network leads to strengthened cortico-cortical connections to allow the new memory to be independent of hippocampus. Modified from Frankland and Bontempi 2005

The multiple trace theory

An alternative to standard consolidation model was proposed in 1997 commonly known as the multiple trace theory (MTT) (Nadel and Moscovitch 1997) (Figure 14). MTT states that even though the new memories are encoded in the hippocampal-cortical networks, hippocampus is still required for rich contextual or spatial detail. Incomplete hippocampal lesion should affect recent memory rather than remote episodic or semantic memories, whereas complete hippocampal lesion should disrupt all episodic memories, regardless of their age. Thus entire hippocampal lesions should produce temporally-graded retrograde amnesia for only semantic but not episodic memories. This theory is contradictory to the reports obtained from patient E.P., who had to undergo extensive bilateral medial temporal lobe lesion. Contrary to the MTT, E.P., had very good autobiographical and spatial memories from his youth (Teng and Squire 1999).



Involvement of prefrontal cortex in remote memory

Several imaging and inactivation studies have indicated towards a role of prefrontal cortex during remote memory recall. Prefrontal cortex has highly interconnected regions (anterior cingulate, prelimbic and infralimbic cortices) which are reciprocally connected to sensory, motor and limbic cortices. By virtue of its high connectivity, it is suited to process remote memory similar to hippocampus for processing recent memories. Upon maturation of memory, the integrative functions of a coherent memory trace possibly get transferred to the prefrontal cortex and also other associative cortices through the strengthening of cortico-cortical connections. Thus remote memory becomes independent to hippocampus and the prefrontal cortex could integrate information from multiple cortical regions (Miyashita 2004) (Figure 15). Interestingly, during recall of remote spatial and contextual memories hippocampal activity gets inhibited but the source of this inhibition is yet unknown.

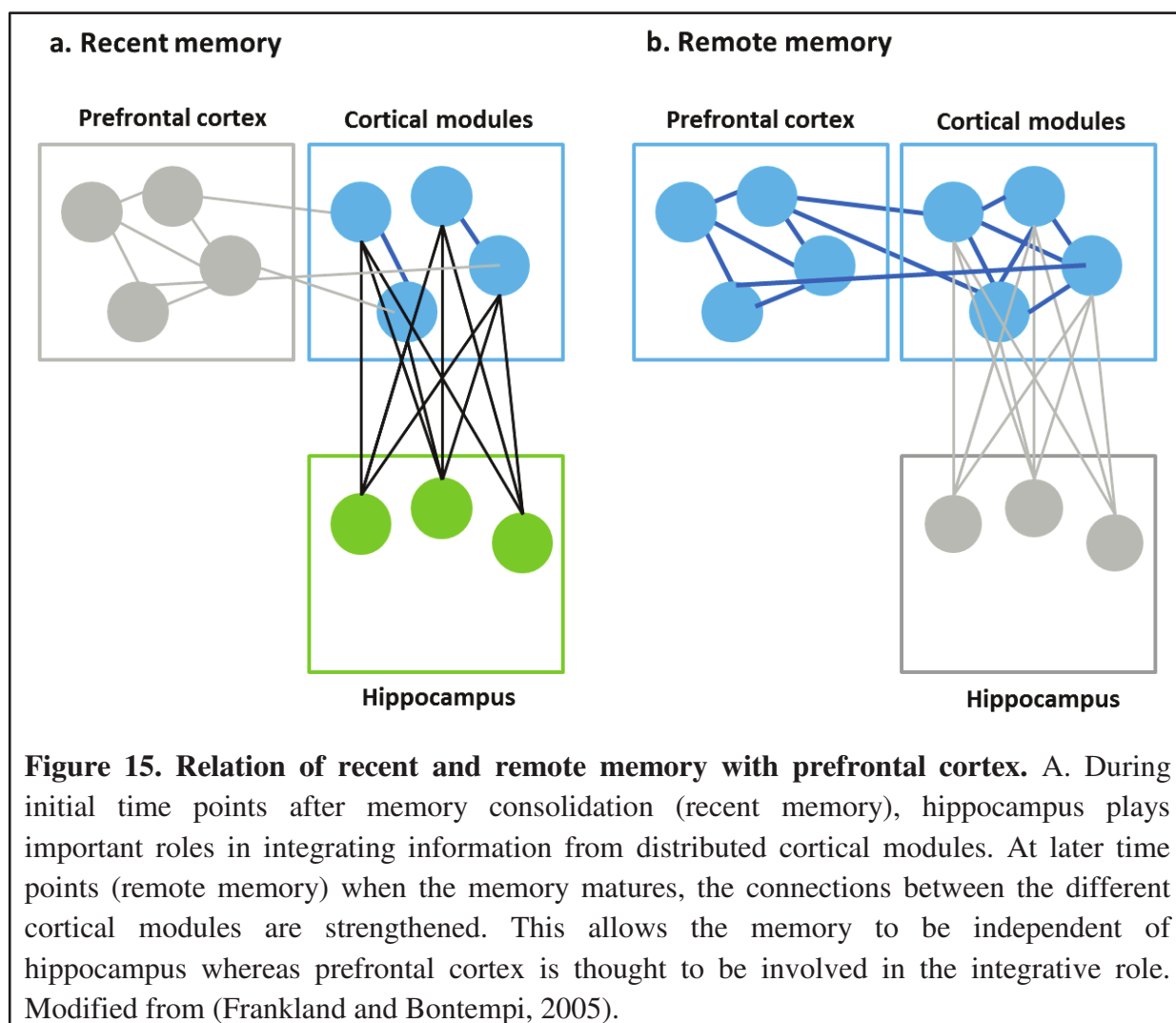

4. Adult Neurogenesis and Memory consolidation

The process of generation of new neurons throughout life in specific regions of the brain is known as adult neurogenesis. The two main neurogenic niches in a mammalian brain are the subventricular zone (SVZ) lining the lateral ventricles and the hippocampal dentate gyrus (DG) (Gage 2000). The neural stem cells or NSPCs possess two most important characteristics: self-renewal and multipotency. Niche-derived and/or intrinsic signals activate stem cells to undergo proliferation and form new neurons. In the DG the main population of cell type known to generate new neurons are the neural progenitor cells (also known as NSPCs) which ultimately differentiate into excitatory granule cells and integrate into the local neural network (Deng, Aimone, and Gage 2010). NSPCs from the SVZ produce neural progenitor cells that migrate via rostral migratory stream (RMS) towards the olfactory bulb (OB). In this section, neurogenesis from the hippocampal dentate gyrus will be discussed considering its involvement with hippocampus dependent learning and memory.

4.1. Neurogenesis process in the Dentate gyrus

Recent advances in clonal lineage-tracing analyses suggest that radial glia-like precursors are the multipotent neural stem cells which are capable of self-renewal and generate both neurons and astrocytes but not oligodendrocytes (Bonaguidi et al. 2011). Both proliferating radial and nonradial precursor cells give rise to intermediate progenitors and further form neuroblasts (Reviewed in Ming and Song 2011) (Figure 16). During the first week after birth, the newly born immature neurons migrate a short distance into the inner granule cell layer where they further differentiate to form dentate granule cells. Local interneurons release ambient GABA (γ -aminobutyric acid) tonically activate these cells. During the second week after birth, the adult-born neurons (DGCs) in the hippocampus extend their dendrites toward the molecular layer and project axons growing through the hilus toward the CA3 (Zhao et al. 2006). At this stage these immature DGCs still significantly differ from the mature ones. They have higher membrane resistance and with different firing properties. As DGCs lack glutamatergic input at this stage, they are also devoid of dendritic spines in the molecular layer. However, these immature DGCs receive synaptic GABAergic input possibly from local interneurons. During the third week after birth, the adult-born DGCs further involve in synaptic integration into the existing neural circuit. At around day 16, spines start to appear

from dendrites which enables them to form synapses with the afferent axon fibres in the perforant pathway coming from the entorhinal Cortex. Initially filopodia forms the major population spines that targets axon boutons which are already in synapse with other spines. Around 4–6 weeks of age, the adult-born DGCs displays stronger synaptic plasticity compared to the mature DGCs. NMDA receptor subunit NR2B influences this increased plasticity (Ge et al. 2007). At 8 weeks of age, the adult-born DGCs exhibits similar basic physiological properties and synaptic plasticity compare mature DGCs and are indistinguishable (Deng, Aimone, and Gage 2010).

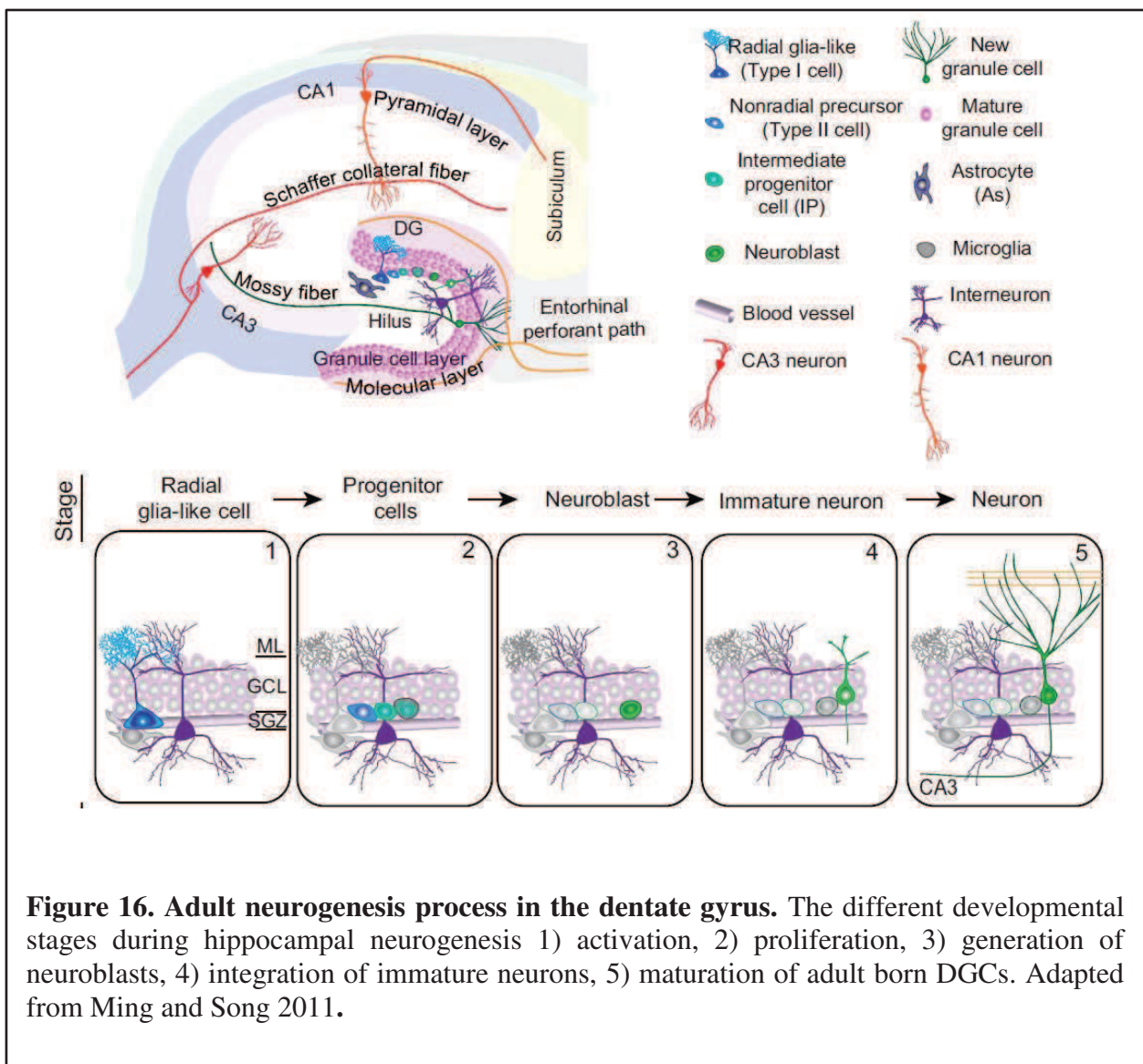

Figure 16. Adult neurogenesis process in the dentate gyrus. The different developmental stages during hippocampal neurogenesis 1) activation, 2) proliferation, 3) generation of neuroblasts, 4) integration of immature neurons, 5) maturation of adult born DGCs. Adapted from Ming and Song 2011.

4.2. Systemic regulation of adult neurogenesis

Numerous factors associated with behaviour and cognitive state of an animal can regulate adult neurogenesis which impacts on learning and memory (Deng, Aimone, and Gage 2010). Some of these factors include hippocampus dependent learning tasks, housing in enriched environment and voluntary running. Whereas factors that inhibits hippocampal neurogenesis are stress, certain forms of inflammation, alcohol abuse and age, among other factors (Herrera et al. 2003; Zhao, Deng, and Gage 2008). Hippocampus dependent learning task is one of the well-studied models to analyse adult neurogenesis. Spatial navigation learning in the Morris water maze (MWM) increases survival of DGCs that were born 7 days before the start of the task (Dupret et al. 2007). These survived DGCs forms GABAergic synapses with the local network and enters the most active state during the MWM learning. Several other reports collectively suggest that neurogenesis events and survival of new neurons are strictly regulated by learning. In other words, learning selectively incorporates or removes adult-born DGCs based on their maturity and functional relevance. Living in enriched environment (EE) also improves hippocampal neurogenesis by increasing the survival of adult-born DGCs. One week EE increases the survival of adult-born DGCs younger than 3 weeks. EE also improves performance in learning and memory related tasks like MWM and object recognition tests (Kempermann, Kuhn, and Gage 1997; Bruel-Jungerman, Laroche, and Rampon 2005). However, the essence of hippocampal neurogenesis in these memory related tasks is still debatable (Bruel-Jungerman, Laroche, and Rampon 2005; Hirohashi et al. 1991). Physical exercise has been shown to improve cognition and other brain functions (Hillman, Erickson, and Kramer 2008; Henriette van Praag 2009). Voluntary running increases proliferation and survival of NPCs in the DG. Increased amplitude of LTP in the DG and improved performance in MWM after voluntary running indicates a close correlation between increased neurogenesis and cognitive improvement. High frequency stimulation of the perforant pathway mediated LTP induction in the DG has shown to increase NPCs proliferation and survival of adult born DGCs (Bruel-Jungerman et al. 2006; Kowaluk and Fung 1991). Pathological conditions such as neurodegenerative disorders have also shown to affect the hippocampal circuit activity thereby causing altered proliferation of NPCs and morphological abnormalities in adult-born DGCs (reviewed in Zhao, Deng, and Gage 2008).

4.3. Functions of immature adult born neurons

New born neurons are thought to play significant roles in learning and memory (Deng, Aimone, and Gage 2010). Improved neurogenesis contributes to hippocampus dependent memory tasks like the Morris water maze (Kempermann, Kuhn, and Gage 1997; H. van Praag et al. 1999). Preferential recruitment of adult born DGCs into the hippocampal neuronal circuits corresponds to improved novelty recognition, contextual fear conditioning, spatial information processing and memory formation (Y. Gu, Janoschka, and Ge 2013). Transgenesis- and virus-based strategies mediated increase or depletion of neurogenesis established its role in spatial and object recognition memory (Jessberger et al. 2009), fear conditioning and synaptic plasticity (Saxe et al. 2006) and pattern separation (Clelland et al. 2009; Sahay et al. 2011; Nakashiba et al. 2012). The critical period between 3 and 6 weeks when the plasticity of the adult DGCs is elevated, is considered to be essential for adult brain behaviour (Marín-Burgin et al. 2012).

Two important modes through which an immature neuron could impact directly on adult brain function are; a) acting as an information processing unit and b) as an active modulator of local circuitry (Christian, Song, and Ming 2014). Even though the number of immature neurons are regulated and most of them do not survive for long, but selective recruitment of excitable immature neurons with increased synaptic plasticity will enable these cells to be an active member for information processing in the trisynaptic circuit (Christian, Song, and Ming 2014).

4.4. Adult hippocampal neurogenesis and cognition

After the discovery of neurogenesis in postnatal brain, Altman in 1967 proposed the critical role of adult neurogenesis in learning and memory. The first experimental evidence for the role of adult neurogenesis in behavioural paradigm of mammals came from Shors et al 2001, where antimitotic agent mediated blockage of neurogenesis disrupted trace eye-blink conditioning and trace fear conditioning but not spatial memory (Shors et al. 2001). Since then, the field of neurogenesis and behaviour has improved a great deal with advancements in sophisticated genetic and optogenetic approaches. Ablation of hippocampal neurogenesis can either improve or have no effect on acquisition of spatial learning or associative memory tasks. Optogenetically silencing dentate new-born neurons at 4 weeks age but not of earlier

age impairs the retrieval of learned fear-conditioned contexts (Y. Gu et al. 2012). Additionally, indirect improvement of adult neurogenesis by environmental enrichment, running, etc leads to enhancement of spatial and associative memory (Koehl and Abrous 2011; Lepousez, Nissant, and Lledo 2015). However, the causal link between adult neurogenesis and memory formation is still contradictory and debatable.

Pattern separation and dentate gyrus

Adult hippocampal neurogenesis has recently been found to be closely associated to pattern separation. Especially the DGCs between 3 and 6 weeks age with increased plasticity is considered to be an important contributor of pattern separation. The process of transforming very similar experiences into distinct non-overlapping neural representations is known as pattern separation. Pattern separation occurs in such situation when the output firing patterns of a network are less similar to one another than the input firing patterns (Deng, Aimone, and Gage 2010). The anatomy of the dentate gyrus is considered to be ideal for pattern separation as it contains around ten times more neurons than its principal input, the entorhinal cortex (EC). Evidences suggest that even similar inputs activate distinct populations of DGCs making the DG finely tuned for pattern separation. Thus the dentate gyrus drives the encoding of two similar events into memories that do not converge in future (Figure 17).

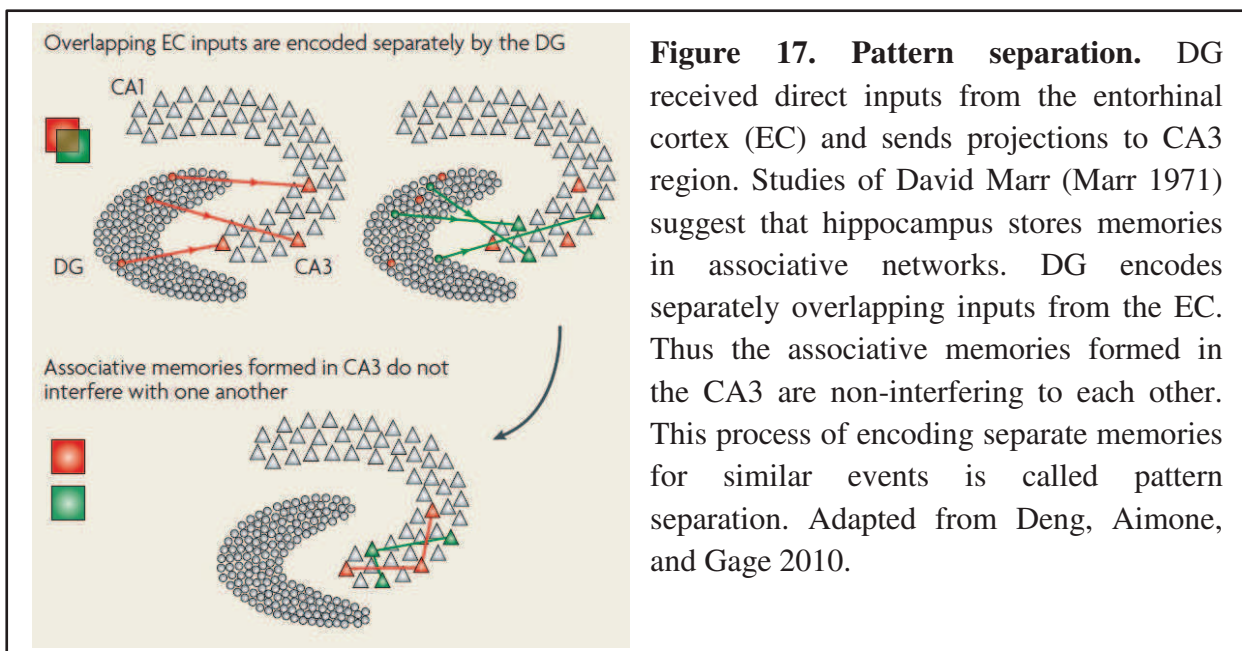

Several recent reports suggest that adult neurogenesis modulates pattern separation (Figure 18). Clelland and colleagues first demonstrated using two-choice touch screen spatial

discrimination task that blocking adult neurogenesis directly impacts on pattern separation. Hippocampal X-irradiation mediated blocking neurogenesis impaired the animal's ability to detect small or fine spatial discrimination but not large (Clelland et al. 2009). Later Sahay and colleagues using a contextual fear discrimination learning task concluded similar results that distinguishing between similar contextual representations requires new neurons (Sahay et al. 2011). These studies strongly support the role of adult neurogenesis in pattern separation in three different dentate gyrus dependent behavioral paradigms. If the hypothesis is true then increasing the adult neurogenesis in DG should ideally improve pattern separation. Sahay and colleagues thus developed genetically modified mice with more functionally integrated adult-born dentate granule neurons (also known as ibax mice). In contextual fear discrimination learning task, these ibax mice were better at distinguishing between two similar contexts. These reports suggest that pattern separation could be improved by increasing adult neurogenesis.

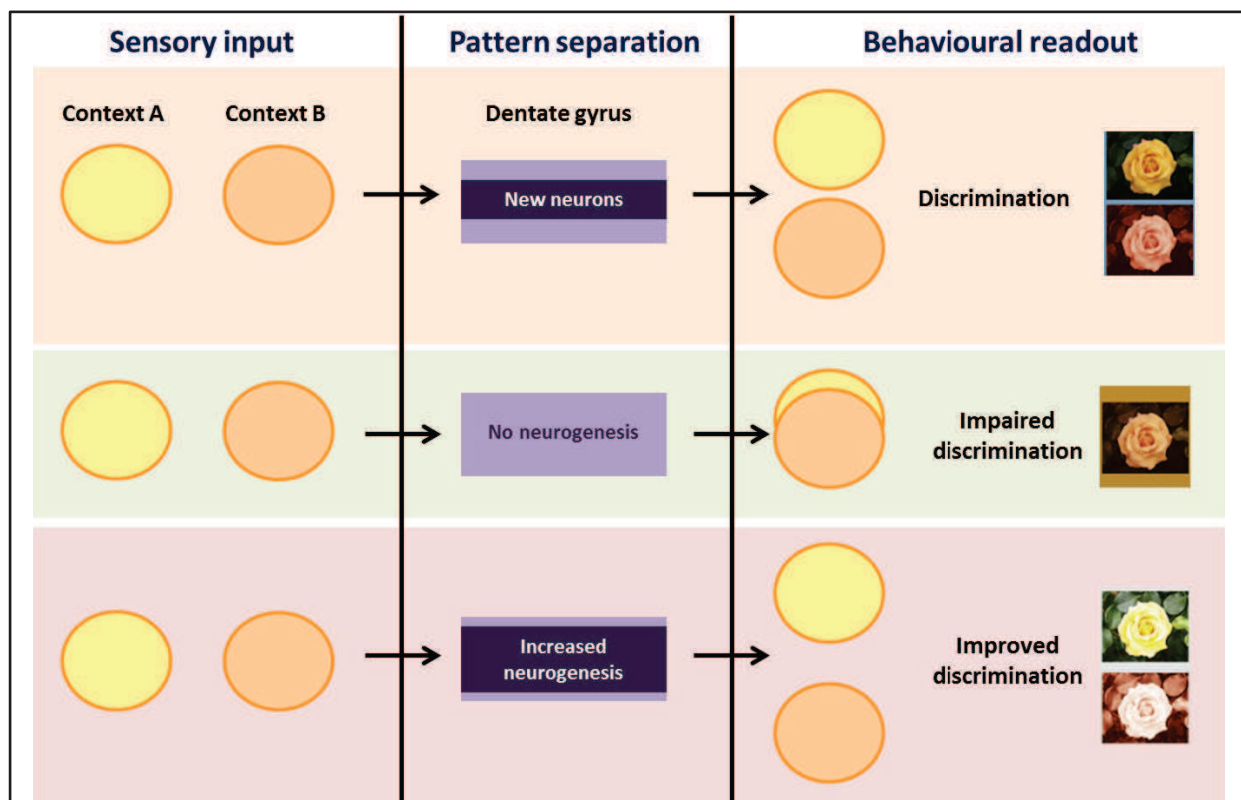

Figure 18. Neurogenesis and pattern separation. The dentate gyrus is essential for the discrimination between two similar contexts (Context A and B) in a process called pattern separation. Pattern separation requires adult neurogenesis that generates new neurons. When adult neurogenesis is blocked, pattern separation is impaired. However, increased neurogenesis by genetic manipulation enhances the discrimination between the two contexts.

CHAPTER 2: Molecular Mechanism of Memory

CHAPTER 2: Molecular Mechanism of Memory

1. Introduction to molecular events during memory consolidation

Regulation of gene expression is pivotal for the storage of long-term memory. Memory consolidation is the temporally limited process that is required for conversion of memory in the labile and short-term lasting state to a more stable long-term phase. Consolidation can be regarded as the phase during memory formation where new protein synthesis is crucial.

Representation of signaling cascades during memory consolidation is extremely complex. The major components during different steps of the signaling pathway during memory consolidation have been discussed in this chapter. Briefly, the synapses are plastic structure present on the dendrites of hippocampus. Learning leads to activation and enlargement of the synapses. Neurotransmitters released from the synapses binds with the receptors present on the post-synaptic membranes (Figure 19). Binding of the neurotransmitters activates the receptors which in turn activates various kinase cascades and intracellular signals depending on the context and the receptor types. Activated kinases translocate into the nucleus and activate the constitutive transcription factors (Herdegen and Leah, 1998). The constitutive transcription factors are transcription factors that get covalently modified (like phosphorylation) and drives transcription of IEGs. Some IEGs themselves acts as transcription factors and drives expression of late genes. These gene products are essential for the maintenance of synaptic efficacy. The activation of these pathways and concomitant changes in the morphology of the cytoskeleton are the deciding steps during memory consolidation. These molecular processes are related to short-term, long-term and persistence of memory mechanisms.

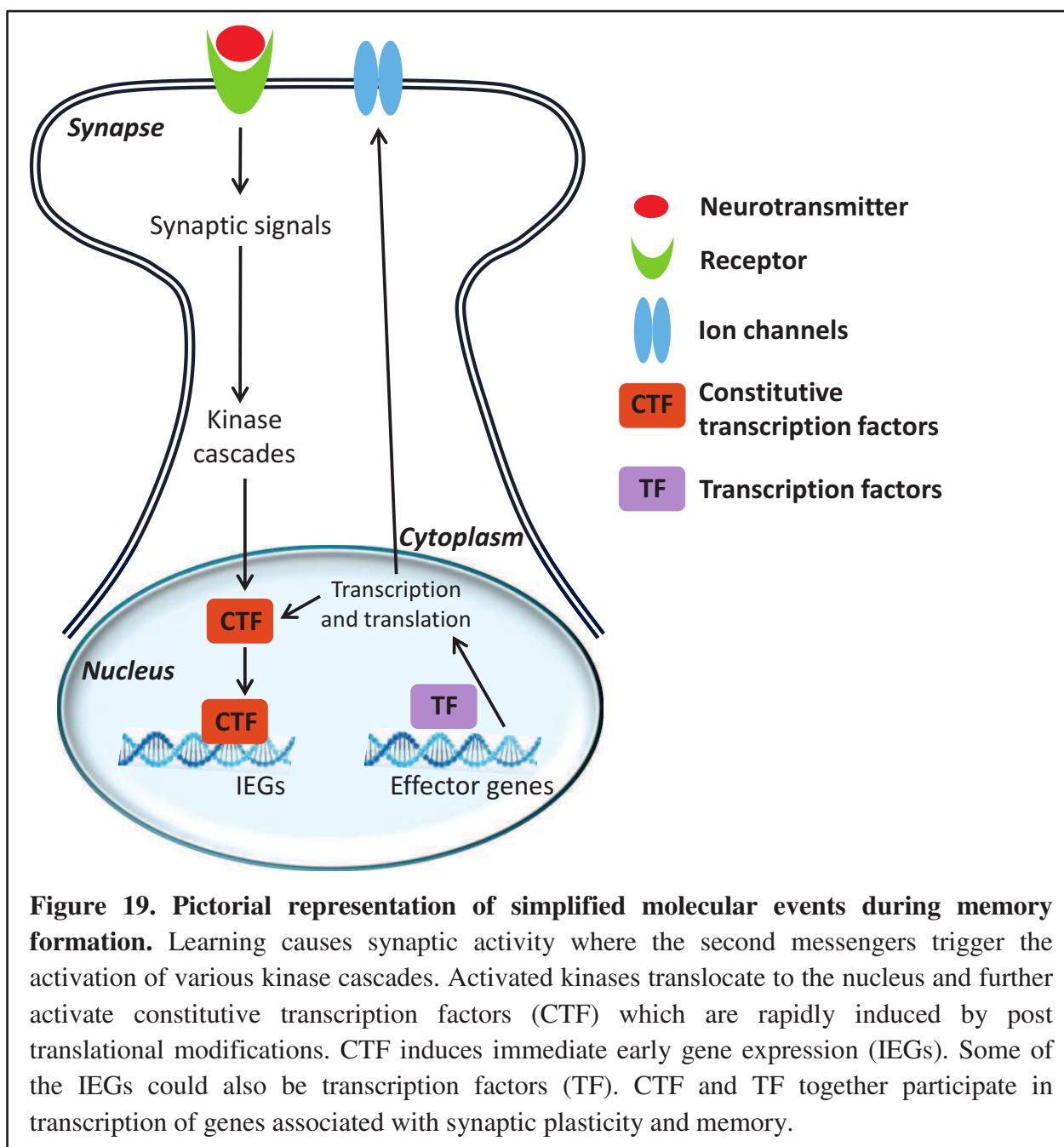

2. Growth factors involved in synaptic plasticity and memory

Growth factors (GF) are molecules that are secreted upon stimuli and bind to membrane-associated extracellular receptors and activates intracellular signaling cascades that leads to cellular survival and growth. Nerve growth factor (NGF) is the first fully characterised GF. Classification of GF is based on the signaling cascades that are activated by the receptors. Receptor tyrosine kinases and serine–threonine kinases are the two main classes of receptors.

Neurotrophin family is one such GF family that signal through receptor tyrosine kinases. The neurotrophin family, includes NGF, brain-derived neurotrophic factor (BDNF), neurotrophin 3 (NT-3), and neurotrophin 4/5 (NT-4/5) (Huang and Reichardt, 2003). Transforming growth factor beta (TGF β) superfamily including TGF β , activin, and bone morphogenic proteins (BMPs) are the other classes of GF that signals thorough serine–threonine kinases. However, the developmental plasticity of a neuron involves considerable overlap in the roles of different families of GF. Diverse range of GFs are implicated as critical component in long-lasting plasticity (reviewed in (Kopec and Carew, 2013) and the temporal and spatial regulation of signaling cascade by GF mediated distinct functional outcomes is an important aspect in dendritic plasticity and memory formation. In this section, implications of brain-derived neurotrophic factor (BDNF) will be discussed further to understand its role in plasticity and long-term memory.

Brain-derived neurotrophic factor (BDNF)

BDNF is an activity dependent gene that encodes a neurotrophin. *Bdnf* gene has a highly complicated structure and regulation as it contains total 24 transcript variants produced with 9 promoters (Figure 20). However, all the translated products from all the transcripts are identical mature dimeric protein. The promoters play important roles in tissue specific expression of different transcript variants of BDNF. However, various stimuli like physical exercise, seizures, ischemia, osmotic stress, and antidepressant treatment causes differential regulation of specific exon-containing transcripts of BDNF. BDNF is initially translated as a precursor, pre-proBDNF protein and form a cleavage into a 32-kDa proBDNF protein. 14 kDa mature BDNF (mBDNF) is formed either after proteolytic cleavage intracellularly or secreted as proBDNF and then cleaved by extracellular proteases. BDNF is predominantly localised intracellularly at the somatodendrites but is also present in close proximity to the dendritic spines (Tongiorgi, 2008). BDNF can be localised at both pre-and post-synaptic compartments its release upon activity is dependent by three main mechanisms: a) Ca²⁺ influx-dependent release from postsynaptic sites, b) Ca²⁺ influx- dependent release from presynaptic sites, c) Ca²⁺ influx-independent release that relies on Ca²⁺ release from intracellular stores (reviewed in (Cunha et al., 2010).

BDNF is expressed in response to activity is secreted in the synapses where it binds to tyrosine kinase receptor B (trkB) and p75 neurotrophin receptors localised at both pre-and postsynaptic membranes (Figure 21). BDNF induction promotes dendritic outgrowth and synapse maturation, however the effect of BDNF is extremely complex. BDNF selectively acts on dendritic outgrowth; its application in primary somatosensory cortex enhances dendritic outgrowth in layer II/III and layer IV neurons, whereas inhibits outgrowth in layer VI neurons (Niblock et al., 2000). *Bdnf* conditional knockout mouse also confirms its regulation of dendritic outgrowth in layer II/III cortical neurons (Gorski et al., 2003a). Furthermore, *bdnf* knock-in mouse with a polymorphic variant of BDNF (Val66Met) also displays decreased dendritic complexity and dysregulated trafficking, distribution and activity-dependent release of BDNF from neurons (Chen et al., 2006). The val66met polymorphic variant of BDNF (Val66Met) is also found in human patients with memory deficits and psychiatric disorders (Bath and Lee, 2006) suggesting significant role of BDNF in neural connectivity and cognition.

BDNF and synaptic plasticity

Synaptic plasticity is closely correlated with learning and memory. LTP is the best studied form of synaptic plasticity. Stimulation of LTP results in activation of a number of signaling cascades including the ones activated by BDNF. BDNF is implicated in LTP induction at hippocampal synapses at the Schaffer collateral → CA1 synapse (Kang and Schuman, 1995), dentate gyrus (Messaoudi et al., 2002) and also in the visual cortex (Akaneya et al., 1997). The role of BDNF was initially reported *in vitro* where exogenous BDNF sufficiently induced LTP in young hippocampal slices. Later *in vivo* role of BDNF in LTP induction was established from transgenic mice. BDNF null mutant mice showed severe impairment in LTP induction at the Schaffer collateral → CA1 synapse. Similarly, heterozygous BDNF mice showed cortical LTP impairment (Bartoletti et al., 2002). Interestingly, hippocampal slices from these mice treated with recombinant BDNF could reversed deficits in LTP and restore the synaptic transmission (Pozzo-Miller et al., 1999).

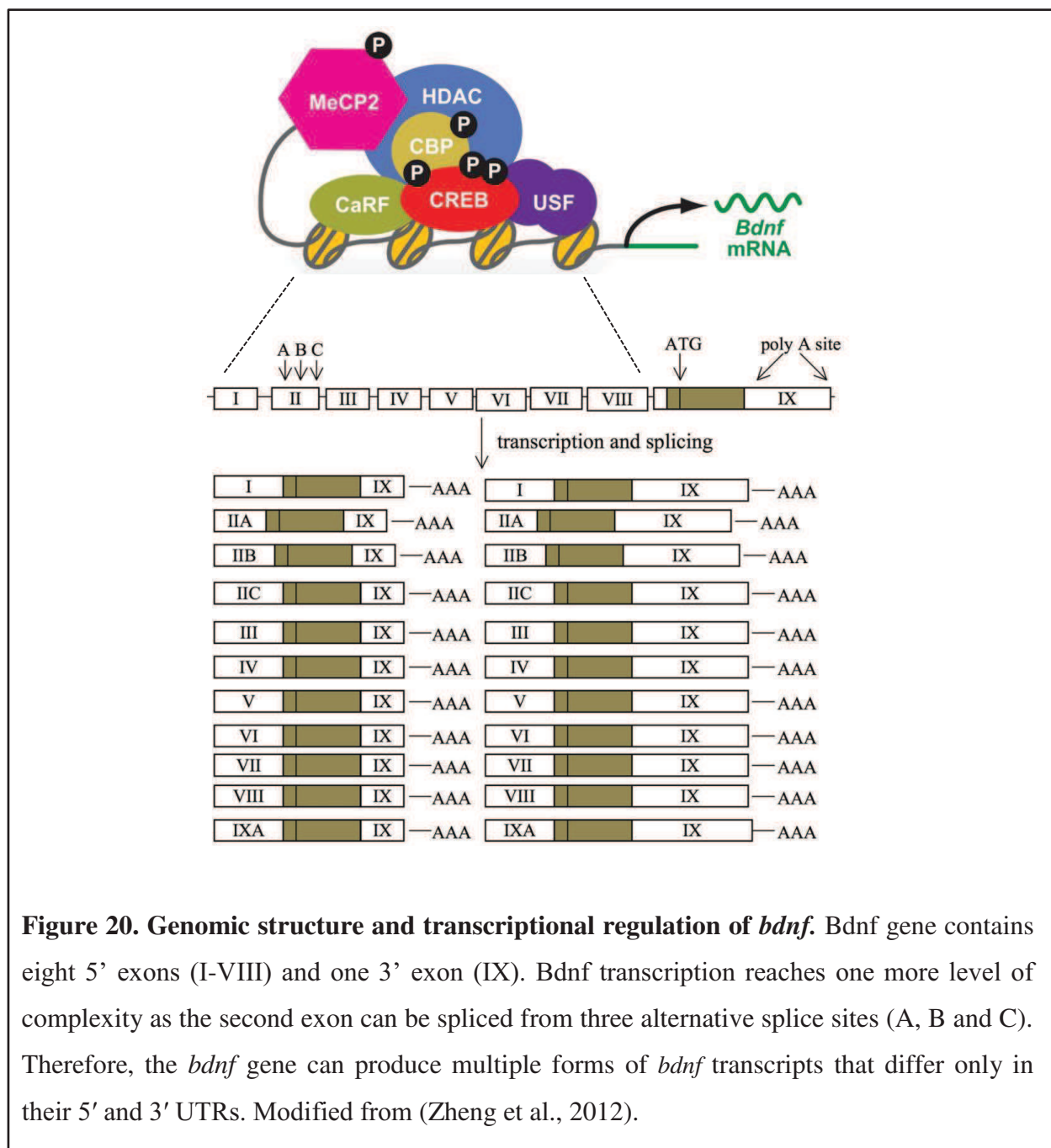

BDNF is also considered to be essential for late LTP (L-LTP). L-LTP process needs transcription and translation and depends on cAMP signalling and CREB. The proteolytic conversion of proBDNF into mature BDNF is essential for L-LTP. Mature BDNF can itself trigger L-LTP in absence of protein synthesis suggesting BDNF mediated activation of TrkB signaling is sufficient to induce L-LTP. Concomitantly, blockage of TrkB signalling at pre- and postsynaptic sites impairs L-LTP (Gärtner et al., 2006). Further research established BDNF role in the maintenance of L-LTP (Barco et al., 2005).

BDNF and Long-term memory

Investigation in rodents has contributed immensely to establish the role of BDNF in learning and memory. BDNF gene expression is induced in the hippocampus of rats following training in Morris water maze (MWM; (Bousiges et al., 2010)), radial arm maze, passive avoidance and contextual fear conditioning (Cunha et al., 2010). Such finding relates to the importance of BDNF activity in various hippocampus dependent memory tasks. Essential brain regions responsible for cognitive function such as hippocampus, neocortex, cerebellum, striatum and amygdala shows highest expression of BDNF proteins (Kawamoto et al., 1996). BDNF activity is crucial for the acquisition of spatial memory. Intra-hippocampal BDNF administration of BDNF significantly improves spatial memory in MWM task (Cirulli et al., 2004), whereas infusion of anti-BDNF antibody before the training impairs spatial memory (Mu et al., 1999). Also, inhibition of endogenous BDNF by infusion of anti-BDNF antibody at the parietal cortex impairs inhibitory avoidance by blocking CREB activation (Alonso et al., 2005). Recent studies suggest that NMDA receptor- and CREB-dependent mechanisms regulate expression of specific transcript variants of BDNF during the consolidation of long-term memory. To understand the role of BDNF in cognitive function several lines of transgenic mice with mutation in BDNF gene has been developed. BDNF null mutation mice die within 2 days after birth, so no behavioural studies could be studied in these mice (Ernfors et al., 1994). Heterozygous BDNF KO has a normal life span and shows reduced LTP in the CA1 region of the hippocampus in homozygous mice and heterozygous KO mice. BDNF heterozygous KO mice are deficient in spatial learning (Linnarsson et al., 1997) and contextual fear conditioning. Recently, BDNF conditional KO mice have been developed to circumvent the postnatal lethality problem and of developmental effects. Forebrain specific inducible loss of BDNF conditional mice shows impaired contextual fear conditioning and hippocampal LTP (Monteggia et al., 2004). Mice lacking BDNF from the early embryonic development (Emx-BDNF-KO) specifically in forebrain regions shows deficits in spatial learning in MWM (Gorski et al., 2003b). Site-specific deletion of BDNF in the dorsal hippocampus using lentiviral delivery of CRE recombinase shows impairment in MWM and novel object recognition tests (Heldt et al., 2007). Inhibition of local translation of BDNF was performed using administration of antisense oligonucleotides or RNA interference (RNAi) in non-transgenic mice. Spatial learning in radial arm maze was impaired in rats with intracerebroventricular infusion of antisense BDNF oligonucleotides which blocks BDNF

translation (Mizuno et al., 2000). Hippocampal infusion of antisense BDNF cDNA prevents consolidation of contextual fear conditioning (Lee et al., 2004). Thus the combined results from the transgenic mice models of BDNF mutations and local deletion of BDNF established its essential role in the long-term memory process.

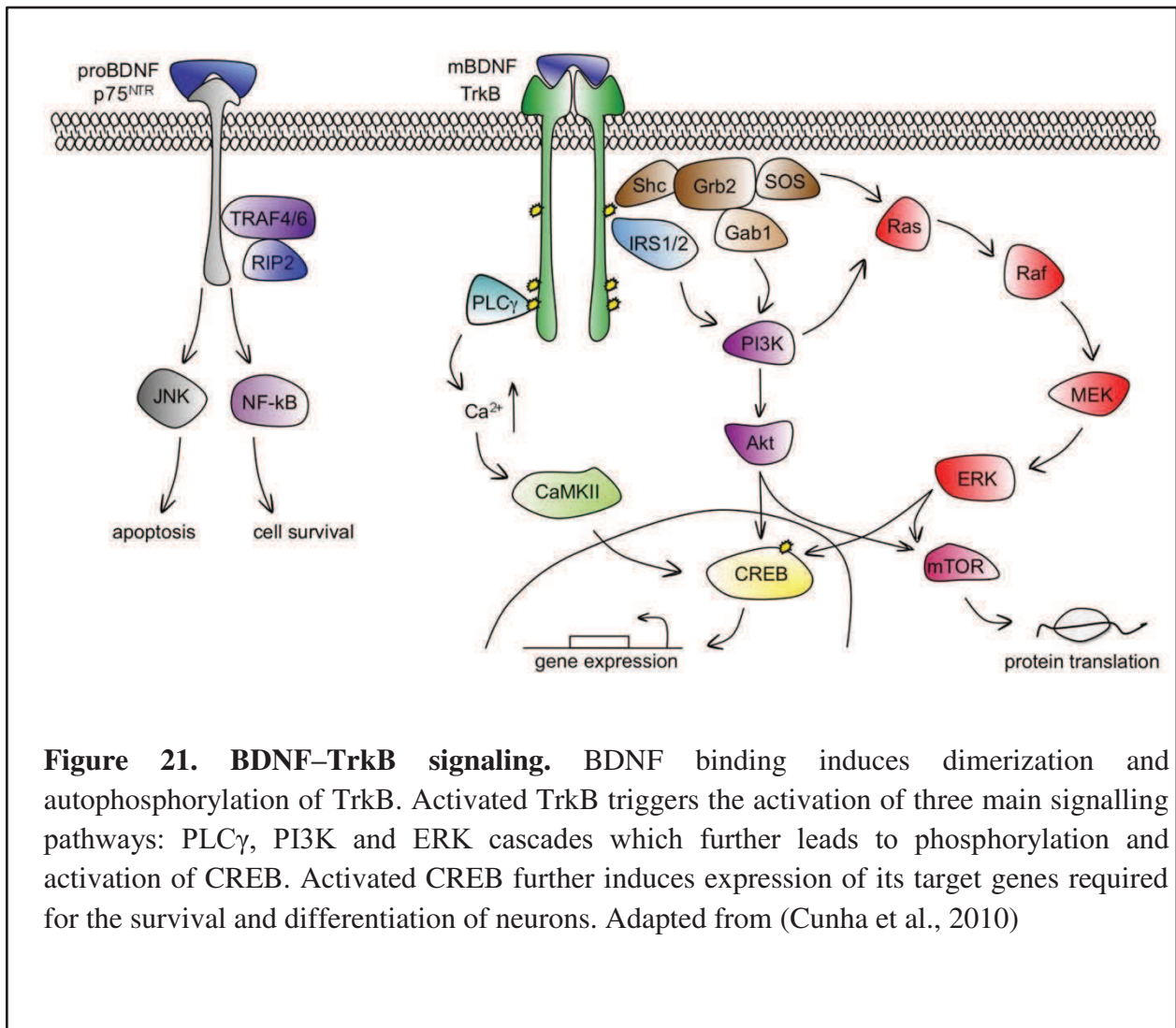

Figure 21. BDNF–TrkB signaling. BDNF binding induces dimerization and autophosphorylation of TrkB. Activated TrkB triggers the activation of three main signalling pathways: PLCγ, PI3K and ERK cascades which further leads to phosphorylation and activation of CREB. Activated CREB further induces expression of its target genes required for the survival and differentiation of neurons. Adapted from (Cunha et al., 2010)

3. Signaling cascades involved during memory formation

MAPK signaling cascade in synaptic plasticity and memory consolidation

The mitogen-activated protein kinase (MAPK) cascade activates extracellular signal-regulated kinases-1 and -2 (ERK1 and ERK2). MAPK cascade is crucial for cell type specific differentiation and proliferation. However, recent reports establish the essence of MAPK pathway in control of synaptic plasticity in the adult brain (Reviewed in Thomas and Huganir, 2004).

The best characterised MAPK pathway involves activation of ERK1 and ERK2 in response to growth factors and other stimuli. The ERK signalling is implicated in neuronal transcription and regulation of synaptic targets to control plasticity. Extracellular stimuli cause increase in activated GTP-bound form of small G protein Ras which leads to activation of ERK1 and ERK2. Ras-GTP levels are increased by enhanced activity of guanyl nucleotide exchange factors (GEFs), decreased activity of GTPase-activating proteins (GAPs) or both. Ras-GTP further activates protein kinase Raf which activates MAPK/ERK kinase (MEK) by phosphorylation. Activated MEKs thereby phosphorylate and activate ERK1 and ERK2 (also known as p44 and p42 MAPK, respectively). ERKs have diverse sets of targets including transcription factors, cytoskeletal proteins, regulatory enzymes and, importantly, other kinases. The first evidence of ERKs involvement in memory related signal transductions was obtained from the discovery that excitatory glutamatergic signalling leads to activation of ERKs in neuron (Fiore et al., 1993). Neuronal ERK is activated upon membrane depolarization or glutamatergic signalling (Figure 22). This pathway of ERK activation requires calcium influx and Ras activation. NMDA (N-methyl D-aspartate)-type glutamate receptors or voltage-gated calcium channels can facilitate calcium influx.

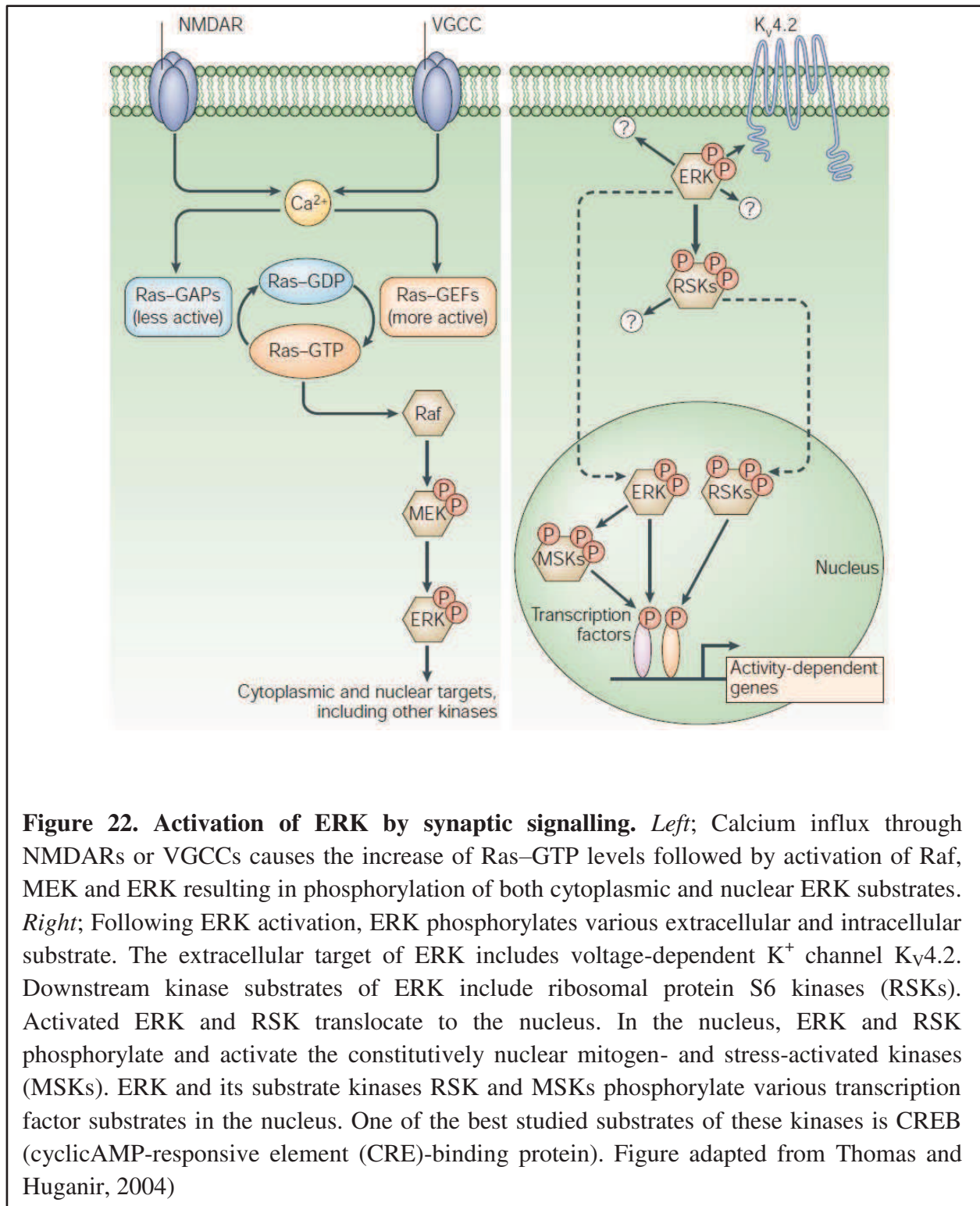

Figure 22. Activation of ERK by synaptic signalling. *Left;* Calcium influx through NMDARs or VGCCs causes the increase of Ras-GTP levels followed by activation of Raf, MEK and ERK resulting in phosphorylation of both cytoplasmic and nuclear ERK substrates. *Right;* Following ERK activation, ERK phosphorylates various extracellular and intracellular substrate. The extracellular target of ERK includes voltage-dependent K⁺ channel K_v4.2. Downstream kinase substrates of ERK include ribosomal protein S6 kinases (RSKs). Activated ERK and RSK translocate to the nucleus. In the nucleus, ERK and RSK phosphorylate and activate the constitutively nuclear mitogen- and stress-activated kinases (MSKs). ERK and its substrate kinases RSK and MSKs phosphorylate various transcription factor substrates in the nucleus. One of the best studied substrates of these kinases is CREB (cyclicAMP-responsive element (CRE)-binding protein). Figure adapted from Thomas and Huganir, 2004)

Functions of Neuronal ERK signalling in synaptic plasticity

Development of specific inhibitors of MAPK enabled to elucidate the importance of ERK and its downstream kinases in adult brain. Protein phosphorylation holds a key role in the induction of two important forms of synaptic plasticity; LTP and LTD. High-frequency

stimulation mediated LTP induction activates ERK in hippocampus. MEK inhibitor PD 98059 blocks induction of LTP and ERK activity in the hippocampus (English and Sweatt, 1996); (Atkins et al., 1998). ERK signalling role has been best studied for the LTP from hippocampal CA3–CA1 synapses that requires NMDA receptor activation. Research from various groups for the last decade has demonstrated the role of ERK signalling in various forms of synaptic plasticity like NMDA receptor (NMDAR)-independent forms of LTP in hippocampal area CA1, and LTP in dentate gyrus and amygdala (Adams and Sweatt, 2002).

Role of ERK signalling in learning and memory

Evidences for involvement of ERK signalling in learning and memory were also obtained by using MEK inhibitors that prevent LTP. These inhibitors not only blocks LTP but also affect learning and memory in behaving animals. Spatial learning and fear conditioning are the two forms of long-term memory for which role of ERK signalling has been best characterised. Spatial memory assessment by MWM test which the ability of an animal to learn and remember the location of a hidden platform. Importantly, MWM training to locate a hidden platform induces ERK activation in the hippocampus. Whereas, administration of a potent inhibitor of ERK activation, SL327 impairs the ability of an animal to remember the location of a hidden platform (Selcher et al., 1999). The MEK inhibitors induces deficits in memory retention but do not affect memory acquisition. Interestingly, infusion of MEK inhibitor into the entorhinal cortex (the site in the brain which projects to the hippocampus) also imparts MWM performance (Hebert and Dash, 2002). Thus, these results confirm the importance of ERK signalling in the consolidation of long-term spatial memory. Fear conditioning is another form of long term memory where an animal has to learn to associate the cue or context with the foot-shock. Like spatial learning, fear conditioning also induces ERK activation, whereas MEK inhibitors reduces the levels of activated ERK and shows decreased memory consolidation (Atkins et al., 1998); (Schafe et al., 2000). Implications of ERK signalling have also been explored in the memory to remember taste. Rats subjected to new taste leads to ERK activation in the insular cortex. Consistent to long-term memory results, MEK inhibitors prevents the memory of new taste (Berman et al., 1998).

4. Implications of transcription factors in synaptic plasticity and memory

Transcriptional requirement for long-term synaptic plasticity and long-term memory formation is a well-established fact. Behavioural studies using protein synthesis inhibitors indicated the requirement of protein synthesis in the long-term memory but not for the short-term memory (Davis and Squire 1984). Later this phenomena was fine tuned to the requirement of transcription and translation for long-lasting forms of synaptic plasticity, such as long-term potentiation (LTP) (Kandel 2001). It was further confirmed that gene expression proceeding immediately after learning is essential for establishment and/or maintenance of long-lasting neuronal changes. Extensive research in last decade has identified various transcription factors and their partners involved in this crucial biological process.

CREB

CREB is a transcription factor initially identified to be activated by phosphorylation upon stimulation by cAMP. CREB recognises the palindromic octanucleotide sequences TGACGTCA classically known as the cAMP response elements (CRE). Three homologous genes of CREB (or CREB/ATF) has been identified; *creb*, cAMP response element modulator (*crem*), and activating transcription factor-1 (*atf-1*). The protein product of these genes are also highly homologous proteins named after their parent gene; CREB, CREM, and ATF-1. The basic region-leucine zipper (bZIP) domain located at the C-terminus region is a common structural motif present in all these homologs (Figure 23). Interestingly, CREB family members can form heterodimers with other bZIP transcription factors such as C/EBPs, Fos, and Jun proteins to provide extensive diversity in the regulation of target genes. Functions of CREB are highly regulated by its post-translational modification. One of the most important PTM of CREB is phosphorylation at Ser-133 which resides in its KID domain leading to its activation. Various signalling processes can stimulate CREB phosphorylation such as voltage- or ligand-gated channels such as NMDA receptors mediated increase in intracellular Ca^{2+} , activated G protein-coupled receptors mediated increase in cAMP or activation of receptor tyrosine kinase by growth factors (Lonze and Ginty, 2002) (Figure 24).

Involvement of cAMP/PKA-signaling pathway in synaptic facilitation and sensitization was first obtained from studies in *Aplysia* (Brunelli et al., 1976). Later in 1986, (Montminy et al., 1986) described a conserved DNA sequence in the promoter elements which are activated in response to cAMP called CRE – the cAMP Response Element. The CRE region present on the control regions of a gene is the binding sites for various transcription factors. Later in 1987, CREB (cAMP Response Element Binding protein) was identified to be one such transcription factors that bind to the CRE element (Montminy and Bilezikjian, 1987). CREB binds to the CRE only after it is phosphorylated by either PKA, MAPK or CaMK (Montminy, 1997). Role of cAMP activated pathway mediated CRE driven transcription in memory-related synaptic plasticity was first provided by Dash et al., 1990. In that pioneering work, it was conclusively shown that LTF in *Aplysia* neurons activates PKA dependent gene expression via *Aplysia* CREB. Inhibition of CREB1 binding to DNA response element blocked LTF.

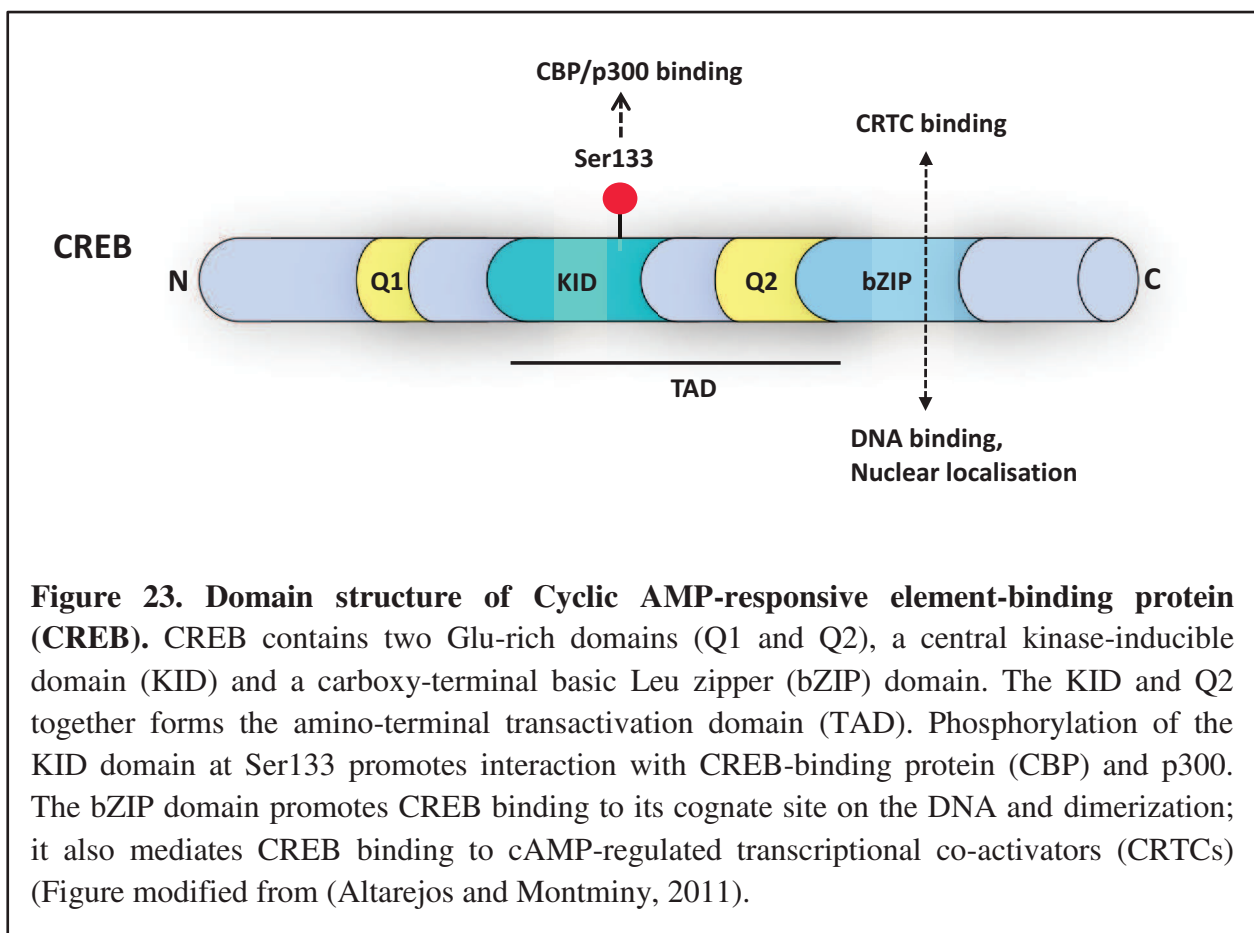

The upstream signalling cascade of CREB is mostly conserved throughout the evolution and the role of CREB in synaptic plasticity in invertebrates has also been reproduced in the mammalian brain (Kandel, 2012). Knockout of α and Δ –isoforms of CREB in mice brain

results in severe deficits in several types of memory including spatial, contextual, and cued (Bourtchuladze et al., 1994). Hippocampal LTP was also impaired in CREB α/Δ knock-out mice. Extensive studies from various research groups confirm the requirement of CREB function in LTP and long term memory (Alberini, 1999).

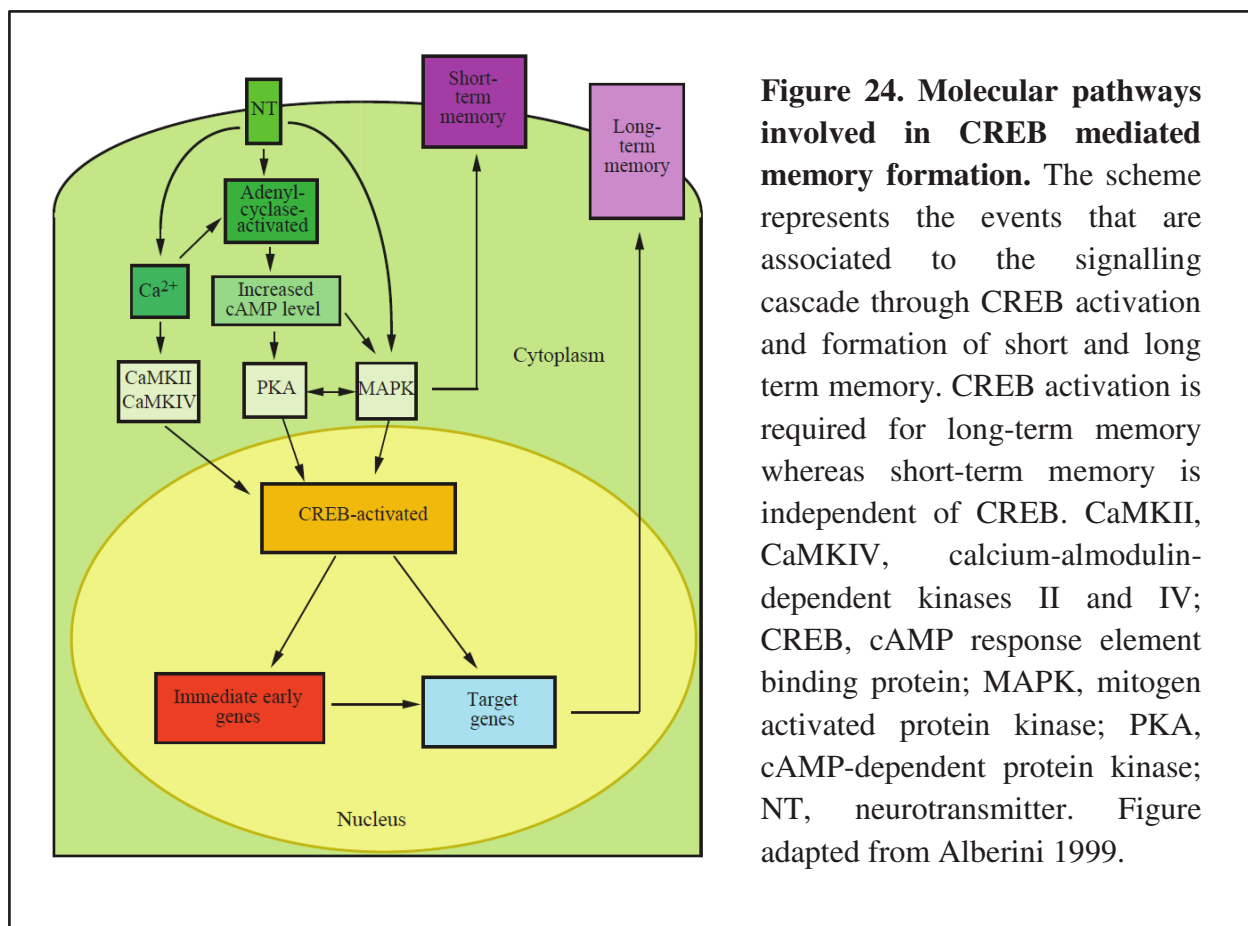

Ser133 phosphorylation of endogenous CREB is required for its transcriptional activity (Impey et al., 1998). Moreover, inhibitory avoidance learning induces CREB phosphorylation in Ser133 in CA1 and the dentate gyrus (DG) of the hippocampus between 6-9 hours after training. The increased phosphorylation also coincided with increased CRE-dependent gene expression in the same hippocampal region (Impey et al., 1998) (Taubenfeld et al., 1999). Viral vector mediated induction of CREB levels in dorsal hippocampus substantially increased spatial memory in weakly trained mice. Indeed, brain-wide disruption of CREB activity in transgenic mice showed impairment in spatial memory (Sekeris et al., 2010). CREB activity is therefore essential for hippocampal molecular machinery associated with memory formation.

5. Neuronal activity-regulated gene expression during memory formation

Immediate early genes (IEGs) in memory

c-fos

The first evidence of an external stimuli induced gene expression came from a study by Greenberg & Ziff in quiescent 3T3 fibroblasts. Platelet-derived growth factor (PDGF) led to rapid induction of *c-fos* proto-oncogene in this cell lines (Greenberg and Ziff, 1984). *c-fos* and few other genes termed as immediate early genes (IEGs) shows increased expression (within 5 minutes for *c-fos*) after activity. Physiological significance of *c-fos* expression was shown later by various groups. In neuronal cells, various stimuli can induce transcription of *c-fos*. Initial evidences suggested that activation of nicotinic acetylcholine receptor, increased levels of extracellular potassium chloride mediated membrane depolarization and calcium influx via L-type voltage-gated calcium channels (L-VGCCs) stimulates *c-fos* gene expression (Jones et al., 1988). Later Morgan et al showed *c-fos* upregulation in brain regions after seizures and a various physiological stimuli (Morgan et al., 1987). Presently, *c-fos* and other IEGs are routinely used to mark the activated neurons.

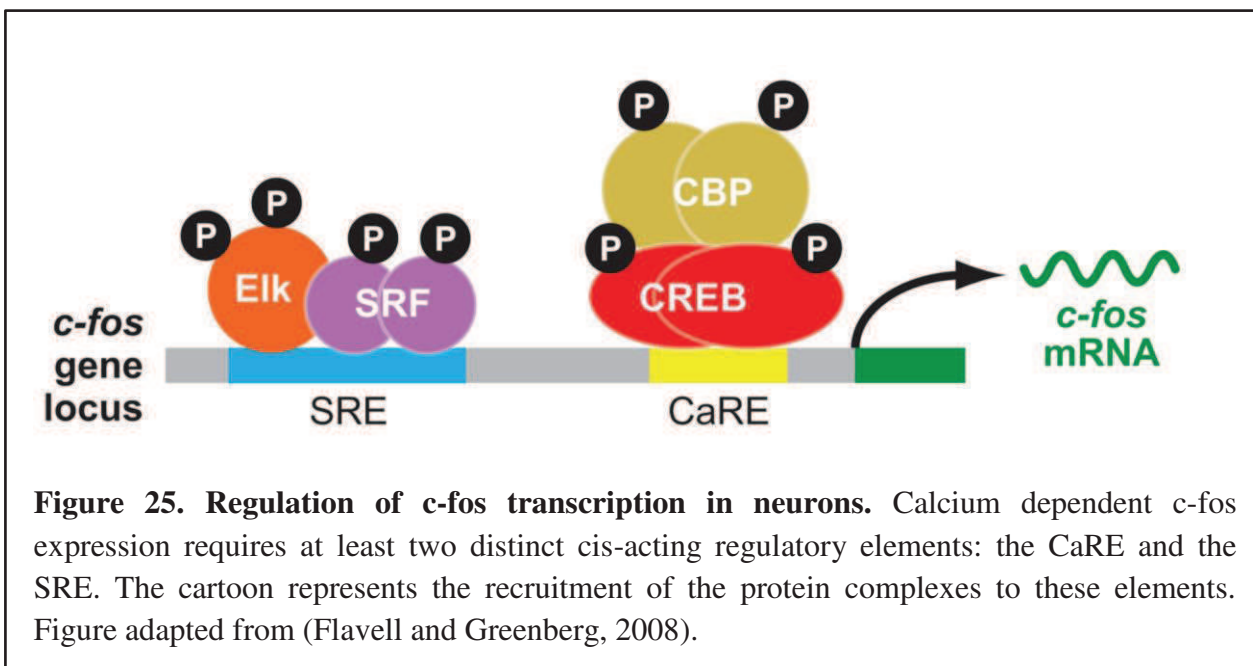

Arc

Plasticity of synaptic connections is thought to hold an immense role in the consolidation and storage of memory. Synaptic plasticity dysfunction is reported in various neurodegenerative diseases including Alzheimer's. Thus translation of neural activity patterns into long lasting changes in the synapse is a centre stage of basic and clinical neuroscientific research. Glutamatergic synapses possess the potential to express diverse forms of plasticity including several mechanistically distinct kinds of synaptic strengthening (potentiation), weakening (depression) in response to synaptic inputs. These key processes involve new gene expression and protein synthesis to enable synaptic modification and long-term changes in behaviour. A dendritic tree of a neuron in adult brain consists of around 10,000 dendritic spines, each of which is capable of forming excitatory, glutamatergic synapse. Thus the question is: as the gene expression occurs in the nucleus, how activation of a set of synapse leads to protein synthesis-dependent modification of those synapses?

Regulation of Arc expression

Arc/Arg3.1 (activityregulated cytoskeleton-associated protein/activity-regulated gene 3.1) is an immediate early gene (IEG) that has vital relevance to synaptic plasticity and memory Reviewed in (Bramham et al., 2010). Learning experience, induction of LTP by HFS or BDNF triggers expression of ARC mRNA in the principal neurons of rodent brain (Waltereit et al., 2001); (Ying et al., 2002); (Miyashita et al., 2008). Following LTP induction, ARC expression requires activation of N-methyl-D aspartate receptor (NMDAR) type glutamate receptors and extracellular signal- regulated kinase (ERK) (Steward and Worley, 2001). Pharmacological application of BDNF or group 1 mGluR agonist dihydroxyphenylglycine (DHPG) in hippocampal neurons also activates ARC gene expression. Increased levels of intracellular calcium and cAMP also induces Arc in hippocampal neurons upon activation of protein kinase A (PKA) and ERK (Waltereit et al., 2001). Muscarinic, acetylcholine receptor agonists increases Arc expression in SH-SY5Y neuroblastoma cell through ERK upstream proteins cytoplasmic tyrosine kinase Src and protein kinase C (PKC) (Teber et al., 2004). However AMPA-type glutamate receptors downregulates Arc expression in hippocampal neurons (Rao et al., 2006). Thus is evident that ERK signalling is an important component for the regulation of Arc expression.

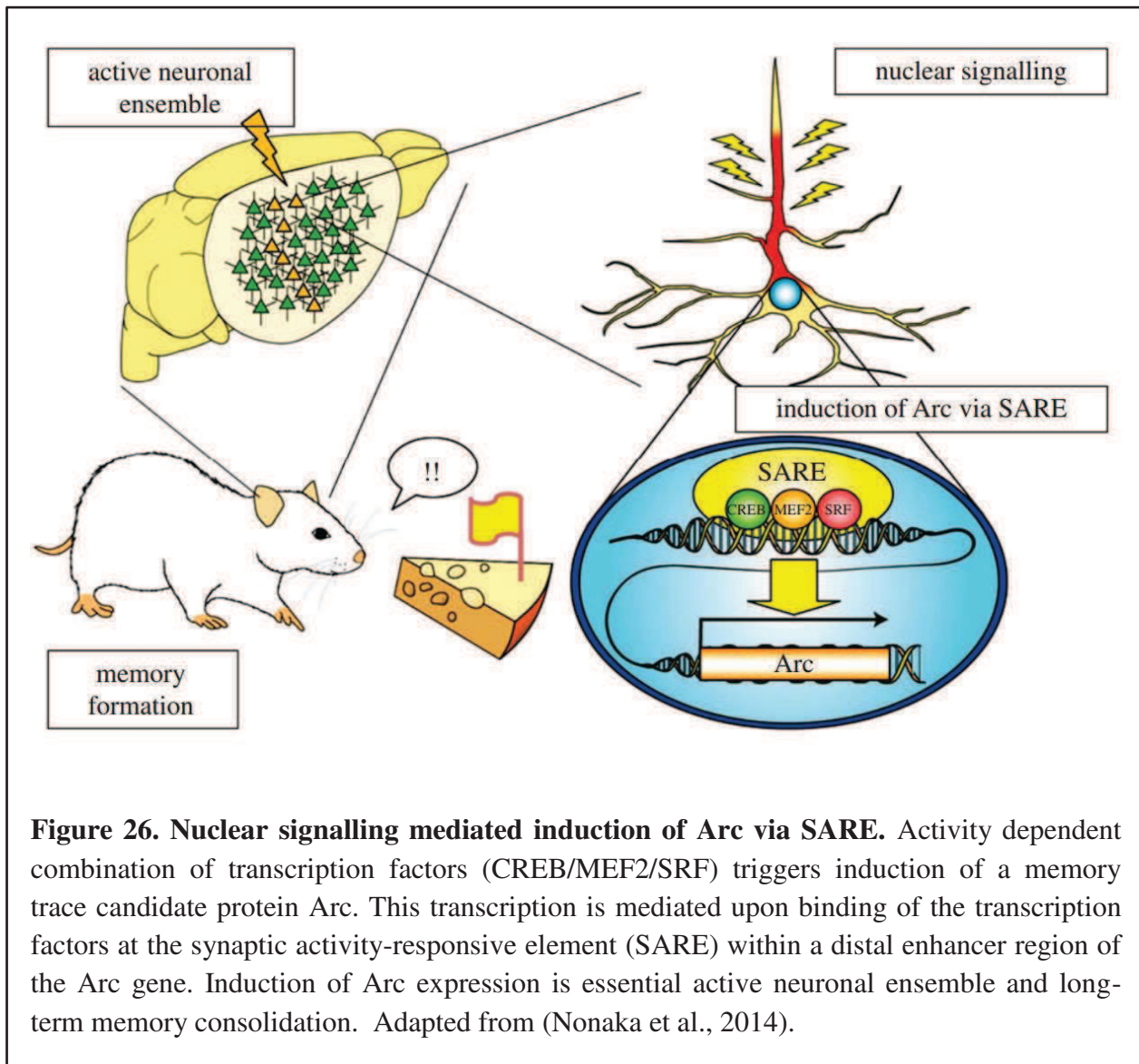

Interestingly, Arc promoter consists of a unique activity-sensor named the synaptic activity-responsive element (SARE) of approximately 100 bp in size and located at around 7 kb upstream of the Arc transcription initiation site (Kawashima et al., 2009). The SARE contains clusters of CREB, SRF, and myocyte enhancer factor-2 (MEF2) protein binding site. The SARE is necessary for synaptic activity-induced Arc expression in hippocampal neurons (Figure 26). Arc also has two enhancers at 6.5 kb and 1.4 kb upstream of transcription start site. The distal site has a highly conserved SRE that binds serum response factor (SRF) and is recruited by synaptic activity, forskolin and BDNF whereas the proximal enhancer has a conserved “Zeste-like” element. The proximal site enhances Arc expression upon synaptic activity and BDNF application (Pintchovski et al., 2009).

Function of Arc in long-term synaptic plasticity

Arc antisense (AS) oligodeoxynucleotides mediated silencing Arc results in impaired maintenance of LTP but not the induction of LTP (Messaoudi et al., 2007). Local infusion of Arc AS at various times after LTP induction revealed several facts like: a) LTP consolidation requires sustained Arc translation during a time-window that starts within minutes of LTP induction and lasts for 2–4 h, and b) Arc protein underlying LTP consolidation is rapidly degraded (Bramham et al., 2010). Late phase LTP also involves structural changes at the synapse like expansion of the postsynaptic density and enlargement of postsynaptic dendritic spines (Bourne and Harris, 2008). F-actin is an essential protein for this structural change to occur. Importantly, F-actin stabilizing drug, jasplakinolide blocks Arc AS ability to reverse LTP. Thus Arc mediated promotion of LTP consolidation is through regulation of actin dynamics. Further research using Arc AS evidenced F-actin dynamics and regulation of eIF4E phosphorylation during LTP is coupled to Arc synthesis.

Several reports support the fact that brain-derived neurotrophic factor (BDNF) increases protein synthesis dependent LTP (Lynch et al., 2007). BDNF is released after high-frequency electrical stimulation (HFS) from the excitatory neurons. BDNF release leads to activation of postsynaptic TrkB receptors which can further induce BDNF secretion. Disruption of BDNF-TrkB interaction blocks late phase LTP. Exogenous BDNF application triggers lasting potentiation of excitatory synaptic transmission (BDNF-LTP) in multiple regions of brain. BDNF-LTP in the dentate gyrus requires transport of Arc mRNA into granule cell dendrites (Ying et al., 2002). Interestingly, inhibition of Arc expression by AS treatment abolishes BDNF-LTP (Messaoudi et al., 2007) suggesting exogenous BDNF activates Arc gene expression and Arc synthesis-dependent LTP.

NMDARs or group I mGluRs activation can induce two distinct forms of LTD on excitatory synapses. Both the forms require different signalling cascades to reduce surface expression and endocytosis of AMPARs. Metabotropic glutamate receptor (mGluR)-dependent long-term depression (mGluR-LTD) depends on protein synthesis in the dendrites occurring within minutes of mGluR activation. Arc participates in mGluR-dependent LTD and homeostatic plasticity by mediating internalization of surface AMPAR-type glutamate receptors via interacting with components of the endocytic machinery (dynamin and endophilin 2/3) (Waung et al., 2008). Activation of group I mGluR rapidly increases dendritic Arc protein synthesis essential for mGluR-dependent LTD. Furthermore, overexpression of Arc protein

expression leads to decrease of basal levels of AMPARs. Arc KO mice are impaired with both chemically and synaptically induced mGluR-dependent LTD at the Schaffer collateral to CA1 pyramidal cell synapse (Park et al., 2008). Activation of mGluRs mediated Arc translation requires a Ca²⁺/calmodulin-dependent kinase, eEF2K. Upon mGluR activation eEF2K dissociates from group I mGluR and phosphorylates eEF2 that inhibits general protein synthesis thus supporting Arc translation. This was further supported by the fact that eEF2K deletion shows selective deficit of rapid mGluR-dependent Arc protein synthesis and both chemically and synaptically induced mGluR-LTD.

Arc and memory consolidation

Intrahippocampal infusion of Arc AS disrupts LTP consolidation and impairs long-term spatial memory but do not alters acquisition and short-term memory performance (Guzowski et al., 2000). Development of Arc KO mice provided further insights into importance of Arc in memory consolidation. Arc is required for long-term memory for a variety of hippocampal-dependent and hippocampal-independent tasks, including spatial learning in the Morris water maze (MWM) and object recognition. Interestingly, FISH studies revealed that repeated exploration in an environment induces transcription of Arc in the same discrete population of hippocampal pyramidal neurons, whereas exploration in two completely different environment activates a partly nonoverlapping neuronal population (Vazdarjanova and Guzowski, 2004).

Zif268

Zif268 is an immediate early gene that is a member of the Egr family of inducible transcription factors. It encodes a zinc-finger transcription factor which is rapidly induced after LTP and several forms of learning (Reviewed in (Bozon et al., 2002). Initial studies showed that Zif268 mRNA and protein levels are highly expressed in granule cells after LTP in the stimulated dentate gyrus (Wisden et al., 1990). Zif268 expression is induced between 10 min and 2 h after LTP stimulation and depends on NMDA receptor activation. Zif268 expression after LTP induction results in the binding of Zif268 proteins to its response elements (Williams et al., 2000).

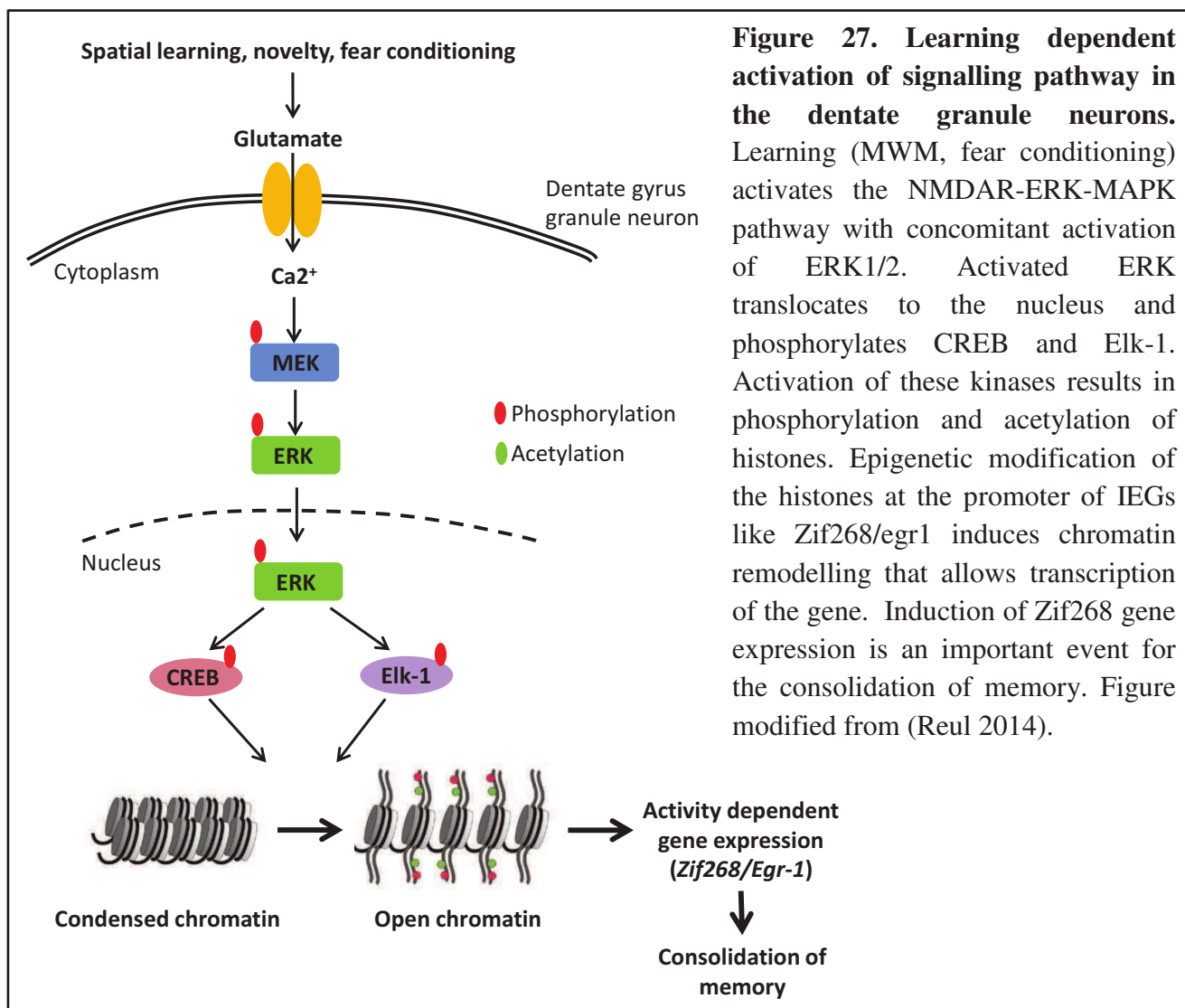

Figure 27. Learning dependent activation of signalling pathway in the dentate granule neurons. Learning (MWM, fear conditioning) activates the NMDAR-ERK-MAPK pathway with concomitant activation of ERK1/2. Activated ERK translocates to the nucleus and phosphorylates CREB and Elk-1. Activation of these kinases results in phosphorylation and acetylation of histones. Epigenetic modification of the histones at the promoter of IEGs like *Zif268/egr1* induces chromatin remodelling that allows transcription of the gene. Induction of *Zif268* gene expression is an important event for the consolidation of memory. Figure modified from (Reul 2014).

Role of Zif268 in synaptic plasticity

Evidences of *Zif268* role in late LTP and for long-term memory were obtained from *Zif268* mutant mice models. *Zif268* KO mice showed normal gross hippocampal anatomy (Topilko et al., 1998). Absence of *Zif268* did not affect the early phase of LTP induction in the dentate gyrus, whereas maintenance of LTP over 24 h was affected. Similarly, *Zif268* heterozygous mice also showed similar rapid decay of LTP suggesting full dose of *Zif268* is required for LTP persistence in brain. Conversely, transgenic mice overexpressing *Zif268* in the forebrain showed enhanced LTP in the dentate gyrus (Penke et al., 2014). As discussed before, MAPK/ERK cascade plays important roles in synaptic plasticity and certain types of learning. Activated kinases of this pathway translocate into the nucleus and regulate transcriptional activity of several IEGs. LTP induction in the dentate gyrus leads to activation

of MAPK/ERK and leads to rapid translocation into the nucleus where it phosphorylates two downstream transcription factors, CREB and Elk-1. Inhibition of MAPK/ERK phosphorylation leads to inhibition of CREB and Elk-1 phosphorylation and blockage of LTP-dependent transcriptional activation of Zif268 in dentate granule cells (Davis et al., 2000). Thus, the model could be proposed in which MAPK/ERK dependent activated CREB and Elk-1 binds to CRE and SRE response elements on the Zif268 promoter and contributes to the maintenance of LTP. Various stimuli like LTP, stimulation of the basolateral amygdala tetanic stimulation of the thalamocortical tract can lead to upregulation of Zif268 in CA1 of the hippocampus, insular cortex and in visual cortex respectively. Apart from LTP, Zif268 is also implicated with LTD. group I metabotropic glutamate receptor agonist DHPG in organotypic slices of the hippocampus mediated LTD leads to overexpression of several IEGs, including Zif268 (Lindecke et al., 2006).

Role of Zif268 in learning and memory

Upregulation of IEG Zif268 in an activity dependent manner after LTP induction provoked researchers to study the link with learning and memory. Learning mediated upregulation of Zif268 has been reported for various learning and memory paradigm in different regions of brain (reviewed in (Tischmeyer and Grimm, 1999)). Notably, Zif268 and other IEGs are shown to be upregulated in the hippocampus following spatial training or cued navigation (Soulé et al., 2008) and in the dentate gyrus after spatial exploration of objects (Clarke et al., 2010). Demonstration of involvement of Zif268 in memory consolidation was first obtained from Zif268 knockout mice. Zif268 mutant mice shows no short term memory deficits but are impaired in long-term memory tasks like social transmission of food preference task, taste aversion memory, spatial memory, object recognition memory, and object-place recognition memory (Jones et al., 2001), (Bozon et al., 2003), (Davis et al., 2010)). Consolidation of contextual fear memory has also recently been shown to be impaired in Zif268 knockout mice (Besnard et al., 2013). Epigenetic regulation like DNA methylation and histone phosphorylation, acetylation, and methylation at the Zif268 promoter is also considered to be important during long-term memory formation (Figure 27) (Zovkic et al., 2013). Interestingly, object exploration induces rapid histone phosphorylation, acetylation, and methylation at the Zif268 promoter in the hippocampus and the prefrontal cortex. Inhibition of these epigenetic marks at the promoter of Zif268 impairs recognition memory, whereas

intensive training mediated increase of these marks favours recognition memory (Gräff et al., 2012). This concept was further confirmed by generation of inducible transgenic mouse model that specifically induces *Zif268* expression in forebrain neurons. Gain of function of *Zif268* did not alter the ability to form a long-term memory of objects but increased the ability to form a long-term memory of the spatial location of objects. This increase was corresponding to increased LTP from dentate gyrus and activity dependent expression of *Zif268* and its selected target genes (Penke et al., 2014). All these studies indicate the function of *Zif268* in the synaptic plasticity and encoding process of newly acquired memory.

CHAPTER 3: Epigenetics and Memory

CHAPTER 3: Epigenetics and Memory

1. Basic introduction to Epigenetics

1.1. Definition and introduction

During the past 50 years the meaning and definition of the term epigenetics has undergone series of modifications with our improved understanding about the molecular mechanism behind regulation of gene expression in eukaryotes. The term epigenetics was first coined by C. H. Waddington in 1942. Until 1950, the term epigenetics was used in a very broad way to categorize all the developmental events from the fertilisation of zygote to the maturation of an organism (Waddington 1953). According to our present understanding, epigenetics could be defined as a process of heritable changes in gene function without changes in DNA sequence (Felsenfeld 2014).

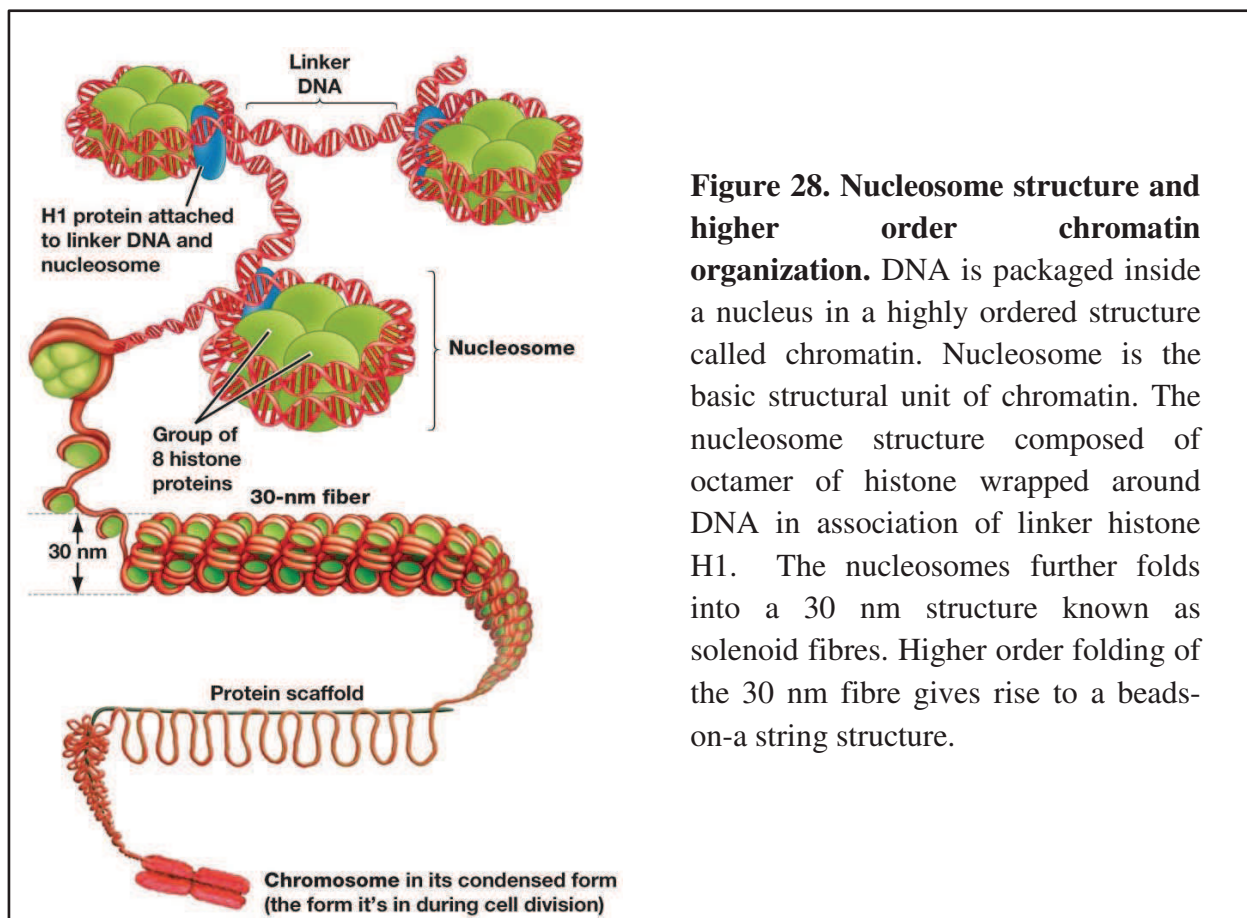

Figure 28. Nucleosome structure and higher order chromatin organization. DNA is packaged inside a nucleus in a highly ordered structure called chromatin. Nucleosome is the basic structural unit of chromatin. The nucleosome structure composed of octamer of histone wrapped around DNA in association of linker histone H1. The nucleosomes further folds into a 30 nm structure known as solenoid fibres. Higher order folding of the 30 nm fibre gives rise to a beads-on-a string structure.

Development of a multicellular organism from a single nucleus, the zygote requires a precise transcriptional mechanism which includes series of transcriptional of multiple set of genes at

specific time point, in the right population of cells, and in the correct amount. Any dysregulation of the transcriptional program may result in developmental defect but also cause various disease phenotypes. Major research has been performed to understand the components of the transcriptional machinery and how they function together to control the transcription which makes the process so perfectly precise that is required for normal development. This process requires a close interplay between the RNA pol II transcriptional machinery and the chromatin structure. The Chromatin structure is controlled at the gene level, the methylation status of the DNA and also by the presence of different modifications present at the nucleosomal level (Conaway 2012).

DNA is packed inside the nucleus of a eukaryotic cell in a highly organised structure known as chromatin (Figure 28). The DNA is packed in a series of nucleosomes each containing ~146 bp of DNA wrapped around histone octamer containing two copies each of histones H2A, H2B, H3, and H4 (Kornberg 1977). These nucleosomes fold further to form chromatin fibres that allow several meters long mammalian DNA to fit inside a nucleus whose diameter is in range of few micrometres. This compaction provides an opportunity to regulate gene expression in a highly controlled manner.

The histone N-terminal tails are subjected to various post translational modifications (PTMs) (Figure 29). These PTMs not only acts as a regulatory switch along the process of transcription but also form a collective pattern or ‘language’ that results into distinct gene expression patterns. Along the histone PTMs, several other factors like DNA methylation, small nuclear RNA and histone variants together in a combination forms a potent regulatory network which is termed as ‘epigenetic network’.

1.2. Different Histone Post translational modifications

Among the different histone PTMs, the modifications that play crucial roles in transcription regulation are acetylation, methylation, phosphorylation, ubiquitination, SUMOylation and others. Histone PTMs provides a level of specificity towards the chromatin state. Some specific modifications marks are exclusively associated with specific locus of a chromosome and the chromatin state that forms a global chromatin environment thus dividing the entire genome into euchromatic and heterochromatic regions.

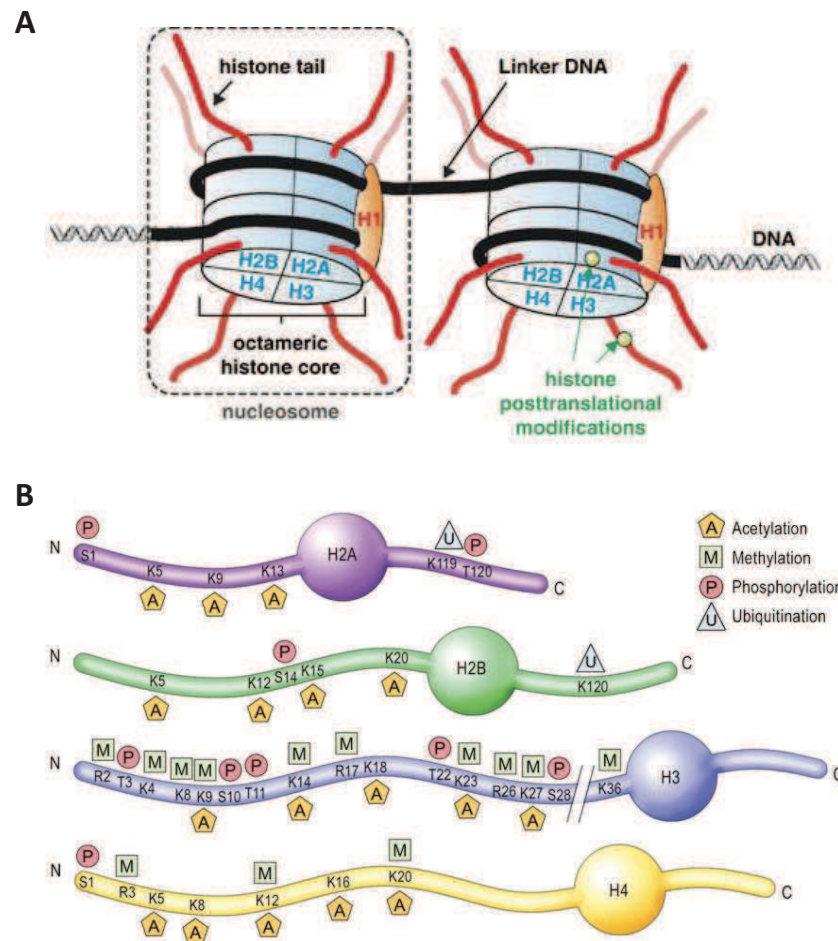

Figure 29. Histone post translational modifications. Histones are subjected to posttranslational modification like acetylation, methylation, phosphorylation and etc predominantly on their N-terminal tails. Several epigenetic modifications are occurs in their globular core region as well. **B.** The amino (N) and Carboxyl (C) terminus of histone H2A, H2B, H3 and H4 has been shown. Figure adapted from Füllgrabe, Kavanagh, and Joseph 2011 and (Alberini 2009).

Histone Methylation

Enzymes catalysing lysine methylation are known as lysine methyltransferases which transfer methyl group from S-Adenosyl Methionine (SAM) to lysine residues of proteins. Except few (DOT1), all lysine methyltransferases possess a unique SET domain (Suppressors of variegation Enhancers of zeste and Tristae), which is enough for their enzymatic activity. There are around 73 SET domain containing proteins encoded in the human genome which possess the enzymatic activity. The major substrate of lysine methyltransferases are the histone H3 (K4, K9, K27, K36, K79), H4 (K20), H2B (K5) and linker histone H1 (K26).

Depending on the residues, lysine methylation is associated with both activation and repression of transcription (Rea et al. 2000). Histone lysine methylation exists in three states: monomethylated, dimethylated, and trimethylated. Transcriptionally silent regions of the chromatin are composed of di- and tri- methylation of histone H3 at lysine 9 (H3K9), whereas the active locus are associated with di- and tri- methylation of histone H3 at lysine 4 (H3K4) (Sims, Nishioka, and Reinberg 2003; Martin and Zhang 2005 ; Vermeulen et al. 2007).

Protein arginine methyltransferases (PRMTs) catalyse the addition of methyl group from the methyl cofactor, SAM to the guanidino-nitrogen of the arginine residue on proteins. There are 9 PRMTs been identified and based on symmetric and asymmetric arginine demethylation, arginine methylation is classified into two groups. Apart from histones, arginine methyltransferases has several other non-histone protein substrates. Arginine methylation contributes to various biological phenomena including RNA processing, DNA damage and repair, cell signaling and most importantly in transcription (Bedford and Clarke 2009).

Histone Phosphorylation

Protein phosphorylation is another posttranslational modification where an amino acid residue (Serine, Threonine, and Tyrosine) is phosphorylated by the catalytic activity of protein kinases by addition of a covalently bound phosphate group. The reverse reaction is catalysed by protein phosphatases. Protein phosphorylation was first reported by Phoebus Levene in 1906 with the discovery of phosphorylated vitelline. Physiological role of protein phosphorylation was later reported in 1955 by Eddie Fischer and Ed Krebs (E. H. Fischer and Krebs 1955). Some of the important functions of protein phosphorylation lies in the regulation of signalling pathways and cellular processes that mediate metabolism, transcription, cell-cycle progression, differentiation, cytoskeleton arrangement and cell movement, apoptosis, intercellular communication, and neuronal and immunological functions (L. N. Johnson 2009). Histones are abundantly phosphorylated in physiological conditions. Interestingly, phosphorylation of histones is often related to proliferative gene regulation. Histone phosphorylation is associated with a series of signalling cascades and other histone PTM marks are linked in the crosstalk. One such instance is the ERK/MAPK pathway regulation of the histone H3 phosphorylation following contextual fear conditioning.

MSK1 and MSK2 (mitogen and stress-activated protein kinase) mediates histone H3 phosphorylation *in vitro* (Soloaga et al. 2003). Chwang and colleagues showed that activation of ERK/MAPK *in vitro* significantly increased histone H3 phosphorylation in hippocampal area CA1 whereas blocking the MAP kinase/ERK kinase using inhibitors blocks the increase in histone H3 phosphorylation after contextual fear conditioning (Chwang et al. 2006). Finally, activation of the MAPK pathway leads to enrichment of both H3S10 phosphorylation and H3K14 acetylation at the promoters of immediate early genes *c-Fos* and *c-Jun* (Clayton et al. 2000; Cheung et al. 2000).

Histone acetylation

Acetylation is a reversible process catalysed by the histone/lysine acetyltransferases (HATs/KATs) whereas the reverse reaction is catalysed by the histone/lysine deacetylases (HDACs/KDACs) utilizing the cofactor acetyl CoA. Core histones are acetylated by HATs through the addition of an acetyl group from the pseudo-substrate acetyl coenzyme A (acetyl-CoA) to the lysine residue on the ϵ -amino group on the N terminal of histones. The two major biological processes initiated by lysine acetylation are a) recruitment of coactivators and b) participation of co-repressor complexes through HDACs. These two functions alter the chromatin structure and hence lead to functional consequences. Recent reports suggest that individual histone core acetylation could influence the nucleosome structure (Reviewed in (Tessarz and Kouzarides 2014)). One such histone core modification is histone H3K56 acetylation mark (Xu, Zhang, and Grunstein 2005, Masumoto et al. 2005), which is found in up to 40% of all H3 molecules in yeast. H3K56 acetylation is positioned at the entry–exit point of the DNA on the nucleosome (Luger et al. 1997) and thereby affects the compaction state of the chromatin. The acetylation of H3K56 do not drastically change the overall stability of the nucleosome but instead triggers the unwrapping of the DNA close to the DNA entry–exit site (where H3K56 is located) to regulate higher order chromatin organisation (Simon et al. 2011) (Figure 30).

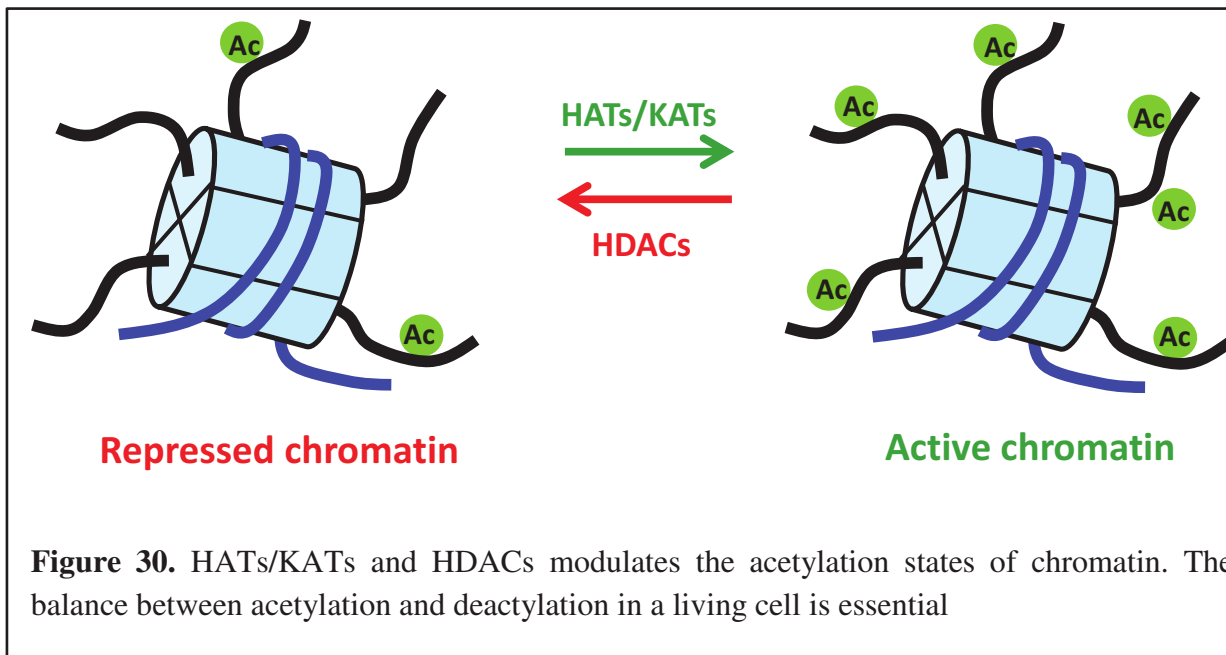

The balance between acetylation and deacetylation inside living cells is highly dynamic (Figure 30). Any alteration in the histone acetylation balance could result in disease phenotype. Several histone acetylation marks are present on the promoters of actively transcribed genes. Neurons are highly sensitive to histone acetylation alteration. Many environmental stimuli or therapeutic intervention causes alteration in histone acetylation balance. The involvement of histone acetylation in synaptic plasticity and memory will be discussed in details later in this chapter.

1.3. Writers and Erasers of acetylation

1.3.1. Classification of HATs/KATs

- Depending on their cellular localization HATs/KATs are classified into nuclear or type A and cytosolic or type B HATs. There are only three cytosolic HATs: HAT1 (KAT1), HAT2 and HAT4 (Blackwell et al. 2007 ; Chang et al. 1997 ; Takahashi et al. 2006) reported till date and they have shown to acetylate nascent histones.
- Nuclear HATs are classified into five families depending on their structural and functional differences.

- ***GNAT family:*** The 3 members of this family are Gcn5 (KAT2A), p300/CBP associated factor (PCAF/KAT2B) and ELP3 (KAT9). GCN5 and PCAF are associated with various transcriptional complexes which are involved in diverse physiological functions (Nagy and Tora 2007).
- ***CBP/p300 family:*** The two homologs of this family of KATs are p300 (KAT3B) and CREB binding protein (CBP/KAT3A). These two KATs also functions as transcriptional co-activators and possesses several overlapping biological functions (Kalkhoven 2004).
- ***MYST family:*** the major members of MYST family are Tip60 (KAT5), MOZ (KAT6A), MOF (KAT8), MORF (KAT6B) and HBO1 (KAT7). MYST family KATs plays crucial roles in DNA damage repair, development and differentiation (Sapountzi and Côté 2011).
- ***Transcription factors:*** Several transcription factors are reported to possess intrinsic KAT activity. TFIIC90 (KAT12), ATF2 and TAF1 (KAT4) are few of the members that directly affect transcription.
- ***Nuclear hormone:*** SRC1 (KAT13A) and ACTR (KAT13B), possess KAT activity and also act as transcriptional coactivators. They are also often associated with p300/CBP mediated coactivator complexes.
- ***Other members:*** CIITA, CDYL are also reported to possess intrinsic KAT activity but they are not yet classified into any of the above mentioned families of KATs.

1.3.2. Structures of HATs/KATs: p300, CBP and PCAF

p300 and CBP are highly similar KATs both in the context of structure and function. Both the proteins contain several well-defined domains including the CH1, KIX, CH3 (ZZ-TAZ2) and NCBBD domains (Figure 31: p300 and 32: CBP) (Goodman and Smolik 2000). By virtue of these domains, p300 and CBP interacts with a diverse range of proteins including numerous transcription factors and the basal transcription machinery as well as with other coactivators. These domains are linked to the catalytic core that contains the bromodomain, CH2 region and KAT domain (L. Zeng et al. 2008), (Mujtaba et al. 2004). The KAT domain is the catalytic domain for its acetyltransferase activity whereas the bromodomain recognises the acetylated substrates. Biophysical studies suggests that the CH2 domain has a PHD domain

that typically binds trimethylated histone H3 Lys4 (H3K4me3) and unmodified histone tails (Ragvin et al. 2004; Sanchez and Zhou 2011).

p300 is a 2414 amino acid protein was originally identified using an array of protein-interactions with the adenoviral E1A oncoprotein. p300 has roles in varied biological functions including proliferation, cell cycle regulation, apoptosis, differentiation, and DNA damage response. p300 transcriptional coactivator function primarily involves a number of nuclear proteins which includes oncoproteins (e.g., myb, jun, fos), transforming viral proteins (e.g., E1A, E6, and large T antigen), and tumor suppressor proteins (e.g., p53, E2F, Rb, and BRCA1). Apart from the histone proteins, the non-histone protein substrate for p300 acetyltransferase is ever increasing with varied functional consequences. Recently, the crystal structure of the catalytic core of p300 containing its bromodomain, CH2 region and HAT domain has been reported. The crystal structure revealed that the conformation of p300 allows its RING domain to positioned over the HAT substrate-binding pocket. Thus mutation on p300 RING domain in several cancers causes upregulation of its KAT activity.

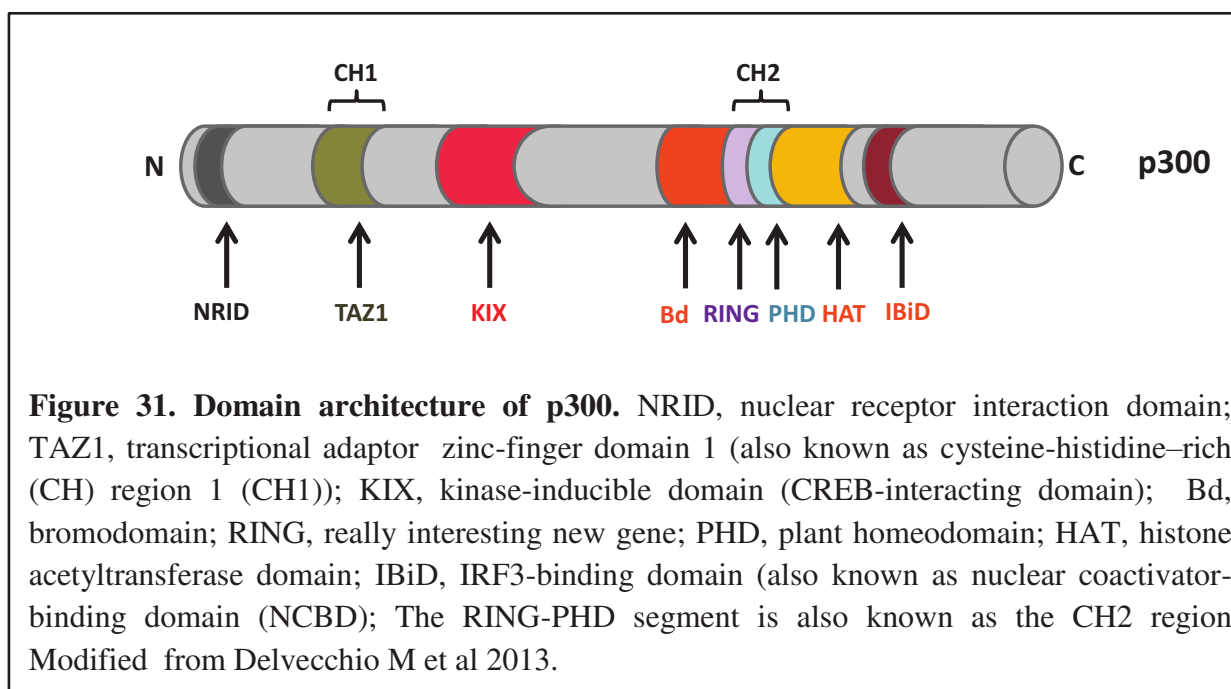

CBP is a transcriptional coactivator that regulates transcription by a) direct interaction with the basal transcriptional machinery, b) direct interaction with transcription factors and c) by modulating the chromatin structure through its KAT activity (Goodman and Smolik 2000;

Kalkhoven 2004). CBP shares very similar structural domains with p300. Studies by Korzus and colleagues suggested that the KAT domain of CBP is important for memory storage (Korzus, Rosenfeld, and Mayford 2004). CBP gets recruited to the DNA by transcription factors through direct protein-protein interaction through its amino terminus (Oike et al. 1999; Bourtchouladze et al. 2003; Wood et al. 2005). The KIX domain of CBP is highly conserved and shows sequence similarity among different species of yeast and animals (Figure 32B). The CBP KIX domain is one of the most crucial domains of CBP that participates in recruitment of CBP by various transcriptional factors and drive gene expression. CREB is one such factor that binds to CBP through its KIX domain. Extracellular stimuli mediated activation of multiple signaling transduction cascades activates phosphorylation of CREB at Ser 133 in the kinase inducible domain (KID) resulting in association between phospho-KID and the KIX domain of CBP (Parker et al. 1996). To understand the significance of the CBP KIX domain, a transgenic mice was generated where the CBP KIX domain was mutated whereas the HAT domain was intact (Kasper et al. 2002). Behavioral studies suggested the importance of the CBP KIX domain in the long-term storage of hippocampus-dependent memory (Wood et al. 2006). IbiD is another domain of CBP present in its C-terminus is responsible for the interaction with IRF-3. IbiD domain is essential for binding of various viral related proteins like Ets-2, the adenoviral oncoprotein E1A, nuclear receptor coactivator (NCoA) protein TIF-2, and an IRF homolog encoded by the Kaposi's sarcoma-associated herpesvirus (KSHV IRF-1). Biophysical studies suggested that folding and structural transition of IbiD is crucial for interaction with viral protein and thereby establishes a competition between viral and host gene transcription (Lin et al. 2001).

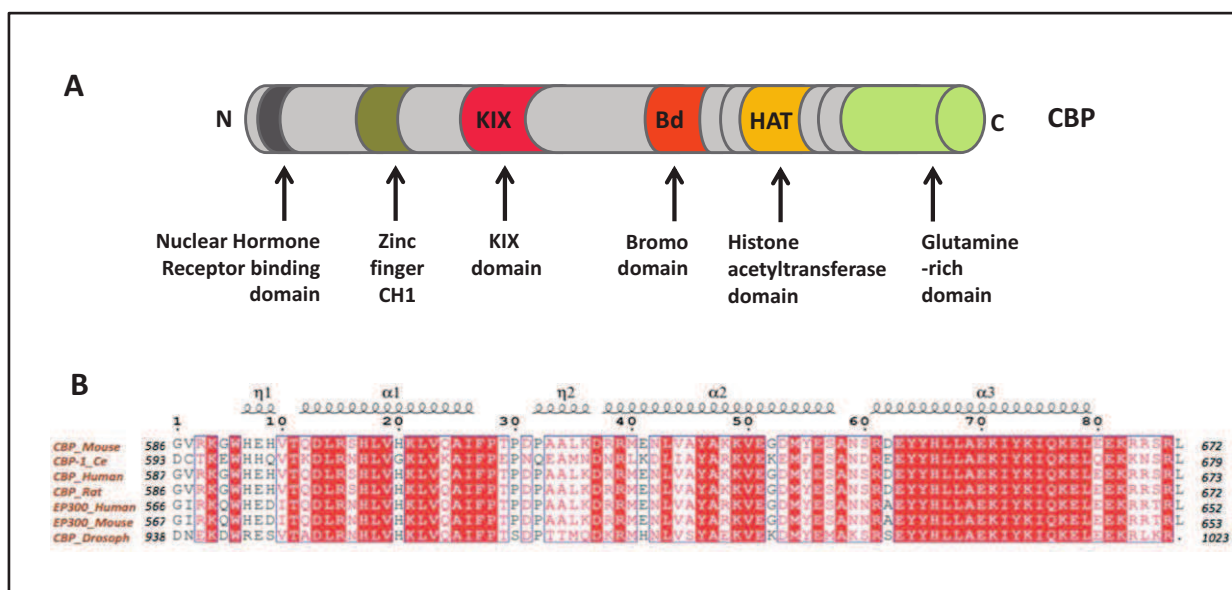

Figure 32. Domain organisation of CBP. A. Cartoon depicting the domain organisation of full length CBP. Full length CBP is composed of multiple domains as depicted in different colour coding. B. Alignment of KIX domain of selected species and isoform sequences showing high conservation of all secondary structural elements. (Figure B adapted from Thakur, Yadav, and Yadav 2014).

PCAF is a 832 amino acid protein with KAT activity and interacts with p300/CBP (Yang et al. 1996). PCAF presents marked similarity with the yeast HAT Gcn5. Its C-terminus presents around 64% homology with yeast KAT Gcn5 (Figure 33). Yeast Gcn5 is a component of the transcription co-activator complex SAGA (Spt–Ada–Gcn5 acetyltransferase). PCAF is also found in a similar transcription co-activator complex. Residues 352–658 contains the acetyltransferase domain and the residues spanning from 1–352 is essential for the interaction with p300/CBP. PCAF bromodomain is located between amino acids 744–832 (Figure 33) (Frisch and Mymryk 2002).

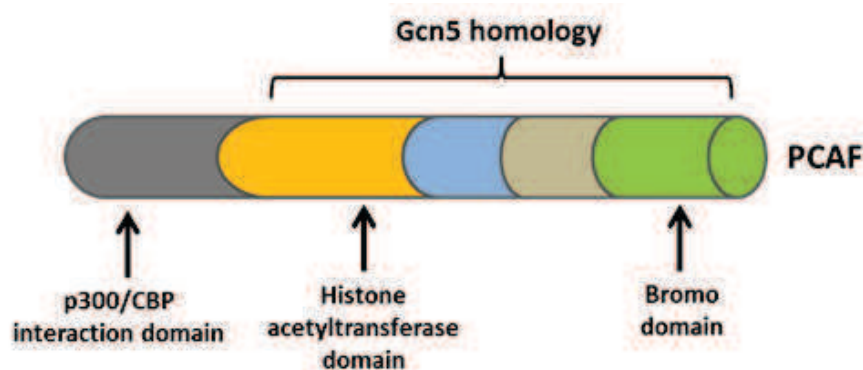

Figure 33. PCAF domain structure

1.3.3. Classification of HDACs

There are around 18 mammalian HDACs that have been identified, characterised and classified based on their sequence similarity to yeast counterparts (Figure 34) (Reviewed in Delcuve GP et al 2012).

1. Classical family of HDACs dependent on Zn^{2+} for deacetylase activity

- a. **Class I HDACs** are closely related to the yeast RPD3. The members of class I HDACs are HDAC1, HDAC2, HDAC3 and HDAC8
 - b. **Class II HDACs** are closely related to yeast HDA1. Class II HDACs are classified into subclass IIa (HDAC4, HDAC5, HDAC7 and HDAC9) and subclass IIb (HDAC6 and HDAC10)
 - c. **Class IV** contains only HDAC11
2. NAD⁺ dependent Sirtuins
- a. **Class III:** SirT1-SirT7

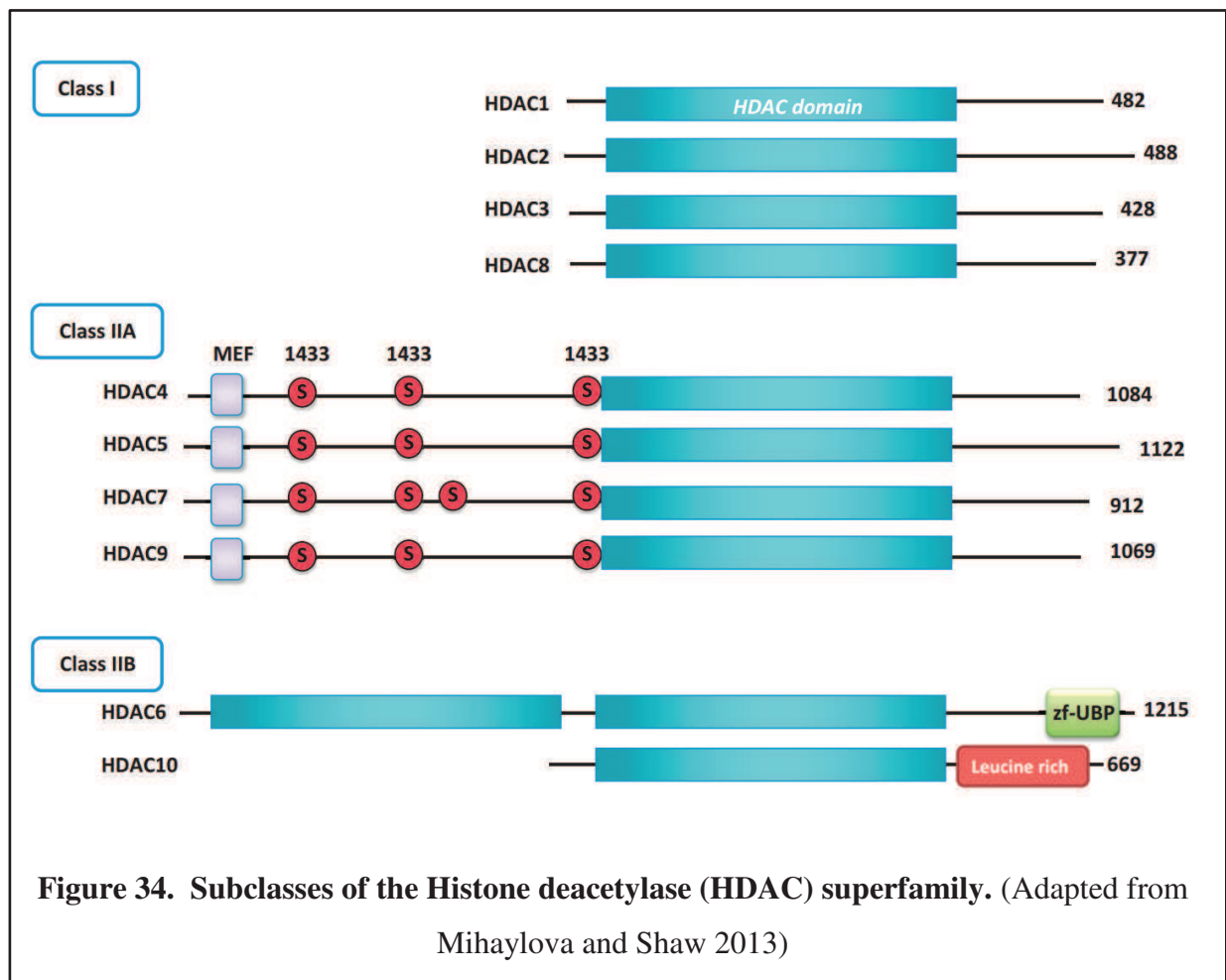

3. Histone acetylation and transcription regulation in memory formation

3.1. Histone acetylation and gene expression

Eukaryotic gene expression is influenced by the chromatin structure, the complex organisation of the protein and DNA which is packed inside the nucleus of a cell. Chromatin state guides the recruitment of the transcription machinery to the site of transcription and control gene expression. The initial hypothesis was that histone acetylation would loosen the electrostatic attraction between DNA and histone tails by neutralising the charge and thereby facilitates transcription (Davie and Chadee 1998). However, studies on yeast suggests the charge neutralization is unlikely the cause (Choi and Howe 2009). *In vitro* studies also showed that acetylation donot weaken the histone tail and DNA interaction at physiological conditions (Mutskov et al. 1998). Thus it could be concluded that the histone acetylation plays broader role than just neutralising charge. Furthermore, most of the acetyltransferases (CBP, p300, PCAF) contains bromodomain that recognises acetyl-lysine residues. So the transcriptional control by histone acetylation could be through direct chromatin structure alteration or by recruitment of other factors. The fact that histone modification can recruit proteins by recognition of the modified proteins by specific domain establishes the concept of histone code hypothesis (Jenuwein and Allis 2001). The histone code hypothesis refers to a combination of post translational modifications present in and between histones which codes for information but is not present in the sequence of the DNA. The specific modifications provide binding sites for proteins that recognise and ‘read’ such marks. The establishment (‘writers’) and removal (‘eraser’) of these modifications are the most essential components in the epigenetic regulation of gene expression that is facilitated by action of chromatin-associated enzymatic complexes (Figure 35). In fact the bromodomains containing proteins acts as the readers (CBP, p300), the chromatin modifying enzymes acts as the writers (CBP, p300, PCAF) and erasers (HDACs). The availability of various histone modification antibodies and HDAC inhibitors led to a thorough understanding of histone acetylation dynamics and its relationship with gene expression. Reports suggest that occupancy of acetylated histones and recruitment of KATs at the gene promoters corresponds with active transcription (Wang et al. 2009, Waterborg 2002). Various studies have showed that alteration of histone acetylation and gene expression regulates diverse biological function.

One such example is the role of histone acetylation in learning and memory formation (reviewed in Peixoto and Abel 2013).

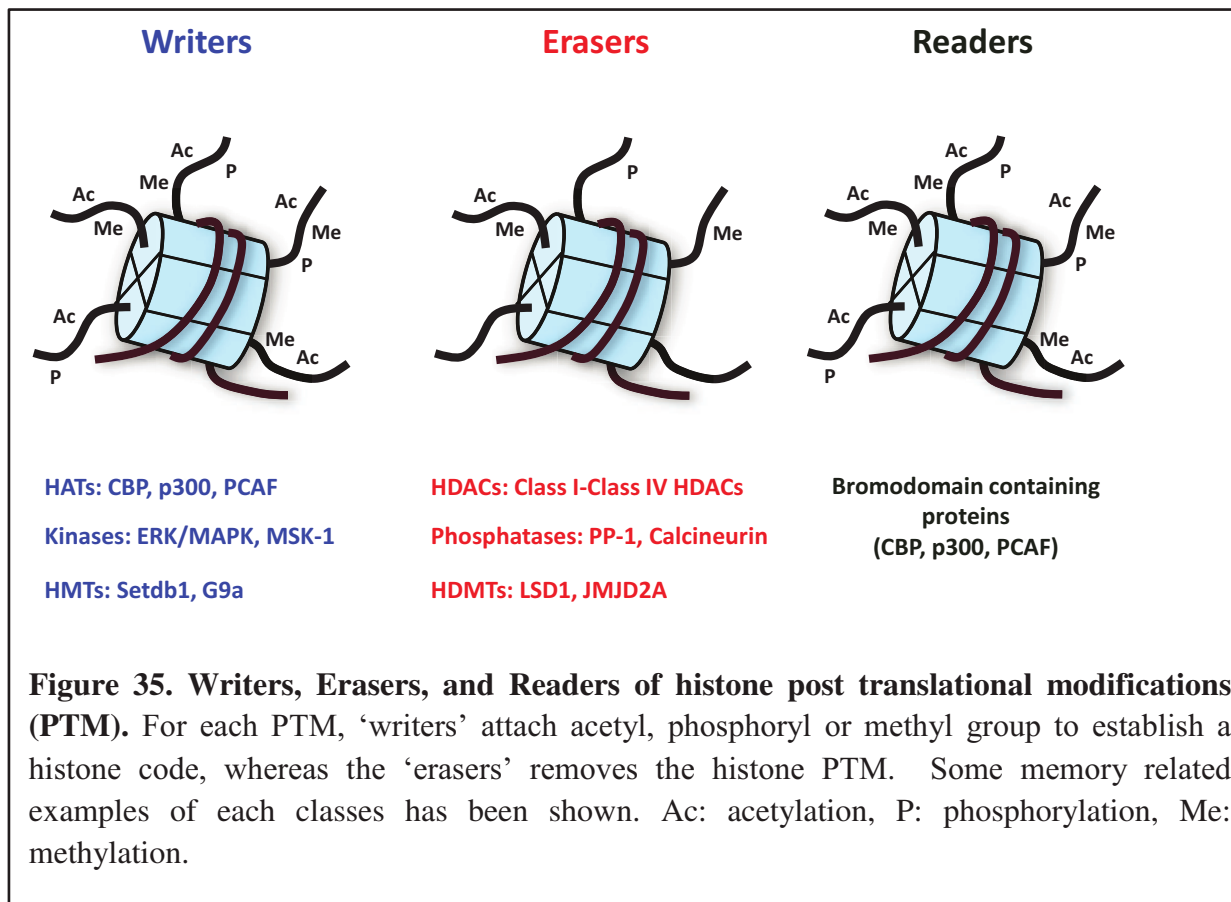

3.2. Histone acetylation and neuronal activity

Several forms of neuronal activity can trigger histone acetylation. For example, potassium chloride-mediated neuronal depolarization and stimulation of dopaminergic, cholinergic and glutamatergic pathways by receptor-specific agonists increases histone acetylation in hippocampus of rodents (Maharana, Sharma, and Sharma 2010, Crosio et al. 2003). It has been observed that all these forms of neuronal activity also lead to phosphorylation-mediated activation of the extracellular regulated kinase (ERK). ERK is a member of the mitogen-activated protein kinase (MAPK) pathway (Sweatt 2001), and direct activation of the ERK by protein kinase C or protein kinase A pathways, which is involved in long term memory formation increased histone acetylation, whereas inhibition of MAPK-ERK pathway blocked histone acetylation (Levenson et al. 2004). Another route to modulate histone acetylation by neuronal activity is by dissociating HDAC2 from the chromatin. Stimulation of neuroplasticity by brain-derived neurotrophic factor (BDNF) in cortical neurons results in

nitrosylation of HDAC2 on cysteine 262 and cysteine 274 in a nNOS- and NO-dependent manner. Nitrosylated HDAC2 dissociates from the chromatin and leads to histone hyperacetylation and activation of neurotrophin-dependent gene expression (Figure 36) (Nott et al. 2008). *BDNF* expression also increases upon calcium dependent de-repression by methyl-CpG-binding protein 2 (MECP2) (W. G. Chen et al. 2003) whereas HDAC2 negatively regulates its expression (J.-S. Guan et al. 2009). Thus neuronal activity triggers *BDNF* expression and subsequently histone acetylation and expression of synaptic plasticity and memory related gene expression. Recently, Malik et al showed that among around 12,000 putative neuronal activity-regulated enhancers where CBP is enriched, 12.4% shows rapid acetylation of H3K27 in response to neuronal activity after membrane depolarisation of cortical neurons that can drive expression of activity regulated genes. Several subsets of these enhancers also requires FOS binding to control the activity-regulated genes essential for nervous system functioning (Malik et al. 2014) (Jonkman and Kenny 2014).

3.3. Histone acetylation and synaptic plasticity

Substantial evidence supports the fact that histone acetylation is involved in synaptic maintenance and communication by controlling the expression of genes involved in the long-lasting forms of synaptic plasticity (Pittenger and Kandel 2003). Long-term facilitation (LTF) at the sensory–motor neurons in the marine mollusc *Aplysia californica* is accompanied with increased occupancy of CBP at the promoter region of CCAAT/enhancer binding protein (CEBP) and synapsin. CEBP is a transcription co-activator of CREB implicated in memory. The increased occupancy of CBP also coincided with increased histone H3K14 and H4K8 acetylation at the promoter of CCAAT-box-enhanced binding protein (C/EBP) (Z. Guan et al. 2002; Hart et al. 2011). However Long-term depression (LTD) is associated with decreased histone acetylation at the promoters of *CEBP*. Furthermore, HDACi trichostatin A (TSA) can enable weak electrical stimulation to induce LTF which normally requires strong electrical stimulation (Hart et al. 2011). Thus it can be concluded that extent of histone acetylation could be a major determinant for the extent of synaptic plasticity and modulation of histone acetylation have the potential to enhance naturally occurring synaptic processes.

The mammalian equivalent of LTF is long-term potentiation (LTP) (Bliss and Collingridge 1993), which is also shown to be regulated by the histone acetylation. Induced LTP is correlated with increased histone H3 and H4 acetylation and stimulates by the application of

the HDACi TSA (Levenson et al. 2004, Miller, Campbell, and Sweatt 2008, Vecsey et al. 2007, Y. Zeng et al. 2011, Yeh, Lin, and Gean 2004) and sodium butyrate (NaB) (Levenson et al. 2004, Sui et al. 2012). Importantly, increase in histone acetylation related to LTP was specifically observed on the promoter regions of genes involved in synaptic transmission, such as the extracellular matrix protein reelin (Sui et al. 2012) and Bdnf (Y. Zeng et al. 2011, Sui et al. 2012). L-LTP is a phase of LTP that requires transcription and synthesis of new proteins. Application of TSA does not affect on basal synaptic transmission but enhances the L-LTP. To further strengthen the present notion that increased histone acetylation promotes LTP, CBP mutant mice (partial or complete deletion) shows decreased histone acetylation and impaired induction of transcription-dependent late-phase LTP, whereas the transcription-independent early phase of LTP remained unaffected (Vecsey et al. 2007; Alarcón et al. 2004 ; Barrett et al. 2011 ; Wood et al. 2005). These results suggest that a strong link exists between histone acetylation and late phase LTP (L-LTP).

Therefore, acetylation of histones plays important role in LTP, and modulation of acetylation by either inhibiting HDACs or activating KATs are possible tool to facilitate LTP in disease conditions.

3.4. Histone acetylation and memory formation

The involvement of histone acetylation upon learning and memory was first evidenced by Levenson et al. during associative learning task. Histone H3K14 acetylation was significantly increased in hippocampal area CA1, after fear conditioning, whereas H4 acetylation was selectively increased after latent inhibition training (Levenson et al. 2004). These initial studies opened a new concept that different learning paradigms could be involved in distinct epigenetic marks in the brain. Several follow-up studies were reported suggesting role of histone hyperacetylation in memory formation for fear conditioning (Koshibu, Gräff, and Mansuy 2011, Bousiges et al. 2013), spatial memory (Bousiges et al. 2010) and other types of memory (Gräff et al. 2012, , Lesburguères et al. 2011, Reul et al. 2009), different phases of a memory (such as reconsolidation or extinction) (Maddox and Schafe 2011, Bredy and Barad 2008, Bredy et al. 2007, Stafford et al. 2012), and in species other than rodents (Danilova et al. 2010). More importantly, the immediate-early genes such as Zif268 (also known as Erg1), Creb and Bdnf, showed increased expression corresponding to the increased histone acetylation at their promoters (Alberini 2009). In a study by Bousiges et al, it was shown that

histone H3K9K14 acetylation is induced upon any experimental condition, whereas histone H2B N terminal lysine acetylation and H4K12 acetylation were more associated to either spatial or fear memory in the hippocampus (Bousiges et al. 2013). Inhibition of nuclear protein phosphatase 1 (PP1) in transgenic mice leads to increased acetylation of histones H2B, H3 and H4. Inhibition of PP1 also leads to improved long-term memory in object recognition and Morris water maze tasks. Furthermore, acetylated H3 occupancy was enriched at the promoters of CREB after object recognition training and PP1 inhibition (Genoux et al. 2002). Administration of small molecule modulators of histone acetylation strengthen the notion that histone acetylation acts as a molecular memory aid. Several HDAC inhibitors has shown to facilitate memory formation (Penney and Tsai 2014, (Gräff and Tsai 2013) whereas KAT inhibition impaired memory formation (Maddox et al. 2013). More importantly, these modulators of acetylation has no effect on the short term memory but was more specific towards long-term (day-old) memories. Thus histone acetylation acts as a crucial component in the memory formation process and manipulating histone acetylation by HDACi have a beneficial effect towards promoting memory formation.

4. Role of lysine acetyltransferases (HATs/KATs) in cognitive function

CREB binding protein (CBP)

CBP, a transcriptional coactivator with lysine acetyltransferase activity has been shown to have important role in memory formation. Several mutant mice models of CBP has been generated that confirms its importance in learning and memory (Oike et al. 1999; Tanaka et al. 1997; Wood et al. 2005). Mutation of CBP has been the cause of Rubinstein–Taybi syndrome (RSTS), a neurodevelopmental disorder characterized by cognitive impairments (Alarcón et al. 2004; Bourchouladze et al. 2003). Early studies demonstrated the importance of the acetyltransferase activity of CBP in the memory consolidation (Korzus, Rosenfeld, and Mayford 2004). Later on the significance of the CBP KIX domain was validated for long term memory formation process. This study established for the first time the *in vivo* function of CBP KIX domain in brain. Phosphorylated CREB (p-CREB) recruits CBP through the KIX domain during long term memory storage to the CRE elements to facilitate CREB dependent gene expression (Wood et al. 2006). Interestingly, HDAC inhibitors mediated improvement of memory consolidation was shown to be dependent on CBP and its

interaction with CREB (Alarcon et al. 2004; Haettig et al. 2011; Korzus, Rosenfeld, and Mayford 2004; Vecsey et al. 2007). The outcome of all the CBP mutation studies establishes its role in memory formation but results from specific tasks were not always comparable (Table 2). Variable results were obtained from fear conditioning and spatial memory making object recognition the only task showing impairment for most of the studies. This variability could be because of incomplete deletion or mutation, where a small population of neurons expressing full length CBP might be enough to generate persistence memory (Peixoto and Abel 2013). Another possibility could be developmental compensation as all the studies were conducted on transgenic mice.

To establish the role of CBP in memory, several groups have come forward to generate conditional mutant model of CBP where CBP could be mutated in the postnatal brain in specific regions of the brain. The first conditional mutation model for CBP was generated by Chen et al (Chen and Olsthoorn 2010). This study described the role of CBP in the excitatory neurons of the postnatal forebrain for both short-term and long-term memory formation. The short-term memory deficits observed in this study fetched controversies as no other CBP mutation models were deficient for short-term memory consolidation. Another study of CBP deleted in postmitotic principal neurons of the forebrain confirmed its role in object recognition memory but not in other behavioural tasks, such as contextual fear conditioning and Morris water maze. The dimer consisting of histones H2A and H2B was found to be the preferred substrate of CBP (Valor et al. 2011). Barrett et al. in 2011 reported that focal deletion of CBP in the CA1 region of mice impairs Long term potentiation (LTP) and long-term memory for contextual fear and object recognition. Endogenous protein and transcript levels of CBP also increased upon learning and memory in the dorsal hippocampus. Learning mediated induction of CBP was associated with increase in histone H2B acetylation (Bousiges et al. 2010, Bousiges et al. 2013). The *in vivo* target histone substrate of CBP has also been extensively studied. Heterozygous deletion of CBP (CBP^{+/-}) transgenic mice showed H2B acetylation deficiency (Alarcon et al, 2004), focal deletion of CBP in hippocampus showed deficiency of H2BK12, H3K14, and H4K8 acetylation (Barrett et al. 2011) whereas forebrain deletion of CBP showed deficits in acetylation of dimer of histones H2A and H2B (Valor et al. 2011). Overall, it can be concluded that CBP mediated acetylation of histone H2B could be one of the major component that is essential for CBP dependent memory formation.

CBP Mutation models	Impairment in specific memory paradigm	Histone acetylation deficiency	Reference
Heterozygous knockout			Tanaka et al, 1997
		H2B acetylation	Alarcon et al, 2004
Dominant-negative	Long term memory deficits in fear conditioning		Oike et al, 1999
	long-term memory (LTM) for two passive avoidance tasks		Bourtchouladze et al, 2003
Spatially restricted transgenic dominant-negative	Deficits in Spatial learning in the Morris water maze and long-term memory for contextual fear conditioning		Wood et al, 2005
Spatially and temporally restricted conditional transgenic dominant-negative	Long term memory: Recognition memory and Spatial memory		Korzus et al, 2004
Homozygous knockin	long-term storage of hippocampus-dependent memory		Wood et al, 2006
Forebrain restricted postnatal knockout	Spatial, associative, and object-recognition memory	H2B and H3 acetylation	Chen et al, 2010
	Novel object recognition	H2A, H2B, H3 and H4 acetylation	Valor et al, 2011
Local deletion using viral injections	Long-term memory for contextual fear and object recognition	H2BK12, H3K14, and H4K8 acetylation	Barrett et al, 2011

Table 2. Mutant mice models of CBP

p300

p300 is the closest homolog of CBP and shares maximum number of substrates for acetylation. In comparison to CBP, p300 role in memory is much less critical. Like CBP, p300 is also associated with RSTS where mutation of p300 has been reported (van Belzen et al. 2011). p300^{+/-} mice represent mild cognitive impairment (Viosca et al. 2010). However, overexpression of a mutant form of p300 and a forebrain specific knockout of p300 results in deficiency in long-term recognition and contextual fear memory (Oliveira et al. 2007; Oliveira et al. 2011). Mode of action of p300 for memory formation is not similar to CBP. CBP interaction with CREB is essential for motor learning, whereas p300-CREB interaction do not show such significance (Oliveira et al. 2006).

p300/CBP-associated factor (PCAF)

PCAF is a transcriptional coactivator with intrinsic KAT activity. PCAF knockout mice show memory impairment depending on the age. 2 months old PCAF KO mice shows short term memory deficits associated with hippocampal alterations in pyramidal cell layer organization, basal levels of Fos immunoreactivity, and MAP kinase activation. At 6 months

and 12 months age, PCAF KO mice develop long term memory deficits (Maurice et al. 2008). Furthermore, PCAF KO mice develop resistance towards amyloid toxicity suggesting role of PCAF in the progression of Alzheimer's disease (Duclot et al. 2010). Small molecule mediated activation of PCAF (SPV106) enhances memory for fear extinction and prevents fear renewal. It was evidenced that PCAF imparts fear extinction by recruiting the repressive transcription factor ATF4 on the promoter of immediate early gene *Zif268* (Wei et al. 2012).

Gcn5l2

RNA sequencing studies from the CA1 region of mice hippocampus showed high expression levels for KAT2A/GCN5L2. This data prompted Dr Fischer's group to generate a conditional knockout mice model for KAT2A. Mice impaired with KAT2A in the excitatory neurons of forebrain showed impairment for hippocampus dependent memory consolidation and synaptic plasticity. It was observed that KAT2A controls the hippocampus dependent memory formation by regulating specific gene expression network associated with neuroactive ligand-receptor interaction (Stilling et al. 2014).

Tip60

Recently association of Tip60 with ARC in primary rat hippocampal neuronal cells has been reported. ARC is an immediate early gene whose role in long term memory is already established. Neuronal activity mediated increased expression of ARC also increases endogenous nuclear Tip60 puncta and thereby recruits Tip60 to the PML bodies. High levels of Tip60 thus acetylate its substrate H4K12 which is a learning-induced chromatin modification (Wee CL et al 2014). Tip60 also interacts with ataxin 1 protein in Spinocerebellar ataxia 1 (SCA1) mouse model and contributes to the progression of neurodegenerative condition characterised with polyglutamine tract expansion in the ataxin-1 protein (Gehrking et al. 2011). Maintenance of the balance between different HATs is crucial for the homeostasis of a neuronal cell. Overexpression of Tip60 in neuronal cells of *Drosophila* leads to increased apoptosis and lethality (Pirooznia, Chiu, et al. 2012). However, overexpression of Tip60 in neurodegenerative condition imparts a neuroprotective effect (Pirooznia, Sarthi, et al. 2012; Pirooznia and Elefant 2013) and rescues axonal transport

deficits in a *Drosophila* model (Johnson et al. 2013). Also Tip60 loss in *Drosophila* causes decreased microtubule acetylation (Sarthi and Elefant 2011). These findings indicate that Tip60 could be acting in a similar pathway as that of HDAC6. Eventhough direct involvement of Tip60 to memory formation is not yet known, but recently it has been implicated with AD pathogenesis. In association with amyloid precursor protein intracellular domain (AICD), Tip60 regulates gene expression (Müller et al. 2013).

5. Histone Deacetylases (HDACs) in Cognitive Processes

HDACs are essential factors required for various biological processes (Ekwall 2005). In adult rodent brain all the 11 HDAC genes are expressed under naïve condition (Broide et al. 2007).

Class I HDACs: HDAC1 is essential for fear extinction learning (Bahari-Javan et al. 2012), whereas no such involvement has been observed in contextual fear learning or spatial memory formation (Guan et al, 2009). HDAC1 mediates its role in fear extinction learning through suppression of immediate early gene expression of *c-fos* and *egr1* by deacetylating H3K9 and subsequently increasing H3K9 tri-methylation at the promoters (Bahari-Javan et al. 2012). Even though HDAC1 and HDAC2 are close homologues, their role in cognitive function differs substantially. Researchers found that HDAC2 negatively regulates the structural and functional synaptic plasticity and hippocampal memory formation. Mice overexpressing HDAC2 in neurons shows impaired LTP, contextual fear learning and spatial memory formation, whereas deletion of HDAC2 shows improved memory, enhanced synaptic density and neuroplasticity (Guan et al, 2009). The increase in memory in HDAC2 knockout mice coincided with increased hippocampal H4K12 acetylation and number of synapses. Increased histone acetylation was observed on the promoters of genes involved in synaptic plasticity and memory, like synaptophysin and bdnf. Absence of HDAC2 improves fear extinction learning (Morris et al. 2013) whereas loss of HDAC1 shows opposite effect. Virus-mediated knock-down of HDAC2 in primary hippocampal neurons leads to increase in excitatory postsynaptic currents whereas loss of HDAC1 shows no such effect (Nelson et al. 2011). Even though the exact molecular mechanism of HDAC2 mediated memory repression is not clearly defined, some recent studies showed role of HDAC2 in the survival of adult born neurons in the dentate gyrus (Jawerka et al. 2010). HDAC2 associates with the

corepressor complex consisting SIN3A, NURD and CoREST (J.-S. Guan et al. 2009) and possibly binds on the chromatin and repress neuroplasticity-related genes and thereby acts on memory blockage (Figure 36). Expression of HDAC2 is in turn regulated by activated glucocorticoid receptor (GR). GR is activated during stress, ageing or neurodegeneration (A β accumulation) and binds to a GR responsive element (GRE) within the HDAC2 promoter region and stimulates the expression of HDAC2 (reviewed in Gräff and Tsai 2013). BDNF treatment activates nitric oxide pathway that nitrosylates HDAC2 at cysteines 262 and 274 and inhibits its ability to bind to the chromatin. Like HDAC2, role of HDAC3 has also been implicated with learning and memory. Focal deletion of HDAC3 in mouse hippocampus increased histone acetylation and object location memory (McQuown and Wood 2011). Specific inhibitor for HDAC8 also improves memory formation in rats but the detailed function of HDAC8 in adult brain has not yet been thoroughly examined (Yang et al, 2013). Thus, the above mentioned studies suggest a potential role of class I HDACs as molecular inhibitors of memory formation (Reviewed in Fischer 2014).

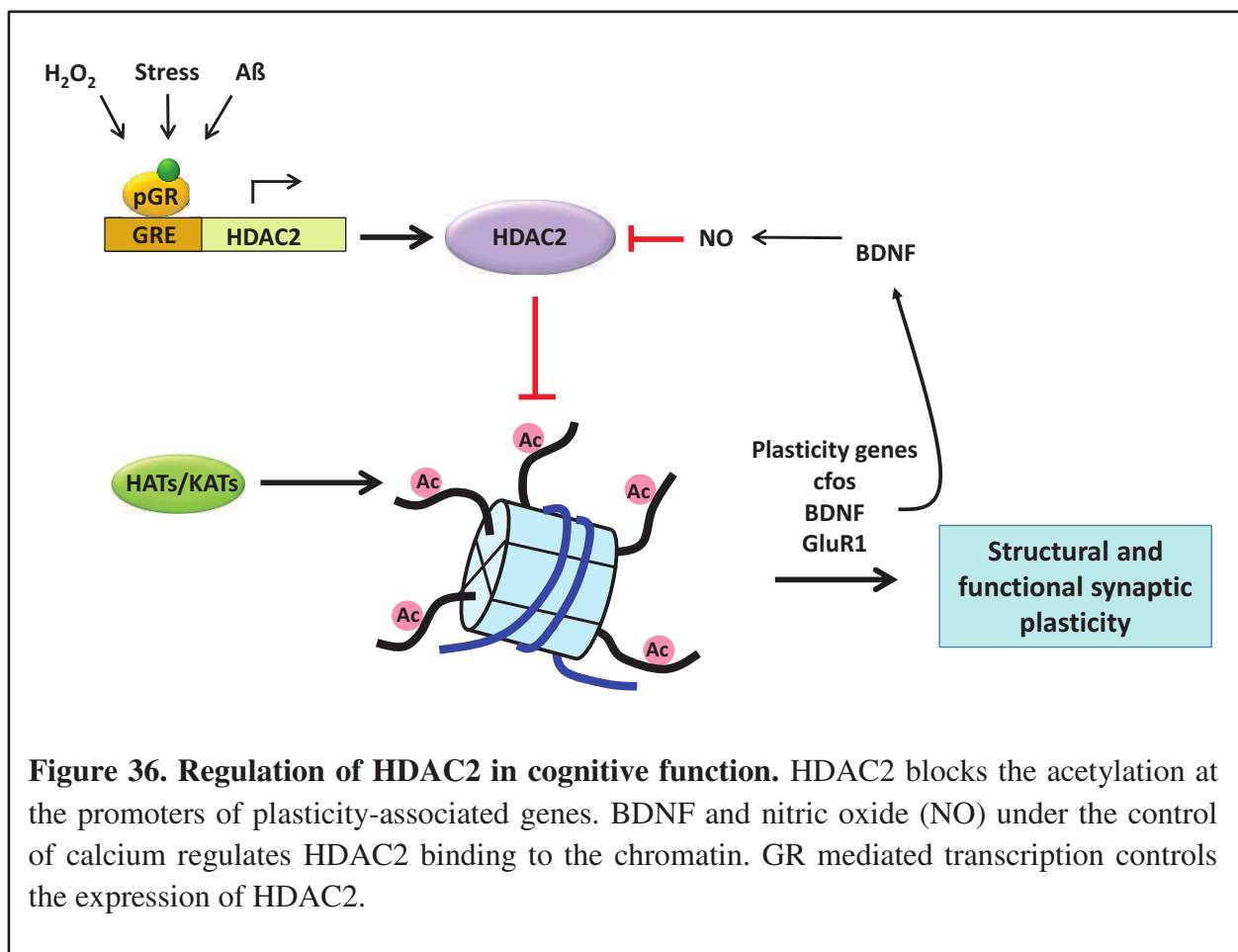

Figure 36. Regulation of HDAC2 in cognitive function. HDAC2 blocks the acetylation at the promoters of plasticity-associated genes. BDNF and nitric oxide (NO) under the control of calcium regulates HDAC2 binding to the chromatin. GR mediated transcription controls the expression of HDAC2.

Class IIa HDACs: Among the class IIa HDACs, HDAC4, HDAC5 and HDAC9 have shown implications in memory processes possibly through non-histone substrates (Lahm et al. 2007). In response to calcium signaling and CamKII activity, HDAC4 shuttles between cytoplasm and the nucleus of cultured hippocampal neurons (Chawla et al, 2003; Backs et al, 2006). Deletion of HDAC4 homolog in the nematode *Caenorhabditis elegans* leads to enhanced long-term memory in a thermotaxic memory task in CamKII-dependent manner (Wang et al, 2011). Overexpression of HDAC4 in nucleus reverts this process whereas deletion of HDAC4 in the cytoplasmic fraction improved memory (M.-S. Kim et al. 2012). Deletion of HDAC4 in the forebrain of adult mice leads to impaired hippocampus-dependent memory formation and plasticity (M.-S. Kim et al. 2012). Recently, HDAC4 has been shown to be a NMDA receptor-dependent transcriptional repressor and regulates several synaptic plasticity related genes (Sando et al. 2012). HDAC5 functions in the control of memory function in an age dependent manner. Deletion of HDAC5 from the forebrain of 2 months old mice shows no cognitive impairment (M.-S. Kim et al. 2012), whereas 10 months age mice lacking HDAC5 shows hippocampus dependent memory impairment (Agis-Balboa et al. 2013). High copy number variation of HDAC9 was observed between patients with schizophrenia with cognitive disabilities and healthy subjects (Tam et al. 2010).

Class IIb and Class IV HDACs: Increased expression of HDAC11 has been noted in the hippocampus of rats after fear conditioning (Gupta-Agarwal et al. 2012). The major substrates of HDAC6 are the cytoplasmic proteins such as tubulin. However, mice lacking HDAC6 shows no overt phenotype and defects in memory formation (Govindarajan et al. 2013).

Thus the current literature on HDACs suggests that HDAC1-HDAC3 is mostly involved in memory dependent process where HDAC2 possibly acts as a crucial factor in the inhibition of cognitive functions in neurodegenerative conditions and ageing.

6. Role of other PTMs in learning and memory

6.1. Histone Phosphorylation in Memory

MAPK pathway is associated to other histone PTMs and regulates gene expression related to memory formation. Hippocampus dependent long term memory consolidation induces histone H3S10 phosphorylation. A cross talk between H3 acetylation and H3S10 phosphorylation exists during hippocampus dependent learning. Histone acetyltransferase CBP can directly bind with phosphorylated histone H3. Moreover, CBP binds with phosphorylated CREB at S133. CBP binding with CREB is essential for gene expression regulation required in long-term memory. This suggests that the interplay between histone acetylation and phosphorylation is another important factor in the regulation of transcription during memory formation.

Memory consolidation in hippocampus and cortex requires temporal and spatial regulation of histone acetylation and phosphorylation activation. Simultaneous as well as combined activation of these PTMs is essential for consolidation of memory. Pharmacological blockage of these histone PTMs impairs memory and memory-related gene expression whereas enhancement improves memory consolidation (Gräff et al. 2012). This result supports the spatiotemporal dynamics of histone acetylation and phosphorylation in memory consolidation.

6.2. Histone Methylation and Memory

Recently reports has provided evidences that implicates histone methylation in the regulation of chromatin structure in the nervous system (Tsankova et al. 2006; Huang and Akbarian 2007; Huang et al. 2007; S. Y. Kim et al. 2007). Contextual fear conditioning induces both trimethylation of H3K4 and demethylation of H3K9 in hippocampus. HDAC inhibitor sodium butyrate (NaB) treatment induces histone acetylation but also increases trimethylation of H3K4 and decreased dimethylation of H3K9. Thus a dynamic link exists between histone acetylation and methylation in the hippocampus during consolidation of fear conditioned memories. Fear conditioning also elevates trimethylation of H3K4 at the promoters of *Zif268* gene which are associated with altered DNA methylation (Gupta et al. 2010).

Mutations in human genes encoding H3K4-specific demethylases (KDM5A, KDM5C) or methyltransferases (KMT2A, KMT2C, KMT2D, and KMT2F) are implicated in various neurodevelopmental disorders and diseases. Recently Akbarian and colleagues reported increased anxiety and robust cognitive deficits without locomotor dysfunction after neuronal ablation of the H3K4-specific methyltransferase, Kmt2a/Mixed-lineage leukemia 1 (Mll1), in mouse postnatal forebrain and adult prefrontal cortex (PFC). Loss of Mll1 resulted in downregulated expression and loss of the transcriptional mark, trimethyl-H3K4, at more than 50 loci (Jakovcevski et al. 2015). Ageing also contributes to alteration of methylation states of histones in the hippocampus especially levels for tri-methylation of histone H3 at lysine 4 (H3K4me3). Interestingly, object learning after environmental enrichment (EE) significantly induces H3K4me3 occupancy around the *Bdnf*, but not the *Zif268*, gene region in the aged hippocampus and rescued memory deficits in aged adult rats (Morse et al. 2015).

*CHAPTER 4: Alzheimer's Disease: Possible
Therapeutics using Epigenetic Drugs*

CHAPTER 4: Alzheimer's Disease: Possible Therapeutics using Epigenetic Drugs

1. Basic introduction to Alzheimer's disease (AD)

1.1. History

Alzheimer's disease was first demonstrated by a German psychiatrist and neuropathologist Dr. Alois Alzheimer in a conference lecture in 1906 and later published an article in 1907. In his landmark study, he described a peculiar case from a 51-year-old woman patient named Auguste Deter who had a disease of cerebral cortex (Figure 37). The strange disease was associated with progressive memory and language impairment, disorientation, behavioral symptoms (hallucinations, delusions, paranoia), and psychosocial impairment ("About a Peculiar Disease of the Cerebral Cortex. By Alois Alzheimer, 1907 (Translated by L. Jarvik and H. Greenson)" 1987).

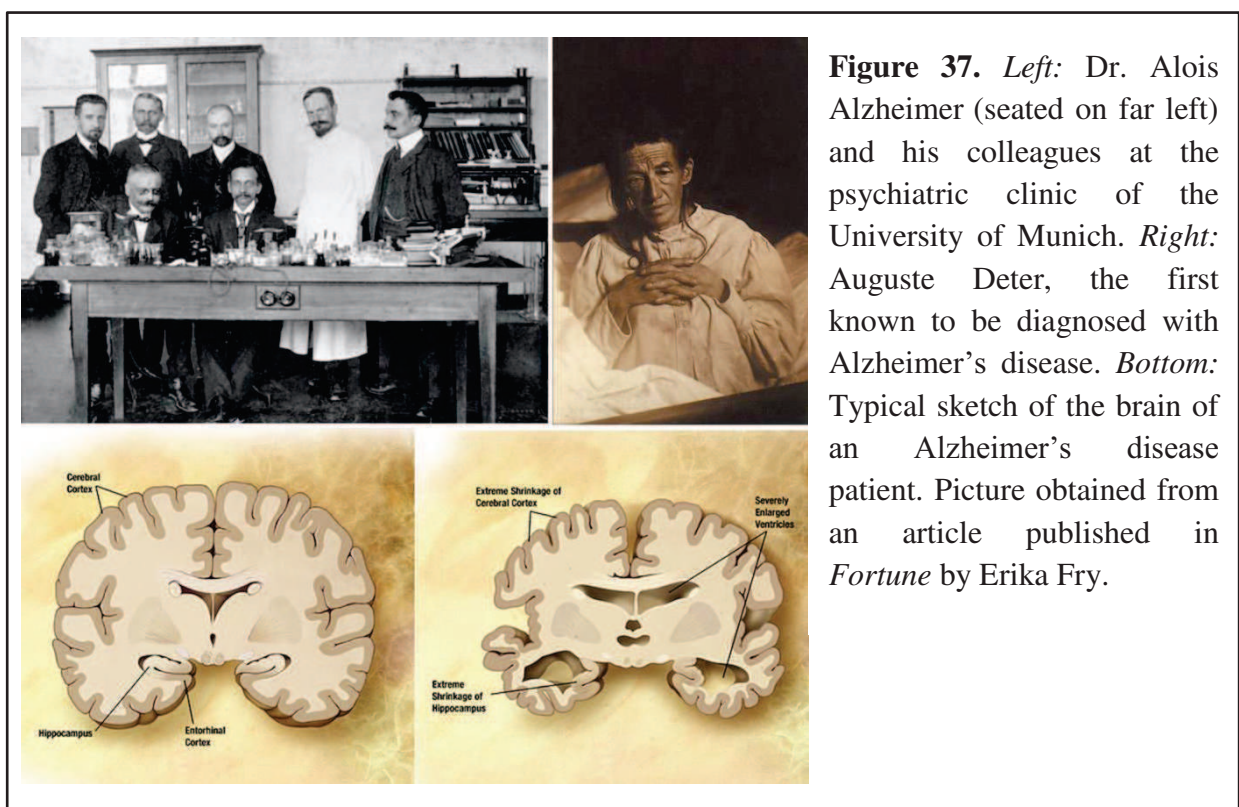

Complete degeneration of the psyche of a patient was not the first time that Dr. Alzheimer had noticed but in all the previous cases the patients were much older in age and all were above seventy years of age. Alzheimer had documented all the conversation he had with Auguste and he used to call it "Disease of Forgetfulness". After her death, Alzheimer with

two Italian physicians used staining techniques to identify amyloid plaques and neurofibrillary tangles in the brain. This was the first time the pathology and clinical symptoms of Alzheimer's disease was presented together.

1.2. Epidemiology of Alzheimer's disease

As the population of the world is rapidly ageing, by the end of the year 2030 the expected number of people suffering from dementia will be around 65 million. Alzheimer's disease is mostly prevalent in North America and Europe. In 1907 when the first case of Alzheimer's disease (AD) was reported, life expectancy was much lesser than that of today. Thus diagnosis above 65 years of age was limited making its devastating impact to be unrecognised. According to recent reports, it is estimated that around 25 to 30 million people suffers from AD worldwide (Figure 38) (Minati et al. 2009). The prevalence of AD is considered to be double after 65 years of age. The life of a patient suffering from AD becomes miserable and also it places a psychological and economic burden on the caregivers and the family.

AD is not caused by a single factor and is considered to be a multifactorial disease. The greatest risk factor for the development of AD is age. Majority of the patients suffering with AD are above 65 years of age. The disease exists in two forms: familial and sporadic. Mutation in a single gene inherited in autosomal-dominant form is the cause of familial form of AD. It accounts for 5% of the cases. Multifactorial etiology including genetic polymorphism is considered to be the factors involved in the sporadic form of AD (Serretti, Olgiati, and De Ronchi 2007). There are three main genes known to be implicated in the familial form of AD. Gene coding for amyloid precursor protein (APP) was the first to be identified in 1991 to get mutated. Genes encoding presenilin-1 and presenilin-2 (PSEN1 and PSEN2) which are part of the γ -secretase complex are the other set of genes known to be mutated. The sporadic form of AD is associated with several genes. Among them all, gene encoding for apolipoprotein E (APOE) is consistently found to be mutated. Increasing evidences suggest that variants of gene encoding for the insulin degrading enzyme (IDE), which actively degrades amyloid- β (A β) may predispose individuals to the disease.

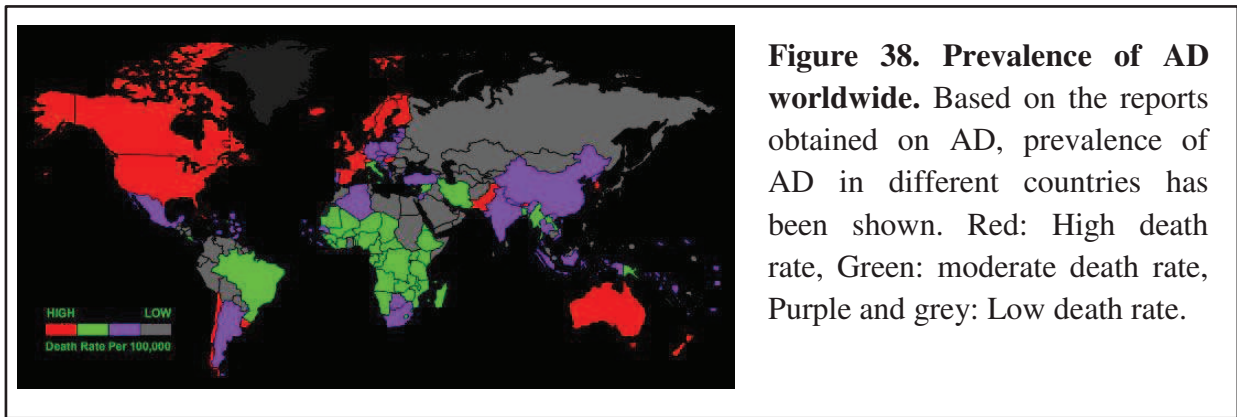

1.3. Symptoms

Pathological Correlates

Clinico-pathological studies confirm the synaptic loss and axonal dysfunction occurring initially in the entorhinal cortex and hippocampus and subsequently in associative neocortical regions to be the cause of cognitive deficits observed in AD. 95% of the cholinergic neurons comprised in the basal nucleus of Meynert and medial septal nucleus are degenerated during the course of the disease. Reduced expression or activity of choline acetyltransferase causes further decline of acetylcholine (Storey, Kinsella, and Slavin 2001; Minati et al. 2009).

Memory

At the preclinical stage, AD is typically associated with impairment of episodic memory. In mild AD, verbal and nonverbal anterograde episodic memory appears with progressive deficits of retrograde episodic memory but relative preserved older memories (Jones, Livner, and Bäckman 2006). This also means that the entorhinal cortex and hippocampus is essential for acquisition and consolidation of new memories but consolidation of long term memories requires diffuse multifocal neocortical representation (Squire and Alvarez 1995). Impairment in recent memory consolidation causes failure to remember recently learned experiences. Disintegration of semantic memory as evident from tests of word list generation by semantic category is also associated with mild AD. Difficulties in generating verbal definitions, empty speech while in conversation are also quite common symptoms. In severe AD, part of implicit memory still remains to be preserved.

Language

As the disease progresses, the grammatical structure of the speech becomes progressively simpler with the language becoming paraphasic. Both written and verbal structure of language declines with loss of function words, however reading aloud is preserved in some cases. In written language, spelling errors gradually increases, prevalently due to phonological errors, accompanied with defects in letter formation starts appearing in moderate AD. Severe AD is associated with complete loss of purposeful verbal communication.

Visual Processing

Visual processing impairment is quite common in AD patients. During the initial stages, drawing, construction and orientation impairment is reported. Loss of semantic and lexical knowledge causes visual agnosia in severe cases.

Executive Function and Attention

AD patients face problems in performing everyday activities which is determined by executive dysfunction. Early AD patients also face difficulties to shift attention from one task or object to another. Even though, ability to sustain attention in patients with AD has not been thoroughly studied, some reports claim increased decrement over time (Berardi, Parasuraman, and Haxby 2005).

Praxis

Apraxic symptoms are prevalent in 30% of patients with mild AD and almost in all patients with severe AD (Baune et al. 2006). Translimbic movement is affected together with ideomotor and ideational apraxia. Ideational apraxia is closely associated with semantic memory loss. Constructional apraxia occurring in early stage leads to rapid decline of cognition (Guérin, Belleville, and Ska 2002). One example of constructional apraxia in AD is defects or impairment of copying a figure very closely or even on a given model (Kwak 2004).

Behavioral Symptoms

Behavioural symptoms appear in almost all the patients of AD at some point during the disease course. One of the most common behavioural symptoms is comorbid depression. Mild AD patients suffer from agitation, anxiety, irritability and apathy, while patients with severe AD develop aggression, increased confusion, aberrant motor behaviour, vocalisation and social isolation. Hallucination, delusion and dysphoria are comparatively less prevalent in AD (Mega et al. 1996). Sleep disturbances is very frequent in AD that significantly contributes to memory deficit and cognitive dysfunction.

1.4. Therapies of AD

Four acetylcholinesterase inhibitors (tacrine, rivastigmine, galantamine and donepezil) and an NMDA receptor antagonist (memantine) are the only 5 US Food and Drug Administration approved for treatment of AD (Pohanka 2011). AD is associated with reduced activity of cholinergic neurons. Thus acetylcholinesterase inhibitors impose a pause or brake to slow down the rate of acetylcholine (ACh) metabolism. These inhibitors shows effect in both mild and advanced stages of AD, only donepezil shows effects in advanced AD (Birks et al. 2009). Memantine is a noncompetitive NMDA receptor antagonist that acts on the glutamatergic system to inhibit overstimulation of glutamate by blocking NMDA receptors (Lipton 2006). Furthermore, administration of these drugs has not shown to delay the disease pathogenesis. Thus presently researchers all throughout the world are exploring the possibility to develop therapeutic strategy to combat the detrimental disease of Alzheimer's (Anand, Gill, and Mahdi 2014). A summary of the present strategies in correlation to pathophysiologic mechanisms for AD is depicted in Table 3.

- | | |
|---|---|
| <p>1. Modulating neurotransmission</p> <ul style="list-style-type: none"> • Cholinesterase inhibitors • N-methylD-aspartate receptor antagonism • GABAergic modulation • Serotonin receptor modulation • Histaminergic modulation • Adenosine receptor modulation <p>2. Tau based therapies</p> <ul style="list-style-type: none"> • Tau phosphorylation inhibition • Microtubule stabilization • Blocking Tau oligomerization • Enhancing Tau degradation • Tau based immunotherapy <p>3. Amyloid based strategies</p> <ul style="list-style-type: none"> • Secretase enzymes modulation • Amyloid transport • Preventing amyloid aggregation • Promoting amyloid clearance • Amyloid based immunotherapy <p>4. Modulating intracellular signaling cascades</p> | <p>5. Oxidative stress reduction</p> <ul style="list-style-type: none"> • Exogenous antioxidant supplementation • Augmenting endogenous defense <p>6. Mitochondrial targeted therapy</p> <p>7. Modulation of cellular calcium homeostasis</p> <p>8. Anti-inflammatory therapy</p> <p>9. Others</p> <ul style="list-style-type: none"> • Gonadotropin supplementation • Lipid modifiers • e Statins • Growth factor supplementation • Metal chelation • Epigenetic modifiers • Caspase inhibitors • Nitric oxide synthase modulation • Nucleic acid drugs • Multi-target directed ligands |
|---|---|

Table 3 . Present Therapeutic strategies in Alzheimer's disease. Adapted from Anand, Gill, and Mahdi 2014

2. Important players associated with pathophysiology of Alzheimer's disease (AD)

2.1. Amyloid Precursor Protein (APP)

2.1.1. APP metabolism

Amyloid Precursor Protein (APP) is a transmembrane glycoprotein of 110–130 kDa which is present abundantly in the central nervous system (CNS). The primary functions of APP lies in synaptic formation and repair, signalling, and cell adhesion (Nathalie and Jean-Noël 2008). Amyloid- β species of 40 and 42 amino acids ($A\beta_{40}$ and $A\beta_{42}$) are the most abundant in brain (Recuero et al. 2004). Metabolism of APP follows two distinct mutually exclusive pathways (Figure 39) (reviewed in (De-Paula et al. 2012):

Secretory pathway (or non-amyloidogenic): α -secretase cleaves APP resulting into a soluble N-terminal fragment ($sAPP\alpha$) and a C-terminal fragment (C83). γ -secretase further cleaves the C-terminal fragment to give rise to a smaller C-terminal fragment of 3 kDa (C3).

Members of the ADAM (a disintegrin and metalloprotease) family mediate the secretory cleavage. α -secretase mediated cleavage of APP in the A β peptide amino acid sequence results in the formation of amyloid peptides (Braak and Braak 1998).

Amyloidogenic pathway: β -secretase alternatively cleaves APP to form a smaller N-terminal fragment (sAPP β) and a longer C terminal fragment (C99). γ -secretase mediated further cleavage of APP gives rise to amyloid- β peptides (A β). Initially A β is formed in monomeric form but progressively aggregates into dimers, trimers, oligomers, protofibrils and fibrils, ultimately deposits to form the amyloid plaque. A β 42 is the most neurotoxic form of A β peptide as it is more prone to aggregation and fibrilization, thus contributing immensely in the pathogenicity of AD (Recuero et al. 2004).

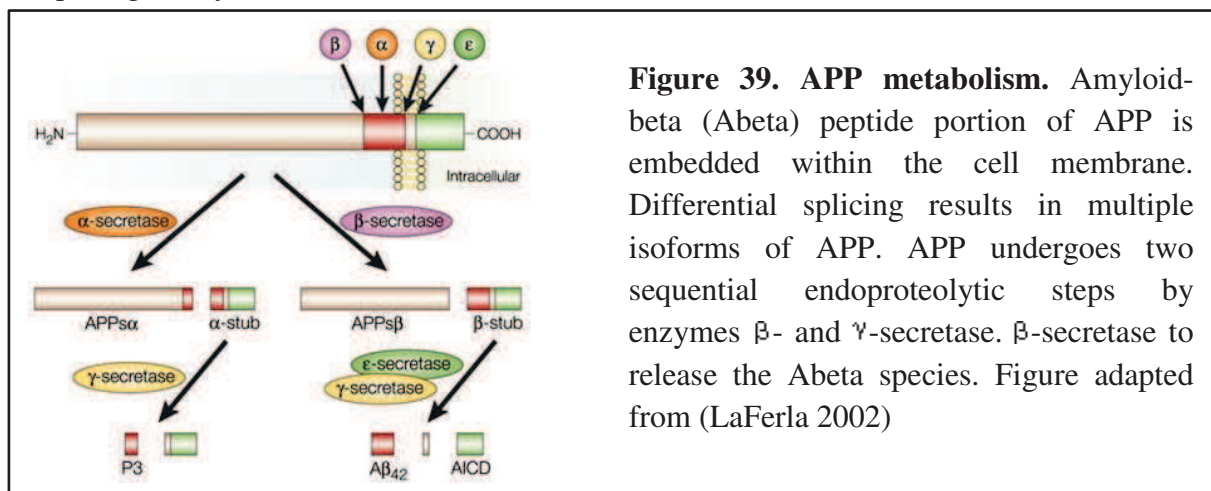
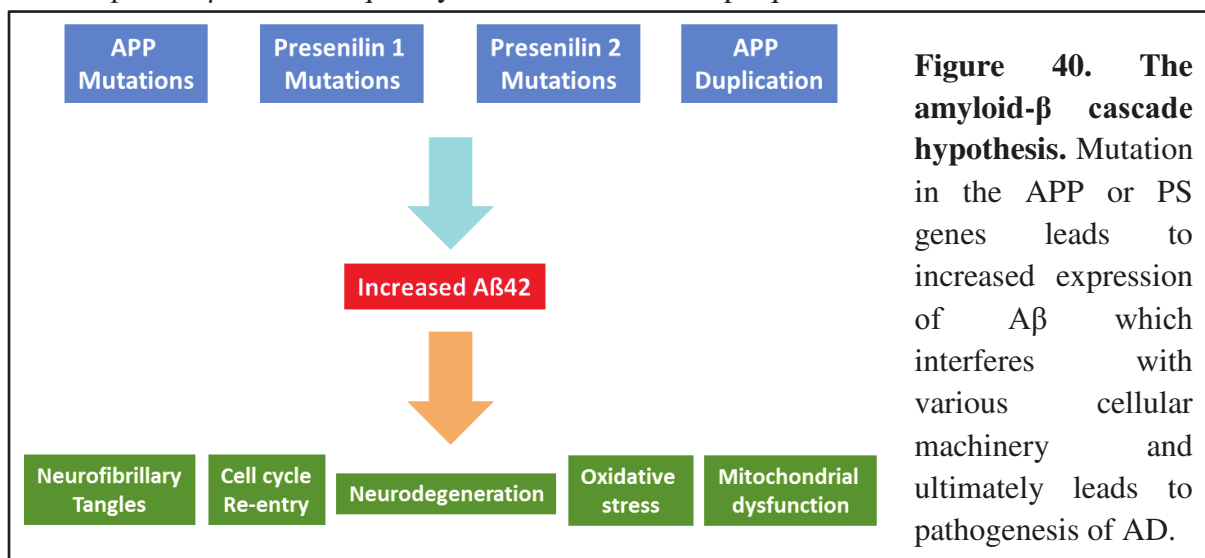

Figure 39. APP metabolism. Amyloid-beta (A β) peptide portion of APP is embedded within the cell membrane. Differential splicing results in multiple isoforms of APP. APP undergoes two sequential endoproteolytic steps by enzymes β - and γ -secretase. β -secretase to release the A β species. Figure adapted from (LaFerla 2002)

2.1.2. The amyloid- β cascade hypothesis

The basic hypothesis of the amyloid- β cascade model is based on the concept of accumulation of A β into neuritic and senile plaques in the brain during early stage causes neurodegeneration leading to AD pathogenesis (Hardy and Selkoe 2002). Increased accumulation of A β could be due to excess production or reduced clearance. A β oligomers interacts with both neurons and glial cells to activate catastrophic effects like mitochondrial dysfunction and increased oxidative stress (Sanz-Blasco et al. 2008), impairment of intracellular signalling pathways and synaptic plasticity, increased Tau phosphorylation, increased GSK-3 β activity, deregulation of calcium metabolism, induction of neuronal apoptosis and cell death (De-Paula et al. 2012). These steps leads to activation of a feedback loop dysfunctioning the APP metabolism and production of excess A β peptides. Deposition of A β fibrils in the neuritic plaques sequentially leads to the formation of phantoms of senile

plaques. The amyloid plaque formation leads to destabilisation of the functioning of a cell and ultimately leads to death (Rhein and Eckert 2007). Normally in a healthy cell, the balance between A β peptide production and clearance from the brain is strictly maintained (Roberts et al. 1994). Apolipoprotein E (APOE) and the insulin-degrading enzyme (IDE) are involved in this process. According to a popular hypothesis, these proteins inhibit A β peptide aggregation by directly binding to it and thereby promoting its clearance (Recuero et al. 2004). The amyloid- β cascade hypothesis was further strengthened by the identification of mutations associated with early-onset AD like mutation in the APP gene, and presenilin 1 and 2 genes (Boeras et al. 2008). Furthermore transgenic animals with mutation on these genes overexpress A β and subsequently lead to formation of plaques.



2.2. ApoE4

2.2.1. ApoE Polymorphisms and Functions in Neurobiology

ApoE2, apoE3, and apoE4 are the three isoforms of ApoE prevalently found in humans. All the three isoforms differs from one another by single amino acid substitution enabling them to have diverse roles in neurobiology (Mahley, Weisgraber, and Huang 2006). ApoE isoforms have specific roles in neurite remodelling and remyelination of new axons (Huang 2006). ApoE-deficient mice shows synaptic and dendritic alteration suggesting roles of apoE in maintenance synapto-dendritic apparatus (Masliah et al. 1995). ApoE also controls glutamate receptor function and synaptic plasticity by regulating its receptor recycling in neurons (Y. Chen et al. 2010). N- and C-terminal domain interaction of apoE is extremely

crucial for its functioning as mutation in this region (Arg-61 to threonine or of Glu-255 to alanine) prevents the domain interaction which leads to several detrimental consequences like proteolytic susceptibility, impairments in neurite outgrowth, and mitochondrial functions (Brodbeck et al. 2011; Chen et al. 2012), and apoE4-associated astrocytic dysfunction (Zhong and Weisgraber 2009).

ApoE is present in different cell types. The source of apoE defines its physiological and pathophysiological pathways. Astrocyte derived apoE isoforms have shown to be involved in A β clearance or deposition (Katsuura et al. 1990). CNS neurons expressed apoE acts upon stresses and injuries (Huang 2006).

2.2.2. Roles of apoE4 in AD Pathogenesis

Study on transgenic mice models of hAPP suggests human apoE stimulates A β clearance. ApoE4 is shown to have less ability to clear A β compared to apoE2 and apoE3. C-terminally truncated forms of apoE4 have been found in AD brain which is inefficient in A β clearance and act to impart neuronal and behavioral deficits in transgenic mice (Bien-Ly et al. 2011).

Several lines of transgenic mice have been developed for apoE without co-expression of mutant hAPP. Results obtained from these studies revealed several role of apoE in the context of AD pathogenicity. Mice expressing apoE4 in the absence of the other isoforms in the neurons shows age and gender dependent spatial learning and memory deficits ApoE4 reduces dendritic spine density *in vivo* and impairs adult hippocampal neurogenesis. The C-terminally truncated forms of apoE4 induce phosphorylation of tau protein and thereby formation of intracellular NFT-like inclusions. Thus the apoE4 fragment induced neurotoxicity could be related to the formation of neurotoxic tau species. Removal of the endogenous tau from the apoE4 fragment-transgenic mice rescues neuronal and behavioural deficits (Andrews-Zwilling et al. 2010).

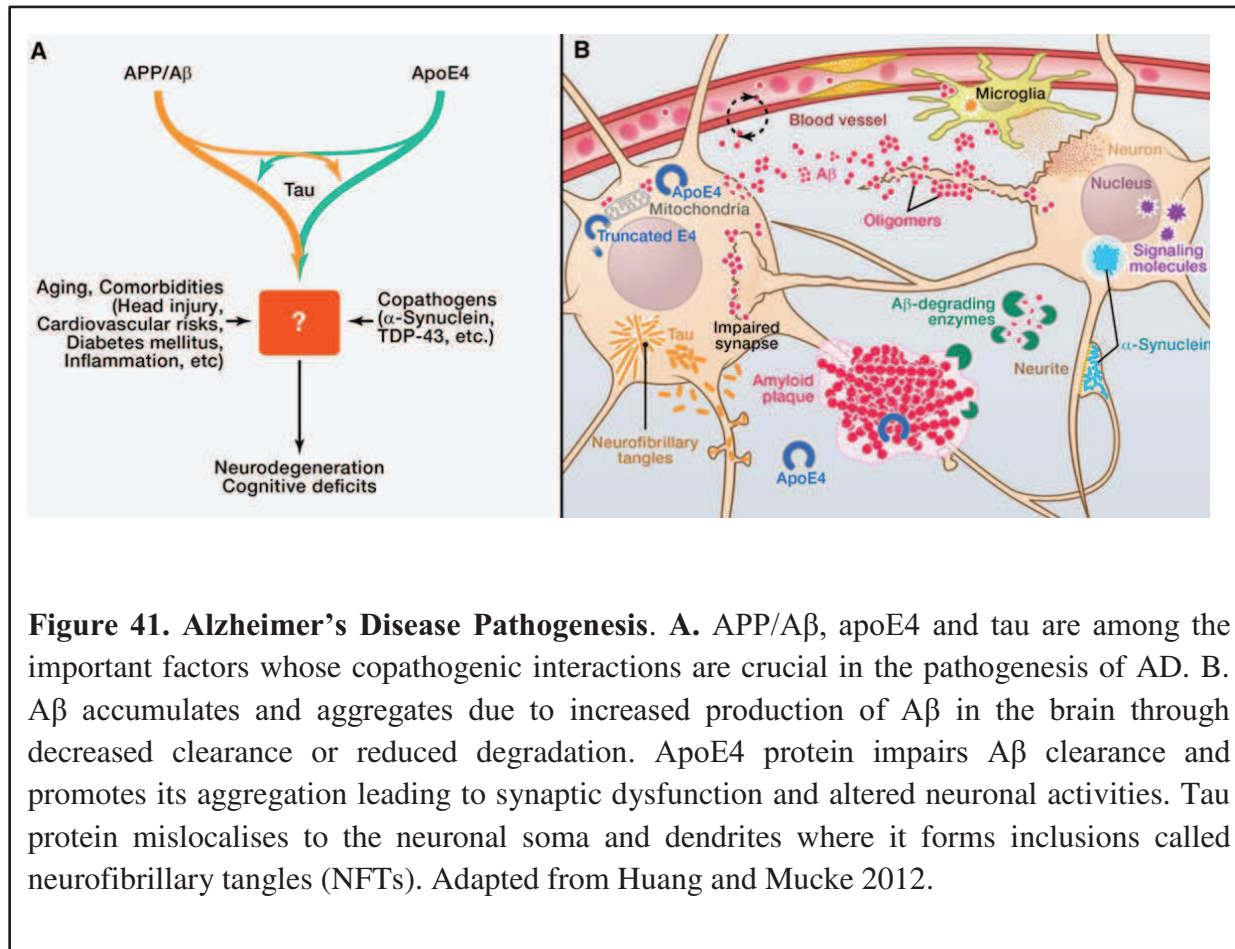

2.3. Tau

Tau is a microtubule stabilising protein which is predominantly found in the neurons. It was discovered simultaneously in The United States and Europe as a protein that is closely associated with tubulin polymerization into microtubules in the brain (Weingarten et al. 1975). Human tau protein exists in 6 different isoforms as a result of alternative mRNA splicing from a single gene known as MAPT. MAPT is located on chromosome 17.

2.3.1. Domain organisation and structure of tau protein

Tau is a hydrophilic protein that appears as a random coiled structure. Brain tau isoforms have two major domains: projection domain (positioned in the amino-terminal region) and microtubule binding domain (positioned in the carboxyl-terminal region). The amino-

terminal region with a high percentage of acidic residues and the proline-rich region form the two sub domains of the projection domain, whereas the basic, true tubulin-binding region and the acidic carboxy-terminal region are the subdomains of the microtubule binding domain. Among several other roles, important functions of the projection domain are to determine the spacing between axonal microtubules (Chen et al. 1992) and interactions with other cytoskeletal proteins (Hirokawa, Shiomura, and Okabe 1988). An interesting feature of the microtubule domain is the presence of three (tau 3R) or four (tau 4R) similar but not identical repetitive sequences of 31 or 32 residues (Figure 42) (Avila et al. 2004). Alternate splicing of exons 2, 3, and 10 in the human adult brain gives rise to at least six isoforms of tau. At least 50% of the isoforms contains the exon 10 encoding sequence, two isoforms contains exon 2, whereas 75% of the isoforms contains exon 3 always associated with exon 2 (Vingtdeux, Sergeant, and Buée 2012). Each isoforms of tau differs from one other by the presence of 3R or 4R repeat-regions in the microtubule binding domain and one (1N), two (2N), or no inserts of 29 amino acids each in the projection domain. Inclusion of the exon 10 encoding region provides tau protein containing four microtubule binding repeats (MTBRs) (4R tau: 0N4R, 1N4R, 2N4R), whereas exclusion of exon 10 leads to expression of tau with three MTBRs (3R tau: 0N3R, 1N3R, 2N3R) (Sergeant, Delacourte, and Buée 2005; Goedert and Jakes 1990). Each of these isoforms presents specific physiological roles as they are differentially expressed during development of brain. Differential distribution of tau isoforms have been noted in neuronal subpopulations. Mis-splicing of tau plays significant roles in the pathological conditions like frontotemporal dementia linked to chromosome 17 where it is linked to development of neurofibrillary degeneration (Sergeant et al. 2008). Major portion of tau protein is present in axons from neurons while it is also present in the oligodendrocytes.

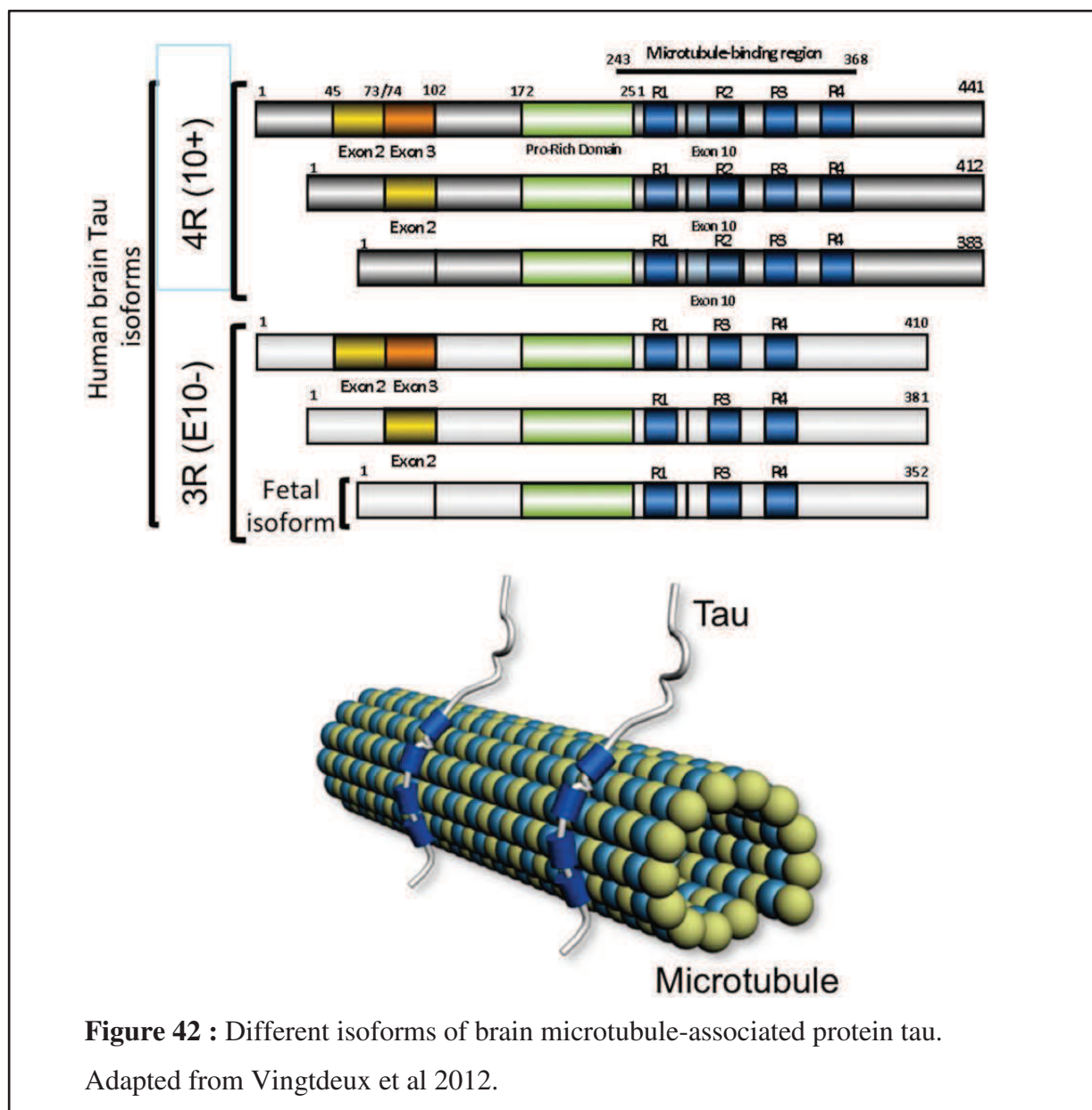

Figure 42 : Different isoforms of brain microtubule-associated protein tau.

Adapted from Vingtdeux et al 2012.

2.3.2. Physiological functions of Tau

One of the major functions of tau protein in the physiological condition is to facilitate tubulin assembly (Weingarten et al). Subsequent studies both *in vitro* and *in vivo* showed its roles in the stabilisation of polymerised microtubules and suppression of microtubule dynamics (Bré and Karsenti 1990, Drubin and Kirschner 1986, Maccioni et al. 1989, Panda et al. 1995). Decreased levels of tau by antisense oligonucleotides showed the involvement of tau in neurite outgrowth (Caceres and Kosik 1990, Caceres, Potrebic, and Kosik 1991). Tau also influences axonal transport as its binding site on tubulin overlaps with other proteins including molecular motor kinesin. Tau deficiency in mice is not lethal. Mouse deficient with tau shows decreased microtubule numbers in small caliber axons, muscle weakness, and

some behavioral deficits (Harada et al. 1994, Ikegami, Harada, and Hirokawa 2000). A possible explanation could be compensation by other proteins in mice lacking tau.

2.3.3. Tau pathology in AD and other tauopathies

Tau is an important protein implicated in the maintenance of microtubule stability. Alteration in the amount or conformation of tau protein could disrupt the role of tau as a microtubule stabiliser and other processes where it is associated. Phosphorylation of tau alters its ability to interact with microtubules. Hyper-phosphorylation of tau is a major contributor for the aberrant aggregates found in neurons and sometimes in glia of patients with neurological disorders commonly known as tauopathies. AD is associated with presence of two main pathological structures in the brain: senile plaques (composed of the amyloid peptide), and neurofibrillary tangles (NFT). NFTs are composed of paired helical filaments (PHFs) composed of aberrant tau protein polymers. Increased number of NFT correlates with degree of dementia in patients.

Tau pathology is closely linked to synaptic loss or dysfunction that correlates better with cognitive deficits observed in patients with AD or other tauopathies. Braak and Braak in 1991 first described that AD related tauopathy follows a characteristic pattern to spread tau aggregation pathology in the brain (Figure 43) (Braak and Braak 1991). Neurofibrillary tangles first severely affects the hippocampus and entorhinal cortex and then slowly progresses and spreads to temporal, parietal, and frontal cortices. The aggregation of tau forms in neocortical regions much earlier than the first appearance of NFTs (García-Sierra et al. 2001, Mukaetova-Ladinska et al. 2000). PHF-tau aggregation starts appearing from Braak stage 2 onwards whereas tangles can be detected by microscopic techniques from Braak stage 4 in the neocortex. Recent evidences suggests that tau pathology in the medial temporal lobe precedes A β accumulation thus indicates that amyloid deposition is not a prerequisite for dementia (Harrington 2012).

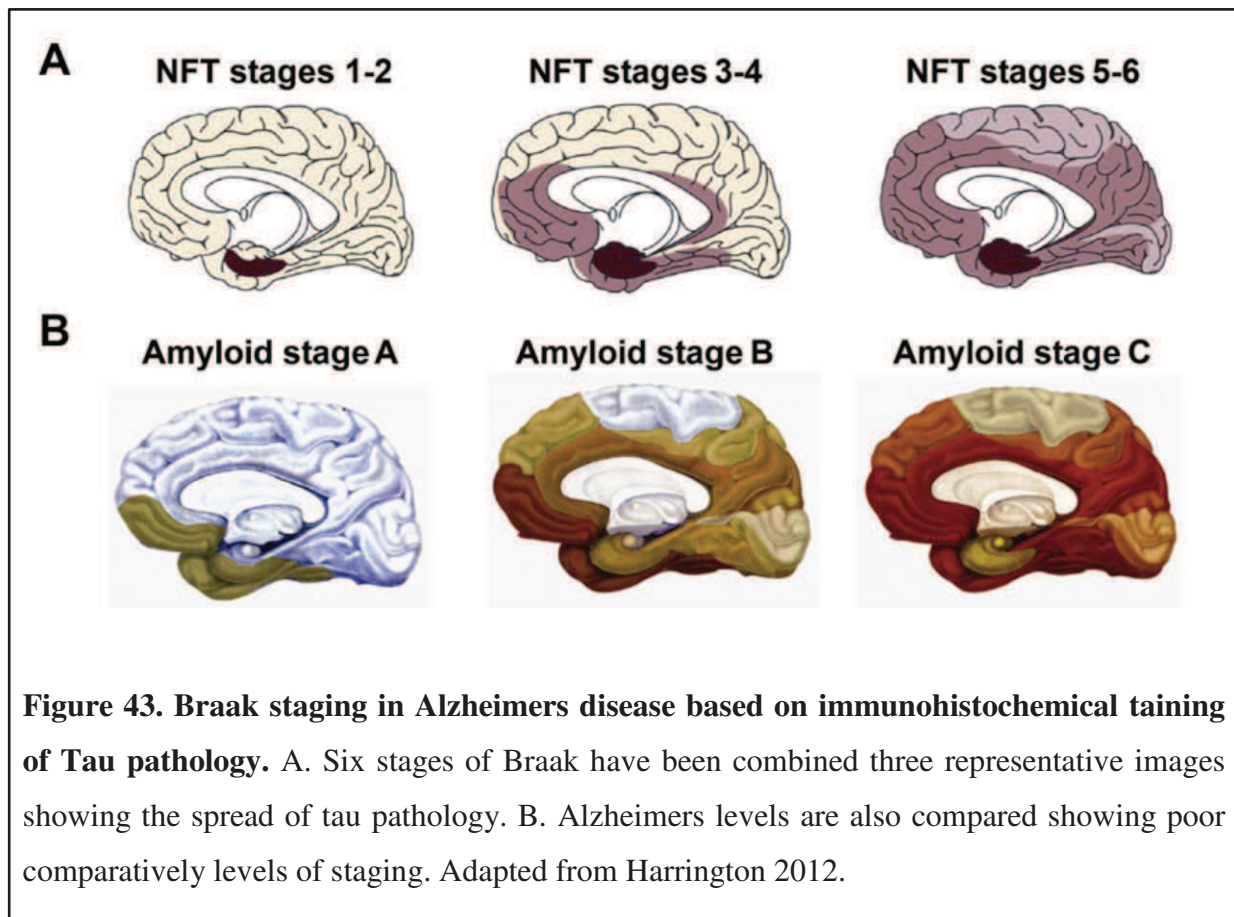

Abnormal hyperphosphorylation of tau (Tau pathology in Alzheimer disease and other tauopathies)

Hyperphosphorylation of tau protein leads to accumulation and forms NFTs. NFT is associated with neurofibrillary degeneration and dementia commonly described as tauopathies. Ever since the discovery of mutation in tau gene in diseases like frontotemporal dementia with Parkinsonism linked to chromosome-17 (FTDP-17), has established abnormalities of tau protein as a primary event in diseases associated with neurodegeneration and dementia (Grover et al. 1999). Abnormal hyperphosphorylation of tau robustly affects the neurons in AD. It is not only found in the neurofibrillary tangles but also in the cytosol from AD brains (K. Iqbal et al. 1986). Tau present in tangles is generally subjected to ubiquitination, whereas abnormally hyperphosphorylated tau obtained from AD brains shows no ubiquitin reactivity suggesting abnormal hyperphosphorylation of tau precedes its accumulation inside the neurofibrillary tangles (Khalid Iqbal et al. 2005).

3. Tau as a model system to study Alzheimer's disease and other tauopathies: THY-Tau22

Transgenic Tau mice models are valuable system to study various aspects of tauopathies and AD tau pathology. During the last decade, several models with single tau mutations has been reported which includes P301L, P301S, G272V, V337M, and R406W, or overexpression of human tau isoforms. However, none of these models could reproduce spectrum of tau associated tangle pathology as observed in AD. Furthermore, most of these models show motor deficits and hind limb paralysis possibly by increased deposition of tau in the spinal cord thus making behavioural analysis to be a difficult job.

In 2006, Luc Buée and colleagues generated a novel mouse model (THY-Tau22) expressing human 4-repeat tau with the double mutations G272V and P301S under the Thy1.2 promoter (Schindowski et al. 2006). THY-Tau22 mice do not shows any motor deficits and dystonic posture that could interfere with behavioural testing. None of the body organs tested (heart, kidneys, spleen, muscle, gland and thymus) except brain showed expression of human tau. Interestingly THY-Tau22 mice show hyperphosphorylation of tau on several Alzheimer's disease-relevant tau epitopes (AT8, AT100, AT180, AT270, 12E8, tau-pSer396, and AP422). Neurofibrillary tangle-like inclusions (Gallyas and MC1-positive) with rare ghost tangles and PHF-like filaments, as well as mild astrogliosis are also prominent features of this model. Pyramidal cell layer of the CA1 region and the frontal cortex from 6 months age showed tau aggregated neurons whereas it was detected in the DG, the CA3 region, and the amygdala at 12 months age. Ghost tangles started appearing in the CA1 at 12 months age. AD is associated with reactive astrocytes and microglia that causes neuronal damage. Aged THY-Tau22 mice showed increased number of astroglial GFAP-positive cells especially in the hippocampal hilus region, cerebral cortex, corpus callosum, CA1 region, and the CA3 region. Interestingly, accumulation of astroglial and microglial cells was detected in close vicinity to neurons with high load of phospho-tau (Schindowski et al. 2006).

Hippocampal synaptic plasticity

Long-term changes in hippocampal synaptic transmission including both LTP and LTD are thought to be essential for the consolidation of spatial memory. THY-Tau22 mice shows normal long-term potentiation (LTP) with no significant difference from the WT in field

recordings from CA1 region (Schindowski et al. 2006). THY-Tau22 mice showed defects in the late long-term depression (LTD) hippocampal CA1-region in vitro (Van der Jeugd et al. 2011). However, impaired late LTD can be rescued by inhibition of glycogen synthase kinase-3 (GSK3b) activity and also by protein-phosphatase 2A agonist selenite (Ahmed et al. 2015). In support to the finding, increased phosphorylation of GSK3b at Y216 and decreased total phosphatase activity has been detected in the hippocampal tissues of THY-Tau22 mice. Thus the phospho-tau/total tau imbalance could be the major reason for the impaired LTD observed in THY-Tau22 mice.

Brain-derived neurotrophic factor (BDNF) mRNA and protein levels are reported to be reduced in cortex and hippocampus of AD patients. The alteration of BDNF expression is considered to be due to the toxic accumulation of A β (Peng et al. 2009). Thus the memory impairment observed in AD is partly due to A β induced loss of BDNF expression. However, down-regulation of BDNF transcript or protein levels were not observed in THY-Tau22 mice (Burnouf et al. 2012). In physiological conditions, BDNF involves TrkB and N-methyl-D-Aspartate receptors (NMDAR) to induce AMPA receptor dependent hippocampal basal synaptic transmission (Minichiello 2009). In THY-Tau22 mice exogenous BDNF fails to enhance synaptic transmission. The loss of BDNF response is attributed to impaired NMDAR function. Phosphorylation of NR2B at the Y1472, which is a critical component for NMDAR function, is reduced in THY-Tau22 mice. Moreover the two main NR2B kinases NR2B and Src interact with Tau and mislocalises to the pathological tau fraction (Burnouf et al. 2013).

Behavioral abnormalities

Accumulation of tau pathology causes age dependent cognitive decline in THY-Tau22 mice. 3-4 months mice show no spatial memory deficits whereas it is impaired from 8 months onwards. Non-spatial memory defects starts as early as 6 months age (Van der Jeugd, Vermaercke, et al. 2013). 6 months age THY-Tau22 mice shows reduced anxiety-like behavior when tested in an elevated plus maze. In the Morris water maze (MWM), THY-Tau22 mice shows delayed learning possibly because of the presence of phospho-tau in the hippocampus (Schindowski et al. 2006). Transgenic mice models of AD have provided huge amount of information towards the understanding of AD pathogenesis and possible treatment. Most of these models show similar AD neuropathology and cognitive symptoms as observed

in AD patients. Behavioral and psychological signs and symptoms of dementia (BPSD) has also been partially observed in APP transgenic mice (Lalonde, Fukuchi, and Strazielle 2012). Thus occurrence of BPSD-like behavioral changes in THY-Tau22 has also been recently studied in addition to the cognitive impairments. 12 months old THY-Tau22 mice displays increased depression-like and aggressive behavior in accordance to disturbances in nocturnal activity. Decreased hippocampal concentration of serotonin, or 5-hydroxytryptamine (5-HT), and 5-hydroxyindoleacetic acid (5-HIAA) 5-HT and 5-HIAA, the main metabolite of serotonin was found to be responsible for the observed behavioural and psychological state. (Van der Jeugd, Blum, et al. 2013).

4. Histone modifications and AD: Implications of small molecule modulators of HATs as a therapeutic possibility

4.1. Non-histone protein acetylation and AD

Epigenetic processes are considered to be heritable changes that alters gene expression without any changes in their coding sequence (Egger et al. 2004). Epigenetic processes includes a wide array of modifications like acetylation, phosphorylation, methylation, ubiquitination, ADP ribosylation, and sumoylation, DNA methylation, and non-coding RNAs (Goldberg, Allis, and Bernstein 2007). Histone acetylation is one such epigenetic modification whose dysregulation leads to alteration in the transduction cascade such as cell differentiation, cell apoptosis, vascular remodeling, inflammation reaction, immune responses, neuronal plasticity, and metabolic reprogramming (Reviewed in Lu et al. 2015). Altered acetylation of several non-histone proteins both nuclear and cytoplasmic like NF- κ B (Chen Lf et al. 2001), p53 (Barlev et al. 2001), alpha tubulin (Perez et al. 2009), and tau (Min et al. 2010; Irwin et al. 2012) has also been linked to AD pathology.

p300/CBP acetylates **NF- κ B** at multiple residues including Lys-122, -123, -218, -221, and -310. PCAF (p300/CBP associated factor) mediated acetylation of NF- κ B at Lys- 122 activate the A β -induced function of NF- κ B. C-30-27, a selective inhibitor of PCAF inhibits NF- κ B at Lys- 122 and thereby supresses both A β -induced cytokine production and A β -mediated

neuronal cell death in cell lines by blocking NF- κ B-mediated inflammatory response induced by A β (Park et al. 2013, Park et al. 2015).

p53 is one of the first non-histone protein that was identified to be acetylated. p53 is regarded as a strong transcription factor that drives activation and repression of a large number of genes in a context specific manner that defines its tumour suppressor activity (Levine 2011, Soria et al. 2010). Various biochemical studies confirmed that CBP acetylates p53 on multiple lysines in the carboxyl terminus (K370, K372, K373, K381, and K382) and also in the DNA binding domain (K164) (Tang et al. 2008). One report states p53 acetylations are significantly increased in AD brain tissue where p300 is considered to acetylate p53 at the C-terminal domain in AD brain (Aubry et al. 2015). Neuronal outgrowth and maturation also involves p53 hyperacetylation by CBP/p300. On the other hand, SIRT1 agonist resveratrol is able to decrease p53 acetylation and rescues increased p53 acetylation in the inducible p25 transgenic mouse, a model of AD and tauopathies. Resveratrol treatment reduced neurodegeneration in the hippocampus and rescued learning deficiency (Kim et al. 2007).

Tau acetylation also plays crucial role in neurodegeneration and AD pathogenesis. Tau function gets modulated by acetylation at different residues but have different consequences. Tau K280 acetylation within the microtubule-binding motif has been reported in Alzheimer's disease patients. Acetylated-tau pathology presents a similar spatial distribution pattern compared to the hyperphosphorylated tau (Cohen et al. 2011). Sang-Won Min and colleagues identified several acetylation sites on tau protein that are elevated in patients at early and moderate Braak stages of tauopathy. This study suggested that acetylation of tau prevents degradation of phosphorylated tau (p-tau). p300 was identified to be the HAT that is involved in acetylating these sites whereas the class III protein deacetylase SIRT1 in deacetylation (Min et al. 2010). Possibly acetylation of tau reduces solubility and microtubule assembly thus increases tau fibrillization to contribute to tau-mediated neurodegeneration (Irwin et al. 2012). CBP mediated acetylation of tau at Lys 280 leads to increased tau aggregation (Cohen et al. 2011). Recently, Cook and colleagues showed a beneficial effect of tau acetylation. They identified the KXGS motifs of tau protein to be acetylated. Acetylation on the KXGS motifs inhibits the phosphorylation in the same site and also prevents tau aggregation. Hypoacetylation of tau in the KXGS has been demonstrated in patients with AD, as well as a mouse model of tauopathy where histone deacetylase 6 (HDAC6) was identified to be the enzyme that deacetylates these specific sites (Cook, Carlomagno, et al. 2014). Interestingly,

tau protein possesses intrinsic acetyltransferase activity and could auto acetylate using a mechanism similar to that employed by MYST-family acetyltransferases (Cohen et al. 2013). HDAC6 deacetylates both tau and tubulin and thereby contributes to tau-microtubule interactions and microtubule stability (Cook, Stankowski, et al. 2014, Cook, Carlomagno, et al. 2014).

4.2. Histone acetylation and AD

Histone acetylation homeostasis impairment is closely associated with memory impairment. As described in details in Chapter 2, histone acetylation is transiently increased in the dorsal hippocampus of rats after spatial learning suggesting importance of acetylation in memory consolidation. Gjoneska et al observed decreased occupancy of histone H3 lys 27 acetylation at the regulatory regions of synaptic plasticity genes in the p25 transgenic model of AD. Interestingly, increased occupancy of H3 lys 27 acetylation was found at regulatory regions of immune response genes. These genes are targeted by ETS (E26 transformation-specific) family of transcriptional regulators. These changes in the acetylation profile also corresponds to the gene expression changes (Gjoneska et al. 2015). Global histone acetylation levels in aged mice are generally decreased as compared to young ones. This decreased acetylation can be reversed by HDAC inhibitors and improves the memory deficits (Gräff et al. 2012). However, in neuroblastoma cells A β peptide deposits hyperacetylates histones (Gu et al. 2013). Genes related to APP metabolism are also regulated by histone acetylation. Hyperacetylation of histone H3 is detected at the BACE1 promoter in APP/PS1/tau triple transgenic mice (Marques et al. 2012). Decreased H3 acetylation at the gene promoter of Neprilysin (NEP), the principal degrader of A β peptides leads to its downregulation in hypoxia stimulated mouse cortical and hippocampal neurons (Wang et al. 2011). All these information suggests a strong influence of histone acetylation in AD pathogenesis but the detailed understanding of these events and the exact role of histone acetylation is presently missing.

4.3. Histone deacetylases in AD

HDAC2 is widely expressed in the CNS and acts as a negative regulator to synaptic plasticity and memory. Knocking out HDAC2 in CK-p25 mice model by short-hairpin-RNA rescues

memory loss and re-establishes the structural synaptic plasticity (Gräff et al. 2012). Cortices and hippocampi from post-mortem brain samples of AD patients shows increased levels of HDAC6 protein (Ding, Dolan, and Johnson 2008). Decreasing the HDAC6 in a mouse model of AD ameliorates learning and memory deficits and α -tubulin acetylation (Govindarajan et al. 2013). Cytoplasmic HDAC6 is thought to participate in tau metabolism, whereas increased levels of HDAC6 correlates with tau burden and decreased HDAC6 levels prevents tau aggregation. Furthermore, tau can also act as HDAC6 inhibitor and overexpression of tau corresponds to tubulin hyperacetylation. SIRT1 levels are significantly reduced in the parietal cortex, but not in the cerebellum. Increased activity of SIRT1 in hippocampus of p25 transgenic mouse model of AD reduces neurodegeneration. SIRT1 agonist resveratrol compensates the acetylation status of PGC-1 α and p53 to prevent learning impairment (Kim et al. 2007). Thus HDACs are being thoroughly explored in the pathogenesis of AD to be used as a possible therapeutic target in the treatment of AD.

4.4. Small molecule modulators of acetylation in the treatment of AD

4.4.1. HDAC inhibitors

HDAC inhibitors were initially identified for the treatment of cancer. Interestingly, HDAC inhibitors can significantly restore learning and memory deficits in mouse models of AD even in early stages. Thus the report by Fischer and colleagues in 2007 established a promising background for HDAC inhibitors to be used as therapeutics in neurodegenerative conditions (Fischer et al. 2007). Later, several groups had successfully used different HDAC inhibitors to rescue memory loss and synaptic plasticity in various mouse models of AD. HDAC inhibitors trichostatin A (TSA), VPA, SAHA (vorinostat) or sodium butyrate increases synaptic remodelling and contextual memory by enhancing acetylation of H3 and H4 on promoters of specific genes (Reviewed in Lu et al. 2015). 4-phenylbutyrate (PBA) reinstates fear learning in the Tg2576 mouse model of AD. PBA reversed learning deficits by clearing intraneuronal A β accumulation and restoration of CA1 dendritic spine densities (Ricobaraza et al. 2012). Daily injections of PBA reverses spatial memory deficits and by normalising tau hyperphosphorylation in the hippocampus and dendritic spine density (Ricobaraza et al. 2009). Trichostatin A (TSA) treatment in APP/PS1 mouse model of AD rescued both acetylated H4 levels and contextual freezing and CA3-CA1 LTP (Francis et al.

2009). Sodium butyrate increases recruitment of acetylated histone H3/H4 at the DHCR24 enhancer and increases its gene expression which is reported to be reduced in the temporal lobes of AD patients (Drzewinska, Walczak-Drzewiecka, and Ratajewski 2011). However, most of the HDAC inhibitors are non-selective and targets both nuclear and cytoplasmic histone and non-histone protein acetylation. Some HDAC inhibitors like TSA selectively targets the expression of memory-related genes (Vecsey et al. 2007). Thus manipulating the structure of HDAC inhibitors to obtain more specific molecules could prove to be of immense contribution in the therapeutic implications of AD.

4.4.2. HAT activators

HAT activators are the result of recent advances in the interdisciplinary field of chemical synthesis and biology. Several HAT activators are been reported but almost none has been reported to be tested in AD mouse models. The first reported HAT activator is N-(4-chloro-3-trifluoromethyl-phenyl)- 2-ethoxy-6-pentadecyl-benza-mide (CTPB), derivatized using anacardic acid could specifically activate HAT function of p300 *in vitro*. Nemorosone, a derivative of benzophenone is another HAT activator that shows strong activity to induce CBP/p300 HAT function. However, most of the HAT activator molecules are impermeable to the Blood Brain Barrier (BBB) posing a barrier for applications as therapeutics. Among other, only two HAT activators have shown permeability towards BBB after systemic administration in adult mice; SPV106 (PCAF activator) (Wei et al. 2012) and CSP-TTK21 (p300/CBP activator) (Chatterjee et al. 2013).

Pentadecyldenemalonate or SPV106 is the only reported PCAF activator that could enhance PCAF acetyltransferase function and increase H3 acetylation in mice brain. Fear conditioning and extinction are two different learning forms which involves different molecular pathways. p300/CBP mediated acetylation in the hippocampus is essential to form contextual fear, fear extinction also depends on epigenetic regulation. Systemic administration of PCAF activator SPV106 in C57BL/6 mice resulted in enhanced memory for fear extinction and prevented fear renewal. It was also demonstrated that activation of PCAF HAT function induced recruitment of repressive transcription factor ATF4 to the promoter of the immediate early gene *zif268* further inhibiting its expression. This finding suggests that modulation of HAT function of a transcriptional coactivator such as PCAF could be further exploited for the treatment of fear-related anxiety disorders (Wei et al. 2012).

Selective screening using a low throughput HAT assays provided a TTK21 [N-(4-chloro-3-trifluoromethyl-phenyl)-2-n-propoxy-benzamide], a derivative of CTPB which is a first generation HAT activator. TTK21 showed specificity towards CBP and p300 HAT activity but like its parent compound it was also impermeable to mammalian cell membrane and the BBB. Thus TTK21 was chemically conjugated with a glucose derived carbon nanosphere CSP. The conjugated product, CSP-TTK21 could traverse the BBB and could efficiently induce histone acetylation in adult mice brain. Further studies showed that CSP-TTK21 improves adult neurogenesis by favouring dendritic maturation and differentiation in wild type mice. CSP-TTK21 can also increase spatial memory consolidation and enhances memory related gene expression (Chatterjee et al. 2013).

SECTION II

Experimental Contributions

PUBLICATION 1.

**A Novel Activator of CBP/p300 Acetyltransferases Promotes Neurogenesis
and Extends Memory Duration in Adult Mice**

Snehajyoti Chatterjee*, Pushpak Mizar*, Raphaelle Cassel*, Romain Neidl, B. Ruthrotha Selvi, Dalvoy Vasudevarao Mohankrishna, Bhusainahalli M.Vedamurthy, Anne Schneider, Olivier Bousiges, Chantal Mathis, Jean-Christophe Cassel, Muthusamy Eswaramoorthy, Tapas K. Kundu, and Anne-Laurence Boutillier

* Authors contributed equally

Article published in *J Neurosci.* **2013**;33(26):10698-712

Background of Research and Objectives

Histone acetylation is thought to be essential for synaptic plasticity and memory. Research from various groups from the last decade has indicated the importance of histone acetylation in the brain function and alteration of it results in cognitive defects. The best example of acetylation modulation is the use of HDAC inhibitors in the study of memory processes. Researchers use HDAC inhibitors as a tool to target HDACs and thereby activate histone acetylation. Activation of histone acetylation by HDAC inhibitors impacts on maintenance of LTP and also improves long-term memory as tested for different forms of memory and different contexts. Importantly, histone acetylation activation by HDAC inhibitors is a rather indirect process and apart from deacetylation activity, which also occurs on non histone proteins, HDACs are associated with various other biological functions as they are components of transcription co-repressor complexes on the chromatin.

The role of HDACs in memory and diseases has been an intense area of research. Researchers have demonstrated the role of several HDACs in memory processes. However, our knowledge on the role of HATs in memory related processes is mostly based on CBP. Mutation of CBP causes Rubinstein Taybi syndrome, a pathological condition characterized with cognitive deficits (Petrij et al ., 1995; Kalkhoven et al ., 2003; Alarcón et al., 2004; Barco, 2007). CBP function in learning and memory has been deciphered with knock-down and deletion genetic models (Barco, 2007; Oliveira et al., 2006; Barrett et al., 2011; Oliveira et al., 2011 ; Chen et al., 2010 ; Valor et al., 2011). Spatial learning induces expression of several HATs including CBP/p300 suggesting its importance during memory formation process (Bousiges et al., 2010). Also viral delivery of CBP in the hippocampus of a mouse model of Alzheimer's disease rescues deficits in learning and memory (Caccamo et al., 2010). All these results supports that stimulation of CBP can be a potential therapeutic tool for the treatment of memory related disorders including Alzheimer's disease.

Thus when I started my research at the laboratory of Dr Tapas K Kundu, Bangalore, India, the aim was to directly target the CBP HAT function by a pharmacological mean to modulate histone acetylation levels and study its effect in biological functions. Researches in the Kundu's lab were mostly focussed on cancer research. Upon a collaboration with Dr. AL Boutillier's group that started in 2003, a new axe of research was developed towards the re-activation of proper HAT/CBP functions in neurodegenerative diseases and cognitive functions. Activation of HATs would provide better understanding of the importance of specific HATs in different processes, such as neuronal survival and memory formation, and with hypothetically less non-specific and global histone acetylation.

Search for KAT activator

The HAT domain is the region which catalyzes the acetyltransferase activity of HATs. The HAT domain has been studied thoroughly and the crystal structure of CBP and p300 HAT domain is already reported. The HAT domain has been of immense interest for chemical biologists to modulate the acetyltransferase function of HATs. Several small molecules (synthetic or natural chemical probes) have been designed to target this domain. Using small molecules that can activate the enzymatic function of HATs is an emerging concept and only a few of them has been reported. The first reported HAT activator molecule, N-(4-chloro-3-trifluoromethyl-phenyl)-2-ethoxy-6-pentadecyl-benza-mide (CTPB) was derived from anacardic acid obtained from cashew-nut shell liquid. CTPB was synthesised in Dr Kundu's laboratory, India (Balasubramanyam et al., 2003). CTPB activates p300 but not PCAF HAT function *in vitro*. Surface-enhanced Raman spectroscopy analysis suggests that the CTPB binding on p300 HAT domain induces a conformational change that helps in the recruitment of more acetyl-CoA and auto-acetylation (Mantelingu et al., 2007). In need of a more stable and potent activator of HATs, CTPB was further derivatized to a series of small molecules and a library was created. I was associated with the work on the modulation of HAT domain by small molecules in Dr Kundu's laboratory. We tested the activity of these molecules using a low throughput HAT activity assay. Among all the derivatives, TTK21 showed the best activity and specificity towards CBP and p300. The main purpose to synthesize these HAT activators was to test its function in animal brain. Thus the first step before testing a molecule's effect in animal model is to check its activity in cell lines. We treated TTK21 in SHSY-5Y cell lines and found that the molecule cannot cross the cell membrane and is inactive in mammalian cell lines.

Need for a vehicle to carry the HAT activator

Molecular biology and Nanotechnology is working hands on hands for the last decade to develop therapeutic approach for drug delivery. The best outcome of interdisciplinary science is that we can share knowledge from each sections of science and can develop technology which is not possible to do alone. We learned that Dr Eswaramoorthy's group in JNCASR, India had developed a glucose derived carbon nanosphere (CSP) which can cross the mammalian cell membrane and can also cross the blood-brain barrier (BBB) in mice. Initial

studies from the collaborative work between the two research groups had chemically adsorbed HAT activator CTPB on CSP (CSP CTPB). Then, the adsorbed compound could be tested in Dr. Boutillier's laboratory and successful delivery of the HAT activator molecule in mice brain was achieved in the Rat (Selvi et al., 2008). We took the opportunity of the available technology and started investigating the mechanistic details of the CSP entry into mammalian cells. We showed that CSP entry into living cells follows an ATP dependent clathrin mediated endocytosis process. CSP also showed strong preference towards cells with higher levels of glucose transporters (Selvi et al., 2012). Thus the molecule proved to be a potential vehicle to target individual organs like brain with great specificity.

CSP-TTK21 conjugation and beginning of a fascinating approach to boost memory in non-transgenic mice

We successfully chemically conjugated CSP with HAT activator TTK21 (named it as CSP-TTK21) and confirmed the conjugation by various biophysical methods. CSP-TTK21 unlike the unconjugated TTK21 molecule could cross the mammalian cell membrane and also pass the blood-brain barrier (BBB) in mice. The conjugated material takes around 24 hours to enter rodent brain and within 72 hours after the *i.p.* administration, as followed with CSP intrinsic fluorescence. As CSP-TTK21 could potentially impact on the histone acetylation levels of the brain, studying its consequences in a neurobiological context was of immense interest. This established the foundation for exploring the implications of the CBP activation by HAT activator CSP-TTK21 in memory related processes. The collaboration with Dr Boutillier's group opened the door for me to visit her lab for a short stay of 3 months. My initial results obtained in Dr Boutillier's laboratory supported the potential role of CSP-TTK21 mediated CBP activation in the memory related processes. We found that CSP-TTK21 by activating histone acetylation in the dorsal hippocampus also promoted the formation of long and highly branched doublecortin-positive neurons in the dentate gyrus only after single dose of injection (500µg/mice). This was the first series of data that suggested that HAT activation could also favour maturation and differentiation of adult neuronal progenitors. Finally, we also evidenced that CSP-TTK21 improved spatial memory in remote long-term without improving retention of a recent memory.

The first series of data obtained from my short visit in Dr Boutillier's laboratory was further supported by CEFIPRA between the collaborative labs of Dr Kundu and Dr Boutillier,

including funding of my PhD in Dr Boutillier's laboratory in Strasbourg, France. I joined in Dr Boutillier's laboratory in January, 2013 as a PhD student.

After joining as a PhD student, we studied the distribution of CSP-TTK21 in different regions of mice brain and other body tissues. Then the major question was the mechanism by which CSP-TTK21 activates memory formation. We evaluated the gene expression patterns of memory and activity related genes and also validated the acetylation status of histone H2B on the promoters of those genes after single injection of CSP-TTK21.

The data obtained on the effect of CSP-TTK21 in healthy adult mice were published in the Journal of Neuroscience (Chatterjee et al., 2013) and the molecule (CSP-TTK21) has been patented (W02013/160885).

10698 • The Journal of Neuroscience, June 26, 2013 • 33(26):10698–10712

Cellular/Molecular

A Novel Activator of CBP/p300 Acetyltransferases Promotes Neurogenesis and Extends Memory Duration in Adult Mice

Snehajyoti Chatterjee,^{1,3*} Pushpak Mizar,^{1*} Raphaelle Cassel,^{3*} Romain Neidl,³ B. Ruthrotha Selvi,¹ Dalvoy Vasudevarao Mohankrishna,¹ Bhusainahalli M. Vedamurthy,¹ Anne Schneider,³ Olivier Bousiges,³ Chantal Mathis,³ Jean-Christophe Cassel,³ Muthusamy Eswaramoorthy,² Tapas K. Kundu,¹ and Anne-Laurence Boutillier³

¹Transcription and Disease Laboratory, Molecular Biology and Genetics Unit, and ²Chemistry and Physics of Materials Unit, Jawaharlal Nehru Centre for Advanced Scientific Research, Jakkur, Bangalore 560064, India, and ³Laboratoire de Neurosciences Cognitives et Adaptatives, Unité Mixte de Recherche 7364 Université de Strasbourg, Centre National de la Recherche Scientifique, Faculté de Psychologie, Groupe de Recherche 2905 NeuroMem, Strasbourg 67000, France

Although the brain functions of specific acetyltransferases such as the CREB-binding protein (CBP) and p300 have been well documented using mutant transgenic mice models, studies based on their direct pharmacological activation are still missing due to the lack of cell-permeable activators. Here we present a small-molecule (TTK21) activator of the histone acetyltransferases CBP/p300, which, when conjugated to glucose-based carbon nanosphere (CSP), passed the blood–brain barrier, induced no toxicity, and reached different parts of the brain. After intraperitoneal administration in mice, CSP-TTK21 significantly acetylated histones in the hippocampus and frontal cortex. Remarkably, CSP-TTK21 treatment promoted the formation of long and highly branched doublecortin-positive neurons in the subgranular zone of the dentate gyrus and reduced BrdU incorporation, suggesting that CBP/p300 activation favors maturation and differentiation of adult neuronal progenitors. In addition, mRNA levels of the neuroD1 differentiation marker and BDNF, a neurotrophin required for the terminal differentiation of newly generated neurons, were both increased in the hippocampus concomitantly with an enrichment of acetylated-histone on their proximal promoter. Finally, we found that CBP/p300 activation during a spatial training, while not improving retention of a recent memory, resulted in a significant extension of memory duration. This report is the first evidence for CBP/p300-mediated histone acetylation in the brain by an activator molecule, which has beneficial implications for the brain functions of adult neurogenesis and long-term memory. We propose that direct stimulation of acetyltransferase function could be useful in terms of therapeutic options for brain diseases.

Introduction

Epigenetic modifications are emerging as fundamental mechanisms involved in regulations of adaptive behaviors (Hsieh and

Eisch, 2010; Gräff et al., 2011). The site-specific acetylation of histone proteins within chromatin is an epigenetic modification that participates in the regulation of gene expression and, although highly dynamic, is believed to produce long-lasting changes that sustain physiological processes and behavior (Gräff et al., 2011). In neurons particularly, where *de novo* gene expression is known to support long-term memory formation, histone acetylation greatly participates in synaptic plasticity, learning, and memory (for review, see Peixoto and Abel, 2013). Epigenetic alterations, including those on histone acetylation, can lead to the cognitive dysfunctions found in pathological conditions (Gräff et al., 2012). Therefore, pharmacological enhancement of signaling, including transcriptional processes that mediate long-term memory formation, provides a potential therapeutic strategy for cognitive disorders involving aberrant neuroplasticity.

Reversible acetylation is regulated by specific enzymes, histone/lysine acetyltransferases (HAT/KAT), which add an acetyl group to lysine residues of proteins including histone tails and deacetylases (HDACs) catalyzing the opposite reaction (Yang and Seto, 2007). During the last decade, investigators have modulated cellular acetylation homeostasis in neurodegenerative conditions, especially those associated with cognitive impairments, using HDAC inhibitors as a potential therapeutic intervention (Kazantsev and Thompson, 2008; Fischer et al., 2010). However, caveats remain as to the specificity of these inhibitors,

Received Dec. 18, 2012; revised April 18, 2013; accepted May 8, 2013.

Author contributions: S.C., P.M., R.C., B.R.S., T.K.K., and A.-L.B. designed research; S.C., P.M., R.C., R.N., B.R.S., D.V.M., B.M.V., A.S., O.B., M.E., T.K.K., and A.-L.B. performed research; S.C., P.M., R.C., R.N., B.R.S., D.V.M., B.M.V., A.S., O.B., C.M., J.-C.C., M.E., T.K.K., and A.-L.B. analyzed data; S.C., J.-C.C., T.K.K., and A.-L.B. wrote the paper.

This work was supported by the Centre National de la Recherche Scientifique, the University of Strasbourg, the Department of Biotechnology, the Government of India (Grant #BT/CSH/GIA/1752 to T.K.K.), the Jawaharlal Nehru Centre for Advanced Scientific Research, ANR (Grant #ANR-12-MALZ-0002-01 to A.-L.B.), the Indo-French Centre for the Promotion of Advanced Research (Grant #4803-3 to T.K.K. and A.-L.B.), Ligue Européenne Contre la Maladie d'Alzheimer (Project #10702 to A.-L.B.), and Alsace Alzheimer 67 (to A.-L.B. and Dr. F. Blanc). T.K.K. is the recipient of a Sir J.C. Bose national fellowship, Department of Science and Technology, Government of India. R.C. and R.N. are recipients of a doctoral fellowship from the French government. A.S. is supported by the Fondation Unistra-don Pierre Fabre and by the ANR (Grant #ANR-12-MALZ-0002-01). We thank O. Bildstein, O. Egesi, and G. Edomwonyi (Unité Mixte de Recherche 7364) for assistance in animal care and B. Cosquer, K. Herbeaux, and M.-M. Klein (Unité Mixte de Recherche 7364) for excellent technical assistance. We thank Parijat Senapati and Dr Rahul Modak for providing the p300 enzyme. Publication costs are supported by the Neurex network.

The authors declare no competing financial interests.

*S.C., P.M., and R.C. contributed equally to this work.

Correspondence should be addressed to either of the following: Anne-Laurence Boutillier, Laboratoire de Neurosciences Cognitives et Adaptatives, UMR 7364 CNRS, Université de Strasbourg, 12 rue Goethe, 67000 Strasbourg, France. E-mail: laurette@unistra.fr; or Tapas K. Kundu, Transcription and Disease Laboratory, Molecular Biology and Genetics Unit, Jawaharlal Nehru Centre for Advanced Scientific Research, Jakkur, Bangalore 560064, India. E-mail: tapas@jncasr.ac.in.

DOI:10.1523/JNEUROSCI.5772-12.2013

Copyright © 2013 the authors 0270-6474/13/3310698-15\$15.00/0

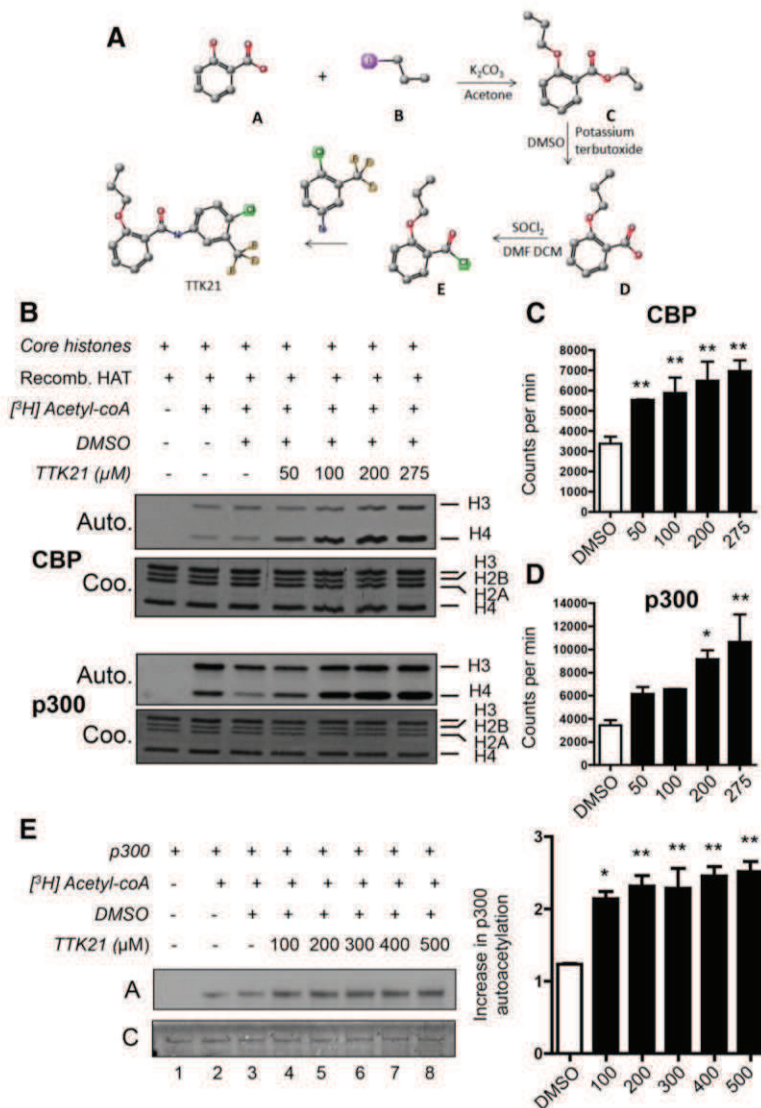

Figure 1. Small-molecule activator of lysine acetyltransferase (KAT) CBP/p300. **A**, Synthesis of the KAT activator TTK21 from salicylic acid. **B**, Gel fluorography assay shows a concentration-dependent activation of CBP and p300 by TTK21. TTK21 at different concentrations (50, 100, 200, and 275 μM as noted) dissolved in DMSO was added to reaction mixture to the desired concentration. Auto indicates autoradiogram; Coo, Coomassie gel. **C, D**, Concentration-dependent activation of CBP (**C**) and p300 (**D**) by TTK21 as shown by filter-binding assay using TTK21 at 50, 100, 200, and 275 μM . One-way ANOVA followed by Dunnett's test comparing all columns to DMSO control column (** $p < 0.01$; * $p < 0.05$, $n = 4$). **E**, Effect of TTK21 on the p300 auto-acetylation activity. Left: Autoradiogram showing auto-acetylation assays performed using full-length p300 in the absence of radioactive acetyl CoA [^3H] (lane 1) and in the presence of radioactive acetyl CoA [^3H] (lanes 2–8); lanes 4–8, p300 in the presence of increasing concentrations of TTK21 (100–500 μM); lane 3, DMSO only added as solvent control. Reaction mixtures were resolved by SDS-PAGE and processed for fluorography. Right: Quantification of the intensities of the bands from the autoradiogram. One-way ANOVA followed by Dunnett's test comparing all columns with the DMSO control column (** $p < 0.01$; * $p < 0.05$, $n = 3$).

and their long-term effects could be detrimental to the neurons. Therefore, the direct pharmacological activation of acetyltransferases could be an alternative that was not developed due to the lack of a cell-permeable HAT/KAT activator. The role of specific acetyltransferases such as the CREB-binding protein (CBP) in learning and memory has been demonstrated quite convincingly by knock-down and deletion studies (Barrett and Wood, 2008;

Chen et al., 2010; Barrett et al., 2011; Valor et al., 2011). The continued requirement of specific acetyltransferases throughout life may be required in addition to their proper developmental regulation (Barco, 2007). Our recent data demonstrated that the expression of several acetyltransferases (including CBP/p300) increased in the course of spatial memory acquisition, bringing the importance of their dynamic regulation during memory formation into question (Bousiges et al., 2010). Recently, a successful rescue of learning and memory defects was achieved by viral brain delivery of CBP into the hippocampus of a mouse model of Alzheimer's disease (Caccamo et al., 2010). These studies support the development of molecules able to stimulate the acetyltransferase function directly as a new potential therapeutic tool for treating memory dysfunctions, including Alzheimer's disease (Selvi et al., 2010; Valor et al., 2013).

The present study provides the first evidence for pharmacological HAT/KAT activation (CBP/p300) after systemic injection of a carbon-nanosphere-coupled small activator molecule (CSP-TTK21) in adult mice. This activation has direct consequences on brain functions because it induced differentiation of newly generated neurons and extended memory duration. Therefore, by promoting increased plasticity, acetyltransferase activators such as CSP-TTK21 could have a significant impact on detrimental age-related brain decline.

Materials and Methods

Synthesis of TTK21

For synthesis of TTK21 (Fig. 1), salicylic acid A (14.5 mmol) and iodopropane B (43.4 mmol) dissolved in acetone were added to anhydrous K_2CO_3 (43.4 mmol). The reaction mixture was refluxed for 3–4 h and, upon completion, evaporated in a vacuum and treated using ethyl acetate and water. The combined organic extract was dried over NaSO_4 and then evaporated. The crude product thus obtained was purified using ethyl acetate and hexane (1:20) as an eluent to yield 94% of the pure product C. Potassium tertiary butoxide (11 mmol) was added to solution of C (9 mmol) in DMSO at 0°C . The reaction mixture was stirred at 0°C for 30 min and then at room temperature for 2–3 h. The reaction upon completion was treated using ice-cold water and then extracted with dichloromethane (DCM). The combined organic layer was dried over NaSO_4 and then evaporated. The crude product thus obtained was purified by recrystallization using ethanol as the solvent to obtain 95% of the desired product D. Solution D (3.3 mmol) in 10 ml of DCM was cooled in ice and a cold solution of SOCl_2 (3.66 mmol) dissolved in 2 ml of DCM was added dropwise. A few drops of dimethyl formamide (DMF) were added to the solution. The reaction mixture was refluxed for 2 h. Upon completion, the reaction was evaporated in vacuum to obtain crude product E. Compound D was dissolved in DCM (3.1 mmol) in

another round-bottom flask and a solution of Et₃N (5.58 mmol) was added dropwise at 0°C. The reaction mixture was stirred at room temperature for 30 min. The resulting solution was added dropwise to the crude product E dissolved in DCM. The reaction mixture was refluxed for 3–4 h. The reaction upon completion was treated using water and DCM. The combined organic extract was evaporated in a vacuum to yield a crude product that was purified using recrystallization to yield the pure product TTK21 (92% yield).

Conjugation of CSP with TTK21

The carbon nanospheres (CSP) were prepared by the hydrothermal treatment of glucose at 180°C for 18 h (Selvi et al., 2008). One equivalent of SOCl₂ diluted in DCM was added dropwise to a suspension of 100 mg of CSP in DCM, followed by the addition of few drops of DMF (Fig. 2B). The reaction mixture was stirred at room temperature for 8–9 h. TTK21 dissolved in DCM was added dropwise to this solution. The reaction mixture was stirred for 8–9 h at room temperature. The solvent was then evaporated and washed with cold water. The crude product was centrifuged and the supernatant (i.e., water) was removed; this procedure was repeated 7–8 times. Washing was then performed using DCM and the supernatant was subsequently tested for absence of TTK21. The CSP-TTK21 conjugated was then dried at 60°C for 2–3 d.

Core histone purification from HeLa nuclear pellet

The HeLa nuclear pellet was homogenized in 0.1 M potassium phosphate buffer, pH 6.7, containing 0.1 mM EDTA, 10% glycerol, 0.1 mM PMSF, and 0.1 mM DTT with a 630 mM salt concentration. The supernatant was kept for binding with hydroxyapatite. Subsequent washes were with 630 mM salt over a prolonged period (12 h). Histone octamer was eluted with 2 M salt and dialyzed against BC100 (20 mM Tris, pH 7.9, 100 mM KCl, 20% glycerol, 0.1 mM DTT). The Bio-Rad protein reagent assay was used to estimate the protein concentration and electrophoresed on 15% SDS PAGE.

Purification of recombinant proteins

Full-length His₆-p300 was purified from recombinant baculovirus-infected Sf21 cells as described previously (Kundu et al., 1999). Briefly, Sf cells were infected with appropriate concentration of recombinant baculovirus followed by affinity chromatography of the cell lysate using Ni-NTA resin (Qiagen). FLAG-tagged CBP was also purified using similar techniques of infection of recombinant baculovirus into Sf21 cells, followed by affinity chromatography of the cell lysate using M2-agarose beads (Sigma). The proteins were eluted using FLAG peptide (Sigma).

HAT assays

Filter-binding assays. Highly purified HeLa core histones were incubated in HAT assay buffer at 30°C for 10 min with or without baculovirus-expressed recombinant p300 or CBP in the presence or absence of TTK21, followed by addition of 1 μl of 3.6 Ci/mmol [³H]acetyl-CoA (NEN-PerkinElmer) and incubated for 10 min in a final volume of 30 μl at 30°C. The mixture was blotted onto P-81 (Whatman) filter paper and

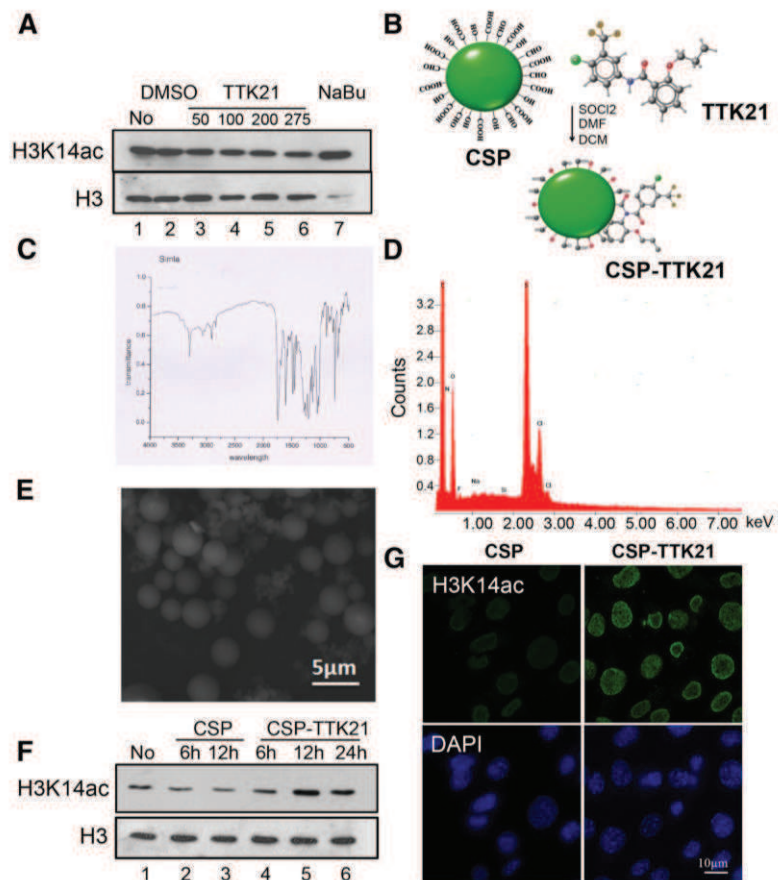

Figure 2. CSP conjugated activator (TTK21) induces histone H3 acetylation in SHSY-5Y neural cells. **A**, TTK21 alone is impermeable to cells. Western blot analysis of TTK21 untreated and treated HeLa cells for 24 h. Lane 1, untreated cells; lane 2, DMSO-treated cells; lane 3, 50 μM TTK21 treatment; lane 4, 100 μM TTK21; lane 5, 200 μM TTK21; lane 6, 275 μM TTK21; lane 7, 500 μM broad spectrum histone deacetylase inhibitor NaBu-treated cells showing hyperacetylation of histone H3. Acetylated H3 antibody was used to probe the blot and was also probed with H3 antibody for equal amount of protein loading control. **B**, Synthesis of CSP-TTK21. **C**, Chemical characterization of TTK21 conjugated to CSPs (CSP-TTK21) using infrared spectroscopy analysis of CSP-TTK21. **D**, EDX analysis of CSP-TTK21 showing the presence of fluorine, thereby confirming the conjugation of TTK21 with CSP. **E**, Scanning electron microscopy image of CSP-TTK21 showing that the particle retains its original spherical shape after conjugation. **F**, CSP-TTK21 induces histone hyperacetylation in SHSY-5Y cells. Immunoblotting analysis of SHSY-5Y cells treated with CSP (50 μg/ml) treated for 6 and 12 h (lanes 2 and 3, respectively) and CSP-TTK21 (50 μg/ml) upon 6, 12, and 24 h of treatment (lanes 4, 5, and 6, respectively) using antibodies against acetyl H3Lys 14 and reprobed with H3 antibody. **G**, SHSY-5Y cells were treated with CSP-TTK21 (50 μg/ml), CSP (50 μg/ml) for 24 h and histone acetylation was estimated by immunofluorescence analysis using antibodies against acetyl H3Lys 14.

radioactive counts were recorded on a Wallac 1409 liquid scintillator counter.

Gel fluorography assay. Histones were isolated by TCA precipitation using 25% TCA. The pellet was washed twice with acetone and dissolved in 2× SDS loading dye, heated for 5 min, and separated using 15% SDS-PAGE. Coomassie staining was performed to ascertain the presence of equal loading in each reaction and was later dehydrated in DMSO for 1 h. Dehydrated gel was later incubated in scintillation fluid (2,5 diphenyl oxazole solution in DMSO) for 45 min and rehydrated again in distilled water for 4 h. The gel was then dried using a gel drier and later exposed in an x-ray cassette using a film for 5 d in a -80°C cooler. The film was then developed to obtain the intensity profiles for each of the reactions.

p300 Auto-acetylation assay. Auto-acetylation reactions of full-length p300 were performed in lysine acetyltransferase assay buffer at 30°C for 10 min with or without TTK21, followed by the addition of 1 μl of 4.7

Ci/mmol [^3H]acetyl-CoA (NEN–PerkinElmer). The reaction mixture was further incubated for another 10 min at 30°C. The ^3H -labeled acetylated p300 was visualized by fluorography followed by autoradiography.

Immunofluorescence in SHSY-5Y cells. Cells were grown on poly-L-lysine-coated coverslips at 37°C in a 5% CO_2 incubator. After treatment for the indicated times, cells were washed with PBS and fixed with 4% paraformaldehyde (in PBS) for 20 min at room temperature. Cells were permeabilized using 1% Triton X-100 (in PBS) for 10 min and washed with PBS for 3×10 min. Nonspecific blocking was performed using 5% FBS (in PBS) for 45 min at 37°C. Primary antibody was added in appropriate dilutions for 1 h at room temperature. Cells were then washed with washing buffer (1% FBS in PBS) 4 times at 3 min each. Secondary antibody tagged with fluorescent dye was added in appropriate dilutions for 1 h at room temperature, followed by washes with washing buffer. The nuclei were then stained with Hoechst (1:10,000 dilutions) for 20 min. After two PBS washes, coverslips were inverted onto a microscopic slide with $>2 \mu\text{l}$ of 70% glycerol (in PBS) and imaged using a confocal microscope.

Animals. Experimental protocols and animal care were in compliance with the institutional guidelines (council directive 87/848, October 19, 1987, Ministère de l'agriculture et de la Forêt, Service Vétérinaire de la Santé et de la Protection Animale) and international laws (directive 86-609, 24 November 1986, European Community) and policies (personal authorizations #67-117 for A.-L.B., #67-215 for J.-C.C., and #67-292 for C.M.). B57BL6/J male mice were purchased from Charles River Laboratories and behaviorally tested at ~3 months of age. They were housed individually under a 12 h light/dark cycle (lights on at 7:00 A.M.). Access to food and water was *ad libitum* in a temperature- and humidity-controlled room ($22 \pm 1^\circ\text{C}$ and $55 \pm 5\%$, respectively).

Immunofluorescence and Immunohistochemistry for animal tissue. Mice were injected with indicated amounts of the molecules. For BrdU counting, mice were injected with 100 mg/kg BrdU (B5002; Sigma) according to different protocols as noted in the text and represented in Figure 5G, H, J. After defined time periods, mice were deeply anesthetized with pentobarbital (60 mg/kg) and perfused transcardially with 150 ml of ice-cold paraformaldehyde (4% in 0.1 M PB, 4°C). Brains were then rapidly removed from the skull and postfixed for 6 h in the same fixative at 4°C. Fixed brains were then kept in sucrose at 4°C for 48 h. Freezing of the brains was performed in isopentane for 1 min at -40°C . The brains were stored in a -80°C freezer until being further processed. Coronal sections, 20 μm in thickness, were made through the dorsal hippocampus using a Vibratome (VT1000M; Leica). The tissue sections were permeabilized in $1 \times \text{PBS}/\text{Triton X-100}$ 2% for 15 min. Nonspecific labeling was blocked by $1 \times \text{PBS}/0.1\%$ Triton X-100/5% horse serum for 30 min at 37°C. For BrdU immunolabeling, sections were denatured for 2 h in $2 \times \text{HCl}$ at room temperature and then washed 4 times in PBS, pH 7.35, prior to the blocking step. The sections were then incubated overnight with the indicated antibodies (doublecortin [DCX] #sc-8066, Santa Cruz Biotechnology; acetylated-H3K14 #1921, Eptomics; acetyl-histone H2B #07-373, Millipore). After 3 washes, sections were incubated with the appropriate secondary antibody. For immunofluorescence, sections were incubated with donkey anti-rabbit conjugated with fluorescent dye (1 h at room temperature), followed by 3 washes with $1 \times \text{PBS}/0.1\%$ Triton X-100, and the nuclei were stained with Hoechst (1:1000 dilutions) for 5 min. After two PBS washes, the sections were mounted. For immunohistochemistry, sections were further incubated with anti-rabbit horseradish peroxidase-conjugated antibody (#sc2004; Santa Cruz Biotechnology) for 1 h. After three washes with $1 \times \text{PBS}/0.1\%$ Triton X-100, 0.05% DAB (with 0.04 M Tris, pH 7.5, 0.03% H_2O_2) was added and sections were mounted with a Roti Histokit II (Roth). For immunofluorescence, images were acquired with a Zeiss LSM510 confocal imaging system.

DCX-positive neurons, dendritic length, and branching counting. Counting was done in two groups of mice (CSP or CSP-TTK21, $n = 3/\text{group}$) that were left in their home cages for 3 d after injections. After DCX immunohistochemistry, images were acquired with a Zeiss LSM510 confocal imaging system and analyzed with the Zeiss LSM image browser. Sections containing the dorsal hippocampus ($n = 4-6/\text{animal}$) were then evaluated by an experimenter blind to the treatment for the

number of DCX-positive neurons. For each of these sections, the longest dendrite of each DCX-positive neuron was drawn on the image and the lengths given by the software were averaged per animal. One area in a similar hippocampal region was cropped out ($n = 5/\text{animal}$) and lines were drawn at 60, 90, and 120 μm from the DCX-positive nuclei (in the subgranular zone [SGZ]). The number of dendrites crossing each of these lines was then counted and averaged per hippocampus per animal.

Protein preparation and Western blot analyses. Animals were killed by cervical elongation. Their brains were rapidly removed from the skull and transferred on ice. Freshly dissected tissues were then immediately frozen at -80°C . Tissues were lysed and homogenized in Laemmli buffer. After 10 min at 70°C, samples were sonicated for 10 s (ultrasonic processor, power 60%), boiled 5 min, centrifuged ($20,000 \times g$ for 5 min) and the supernatant was frozen at -20°C . Protein concentration was measured using the RC-DC Protein Assay (Bio-Rad). Western blots were performed as described previously (Bousiges et al., 2010) with antibodies against acetyl-histone H2B (#07-373; Millipore), acetylated-histone H2BK5 (#07-382; Millipore), H3 histone (#ab1791; Abcam), acetyl histone H3 lys 14 (#1921; Eptomics), acetyl Histone H3 (#06-599; Millipore), and H2B histone (#H2-28; Euromedex); pro-BDNF (#AB9612; Millipore), GFAP (#MAB360; Millipore), NeuN (#ABN78; Millipore), and β -actin (#ab16039; Abcam). Secondary HRP-conjugated antibodies were from Jackson ImmunoResearch. Blots were revealed with ECL and exposed with Hyperfilm ECL (GE Healthcare). Results were quantified using ImageJ software.

Real-time qRT-PCR. Tissues were finely cut with a razor blade and homogenized with a Dounce in TRIzol reagent (Invitrogen). After chloroform extraction, RNAs were ethanol precipitated twice. Only RNA samples with an OD 260/280 and OD 260/230 ratio close to 2.0 were selected for reverse transcription. RNA samples were denatured 10 min at 70°C and cDNA synthesis was performed on 1 μg of total RNA (iScript cDNA synthesis kit; Bio-Rad). qRT-PCR analysis was performed on a Bio-Rad iCycler System (CFX) using SsoAdvanced SYBR Green Super-Mix (Bio-Rad). A specific standard curve was performed in parallel for each gene, and each sample was quantified in duplicate ($n = 5-6$). qRT-PCR conditions were 3 min at 94°C, followed by 40 cycles of 45 s at 94°C and 10 s at 60°C. Data were analyzed by gene regression using iCycler software and normalized to the polymerase II RNA levels.

Chromatin immunoprecipitation. Freshly dissected tissues were chopped with a razor blade and rapidly put in 5 ml of PBS containing 1% formaldehyde for 15 min at room temperature. The fixation step was stopped by the addition of glycine (0.125 M final concentration). Samples were prepared as described previously (Panteleeva et al., 2007), snap frozen in liquid nitrogen, and stored at -80°C until needed. An equal amount (120 μg) of DNA/protein complex was assayed and brought to a volume of 500 μl of with chromatin immunoprecipitation dilution buffer (0.01% SDS, 1.1% Triton X-100, 1.2 mM EDTA, 16.7 mM Tris-Cl, pH 8.1, 167 mM NaCl). A fraction of supernatants (20 μl) from each sample were saved before immunoprecipitation and served as "total input chromatin." The remaining supernatant was incubated overnight at 4°C with 2 μg of the primary antibody against acetyl-histone H2B (#ab1759; Abcam) or no antibody (negative control). This was followed by incubation with a mix of protein A/G Dynabeads (Invitrogen) for 2 h. After several wash steps (low salt, high salt, LiCl, and TE buffers), complexes were eluted in 200 μl of elution buffer (1% SDS, 0.1 M NaHCO_3). The cross-linking was reversed (overnight at 65°C) and the DNA was subsequently purified with RNase (30 min at 37°C), proteinase K (2 h at 45°C), phenol/chloroform extraction, and ethanol precipitation. After a last wash with 70% ethanol, pellets were resuspended in 50 μl of nuclease-free Milli-Q water and analyzed by semiquantitative PCR (MyCycler system; Bio-Rad). Primers for neuroD1 promoter were as follows: left: 5'-gtccggagctctactaactg-3' and right: 5'-gaaccactgacctgctat-3', and those for bdnf PI and IV have been described previously (Zajac et al., 2010). Chromatin immunoprecipitations were quality controlled by the use of control genes that were either expressed ubiquitously (GAPDH) or not expressed in the hippocampus (TSH2B).

Statistical analysis of biochemical studies. Statistical analyses were performed using Student's *t* test or one-way ANOVA followed by Neuman-Keuls multiple-comparison test when appropriate (Prism software

version 4.0b; GraphPad). Data are expressed as the means \pm SEM. Differences at $p < 0.05$ were considered significant.

Spatial learning and memory testing in the Morris water maze. Using a circular pool (Ø140) half-filled with opaque water (22°C) and located in a room with several well contrasted extra-maze cues, the aversively motivated task consisted of the mice learning, over four successive trials/d, the location of an escape platform hidden under the water surface at a fixed position. The two first training days were for habituation to increasing water levels. The strength and precision of memory were tested in a probe trial, for which the platform was removed and the animal was left for 60 s in the water. When remembering the platform location, the mice typically displayed a swimming pattern focused on the quadrant of the former platform location (where they typically spent a cumulated time corresponding to 35–50% of the probe trial duration). Ten to 12 mice in each group (CSP or CSP-TTK21 injected) were trained for task acquisition over three consecutive days (“weak learning”). The distance was recorded by a video tracking system (Ethovision; Noldus). The variable taken into account for probe trial analysis was the time spent in each of the four quadrants.

Statistical analyses for behavioral studies. Performance recorded during acquisition (latency to the platform) was evaluated using a two-way ANOVA for repeated measures considering the factors of “day” (1–3) and “treatment” (CSP vs CSP-TTK21). Probe trial performance was analyzed using a *t* test comparing the time spent in the target quadrant to chance (i.e., 15 s) and the time spent in the target quadrant to the average time in the other three quadrants. Values of $p < 0.05$ were considered significant and are noted in the text.

Results

TTK21, a small-molecule activator of CBP/p300 acetyltransferases induces acetylation *in vitro*

Based on the previously discovered first small-molecule HAT/KAT activator CTPB (Balasubramanyam et al., 2003), we have synthesized several derivatives. Through a low-throughput enzyme assay screening, TTK21 (*N*-(4-chloro-3-trifluoromethylphenyl)-2-*N*-propoxy-benzamide) was selected. The synthesis steps of TTK21 are depicted in Figure 1A (see Materials and Methods) where salicylic acid was taken as a synthon. Concentration-dependent activation of CBP and p300 by TTK21 was tested in gel fluorography studies (Fig. 1B) and filter-binding assays (Fig. 1C,D). The compound could efficiently activate the CBP HAT activity in a concentration-dependent manner, with a maximal activation at 250–275 μ M (Fig. 1B,C) compared with the control solvent, DMSO. As expected, TTK21 activated the HAT activity of the functional ortholog of CBP, p300, to approximately the same extent at the maximal concentration of 275 μ M compared with control (Fig. 1B,D). As revealed in the highly purified *in vitro* assay system, both CBP and p300 predominantly acetylated the core histones H3 and H4 (Fig. 1B). However, although H2B and H2A core histones have been described as CBP targets *in vivo*, especially in the brain (Valor et al., 2011), we could not detect their acetylation *in vitro*. The activation of p300/CBP HAT activity could be achieved by several means, including the induction of auto-acetylation. The *trans*-auto-acetylation of p300/CBP, which is regulated by several protein factors and post-translational modifications of the enzymes, induces the p300/CBP HAT activity (Arif et al., 2010 and references therein). We therefore performed an auto-acetylation assay on full-length recombinant p300 with increasing concentrations of TTK21. As depicted in Figure 1E, TTK21 significantly induced auto-acetylation of p300 at 100 μ M concentration compared with DMSO. Increase in the concentration of TTK21 (up to 500 μ M) did not induce further auto-acetylation.

Covalently conjugated CSP-TTK21 efficiently enters membranes and induces HAT activation in living cells

As for its parent compound, CTPB, TTK21 is poorly permeable to living cells. HeLa cells were treated with increasing concentrations (50, 100, 200, and 275 μ M) of TTK21 and sodium butyrate, a permeant HDAC inhibitor (5 mM NaBu), was used as positive control. Histone acetylation levels were measured after 24 h. Western blot analysis using antibody against acetylated-H3K14 showed no significant alteration of histone H3 acetylation in response to TTK21 treatment (Fig. 2A, compare lanes 3–6 with the no treatment control lane 1 or the DMSO vehicle lane 2), whereas NaBu indeed activated H3 acetylation (Fig. 2A, lane 7). These data suggest the inability of the molecule to enter into mammalian cells. Therefore, TTK21 was conjugated to a glucose-derived CSP that is self-fluorescent and permeable to mammalian cells (Selvi et al., 2008). For the chemical conjugation, the functional groups present on the surface of CSP were used as described in the Materials and Methods section to covalently bind TTK21 and the CSP nanoparticle (Fig. 2B). The conjugation was confirmed by infrared spectroscopy and energy-dispersive x-ray spectroscopy analysis (Fig. 2C,D, respectively). Infrared spectroscopy showed bands specific for the functional groups for TTK21, whereas specific peak for fluorine was found in CSP-TTK21, which is present in the CF_3 group of TTK21. The electron microscopic images of CSP-TTK21 showed that, upon conjugation, the spherical shape of the nanoparticles was conserved (Fig. 2E). To investigate whether the covalent conjugation with CSP could enable TTK21 to enter mammalian cells, SHSY-5Y cells were either treated with CSP (50 μ g/ml) or CSP-TTK21 (50 μ g/ml) for 6, 12, or 24 h. Immunoblotting analysis was performed on purified histones using an antibody against acetylated-H3K14. Enhancement of H3K14ac was observed over time in CSP-TTK21 (compare Fig. 2F, lanes 4–6 with lanes 1–3). Maximum acetylated H3K14 levels were observed upon 12 h of CSP-TTK21 treatment (Fig. 2F). CSP-TTK21-induced acetylated H3K14 was further confirmed by immunofluorescence performed on CSP- and CSP-TTK21-treated SHSY-5Y cells (Fig. 2G). These findings suggested that although TTK21 itself cannot enter the living cells, the nanoparticle-conjugated material CSP-TTK21 could cross the mammalian cell membranes (including nuclear membranes) to induce histone hyperacetylation.

CSP-TTK21 located in the brain induces histone acetylation in the frontal cortex and dorsal hippocampus

The glucose-derived CSPs possess the unique ability to cross the blood–brain barrier in mice (Selvi et al., 2008; Selvi et al., 2012). Therefore, we next investigated the presence of CSP-TTK21 in different organs after intraperitoneal administration of CSP-TTK21 (20 mg/kg). After 1 d, brain, liver, lungs, kidney, and spleen tissue were isolated, fixed with paraformaldehyde, and processed for fluorescence imaging. The self-fluorescent CSP molecule could be observed on 5- μ m-thick sections and its nuclear localization was counted in the different tissues (Fig. 3A). CSP-TTK21 was detected predominantly in the brain, liver, and spleen. It was mostly absent in the lungs and undetectable in the kidneys (Fig. 3A). We further investigated the retention time in liver and spleen and found that CSP content was dramatically decreased after 3 d and almost undetectable after 7 d (Fig. 3B,C), showing a rapid turnover of the CSP-coupled molecule in these peripheral organs. We next performed a time course study on CSP-TTK21 retention in the brain (1, 3, 7, 14, and 21 d) after intraperitoneal administration. Typical fluorescence microscopy imaging of the cortical area is presented in Figure 3D for days 1

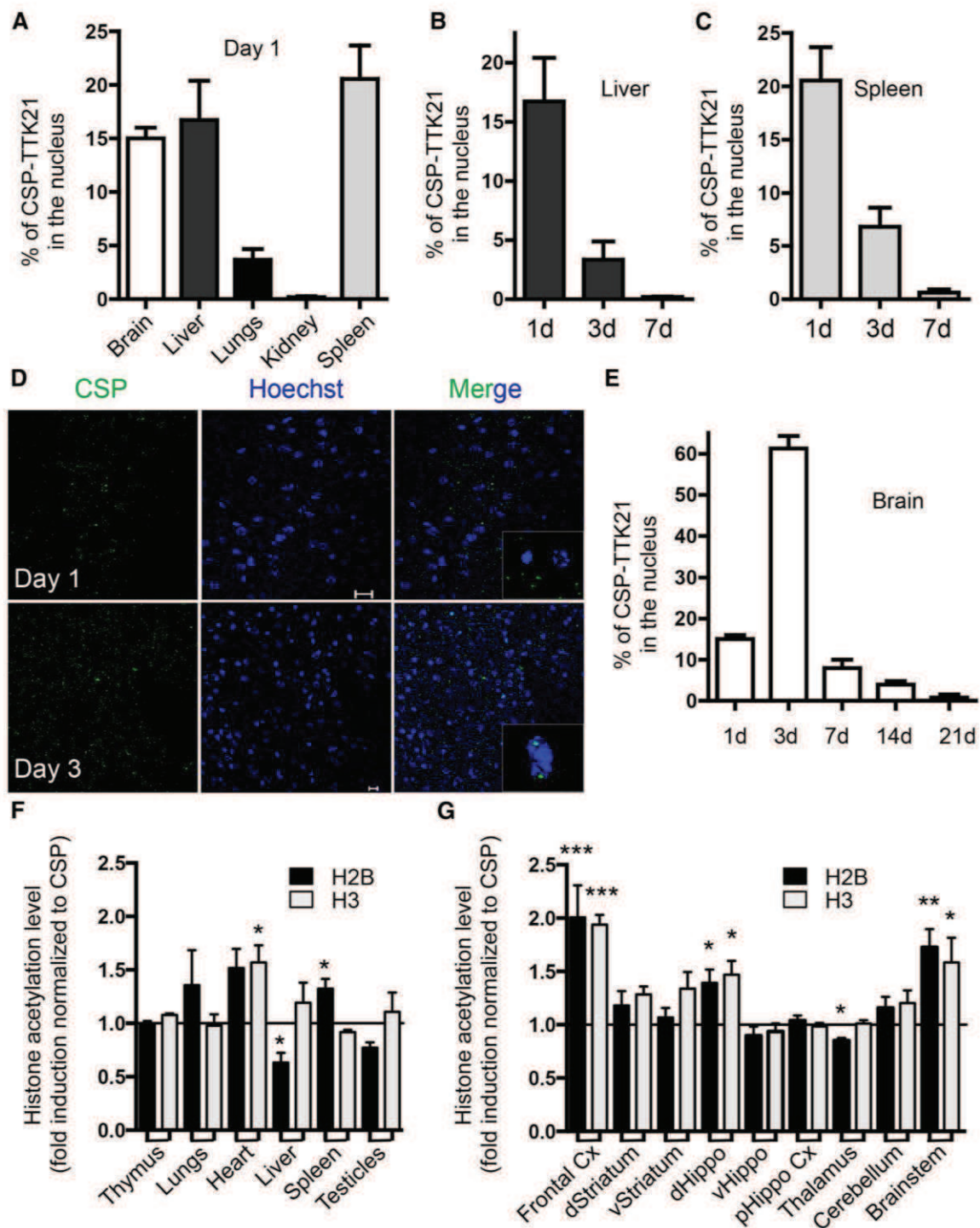

Figure 3. CSP-TTK21 is located in the brain after a single intraperitoneal (i.p.) injection. **A**, Localization of CSP-TTK21 in different organs of mice 1 d after an i.p. injection. Mice ($n = 5$) were injected with 20 mg/kg CSP-TTK21 and killed 24 h later. Brain, liver, lungs, kidney, and spleen were isolated and processed for histochemistry. CSP-TTK21 was detected by excitation at 514 nm. Nucleus of the cells in various tissues was stained with Hoechst. Histograms represent the quantification of the percentage of cells containing intranuclear CSP-TTK21. After 1 d, CSP-TTK21 molecules are mainly found in the brain, liver, and spleen. **B**, **C**, Time-dependent presence of CSP-TTK21 in mice liver (**B**) and spleen (**C**) after a single i.p. injection. Same as in **A**, except that 3 groups of mice were used ($n = 3$) and killed at different days after injection as noted (1, 3, and 7 d). CSP-TTK21 molecules levels are largely reduced 3 d after injection and almost absent after 7 d. **D**, **E**, Time-dependent presence of CSP-TTK21 in mice brain after a single i.p. injection. Five groups of mice ($n = 3$) that were used ($n = 3$) and killed at different days after (Figure legend continues.)

and 3, with the inset showing nuclear localization. Quantification of intranuclear CSP for the whole time course is represented in Figure 3E. In contrast to liver and spleen, we found that the percentage of nuclear-located CSP-TTK21 molecules was dramatically elevated 3 d after the intraperitoneal injection (61% for day 3 compared with 15% for day 1; $p = 0.0001$ at day 3 relative to all the other days, one-way ANOVA followed by Newman–Keuls multiple-comparison test). From day 7 onwards, a gradual decrease of CSP-TTK21 in the brain tissue was observed and, at day 21, almost no nanoparticle could be detected in nuclei (Fig. 3E). To further establish the activity of the HAT activator molecule associated with its distribution in the body, we dissected several peripheral organs on a group of CSP- and CSP-TTK21-injected mice (20 mg/kg; $n = 4–6$) 3 d after its intraperitoneal administration and analyzed histone H3K9K14 and H2B N-terminus acetylation by Western blot (Fig. 3F). We found a significant increase in H2B tetra-acetylation in response to CSP-TTK21 in the spleen ($p = 0.0284$); a trend to increase was observed in the heart ($p = 0.0610$) and a significant decrease was measured in the liver ($p = 0.0193$). H3K9K14ac was found significantly increased only in the heart ($p = 0.0372$). Therefore, it seems that the CSP-driven activator displays some preference in the heart and the spleen, the major effect being 1.5-fold, and no acetylation was measured in the thymus, lungs, or testicles. Clearance of the molecule observed in the spleen was almost complete within 7 d (Fig. 3C) and the animals did not show any apparent behavioral or physiological abnormalities throughout this time, suggesting the nontoxic nature of CSP-TTK21 in the mouse system. We then assessed the efficacy of the HAT activator in different parts of the brain. Several brain regions were thoroughly dissected (Fig. 3G) and analyzed as in Figure 3F. The frontal cortex was the main region displaying the acetylated histones H2B ($p = 0.0052$) and H3 ($p = 0.0008$), levels reaching approximately a 2-fold increase. H4K12 acetylation was also significantly activated in this brain region by 1.4-fold ($*p = 0.05$), whereas H2AK5

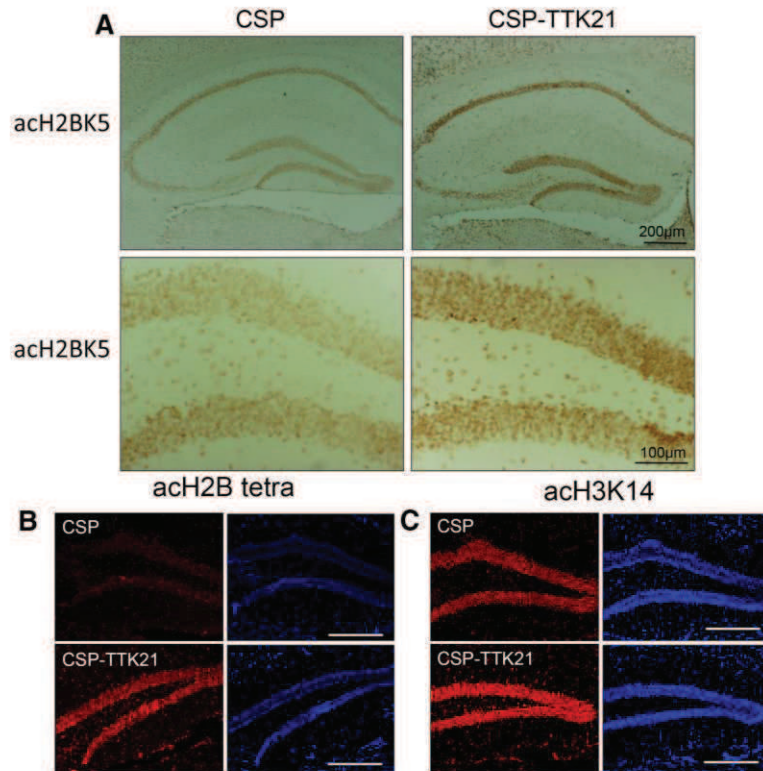

Figure 4. CSP-TTK21 induces histone acetylation on several residues of H2B and H3 in the mouse dorsal hippocampus. Mice were injected with either CSP alone or CSP-TTK21 (20 mg/kg each) and killed 3 d later. **A**, Immunohistochemistry was performed on 20- μ m-thick cryosections with an anti-acetylated-H2BK5 antibody. Acetylation was increased in all hippocampal areas. Scale bar, 200 μ m. A focus on the dentate gyrus is shown below. Scale bar, 100 μ m. **B**, **C**, Immunofluorescent labeling of mouse dorsal hippocampus using antibodies against tetra-acetylated H2B (**B**) and acetylated-H3K14 (**C**). Scale bar, 100 μ m.

levels remained unchanged in response to CSP-TTK21 (data not shown). H2B and H3 histone acetylation were significantly activated by the CSP-TTK21 molecule in the dorsal hippocampus (H2Bac, 1.39-fold, $*p = 0.0432$; H3ac, 1.47-fold, $*p = 0.0119$) and brainstem (H2Bac, 1.72-fold, $**p = 0.001$; H3ac, 1.58, $*p = 0.0284$), whereas a trend was measured for H3ac in the striatum (dorsal, $p = 0.0567$; ventral, 0.0542). Overall, these data show that the CSP-TTK21 molecule can affect different brain subregions and different tissues. This may be due to its mode of entry into mammalian cells described so far, which is ATP, clathrin, and glucose transporter dependent (Selvi et al., 2012). The exact mechanisms of this specificity remain to be established.

Because the dorsal hippocampus plays an important role in several brain functions and has specific structural features, we further measured the level of different acetylation histone marks in response to CSP-TTK21 of treated mice using immunohistochemistry (Fig. 4A–C). We found that acetylated-H2BK5 was increased after CSP-TTK21 treatment equally within the different area of the dorsal hippocampus (CA1, CA3, and dentate gyrus; Fig. 4A). The tetra-acetylated form of H2B and acetylated H3K14 were also equally increased and distributed in the dorsal hippocampus subregions, and representative confocal images focused on the dentate gyrus obtained after immunofluorescence labeling are shown (Fig. 4B, C).

These data demonstrate that the CSP-driven molecule displays HAT activation by acetylating several histone acetylation

(Figure legend continued.) injection as noted (1, 3, 7, 14, and 21 d). Typical photographs for days 1 and 3 are shown (**D**). Magnified image of the nucleus from days 1 and 3 showing localization of CSP-TTK21 in the nuclei (inset of the respective figures). Scale bar, 10 μ m. **E**, Quantification of the percentage of cells containing intranuclear CSP-TTK21. Note that large amounts of CSP-TTK21 molecules are located in the nuclei of brain cells at 3 d after injection and that the molecules are rapidly cleared out of cells. **F**, **G**, Three days after i.p. injection of either CSP alone or CSP-TTK21 (20 mg/kg body weight), different organs or brain subregions were dissected out and Western blots were performed on total protein extracts with acetylated H2B or H3 and total H2B. Quantification of acetylated histone levels is shown relative to the total amount of the H2B ($n = 4–6$). Student's *t* test, $*p < 0.05$ and $**p < 0.01$ compared with CSP control. #Close to significance. Cx indicates cortex; d, dorsal; Hippo, hippocampus; v, ventral; p, para.

marks in important brain structures such as the hippocampus and the frontal cortex.

HAT activation *in vivo* induces differentiation and maturation steps of adult hippocampal neurogenesis

The hippocampus is a major neurogenic niche of the brain, neural progenitor cells being formed in the SGZ and further differentiating within the dentate gyrus (Kempermann, 2012). Having shown a significant effect of CSP-TTK21 on histone acetylation levels in the dorsal hippocampus at day 3 after injection, we investigated whether CBP/p300 activation *in vivo* could affect adult neurogenesis. We performed immunohistochemistry studies on DCX, a marker of new, yet immature neurons in the adult brain, 3 d after injection of CSP or CSP-TTK21 (Fig. 5A–D, the timeline of the experimental protocol is shown on the upper right). Typically, 4–6 sections were analyzed per animal ($n = 3$). Overall, a clear increase of dendritic branching was observed on the dorsal hippocampus in response to CSP-TTK21 (Fig. 5A), which was not accompanied by an increase of DCX-positive neurons over the 3 d (Fig. 5B; $p = 0.1311$). In average, new neurons showed a significant increase in the length of their dendritic trees (Fig. 5C; $*p = 0.0177$). A thorough counting of specific areas within the dorsal dentate gyrus showed that DCX-positive neurons were particularly well branched in CSP-TTK21 compared with CSP-treated mice, especially in the vicinity of the dendrites' extremities (e.g., 120 μm distance from the SGZ; Fig. 5D; CSP-TTK21 vs CSP, $*p = 0.0115$ at 60 μm ; $*p = 0.0270$ at 90 μm and $*p = 0.0389$ at 120 μm ; $n = 5/\text{animal}$). In view of their maturation status at the time of treatment, increased DCX labeling by CSP-TTK21 is likely to result from activation of the maturation process of young neurons generated before the injection of the molecules. It was therefore interesting to further measure the effect of CSP-TTK21 on the proliferation of progenitors. One group of mice received a single injection of BrdU (100 mg/kg) 1.5 d after injection of the molecules (Fig. 5F, G). The mice were killed 2 h later, thus giving the net proliferation status of progenitors at that time. A typical image is shown in Figure 5F and quantification is presented in Figure 5G. We measured a decreased number of BrdU-positive cells in CSP-TTK21-treated animals compared with CSP alone (31.4 vs 19.9 BrdU-positive cells, $*p = 0.0383$, $n = 4/\text{animal}$), suggesting an antiproliferative effect of the HAT activator. To determine the fate of these newly generated neurons, different time courses were investigated: 10 d (Fig. 5H) and 21 d (Fig. 5I, J) after the molecule injection on different groups of mice. The timeline of CSP, CSP-TTK21, and BrdU administration is represented above the quantifications. Despite the first antiproliferative effect measured at day 1.5, an equal number of BrdU-positive cells was observed in CSP- and CSP-TTK21-treated mice at day 10, suggesting that progenitors survival slightly increased. Double immunolabeling with BrdU and DCX was performed 21 d after CSP-TTK21 injection and the number of BrdU-positive/DCX-positive neurons was counted throughout the dentate gyrus (hill included). We found that 75% of the BrdU-positive cells were DCX-positive in both CSP and CSP-TTK21 conditions (Fig. 5I), suggesting that the HAT activator did not influence the fate of the progenitors. A representative image of BrdU-positive/DCX-positive neurons as typically found in the SGZ is shown in Figure 5J.

Finally, we evaluated several mature or immature cell type markers (neurons vs glial cells) by qRT-PCR at two time points: 1.5 and 3 d after injection (Fig. 5K). Because increased amounts of DCX proteins were observed by immunohistochemistry, DCX mRNA levels were measured and were found to be significantly

increased at day 3 after injection ($*p = 0.0328$, $n = 5-6$). The TUC4 protein (TOAD [Turned On After Division]/Ulip/CRMP) reaches its highest expression levels in early postmitotic neurons and, as is the case for DCX, is expressed in immature neurons, but not in neural progenitors or adult neurons (Quinn et al., 1999), and is therefore a good candidate for CSP-TTK21 activation. Nevertheless, TUC4 only tended to increase in response to CSP-TTK21 treatment compared with CSP ($p = 0.0988$, $n = 5$). However, both DCX and TUC4 were significantly increased at day 3 compared with day 1.5 after injection of CSP-TTK21 ($\#p = 0.0121$, $n = 5$ and $\#p = 0.0377$, $n = 5$, respectively). For glial markers, the immature glial protein vimentin showed a trend to be repressed compared with CSP at the early time point (day 1.5; $p = 0.0542$), but remained unchanged at day 3 ($p = 0.5808$) (Fig. 5K). Vimentin mRNAs were indeed lowered by 30% when day 1.5 was compared with day 3 ($p = 0.0371$). GFAP levels remained unchanged whatever the comparison. The meaning of this early downregulation of vimentin is not known, but it is unlikely to play a major role because vimentin levels were unchanged at day 3. In addition, we previously observed no significant changes in the percentage of newly generated neuron after injection of the activator molecule among the BrdU-positive cells (Fig. 5I, J), so, by extension, no change in the number of glial cells was expected either.

CSP-TTK21 induces *neuroD1* and *BDNF* gene expression in the hippocampus by increasing chromatin acetylation of their promoters

We next evaluated, using qRT-PCR, the expression of *neuroD1* and *bdnf*, two genes that are associated with neuronal differentiation and maturation: *neuroD1* is a key transcription factor essential for terminal differentiation of the granule cells in the hippocampus (Gao et al., 2009) and *bdnf* depletion studies targeted in the hippocampus have recently demonstrated its crucial role for the terminal differentiation of new neurons in the adult mice (Chan et al., 2008). We found a significant increase of *neuroD1* mRNA as soon as 1.5 d after CSP-TTK21 injection in mice (1.34-fold, $p = 0.0344$, $n = 5$), and the mean mRNA level was still larger, although not significantly, after 3 d (1.21-fold, $p = 0.3876$, $n = 5$; Fig. 6A). The *bdnf* gene has a very complex structure that allows the production of different splice variants and, in the hippocampus, it is regulated through activation of different promoters, mainly I and IV (Lubin et al., 2008; Tian et al., 2009). Total (tot *bdnf*), exon I (*bdnf_eI*), and exon IV (*bdnf_eIV*) *bdnf* mRNA levels were measured in response to CSP-TTK21 (Fig. 6B). At day 1.5 after injection, total *bdnf* transcripts were already significantly increased by >2-fold in CSP-TTK21-treated animals compared with CSP controls ($**p = 0.0041$, $n = 5$), an effect mediated in part through *bdnfI* promoter activation (1.40-fold, $**p = 0.0090$, $n = 5$). At this early time point, *bdnf_eIV* transcripts were not altered by the treatment ($p = 0.2911$, $n = 5$). At day 3, total *bdnf* transcripts were still significantly induced by CSP-TTK21 ($*p = 0.0352$, $n = 5$) compared with CSP, but less markedly than at day 1.5 (1.4- vs 2.32-fold). Both *bdnf_eI* and *bdnf_eIV* transcripts were upregulated in response to CSP-TTK21 (1.58-fold, $*p = 0.0305$ and 1.52-fold, $**p = 0.0099$, respectively).

We next prepared the chromatin from dorsal hippocampi of mice 1.5 d after injection of CSP or CSP-TTK21 ($n = 3/\text{group}$) to determine whether *neuroD1* and *bdnf* promoters were enriched with acetylated-H2B histone. Gels from semiquantitative PCR analyses of promoters are shown in Figure 6C and the quantification of immunoprecipitated DNA relative to its corresponding input is presented in Figure 6D. In good correlation with gene

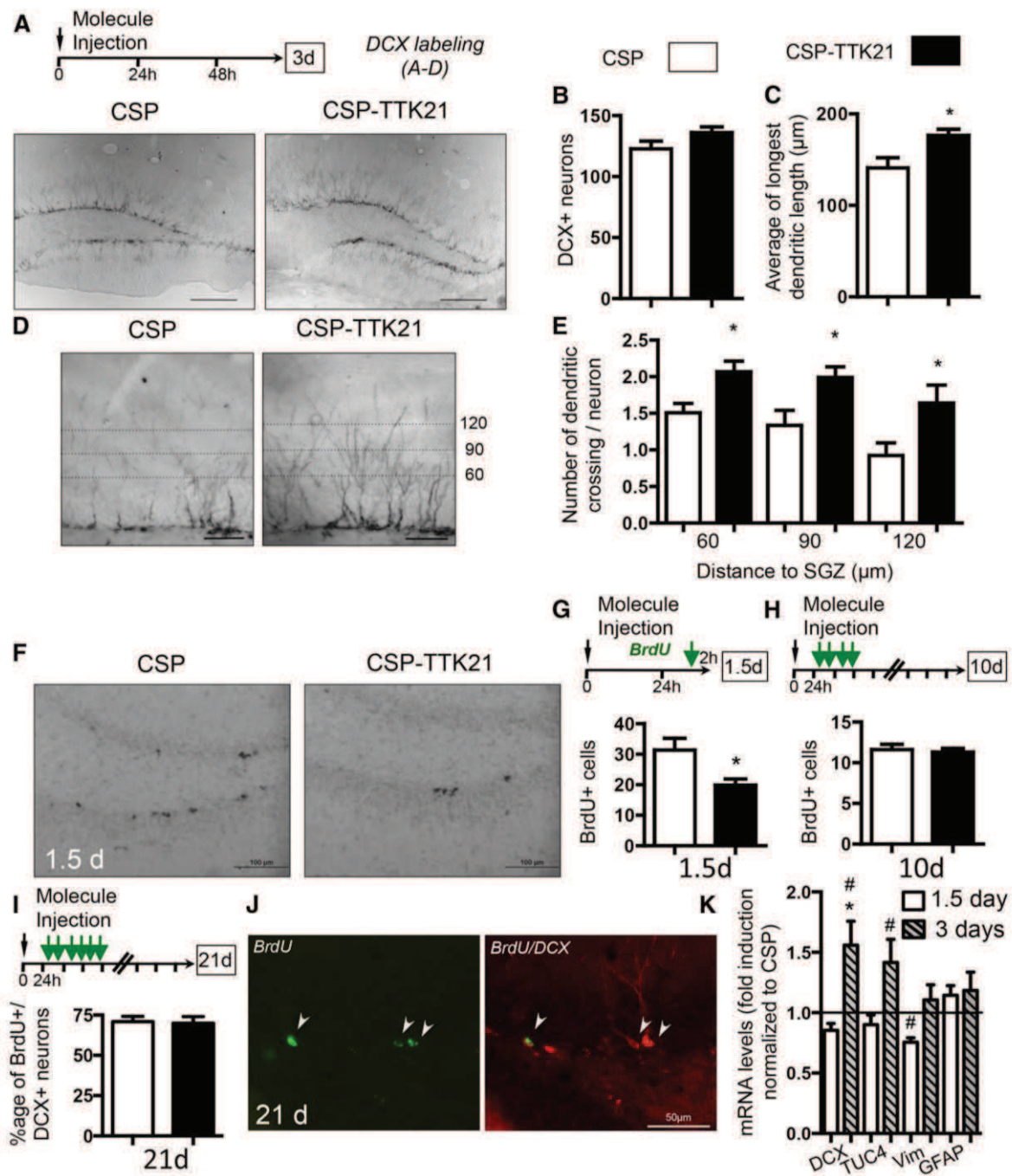

Figure 5. CSP-TTK21 stimulates the maturation step of adult neurogenesis in the SGZ of the dentate gyrus. **A–D**, Immunohistochemistry analysis of the dentate gyrus of mice 3 d after intraperitoneal injection of either CSP alone or CSP-TTK21 (20 mg/kg body weight) using an antibody against DCX followed by DAB staining. A typical photograph is shown (**A**). Scale bars, 100 μm. The timeline for injection and euthanasia is shown. **B**, Histograms representing the number of DCX-positive neurons per section (4–6 sections/animal). **C**, The average of the longest dendrites associated to all DCX-positive new neurons within one hippocampus was calculated and is represented as a histogram for each condition (CSP: 141.1 μm vs CSP-TTK21: 176.9 μm, **p* = 0.0177, 4–6 sections/animal). **D**, Typical cropped image from **A** is shown, on which the number of dendrites crossing virtual lines drawn at 60, 90, and 120 μm from the SGZ was counted (*n* = 5 images/animal). **E**, Histograms represent the dendritic crossing per DCX-positive neuron averaged from 3 animals. Student's *t* test. **p* < 0.05. Scale bars, 100 μm. Note that dendritic branching is still dense at the very end of the dendrites in CSP-TTK21 compared with CSP treated mice. **F–J**, CSP-TTK21 effect on adult neurogenesis after BrdU injection (100 mg/kg). Different protocols have been performed to show proliferative and/or survival effects after 1.5 d (**F,G**), 10 d (**H**), or 21 d (**I,J**). Protocols are schematically summarized above each quantitated histograms, in which the number of BrdU injections and their timing are represented by a green arrow (**G–I**). Representative images (**F**) show that CSP-TTK21 exerts an antiproliferative effect on newly generated neurons at an early time point after injection (1.5 d; *n* = 3–4/group). Scale bars, 100 μm. **H**, A similar number of BrdU-positive neurons was counted in both CSP- and CSP-TTK21-treated mice (*n* = 3/group) (*Figure legend continues*.)

expression studies (Fig. 6*A,B*), there was a significant enrichment in acetylated histone on the *neuroD1* and *bdnf* PI promoters in response to CSP-TTK21 treatment, whereas acetylated histone at the *bdnf* PIV promoter remained unchanged. Therefore, our studies support a molecular link between the acetylation of H2B by the HAT activator molecule and the expression of *neuroD1* and *bdnf*, two genes implicated in enhanced maturation and differentiation of adult neuronal progenitors in response to CSP-TTK21 injection.

Last, we verified that increased *bdnf* gene expression was leading to the production of its precursor protein pro-BDNF in the dorsal hippocampus of CSP- and CSP-TTK21-treated mice 1.5 and 3 d after injection (Fig. 6*E,F*). We show that CSP-TTK21 induces a significant 1.5-fold increase in protein levels at both days (day 1.5: $p = 0.0008$ and day 3: $p = 0.0015$, $n = 5$), whereas GFAP and NeuN protein levels remained unchanged upon treatment. Therefore, increased *bdnf* mRNA levels at both 1.5 and 3 d after injection could account for the increased pro-BDNF protein levels found at these time points.

CSP-TTK21 treatment extends memory duration in adult mice

Because CSP-TTK21 activates histone acetylation in the brain and differentiation of newly generated neurons, we further tested the HAT activator as a potential promnesic molecule in a hippocampus-dependent task taxing spatial reference memory. We first defined the retention profile of mice in our experimental room following a weak learning protocol of acquisition (Fig. 7*A*). Compared with a standard protocol of 5 training days or more, our mice ($n = 30$) were trained in the Morris water maze for only 3 d: they had to search the location of platform hidden at a fixed place. Latencies to reach the platform are shown in Figure 7*A*, left. There was a significant improvement of learning over the 3 d ($F_{(2,58)} = 7.46$; $p < 0.01$). After acquisition, a 60 s probe test, for which the platform was removed, was given at postacquisition delays of 2, 7, or 14 d ($n = 10$ /group). The time spent in the target quadrant (T) was compared with the average time spent in the 3 other quadrants (O) (Fig. 7*A*, right). Despite mild learning, mice did significantly recall the platform location after 2 d of rest ($***p < 0.0001$) and even after 7 d ($***p = 0.0008$). However, they had forgotten this location after 14 d ($p = 0.0728$). We also compared whether the searching time in the target quadrant was significantly superior to that accounting for a random distribution of the swim track pattern (15 s, solid line), which was the case for retention tested after 2 ($###p = 0.0025$), 7 ($#p = 0.0109$), but not 14 ($p = 0.1160$) days. Therefore, we further evaluated retention performance of new groups of mice treated with either CSP alone as control or CSP-TTK21 at two different time points (Fig. 7*B*). In this protocol, we made a single injection of the molecule 3 d before acquisition, so that when the training started (Acqui-

sition A1), the hippocampus already displayed increased acetylation levels (Fig. 4), accelerated maturation of young adult neurons (Fig. 5*A–D*), and increased pro-BDNF expression (Fig. 6*F*). We tested retention after 2 d, because at this retention time, performance can still be ameliorated despite mice already displaying searching scores above chance. Indeed, this mouse strain could reach an average of 30–33 s of focused search in the target quadrant after a regular 5-day training in our experimental room (data not shown). However, as seen in Figure 7*C*, right, whether treated with HAT activator (CSP-TTK21) or not (CSP alone), performance of the mice was similar: they were significantly increased in the target quadrant compared with the other quadrants ($***p = 0.0001$ for both CSP and CSP-TTK21 groups, $n = 10$) and the search time in the target quadrant was significantly larger than chance ($###p = 0.0001$ for CSP and $###p = 0.0006$ for CSP-TTK21). Scores reached by CSP-TTK21-treated mice were equal to those of CSP-treated mice (23.6 vs 23.9 s in T). We also tested retention performance after 16 d, a retention day at which searching scores of mice trained for 3 d are usually not different from chance. Figure 7*D* shows that CSP-treated mice ($n = 12$) performed as well as nontreated mice (shown in Fig. 7*A*, 14 d); the search did not focus on the target quadrant and it was not different from chance in the target quadrant. However, CSP-TTK21-treated mice did show a significant search in the target quadrant compared with others ($***p = 0.001$) and the searching score was above chance ($#p = 0.0117$). CSP-TTK21 treatment had no effect on acquisition performance (Fig. 7*C,D*, left). ANOVA revealed a significant effect of day for each group (Fig. 7*C*: $F_{(2,36)} = 9.06$; $p < 0.001$; Figure 7*D*: $F_{(2,44)} = 17.87$; $p < 0.00001$), but no significant effect of treatment (Fig. 7*C*: $F_{(1,18)} = 0.35$; $p = 0.55$; Fig. 7*D*: $F_{(1,22)} = 0.28$; $p = 0.59$). These data show that CSP-TTK21-induced HAT activation in mice affects the persistence of a spatial memory by extending the time during which this memory can be retrieved.

Finally, we measured the expression of several genes related to memory and hippocampal/neuronal excitability: *Egr-1*, *Arc*, *cFos* (Guzowski et al., 2001), *CREB1* (Lopez de Armentia et al., 2007), *Fosl2*, and *Nr4A2* (Hawk and Abel, 2011; Hawk et al., 2012) at the basal level (nonbehaving animals) and in response to CSP-TTK21 compared with CSP alone (Fig. 8). None of the genes tested was altered at day 1.5. However, *Nr4A2* and *cFos* showed a significant increase 3 d after injection compared with CSP controls (1.48-fold, $*p = 0.0410$ and 1.87-fold, $**p = 0.0092$, respectively). *cFos* was also significantly induced at day 3 compared with day 1.5 (1.79-fold, $##p = 0.0029$). *Fosl2* showed a nonsignificant trend to increase at day 3 compared with CSP controls (1.47-fold, $p = 0.0948$) and it was significantly increased at day 3 compared with day 1.5 (1.9-fold, $#p = 0.0159$). *CREB1* presented a nonsignificant induction ($p = 0.1189$) and *Egr-1* and *Arc* levels remained unchanged after CBP/p300 activation.

Discussion

In this study, we synthesized a novel HAT activator molecule (CSP-TTK21) and demonstrated its ability to improve some brain functions *in vivo*. We first showed that TTK21 activates CBP and p300 *in vitro*. Covalently bound to a CSP nanosphere, it increased histone acetylation in several brain regions, including the frontal cortex and the dorsal hippocampus, without apparent toxicity. Functional analyses showed that CSP-TTK21 promoted differentiation and maturation of young adult hippocampal neurons and improved long-term retention of a spatial memory. Because pharmacological activation of CBP/p300 has never been achieved *in vivo*, mostly because of the poor permeability of HAT activators (Selvi et al., 2008),

←

(Figure legend continued.) 10 d after the injections. *I, J*, CSP and CSP-TTK21-treated mice ($n = 3$ /group) were injected with BrdU twice a day for 3 d and killed at day 21 for BrdU and DCX colabeling. The images shown in *J* depict three BrdU-positive/DCX-positive neurons as typically observed in CSP-TTK21 mice. Scale bar, 50 μm . The same results were observed in the CSP-treated group. Quantification in *I* shows that ~75% of the all BrdU-positive cells counted in the dentate gyrus (hill included) are double labeled with DCX. *K*, qRT-PCR analyses of mRNA levels in response to CSP and CSP-TTK21 treatment. Mice ($n = 5$ /group) were treated and killed either 1.5 or 3 d after intraperitoneal injection as indicated. Data are represented as the fold induction by CSP-TTK21 normalized to CSP alone. mRNA quantities have been normalized with RNA *poll* levels measured in each sample. Student's *t* test, $*p < 0.05$ when CSP-TTK21 is compared with CSP alone; $#p < 0.05$ when CSP-TTK21 at day 3 is compared with CSP-TTK21 at day 1.5.

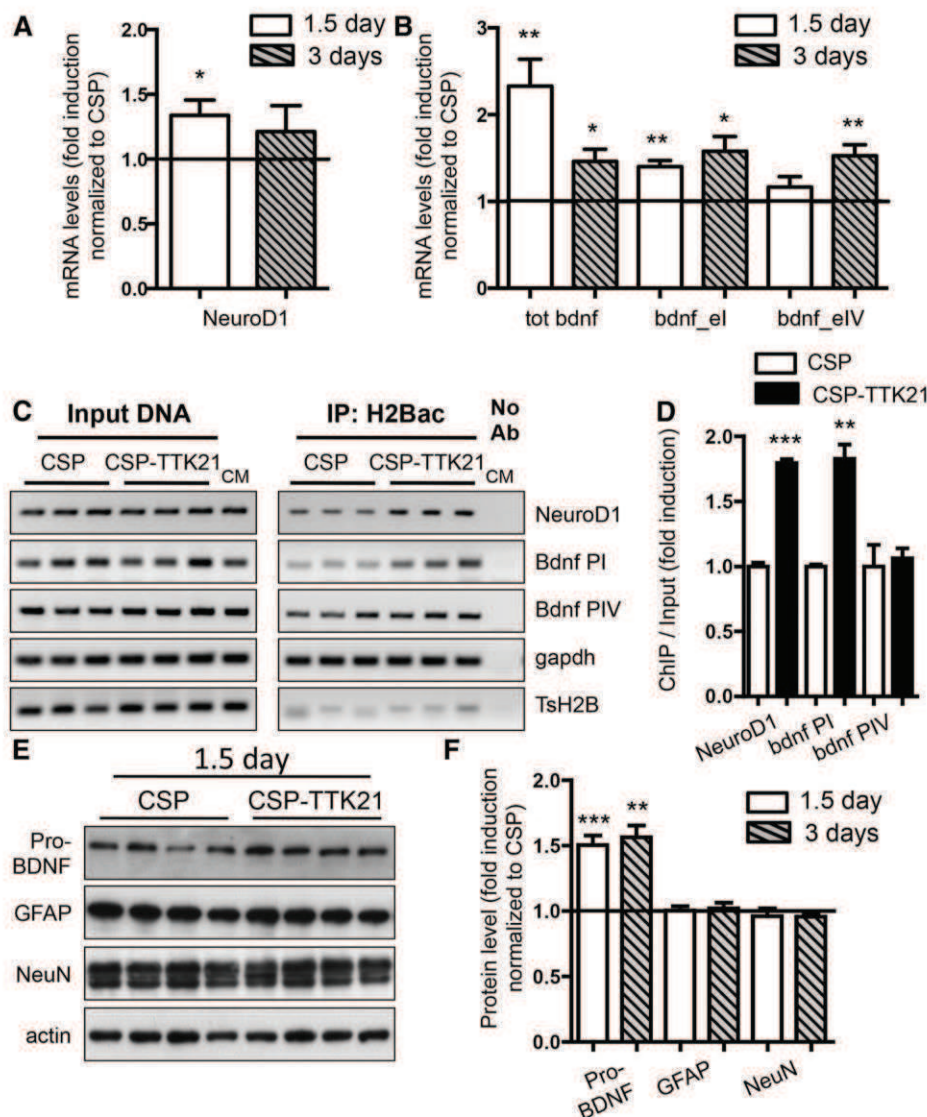

Figure 6. CSP-TTK21 stimulates *neuroD1* and *bdnf* expression in the hippocampus. **A, B**, qRT-PCR analyses of mRNA levels in response to CSP and CSP-TTK21 treatment. Mice ($n = 5$ /group) were treated and killed either 1.5 or 3 d after intraperitoneal injection as indicated. Data are represented as the fold induction by CSP-TTK21 normalized to CSP alone. mRNA quantities have been normalized with RNA *poll1* levels measured in each sample. Student's *t* test, $*p < 0.05$, $**p < 0.01$, when CSP-TTK21 is compared with CSP alone. At day 1.5 after injection, *neuroD1* mRNA levels are significantly increased in mice treated with the HAT activator (**A**), and mRNA representative of total *Bdnf*, in part through activation of its promoter I, but not of promoter IV. At day 3, both *bdnf* exon I and IV were upregulated by CSP-TTK21 treatment (**B**). **C, D**, Chromatin immunoprecipitation performed on dorsal hippocampus of mice injected with either CSP or CSP-TTK21 ($n = 3$ /group). Chromatin was isolated 1.5 d after molecule injection. Specific promoter targets were evaluated by semiquantitative PCR. Results are shown in triplicate (**C**) with input DNA (left) and immunoprecipitated samples (right). CM indicates chromatin mix; No Ab, no primary antibody. **D**, Quantification of immunoprecipitated material relative to its input level is represented as the fold induction where the CSP-treated group is arbitrarily set at 1. $**p < 0.01$ and $*p < 0.05$ compared with CSP alone. **E, F**, Western blot analyses of proteins obtained from the dorsal hippocampi of mice treated with CSP or CSP-TT21 for either 1.5 or 3 d. Pro-BDNF was significantly increased by the CBP/p300 activator, whereas the level of the glial (GFAP) and neuronal (NeuN) markers were not changed. Typical autoradiograms obtained for 1.5 d samples are shown (**E**) and their quantification is shown in **F**. Student's *t* test, $***p < 0.001$ and $**p < 0.01$ compared with CSP alone.

these results represent an important scientific advance and open new therapeutic options for brain diseases.

CBP/p300 activation favors differentiation of newly generated neurons in the dorsal hippocampus

A main result of this study is the dramatic effect of CSP-TTK21 on the dendritic network only 3 d after injection. Whereas the number of DCX-labeled neurons was unchanged, there was an

increase in dendritic length and arborization and in mRNAs of immature neuronal markers (DCX, TUC4; Fig. 5), suggesting that the HAT activator had an impact on young hippocampal neurons already generated before its injection and accelerated their maturation. It is likely that CSP-TTK21-induced expression of *neuroD1* contributed to this rapid maturation. Indeed, *neuroD*-lacking mice present hippocampal granule progenitors failing to mature and having little dendritic arborization (Schwab

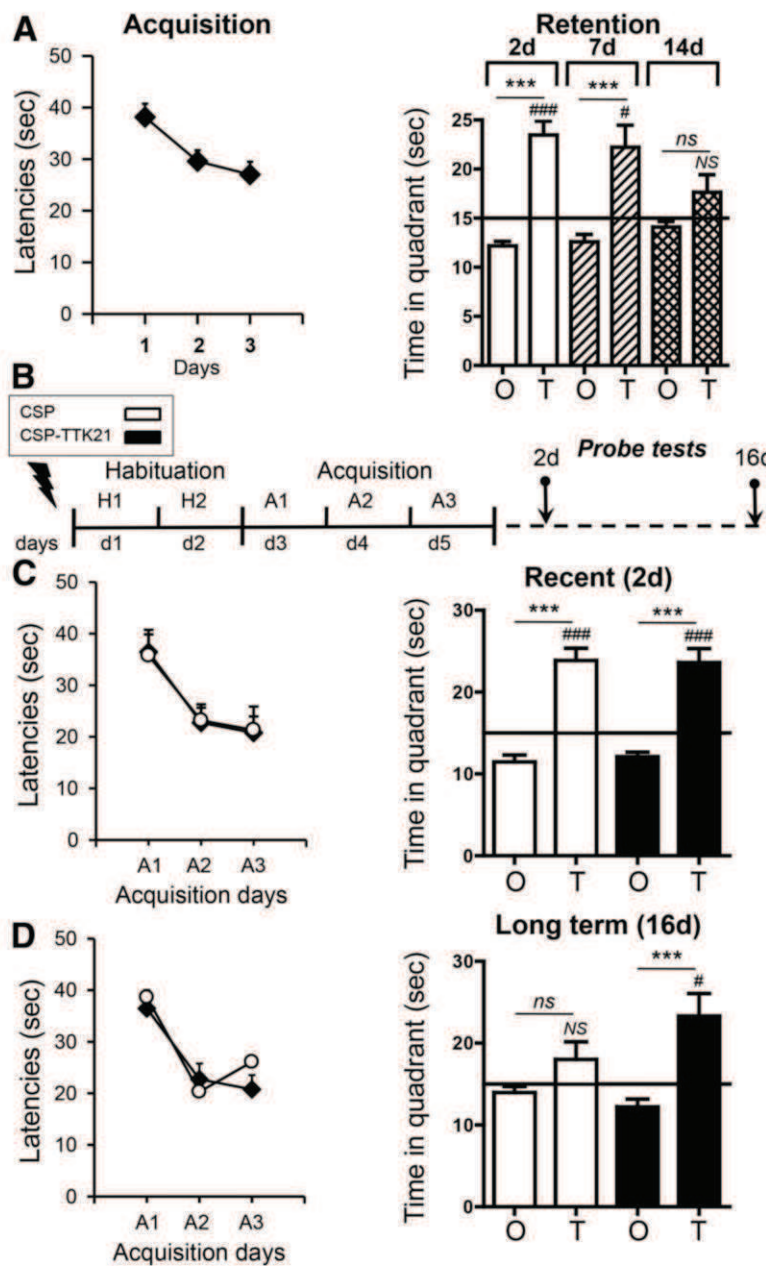

Figure 7. HAT activator-induced acetylation in the brain does not affect learning or recent memory, but extends memory duration. **A**, Three groups of mice ($n = 10/\text{group}$) were trained using a Morris water maze protocol for only 3 d to ensure a “weak learning” (i.e., leaving possibilities of amelioration). Left: Acquisition performance is shown as latencies to reach the platform. Right: Mice were tested for retention in a probe trial performed either after 2, 7, or 14 d after the last training session as indicated. The time spent in the target quadrant (T) is represented; compare with the time spent in the average of the three other quadrants (O). The mice undergoing a weak learning show low but significant retention performance at day 2 and 7 and no recall of the platform location at day 14. **B**, Timeline of CSP and CSP-TTK21 injection relative to the training protocol. **C, D**, Two groups of mice ($n = 20\text{--}22/\text{group}$) treated with either CSP or CSP-TTK21 were trained as in **A** and tested for retention in a probe test either at 2 d for recent memory (**C**) or 16 d for long-term memory (**D**). Latencies are shown on the left. During training, the latencies decreased over sessions in a similar way in both treatment groups to be tested for retention at a 2-day postacquisition delay versus a 16-day delay. Retention scores are shown on the right. Retention of the platform location was lost after 16 d in CSP-treated mice, as expected from results obtained in nontreated mice (**B**, 14 d), but CSP-TTK21 mice still displayed performance accounting for significant retention of the platform location. Student’s t test, $***p < 0.001$ or ns (nonsignificant) comparing T with O. $###p < 0.001$, $\#p < 0.05$, or nonsignificant (NS) when T is compared with random performance (15 s, solid line).

et al., 2000). Concomitantly, there was a reduction of BrdU incorporation, demonstrating an antiproliferative effect of CSP-TTK21. These results are consistent with the fact that differentiation of progenitors follows different processes, such as blockade of the cell cycle, increase of differentiation markers, and production of structural proteins (Kempermann et al., 2004), so that progenitors cannot proliferate and differentiate at the same time. We report herein that these processes are most likely relevant to CBP/p300 activation *in vivo*, which initiate the transcription of specific CBP-dependent genes such as *neuroD1* (Sun et al., 2001). So far, CBP histone acetyltransferase activity was shown to regulate embryonic neural differentiation (Wang et al., 2010). Whether the same holds true in adults was unknown. However, whereas basal adult neurogenesis is not affected in *cbp*^{+/-} mice, it was shown that environment-induced adult neurogenesis was significantly impaired in these mice, suggesting that it is extrinsically regulated by CBP function (Lopez-Atalaya et al., 2011). Therefore, our data support a role of CBP in adult neurogenesis, particularly in neuronal maturation and differentiation.

CSP-TTK21 upregulated the *bdnf* gene and its precursor protein pro-BDNF (Fig. 6). BDNF increases dendritic complexity in the dentate gyrus (Danzer et al., 2002). BDNF depletion studies in the hippocampus revealed a proliferative state of granule progenitors and an increase of nondifferentiated DCX-positive neurons (Chan et al., 2008). Therefore, the antiproliferative effect of CSP-TTK 21 coupled to increased progenitor differentiation is in agreement with increased BDNF levels in the dorsal hippocampus.

Survival and differentiation processes are frequently altered during pathological aging, when persistent hippocampal proliferative capacity remains (Verret et al., 2007). Aberrant neurogenesis and unscheduled neuronal cell cycle events have been reported in animal models of Alzheimer’s disease and in actual patients (Herup, 2012). Manipulating endogenous progenitor cells could be useful for brain repair (Lie et al., 2004). Therefore, our HAT activator could open new horizons for treating neurodegenerative diseases.

A new role for CBP/p300 in the persistence of memory

The dorsal hippocampus plays a major role in memory formation (Frankland and Bontempi, 2005). Many studies have established a role for CBP and p300 in

memory processes (Barco, 2007; Oliveira et al., 2007; Barrett and Wood, 2008; Barrett et al., 2011; Oliveira et al., 2011). The activation of the CREB signaling pathway—a major target of CBP/p300—increases spatial memory strength in weakly trained animals (Sekeres et al., 2010). Therefore, a surprising result was that enhancing CBP/p300 activity in the brain did not enhance spatial memory performance at a short postacquisition delay. CSP-TTK21 treatment, however, was able to extend memory vividness to 16 d after acquisition, a delay at which controls showed bad performance. In fact, it seems that most CBP mutants are deficient in some hippocampus-dependent forms of memory, particularly for object recognition, but not or poorly in spatial memory (Oike et al., 1999; Alarcón et al., 2004; Kozus et al., 2004; Valor et al., 2011). Similarly, conditional p300 knock-out mice exhibit normal spatial memory functions (Oliveira et al., 2011). In all of these studies, retention was tested at short postacquisition delays (< 24 h). Therefore, whereas CBP is not critical for recent memory, it seems implicated in remote spatial memory formation. Consistent with this, CBP/p300 activation results in increased BDNF expression, which is crucial for making memories durable (Bekinschtein et al., 2007; Bekinschtein et al., 2008).

How declarative memories persist for decades is a complex question. Consolidation involves reorganizations at synaptic and system levels, and stabilization of memories requires coordinated hippocampo–cortical interactions (Frankland and Bontempi, 2005; Winocur et al., 2010). We show herein that, in addition to activating histone acetylation in the dorsal hippocampus, CSP-TTK21 injected systemically also induced histone acetylation in the frontal cortex and other brain parts (Fig. 3G). Therefore, because we applied our treatment just before training, one possibility is that CSP-TTK21 allowed a specific tagging in some cortical subregions, thereby reinforcing a hippocampo–cortical dialogue to form a persistent memory, as described recently (Lesburguères et al., 2011).

Adult hippocampal neurogenesis is required for hippocampus-dependent memory, and new adult-generated neurons contribute to spatial memory updating and strengthening (Trouche et al., 2009). Young adult neurons, particularly those that mature after training, are important for remote memory, especially in spatial tasks (Goodman et al., 2010; Arruda-Carvalho et al., 2011). It is also hypothesized that newly formed neurons could facilitate pattern separation and spatial memory resolution/completion by tagging CA3 neurons (Deng et al., 2010; Aimone et al., 2011; Sahay et al., 2011). With our injection timing (3 d before training day 1), the CSP-TTK21-induced differentiation occurred on previously generated new neurons (1–3 weeks old) and therefore might have contributed to more appropriate integration of these young adult neurons within the memory-fixing circuitry at the time of training, an effect that is beneficial for memory (Goodman et al., 2010).

Ultimately, whether the effect on memory retention is relevant to the HAT activator effect on cortical and hippocampal regions or on adult neurogenesis remains to be investigated by more specific approaches.

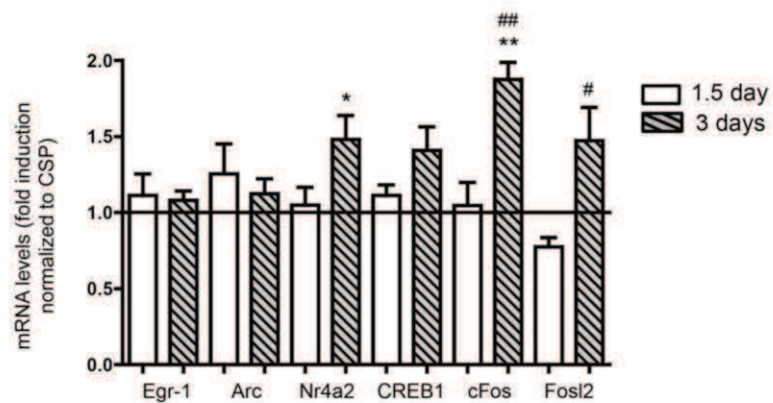

Figure 8. CSP-TTK21 activates selective transcription in the hippocampus. Several memory/plasticity-related genes were evaluated by qRT-PCR in the same conditions as in Fig. 6A. Student's *t* test, * $p < 0.05$, ** $p < 0.01$ comparing CSP-TTK21 with CSP alone. # $p < 0.05$, ## $p < 0.01$ when CSP-TTK21 at day 3 is compared with CSP-TTK21 at day 1.5. Note that gene transcription is not widely activated by CSP-TTK21 in nonbehaving animals, with only a few of the genes (Nr4a2, cFos, Fosl2) being activated 3 d after injection.

A new therapeutic option for memory-related diseases?

In addition to their opposite modes of action, a major difference between HATs and HDACs is their recruitment to the chromatin loci. HDACs are usually part of corepressor complexes targeted to a specific locus by protein/protein interactions such as HDAC1 with MeCP2 (Jones et al., 1998; Nan et al., 1998), dnmt1 (Fuks et al., 2000), or PP1 (Koshibu et al., 2009). HATs such as CBP and p300, in addition to being part of large coactivator complexes, possess bromodomains so that they can be targeted to chromatin through interaction with acetylated histones (Yang, 2004). It is thus plausible that HAT induction may have functional consequences different from those of HDAC inhibition; they will not necessarily be on the same gene at the same time. In addition, specific histone marks are acetylated during memory formation (Bousiges et al., 2013; Peixoto and Abel, 2013), marks that are more reliably performed by activating the writers (HATs) than blocking the erasers (HDACs). In nonbehaving animals, CSP-TTK21 was able to activate specific transcriptional programs related to differentiation (Neuro D1, DCX, TUC4, BDNF), neuronal excitability (cFos), or memory (fosl2, Nr4a2), but transcription was not activated randomly because Egr-1 or Arc was not responsive to CBP/p300 HAT activation (Fig. 8).

Transcriptional dysfunctions have been reported in many neurodegenerative diseases and HDAC inhibitors are widely used in animal models to increase acetylation levels and reestablish genetic programs in the brain (Kazantsev and Thompson, 2008; Gräff et al., 2011). In particular, HDAC inhibitors preserve memory function or ameliorate the pathological condition in animal models of Alzheimer's disease (Ricobaraza et al., 2009; Kilgore et al., 2010; Ricobaraza et al., 2011; Govindarajan et al., 2011; Ricobaraza et al., 2012). Although recent progress has been made in deciphering the role of specific HDACs in learning and memory functions (Guan et al., 2009; McQuown and Wood, 2011; Bahari-Javan et al., 2012; Agis-Balboa et al., 2013) and in adult neurogenesis (Jawerka et al., 2010), HDACs represent a large family of isoforms and it is hard to predict which ones to target in a particular pathological context (Fischer et al., 2010). Furthermore, the development of effective treatments based on HDAC inhibition is limited by a lack of specificity of currently available molecules that often block many, if not all, HDAC isoforms (Khan et al.,

2008). The data presented here open, for the first time, a new era of research to investigate the CBP/p300 activation function in the brain *in vivo*. As an alternative to blocking HDACs, we propose a direct stimulation of acetyltransferase function, which could have important implications in terms of therapeutic options for neurodegenerative diseases, in which increasing the survival and maturation of endogenous progenitor cells may benefit functional recovery.

References

- Agis-Balboa RC, Pavelka Z, Kerimoglu C, Fischer A (2013) Loss of HDAC5 impairs memory function: implications for Alzheimer's disease. *J Alzheimers Dis* 33:35–44. CrossRef Medline
- Aimone JB, Deng W, Gage FH (2011) Resolving new memories: a critical look at the dentate gyrus, adult neurogenesis, and pattern separation. *Neuron* 70:589–596. CrossRef Medline
- Alarcón JM, Malleret G, Touzani K, Vronskaya S, Ishii S, Kandel ER, Barco A (2004) Chromatin acetylation, memory, and LTP are impaired in CBP[±] mice: a model for the cognitive deficit in Rubinstein-Taybi syndrome and its amelioration. *Neuron* 42:947–959. CrossRef Medline
- Arif M, Vedamurthy BM, Choudhari R, Ostwal YB, Mantelingu K, Kodaganur GS, Kundu TK (2010) Nitric oxide-mediated histone hyperacetylation in oral cancer: target for a water-soluble HAT inhibitor, CTK7A. *Chem Biol* 17:903–913. CrossRef Medline
- Arruda-Carvalho M, Sakaguchi M, Akers KG, Josselyn SA, Frankland PW (2011) Posttraining ablation of adult-generated neurons degrades previously acquired memories. *J Neurosci* 31:15113–15127. CrossRef Medline
- Bahari-Javan S, Maddalena A, Kerimoglu C, Wittnam J, Held T, Bähr M, Burkhardt S, Delalle I, Kügler S, Fischer A, Sananbenesi F (2012) HDAC1 regulates fear extinction in mice. *J Neurosci* 32:5062–5073. CrossRef Medline
- Balasubramanyam K, Swaminathan V, Ranganathan A, Kundu TK (2003) Small molecule modulators of histone acetyltransferase p300. *J Biol Chem* 278:19134–19140. CrossRef Medline
- Barco A (2007) The Rubinstein-Taybi syndrome: modeling mental impairment in the mouse. *Genes Brain Behav* 6:32–39. CrossRef Medline
- Barrett RM, Wood MA (2008) Beyond transcription factors: the role of chromatin modifying enzymes in regulating transcription required for memory. *Learn Mem* 15:460–467. CrossRef Medline
- Barrett RM, Malvaez M, Kramar E, Matheos DP, Arrizon A, Cabrera SM, Lynch G, Greene RW, Wood MA (2011) Hippocampal focal knockout of CBP affects specific histone modifications, long-term potentiation, and long-term memory. *Neuropsychopharmacology* 36:1545–1556. CrossRef Medline
- Bekinschtein P, Cammarota M, Igaz LM, Bevilacqua LR, Izquierdo I, Medina JH (2007) Persistence of long-term memory storage requires a late protein synthesis- and BDNF-dependent phase in the hippocampus. *Neuron* 53:261–277. CrossRef Medline
- Bekinschtein P, Cammarota M, Katche C, Slipczuk L, Rossato JJ, Goldin A, Izquierdo I, Medina JH (2008) BDNF is essential to promote persistence of long-term memory storage. *Proc Natl Acad Sci U S A* 105:2711–2716. CrossRef Medline
- Bousiges O, Vasconcelos AP, Neidl R, Cosquer B, Herbeaux K, Panteleeva I, Loeffler JP, Cassel JC, Boutillier AL (2010) Spatial memory consolidation is associated with induction of several lysine-acetyltransferase (histone acetyltransferase) expression levels and H2B/H4 acetylation-dependent transcriptional events in the rat hippocampus. *Neuropsychopharmacology* 35:2521–2537. CrossRef Medline
- Bousiges O, Neidl R, Majchrzak M, Muller MA, Barbelivien A, Pereira de Vasconcelos A, Schneider A, Loeffler JP, Cassel JC, Boutillier AL (2013) Detection of histone acetylation levels in the dorsal hippocampus reveals early tagging on specific residues of H2B and H4 histones in response to learning. *PLoS One* 8:e57816. CrossRef Medline
- Caccamo A, Maldonado MA, Bokov AF, Majumder S, Oddo S (2010) CBP gene transfer increases BDNF levels and ameliorates learning and memory deficits in a mouse model of Alzheimer's disease. *Proc Natl Acad Sci U S A* 107:22687–22692. CrossRef Medline
- Chan JP, Cordeira J, Calderon GA, Iyer LK, Rios M (2008) Depletion of central BDNF in mice impedes terminal differentiation of new granule neurons in the adult hippocampus. *Mol Cell Neurosci* 39:372–383. CrossRef Medline
- Chen G, Zou X, Watanabe H, van Deursen JM, Shen J (2010) CREB binding protein is required for both short-term and long-term memory formation. *J Neurosci* 30:13066–13077. CrossRef Medline
- Danzer SC, Crooks KR, Lo DC, McNamara JO (2002) Increased expression of brain-derived neurotrophic factor induces formation of basal dendrites and axonal branching in dentate granule cells in hippocampal explant cultures. *J Neurosci* 22:9754–9763. Medline
- Deng W, Aimone JB, Gage FH (2010) New neurons and new memories: how does adult hippocampal neurogenesis affect learning and memory? *Nat Rev Neurosci* 11:339–350. CrossRef Medline
- Fischer A, Sananbenesi F, Mungenast A, Tsai LH (2010) Targeting the correct HDAC(s) to treat cognitive disorders. *Trends Pharmacol Sci* 31:605–617. CrossRef Medline
- Frankland PW, Bontempi B (2005) The organization of recent and remote memories. *Nat Rev Neurosci* 6:119–130. CrossRef Medline
- Fuks F, Burgers WA, Brehm A, Hughes-Davies L, Kouzarides T (2000) DNA methyltransferase Dnmt1 associates with histone deacetylase activity. *Nat Genet* 24:88–91. CrossRef Medline
- Gao Z, Ure K, Ables JL, Lagace DC, Nave KA, Goebbels S, Eisch AJ, Hsieh J (2009) Neurod1 is essential for the survival and maturation of adult-born neurons. *Nat Neurosci* 12:1090–1092. CrossRef Medline
- Goodman T, Trouche S, Massou I, Verret L, Zerwas M, Roulet P, Rampon C (2010) Young hippocampal neurons are critical for recent and remote spatial memory in adult mice. *Neuroscience* 171:769–778. CrossRef Medline
- Govindarajan N, Agis-Balboa RC, Walter J, Sananbenesi F, Fischer A (2011) Sodium butyrate improves memory function in an Alzheimer's disease mouse model when administered at an advanced stage of disease progression. *J Alzheimers Dis* 26:187–197. CrossRef Medline
- Gräff J, Kim D, Dobbin MM, Tsai LH (2011) Epigenetic regulation of gene expression in physiological and pathological brain processes. *Physiol Rev* 91:603–649. CrossRef Medline
- Gräff J, Rei D, Guan JS, Wang WY, Seo J, Hennig KM, Nieland TJ, Fass DM, Kao PF, Kahn M, Su SC, Samiei A, Joseph N, Haggarty SJ, Delalle I, Tsai LH (2012) An epigenetic blockade of cognitive functions in the neurodegenerating brain. *Nature* 483:222–226. CrossRef Medline
- Guan JS, Haggarty SJ, Giacometti E, Dannenberg JH, Joseph N, Gao J, Nieland TJ, Zhou Y, Wang X, Mazitschek R, Bradner JE, DePinho RA, Jaenisch R, Tsai LH (2009) HDAC2 negatively regulates memory formation and synaptic plasticity. *Nature* 459:55–60. CrossRef Medline
- Guzowski JF, Setlow B, Wagner EK, McLaugh JL (2001) Experience-dependent gene expression in the rat hippocampus after spatial learning: a comparison of the immediate-early genes *Arc*, *c-fos*, and *zif268*. *J Neurosci* 21:5089–5098. Medline
- Hawk JD, Abel T (2011) The role of NR4A transcription factors in memory formation. *Brain research bulletin* 85:21–29. CrossRef Medline
- Hawk JD, Bookout AL, Poplawski SG, Bridi M, Rao AJ, Sulewski ME, Kroener BT, Manglesdorf DJ, Abel T (2012) NR4A nuclear receptors support memory enhancement by histone deacetylase inhibitors. *J Clin Invest* 122:3593–3602. CrossRef Medline
- Herrup K (2012) The contributions of unscheduled neuronal cell cycle events to the death of neurons in Alzheimer's disease. *Front Biosci (Elite Ed)* 4:2101–2109. Medline
- Hsieh J, Eisch AJ (2010) Epigenetics, hippocampal neurogenesis, and neuropsychiatric disorders: unraveling the genome to understand the mind. *Neurobiol Dis* 39:73–84. CrossRef Medline
- Jawerka M, Colak D, Dimou L, Spiller C, Lager S, Montgomery RL, Olson EN, Wurst W, Göttlicher M, Götz M (2010) The specific role of histone deacetylase 2 in adult neurogenesis. *Neuron Glia Biol* 6:93–107. CrossRef Medline
- Jones PL, Veenstra GJ, Wade PA, Vermaak D, Kass SU, Landsberger N, Strouboulis J, Wolffe AP (1998) Methylated DNA and MeCP2 recruit histone deacetylase to repress transcription. *Nat Genet* 19:187–191. CrossRef Medline
- Kazantsev AG, Thompson LM (2008) Therapeutic application of histone deacetylase inhibitors for central nervous system disorders. *Nat Rev Drug Discov* 7:854–868. CrossRef Medline
- Kempermann G (2012) New neurons for 'survival of the fittest'. *Nat Rev Neurosci* 13:727–736. CrossRef Medline
- Kempermann G, Jessberger S, Steiner B, Kronenberg G (2004) Milestones of neuronal development in the adult hippocampus. *Trends in neurosciences* 27:447–452. CrossRef Medline

- Khan N, Jeffers M, Kumar S, Hackett C, Boldog F, Khramtsov N, Qian X, Mills E, Berghs SC, Carey N, Finn PW, Collins LS, Tumber A, Ritchie JW, Jensen PB, Lichenstein HS, Sehested M (2008) Determination of the class and isoform selectivity of small-molecule histone deacetylase inhibitors. *Biochem J* 409:581–589. [CrossRef Medline](#)
- Kilgore M, Miller CA, Fass DM, Hennig KM, Haggarty SJ, Sweatt JD, Rumbaugh G (2010) Inhibitors of class I histone deacetylases reverse contextual memory deficits in a mouse model of Alzheimer's disease. *Neuropsychopharmacology* 35:870–880. [CrossRef Medline](#)
- Korzus E, Rosenfeld MG, Mayford M (2004) CBP histone acetyltransferase activity is a critical component of memory consolidation. *Neuron* 42:961–972. [CrossRef Medline](#)
- Koshibu K, Gräff J, Beullens M, Heitz FD, Berchtold D, Russig H, Farinelli M, Bollen M, Mansuy IM (2009) Protein phosphatase 1 regulates the histone code for long-term memory. *J Neurosci* 29:13079–13089. [CrossRef Medline](#)
- Kundu TK, Wang Z, Roeder RG (1999) Human TFIIIC relieves chromatin-mediated repression of RNA polymerase III transcription and contains an intrinsic histone acetyltransferase activity. *Mol Cell Biol* 19:1605–1615. [Medline](#)
- Lesburguères E, Gobbo OL, Alaux-Cantin S, Hambucken A, Trifilieff P, Bontempi B (2011) Early tagging of cortical networks is required for the formation of enduring associative memory. *Science* 331:924–928. [CrossRef Medline](#)
- Lie DC, Song H, Colamarino SA, Ming GL, Gage FH (2004) Neurogenesis in the adult brain: new strategies for central nervous system diseases. *Annu Rev Pharmacol Toxicol* 44:399–421. [CrossRef Medline](#)
- Lopez de Armentia M, Jancic D, Olivares R, Alarcón JM, Kandel ER, Barco A (2007) cAMP response element-binding protein-mediated gene expression increases the intrinsic excitability of CA1 pyramidal neurons. *J Neurosci* 27:13909–13918. [CrossRef Medline](#)
- Lopez-Atalaya JP, Ciccarelli A, Viosca J, Valor LM, Jimenez-Minchan M, Canals S, Giustetto M, Barco A (2011) CBP is required for environmental enrichment-induced neurogenesis and cognitive enhancement. *EMBO J* 30:4287–4298. [CrossRef Medline](#)
- Lubin FD, Roth TL, Sweatt JD (2008) Epigenetic regulation of BDNF gene transcription in the consolidation of fear memory. *J Neurosci* 28:10576–10586. [CrossRef Medline](#)
- McQuown SC, Wood MA (2011) HDAC3 and the molecular brake pad hypothesis. *Neurobiol Learn Mem* 96:27–34. [CrossRef Medline](#)
- Nan X, Ng HH, Johnson CA, Laherty CD, Turner BM, Eisenman RN, Bird A (1998) Transcriptional repression by the methyl-CpG-binding protein MeCP2 involves a histone deacetylase complex. *Nature* 393:386–389. [CrossRef Medline](#)
- Oike Y, Hata A, Mamiya T, Kaname T, Noda Y, Suzuki M, Yasue H, Nabeshima T, Araki K, Yamamura K (1999) Truncated CBP protein leads to classical Rubinstein-Taybi syndrome phenotypes in mice: implications for a dominant-negative mechanism. *Hum Mol Genet* 8:387–396. [CrossRef Medline](#)
- Oliveira AM, Wood MA, McDonough CB, Abel T (2007) Transgenic mice expressing an inhibitory truncated form of p300 exhibit long-term memory deficits. *Learn Mem* 14:564–572. [CrossRef Medline](#)
- Oliveira AM, Estévez MA, Hawk JD, Grimes S, Brindle PK, Abel T (2011) Subregion-specific p300 conditional knock-out mice exhibit long-term memory impairments. *Learn Mem* 18:161–169. [CrossRef Medline](#)
- Panteleeva I, Boutillier S, See V, Spiller DG, Rouaux C, Almouzni G, Bailly D, Maison C, Lai HC, Loeffler JP, Boutillier AL (2007) HP1 α guides neuronal fate by timing E2F-targeted genes silencing during terminal differentiation. *The EMBO J* 26:3616–3628. [CrossRef Medline](#)
- Peixoto L, Abel T (2013) The role of histone acetylation in memory formation and cognitive impairments. *Neuropsychopharmacology* 38:62–76. [CrossRef Medline](#)
- Quinn CC, Gray GE, Hockfield S (1999) A family of proteins implicated in axon guidance and outgrowth. *J Neurobiol* 41:158–164. [CrossRef Medline](#)
- Ricobaraza A, Cuadrado-Tejedor M, Pérez-Mediavilla A, Frechilla D, Del Rio J, García-Osta A (2009) Phenylbutyrate ameliorates cognitive deficit and reduces tau pathology in an Alzheimer's disease mouse model. *Neuropsychopharmacology* 34:1721–1732. [CrossRef Medline](#)
- Ricobaraza A, Cuadrado-Tejedor M, García-Osta A (2011) Long-term phenylbutyrate administration prevents memory deficits in Tg2576 mice by decreasing A β . *Front Biosci (Elite Ed)* 3:1375–1384. [Medline](#)
- Ricobaraza A, Cuadrado-Tejedor M, Marco S, Pérez-Otaño I, García-Osta A (2012) Phenylbutyrate rescues dendritic spine loss associated with memory deficits in a mouse model of Alzheimer disease. *Hippocampus* 22:1040–1050. [CrossRef Medline](#)
- Sahay A, Wilson DA, Hen R (2011) Pattern separation: a common function for new neurons in hippocampus and olfactory bulb. *Neuron* 70:582–588. [CrossRef Medline](#)
- Schwab MH, Bartholomae A, Heimrich B, Feldmeyer D, Druffel-Augustin S, Goebels S, Naya FJ, Zhao S, Frotscher M, Tsai MJ, Nave KA (2000) Neuronal basic helix-loop-helix proteins (NEX and BETA2/Neuro D) regulate terminal granule cell differentiation in the hippocampus. *J Neurosci* 20:3714–3724. [Medline](#)
- Sekeres MJ, Neve RL, Frankland PW, Josselyn SA (2010) Dorsal hippocampal CREB is both necessary and sufficient for spatial memory. *Learn Mem* 17:280–283. [CrossRef Medline](#)
- Selvi BR, Jagadeesan D, Suma BS, Nagashankar G, Arif M, Balasubramanyam K, Eswaramoorthy M, Kundu TK (2008) Intrinsically fluorescent carbon nanospheres as a nuclear targeting vector: delivery of membrane-impermeable molecule to modulate gene expression in vivo. *Nano Lett* 8:3182–3188. [CrossRef Medline](#)
- Selvi BR, Cassel JC, Kundu TK, Boutillier AL (2010) Tuning acetylation levels with HAT activators: therapeutic strategy in neurodegenerative diseases. *Biochim Biophys Acta* 1799:840–853. [CrossRef Medline](#)
- Selvi RB, Chatterjee S, Jagadeesan D, Chaturvedi P, Suma BS, Eswaramoorthy M, Kundu TK (2012) ATP driven clathrin dependent entry of carbon nanospheres prefer cells with glucose receptors. *J Nanobiotechnology* 10:35. [CrossRef Medline](#)
- Sun Y, Nadal-Vicens M, Misono S, Lin MZ, Zubiaga A, Hua X, Fan G, Greenberg ME (2001) Neurogenin promotes neurogenesis and inhibits glial differentiation by independent mechanisms. *Cell* 104:365–376. [CrossRef Medline](#)
- Tian F, Hu XZ, Wu X, Jiang H, Pan H, Marini AM, Lipsky RH (2009) Dynamic chromatin remodeling events in hippocampal neurons are associated with NMDA receptor-mediated activation of Bdnf gene promoter 1. *J Neurochem* 109:1375–1388. [CrossRef Medline](#)
- Trouche S, Bontempi B, Roulet P, Rampon C (2009) Recruitment of adult-generated neurons into functional hippocampal networks contributes to updating and strengthening of spatial memory. *Proc Natl Acad Sci U S A* 106:5919–5924. [CrossRef Medline](#)
- Valor LM, Pulopulos MM, Jimenez-Minchan M, Olivares R, Lutz B, Barco A (2011) Ablation of CBP in forebrain principal neurons causes modest memory and transcriptional defects and a dramatic reduction of histone acetylation but does not affect cell viability. *J Neurosci* 31:1652–1663. [CrossRef Medline](#)
- Valor LM, Viosca J, Lopez-Atalaya JP, Barco A (2013) Lysine acetyltransferases CBP and p300 as therapeutic targets in cognitive and neurodegenerative disorders. *Current pharmaceutical design*.
- Verret L, Trouche S, Zerwas M, Rampon C (2007) Hippocampal neurogenesis during normal and pathological aging. *Psychoneuroendocrinology* 32:S26–S30. [CrossRef Medline](#)
- Wang J, Chen J (2010) SIRT1 regulates autoacetylation and histone acetyltransferase activity of TIP60. *J Biol Chem* 285:11458–11464. [CrossRef Medline](#)
- Winocur G, Moscovitch M, Bontempi B (2010) Memory formation and long-term retention in humans and animals: convergence towards a transformation account of hippocampal-neocortical interactions. *Neuropsychologia* 48:2339–2356. [CrossRef Medline](#)
- Yang XJ (2004) Lysine acetylation and the bromodomain: a new partnership for signaling. *Bioessays* 26:1076–1087. [CrossRef Medline](#)
- Yang XJ, Seto E (2007) HATs and HDACs: from structure, function and regulation to novel strategies for therapy and prevention. *Oncogene* 26:5310–5318. [CrossRef Medline](#)
- Zajac MS, Pang TY, Wong N, Weinrich B, Leang LS, Craig JM, Saffery R, Hannan AJ (2010) Wheel running and environmental enrichment differentially modify exon-specific BDNF expression in the hippocampus of wild-type and premotor symptomatic male and female Huntington's disease mice. *Hippocampus* 20:621–636. [CrossRef Medline](#)

Discussion

The present study showed implications of activating acetyltransferase CBP/p300 in memory related processes. Unlike other cell impermeant HAT activators, the novel HAT activator conjugate CSP-TTK21 efficiently crosses the blood brain barrier and activates histone acetylation in the frontal cortex and the dorsal hippocampus of mice brain. Activation of histone acetylation proved beneficial as it induced differentiation and maturation of young hippocampal neurons and improved long-term retention of a spatial memory. This study is the first evidence for direct activation of a CBP/p300 HAT in the brain which by itself is a great achievement and opens a new therapeutic option for brain related diseases.

Significance of improved neuronal maturation in cognitive function

Hippocampal neurogenesis is thought to be implicated in the persistence of long-term memory. Recently it was shown that ablation of neurogenesis by whole brain radiation (WBI) one month before the spatial task led to significant deficits of spatial memory performance in MWM. Additionally decreased neurogenesis also caused reduced expression of BDNF due to decreased acetylation of H3 on BDNF promoters (Ji et al., 2014). Here in this study, we showed that HAT activation in non-transgenic mice improved dendritic length and arborisation of DCX-positive neurons and increases the gene expression of neuronal markers for differentiation like *BDNF* and *NeuroDI* only after 3 days of injection. We observed increased occupancy of acetylated histone H2B on the promoters of *NeuroDI* and *BDNF eI*. We claimed that HAT activator mediated induced expression of *NeuroDI* possibly contributed to the stimulated dendritic maturation. It was already known that *NeuroDI* is a critical component of dendritic maturation and mice lacking *NeuroDI* presents reduced dendritic maturation and arborisation of hippocampal granule progenitors (Schwab et al., 2000). Later a conclusive study from Claire Rampon's group confirmed the importance of *NeuroDI* in the neuronal maturation and functional integration of new neurons during the maturation period (Richetin et al., 2015). In that study, retroviral vectors encoding the reporter gene for *NeuroDI* delivery into dentate gyrus exhibited higher branching complexity and increased total dendritic length of 14 days age neurons. Thus *NeuroDI* provides the newly generated neurons a competitive advantage to receive inputs. *NeuroDI* is a CBP target gene (Sun et al., 2001). Eventhough CBP heterozygous mutation mice (CBP^{+/-}) do not show

defects in basal adult neurogenesis but enriched environment induced adult neurogenesis was significantly impaired in these mice (Lopez-Atalaya et al., 2011). Thus the results support the present notion that CBP contributes to adult neurogenesis possibly through neuronal maturation and differentiation.

Role of CBP/p300 activation in persistence of long-term memory

Active research for the last decade has established the role of CBP and p300 in memory processes (Barco, 2007; Oliveira et al., 2006; Barrett et al., 2011; Oliveira et al., 2011). CBP involvement in spatial memory depends on its binding with CREB through the KIX domain (Chatterjee et al, Unpublished, *Publication 3*). Activation of the CREB signaling pathway increases spatial memory strength in weakly trained animals (Sekeres et al., 2010). Surprisingly, we did not evidence any influence of CBP activation on spatial memory performance at a short postacquisition delay. However, CSP-TTK21 dependent activation of CBP/p300 HAT functions significantly improved remote long-term memory (16 days after acquisition). Different CBP mutant mice show impairment in some hippocampus-dependent forms of memory, particularly object recognition memory is affected whereas spatial memory is either not or poorly affected (Oike et al., 1999; Alarcón et al., 2004; Korzus et al., 2004; Valor et al., 2011). Notably, spatial memory was measured in the above mentioned studies at short post-acquisition delays (24 h or less). Thus CBP seems to be more implicated in the remote spatial memory formation than for recent memory.

Memory consolidation involved reorganization at synaptic and system levels where coordinated hippocampo–cortical interactions stabilizes the memory (Frankland and Bontempi, 2005; Winocur et al., 2010). We have observed that CSP-TTK21 not only activates histone acetylation in the dorsal hippocampus but also activates CBP/p300 mediated histone acetylation in the frontal cortex and some other brain regions. CBP HAT function is essential for long-term encoding in the medial prefrontal cortex (mPFC) circuits as well. Recent reports suggests that reduced function of CBP in the mPFC results in delay-dependent disruption of object-location memory (Vieira and Korzus, 2015). Thus activation of CBP HAT function in the mPFC could possibly complement hippocampus-dependent spatial memory mechanisms and enhance encoding of long-term memory. These findings suggest that CSP-TTK21 mediated increased histone acetylation could mark neurons from some cortical subregions (early tagging), thereby reinforcing a hippocampo–cortical dialogue to form a persistent memory, as described recently (Lesbarguères et al., 2011).

HAT activation, a novel therapeutic approach for memory related disorders?

HAT and HDACs present opposite outcomes in the context of global chromatin acetylation levels, their mode of actions are also different. HATs are the essential components of the transcriptional co-activator complexes and possess bromodomain to recruit themselves to the acetylated histones in the chromatin (Yang, 2004). Whereas, HDACs are part of corepressor complexes that depends on protein-protein interaction to be targeted to the chromatin. Thus it could be presumed that HAT activation would lead to different functional consequences than that of HDAC inhibition. Furthermore, during memory formation specific histone acetylation marks are activated by the HATs rather by blocking HDACs (Bousiges et al., 2013; Peixoto and Abel, 2013). Our results suggest that CSP-TTK21 activates transcription of genes related to differentiation (*Neuro D1, DCX, TUC4, BDNF*), neuronal excitability (*cFos*), or memory (*fosl2, Nr4a2*), however, other target genes of CBP/p300 were not activated like *Egr-1* or *Arc* by a single injection of CSPTTK21 in basal (rest) conditions. BDNF activation is responsive to chromatin acetylation status and is a target of NR4A signaling (Volpicelli et al., 2007; Hawk et al., 2012). HDACi also increases *NR4a2* gene expression, whereas blocking Nr4a signaling interferes with the HDACi induced memory enhancement. Thus CSP-TTK21 possibly activates specific signaling cascades to activate memory processes.

Cognitive impairment is often associated with transcriptional dysfunction as evidenced from various neurodegenerative diseases. HDAC inhibitors are extensively used to increase histone acetylation status in animal models to re-establish genetic programs in the brain (Kazantsev and Thompson, 2008; Gräff et al., 2011). HDACi has shown promising effect to reverse the pathological condition and rescue memory impairments in mice models of Alzheimer's disease (AD) (Ricobaraza et al., 2009; Kilgore et al., 2010; Ricobaraza et al., 2011); Govindarajan et al., 2013; Ricobaraza et al., 2012, Cuadrado-Tejedor et al., 2013).

CBP has been implicated in various neurodegenerative diseases. CBP mutation causes Rubinstein Taybi syndrome, a neurodegenerative condition characterized with mental retardation (Petrij et al., 1995; Oike et al., 1999). In Huntington's disease, CBP interacts with mutant huntingtin protein and results in deregulation of gene expression (Steffan et al., 2000; Steffan et al., 2001). Unpublished results from our lab also suggest that CBP protein levels are significantly decreased in the hippocampus of Alzheimer's disease patients (Bousiges et al, Manuscript under preparation) and in a mice model of Tauopathy (Cassel et al, Manuscript under preparation). In addition, we have also observed decreased amounts of

CBP levels in hippocampal cells expressing high levels of pathogenic phosphorylated Tau protein in mice model of Tauopathy. Thus the strategy to activate the enzymatic function of CBP in pathological condition could actually prove beneficial in a therapeutic perspective.

Perspectives

Single treatment of CSP-TTK21 in healthy adult mice showed promising effect to improve long-term spatial memory by enhancing neuronal maturation and expression of memory related genes. As discussed previously, dysfunctions of HATs like CBP/p300 has been implicated in various neurodegenerative conditions like Alzheimer's disease. Therefore the possibility to rescue cognitive defects in animal models of neurodegeneration by CSP-TTK21 treatment is highly likely. We explored the possibility to ameliorate the memory loss in a mice model of tauopathy (THY-Tau22) by chronic treatment of CSP-TTK21 (*Publication 3*). To use the newly developed HAT activator CSP-TTK21 as a drug to boost memory, it would be necessary to investigate its physiological effect in the animal body. CSP is prepared from glucose and it gets cleared from the brain after 7 days of *i.p.* injection. Eventhough we did not evidenced any toxic effect or abnormal behavioural phenotypes in mice after single injection of CSP-TTK21, a thorough characterization of the toxicity needs to be performed. To develop CSP-TTK21 as a therapeutic drug, the most lethal dose also needs to be determined in different animal models. In *publication 3*, we have administered chronic treatment of CSP-TTK21 in THY-Tau22 mice and have tried to partly answer the toxicity question by measuring the levels of pro-apoptotic marker cleaved caspase-3 in different body parts like liver, spleen, kidneys and heart. To answer the possibility of accumulation of the molecule in these body parts, histone acetylation levels have also been measured. Apparently, the molecule donot show any symptoms of toxic side-effects (*Publication 3*).

We found that CSP-TTK21 activates the acetyltransferase activity of p300/CBP but do not alter the PCAF HAT activity (data not shown). However, recently other HATs like GCN5 and Tip60 has been shown to influence memory related processes (Maurice et al., 2008; Stilling et al., 2014). Thus it would be interesting to investigate whether CSP-TTK21 acts on other HATs or it enhances memory related processes solely by activating CBP/p300. As histone acetylation is linked to gene expression, we also need to perform a complete transcriptomics to study the differential gene expression pattern upon treatment of CSP-

TTK21 in healthy adult mice. Last but not the least; to develop a drug for therapy, effect of oral administration needs to be monitored. So we also need to check if CSP-TTK21 can still reach the brain and retain its HAT activation property after oral administration.

PUBLICATION 2.

CREB-dependent CBP regulations of plasticity-related genes is required for long-term spatial memory formation

Snehajyoti Chatterjee^{1,2}, Anne Schneider-Anthony^{1,2}, Ted Abel³, Jean-Christophe Cassel^{1,2}
and Anne-Laurence Boutillier^{1,2*}

¹ Université de Strasbourg, Laboratoire de Neurosciences Cognitives et Adaptatives (LNCA),
67000 Strasbourg, France

² CNRS, LNCA UMR7364, 67000 Strasbourg, France

³ Department of Biology, University of Pennsylvania, Philadelphia, Pennsylvania, USA

* Corresponding author

Manuscript in preparation

Scientific Context and Objectives

CBP is a lysine acetyltransferase as well as a transcriptional co-activator. CBP interaction with the transcription factor CREB is an essential event in the process of memory formation. Since the last ten years, the role of CBP has been explored during different forms of memory formation mostly using mutant mouse models.

In the present study, we have used a mutant mouse model of CBP (CBP^{KIX/KIX} mice) that contains triple point mutation in the KIX domain of CBP which makes it incapable to interact with phospho-CREB and c-Myb. Woods et al has previously described that CBP^{KIX/KIX} mice were impaired in long-term memory for contextual fear conditioning and novel object recognition (Wood et al., 2006). However, the significance of CBP-CREB interaction has never been tested for spatial memory consolidation in MWM using CBP^{KIX/KIX} mice.

In the present chapter, I have identified that CBP interaction with transcription factors like CREB through the KIX domain is essential for retention for long-term memory but not for short-term retention. Further, I studied the expression profiles of memory and plasticity related genes after spatial learning in two important brain regions for memory consolidation (dorsal hippocampus and prefrontal cortex) in CBP^{KIX/KIX} mice. The gene expression profile has also been compared with acetylation of specific histone marks related to transcriptional activation on the proximal promoters of those genes. Therefore this study provides evidences for the requirement of CBP-CREB interaction through the KIX domain for the persistence of long-term spatial memory.

PUBLICATION 2**CREB-dependent CBP regulations of plasticity-related genes is required for long-term spatial memory formation****Abstract**

Transcription is a key event in the process of long-term memory formation. The transcriptional coactivator and lysine acetyltransferase CREB-binding protein (CBP) is important for hippocampus-dependent long-term memory and hippocampal synaptic plasticity. By virtue of its multiple functional domains, it interacts with a wide array of transcription factors and other functionally relevant proteins. Importantly, almost all the genetically modified *cbp* mutant mice showed impairments in object recognition tasks. However, the role of CBP in the spatial memory consolidation is still debatable. We used CBP^{KIX/KIX} mice carrying inactivating mutations in the CREB-binding (KIX) domain of the coactivator CBP to study the role of CBP KIX domain in spatial memory consolidation. In this study we found that CBP^{KIX/KIX} mice presented a significant but slower acquisition than the WT mice, but did not show long-term spatial memory retention in the Morris water maze, neither at recent nor at remote retention times. However, short-term retention was not impaired. Using quantitative real-time RT-PCR, we found that the expression of specific memory and plasticity related genes was not induced by spatial training in both the dorsal hippocampus and frontal cortex of CBP^{KIX/KIX} compared to WT mice. Further studies in the dorsal hippocampus revealed that two of these genes (*Zif268* and *Nr4a1*) presented a marked decrease of acetylated H2B histone (H2BK5 acetylation) occupancy at their gene promoters. Thus the interaction of the transcriptional coactivator CBP via the KIX domain with CREB impairs the activation of genes required for the long-term storage of spatial memory.

Keywords: CBP KIX domain, spatial memory, chromatin, histone acetylation, hippocampus

Introduction

The process of memory formation has been a subject for intense research and is known to involve multiple complex steps at both synaptic and systemic level of consolidation. Learning induces series of transcription dependent processes known as memory consolidation that involves conversion of short term memory to a more stable-long term memory. Histone acetylation is a post translational modification catalyzed by lysine acetyltransferases (KATs/HATs) that add an acetyl group from acetyl-coA to the ϵ -amino group of a lysine residue. The reverse reaction is catalyzed by lysine deacetylases (KDACs/HDACs). CREB binding protein (CBP) is a transcriptional coactivator displaying HAT properties. Among all the HATs, the role of CBP in long-term memory storage is best demonstrated (Oike et al., 1999; Bourtchouladze et al., 2003; Alarcón et al., 2004; Korzus et al., 2004; Wood et al., 2005). Various transgenic CBP mutant mouse models have been reported with either entire CBP allele deletion (Alarcon et al., 2004), expressing a dominant-negative truncation mutant of CBP (Oike et al., 1999; Bourtchouladze et al., 2003; Wood et al., 2005) or expressing a HAT activity deficient CBP (Korzus et al., 2004). All these mice models showed memory impairments in novel object recognition tasks, whereas results from spatial memory were variable. Initially it was shown that the histone acetyltransferase domain (HAT domain) of CBP is pivotal for spatial memory consolidation, whereas overtraining could compensate the deficiency (Korzus et al., 2004). However, mice bearing conditional knockout CBP from principal neurons of the forebrain (Valor et al., 2011) and haploinsufficiency for CBP (CBP^{+/-} mice) (Alarcón et al., 2004) displayed normal spatial memory in the MWM. Wood et al demonstrated the role of CBP KIX domain in consolidation of long-term memory for contextual fear conditioning and novel object recognition (Wood et al., 2006). Also HDAC inhibitor mediated improvement of long-term memory is CBP KIX domain dependent and involves interaction with CREB (Haettig et al., 2011; Vecsey et al., 2007).

CBP binds to multiple transcription factors (Goodman and Smolik, 2000) including the phosphorylated form of cyclic-AMP response element binding protein (CREB) through the KIX domain. CREB is a transcription factor involved in the transcriptional machinery responsible for memory related gene expression (Kida and Serita, 2014). Knockdown of CREB results in impairment of spatial memory whereas overexpression of CREB in dorsal hippocampus causes memory improvement (Sekeres et al., 2010; Pittenger et al., 2002) suggesting hippocampal CREB is necessary for spatial memory formation (Porte et al., 2008;

Benito and Barco, 2010). However, constitutively active CREB in the hippocampus (VP-16 mice) impairs retrieval of spatial memory (Viosca et al., 2009). Therefore, learning and retrieval of spatial memory requires a tight regulation of CREB pathway (Benito and Barco, 2010). CBP KIX domain and CREB interaction is mediated by phosphorylation of CREB at Ser133 through its kinase inducible domain (KID). This CBP / phospho-CREB interaction is influenced by various external stimuli and thereby activation of a series of signalling cascades (Mayr and Montminy, 2001) that contributes to long-term memory formation.

In this study, we examined the influence of CBP KIX domain on different forms of spatial memory: short-term and long-term memory (both recent and remote) retention. We used a mutant mouse model, CBP^{KIX/KIX} mice that contains triple point-mutations in the KIX domain of CBP which makes it incapable to interact with phospho-CREB and c-Myb but harbours intact HAT domain (Kasper et al., 2002). We demonstrate that CBP KIX domain is necessary for persistence of long-term spatial memory but not short-term retention. The global histone acetylation in the dorsal hippocampus after spatial learning is mostly unaffected in the CBP^{KIX/KIX} mice. However, regulation of learning induced gene expression is impaired in two important brain regions: dorsal hippocampus and frontal cortex. We also provide evidences of reduced occupancy of acetylated histone H2BK5 at the promoters of Zif268 and NR4a1 in the dorsal hippocampus of CBP^{KIX/KIX} mice after spatial learning. Thus, our data show that targeted CREB/CBP acetylation at plasticity-related genes is necessary to form long-term spatial memory.

Materials and methods

Animals

The CBP^{KIX/KIX} mice for experiments were generated from heterozygous mating (from C57BL/6 genetic background), and wild-type littermates were used as controls. Mice (CBP^{KIX/KIX}, n=20 and their control littermates, WT n=28) were 3 months old at the time of the experiment. They were housed in groups of 2-3 under 12-h light/12 h-dark cycle, with all behavioral testing carried out during the light portion of the cycle (lights on at 7:00 A.M.). Access to food and water was ad libitum in a temperature- and humidity controlled room (22°C and 55 +/- 5%, respectively). Experimental protocols and animal care were in compliance with the national (council directive 87-848, 19 october 1987, Ministère de

l'Agriculture et de la Forêt, Service Vétérinaire de la Santé et de la Protection Animale) and international (directive 86-609, 24 November 1986, European Community and new guidelines of the European Parliament 2010/63/UE of September 22, 2010) laws and policies.

Euthanasia for biochemical studies

After 2 days of habituation (H1, H2), 3 months old CBP^{KIX/KIX} mice (CBP^{KIX}, n =12) and their wild-type littermates (WT, n =12) were trained to search for a hidden platform (HPf) for 3 consecutive days (A1-A3). Mice were euthanized one hour after the last trial. One more group of CBP^{KIX/KIX} mice (CBP^{KIX}, n=3) and wild-type littermates (WT, n=4) were euthanized to serve as Home Cage (HC) control. Euthanasia was performed by cervical dislocation. Brains were quickly removed and sub-dissected to isolate dorsal hippocampus, ventral hippocampus, frontal cortex and cerebellum, flash frozen in liquid nitrogen and stored at -80°C. Dorsal hippocampus and frontal cortex collected from the learning group of mice were separated (CBP^{KIX/KIX}, n=6 and WT, n=6) and were divided into two fractions for western blot and RNA preparation respectively. The rest dorsal hippocampus (CBP^{KIX/KIX}, n=6 and WT, n=6) were processed for ChIP experiments.

Protein preparation and Western blot analyses

Tissues were lysed and homogenized in Laemmli buffer. After 10 min at 70°C, samples were sonicated twice for 15 s (ultrasonic processor, power 35%), boiled 5 min, centrifuged (20,000 X g for 5 min) and the supernatant was frozen at -20°C. Protein concentration was measured using the RC-DC Protein Assay (Bio-Rad). Western blots were performed as described previously (Chatterjee et al., 2013) with antibodies against acetyl-histone H2B (#07-373; Millipore), acetylated-histone H2BK5 (#07-382; Millipore), H3 histone (#ab1791; Abcam), acetyl Histone H3 (#06-599; Millipore), and H2B histone (#H2-28; Euromedex); and β-actin (#ab16039; Abcam). Secondary HRP-conjugated antibodies were from Jackson ImmunoResearch. Blots were revealed with ECL and exposed with Hyperfilm ECL (GE Healthcare). Results were quantified using ImageJ software.

RNA preparation and RTqPCR

Tissues were finely cut with a razor blade and homogenized with a Dounce in TRIzol reagent (Invitrogen). After chloroform extraction, RNAs were ethanol precipitated twice. Only RNA samples with an OD 260/280 and OD 260/230 ratio close to 2.0 were selected for reverse transcription. RNA samples were denatured 10 min at 70°C and cDNA synthesis was

performed on 1µg of total RNA (iScript cDNA synthesis kit; Bio-Rad). qRT-PCR analysis was performed on a Bio-Rad iCycler System (CFX) using SsoAdvanced SYBR Green Super-Mix (Bio-Rad). A specific standard curve was performed in parallel for each gene, and each sample was quantified in duplicate. qRTPCR conditions were 3 min at 95°C, followed by 40 cycles of two step PCR of 5 s at 94°C and 20 s at 60°C. Data were analysed by gene regression using iCycler software and normalized to the polymerase II, 36B4 and TBP RNA levels. Primers used for amplification were:

<i>Arc</i>	forward 5'-AGCAGCAGACCTGACATCCT-3' reverse 5'-GTGATGCCCTTCCAGACAT-3'
<i>FosL2</i>	forward 5'-CAGCCAAGTGTCGGAACC-3' reverse 5'-CTGCAGCTCAGCAATCTCTTT-3'
<i>Dusp1</i>	forward 5'-GGAGGATATGAAGCGTTTTTCGG-3' reverse 5'-GGATTCTGCACTGTCAGGCACA-3'
<i>cfos</i>	forward 5'-CGGGTTTCAACGCCGACTA-3' reverse 5'-TTGGCACTAGAGACGGACAGA-3'
<i>Zif268</i>	forward 5'-TACGAGCACCTGACCACAGA-3' reverse 5'-GGGTAGTTTGGGTGGGATAAC-3'
<i>Fosb</i>	forward 5'-CCGAGAAGAGACACTTACCCCA-3' reverse 5'-AAGTCGATCTGTCAGCTCCCTC-3'
<i>Icer</i>	forward 5'-GGTGACATGCCAACTTACCAGA- reverse 5'-TTGCGACTTGCTTCTTCTGC-3'
<i>Junb</i>	forward 5'-CTTTAAAGAGGAACCGCAGACC-3' reverse 5'-CGCTTTCGCTCCACTTTGAT-3'
<i>Nr4a1</i>	forward 5'-AAAATCCCTGGCTTCATTGAG-3' reverse 5'-TTTAGATCGGTATGCCAGGCG-3'
<i>Nr4a2</i>	forward 5'-CTCCAATCCGGGAATGAC-3' reverse 5'-AGAGCCAGTCAGGAGATCGT-3'
<i>Nr4a3</i>	forward 5'-GTGGCTCGACTCCATTAAAGAC-3' reverse 5'-GTGCATAGCTCCTCCACTCTCT-3'
<i>RNA Pol II</i>	forward 5'-AATCCGCATCATGAACAGTG-3' reverse 5'-TCATCCATTTTATCCACCACC-3'
<i>TBP</i>	forward 5'-AGTTCCGGAAAATGGTGTGC-3' reverse 5'-CACCATGTTCTGGATCTTGAAGT-3'

36B4 forward 5'-ACTGGTCTAGGACCCGAGAAG-3'
reverse 5'-TCCCACCTTGTCTCCAGTCT-3'

Chromatin immunoprecipitation (ChIP)

Dorsal hippocampus from 2 animals from same genetic background, age and training were mixed together and chopped with a razor blade to allow them to be mixed homogenously. The protocol described in Chatterjee et al., 2013 was adopted for the chromatin pull down. We used two different antibodies; acetylated-histone H2BK5 (#07-382; Millipore) and acetylated-histone H3K27(#ab4729; Abcam) for two separate pulldowns. For each pull down, we used no antibody as negative controls. No antibody control consisted of hippocampi from one WT and one CBP^{KIX/KIX} mice pulled together. Chromatin immunoprecipitations were quality controlled by the use of control genes that were either expressed ubiquitously (GAPDH) or not expressed in the hippocampus (TSH2B).

Nr4a1 forward 5'- CCCTTGTATGGCCAAAGCTC-3'
reverse 5'- CTCCGCAGTCCTTCTAGCAC-3'

Nr4a2 forward 5'- CCGTTCCCACCTTAAAATCA-3'
reverse 5'- CTGCCAACATGCACCTAAAG-3'

Nr4a3 forward 5'- GAGGGAGGAGGAGGGTGACGTA-3'
reverse 5'- CATAGAGTGCCTGGAATGCGAGA-3'

fos forward 5'- CACGGCCGGTCCCTGTTGTTC-3'
reverse 5'- GTCGCGGTTGGAGTAGTAGGCG-3'

DUSP1 forward 5'- TCAGCGGGGAGTTTTTGTG-3'
reverse 5'- CTGTGAGTGACCCTCAAAGTGG-3'

Zif268 forward 5'-GTGCCACCACTCTTGGAT-3'
reverse 5'-CGAATCGGCCTCTATTTCAA-3'

bdnf PIV forward 5'-GGCTTCTGTGTGCGTGAATTTGC-3'
reverse 5'-AAAGTGGGTGGGAGTCCACGAG-3'

Morris water maze for spatial memory learning and memory testing

Evaluation of spatial memory was performed using the Morris Water Maze task (MWM) as described in Chatterjee et al., 2013. For the spatial memory tests, 3 independent groups of mice CBP^{KIX/KIX} and their wild-type littermates (WT) were trained for 5 days to locate a

hidden platform under the surface of water using the visual cues present in the room. After the last training session, the platform was removed and all the three groups undertook one probe test (PT) at different time to measure short term (PT 1 hr), recent (PT 24hr) or remote (PT 30 days) memory. During the probe test, the mice were introduced on the opposite quadrant (respect to the target quadrant) were allowed to swim for 60 s. Spatial memory during the probe test was quantified by measuring the amount of time spent by the mice searching in the target quadrant versus the average time spent in three other equivalent quadrants. For the biochemical studies, mice were trained for 3 consecutive days and one hour after the last trial on the 3rd day they were euthanized by cervical dislocation. The brains were extracted and the dorsal hippocampus and frontal cortex were immediately dissected out, flashed freeze in liquid nitrogen and stored at -80⁰C.

Statistical analyses for biochemical studies

Statistical analyses were performed using Student's t test (Statistica software). Data are expressed as the means + SEM. Differences at $p < 0.05$ were considered as significant.

Statistical analyses for behavioral studies

Performance recorded during acquisition (latency to the platform) was evaluated using a two-way ANOVA for repeated measures considering the factors of “day” (1–5) and “genotype” (WT vs CBP^{KIX/KIX}). Probe trial performance was analysed using a t test comparing the time spent in the target quadrant to chance (i.e., 15 s) and the time spent in the target quadrant to the average time in the other three quadrants. Values of $p < 0.05$ were considered significant and are noted in the text.

Results

CBP^{KIX/KIX} mice are deficient in long-term memory consolidation but not short-term retention

We analyzed the consequences of CBP KIX domain mutation for spatial memory formation. CBP^{KIX/KIX} mice and their wild-type littermates (WT) were subjected to a hippocampus dependent memory task in the MWM. CBP^{KIX/KIX} (3 groups of mice, n=20 total) and their wild-type littermates (WT, n=28) were trained over 5 consecutive days to locate a hidden platform positioned at a fixed location. Three groups of mice (n=6-8/group) were made in

order to test three different retention times. **Figure 1A** shows the latencies for the three groups analyzed together. Both WT and CBP^{KIX/KIX} mice showed a day-to-day decrease (D1 to D5) in escape latencies [F(4,184)=39.20, $p=0.0001$] suggesting significant learning of the task. Individual learning curves for each group have been represented in **Supplementary Figure S1**. A “genotype” effect was also observed during the acquisition days [F(1, 46)=29.33, $p=0.0001$] (**Figure 1A, inset**). However, no interaction of “Genotype” and “Days” was observed over the acquisition days [F(4,184)=1.48, $p=0.208$ (ns)]. CBP^{KIX/KIX} mice showed an overall improvement comparable to their wild type littermates. During the acquisition sessions, the average speed of exploration for the WT and CBP^{KIX/KIX} mice were relatively constant and no significant interaction was noted between “training days” and “genotype” [F(4, 184)=0.441, $p=0.778$ (ns)] (**Figure 1B**). Time spent in the thigmo zone showed strong interaction of “Genotype” and “Days” over the acquisition [F(4,184)=11.92, $p=0.00001$]. CBP^{KIX/KIX} showed very high thigmotactic swimming during the first three days of acquisition compared to the WT (D1; $p=0.000008$, D2; $p=0.0014$, D3; $p=0.033$, WT Vs CBP^{KIX/KIX}). By day 4 and 5 of acquisition the thigmotaxis was significantly decreased and the performance was similar to that of WT mice (D4; $p=0.539$ and D5; $p=0.59$, WT Vs CBP^{KIX/KIX}) (**Figure 1C**). These results suggest that CBP^{KIX/KIX} mice can still improve their performance in MWM even without CBP-CREB interaction.

Our next aim was to study the effect of CBP KIX domain mutation in the short-term retention, recent and remote form of long-term memory. We tested the retention of the 3 independent groups of mice at a different time to measure either short term, (WT, n=10; CBP^{KIX/KIX}, n=6, PT 1hr) recent (WT, n=10; CBP^{KIX/KIX}, n=6, PT 24hr) or remote (WT, n=8; CBP^{KIX/KIX}, n=8, PT 30 days) memory. The time spent in the target quadrant was compared with the average time spent in the 3 other quadrants on each probe tests (**Figure 2 A, C and E**). As evidenced from the swim tracks (**Figure 2 B, D and F**), WT control mice showed significant retention of the platform location compared to random search in other quadrants (Short-term, $p=0.0001$; Recent memory, $p=0.0001$; Remote memory, $p=0.0025$) and their retention scores were above random (15s) at all the three delays (Short-term, $p=0.0001$; Recent memory, $p=0.0005$; Remote memory, $p=0.0226$) suggesting that they had constructed an enduring spatial memory. Performance of CBP^{KIX/KIX} mice was not different from WT littermates for short-term retention: they explored significantly more in the target quadrant compared to the average of the other three quadrants ($p=0.0058$) and the searching score was above chance (15s) ($p=0.0398$). Importantly, in the 1 hr delay probe trial CBP^{KIX/KIX} mice and the WT mice took similar amounts of time to reach the target quadrant for the first visit

(latency to first visit to TQ) (**Supplementary Figure S2A**). However, $CBP^{KIX/KIX}$ mice displayed less precision to search as indicated by significant differences in the annulus crossing ($p=0.0396$) (**Supplementary Figure S2B**). These results indicate that $CBP^{KIX/KIX}$ mice are not or only weakly impaired in short-term memory. Interestingly, retention of spatial memory for both recent and remote memory was impaired in $CBP^{KIX/KIX}$ mice (**Figure 2 C-F**). $CBP^{KIX/KIX}$ mice performance was not significantly higher in the target quadrant compared to the other quadrants for both recent and remote memory retention (Recent, $p=0.9411$; Remote, $p=0.0547$) and these mice failed to score above chance level (15s) (Recent, $p=0.9563$; Remote, $p=0.1421$). Performance score in the target platform of $CBP^{KIX/KIX}$ mice was significantly below compared to their WT littermates for both recent and remote memory retention (Recent, $p=0.0029$; Remote, $p=0.0052$) (*Recent*: **Figure 2C** and *Remote*: **Figure 2E**). Furthermore, the latency to visit the target quadrant was significantly higher in $CBP^{KIX/KIX}$ mice compared to the WT (Recent, $p=0.004$; Remote, $p=0.0092$; **Supplementary Figure S2C and E**). Lastly, significant differences in annulus crossings were also observed in $CBP^{KIX/KIX}$ mice compared to the WT in recent ($p=0.0018$) and remote ($p=0.0075$) memory retention (**Supplementary Figure 2D and F**). These results suggest that $CBP^{KIX/KIX}$ mice have severe defects to translate a short term memory into a long-term memory. Thus, they indicate a crucial role of CBP-CREB interaction in long-term spatial memory formation.

Histone acetylation study in $CBP^{KIX/KIX}$ mice

As we observed long-term memory impairments in $CBP^{KIX/KIX}$ mice, we investigated the molecular factors involved in CBP dependent spatial memory consolidation. Spatial learning induces histone acetylation in the dorsal hippocampus of rat brain (Bousiges et al., 2010). Therefore, we analysed the histone acetylation status on both non-behaving and behaving mice in the dorsal hippocampus. Among all the histone acetylation marks tested, no significant changes in histone acetylation were observed between WT and $CBP^{KIX/KIX}$ mice in the dorsal hippocampus of non-behaving mice (**Figure 3A and Supplementary Figure S3A**). We next analyzed the levels of histone acetylation in the dorsal hippocampus of WT ($n=6$) and $CBP^{KIX/KIX}$ ($n=6$) mice after 3 days of spatial learning in MWM (Learning curves shown in **Supplementary Figure S4**). Interestingly, significant differences of histone H2B K5 acetylation were observed between the WT and $CBP^{KIX/KIX}$ mice after spatial learning ($p=0.0165$). However, no such changes were observed for other histone acetylation marks

tested like H2B K5, 12, 15, 20 ac ($p=0.4193$), H3 K9, 14 ac ($p=0.9347$), H3 K27ac ($p=0.4216$) and H4 K12 ac ($p=0.0901$) (**Figure 3B and Supplementary Figure S3B**).

CREB activation by phosphorylation at Ser-133 is a critical event during memory formation. Phosphorylated CREB at Ser-133 binds with CBP through KIX domain and drives transcription of CREB target genes. Therefore, we next analyzed the basal and activated form of CREB at home cage condition and after spatial learning in the dorsal hippocampus. Total CREB protein levels were comparable between WT and CBP^{KIX/KIX} mice at both basal condition ($p=0.4254$) (**Supplementary Figure 5A**) and after spatial learning ($p=0.5716$) (**Supplementary Figure 5B**). No significant changes in phosphorylated CREB at Ser133 was also observed in basal condition, however a non-significant decrease was observed in CBP^{KIX/KIX} after learning ($p=0.1066$).

CBP^{KIX/KIX} mice shows differential gene expression pattern upon spatial learning

Long-term memory consolidation requires gene expression; therefore, we presumed that spatial learning dependent CREB target gene expression could be perturbed in the brains of CBP^{KIX/KIX} mice. To test the hypothesis, we used RT-qPCR to analyze the gene expression profiles of several memory- and plasticity- related genes in the dorsal hippocampus and frontal cortex after three days of spatial learning.

We evaluated the expression of Nr4A gene family in the dorsal hippocampus to study the effect of spatial learning in CBP^{KIX/KIX} mice. Spatial learning had a significant overall effect on gene expression for Nr4A family (**Figure 4A**). Notably, mRNA expression of *Nr4a1* and *Nr4a2* were significantly decreased in CBP^{KIX/KIX} mice compared to their WT littermates (*Nr4a1*: $p=0.0144$; *Nr4a2*: $p=0.0008$) (**Figure 4A**). However, no change in *Nr4a3* gene expression was observed between the two genotypes (*Nr4a3*: $p=0.9162$). We next evaluated the expression profile of *bdnf* in dorsal hippocampus after spatial learning. *bdnf* gene produces different splice variants. In the hippocampus, *bdnf* gene regulation is activated by different promoters; most importantly promoter I and IV are implicated in various forms of memory. Total (tot *bdnf*), exon I (*bdnf_eI*), and exon IV (*bdnf_eIV*) *bdnf* mRNA levels were measured in response to spatial learning. No significant changes in *bdnf* transcript variants were observed in CBP^{KIX/KIX} mice (**Figure 4B**). It was shown that other CREB target genes like *Dusp1*, *Fosb*, *Bdnf IV*, and *Icer* activation upon contextual fear conditioning is impaired in CBP^{KIX/KIX} mice (Wood et al., 2006). Therefore, we next checked gene expression patterns of CREB target genes *cfos*, *FosL2*, *Fosb*, *Zif268*, *ARC*, *JunB* and *Dusp1*. Several of these

genes have been implicated in memory storage (Herdegen and Leah, 1998; Conti et al., 2002; 2004; Kida et al., 2002; Conkright et al., 2003; Fass et al., 2003; Penke et al., 2011). As shown in **Figure 4C**, spatial learning dependent gene expression of *cfos* ($p=0.0013$), *FosL2* ($p=0.0037$), *FosB* ($p=0.0164$), *Zif268* ($p=0.0322$), *JunB* ($p=0.0004$) and *DUSP1* ($p=0.0052$) were significantly reduced in $CBP^{KIX/KIX}$ compared to WT. These results suggest that $CBP^{KIX/KIX}$ mice are impaired in expression of learning induced CREB target genes in the dorsal hippocampus.

Prefrontal cortex is another brain region implicated in long-term memory storage (Frankland and Bontempi, 2005; Jo et al., 2007). Prefrontal cortex has highly interconnected regions (anterior cingulate, prelimbic and infralimbic cortices) which are reciprocally connected to sensory, motor and limbic cortices. Its high connectivity makes it well suited to process long-term memory (Frankland and Bontempi, 2005). Lesions in the mPFC of rats disrupt spatial memory retrieval corresponding to decreased expression of immediate early gene *c-fos* in mPFC and the hippocampus (Jo et al., 2007). Therefore, we measured the gene expression profile in prefrontal cortex for all the sets of genes that we tested in the dorsal hippocampus upon spatial learning between these two important brain structures. As in the dorsal hippocampus, Nr4A subfamily of genes showed similar trend of expression pattern in the frontal cortex (**Figure 5A**). *Nr4a1* and *Nr4a2* mRNA expression was significantly down-regulated in $CBP^{KIX/KIX}$ mice compared to its WT littermate upon learning in the frontal cortex (*Nr4a1*; $p=0.0014$, *Nr4a2*; $p=0.0019$). Notably, we observed a non-significant decrease in *Nr4a3* transcript levels ($p=0.0854$) (**Figure 5A**). *Bdnf* splice variants, *eI* and *total bdnf* did not show any alteration of expression between genotypes (**Figure 5B**). However, *bdnf eIV* was significantly reduced in $CBP^{KIX/KIX}$ mice ($p=0.0307$). again, similarly to that observed in the dorsal hippocampus, significant differences in mRNA levels were observed for *cfos* ($p=0.0009$), *FosL2* ($p=0.0032$), *FosB* ($p=0.0291$), *Zif268* ($p=0.0057$), *JunB* ($p=0.0576$) and *DUSP1* ($p=0.0002$) between $CBP^{KIX/KIX}$ and WT mice (**Figure 5C**). *ARC* was unchanged in both dorsal hippocampus and frontal cortex between the two genotypes (Dorsal hippocampus: $p=0.2267$; Frontal cortex: $p=0.4146$). Thus, several memory and plasticity related gene expression is impaired in both dorsal hippocampus and prefrontal cortex of $CBP^{KIX/KIX}$ mice, which could correspond to defects at the systemic consolidation level and thus, impairment in long-term memory formation as observed in MWM tests.

Reduced occupancy of acetylated histones at Nr4A1 and zif268 gene promoters during spatial learning

Histone acetylation at the proximal promoters of genes is closely related to its transcriptional status (Grunstein, 1997). Spatial learning induces histone acetylation, such as H2B acetylation, at the promoters of memory and plasticity related genes like bdnf eIV, cfos, FosB and Zif268 (Bousiges et al., 2010). H3K27ac, another targeted acetylation of CBP (Tie et al., 2009), is a mark associated to enhancers at activity-regulated genes (Malik et al., 2014). Recruitment of CBP on the promoters of its target genes upon neuronal activity could thus lead to acetylation of their promoter and further recruitment of the general transcriptional machinery that drives gene transcription (Hawk et al., 2012). Therefore, we further investigated the histone acetylation status at the promoters of spatial learning induced genes using chromatin immunoprecipitation (ChIP) with antibodies specific to acetylated histone H2BK5 and H3K27. Compared to control WT mice, the occupancy of H2BK5 acetylation mark was significantly reduced on the proximal promoter of Nr4a1 ($p=0.0453$) gene in the dorsal hippocampus of CBP^{KIX/KIX} mice after spatial learning (**Figure 6A**). A non-significant trend of decreased H2BK5 acetylation was also seen at Nr4a2 ($p=0.1228$) promoter and no such change on Nr4a3 ($p=0.2208$) promoter. No significant differences were observed in the levels of H3K27 acetylation on the promoters of Nr4a1 ($p=0.2343$), Nr4a2 ($p=0.5094$) and Nr4a3 ($p=0.1863$) gene (**Figure 6B**). We also analyzed the occupancies of histone acetylation on the promoters of other memory and plasticity related genes that showed altered expression in dorsal hippocampus of CBP^{KIX/KIX} mice after spatial learning. Acetylated H2BK5 was significantly reduced on Zif268 promoter ($p=0.0281$) whereas no such changes were observed for cfos ($p=0.1892$), bdnf PIV ($p=0.3556$) and DUSP1 ($p=0.4536$) (**Figure 6A**). A non-significant tendency of decreased acetylation of H3K27 was seen on the promoter of cfos ($p=0.0802$), whereas H3K27 acetylation was mostly unchanged at the promoters of Zif268 ($p=0.3214$), bdnf PIV ($p=0.8556$) and DUSP1 ($p=0.603$) in CBP^{KIX/KIX} mice. Taken together, these results show that only *Nr4a1* and *Zif268* CBP-CREB target genes display reduced H2BK5ac on their proximal promoter in CBP^{KIX/KIX} mice after spatial learning.

Discussion

In the present study, we showed that CBP^{KIX/KIX} mice are dramatically impaired in retention of long-term spatial memory (both recent and remote) while short-term memory is relatively

spared. These mutant mice also showed delayed acquisition performances compared to the WT mice. We further showed that the expressions of specific activity-dependent genes were impaired in both dorsal hippocampus and frontal cortex of CBP^{KIX/KIX} mice during spatial training. In addition, lysine 5 of histone H2B, a target of CBP, was under-acetylated in response to learning. In the dorsal hippocampus of CBP^{KIX/KIX} mice, this histone mark was also decreased at the proximal promoters of two downregulated genes, e.g. Nr4a1 and Zif268 promoters, with both important functions in spatial memory formation. Thus the present study indicates that CBP interaction with transcription factors (like CREB) through its KIX domain could drive proper chromatin modification at specific sites that could be essential for the persistence of spatial information in memory.

Intact CBP KIX domain is required for long-term memory formation

In this study, we found that CBP^{KIX/KIX} mice were able to learn a complex spatial task such as the Morris water maze, even though their performance in the initial training days was significantly below the WT. Reduced learning during the first 3 days of training was also accompanied by high thigmotactic behavior. High thigmotaxis could be due to stress-related factors, with which mice were able to cope during the course of the training. We tested several parameters to test the retention at different time-points: measurements of time in target quadrant, number of annulus crossings and latency to the first visit of the target quadrant. The results suggest that CBP^{KIX/KIX} mice showed adequate performance in 1 hr short-term memory. Even though the CBP^{KIX/KIX} mice still searched in the target quadrant for a significant amount of time, the search was less precise than in the WT mice. However, the scores of annulus crossing by CBP^{KIX/KIX} mice for the retention of short-term memory (4.6) were similar to the scores of WT mice during the retention of recent (5.1) and remote (5.5) memory, indicating that CBP^{KIX/KIX} mice can store the location of the platform in their short-term memory. Interestingly, recent and remote spatial memory was strongly impaired in CBP^{KIX/KIX} mice as indicated by significantly reduced time to search for target quadrant, decreased number of target annulus crossing, and high latency to the first visit of the target quadrant.

Activation of the CREB signaling pathway is one of the fundamental events during the process of spatial memory consolidation (Sekeres et al., 2010; Barco and Marie, 2011; Kandel, 2012). CREB is considered to be a major component that controls the conversion of short-term forms of plasticity to long-term forms underlying long-term memory formation (Lonze and Ginty, 2002; Barco and Marie, 2011; Gruart et al., 2012). Interestingly, *creb* mutant mice showed deficiency in spatial memory retention after one-hour post-acquisition (Sekeres et al., 2010). Thus, as $CBP^{KIX/KIX}$ mice were not deficient in short-term retention, it is likely that CREB signalling has been initiated independently of CBP-CREB interaction, through other activators such as CRTCs (Iourgenko et al., 2003; Sekeres et al., 2012). Studies with mice expressing constitutively active CREB with strong transcriptional transactivator function (known as VP16-CREB) suggest that spatial learning and memory retention requires precise regulation of CREB pathway (Viosca et al., 2009). The role of CBP in the process of memory formation has also been investigated. Almost all the previously described *cbp* mutant models showed deficiencies in some hippocampus-dependent forms of memory, particularly for object recognition tasks, whereas spatial memory was altered in only few of them (Oike et al., 1999; Alarcón et al., 2004; Korzus et al., 2004). Importantly, HAT domain mutant mice of CBP were deficient in long-term spatial memory whereas short-term memory was sparse. Interestingly, deficiency in long-term spatial memory could be completely rescued by intense training in these mice (Korzus et al., 2004). Mice with complete knock out of CBP (cKO) in the excitatory neurons of the postnatal forebrain were impaired in both short- and long-term spatial memory (Chen et al., 2010). On the contrary, CBP deletion from postmitotic principal neurons of the forebrain of mice displayed intact spatial memory (Valor et al., 2011). CBP haploinsufficiency mice ($CBP^{+/-}$ mice) have no deficits in spatial memory in MWM (Alarcón et al., 2004) but are impaired in environmental enrichment (EE)-mediated enhancement of spatial memory (Lopez-Atalaya et al., 2011).

Two possible explanations could account for our contradictory results on $CBP^{KIX/KIX}$ mice with findings from CBP cKO mice, where CBP is deleted only at the adult stage (Valor et al., 2011), which have no impairment in long-term memory storage during spatial memory tests. Firstly, in complete absence of CBP (as in the case of CBP cKO), some other factors might compensate for the loss of CBP and therefore can still restore memory-related functions. In $CBP^{KIX/KIX}$ mice, a mutant form of CBP is present in the neurons. As a result CBP cannot be replaced (i.e. the mutation would be considered as dominant); however it cannot trigger its transcriptional co-activator function by activating its target gene expression through

association with phospho-CREB. Secondly, CBP^{KIX/KIX} mice express the mutant form of CBP from developmental stages. Therefore, it could be possible that the fundamental neuronal networks or neuronal activity might be altered in the CBP^{KIX/KIX} mice (like synaptic plasticity and neurogenesis) as CBP is essential for embryonic neural differentiation in brain (Wang et al., 2010). Recent evidence also suggests that CBP is a key regulator of interneuron development in brain (Tsui et al., 2014). Therefore, mutation in CBP from developmental stages (as in the case with CBP^{KIX/KIX} mice) could affect the normal development of the brain and thus could result in defects at both synaptic- and systems level during memory consolidation.

CBP-CREB interaction targets specific IEGs during spatial learning

Memory consolidation requires transient gene expression within a strict window of time. These genes maintain a specific pattern of expression after hours from learning that is associated with waves of transcription which are required for memory consolidation (Alberini and Kandel, 2015). These transcriptional waves emerge from precisely timed and coordinated activities of specific transcriptional regulatory proteins that recruit epigenetic modifying enzymes and transcriptional machinery to the promoters of memory-related genes (Peixoto and Abel, 2013). Transcription of immediate early genes (IEGs) are induced by activity following learning, is one such critical step during long-term memory formation (Guzowski, 2002). It was previously demonstrated that 3 days of spatial learning is sufficient to increase memory and plasticity related gene expression like *bdnf eIV*, *cfos*, *Zif268* and *FosB* in the dorsal hippocampus of rats within one hour after the last training session in MWM (Bousiges et al., 2010). In our study, CBP^{KIX/KIX} mice showed impaired expression of several memory and plasticity related genes after spatial learning including *NR4a1*, *Nr4a2*, *cfos*, *FosL2*, *FosB*, *JunB*, *DUSP1* and *Zif268* in both dorsal hippocampus and frontal cortex. Similarly, *FosB* was found downregulated in home cage CBP^{KIX/KIX} mice and contextual fear conditioning failed to rescue the *FosB* gene expression in the hippocampus (Wood et al., 2005). Notably, transgenic mice deficient to CBP HAT domain also display significantly decreased hippocampal *FosB* expression (Korzus et al., 2004).

In our study, *Nr4a1* and *Nr4a2* transcript levels were strongly reduced in both the dorsal hippocampus and frontal cortex of CBP^{KIX/KIX} mice compared to control WT mice. The Nr4A subfamily of nuclear receptors are critical regulators of long-term memory storage and

hippocampal synaptic plasticity (Hawk and Abel, 2011, Hawk et al., 2012, McNulty et al., 2012; Bridi and Abel, 2013). Blocking Nr4A activity in memory-supporting brain regions impairs long-term memory but do not impact on short-term memory in mice (Hawk et al., 2012). Antisense oligodeoxynucleotide injection mediated knockdown of Nr4a2 into the hippocampus disrupts long-term memory in a spatial discrimination task (Colón-Cesario et al., 2006). Interestingly, Nr4a1 and Nr4a2 have been differentially implicated in long-term memory for object location / recognition, Nr4a2 being associated with both types of memory, while Nr4a1 was necessary only for object location (McNulty et al., 2012). Thus, *Nr4a* family regulation seems to be a component of spatial processing. Importantly, we found that *Nr4a1* and *Nr4a2* mRNA expression was attenuated by mutation on KIX domain of CBP in both brain structures, suggesting that the lack of NR4A activation could impact in the memory consolidation process of CBP^{KIX/KIX} mice.

Apart from NR4A subfamily and *FosB*, we also observed significantly decreased expression of CREB target genes *cfos*, *FosL2*, *FosB*, *JunB*, *DUSP1* and *Zif268* in CBP^{KIX/KIX} mice upon learning. Expression of activity-dependent genes (*Zif268* and *c-fos*) are increased in hippocampus after recall of recent memory whereas recall of remote memory induces its expression in the prefrontal cortex (Frankland et al., 2004). Both *cfos* and *Zif268* are also responsive to spatial learning in the hippocampus (Bousiges et al., 2010) whereas activation of CBP HAT function by small molecule activator, CSP-TTK21, can induce *Nr4a2*, *cfos* and *FosL2* gene expression in basal (non behaving animals) conditions (Chatterjee et al., 2013). Furthermore, ablation of CBP in mice forebrain results in reduced mRNA expression of *Nr4a1* and *Zif268* in CA1 after exposure to novelty (Valor et al., 2011). NR4A activity is required for long-term but not short-term memory whereas retrieval of long-term recent and remote memory requires *cfos* and *Zif268* expression in dorsal hippocampus and prefrontal cortex respectively (Frankland et al., 2004). *Zif268* is strongly implicated in spatial memory and stabilization of late long-term potentiation (Veyrac et al., 2014). *Zif268* is essential for learning dependent functional integration of adult hippocampal new-born neurons into spatial memory network (Veyrac et al., 2013). Mice lacking *Zif268* are deficient in long-term spatial memory consolidation (Jones et al., 2001) whereas gain-of function of *Zif268* leads to increased hippocampal functioning to form long-term spatial memory (Penke et al., 2014). Taken together, these findings suggest that *Zif268*, *Nr4a1* and *Nr4a2* have substantial role in spatial memory and could be a major target of CBP-CREB during spatial memory consolidation.

Specific deacetylation at Nr4A1 and Zif268 promoters in CBP^{KIX/KIX} mice

Transcription requires not only recruitment of transcription factors, but also removal of repressive histone marks as well as acetylated chromatin at the promoters. CBP recruitment reverses the transcriptionally silent chromatin by acetylation dependent chromatin remodelling (Fischle et al., 2003). In this study, we tested two histone acetylation marks that have been reported to be targeted by CBP: H2BK5ac and H3K27ac. The H2B histone is strongly deacetylated in the hippocampus of CBP deficient mice (Alarcon et al., 2004; Valor et al., 2011). Particularly, H2BK5 was found on the transcription start site (TSS) of active genes and thus, is a mark of active transcription (Wang et al., 2008). The acetylation of H2BK5 is also highly responsive to spatial learning (Bousiges et al., 2013). We observed decreased occupancies of acetylated histone H2BK5 on the proximal promoter of Nr4a1 and Zif268 gene in the dorsal hippocampus of CBP^{KIX/KIX} mice after spatial learning. These are two important components of spatial memory learning processes. Nr4A gene expression is regulated by histone acetylation and blocking Nr4A signaling inhibits the HDAC inhibitor mediated enhancement of memory (Hawk et al., 2012). Importantly, Zif268 promoter is also responsive to histone acetylation (Guan et al., 2009) and increased promoter histone acetylation correlates with increased *Zif268* expression in the hippocampus (Xie et al., 2013). Further, object exploration increases histone acetylation at Zif268 promoter in the hippocampus and the prefrontal cortex (Gräff et al., 2012).

CBP was also shown to acetylate H3K27 (Tie et al., 2009) and this mark is found to be highly enriched at promoter regions of transcriptionally active genes (Wang et al., 2008). Particularly, CBP binding increased acetylation of H3K27 after membrane depolarization of cortical neurons function to regulate activity-dependent transcription (Malik et al., 2014). However, no significant differences of acetylation of H3K27 were observed on the promoters of the IEGs we have tested, a non-significant tendency was seen on *cfos* promoter. One possible explanation is that H3K27 acetylation could be target of other HATs like p300 (Bedford and Brindle, 2012; Hilton et al., 2015) and are possibly recruited to the chromatin through its KIX domain. However, p300 binding with CREB may not be sufficiently able to activate the learning dependent transcription of CREB target genes required for memory formation, possibly due to incomplete recruitment of the transcriptional machinery. This hypothesis is further supported by the fact that mice mutated on p300 KIX domain (p300^{KIX/KIX} mice) shows normal motor learning whereas analogous mutation on CBP KIX domain (CBP^{KIX/KIX} mice) shows motor learning deficits (Oliveira et al., 2006). Therefore,

our results further suggests that acetylation at the promoters of IEGs are not sufficient to induce transcription, if CBP KIX interaction with factors such as CREB can not occur, as it is required to initiate the transcriptional process.

Taken together, our data suggests that IEGs activation are predominantly regulated by CBP-CREB interaction during spatial memory consolidation. They further evidence an H2BK5ac – dependent regulatory mechanisms targeted by CBP KIX domain on *Nr4a1* and *Zif268* proximal promoters.

Conclusion

In the current study, we established that the KIX domain of CBP is a pivotal component in the persistence of long-term spatial memory. Mutation in KIX domain resulted in differential gene expression pattern in two important brain regions essential for spatial memory consolidation (dorsal hippocampus and prefrontal cortex). Impaired long-term but not short-term memory also supported the gene expression data and indicated roles of *Nr4a1* and *Zif268* expression. Thus, the present study extends our knowledge on the function of a specific domain of the transcriptional coactivator and lysine acetyltransferase CBP in the complex process of spatial memory formation.

Acknowledgement: SC was supported by CEFIPRA fellowship (Grant #4803-3 to A.-L.B and T.K.K.). This work was supported by the Centre National de la Recherche Scientifique, the University of Strasbourg and the Indo-French Centre for the Promotion of Advanced Research (Grant #4803-3 to A.-L.B and T.K.K.). We thank A. Bombardier for genotyping and production of transgenic mice. O. Bildstein, D. Egesi and G. Edomwonyi for their assistance with animal care.

Author's contribution: SC performed the MWM tests, Western-blot, gene expression studies and chromatin immunoprecipitation (ChIP), ASA performed the RNA extraction from dorsal hippocampus. CBP^{KIX/KIX} mice were obtained from TA's laboratory. SC, JCC and ALB designed the experiments, analyzed the data and wrote the manuscript.

Disclosure statement: Authors declare no conflicts of interest

References

- Alarcón, J.M., Malleret, G., Touzani, K., Vronskaya, S., Ishii, S., Kandel, E.R., and Barco, A. (2004). Chromatin acetylation, memory, and LTP are impaired in CBP^{+/-} mice: a model for the cognitive deficit in Rubinstein-Taybi syndrome and its amelioration. *Neuron* 42, 947–959.
- Alberini, C.M., and Kandel, E.R. (2015). The regulation of transcription in memory consolidation. *Cold Spring Harb. Perspect. Biol.* 7, a021741.
- Barco, A., and Marie, H. (2011). Genetic approaches to investigate the role of CREB in neuronal plasticity and memory. *Mol. Neurobiol.* 44, 330–349.
- Bedford, D.C., and Brindle, P.K. (2012). Is histone acetylation the most important physiological function for CBP and p300? *Aging* 4, 247–255.
- Benito, E., and Barco, A. (2010). CREB's control of intrinsic and synaptic plasticity: implications for CREB-dependent memory models. *Trends Neurosci.* 33, 230–240.
- Bourtchouladze, R., Lidge, R., Catapano, R., Stanley, J., Gossweiler, S., Romashko, D., Scott, R., and Tully, T. (2003). A mouse model of Rubinstein-Taybi syndrome: defective long-term memory is ameliorated by inhibitors of phosphodiesterase 4. *Proc. Natl. Acad. Sci. U. S. A.* 100, 10518–10522.
- Bousiges, O., Vasconcelos, A.P. de, Neidl, R., Cosquer, B., Herbeaux, K., Panteleeva, I., Loeffler, J.-P., Cassel, J.-C., and Boutillier, A.-L. (2010). Spatial memory consolidation is associated with induction of several lysine-acetyltransferase (histone acetyltransferase) expression levels and H2B/H4 acetylation-dependent transcriptional events in the rat hippocampus. *Neuropsychopharmacol. Off. Publ. Am. Coll. Neuropsychopharmacol.* 35, 2521–2537.
- Bousiges, O., Neidl, R., Majchrzak, M., Muller, M.-A., Barbelivien, A., Pereira de Vasconcelos, A., Schneider, A., Loeffler, J.-P., Cassel, J.-C., and Boutillier, A.-L. (2013). Detection of histone acetylation levels in the dorsal hippocampus reveals early tagging on specific residues of H2B and H4 histones in response to learning. *PloS One* 8, e57816.
- Bridi, M.S., and Abel, T. (2013). The NR4A orphan nuclear receptors mediate transcription-dependent hippocampal synaptic plasticity. *Neurobiol. Learn. Mem.* 105, 151–158.
- Chatterjee, S., Mizar, P., Cassel, R., Neidl, R., Selvi, B.R., Mohankrishna, D.V., Vedamurthy, B.M., Schneider, A., Bousiges, O., Mathis, C., et al. (2013). A novel activator of CBP/p300 acetyltransferases promotes neurogenesis and extends memory duration in adult mice. *J. Neurosci. Off. J. Soc. Neurosci.* 33, 10698–10712.
- Chen, G., Zou, X., Watanabe, H., van Deursen, J.M., and Shen, J. (2010). CREB binding protein is required for both short-term and long-term memory formation. *J. Neurosci. Off. J. Soc. Neurosci.* 30, 13066–13077.

Colón-Cesario, W.I., Martínez-Montemayor, M.M., Morales, S., Félix, J., Cruz, J., Adorno, M., Pereira, L., Colón, N., Maldonado-Vlaar, C.S., and Peña de Ortiz, S. (2006). Knockdown of Nurr1 in the rat hippocampus: implications to spatial discrimination learning and memory. *Learn. Mem. Cold Spring Harb. N* 13, 734–744.

Conkright, M.D., Guzmán, E., Flechner, L., Su, A.I., Hogenesch, J.B., and Montminy, M. (2003). Genome-wide analysis of CREB target genes reveals a core promoter requirement for cAMP responsiveness. *Mol. Cell* 11, 1101–1108.

Conti, A.C., Cryan, J.F., Dalvi, A., Lucki, I., and Blendy, J.A. (2002). cAMP response element-binding protein is essential for the upregulation of brain-derived neurotrophic factor transcription, but not the behavioral or endocrine responses to antidepressant drugs. *J. Neurosci. Off. J. Soc. Neurosci.* 22, 3262–3268.

Conti, A.C., Kuo, Y.-C., Valentino, R.J., and Blendy, J.A. (2004). Inducible cAMP early repressor regulates corticosterone suppression after tricyclic antidepressant treatment. *J. Neurosci. Off. J. Soc. Neurosci.* 24, 1967–1975.

Fass, D.M., Butler, J.E.F., and Goodman, R.H. (2003). Deacetylase activity is required for cAMP activation of a subset of CREB target genes. *J. Biol. Chem.* 278, 43014–43019.

Fischle, W., Wang, Y., and Allis, C.D. (2003). Histone and chromatin cross-talk. *Curr. Opin. Cell Biol.* 15, 172–183.

Frankland, P.W., and Bontempi, B. (2005). The organization of recent and remote memories. *Nat. Rev. Neurosci.* 6, 119–130.

Frankland, P.W., Bontempi, B., Talton, L.E., Kaczmarek, L., and Silva, A.J. (2004). The involvement of the anterior cingulate cortex in remote contextual fear memory. *Science* 304, 881–883.

Goodman, R.H., and Smolik, S. (2000). CBP/p300 in cell growth, transformation, and development. *Genes Dev.* 14, 1553–1577.

Gräff, J., Woldemichael, B.T., Berchtold, D., Dewarrat, G., and Mansuy, I.M. (2012). Dynamic histone marks in the hippocampus and cortex facilitate memory consolidation. *Nat. Commun.* 3, 991.

Gruart, A., Benito, E., Delgado-García, J.M., and Barco, A. (2012). Enhanced cAMP response element-binding protein activity increases neuronal excitability, hippocampal long-term potentiation, and classical eyeblink conditioning in alert behaving mice. *J. Neurosci. Off. J. Soc. Neurosci.* 32, 17431–17441.

Grunstein, M. (1997). Histone acetylation in chromatin structure and transcription. *Nature* 389, 349–352.

Guan, J.-S., Haggarty, S.J., Giacometti, E., Dannenberg, J.-H., Joseph, N., Gao, J., Nieland, T.J.F., Zhou, Y., Wang, X., Mazitschek, R., et al. (2009). HDAC2 negatively regulates memory formation and synaptic plasticity. *Nature* 459, 55–60.

Guzowski, J.F. (2002). Insights into immediate-early gene function in hippocampal memory consolidation using antisense oligonucleotide and fluorescent imaging approaches. *Hippocampus* 12, 86–104.

Haettig, J., Stefanko, D.P., Multani, M.L., Figueroa, D.X., McQuown, S.C., and Wood, M.A. (2011). HDAC inhibition modulates hippocampus-dependent long-term memory for object location in a CBP-dependent manner. *Learn. Mem. Cold Spring Harb. N* 18, 71–79.

Hawk, J.D., and Abel, T. (2011). The role of NR4A transcription factors in memory formation. *Brain Res. Bull.* 85, 21–29.

Hawk, J.D., Bookout, A.L., Poplawski, S.G., Bridi, M., Rao, A.J., Sulewski, M.E., Kroener, B.T., Manglesdorf, D.J., and Abel, T. (2012). NR4A nuclear receptors support memory enhancement by histone deacetylase inhibitors. *J. Clin. Invest.* 122, 3593–3602.

Herdegen, T., and Leah, J.D. (1998). Inducible and constitutive transcription factors in the mammalian nervous system: control of gene expression by Jun, Fos and Krox, and CREB/ATF proteins. *Brain Res. Brain Res. Rev.* 28, 370–490.

Iourgenko, V., Zhang, W., Mickanin, C., Daly, I., Jiang, C., Hexham, J.M., Orth, A.P., Miraglia, L., Meltzer, J., Garza, D., et al. (2003). Identification of a family of cAMP response element-binding protein coactivators by genome-scale functional analysis in mammalian cells. *Proc. Natl. Acad. Sci. U. S. A.* 100, 12147–12152.

Jo, Y.S., Park, E.H., Kim, I.H., Park, S.K., Kim, H., Kim, H.T., and Choi, J.-S. (2007). The medial prefrontal cortex is involved in spatial memory retrieval under partial-cue conditions. *J. Neurosci. Off. J. Soc. Neurosci.* 27, 13567–13578.

Jones, M.W., Errington, M.L., French, P.J., Fine, A., Bliss, T.V., Garel, S., Charnay, P., Bozon, B., Laroche, S., and Davis, S. (2001). A requirement for the immediate early gene *Zif268* in the expression of late LTP and long-term memories. *Nat. Neurosci.* 4, 289–296.

Kandel, E.R. (2012). The molecular biology of memory: cAMP, PKA, CRE, CREB-1, CREB-2, and CPEB. *Mol. Brain* 5, 14.

Kasper, L.H., Boussouar, F., Ney, P.A., Jackson, C.W., Rehg, J., van Deursen, J.M., and Brindle, P.K. (2002). A transcription-factor-binding surface of coactivator p300 is required for haematopoiesis. *Nature* 419, 738–743.

Kida, S., and Serita, T. (2014). Functional roles of CREB as a positive regulator in the formation and enhancement of memory. *Brain Res. Bull.* 105, 17–24.

Kida, S., Josselyn, S.A., Peña de Ortiz, S., Kogan, J.H., Chevere, I., Masushige, S., and Silva, A.J. (2002). CREB required for the stability of new and reactivated fear memories. *Nat. Neurosci.* 5, 348–355.

Korzus, E., Rosenfeld, M.G., and Mayford, M. (2004). CBP histone acetyltransferase activity is a critical component of memory consolidation. *Neuron* 42, 961–972.

Lonze, B.E., and Ginty, D.D. (2002). Function and regulation of CREB family transcription factors in the nervous system. *Neuron* 35, 605–623.

Lopez-Atalaya, J.P., Ciccarelli, A., Viosca, J., Valor, L.M., Jimenez-Minchan, M., Canals, S., Giustetto, M., and Barco, A. (2011). CBP is required for environmental enrichment-induced neurogenesis and cognitive enhancement. *EMBO J.* 30, 4287–4298.

Malik, A.N., Vierbuchen, T., Hemberg, M., Rubin, A.A., Ling, E., Couch, C.H., Stroud, H., Spiegel, I., Farh, K.K.-H., Harmin, D.A., et al. (2014). Genome-wide identification and characterization of functional neuronal activity-dependent enhancers. *Nat. Neurosci.* 17, 1330–1339.

Mayr, B., and Montminy, M. (2001). Transcriptional regulation by the phosphorylation-dependent factor CREB. *Nat. Rev. Mol. Cell Biol.* 2, 599–609.

McNulty, S.E., Barrett, R.M., Vogel-Ciernia, A., Malvaez, M., Hernandez, N., Davatolhagh, M.F., Matheos, D.P., Schiffman, A., and Wood, M.A. (2012). Differential roles for Nr4a1 and Nr4a2 in object location vs. object recognition long-term memory. *Learn. Mem. Cold Spring Harb. N* 19, 588–592.

Oike, Y., Hata, A., Mamiya, T., Kaname, T., Noda, Y., Suzuki, M., Yasue, H., Nabeshima, T., Araki, K., and Yamamura, K. (1999). Truncated CBP protein leads to classical Rubinstein-Taybi syndrome phenotypes in mice: implications for a dominant-negative mechanism. *Hum. Mol. Genet.* 8, 387–396.

Oliveira, A.M.M., Abel, T., Brindle, P.K., and Wood, M.A. (2006). Differential role for CBP and p300 CREB-binding domain in motor skill learning. *Behav. Neurosci.* 120, 724–729.

Peixoto, L., and Abel, T. (2013). The role of histone acetylation in memory formation and cognitive impairments. *Neuropsychopharmacol. Off. Publ. Am. Coll. Neuropsychopharmacol.* 38, 62–76.

Penke, Z., Chagneau, C., and Laroche, S. (2011). Contribution of Egr1/zif268 to Activity-Dependent Arc/Arg3.1 Transcription in the Dentate Gyrus and Area CA1 of the Hippocampus. *Front. Behav. Neurosci.* 5, 48.

Penke, Z., Morice, E., Veyrac, A., Gros, A., Chagneau, C., LeBlanc, P., Samson, N., Baumgärtel, K., Mansuy, I.M., Davis, S., et al. (2014). Zif268/Egr1 gain of function facilitates hippocampal synaptic plasticity and long-term spatial recognition memory. *Philos. Trans. R. Soc. Lond. B. Biol. Sci.* 369, 20130159.

Pittenger, C., Huang, Y.Y., Paletzki, R.F., Bourtchouladze, R., Scanlin, H., Vronskaya, S., and Kandel, E.R. (2002). Reversible inhibition of CREB/ATF transcription factors in region CA1 of the dorsal hippocampus disrupts hippocampus-dependent spatial memory. *Neuron* 34, 447–462.

Plath, N., Ohana, O., Dammermann, B., Errington, M.L., Schmitz, D., Gross, C., Mao, X., Engelsberg, A., Mahlke, C., Welzl, H., et al. (2006). *Arc/Arg3.1* is essential for the consolidation of synaptic plasticity and memories. *Neuron* 52, 437–444.

Porte, Y., Buhot, M.C., and Mons, N.E. (2008). Spatial memory in the Morris water maze and activation of cyclic AMP response element-binding (CREB) protein within the mouse hippocampus. *Learn. Mem. Cold Spring Harb. N* 15, 885–894.

Sekeres, M.J., Neve, R.L., Frankland, P.W., and Josselyn, S.A. (2010). Dorsal hippocampal CREB is both necessary and sufficient for spatial memory. *Learn. Mem. Cold Spring Harb. N* 17, 280–283.

Sekeres, M.J., Mercaldo, V., Richards, B., Sargin, D., Mahadevan, V., Woodin, M.A., Frankland, P.W., and Josselyn, S.A. (2012). Increasing *CRTC1* function in the dentate gyrus during memory formation or reactivation increases memory strength without compromising memory quality. *J. Neurosci. Off. J. Soc. Neurosci.* 32, 17857–17868.

Tie, F., Banerjee, R., Stratton, C.A., Prasad-Sinha, J., Stepanik, V., Zlobin, A., Diaz, M.O., Scacheri, P.C., and Harte, P.J. (2009). CBP-mediated acetylation of histone H3 lysine 27 antagonizes *Drosophila* Polycomb silencing. *Dev. Camb. Engl.* 136, 3131–3141.

Tsui, D., Voronova, A., Gallagher, D., Kaplan, D.R., Miller, F.D., and Wang, J. (2014). CBP regulates the differentiation of interneurons from ventral forebrain neural precursors during murine development. *Dev. Biol.* 385, 230–241.

Valor, L.M., Pulopulos, M.M., Jimenez-Minchan, M., Olivares, R., Lutz, B., and Barco, A. (2011). Ablation of CBP in forebrain principal neurons causes modest memory and transcriptional defects and a dramatic reduction of histone acetylation but does not affect cell viability. *J. Neurosci. Off. J. Soc. Neurosci.* 31, 1652–1663.

Vecsey, C.G., Hawk, J.D., Lattal, K.M., Stein, J.M., Fabian, S.A., Attner, M.A., Cabrera, S.M., McDonough, C.B., Brindle, P.K., Abel, T., et al. (2007). Histone deacetylase inhibitors enhance memory and synaptic plasticity via CREB:CBP-dependent transcriptional activation. *J. Neurosci. Off. J. Soc. Neurosci.* 27, 6128–6140.

Veyrac, A., Gros, A., Bruel-Jungerman, E., Rochefort, C., Kleine Borgmann, F.B., Jessberger, S., and Laroche, S. (2013). *Zif268/egr1* gene controls the selection, maturation and functional integration of adult hippocampal newborn neurons by learning. *Proc. Natl. Acad. Sci. U. S. A.* 110, 7062–7067.

Veyrac, A., Besnard, A., Caboche, J., Davis, S., and Laroche, S. (2014). The transcription factor *Zif268/Egr1*, brain plasticity, and memory. *Prog. Mol. Biol. Transl. Sci.* 122, 89–129.

Viosca, J., Malleret, G., Bourtchouladze, R., Benito, E., Vronskava, S., Kandel, E.R., and Barco, A. (2009). Chronic enhancement of CREB activity in the hippocampus interferes with the retrieval of spatial information. *Learn. Mem. Cold Spring Harb. N* 16, 198–209.

Wang, J., Weaver, I.C.G., Gauthier-Fisher, A., Wang, H., He, L., Yeomans, J., Wondisford, F., Kaplan, D.R., and Miller, F.D. (2010). CBP histone acetyltransferase activity regulates embryonic neural differentiation in the normal and Rubinstein-Taybi syndrome brain. *Dev. Cell* 18, 114–125.

Wang, Z., Zang, C., Rosenfeld, J.A., Schones, D.E., Barski, A., Cuddapah, S., Cui, K., Roh, T.-Y., Peng, W., Zhang, M.Q., et al. (2008). Combinatorial patterns of histone acetylations and methylations in the human genome. *Nat. Genet.* 40, 897–903.

Wood, M.A., Kaplan, M.P., Park, A., Blanchard, E.J., Oliveira, A.M.M., Lombardi, T.L., and Abel, T. (2005). Transgenic mice expressing a truncated form of CREB-binding protein (CBP) exhibit deficits in hippocampal synaptic plasticity and memory storage. *Learn. Mem. Cold Spring Harb. N* 12, 111–119.

Wood, M.A., Attner, M.A., Oliveira, A.M.M., Brindle, P.K., and Abel, T. (2006). A transcription factor-binding domain of the coactivator CBP is essential for long-term memory and the expression of specific target genes. *Learn. Mem. Cold Spring Harb. N* 13, 609–617.

Xie, L., Korkmaz, K.S., Braun, K., and Bock, J. (2013). Early life stress-induced histone acetylations correlate with activation of the synaptic plasticity genes *Arc* and *Egr1* in the mouse hippocampus. *J. Neurochem.* 125, 457–464.

Figures and figure legends

Figure 1.

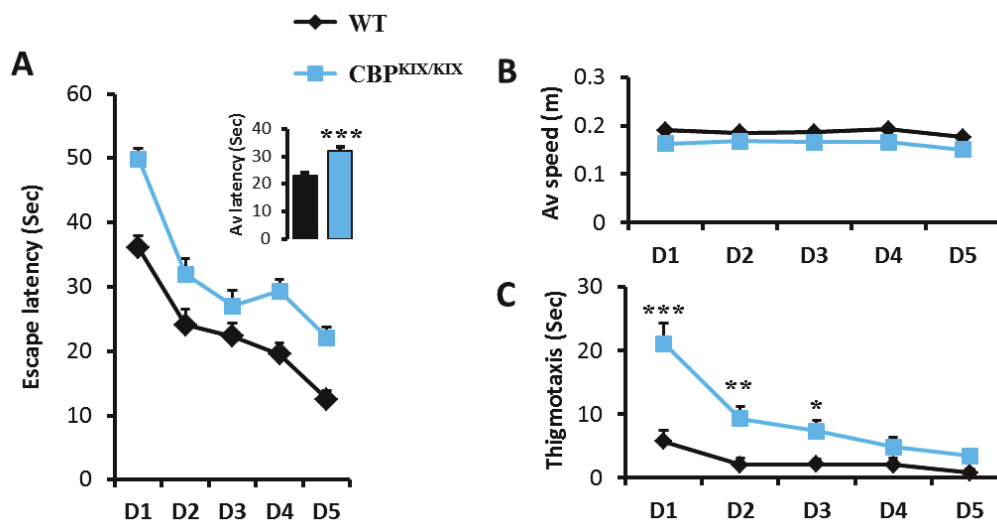

Figure 1. Learning performance of CBP^{KIX/KIX} mice in the Morris water maze. 3 groups of CBP^{KIX/KIX} mice (total n=20) and their wild-type littermates (WT, n=28) were trained during 5 days to search for a hidden platform positioned at a fixed location in the MWM. **A**, Acquisition performance shown as latencies to reach the platform. During training, the latencies decreased over sessions for both WT and CBP^{KIX/KIX} mice. The inset shows the average performance of mice collapsed over the five days of training. Av, average. **B**, Average swim speed and **C**, thigmotactic swimming depending on the acquisition day and genotype. CBP^{KIX/KIX} mice started the acquisition with very high thigmotaxis but gradually reduced during the acquisition days. Anova for repeated measures: * $p < 0.05$, ** $p < 0.001$ *** $p < 0.0001$, when performance (escape latency, average speed and thigmotactic swimming) across the 5 days is compared between the genotypes.

Figure 2.

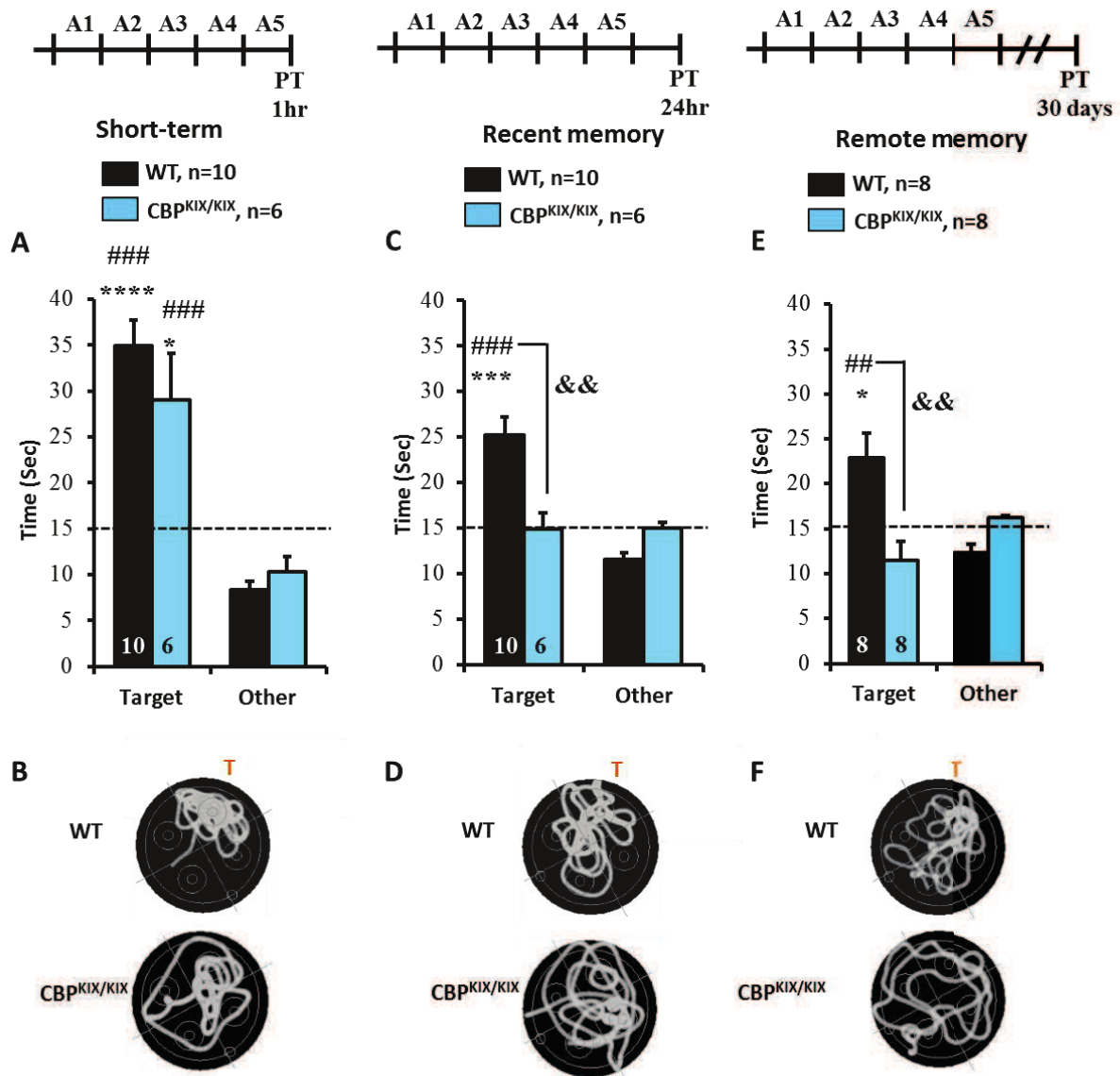

Figure 2. $CBP^{KIX/KIX}$ mice exhibit evidence for short-term retention but are impaired in long-term spatial memory (recent and remote). Three independent groups of mice, $CBP^{KIX/KIX}$ and their wild-type littermates (WT) were trained during 5 days to search for a hidden platform positioned at a fixed location in the Morris water maze. After the last training session, the platform was removed and each group undertook one probe test (PT) at a different time to measure either **A-B**, short term, (WT, n=10; $CBP^{KIX/KIX}$, n=6, PT 1hr), **C-D**, recent (WT, n=10; $CBP^{KIX/KIX}$, n=6, PT 24hr) or **E-F**, remote (WT, n=8; $CBP^{KIX/KIX}$, n=8, PT 30 days) memory. **A**, **C** and **E**, WT mice showed a significant retention of the platform location compared to random performance at all three delays, while $CBP^{KIX/KIX}$ mice could recall the platform location after one hour (short memory), but not after 1 day (recent

memory) or 30 days (remote memory). **B**, **D** and **F**, Representative pictures of the swim tracks during the respective probe tests (**B**: Short-term, **D**: Recent and **F**: Remote memory). Student's t test: * $p < 0.05$, ** $p < 0.01$, *** $p < 0.001$, **** $p < 0.0001$, when time in target quadrant (Target) is compared with random performance (15 s, dotted line); ## $p < 0.01$ ### $p < 0.001$ when performance in the target quadrant (Target) is compared to the mean of the 3 other quadrants (Other); && $p < 0.01$ when performance of CBP^{KIX/KIX} in the target quadrant (Target) is compared with WT.

Figure 3.

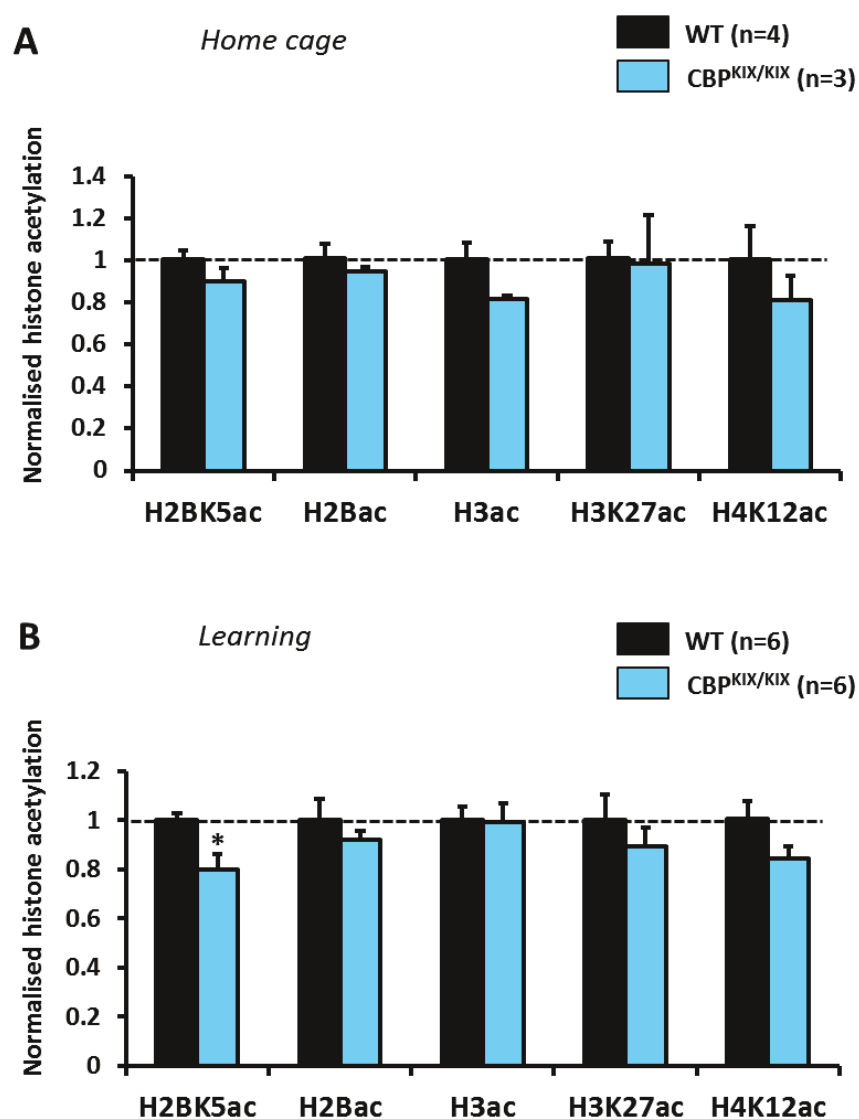

Figure 3. Bulk histone acetylation levels at basal condition and after spatial learning in the dorsal hippocampus of CBP^{KIX/KIX} and WT mice. CBP^{KIX/KIX} mice (CBP^{KIX}, n = 6) and their wild-type littermates (WT, n=6) were trained in MWM for 3 consecutive days followed by euthanasia one hour after the last trial. One more group of CBP^{KIX/KIX} mice (n=3) and wild-type (n =4) were also euthanized to serve as Home Cage (HC) control. Laemmli lysates from dorsal hippocampus were subjected to western blot analysis for histone acetylation marks as noted. Quantification of H3 and H2B acetylated histone levels is shown relative to the respective total amounts of the H3 or H2B. **A**, Histone acetylation levels at the basal level (Home cage), **B**, Histone acetylation levels after training (learning). Student's t test: * $p < 0.05$, when CBP^{KIX/KIX} mice is compared with WT.

Figure 4.

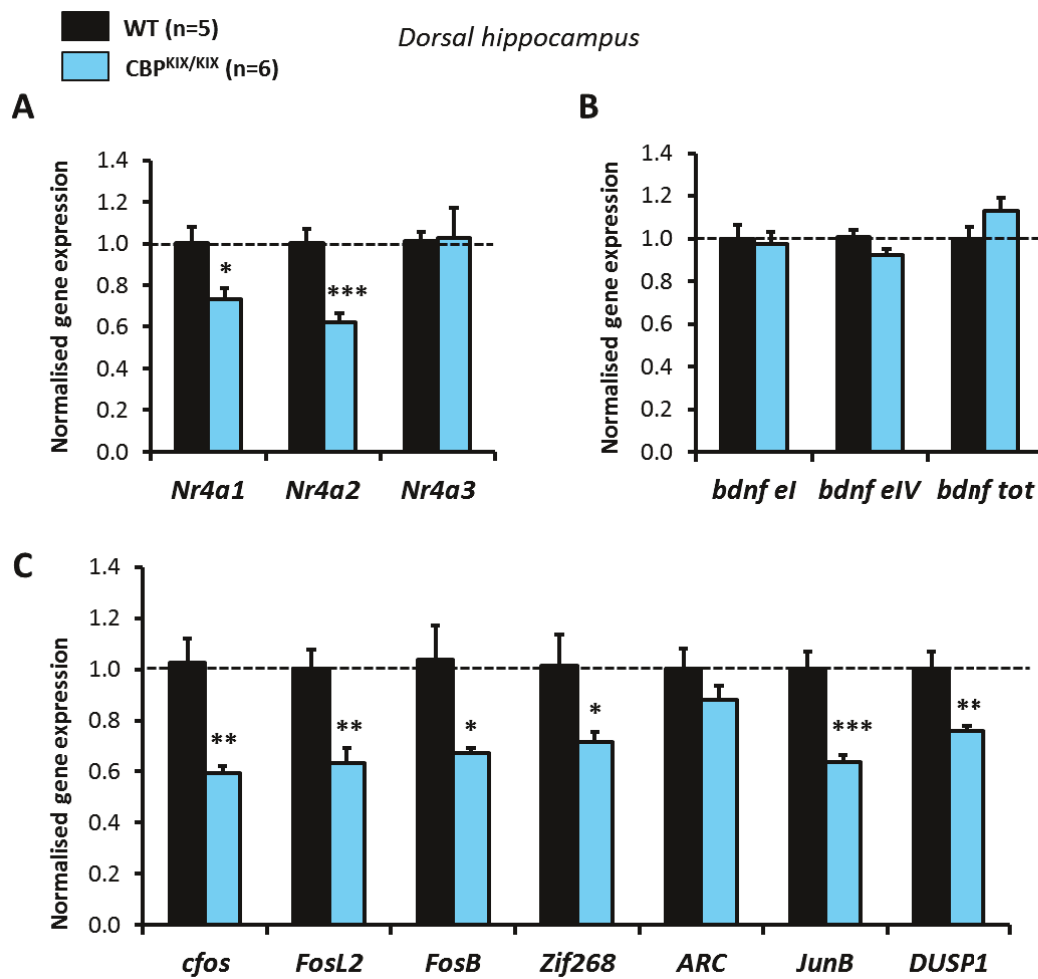

Figure 4. Differential regulation of gene expression in the dorsal hippocampus of CBP^{KIX/KIX} and WT mice after spatial learning. CBP^{KIX/KIX} mice (CBP^{KIX}, n = 6) and their wild-type littermates (WT, n = 6) were trained in MWM for 3 consecutive days followed by euthanasia one hour after the last trial. Total mRNAs were isolated and processed for RT-qPCR for **A**, *Nr4A* family of receptors, **B**, *bdnf* variants *bdnf exon I* (*Bdnf eI*), *exon IV* (*Bdnf eIV*) and *total bdnf* (*Bdnf tot*) and **C**, several immediate early / activity-dependent genes. Relative expression levels were normalized to the mean of 3 control genes (*RNA Pol II*, *36B4* and *TBP*). Student's t test: * $p < 0.05$, ** $p < 0.01$, *** $p < 0.001$, when CBP^{KIX/KIX} is compared with WT mice.

Figure 5.

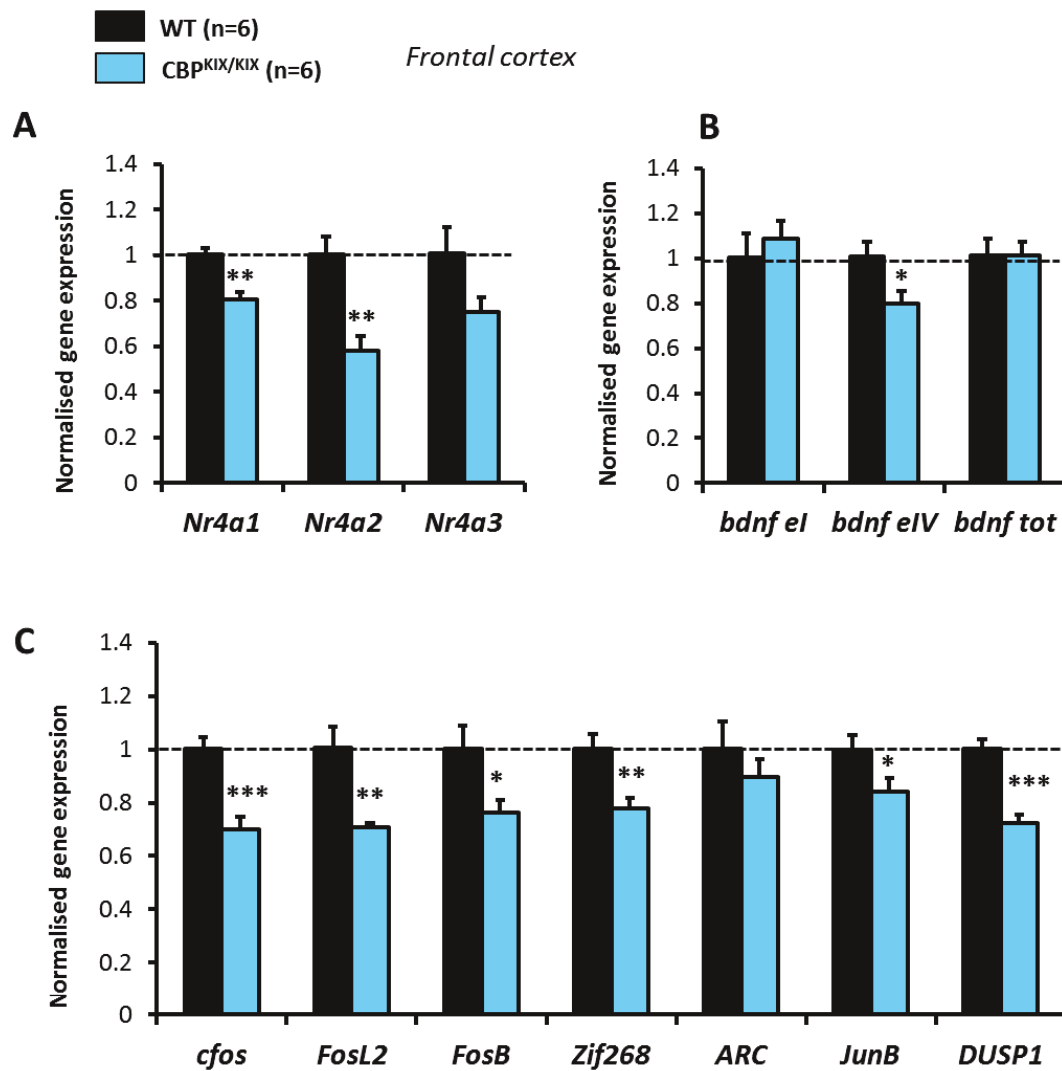

Figure 5. Differential regulation of gene expression in the frontal cortex of CBP^{KIX/KIX} and WT mice after spatial learning. CBP^{KIX/KIX} mice (CBP^{KIX}, n = 6) and their wild-type littermates (WT, n = 6) were trained in MWM for 3 consecutive days followed by euthanasia one hour after the last trial. Total mRNAs were isolated and processed for RT-qPCR for **A**, *Nr4A* family of receptors, **B**, *bdnf* variants *bdnf exonI* (*Bdnf eI*), *exon IV* (*Bdnf eIV*) and *total bdnf* (*Bdnf tot*) and **C**, several immediate early / activity-dependent genes. Relative expression levels were normalized to the mean of 3 control genes (*RNA Pol II*, *36B4* and *TBP*). Student's t test: **p*<0.05, ***p*<0.01, *** *p*<0.001, when CBP^{KIX/KIX} is compared with WT mice.

Figure 6.

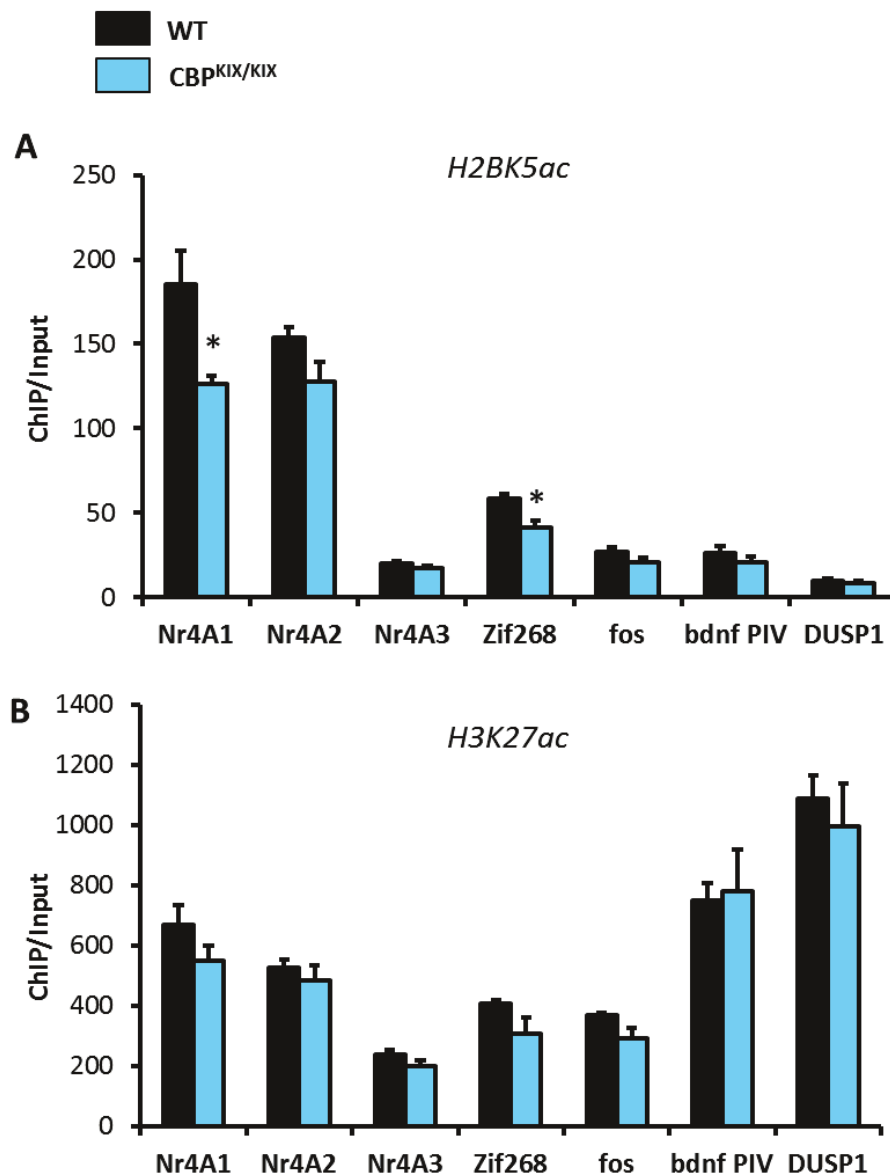
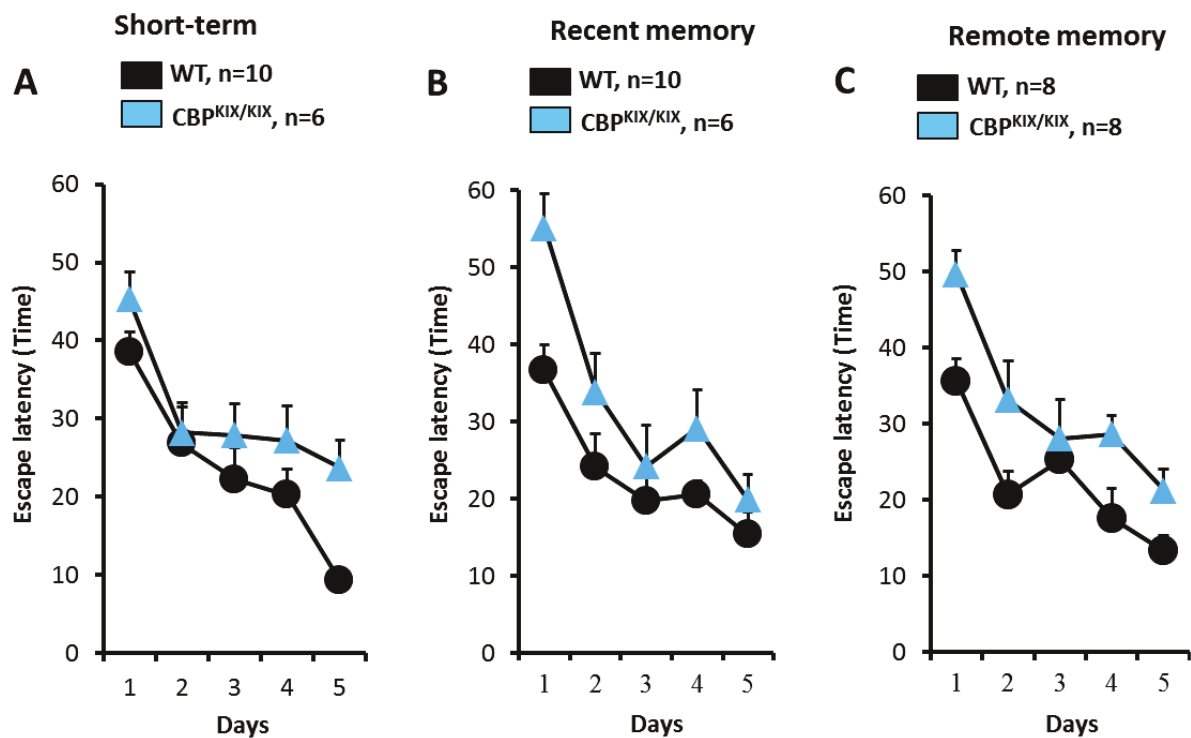

Figure 6. Occupancy of acetylated histone H2BK5 is reduced at proximal promoters of Nr4a1 and Zif268 after spatial learning in the dorsal hippocampus of CBP^{KIX/KIX} versus WT mice. Chromatin immunoprecipitation performed on dorsal hippocampus of control WT and CBP^{KIX/KIX} mice after spatial learning (n=3/group). Specific promoter targets were evaluated by RT qPCR. Quantification of immuno-precipitated material relative to its input level is represented relative to no antibody control which is arbitrarily set at 1. **A**, CBP^{KIX/KIX} mice has reduced occupancy of acetylated histone H2BK5 at the promoter of Nr4a1 and Zif268. **B**, No significant deficits of H3K27 acetylation was detected on the promoters of Nr4A family and other memory related genes. **p*0.05 (Student's t-test: WT Vs CBP^{KIX/KIX}).

Supplementary figure S1.



Supplementary figure S1. Acquisition performances shown as latencies to reach the platform for all the three respective experiments **A**, Short term, **B**, Recent, **C**, Remote memory). During training, the latencies decreased over sessions in all the three groups tested (Short term: WT, $p=0.0001$, CBP^{KIX/KIX}, $p=0.0039$; Recent memory: WT, $p=0.0252$, CBP^{KIX/KIX}, $p=0.0001$; Remote memory, WT, $p=0.0002$, CBP^{KIX/KIX}, $p=0.0001$, day 1 compared to day 5 using Anova repeated measures).

Supplementary figure S2.

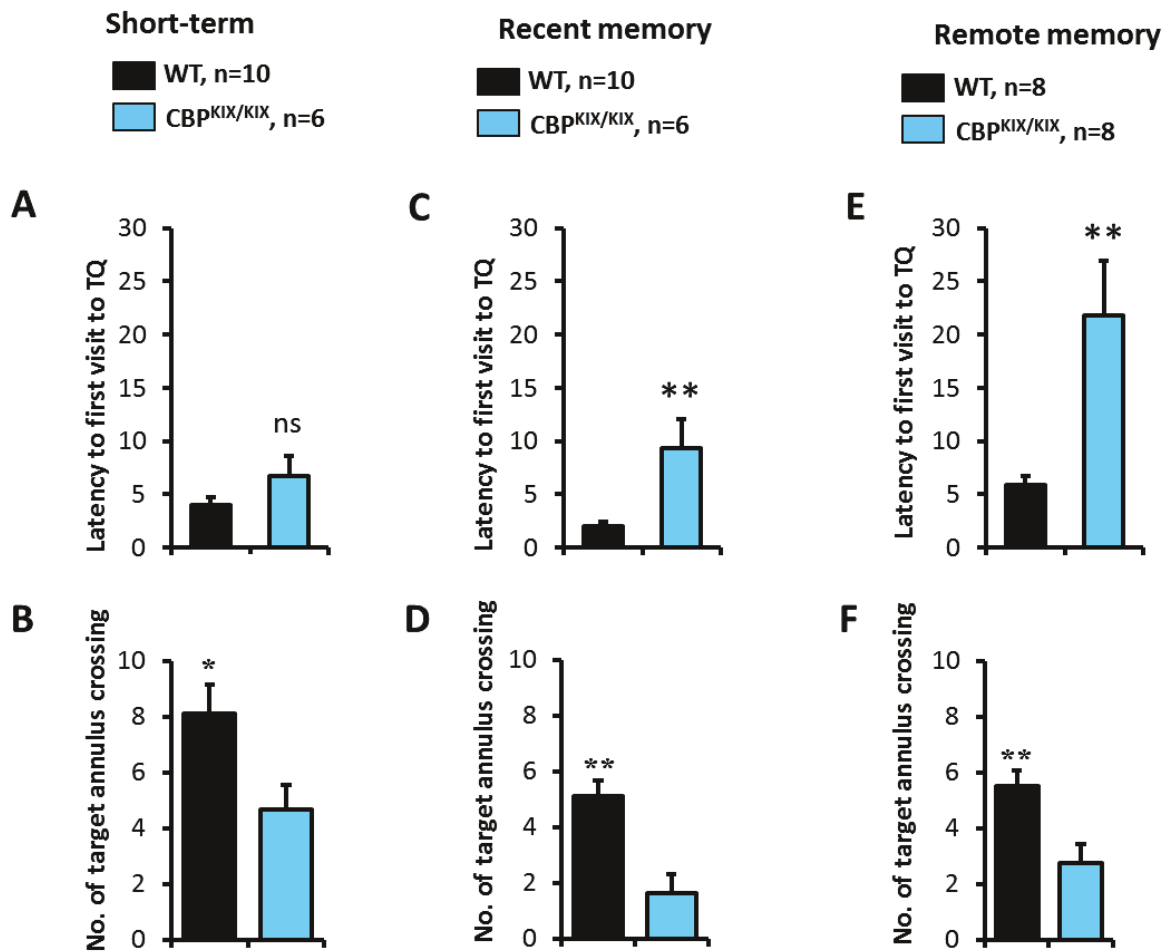

Supplementary figure S2. CBP^{KIX/KIX} mice are deficient in long-term memory but not for short-term. **A, C and E**, Time taken by the mice to reach the target quadrant for the first time (latency to first visit) during the respective probe tests (**A**: Short-term, **C**: Recent, **E**: Remote memory) *Below*; **B, D and F**, represents the number of annulus crossing during respective probe test. Student's t test: * $p < 0.05$, ** $p < 0.01$, (comparing WT with CBP^{KIX/KIX}). *ns* represents statistically non-significant.

Supplementary figure S3.

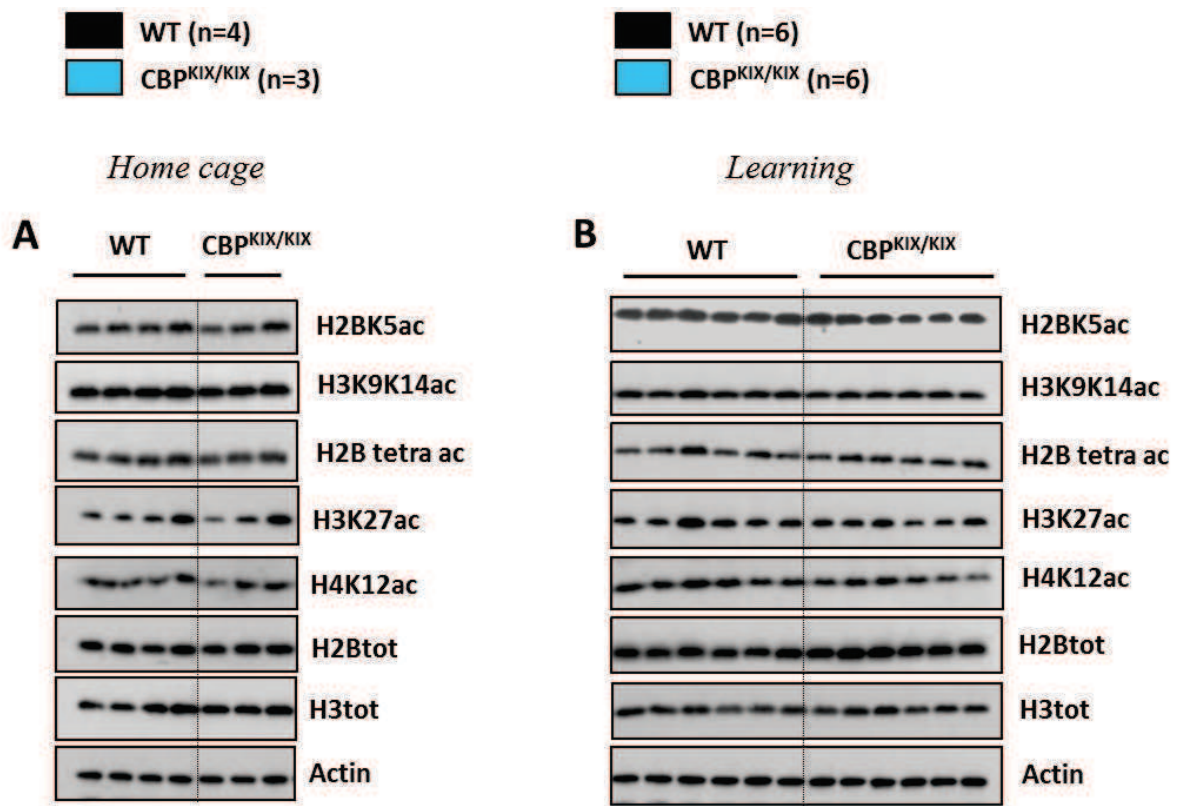

Supplementary figure S3. Histone acetylation levels in the dorsal hippocampus of $CBP^{KIX/KIX}$ mice at basal level. Laemmli lysates from dorsal hippocampus of **A**, home cage $CBP^{KIX/KIX}$ mice (n=3) and their wild type littermates (WT) (n=4) and **B**, after spatial learning of $CBP^{KIX/KIX}$ mice (n=6) and their wild type littermates (WT) (n=4) were prepared for western-blot analysis. Different histone acetylation marks were analysed as noted, considering total H2B and H3 histones as loading controls. Quantification of acetylated histone levels is shown relative to the total amount of the H3 or H2B.

Supplementary figure S4.

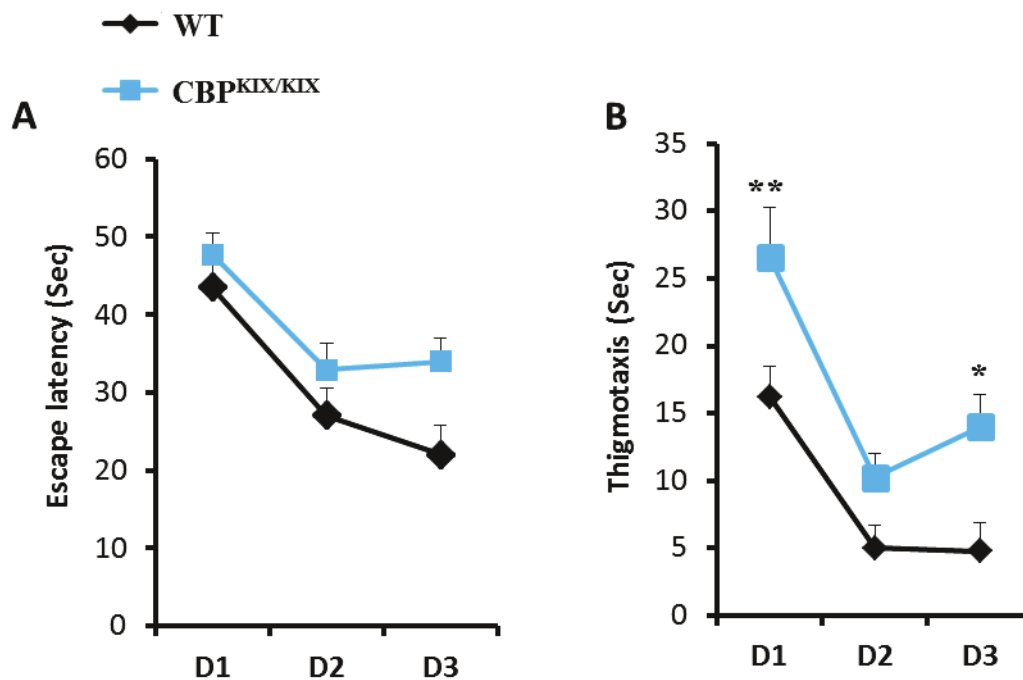

Supplementary figure S4. WT and CBP^{KIX/KIX} mice were trained in MWM for 3 consecutive days to locate a hidden platform. **A**, Time taken by the mice to reach the target platform has been plotted. Both WT and CBP^{KIX/KIX} mice learned to locate the hidden platform at the end of 3rd day of training (WT: $p=0.0001$; CBP^{KIX/KIX}: $p=0.0026$, performance of day 1 compared to that of day 3, student's t-test). **B**, Time spent by the mice in the thigmo zone has been plotted. CBP^{KIX/KIX} mice showed significantly higher thigmotaxis on day 1 compared to the WT ($p=0.0039$), however it slowly reduced during each days of training. One hour from the last trial on day 3, all the mice were euthanized and their brains were dissected out. The samples were separated into two groups. One group of samples were processed for western blots and gene expression (WT, $n=6$; CBP^{KIX/KIX}, $n=6$) and the other group was processed for chromatin immunoprecipitation (ChIP; WT, $n=6$; CBP^{KIX/KIX}, $n=6$).

Supplementary figure S5.

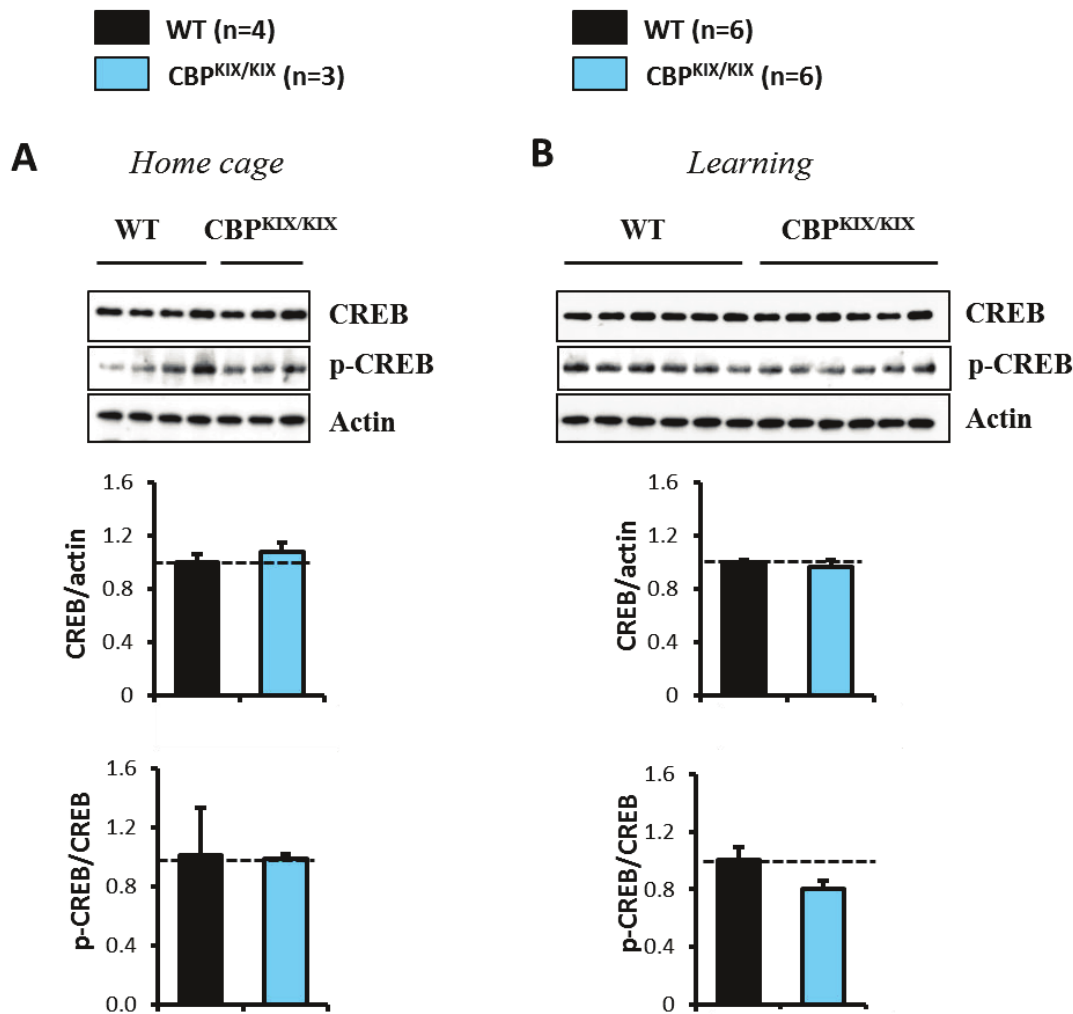

Supplementary figure S5. Western blot analysis of CREB from home cage and after spatial learning in WT and CBP^{KIX/KIX} mice. Protein lysates prepared from **A**, home cage [WT (n=4), CBP^{KIX/KIX} mice (n=3)] and **B**, after 3 days of spatial learning [WT (n=6), CBP^{KIX/KIX} mice (n=6)] were processed for western blot analysis. Representative pictures of western blots with antibodies recognising CREB, phosphor-CREB at Ser133 have been shown. Actin was used as a loading control. *Below*, Quantification of the blots shows that no significant differences in the above mentioned protein levels have been observed neither between the two genotypes nor with conditions.

Supplementary figure S6.

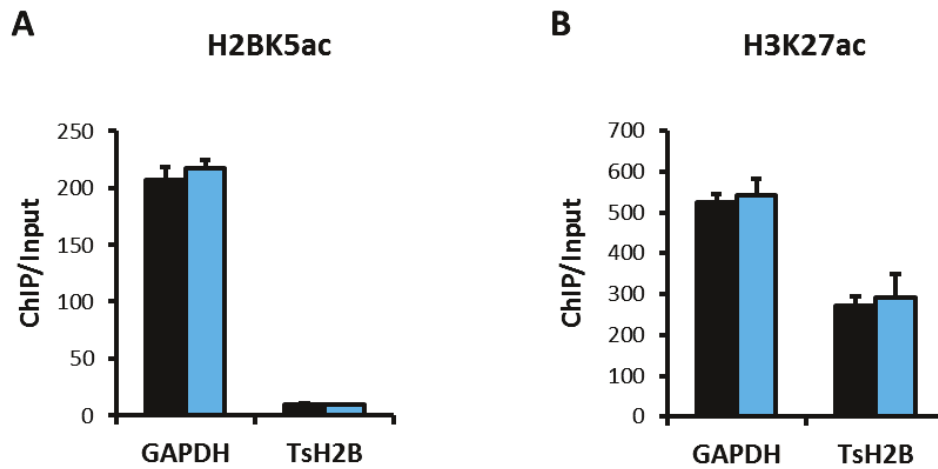

Supplementary figure S6. Quality control analysis of chromatin immunoprecipitations using A, H2BK5ac, B, H3K27ac antibodies. Pulldowns showed higher occupancies on GAPDH promoter with both antibodies in both groups (WT and CBP^{KIX/KIX}), while no (H2BK5ac) or less (H3K27ac) immunoprecipitated DNA was obtained with the TsH2B promoter. Abbreviations; ac: acetylation, TsH2B: testis specific H2B.

Perspectives

The data presented in *publication 2*, show the importance of CBP KIX domain in the persistence of long-term spatial memory. Mutation in the CBP KIX domain has been previously studied in other memory paradigms like fear conditioning and object tasks, but the present study sheds light for the first time on its effect on spatial memory in the MWM. We showed alteration in gene expression and chromatin acetylation at proximal promoters of *Zif268* and *Nr4a1* gene after spatial learning in the dorsal hippocampus. *Zif268* role in spatial memory formation has been thoroughly investigated. Knock out mice models of *Zif268* are impaired in consolidation of hippocampus dependent long-term memory whereas short-term memory remains intact (Plath et al., 2006, Jones et al., 2001). Further, gain of function of *Zif268* has been shown to enhance hippocampal capacity to form long-term spatial memory (Penke et al., 2014). *Nr4A* family has also been implicated in spatial memory (Hawk and Abel, 2011). Therefore, a proof of concept experiment could be performed to overexpress these two activity dependent genes in $CBP^{KIX/KIX}$ mice to check if it reverses spatial memory deficits.

CREB signalling can be initiated independently of CBP-CREB interaction through CREB regulated transcription coactivators (CRTC) (Iourgenko et al., 2003). Therefore, it is intriguing to understand: why CRTCs cannot activate the transcription of all the immediate early genes in $CBP^{KIX/KIX}$ mice after spatial learning. Therefore, overexpression of CRTCs in dorsal hippocampus of $CBP^{KIX/KIX}$ mice using viral vectors based expression could be tested if excess amounts of CRTCs could rescue the spatial memory impairment.

As $CBP^{KIX/KIX}$ mice have impaired long-term memory, but intact short term-memory, activation of CBP HAT function by small molecule activator CSP-TTK21 could be tested to further verify if activation of CBP HAT function could initiate long-term memory, independent of its recruitment to the chromatin through CREB interaction. As $CBP^{KIX/KIX}$ mice have intact HAT domain, it is predictable CSP-TTK21 could activate CBP HAT function. But the target acetylation may not be locus specific (acetylation on specific proximal promoters) due to blockage of CBP recruitment by CREB. Therefore HAT activation may not be able to completely rescue the transcriptional and cognitive deficits in $CBP^{KIX/KIX}$ mice. Such experiment would further validate the importance of locus specific

recruitment of CBP by CREB during memory formation. The results from this study would also indicate the importance of the two major functions of CBP (transcriptional co-activation through CREB interaction and lysine acetyltransferase activity) in spatial memory formation.

PUBLICATION 3

Chronic treatment of a Tau mouse model with a HAT activator increases maturation of newly generated neurons and improves hippocampus-dependent memory

Snehajyoti Chatterjee¹, Meliza Sendid-Chouala², Manoj Kumar³, Raphaelle Cassel¹, Brigitte Cosquer¹, Sharmistha Halder Sinha³, Piyush Chaturderby⁴, Muthusamy Eswaramoorthy⁴, Jean-Christophe Cassel¹, Luc Buée², David Blum², Tapas K Kundu³ and Anne-Laurence Boutillier^{1*}

¹Laboratoire de Neurosciences Cognitives et Adaptatives, Unité Mixte de Recherche 7364 Université de Strasbourg, Centre National de la Recherche Scientifique, Faculté de Psychologie, Groupe de Recherche 2905 NeuroMem, Strasbourg 67000, France

²Université Lille-Nord de France, UDSL, Lille, France

³Transcription and Disease Laboratory, Molecular Biology and Genetics Unit, and

⁴Chemistry and Physics of Materials Unit, Jawaharlal Nehru Centre for Advanced Scientific Research, Jakkur, Bangalore 560064, India

* Corresponding author

Manuscript under preparation

Scientific Context and Objectives

In the publication 1, we have reported a novel activator of CBP/p300 HAT function (CSP-TTK21) that can cross the blood brain barrier and induce histone acetylation in mice brain. Upon reaching the brain of healthy adult mice, it potentiates two important hippocampal functions: adult neurogenesis and long-term spatial memory (Chatterjee et al., 2013). Therefore, our next step was to investigate whether this HAT activator CSP-TTK21 treatment could bring any benefit in a mice model of cognitive impairment. For this study, we used THY-Tau22 mice that express four-repeats of human tau mutated at sites G272V and P301S under a Thy1.2-promotor. THY-Tau22 mice shows Alzheimer's-like hippocampal Tau pathology and hippocampus-dependent memory impairments (Schindowski et al., 2006; Belarbi et al., 2011; Van der Jeugd et al., 2013). THY-Tau22 shows age related decline of hippocampus dependent learning and memory (Van der Jeugd et al., 2013) and attenuated late-phase LTD of synaptic transmission (Van der Jeugd et al., 2011).

Studies from my lab have shown that 8 months old THY-Tau22 mice trained in MWM for five consecutive days to locate a hidden platform shows deficits in retention of long-term spatial memory (*Schneider, Cassel, Chatterjee et al, Manuscript in preparation; Supporting Results SR2*). Sub-chronic treatment of CSP-TTK21 (3 injections, once-per week) in THY-Tau22 mice ameliorated the memory deficits with a concomitant rescue of some gene expression in learning conditions, as assessed by transcriptomic analyses (RNAseq studies). Particularly several genes related to memory and plasticity were found deregulated in the Tau mice versus the WT mice after spatial learning, and of most interest, a set of genes related to ion transport and voltage-gated ion channels were found up-regulated by CSP-TTK21 treatment (*Schneider, Cassel, Chatterjee et al, Manuscript in preparation; Supporting Results SR3*). However, such sub-chronic treatment did not significantly improve adult neurogenesis that is otherwise severely impaired in this Tau mouse model (not shown), suggesting that the mice do not fully recover with the treatment.

Therefore, the hypothesis behind the present study was that if we treat THY-Tau22 mice with the HAT activator CSP-TTK21 from an early time point (as early as 3 months of age), we might be able not only to improve memory functions, but also improve adult neurogenesis and may be delay the onset of the disease pathology. We then treated THY-Tau22 mice with

CSP-TTK21 from 3 months of age and continued treatment until 8 months of age. We analyzed the effects of CSP-TTK21 chronic treatment in two important hippocampus dependent functions: adult neurogenesis and long-term spatial memory. We further investigated the expression profiles of several memory and plasticity related genes (like immediate early genes, synaptic formation- and synaptic plasticity- related genes). As we performed the chronic treatment, we aimed to evaluate the toxic side-effects if any appearing due to the chronic treatment. Finally, we also studied the anatomopathology to determine if the molecule could actually delay the disease pathology.

These are important features to determine in order to test whether such molecule can stand as a new therapeutic opportunity for memory-related disorders such as Alzheimer's disease.

PUBLICATION 3**Chronic treatment of a Tau mouse model with a HAT activator increases maturation of newly generated neurons and improves hippocampus-dependent memory****Abstract**

Alzheimer's disease (AD) is a neurodegenerative condition which, besides its two histopathological hallmarks: amyloid plaques and tauopathy, is also characterized by neuronal loss and memory impairments. Recent evidences indicate that epigenetic modifications participate in higher brain functions such as brain plasticity and memory formation. Based on our previous finding that CSP-TTK21 activates CBP and induces spatial memory persistence in wild-type mice, we further aimed to explore the effect of CSP-TTK21 in a mouse model of AD presenting Tau pathology. We investigated the effects of chronic treatment with an activator of CBP/p300 HAT (CSP-TTK21) in Tau mouse model (THY-Tau22 mice). Male THY-Tau22 mice were injected (once in two weeks) with either vehicle (CSP) or HAT activator (CSP-TTK21) from 3 months of age (i.e. before the development of memory-related symptoms of the pathology) until 8 months of age. In the Morris Water Maze (MWM) task, control THY-Tau22 (CSP- treated) mice showed deficiency in retention of long-term memory, whereas it was completely restored in response to the chronic treatment with CSP-TTK21. Interestingly, CSP-TTK21 treatment significantly improved the dendritic arborization of doublecortin (DCX)-positive neurons in the dorsal dentate gyrus. CSP-TTK21 treatment also rescued expression of Immediate-early genes (*ARC* and *Zif268*) and synaptic plasticity related genes (*Synaptophysin* and *Gria2*) that were otherwise decreased in THY-Tau22 mice. CSP-TTK21 treatment did not induce any change in the body weight throughout the course of treatment and caused no apparent toxicity as evidenced from the constant levels of cleaved caspase-3 from different body organs and brain parts. However, CSP-TTK21 did not reduce the phospho-tau load in either hippocampus or frontal cortex. Therefore chronic treatment of THY-Tau22 mice with CSP-TTK21 preserved the hippocampal functions that helped to restore adult neurogenesis and the persistence of long-term memory without affecting the severity of the disease.

Keywords: HAT activator, CBP, spatial memory, gene expression, tau pathology

Introduction

Alzheimer's disease (AD) is a common neurodegenerative disease and the major cause of dementia. AD is characterized by progressive memory loss and cognitive impairment. The two major clinical hallmarks of AD are senile plaques and neurofibrillary tangles (NFT). NFTs are formed from intraneuronal fibrillar aggregates of hyper- and abnormally phosphorylated Tau proteins. NFTs initially appears in entorhinal cortex and hippocampus and as the disease progresses it profoundly spreads to the temporal and frontal lobes and the symptom worsens (Braak et al., 1998, Braak and Del Tredici, 2011). Memory formation requires gene expression for consolidation of information (Alberini and Kandel, 2015). Regulation of gene expression is a critical step underlying memory consolidation (Peixoto and Abel, 2013). Dysregulation in transcription alters the physiological balance of a cell leading to neuronal death (Rouaux et al., 2003) and could contribute towards AD pathogenesis (Marambaud and Robakis, 2005, Chen et al., 2013).

One of the fundamental mechanisms of gene expression regulation is chromatin remodelling, especially through histone-tail acetylation. Histone acetylation is catalyzed by Histone acetyltransferases (HATs) that alters the local chromatin conformation and improves the accessibility of transcriptional regulatory proteins to the DNA (Goldberg et al., 2007) thus facilitating gene transcription (Berger, 2007; Jenuwein and Allis, 2001; Kouzarides, 2007; Hilton et al., 2015). The reverse reaction is catalyzed by histone deacetylases (HDACs) that removes the acetyl groups and results in compact chromatin structure and reduced transcription. Recently, histone acetylation has been on prime focus of behavioral biologists. In particular, histone acetylation participates in the processes involved during synaptic plasticity, learning and memory (Peixoto and Abel, 2013; Lopez-Atalaya and Barco, 2014). Therefore modulation of histone acetylation is emerging as a possible therapeutic strategy in the treatment of AD (Valor et al., 2013; Fischer, 2014). HDAC inhibitors have been broadly used to rescue memory deficits in various modes of neurodegenerative diseases (Ricobaraza et al., 2009; 2012; Benito et al., 2015). However, in the present study, we have employed an alternative strategy of activating acetylation process by direct pharmacological activation of HATs. We have previously reported a small molecule activator of HAT CBP/p300, CSP-TTK21 (Chatterjee et al., 2013). CSP-TTK21 is cell permeable HAT activator that could pass the blood-brain barrier and induce histone acetylation in the dorsal hippocampus and frontal cortex of mice brain. CSP-TTK21 promotes formation of long and highly branched

doublecortin-positive (DCX⁺) neurons in the subgranular zone of the dentate gyrus and facilitates long-term memory formation in healthy adult mice. Therefore, the molecule could be a potential therapeutic agent in diseases associated with cognitive impairment like Alzheimer's disease.

For this study, we used THY-Tau22 mice that express human 4-repeat tau mutated at sites G272V and P301S under a Thy1.2-promotor. THY-Tau22 mice exhibit AD-like hippocampal Tau pathology and hippocampus-dependent memory impairments (Schindowski et al., 2006; Belarbi et al., 2011; Van der Jeugd et al., 2013). These mice present hyperphosphorylation and abnormal phosphorylation of tau protein at major sites characterized in AD. The tau phosphorylation starts as early as 3 months in the CA1 and cortex, later the abnormal phosphorylation spreads to the other brain regions like striatum, the olfactory bulb, the occipital cortex, the amygdala, the ventral thalamic nuclei, and deep layers of the entorhinal cortex. NFT-like inclusions characterized with massive hyper- and abnormal phosphorylation of tau occurs at around 6 months of age, and the degenerative processes begins from 10 months of age (Schindowski et al., 2006). THY-Tau22 shows age related cognitive decline including hippocampus dependent learning and memory deficits (Van der Jeugd et al., 2013) and attenuated late-phase LTD of synaptic transmission (Van der Jeugd et al., 2011). In the present study, we investigated the effects of a chronic treatment with CSP-TTK21 in THY-Tau22 mice from 3 months till 8 months of age. Chronic treatment clearly preserved the persistence of long-term memory as evidenced from MWM tests. Interestingly, *ARC* and *Zif268* transcript levels were reinstated in the dorsal hippocampus after chronic treatment compared to control THY-Tau22 mice (treated with CSP only). In addition, CSP-TTK21 treated THY-Tau22 mice showed improved dendritic arborization from newly generated neurons in dorsal dentate gyrus. However, neither phospho-Tau proteins nor inflammation were impacted by the treatment, suggesting that the HAT activator CSP-TTK21 improved hippocampal function in THY-Tau22 mice without affecting their anatomopathological status.

Materials and methods

Animals

THY-Tau22 mice expresses human 4-repeat Tau mutated at sites G272V and P301S under the control of Thy1.2 promoter (Schindowski et al., 2006). THY-Tau22 mice is characterized

with major expression of tau in the hippocampal formation and cortex, whereas no significant pathology in the spinal cord. Heterozygous male mice were used in each experiment. Sex-matched non-transgenic littermates (WT) were used as controls. WT and THY-Tau22 mice were housed in a pathogen-free facility (3-4 mice/ cage) maintained on a 12-hour light and/or 12-hour dark cycle with ad libitum access to food and water. Experimental protocols and animal care were in compliance with the national (council directive 87-848, 19 October 1987, Ministère de l'Agriculture et de la Forêt, Service Vétérinaire de la Santé et de la Protection Animale) and international (directive 86-609, 24 November 1986, European Community and new guidelines of the European Parliament 2010/63/UE of September 22, 2010) laws and policies (ethical committee authorization AL/100/107/02/13).

Chronic treatment of CSP or CSP-TTK21

CSP was synthesized from glucose upon heating under very high temperature and pressure as described previously (Selvi et al., 2008). TTK21 was synthesized from salicylic acid and conjugated with CSP as described previously (Chatterjee et al., 2013). CSP/ CSP-TTK21 were stored at -20°C in multiple aliquots. For the chronic treatment, animals were randomized on body weight and CSP/ CSP-TTK21 were injected intraperitoneally at the dose of 20mg/kg of body weight with groups as follows: WT/Saline, n=8; THY-Tau22/CSP, n=8; THY-Tau22/CSP-TTK21, n=9. Each mouse received injections once per 2 weeks and body weights were measured before each injection. Chronic treatment started at an age when tau pathology and memory impairments are slight or even absent in THY-Tau22 mice (3 months) and continued until 8 months of age, when transgenic mice exhibit memory deficits, deficient adult neurogenesis, anatomopathological hallmarks of tauopathy (Tau aggregates) and inflammation (Schindowski et al., 2006; Van der Jeugd et al., 2013).

Actigraphy

The mice were placed individually in transparent cages and adapted to the shelves of the testing device. Two infrared light beams passing through each cage were targeted on two photocells that were placed 2.5 cm above the cage floor level 28 cm apart. The number of cage crossings was recorded by a computer over during two days and one night cycles. Comparison of the global activity during the day vs during the night was done using the mean of activity for day compared to mean activity for night. Values of $p < 0.05$ were considered significant.

Spatial memory assessment using the Morris water maze (MWM) test

Evaluation of spatial memory was performed using the Morris Water Maze task (MWM). The circular water maze tank (Atlantis) was located in a room with several visual extra maze cues. The maze was filled with water made opaque by powdered chalk (Blanc de meudon) at 21⁰C. To escape from the cold water, the mice needs to learn the location of an escape platform placed in a fixed position under the water surface. The mice were habituated for two consecutive days with one trial per day before the training period. The first day of habituation consisted of 1 minute trial with a visible platform and 5cm of water, whereas the second day habituation consisted of a 2 minute free swim trail without any platform. During the acquisition days, mice were trained for four trials per day with maximum duration of 60 s for five consecutive days. At the start of each trial, mice were placed in the pool, facing the wall in one of four start locations (varied pseudo-randomly). Each trial was automatically terminated whenever the mice reached the platform or after the completion of 60 s. Mice failing to reach the platform were gently guided to reach the platform. After each trial, mice were allowed to stay on top of the platform for 10-12 s. Latency to reach the platform, distance travelled, swim speed and time in the thigmo zone were recorded and computed using a video-tracking system (Any maze). Three independent groups of mice THY-Tau22 CSP, THY-Tau22 CSP-TTK21 and their sex-matched wild-type littermates (WT) injected with saline were trained for 5 days of spatial learning. After the last training session, the platform was removed and all the three groups undertook a probe test (PT) 10 days after the last training day. During the probe test, the mice were introduced at the centre of the pool and were allowed to swim for 60 s. Spatial memory during the probe test was quantified by measuring the amount of time spent by the mice searching in the target quadrant versus the average time spent in the three other quadrants. Two hours after each probe tests, mice were tested for consequitive probe tests with a gap period of two hours for extinction. At the end of each trial (60 s), mouse was immediately taken out of the pool and were returned to its home cage.

Euthanasia

One day after the completion of the MWM task, 8 month-old mice were euthanized by cervical dislocation followed by decapitation. Brains were rapidly removed from the skull, rinsed in ice cold PBS and tissues were dissected. Half-brain lobes (n=3/group) were processed for post-fixation to be used for immunohistochemistry and the rest of the brains were sub-dissected (n=7/group) to isolate either hippocampus, or separated dorsal

hippocampus and ventral hippocampus, frontal cortex and cerebellum. Tissues were then flash frozen in liquid nitrogen and stored at -80°C . Body parts (kidney, liver, spleen and heart) were also collected, flash frozen and stored at -80°C .

Protein lysate preparation and Western blot analysis

For *histone acetylation analysis*, the tissues were homogenized in laemmli buffer, sonicated for 15 seconds twice (ultrasonic processor, power 40%), heated at 70°C for 10 min followed by boiling. The lysates were then centrifuged ($20,000g$ for 5 min) and supernatant were stored at -20°C . Total protein concentration was determined by using RC-DC Protein Assay (Bio-Rad) kit. Western blots were performed as described previously (Chatterjee et al., 2013) with antibodies against acetyl-histone H2B(#07-373; Millipore), acetyl-histone H2BK5 (#07-382; Millipore), H3 histone (#ab1791; Abcam), acetyl-histone H3 K9K14 (#06-599; Millipore), histone H2B (#H2-28; Euromedex), acetyl-histone H3K27 (#07-360; Millipore), acetyl-tubulin (#05-829; Santa Cruz), tubulin (#NG1852175; Millipore), acetyl NF- κB (p65 acK310, #ab52175; Abcam), caspase 3 (#sc-271759; Santacruz), NR2B (CS), pNR2B Y1472 (CS) and Actin (#ab16039; Abcam). Secondary antibodies conjugated with HRP against rabbit and mouse was purchased from Jackson ImmunoResearch. Protein blots were revealed with ECL clarity (BioRad) using the Chemidoc Touch Imaging System (BioRad). Results were quantified using Image Lab, Biorad software. Histone acetylation was normalized with either total histone H3 or H2B. Each protein was normalized with the total proteins present in the Nitrocellulose membrane (Biorad) after transfer from the 4-20% SDS gels (Biorad).

For Tau protein analysis, samples were homogenized in Tris buffer (pH7.4) containing 10% sucrose and protease inhibitors (Complete; Roche Diagnostics GmbH, Meylan, France). The homogenates were sonicated and left under agitation for 1hr at 4°C . Protein amounts were evaluated using BCA assay (Pierce). Samples were subsequently diluted in 2X reducing LDS sample buffer (Life Technology, Saint-Aubin, France) and denatured at 100°C for 5 min. $10\mu\text{g}$ of lysates were loaded on 4-20% MOPS NuPAGE gels (Invitrogen), and transferred on to nitrocellulose membranes. After transfer, the nitrocellulose membranes were saturated on 5% non-fat dry milk or BSA in TNT buffer (Tris 15 mM pH 8, NaCl 140 mM, 0.05% Tween) and incubated with appropriate primary and secondary antibodies. Tau antibodies used for western blots were AT100 (Thermo Scientific), pSer214 (Invitrogen), pThr181 (Thermo Scientific), pSer404 (Invitrogen), Tau1 (Millipore). Signals were visualized using

chemiluminescence kits (ECL, Amersham Bioscience, Velizy- Villacoublay, France) on a LAS3000 imaging system (Fujifilm). Results were normalized to GAPDH and quantifications were performed using ImageJ software (Scion Software).

For sarcosyl-soluble/insoluble protein preparation, hippocampus were homogenized and sonicated in lysis buffer (10mM Tris-HCl, pH 7.4, 0.32M sucrose, 800mM NaCl and 1mM EGTA with protease inhibitors), and centrifuged at 12,000 g for 10 min at 4 °C. The supernatant was then incubated for 1 hr in 1% sarcosyl (N-laurylsarkosine sodium salt, Sigma, Saint-Quentin-Fallavier, France) at ambient temperature. The lysate was then centrifuged at 1,00,000 g for 1 h at 4 °C. The supernatant contained the sarcosyl-soluble and the pellet contained the sarcosyl-insoluble Tau species. Sarkosyl-insoluble fraction was resuspended in 2XLDS, whereas sarcosyl-soluble fraction was mixed with LDS 2X, supplemented with reducing agents (Invitrogen, Saint Aubin, France). Both the fraction of samples were loaded onto NuPage Novex (Invitrogen) gels at a ratio of 1:2 (v:v) (Laurent et al., 2014).

Real-time qRT-PCR

RNA preparation followed by Real-time qRT-PCR analysis were performed as described previously (Chatterjee et al., 2013). Briefly, tissues were finely cut using a razor blade homogenization was performed using a Dounce in TRIzol reagent (Invitrogen). Separation of the aqueous layer containing the RNA was followed by chloroform extraction and ethanol precipitation. RNA samples with OD^{260/280} and OD^{260/230} ratio close to 2.0 were considered for reverse transcription. RNA samples were denatured at 70°C for 10 min and 1µg of total RNA was processed for cDNA synthesis (iScript cDNA synthesis kit; Bio-Rad). qRT-PCR analysis was performed on a Bio-Rad iCycler System (CFX) using SsoAdvanced SYBR Green Super- Mix (Bio-Rad). Each samples (n=6) were quantified in technical duplicate. The conditions for qRT-PCR was 3 min at 94°C, followed by 40 cycles of 45 s at 94°C and 10 s at 60°C. Data were analyzed by gene regression using iCycler software and normalized to the RNA polymerase II levels. Primers used for amplification were:

Arc forward 5'-AGCAGCAGACCTGACATCCT-3'
reverse 5'-GTGATGCCCTTTCCAGACAT-3'

Dusp1 forward 5'-GGAGGATATGAAGCGTTTTTCGG-3'
reverse 5'-GGATTCTGCACTGTCAGGCACA-3'

cfos forward 5'-CGGGTTTCAACGCCGACTA-3'

	reverse 5'-TTGGCACTAGAGACGGACAGA-3'
Zif268	forward 5'-TATGAGCACCTGACCACAGA-3'
	reverse 5'-GAGTCGTTTGGCTGGGATAAC-3'
DCX	forward 5'-TAAAAGCCCAGGCCCAAT-3'
	reverse 5'-TTGAGAGCTGACTGGTGGAA-3'
PSD95	forward 5'-CCCCTACCCCTCCTGAGAAT-3'
	reverse 5'-GAGGGGAAGGAGAAGGTTGG-3'
SYP	forward 5'-CAAGGCTACGGCCAACAG-3'
	reverse 5'-GGTCTTCGTGGGCTTCACT-3'
SAP97	forward 5'-AGTGACGAAGTCGGAGTGATT-3'
	reverse 5'-GTCAGGGATCTCCCCTTTATCT-3'
SAP102	forward 5'-GTCTGGGTCTCTCCGAAGCA-3'
	reverse 5'-AACCCAGGGAAGTCCCAGTT-3'
NR2A	forward 5'-ACTGCCGCATCTTCCATGTT-3'
	reverse 5'-GGGTGCACCTGATAGCCTTC-3'
NR2B	forward 5'-CTGCCGAACGCTTGACTT-3'
	reverse 5'-CAAGAGAGCCCAGATTCCAG-3'
Gria2	forward 5'-GATGGCACGCATCCATTTGT-3'
	reverse 5'-GATAGCAGTCACCTGCCACT-3'
Gria3	forward 5'-ACCCAATGGTCCAGCAATT-3'
	reverse 5'-TGCCTCCTCAGGTATCGGAA-3'
human tau	forward 5'-ATGGCTGAGCCCCGCCAGGAG-3'
	reverse 5'-TGGAGGTTCCACCAGAGCTGGG-3'
murine tau	forward 5'-AGCAGGCATCGGAGACAC-3'
	reverse 5'-CATTCCTGTCCTGTCTTTGC-3'
RNA Pol II	forward 5'-AATCCGCATCATGAACAGTG-3'
	reverse 5'-TCATCCATTTTATCCACCACC-3'

Immunofluorescence and Immunohistochemistry

Half-brain lobes from the chronic treatment group of mice were post fixed with ice-cold paraformaldehyde (4% in 0.1 M PB, 4°C) for 6 h and transferred in sucrose at 4°C for 48 h. Brains were then freezeed in isopentane for 1 min at -40°C. Brains were then stored at -80°C before further use. 20µm thick coronal sections were cut through the dorsal hippocampus using a Vibratome (VT1000M; Leica). For the staining protocol, the tissues were first

permeabilized in 1XPBS/Triton X-100 2% for 15 min. Blocking of nonspecific labelling was done by incubating in 1X PBS/0.1% Triton X-100/5% horse serum for 30 min at 37°C. The sections were then incubated overnight with the indicated antibodies (doublecortin [DCX] #ab18723, Abcam). Tissues were washed 3 times with 1X PBS/0.1% Triton X-100, and incubated with the appropriate secondary antibodies. For immunofluorescence, sections were incubated with donkey anti-rabbit conjugated with fluorescent dye (1 h at room temperature). Then the tissues were washed 3 times with 1X PBS/0.1% Triton X-100, and the nuclei were stained with Hoechst for 5 min. Three PBS washes were given before mounting the sections with Mowiol (4-88; 81381, Sigma-Aldrich). For immunohistochemistry, after the primary antibody step, the sections were incubated with anti-rabbit and anti-mouse horseradish peroxidase-conjugated antibody (Santa Cruz Biotechnology) for 1 h. The sections were then washed 3 times in 1XPBS/0.1% Triton X-100. The sections were immersed in 0.05% DAB (with 0.04 M Tris, pH 7.5, 0.03% H₂O₂) until a brown colour appeared. Sections were further washed in 1X PBS and mounted with Mowiol (4-88; 81381, Sigma-Aldrich). Images were acquired using a microscope (Olympus AHB-T-3).

DCX-positive neurons and total dendritic length measurements

Counting was done in three groups of mice [WT (Saline), THY-Tau22 (CSP) or THY-Tau22 (CSP-TTK21), n=3/group] that underwent chronic treatment followed by MWM. After DCX immunohistochemistry, images were acquired with fluorescent microscope (Olympus AHB-T-3). Sections containing the dorsal hippocampus (n=5–6/animal) were then evaluated blindly to the treatment for the number of DCX⁺ neurons. For the dendritic arborisation study, images were analysed in ImageJ software using NeuronJ plugin. Total DCX positive dendritic projection originating from a single neuron from an area in a similar hippocampal region was measured. The total length of the DCX⁺ dendrite given by the software was averaged per animal.

Statistical analysis for biochemical studies

All statistical analysis involving 3 groups (WT saline, THY-Tau22 CSP and THY-Tau22 CSP-TTK21) were performed using ANOVA followed by Newman-Keuls multiple comparison test when appropriate. For comparison between two groups, student's t-test was performed. Data were expressed as the mean +SEM (standard error of mean). The significant level was set at p<0.05.

Statistical analysis for behavioural studies

One- or two- way ANOVA were used for MWM data analysis with repeated measures when appropriate. Various performances criteria recorded during acquisition (escape latencies, average speed, and distance to reach the platform) were analysed using ANOVA. ANOVA analysis was followed by Newman-Keuls multiple comparison test when appropriate. For the retention tests (probe test and extinctions), the time spent in the target quadrant were compared with the chance level (15 sec for a test duration of 60 sec in 4 quadrants) using a one-sample student's t-test. ANOVA factorial was used to analyze the 'treatment' and 'genotype' effect for the time spent in the target quadrants or the number of annulus crossing. Results were expressed as means of +SEM. Values of $p < 0.05$ were considered as statistically significant.

Results

Chronic treatment with CSP-TTK21 restored persistence of long-term spatial memory in THY-Tau22 mice

THY-Tau22 mice display deficits in hippocampal synaptic transmission and behavioral impairment characterized by reduced anxiety and progressive age dependent deficits in cognitive function (Schindowski et al., 2006). Unpublished data from our lab showed that 8 months old THY-Tau22 mice trained for five consecutive days in MWM are deficient in retention of spatial memory when tested ten days after the last training day (Cassel et al, Manuscript in preparation; **Supporting Results SR2**). We have previously reported that activation of CBP/p300 function by administration of HAT activator CSP-TTK21 improves long-term retention of spatial memory in healthy adult mice (Chatterjee et al., 2013). Thus our initial hypothesis was to start the chronic treatment of CSP-TTK21 from an early time-point of the disease pathology so that we might be able to prevent or delay the disease onset. We separated male THY-Tau22 mice in two groups. One group received injections of HAT activator CSP-TTK21 (n=9) and the other group received injections of vehicle only (CSP, n=8). WT control litter-mates were injected with saline (WT, n=8). The chronic injections were started at 3 months of age with one injection per two weeks and were continued for 5 months (**Figure 1A**). We have previously shown that CSP-TTK21 reaches the brain cells

within 3 days after injection and gets cleared out after 7 days. To maintain the potential effect of the molecule in the mice brain, we selected a gap period of two weeks between two injections. We hypothesized that the pharmacological effect would diminish progressively after activation of HAT and can be again reinstated following the next injection. After the completion of the chronic treatment, sleep/ wake pattern were studied. THY-Tau22 mice show increased nocturnal activity possibly due to melatonin dysregulation in Tau mutant mice (Van der Jeugd et al., 2013). THY-Tau22 mice showed nocturnal hyperactivity during the period of cage activity ($p=0.0007$, when THY-Tau22 compared to WT; $p=0.0038$ when THY-Tau22 CSP-TTK21 compared to WT) (**Figure S1**). However, we did not evidence any impact of chronic treatment with CSP-TTK21 in the dysregulation of nocturnal activity in THY-Tau22 mice ($p= 0.3263$). Therefore, CSP-TTK21 treatment does not reform the pathological nocturnal hyperactivity in THY-Tau22 mice.

Five days after the last injection (10th injection), the 3 groups of mice were subjected to the Morris water maze (MWM) test. During a 5-day training period, all the mice were tested in four trials per day for their ability to locate a hidden platform using visual clues surrounding the MWM pool. ANOVA with repeated measure on the latency to find the hidden platform during the training phase showed no genotype or treatment effect ($p=0.7621$). The acquisition was comparable between all the 3 groups, with all of them spending less time each day to reach the platform (D1 Vs D5; WT: $p=0.0171$, THY-Tau22 CSP: $p=0.0035$, THY-Tau22 CSP-TTK21: $p=0.0451$) (**Figure 1B**). To examine the retention of spatial memory, a probe test was performed 10 days after the last training day. The time spend by the control THY-Tau22 (CSP injected) mice in the target quadrant was not higher than the chance (15s, $p= 0.5411$) suggesting that the THY-Tau22 mice could not recall the platform location. However, the THY-Tau22 mice treated with CSP-TTK21 performed significantly higher than the chance level (15s, $P=0.0001$) and their performance score was also significantly better than the CSP treated THY-Tau22 mice ($p=0.0059$) suggesting a beneficial effect of CSP-TTK21 treatment. The performance of the WT mice was similar to the THY-Tau22 CSP-TTK21 mice (**Figure 1C**). To determine if the chronic treatment of CSP-TTK21 could improve the precision of search, we examined the number of annulus crossing during the probe test. ANOVA revealed a significantly precise search by WT and CSP-TTK21 treated THY-Tau22 mice compared to the control THY-Tau22 mice (WT Vs THY-Tau22 CSP: $p=0.0345$; THY-Tau22 CSP-TTK21 Vs THY-Tau22 CSP: $p=0.0398$) (**Figure 1D**). Thus the chronic treatment with CSP-TTK21 significantly rescued the loss of spatial memory in THY-

Tau22 mice. We next investigated if the memory in the CSP-TTK21 treated mice extinguished normally like the WT mice. Therefore, we subjected all the mice to several trials of extinction (Ext 1-4 at 2 h intervals) after the initial probe test. The WT mice spent progressively less time in the target quadrant in the subsequent extinction tests suggesting normal extinction of spatial memory (**Figure 1F**). Typically, THY-Tau22 mice treated with CSP-TTK21 performed similar to the WT mice as their preference to the target quadrant progressively reduced to chance level. On the 4th extinction test (Ext 4), both the groups (WT and THY-Tau22 CSP-TTK21) searched randomly and their performance was not higher than the chance level suggesting complete extinction of spatial memory. The extinction tests did not alter the performance of the THY-Tau22 CSP mice as they were already deficient in the first probe test. Therefore the treatment with CSP-TTK21 improved the consolidation process of spatial memory formation without altering the normal process of memory extinction.

We have previously reported that single injection of CSP-TTK21 is sufficient to improve long-term spatial memory in non-transgenic adult mice (Chatterjee et al., 2013). As the last injection (10th injection) of the chronic treatment was only five days before the start of the MWM task, spatial memory improvement of THY-Tau22 mice may be the result from the last injection only, and not from the chronic effect of the molecule. Therefore, it was essential to verify the effect of a single dose of CSP-TTK21 in the persistence of long term memory in THY-Tau22 mice. We designed a similar experiment with a new set of mice and divided into 3 groups (WT, THY-Tau22 CSP and THY-Tau22 CSP-TTK21, n=8/group). All the THY-Tau22 mice received a single dose of either CSP alone or CSP-TTK21 whereas the WT were injected with saline (**Figure S2A**). Similar to the MWM test performed after chronic treatment, five days after the acute treatment all the mice were trained in MWM for five consecutive days to locate a hidden platform. All the 3 groups of mice learned to locate the hidden platform during the course of training (**Figure S2B**). The probe test was performed after a delay of 10 days from the last training day. During the probe test, WT mice spent significantly longer time in the target quadrant compared to the chance level (15s, $p=0.0009$). However, both control THY-Tau22 and CSP-TTK21 treated THY-Tau22 mice failed to search for longer duration in the target quadrant compared to the chance (THY-Tau22 CSP: $p=0.3595$; THY-Tau22 CSP-TTK21: $p=0.7309$). The performance score in the target quadrant for both THY-Tau22 CSP and THY-Tau22 CSP-TTK21 mice were significantly lower than the WT mice (WT Vs THY-Tau22 CSP: $p= 0.0003$; and WT Vs THY-Tau22 CSP-TTK21: $p= 0.0009$) (**Figure S2C**). Thus, a single dose of CSP-TTK21 treatment is not sufficient to improve the cognitive deficits in pathological THY-Tau22 mice.

Chronic treatment of CSP-TTK21 increases the transcription of genes underlying memory and plasticity in THY-Tau22 mice

Gene expression is a pivotal step in the consolidation of long-term memory (Alberini and Kandel, 2015), as transient activation of immediate early genes (IEGs) is needed for the successive waves of gene expression (Jones et al., 2001). Importantly, induction of some IEGs like *c-fos*, *Zif268* and *ARC* is impaired in the hippocampus of THY-Tau22 mice (Burlot et al., 2015). Therefore to identify the mechanism by which chronic treatment of CSP-TTK21 rescues cognitive deficits in THY-Tau22 mice, we investigated the gene expression patterns of few of those IEGs. We analyzed the expression of 4 immediate early genes in the dorsal hippocampus (*c-fos*, *ARC*, *Zif268* and *DUSP1*). Gene expression of *ARC* and *Zif268* was significantly weaker in control THY-Tau22 mice compared to the WT (*ARC*: $p=0.0006$; *Zif268*: $p=0.0488$). Interestingly, chronic CSP-TTK21 treatment improved the gene expression of *ARC* and *Zif268* in the THY-Tau22 mice to a level similar to that of WT. *DUSP1* expression was unaffected in all the 3 groups of mice. *c-fos* expression was similar in both WT and control THY-Tau22 mice and CSP-TTK21 treatment tend to increase *c-fos* transcript levels but non-significantly in the THY-Tau22 mice (**Figure 2A**).

Activation of histone acetylation by HDAC inhibitors in transgenic mouse model of AD restores expression of synaptic genes (Ricobaraza et al., 2009, 2012). Therefore, we measured the expression of few genes related to synaptic plasticity. Interestingly, the expression of genes related to synaptic formation like *synaptophysin* (*SYP*) and *SAP97* was reduced in the control THY-Tau22 mice compared to the WT (*SYP*: $p=0.0002$; *SAP97*: $p=0.0153$). Chronic treatment of CSP-TTK21 rescued the expression of *SYP* in the THY-Tau22 mice ($p=0.0005$) (**Figure 2B**). Eventhough, the transcript levels of *PSD95* in WT and THY-Tau22 were comparable, a tendency to increase was observed in the CSP-TTK21 treated THY-Tau22 group (**Figure 2B**). Consistent with previous finding we evidenced no change in gene expression of NMDAR subunits *NR2A* and *NR2B* between WT and THY-Tau22 CSP mice (Burnouf et al., 2013) and the treatment had no effect on these genes (**Figure 2B**). However, AMPA receptor *Gria2* expression was reduced in control THY-Tau22 mice ($p=0.05$, compared to WT) and robustly increased by CSP-TTK21 treatment ($p=0.0017$, compared to THY-Tau22 CSP). mRNA expression of *Gria3* was not altered in both the genotypes (**Figure 2C**).

Chronic treatment with CSP-TTK21 increases maturation of adult-born dentate granule cells in THY-Tau22 mice

We have previously shown that CSP-TTK21 induces neuronal differentiation and maturation of adult-generated dentate granule cells in healthy adult mice (Chatterjee et al., 2013). We performed immunohistochemistry studies for DCX (immature neuronal marker) to investigate the degree of maturation and differentiation of DCX-positive cells in the dorsal dentate gyrus. Typically, 5–6 sections were analyzed per animal (n=3/ group). Overall, the number of DCX positive neurons was relatively comparable in the three mice group, although a slight but non-significant decrease was observed in control THY-Tau22 mice compared to WT and CSP-TTK21 treated THY-Tau22 mice (**Figure 3A and B**). We evaluated the dendritic arborization of the DCX⁺ neurons by measuring the total length of the dendrites originating from a single granule cell in specific regions within the dorsal dentate gyrus (**Figure 3C and D**). The total length of the dendrites from a single neuronal tree was significantly lower in the control THY-Tau22 mice compared to the WT ($p= 0.0002$) suggesting that THY-Tau22 mice presents less complex dendritic arborization. However, CSP-TTK21 treated THY-Tau22 mice showed significantly improved and complex dendritic arborization compared to control THY-Tau22 mice ($p=0.0003$). Eventhough, the chronic treatment with CSP-TTK21 improved the dendritic complexity in THY-Tau22 mice but there was still a significant difference compared to the WT ($p= 0.0404$), suggesting that restoration is not full. Control THY-Tau22 mice showed a slight decrease of *DCX* transcript levels compared to the WT ($p= 0.0923$), that tended to be more elevated in the THY-Tau22 CSP-TTK21 mice, but these remained non-significant tendencies (**Figure 3E**). We have previously reported that CSP-TTK21 induced *NeuroD1* and *bdnf eI* gene expression in the hippocampus of adult mice (Chatterjee et al., 2013). However, here we found that *NeuroD1* and transcript levels were significantly lower in both CSP and CSP-TTK21 treated THY-Tau22 compared to the WT mice (WT Vs THY-Tau22 CSP: $p= 0.0006$; WT Vs THY-Tau22 CSP-TTK21: $p= 0.0004$) (**Figure 3E**). Nevertheless, if WT and control THY-Tau22 mice showed similar levels of *bdnf eI* transcript levels, THY-Tau22 injected with CSP-TTK21 showed significantly increased amounts of *bdnf eI* compared to the WT ($p= 0.0055$) and control THY-Tau22 ($p= 0.004$) (**Figure 3E**).

CSP-TTK21 does not impart any apparent toxicity in different body organs or brain parts of THY-Tau22 mice after chronic administration

The limitation of chronic treatment of a drug is its toxic side-effects. Toxicity could arise from accumulation in liver, spleen and kidneys as the drug needs to pass these organs before getting cleared out of the body or get metabolized. We applied three strategies to measure any evidence of drug induced toxicity after chronic treatment. Firstly, drug induced toxicity could be determined by monitoring body weights which is considered to be a sensitive but non-specific, indicator of health (Kukowska-Latallo et al., 2005). Secondly, cell or tissue toxicity could lead to cleavage of pro-apoptotic factors like caspase-3 that in turn activates the cellular apoptosis pathways. Thirdly, if the drug gets accumulated or trapped in any body organs, then it could be detected by its substrate activity. As CSP-TTK21 is a HAT activator, the levels of acetylated histones in these body parts would indicate the presence of the drug.

The body weight of all the mice was monitored at each injection day, throughout the course of the chronic treatment. THY-Tau22 mice exhibit a decrease in body weight compared to the WT (Schindowski et al., 2006). We indeed evidenced a significant loss of body weight in control THY-Tau22 mice ($p=0.0001$, WT Vs THY-Tau22 CSP), that was not impacted by the CSP-TTK21 treatment ($p=0.0001$, WT Vs THY-Tau22 CSP-TTK21) (**Figure 4A**).

We then measured the levels of procaspase 3 (32 KDa) and cleaved caspase 3 (17-20 KDa) protein fragments that could account for any cellular toxic effect upon chronic treatment. As, CSP-TTK21 targets the brain tissues, we analyzed caspase 3 levels in frontal cortex and hippocampus. Similar amounts of pro-caspase 3 levels were detected in the frontal cortex and ventral hippocampus between control and CSP-TTK21 treated THY-Tau22 mice (**Figure 4B and figure S3A**). However, we failed to detect any cleaved caspase 3 in the brain lysate blots possibly due to presence of extremely low levels. In the four body organs tested (kidney, spleen, liver and heart), we found similar procaspase 3 protein levels between control and CSP-TTK21 treated THY-Tau22 mice in spleen, liver and heart (**Figure 4C and figure S3B**). However, a non-significant tendency of increase was observed in kidney ($p=0.1124$). Levels of cleaved caspase 3 also showed similar pattern between control and CSP-TTK21 treated THY-Tau22 mice in kidney, heart and liver, whereas in spleen a significant reduction was observed in the THY-Tau22 treated with CSP-TTK21 ($p=0.0361$) (**Figure 4C and Figure S3B**).

The acetylation status of histones H2B and H3 in liver, spleen, kidneys and heart were then compared between the THY-Tau22 chronically injected with CSP or CSP-TTK21. Western blot studies revealed that the acetylation level of histones H2B and H3 were comparable between the two groups (control and CSP-TTK21 treated THY-Tau22 mice) in all the 4 organs tested (**Figure S4A and S4B**). These results indicate the absence of prolonged side-effects of the drug CSP-TTK21 in these organs, as it may have been rapidly cleared out or metabolized after each *i.p.* injection.

We have also evaluated the global histone acetylation status in the frontal cortex and ventral hippocampus of THY-Tau22 mice after chronic treatment. Histone H2B acetylation was predominantly unaltered in both frontal cortex and ventral hippocampus in THY-Tau22 mice after CSP-TTK21 treatment (**Figure S5A and S5B**). Histone H3 acetylation was reduced in the frontal cortex in the control THY-Tau22 mice compared to WT ($p=0.0488$), however CSP-TTK21 treatment failed to rescue such reduction in histone H3 acetylation in THY-Tau22 mice ($p=0.3071$, THY-Tau22 CSP Vs CSP-TTK21). Apart from histones, HATs have many non-histone proteins as substrates for acetylation. Acetylation of some of the non-histone proteins are associated with neurodegenerative diseases and have close connection with synaptic plasticity and memory (Schneider et al., 2013). We checked the acetylation levels of two non-histone proteins; tubulin (cytoplasmic) and NF- κ B (nuclear) in the frontal cortex. Western blots revealed no alteration in the acetylated tubulin in all the 3 groups of animals (**Figure S5C and S5D**). NF- κ B acetylation was similar between WT and control THY-Tau22 mice, whereas a non-significant increase was observed in THY-Tau22 CSP-TTK21 mice (**Figure S5D**).

In conclusion, chronic CSP-TTK21 treatment (total of 10 injections) of THY-Tau22 mice does not impact on histone (i.e. H2B, H3) and non-histone (i.e. NF κ B, tubulin) acetylation status, 21 days after the last injection, underlining that the molecule does not induce persistent acetylation in the brain structures nor in the body organs tested. The caspase study also suggests a non-toxic nature of chronic CSP-TTK21 treatment.

Chronic treatment of CSP-TTK21 did not affect tau phosphorylation in THY-Tau22 mice

THY-Tau22 mice exhibit elevated phosphorylation of Tau protein as characterized in AD pathology that correlates with memory deficits (Schindowski et al., 2006; Belarbi et al., 2011; Burnouf et al., 2013). Therefore, the beneficial effect seen after CSP-TTK21 chronic

treatment on spatial memory of THY-Tau22 mice prompted us to investigate the anatomopathological status in these mice. We analyzed the phosphorylation levels of tau on various epitopes in the hippocampus and frontal cortex of THY-Tau22 mice. We evaluated Tau phosphorylation at Ser214, Ser404 (physiological epitopes), Thr181 and Ser199 (pathological) and tau dephosphorylation using Tau1 antibody by western blot studies. The data revealed that chronic treatment with CSP-TTK21 did not alter any of the phospho-Tau epitopes in the hippocampus (**Figure 5A, B and Figure S6**) or frontal cortex (**Figure S7A and B**) relative to total Tau levels. Tau1 levels representing the dephosphorylated Tau epitopes was found unchanged in both hippocampus and frontal cortex of control and CSP-TTK21 treated THY-Tau22 mice. We have also used antibodies recognizing Tau protein at either N- or C- terminal regions. No change in total tau at C- or N-terminal was observed between control and CSP-TTK21 treated THY-Tau22 mice in both the brain structures (**Figure 5B**). However, a non-significantly reduced levels of C-ter fragments were observed in the frontal cortex of CSP-TTK21 injected THY-Tau22 mice compared to control THY-Tau22 mice ($p=0.0896$; fragments between 25 and 35 kDa) (**Figure S7A and B**). The impact of chronic CSP-TTK21 treatment was also evaluated on Tau aggregation after biochemical fractionation and analyses of the sarkosyl-soluble and insoluble fractions in the hippocampus of THY-Tau22 mice (**Figure 5C**). We observed similar amounts of sarkosyl insoluble tau in CSP and CSP-TTK21 treated THY-Tau22 mice (**Figure 5D**). In addition, treatment of CSP-TTK21 did not altered the gene expression of inflammatory marker CCL4 in the dorsal hippocampus of THY-Tau22 mice (**Figure S8A**) ($p=0.5705$, THY-Tau22 CSP Vs CSP-TTK21 treatment). Finally, we verified that the transcript levels of human- and murine- tau were not modified by the chronic treatment in the dorsal hippocampus of THY-Tau22 mice (**Figure S8B**).

Together, these data indicate that chronic treatment with CSP-TTK21 did not impact on Tau pathology and possibly activates parallel pathways to boost memory functions and adult neurogenesis and overcome the detrimental effect of Tau hyper- or abnormal-phosphorylation.

Discussion

The present study was designed to evaluate the implications of a newly developed HAT activator CSP-TTK21 as a new therapeutic strategy against cognitive impairment associated with Tau pathology. In this study we evidenced that a chronic treatment of THY-Tau22 mice with the HAT activator CSP-TTK21 restored long-term spatial reference memory, without altering the memory trace extinction. We show that such treatment increases gene transcription of activity/ memory genes (*Zif268*, *ARC*) as well as plasticity genes (*Synaptophysin* and *Gria2*) and also improves differentiation of newly-generated neurons in the hippocampus. However, the improvement of cognitive function by CSP-TTK21 was independent of pathogenic Tau load in the hippocampus and frontal cortex as hyper- and abnormal- phosphorylated forms of Tau proteins were unaltered after the treatment.

Reversal of cognitive defects in THY-Tau22 mice by CSP-TTK21 treatment

While CBP plays an important role in the formation of long-term memory (Barco, 2007, Barrett and Wood, 2008, Barrett et al., 2011), reduced activity of CBP has been associated with various neurodegenerative conditions (Valor et al., 2013; Schneider et al., 2013). The most common therapeutic strategy to recover from such conditions is by employing HDAC inhibitors (Gräff and Tsai, 2013). However, a more direct approach to activate CBP function by genetic or pharmacological interventions will provide more specificity and possibly similar outcomes (Reviewed in Valor et al., 2013). The first evidence of beneficial effect of CBP activation in a mouse model of cognitive impairment was reported by Caccamo et al. in 2010. Brain viral delivery of CBP improved learning and spatial memory deficits in a mouse model of AD (Caccamo et al., 2010). Later, we have reported that pharmacological activation of CBP HAT function in mice brain improved retention of long-term spatial memory (Chatterjee et al., 2013). In addition, stimulation of CREB signalling pathway in the dorsal hippocampus (one major target of CBP/p300) leads to improved spatial memory in weakly trained animals (Sekeres et al., 2010). We have observed decreased expression of CBP protein levels in the dorsal hippocampus of 12 months old THY-Tau22 mice (Supporting Results, SR1) and total degradation in brains of latest stage AD patients (Data not shown, *Manuscript in preparation*,). Therefore the strategy to activate the remaining CBP protein to prolong its effect as possible is of extreme significance in the pathophysiology of Alzheimer's diseases. The chronic treatment with CSP-TTK21 significantly rescued

cognitive deficits in long-term retention of spatial memory in THY-Tau22 mice, whereas single dose of CSP-TTK21 failed to reverse such memory deficits. Thus, a steady activation of brain CBP function is essential to improve cognitive impairment in THY-Tau22 mice. Therefore, these results further strengthen the present notion that activation of CBP function is a potential therapeutic approach to ameliorate memory deficits as observed in AD.

CSP-TTK21 targets transcription of memory related genes

Our gene expression studies demonstrate that chronic treatment with CSP-TTK21 impacts on the transcription of immediate early genes (IEGs). We identified that CSP-TTK21 treatment completely re-established the transcript levels of two immediate early genes (IEGs) *ARC* and *Zif268*, that we (this study) and others (Burlot et al., 2015) found decreased in the dorsal hippocampus of THY-Tau22 mice. *ARC* mRNA expression is also impaired in the hippocampus in other tauopathy mouse models (Fox et al., 2011, Alldred et al., 2012). Both *ARC* and *Zif268* are implicated in synaptic plasticity and spatial memory formation (Bramham et al., 2010, Veyrac et al., 2014). Knock out mouse models of either *ARC* or *Zif268* shows deficiency for consolidation of hippocampus dependent long-term memory whereas short-term memory remains intact (Plath et al., 2006, (Jones et al., 2001c). Additionally, gain of function of *Zif268* was recently reported to enhance hippocampal capacity to form long-term spatial memory (Penke et al., 2014). Interestingly, *ARC* is also a direct transcriptional target of *Zif268* (Li et al., 2005; Koldamova et al., 2014). Our results from the chronic treatment demonstrate that CSP-TTK21 targets the activity dependent genes such as *ARC* and *Zif268* to restore spatial memory related molecular events in THY-Tau22 mice. CSP-TTK21 chronic treatment from an early age (3 months for this study) probably resulted in steady maintenance of the basal levels of these immediate early genes in the dorsal hippocampus of THY-Tau22 mice during the 5 months of treatment. Apart from the IEGs, we also evidenced decreased transcript levels of *synaptophysin*, *SAP97* and *SAP102* that are implicated in synaptic formation (Regalado et al., 2006) and are responsive to modulation upon HDACi treatment (Ricobaraza et al., 2012). Interestingly, chronic treatment with CSP-TTK21 rescued the loss of *synaptophysin* in THY-Tau22 mice. Another important component related to synaptic plasticity is the regulation of glutamate receptors. We observed decreased transcript levels of AMPA receptor *Gria2* in THY-Tau22 mice that were robustly increased by the chronic treatment. Taken together, these experiments show that CSP-TTK21 treatment restores hippocampal plasticity and activity/memory –related markers in the hippocampus, markers that are otherwise deficient in the tau model.

CSP-TTK21 treatment improves neuronal differentiation

Adult hippocampal neurogenesis occurs throughout the life span whereas most of the newly generated neurons fail to survive before getting integrated into the neural circuits. In response to experience, new neurons from 2 to 4 weeks from birth are the most likely recruited into the dentate gyrus/hippocampus circuitry supporting spatial memory (Kee et al., 2007; Goodman et al., 2010). New neurons from DG granule cells receive inputs from the entorhinal cortex at 3 to 5 weeks after birth (Deshpande et al., 2013) and blockade of these inputs results in deficits in DG dependent tasks like pattern separation (Vivar et al., 2012). Neuronal maturation characterized with increased dendritic arborization provides more possibility for connectivity after experience dependent circuit remodelling (Bergami et al., 2015). Here in this study we showed that CSP-TTK21 treated THY-Tau22 mice presented increased dendritic arborization and complexity of DCX positive neurons in the dorsal dentate gyrus. These findings support the present notion that CSP-TTK21 chronic treatment improves the differentiation of newly generated neurons. Furthermore, secondary dendrites from the stratum radiatum in CA1 of THY-Tau22 mice were recently reported to present reduced length and decreased spine density (Burlot et al., 2015). Therefore, it is possible that THY-Tau22 mice present reduced hippocampal connectivity that could be compensated by CSP-TTK21 treatments. However, it is yet to be determined whether CSP-TTK21 treatment improves the recruitment of the newly generated neurons into the neural network supporting spatial memory and it acts on spine densities in immature and mature neurons. One important factor identified to be crucial for dendritic maturation and development of adult new-born dentate granule cells is Zif268. Mice lacking Zif268 (Zif268 KO mice) exhibits defects in morphological maturation of adult new-born neurons in the dentate gyrus. These mice also presents defective dendritic arborization characterized with reduced mean dendrite length of matured neurons. Furthermore, Zif268 is required for the recruitment of new-born dentate granule cells into spatial memory network (Veyrac et al., 2013). We found that *Zif268* gene expression was compromised in the dorsal hippocampus of THY-Tau22 mice and was rescued by CSP-TTK21 treatment. Therefore activating Zif268 function by CSP-TTK21 proves valuable to restore hippocampal plasticity and long term spatial memory storage. In addition, we observed a tendency of decrease in DCX transcript levels in the dorsal hippocampus of THY-Tau22 mice whereas a partial rescue was observed after treatment with CSP-TTK21. However, NeuroD1 gene expression decrease was not rescued upon CSP-TTK21 chronic treatment. One possible explanation is that CSP-TTK21 only transiently induces the transcription of NeuroD1 after each injection.

Taken together, these results underline the importance of chronic treatment of CSP-TTK21 to ameliorate the deficits of hippocampus dependent-memory formation in THY-Tau22 mice and point to Zif268 as an important player in the ability of CSP-TTK21 to restore hippocampal functions.

In summary, our data indicates that cognitive impairment as observed in a mouse model of tauopathy can be restored by chronic CSPTTK21. These results support the implication of pharmacological activation of CBP into adult brains as a potential therapeutic approach for AD and other related neurodegenerative disorders. However, this treatment did not affect tau pathology. Previous papers already showed restoration of cognitive functions without Tau pathology alteration in mouse models of tauopathy (Caccamo et al., 2010; Yang et al., 2015; Brownlow et al., 2014; Burlot et al., 2015), so in a therapeutic point of view, such strategy could still delay the patient's dependency for care giving. In addition, prolonged modulation of CBP by CSP-TTK21 did not impart any apparent toxic side-effects which are important evidences from a therapeutic perspective. Apart from AD, CBP dysfunction is also common in other neurodegenerative diseases like Huntington disease (Giralt et al., 2012) and Rubinstein–Taybi syndrome (Alarcón et al., 2004; Valor et al., 2013). Therefore, pharmacological activation of CBP in the brain could be a powerful therapeutic tool for the treatment of diseases associated with cognitive impairment.

Disclosure statement: The authors declare no conflict of interest.

Acknowledgements: We thank Mariane Litt for her help in the western blots studies. SC was supported by CEFIPRA fellowship (Grant #4803-3 to A.-L.B and T.K.K.). This work was supported by the Centre National de la Recherche Scientifique, the University of Strasbourg, Alsace Alzheimer 67, ANR (Grant #ANR-12-MALZ-0002-01 to A.-L.B.), the Indo-French Centre for the Promotion of Advanced Research (Grant #4803-3 to A.-L.B and T.K.K.), the Department of Biotechnology, the Government of India (Grant #BT/ CSH/GIA/1752 to T.K.K.), the Jawaharlal Nehru Centre for Advanced Scientific Research. We wish to thank O Bildstein, D. Egesi, G. Edomwonyi and C Strittmatter for their assistance with production of transgenic mice and animal care.

Author's contribution: SC performed the MWM tests, gene expression studies, IHC and western blots. "CSP" was prepared in ME's laboratory by PC. SHS synthesized "TTK21"

and conjugated it to “CSP” in TKK’s laboratory. MK characterized the biological activity of “CSP-TTK21” in cell lines. BC performed the *i.p.* injections and helped with the IHC. RC helped in the MWM studies and *i.p.* injections. MSC, LB and DB performed tau pathology experiments and analyzed the data. SC, JCC and ALB designed the experiments, analyzed the data and wrote the manuscript.

References

- Alarcón, J.M., Malleret, G., Touzani, K., Vronskaya, S., Ishii, S., Kandel, E.R., and Barco, A. (2004). Chromatin acetylation, memory, and LTP are impaired in CBP^{+/-} mice: a model for the cognitive deficit in Rubinstein-Taybi syndrome and its amelioration. *Neuron* 42, 947–959.
- Alberini, C.M., and Kandel, E.R. (2015). The regulation of transcription in memory consolidation. *Cold Spring Harb. Perspect. Biol.* 7, a021741.
- Allred, M.J., Duff, K.E., and Ginsberg, S.D. (2012). Microarray analysis of CA1 pyramidal neurons in a mouse model of tauopathy reveals progressive synaptic dysfunction. *Neurobiol. Dis.* 45, 751–762.
- Barco, A. (2007). The Rubinstein-Taybi syndrome: modeling mental impairment in the mouse. *Genes Brain Behav.* 6 *Suppl 1*, 32–39.
- Barrett, R.M., and Wood, M.A. (2008). Beyond transcription factors: the role of chromatin modifying enzymes in regulating transcription required for memory. *Learn. Mem. Cold Spring Harb. N* 15, 460–467.
- Barrett, R.M., Malvaez, M., Kramar, E., Matheos, D.P., Arrizon, A., Cabrera, S.M., Lynch, G., Greene, R.W., and Wood, M.A. (2011). Hippocampal focal knockout of CBP affects specific histone modifications, long-term potentiation, and long-term memory. *Neuropsychopharmacol. Off. Publ. Am. Coll. Neuropsychopharmacol.* 36, 1545–1556.
- Belarbi, K., Burnouf, S., Fernandez-Gomez, F.-J., Desmercières, J., Troquier, L., Brouillette, J., Tsambou, L., Grosjean, M.-E., Caillierez, R., Demeyer, D., et al. (2011). Loss of medial septum cholinergic neurons in THY-Tau22 mouse model: what links with tau pathology? *Curr. Alzheimer Res.* 8, 633–638.
- Benito, E., Urbanke, H., Ramachandran, B., Barth, J., Halder, R., Awasthi, A., Jain, G., Capece, V., Burkhardt, S., Navarro-Sala, M., et al. (2015). HDAC inhibitor-dependent transcriptome and memory reinstatement in cognitive decline models. *J. Clin. Invest.* 125, 3572–3584.
- Bergami, M., Masserdotti, G., Temprana, S.G., Motori, E., Eriksson, T.M., Göbel, J., Yang, S.M., Conzelmann, K.-K., Schinder, A.F., Götz, M., et al. (2015). A critical period for experience-dependent remodeling of adult-born neuron connectivity. *Neuron* 85, 710–717.

Berger, S.L. (2007). The complex language of chromatin regulation during transcription. *Nature* 447, 407–412.

Braak, H., and Del Tredici, K. (2011). The pathological process underlying Alzheimer's disease in individuals under thirty. *Acta Neuropathol. (Berl.)* 121, 171–181.

Braak, H., de Vos, R.A., Jansen, E.N., Bratzke, H., and Braak, E. (1998). Neuropathological hallmarks of Alzheimer's and Parkinson's diseases. *Prog. Brain Res.* 117, 267–285.

Bramham, C.R., Alme, M.N., Bittins, M., Kuipers, S.D., Nair, R.R., Pai, B., Panja, D., Schubert, M., Soule, J., Tiron, A., et al. (2010). The Arc of synaptic memory. *Exp. Brain Res.* 200, 125–140.

Brownlow, M.L., Joly-Amado, A., Azam, S., Elza, M., Selenica, M.-L., Pappas, C., Small, B., Engelman, R., Gordon, M.N., and Morgan, D. (2014). Partial rescue of memory deficits induced by calorie restriction in a mouse model of tau deposition. *Behav. Brain Res.* 271, 79–88.

Burlot, M.-A., Braudeau, J., Michaelsen-Preusse, K., Potier, B., Ayciriex, S., Varin, J., Gautier, B., Djelti, F., Audrain, M., Dauphinot, L., et al. (2015). Cholesterol 24-hydroxylase defect is implicated in memory impairments associated with Alzheimer-like Tau pathology. *Hum. Mol. Genet.*

Burnouf, S., Martire, A., Derisbourg, M., Laurent, C., Belarbi, K., Leboucher, A., Fernandez-Gomez, F.J., Troquier, L., Eddarkaoui, S., Grosjean, M.-E., et al. (2013). NMDA receptor dysfunction contributes to impaired brain-derived neurotrophic factor-induced facilitation of hippocampal synaptic transmission in a Tau transgenic model. *Aging Cell* 12, 11–23.

Caccamo, A., Maldonado, M.A., Bokov, A.F., Majumder, S., and Oddo, S. (2010). CBP gene transfer increases BDNF levels and ameliorates learning and memory deficits in a mouse model of Alzheimer's disease. *Proc. Natl. Acad. Sci. U. S. A.* 107, 22687–22692.

Chatterjee, S., Mizar, P., Cassel, R., Neidl, R., Selvi, B.R., Mohankrishna, D.V., Vedamurthy, B.M., Schneider, A., Bousiges, O., Mathis, C., et al. (2013). A novel activator of CBP/p300 acetyltransferases promotes neurogenesis and extends memory duration in adult mice. *J. Neurosci. Off. J. Soc. Neurosci.* 33, 10698–10712.

Chen, X.-F., Zhang, Y., Xu, H., and Bu, G. (2013). Transcriptional regulation and its misregulation in Alzheimer's disease. *Mol. Brain* 6, 44.

Deshpande, A., Bergami, M., Ghanem, A., Conzelmann, K.-K., Lepier, A., Götz, M., and Berninger, B. (2013). Retrograde monosynaptic tracing reveals the temporal evolution of inputs onto new neurons in the adult dentate gyrus and olfactory bulb. *Proc. Natl. Acad. Sci. U. S. A.* 110, E1152–E1161.

Fischer, A. (2014). Targeting histone-modifications in Alzheimer's disease. What is the evidence that this is a promising therapeutic avenue? *Neuropharmacology* 80, 95–102.

Fox, L.M., William, C.M., Adamowicz, D.H., Pitstick, R., Carlson, G.A., Spires-Jones, T.L., and Hyman, B.T. (2011). Soluble tau species, not neurofibrillary aggregates, disrupt neural system integration in a tau transgenic model. *J. Neuropathol. Exp. Neurol.* 70, 588–595.

- Giralt, A., Puigdemívol, M., Carretón, O., Paoletti, P., Valero, J., Parra-Damas, A., Saura, C.A., Alberch, J., and Ginés, S. (2012). Long-term memory deficits in Huntington's disease are associated with reduced CBP histone acetylase activity. *Hum. Mol. Genet.* *21*, 1203–1216.
- Goldberg, A.D., Allis, C.D., and Bernstein, E. (2007). Epigenetics: a landscape takes shape. *Cell* *128*, 635–638.
- Goodman, T., Trouche, S., Massou, I., Verret, L., Zerwas, M., Roulet, P., and Rampon, C. (2010). Young hippocampal neurons are critical for recent and remote spatial memory in adult mice. *Neuroscience* *171*, 769–778.
- Gräff, J., and Tsai, L.-H. (2013). The potential of HDAC inhibitors as cognitive enhancers. *Annu. Rev. Pharmacol. Toxicol.* *53*, 311–330.
- Hilton, I.B., D'Ippolito, A.M., Vockley, C.M., Thakore, P.I., Crawford, G.E., Reddy, T.E., and Gersbach, C.A. (2015). Epigenome editing by a CRISPR-Cas9-based acetyltransferase activates genes from promoters and enhancers. *Nat. Biotechnol.* *33*, 510–517.
- Jenuwein, T., and Allis, C.D. (2001). Translating the histone code. *Science* *293*, 1074–1080.
- Jones, M.W., Errington, M.L., French, P.J., Fine, A., Bliss, T.V., Garel, S., Charnay, P., Bozon, B., Laroche, S., and Davis, S. (2001). A requirement for the immediate early gene *Zif268* in the expression of late LTP and long-term memories. *Nat. Neurosci.* *4*, 289–296.
- Kee, N., Teixeira, C.M., Wang, A.H., and Frankland, P.W. (2007). Preferential incorporation of adult-generated granule cells into spatial memory networks in the dentate gyrus. *Nat. Neurosci.* *10*, 355–362.
- Koldamova, R., Schug, J., Lefterova, M., Cronican, A.A., Fitz, N.F., Davenport, F.A., Carter, A., Castranio, E.L., and Lefterov, I. (2014). Genome-wide approaches reveal *EGR1*-controlled regulatory networks associated with neurodegeneration. *Neurobiol. Dis.* *63*, 107–114.
- Kouzarides, T. (2007). Chromatin modifications and their function. *Cell* *128*, 693–705.
- Kukowska-Latallo, J.F., Candido, K.A., Cao, Z., Nigavekar, S.S., Majoros, I.J., Thomas, T.P., Balogh, L.P., Khan, M.K., and Baker, J.R. (2005). Nanoparticle targeting of anticancer drug improves therapeutic response in animal model of human epithelial cancer. *Cancer Res.* *65*, 5317–5324.
- Laurent, C., Burnouf, S., Ferry, B., Batalha, V.L., Coelho, J.E., Baqi, Y., Malik, E., Mariciniak, E., Parrot, S., Van der Jeugd, A., et al. (2014). A2A adenosine receptor deletion is protective in a mouse model of Tauopathy. *Mol. Psychiatry*.
- Li, L., Carter, J., Gao, X., Whitehead, J., and Tourtellotte, W.G. (2005). The neuroplasticity-associated arc gene is a direct transcriptional target of early growth response (Egr) transcription factors. *Mol. Cell. Biol.* *25*, 10286–10300.
- Lopez-Atalaya, J.P., and Barco, A. (2014). Can changes in histone acetylation contribute to memory formation? *Trends Genet. TIG* *30*, 529–539.

- Marambaud, P., and Robakis, N.K. (2005). Genetic and molecular aspects of Alzheimer's disease shed light on new mechanisms of transcriptional regulation. *Genes Brain Behav.* *4*, 134–146.
- Peixoto, L., and Abel, T. (2013). The role of histone acetylation in memory formation and cognitive impairments. *Neuropsychopharmacol. Off. Publ. Am. Coll. Neuropsychopharmacol.* *38*, 62–76.
- Penke, Z., Morice, E., Veyrac, A., Gros, A., Chagneau, C., LeBlanc, P., Samson, N., Baumgärtel, K., Mansuy, I.M., Davis, S., et al. (2014). Zif268/Egr1 gain of function facilitates hippocampal synaptic plasticity and long-term spatial recognition memory. *Philos. Trans. R. Soc. Lond. B. Biol. Sci.* *369*, 20130159.
- Plath, N., Ohana, O., Dammermann, B., Errington, M.L., Schmitz, D., Gross, C., Mao, X., Engelsberg, A., Mahlke, C., Welzl, H., et al. (2006). Arc/Arg3.1 is essential for the consolidation of synaptic plasticity and memories. *Neuron* *52*, 437–444.
- Regalado, M.P., Terry-Lorenzo, R.T., Waites, C.L., Garner, C.C., and Malenka, R.C. (2006). Transsynaptic signaling by postsynaptic synapse-associated protein 97. *J. Neurosci. Off. J. Soc. Neurosci.* *26*, 2343–2357.
- Ricobaraza, A., Cuadrado-Tejedor, M., Pérez-Mediavilla, A., Frechilla, D., Del Río, J., and García-Osta, A. (2009). Phenylbutyrate ameliorates cognitive deficit and reduces tau pathology in an Alzheimer's disease mouse model. *Neuropsychopharmacol. Off. Publ. Am. Coll. Neuropsychopharmacol.* *34*, 1721–1732.
- Ricobaraza, A., Cuadrado-Tejedor, M., Marco, S., Pérez-Otaño, I., and García-Osta, A. (2012). Phenylbutyrate rescues dendritic spine loss associated with memory deficits in a mouse model of Alzheimer disease. *Hippocampus* *22*, 1040–1050.
- Rouaux, C., Jokic, N., Mbebi, C., Boutillier, S., Loeffler, J.-P., and Boutillier, A.-L. (2003). Critical loss of CBP/p300 histone acetylase activity by caspase-6 during neurodegeneration. *EMBO J.* *22*, 6537–6549.
- Schindowski, K., Bretteville, A., Leroy, K., Bégard, S., Brion, J.-P., Hamdane, M., and Buée, L. (2006). Alzheimer's disease-like tau neuropathology leads to memory deficits and loss of functional synapses in a novel mutated tau transgenic mouse without any motor deficits. *Am. J. Pathol.* *169*, 599–616.
- Schneider, A., Chatterjee, S., Bousiges, O., Selvi, B.R., Swaminathan, A., Cassel, R., Blanc, F., Kundu, T.K., and Boutillier, A.-L. (2013). Acetyltransferases (HATs) as targets for neurological therapeutics. *Neurother. J. Am. Soc. Exp. Neurother.* *10*, 568–588.
- Sekeres, M.J., Neve, R.L., Frankland, P.W., and Josselyn, S.A. (2010). Dorsal hippocampal CREB is both necessary and sufficient for spatial memory. *Learn. Mem. Cold Spring Harb. N* *17*, 280–283.
- Selvi, B.R., Jagadeesan, D., Suma, B.S., Nagashankar, G., Arif, M., Balasubramanyam, K., Eswaramoorthy, M., and Kundu, T.K. (2008). Intrinsically fluorescent carbon nanospheres as a nuclear targeting vector: delivery of membrane-impermeable molecule to modulate gene expression in vivo. *Nano Lett.* *8*, 3182–3188.

Valor, L.M., Viosca, J., Lopez-Atalaya, J.P., and Barco, A. (2013). Lysine acetyltransferases CBP and p300 as therapeutic targets in cognitive and neurodegenerative disorders. *Curr. Pharm. Des.* *19*, 5051–5064.

Van der Jeugd, A., Ahmed, T., Burnouf, S., Belarbi, K., Hamdame, M., Grosjean, M.-E., Humez, S., Balschun, D., Blum, D., Buée, L., et al. (2011). Hippocampal tauopathy in tau transgenic mice coincides with impaired hippocampus-dependent learning and memory, and attenuated late-phase long-term depression of synaptic transmission. *Neurobiol. Learn. Mem.* *95*, 296–304.

Van der Jeugd, A., Blum, D., Raison, S., Eddarkaoui, S., Buée, L., and D’Hooge, R. (2013). Observations in THY-Tau22 mice that resemble behavioral and psychological signs and symptoms of dementia. *Behav. Brain Res.* *242*, 34–39.

Veyrac, A., Gros, A., Bruel-Jungerman, E., Rochefort, C., Kleine Borgmann, F.B., Jessberger, S., and Laroche, S. (2013). Zif268/egr1 gene controls the selection, maturation and functional integration of adult hippocampal newborn neurons by learning. *Proc. Natl. Acad. Sci. U. S. A.* *110*, 7062–7067.

Veyrac, A., Besnard, A., Caboche, J., Davis, S., and Laroche, S. (2014). The transcription factor Zif268/Egr1, brain plasticity, and memory. *Prog. Mol. Biol. Transl. Sci.* *122*, 89–129.

Vivar, C., Potter, M.C., Choi, J., Lee, J.-Y., Stringer, T.P., Callaway, E.M., Gage, F.H., Suh, H., and van Praag, H. (2012). Monosynaptic inputs to new neurons in the dentate gyrus. *Nat. Commun.* *3*, 1107.

Yang, S., Cacquevel, M., Saksida, L.M., Bussey, T.J., Schneider, B.L., Aebischer, P., Melani, R., Pizzorusso, T., Fawcett, J.W., and Spillantini, M.G. (2015). Perineuronal net digestion with chondroitinase restores memory in mice with tau pathology. *Exp. Neurol.* *265*, 48–58.

Figures and figure legends

Figure 1

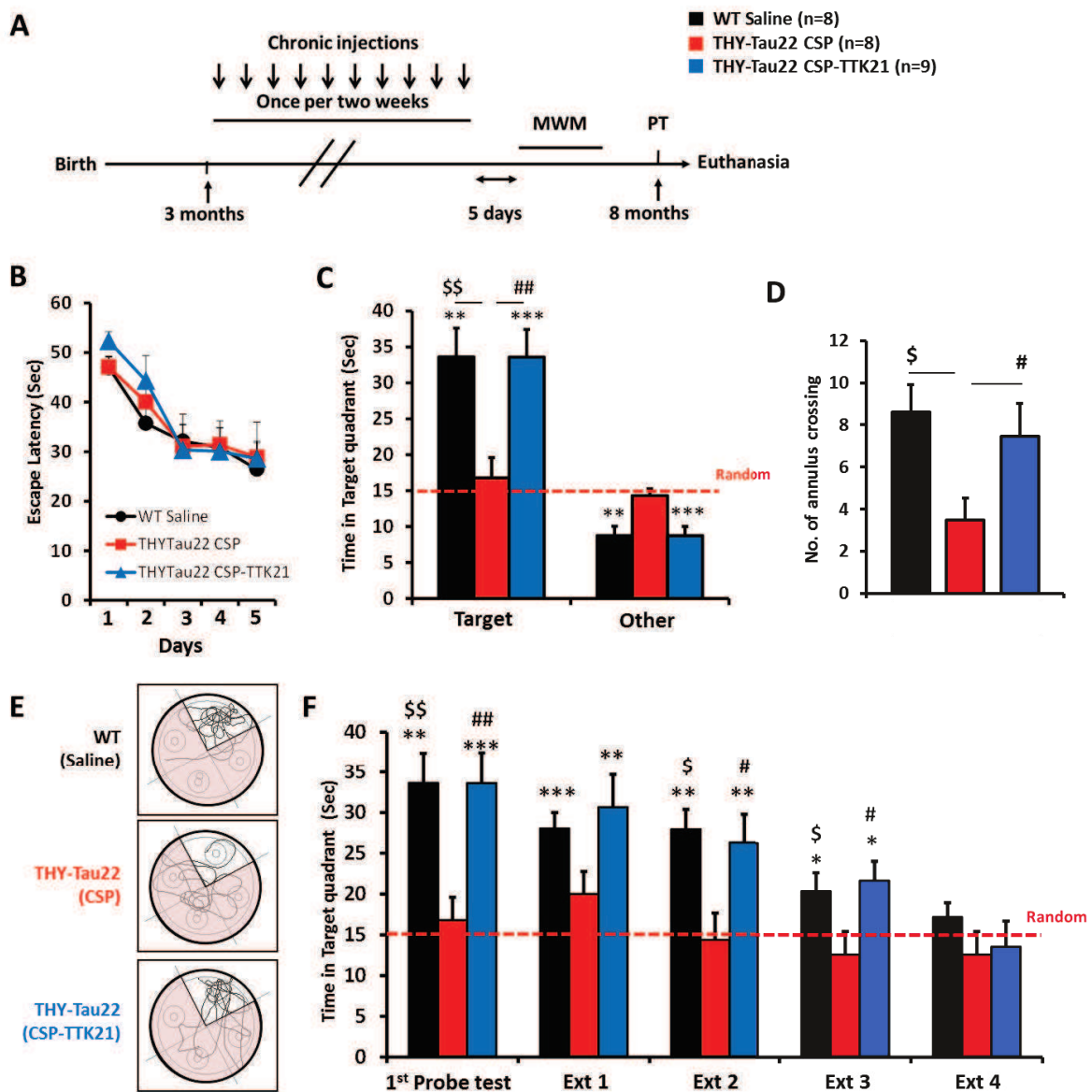

Figure 1. Chronic treatment of CSP-TTK21 reduced memory deficits in THY-Tau22 mice. **A**, Timeline of the chronic treatment relative to the MWM training protocol. Chronic treatment of either CSP (n=8) or CSP-TTK21 (n=9) was started on 3 months age THY-Tau22 mice. Sex matched control littermates (WT, n=8) were injected with saline. Intraperitoneal injections were administered every 2 weeks (1 injection/ 2 weeks). The chronic treatment were continued for 5 months during which 10 injection were made. The spatial memory test was started after 5 days from the last injection (10th injection). The experiment was planned in such way that during the memory test the age of all the mice will

be 8 months. After sufficient time from extinction tests, the mice were euthenised and various brain region and body tissues were collected. **B**, Acquisition curve showing the latency to reach the platform during the MWM training. All the 3 groups of mice learned to locate the hidden platform gradually during each days of training. **C**, Retention was tested during the probe test after a delay of 10 days from the last acquisition for persistence of long-term memory. Time spent in the target quadrant and the mean of time spent in the other quadrants were measured. WT and THY-Tau22 mice spent significantly more time in the target quadrant compared to the THY-Tau22 CSP mice. **D**, Measurement of number of target annulus crossing in the correct quadrant during the probe test. **E**, Representative tracking images of probe test. **F**, Extinction tests were performed after 2-hour intervals from the probe test. Performance score of WT and THY-Tau22 CSP-TTK21 mice were significantly higher than that of THY-Tau CSP for Ex 1 to Ex 3 and were also significantly higher than the chance. Dotted line indicates the chance level (15s). Results are expressed as mean +SEM. * $p < 0.05$, ** $p < 0.01$, *** $p < 0.001$, student's t-test compared to chance level. $^{\$}$ $p < 0.01$ when WT compared to THY-Tau22 CSP, and $^{\#\#}$ $p < 0.01$ when THY-Tau22 CSP compared to THY-Tau22 CSP-TTK21; ANOVA factorial followed by Newman-Keuls post-hoc test.

Figure 2

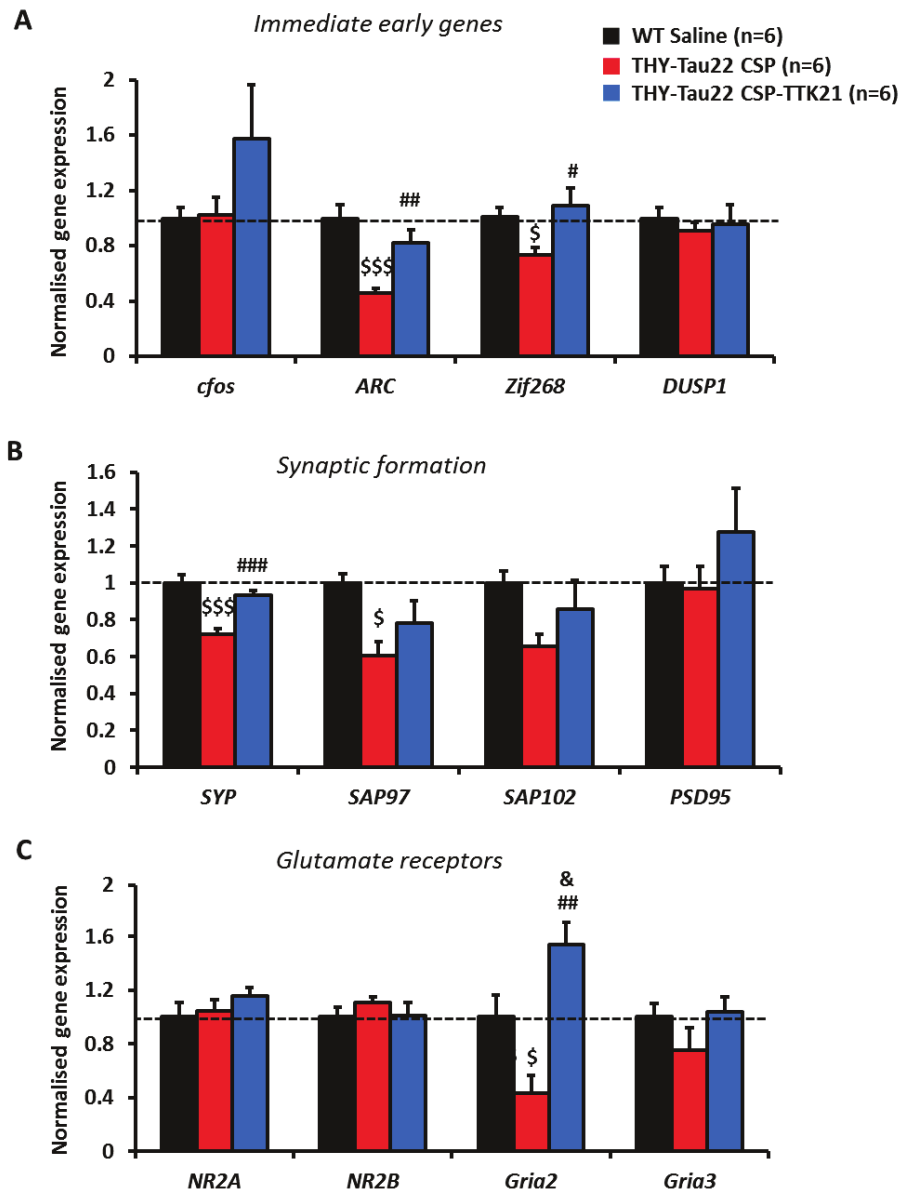

Figure 2. Chronic treatment of CSP-TTK21 enhances the mRNA expression of specific memory and plasticity genes in the dorsal hippocampus of THY-Tau22 mice. Quantitative real-time PCR analysis was performed to check the mRNA expression profiles of **A**, Immediate early genes (*c-fos*, *ARC*, *Zif268* and *DUSP1*), **B**, Synaptic formation (*SYP*, *SAP97*, *SAP102*, *PSD95*), and **C**, Glutamate receptor sub-types: Ionotropic (*NR2A*, *NR2B*) and AMPA (*Gria2* and *Gria3*). \$ $p < 0.05$, \$\$\$ $p < 0.001$ THY-Tau22 CSP vs WT mice; # $p < 0.05$, ## $p < 0.01$, ### $p < 0.001$ THY-Tau22 CSP vs THY-Tau22 CSP-TTK21, & $p < 0.05$, THY-Tau22 CSP-TTK21 Vs WT mice, Anova followed by Newman-Keuls post hoc test. Graphs indicate relative changes in mRNA levels normalized to *RNA Pol II*.

Figure 3

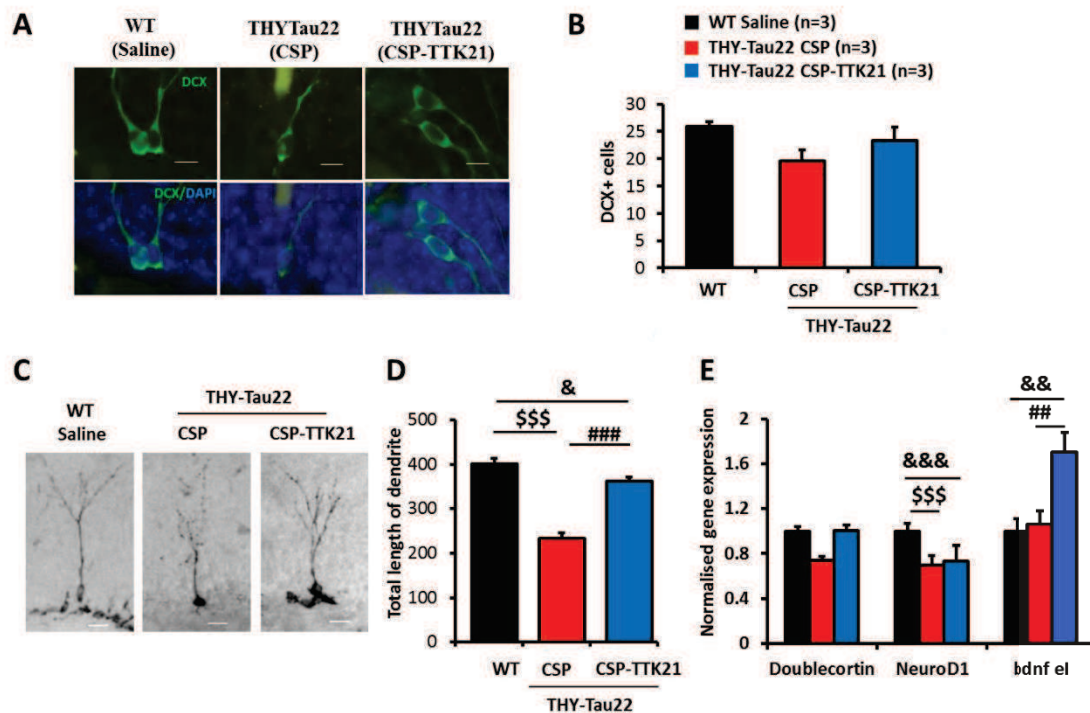

Figure 3. CSP-TTK21 treatment stimulates the maturation of adult-born granule cells in the SGZ of the dentate gyrus. **A**, Immunolabelling of the dentate gyrus of the chronic treatment mice WT (n=3), THY-Tau22 CSP (n=3) and THY-Tau22 CSP-TTK21 (n=3) with doublecortin (DCX) antibody. Representative fluorescence microscopic images of DCX⁺ (green) neurons in the dorsal dentate gyrus. DAPI (blue) was used to label the nucleus. Scale bar represents 10 μ m. **B**, Quantification revealed a non-significant decrease in total DCX⁺ neuron in the dentate gyrus of THY-Tau22 CSP compared to WT mice. **C**, Typical image of dendritic arborisation with DCX immunoreactivity has been shown. Scale bar represents 20 μ m. **D**, Histogram represents the total length of the dendrites originating from a single DCX positive neuron averaged from 3 animals. ($^{$$$}p < 0.001$ THY-Tau22 CSP vs. saline-treated WT mice; $^{###}p < 0.001$ THY-Tau22 CSP vs THY-Tau22 CSP-TTK21, $^{\&}p < 0.05$ THY-Tau22 CSP-TTK21 vs WT mice, Anova followed by Newman-Keuls post hoc test). Note that the dendritic arborisation is more complex in THY-Tau22 CSP-TTK21 compared to the THY-Tau22 CSP injected mice. **E**, qRT-PCR analyses of mRNA levels of *doublecortin*, *NeuroD1*, and *bdnf el* in response to CSP and CSP-TTK21 chronic treatment of THY-Tau22 and saline treated WT mice (n=6/group). mRNA quantities were normalized with RNA Pol II levels measured in each sample. $^{$$$}p < 0.001$ THY-Tau22 CSP vs WT mice, $^{\&\&\&}p < 0.001$ THY-Tau22 CSP-TTK21 vs WT mice, $^{##}p < 0.01$ THY-Tau22 CSP Vs THY-Tau22 CSP-TTK21 (Anova followed by Newman-Keuls post hoc test).

Figure 4

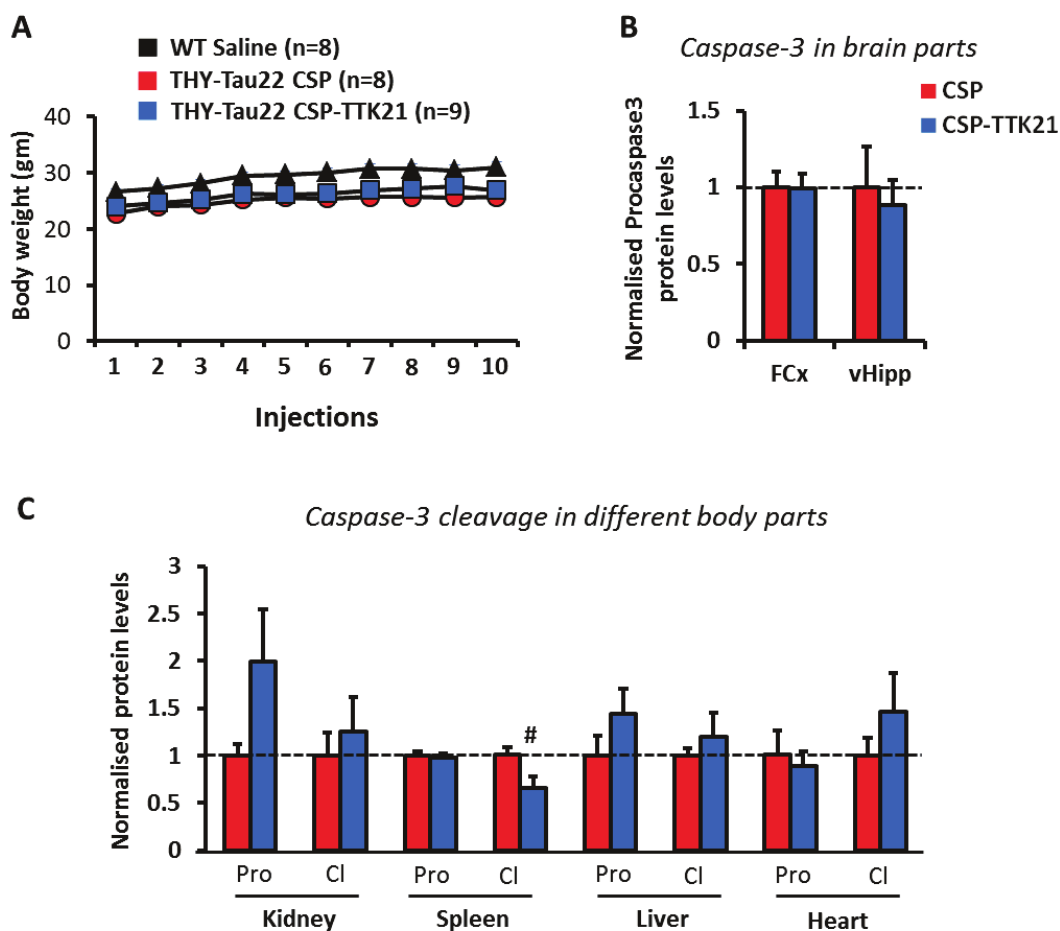

Figure 4. CSP-TTK21 do not impart toxicity in THY-Tau22 mice after chronic treatment. **A**, Body weights of mice measured during each injection days during the chronic treatment (10 injections) were plotted. Influence of treatment on body weight was evaluated using ANOVA for repeated measures considering the factor ‘genotype’ and ‘treatment’. No significant changes in body weights were detected between THY-Tau CSP and THY-Tau CSP-TTK21 mice. **B-C**, One day after the behavioural studies, different body organs and brain sub-parts were dissected out (body: kidney, liver, spleen and heart; brain: Frontal cortex and ventral hippocampus) and Western blots were performed on total protein extracts. **B**, Total pro-caspase3 levels were quantified from samples obtained from brain parts. **C**, Quantification of procaspase and cleaved caspase protein levels is shown relative to the total proteins in the different organs. No signals from cleaved caspase3 were detected. Student’s t test, # $p < 0.05$ (THY-Tau22 CSP compared to THY-Tau22 CSP-TTK21). Annotations- Pro: Procaspase3; Cl: Cleaved caspase3, FCx: Frontal cortex and vHipp: Ventral hippocampus.

Figure 5

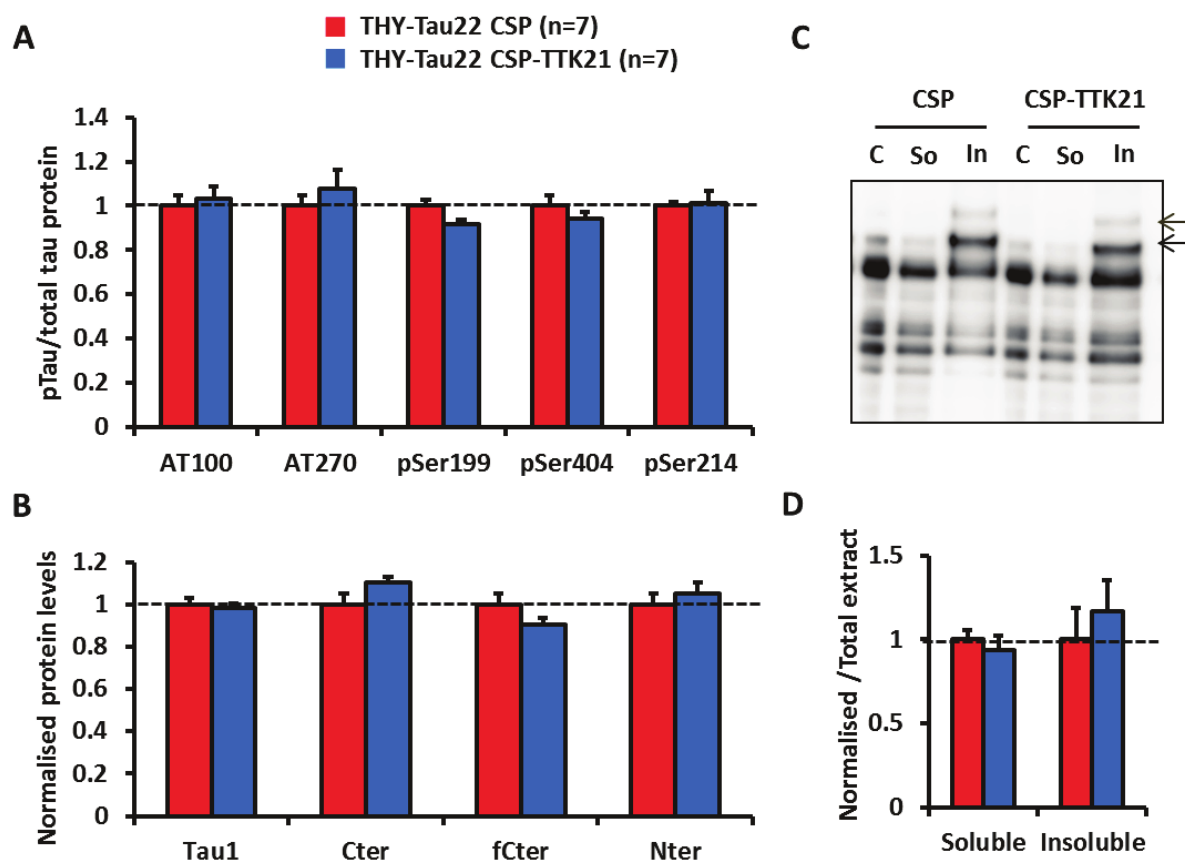
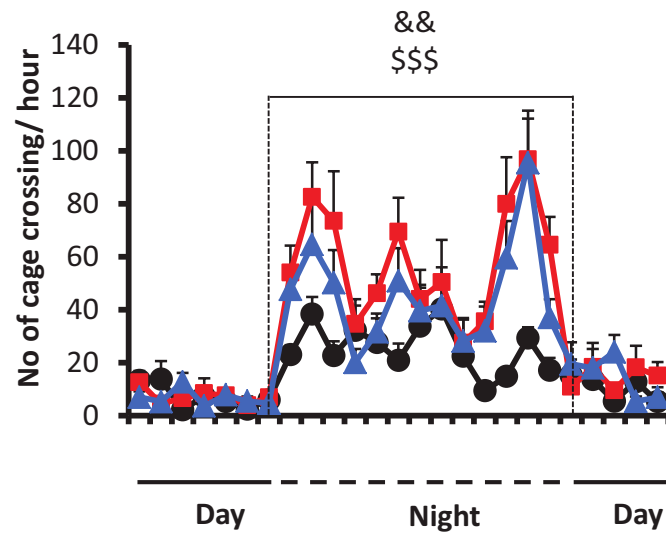

Figure 5. CSP-TTK21 chronic treatment does not impact on tau phosphorylation and tau fragments in the hippocampus of THY-Tau22 mice. **A-B**, Western blot analysis of tau phosphorylation in the hippocampus of THY-Tau22 mice treated with CSP or CSP-TTK21 using antibodies targeting physiological pSer214, pSer404 and pathologic AT100 (pThr212/Ser214), AT270 (pThr181) and pSer199 tau epitopes. Quantifications were performed over total human tau levels (Nter). No significant alteration in the phosphorylation of tau was detected between CSP or CSP-TTK21 treated mice in hippocampus. Total tau levels were quantified versus GAPDH. GAPDH was used as a loading control. Results are expressed as means + SEM. **C**, Sarkosyl-soluble/insoluble Tau was extracted from hippocampus of THY-Tau22 mice treated with CSP or CSP-TTK21. **D**, Quantification revealed that CSP-TTK21 did not impact on Tau insolubility as demonstrated using antibodies raised against total human tau (Nter). Results are expressed as mean percentage + SEM of THY-Tau22 animals (n=7/group). Abbreviations: C: crude extract, So: soluble extract and In: Insoluble extract.

Supplementary figure S1



Supplementary figure S1. Activity testing after chronic treatment. Activity graph with the number of cage crossings per hour was plotted for 2 days and 1 night. THY-Tau22 mice (both CSP and CSP-TTK21 injected) showed increased nocturnal activity compared to the saline injected control littermates (WT). $$$$ p < 0.001$ when THY-Tau22 (CSP) compared to WT; $&& p < 0.01$ when THY-Tau22 (CSP-TTK21) compared to WT.

Supplementary figure S2

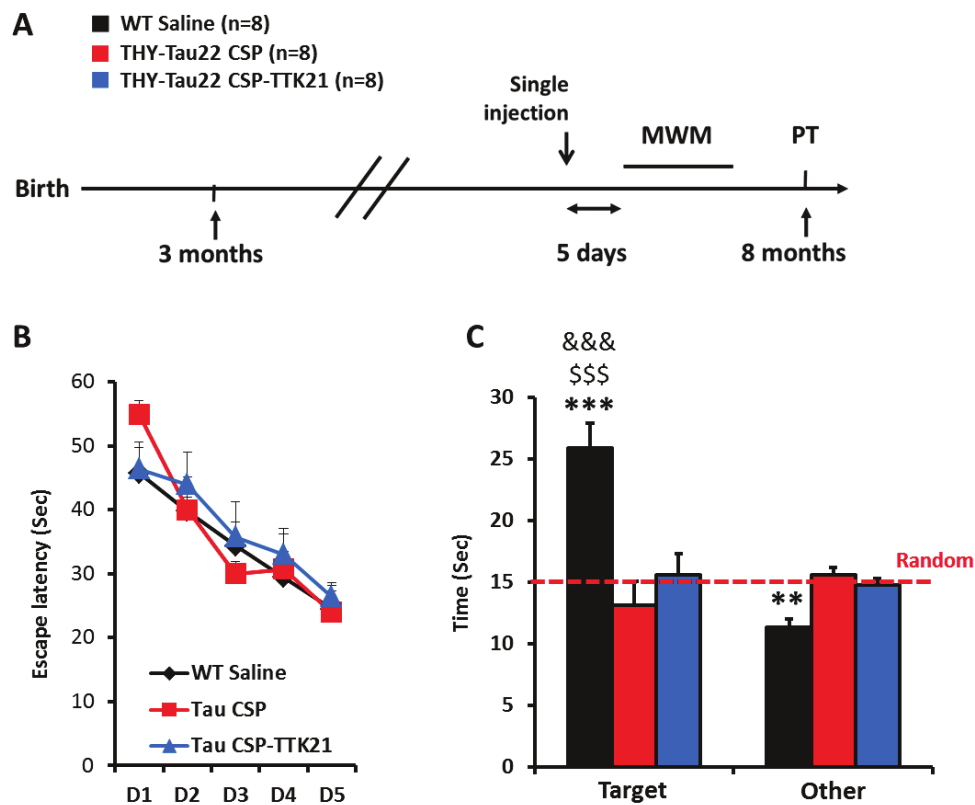

Supplementary figure S2. Chronic treatment of CSP-TTK21 reduced memory deficits

in THY-Tau22 mice. **A**, Timeline of the chronic treatment relative to the MWM training protocol. Single i.p. injection of either CSP or CSP-TTK21 was administered on THY-Tau22 mice. Sex matched control littermates (WT) were injected with saline. The spatial memory test was started after 5 days from the injection. The experiment was planned in such way that during the memory test the age of all the mice will be 8 months similar to the chronic treatment condition. **B**, Acquisition curve showing the latency to reach the platform during the MWM training. All the 3 groups of mice learned to locate the hidden platform gradually during each days of training. **C**, Retention was tested during the probe test after a delay of 10 days from the last acquisition for persistence of long-term memory. Time spent in the target quadrant and the mean of time spent in the other quadrants were measured. WT mice spent significantly more time in the target quadrant compared to the THY-Tau22 CSP and THY-Tau22 CSP-TTK21 mice. Results are expressed as means + SEM. * $p < 0.05$, ** $p < 0.01$, *** $p < 0.001$, student's t-test compared to chance level. \$\$\$ $p < 0.001$ when WT compared to THY-Tau22 CSP, and &&& $p < 0.001$ when WT compared to THY-Tau22 CSP-TTK21; ANOVA factorial followed by Newman-Keuls post-hoc test.

Supplementary figure S3

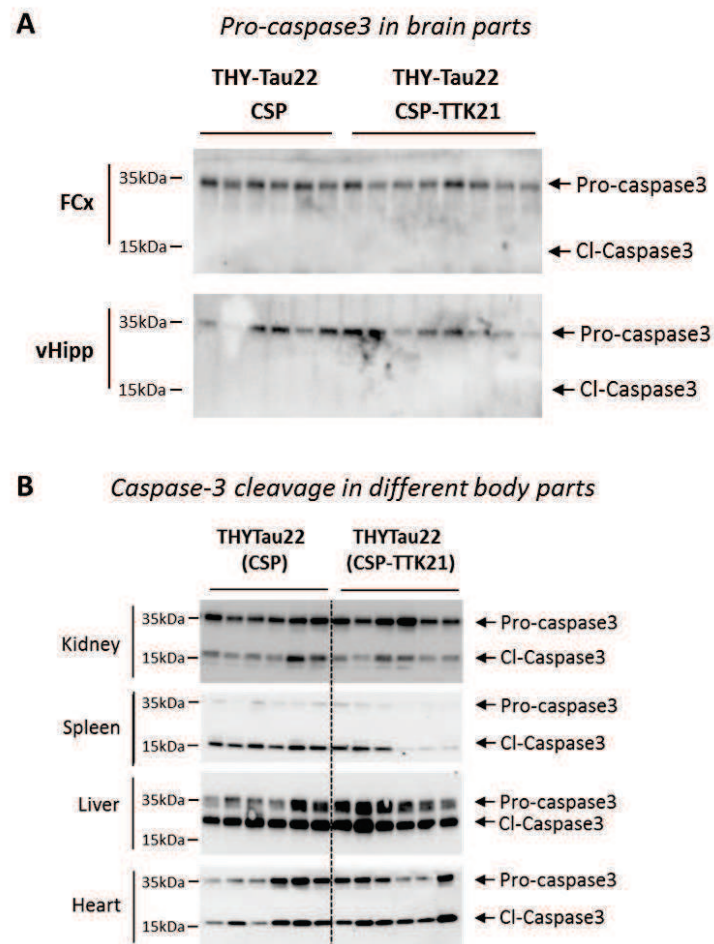

Supplementary figure S3. Representative Westernblot images of procaspase and cleaved caspase protein levels are shown relative to the total proteins in the **A**, Body parts and; **B**, brain regions.

Supplementary figure S4

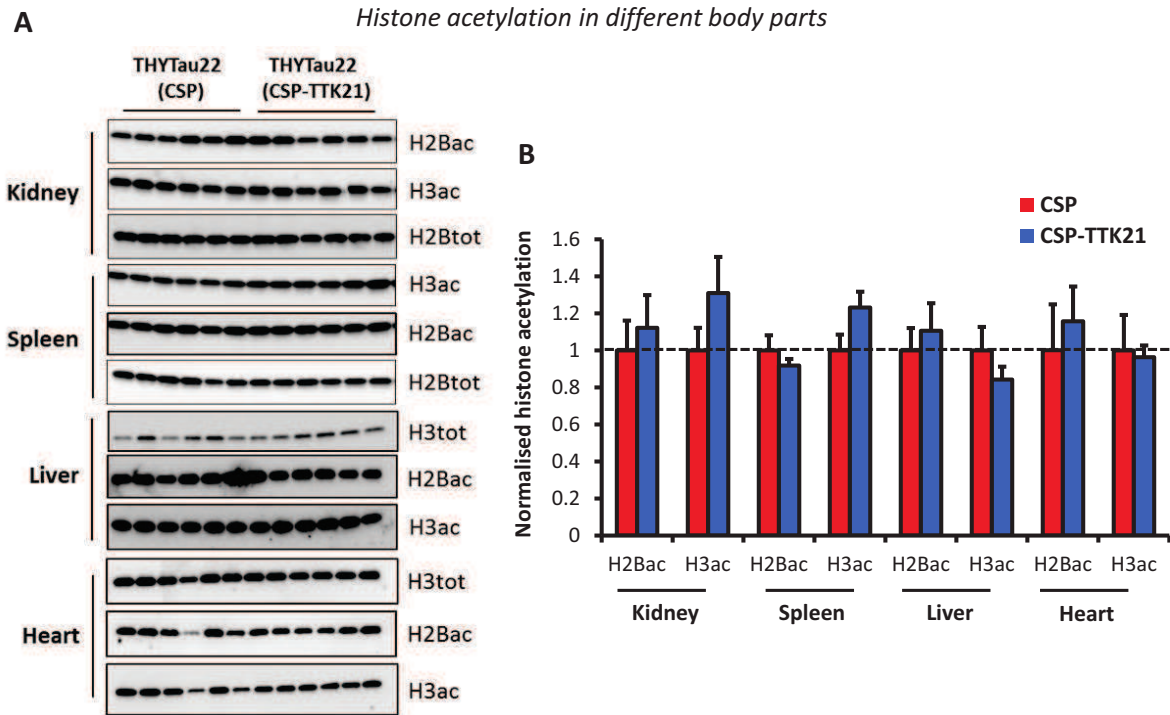

Supplementary figure S4. A, Representative Westernblot images of Histone H2B and H3 acetylation and total histones H2B or H3 in different body parts (kidney, spleen, liver and heart), **B**, Quantification of acetylated histone levels is shown relative to the total histones H2B or H3 in the different parts. Results are expressed as means + SEM.

Supplementary figure S5

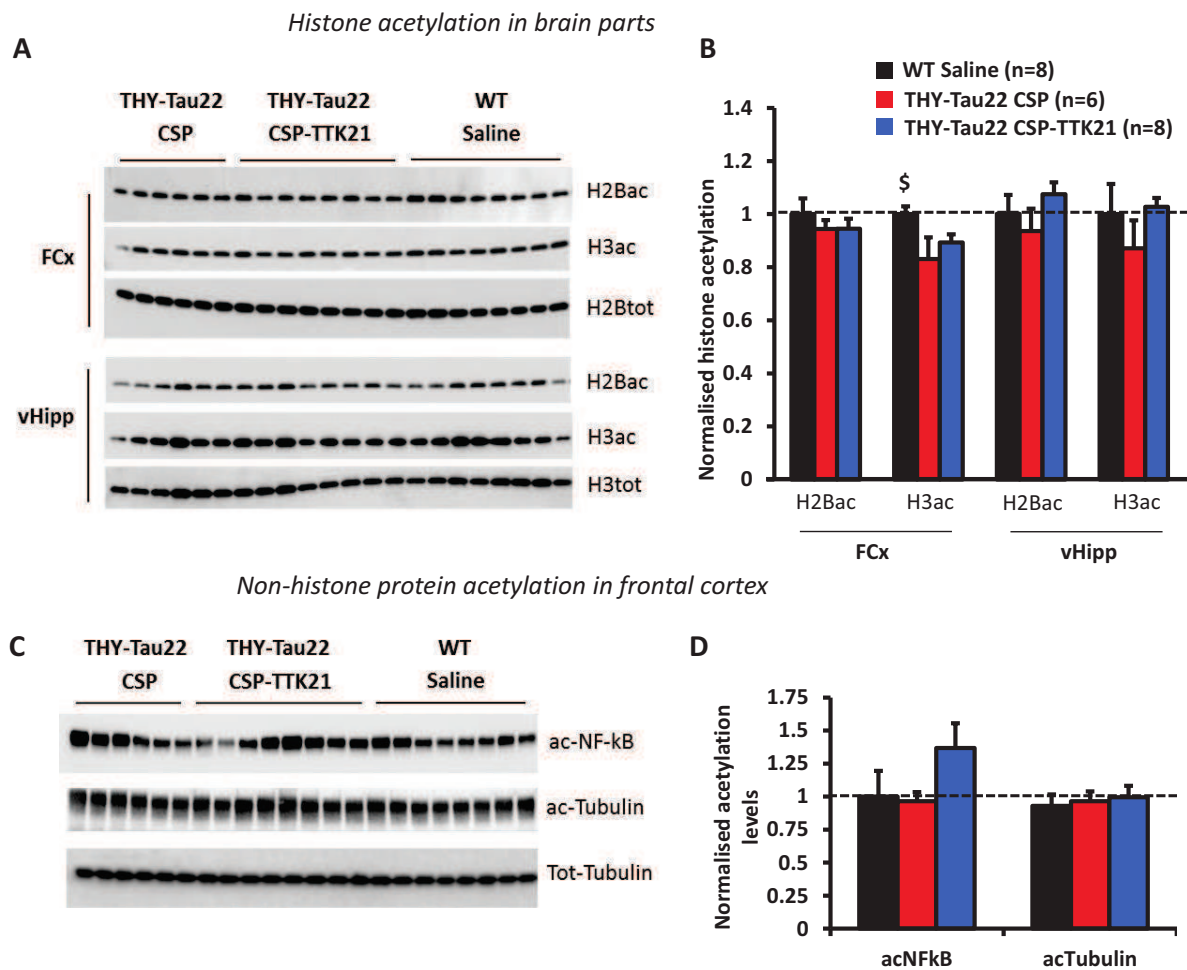

Supplementary figure S5. **A**, Representative images of Western blot for; Histone H2B and H3 acetylation and total histones H2B or H3 in the brain parts (frontal cortex and ventral hippocampus), **B**, Quantification of acetylated histone levels is shown relative to the total histones H2B or H3 in the brain parts, **C**, Representative images of Western blot for; acetylated NFkB (ac p65), acetylated tubulin and total tubulin in the frontal cortex of mice brain, **D**, Quantification of non-histone protein acetylation (NFkB and tubulin) levels is shown relative to the total protein levels. Results are expressed as means + SEM.

Supplementary figure S6

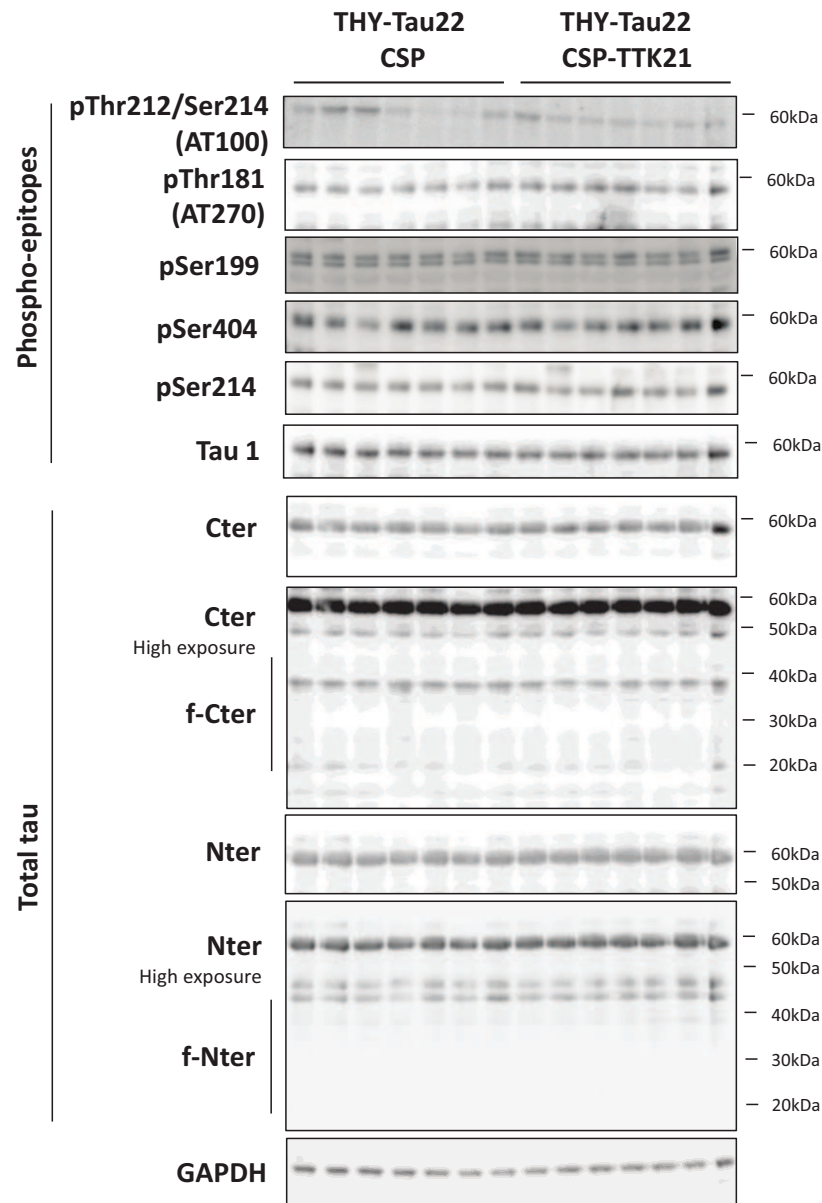

Supplementary figure S6. CSP-TTK21 chronic treatment does not impact on tau phosphorylation and tau fragments in the hippocampus of THY-Tau22 mice. Representative images of Western blot analysis of tau phosphorylation in the hippocampus of THY-Tau22 mice treated with CSP or CSP-TTK21 using antibodies targeting physiological pSer214, pSer404 and pathologic AT100 (pThr212/Ser214), AT270 (pThr181) and pSer199 tau epitopes.

Supplementary figure S7

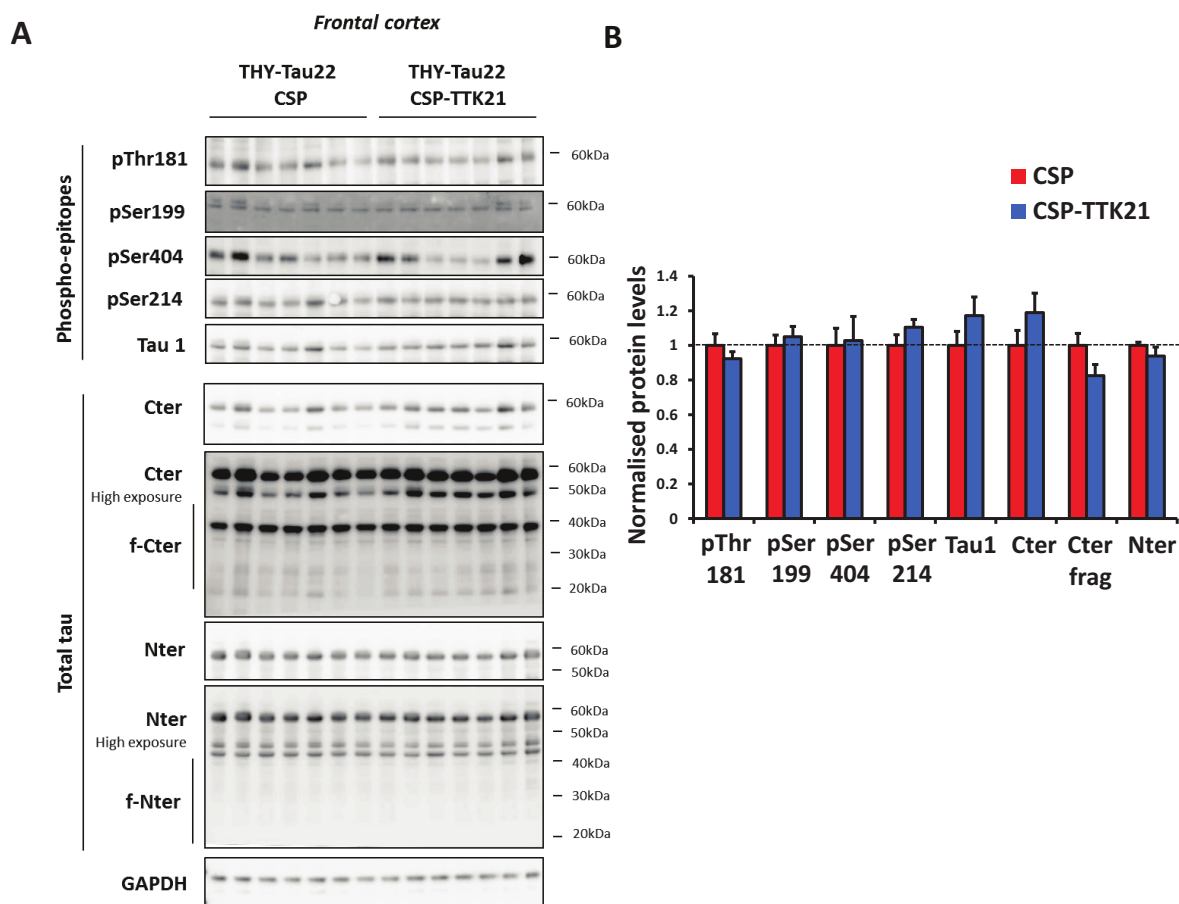

Supplementary figure S7. CSP-TTK21 chronic treatment does not impact on tau phosphorylation and tau fragments in the frontal cortex of THY-Tau22 mice. **A**, Western blot analysis of tau phosphorylation in the frontal cortex of THY-Tau22 mice treated with CSP or CSP-TTK21 using antibodies targeting physiological pSer214, pSer404 and pathologic pThr181 and pSer199 tau epitopes. **B**, Quantifications were performed over total human tau levels (Nter). No significant alteration in the phosphorylation of tau was detected between CSP or CSP-TTK21 treated mice in the frontal cortex. Total tau levels were quantified versus GAPDH. GAPDH was used as a loading control. Results are expressed as means + SEM.

Supplementary figure S8

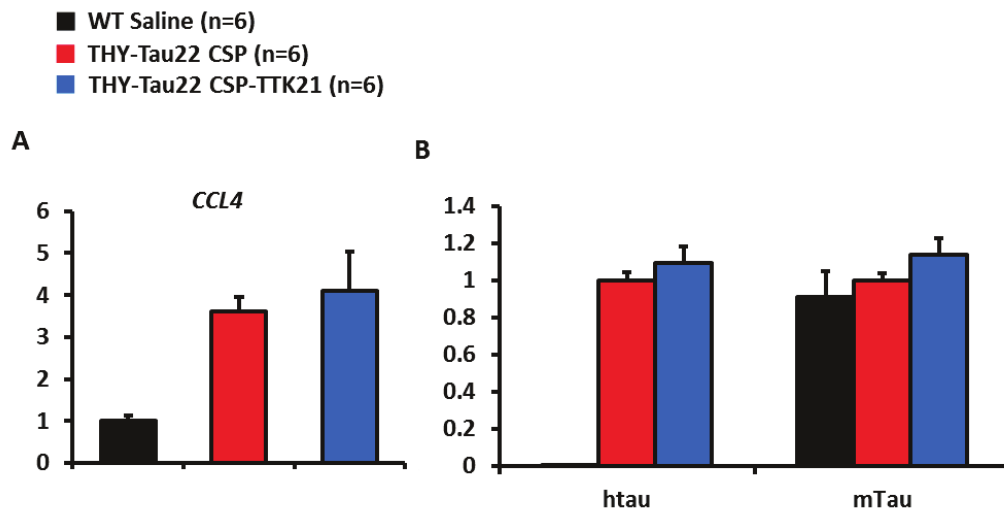

Supplementary figure S8. mRNA expression of A, Inflammatory marker CCL4 and B, human and murine tau gene in the dorsal hippocampus of WT or THY-Tau22 mice treated with CSP or CSP-TTK21. Results were normalised relative to RNA Pol II transcript levels.

Perspectives

The chronic treatment with the HAT activator CSP-TTK21 rescued retention of spatial memory in THY-Tau22 mice, in the long term (persistence over 10 days). Effect of CSP-TTK21 treatment was also observed in the maturation and differentiation of DCX expressing neurons in the dorsal dentate gyrus. The improvement of neurogenesis events was accompanied with rescue of expression of IEGs like *ARC* and *Zif268*. However, it is still unclear if the CSP-TTK21 chronic treatment helps to recruit more newly generated neurons into the neural network supporting spatial memory. It will also be interesting to investigate if CSP-TTK21 treatment improves the number of neurons that are activated during spatial memory formation in the hippocampus, or even in other implicated area for systems consolidation such as the prefrontal cortex. To answer these questions, we are presently administering another chronic treatment in a new group of THY-Tau22 mice. The chronic treatment will be followed by 3 days of MWM training. Three weeks before the training BrdU will be injected to track how many newly born neurons are recruited in the circuitry depending on the treatment. Immunohistochemistry will be performed to thoroughly study the influence of CSP-TTK21 chronic treatment in the process of 1/ neuronal activation (*zif268*, *cfos* –positive neuron countings) and 2/ adult neurogenesis and recruitment of adult born neurons into networks supporting spatial memory (double labeling of BrdU and *zif268* or *cfos*).

Supporting Results

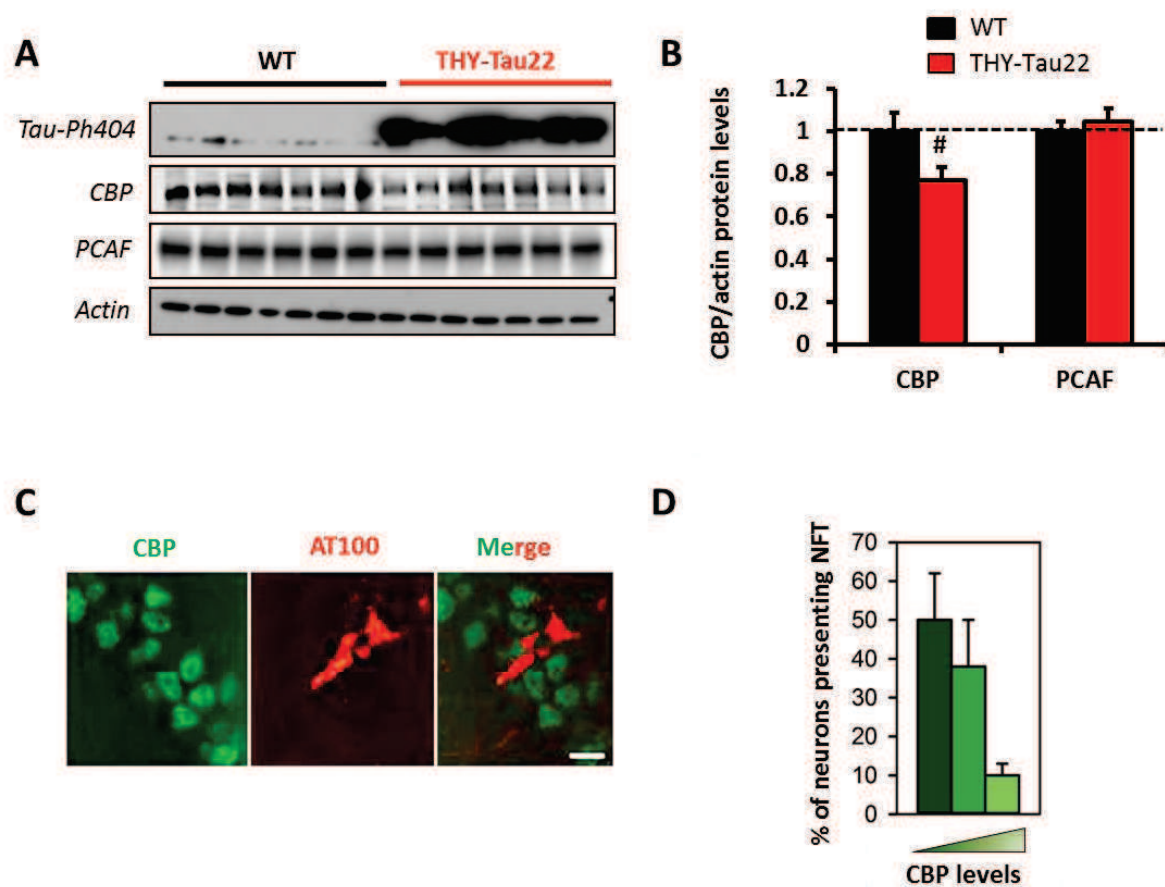
Supporting Results, SR1

Supporting Results Figure SR1. CBP protein dysregulation in dorsal hippocampus of 12 months old THY-Tau22 mice. **A and B**, Brains of 12 months age male THY-Tau22 (n=7) and WT (n=7) were sub-dissected to collect dorsal hippocampus. Western blots performed on dorsal hippocampus of 12 months old THY-Tau22 mice reveals that CBP protein levels are significantly down-regulated compared to WT mice ($p=0.0453$, t-test comparing THY-Tau22 Vs WT) whereas no significant changes in PCAF levels were observed. Actin was used as loading control. **C**, Co-immunostaining using antibodies recognising pathogenic tau (AT100) mostly found in the neurofibrillary tangles (NFTs) and CBP were performed on CA1 region of dorsal hippocampus from 12 months old THY-Tau22 mice. **D**, Quantification of co-localisation suggested that CBP is progressively degraded in neurons presenting increasing levels of pathogenic tau (AT100). Results are expressed as mean +SEM. [#] $p<0.05$, student's t-test when WT is compared with THY-Tau22.

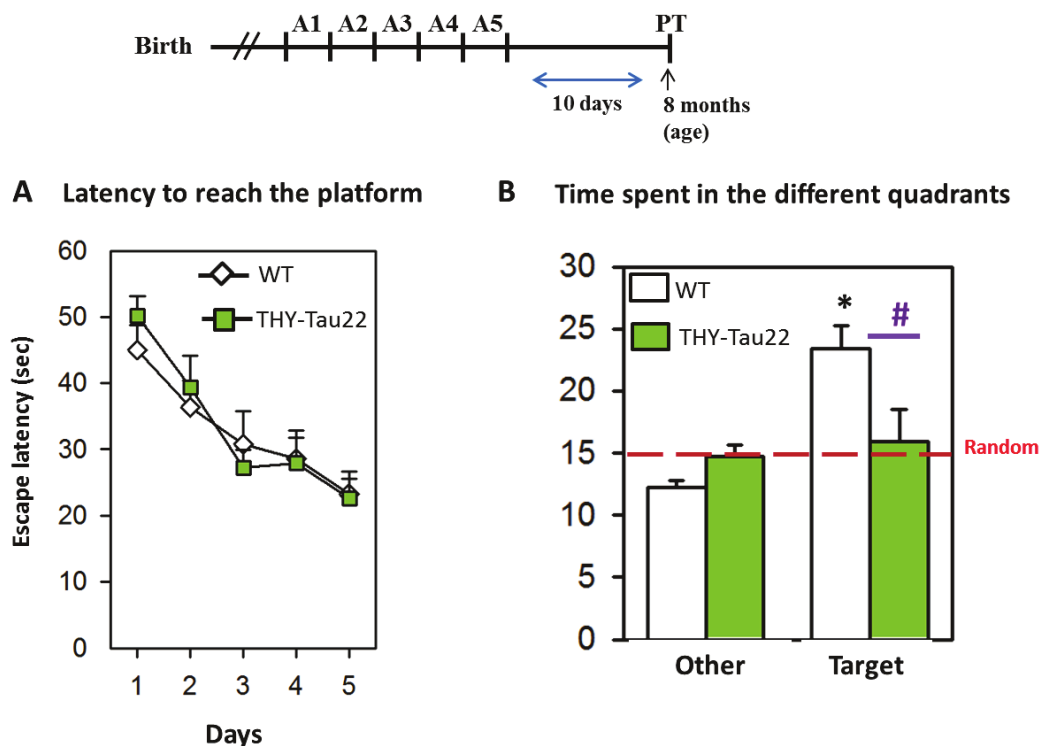
Supporting Results SR2

Supporting Results Figure SR2. 8 months old THY-Tau22 mice are deficient in persistence of long term memory. 8 months old male THY-Tau22 (n=12) and their control littermates, WT (n=15) mice were subjected to the Morris water maze (MWM) test. During a 5-day training period (A1-A5), all the mice were tested in four trials per day for their ability to locate a hidden platform using visual clues surrounding the MWM pool. **A**, Acquisition curve showing the latency to reach the platform during the MWM training. Both the groups of mice learned to locate the hidden platform gradually during each days of training. **B**, Retention was tested during the probe test after a delay of 10 days from the last acquisition for persistence of long-term memory. Time spent in the target quadrant and the mean of time spent in the other quadrants were measured. WT mice spent significantly more time in the target quadrant compared to the THY-Tau22 mice. This results suggests that THY-Tau22 mice shows deficiency in retention of spatial memory from 8 months of age. Results are expressed as mean +SEM. * $p < 0.05$, student's t-test compared to chance level; # $p < 0.05$, student's t-test when performance of WT is compared with THY-Tau22.

Supporting Results SR3A

Transcriptomics analysis in WT and THY-Tau22 mice after sub-chronic treatment of CSP-TTK21 (Home cage)

RNAseq under BASAL conditions

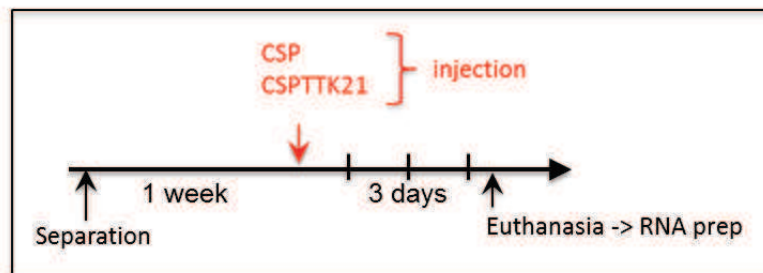

Comparison	Number of under-expressed genes *	Number of over-expressed genes *
TAU CSP vs. WT CSP	15	36
WT CSP vs. WT CSPTTK21	5	23
TAU CSPTTK21 vs. TAU CSP	4	30

Number of significantly differentially expressed genes.

*p-value adjusted for multiple testing < 0.05 – FC: no threshold

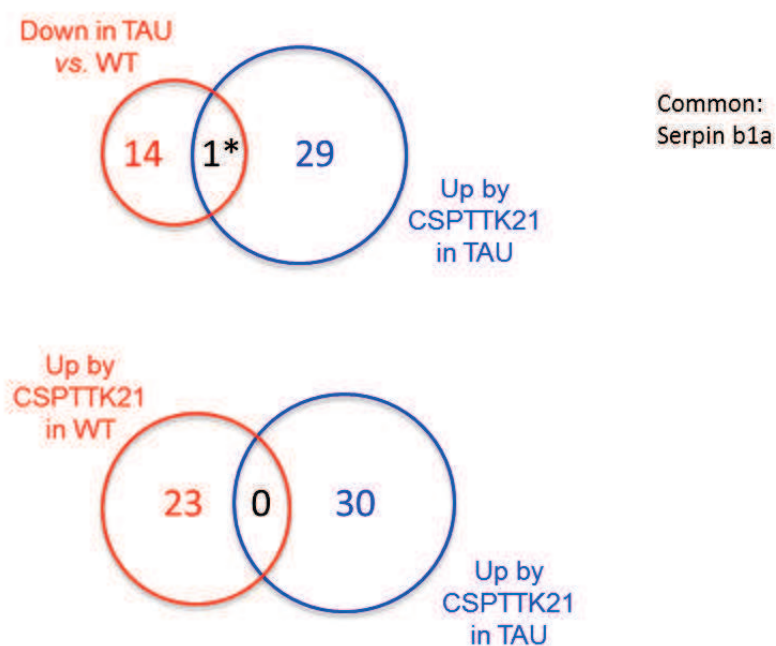

Under-expressed genes (15 genes)
TAU vs. WT; Adj_p < 0.05
Analyses with GREAT version 3.0.0

Job ID: 20151002-public-3.0.0-yotJB
 Display name: user-provided data

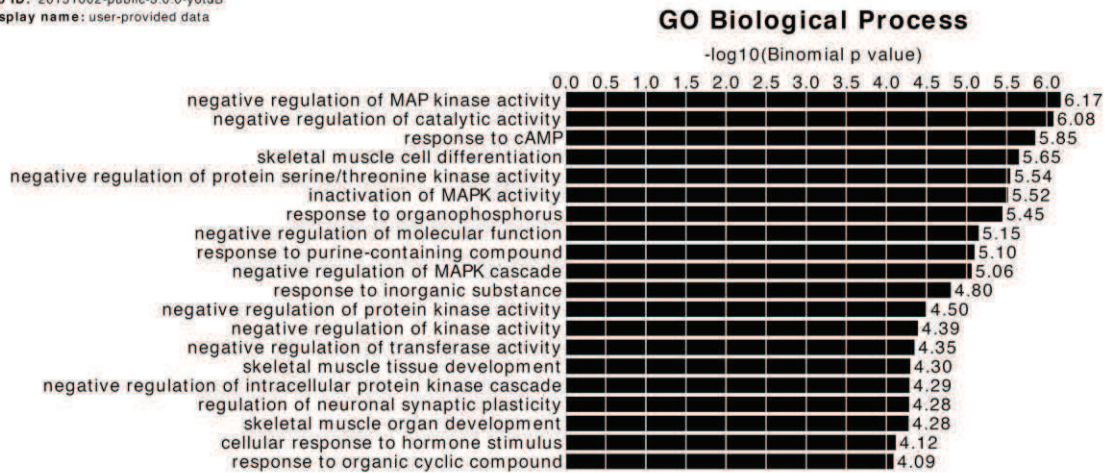

Job ID: 20151002-public-3.0.0-yotJB
 Display name: user-provided data



Job ID: 20151002-public-3.0.0-yotJB
 Display name: user-provided data

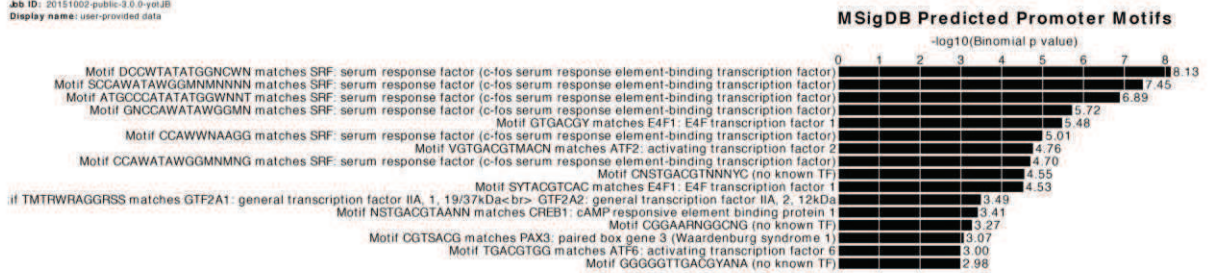

Over-expressed genes (36 genes)
TAU vs. WT; Adj_p < 0.05
Analyses with GREAT version 3.0.0

Job ID: 20151012-public-3.0.0-BJN266
 Display name: user-provided data

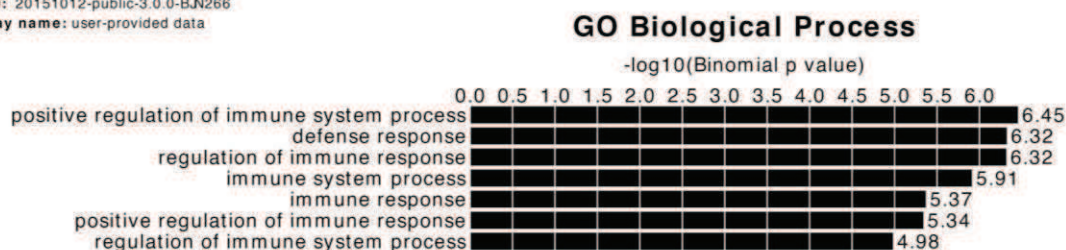

Job ID: 20151012-public-3.0.0-BJN266
 Display name: user-provided data

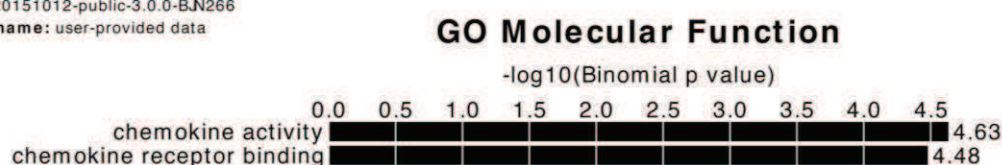

Job ID: 20151012-public-3.0.0-BJN266
 Display name: user-provided data

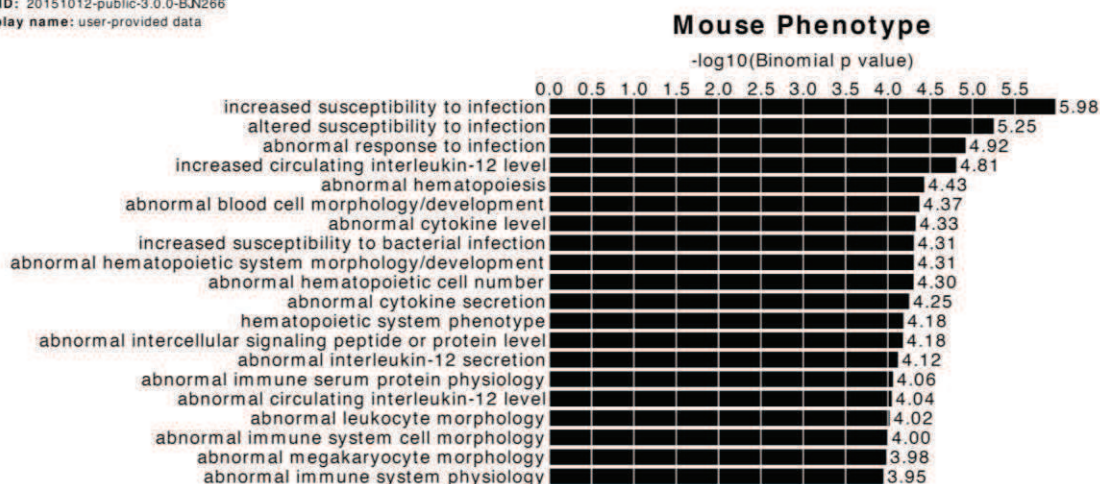

Job ID: 20151012-public-3.0.0-BJN266
 Display name: user-provided data

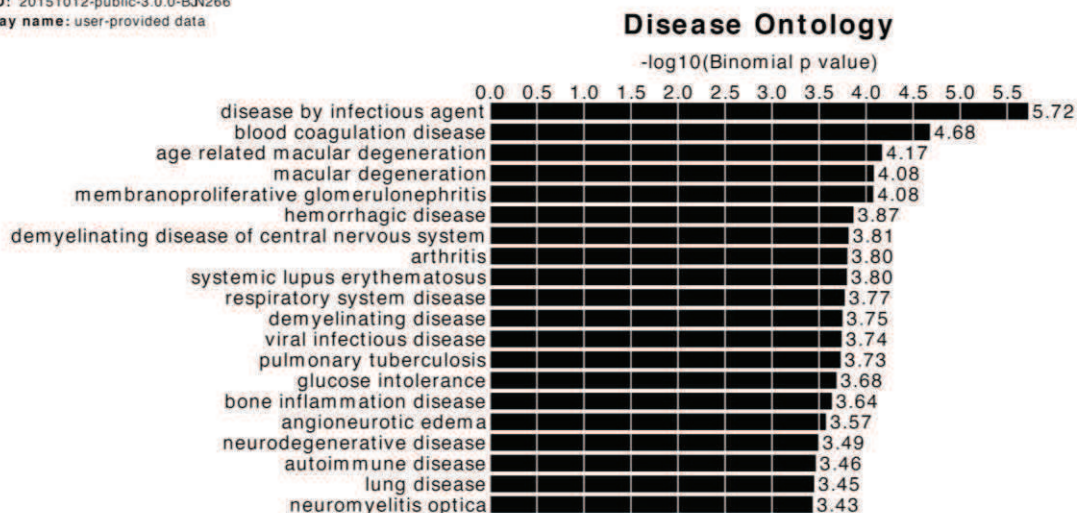

Supporting Results

Over-expressed genes (23 genes) WT CSP vs. WT CSPTTK21; Adj_p < 0.05 Analyses with GREAT version 3.0.0

Job ID: 20151012-public-3.0.0-UW1Eyd
Display name: user-provided data

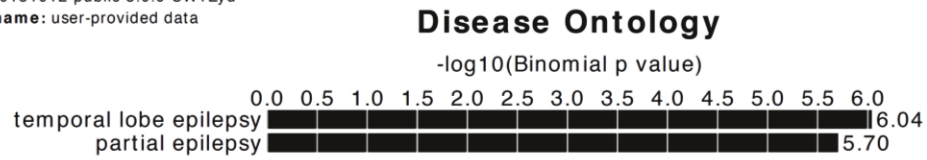

Over-expressed genes (30 genes) TAU CSP vs. TAU CSPTTK21; Adj_p < 0.05 Analyses with GREAT version 3.0.0

Job ID: 20151012-public-3.0.0-pCKun
Display name: user-provided data

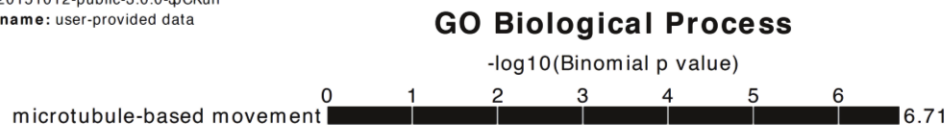

Job ID: 20151012-public-3.0.0-pCKun
Display name: user-provided data

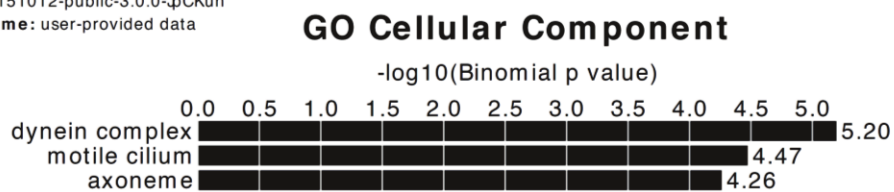

Supporting Results SR3B

Transcriptomics analysis in WT and THY-Tau22 mice after sub-chronic treatment of CSP-TTK21 (Learning)

RNAseq under BEHAVIOR conditions

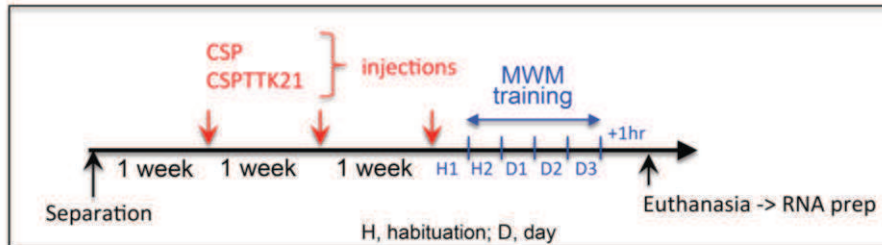

Comparison	Number of under-expressed genes *	Number of over-expressed genes *
Tau Learning vs. WT Learning	1968	792
Tau Learning CSPTTK21 vs. Tau Learning CSP	82	98
WT Learning vs. WT Home Cage	663	1000

Number of significantly differentially expressed genes.
 *p-value adjusted for multiple testing < 0.05 – FC > log2=0.2

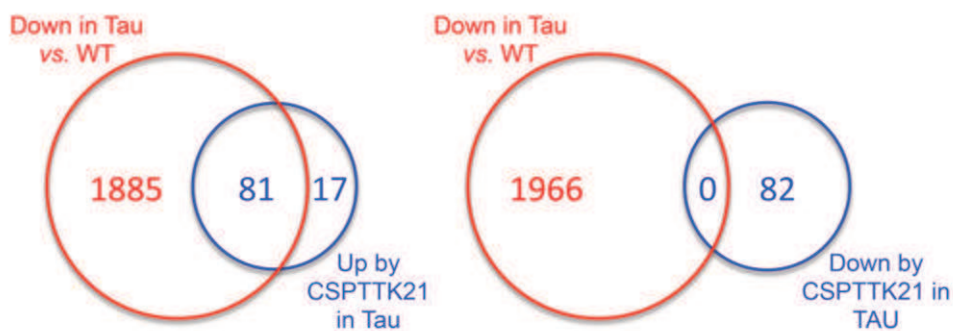

Under-expressed genes (1968 genes)
TAU LEARN vs. WT LEARN; *Adj_p* < 0.05; *FC* > log2=0.2
Analyses with GREAT version 3.0.0

Job ID: 20151012-public-3.0.0-bVLI4
 Display name: user-provided data

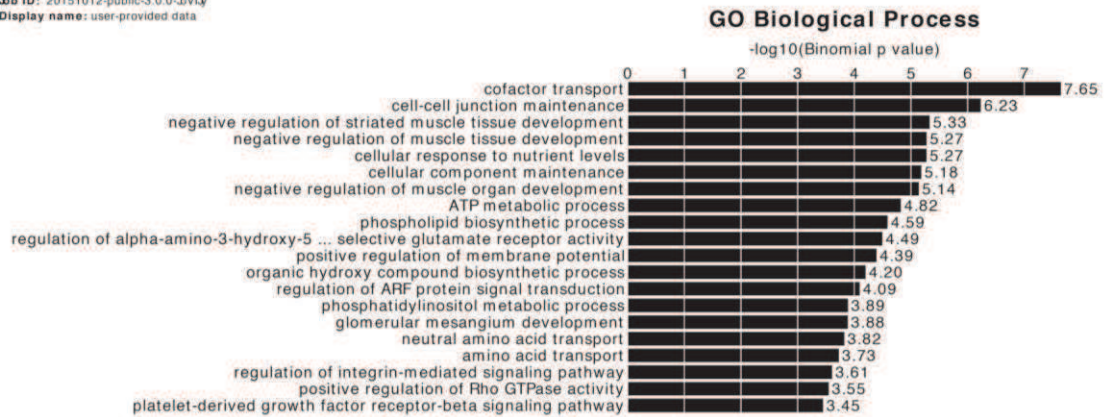

Job ID: 20151012-public-3.0.0-bVLI4
 Display name: user-provided data

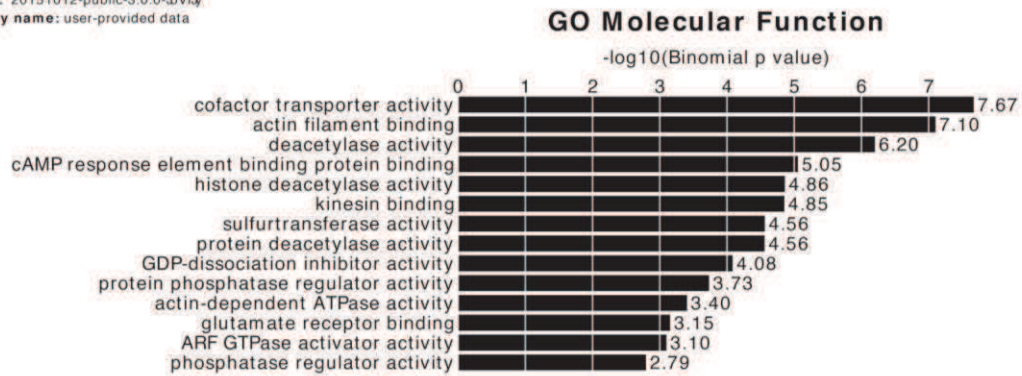

Job ID: 20151012-public-3.0.0-bVLI4
 Display name: user-provided data

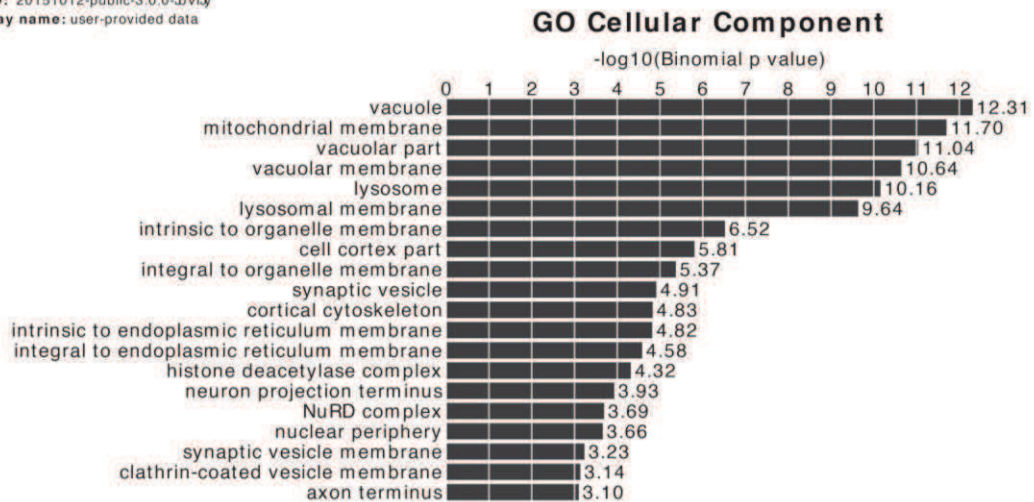

Job ID: 20151012-public-3.0.0-bVLI4
 Display name: user-provided data

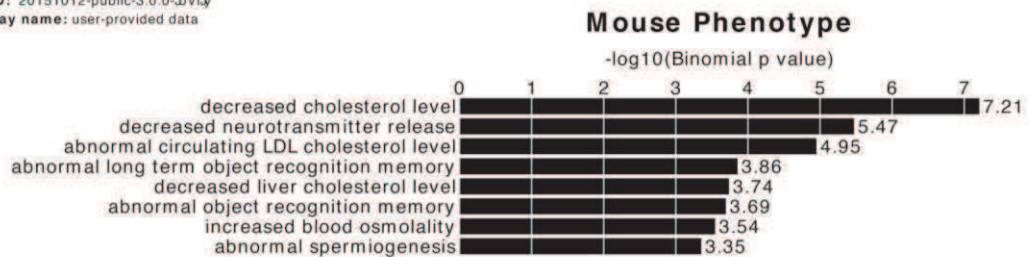

Under-expressed genes (373 genes)
TAU LEARN vs. WT LEARN; *Adj_p* < 10E-10
Analyses with GREAT version 3.0.0

Job ID: 20151012-public-3.0.0-Dq9qvw
Display name: user-provided data

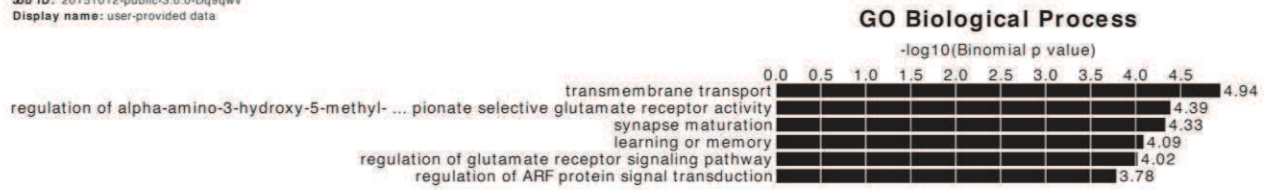

Job ID: 20151012-public-3.0.0-Dq9qvw
Display name: user-provided data

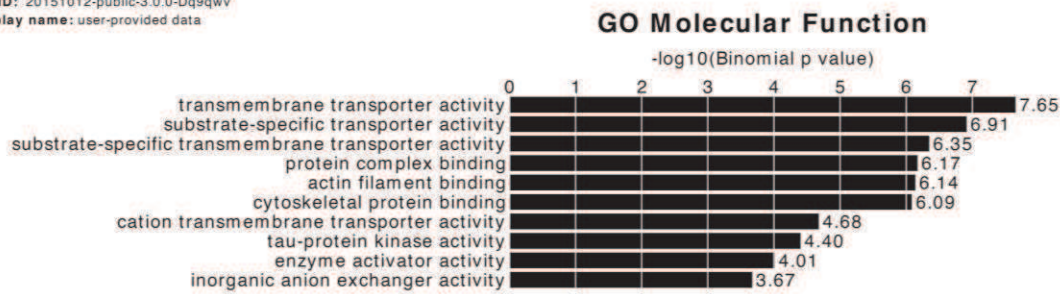

Job ID: 20151012-public-3.0.0-Dq9qvw
Display name: user-provided data

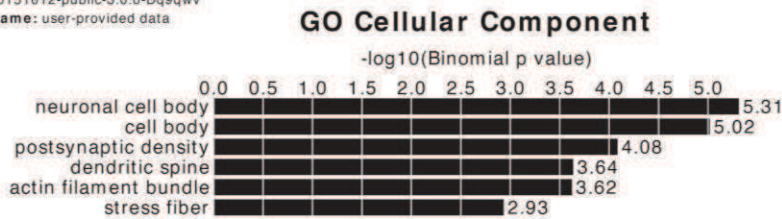

Job ID: 20151012-public-3.0.0-Dq9qvw
Display name: user-provided data

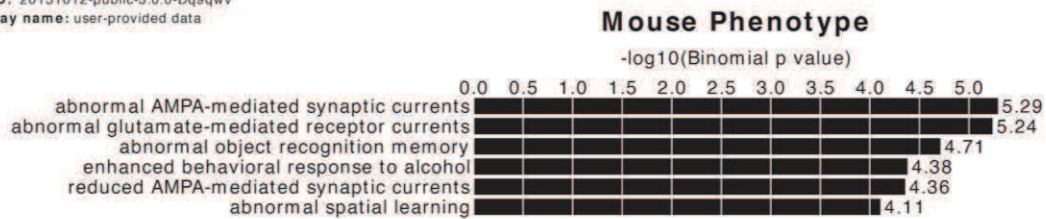

Job ID: 20151012-public-3.0.0-Dq9qvw
Display name: user-provided data

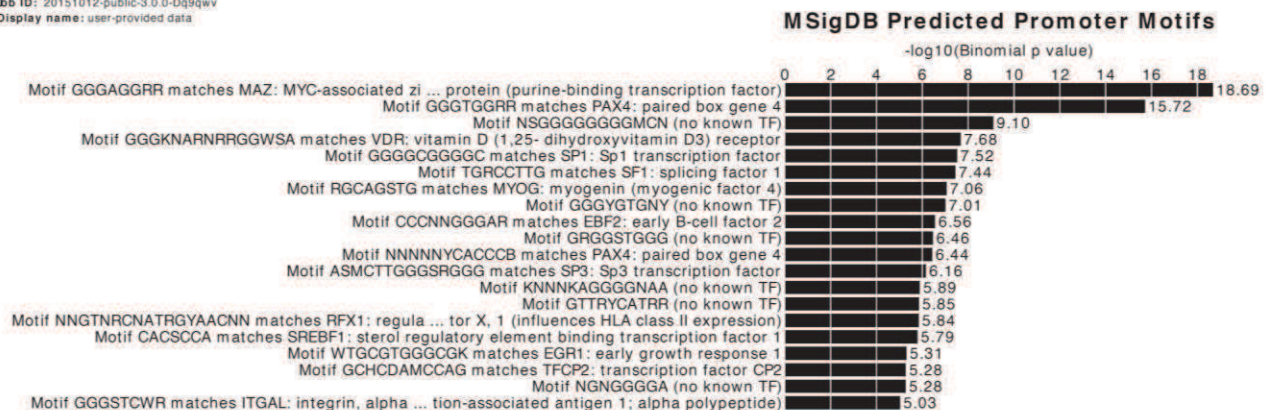

Over-expressed genes (98 genes)
TAU LEARN CSPTTK21 vs. TAU LEARN CSP; Adj_p < 0.05; FC > log2=0.2
Analyses with GREAT version 3.0.0

Job ID: 20150704-public-3.0.0-QsmfFP
 Display name: user-provided data

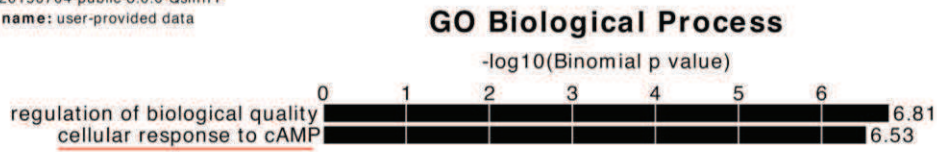

Job ID: 20150704-public-3.0.0-QsmfFP
 Display name: user-provided data

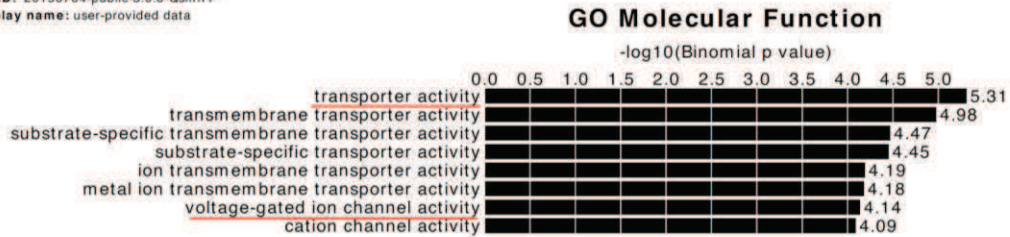

Job ID: 20150707-public-3.0.0-Kl3yMU
 Display name: user-provided data

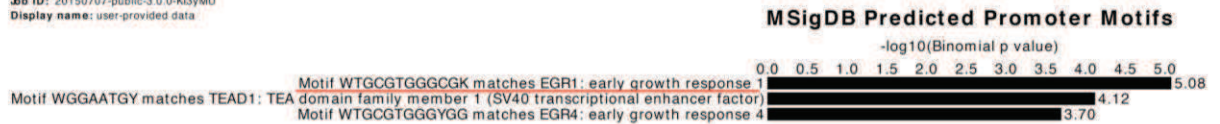

GREAT version 3.0.0 Species assembly: mm9

Cellular Response to cAMP

Association rule: Basal+extension: 5000 bp upstream, 1000 bp downstream, 1000000 bp max extension, curated regulatory domains included

- Aqp1 unnamed (+6062)
- Crhbp unnamed (+6730)
- Egr1 unnamed (+2581)
- Egr2 unnamed (+963)
- Igfbp5 unnamed (+36395)
- Slc8a3 unnamed (+67632)

GREAT version 3.0.0 Species assembly: mm9

Voltage gated ion channel activity

Association rule: Basal+extension: 5000 bp upstream, 1000 bp downstream, 1000000 bp max extension, curated regulatory domains included

- Cacna1e unnamed (-372083)
- Cacng3 unnamed (+48824)
- Clic6 unnamed (+15356)
- Hcn2 unnamed (+9737)
- Kcnab3 unnamed (+3392)
- Kcne2 unnamed (+2870)
- Kcnh7 unnamed (+245427)
- Kcnj13 unnamed (+4183)
- Kcnk3 unnamed (+18550)
- Scn4b unnamed (+7858)

Supporting Results

GREAT version 3.0.0Species assembly: mm9

Transporter activity

Association rule: Basal+extension: 5000 bp upstream, 1000 bp downstream, 1000000 bp max extension, curated regulatory domains included

Abca4	unnamed (+67809)
Aqp1	unnamed (+6062)
Bcr	unnamed (+62014)
Cacna1e	unnamed (-372083)
Cacng3	unnamed (+48824)
Clic6	unnamed (+15356)
Folr1	unnamed (+6123)
Folr2	unnamed (-19243)
Hcn2	unnamed (+9737)
Jph2	unnamed (+134301)
Kcnab3	unnamed (+3392)
Kcne2	unnamed (+2870)
Kcnh7	unnamed (+245427)
Kcnj13	unnamed (+4183)
Kcnk3	unnamed (+18550)
Scn4b	unnamed (+7858)
Slc16a8	unnamed (+1873)
Slc17a6	unnamed (+24648)
Slc19a2	unnamed (-62988)
Slc32a1	unnamed (+2486)
Slc4a2	unnamed (+7162)
Slc4a5	unnamed (+42559)
Slc8a3	unnamed (+67632)
Syt2	unnamed (+21925)
Trpv4	unnamed (+18134)
Wfs1	unnamed (+11439)

GREAT version 3.0.0Species assembly: mm9

Predicted Promoter Motif: EGR1

Association rule: Basal+extension: 5000 bp upstream, 1000 bp downstream, 1000000 bp max extension, curated regulatory domains included

Ace*	unnamed (+11010)
Atp1b2*	unnamed (+2990)
Cacna1e	unnamed (-372083)
Egr1*	unnamed (+2581)
Fev*	unnamed (+29236)
Git1*	unnamed (+7112)
Kcnab3*	unnamed (+3392)
Rbbp6*	unnamed (-249996)
Runx1*	unnamed (+312576)
Srcin1*	unnamed (-53340)
Stard13*	unnamed (+216986)
Zfp1*	unnamed (+27555)

* Indicates EGR1-responsive genes that are found down-regulated in TAU LEARN vs WT LEARN and up-regulated by CSPTTK21 in TAU LEARN vs. TAU LEARN CSP (amongst the 81 genes in common)

Other comparisons

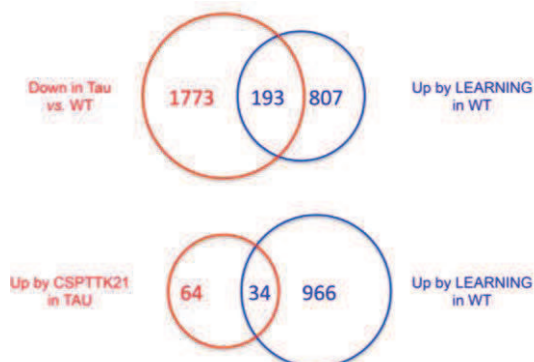

Supporting Results SR4

1 - Ex vivo hippocampal slice preparation.

Each day, a mouse was anesthetized with halothane and decapitated. The brain was rapidly removed from the skull and placed in a chilled (0-3°C) artificial cerebrospinal fluid (ACSF) containing (mM) NaCl 124, KCl 3.5, MgSO₄ 1.5, CaCl₂ 2.5, NaHCO₃ 26.2, NaH₂PO₄ 1.2, glucose 11. Transverse slices (300-400 μm thick) were cut using a vibratome and placed in a holding chamber (at 27°C) containing the ACSF solution, at least one hour before recording. Each slice was individually transferred to a submersion-type recording chamber and submerged with ACSF continuously superfused and equilibrated with 95% O₂, 5% CO₂.

2 - Extracellular recordings

Recordings were obtained at room temperature from the apical dendritic layers of the hippocampal CA1 area, using glass micropipettes filled with 2M NaCl and with a resistance of 2-6 MΩ. Presynaptic fiber volleys (PFV) and field excitatory postsynaptic potentials (fEPSPs), mostly resulting from the activation of AMPA receptors, were evoked by electrical stimulation of Schaeffer collaterals afferent to CA1 and commissural fibres in the stratum radiatum. Test stimuli (100 μs duration) were applied every 10 seconds. The magnitude of fEPSPs was determined by measuring the slope of fEPSPs. Three successive fEPSPs were used to calculate an average slope plotted against time.

Long term depression (LTD) was induced by applying a low frequency stimulation at 2 Hz (1200 pulses for 10 min)

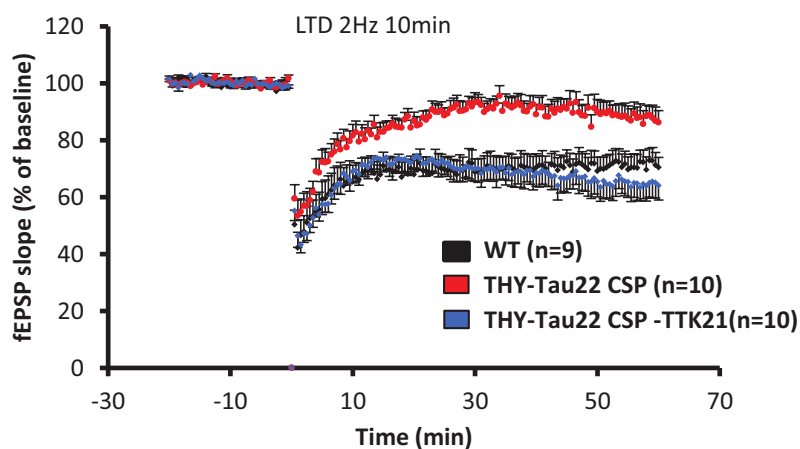

Supporting Results Figure SR4. Sub-chronic treatment of CSP-TTK21 rescues deficits in long-term depression. Time course of LTD: LTD is expressed as a percent change in fEPSP (field excitatory postsynaptic potentials) slope across time. After a 20 min baseline, a low-frequency stimulation (LFS, 2Hz for 10 min) was applied (arrow). Recording was stopped during the 10 min conditioning stimulation and resumed after completion of LFS. LFS induced a strong depression of the fEPSP slope, which recovered partially to reach a stable level of depression about 20 min after stimulation. LTD values were measured between the 50th and 60th min after the end of the LFS. LTD is significantly different in control THY-Tau22 (CSP treated: $88.4 \pm 4.1\%$ of the baseline, $n=10$) as compared to controls (WT: $71.1 \pm 4.4\%$, $n=9$) ($F_{(1,17)}=8.8$, $p=0.008^{**}$). CSP-TTK21 treated THY-Tau22 group restores LTD to control levels ($64.9 \pm 5.2\%$, $n=10$)(WT vs THY-Tau22 CSP-TTK21:

$F_{(1,17)}=0.83$, $p=0.37$, ns).

SECTION III

General Discussion and Future Perspectives

Overview

The focus of my thesis has been to establish whether small molecule activator of CBP/p300 HAT function could be relevant to reverse memory dysfunctions in neurodegenerative diseases such as Alzheimer's (AD). Particularly, we studied the role of CBP in the context of spatial memory formation, a form of memory that is very early dismantled in AD. In *Publication 1*, we first characterized and described the small molecule activator of CBP/p300 HAT (CSP-TTK21) in normal adult mice. We showed that CBP/p300 activation in brain causes increased hippocampal neurogenesis and the persistence of long-term spatial memory. In *Publication 2*, we further confirmed the role of CBP and its interactions with factors binding the KIX domain such as CREB, in recent and remote spatial memory using a transgenic mouse model of CBP with intact HAT domain but impaired KIX domain (CBP^{KIX/KIX} mice). We showed that intact CBP/KIX is required for consolidation of long-term spatial memory and expression of learning induced gene expression. In *Publication 3*, we showed that targeting CBP/p300 HAT activity by CSP-TTK21 rescues cognitive deficits of long-term spatial memory, as well as LTD, in a mouse model of tauopathy (THY-Tau22 mice). This was also associated with rescue of gene expression of activity-dependent genes critically related to spatial memory.

What did we learn about the role of CBP in spatial memory?

CBP is a lysine acetyltransferase that also acts as a transcriptional co-activator. CBP mutation has been linked to Rubinstein–Taybi syndrome (RSTS) (Petrij et al., 1995), a neurodevelopmental disorder characterized by cognitive impairments (Alarcón et al., 2004; Bourtchouladze et al., 2003). Among all other HATs, CBP has been most extensively studied in memory related processes. However, the role of CBP in spatial memory is still contradictory.

My thesis work further confirms the important role of CBP in the storage of long-term spatial memory. To study the function of CBP in spatial memory formation, we adapted two different strategies: 1) mutant mice model of CBP, and 2) pharmacological activation of CBP HAT function.

Evidences from transgenic mouse models

CBP role in spatial memory is a topic of debate because of different outcomes in spatial memory by using various mutant models of CBP. Studies from different mutant mouse models of CBP proves its importance in memory formation but results from specific tasks were not always comparable (reviewed in Valor et al., 2013; introduction of the thesis p. 13 and discussed in *Publication 2*).

In this study, we investigated the role of CBP when its HAT domain is intact but its recruitment to CRE elements through CREB is impaired. Wood et al., in 2006 has described that CBP^{KIX/KIX} mice were impaired in long-term memory for contextual fear conditioning and novel object recognition (Wood et al., 2006). However, CBP^{KIX/KIX} mice were never tested for spatial memory in MWM. The results from *Publication 2* clearly depict a significant role of CBP interaction with CREB through its KIX domain in the context of consolidation of spatial memory at the systems levels. We showed that CBP^{KIX/KIX} mice present significant but delayed acquisition performances and significant short-term (1hr) memory. However, they are impaired in consolidation of long-term spatial memory as they fail to show any retention in both recent (24hr) and remote (30 days) memory. Yet, CBP cKO mice do not show such deficit in recent memory (Valor et al., 2011), suggesting that this deficit may be in part due to neurodevelopmental defects in the CBP^{KIX/KIX} mice, or that compensation can occur when CBP is totally deleted, whereas it can not when a mutated form of CBP is present (dominant mutation). Further, CBP^{KIX/KIX} mice present deficits in learning induced expression of memory and plasticity related genes in the dorsal hippocampus and the frontal cortex. CBP gets recruited by phosphorylated CREB at Ser133 to activate transcription (Chrivia et al., 1993; Parker et al., 1996). However, CREB-mediated transcription can also be initiated by another mechanism through CREB regulated transcription coactivators (CRTC) (Iourgenko et al., 2003). CRTCs can activate transcription independent of phosphorylation of CREB through interaction with the basic leucine zipper domain of CREB (Iourgenko et al., 2003; Conkright et al., 2003). Importantly, viral vectors mediated local or acute increase of CRTC levels in dorsal hippocampus dentate gyrus region of mice before training leads to enhanced memory consolidation suggesting its important role in memory processes (Sekeres et al., 2012). Furthermore, depletion of endogenous CREB in the dorsal hippocampus leads to impairment of spatial memory (Sekeres et al., 2010). Taken together, these data support the fact that recent retention of spatial memory can occur independently of CBP, as CRTC and CREB function could be sufficient. Our data obtained in

General Discussion and Future Perspectives

CBP^{KIX/KIX} mice thus suggest that the persistence of long-term storage of spatial memory requires recruitment of CBP on the CRE regions through interaction with phospho-CREB to activate transcription of CBP:CREB target genes and this can not be compensated by CRTCs members. This does not preclude the intervention of other transcription factors than CREB binding the KIX domain (e.g; c-Myb; Kasper et al., 2002). CBP recruitment at the promoter coincides with activation of gene expression of some activity dependent genes (Figure 44). This likely occurs through histone acetylation, and we found the levels of H2BK5ac to be decreased at activity dependent genes, e.g. *Nr4a1* and *Zif268*. These genes have established roles in long-term memory formation (Hawk et al., 2012; Penke et al., 2014). Notably *Zif268* was shown to enhance the capacity to form a spatial long-term memory and determine the strength of newly encoded memories (Penke et al., 2014). The lack of H2BK5ac (and may be other marks) at their promoter during spatial learning when compared to WT mice, may partly sign the important role of CBP:CREB in targeting loci-specific acetylation at plasticity genes, that may be required for inducing processes necessary for long-term retention. This is reminiscent with the early data from Korzus et al (2004), which showed that mice expressing CBP deleted from its HAT function could not recall spatial memory at 24hr. Histone acetylation at specific sites may lack in these mice (i.e. *Zif268* proximal promoter may not be hyperacetylated) to further lead to proper spatial memory-associated gene expression profiles. Thus, it would be interesting to check the genes activated by spatial learning and their H2Bac occupancy in such mice.

Taken together, these finding suggests that CBP plays a major role in the formation of long-term spatial memory, likely through its recruitment at specific gene promoter loci through CREB/CRE, such as those of *Nr4a1* and *Zif268*.

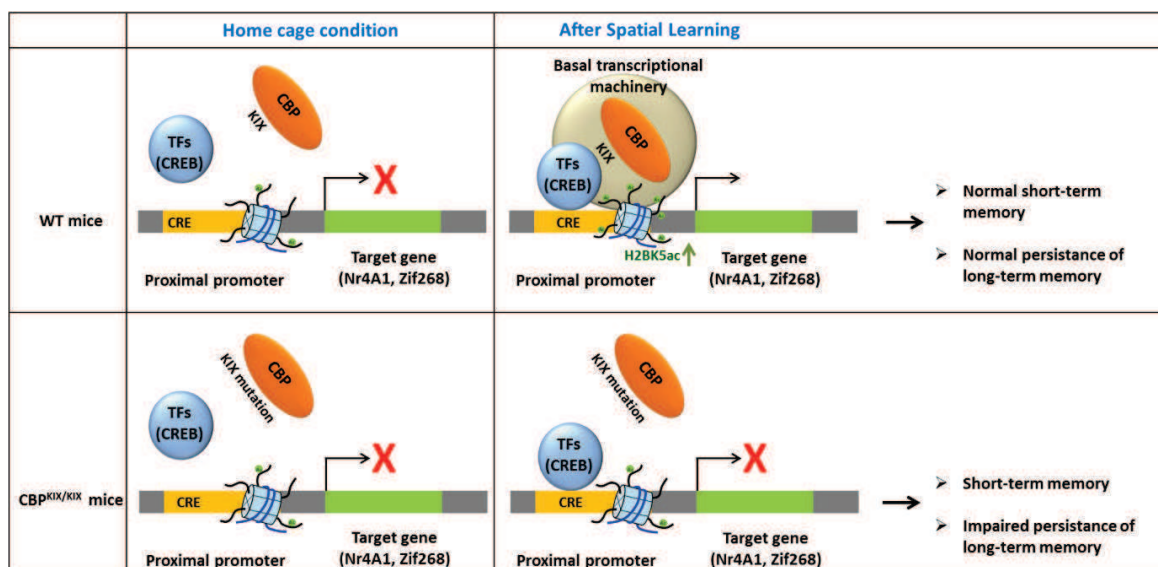

Figure 44. CBP interaction with CREB through its KIX domain is essential for its recruitment at the proximal promoters of activity dependent gene expression. In WT mice, upon spatial learning CBP gets recruited to CRE regions on the promoters of genes like (Nr4A1, Zif268 and others) through interaction with CREB. CBP recruitment follows two important events related to gene transcription: histone acetylation at the promoters (H2BK5ac) and recruitment of the transcriptional machinery. However, mutant CBP that are deficient to bind with CREB or other transcription factors through its KIX domain will not present increased acetylation at the proximal promoters, and this may contribute to decreased gene transcription of memory and plasticity related genes. Figure modified from Vecsey et al., 2007.

Evidences from pharmacological based strategy

We used a direct strategy to activate CBP HAT function by using pharmacological approach. Small molecule based activation of histone acetylation is generally achieved by using HDAC inhibitors that indirectly activates histone and non-histone protein acetylation by inhibiting HDACs. The *Publication 1* of my thesis introduced a novel approach to modulate CBP/p300 HAT function in mice brain. We have employed an alternative strategy to directly activate acetylation by using small molecule activators of CBP/p300 HAT (CSP-TTK21).

The strategy to activate CBP/p300 HAT in mice brain helped us to understand the involvement of CBP/p300 acetyltransferase activities in some fundamental processes in brain related to memory and plasticity.

HAT activator TTK21 enhances the acetyltransferase activity of CBP/p300 by inducing the auto-acetylation of the protein. Increased HAT activity leads to enhanced histone acetylation *in vitro*. As mentioned in *Publication 1*, TTK21 cannot pass through mammalian cell membrane by itself but needs a vehicle, CSP. Covalent conjugation of CSP-TTK21 opened a new direction for our investigation on implications of activating CBP HAT function to study spatial memory in both WT and transgenic mouse models of cognitive impairment. We evidenced effects on two important hippocampal functions by single dose of CSP-TTK21 in healthy adult mice brain: 1) adult neurogenesis and 2) spatial memory formation. CSP-TTK21 treatment supported maturation and differentiation of adult neuronal progenitors from subgranular zone of the dentate gyrus as indicated from long and highly-branched doublecortin-positive neurons in that region of hippocampus. Importantly, we observed that CSP-TTK21 treatment improved extension of memory duration for remote memory, that was

otherwise lost in the WT mice after the mild training. One possible connection of CBP in remote memory could be through adult neurogenesis. Notably, environmental enrichment induced neurogenesis is strongly impaired in CBP^{+/-} mice and enriched mice can not further improve their water maze score (Lopez-Atalaya et al., 2011). New adult generated neurons in hippocampus contribute towards the strengthening of spatial memory (Trouche et al., 2009). Targeted ablation of adult born neurons in the hippocampus after training impairs the retention of remote spatial memory (Arruda-Carvalho et al., 2011). Moreover, genetic deletion of immature adult generated neurons leads to deficits in long-term spatial memory (Deng et al., 2009). Recruitment of these new adult generated neurons to the neuronal network supporting spatial memory is essential for remote spatial memory (Goodman et al., 2010). Our results on the THY-Tau22 mice after chronic treatment with HAT activator CSP-TTK21 significantly improved adult neurogenesis, but also improved precision of search in the target quadrant, which fits with the current notion that adult neurogenesis is important in processes that require precision (e.g. pattern separation; Clelland et al 2009). Thus, a possibility is that persistence of spatial memory consolidation requires activation of new neurons, a process in which CBP is implicated. Nevertheless, it remains that the HAT activator molecule may have favor the dialog of the hippocampus with other cortical regions (e.g. prefrontal cortex) to improve remote memory formation and consolidation by the systems.

This study justifies the present notion that targeting CBP HAT function could be beneficial from the context of neurogenesis and memory formation. Therefore, the therapeutic potential for using HAT activator in memory impairment diseases is immense.

Targeting CBP/p300 HAT could be a relevant therapeutic approach in memory impairment related diseases

Activation of CBP/p300 HAT activity provided valuable information about its function in healthy adult mice brain. Therefore, we used a transgenic mouse model of tauopathy (THY-Tau22) that shows age dependent cognitive impairment (Schindowski et al., 2006). Interestingly, CBP is down-regulated in the dorsal hippocampus of 12 months old THY-Tau22 mice (Supporting Results, SR 1A and 1B, p233), where pathogenic Tau (AT100) expressing neurons shows reduced levels of CBP protein in the dorsal CA1 region (Supporting Results, SR 1C and 1D, p233). CBP degradation has also been observed in brain

General Discussion and Future Perspectives

samples from human patients of Alzheimer's disease (Bousiges O et al and Boutillier AL, *Manuscript in preparation*). Therefore, restoring the activity of CBP from an early time-point of disease pathology or activation of the remaining CBP proteins in the cells could prove beneficial in a therapeutic background. We targeted CBP HAT function in THY-Tau22 mice that already show spatial memory deficits from 8 months of age (Supporting Results, SR2, p234). To investigate the effect of HAT activator CSP-TTK21 treatment in THY-Tau22 mice, we have tested two different protocols of CSP-TTK21 injection in 8 months old THY-Tau22 mice: chronic protocol (10 injections, once per two weeks) and sub-chronic protocol (3 injections, once per week). Based on these two experimental protocols, we have identified several implications of CBP/p300 HAT activation in THY-Tau22 mice model.

Reversal of spatial memory deficits

THY-Tau22 mice show no detectable learning impairments in our experimental conditions using MWM, but shows deficits in long-term retention of spatial memory from 8 months of age (Supporting Results, SR2, p234). We have seen that administration of both protocols (sub-chronic and chronic) can successfully rescue the deficits in cognitive impairment of spatial memory in THY-Tau22 mice. The improved memory by CSP-TTK21 treatment can also extinguish normally after chronic injection if subjected for consecutive extinction tests. These results are in agreement with previous findings, where overexpression of CBP by viral based delivery in brains of AD mice improves spatial memory deficits (Caccamo et al., 2010). We have identified several other memory- and plasticity- related elements (mentioned below) to be modulated upon CSP-TTK21 treatment which could account for reversal of memory deficits in THY-Tau22 mice.

Transcriptional programs

CSP-TTK21 treatment targets the transcriptional programs during memory consolidation in the dorsal hippocampus of THY-Tau22 mice. THY-Tau22 mice show reduced expression of the immediate early genes *Zif268* and *ARC* in the dorsal hippocampus (Burlot et al., 2015). Notably, CSP-TTK21 treatment rescues such gene expression defects. *Zif268* and *ARC* are both known to be target of CBP (Miller et al., 2012; Giralt et al., 2012). Importantly, *ARC* and *Zif268* are integral components of synaptic plasticity and memory as mice lacking either *ARC* or *Zif268* are impaired in hippocampus dependent long-term memory formation (Bramham et al., 2010 ; Veyrac et al., 2014 ; Plath et al., 2006 ; Jones et al., 2001). Also, gain of function of *Zif268* improves hippocampal capacity to form long-term spatial memory

(Penke et al., 2014). Furthermore, our RNA sequencing studies performed after spatial learning suggests that CSP-TTK21 treatment activates *Zif268* and also a series of *Zif268*-target genes (Supporting Results, SR3, p235). Importantly, many of these *Zif268*-target genes up-regulated by the molecule were down-regulated in THY-Tau22 mice, suggesting that *Zif268* recovery could be a key player in CSP-TTK21 effect and thus CBP activation-induced recovery during spatial learning (Supporting Results, SR3, p235). Of note, *Zif268* transcript levels were also impaired in the CBP^{KIXKIX} mice during learning, showing the strong link between CREB, CBP and *Zif268* in spatial learning. Therefore, considering the important roles of *Zif268* and *ARC* in long-term memory; induction of these two IEGs in mice models of memory impairment is already a promising advancement as a potential therapeutics.

Synaptic plasticity

Chronic HAT activator treatment also increased the mRNA expression of genes related to synaptic formation (*SYP*) and synaptic plasticity (*Gria2*) which are otherwise downregulated in THY-Tau22 mice. THY-Tau22 mice presented impaired synaptic plasticity characterized by reduced dendritic spines from CA1 pyramidal neurons (Burlot et al., 2015) and impaired long-term depression (LTD) (Van der Jeugd et al., 2011). LTD, the physiological counterpart of LTP is also crucial for some types of hippocampus-dependent learning (Brigman et al., 2010; Goh and Manahan-Vaughan, 2013). THY-Tau22 mice have impairments particularly in the late phase of LTD that occurs parallel to pathogenic Tau progression and memory impairments (Belarbi et al., 2011; Ahmed et al., 2015). Our gene expression data reveals that CSP-TTK21 could re-establish a gene expression network associated with voltage gated ion channels and transmembrane transporter activity, suggesting it could re-establish proper membrane potential and electrical activity in the hippocampus during learning and memory (Supporting Results, SR3). This is also supported by the fact that CSP-TTK21 treatment totally restored the impaired LTD in THY-Tau22 mice (Supporting Results, SR4, p244). Therefore, the cognitive improvement after CSP-TTK21 could also be due to the reinstatement of LTD in THY-Tau22 mice. However, we still need to analyze the effect of CSP-TTK21 treatment in the dendritic spine formation after spatial learning. Thus our data, suggests that activation of CBP/p300 HAT function in a mice model of tauopathy could rescue defects in synaptic plasticity and therefore contribute towards re-establishment of normal hippocampal function during spatial memory formation.

Adult Neurogenesis

CSP-TTK21 treatment also impacts on the adult hippocampal neurogenesis in THY-Tau22 mice. Maturation and differentiation of adult-born dentate granule cells (3-5 weeks age) require synaptic contact from afferents of the entorhinal cortex (Vivar et al., 2012; Deshpande et al., 2013). THY-Tau22 mice show reduced dendritic arborization of newly generated neurons (DCX+ neurons) from the sub-granular zone of dorsal dentate gyrus. We have seen that sub-chronic treatment (3 injections) is not sufficient to reverse such defects; however, chronic treatment with CSP-TTK21 recovers such dendritic morphology. Therefore a persistent boost of transcriptional programs by CSP-TTK21 treatment from an early time-point (from 3 months of age to 8 months age) can actually delay the deficits in neurogenesis in THY-Tau22 mice. However, we still need to analyze the effect of CSP-TTK21 treatment in the recruitment of these newly generated dentate granule cells into the neuronal network supporting spatial memory (under investigation).

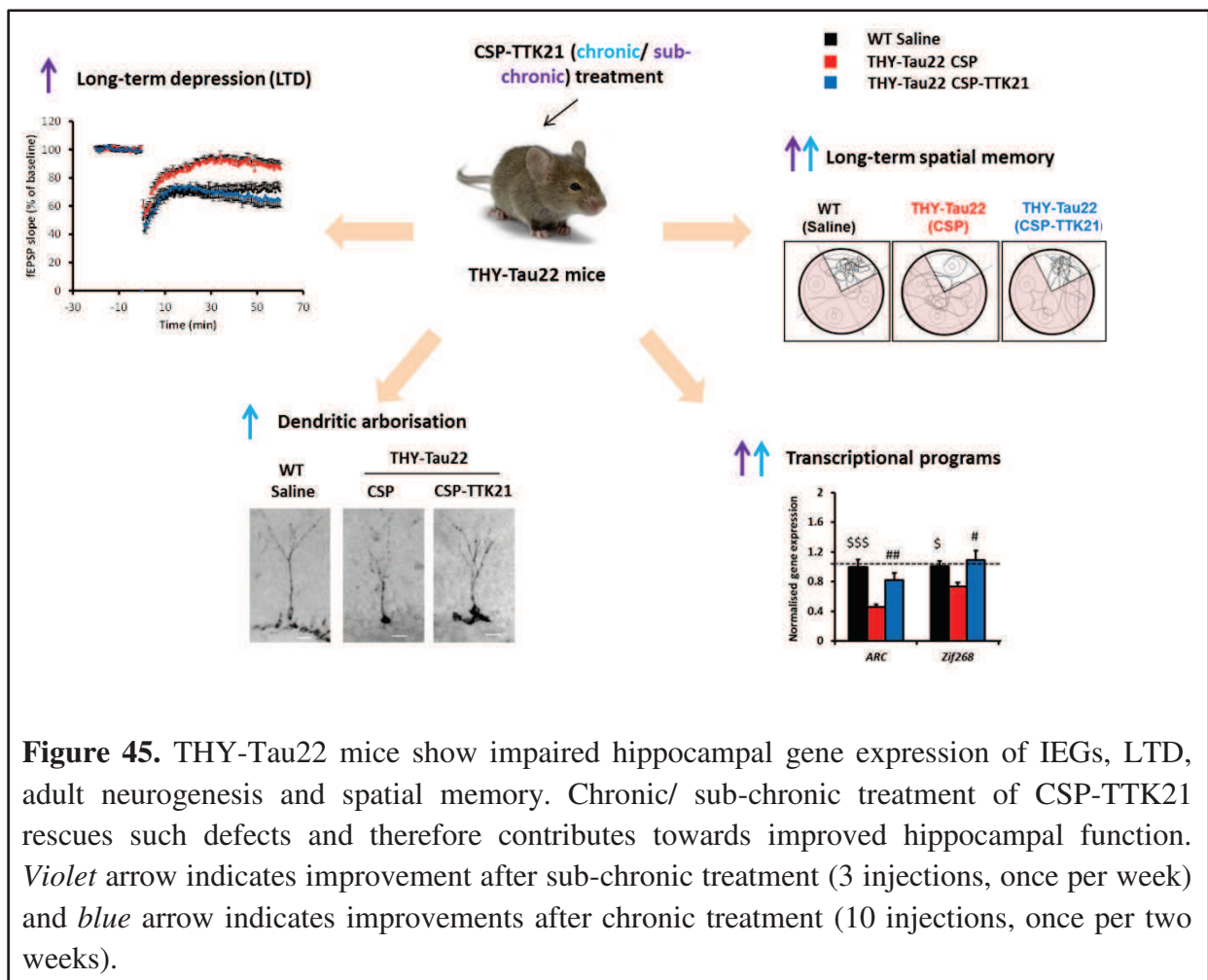

Figure 45. THY-Tau22 mice show impaired hippocampal gene expression of IEGs, LTD, adult neurogenesis and spatial memory. Chronic/ sub-chronic treatment of CSP-TTK21 rescues such defects and therefore contributes towards improved hippocampal function. *Violet* arrow indicates improvement after sub-chronic treatment (3 injections, once per week) and *blue* arrow indicates improvements after chronic treatment (10 injections, once per two weeks).

Future perspectives

What's next?

Further validation of CSP-TTK21 for therapeutic application

Findings from my thesis show convincing data about the implication of CSP-TTK21, an activator of CBP/p300 HAT, in memory related processes. Data obtained from the THY-Tau22 mice model shows that CSP-TTK21 treatment could rescue several defects of hippocampal processes related to memory formation like reinstatement of gene expression networks, adult neurogenesis, long-term depression and long-term spatial memory. Further, we show that long term (chronic) treatment is not deleterious for the mice. Therefore, the potential for this molecule to be used as a therapeutic intervention for the treatment of diseases related to memory impairment is immense. However, translation of CSP-TTK21 as a therapeutic agent requires validation of several parameters/ factors:

Proteomics approach for substrate specificity. We have checked that CSP-TTK21 induces acetyltransferase activity of CBP and p300. However, it needs to be further verified whether other HATs are also targets of CSP-TTK21. Therefore *in vitro* HAT assays using recombinant proteins of different HATs needs to be checked with CSP-TTK21. Further, we need to perform a proteomics based study to identify the targets of CBP/p300 activation by CSP-TTK21 *in vivo*. Using mass spectrometric methods, we can identify the histone and non-histone protein acetylation marks induced by CSP-TTK21 in mice brain.

Mode of administration. All the results obtained using CSP-TTK21 in my thesis are after intraperitoneal administration in mice, therefore other modes of administration also need to be verified. Oral drug administration is the most common mode of treatment, and recently, HDAC inhibitor vorinostat showed promising results in mice models of ageing and amyloid deposition after oral administration (Benito et al., 2015). Therefore, we also need to check if CSP-TTK21 could still cross the blood-brain barrier after oral administration and retain its HAT activation property and non-toxic nature.

Test CSP-TTK21 effect in CBP mutant mice. To prove the current notion that improvement of spatial memory by CSP-TTK21 is mainly due to activation of CBP, we need to treat a mutant CBP mouse strain (e.g. CBPcKO, Valor et al., 2011) with CSP-TTK21. As these mice do not show impairment in spatial retention, we could check whether the molecule fails to improve spatial learning memory following a mild training protocol as used for WT mice in Chatterjee et al. (2013). Further, CBP HAT domain is essential for consolidation of long-term memory (Korzus et al., 2004). Our data obtained from mostly *in vitro* studies indicates that CSP-TTK21 mainly targets CBP to activate its HAT function. Therefore to prove whether CSP-TTK21 effect is mainly due to activation of CBP's HAT function, we need to treat *CBP HAT^{-/-}* mice with CSP-TTK21. If the molecule treatment fails to improve memory durations, it would be a proof of concept that CSP-TTK21 mainly targets CBP and its HAT function to improve hippocampus dependent memory formation.

Neuronal vs non-neuronal population. Alzheimer's disease is associated with neuronal degeneration, a massive increase in glial population of cells and increased inflammatory responses, which is also seen in our THY-Tau22 mouse model as early as 8 months of age (Supporting Results, SR3). We have previously shown that CSP can cross both neuronal and glial cells in cultured cell lines (Selvi et al., 2008; Selvi et al., 2012). Therefore, it would be of utmost importance to check the effect of CSP-TTK21 treatment separately in neuronal and glial population of cells in the hippocampus. Chronic treatment of CSP-TTK21 does not alter the pathogenic Tau load in THY-Tau22 mice which occurs in the neurons. However, it is not yet clear if the molecule enters the glial progenitors and alters their activity. Therefore a thorough characterization of the effects (transcriptional and pathological) of CSP-TTK21 in sorted population of brain cells (neuronal vs. non neuronal; Benito et al., 2015) needs to be performed.

HAT activation in Zif268 KO mice. Our RNA sequencing studies after spatial learning shows that sub-chronic treatment with CSP-TTK21 causes increase in transcription of Zif268 target genes in dorsal hippocampus of THY-Tau22 mice (Supporting Results, SR3). This study indicates an important role of Zif268 in the improvement of cognitive function by CSP-TTK21. For proof of concept, Zif268 KO mice could be treated with CSP-TTK21 and their spatial memory performances in MWM could then be analyzed. If CSP-TTK21 treatment fails to rescue spatial memory deficits, it would conclusively prove the importance of Zif268

activation as one of the major event downstream of CBP/p300 activation caused by CSP-TTK21 treatment.

Other behavioural tasks. Almost all the mutant mice models of CBP shows memory impairments in *object recognition tasks*. Therefore, implication of HAT activation in object recognition tasks should also be tested. *Pattern separation* is considered to be dependent on adult hippocampal neurogenesis (Sahay et al., 2011). CSP-TTK21 treatment also improves adult hippocampal neurogenesis in both healthy and pathogenic mice. CSP-TTK21 treated mice could be tested in behavioral tasks dependent on pattern separation. The results obtained would nicely establish the role of CBP function in pattern separation.

Implications in therapeutics

Test in different mice models of cognitive impairment. We have shown implication of CSP-TTK21 treatment on a mouse model of memory impairment (THY-Tau22 mice), but to be used as a therapeutics, we need to verify the beneficial effects of CSP-TTK21 in other mice models of cognitive impairment.

- **Alzheimer's disease (AD).** Apart from tauopathy; ageing and amyloid burden are the other major contributors for the pathogenesis of Alzheimer's disease. Therefore, testing the implications of CSP-TTK21 treatment in mice models of age-associated memory impairment and amyloid deposition will provide valuable information about the strategy to activate HATs as therapeutics. As APP-PS mice strains develop both amyloid plaques and neurofibrillary tangles (NFTs), treatment with CSP-TTK21 would reflect its implications for the treatment of AD.
- **Huntington's disease (HD)** is also associated with deficits in long-term memory mostly due to reduced CBP histone acetyltransferase activity (Giralt et al., 2012) and extensive down-regulation of genes controlling neuronal function (Achour et al., 2015). As CSP-TTK21 treatment induces CBP HAT activity and also increases target gene expression, chronic treatment of CSP-TTK21 may provide beneficial effects in mouse models of HD.
- **Rubinstein–Taybi syndrome (RTS)**, a complex autosomal-dominant disease characterized with cognitive impairments (Rubinstein and Taybi, 1963) is associated with mutation in gene encoding *cbp* (Petrij et al., 1995). Mice models of

General Discussion and Future Perspectives

haploinsufficiency form of Rubinstein-Taybi syndrome (RTS; $CBP^{+/-}$) have deficiencies in some forms of long-term memory, and late phase of hippocampal long-term potentiation (L-LTP) (Alarcón et al., 2004). Therefore, it would be intriguing to check if HAT activation could ameliorate the cognitive impairment by activating the limited amounts of CBP in this mouse model.

Therapeutic application in non-human primate models. Study of brain and behavioural changes in non-human primate models provides more biological resemblances to humans. Moreover, the two major factors contributing towards AD pathogenesis: $A\beta$ and tau proteins are highly homologous among primates. Importantly, ageing induces senile ($A\beta$) plaques and cerebral β -amyloid angiopathy in nonhuman primates (Heuer et al., 2012). Therefore the therapeutic implications of CBP/p300 activation could be tested in these primate models.

Annexe

PUBLICATION 4.

Acetyltransferases (HATs) as Targets for Neurological Therapeutics

Anne Schneider, Snehajyoti Chatterjee, Olivier Bousiges, B. Ruthrotha Selvi, Amrutha Swaminathan, Raphaëlle Cassel, Frédéric Blanc, Tapas K. Kundu, Anne-Laurence Boutillier

Published in Neurotherapeutics. 2013;**10**(4):568-88.

Neurotherapeutics (2013) 10:568–588
DOI 10.1007/s13311-013-0204-7

REVIEW

Acetyltransferases (HATs) as Targets for Neurological Therapeutics

Anne Schneider · Snehajyoti Chatterjee · Olivier Bousiges ·
B. Ruthrotha Selvi · Amrutha Swaminathan · Raphaelle Cassel ·
Frédéric Blanc · Tapas K. Kundu · Anne-Laurence Boutillier

Published online: 5 September 2013
© The American Society for Experimental NeuroTherapeutics, Inc. 2013

Abstract The acetylation of histone and non-histone proteins controls a great deal of cellular functions, thereby affecting the entire organism, including the brain. Acetylation modifications are mediated through histone acetyltransferases (HAT) and deacetylases (HDAC), and the balance of these enzymes regulates neuronal homeostasis, maintaining the pre-existing acetyl marks responsible for the global chromatin structure, as well as regulating specific dynamic acetyl marks that respond to changes and facilitate neurons to encode and strengthen long-term events in the brain circuitry (e.g., memory formation). Unfortunately, the dysfunction of these finely-tuned regulations might lead to pathological conditions, and the deregulation of the HAT/HDAC balance has been implicated in neurological disorders. During the last decade, research has focused on HDAC inhibitors that induce a histone hyperacetylated state to compensate acetylation deficits. The use of these inhibitors as a therapeutic option was efficient in several animal models of neurological disorders. The elaboration of new cell-permeant HAT activators opens a new era of research on acetylation regulation. Although pathological animal models have not been tested yet, HAT activator molecules have already proven to be beneficial in ameliorating brain functions associated with

learning and memory, and adult neurogenesis in wild-type animals. Thus, HAT activator molecules contribute to an exciting area of research.

Keywords HAT activator molecule · Lysine acetylation · CREB-binding protein · Learning and memory · Adult neurogenesis · Neurodegenerative diseases

Introduction

DNA is packed in the nucleus of mammalian cells in association with histones, non-histone proteins, and RNA in a highly organized structure known as chromatin. A nucleosome is a single unit of chromatin comprising 146 base pairs of DNA wrapped around histone octamers. The histone N-terminal tails are subjected to various post-translational modifications, including acetylation, methylation, phosphorylation, ubiquitination, and sumoylation [1, 2]. Histone acetyltransferase (HAT) catalyzes the acetylation of core histones through the addition of an acetyl group from the pseudo-substrate acetyl coenzyme A (acetyl-CoA) to the lysine residue on the ϵ -amino group on the N-terminal of histones. Apart from histone, HATs also have many non-histone protein substrates, suggesting a new nomenclature, KAT for lysine (K) acetyl transferase, replacing the term HAT [3]. However, in the following sections, we will use HAT to avoid possible confusion. Another class of enzymes, histone deacetylases (HDACs), catalyzes deacetylation through the hydrolysis of an acetyl moiety from the lysine residue.

Although the functional implications of each of these modifications have not been fully elucidated, studies have shown that it is difficult to identify the dynamic acetyl mark(s) that specifically respond to a pathway from the overall pre-existing marks that maintain the global chromatin structure. In terms of function, lysine acetylation initiates molecular processes leading to two biochemical consequences: 1) the recruitment of

A. Schneider · S. Chatterjee · O. Bousiges · R. Cassel ·
A.-L. Boutillier (✉)

Laboratoire de Neurosciences Cognitives et Adaptatives (LNCA),
UMR7364, Université de Strasbourg-CNRS, GDR CNRS 2905,
Faculté de Psychologie, 12 rue Goethe, 67000 Strasbourg, France
e-mail: laurette@unistra.fr

B. R. Selvi · A. Swaminathan · T. K. Kundu
Transcription and Disease Laboratory, Molecular Biology and
Genetics Unit, Jawaharlal Nehru Centre for Advanced Scientific
Research, Jakkur, Bangalore 560064, India

F. Blanc
Service de Neuropsychologie and CMRR (Centre Mémoire de
Ressources et de recherche) Laboratoire ICube,
Université de Strasbourg, CNRS, équipe IMIS-Neurocrypto,
1, place de l'Hôpital, 67000 Strasbourg, France

 Springer

coactivator complexes through conserved domains, such as bromodomains; and 2) the participation of co-repressor complexes through HDACs. Together, these changes will affect chromatin structure, leading to further functional consequences. Indeed, strict regulation of the dynamic balance between acetylation and deacetylation is critical for various cellular physiological phenomena, such as proliferation, differentiation, cell growth and gene expression. Most recently, the acetylation balance has been implicated in intracellular pH regulation [4].

Alterations in the acetylation balance have been shown in neurologic disorders and neurodegenerative diseases [5–7]. Despite decoding chromatin language in pathological conditions or cognitively deficient states, HDAC inhibitors (HDACi) might represent a good therapeutic option, as these compounds induce a histone hyperacetylated state that might compensate for acetylation deficits. HDACi-based therapeutic strategies were first applied to models of polyglutamine (polyQ) diseases, such as Huntington's [8, 9] and Kennedy's [10], and then subsequently revealed to be successful to some extent in several other animal models of neurodegenerative disease [5, 6, 11, 12]. Importantly, this strategy has also been successfully applied in animals subjected to experimental brain damage [13, 14] and recently shown to improve memory functions in aged mice [15]. HDACi are the only molecules used for increasing cellular acetylation, and two of these molecules have been approved for clinical use in cutaneous T cell lymphoma [16]. However, caveats remain as to the specificity and the molecular and cellular mechanisms underlying the activity of these inhibitors in neurons, whereby long-term application might be detrimental.

In this review, we will briefly describe different HAT families and the regulation, function, and important role of these molecules in the cell fate specification of neural stem cells. As enzymes, HATs are druggable, and few HAT activator molecules have been developed. We will also discuss the mechanisms for HAT regulation and impairment in neurodegenerative diseases and neuronal plasticity to understand the benefits of therapeutic strategies based on reactivating acetylation using HAT activators versus HDAC inhibitors. Moreover, we will describe two interesting studies concerning HAT activator molecules.

Although lysine acetylation is best characterized in the context of nuclear histones, combinatorial approaches and proteomic analyses have revealed almost 2,000 acetylated proteins in the cell that are involved in a broad range of cellular functions [17, 18]. Thus, the potential effect of HAT activation or impairment on nonhistone targets will also be reviewed.

HATs

Families of HATs

HATs catalyze the acetylation of lysine residues, which has been accepted as an important epigenetic marker. Acetylation

occurs on both histone and nonhistone proteins, with an estimated 2,000–4,000 acetylated proteins and 15,000 acetylation sites in animal tissues [19]. The majority of the functional attributes of acetylation have been revealed as a result of several decades of research on histone acetylation, with recent evidence of nonhistone protein acetylation. In the context of chromatin, histones undergo acetylation to yield a more relaxed chromatin conformation resulting from hydrophobicity, a net change in the overall charge, and reduced electrostatic interactions. Acetylated histones recruit bromodomain-containing proteins, which are primarily transcription factors and cofactors, further enhancing gene expression [20]. HATs are highly conserved from yeasts to humans. Figure 1 summarizes the different HAT and HDAC families. These enzymes are broadly classified into cytoplasmic type A and nuclear type B HATs. Nuclear HATs are subclassified into 5 major families: 1) Gcn5-related N-acetyltransferases (GNAT), 2) p300/cyclic adenosine monophosphate response element-binding protein (CREB) binding protein (CBP), 3) MOZ, yeast YBF2, SAS2, and TIP60 (MYST), 4) transcription factor-related HATs, and 5) nuclear receptor-associated HATs. GCN5, a member of the GNAT family was the first identified acetyltransferase. The major members of the GNAT family are general control of amino acid synthesis 5 (Gcn5); elongation protein 3 (ELP3); p300/CBP-associated factor (PCAF); chromodomain on chromosome Y protein; establishment of cohesion 1; establishment of cohesion 1 homolog 1; establishment of cohesion 1 homolog 2 (a paralog of establishment of cohesion 1 homolog 1); ADA-two-A containing 2; and mechanosensory abnormal 17 [21]. GNATs comprise a conserved acetyltransferase domain, a bromodomain that recognizes acetylated lysine residues, and a transcription coactivator ADA2-binding domain. The 2 paralogs of p300/CBP family are transcriptional coactivators p300 and CBP. The 5 principal protein interaction domains of p300 and CBP are the nuclear receptor interaction domain; the CREB and myeloblastosis (MYB)-interaction domain; the kinase inducible binding domain (KIX), which binds to the Ser-133-phosphorylated kinase inducible domain region of CREB; the cysteine/histidine regions (CH1 and CH3); and the interferon response-binding domain, which is also the steroid receptor coactivator 1 interacting domain of CBP [22]. p300/CBP also possesses an acetyltransferase domain, bromodomain, and a plant homeodomain-type zinc finger motif. The members of the MYST family of acetyltransferases, including TAT interacting proteins 60 (Tip60), monocytic leukaemia zinc-finger protein (MOZ), males absent on the first (MOF), monocytic leukaemia zinc-finger protein related factor (MORF) and human acetylase binding to ORC1 (HBO1), have a 240 amino acid-long MYST region with a canonical acetyl-CoA-binding site and a C2HC-type zinc finger motif. Most of the MYST family acetyltransferases are characterized by the presence of a chromodomain,

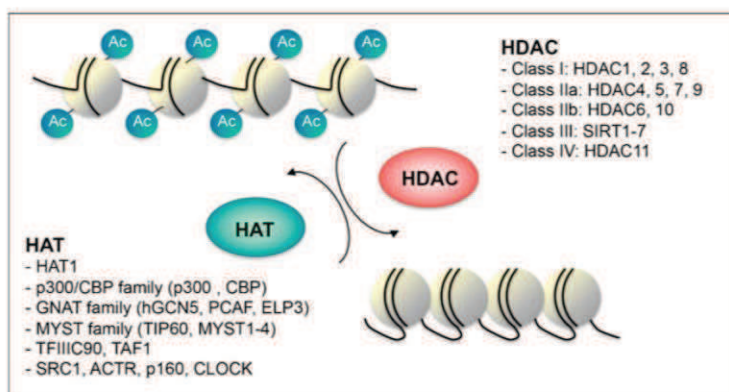

Fig. 1 Histone acetyltransferase (HAT) and histone deacetylase (HDAC) families. Illustration of chromatin conformation according to the HAT/HDAC balance. The acetylation levels of nucleosome histone tails, at lysine residues, are determined through the interplay between acetylation and deacetylation mechanisms engaged respectively through HATs and HDACs enzymes. The different families and classes of enzymes are noted. Ac = Acetyl; CBP = cyclic adenosine monophosphate response element-binding (CREB) binding protein; GNAT = Gcn5-related N-acetyltransferases; hGCN5 =

human general control of amino acid synthesis protein 5-like 2; PCAF = p300/CBP-associated factor; ELP3 = elongation protein 3; MYST = MOZ/YBF2/SAS2/TIP60; TIP60 = TAT interacting proteins 60; TFIIC90 = transcription factor IIIC 90kDa; TAF1 = TATA Box Binding Protein-Associated Factor, SRC1 = steroid receptor coactivator 1; ACTR = SRC-3, steroid receptor coactivator/AIB-1, Activated In Breast cancer-1/TRAM-1, thyroid hormone receptor activator molecule 1/ NCOA3, nuclear receptor coactivator 3

involved in protein–protein interactions. Structural alignments suggest these chromodomains to be slightly different than the canonical polycomb associated chromodomains [23].

HAT activities have been identified in several proteins associated with transcription activation through hormonal signals. This family of HATs is classified as nuclear receptor coactivators, which include steroid receptor coactivator-1, SRC-3, steroid receptor coactivator/AIB-1, Activated In Breast cancer-1/ TRAM-1, thyroid hormone receptor activator molecule 1/ NCOA3, nuclear receptor coactivator 3 (ACTR), and transcriptional intermediary factor 2 (reviewed in [24]). These enzymes are evolutionarily related to HATs, which interact with p300. The transcription factor-related HATs include TATA box binding protein (TBP)-associated factor TAFII250 and TFIIC. TAFII250 is a subunit of the general transcription factor transcription initiation factor II D (TFIID). The general function of TFIIC involves the initiation of the transcription promoter complex through DNA binding and the recruitment of TBP-containing TFIIB and RNA polymerase III [25]. At least three subunits of TFIIC (TFIIC110 and TFIIC90) harbor HAT activity *in vitro* [26]. However, this classification should be reconsidered, as several nuclear HATs exhibit nuclear cytoplasmic shuttling, and cytoplasmic lysine acetylation has been associated with important physiological outcomes [27].

HAT Function and Regulations

Acetylation plays a central role in numerous biological processes, including gene expression [28, 29], chromatin dynamics, cell-cycle progression [30–33], DNA repair [34], and

apoptosis. HATs are regulated through various mechanisms, including auto-acetylation, signaling pathways-induced modifications, and cellular metabolites.

Auto-acetylation

Auto-acetylation involves the regulation of enzyme activity through the acetylation lysine residues, typically resulting in increased catalytic activity. The first reported acetyltransferase to undergo auto-acetylation is Tip60. Lysine 327 in the active site of the MYST domain is conserved amongst all the MYST proteins and acts as a key regulatory marker for enzyme activity upon acetylation. The intra- or intermolecular auto-acetylation of p300/CBP-associated factor (PCAF) specifically targets 5 lysine residues in the nuclear localization signal. Auto-acetylated PCAF localizes to the nucleus and activates gene transcription. Deacetylated PCAF is located primarily in the cytoplasm of apoptotic cells, suggesting a role for PCAF auto-acetylation in the regulation of cellular processes [35]. Similarly, p300 and CBP activity is also regulated through auto-acetylation [36]. The auto-acetylation of p300 induces a structural conformational change, leading to the exposure of substrate-binding regions. p300 auto-acetylation results in the acetylation of approximately 12 lysine residues in the unique activation loop of p300. Thus, the acetylation status of this enzyme facilitates the compartmentalization and induction enzymatic activity [36]. To maintain acetylation homeostasis, the nicotinamide adenine dinucleotide (+)-dependent HDAC sirtuin 2 (SIRT2) regulates p300 auto-acetylation [37]. HDAC3 deacetylates PCAF [38] and SIRT1 deacetylates Tip60 [39].

HAT Function of CBP

The HAT function of CBP can be regulated by different signaling pathways affecting its phosphorylation status by nuclear calcium or cyclic adenosine monophosphate pathways [40, 41], or its arginine methylation level by the coactivator-associated arginine methyltransferase 1 [42, 43]. Such modifications affect the enzymatic activity.

Cellular Metabolites

Cellular metabolites, such as nicotinamide adenine dinucleotide (+) and acetate, also act as regulators of acetylation. These compounds modulate HDACs; however, the direct roles of cellular metabolites on HATs have not been thoroughly investigated [4, 44].

HATs During Neural Development

Among the HATs, CBP/p300 are crucial enzymes in development; mutations and deletions of either enzyme causes Rubinstein-Taybi syndrome, characterized by mental disability, among other features [45]. Several studies have described a role for CBP/p300 in neural development. In mice, the mono-allelic abrogation or loss of the enzymatic activity of either enzyme results in embryonic lethality observed as early as E9.0 to E11.5 in a dominant fashion, consistent with the early stages of neural development, with impaired hematopoiesis, angiogenesis, heart, lung, and intestine organogenesis [46–49]. Interestingly, an analysis of the distribution of the p300 messenger RNA (mRNA) during mouse development showed the elevated expression in the neural tissue, suggesting the involvement of this enzyme in neural development. Consistently, knocking out CBP or p300 leads to an open neural tube, potentially reflecting defects in twist (without changes in twist expression) or other transcription factors, such as paired box 3 (PAX3) and activating enhancer binding protein 2 (AP2), thereby affecting neural development [49, 50]. Neural tube closure typically begins at E8.5 and spreads along neural folds; however, in CBP-null embryos, different types of neural tube closure defects are observed. Hemorrhaging in the telencephalon and mesencephalon, reflecting defective vasculature, has also been observed and hypothesized as the primary cause of embryonic death [50].

At the molecular level, HATs have been implicated in the cell fate specification of neuronal stem cells (NSC) (Fig. 2). p300 bridges signal transducers and activators of transcription 3 and mothers against decapentaplegic homolog 1 (Smad1), leading to synergistic astrocyte differentiation from neural progenitors [51]. CBP/p300 complexes with the transcription factor neurogenin 2 and the retinoic acid receptor to induce histone acetylation and transcriptionally active chromatin during motor neuron specification [52]. The closely related basic helix-loop-

helix (bHLH) factor neurogenin 1 (Ngn1) represses gliogenesis through the sequestration of the CBP-Smad1 complex away from astrocyte differentiation genes, such as glial fibrillary acidic protein (GFAP), during neurogenesis [53]. CBP/p300 and Smad1, separately or together, subsequently associate with neurogenin at neural-specific promoters, such as NeuroD, thereby promoting neuronal differentiation [53]. The post-translational modifications of CBP and p300 also regulate the functions of these enzymes, and the phosphorylation of CBP through the atypical protein kinase C (aPKCC) plays a critical role in controlling glial and neuronal differentiation [54].

Among the other families of HATs, the role of Gcn5 in neural development has also been documented, as the acetyltransferase activity and sufficient expression of this enzyme are required for neural tube closure in mice [55, 56]. Surprisingly, while p300 HAT mutants exhibit defects in multiple organ systems, the effects of mutating Gcn5 are restricted to the neural tissue, implicating the specificity of Gcn5 acetyltransferase activity, with potential redundancy with PCAF in other tissues [55]. Gcn5 also plays HAT-independent roles during development, and the complete loss of this protein leads to early embryonic lethality after gastrulation [57, 58]. Gcn5, as a member of the Spt-Ada-Gcn5-acetyltransferase (SAGA) complex, accelerates neural dysfunction characteristic of polyQ-Atxn7, which causes spinocerebellar ataxia type 7 [59]. At the transcriptional level, knocking out Gcn5 in NSCs leads to changes in gene expression in a pattern similar to the Myc knockout (KO). This functional overlap indicates that Gcn5/Myc coregulate transcriptional programs in NSCs, a process required for stem cell proliferation and normal brain growth [60]. Interestingly, the KO of both CBP/p300 and Gcn5 leads to neural tube closure defects, reminiscent of knocking out other transcriptional regulators, such as p53, suggesting the complex, but overlapping, functions of various factors in neural tube closure.

While the effects of knocking out other proteins of the Tip60/NuA4 complex have been studied previously, the function of the MYST family of HATs in neural development remains unknown. However, the role of the interaction between Tip60 and ATXN1 in spinocerebellar ataxia type 1 pathogenesis, involving cerebellar degeneration, implicates a role for these HATs in neural development [61].

Though the roles of different HATs in neural development have been well-studied or at least indicated, further extensive studies will be required to provide a more detailed picture of the role of histone acetylation in the regulation of transcriptional programs during neural development.

Because acetylation plays a significant role during neural development, it would be intuitively obvious that deacetylation through HDACs also plays a role in modulating cell differentiation during neural development. Particularly, HDAC1 and HDAC2 play a role in oligodendrocyte differentiation through crosstalk with the canonical Wnt signaling pathway, mediated

through transcription factor 7-like 2 (TCF7L2) [62] (Fig. 2). The inhibition of HDAC1 and HDAC2 causes the developmental plasticity of precursors, leading to differentiation into other cell types [63, 64].

Druggability of HAT Domains

An imbalance in acetylation homeostasis leads to a plethora of disease conditions; hence, the modulation of the activity of HATs could be an efficient method for therapeutics. Several domains of HAT, which play essential roles in the cell, can be targeted using small molecule modulators. These targets include 1) HAT domains, 2) auto-acetylation residues/regions, and 3) bromodomains, which recognize acetylation marks. These can be targeted and modulated using a small molecule or peptide approach. Several groups worldwide are designing synthetic or natural chemical probes that target epigenetic modifications. Small-molecule chemical probes have recently contributed to advances in the search for epigenetic drugs. The first reported HAT inhibitor, Lys-CoA, specifically inhibited p300 HAT activity [65]. Extracts from plants with medicinal value have served as therapeutics in the medieval world and

present an excellent platform to develop new-generation therapeutics. The first reported HAT inhibitor from natural sources was obtained from *Garcinia indica*. Garcinol from *G. indica* nonspecifically inhibits p300 and PCAF HAT activity, but, recently, this inhibitor has shown great promise as a potent anticancer drug [66]. Owing to the specific focus of this article, we shall confine the review to HAT activators and their therapeutic potential.

Known HAT Activator Molecules (Structure and Their Possible Mechanism of Action)

The use of small molecules to modulate enzyme function is an emerging concept, and various molecules (synthetic and natural) have been identified with strong therapeutic potential against numerous diseases, including cancer, AIDS, diabetes, depression, and neurodegenerative conditions [7, 67, 68]. HAT activators are a class of small-molecule modulators that activate enzyme activity. The first reported and the most characterized HAT activator is N-(4-chloro-3-trifluoromethyl-phenyl)-2-ethoxy-6-pentadecyl-benza-mide (CTPB), derivatized using anacardic acid as a synthon [69, 70]. Anacardic acid

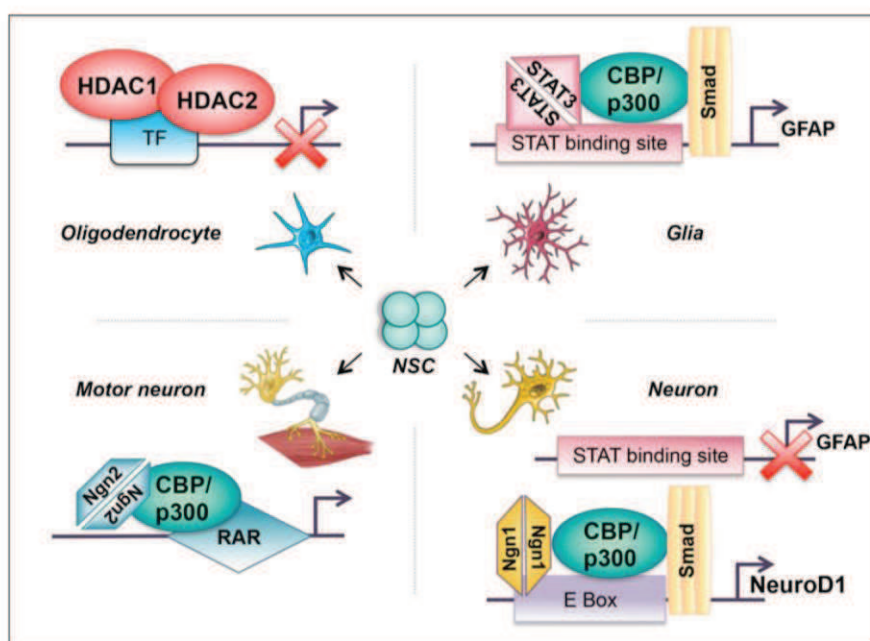

Fig. 2 Role of acetylation in different lineage determination. The neural stem cells (NSCs) exist in a niche, which can be differentially modulated to specific neuronal lineages. A differential recruitment of specific transcription factors (TF) to the same acetyltransferases determine specific neural cell fates from the NSCs. Cyclic adenosine monophosphate response element-binding (CREB) binding protein (CBP)/p300 histone acetyltransferases (HATs) interact with STAT and SMAD activating glial fibrillary acidic protein (GFAP) expression, thus specifying the glial lineage. Increased expression of neurogenin (Ngn1) titrates this complex, thus leading to the

release of STAT, blocking GFAP expression. The new Ngn1-CBP/p300-SMAD complex subsequently binds to the E box elements, which results in a neuron cell type due to the activation of NeuroD1 expression [53]. CBP/p300 when bound to retinoic acid receptor (RAR) and neurogenin 2 (Ngn2) leads to a differentiation of the motor neuron cells. The deacetylases histone deacetylases (HDACs) HDAC1 and HDAC2 act as a general repressor, blocking the transcription factor and thereby resulting in oligodendrocyte specification

can be isolated from cashew nut shell liquid, and this compound acts as an inhibitor of p300 and PCAF HAT activity. In contrast, CTPB can efficiently activate p300 HAT activity in a concentration-dependent manner, but does not alter PCAF HAT activity. *In vitro* CTPB induces the maximum activation of p300 HAT activity to ~4-fold at a 200–275 μM concentration. Interestingly, CTPB could also enhance p300 HAT-dependent transcription from a chromatin template *in vitro*. The mechanism of activation through CTPB and its derivative N-(4-chloro-3-trifluoromethyl-phenyl)-2-ethoxy-benzamide (CTB) was explored using surface-enhanced Raman spectroscopy, indicating a conformational change upon activator binding, which possibly recruits more acetyl-CoA and enhances auto-acetylation. Furthermore, the location of –CF₃ and –Cl at the para position of the benzamide ring of CTPB and CTB is critical for HAT activation [71]. As CTPB and CTB are hydrophobic in nature, these compounds might form micelle-like structures in aqueous solution and directly bind to the hydrophobic pockets of p300. As most of the hydrophobic pockets of p300 are present in proximity to the HAT domain, the –CF₃ and –Cl regions of these molecules could bind to the amide groups of the α -helix and β -sheets of p300 HAT domain and alter its conformation. In need of a more stable and potent activator of HATs, TTK21 was synthesized from salicylic acid. TTK21 enhances p300 and CBP acetylation *in vitro* and, upon conjugation with a carbon nanosphere (CSP), could enter the nucleus of the neural-derived cells, SHSY-5Y, and cross the blood–brain barrier (BBB), inducing histone H2B and H3 acetylation in specific regions of the mouse brain [72] (described in detail in the section ‘Potential use of HAT Activator as Therapeutic Option’).

Another small molecule with strong HAT activation ability towards p300/CBP is nemorosone, a derivative of benzophenone. Nemorosone is a polyisoprenylated benzophenone derivative that bears a C(1) acyl group and an adjacent C(8) quaternary center without any secondary cyclization. Thermodynamic studies using surface plasmon resonance indicated that nemorosone has high affinity towards p300 protein (0.25 μM), and this interaction is associated with a low kinetic dissociation constant ($3.2 \times 10^{-4} \text{ s}^{-1}$), suggesting a hardly dissociable complex with a stable tertiary structure. Furthermore, the major region of nemorosone, which interacts with p300, was identified as a hydroxylated enol involving C(2), C(3), and C(4) [73]. Efforts to isolate small-molecule activators using the basic backbone structure of anacardic acid are currently underway. In a recent study, pentadecylidenemalonate was prepared, which surprisingly showed mixed inhibitor/activator properties towards HATs, as this chemical inhibited p300/CBP HAT activity and activated PCAF HAT activity [74, 75]. Pentadecylidenemalonate/SPV106 could cross mammalian cell membranes and enhance histone H3 acetylation. Moreover, this chemical is also the only reported PCAF activator.

HAT Impairment in Neurodegenerative Disorders

Neurodegenerative diseases, such as Huntington’s (HD), Parkinson’s (PD), Alzheimer’s (AD), or amyotrophic lateral sclerosis (ALS), are characterized by a progressive loss of neuronal structure and function that leads to neuronal death. In these diseases, impairments of HAT activity, histone, and nonhistone protein acetylation have been reported, associated with a decrease of cognitive functions and/or motor impairments. In this section, we will describe how HAT function is impaired in different pathologies (e.g., nuclear delocalization, enzymatic activity inhibition, etc.), how this dysregulation will contribute to the overall pathogenic process, and how maintaining adequate HAT/HDAC homeostasis in the cell is particularly important for neuronal survival [76–78], and how HATs might constitute targets for new therapeutic strategies. Table 1 summarizes the substrates of HATs and their potential links to neurological disorders.

HD

HD is a rare and fatal inheritable genetic disorder characterized by a loss of coordination (chorea), cognitive dysfunction, and psychiatric symptoms. At the cellular level, HD is characterized by intraneuronal inclusions, alterations in synaptic function and widespread neuronal death at the late stage of the disease, the striatum being the most affected region. Other brain regions, such as the cortex and the cerebellum, are also affected [79]. HD reflects an abnormally high number of unstable CAG repeats within the 5’-end of the coding region of the gene encoding the Huntingtin (Htt) protein. The number of repeats affects the severity and the onset of the disease, generally initiated at mid-life. The polyQ expansions alter the Htt protein functions and confer self-aggregation properties [80].

An initial study demonstrated that CBP is found in polyQ aggregates [81]. Indeed, CAG expansions bind and sequester transcriptional regulators, including CBP and PCAF in animal models [8, 9]. The resulting depletion of CBP from the nucleus induced a loss in its activity and a decrease in CBP-activated gene expression [9, 82, 83]. Interestingly, the soluble form of mutant Htt also promoted the degradation of CBP [84]. In addition, CBP sequestration into ubiquitin-positive nuclear inclusions and decreased CBP-mediated activation of gene expression [e.g., *brain-derived neurotrophic factor (Bdnf)*] were shown in a newly generated mouse model displaying HD-like-2, consistent with observations in HD patient brains [85]. In *Drosophila* models, reduced PCAF levels were associated with enhanced neurodegeneration. The CBP/p300 family also exhibited a strong influence over HD pathology, while the MYST family members had less of an effect [86].

HAT disruption in HD has several downstream consequences that might play a role in the pathophysiology of the disease. For instance, CBP alterations could directly affect

Table 1 Histone acetyltransferases (HATs), their substrates, and potential links to neurological diseases. Summary of the different HATs for which a potential relationship to pathological conditions or mechanisms has been documented. The associated modifications of histone and non-histone

substrates induced through HAT impairments and potentially implicated in these diseases are also reported. The model (cellular, animal, or human) and the brain tissues in which modifications have been observed are indicated

HATs	Substrates	Models	Related pathologies or mechanisms	
CBP	Histone	H3, H4	<i>In vitro</i> , cellular and <i>Drosophila</i> lines	HD [8]
		H3	HdhQ7/Q111 mice (hipp)	HD [88]
		H3, H4	Cellular and C57BL/6J mice (striatum, substantia nigra)	PD [111]
		H3	SOD1 G86R mice (spinal cord)	ALS [76, 126]
		H3	EID1 transgenic mice (hipp)	AD [157]
		H2A, H2B >> H3, H4	<i>Chp</i> ^{+/+} ; cKO CBP mice (hipp)	LTM [199, 204]
		H2B >> H3, H4	Adenoviral CBP inhibition (hipp)	LTP and LTM [205]
		Non-Histone	p53	Cellular and R6/2 mice (striatum)
	UBF-1		Cellular	HD [92]
	Htt		Cellular, mice (cotex, striatum), <i>Caenorhabditis elegans</i> models, and human brain	HD [91]
	α -tubulin		Human brain	HD [94]
	p53		Cellular	Axon regeneration [137, 138]
	P300	Histone	H3	EID1 transgenic mice (hipp)
H3			EID1 transgenic mice (hipp)	AD [157]
Non-histone		p65	Cellular, transgenic mice (substantia nigra)	PD [112]
		p53	EID1 transgenic mice (hipp)	AD [157]
		Tau	Cellular and human brain	AD [162]
ELP3	Non-histone	α -tubulin	Cellular	ALS [128]
		Bruchpilot (ELKS)	<i>Drosophila</i> lines	ALS [132]
PCAF	Histone	H3, H4	<i>In vitro</i> , cellular, and <i>Drosophila</i> lines	HD [8]
		/	<i>Drosophila</i> lines	HD [86]

CBP=cyclic adenosine monophosphate response element-binding (CREB) binding protein; ELP3=elongation protein 3; PCAF=p300/CBP-associated factor; UBF-1=upstream binding factor-1; Htt=huntingtin; hipp=hippocampus; SOD1=superoxide dismutase 1, EID1=EP300-interacting inhibitor of differentiation 1; cKO=conditional knockout; HD=Huntington's disease; PD Parkinson's disease; ALS=amyotrophic lateral sclerosis; AD=Alzheimer's disease; LTM=long-term memory; LTP=long-term potentiation

striatal regulations, and thereby motor impairment, influencing the transcription dependent of its binding partner CREB, a key regulator of striatal vulnerability [87]. A decrease of histone H3ac, associated with decreased CBP/CREB-dependent gene expression, was observed in the hippocampus of the HdhQ7/Q111 transgenic mouse model, an event that might explain some cognitive deficits associated with HD [88]. A 30 % increase in *Hdac1* expression was also observed in the cortices and striata of HD R6/2 mice, but is unlikely to be a cause of a detectable decrease in global histone acetylation [89]. Alterations in the acetylation of CBP-target nonhistone proteins, such as p53 [9, 90, 91] or the upstream binding factor-1 [92] also play a role in the progression of the disease. The Htt protein is subjected to acetylation that targets mutant Htt to autophagosomes for degradation [91]. The turnover of mutant Htt is thus regulated through the balance between CBP and HDAC1, and the loss of CBP in HD might explain the accumulation of mutant Htt [91]. Moreover, the acetylation of tubulin (likely through cytoplasmic acetyltransferases)

regulates anterograde and retrograde axonal transport through signaling the anchoring of molecular motors, such as Kinesin-1 to microtubules [93]. As a decrease of acetylated-tubulin has been observed in postmortem brain samples [94], one could predict that a disruption of intracellular trafficking could occur in HD patients, as observed in HD mice neuronal culture and leading to the alteration to the alteration of vesicular BDNF transport [95].

At the level of bulk chromatin, a genome-wide deacetylation of H3 histone (H3K9K14ac) was observed in the striatum of the R6/2 mouse model, but no association with a specific HAT was observed [96]. However, the authors observed that an H3ac association at specific gene loci strongly correlated with expressed genes in both wild-type and transgenic striata, suggesting that these changes in histone H3ac, although genome-wide, were not sufficient to trigger the transcriptional dysfunctions associated with HD [96].

Several studies of HD using *in vitro* and *in vivo* models have confirmed CBP involvement in HD physiopathology;

thus, the use of a molecule to activate HAT function would be of prime interest. The partial rescue of neuronal loss was described after CBP overexpression, whereas the genetic depletion of CBP worsened the phenotype of HD mice [83, 97, 98]. However, the overexpression of PCAF was not sufficient to ameliorate the HD phenotype in transgenic flies, suggesting that therapeutic strategies aimed at increasing PCAF protein levels are likely ineffective in ameliorating HD pathology; notably, increasing the HAT activity of PCAF has not been tested, and other trials targeting PCAF activity are needed [86]. Increasing the acetylation of histones and non-histone proteins via the use of HDAC inhibitors also counteracts neurodegeneration [8, 88, 99–101]. Intriguingly, McFarlan et al. [96] also demonstrated that HDAC inhibition re-established altered transcriptional levels in the striatum of the R6/2 mouse model, but only slightly improved H3ac binding to specific promoter, emphasizing the idea that the overall chromatin environment surrounding a gene would be more adapted to therapeutic targeting than simply increasing the acetylation of the histones.

PD

PD is a late-onset neurodegenerative disorder characterized by progressive motor dysfunctions (loss of muscle rigidity, tremor, and bradykinesia), the selective loss of nigrostriatal dopaminergic neurons and the presence of intraneuronal protein inclusions, called Lewy bodies (LBs), in the patient's brain. PD has been associated with both environmental and genetic factors, with most of the cases (90 %) being sporadic. However, gene mutations or variations in the number of transcript copies lead to the appearance of hereditary PD forms. These genes include *PARK2* (implicated in the targeting to proteasomal complex), *PINK1* (involved in mitochondrial response to stress), and *α-synuclein* (which forms, when misfolded, the large intracellular aggregates termed LBs) [102, 103].

Several leads for PD pathophysiology have recently emerged. First, according to the range of mutated genes described in this disorder, defective proteasomal machinery or mitochondrial dysfunctions could intervene in the pathological mechanism. More recently, the involvement of deficient epigenetic regulations has also been described, despite the fact that no particular HAT has been implicated in PD. Indeed, in *Drosophila*, toxic nuclear aggregates of *α-synuclein* interact with histone H3 and promote its deacetylation, possibly through a histone-“masking” mechanism [104]. Consistent with this result, several studies targeting HDAC members through sodium butyrate or valproic acid have shown an increase in histone acetylation, associated with pro-survival and anti-inflammatory effects, and decreased neurotoxicity markers [105–110].

Surprisingly, other studies have associated increased HAT activity with PD. The exposure to Dieldrin, a neurotoxic pesticide associated with PD etiopathogenesis, was shown to

induce histone H3 and H4 hyperacetylation via the time-dependent CBP accumulation in dopaminergic neurons [111]. Alternatively, wild-type *α-synuclein* reduces p300 expression level and HAT activity. As a consequence, the reduced acetylation of the p65 subunit of NFκB was observed, eventually leading to a decrease in the transactivation of the pro-apoptotic gene *PKCδ*. Native *α-synuclein* exhibits a neuroprotective effect through the inhibition of p300 HAT activity [112]; however, the interaction between mutant *α-synuclein* and p300 remains elusive.

ALS

ALS is a fatal adult-onset neuromuscular disorder, affecting upper and lower motor neurons, and leading to progressive muscle wasting, paralysis, and, eventually, death [113]. Motor neuron degeneration is associated primarily with the pathological aggregation of ubiquitin, fused in sarcoma protein, and the transactive response DNA binding protein (TAR) DNA-binding protein of 43-kDa in the cytoplasm of motor neuron cell bodies [114, 115]. In addition, ALS has also been associated with an important impairment of energy metabolism [116]. Although most ALS cases occur sporadically, 10 % of all ALS cases are inherited, among which 10–20 % are caused by mutations in the gene encoding superoxide dismutase-1 (SOD1). These mutations confer an adverse pro-apoptotic activity to SOD1, which is associated with oxidative damage and mitochondrial function disturbance, leading to increased neuronal vulnerability. Most of the SOD1 mutant proteins are prone to aggregation, and cytoplasmic inclusions have been detected in human patients and model systems [113, 117]. Even if the premature death of motor neurons is determinant in the onset of this disorder, the molecular mechanism of neuronal degeneration are multi-factorial, and the cause of ALS pathogenicity remains a matter of debate [118, 119].

The study of a symptomatic ALS mice model (SOD1 G86R) identified the loss of CBP and decreased histone H3ac in the lumbar spinal cord cholinergic motor neurons [76]. A gene expression profile analysis performed on laser microdissected degenerating motor neurons from sporadic ALS patients revealed the down-regulation of the *cbp* gene [120]. A comparison of HDAC expression revealed a reduction of HDAC 11 mRNA and increased HDAC 2 levels in postmortem ALS brain and spinal cord specimens [121]. Mouse models bearing a *SOD1* mutation have been used to test therapeutic strategies with HDACi. Some studies have described an amelioration of motor performance and/or an increased survival of motor neurons in the G93A transgenic ALS mouse model, with phenylbutyrate [122] or valproate [123]. Sodium phenylbutyrate combined with an antioxidant [124] or riluzole [125] showed a beneficial effect. However, in the G86R mouse model, valproate restored histone acetylation in the spinal cord and CBP levels in motor neurons, but failed

to improve mice survival, as a major detrimental effect on the neuromuscular junction was observed [126].

Altered microtubule-dependent trafficking associated with the damaged transport of mitochondria was identified in ALS [127]. Microtubule trafficking is affected by the acetylation of α -tubulin through the HAT ELP3 [128], and allelic variants of ELP3 were associated with sporadic cases of ALS [129]. Recent evidence obtained from the SOD1 G93A mouse model showed that the deletion of HDAC6, a HDAC that deacetylates α -tubulin, did not affect disease onset, but significantly extended mice survival. This protective effect was associated with an increased level of α -tubulin acetylation that maintains motor axon integrity [130]. Recently, a controversial study showed that HDAC6 knockdown increased the formation of large aggresome-like inclusions of mutant SOD1. This phenotype was associated with an increase of α -tubulin acetylation and retrograde transport of mutated proteins. Mutant SOD1 oligomers and small aggregates sequester and inactivate HDAC6, favoring tubulin acetylation and leading to the formation of large pathologic inclusions [131]. Thus, if ELP3 represents a strong candidate to design new activator-based therapies, then much effort must be made to understand the precise outcomes of tubulin acetylation. Moreover, ELP3 has been recently described to acetylate Bruchpilot, a large cytoskeletal-like protein detected in the presynaptic active zones in *Drosophila*, thereby regulating synaptic vesicle capture and neurotransmitter release efficiency. ELP3 loss-of-function or decreased expression, as in ALS, could thus result in the alteration of active zones function and morphology [132].

The site-specific acetylation of p53 leads to selective response to various signals [133]. The abnormal regulation of p53 has been observed in ALS patients [134], and cellular and animal ALS models [135, 136]. Interestingly, p53 acetylation at K320 through p300/CBP and PCAF serves as a prosurvival signal, and promotes neurite outgrowth and neuronal maturation [137]. Activating HAT activity in ALS motor neurons might mediate p53 K320 acetylation and facilitate targeting toward pro-survival rather than pro-apoptotic functions. However, an increase of p53 acetylation on K382, a known substrate for p300/CBP and HDAC SIRT1, induced apoptotic functions [138]. Thus, the CBP loss [76, 126] and SIRT1 overexpression [139] observed in motor neurons might induce a neuroprotective effect.

Overall, it is difficult to predict the expected effect of acetylation modulators in complex neurodegenerative diseases that affect several non-neuronal cell types [119, 140]. In particular, the effect of HAT activation in the neuromuscular junction, which is tightly regulated through chromatin acetylation [141, 142], has not been documented; however, studies have shown the deleterious effect of valproate [126].

AD and Related Diseases

AD is an age-related neurodegenerative disorder characterized by a progressive loss of memory and a deterioration of cognitive functions [143]. From the histopathologic point of view, neurofibrillary tangles (aggregates of cytoskeletal hyperphosphorylated tau protein), extracellular amyloid plaques [formed by the pathologic proteolytic processing of amyloid β precursor protein (APP)], and massive neuronal death are observed in several brain regions (cortex, hippocampus, and amygdala) [144, 145]. One distinctive hallmark of AD is the progressive and irreversible loss of cholinergic neurons in the basal forebrain [146]. Most AD cases are late in onset and are likely influenced by both genetic and environmental factors. Familial (FAD) forms represent 0.1 % of AD cases and have an autosomal dominant transmission mode associated with mutations in three genes: the *APP* gene, and the *presenilins 1* and *2*. In addition, one genetic risk factor, the $\epsilon 4$ allele of apolipoprotein, has been firmly implicated in AD, but the identification of many new risk genes for late-onset disease are still being discovered [147].

Recent literature shows that epigenetic regulations could stand as a valuable therapeutic strategy for AD [148]. Particularly, several studies report acetylation dysregulations associated with pathological markers of this disease. We have previously shown that the activation of the APP-dependent signaling targeted CBP to a caspase-6 degradation in primary cortical neuron cultures [76]. Notably, caspase-6 activity was highlighted in neurofibrillary tangles of AD brain patients [149–151]. Thus, the caspase 6-dependent degradation of CBP in AD, leading to an acetyltransferase loss in diseased neurons, has been hypothesized, suggesting HAT activation as an interesting strategy in AD. In addition, the genes encoding presenilins PS1 and PS2 have also been associated with CBP dysfunctions in specific cortical regions; the deletion of these two genes leads to a reduction of CBP protein and mRNA levels in both the cytoplasm and nucleus of cortical cells, whereas the total and phosphorylated forms of CREB remain unchanged. As a consequence, the genes regulated through the CREB/CBP complex are partially repressed [152]. This study suggests a positive regulation of CBP expression through presenilins. Interestingly, these conditional PS1^{-/-}/PS2^{-/-} mutants presented a decreased long-term potentiation (LTP), associated with long-term memory (LTM) deficits and hyperphosphorylated tau [152]. Thus, the effect of PS absence clearly alters the CBP-dependent pathway, and the effect of FAD-associated PS mutations remains unknown. Two studies conducted in cellular systems further reported that the overexpression of wild-type PS1 stimulated the transcriptional activity ability of CBP and of p300, while FAD-associated PS1 mutations did not produce this effect [153, 154]. However, Marambaud et al. [155] described a molecular pathway linking FAD-associated PS1 mutations with increased CBP function in cellular models. Briefly, the authors proposed that

FAD mutations inhibit the production of an intracellular peptide N-Cad/CTF2 originally cleaved through wild-type PS1, thereby preventing CBP degradation and resulting in up-regulated CREB-mediated transcription. Importantly, whether this mechanism exists *in vivo* remains unknown.

A convincing experiment reporting the beneficial effect of CBP overexpression in an AD pathological model was recently published, showing that the *in vivo* hippocampal administration of viral particles carrying CBP restored the learning and memory deficits of AD triple transgenic mice [156]. Thus, by directly modulating CBP levels, the authors re-established CREB activity and BDNF expression in the hippocampus. Therefore, increasing CBP activity might be an interesting therapeutic tool in this case. In addition, an endogenous inhibitor of p300/CBP (EP300-interacting inhibitor of differentiation 1 or EID1) was shown to translocate from the cytoplasm to the nucleus in the hippocampus of the brain of an AD patient [157]. Interestingly, the authors showed that the neuron-specific expression of human EID1 gene in a mouse model reduced hippocampal LTP and impaired spatial memory. This phenotype was associated with the hypo-acetylation of histone H3 and p53 [157]. This study also confirmed an association between CBP activity deregulation and human pathology.

The acetylation modulation could also affect the pathological marks of AD. A recent study has shown an interesting action of PCAF in an AD non-transgenic mice model, as intracerebroventricular injections of A β peptides failed to induce toxicity in PCAF KO mice; indeed, these peptides that had a deleterious effect in wild-type mice and did not worsen PCAF KO mice memory deficits [158]. Consistent with these observations, neprilysin, a peptidase promoting A β degradation, presented increased expression in PCAF KO, rendering these mice insensitive to amyloid toxicity [158]. Moreover, restoring brain levels of CBP, while improving memory function, did not modify A β levels, plaques, or Tau immunoreactivity in a model exhibiting both amyloid plaques and neurofibrillary tangles [156]. Restoring memory functions with the HDAC inhibitor 4-phenylbutyrate increased dendritic spine density in CA1 and the clearance of intraneuronal A β accumulation [159, 160], even when a similar treatment did not affect A β levels and plaques [161]. Further, HDAC inhibition promotes decreased tau phosphorylation through, at least, down-regulating GSK3 β activity [161]. Nonetheless, the inhibition of p300 and likely CBP has been associated with decreased Tau acetylation and the elimination of hyperphosphorylated Tau species [162]. In addition, an aggregation of acetylated-tau was found in pathological brains of AD patients and, hence, was suggested to be a new AD pathological hallmark [163]. These investigators further demonstrated in cellular systems that tau itself had a MYST-like acetyltransferase activity that could account for its self-acetylation [164]. Therefore, activating these HATs could result in increased Tau deposits. Thus, it

is essential to determine whether the effects of HAT activation affect the mechanisms underlying AD pathology development.

Few studies have examined the role of acetylation in memory disorders other than AD, and no studies have shown a role for HAT in these diseases. One exception is frontotemporal dementia, a neurologic disease involving behavioral and language problems, leading to memory deficits. Some familial cases reflect progranulin haploinsufficiency [165]. A recent study showed that the HDAC inhibitor suberoylanilide hydroxamic acid (SAHA) increased progranulin mRNA and protein expression in haploinsufficiency progranulin human cells [166], suggesting that increasing acetylation should be beneficial. Notably, increased HDAC6 levels have been reported in the temporal cortex of patients with frontotemporal lobar degeneration with TAR DNA-binding protein of 43-kDa inclusions [167], suggesting that hypoacetylation could be involved in the pathophysiology. HDAC6 concentration had also been shown in LBs in PD and dementia with LBs [168]. However, LBs might represent a cytoprotective response to sequester toxic proteins [169]; thus, the effect of HDAC6 accumulation in α -synuclein aggregates remains unknown. Overall, these studies suggest an important role for nuclear and cytoplasmic acetylation regulation in these diseases.

HAT in Synaptic Plasticity and Memory

During the last decade, several studies described the involvement of epigenetic regulations in cognitive functions. These mechanisms facilitate the adaptation of neuronal gene expression patterns according to experience, broadening the functions of neuronal networks. Indeed, transcriptional regulations are required in LTM formation *in vivo* [170, 171], as in *ex vivo* models of synaptic plasticity (LTP) [172, 173], and are highly dependent of CREB and NF κ B activities [174, 175]. Among these regulations, histone acetylation plays an important and well-characterized role, whereby both HATs and HDACs are key regulators of cognitive processes. Moreover, emerging evidence has also implicated non-histone protein acetylation in cognitive functions. Although we present seminal studies supporting the involvement of acetylation mechanisms in memory and plasticity, we will focus on newly published findings, as extensive and complete literature is available on this topic [11, 176–178].

Histone Acetylation in Synaptic Plasticity and Memory

The induction of H3 acetylation has been previously reported in hippocampal CA1 formation at 1 h after contextual fear conditioning (CxFC; a commonly used task for hippocampus-dependent associative learning) [179]. This rise in histone acetylation was associated with an activation of both N-methyl-D-aspartate receptors and the extracellular signal-

regulated kinase (ERK) signaling pathway, which are upstream factors for the stabilization and the formation of LTM. In 2010, Peleg et al. [15] revealed that CxFC causes an increase of several histones residues (H3K9K14, H4K5K8K12), as observed 1 h after exposure to the trial, in 3-month-old wild-type mice. Genome-wide analyses revealed that H4K12 acetylation was associated with transcriptional modifications after learning, and the differential expression of 2,229 genes was identified through chromatin immunoprecipitation sequencing. The expression of the *formin 2* gene (an actin nucleator, important for synaptic plasticity and memory) was increased in a H4K12 acetylation-dependent manner [15]. The same year, we [180] also demonstrated that hippocampal-dependent spatial memory consolidation in the Morris Water Maze (MWM) increased H3K9K14 and H4K12 histone residues in the H2B N-terminus region. Interestingly, these hyperacetylations were associated with the increased expression and activity of several HATs, among which the proximal promoter of CBP was enriched in the acetylated forms of histones. The up-regulation of several memory-related genes (*cFos* and *Bdnf-IV*) was also identified in association with increased CBP activity [180]. In addition, the BDNF neurotrophin plays an important role in synaptic plasticity and behavioral adaptations. Interestingly, H3K9K14 acetylation was increased after BDNF treatment, another HDAC activity-dependent mechanism [181]. Indeed, the use of trichostatin A (TSA) and SAHA on hippocampal slices treated with BDNF abolished the histone acetylation induction and BDNF-positive effect on dendritic spines. A recent study from our laboratory further assessed acetylation responses during early stages of spatial and fear memory learning before trace consolidation. In both cases, H2B N-terminal (K5K12K15K20), H3K9K14, and H4K12 acetylation was increased in the learning paradigm, whereas H3K9K14 acetylation was already activated in response to the experimental context (swimming, exploration...) [182]. Thus, it is likely that specific acetylation marks on H2B and H4 histones play a role during memory formation, while the acetylation of H3K9K14 could be more easily modified in response to the environment (i.e., processing of the context). It is suggested that the rapid acetylation of the chromatin at H3K9K14 occurs within 1 h of the processing of the context whether a memory is formed or not, which could relax the chromatin to facilitate gene promoter access or tag chromatin for further acetylation on H2B- and H4-specific marks. Notably, chromatin structure modifications, such as the acetylation of H3 and H4 at specific residues, also occur in response to an enrichment of the environment [14]. Thus, increasing HAT activity could thus be an interesting tool to restore hippocampus-dependent memory formation.

Several studies, inhibiting or activating HDACs, have also shown their implications in memory processes. Thus, HDAC2 overexpression has been associated with an impairment of

hippocampus-dependent memory formation (cued, and CxFC and MWM) and working memory in mice, while HDAC2 KO presented enhanced memory formation. HDAC1 overexpression had no effect on these tasks [183]. Transgenic mice with focal homozygous deletions in *Hdac3* in the CA1 region of the dorsal hippocampus demonstrated enhanced LTM for object location together with increased H4K8 acetylation and the transcription of both *Nr4a2* and *c-fos* [184]. More recently, HDAC1 activity has been associated with fear memory extinction for the inhibition of excess fear. The overexpression of HDAC1 in the adult mouse hippocampus increased this specific form of learning [185]. Furthermore, the loss of HDAC4 (in 2-month-old mice) and HDAC5 (in 10- but not 2-month-old mice) impaired memory functions, with an alteration in the CxFC and the MWM tasks in both cases [186, 187].

Changes in histone acetylation have also been observed in other brain regions, such as the lateral amygdala. In rats, an amygdala-dependent auditory fear conditioning training stimulates H3 acetylation in an ERK signaling-dependent manner. Consistent with this result, the treatment of amygdala slices with TSA causes an enhancement of LTP [188]. Cued fear conditioning was also impaired after HDAC5 knockdown (in 10-month-old mice) or HDAC2 overexpression (in 4-month-old mice) [183, 186], confirming a link between histone acetylation and amygdala proper functioning.

Non-histone Protein Acetylation in Synaptic Plasticity and Memory

In addition to histones, the acetylation of non-histone proteins has also been associated with the processes of synaptic plasticity and memory formation. In 2007, Zhang and collaborators identified an F-actin binding protein, cortactin, as a new target for acetylation. Cortactin acetylation is regulated through different factors (PCAF, p300, HDAC6, and SIRT1), leading to the reduction of cortactin binding to F-actin and cell mobility [189, 190]. Recently, Cortactin acetylation was also shown to affect dendritic spine morphogenesis, promoting the dendritic clustering of PSD95 and Shank1, two post-synaptic proteins, in excitatory hippocampal synapses. Cortactin acetylation can be promoted through BDNF and glutamate stimulation [191].

Nuclear factor kappa B (NF κ B) is another non-histone substrate for acetylation; its function in synaptic plasticity and several types of LTM has previously been established and reviewed elsewhere [192, 193]. Interestingly, in cultured cells, it was shown that CBP and p300 acetylate the NF κ B p65 subunit in a stimulus-dependent manner, which, subsequently, could be deacetylated through HDAC3. p65 acetylation regulates NF κ B nuclear function, and acetylation increases its DNA binding affinity (K221) and transcriptional activity (K301) [194]. In contrast, I κ B α binds and sequesters the deacetylated form, switching NF κ B function off [195].

Consistent with these *in cellulo* studies, visual fear conditioning induces NF κ B activity in the rat amygdala through increased CBP activity and p65-CBP interactions, associated with an enhancement of p65 acetylation and DNA binding [196]. More recently, a function for NF κ B acetylation has been described in depression. Treatment of the depressed Flinders Sensitive Line rats with L-acetylcarnitine (LAC; an endogenous acetylating agent) had a rapid (3 days) and long-lasting (2 weeks after drug withdrawal) antidepressant action. LAC rescued mGlu2 receptor mRNA and protein expression in the hippocampus of these rats via increased p65 K310 acetylation and the downstream activation of NF κ B. Moreover, LAC re-establishes H3 K27 acetylation of both *grm2* (encoding the mGlu2 protein) and *bdnf* promoters, particularly in the depressed rats' prefrontal cortex [197]. Notably, epigenetic modifications are consistently implicated in the physiopathology of major depressive diseases and psychiatric-related disorders, such as addiction, schizophrenia, or vulnerability to stress, as reviewed in [11]. The use of an HAT activator could thus represent an interesting therapeutic option in such disorders, particularly in depressive and schizophrenic behaviors, where an impairment of acetylation was reported.

Transgenic HAT Animal Models

The involvement of lysine acetylation in memory and synaptic plasticity has led to the generation of several transgenic models to study the functions and consequences of the loss of HATs in these processes.

To gain insights into the functions of CBPs, several mouse strains were generated, including hemizygous, conditional KO, transgenic and region-specific (viral induction)-depleted mice. These models are reviewed in [198], and have been analyzed at the molecular level in different learning and memory tasks. Studies examining the effect of a partial or total loss of CBP function show the involvement of its HAT activity in LTP and LTM, and suggest that CBP is not required for the formation of short-term memory (STM) [47, 199–202]. Nevertheless, another study using a conditional model with complete CBP inactivation in excitatory neurons of the forebrain showed an impairment of both memory types [203]. However, more recent studies confirm CBP involvement in LTM. The use of a conditional KO CBP model in forebrain neurons identified an alteration of LTM in an object recognition task, whereas the performances of CBP in the MWM or in a CxFC task were not altered [204]. However, CBP loss in the dorsal CA1 hippocampus, through adenovirus injections, induced alterations of histones H2B, H3, and H4 acetylations, and a loss of CBP-dependent transcriptional programs [205]. These mice exhibited deficits in LTP and in the formation of LTM during object recognition and CxFC tasks, confirming that CBP-dependent chromatin modifications are involved in

the consolidation of certain forms of memory. Thus, CBP HAT function is clearly involved in the normal adult CNS functioning, particularly in synaptic plasticity mechanisms associated with learning and memory.

p300 conditional transgenic mice, expressing an inhibitory truncated form of p300, have LTM deficits in object recognition and CxFC tasks. These mice lack activation domains and the p300 C-terminal domain containing the HAT function, causing an overall decrease in acetylation of H3K9K14 residues in the forebrain [206]. Moreover, p300 conditional ablation in specific forebrain subregions, during the postnatal period, leads to long-term recognition and contextual fear memory deficits [207].

PCAF KO mice exhibit STM impairments at 2 months of age, while no LTM deficits were detected [208]. These alterations are associated with a strong response to stress (corticosterone increase). At 6 months, these mice show altered LTM, as shown with the MWM task, and this phenotype remains, even after 12 months. This transgenic model is characterized by a complete PCAF inactivation, resulting in the altered expression or activation of different factors involved in STM processes (cFos and ERK1).

Potential use of HAT Activator as a Therapeutic Option

The impairment (e.g., deregulation, degradation, sequestration, etc.) of HAT(s) has been described in several neurodegenerative diseases ('HAT Impairment in Neurodegenerative Disorders' section) and neurodevelopmental disorders. Thus, the specific activation of HAT activity could be useful in pathological situations where a decrease in the levels of these enzymes has been described. One example is the case of the Rubinstein–Taybi syndrome that presents a haploinsufficiency in CBP and, in some cases, p300 [45, 209–211]. A therapeutic strategy based on CBP/p300 reactivation could be useful, even in the adult, for re-establishing at least some cognitive functions [198, 212], particularly for ALS, in which motor neurons present lower quantities of CBP owing to degradation [76]. In addition, HDACi are poorly efficient in this context, as these molecules were deleterious for the neuromuscular junction, despite a significant improvement of motor neuron survival [126]. A HAT activator could also be relevant for its use in AD and related diseases, as this molecule could improve both neuronal survival, neurogenesis, and memory-related alterations (see below). However, the efficacy of HAT activators in pathological animal models remains undocumented.

HAT Activation vs HDAC Inhibition as a Therapeutic Strategy

How HDACi efficiently affects pathological mechanisms is not well understood [5]. Notably, amongst the 14 HDAC

isoforms described so far, class I HDAC2 and HDAC3 (but not HDAC1) have been associated with the promoters of genes implicated in synaptic plasticity [183, 213], potentially explaining some of the HDACi beneficial effects on memory formation. HDAC2 was further increased in AD postmortem brains [214]. Interestingly, at least one wild-type allele of *cbp* was required to mediate the effects of HDAC inhibition on memory functions [215]. A supportive study demonstrated that HDACi were inefficient in a complete knock down of *cbp* [203]. Thus, simply inducing a histone hyperacetylated state with HDACi does not adequately replace HAT activation, at least in certain functions (i.e., memory formation), likely reflecting the other potential roles of HAT (e.g., CBP). The indirect (HDAC inhibitor-mediated) activation of p300/CBP HAT auto-acetylation, which stimulates HAT activity [36, 216], could also contribute to the beneficial effects of HDACi. Thus, it seems essential to envisage direct stimulation of the HAT function, as a new therapeutic tool in neurodegenerative diseases; by directly targeting the remaining HAT(s), one could re-activate the deficient enzymatic function, as well as all the other related functions that are not typically considered using an HDACi strategy. HATs are recruited at promoter loci through, in part, lysine acetylation recognition of conserved bromodomains [20]; together with the proper bound coactivator complexes, HATs acetylate nucleosomes at specific promoter sites (see 4, 5/ in Fig. 3). Following an HDACi treatment, the global levels of acetylation are indeed

increased, but this activation will not necessarily occur at specific defective HAT-targeted sites.

In addition, Hazzalin and Mahadevan [217] showed that the turnover of histone acetylation is important to produce gene induction, as observed for the *fos* and *jun* genes. Indeed, HDACi rapidly enhanced histone acetylation at these genes, but inhibited their transcription; these results are in contrast to the predominant view that increased histone acetylation is characteristic of enhanced transcription [217]. Thus, on certain genes, HDACi directly inhibits gene induction, reminiscent of the low percentage of genes that are actually activated after HDACi treatment [218]. This result also suggests that both HAT and HDAC complexes have to be present and active to the specific acetylation mark to activate transcription, suggesting that a strategy aimed at activating the HAT function might be more efficient than inhibiting the HDAC to re-establish proper transcription in a given pathological context (see 6/ in Fig. 3).

Last, the effects of HDAC inhibition and HAT activation on nonhistone proteins (e.g., p53, NFκB, cortactin, tubulin, etc.), i.e., those not directly associated with transcription, should be further documented in pathological conditions.

In vivo Effect of HAT Activators on Brain Functions

Only a few HAT activators have been produced, and most of these molecules are cell impermeant [69, 70]. So far, only two

Fig. 3 Histone acetyltransferase (HAT) activation as a therapeutic strategy. Illustration of the beneficial effects of the use of a HAT activator at the cellular level (see "HAT Activation vs HDAC Inhibition as a Therapeutic Strategy"). The activation of the HAT preserves the "acetylation code" of nuclear and cytoplasmic proteins (1–3), along with a proper positioning at gene loci (4) and recruitment of coactivators (5). Importantly, this strategy will preserve the histone deacetylase (HDAC) activity surrounding gene loci (6), otherwise impaired when following an HDAC inhibition strategy. Therefore, as both HAT and HDAC activities are present, a correct acetylation turn-over is possible, allowing transcriptional proceedings, see [217]. Ac=Acetyl; NFκB=nuclear factor kappa B; UBF-1=upstream binding factor-1; CoAct=coactivator; CoRep=co-repressor; TF=transcription factor; RNApolII=RNA polymerase II

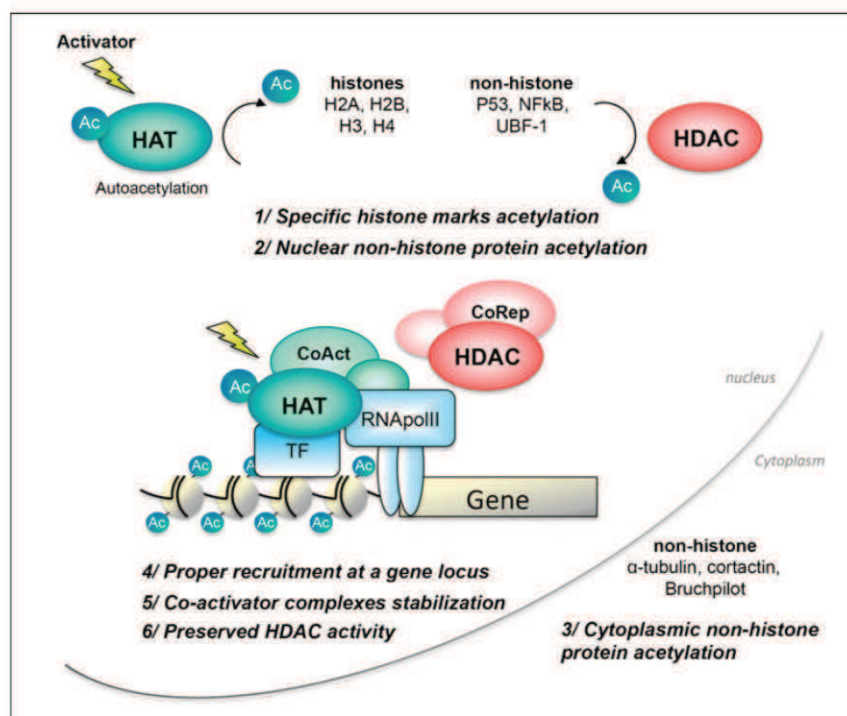

HAT activator molecules, a PCAF activator, SPV106 [219], and a CBP/P300 activator, CSP-TTK21 [72], have been shown to cross the BBB, consistent with the use of these compounds to study brain functions *in vivo*. Both of these compounds were active after systemic administration in adult mice (Fig. 4).

Wei et al. [219] used SPV106 to demonstrate a role for PCAF in fear extinction. Fear conditioning and extinction are two distinct forms of learning that engage different molecular pathways. Fear extinction involves the gradual reduction in the fear response through the repeated presentation of a non-reinforced conditioned stimulus, which generates a new memory that competes with the original fear memory trace. As hippocampal acetylation or HATs such as CBP/P300 are essential to form contextual fear, fear extinction also involves epigenetic mechanisms [185, 220–222]. Notably, as discussed

above, HDAC1 regulates extinction learning via a mechanism involving H3K9 deacetylation and the subsequent trimethylation of target genes [185]. Interestingly, HDAC1 was up-regulated in postmortem brain samples from schizophrenic patients [223, 224]. Using a pharmacological approach with the PCAF activator SPV106 and the PCAF inhibitor (H3-CoA-20-Tat), these authors demonstrated that PCAF activity facilitated the formation of fear extinction memory, but was not essential for fear acquisition [219]. These results suggest that PCAF regulation is an attractive target for the treatment of fear-related anxiety disorders.

Based on the small molecule HAT activator CTPB [69], we have synthesized several derivatives, from which TTK21 [N-(4-chloro-3-trifluoromethyl-phenyl)-2-n-propoxy-benzamide] was selected using a low-throughput enzyme assay, as this molecule efficiently activated the HAT activity of the CBP and

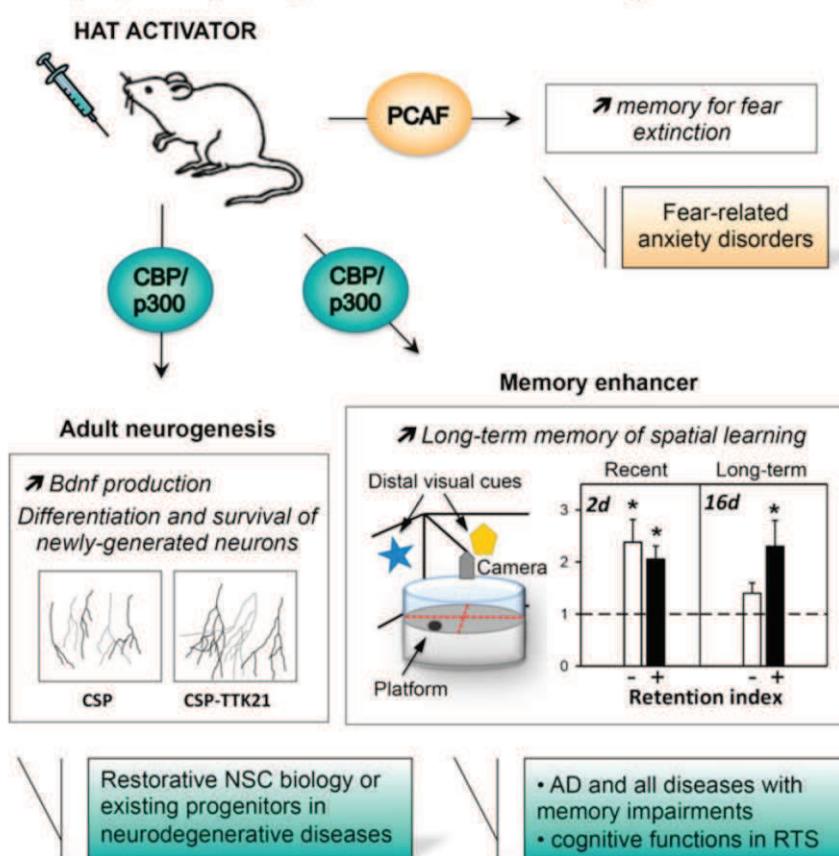

Fig. 4 Effects of histone acetyltransferase (HAT) activator molecules on brain functions and their potential therapeutic use in diseases. In rodent models, the described effects of different HAT activators [SPV106 for p300/cyclic adenosine monophosphate response element-binding (CREB)-associated factor (PCAF) [219] or carbon nanosphere (CSP)-TTK21 for CREB-binding protein (CBP)/p300 [72] are depicted]. The drawings represent the effect of CSP-TTK21 on newly generated (doublecortin-positive) neurons with increased dendritic branching measured in the hippocampus of adult mice 3 days after CSP-TTK21 injection. For spatial

memory, CSP (-) or CSP-TTK21 (+)-injected mice were tested in the Morris water maze and retention was evaluated 2 days (recent, 2d) or 16 days (long-term, 16d) after a weak protocol of acquisition. The retention index indicates significant retention of the platform location in the CSP-TTK21 injected group at long delays without effect on recent memory (* $p < 0.05$). For further details see [72]. The potential applications in diseases are summarized in the boxes (see text). NSC=neural stem cells; AD=Alzheimer's disease; RTS=Rubinstein Taybi syndrome

p300 HATs [72]. However, similar to the parent compound CTPB, TTK21 was poorly permeable to living cells, but when conjugated to a glucose-derived CSP, CSP-TTK21 was able to cross membranes and induce histone acetylation. Moreover, after systemic injection, we detected acetylated histones in the frontal cortex and dorsal hippocampus of adult C57BL/6J mice, showing that the new CSP-TTK21 compound passes the BBB and reaches different parts of the brain. The effect of this HAT activator was also tested on 2 important hippocampal functions: adult neurogenesis and spatial memory formation. Remarkably, CSP-TTK21 treatment promoted the formation of long and highly-branched doublecortin-positive neurons in the subgranular zone of the dentate gyrus, suggesting that CBP/p300 activation favors the maturation and differentiation of adult neuronal progenitors. At the molecular level, we observed that CSP-TTK21 induced mRNA levels of the neuroD1 differentiation marker and BDNF, a neurotrophin required for the terminal differentiation of newly generated neurons. The concomitant enrichment of acetylated-histone was measured on the proximal promoter of these two genes. Finally, we observed that CBP/p300 activation during spatial training, while not improving the retention of recent memory (2 days), resulted in a significant extension of memory duration over 16 days. Thus, by inducing adult neurogenesis and LTM formation, our data show that the direct stimulation of CBP/p300 HAT function could have important effects in terms of therapeutic options for brain diseases (Fig. 4).

Concluding Remarks

Taken together, the results obtained *in vivo* show that new HAT activator molecules represent an important scientific advance and provide new therapeutic options for brain diseases. Indeed, molecules that favor and promote the *in vivo* maturation and differentiation of newly generated neurons in the adult present an obvious advantage in several neurodegenerative diseases. For instance, the transplantation of neural stem cells (NSC) rescued dysfunctional neurons in 2 studies associated with PD [225] and spinal cord injury [226]. Beneficial results were also observed in a mutant SOD mouse model of ALS [227]. Thus, the transplantation of undifferentiated NSCs achieves functional effects in animal models of neurologic disorders [228, 229], and it is likely that restorative NSC biology could be assisted by HAT activator molecules, thereby promoting neurotrophin production and the maturation of progenitors on site ([72]; Figs. 2 and 4). Notably, impaired neurogenesis, and specifically the survival and differentiation of neuronal progenitors, have been reported in mouse models of AD [230, 231]. Thus, the activation of differentiation programs (*neuroD1*, *bdnf*) in pathological brains might be a promising strategy in AD.

Moreover, the positive effect of environmental enrichment (EE) is associated with increased histone-tail acetylation in

young rodents [14, 232, 233]. EE promotes various plasticity mechanisms in the hippocampus, including *bdnf* gene up-regulation, enhanced dendritic branching, and the stimulation of adult neurogenesis [234–237], reminiscent of our observations that CSP-TTK21 activates CBP/p300 activity. Furthermore, CBP-deficient mice present no response to the beneficial effect of EE on the induction and enhancement of spatial navigation capabilities during neurogenesis, highlighting the contribution of CBP to EE effects [233]. However, EE efficiently restored brain functions in animal models of neurodegenerative diseases [14, 238]. Together, these data suggest that therapeutic approaches with HAT activator molecules could present regulations similar to those induced through EE. This approach might combat pathological signaling or improve successful aging, as the aging brain retains considerable functional plasticity.

Thus, HAT activator molecules provide a promising and exciting area of research, but improvement of drug design, specificity, and targeting to the brain is still required. Notably, HAT activator molecules need further testing in animal models of neurologic pathologies.

Acknowledgments This work was supported by funding from the Centre National de la Recherche Scientifique (CNRS), the University of Strasbourg, the Department of Biotechnology, the Government of India (Grant/ DBT/ CSH/ GIA/ 1752 to TKK), the Jawaharlal Nehru Centre for Advanced Scientific Research (JNCASR), Agence Nationale de la Recherche (ANR-12-MALZ-0002-01 to ALB), the Indo-French Centre for the Promotion of Advanced Research (IFCPAR/CEFIPRA No.4803-3 to T.K. Kundu and A.L. Boutillier), and Alsace Alzheimer 67 association (to A.L. Boutillier and F. Blanc). T.K. Kundu is a recipient of the Sir JC Bose national fellowship from the Department of Science and Technology through the government of India. Raphaëlle Cassel received a doctoral fellowship from the French government. A. Schneider was supported through the Agence Nationale pour la Recherche (ANR-12-MALZ-0002). Frédéric Blanc reports receiving personal fees from Eisai, Piramal, Biogen Novartis, Janssen, Lundbeck, Pfizer, and Biogen, and non-financial support from Novartis, Lundbeck, Bayer Schering, Merck Serono, TEVA Neurosciences, and Pfizer, outside of the submitted work. Amrutha Swaminathan reports receiving grants from the Council for Scientific and Industrial Research, outside of the submitted work. Anne L. Boutillier, S. Chatterjee, and T.K. Kundu have a patent HAT Activator CSP-TTK21 pending. Olivier Bousiges, R. Cassel, A. Schneider, and B.R. Selvi. have nothing to disclose.

Required Author Forms Disclosure forms provided by the authors are available with the online version of this article.

Disclosures None.

References

- Izzo A, Schneider R. Chatting histone modifications in mammals. *Brief Funct Genomics* 2010;9:429–443.
- Lee JS, Smith E, Shilatifard A. The language of histone crosstalk. *Cell* 2010;142:682–685.
- Allis CD, Berger SL, Cote J, et al. New nomenclature for chromatin-modifying enzymes. *Cell* 2007;131:633–636.

4. McBrian MA, Behbahan IS, Ferrari R, et al. Histone acetylation regulates intracellular pH. *Mol Cell* 2013;49:310–321.
5. Abel T, Zukin RS. Epigenetic targets of HDAC inhibition in neurodegenerative and psychiatric disorders. *Curr Opin Pharmacol* 2008;8:57–64.
6. Chuang DM, Leng Y, Marinova Z, Kim HJ, Chiu CT. Multiple roles of HDAC inhibition in neurodegenerative conditions. *Trends Neurosci* 2009;32:591–601.
7. Selvi BR, Cassel JC, Kundu TK, Boutillier AL. Tuning acetylation levels with HAT activators: therapeutic strategy in neurodegenerative diseases. *Biochim Biophys Acta* 2010;1799:840–853.
8. Steffan JS, Bodai L, Pallos J, et al. Histone deacetylase inhibitors arrest polyglutamine-dependent neurodegeneration in *Drosophila*. *Nature* 2001;413:739–743.
9. Steffan JS, Kazantsev A, Spasic-Boskovic O, et al. The Huntington's disease protein interacts with p53 and CREB-binding protein and represses transcription. *Proc Natl Acad Sci U S A* 2000;97:6763–6768.
10. Minamiyama M, Katsuno M, Adachi H, et al. Sodium butyrate ameliorates phenotypic expression in a transgenic mouse model of spinal and bulbar muscular atrophy. *Hum Mol Genet* 2004;13:1183–1192.
11. Graff J, Kim D, Dobbin MM, Tsai LH. Epigenetic regulation of gene expression in physiological and pathological brain processes. *Physiol Rev* 2011;91:603–649.
12. Sleiman SF, Basso M, Mahishi L, et al. Putting the 'HAT' back on survival signalling: the promises and challenges of HDAC inhibition in the treatment of neurological conditions. *Expert Opin Investig Drugs* 2009;18:573–584.
13. Dash PK, Orsi SA, Moore AN. Histone deacetylase inhibition combined with behavioral therapy enhances learning and memory following traumatic brain injury. *Neuroscience* 2009;163:1–8.
14. Fischer A, Sananbenesi F, Wang X, Dobbin M, Tsai LH. Recovery of learning and memory is associated with chromatin remodelling. *Nature* 2007;447:178–182.
15. Peleg S, Sananbenesi F, Zovoilis A, et al. Altered histone acetylation is associated with age-dependent memory impairment in mice. *Science* 2010;328:753–756.
16. Marks PA, Breslow R. Dimethyl sulfoxide to vorinostat: development of this histone deacetylase inhibitor as an anticancer drug. *Nat Biotechnol* 2007;25:84–90.
17. Choudhary C, Kumar C, Gnad F, et al. Lysine acetylation targets protein complexes and co-regulates major cellular functions. *Science* 2009;325:834–840.
18. Zhao S, Xu W, Jiang W, et al. Regulation of cellular metabolism by protein lysine acetylation. *Science* 2010;327:1000–1004.
19. Lundby A, Lage K, Weinert BT, et al. Proteomic analysis of lysine acetylation sites in rat tissues reveals organ specificity and subcellular patterns. *Cell Rep* 2012;2:419–431.
20. Zeng L, Zhou MM. Bromodomain: an acetyl-lysine binding domain. *FEBS Lett* 2002;513:124–128.
21. You L, Nie J, Sun WJ, Zheng ZQ, Yang XJ. Lysine acetylation: enzymes, bromodomains and links to different diseases. *Essays Biochem* 2012;52:1–12.
22. Livengood JA, Scoggin KE, Van Orden K, et al. p53 transcriptional activity is mediated through the SRC1-interacting domain of CBP/p300. *J Biol Chem* 2002;277:9054–9061.
23. Sanjuan R, Marin I. Tracing the origin of the compensasome: evolutionary history of DEAH helicase and MYST acetyltransferase gene families. *Mol Biol Evol* 2001;18:330–343.
24. Steiner DE, Berger SL. Acetylation of histones and transcription-related factors. *Microbiol Mol Biol Rev* 2000;64:435–459.
25. Lassar AB, Martin PL, Roeder RG. Transcription of class III genes: formation of preinitiation complexes. *Science* 1983;222:740–748.
26. Kundu TK, Wang Z, Roeder RG. Human TFIIC relieves chromatin-mediated repression of RNA polymerase III transcription and contains an intrinsic histone acetyltransferase activity. *Mol Cell Biol* 1999;19:1605–1615.
27. Sadoul K, Wang J, Diagouraga B, Khochbin S. The tale of protein lysine acetylation in the cytoplasm. *J Biomed Biotechnol* 2011;2011:970382.
28. Kornberg RD, Lorch Y. Chromatin-modifying and -remodeling complexes. *Curr Opin Genet Develop* 1999;9:148–151.
29. Struhl K. Histone acetylation and transcriptional regulatory mechanisms. *Genes Develop* 1998;12:599–606.
30. Clarke AS, Lowell JE, Jacobson SJ, Pillus L. Esa1p is an essential histone acetyltransferase required for cell cycle progression. *Mol Cell Biol* 1999;19:2515–2526.
31. Iizuka M, Stillman B. Histone acetyltransferase HBO1 interacts with the ORC1 subunit of the human initiator protein. *J Biol Chem* 1999;274:23027–23034.
32. Magnaghi-Jaulin L, Ait-Si-Ali S, Harel-Bellan A. Histone acetylation and the control of the cell cycle. *Prog Cell Cycle Res* 2000;4:41–47.
33. Smith ER, Eisen A, Gu W, et al. ESA1 is a histone acetyltransferase that is essential for growth in yeast. *Proc Natl Acad Sci U S A* 1998;95:3561–3565.
34. Chatterjee S, Senapati P, Kundu TK. Post-translational modifications of lysine in DNA-damage repair. *Essays Biochem* 2012;52:93–111.
35. Blanco JC, Minucci S, Lu J, et al. The histone acetylase PCAF is a nuclear receptor coactivator. *Genes Develop* 1998;12:1638–1651.
36. Thompson PR, Wang D, Wang L, et al. Regulation of the p300 HAT domain via a novel activation loop. *Nat Struct Mol Biol* 2004;11:308–315.
37. Black JC, Mosley A, Kitada T, Washburn M, Carey M. The SIRT2 deacetylase regulates autoacetylation of p300. *Mol Cell* 2008;32:449–455.
38. Gregoire S, Xiao L, Nie J, et al. Histone deacetylase 3 interacts with and deacetylates myocyte enhancer factor 2. *Mol Cell Biol* 2007;27:1280–1295.
39. Wang J, Chen J. SIRT1 regulates autoacetylation and histone acetyltransferase activity of TIP60. *J Biol Chem* 2010;285:11458–11464.
40. Bengtson CP, Bading H. Nuclear calcium signaling. *Adv Exp Med Biol* 2012;970:377–405.
41. Vo N, Goodman RH. CREB-binding protein and p300 in transcriptional regulation. *J Biol Chem* 2001;276:13505–13508.
42. Chevillard-Briet M, Trouche D, Vandel L. Control of CBP co-activating activity by arginine methylation. *EMBO J* 2002;21:5457–5466.
43. Daujat S, Bauer UM, Shah V, Turner B, Berger S, Kouzarides T. Crosstalk between CARM1 methylation and CBP acetylation on histone H3. *Curr Biol* 2002;12:2090–2097.
44. Soliman ML, Rosenberger TA. Acetate supplementation increases brain histone acetylation and inhibits histone deacetylase activity and expression. *Mol Cell Biochem* 2011;352:173–180.
45. Kalkhoven E, Roelfsema JH, Teunissen H, et al. Loss of CBP acetyltransferase activity by PHD finger mutations in Rubinstein-Taybi syndrome. *Hum Mol Genet* 2003;12:441–450.
46. Kung AL, Rebel VI, Bronson RT, et al. Gene dose-dependent control of hematopoiesis and hematologic tumor suppression by CBP. *Genes Develop* 2000;14:272–277.
47. Oike Y, Hata A, Mamiya T, et al. Truncated CBP protein leads to classical Rubinstein-Taybi syndrome phenotypes in mice: implications for a dominant-negative mechanism. *Hum Mol Genet* 1999;8:387–396.
48. Shikama N, Lutz W, Kretschmar R, et al. Essential function of p300 acetyltransferase activity in heart, lung and small intestine formation. *EMBO J* 2003;22:5175–5185.

49. Yao TP, Oh SP, Fuchs M, et al. Gene dosage-dependent embryonic development and proliferation defects in mice lacking the transcriptional integrator p300. *Cell* 1998;93:361–372.
50. Tanaka Y, Naruse I, Hongo T, et al. Extensive brain hemorrhage and embryonic lethality in a mouse null mutant of CREB-binding protein. *Mech Develop* 2000;95:133–145.
51. Nakashima K, Yanagisawa M, Arakawa H, et al. Synergistic signaling in fetal brain by STAT3-Smad1 complex bridged by p300. *Science* 1999;284:479–482.
52. Lee S, Lee B, Lee JW, Lee SK. Retinoid signaling and neurogenin2 function are coupled for the specification of spinal motor neurons through a chromatin modifier CBP. *Neuron* 2009;62:641–654.
53. Sun Y, Nadal-Vicens M, Misono S, et al. Neurogenin promotes neurogenesis and inhibits glial differentiation by independent mechanisms. *Cell* 2001;104:365–376.
54. Wang J, Weaver IC, Gauthier-Fisher A, et al. CBP histone acetyltransferase activity regulates embryonic neural differentiation in the normal and Rubinstein-Taybi syndrome brain. *Develop Cell* 2010;18:114–125.
55. Bu P, Evrard Y, Lozano G, Dent SY. Loss of Gen5 acetyltransferase activity leads to neural tube closure defects and exencephaly in mouse embryos. *Mol Cell Biol* 2007;27:3405–3416.
56. Lin W, Zhang Z, Srajer G, et al. Proper expression of the Gen5 histone acetyltransferase is required for neural tube closure in mouse embryos. *Dev Dyn* 2008;237:928–940.
57. Xu W, Edmondson DG, Evrard YA, Wakamiya M, Behringer RR, Roth SY. Loss of Gen5/2 leads to increased apoptosis and mesodermal defects during mouse development. *Nat Genetics* 2000;26:229–232.
58. Yamauchi T, Yamauchi J, Kuwata T, et al. Distinct but overlapping roles of histone acetylase PCAF and of the closely related PCAF-B/GCN5 in mouse embryogenesis. *Proc Natl Acad Sci U S A* 2000;97:11303–11306.
59. Chen YC, Gatchel JR, Lewis RW, et al. Gen5 loss-of-function accelerates cerebellar and retinal degeneration in a SCA7 mouse model. *Hum Mol Genetics* 2012;21:394–405.
60. Martinez-Cerdeno V, Lemen JM, Chan V, et al. N-Myc and GCN5 regulate significantly overlapping transcriptional programs in neural stem cells. *PLoS One* 2012;7:e39456.
61. Gehrking KM, Andresen JM, Duvick L, Lough J, Zoghbi HY, Orr HT. Partial loss of Tip60 slows mid-stage neurodegeneration in a spinocerebellar ataxia type 1 (SCA1) mouse model. *Hum Mol Genetics* 2011;20:2204–2212.
62. Ye F, Chen Y, Hoang T, et al. HDAC1 and HDAC2 regulate oligodendrocyte differentiation by disrupting the beta-catenin-TCF interaction. *Nat Neurosci* 2009;12:829–838.
63. Lyssiotis CA, Walker J, Wu C, Kondo T, Schultz PG, Wu X. Inhibition of histone deacetylase activity induces developmental plasticity in oligodendrocyte precursor cells. *Proc Natl Acad Sci U S A* 2007;104:14982–14987.
64. Marin-Husstege M, Muggironi M, Liu A, Casaccia-Bonnel P. Histone deacetylase activity is necessary for oligodendrocyte lineage progression. *J Neurosci* 2002;22:10333–10345.
65. Lau OD, Kundu TK, Soccio RE, et al. HATs off: selective synthetic inhibitors of the histone acetyltransferases p300 and PCAF. *Mol Cell* 2000;5:589–595.
66. Collins HM, Abdelghany MK, Messmer M, et al. Differential effects of garcinol and curcumin on histone and p53 modifications in tumour cells. *BMC Cancer* 2013;13:37.
67. Selvi BR, Chatterjee S, Modak R, Eswaramoorthy M, Kundu TK. Histone acetylation as a therapeutic target. *Subcell Biochem* 2012;61:567–596.
68. Swaminathan V, Reddy BA, Ruthrotha Selvi B, Sukanya MS, Kundu TK. Small molecule modulators in epigenetics: implications in gene expression and therapeutics. *Subcell Biochem* 2007;41:397–428.
69. Balasubramanyam K, Swaminathan V, Ranganathan A, Kundu TK. Small molecule modulators of histone acetyltransferase p300. *J Biol Chem* 2003;278:19134–19140.
70. Souto JA, Benedetti R, Otto K, et al. New anacardic acid-inspired benzamides: histone lysine acetyltransferase activators. *ChemMedChem* 2010;5:1530–1540.
71. Mantelingu K, Kishore AH, Balasubramanyam K, et al. Activation of p300 histone acetyltransferase by small molecules altering enzyme structure: probed by surface-enhanced Raman spectroscopy. *J Phys Chem B* 2007;111:4527–4534.
72. Chatterjee S, Mizar P, Cassel R, et al. A novel activator of CBP/p300 acetyltransferases promotes neurogenesis and extends memory duration in adult mice. *J Neurosci* 2013;33:10698–10712.
73. Dal Piaz F, Tosco A, Eletto D, et al. The identification of a novel natural activator of p300 histone acetyltransferase provides new insights into the modulation mechanism of this enzyme. *Chembiochem* 2010;11:818–827.
74. Milite C, Castellano S, Benedetti R, et al. Modulation of the activity of histone acetyltransferases by long chain alkylidenemalonates (LoCAMs). *Bioorg Med Chem* 2011;19:3690–3701.
75. Sbardella G, Castellano S, Vicidomini C, et al. Identification of long chain alkylidenemalonates as novel small molecule modulators of histone acetyltransferases. *Bioorg Med Chem Lett* 2008;18:2788–2792.
76. Rouaux C, Jokic N, Mbebi C, Boutillier S, Loeffler JP, Boutillier AL. Critical loss of CBP/p300 histone acetylase activity by caspase-6 during neurodegeneration. *EMBO J* 2003;22:6537–6549.
77. Rouaux C, Loeffler JP, Boutillier AL. Targeting CREB-binding protein (CBP) loss of function as a therapeutic strategy in neurological disorders. *Biochem Pharmacol* 2004;68:1157–1164.
78. Saha RN, Pahan K. HATs and HDACs in neurodegeneration: a tale of disconcerted acetylation homeostasis. *Cell Death Differ* 2006;13:539–550.
79. Kumar P, Kalonia H, Kumar A. Huntington's disease: pathogenesis to animal models. *Pharmacol Rep* 2010;62:1–14.
80. Orr HT, Zoghbi HY. Trinucleotide repeat disorders. *Annu Rev Neurosci* 2007;30:575–621.
81. Kazantsev A, Preisinger E, Dranovsky A, Goldgaber D, Housman D. Insoluble detergent-resistant aggregates form between pathological and nonpathological lengths of polyglutamine in mammalian cells. *Proc Natl Acad Sci U S A* 1999;96:11404–11409.
82. Cong SY, Peppers BA, Evert BO, et al. Mutant huntingtin represses CBP, but not p300, by binding and protein degradation. *Mol Cell Neurosci* 2005;30:560–571.
83. Jiang H, Poirier MA, Liang Y, et al. Depletion of CBP is directly linked with cellular toxicity caused by mutant huntingtin. *Neurobiol Dis* 2006;23:543–551.
84. Choi YJ, Kim SI, Lee JW, et al. Suppression of aggregate formation of mutant huntingtin potentiates CREB-binding protein sequestration and apoptotic cell death. *Mol Cell Neurosci* 2012;49:127–137.
85. Wilburn B, Rudnicki DD, Zhao J, et al. An antisense CAG repeat transcript at JPH3 locus mediates expanded polyglutamine protein toxicity in Huntington's disease-like 2 mice. *Neuron* 2011;70:427–440.
86. Bodai L, Pallos J, Thompson LM, Marsh JL. Pcaf modulates polyglutamine pathology in a Drosophila model of Huntington's disease. *Neurodegener Dis* 2012;9:104–106.
87. Choi YS, Lee B, Cho HY, et al. CREB is a key regulator of striatal vulnerability in chemical and genetic models of Huntington's disease. *Neurobiol Dis* 2009;36:259–268.
88. Giralt A, Puigdel·liviol M, Carreton O, et al. Long-term memory deficits in Huntington's disease are associated with reduced CBP histone acetylase activity. *Hum Mol Genet* 2012;21:1203–1216.
89. Quinti L, Chopra V, Rotili D, et al. Evaluation of histone deacetylases as drug targets in Huntington's disease models. *Study*

- of HDACs in brain tissues from R6/2 and CAG140 knock-in HD mouse models and human patients and in a neuronal HD cell model. *PLoS Curr* 2010;2.
90. Bae BI, Xu H, Igarashi S, et al. p53 mediates cellular dysfunction and behavioral abnormalities in Huntington's disease. *Neuron* 2005;47:29–41.
 91. Jeong H, Then F, Melia TJ, Jr, et al. Acetylation targets mutant huntingtin to autophagosomes for degradation. *Cell* 2009;137:60–72.
 92. Lee J, Hwang YJ, Boo JH, et al. Dysregulation of upstream binding factor-1 acetylation at K352 is linked to impaired ribosomal DNA transcription in Huntington's disease. *Cell Death Differ* 2011;18:1726–1735.
 93. Reed NA, Cai D, Blasius TL, et al. Microtubule acetylation promotes kinesin-1 binding and transport. *Curr Biol* 2006;16:2166–2172.
 94. Nguyen T, Mehta NR, Conant K, et al. Axonal protective effects of the myelin-associated glycoprotein. *J Neurosci* 2009;29:630–637.
 95. Gauthier LR, Charrin BC, Borrell-Pages M, et al. Huntingtin controls neurotrophic support and survival of neurons by enhancing BDNF vesicular transport along microtubules. *Cell* 2004;118:127–138.
 96. McFarland KN, Das S, Sun TT, et al. Genome-wide histone acetylation is altered in a transgenic mouse model of Huntington's disease. *PLoS One* 2012;7:e41423.
 97. Klevytska AM, Tebbenkamp AT, Savonenko AV, Borchelt DR. Partial depletion of CREB-binding protein reduces life expectancy in a mouse model of Huntington disease. *J Neuropathol Exp Neurol* 2010;69:396–404.
 98. Taylor JP, Taye AA, Campbell C, Kazemi-Esfarjani P, Fischbeck KH, Min KT. Aberrant histone acetylation, altered transcription, and retinal degeneration in a *Drosophila* model of polyglutamine disease are rescued by CREB-binding protein. *Genes Develop* 2003;17:1463–1468.
 99. Dompierre JP, Godin JD, Charrin BC, et al. Histone deacetylase 6 inhibition compensates for the transport deficit in Huntington's disease by increasing tubulin acetylation. *J Neurosci* 2007;27:3571–3583.
 100. Ferrante RJ, Kubilus JK, Lee J, et al. Histone deacetylase inhibition by sodium butyrate chemotherapy ameliorates the neurodegenerative phenotype in Huntington's disease mice. *J Neurosci* 2003;23:9418–9427.
 101. Gardian G, Browne SE, Choi DK, et al. Neuroprotective effects of phenylbutyrate in the N171-82Q transgenic mouse model of Huntington's disease. *J Biol Chem* 2005;280:556–563.
 102. Goedert M, Spillantini MG, Del Tredici K, Braak H. 100 years of Lewy pathology. *Nat Rev Neurol* 2013;9:13–24.
 103. Yasuda T, Mochizuki H. The regulatory role of alpha-synuclein and parkin in neuronal cell apoptosis; possible implications for the pathogenesis of Parkinson's disease. *Apoptosis* 2010;15:1312–1321.
 104. Kontopoulos E, Parvin JD, Feany MB. Alpha-synuclein acts in the nucleus to inhibit histone acetylation and promote neurotoxicity. *Hum Mol Genet* 2006;15:3012–3023.
 105. Chen PS, Peng GS, Li G, et al. Valproate protects dopaminergic neurons in midbrain neuron/glia cultures by stimulating the release of neurotrophic factors from astrocytes. *Mol Psychiatry* 2006;11:1116–1125.
 106. Chen PS, Wang CC, Bortner CD, et al. Valproic acid and other histone deacetylase inhibitors induce microglial apoptosis and attenuate lipopolysaccharide-induced dopaminergic neurotoxicity. *Neuroscience* 2007;149:203–212.
 107. Gardian G, Yang L, Cleren C, Calingasan NY, Klivenyi P, Beal MF. Neuroprotective effects of phenylbutyrate against MPTP neurotoxicity. *Neuromol Med* 2004;5:235–241.
 108. Gottlicher M, Minucci S, Zhu P, et al. Valproic acid defines a novel class of HDAC inhibitors inducing differentiation of transformed cells. *EMBO J* 2001;20:6969–6978.
 109. Monti B, Gatta V, Piretti F, Raffaelli SS, Virgili M, Contestabile A. Valproic acid is neuroprotective in the rotenone rat model of Parkinson's disease: involvement of alpha-synuclein. *Neurotox Res* 2010;17:130–141.
 110. Outeiro TF, Kontopoulos E, Altmann SM, et al. Sirtuin 2 inhibitors rescue alpha-synuclein-mediated toxicity in models of Parkinson's disease. *Science* 2007;317:516–519.
 111. Song C, Kanthasamy A, Anantharam V, Sun F, Kanthasamy AG. Environmental neurotoxic pesticide increases histone acetylation to promote apoptosis in dopaminergic neuronal cells: relevance to epigenetic mechanisms of neurodegeneration. *Mol Pharmacol* 2010;77:621–632.
 112. Jin H, Kanthasamy A, Ghosh A, Yang Y, Anantharam V, Kanthasamy AG. alpha-Synuclein negatively regulates protein kinase Cdelta expression to suppress apoptosis in dopaminergic neurons by reducing p300 histone acetyltransferase activity. *J Neurosci* 2011;31:2035–2051.
 113. Turner MR, Hardiman O, Benatar M, et al. Controversies and priorities in amyotrophic lateral sclerosis. *Lancet Neurol* 2013;12:310–322.
 114. Mackenzie IR, Bigio EH, Ince PG, et al. Pathological TDP-43 distinguishes sporadic amyotrophic lateral sclerosis from amyotrophic lateral sclerosis with SOD1 mutations. *Ann Neurol* 2007;61:427–434.
 115. Deng HX, Zhai H, Bigio EH, et al. FUS-immunoreactive inclusions are a common feature in sporadic and non-SOD1 familial amyotrophic lateral sclerosis. *Ann Neurol* 2010;67:739–748.
 116. Dupuis L, Pradat PF, Ludolph AC, Loeffler JP. Energy metabolism in amyotrophic lateral sclerosis. *Lancet Neurol* 2011;10:75–82.
 117. Gibson SB, Bromberg MB. Amyotrophic lateral sclerosis: drug therapy from the bench to the bedside. *Semin Neurol* 2012;32:173–178.
 118. Ilieva H, Polymenidou M, Cleveland DW. Non-cell autonomous toxicity in neurodegenerative disorders: ALS and beyond. *J Cell Biol* 2009;187:761–772.
 119. Dupuis L, Loeffler JP. Neuromuscular junction destruction during amyotrophic lateral sclerosis: insights from transgenic models. *Curr Opin Pharmacol* 2009;9:341–346.
 120. Jiang YM, Yamamoto M, Kobayashi Y, et al. Gene expression profile of spinal motor neurons in sporadic amyotrophic lateral sclerosis. *Ann Neurol* 2005;57:236–251.
 121. Janssen C, Schmalbach S, Boeselt S, Sarlette A, Dengler R, Petri S. Differential histone deacetylase mRNA expression patterns in amyotrophic lateral sclerosis. *J Neuropathol Exp Neurol* 2010;69:573–581.
 122. Ryu H, Smith K, Camelo SI, et al. Sodium phenylbutyrate prolongs survival and regulates expression of anti-apoptotic genes in transgenic amyotrophic lateral sclerosis mice. *J Neurochem* 2005;93:1087–1098.
 123. Sugai F, Yamamoto Y, Miyaguchi K, et al. Benefit of valproic acid in suppressing disease progression of ALS model mice. *Eur J Neurosci* 2004;20:3179–3183.
 124. Petri S, Kiaei M, Kipiani K, et al. Additive neuroprotective effects of a histone deacetylase inhibitor and a catalytic antioxidant in a transgenic mouse model of amyotrophic lateral sclerosis. *Neurobiol Dis* 2006;22:40–49.
 125. Del Signore SJ, Amante DJ, Kim J, et al. Combined riluzole and sodium phenylbutyrate therapy in transgenic amyotrophic lateral sclerosis mice. *Amyotroph Lateral Scler* 2009;10:85–94.
 126. Rouaux C, Panteleeva I, Rene F, et al. Sodium valproate exerts neuroprotective effects in vivo through CREB-binding protein-dependent mechanisms but does not improve survival in an amyotrophic lateral sclerosis mouse model. *J Neurosci* 2007;27:5535–5545.
 127. De Vos KJ, Chapman AL, Tennant ME, et al. Familial amyotrophic lateral sclerosis-linked SOD1 mutants perturb fast axonal transport

- to reduce axonal mitochondria content. *Hum Mol Genet* 2007;16:2720–2728.
128. Creppe C, Malinouskaya L, Volvert ML, et al. Elongator controls the migration and differentiation of cortical neurons through acetylation of alpha-tubulin. *Cell* 2009;136:551–564.
 129. Simpson CL, Lemmens R, Miskiewicz K, et al. Variants of the elongator protein 3 (ELP3) gene are associated with motor neuron degeneration. *Hum Mol Genet* 2009;18:472–481.
 130. Taes I, Timmers M, Hersmus N, et al. Hdac6 deletion delays disease progression in the SOD1G93A mouse model of ALS. *Hum Mol Genet* 2013;22:1783–1790.
 131. Gal J, Chen J, Barnett KR, Yang L, Brumley E, Zhu H. HDAC6 regulates mutant SOD1 aggregation through two SMIR motifs and tubulin acetylation. *J Biol Chem* 2013;288:15035–15045.
 132. Miskiewicz K, Jose LE, Bento-Abreu A, et al. ELP3 controls active zone morphology by acetylating the ELKS family member Bruchpilot. *Neuron* 2011;72:776–788.
 133. Roy S, Tenniswood M. Site-specific acetylation of p53 directs selective transcription complex assembly. *J Biol Chem* 2007;282:4765–4771.
 134. Martin LJ, Liu Z. DNA damage profiling in motor neurons: a single-cell analysis by comet assay. *Neurochem Res* 2002;27:1093–1104.
 135. Barbosa LF, Cerqueira FM, Macedo AF, et al. Increased SOD1 association with chromatin, DNA damage, p53 activation, and apoptosis in a cellular model of SOD1-linked ALS. *Biochim Biophys Acta* 2010;1802:462–471.
 136. Gonzalez de Aguilar JL, Gordon JW, Rene F, et al. Alteration of the Bcl-x/Bax ratio in a transgenic mouse model of amyotrophic lateral sclerosis: evidence for the implication of the p53 signaling pathway. *Neurobiol Dis* 2000;7:406–415.
 137. Di Giovanni S, Knights CD, Rao M, et al. The tumor suppressor protein p53 is required for neurite outgrowth and axon regeneration. *EMBO J* 2006;25:4084–4096.
 138. Pearson M, Carbone R, Sebastiani C, et al. PML regulates p53 acetylation and premature senescence induced by oncogenic Ras. *Nature* 2000;406:207–210.
 139. Kim D, Nguyen MD, Dobbin MM, et al. SIRT1 deacetylase protects against neurodegeneration in models for Alzheimer's disease and amyotrophic lateral sclerosis. *EMBO J* 2007;26:3169–3179.
 140. Boillee S, Vandé Velde C, Cleveland DW. ALS: a disease of motor neurons and their nonneuronal neighbors. *Neuron* 2006;52:39–59.
 141. Mejat A, Ramond F, Bassel-Duby R, Khochbin S, Olson EN, Schaeffer L. Histone deacetylase 9 couples neuronal activity to muscle chromatin acetylation and gene expression. *Nat Neurosci* 2005;8:313–321.
 142. Ravel-Chapuis A, Vandromme M, Thomas JL, Schaeffer L. Postsynaptic chromatin is under neural control at the neuromuscular junction. *EMBO J* 2007;26:1117–1128.
 143. Selkoe DJ. Preventing Alzheimer's disease. *Science* 2012;337:1488–1492.
 144. Hardy JA, Higgins GA. Alzheimer's disease: the amyloid cascade hypothesis. *Science* 1992;256:184–185.
 145. Iqbal K, Liu F, Gong CX, Alonso Adel C, Grundke-Iqbal I. Mechanisms of tau-induced neurodegeneration. *Acta Neuropathol* 2009;118:53–69.
 146. Davies P, Maloney AJ. Selective loss of central cholinergic neurons in Alzheimer's disease. *Lancet* 1976;2:1403.
 147. Bettens K, Slegers K, Van Broeckhoven C. Genetic insights in Alzheimer's disease. *Lancet Neurol* 2013;12:92–104.
 148. Adwan L, Zawia NH. Epigenetics: A novel therapeutic approach for the treatment of Alzheimer's disease. *Pharmacol Therap* 2013;139:41–50.
 149. Albrecht S, Bourdeau M, Bennett D, Mufson EJ, Bhattacharjee M, LeBlanc AC. Activation of caspase-6 in aging and mild cognitive impairment. *Am J Pathol* 2007;170:1200–1209.
 150. Guo H, Albrecht S, Bourdeau M, Petzke T, Bergeron C, LeBlanc AC. Active caspase-6 and caspase-6-cleaved tau in neurofibrillary threads, neuritic plaques, and neurofibrillary tangles of Alzheimer's disease. *Am J Pathol* 2004;165:523–531.
 151. Guo H, Petrin D, Zhang Y, Bergeron C, Goodyer CG, LeBlanc AC. Caspase-1 activation of caspase-6 in human apoptotic neurons. *Cell Death Differ* 2006;13:285–292.
 152. Saura CA, Choi SY, Beglopoulos V, et al. Loss of presenilin function causes impairments of memory and synaptic plasticity followed by age-dependent neurodegeneration. *Neuron* 2004;42:23–36.
 153. Francis YI, Diss JK, Kariti M, Stephanou A, Latchman DS. p300 activation by Presenilin 1 but not by its M146L mutant. *Neurosci Lett* 2007;413:137–140.
 154. Francis YI, Stephanou A, Latchman DS. CREB-binding protein activation by presenilin 1 but not by its M146L mutant. *Neuroreport* 2006;17:917–921.
 155. Marambaud P, Wen PH, Dutt A, et al. A CBP binding transcriptional repressor produced by the PS1/epsilon-cleavage of N-cadherin is inhibited by PS1 FAD mutations. *Cell* 2003;114:635–645.
 156. Caccamo A, Maldonado MA, Bokov AF, Majumder S, Oddo S. CBP gene transfer increases BDNF levels and ameliorates learning and memory deficits in a mouse model of Alzheimer's disease. *Proc Natl Acad Sci U S A* 2010;107:22687–22692.
 157. Liu R, Lei JX, Luo C, et al. Increased EID1 nuclear translocation impairs synaptic plasticity and memory function associated with pathogenesis of Alzheimer's disease. *Neurobiol Dis* 2012;45:902–912.
 158. Duclot F, Meffre J, Jacquet C, Gongora C, Maurice T. Mice knock out for the histone acetyltransferase p300/CREB binding protein-associated factor develop a resistance to amyloid toxicity. *Neuroscience* 2010;167:850–863.
 159. Ricobaraza A, Cuadrado-Tejedor M, Garcia-Osta A. Long-term phenylbutyrate administration prevents memory deficits in Tg2576 mice by decreasing Abeta. *Front Biosci (Elite Ed)* 2011;3:1375–1384.
 160. Ricobaraza A, Cuadrado-Tejedor M, Marco S, Perez-Otano I, Garcia-Osta A. Phenylbutyrate rescues dendritic spine loss associated with memory deficits in a mouse model of Alzheimer disease. *Hippocampus* 2012;22:1040–1050.
 161. Ricobaraza A, Cuadrado-Tejedor M, Perez-Mediavilla A, Frechilla D, Del Rio J, Garcia-Osta A. Phenylbutyrate ameliorates cognitive deficit and reduces tau pathology in an Alzheimer's disease mouse model. *Neuropsychopharmacology* 2009;34:1721–1732.
 162. Min SW, Cho SH, Zhou Y, et al. Acetylation of tau inhibits its degradation and contributes to tauopathy. *Neuron* 2010;67:953–966.
 163. Irvin DJ, Cohen TJ, Grossman M, et al. Acetylated tau, a novel pathological signature in Alzheimer's disease and other tauopathies. *Brain* 2012;135:807–818.
 164. Cohen TJ, Friedmann D, Hwang AW, Marmorstein R, Lee VM. The microtubule-associated tau protein has intrinsic acetyltransferase activity. *Nat Struct Mol Biol* 2013;20:756–762.
 165. Mackenzie IR, Baker M, Pickering-Brown S, et al. The neuropathology of frontotemporal lobar degeneration caused by mutations in the progranulin gene. *Brain* 2006;129:3081–3090.
 166. Cenik B, Sephton CF, Dewey CM, et al. Suberoylanilide hydroxamic acid (vorinostat) up-regulates progranulin transcription: rational therapeutic approach to frontotemporal dementia. *J Biol Chem* 2011;286:16101–16108.
 167. Odagiri S, Tanji K, Mori F, et al. Brain expression level and activity of HDAC6 protein in neurodegenerative dementia. *Biochem Biophys Res Commun* 2013;430:394–399.
 168. Kawaguchi Y, Kovaacs JJ, McLaurin A, Vance JM, Ito A, Yao TP. The deacetylase HDAC6 regulates aggresome formation and cell viability in response to misfolded protein stress. *Cell* 2003;115:727–738.
 169. Miki Y, Mori F, Tanji K, Kakita A, Takahashi H, Wakabayashi K. Accumulation of histone deacetylase 6, an aggresome-related protein, is specific to Lewy bodies and glial cytoplasmic inclusions. *Neuropathology* 2011;31:561–568.

170. Agranoff BW. Memory and protein synthesis. *Sci Am* 1967;216:115–122.
171. Flood JF, Rosenzweig MR, Bennett EL, Orme AE. The influence of duration of protein synthesis inhibition on memory. *Physiol Behav* 1973;10:555–562.
172. Nguyen PV, Abel T, Kandel ER. Requirement of a critical period of transcription for induction of a late phase of LTP. *Science* 1994;265:1104–1107.
173. Stanton PK, Sarvey JM. Blockade of long-term potentiation in rat hippocampal CA1 region by inhibitors of protein synthesis. *J Neurosci* 1984;4:3080–3088.
174. Gutierrez H, Davies AM. Regulation of neural process growth, elaboration and structural plasticity by NF-kappaB. *Trends Neurosci* 2011;34:316–325.
175. Sakamoto K, Karelina K, Obrietan K. CREB: a multifaceted regulator of neuronal plasticity and protection. *J Neurochem* 2011;116:1–9.
176. Graff J, Tsai LH. Histone acetylation: molecular mnemonics on the chromatin. *Nat Rev Neurosci* 2013;14:97–111.
177. Peixoto L, Abel T. The role of histone acetylation in memory formation and cognitive impairments. *Neuropsychopharmacology* 2013;38:62–76.
178. Zocchi L, Sassone-Corsi P. Joining the dots: from chromatin remodeling to neuronal plasticity. *Curr Opin Neurobiol* 2010;20:432–440.
179. Levenson JM, O'Riordan KJ, Brown KD, Trinh MA, Molfese DL, Sweatt JD. Regulation of histone acetylation during memory formation in the hippocampus. *J Biol Chem* 2004;279:40545–40559.
180. Bousiges O, Vasconcelos AP, Neidl R, et al. Spatial memory consolidation is associated with induction of several lysine-acetyltransferase (histone acetyltransferase) expression levels and H2B/H4 acetylation-dependent transcriptional events in the rat hippocampus. *Neuropsychopharmacology* 2010;35:2521–2537.
181. Calfa G, Chapleau CA, Campbell S, et al. HDAC activity is required for BDNF to increase quantal neurotransmitter release and dendritic spine density in CA1 pyramidal neurons. *Hippocampus* 2012;22:1493–1500.
182. Bousiges O, Neidl R, Majchrzak M, et al. Detection of Histone acetylation levels in the dorsal hippocampus reveals early tagging on specific residues of H2B and H4 histones in response to learning. *PLoS One* 2013;8:e57816.
183. Guan JS, Haggarty SJ, Giacometti E, et al. HDAC2 negatively regulates memory formation and synaptic plasticity. *Nature* 2009;459:55–60.
184. McQuown SC, Barrett RM, Matheos DP, et al. HDAC3 is a critical negative regulator of long-term memory formation. *J Neurosci* 2011;31:764–774.
185. Bahari-Javan S, Maddalena A, Kerimoglu C, et al. HDAC1 regulates fear extinction in mice. *J Neurosci* 2012;32:5062–5073.
186. Agis-Balboa RC, Pavelka Z, Kerimoglu C, Fischer A. Loss of HDAC5 impairs memory function: implications for Alzheimer's disease. *J Alzheimers Dis* 2013;33:35–44.
187. Kim MS, Akhtar MW, Adachi M, et al. An essential role for histone deacetylase 4 in synaptic plasticity and memory formation. *J Neurosci* 2012;32:10879–10886.
188. Monsey MS, Ota KT, Akingbade IF, Hong ES, Schafe GE. Epigenetic alterations are critical for fear memory consolidation and synaptic plasticity in the lateral amygdala. *PLoS One* 2011;6:e19958.
189. Zhang X, Yuan Z, Zhang Y, et al. HDAC6 modulates cell motility by altering the acetylation level of cortactin. *Mol Cell* 2007;27:197–213.
190. Zhang Y, Zhang M, Dong H, et al. Deacetylation of cortactin by SIRT1 promotes cell migration. *Oncogene* 2009;28:445–460.
191. Catarino T, Ribeiro L, Santos SD, Carvalho AL. Regulation of synapse composition by protein acetylation: the role of acetylated cortactin. *J Cell Sci* 2013;126:149–162.
192. Alberini CM. Transcription factors in long-term memory and synaptic plasticity. *Physiol Rev* 2009;89:121–145.
193. Mattson MP, Meffert MK. Roles for NF-kappaB in nerve cell survival, plasticity, and disease. *Cell Death Differ* 2006;13:852–860.
194. Chen LF, Mu Y, Greene WC. Acetylation of RelA at discrete sites regulates distinct nuclear functions of NF-kappaB. *EMBO J* 2002;21:6539–6548.
195. Chen L, Fischle W, Verdin E, Greene WC. Duration of nuclear NF-kappaB action regulated by reversible acetylation. *Science* 2001;293:1653–1657.
196. Yeh SH, Lin CH, Gean PW. Acetylation of nuclear factor-kappaB in rat amygdala improves long-term but not short-term retention of fear memory. *Mol Pharmacol* 2004;65:1286–1292.
197. Nasca C, Xenos D, Barone Y, et al. L-acetylcarnitine causes rapid antidepressant effects through the epigenetic induction of mGlu2 receptors. *Proc Natl Acad Sci U S A* 2013;110:4804–4809.
198. Valor LM, Viosca J, Lopez-Atalaya JP, Barco A. Lysine acetyltransferases CBP and p300 as therapeutic targets in cognitive and neurodegenerative disorders. *Curr Pharm Design* 2013 Feb 19 [Epub ahead of print].
199. Alarcon JM, Malleret G, Touzani K, et al. Chromatin acetylation, memory, and LTP are impaired in CBP^{+/−} mice: a model for the cognitive deficit in Rubinstein-Taybi syndrome and its amelioration. *Neuron* 2004;42:947–959.
200. Bourchouladze R, Lidge R, Catapano R, et al. A mouse model of Rubinstein-Taybi syndrome: defective long-term memory is ameliorated by inhibitors of phosphodiesterase 4. *Proc Natl Acad Sci U S A* 2003;100:10518–10522.
201. Korzus E, Rosenfeld MG, Mayford M. CBP histone acetyltransferase activity is a critical component of memory consolidation. *Neuron* 2004;42:961–972.
202. Wood MA, Kaplan MP, Park A, et al. Transgenic mice expressing a truncated form of CREB-binding protein (CBP) exhibit deficits in hippocampal synaptic plasticity and memory storage. *Learn Mem* 2005;12:111–119.
203. Chen G, Zou X, Watanabe H, van Deursen JM, Shen J. CREB binding protein is required for both short-term and long-term memory formation. *J Neurosci* 2010;30:13066–13077.
204. Valor LM, Pulopulos MM, Jimenez-Minchán M, Olivares R, Lutz B, Barco A. Ablation of CBP in forebrain principal neurons causes modest memory and transcriptional defects and a dramatic reduction of histone acetylation but does not affect cell viability. *J Neurosci* 2011;31:1652–1663.
205. Barrett RM, Malvaez M, Kramar E, et al. Hippocampal focal knockout of CBP affects specific histone modifications, long-term potentiation, and long-term memory. *Neuropsychopharmacology* 2011;36:1545–1556.
206. Oliveira AM, Wood MA, McDonough CB, Abel T. Transgenic mice expressing an inhibitory truncated form of p300 exhibit long-term memory deficits. *Learning Memory* 2007;14:564–572.
207. Oliveira AM, Estevez MA, Hawk JD, Grimes S, Brindle PK, Abel T. Subregion-specific p300 conditional knock-out mice exhibit long-term memory impairments. *Learn Mem* 2011;18:161–169.
208. Maurice T, Duclot F, Meunier J, et al. Altered memory capacities and response to stress in p300/CBP-associated factor (PCAF) histone acetylase knockout mice. *Neuropsychopharmacology* 2008;33:1584–1602.
209. Bartholdi D, Roelfsema JH, Papadia F, et al. Genetic heterogeneity in Rubinstein-Taybi syndrome: delineation of the phenotype of the first patients carrying mutations in EP300. *J Med Genet* 2007;44:327–333.
210. Roelfsema JH, White SJ, Ariyurek Y, et al. Genetic heterogeneity in Rubinstein-Taybi syndrome: mutations in both the CBP and EP300 genes cause disease. *Am J Hum Genet* 2005;76:572–580.
211. Viosca J, Lopez-Atalaya JP, Olivares R, Eckner R, Barco A. Syndromic features and mild cognitive impairment in mice with genetic reduction on p300 activity: Differential contribution of p300

- and CBP to Rubinstein-Taybi syndrome etiology. *Neurobiol Dis* 2010;37:186–194.
212. Hallam TM, Bourtehouladze R. Rubinstein-Taybi syndrome: molecular findings and therapeutic approaches to improve cognitive dysfunction. *Cell Mol Life Sci* 2006;63:1725–1735.
 213. McQuown SC, Wood MA. HDAC3 and the molecular brake pad hypothesis. *Neurobiol Learn Mem* 2011;96:27–34.
 214. Graff J, Rei D, Guan JS, et al. An epigenetic blockade of cognitive functions in the neurodegenerating brain. *Nature* 2012;483:222–226.
 215. Vecsey CG, Hawk JD, Lattal KM, et al. Histone deacetylase inhibitors enhance memory and synaptic plasticity via CREB:CBP-dependent transcriptional activation. *J Neurosci* 2007;27:6128–6140.
 216. Dancy BM, Crump NT, Peterson DJ, et al. Live-cell studies of p300/CBP histone acetyltransferase activity and inhibition. *Chembiochem* 2012;13:2113–2121.
 217. Hazzalin CA, Mahadevan LC. Dynamic acetylation of all lysine 4-methylated histone H3 in the mouse nucleus: analysis at c-fos and c-jun. *PLoS Biol* 2005;3:e393.
 218. Xu WS, Parmigiani RB, Marks PA. Histone deacetylase inhibitors: molecular mechanisms of action. *Oncogene* 2007;26:5541–5552.
 219. Wei W, Coelho CM, Li X, et al. p300/CBP-associated factor selectively regulates the extinction of conditioned fear. *J Neurosci* 2012;32:11930–11941.
 220. Bredy TW, Wu H, Crego C, Zellhoefer J, Sun YE, Barad M. Histone modifications around individual BDNF gene promoters in prefrontal cortex are associated with extinction of conditioned fear. *Learn Mem* 2007;14:268–276.
 221. Lattal KM, Barrett RM, Wood MA. Systemic or intrahippocampal delivery of histone deacetylase inhibitors facilitates fear extinction. *Behav Neurosci* 2007;121:1125–1131.
 222. Stafford JM, Raybuck JD, Ryabinin AE, Lattal KM. Increasing histone acetylation in the hippocampus-entorhinal network enhances fear extinction. *Biol Psychiatry* 2012;72:25–33.
 223. Benes FM. Searching for unique endophenotypes for schizophrenia and bipolar disorder within neural circuits and their molecular regulatory mechanisms. *Schizophr Bull* 2007;33:932–936.
 224. Sharma RP, Grayson DR, Gavin DP. Histone deacetylase 1 expression is increased in the prefrontal cortex of schizophrenia subjects: analysis of the National Brain Databank microarray collection. *Schizophr Res* 2008;98:111–117.
 225. Ourednik J, Ourednik V, Lynch WP, Schachner M, Snyder EY. Neural stem cells display an inherent mechanism for rescuing dysfunctional neurons. *Nat Biotechnol* 2002;20:1103–1110.
 226. Teng YD, Lavik EB, Qu X, et al. Functional recovery following traumatic spinal cord injury mediated by a unique polymer scaffold seeded with neural stem cells. *Proc Natl Acad Sci U S A* 2002;99:3024–3029.
 227. Clement AM, Nguyen MD, Roberts EA, et al. Wild-type nonneuronal cells extend survival of SOD1 mutant motor neurons in ALS mice. *Science* 2003;302:113–117.
 228. Carletti B, Piemonte F, Rossi F. Neuroprotection: the emerging concept of restorative neural stem cell biology for the treatment of neurodegenerative diseases. *Curr Neuropharmacol* 2011;9:313–317.
 229. Rossi F, Cattaneo E. Opinion: neural stem cell therapy for neurological diseases: dreams and reality. *Nature reviews Neurosci* 2002;3:401–409.
 230. Faure A, Verret L, Bozon B, et al. Impaired neurogenesis, neuronal loss, and brain functional deficits in the APPxPS1-Ki mouse model of Alzheimer's disease. *Neurobiol Aging* 2011;32:407–418.
 231. Verret L, Jankowsky JL, Xu GM, Borchelt DR, Rampon C. Alzheimer's-type amyloidosis in transgenic mice impairs survival of newborn neurons derived from adult hippocampal neurogenesis. *J Neurosci* 2007;27:6771–6780.
 232. Branchi I, Karpova NN, D'Andrea I, Castren E, Alleva E. Epigenetic modifications induced by early enrichment are associated with changes in timing of induction of BDNF expression. *Neurosci Lett* 2011;495:168–172.
 233. Lopez-Atalaya JP, Ciccirelli A, Viosca J, et al. CBP is required for environmental enrichment-induced neurogenesis and cognitive enhancement. *EMBO J* 2011;30:4287–4298.
 234. Nithianantharajah J, Hannan AJ. Enriched environments, experience-dependent plasticity and disorders of the nervous system. *Nat Rev Neurosci* 2006;7:697–709.
 235. O'Callaghan RM, Griffin EW, Kelly AM. Long-term treadmill exposure protects against age-related neurodegenerative change in the rat hippocampus. *Hippocampus* 2009;19:1019–1029.
 236. Rossi C, Angelucci A, Costantin L, et al. Brain-derived neurotrophic factor (BDNF) is required for the enhancement of hippocampal neurogenesis following environmental enrichment. *Eur J Neurosci* 2006;24:1850–1856.
 237. Simpson J, Kelly JP. The impact of environmental enrichment in laboratory rats—behavioural and neurochemical aspects. *Behav Brain Res* 2011;222:246–264.
 238. Nithianantharajah J, Hannan AJ. Mechanisms mediating brain and cognitive reserve: experience-dependent neuroprotection and functional compensation in animal models of neurodegenerative diseases. *Prog Neuropsychopharmacol Biol Psychiatry* 2011;35:331–339.

PUBLICATION 5.

Multifunctional chromatin organizing protein, PC4 is critical for brain plasticity

Amrutha Swaminathan¹, H el ene Delage², Snehajyoti Chatterjee³, Laurence Belgarbi-Dutron², Rapha elle Cassel³, Nicole Martinez², Brigitte Cosquer³, Sujata Kumari¹, Fabien Mongelard², B eatrice Lannes⁴, Jean-Christophe Cassel³, Anne-Laurence Boutillier^{3,*}, Philippe Bouvet^{2,*}, Tapas K Kundu^{1,*}.

¹ Transcription and Disease Laboratory, Molecular Biology and Genetics Unit, Jawaharlal Nehru Centre for Advanced Scientific Research, Jakkur P. O, Bangalore-560064, India. ² Laboratoire Joliot-Curie - Ecole Normale Sup erieure de Lyon, CNRS USR 3010, 69364 Lyon, France. ³ Laboratoire de Neurosciences Cognitives et Adaptatives (LNCA), UMR7364, Universit  de Strasbourg-CNRS, GDR CNRS 2905, Facult  de Psychologie, 12 rue Goethe, 67000, Strasbourg, France. ⁴ D epartement de Pathologie, H opital de Hautepierre, Universit  de Strasbourg, Strasbourg, France.

*Address for correspondence (e-mail: tapas@jncasr. ac. in, philippe. bouvet@ens-lyon. fr, laurette@unistra. fr)

Manuscript submitted to *Cerebral Cortex*

Abstract

Though the elaborate combination of histone and non-histone protein complexes defines chromatin organization and hence regulates numerous nuclear processes, the role of chromatin organizing proteins remains unexplored at the organismal level. The highly abundant, multifunctional, chromatin-associated protein and transcriptional coactivator, PC4/Sub1 is absolutely critical for life, as its absence leads to embryonic lethality. Here, we report results obtained with conditional PC4 knockout (PC4f/f Nestin-Cre) mice where PC4 is knocked out specifically in the brain. Compared to the control (PC4+/+ Nestin-Cre) mice, PC4f/f Nestin-Cre mice are smaller, with decreased nocturnal activity, but are fertile and show no motor dysfunction. Neurons in different areas of the brain of these mice show sensitivity to hypoxia/anoxia, and decreased adult neurogenesis was observed in the dentate gyrus. Interestingly, PC4f/f Nestin-Cre mice exhibit a severe deficit in spatial memory extinction, while acquisition and long-term retention were unaffected. Gene expression analysis of the dorsal hippocampus of PC4f/f Nestin-Cre mice revealed dysregulated expression of several neural function-associated genes, which could be a result of impaired chromatin organization or dysregulated transcriptional output. Finally, PC4 was consistently found to localize on the promoters of up- and downregulated genes, indicating that PC4 regulates the expression of these genes. These observations indicate that non-histone chromatin-associated proteins like PC4 play a significant role in neuronal plasticity.

Keywords: Chromatin organization, conditional knockout, gene expression, neurogenesis, spatial memory extinction.

References

- Achour, M., Le Gras, S., Keime, C., Parmentier, F., Lejeune, F.-X., Boutillier, A.-L., Néri, C., Davidson, I., and Merienne, K. (2015). Neuronal identity genes regulated by super-enhancers are preferentially down-regulated in the striatum of Huntington's disease mice. *Hum. Mol. Genet.* 24, 3481–3496.
- Acsády, L., Arabadzisz, D., and Freund, T.F. (1996). Correlated morphological and neurochemical features identify different subsets of vasoactive intestinal polypeptide-immunoreactive interneurons in rat hippocampus. *Neuroscience* 73, 299–315.
- Adams, J.P., and Sweatt, J.D. (2002). Molecular psychology: roles for the ERK MAP kinase cascade in memory. *Annu. Rev. Pharmacol. Toxicol.* 42, 135–163.
- Agis-Balboa, R.C., Pavelka, Z., Kerimoglu, C., and Fischer, A. (2013). Loss of HDAC5 impairs memory function: implications for Alzheimer's disease. *J. Alzheimers Dis. JAD* 33, 35–44.
- Agulhon, C., Fiacco, T.A., and McCarthy, K.D. (2010). Hippocampal short- and long-term plasticity are not modulated by astrocyte Ca²⁺ signaling. *Science* 327, 1250–1254.
- Ahmed, T., Blum, D., Burnouf, S., Demeyer, D., Buée-Scherrer, V., D'Hooge, R., Buée, L., and Balschun, D. (2015). Rescue of impaired late-phase long-term depression in a tau transgenic mouse model. *Neurobiol. Aging* 36, 730–739.
- Akaneya, Y., Tsumoto, T., Kinoshita, S., and Hatanaka, H. (1997). Brain-derived neurotrophic factor enhances long-term potentiation in rat visual cortex. *J. Neurosci. Off. J. Soc. Neurosci.* 17, 6707–6716.
- Alarcón, J.M., Malleret, G., Touzani, K., Vronskaya, S., Ishii, S., Kandel, E.R., and Barco, A. (2004). Chromatin acetylation, memory, and LTP are impaired in CBP^{+/-} mice: a model for the cognitive deficit in Rubinstein-Taybi syndrome and its amelioration. *Neuron* 42, 947–959.
- Alarcon, J.M., Hodgman, R., Theis, M., Huang, Y.-S., Kandel, E.R., and Richter, J.D. (2004). Selective modulation of some forms of schaffer collateral-CA1 synaptic plasticity in mice with a disruption of the CPEB-1 gene. *Learn. Mem. Cold Spring Harb. N* 11, 318–327.
- Alberini, C.M. (1999). Genes to remember. *J. Exp. Biol.* 202, 2887–2891.
- Alberini, C.M. (2009). Transcription factors in long-term memory and synaptic plasticity. *Physiol. Rev.* 89, 121–145.
- Alberini, C.M., and Kandel, E.R. (2015). The regulation of transcription in memory consolidation. *Cold Spring Harb. Perspect. Biol.* 7, a021741.
- Alberini, C.M., Ghirardi, M., Metz, R., and Kandel, E.R. (1994). C/EBP is an immediate-early gene required for the consolidation of long-term facilitation in *Aplysia*. *Cell* 76, 1099–1114.
- Alldred, M.J., Duff, K.E., and Ginsberg, S.D. (2012). Microarray analysis of CA1 pyramidal neurons in a mouse model of tauopathy reveals progressive synaptic dysfunction. *Neurobiol. Dis.* 45, 751–762.
- Alonso, M., Bekinschtein, P., Cammarota, M., Vianna, M.R.M., Izquierdo, I., and Medina, J.H. (2005). Endogenous BDNF is required for long-term memory formation in the rat parietal cortex. *Learn. Mem. Cold Spring Harb. N* 12, 504–510.

References

- Altarejos, J.Y., and Montminy, M. (2011). CREB and the CRTC co-activators: sensors for hormonal and metabolic signals. *Nat. Rev. Mol. Cell Biol.* 12, 141–151.
- Anand, R., Gill, K.D., and Mahdi, A.A. (2014). Therapeutics of Alzheimer's disease: Past, present and future. *Neuropharmacology* 76 Pt A, 27–50.
- Andrews-Zwilling, Y., Bien-Ly, N., Xu, Q., Li, G., Bernardo, A., Yoon, S.Y., Zwilling, D., Yan, T.X., Chen, L., and Huang, Y. (2010). Apolipoprotein E4 causes age- and Tau-dependent impairment of GABAergic interneurons, leading to learning and memory deficits in mice. *J. Neurosci. Off. J. Soc. Neurosci.* 30, 13707–13717.
- Arruda-Carvalho, M., Sakaguchi, M., Akers, K.G., Josselyn, S.A., and Frankland, P.W. (2011). Posttraining ablation of adult-generated neurons degrades previously acquired memories. *J. Neurosci. Off. J. Soc. Neurosci.* 31, 15113–15127.
- Atkins, C.M., Selcher, J.C., Petraitis, J.J., Trzaskos, J.M., and Sweatt, J.D. (1998). The MAPK cascade is required for mammalian associative learning. *Nat. Neurosci.* 1, 602–609.
- Aubry, S., Shin, W., Crary, J.F., Lefort, R., Qureshi, Y.H., Lefebvre, C., Califano, A., and Shelanski, M.L. (2015). Assembly and interrogation of Alzheimer's disease genetic networks reveal novel regulators of progression. *PLoS One* 10, e0120352.
- Avila, J., Lucas, J.J., Perez, M., and Hernandez, F. (2004). Role of tau protein in both physiological and pathological conditions. *Physiol. Rev.* 84, 361–384.

B

- Bahari-Javan, S., Maddalena, A., Kerimoglu, C., Wittnam, J., Held, T., Bähr, M., Burkhardt, S., Delalle, I., Kügler, S., Fischer, A., et al. (2012). HDAC1 regulates fear extinction in mice. *J. Neurosci. Off. J. Soc. Neurosci.* 32, 5062–5073.
- Balasubramanyam, K., Swaminathan, V., Ranganathan, A., and Kundu, T.K. (2003). Small molecule modulators of histone acetyltransferase p300. *J. Biol. Chem.* 278, 19134–19140.
- Barco, A. (2007). The Rubinstein-Taybi syndrome: modeling mental impairment in the mouse. *Genes Brain Behav.* 6 Suppl 1, 32–39.
- Barco, A., and Marie, H. (2011). Genetic approaches to investigate the role of CREB in neuronal plasticity and memory. *Mol. Neurobiol.* 44, 330–349.
- Barco, A., Patterson, S.L., Patterson, S., Alarcon, J.M., Gromova, P., Mata-Roig, M., Morozov, A., and Kandel, E.R. (2005). Gene expression profiling of facilitated L-LTP in VP16-CREB mice reveals that BDNF is critical for the maintenance of LTP and its synaptic capture. *Neuron* 48, 123–137.
- Barlev, N.A., Liu, L., Chehab, N.H., Mansfield, K., Harris, K.G., Halazonetis, T.D., and Berger, S.L. (2001). Acetylation of p53 activates transcription through recruitment of coactivators/histone acetyltransferases. *Mol. Cell* 8, 1243–1254.
- Barrett, R.M., and Wood, M.A. (2008). Beyond transcription factors: the role of chromatin modifying enzymes in regulating transcription required for memory. *Learn. Mem. Cold Spring Harb. N* 15, 460–467.
- Barrett, R.M., Malvaez, M., Kramar, E., Matheos, D.P., Arrizon, A., Cabrera, S.M., Lynch, G., Greene, R.W., and Wood, M.A. (2011). Hippocampal focal knockout of CBP affects specific histone modifications, long-term potentiation, and long-term memory. *Neuropsychopharmacol. Off. Publ. Am. Coll. Neuropsychopharmacol.* 36, 1545–1556.

References

- Bartoletti, A., Cancedda, L., Reid, S.W., Tessarollo, L., Porciatti, V., Pizzorusso, T., and Maffei, L. (2002). Heterozygous knock-out mice for brain-derived neurotrophic factor show a pathway-specific impairment of long-term potentiation but normal critical period for monocular deprivation. *J. Neurosci. Off. J. Soc. Neurosci.* 22, 10072–10077.
- Bath, K.G., and Lee, F.S. (2006). Variant BDNF (Val66Met) impact on brain structure and function. *Cogn. Affect. Behav. Neurosci.* 6, 79–85.
- Baune, B.T., Suslow, T., Engeli, A., Arolt, V., and Berger, K. (2006). The association between depressive mood and cognitive performance in an elderly general population - the MEMO Study. *Dement. Geriatr. Cogn. Disord.* 22, 142–149.
- Bedford, D.C., and Brindle, P.K. (2012). Is histone acetylation the most important physiological function for CBP and p300? *Aging* 4, 247–255.
- Bedford, M.T., and Clarke, S.G. (2009). Protein arginine methylation in mammals: who, what, and why. *Mol. Cell* 33, 1–13.
- Belarbi, K., Burnouf, S., Fernandez-Gomez, F.-J., Desmercières, J., Troquier, L., Brouillette, J., Tsambou, L., Grosjean, M.-E., Caillierez, R., Demeyer, D., et al. (2011). Loss of medial septum cholinergic neurons in THY-Tau22 mouse model: what links with tau pathology? *Curr. Alzheimer Res.* 8, 633–638.
- van Belzen, M., Bartsch, O., Lacombe, D., Peters, D.J.M., and Hennekam, R.C.M. (2011). Rubinstein-Taybi syndrome (CREBBP, EP300). *Eur. J. Hum. Genet. EJHG* 19, preceding 118–120.
- Benito, E., and Barco, A. (2010). CREB's control of intrinsic and synaptic plasticity: implications for CREB-dependent memory models. *Trends Neurosci.* 33, 230–240.
- Benito, E., Urbanke, H., Ramachandran, B., Barth, J., Halder, R., Awasthi, A., Jain, G., Capece, V., Burkhardt, S., Navarro-Sala, M., et al. (2015). HDAC inhibitor-dependent transcriptome and memory reinstatement in cognitive decline models. *J. Clin. Invest.* 125, 3572–3584.
- Berardi, A.M., Parasuraman, R., and Haxby, J.V. (2005). Sustained attention in mild Alzheimer's disease. *Dev. Neuropsychol.* 28, 507–537.
- Bergami, M., Masserdotti, G., Temprana, S.G., Motori, E., Eriksson, T.M., Göbel, J., Yang, S.M., Conzelmann, K.-K., Schinder, A.F., Götz, M., et al. (2015). A critical period for experience-dependent remodeling of adult-born neuron connectivity. *Neuron* 85, 710–717.
- Berger, S.L. (2007). The complex language of chromatin regulation during transcription. *Nature* 447, 407–412.
- Berman, D.E., Hazvi, S., Rosenblum, K., Seger, R., and Dudai, Y. (1998). Specific and differential activation of mitogen-activated protein kinase cascades by unfamiliar taste in the insular cortex of the behaving rat. *J. Neurosci. Off. J. Soc. Neurosci.* 18, 10037–10044.
- Besnard, A., Caboche, J., and Laroche, S. (2013). Recall and reconsolidation of contextual fear memory: differential control by ERK and Zif268 expression dosage. *PLoS One* 8, e72006.
- Bien-Ly, N., Andrews-Zwilling, Y., Xu, Q., Bernardo, A., Wang, C., and Huang, Y. (2011). C-terminal-truncated apolipoprotein (apo) E4 inefficiently clears amyloid-beta (Abeta) and acts in concert with Abeta to elicit neuronal and behavioral deficits in mice. *Proc. Natl. Acad. Sci. U. S. A.* 108, 4236–4241.

References

- Bindschäedler, C., Peter-Favre, C., Maeder, P., Hirsbrunner, T., and Clarke, S. (2011). Growing up with bilateral hippocampal atrophy: from childhood to teenage. *Cortex J. Devoted Study Nerv. Syst. Behav.* 47, 931–944.
- Bird, C.M., and Burgess, N. (2008). The hippocampus and memory: insights from spatial processing. *Nat. Rev. Neurosci.* 9, 182–194.
- Birks, J., Grimley Evans, J., Iakovidou, V., Tsolaki, M., and Holt, F.E. (2009). Rivastigmine for Alzheimer's disease. *Cochrane Database Syst. Rev.* CD001191.
- Blackwell, J.S., Wilkinson, S.T., Mosammaparast, N., and Pemberton, L.F. (2007). Mutational analysis of H3 and H4 N termini reveals distinct roles in nuclear import. *J. Biol. Chem.* 282, 20142–20150.
- Bliss, T.V., and Collingridge, G.L. (1993). A synaptic model of memory: long-term potentiation in the hippocampus. *Nature* 361, 31–39.
- Boeras, D.I., Granic, A., Padmanabhan, J., Crespo, N.C., Rojiani, A.M., and Potter, H. (2008). Alzheimer's presenilin 1 causes chromosome missegregation and aneuploidy. *Neurobiol. Aging* 29, 319–328.
- Bonaguidi, M.A., Wheeler, M.A., Shapiro, J.S., Stadel, R.P., Sun, G.J., Ming, G., and Song, H. (2011). In vivo clonal analysis reveals self-renewing and multipotent adult neural stem cell characteristics. *Cell* 145, 1142–1155.
- Bourne, J.N., and Harris, K.M. (2008). Balancing structure and function at hippocampal dendritic spines. *Annu. Rev. Neurosci.* 31, 47–67.
- Bourtchouladze, R., Abel, T., Berman, N., Gordon, R., Lapidus, K., and Kandel, E.R. (1998). Different training procedures recruit either one or two critical periods for contextual memory consolidation, each of which requires protein synthesis and PKA. *Learn. Mem. Cold Spring Harb. N* 5, 365–374.
- Bourtchouladze, R., Lidge, R., Catapano, R., Stanley, J., Gossweiler, S., Romashko, D., Scott, R., and Tully, T. (2003). A mouse model of Rubinstein-Taybi syndrome: defective long-term memory is ameliorated by inhibitors of phosphodiesterase 4. *Proc. Natl. Acad. Sci. U. S. A.* 100, 10518–10522.
- Bourtchouladze, R., Frenguelli, B., Blendy, J., Cioffi, D., Schutz, G., and Silva, A.J. (1994). Deficient long-term memory in mice with a targeted mutation of the cAMP-responsive element-binding protein. *Cell* 79, 59–68.
- Bousiges, O., Vasconcelos, A.P. de, Neidl, R., Cosquer, B., Herbeaux, K., Panteleeva, I., Loeffler, J.-P., Cassel, J.-C., and Boutillier, A.-L. (2010). Spatial memory consolidation is associated with induction of several lysine-acetyltransferase (histone acetyltransferase) expression levels and H2B/H4 acetylation-dependent transcriptional events in the rat hippocampus. *Neuropsychopharmacol. Off. Publ. Am. Coll. Neuropsychopharmacol.* 35, 2521–2537.
- Bousiges, O., Neidl, R., Majchrzak, M., Müller, M.-A., Barbelivien, A., Pereira de Vasconcelos, A., Schneider, A., Loeffler, J.-P., Cassel, J.-C., and Boutillier, A.-L. (2013). Detection of histone acetylation levels in the dorsal hippocampus reveals early tagging on specific residues of H2B and H4 histones in response to learning. *PLoS One* 8, e57816.
- Bozon, B., Davis, S., and Laroche, S. (2002). Regulated transcription of the immediate-early gene *Zif268*: mechanisms and gene dosage-dependent function in synaptic plasticity and memory formation. *Hippocampus* 12, 570–577.

References

- Bozon, B., Davis, S., and Laroche, S. (2003). A requirement for the immediate early gene *zif268* in reconsolidation of recognition memory after retrieval. *Neuron* 40, 695–701.
- Braak, H., and Braak, E. (1991). Neuropathological staging of Alzheimer-related changes. *Acta Neuropathol. (Berl.)* 82, 239–259.
- Braak, H., and Braak, E. (1998). Evolution of neuronal changes in the course of Alzheimer's disease. *J. Neural Transm. Suppl.* 53, 127–140.
- Braak, H., and Del Tredici, K. (2011). The pathological process underlying Alzheimer's disease in individuals under thirty. *Acta Neuropathol. (Berl.)* 121, 171–181.
- Braak, H., de Vos, R.A., Jansen, E.N., Bratzke, H., and Braak, E. (1998). Neuropathological hallmarks of Alzheimer's and Parkinson's diseases. *Prog. Brain Res.* 117, 267–285.
- Bramham, C.R. (2007). Control of synaptic consolidation in the dentate gyrus: mechanisms, functions, and therapeutic implications. *Prog. Brain Res.* 163, 453–471.
- Bramham, C.R., Alme, M.N., Bittins, M., Kuipers, S.D., Nair, R.R., Pai, B., Panja, D., Schubert, M., Soule, J., Tiron, A., et al. (2010). The Arc of synaptic memory. *Exp. Brain Res.* 200, 125–140.
- Brandeis, R., Brandys, Y., and Yehuda, S. (1989). The use of the Morris Water Maze in the study of memory and learning. *Int. J. Neurosci.* 48, 29–69.
- Bré, M.H., and Karsenti, E. (1990). Effects of brain microtubule-associated proteins on microtubule dynamics and the nucleating activity of centrosomes. *Cell Motil. Cytoskeleton* 15, 88–98.
- Bredy, T.W., and Barad, M. (2008). The histone deacetylase inhibitor valproic acid enhances acquisition, extinction, and reconsolidation of conditioned fear. *Learn. Mem. Cold Spring Harb. N* 15, 39–45.
- Bredy, T.W., Wu, H., Crego, C., Zellhoefer, J., Sun, Y.E., and Barad, M. (2007). Histone modifications around individual BDNF gene promoters in prefrontal cortex are associated with extinction of conditioned fear. *Learn. Mem. Cold Spring Harb. N* 14, 268–276.
- Bridi, M.S., and Abel, T. (2013). The NR4A orphan nuclear receptors mediate transcription-dependent hippocampal synaptic plasticity. *Neurobiol. Learn. Mem.* 105, 151–158.
- Brigman, J.L., Wright, T., Talani, G., Prasad-Mulcare, S., Jinde, S., Seabold, G.K., Mathur, P., Davis, M.I., Bock, R., Gustin, R.M., et al. (2010). Loss of GluN2B-containing NMDA receptors in CA1 hippocampus and cortex impairs long-term depression, reduces dendritic spine density, and disrupts learning. *J. Neurosci. Off. J. Soc. Neurosci.* 30, 4590–4600.
- Brodbeck, J., McGuire, J., Liu, Z., Meyer-Franke, A., Balestra, M.E., Jeong, D., Pleiss, M., McComas, C., Hess, F., Witter, D., et al. (2011). Structure-dependent impairment of intracellular apolipoprotein E4 trafficking and its detrimental effects are rescued by small-molecule structure correctors. *J. Biol. Chem.* 286, 17217–17226.
- Broide, R.S., Redwine, J.M., Aftahi, N., Young, W., Bloom, F.E., and Winrow, C.J. (2007). Distribution of histone deacetylases 1-11 in the rat brain. *J. Mol. Neurosci.* MN 31, 47–58.
- Brooks, D.N., and Baddeley, A.D. (1976). What can amnesic patients learn? *Neuropsychologia* 14, 111–122.
- Brownlow, M.L., Joly-Amado, A., Azam, S., Elza, M., Selenica, M.-L., Pappas, C., Small, B., Engelman, R., Gordon, M.N., and Morgan, D. (2014). Partial rescue of memory deficits induced by calorie restriction in a mouse model of tau deposition. *Behav. Brain Res.* 271, 79–88.

References

- Bruel-Jungerman, E., Laroche, S., and Rampon, C. (2005). New neurons in the dentate gyrus are involved in the expression of enhanced long-term memory following environmental enrichment. *Eur. J. Neurosci.* 21, 513–521.
- Bruel-Jungerman, E., Davis, S., Rampon, C., and Laroche, S. (2006). Long-term potentiation enhances neurogenesis in the adult dentate gyrus. *J. Neurosci. Off. J. Soc. Neurosci.* 26, 5888–5893.
- Brunelli, M., Castellucci, V., and Kandel, E.R. (1976). Synaptic facilitation and behavioral sensitization in *Aplysia*: possible role of serotonin and cyclic AMP. *Science* 194, 1178–1181.
- Bucci, D.J., Chiba, A.A., and Gallagher, M. (1995). Spatial learning in male and female Long-Evans rats. *Behav. Neurosci.* 109, 180–183.
- Burlot, M.-A., Braudeau, J., Michaelsen-Preusse, K., Potier, B., Ayciriex, S., Varin, J., Gautier, B., Djelti, F., Audrain, M., Dauphinot, L., et al. (2015). Cholesterol 24-hydroxylase defect is implicated in memory impairments associated with Alzheimer-like Tau pathology. *Hum. Mol. Genet.*
- Burnouf, S., Belarbi, K., Troquier, L., Derisbourg, M., Demeyer, D., Leboucher, A., Laurent, C., Hamdane, M., Buee, L., and Blum, D. (2012). Hippocampal BDNF expression in a tau transgenic mouse model. *Curr. Alzheimer Res.* 9, 406–410.
- Burnouf, S., Martire, A., Derisbourg, M., Laurent, C., Belarbi, K., Leboucher, A., Fernandez-Gomez, F.J., Troquier, L., Eddarkaoui, S., Grosjean, M.-E., et al. (2013). NMDA receptor dysfunction contributes to impaired brain-derived neurotrophic factor-induced facilitation of hippocampal synaptic transmission in a Tau transgenic model. *Aging Cell* 12, 11–23.

C

- Caccamo, A., Maldonado, M.A., Bokov, A.F., Majumder, S., and Oddo, S. (2010). CBP gene transfer increases BDNF levels and ameliorates learning and memory deficits in a mouse model of Alzheimer's disease. *Proc. Natl. Acad. Sci. U. S. A.* 107, 22687–22692.
- Caceres, A., and Kosik, K.S. (1990). Inhibition of neurite polarity by tau antisense oligonucleotides in primary cerebellar neurons. *Nature* 343, 461–463.
- Caceres, A., Potrebic, S., and Kosik, K.S. (1991). The effect of tau antisense oligonucleotides on neurite formation of cultured cerebellar macroneurons. *J. Neurosci. Off. J. Soc. Neurosci.* 11, 1515–1523.
- Caroni, P., Chowdhury, A., and Lahr, M. (2014). Synapse rearrangements upon learning: from divergent-sparse connectivity to dedicated sub-circuits. *Trends Neurosci.* 37, 604–614.
- Chang, L., Loranger, S.S., Mizzen, C., Ernst, S.G., Allis, C.D., and Annunziato, A.T. (1997). Histones in transit: cytosolic histone complexes and diacetylation of H4 during nucleosome assembly in human cells. *Biochemistry (Mosc.)* 36, 469–480.
- Chatterjee, S., Mizar, P., Cassel, R., Neidl, R., Selvi, B.R., Mohankrishna, D.V., Vedamurthy, B.M., Schneider, A., Bousiges, O., Mathis, C., et al. (2013). A novel activator of CBP/p300 acetyltransferases promotes neurogenesis and extends memory duration in adult mice. *J. Neurosci. Off. J. Soc. Neurosci.* 33, 10698–10712.
- Chen, S.-C., and Olsthoorn, R.C.L. (2010). In vitro and in vivo studies of the RNA conformational switch in Alfalfa mosaic virus. *J. Virol.* 84, 1423–1429.

References

- Chen, G., Zou, X., Watanabe, H., van Deursen, J.M., and Shen, J. (2010). CREB binding protein is required for both short-term and long-term memory formation. *J. Neurosci. Off. J. Soc. Neurosci.* 30, 13066–13077.
- Chen, H.-K., Liu, Z., Meyer-Franke, A., Brodbeck, J., Miranda, R.D., McGuire, J.G., Pleiss, M.A., Ji, Z.-S., Balestra, M.E., Walker, D.W., et al. (2012). Small molecule structure correctors abolish detrimental effects of apolipoprotein E4 in cultured neurons. *J. Biol. Chem.* 287, 5253–5266.
- Chen, J., Kanai, Y., Cowan, N.J., and Hirokawa, N. (1992). Projection domains of MAP2 and tau determine spacings between microtubules in dendrites and axons. *Nature* 360, 674–677.
- Chen, W.G., Chang, Q., Lin, Y., Meissner, A., West, A.E., Griffith, E.C., Jaenisch, R., and Greenberg, M.E. (2003). Derepression of BDNF transcription involves calcium-dependent phosphorylation of MeCP2. *Science* 302, 885–889.
- Chen, X.-F., Zhang, Y., Xu, H., and Bu, G. (2013). Transcriptional regulation and its misregulation in Alzheimer's disease. *Mol. Brain* 6, 44.
- Chen, Y., Durakoglugil, M.S., Xian, X., and Herz, J. (2010). ApoE4 reduces glutamate receptor function and synaptic plasticity by selectively impairing ApoE receptor recycling. *Proc. Natl. Acad. Sci. U. S. A.* 107, 12011–12016.
- Chen, Z.-Y., Jing, D., Bath, K.G., Ieraci, A., Khan, T., Siao, C.-J., Herrera, D.G., Toth, M., Yang, C., McEwen, B.S., et al. (2006). Genetic variant BDNF (Val66Met) polymorphism alters anxiety-related behavior. *Science* 314, 140–143.
- Chen Lf, null, Fischle, W., Verdin, E., and Greene, W.C. (2001). Duration of nuclear NF-kappaB action regulated by reversible acetylation. *Science* 293, 1653–1657.
- Cheung, P., Tanner, K.G., Cheung, W.L., Sassone-Corsi, P., Denu, J.M., and Allis, C.D. (2000). Synergistic coupling of histone H3 phosphorylation and acetylation in response to epidermal growth factor stimulation. *Mol. Cell* 5, 905–915.
- Chicurel, M.E., and Harris, K.M. (1992). Three-dimensional analysis of the structure and composition of CA3 branched dendritic spines and their synaptic relationships with mossy fiber boutons in the rat hippocampus. *J. Comp. Neurol.* 325, 169–182.
- Choi, J.K., and Howe, L.J. (2009). Histone acetylation: truth of consequences? *Biochem. Cell Biol. Biochim. Biol. Cell.* 87, 139–150.
- Christian, K.M., Song, H., and Ming, G. (2014). Functions and dysfunctions of adult hippocampal neurogenesis. *Annu. Rev. Neurosci.* 37, 243–262.
- Chrivia, J.C., Kwok, R.P., Lamb, N., Hagiwara, M., Montminy, M.R., and Goodman, R.H. (1993). Phosphorylated CREB binds specifically to the nuclear protein CBP. *Nature* 365, 855–859.
- Chwang, W.B., O'Riordan, K.J., Levenson, J.M., and Sweatt, J.D. (2006). ERK/MAPK regulates hippocampal histone phosphorylation following contextual fear conditioning. *Learn. Mem. Cold Spring Harb. N* 13, 322–328.
- Cirulli, F., Berry, A., Chiarotti, F., and Alleva, E. (2004). Intrahippocampal administration of BDNF in adult rats affects short-term behavioral plasticity in the Morris water maze and performance in the elevated plus-maze. *Hippocampus* 14, 802–807.
- Clarke, J.R., Cammarota, M., Gruart, A., Izquierdo, I., and Delgado-García, J.M. (2010). Plastic modifications induced by object recognition memory processing. *Proc. Natl. Acad. Sci. U. S. A.* 107, 2652–2657.

References

- Clayton, A.L., Rose, S., Barratt, M.J., and Mahadevan, L.C. (2000). Phosphoacetylation of histone H3 on c-fos- and c-jun-associated nucleosomes upon gene activation. *EMBO J.* 19, 3714–3726.
- Clelland, C.D., Choi, M., Romberg, C., Clemenson, G.D., Fragniere, A., Tyers, P., Jessberger, S., Saksida, L.M., Barker, R.A., Gage, F.H., et al. (2009). A functional role for adult hippocampal neurogenesis in spatial pattern separation. *Science* 325, 210–213.
- Cohen, N.J., and Squire, L.R. (1980). Preserved learning and retention of pattern-analyzing skill in amnesia: dissociation of knowing how and knowing that. *Science* 210, 207–210.
- Cohen, T.J., Guo, J.L., Hurtado, D.E., Kwong, L.K., Mills, I.P., Trojanowski, J.Q., and Lee, V.M.Y. (2011). The acetylation of tau inhibits its function and promotes pathological tau aggregation. *Nat. Commun.* 2, 252.
- Cohen, T.J., Friedmann, D., Hwang, A.W., Marmorstein, R., and Lee, V.M.Y. (2013). The microtubule-associated tau protein has intrinsic acetyltransferase activity. *Nat. Struct. Mol. Biol.* 20, 756–762.
- Colón-Cesario, W.I., Martínez-Montemayor, M.M., Morales, S., Félix, J., Cruz, J., Adorno, M., Pereira, L., Colón, N., Maldonado-Vlaar, C.S., and Peña de Ortiz, S. (2006). Knockdown of Nurr1 in the rat hippocampus: implications to spatial discrimination learning and memory. *Learn. Mem. Cold Spring Harb. N* 13, 734–744.
- Conaway, J.W. (2012). Introduction to Theme “Chromatin, Epigenetics, and Transcription.” *Annu. Rev. Biochem.* 81, 61–64.
- Conkright, M.D., Guzmán, E., Flechner, L., Su, A.I., Hogenesch, J.B., and Montminy, M. (2003a). Genome-wide analysis of CREB target genes reveals a core promoter requirement for cAMP responsiveness. *Mol. Cell* 11, 1101–1108.
- Conkright, M.D., Canettieri, G., Sreaton, R., Guzman, E., Miraglia, L., Hogenesch, J.B., and Montminy, M. (2003b). TORCs: transducers of regulated CREB activity. *Mol. Cell* 12, 413–423.
- Conti, A.C., Cryan, J.F., Dalvi, A., Lucki, I., and Blendy, J.A. (2002). cAMP response element-binding protein is essential for the upregulation of brain-derived neurotrophic factor transcription, but not the behavioral or endocrine responses to antidepressant drugs. *J. Neurosci. Off. J. Soc. Neurosci.* 22, 3262–3268.
- Conti, A.C., Kuo, Y.-C., Valentino, R.J., and Blendy, J.A. (2004). Inducible cAMP early repressor regulates corticosterone suppression after tricyclic antidepressant treatment. *J. Neurosci. Off. J. Soc. Neurosci.* 24, 1967–1975.
- Cook, C., Carlomagno, Y., Gendron, T.F., Dunmore, J., Scheffel, K., Stetler, C., Davis, M., Dickson, D., Jarpe, M., DeTure, M., et al. (2014). Acetylation of the KXGS motifs in tau is a critical determinant in modulation of tau aggregation and clearance. *Hum. Mol. Genet.* 23, 104–116.
- Crampton, S.J., and O’Keeffe, G.W. (2013). NF- κ B: emerging roles in hippocampal development and function. *Int. J. Biochem. Cell Biol.* 45, 1821–1824.
- Crosio, C., Heitz, E., Allis, C.D., Borrelli, E., and Sassone-Corsi, P. (2003). Chromatin remodeling and neuronal response: multiple signaling pathways induce specific histone H3 modifications and early gene expression in hippocampal neurons. *J. Cell Sci.* 116, 4905–4914.

References

Cuadrado-Tejedor, M., Ricobaraza, A.L., Torrijo, R., Franco, R., and Garcia-Osta, A. (2013). Phenylbutyrate is a multifaceted drug that exerts neuroprotective effects and reverses the Alzheimer's disease-like phenotype of a commonly used mouse model. *Curr. Pharm. Des.* 19, 5076–5084.

Cunha, C., Brambilla, R., and Thomas, K.L. (2010). A simple role for BDNF in learning and memory? *Front. Mol. Neurosci.* 3, 1.



Danilova, A.B., Kharchenko, O.A., Shevchenko, K.G., and Grinkevich, L.N. (2010). Histone H3 Acetylation is Asymmetrically Induced Upon Learning in Identified Neurons of the Food Aversion Network in the Mollusk *Helix Lucorum*. *Front. Behav. Neurosci.* 4, 180.

Dash, P.K., Hochner, B., and Kandel, E.R. (1990). Injection of the cAMP-responsive element into the nucleus of *Aplysia* sensory neurons blocks long-term facilitation. *Nature* 345, 718–721.

Davie, J.R., and Chadee, D.N. (1998). Regulation and regulatory parameters of histone modifications. *J. Cell. Biochem. Suppl.* 30-31, 203–213.

Davis, S., Vanhoutte, P., Pages, C., Caboche, J., and Laroche, S. (2000). The MAPK/ERK cascade targets both Elk-1 and cAMP response element-binding protein to control long-term potentiation-dependent gene expression in the dentate gyrus in vivo. *J. Neurosci. Off. J. Soc. Neurosci.* 20, 4563–4572.

Davis, S., Renaudineau, S., Poirier, R., Poucet, B., Save, E., and Laroche, S. (2010). The formation and stability of recognition memory: what happens upon recall? *Front. Behav. Neurosci.* 4, 177.

Deng, W., Saxe, M.D., Gallina, I.S., and Gage, F.H. (2009). Adult-born hippocampal dentate granule cells undergoing maturation modulate learning and memory in the brain. *J. Neurosci. Off. J. Soc. Neurosci.* 29, 13532–13542.

Deng, W., Aimone, J.B., and Gage, F.H. (2010). New neurons and new memories: how does adult hippocampal neurogenesis affect learning and memory? *Nat. Rev. Neurosci.* 11, 339–350.

De-Paula, V.J., Radanovic, M., Diniz, B.S., and Forlenza, O.V. (2012). Alzheimer's disease. *Subcell. Biochem.* 65, 329–352.

Derdikman, D., and Moser, E.I. (2010). A manifold of spatial maps in the brain. *Trends Cogn. Sci.* 14, 561–569.

Deshpande, A., Bergami, M., Ghanem, A., Conzelmann, K.-K., Lepier, A., Götz, M., and Berninger, B. (2013). Retrograde monosynaptic tracing reveals the temporal evolution of inputs onto new neurons in the adult dentate gyrus and olfactory bulb. *Proc. Natl. Acad. Sci. U. S. A.* 110, E1152–E1161.

D'Hooge, R., and De Deyn, P.P. (2001). Applications of the Morris water maze in the study of learning and memory. *Brain Res. Brain Res. Rev.* 36, 60–90.

Diba, K., and Buzsáki, G. (2007). Forward and reverse hippocampal place-cell sequences during ripples. *Nat. Neurosci.* 10, 1241–1242.

Ding, H., Dolan, P.J., and Johnson, G.V.W. (2008). Histone deacetylase 6 interacts with the microtubule-associated protein tau. *J. Neurochem.* 106, 2119–2130.

References

- Dingledine, R., Borges, K., Bowie, D., and Traynelis, S.F. (1999). The glutamate receptor ion channels. *Pharmacol. Rev.* 51, 7–61.
- Drake, C.T., Milner, T.A., and Patterson, S.L. (1999). Ultrastructural localization of full-length trkB immunoreactivity in rat hippocampus suggests multiple roles in modulating activity-dependent synaptic plasticity. *J. Neurosci. Off. J. Soc. Neurosci.* 19, 8009–8026.
- Drubin, D.G., and Kirschner, M.W. (1986). Tau protein function in living cells. *J. Cell Biol.* 103, 2739–2746.
- Drzewinska, J., Walczak-Drzewiecka, A., and Ratajewski, M. (2011). Identification and analysis of the promoter region of the human DHCR24 gene: involvement of DNA methylation and histone acetylation. *Mol. Biol. Rep.* 38, 1091–1101.
- Duclot, F., Meffre, J., Jacquet, C., Gongora, C., and Maurice, T. (2010). Mice knock out for the histone acetyltransferase p300/CREB binding protein-associated factor develop a resistance to amyloid toxicity. *Neuroscience* 167, 850–863.
- Dupret, D., Fabre, A., Döbrössy, M.D., Panatier, A., Rodríguez, J.J., Lamarque, S., Lemaire, V., Olier, S.H.R., Piazza, P.-V., and Abrous, D.N. (2007). Spatial learning depends on both the addition and removal of new hippocampal neurons. *PLoS Biol.* 5, e214.

E

-
- Egger, G., Liang, G., Aparicio, A., and Jones, P.A. (2004). Epigenetics in human disease and prospects for epigenetic therapy. *Nature* 429, 457–463.
- Ekwall, K. (2005). Genome-wide analysis of HDAC function. *Trends Genet. TIG* 21, 608–615.
- English, J.D., and Sweatt, J.D. (1996). Activation of p42 mitogen-activated protein kinase in hippocampal long term potentiation. *J. Biol. Chem.* 271, 24329–24332.
- Ernfors, P., Lee, K.F., and Jaenisch, R. (1994). Mice lacking brain-derived neurotrophic factor develop with sensory deficits. *Nature* 368, 147–150.

F

-
- Fass, D.M., Butler, J.E.F., and Goodman, R.H. (2003). Deacetylase activity is required for cAMP activation of a subset of CREB target genes. *J. Biol. Chem.* 278, 43014–43019.
- Felsenfeld, G. (2014). A Brief History of Epigenetics. *Cold Spring Harb. Perspect. Biol.* 6, a018200–a018200.
- Fiore, R.S., Murphy, T.H., Sanghera, J.S., Pelech, S.L., and Baraban, J.M. (1993). Activation of p42 mitogen-activated protein kinase by glutamate receptor stimulation in rat primary cortical cultures. *J. Neurochem.* 61, 1626–1633.
- Fischer, A. (2014a). Epigenetic memory: the Lamarckian brain. *EMBO J.* 33, 945–967.
- Fischer, A. (2014b). Targeting histone-modifications in Alzheimer's disease. What is the evidence that this is a promising therapeutic avenue? *Neuropharmacology* 80, 95–102.
- Fischer, E.H., and Krebs, E.G. (1955). Conversion of phosphorylase b to phosphorylase a in muscle extracts. *J. Biol. Chem.* 216, 121–132.
- Fischer, A., Sananbenesi, F., Wang, X., Dobbin, M., and Tsai, L.-H. (2007). Recovery of learning and memory is associated with chromatin remodelling. *Nature* 447, 178–182.
- Fischle, W., Wang, Y., and Allis, C.D. (2003). Histone and chromatin cross-talk. *Curr. Opin. Cell Biol.* 15, 172–183.

References

- Flavell, S.W., and Greenberg, M.E. (2008). Signaling mechanisms linking neuronal activity to gene expression and plasticity of the nervous system. *Annu. Rev. Neurosci.* 31, 563–590.
- Fox, L.M., William, C.M., Adamowicz, D.H., Pitstick, R., Carlson, G.A., Spires-Jones, T.L., and Hyman, B.T. (2011). Soluble tau species, not neurofibrillary aggregates, disrupt neural system integration in a tau transgenic model. *J. Neuropathol. Exp. Neurol.* 70, 588–595.
- Francis, Y.I., Fà, M., Ashraf, H., Zhang, H., Staniszewski, A., Latchman, D.S., and Arancio, O. (2009). Dysregulation of histone acetylation in the APP/PS1 mouse model of Alzheimer's disease. *J. Alzheimers Dis. JAD* 18, 131–139.
- Frankland, P.W., and Bontempi, B. (2005). The organization of recent and remote memories. *Nat. Rev. Neurosci.* 6, 119–130.
- Frankland, P.W., Bontempi, B., Talton, L.E., Kaczmarek, L., and Silva, A.J. (2004). The involvement of the anterior cingulate cortex in remote contextual fear memory. *Science* 304, 881–883.
- Frisch, S.M., and Mymryk, J.S. (2002). Adenovirus-5 E1A: paradox and paradigm. *Nat. Rev. Mol. Cell Biol.* 3, 441–452.
- Frotscher, M., Seress, L., Schwerdtfeger, W.K., and Buhl, E. (1991). The mossy cells of the fascia dentata: a comparative study of their fine structure and synaptic connections in rodents and primates. *J. Comp. Neurol.* 312, 145–163.
- Füllgrabe, J., Kavanagh, E., and Joseph, B. (2011). Histone onco-modifications. *Oncogene* 30, 3391–3403.



-
- Gabrieli, J.D., Cohen, N.J., and Corkin, S. (1988). The impaired learning of semantic knowledge following bilateral medial temporal-lobe resection. *Brain Cogn.* 7, 157–177.
- Gage, F.H. (2000). Mammalian neural stem cells. *Science* 287, 1433–1438.
- García-Sierra, F., Wischik, C.M., Harrington, C.R., Luna-Muñoz, J., and Mena, R. (2001). Accumulation of C-terminally truncated tau protein associated with vulnerability of the perforant pathway in early stages of neurofibrillary pathology in Alzheimer's disease. *J. Chem. Neuroanat.* 22, 65–77.
- Gardiner, J.M., Brandt, K.R., Baddeley, A.D., Vargha-Khadem, F., and Mishkin, M. (2008). Charting the acquisition of semantic knowledge in a case of developmental amnesia. *Neuropsychologia* 46, 2865–2868.
- Garner, A.R., Rowland, D.C., Hwang, S.Y., Baumgaertel, K., Roth, B.L., Kentros, C., and Mayford, M. (2012). Generation of a synthetic memory trace. *Science* 335, 1513–1516.
- Gärtner, A., Polnau, D.G., Staiger, V., Sciarretta, C., Minichiello, L., Thoenen, H., Bonhoeffer, T., and Korte, M. (2006). Hippocampal long-term potentiation is supported by presynaptic and postsynaptic tyrosine receptor kinase B-mediated phospholipase Cgamma signaling. *J. Neurosci. Off. J. Soc. Neurosci.* 26, 3496–3504.
- Ge, S., Yang, C.-H., Hsu, K.-S., Ming, G.-L., and Song, H. (2007). A critical period for enhanced synaptic plasticity in newly generated neurons of the adult brain. *Neuron* 54, 559–566.
- Gehrking, K.M., Andresen, J.M., Duvick, L., Lough, J., Zoghbi, H.Y., and Orr, H.T. (2011). Partial loss of Tip60 slows mid-stage neurodegeneration in a spinocerebellar ataxia type 1 (SCA1) mouse model. *Hum. Mol. Genet.* 20, 2204–2212.

References

- Genoux, D., Haditsch, U., Knobloch, M., Michalon, A., Storm, D., and Mansuy, I.M. (2002). Protein phosphatase 1 is a molecular constraint on learning and memory. *Nature* 418, 970–975.
- Giralt, A., Puigdellívol, M., Carretón, O., Paoletti, P., Valero, J., Parra-Damas, A., Saura, C.A., Alberch, J., and Ginés, S. (2012). Long-term memory deficits in Huntington’s disease are associated with reduced CBP histone acetylase activity. *Hum. Mol. Genet.* 21, 1203–1216.
- Gjoneska, E., Pfenning, A.R., Mathys, H., Quon, G., Kundaje, A., Tsai, L.-H., and Kellis, M. (2015). Conserved epigenomic signals in mice and humans reveal immune basis of Alzheimer’s disease. *Nature* 518, 365–369.
- Goedert, M., and Jakes, R. (1990). Expression of separate isoforms of human tau protein: correlation with the tau pattern in brain and effects on tubulin polymerization. *EMBO J.* 9, 4225–4230.
- Goh, J.J., and Manahan-Vaughan, D. (2013). Endogenous hippocampal LTD that is enabled by spatial object recognition requires activation of NMDA receptors and the metabotropic glutamate receptor, mGlu5. *Hippocampus* 23, 129–138.
- Goldberg, A.D., Allis, C.D., and Bernstein, E. (2007). Epigenetics: a landscape takes shape. *Cell* 128, 635–638.
- Goodman, R.H., and Smolik, S. (2000). CBP/p300 in cell growth, transformation, and development. *Genes Dev.* 14, 1553–1577.
- Goodman, T., Trouche, S., Massou, I., Verret, L., Zerwas, M., Roulet, P., and Rampon, C. (2010). Young hippocampal neurons are critical for recent and remote spatial memory in adult mice. *Neuroscience* 171, 769–778.
- Gorski, J.A., Zeiler, S.R., Tamowski, S., and Jones, K.R. (2003a). Brain-derived neurotrophic factor is required for the maintenance of cortical dendrites. *J. Neurosci. Off. J. Soc. Neurosci.* 23, 6856–6865.
- Gorski, J.A., Balogh, S.A., Wehner, J.M., and Jones, K.R. (2003b). Learning deficits in forebrain-restricted brain-derived neurotrophic factor mutant mice. *Neuroscience* 121, 341–354.
- Govindarajan, N., Rao, P., Burkhardt, S., Sananbenesi, F., Schlüter, O.M., Bradke, F., Lu, J., and Fischer, A. (2013). Reducing HDAC6 ameliorates cognitive deficits in a mouse model for Alzheimer’s disease. *EMBO Mol. Med.* 5, 52–63.
- Gräff, J., and Tsai, L.-H. (2013). The potential of HDAC inhibitors as cognitive enhancers. *Annu. Rev. Pharmacol. Toxicol.* 53, 311–330.
- Gräff, J., Kim, D., Dobbin, M.M., and Tsai, L.-H. (2011). Epigenetic regulation of gene expression in physiological and pathological brain processes. *Physiol. Rev.* 91, 603–649.
- Gräff, J., Woldemichael, B.T., Berchtold, D., Dewarrat, G., and Mansuy, I.M. (2012). Dynamic histone marks in the hippocampus and cortex facilitate memory consolidation. *Nat. Commun.* 3, 991.
- Greenberg, M.E., and Ziff, E.B. (1984). Stimulation of 3T3 cells induces transcription of the c-fos proto-oncogene. *Nature* 311, 433–438.
- Grover, A., Houlden, H., Baker, M., Adamson, J., Lewis, J., Prihar, G., Pickering-Brown, S., Duff, K., and Hutton, M. (1999). 5’ splice site mutations in tau associated with the inherited

References

- dementia FTDP-17 affect a stem-loop structure that regulates alternative splicing of exon 10. *J. Biol. Chem.* 274, 15134–15143.
- Gruart, A., Benito, E., Delgado-García, J.M., and Barco, A. (2012). Enhanced cAMP response element-binding protein activity increases neuronal excitability, hippocampal long-term potentiation, and classical eyeblink conditioning in alert behaving mice. *J. Neurosci. Off. J. Soc. Neurosci.* 32, 17431–17441.
- Grunstein, M. (1997). Histone acetylation in chromatin structure and transcription. *Nature* 389, 349–352.
- Gu, X., Sun, J., Li, S., Wu, X., and Li, L. (2013a). Oxidative stress induces DNA demethylation and histone acetylation in SH-SY5Y cells: potential epigenetic mechanisms in gene transcription in A β production. *Neurobiol. Aging* 34, 1069–1079.
- Gu, Y., Arruda-Carvalho, M., Wang, J., Janoschka, S.R., Josselyn, S.A., Frankland, P.W., and Ge, S. (2012). Optical controlling reveals time-dependent roles for adult-born dentate granule cells. *Nat. Neurosci.* 15, 1700–1706.
- Gu, Y., Janoschka, S., and Ge, S. (2013b). Neurogenesis and hippocampal plasticity in adult brain. *Curr. Top. Behav. Neurosci.* 15, 31–48.
- Guan, J.-S., Haggarty, S.J., Giacometti, E., Dannenberg, J.-H., Joseph, N., Gao, J., Nieland, T.J.F., Zhou, Y., Wang, X., Mazitschek, R., et al. (2009). HDAC2 negatively regulates memory formation and synaptic plasticity. *Nature* 459, 55–60.
- Guan, Z., Giustetto, M., Lomvardas, S., Kim, J.-H., Miniaci, M.C., Schwartz, J.H., Thanos, D., and Kandel, E.R. (2002). Integration of long-term-memory-related synaptic plasticity involves bidirectional regulation of gene expression and chromatin structure. *Cell* 111, 483–493.
- Guérin, F., Belleville, S., and Ska, B. (2002). Characterization of visuoconstructional disabilities in patients with probable dementia of Alzheimer's type. *J. Clin. Exp. Neuropsychol.* 24, 1–17.
- Gupta, S., Kim, S.Y., Artis, S., Molfese, D.L., Schumacher, A., Sweatt, J.D., Paylor, R.E., and Lubin, F.D. (2010). Histone methylation regulates memory formation. *J. Neurosci. Off. J. Soc. Neurosci.* 30, 3589–3599.
- Gupta-Agarwal, S., Franklin, A.V., Deramus, T., Wheelock, M., Davis, R.L., McMahon, L.L., and Lubin, F.D. (2012). G9a/GLP histone lysine dimethyltransferase complex activity in the hippocampus and the entorhinal cortex is required for gene activation and silencing during memory consolidation. *J. Neurosci. Off. J. Soc. Neurosci.* 32, 5440–5453.
- Guzowski, J.F. (2002). Insights into immediate-early gene function in hippocampal memory consolidation using antisense oligonucleotide and fluorescent imaging approaches. *Hippocampus* 12, 86–104.
- Guzowski, J.F., McNaughton, B.L., Barnes, C.A., and Worley, P.F. (1999). Environment-specific expression of the immediate-early gene *Arc* in hippocampal neuronal ensembles. *Nat. Neurosci.* 2, 1120–1124.
- Guzowski, J.F., Lyford, G.L., Stevenson, G.D., Houston, F.P., McGaugh, J.L., Worley, P.F., and Barnes, C.A. (2000). Inhibition of activity-dependent *arc* protein expression in the rat hippocampus impairs the maintenance of long-term potentiation and the consolidation of long-term memory. *J. Neurosci. Off. J. Soc. Neurosci.* 20, 3993–4001.

H

- Haettig, J., Stefanko, D.P., Multani, M.L., Figueroa, D.X., McQuown, S.C., and Wood, M.A. (2011). HDAC inhibition modulates hippocampus-dependent long-term memory for object location in a CBP-dependent manner. *Learn. Mem. Cold Spring Harb. N* 18, 71–79.
- Harada, A., Oguchi, K., Okabe, S., Kuno, J., Terada, S., Ohshima, T., Sato-Yoshitake, R., Takei, Y., Noda, T., and Hirokawa, N. (1994). Altered microtubule organization in small-calibre axons of mice lacking tau protein. *Nature* 369, 488–491.
- Hardy, J., and Selkoe, D.J. (2002). The amyloid hypothesis of Alzheimer's disease: progress and problems on the road to therapeutics. *Science* 297, 353–356.
- Harrington, C.R. (2012). The molecular pathology of Alzheimer's disease. *Neuroimaging Clin. N. Am.* 22, 11–22, vii.
- Hart, A.K., Fioravante, D., Liu, R.-Y., Phares, G.A., Cleary, L.J., and Byrne, J.H. (2011). Serotonin-mediated synapsin expression is necessary for long-term facilitation of the *Aplysia* sensorimotor synapse. *J. Neurosci. Off. J. Soc. Neurosci.* 31, 18401–18411.
- Hawk, J.D., and Abel, T. (2011). The role of NR4A transcription factors in memory formation. *Brain Res. Bull.* 85, 21–29.
- Hawk, J.D., Bookout, A.L., Poplawski, S.G., Bridi, M., Rao, A.J., Sulewski, M.E., Kroener, B.T., Manglesdorf, D.J., and Abel, T. (2012). NR4A nuclear receptors support memory enhancement by histone deacetylase inhibitors. *J. Clin. Invest.* 122, 3593–3602.
- Hebb, C.O., and Konzett, H. (1949). Difference between morphine and synthetic analgesics in their actions on ganglionic transmission. *Nature* 163, 720.
- Hebert, A.E., and Dash, P.K. (2002). Extracellular signal-regulated kinase activity in the entorhinal cortex is necessary for long-term spatial memory. *Learn. Mem. Cold Spring Harb. N* 9, 156–166.
- Heldt, S.A., Stanek, L., Chhatwal, J.P., and Ressler, K.J. (2007). Hippocampus-specific deletion of BDNF in adult mice impairs spatial memory and extinction of aversive memories. *Mol. Psychiatry* 12, 656–670.
- Helmstetter, F.J., Parsons, R.G., and Gafford, G.M. (2008). Macromolecular synthesis, distributed synaptic plasticity, and fear conditioning. *Neurobiol. Learn. Mem.* 89, 324–337.
- Henke, K. (2010). A model for memory systems based on processing modes rather than consciousness. *Nat. Rev. Neurosci.* 11, 523–532.
- Henneberger, C., Papouin, T., Oliet, S.H.R., and Rusakov, D.A. (2010). Long-term potentiation depends on release of D-serine from astrocytes. *Nature* 463, 232–236.
- Herdegen, T., and Leah, J.D. (1998). Inducible and constitutive transcription factors in the mammalian nervous system: control of gene expression by Jun, Fos and Krox, and CREB/ATF proteins. *Brain Res. Brain Res. Rev.* 28, 370–490.
- Herrera, D.G., Yague, A.G., Johnsen-Soriano, S., Bosch-Morell, F., Collado-Morente, L., Muriach, M., Romero, F.J., and Garcia-Verdugo, J.M. (2003). Selective impairment of hippocampal neurogenesis by chronic alcoholism: protective effects of an antioxidant. *Proc. Natl. Acad. Sci. U. S. A.* 100, 7919–7924.
- Heuer, E., Rosen, R.F., Cintron, A., and Walker, L.C. (2012). Nonhuman primate models of Alzheimer-like cerebral proteopathy. *Curr. Pharm. Des.* 18, 1159–1169.

References

- Hierholzer, E. (1977). [Reconstruction of the spacial configuration of the spine from stereoradiographs (author's transl)]. *RöFo Fortschritte Auf Dem Geb. Röntgenstrahlen Nukl.* 126, 22–28.
- Hillman, C.H., Erickson, K.I., and Kramer, A.F. (2008). Be smart, exercise your heart: exercise effects on brain and cognition. *Nat. Rev. Neurosci.* 9, 58–65.
- Hilton, I.B., D'Ippolito, A.M., Vockley, C.M., Thakore, P.I., Crawford, G.E., Reddy, T.E., and Gersbach, C.A. (2015). Epigenome editing by a CRISPR-Cas9-based acetyltransferase activates genes from promoters and enhancers. *Nat. Biotechnol.* 33, 510–517.
- Hirohashi, S., Tanaka, M., Uchida, H., Kitano, S., Ohmichi, R., Iwasaki, S., and Ohishi, H. (1991). [Utility of MRI in the early diagnosis of hepatocellular carcinoma--comparison with US, CT and DSA]. *Nihon Rinsho Jpn. J. Clin. Med.* 49, 1805–1809.
- Hirokawa, N., Shiomura, Y., and Okabe, S. (1988). Tau proteins: the molecular structure and mode of binding on microtubules. *J. Cell Biol.* 107, 1449–1459.
- Ho, V.M., Lee, J.-A., and Martin, K.C. (2011). The cell biology of synaptic plasticity. *Science* 334, 623–628.
- Huang, Y. (2006). Molecular and cellular mechanisms of apolipoprotein E4 neurotoxicity and potential therapeutic strategies. *Curr. Opin. Drug Discov. Devel.* 9, 627–641.
- Huang, E.J., and Reichardt, L.F. (2003). Trk receptors: roles in neuronal signal transduction. *Annu. Rev. Biochem.* 72, 609–642.
- Huang, H.-S., and Akbarian, S. (2007). GAD1 mRNA expression and DNA methylation in prefrontal cortex of subjects with schizophrenia. *PloS One* 2, e809.
- Huang, Y., and Mucke, L. (2012). Alzheimer mechanisms and therapeutic strategies. *Cell* 148, 1204–1222.
- Huang, H.-S., Matevosian, A., Whittle, C., Kim, S.Y., Schumacher, A., Baker, S.P., and Akbarian, S. (2007). Prefrontal dysfunction in schizophrenia involves mixed-lineage leukemia 1-regulated histone methylation at GABAergic gene promoters. *J. Neurosci. Off. J. Soc. Neurosci.* 27, 11254–11262.

I

-
- Ikegami, S., Harada, A., and Hirokawa, N. (2000). Muscle weakness, hyperactivity, and impairment in fear conditioning in tau-deficient mice. *Neurosci. Lett.* 279, 129–132.
- Impey, S., Smith, D.M., Obrietan, K., Donahue, R., Wade, C., and Storm, D.R. (1998). Stimulation of cAMP response element (CRE)-mediated transcription during contextual learning. *Nat. Neurosci.* 1, 595–601.
- Iourgenko, V., Zhang, W., Mickanin, C., Daly, I., Jiang, C., Hexham, J.M., Orth, A.P., Miraglia, L., Meltzer, J., Garza, D., et al. (2003). Identification of a family of cAMP response element-binding protein coactivators by genome-scale functional analysis in mammalian cells. *Proc. Natl. Acad. Sci. U. S. A.* 100, 12147–12152.
- Iqbal, K., Grundke-Iqbal, I., Zaidi, T., Merz, P.A., Wen, G.Y., Shaikh, S.S., Wisniewski, H.M., Alafuzoff, I., and Winblad, B. (1986). Defective brain microtubule assembly in Alzheimer's disease. *Lancet Lond. Engl.* 2, 421–426.
- Iqbal, K., Alonso, A. del C., Chen, S., Chohan, M.O., El-Akkad, E., Gong, C.-X., Khatoon, S., Li, B., Liu, F., Rahman, A., et al. (2005). Tau pathology in Alzheimer disease and other tauopathies. *Biochim. Biophys. Acta* 1739, 198–210.

References

- Irwin, D.J., Cohen, T.J., Grossman, M., Arnold, S.E., Xie, S.X., Lee, V.M.-Y., and Trojanowski, J.Q. (2012). Acetylated tau, a novel pathological signature in Alzheimer's disease and other tauopathies. *Brain J. Neurol.* 135, 807–818.
- Ishizuka, N., Cowan, W.M., and Amaral, D.G. (1995). A quantitative analysis of the dendritic organization of pyramidal cells in the rat hippocampus. *J. Comp. Neurol.* 362, 17–45.

J

- Jakovcevski, M., Ruan, H., Shen, E.Y., Dincer, A., Javidfar, B., Ma, Q., Peter, C.J., Cheung, I., Mitchell, A.C., Jiang, Y., et al. (2015). Neuronal Kmt2a/Mll1 histone methyltransferase is essential for prefrontal synaptic plasticity and working memory. *J. Neurosci. Off. J. Soc. Neurosci.* 35, 5097–5108.
- Jarome, T.J., and Helmstetter, F.J. (2014). Protein degradation and protein synthesis in long-term memory formation. *Front. Mol. Neurosci.* 7, 61.
- Jawerka, M., Colak, D., Dimou, L., Spiller, C., Lagger, S., Montgomery, R.L., Olson, E.N., Wurst, W., Göttlicher, M., and Götz, M. (2010). The specific role of histone deacetylase 2 in adult neurogenesis. *Neuron Glia Biol.* 6, 93–107.
- Jenuwein, T., and Allis, C.D. (2001). Translating the histone code. *Science* 293, 1074–1080.
- Jessberger, S., Clark, R.E., Broadbent, N.J., Clemenson, G.D., Consiglio, A., Lie, D.C., Squire, L.R., and Gage, F.H. (2009). Dentate gyrus-specific knockdown of adult neurogenesis impairs spatial and object recognition memory in adult rats. *Learn. Mem. Cold Spring Harb. N* 16, 147–154.
- Ji, S., Tian, Y., Lu, Y., Sun, R., Ji, J., Zhang, L., and Duan, S. (2014). Irradiation-induced hippocampal neurogenesis impairment is associated with epigenetic regulation of bdnf gene transcription. *Brain Res.* 1577, 77–88.
- Jo, Y.S., Park, E.H., Kim, I.H., Park, S.K., Kim, H., Kim, H.T., and Choi, J.-S. (2007). The medial prefrontal cortex is involved in spatial memory retrieval under partial-cue conditions. *J. Neurosci. Off. J. Soc. Neurosci.* 27, 13567–13578.
- Johansen, J.P., Cain, C.K., Ostroff, L.E., and LeDoux, J.E. (2011). Molecular mechanisms of fear learning and memory. *Cell* 147, 509–524.
- Johnson, L.N. (2009). The regulation of protein phosphorylation. *Biochem. Soc. Trans.* 37, 627–641.
- Johnson, A.A., Sarthi, J., Pirooznia, S.K., Reube, W., and Elefant, F. (2013). Increasing Tip60 HAT levels rescues axonal transport defects and associated behavioral phenotypes in a *Drosophila* Alzheimer's disease model. *J. Neurosci. Off. J. Soc. Neurosci.* 33, 7535–7547.
- Jones, M.W., Errington, M.L., French, P.J., Fine, A., Bliss, T.V., Garel, S., Charnay, P., Bozon, B., Laroche, S., and Davis, S. (2001). A requirement for the immediate early gene *Zif268* in the expression of late LTP and long-term memories. *Nat. Neurosci.* 4, 289–296.
- Jones, S., Livner, A., and Bäckman, L. (2006). Patterns of prospective and retrospective memory impairment in preclinical Alzheimer's disease. *Neuropsychology* 20, 144–152.
- Jones, S.D., Hall, D.J., Rollins, B.J., and Stiles, C.D. (1988). Platelet-derived growth factor generates at least two distinct intracellular signals that modulate gene expression. *Cold Spring Harb. Symp. Quant. Biol.* 53 Pt 1, 531–536.
- Jonides, J., Lewis, R.L., Nee, D.E., Lustig, C.A., Berman, M.G., and Moore, K.S. (2008). The mind and brain of short-term memory. *Annu. Rev. Psychol.* 59, 193–224.

References

Jonkman, S., and Kenny, P.J. (2014). Promoting FOS to an enhanced position. *Nat. Neurosci.* 17, 1291–1293.

K

Kalkhoven, E. (2004). CBP and p300: HATs for different occasions. *Biochem. Pharmacol.* 68, 1145–1155.

Kandel, E.R. (2001). The molecular biology of memory storage: a dialogue between genes and synapses. *Science* 294, 1030–1038.

Kandel, E.R. (2012). The molecular biology of memory: cAMP, PKA, CRE, CREB-1, CREB-2, and CPEB. *Mol. Brain* 5, 14.

Kang, H., and Schuman, E.M. (1995). Long-lasting neurotrophin-induced enhancement of synaptic transmission in the adult hippocampus. *Science* 267, 1658–1662.

Kasper, L.H., Boussouar, F., Ney, P.A., Jackson, C.W., Rehg, J., van Deursen, J.M., and Brindle, P.K. (2002). A transcription-factor-binding surface of coactivator p300 is required for haematopoiesis. *Nature* 419, 738–743.

Katsuura, G., Arimura, A., Koves, K., and Gottschall, P.E. (1990). Involvement of organum vasculosum of lamina terminalis and preoptic area in interleukin 1 beta-induced ACTH release. *Am. J. Physiol.* 258, E163–E171.

Kawamoto, Y., Nakamura, S., Nakano, S., Oka, N., Akiguchi, I., and Kimura, J. (1996). Immunohistochemical localization of brain-derived neurotrophic factor in adult rat brain. *Neuroscience* 74, 1209–1226.

Kawashima, T., Okuno, H., Nonaka, M., Adachi-Morishima, A., Kyo, N., Okamura, M., Takemoto-Kimura, S., Worley, P.F., and Bito, H. (2009). Synaptic activity-responsive element in the Arc/Arg3.1 promoter essential for synapse-to-nucleus signaling in activated neurons. *Proc. Natl. Acad. Sci. U. S. A.* 106, 316–321.

Kazantsev, A.G., and Thompson, L.M. (2008). Therapeutic application of histone deacetylase inhibitors for central nervous system disorders. *Nat. Rev. Drug Discov.* 7, 854–868.

Kee, N., Teixeira, C.M., Wang, A.H., and Frankland, P.W. (2007). Preferential incorporation of adult-generated granule cells into spatial memory networks in the dentate gyrus. *Nat. Neurosci.* 10, 355–362.

Kempermann, G., Kuhn, H.G., and Gage, F.H. (1997). More hippocampal neurons in adult mice living in an enriched environment. *Nature* 386, 493–495.

Kessels, R.P., de Haan, E.H., Kappelle, L.J., and Postma, A. (2001). Varieties of human spatial memory: a meta-analysis on the effects of hippocampal lesions. *Brain Res. Brain Res. Rev.* 35, 295–303.

Kheirbek, M.A., Klemenhagen, K.C., Sahay, A., and Hen, R. (2012). Neurogenesis and generalization: a new approach to stratify and treat anxiety disorders. *Nat. Neurosci.* 15, 1613–1620.

Kida, S., and Serita, T. (2014). Functional roles of CREB as a positive regulator in the formation and enhancement of memory. *Brain Res. Bull.* 105, 17–24.

Kida, S., Josselyn, S.A., Peña de Ortiz, S., Kogan, J.H., Chevere, I., Masushige, S., and Silva, A.J. (2002). CREB required for the stability of new and reactivated fear memories. *Nat. Neurosci.* 5, 348–355.

References

- Kilgore, M., Miller, C.A., Fass, D.M., Hennig, K.M., Haggarty, S.J., Sweatt, J.D., and Rumbaugh, G. (2010). Inhibitors of class 1 histone deacetylases reverse contextual memory deficits in a mouse model of Alzheimer's disease. *Neuropsychopharmacol. Off. Publ. Am. Coll. Neuropsychopharmacol.* 35, 870–880.
- Kim, D., Nguyen, M.D., Dobbin, M.M., Fischer, A., Sananbenesi, F., Rodgers, J.T., Delalle, I., Baur, J.A., Sui, G., Armour, S.M., et al. (2007a). SIRT1 deacetylase protects against neurodegeneration in models for Alzheimer's disease and amyotrophic lateral sclerosis. *EMBO J.* 26, 3169–3179.
- Kim, M.-S., Akhtar, M.W., Adachi, M., Mahgoub, M., Bassel-Duby, R., Kavalali, E.T., Olson, E.N., and Monteggia, L.M. (2012). An essential role for histone deacetylase 4 in synaptic plasticity and memory formation. *J. Neurosci. Off. J. Soc. Neurosci.* 32, 10879–10886.
- Kim, S.Y., Levenson, J.M., Korsmeyer, S., Sweatt, J.D., and Schumacher, A. (2007b). Developmental regulation of Eed complex composition governs a switch in global histone modification in brain. *J. Biol. Chem.* 282, 9962–9972.
- Kirwan, C.B., Bayley, P.J., Galván, V.V., and Squire, L.R. (2008). Detailed recollection of remote autobiographical memory after damage to the medial temporal lobe. *Proc. Natl. Acad. Sci. U. S. A.* 105, 2676–2680.
- Kjonigsen, L.J., Leergaard, T.B., Witter, M.P., and Bjaalie, J.G. (2011). Digital atlas of anatomical subdivisions and boundaries of the rat hippocampal region. *Front. Neuroinformatics* 5, 2.
- Koehl, M., and Abrous, D.N. (2011). A new chapter in the field of memory: adult hippocampal neurogenesis. *Eur. J. Neurosci.* 33, 1101–1114.
- Koldamova, R., Schug, J., Lefterova, M., Cronican, A.A., Fitz, N.F., Davenport, F.A., Carter, A., Castranio, E.L., and Lefterov, I. (2014). Genome-wide approaches reveal EGR1-controlled regulatory networks associated with neurodegeneration. *Neurobiol. Dis.* 63, 107–114.
- Kopec, A.M., and Carew, T.J. (2013). Growth factor signaling and memory formation: temporal and spatial integration of a molecular network. *Learn. Mem. Cold Spring Harb. N* 20, 531–539.
- Kornberg, R.D. (1977). Structure of chromatin. *Annu. Rev. Biochem.* 46, 931–954.
- Korzus, E., Rosenfeld, M.G., and Mayford, M. (2004). CBP histone acetyltransferase activity is a critical component of memory consolidation. *Neuron* 42, 961–972.
- Koshibu, K., Gräff, J., and Mansuy, I.M. (2011). Nuclear protein phosphatase-1: an epigenetic regulator of fear memory and amygdala long-term potentiation. *Neuroscience* 173, 30–36.
- Kouzarides, T. (2007). Chromatin modifications and their function. *Cell* 128, 693–705.
- Kowaluk, E.A., and Fung, H.L. (1991). Vascular nitric oxide-generating activities for organic nitrites and organic nitrates are distinct. *J. Pharmacol. Exp. Ther.* 259, 519–525.
- Kukowska-Latallo, J.F., Candido, K.A., Cao, Z., Nigavekar, S.S., Majoros, I.J., Thomas, T.P., Balogh, L.P., Khan, M.K., and Baker, J.R. (2005). Nanoparticle targeting of anticancer drug improves therapeutic response in animal model of human epithelial cancer. *Cancer Res.* 65, 5317–5324.

References

Kwak, Y.T. (2004). “Closing-in” phenomenon in Alzheimer’s disease and subcortical vascular dementia. *BMC Neurol.* 4, 3.



Lahm, A., Paolini, C., Pallaoro, M., Nardi, M.C., Jones, P., Neddermann, P., Sambucini, S., Bottomley, M.J., Lo Surdo, P., Carfí, A., et al. (2007). Unraveling the hidden catalytic activity of vertebrate class IIa histone deacetylases. *Proc. Natl. Acad. Sci. U. S. A.* 104, 17335–17340.

Lalonde, R., Fukuchi, K., and Strazielle, C. (2012). APP transgenic mice for modelling behavioural and psychological symptoms of dementia (BPSD). *Neurosci. Biobehav. Rev.* 36, 1357–1375.

Laurent, C., Burnouf, S., Ferry, B., Batalha, V.L., Coelho, J.E., Baqi, Y., Malik, E., Mariciniak, E., Parrot, S., Van der Jeugd, A., et al. (2014). A2A adenosine receptor deletion is protective in a mouse model of Tauopathy. *Mol. Psychiatry.*

Lee, J.L.C., Everitt, B.J., and Thomas, K.L. (2004). Independent cellular processes for hippocampal memory consolidation and reconsolidation. *Science* 304, 839–843.

Lepousez, G., Nissant, A., and Lledo, P.-M. (2015). Adult neurogenesis and the future of the rejuvenating brain circuits. *Neuron* 86, 387–401.

Lesburguères, E., Gobbo, O.L., Alaux-Cantin, S., Hambucken, A., Trifilieff, P., and Bontempi, B. (2011). Early tagging of cortical networks is required for the formation of enduring associative memory. *Science* 331, 924–928.

Levenson, J.M., O’Riordan, K.J., Brown, K.D., Trinh, M.A., Molfese, D.L., and Sweatt, J.D. (2004). Regulation of histone acetylation during memory formation in the hippocampus. *J. Biol. Chem.* 279, 40545–40559.

Levine, A.J. (2011). The paths to death and differentiation. *Cell Death Differ.* 18, 1391–1392.

Li, L., Carter, J., Gao, X., Whitehead, J., and Tourtellotte, W.G. (2005). The neuroplasticity-associated arc gene is a direct transcriptional target of early growth response (Egr) transcription factors. *Mol. Cell. Biol.* 25, 10286–10300.

Lin, C.H., Hare, B.J., Wagner, G., Harrison, S.C., Maniatis, T., and Fraenkel, E. (2001). A small domain of CBP/p300 binds diverse proteins: solution structure and functional studies. *Mol. Cell* 8, 581–590.

Lindecke, A., Korte, M., Zagrebelsky, M., Horejschi, V., Elvers, M., Widera, D., Prüllage, M., Pfeiffer, J., Kaltschmidt, B., and Kaltschmidt, C. (2006). Long-term depression activates transcription of immediate early transcription factor genes: involvement of serum response factor/Elk-1. *Eur. J. Neurosci.* 24, 555–563.

Linnarsson, S., Björklund, A., and Ernfors, P. (1997). Learning deficit in BDNF mutant mice. *Eur. J. Neurosci.* 9, 2581–2587.

Lipton, S.A. (2006). Paradigm shift in neuroprotection by NMDA receptor blockade: memantine and beyond. *Nat. Rev. Drug Discov.* 5, 160–170.

Lisman, J., Schulman, H., and Cline, H. (2002). The molecular basis of CaMKII function in synaptic and behavioural memory. *Nat. Rev. Neurosci.* 3, 175–190.

Lonze, B.E., and Ginty, D.D. (2002). Function and regulation of CREB family transcription factors in the nervous system. *Neuron* 35, 605–623.

References

- Lopez-Atalaya, J.P., and Barco, A. (2014). Can changes in histone acetylation contribute to memory formation? *Trends Genet. TIG* 30, 529–539.
- Lopez-Atalaya, J.P., Ciccarelli, A., Viosca, J., Valor, L.M., Jimenez-Minchan, M., Canals, S., Giustetto, M., and Barco, A. (2011). CBP is required for environmental enrichment-induced neurogenesis and cognitive enhancement. *EMBO J.* 30, 4287–4298.
- Lu, X., Wang, L., Yu, C., Yu, D., and Yu, G. (2015). Histone Acetylation Modifiers in the Pathogenesis of Alzheimer's Disease. *Front. Cell. Neurosci.* 9, 226.
- Luger, K., Rechsteiner, T.J., Flaus, A.J., Wayne, M.M., and Richmond, T.J. (1997). Characterization of nucleosome core particles containing histone proteins made in bacteria. *J. Mol. Biol.* 272, 301–311.
- Lyford, G.L., Yamagata, K., Kaufmann, W.E., Barnes, C.A., Sanders, L.K., Copeland, N.G., Gilbert, D.J., Jenkins, N.A., Lanahan, A.A., and Worley, P.F. (1995). Arc, a growth factor and activity-regulated gene, encodes a novel cytoskeleton-associated protein that is enriched in neuronal dendrites. *Neuron* 14, 433–445.
- Lynch, G., Rex, C.S., and Gall, C.M. (2007). LTP consolidation: substrates, explanatory power, and functional significance. *Neuropharmacology* 52, 12–23.



-
- Maccioni, R.B., Vera, J.C., Dominguez, J., and Avila, J. (1989). A discrete repeated sequence defines a tubulin binding domain on microtubule-associated protein tau. *Arch. Biochem. Biophys.* 275, 568–579.
- Maddox, S.A., and Schafe, G.E. (2011). Epigenetic alterations in the lateral amygdala are required for reconsolidation of a Pavlovian fear memory. *Learn. Mem. Cold Spring Harb. N* 18, 579–593.
- Maddox, S.A., Watts, C.S., Doyère, V., and Schafe, G.E. (2013). A naturally-occurring histone acetyltransferase inhibitor derived from *Garcinia indica* impairs newly acquired and reactivated fear memories. *PloS One* 8, e54463.
- Maharana, C., Sharma, K.P., and Sharma, S.K. (2010). Depolarization induces acetylation of histone H2B in the hippocampus. *Neuroscience* 167, 354–360.
- Mahley, R.W., Weisgraber, K.H., and Huang, Y. (2006). Apolipoprotein E4: a causative factor and therapeutic target in neuropathology, including Alzheimer's disease. *Proc. Natl. Acad. Sci. U. S. A.* 103, 5644–5651.
- Malenka, R.C., Kauer, J.A., Perkel, D.J., Mauk, M.D., Kelly, P.T., Nicoll, R.A., and Waxham, M.N. (1989). An essential role for postsynaptic calmodulin and protein kinase activity in long-term potentiation. *Nature* 340, 554–557.
- Malik, A.N., Vierbuchen, T., Hemberg, M., Rubin, A.A., Ling, E., Couch, C.H., Stroud, H., Spiegel, I., Farh, K.K.-H., Harmin, D.A., et al. (2014). Genome-wide identification and characterization of functional neuronal activity-dependent enhancers. *Nat. Neurosci.* 17, 1330–1339.
- Malinow, R., Schulman, H., and Tsien, R.W. (1989). Inhibition of postsynaptic PKC or CaMKII blocks induction but not expression of LTP. *Science* 245, 862–866.
- Mantelingu, K., Kishore, A.H., Balasubramanyam, K., Kumar, G.V.P., Altaf, M., Swamy, S.N., Selvi, R., Das, C., Narayana, C., Rangappa, K.S., et al. (2007). Activation of p300

References

- histone acetyltransferase by small molecules altering enzyme structure: probed by surface-enhanced Raman spectroscopy. *J. Phys. Chem. B* 111, 4527–4534.
- Marambaud, P., and Robakis, N.K. (2005). Genetic and molecular aspects of Alzheimer's disease shed light on new mechanisms of transcriptional regulation. *Genes Brain Behav.* 4, 134–146.
- Marín-Burgin, A., Mongiat, L.A., Pardi, M.B., and Schinder, A.F. (2012). Unique processing during a period of high excitation/inhibition balance in adult-born neurons. *Science* 335, 1238–1242.
- Marques, S.C.F., Lemos, R., Ferreira, E., Martins, M., de Mendonça, A., Santana, I., Outeiro, T.F., and Pereira, C.M.F. (2012). Epigenetic regulation of BACE1 in Alzheimer's disease patients and in transgenic mice. *Neuroscience* 220, 256–266.
- Marr, D. (1970). A theory for cerebral neocortex. *Proc. R. Soc. Lond. B Biol. Sci.* 176, 161–234.
- Martin, C., and Zhang, Y. (2005). The diverse functions of histone lysine methylation. *Nat. Rev. Mol. Cell Biol.* 6, 838–849.
- Masliah, E., Mallory, M., Ge, N., Alford, M., Veinbergs, I., and Roses, A.D. (1995). Neurodegeneration in the central nervous system of apoE-deficient mice. *Exp. Neurol.* 136, 107–122.
- Masumoto, H., Hawke, D., Kobayashi, R., and Verreault, A. (2005). A role for cell-cycle-regulated histone H3 lysine 56 acetylation in the DNA damage response. *Nature* 436, 294–298.
- Maurice, T., Duclot, F., Meunier, J., Naert, G., Givalois, L., Meffre, J., Célérier, A., Jacquet, C., Copois, V., Mechti, N., et al. (2008). Altered memory capacities and response to stress in p300/CBP-associated factor (PCAF) histone acetylase knockout mice. *Neuropsychopharmacol. Off. Publ. Am. Coll. Neuropsychopharmacol.* 33, 1584–1602.
- Mayr, B., and Montminy, M. (2001). Transcriptional regulation by the phosphorylation-dependent factor CREB. *Nat. Rev. Mol. Cell Biol.* 2, 599–609.
- McNulty, S.E., Barrett, R.M., Vogel-Ciernia, A., Malvaez, M., Hernandez, N., Davatolhagh, M.F., Matheos, D.P., Schiffman, A., and Wood, M.A. (2012). Differential roles for Nr4a1 and Nr4a2 in object location vs. object recognition long-term memory. *Learn. Mem. Cold Spring Harb. N* 19, 588–592.
- McQuown, S.C., and Wood, M.A. (2011). HDAC3 and the molecular brake pad hypothesis. *Neurobiol. Learn. Mem.* 96, 27–34.
- Mega, M.S., Cummings, J.L., Fiorello, T., and Gornbein, J. (1996). The spectrum of behavioral changes in Alzheimer's disease. *Neurology* 46, 130–135.
- Megías, M., Emri, Z., Freund, T.F., and Gulyás, A.I. (2001). Total number and distribution of inhibitory and excitatory synapses on hippocampal CA1 pyramidal cells. *Neuroscience* 102, 527–540.
- Meiri, N., and Rosenblum, K. (1998). Lateral ventricle injection of the protein synthesis inhibitor anisomycin impairs long-term memory in a spatial memory task. *Brain Res.* 789, 48–55.
- Messaoudi, E., Ying, S.-W., Kanhema, T., Croll, S.D., and Bramham, C.R. (2002). Brain-derived neurotrophic factor triggers transcription-dependent, late phase long-term potentiation in vivo. *J. Neurosci. Off. J. Soc. Neurosci.* 22, 7453–7461.

References

- Messaoudi, E., Kanhema, T., Soulé, J., Tiron, A., Dageyte, G., da Silva, B., and Bramham, C.R. (2007). Sustained Arc/Arg3.1 synthesis controls long-term potentiation consolidation through regulation of local actin polymerization in the dentate gyrus in vivo. *J. Neurosci. Off. J. Soc. Neurosci.* 27, 10445–10455.
- Mihaylova, M.M., and Shaw, R.J. (2013). Metabolic reprogramming by class I and II histone deacetylases. *Trends Endocrinol. Metab. TEM* 24, 48–57.
- Miller, C.A., Campbell, S.L., and Sweatt, J.D. (2008). DNA methylation and histone acetylation work in concert to regulate memory formation and synaptic plasticity. *Neurobiol. Learn. Mem.* 89, 599–603.
- Miller, R.S., Wolfe, A., He, L., Radovick, S., and Wondisford, F.E. (2012). CREB binding protein (CBP) activation is required for luteinizing hormone beta expression and normal fertility in mice. *Mol. Cell. Biol.* 32, 2349–2358.
- Min, S.-W., Cho, S.-H., Zhou, Y., Schroeder, S., Haroutunian, V., Seeley, W.W., Huang, E.J., Shen, Y., Masliah, E., Mukherjee, C., et al. (2010). Acetylation of tau inhibits its degradation and contributes to tauopathy. *Neuron* 67, 953–966.
- Minati, L., Edginton, T., Bruzzone, M.G., and Giaccone, G. (2009). Current concepts in Alzheimer's disease: a multidisciplinary review. *Am. J. Alzheimers Dis. Other Demen.* 24, 95–121.
- Ming, G.-L., and Song, H. (2011). Adult neurogenesis in the mammalian brain: significant answers and significant questions. *Neuron* 70, 687–702.
- Minichiello, L. (2009). TrkB signalling pathways in LTP and learning. *Nat. Rev. Neurosci.* 10, 850–860.
- Miyashita, Y. (2004). Cognitive memory: cellular and network machineries and their top-down control. *Science* 306, 435–440.
- Miyashita, T., Kubik, S., Lewandowski, G., and Guzowski, J.F. (2008). Networks of neurons, networks of genes: an integrated view of memory consolidation. *Neurobiol. Learn. Mem.* 89, 269–284.
- Mizuno, M., Yamada, K., Olariu, A., Nawa, H., and Nabeshima, T. (2000). Involvement of brain-derived neurotrophic factor in spatial memory formation and maintenance in a radial arm maze test in rats. *J. Neurosci. Off. J. Soc. Neurosci.* 20, 7116–7121.
- Monteggia, L.M., Barrot, M., Powell, C.M., Berton, O., Galanis, V., Gemelli, T., Meuth, S., Nagy, A., Greene, R.W., and Nestler, E.J. (2004). Essential role of brain-derived neurotrophic factor in adult hippocampal function. *Proc. Natl. Acad. Sci. U. S. A.* 101, 10827–10832.
- Montminy, M. (1997). Transcriptional regulation by cyclic AMP. *Annu. Rev. Biochem.* 66, 807–822.
- Montminy, M.R., and Bilezikjian, L.M. (1987). Binding of a nuclear protein to the cyclic-AMP response element of the somatostatin gene. *Nature* 328, 175–178.
- Montminy, M.R., Sevarino, K.A., Wagner, J.A., Mandel, G., and Goodman, R.H. (1986). Identification of a cyclic-AMP-responsive element within the rat somatostatin gene. *Proc. Natl. Acad. Sci. U. S. A.* 83, 6682–6686.
- Morgan, J.I., Cohen, D.R., Hempstead, J.L., and Curran, T. (1987). Mapping patterns of c-fos expression in the central nervous system after seizure. *Science* 237, 192–197.

References

- Morris, R. (1984). Developments of a water-maze procedure for studying spatial learning in the rat. *J. Neurosci. Methods* 11, 47–60.
- Morris, M.J., Mahgoub, M., Na, E.S., Pranav, H., and Monteggia, L.M. (2013). Loss of histone deacetylase 2 improves working memory and accelerates extinction learning. *J. Neurosci. Off. J. Soc. Neurosci.* 33, 6401–6411.
- Morse, S.J., Butler, A.A., Davis, R.L., Soller, I.J., and Lubin, F.D. (2015). Environmental enrichment reverses histone methylation changes in the aged hippocampus and restores age-related memory deficits. *Biology* 4, 298–313.
- Mu, J.S., Li, W.P., Yao, Z.B., and Zhou, X.F. (1999). Deprivation of endogenous brain-derived neurotrophic factor results in impairment of spatial learning and memory in adult rats. *Brain Res.* 835, 259–265.
- Mujtaba, S., He, Y., Zeng, L., Yan, S., Plotnikova, O., Sachchidanand, null, Sanchez, R., Zeleznik-Le, N.J., Ronai, Z. 'ev, and Zhou, M.-M. (2004). Structural mechanism of the bromodomain of the coactivator CBP in p53 transcriptional activation. *Mol. Cell* 13, 251–263.
- Mukaetova-Ladinska, E.B., Garcia-Siera, F., Hurt, J., Gertz, H.J., Xuereb, J.H., Hills, R., Brayne, C., Huppert, F.A., Paykel, E.S., McGee, M., et al. (2000). Staging of cytoskeletal and beta-amyloid changes in human isocortex reveals biphasic synaptic protein response during progression of Alzheimer's disease. *Am. J. Pathol.* 157, 623–636.
- Müller, T., Schrötter, A., Loose, C., Pfeiffer, K., Theiss, C., Kauth, M., Meyer, H.E., and Marcus, K. (2013). A ternary complex consisting of AICD, FE65, and TIP60 down-regulates Stathmin1. *Biochim. Biophys. Acta* 1834, 387–394.
- Mutskov, V., Gerber, D., Angelov, D., Ausio, J., Workman, J., and Dimitrov, S. (1998). Persistent interactions of core histone tails with nucleosomal DNA following acetylation and transcription factor binding. *Mol. Cell. Biol.* 18, 6293–6304.



-
- Nadel, L., and Moscovitch, M. (1997). Memory consolidation, retrograde amnesia and the hippocampal complex. *Curr. Opin. Neurobiol.* 7, 217–227.
- Nakashiba, T., Cushman, J.D., Pelkey, K.A., Renaudineau, S., Buhl, D.L., McHugh, T.J., Rodriguez Barrera, V., Chittajallu, R., Iwamoto, K.S., McBain, C.J., et al. (2012). Young dentate granule cells mediate pattern separation, whereas old granule cells facilitate pattern completion. *Cell* 149, 188–201.
- Nathalie, P., and Jean-Noël, O. (2008). Processing of amyloid precursor protein and amyloid peptide neurotoxicity. *Curr. Alzheimer Res.* 5, 92–99.
- Nelson, E.D., Bal, M., Kavalali, E.T., and Monteggia, L.M. (2011). Selective impact of MeCP2 and associated histone deacetylases on the dynamics of evoked excitatory neurotransmission. *J. Neurophysiol.* 106, 193–201.
- Niblock, M.M., Brunso-Bechtold, J.K., and Riddle, D.R. (2000). Insulin-like growth factor I stimulates dendritic growth in primary somatosensory cortex. *J. Neurosci. Off. J. Soc. Neurosci.* 20, 4165–4176.
- Nissen, M.J., and Bullemer, P. (1987). Attentional requirements of learning: Evidence from performance measures. *Cognit. Psychol.* 19, 1–32.

References

- Nonaka, M., Fujii, H., Kim, R., Kawashima, T., Okuno, H., and Bito, H. (2014). Untangling the two-way signalling route from synapses to the nucleus, and from the nucleus back to the synapses. *Philos. Trans. R. Soc. Lond. B. Biol. Sci.* 369, 20130150.
- Nott, A., Watson, P.M., Robinson, J.D., Crepaldi, L., and Riccio, A. (2008). S-Nitrosylation of histone deacetylase 2 induces chromatin remodelling in neurons. *Nature* 455, 411–415.

O

- Oike, Y., Takakura, N., Hata, A., Kaname, T., Akizuki, M., Yamaguchi, Y., Yasue, H., Araki, K., Yamamura, K., and Suda, T. (1999). Mice homozygous for a truncated form of CREB-binding protein exhibit defects in hematopoiesis and vasculo-angiogenesis. *Blood* 93, 2771–2779.
- O’Kane, G., Kensinger, E.A., and Corkin, S. (2004). Evidence for semantic learning in profound amnesia: an investigation with patient H.M. *Hippocampus* 14, 417–425.
- Oliveira, A.M.M., Abel, T., Brindle, P.K., and Wood, M.A. (2006). Differential role for CBP and p300 CREB-binding domain in motor skill learning. *Behav. Neurosci.* 120, 724–729.
- Oliveira, A.M.M., Wood, M.A., McDonough, C.B., and Abel, T. (2007). Transgenic mice expressing an inhibitory truncated form of p300 exhibit long-term memory deficits. *Learn. Mem. Cold Spring Harb. N* 14, 564–572.
- Oliveira, A.M.M., Estévez, M.A., Hawk, J.D., Grimes, S., Brindle, P.K., and Abel, T. (2011). Subregion-specific p300 conditional knock-out mice exhibit long-term memory impairments. *Learn. Mem. Cold Spring Harb. N* 18, 161–169.

P

- Panda, D., Goode, B.L., Feinstein, S.C., and Wilson, L. (1995). Kinetic stabilization of microtubule dynamics at steady state by tau and microtubule-binding domains of tau. *Biochemistry (Mosc.)* 34, 11117–11127.
- Park, S., Park, J.M., Kim, S., Kim, J.-A., Shepherd, J.D., Smith-Hicks, C.L., Chowdhury, S., Kaufmann, W., Kuhl, D., Ryazanov, A.G., et al. (2008). Elongation factor 2 and fragile X mental retardation protein control the dynamic translation of Arc/Arg3.1 essential for mGluR-LTD. *Neuron* 59, 70–83.
- Park, S.-Y., Lee, Y.-H., Seong, A.-R., Lee, J., Jun, W., and Yoon, H.-G. (2013). Selective inhibition of PCAF suppresses microglial-mediated β -amyloid neurotoxicity. *Int. J. Mol. Med.* 32, 469–475.
- Park, S.-Y., Kim, M.-J., Kim, Y.J., Lee, Y.-H., Bae, D., Kim, S., Na, Y., and Yoon, H.-G. (2015). Selective PCAF inhibitor ameliorates cognitive and behavioral deficits by suppressing NF- κ B-mediated neuroinflammation induced by A β in a model of Alzheimer’s disease. *Int. J. Mol. Med.* 35, 1109–1118.
- Parker, D., Ferreri, K., Nakajima, T., LaMorte, V.J., Evans, R., Koerber, S.C., Hoeger, C., and Montminy, M.R. (1996). Phosphorylation of CREB at Ser-133 induces complex formation with CREB-binding protein via a direct mechanism. *Mol. Cell. Biol.* 16, 694–703.
- Paul, C.-M., Magda, G., and Abel, S. (2009). Spatial memory: Theoretical basis and comparative review on experimental methods in rodents. *Behav. Brain Res.* 203, 151–164.
- Peixoto, L., and Abel, T. (2013). The role of histone acetylation in memory formation and cognitive impairments. *Neuropsychopharmacol.* 38, 62–76.

References

- Peng, S., Garzon, D.J., Marchese, M., Klein, W., Ginsberg, S.D., Francis, B.M., Mount, H.T.J., Mufson, E.J., Salehi, A., and Fahnstock, M. (2009). Decreased brain-derived neurotrophic factor depends on amyloid aggregation state in transgenic mouse models of Alzheimer's disease. *J. Neurosci. Off. J. Soc. Neurosci.* 29, 9321–9329.
- Penke, Z., Chagneau, C., and Laroche, S. (2011). Contribution of Egr1/zif268 to Activity-Dependent Arc/Arg3.1 Transcription in the Dentate Gyrus and Area CA1 of the Hippocampus. *Front. Behav. Neurosci.* 5, 48.
- Penke, Z., Morice, E., Veyrac, A., Gros, A., Chagneau, C., LeBlanc, P., Samson, N., Baumgärtel, K., Mansuy, I.M., Davis, S., et al. (2014). Zif268/Egr1 gain of function facilitates hippocampal synaptic plasticity and long-term spatial recognition memory. *Philos. Trans. R. Soc. Lond. B. Biol. Sci.* 369, 20130159.
- Penney, J., and Tsai, L.-H. (2014). Histone deacetylases in memory and cognition. *Sci. Signal.* 7, re12.
- Perez, M., Santa-Maria, I., Gomez de Barreda, E., Zhu, X., Cuadros, R., Cabrero, J.R., Sanchez-Madrid, F., Dawson, H.N., Vitek, M.P., Perry, G., et al. (2009). Tau—an inhibitor of deacetylase HDAC6 function. *J. Neurochem.* 109, 1756–1766.
- Petrij, F., Giles, R.H., Dauwerse, H.G., Saris, J.J., Hennekam, R.C., Masuno, M., Tommerup, N., van Ommen, G.J., Goodman, R.H., and Peters, D.J. (1995). Rubinstein-Taybi syndrome caused by mutations in the transcriptional co-activator CBP. *Nature* 376, 348–351.
- Pintchovski, S.A., Peebles, C.L., Kim, H.J., Verdin, E., and Finkbeiner, S. (2009). The serum response factor and a putative novel transcription factor regulate expression of the immediate-early gene Arc/Arg3.1 in neurons. *J. Neurosci. Off. J. Soc. Neurosci.* 29, 1525–1537.
- Pirooznia, S.K., and Elefant, F. (2013). Targeting specific HATs for neurodegenerative disease treatment: translating basic biology to therapeutic possibilities. *Front. Cell. Neurosci.* 7, 30.
- Pirooznia, S.K., Chiu, K., Chan, M.T., Zimmerman, J.E., and Elefant, F. (2012a). Epigenetic regulation of axonal growth of *Drosophila* pacemaker cells by histone acetyltransferase tip60 controls sleep. *Genetics* 192, 1327–1345.
- Pirooznia, S.K., Sarthi, J., Johnson, A.A., Toth, M.S., Chiu, K., Koduri, S., and Elefant, F. (2012b). Tip60 HAT activity mediates APP induced lethality and apoptotic cell death in the CNS of a *Drosophila* Alzheimer's disease model. *PloS One* 7, e41776.
- Pittenger, C., and Kandel, E.R. (2003). In search of general mechanisms for long-lasting plasticity: Aplysia and the hippocampus. *Philos. Trans. R. Soc. Lond. B. Biol. Sci.* 358, 757–763.
- Pittenger, C., Huang, Y.Y., Paletzki, R.F., Bourtchouladze, R., Scanlin, H., Vronskaya, S., and Kandel, E.R. (2002). Reversible inhibition of CREB/ATF transcription factors in region CA1 of the dorsal hippocampus disrupts hippocampus-dependent spatial memory. *Neuron* 34, 447–462.
- Plath, N., Ohana, O., Dammermann, B., Errington, M.L., Schmitz, D., Gross, C., Mao, X., Engelsberg, A., Mahlke, C., Welzl, H., et al. (2006). Arc/Arg3.1 is essential for the consolidation of synaptic plasticity and memories. *Neuron* 52, 437–444.
- Pohanka, M. (2011). Cholinesterases, a target of pharmacology and toxicology. *Biomed. Pap. Med. Fac. Univ. Palacký Olomouc Czechoslov.* 155, 219–229.

References

- Porte, Y., Buhot, M.C., and Mons, N.E. (2008). Spatial memory in the Morris water maze and activation of cyclic AMP response element-binding (CREB) protein within the mouse hippocampus. *Learn. Mem. Cold Spring Harb. N* 15, 885–894.
- Pozzo-Miller, L.D., Gottschalk, W., Zhang, L., McDermott, K., Du, J., Gopalakrishnan, R., Oho, C., Sheng, Z.H., and Lu, B. (1999). Impairments in high-frequency transmission, synaptic vesicle docking, and synaptic protein distribution in the hippocampus of BDNF knockout mice. *J. Neurosci. Off. J. Soc. Neurosci.* 19, 4972–4983.
- van Praag, H. (2009). Exercise and the brain: something to chew on. *Trends Neurosci.* 32, 283–290.
- van Praag, H., Christie, B.R., Sejnowski, T.J., and Gage, F.H. (1999). Running enhances neurogenesis, learning, and long-term potentiation in mice. *Proc. Natl. Acad. Sci. U. S. A.* 96, 13427–13431.



- Ragvin, A., Valvatne, H., Erdal, S., Arskog, V., Tufteland, K.R., Breen, K., ØYan, A.M., Eberharter, A., Gibson, T.J., Becker, P.B., et al. (2004). Nucleosome binding by the bromodomain and PHD finger of the transcriptional cofactor p300. *J. Mol. Biol.* 337, 773–788.
- Rao, V.R., Pintchovski, S.A., Chin, J., Peebles, C.L., Mitra, S., and Finkbeiner, S. (2006). AMPA receptors regulate transcription of the plasticity-related immediate-early gene *Arc*. *Nat. Neurosci.* 9, 887–895.
- Rea, S., Eisenhaber, F., O’Carroll, D., Strahl, B.D., Sun, Z.W., Schmid, M., Opravil, S., Mechtler, K., Ponting, C.P., Allis, C.D., et al. (2000). Regulation of chromatin structure by site-specific histone H3 methyltransferases. *Nature* 406, 593–599.
- Recuero, M., Serrano, E., Bullido, M.J., and Valdivieso, F. (2004). Abeta production as consequence of cellular death of a human neuroblastoma overexpressing APP. *FEBS Lett.* 570, 114–118.
- Regalado, M.P., Terry-Lorenzo, R.T., Waites, C.L., Garner, C.C., and Malenka, R.C. (2006). Transsynaptic signaling by postsynaptic synapse-associated protein 97. *J. Neurosci. Off. J. Soc. Neurosci.* 26, 2343–2357.
- Reul, J.M.H.M., Hesketh, S.A., Collins, A., and Mecnas, M.G. (2009). Epigenetic mechanisms in the dentate gyrus act as a molecular switch in hippocampus-associated memory formation. *Epigenetics* 4, 434–439.
- Rhein, V., and Eckert, A. (2007). Effects of Alzheimer’s amyloid-beta and tau protein on mitochondrial function -- role of glucose metabolism and insulin signalling. *Arch. Physiol. Biochem.* 113, 131–141.
- Richetin, K., Leclerc, C., Toni, N., Gallopin, T., Pech, S., Roybon, L., and Rampon, C. (2015). Genetic manipulation of adult-born hippocampal neurons rescues memory in a mouse model of Alzheimer’s disease. *Brain J. Neurol.* 138, 440–455.
- Ricobaraza, A., Cuadrado-Tejedor, M., Pérez-Mediavilla, A., Frechilla, D., Del Río, J., and García-Osta, A. (2009). Phenylbutyrate ameliorates cognitive deficit and reduces tau pathology in an Alzheimer’s disease mouse model. *Neuropsychopharmacol. Off. Publ. Am. Coll. Neuropsychopharmacol.* 34, 1721–1732.

References

- Ricobaraza, A., Cuadrado-Tejedor, M., and Garcia-Osta, A. (2011). Long-term phenylbutyrate administration prevents memory deficits in Tg2576 mice by decreasing Abeta. *Front. Biosci. Elite Ed.* 3, 1375–1384.
- Ricobaraza, A., Cuadrado-Tejedor, M., Marco, S., Pérez-Otaño, I., and García-Osta, A. (2012). Phenylbutyrate rescues dendritic spine loss associated with memory deficits in a mouse model of Alzheimer disease. *Hippocampus* 22, 1040–1050.
- Roberts, G.W., Gentleman, S.M., Lynch, A., Murray, L., Landon, M., and Graham, D.I. (1994). Beta amyloid protein deposition in the brain after severe head injury: implications for the pathogenesis of Alzheimer's disease. *J. Neurol. Neurosurg. Psychiatry* 57, 419–425.
- Rodríguez, J.J., Davies, H.A., Silva, A.T., De Souza, I.E.J., Peddie, C.J., Colyer, F.M., Lancashire, C.L., Fine, A., Errington, M.L., Bliss, T.V.P., et al. (2005). Long-term potentiation in the rat dentate gyrus is associated with enhanced Arc/Arg3.1 protein expression in spines, dendrites and glia. *Eur. J. Neurosci.* 21, 2384–2396.
- Rollenhagen, A., Sätzler, K., Rodríguez, E.P., Jonas, P., Frotscher, M., and Lübke, J.H.R. (2007). Structural determinants of transmission at large hippocampal mossy fiber synapses. *J. Neurosci. Off. J. Soc. Neurosci.* 27, 10434–10444.
- Romano, A., Freudenthal, R., Merlo, E., and Routtenberg, A. (2006). Evolutionarily-conserved role of the NF-kappaB transcription factor in neural plasticity and memory. *Eur. J. Neurosci.* 24, 1507–1516.
- Rouaux, C., Jokic, N., Mbebi, C., Boutillier, S., Loeffler, J.-P., and Boutillier, A.-L. (2003). Critical loss of CBP/p300 histone acetylase activity by caspase-6 during neurodegeneration. *EMBO J.* 22, 6537–6549.
- Rubinstein, J.H., and Taybi, H. (1963). Broad thumbs and toes and facial abnormalities. A possible mental retardation syndrome. *Am. J. Dis. Child.* 1960 105, 588–608.

S

- Sahay, A., Scobie, K.N., Hill, A.S., O'Carroll, C.M., Kheirbek, M.A., Burghardt, N.S., Fenton, A.A., Dranovsky, A., and Hen, R. (2011a). Increasing adult hippocampal neurogenesis is sufficient to improve pattern separation. *Nature* 472, 466–470.
- Sahay, A., Wilson, D.A., and Hen, R. (2011b). Pattern separation: a common function for new neurons in hippocampus and olfactory bulb. *Neuron* 70, 582–588.
- Sanchez, R., and Zhou, M.-M. (2011). The PHD finger: a versatile epigenome reader. *Trends Biochem. Sci.* 36, 364–372.
- Sando, R., Gounko, N., Pieraut, S., Liao, L., Yates, J., and Maximov, A. (2012). HDAC4 governs a transcriptional program essential for synaptic plasticity and memory. *Cell* 151, 821–834.
- Santi, S., Cappello, S., Riccio, M., Bergami, M., Aicardi, G., Schenk, U., Matteoli, M., and Canossa, M. (2006). Hippocampal neurons recycle BDNF for activity-dependent secretion and LTP maintenance. *EMBO J.* 25, 4372–4380.
- Sanz-Blasco, S., Valero, R.A., Rodríguez-Crespo, I., Villalobos, C., and Núñez, L. (2008). Mitochondrial Ca²⁺ overload underlies Abeta oligomers neurotoxicity providing an unexpected mechanism of neuroprotection by NSAIDs. *PloS One* 3, e2718.
- Sapountzi, V., and Côté, J. (2011). MYST-family histone acetyltransferases: beyond chromatin. *Cell. Mol. Life Sci. CMLS* 68, 1147–1156.

References

- Sarathi, J., and Elefant, F. (2011). dTip60 HAT activity controls synaptic bouton expansion at the *Drosophila* neuromuscular junction. *PLoS One* 6, e26202.
- Saxe, M.D., Battaglia, F., Wang, J.-W., Malleret, G., David, D.J., Monckton, J.E., Garcia, A.D.R., Sofroniew, M.V., Kandel, E.R., Santarelli, L., et al. (2006). Ablation of hippocampal neurogenesis impairs contextual fear conditioning and synaptic plasticity in the dentate gyrus. *Proc. Natl. Acad. Sci. U. S. A.* 103, 17501–17506.
- Schafe, G.E., Atkins, C.M., Swank, M.W., Bauer, E.P., Sweatt, J.D., and LeDoux, J.E. (2000). Activation of ERK/MAP kinase in the amygdala is required for memory consolidation of pavlovian fear conditioning. *J. Neurosci. Off. J. Soc. Neurosci.* 20, 8177–8187.
- Schindowski, K., Bretteville, A., Leroy, K., Bégard, S., Brion, J.-P., Hamdane, M., and Buée, L. (2006). Alzheimer's disease-like tau neuropathology leads to memory deficits and loss of functional synapses in a novel mutated tau transgenic mouse without any motor deficits. *Am. J. Pathol.* 169, 599–616.
- Schmidt-Hieber, C., Jonas, P., and Bischofberger, J. (2007). Subthreshold dendritic signal processing and coincidence detection in dentate gyrus granule cells. *J. Neurosci. Off. J. Soc. Neurosci.* 27, 8430–8441.
- Schneider, A., Chatterjee, S., Bousiges, O., Selvi, B.R., Swaminathan, A., Cassel, R., Blanc, F., Kundu, T.K., and Boutillier, A.-L. (2013). Acetyltransferases (HATs) as targets for neurological therapeutics. *Neurother. J. Am. Soc. Exp. Neurother.* 10, 568–588.
- Schwab, M.H., Bartholomae, A., Heimrich, B., Feldmeyer, D., Druffel-Augustin, S., Goebbels, S., Naya, F.J., Zhao, S., Frotscher, M., Tsai, M.J., et al. (2000). Neuronal basic helix-loop-helix proteins (NEX and BETA2/Neuro D) regulate terminal granule cell differentiation in the hippocampus. *J. Neurosci. Off. J. Soc. Neurosci.* 20, 3714–3724.
- Scoville, W.B., and Milner, B. (1957). Loss of recent memory after bilateral hippocampal lesions. *J. Neurol. Neurosurg. Psychiatry* 20, 11–21.
- Sekeres, M.J., Neve, R.L., Frankland, P.W., and Josselyn, S.A. (2010). Dorsal hippocampal CREB is both necessary and sufficient for spatial memory. *Learn. Mem. Cold Spring Harb. N* 17, 280–283.
- Sekeres, M.J., Mercaldo, V., Richards, B., Sargin, D., Mahadevan, V., Woodin, M.A., Frankland, P.W., and Josselyn, S.A. (2012). Increasing CRTC1 function in the dentate gyrus during memory formation or reactivation increases memory strength without compromising memory quality. *J. Neurosci. Off. J. Soc. Neurosci.* 32, 17857–17868.
- Selcher, J.C., Atkins, C.M., Trzaskos, J.M., Paylor, R., and Sweatt, J.D. (1999). A necessity for MAP kinase activation in mammalian spatial learning. *Learn. Mem. Cold Spring Harb. N* 6, 478–490.
- Selvi, B.R., Jagadeesan, D., Suma, B.S., Nagashankar, G., Arif, M., Balasubramanyam, K., Eswaramoorthy, M., and Kundu, T.K. (2008). Intrinsically fluorescent carbon nanospheres as a nuclear targeting vector: delivery of membrane-impermeable molecule to modulate gene expression in vivo. *Nano Lett.* 8, 3182–3188.
- Selvi, R.B., Chatterjee, S., Jagadeesan, D., Chaturbedy, P., Suma, B.S., Eswaramoorthy, M., and Kundu, T.K. (2012a). ATP driven clathrin dependent entry of carbon nanospheres prefer cells with glucose receptors. *J. Nanobiotechnology* 10, 35.

References

- Selvi, R.B., Chatterjee, S., Jagadeesan, D., Chaturbedy, P., Suma, B.S., Eswaramoorthy, M., and Kundu, T.K. (2012b). ATP driven clathrin dependent entry of carbon nanospheres prefer cells with glucose receptors. *J. Nanobiotechnology* 10, 35.
- Seress, L., and Pokorny, J. (1981). Structure of the granular layer of the rat dentate gyrus. A light microscopic and Golgi study. *J. Anat.* 133, 181–195.
- Sergeant, N., Delacourte, A., and Buée, L. (2005). Tau protein as a differential biomarker of tauopathies. *Biochim. Biophys. Acta* 1739, 179–197.
- Sergeant, N., Bretteville, A., Hamdane, M., Caillet-Boudin, M.-L., Grognet, P., Bombois, S., Blum, D., Delacourte, A., Pasquier, F., Vanmechelen, E., et al. (2008). Biochemistry of Tau in Alzheimer's disease and related neurological disorders. *Expert Rev. Proteomics* 5, 207–224.
- Serretti, A., Olgiati, P., and De Ronchi, D. (2007). Genetics of Alzheimer's disease. A rapidly evolving field. *J. Alzheimers Dis. JAD* 12, 73–92.
- Shadmehr, R., and Holcomb, H.H. (1997). Neural correlates of motor memory consolidation. *Science* 277, 821–825.
- Sherry, D.F., and Hampson, E. (1997). Evolution and the hormonal control of sexually-dimorphic spatial abilities in humans. *Trends Cogn. Sci.* 1, 50–56.
- Shimamura, A.P. (1986). Priming effects of amnesia: evidence for a dissociable memory function. *Q. J. Exp. Psychol. A* 38, 619–644.
- Shors, T.J., Miesegaes, G., Beylin, A., Zhao, M., Rydel, T., and Gould, E. (2001). Neurogenesis in the adult is involved in the formation of trace memories. *Nature* 410, 372–376.
- Silva, A.J., Paylor, R., Wehner, J.M., and Tonegawa, S. (1992). Impaired spatial learning in alpha-calcium-calmodulin kinase II mutant mice. *Science* 257, 206–211.
- Simon, M., North, J.A., Shimko, J.C., Forties, R.A., Ferdinand, M.B., Manohar, M., Zhang, M., Fishel, R., Ottesen, J.J., and Poirier, M.G. (2011). Histone fold modifications control nucleosome unwrapping and disassembly. *Proc. Natl. Acad. Sci. U. S. A.* 108, 12711–12716.
- Sims, R.J., Nishioka, K., and Reinberg, D. (2003). Histone lysine methylation: a signature for chromatin function. *Trends Genet. TIG* 19, 629–639.
- Smith, C.N., and Squire, L.R. (2009). Medial temporal lobe activity during retrieval of semantic memory is related to the age of the memory. *J. Neurosci. Off. J. Soc. Neurosci.* 29, 930–938.
- Snow, W.M., Stoesz, B.M., Kelly, D.M., and Albensi, B.C. (2014). Roles for NF- κ B and gene targets of NF- κ B in synaptic plasticity, memory, and navigation. *Mol. Neurobiol.* 49, 757–770.
- Soloaga, A., Thomson, S., Wiggin, G.R., Rampersaud, N., Dyson, M.H., Hazzalin, C.A., Mahadevan, L.C., and Arthur, J.S.C. (2003). MSK2 and MSK1 mediate the mitogen- and stress-induced phosphorylation of histone H3 and HMG-14. *EMBO J.* 22, 2788–2797.
- Soria, C., Estermann, F.E., Espantman, K.C., and O'Shea, C.C. (2010). Heterochromatin silencing of p53 target genes by a small viral protein. *Nature* 466, 1076–1081.
- Soulé, J., Penke, Z., Kanhema, T., Alme, M.N., Laroche, S., and Bramham, C.R. (2008). Object-place recognition learning triggers rapid induction of plasticity-related immediate early genes and synaptic proteins in the rat dentate gyrus. *Neural Plast.* 2008, 269097.

References

- Squire, L.R., and Alvarez, P. (1995). Retrograde amnesia and memory consolidation: a neurobiological perspective. *Curr. Opin. Neurobiol.* 5, 169–177.
- Stafford, J.M., Raybuck, J.D., Ryabinin, A.E., and Lattal, K.M. (2012). Increasing histone acetylation in the hippocampus-infralimbic network enhances fear extinction. *Biol. Psychiatry* 72, 25–33.
- Steffan, J.S., Kazantsev, A., Spasic-Boskovic, O., Greenwald, M., Zhu, Y.Z., Gohler, H., Wanker, E.E., Bates, G.P., Housman, D.E., and Thompson, L.M. (2000). The Huntington's disease protein interacts with p53 and CREB-binding protein and represses transcription. *Proc. Natl. Acad. Sci. U. S. A.* 97, 6763–6768.
- Steffan, J.S., Bodai, L., Pallos, J., Poelman, M., McCampbell, A., Apostol, B.L., Kazantsev, A., Schmidt, E., Zhu, Y.Z., Greenwald, M., et al. (2001). Histone deacetylase inhibitors arrest polyglutamine-dependent neurodegeneration in *Drosophila*. *Nature* 413, 739–743.
- Steward, O., and Worley, P.F. (2001). Selective targeting of newly synthesized Arc mRNA to active synapses requires NMDA receptor activation. *Neuron* 30, 227–240.
- Stilling, R.M., Röncke, R., Benito, E., Urbanke, H., Capece, V., Burkhardt, S., Bahari-Javan, S., Barth, J., Sananbenesi, F., Schütz, A.L., et al. (2014). K-Lysine acetyltransferase 2a regulates a hippocampal gene expression network linked to memory formation. *EMBO J.* 33, 1912–1927.
- Storey, E., Kinsella, G.J., and Slavin, M.J. (2001). The neuropsychological diagnosis of Alzheimer's disease. *J. Alzheimers Dis. JAD* 3, 261–285.
- Sui, L., Wang, Y., Ju, L.-H., and Chen, M. (2012). Epigenetic regulation of reelin and brain-derived neurotrophic factor genes in long-term potentiation in rat medial prefrontal cortex. *Neurobiol. Learn. Mem.* 97, 425–440.
- Sun, Y., Nadal-Vicens, M., Misono, S., Lin, M.Z., Zubiaga, A., Hua, X., Fan, G., and Greenberg, M.E. (2001). Neurogenin promotes neurogenesis and inhibits glial differentiation by independent mechanisms. *Cell* 104, 365–376.
- Sweatt, J.D. (2001). The neuronal MAP kinase cascade: a biochemical signal integration system subserving synaptic plasticity and memory. *J. Neurochem.* 76, 1–10.

T

-
- Takahashi, H., McCaffery, J.M., Irizarry, R.A., and Boeke, J.D. (2006). Nucleocytosolic acetyl-coenzyme a synthetase is required for histone acetylation and global transcription. *Mol. Cell* 23, 207–217.
- Tam, G.W.C., van de Lagemaat, L.N., Redon, R., Strathdee, K.E., Croning, M.D.R., Malloy, M.P., Muir, W.J., Pickard, B.S., Deary, I.J., Blackwood, D.H.R., et al. (2010). Confirmed rare copy number variants implicate novel genes in schizophrenia. *Biochem. Soc. Trans.* 38, 445–451.
- Tanaka, Y., Naruse, I., Maekawa, T., Masuya, H., Shiroishi, T., and Ishii, S. (1997). Abnormal skeletal patterning in embryos lacking a single Cbp allele: a partial similarity with Rubinstein-Taybi syndrome. *Proc. Natl. Acad. Sci. U. S. A.* 94, 10215–10220.
- Tang, Y., Zhao, W., Chen, Y., Zhao, Y., and Gu, W. (2008). Acetylation is indispensable for p53 activation. *Cell* 133, 612–626.
- Taubenfeld, S.M., Wiig, K.A., Bear, M.F., and Alberini, C.M. (1999). A molecular correlate of memory and amnesia in the hippocampus. *Nat. Neurosci.* 2, 309–310.

References

- Teber, I., Köhling, R., Speckmann, E.-J., Barnekow, A., and Kremerskothen, J. (2004). Muscarinic acetylcholine receptor stimulation induces expression of the activity-regulated cytoskeleton-associated gene (ARC). *Brain Res. Mol. Brain Res.* 121, 131–136.
- Teng, E., and Squire, L.R. (1999). Memory for places learned long ago is intact after hippocampal damage. *Nature* 400, 675–677.
- Tessarz, P., and Kouzarides, T. (2014). Histone core modifications regulating nucleosome structure and dynamics. *Nat. Rev. Mol. Cell Biol.* 15, 703–708.
- Thakur, J.K., Yadav, A., and Yadav, G. (2014). Molecular recognition by the KIX domain and its role in gene regulation. *Nucleic Acids Res.* 42, 2112–2125.
- Thomas, G.M., and Huganir, R.L. (2004). MAPK cascade signalling and synaptic plasticity. *Nat. Rev. Neurosci.* 5, 173–183.
- Tie, F., Banerjee, R., Stratton, C.A., Prasad-Sinha, J., Stepanik, V., Zlobin, A., Diaz, M.O., Scacheri, P.C., and Harte, P.J. (2009). CBP-mediated acetylation of histone H3 lysine 27 antagonizes *Drosophila* Polycomb silencing. *Dev. Camb. Engl.* 136, 3131–3141.
- Tischmeyer, W., and Grimm, R. (1999). Activation of immediate early genes and memory formation. *Cell. Mol. Life Sci. CMLS* 55, 564–574.
- Tongiorgi, E. (2008). Activity-dependent expression of brain-derived neurotrophic factor in dendrites: facts and open questions. *Neurosci. Res.* 61, 335–346.
- Topilko, P., Schneider-Maunoury, S., Levi, G., Trembleau, A., Gourdji, D., Driancourt, M.A., Rao, C.V., and Charnay, P. (1998). Multiple pituitary and ovarian defects in Krox-24 (NGFI-A, Egr-1)-targeted mice. *Mol. Endocrinol. Baltim. Md* 12, 107–122.
- Trouche, S., Bontempi, B., Roulet, P., and Rampon, C. (2009). Recruitment of adult-generated neurons into functional hippocampal networks contributes to updating and strengthening of spatial memory. *Proc. Natl. Acad. Sci. U. S. A.* 106, 5919–5924.
- Tsankova, N.M., Berton, O., Renthal, W., Kumar, A., Neve, R.L., and Nestler, E.J. (2006). Sustained hippocampal chromatin regulation in a mouse model of depression and antidepressant action. *Nat. Neurosci.* 9, 519–525.
- Tsui, D., Voronova, A., Gallagher, D., Kaplan, D.R., Miller, F.D., and Wang, J. (2014). CBP regulates the differentiation of interneurons from ventral forebrain neural precursors during murine development. *Dev. Biol.* 385, 230–241.
- Tulving, E., and Schacter, D.L. (1990). Priming and human memory systems. *Science* 247, 301–306.



-
- Valor, L.M., Pulpulos, M.M., Jimenez-Minchan, M., Olivares, R., Lutz, B., and Barco, A. (2011). Ablation of CBP in forebrain principal neurons causes modest memory and transcriptional defects and a dramatic reduction of histone acetylation but does not affect cell viability. *J. Neurosci. Off. J. Soc. Neurosci.* 31, 1652–1663.
- Valor, L.M., Viosca, J., Lopez-Atalaya, J.P., and Barco, A. (2013). Lysine acetyltransferases CBP and p300 as therapeutic targets in cognitive and neurodegenerative disorders. *Curr. Pharm. Des.* 19, 5051–5064.
- Van der Jeugd, A., Ahmed, T., Burnouf, S., Belarbi, K., Hamdame, M., Grosjean, M.-E., Humez, S., Balschun, D., Blum, D., Buée, L., et al. (2011). Hippocampal tauopathy in tau transgenic mice coincides with impaired hippocampus-dependent learning and memory, and

References

- attenuated late-phase long-term depression of synaptic transmission. *Neurobiol. Learn. Mem.* 95, 296–304.
- Van der Jeugd, A., Vermaercke, B., Derisbourg, M., Lo, A.C., Hamdane, M., Blum, D., Buée, L., and D’Hooge, R. (2013a). Progressive age-related cognitive decline in tau mice. *J. Alzheimers Dis. JAD* 37, 777–788.
- Van der Jeugd, A., Blum, D., Raison, S., Eddarkaoui, S., Buée, L., and D’Hooge, R. (2013b). Observations in THY-Tau22 mice that resemble behavioral and psychological signs and symptoms of dementia. *Behav. Brain Res.* 242, 34–39.
- Vargha-Khadem, F., Gadian, D.G., Watkins, K.E., Connelly, A., Van Paesschen, W., and Mishkin, M. (1997). Differential effects of early hippocampal pathology on episodic and semantic memory. *Science* 277, 376–380.
- Vazdarjanova, A., and Guzowski, J.F. (2004). Differences in hippocampal neuronal population responses to modifications of an environmental context: evidence for distinct, yet complementary, functions of CA3 and CA1 ensembles. *J. Neurosci. Off. J. Soc. Neurosci.* 24, 6489–6496.
- Vazdarjanova, A., Ramirez-Amaya, V., Insel, N., Plummer, T.K., Rosi, S., Chowdhury, S., Mikhael, D., Worley, P.F., Guzowski, J.F., and Barnes, C.A. (2006). Spatial exploration induces ARC, a plasticity-related immediate-early gene, only in calcium/calmodulin-dependent protein kinase II-positive principal excitatory and inhibitory neurons of the rat forebrain. *J. Comp. Neurol.* 498, 317–329.
- Vecsey, C.G., Hawk, J.D., Lattal, K.M., Stein, J.M., Fabian, S.A., Attner, M.A., Cabrera, S.M., McDonough, C.B., Brindle, P.K., Abel, T., et al. (2007). Histone deacetylase inhibitors enhance memory and synaptic plasticity via CREB:CBP-dependent transcriptional activation. *J. Neurosci. Off. J. Soc. Neurosci.* 27, 6128–6140.
- Vermeulen, M., Mulder, K.W., Denissov, S., Pijnappel, W.W.M.P., van Schaik, F.M.A., Varier, R.A., Baltissen, M.P.A., Stunnenberg, H.G., Mann, M., and Timmers, H.T.M. (2007). Selective anchoring of TFIID to nucleosomes by trimethylation of histone H3 lysine 4. *Cell* 131, 58–69.
- Veyrac, A., Gros, A., Bruel-Jungerman, E., Rochefort, C., Kleine Borgmann, F.B., Jessberger, S., and Laroche, S. (2013). Zif268/egr1 gene controls the selection, maturation and functional integration of adult hippocampal newborn neurons by learning. *Proc. Natl. Acad. Sci. U. S. A.* 110, 7062–7067.
- Veyrac, A., Besnard, A., Caboche, J., Davis, S., and Laroche, S. (2014). The transcription factor Zif268/Egr1, brain plasticity, and memory. *Prog. Mol. Biol. Transl. Sci.* 122, 89–129.
- Vieira, P.A., and Korzus, E. (2015). CBP-Dependent memory consolidation in the prefrontal cortex supports object-location learning. *Hippocampus*.
- Vingtdeux, V., Sergeant, N., and Buée, L. (2012). Potential contribution of exosomes to the prion-like propagation of lesions in Alzheimer’s disease. *Front. Physiol.* 3, 229.
- Viosca, J., Malleret, G., Bourtchouladze, R., Benito, E., Vronskava, S., Kandel, E.R., and Barco, A. (2009). Chronic enhancement of CREB activity in the hippocampus interferes with the retrieval of spatial information. *Learn. Mem. Cold Spring Harb. N* 16, 198–209.
- Viosca, J., Lopez-Atalaya, J.P., Olivares, R., Eckner, R., and Barco, A. (2010). Syndromic features and mild cognitive impairment in mice with genetic reduction on p300 activity:

References

Differential contribution of p300 and CBP to Rubinstein-Taybi syndrome etiology. *Neurobiol. Dis.* 37, 186–194.

Vivar, C., Potter, M.C., Choi, J., Lee, J.-Y., Stringer, T.P., Callaway, E.M., Gage, F.H., Suh, H., and van Praag, H. (2012). Monosynaptic inputs to new neurons in the dentate gyrus. *Nat. Commun.* 3, 1107.

Volpicelli, F., Caiazzo, M., Greco, D., Consales, C., Leone, L., Perrone-Capano, C., Colucci D'Amato, L., and di Porzio, U. (2007). Bdnf gene is a downstream target of Nurr1 transcription factor in rat midbrain neurons in vitro. *J. Neurochem.* 102, 441–453.



Waltereit, R., Dammermann, B., Wulff, P., Scafidi, J., Staubli, U., Kauselmann, G., Bundman, M., and Kuhl, D. (2001). Arg3.1/Arc mRNA induction by Ca²⁺ and cAMP requires protein kinase A and mitogen-activated protein kinase/extracellular regulated kinase activation. *J. Neurosci. Off. J. Soc. Neurosci.* 21, 5484–5493.

Wang, J., Weaver, I.C.G., Gauthier-Fisher, A., Wang, H., He, L., Yeomans, J., Wondisford, F., Kaplan, D.R., and Miller, F.D. (2010). CBP histone acetyltransferase activity regulates embryonic neural differentiation in the normal and Rubinstein-Taybi syndrome brain. *Dev. Cell* 18, 114–125.

Wang, Z., Zang, C., Rosenfeld, J.A., Schones, D.E., Barski, A., Cuddapah, S., Cui, K., Roh, T.-Y., Peng, W., Zhang, M.Q., et al. (2008). Combinatorial patterns of histone acetylations and methylations in the human genome. *Nat. Genet.* 40, 897–903.

Wang, Z., Zang, C., Cui, K., Schones, D.E., Barski, A., Peng, W., and Zhao, K. (2009). Genome-wide mapping of HATs and HDACs reveals distinct functions in active and inactive genes. *Cell* 138, 1019–1031.

Wang, Z., Yang, D., Zhang, X., Li, T., Li, J., Tang, Y., and Le, W. (2011). Hypoxia-induced down-regulation of neprilysin by histone modification in mouse primary cortical and hippocampal neurons. *PloS One* 6, e19229.

Waterborg, J.H. (2002). Dynamics of histone acetylation in vivo. A function for acetylation turnover? *Biochem. Cell Biol. Biochim. Biol. Cell.* 80, 363–378.

Waung, M.W., Pfeiffer, B.E., Nosyreva, E.D., Ronesi, J.A., and Huber, K.M. (2008). Rapid translation of Arc/Arg3.1 selectively mediates mGluR-dependent LTD through persistent increases in AMPAR endocytosis rate. *Neuron* 59, 84–97.

Wei, W., Coelho, C.M., Li, X., Marek, R., Yan, S., Anderson, S., Meyers, D., Mukherjee, C., Sbardella, G., Castellano, S., et al. (2012). p300/CBP-associated factor selectively regulates the extinction of conditioned fear. *J. Neurosci. Off. J. Soc. Neurosci.* 32, 11930–11941.

Weingarten, M.D., Lockwood, A.H., Hwo, S.Y., and Kirschner, M.W. (1975). A protein factor essential for microtubule assembly. *Proc. Natl. Acad. Sci. U. S. A.* 72, 1858–1862.

Williams, J.M., Beckmann, A.M., Mason-Parker, S.E., Abraham, W.C., Wilce, P.A., and Tate, W.P. (2000). Sequential increase in Egr-1 and AP-1 DNA binding activity in the dentate gyrus following the induction of long-term potentiation. *Brain Res. Mol. Brain Res.* 77, 258–266.

Wilson, M.A., and McNaughton, B.L. (1994). Reactivation of hippocampal ensemble memories during sleep. *Science* 265, 676–679.

References

- Winocur, G., Moscovitch, M., and Bontempi, B. (2010). Memory formation and long-term retention in humans and animals: convergence towards a transformation account of hippocampal-neocortical interactions. *Neuropsychologia* 48, 2339–2356.
- Wisden, W., Errington, M.L., Williams, S., Dunnett, S.B., Waters, C., Hitchcock, D., Evan, G., Bliss, T.V., and Hunt, S.P. (1990). Differential expression of immediate early genes in the hippocampus and spinal cord. *Neuron* 4, 603–614.
- Witter, M.P. (1993). Organization of the entorhinal-hippocampal system: a review of current anatomical data. *Hippocampus* 3 Spec No, 33–44.
- Witter, M.P., Naber, P.A., van Haften, T., Machielsen, W.C., Rombouts, S.A., Barkhof, F., Scheltens, P., and Lopes da Silva, F.H. (2000). Cortico-hippocampal communication by way of parallel parahippocampal-subicular pathways. *Hippocampus* 10, 398–410.
- Won, J., and Hogan, N. (1995). Stability properties of human reaching movements. *Exp. Brain Res.* 107, 125–136.
- Wood, M.A., Kaplan, M.P., Park, A., Blanchard, E.J., Oliveira, A.M.M., Lombardi, T.L., and Abel, T. (2005). Transgenic mice expressing a truncated form of CREB-binding protein (CBP) exhibit deficits in hippocampal synaptic plasticity and memory storage. *Learn. Mem. Cold Spring Harb. N* 12, 111–119.
- Wood, M.A., Attner, M.A., Oliveira, A.M.M., Brindle, P.K., and Abel, T. (2006). A transcription factor-binding domain of the coactivator CBP is essential for long-term memory and the expression of specific target genes. *Learn. Mem. Cold Spring Harb. N* 13, 609–617.

χ

-
- Xie, L., Korkmaz, K.S., Braun, K., and Bock, J. (2013). Early life stress-induced histone acetylations correlate with activation of the synaptic plasticity genes *Arc* and *Egr1* in the mouse hippocampus. *J. Neurochem.* 125, 457–464.
- Xu, F., Zhang, K., and Grunstein, M. (2005). Acetylation in histone H3 globular domain regulates gene expression in yeast. *Cell* 121, 375–385.

γ

-
- Yang, X.-J. (2004). Lysine acetylation and the bromodomain: a new partnership for signaling. *BioEssays News Rev. Mol. Cell. Dev. Biol.* 26, 1076–1087.
- Yang, S., Cacquevel, M., Saksida, L.M., Bussey, T.J., Schneider, B.L., Aebischer, P., Melani, R., Pizzorusso, T., Fawcett, J.W., and Spillantini, M.G. (2015). Perineuronal net digestion with chondroitinase restores memory in mice with tau pathology. *Exp. Neurol.* 265, 48–58.
- Yang, X.J., Ogryzko, V.V., Nishikawa, J., Howard, B.H., and Nakatani, Y. (1996). A p300/CBP-associated factor that competes with the adenoviral oncoprotein E1A. *Nature* 382, 319–324.
- Yeh, S.-H., Lin, C.-H., and Gean, P.-W. (2004). Acetylation of nuclear factor-kappaB in rat amygdala improves long-term but not short-term retention of fear memory. *Mol. Pharmacol.* 65, 1286–1292.
- Ying, S.-W., Futter, M., Rosenblum, K., Webber, M.J., Hunt, S.P., Bliss, T.V.P., and Bramham, C.R. (2002). Brain-derived neurotrophic factor induces long-term potentiation in intact adult hippocampus: requirement for ERK activation coupled to CREB and upregulation of *Arc* synthesis. *J. Neurosci. Off. J. Soc. Neurosci.* 22, 1532–1540.

Z

- Zeng, L., Zhang, Q., Gerona-Navarro, G., Moshkina, N., and Zhou, M.-M. (2008). Structural basis of site-specific histone recognition by the bromodomains of human coactivators PCAF and CBP/p300. *Struct. Lond. Engl.* 16, 643–652.
- Zeng, Y., Tan, M., Kohyama, J., Sneddon, M., Watson, J.B., Sun, Y.E., and Xie, C.-W. (2011). Epigenetic enhancement of BDNF signaling rescues synaptic plasticity in aging. *J. Neurosci. Off. J. Soc. Neurosci.* 31, 17800–17810.
- Zhao, C., Teng, E.M., Summers, R.G., Ming, G.-L., and Gage, F.H. (2006). Distinct morphological stages of dentate granule neuron maturation in the adult mouse hippocampus. *J. Neurosci. Off. J. Soc. Neurosci.* 26, 3–11.
- Zhao, C., Deng, W., and Gage, F.H. (2008). Mechanisms and functional implications of adult neurogenesis. *Cell* 132, 645–660.
- Zheng, F., Zhou, X., Moon, C., and Wang, H. (2012). Regulation of brain-derived neurotrophic factor expression in neurons. *Int. J. Physiol. Pathophysiol. Pharmacol.* 4, 188–200.
- Zhong, N., and Weisgraber, K.H. (2009). Understanding the association of apolipoprotein E4 with Alzheimer disease: clues from its structure. *J. Biol. Chem.* 284, 6027–6031.
- Zola-Morgan, S., and Squire, L.R. (1984). Preserved learning in monkeys with medial temporal lesions: sparing of motor and cognitive skills. *J. Neurosci. Off. J. Soc. Neurosci.* 4, 1072–1085.
- Zovkic, I.B., Guzman-Karlsson, M.C., and Sweatt, J.D. (2013). Epigenetic regulation of memory formation and maintenance. *Learn. Mem. Cold Spring Harb. N* 20, 61–74.
- About a peculiar disease of the cerebral cortex. By Alois Alzheimer, 1907 (Translated by L. Jarvik and H. Greenson). *Alzheimer Dis. Assoc. Disord.* 1, 3–8.

Introduction générale et objectifs de la thèse (In French)

Le cadre général de la thèse

La caractéristique la plus fascinante du cerveau est sa capacité à former des souvenirs à long terme et de les stocker pour des durées allant de quelques jours à quelques semaines, voire durant une vie entière. La formation de la mémoire à long terme est un processus complexe associée à des modifications structurelles dans le cerveau. La formation de la mémoire à long terme ne se produit pas immédiatement après l'apprentissage, la mémoire est initialement dans un état fragile. Elle subit ensuite un processus de stabilisation correspondant à la consolidation de la mémoire pendant laquelle la mémoire devient moins sensible aux perturbations. Mécaniquement, l'expression de novo des gènes est un événement critique lors de la consolidation de la mémoire, ce qui est fondamental pour la consolidation cellulaire ou moléculaire. L'expression des gènes lors de la consolidation de la mémoire nécessite plusieurs mécanismes qui se chevauchent, y compris le recrutement de facteurs de transcription, les co-activateurs de transcription et les régulateurs. L'un des principaux mécanismes de régulation de l'expression des gènes est par remodelage de la chromatine, grâce à des modifications de l'extrémité des histones, dont l'acétylation est un acteur important. Les enzymes qui catalysent le transfert du groupe acétyle sur les résidus lysine de protéines histones ou non-histones sont les histones/lysine acétyltransférases (HATs / KATs). La réaction inverse est catalysée par des histone désacétylases (HDAC). Récemment, les acétylations des histones ont montré qu'elles étaient capables de moduler les processus liés à la mémoire. En particulier, l'acétylation des histones participe aux processus impliqués durant la plasticité synaptique, l'apprentissage et la formation de la mémoire à long terme.

CBP est une des HAT qui a montré fonctions importantes dans la formation de mémoire à long terme. CBP fonctionne comme acétyltransférase et comme co-activateur transcriptionnel. A la fois l'activité acétyltransférase et la fonction de coactivateur de la transcription sont essentiels pour la formation de mémoire à long terme. Enfin, la dérégulation de CBP a été observée dans des maladies neurodégénératives comme la maladie d'Alzheimer et la maladie de Huntington. Par conséquent, cibler les fonctions de CBP dans des conditions pathologiques pourrait fournir des résultats bénéfiques.

Objectifs de la thèse

Le rôle de la CBP dans la mémoire spatiale est sujet à débat, parce que différents modèles de souris CBP mutées ont fourni des résultats différents dans la mémoire spatiale. Les études de différents modèles de souris mutantes de CBP prouvent son importance dans la formation de la mémoire, mais les résultats concernant des tâches spécifiques ne sont pas toujours comparables (décrits dans Valor et al., 2013). Alors que la plupart des modèles de souris mutantes ont présenté des déficits dans les tâches de reconnaissance d'objets, les résultats de la mémoire spatiale étaient la plupart du temps variables. Les souris dépourvues d'un allèle de CBP ne montrent aucun déficit dans la formation de la mémoire spatiale, ni dans la rétention récente (Alarcon et al., 2004), alors que ces souris CBP +/- présentent une diminution de leurs facultés dans un test de mémoire spatiale suite à un élevage dans un environnement enrichissement (EE) (Lopez- Atalaya et al., 2011). Les souris avec une mutation de CBP au niveau du domaine de la fonction HAT, présentaient une altération du maintien de la mémoire spatiale à long terme alors que la mémoire à court terme était peu impactée (Korzus et al., 2004). Notamment, le déficit de mémoire récente à long terme pourrait être inversé après un entraînement intense (Korzus et al., 2004).

Pourtant, les souris knock-out conditionnel (CKO) de CBP dans les neurones excitateurs du cerveau antérieur postnatale de souris développées dans le laboratoire de J. Shen avait entraîné une déficience complète de la mémoire spatiale à court et à long terme (Chen et al., 2010), tandis que la suppression de CBP les neurones principaux du cerveau antérieur de souris développées dans le laboratoire de A. Barco affiche une mémoire spatiale intacte (Valor et al., 2011).

Ainsi, les groupes de recherche ce sont intéressés aux souris transgéniques portant des acétyltransferases mutés, plutôt que de regarder l'aspect dynamique de la régulation des acétyltransférases. Les données obtenues dans le laboratoire avant mes études de doctorat, apportent un point de vue très intéressant, ainsi Bousiges et al. (2010) ont montré que l'expression de plusieurs acétyltransférases (CBP, mais aussi EP300 et PCAF) est augmentée lors de la consolidation de la mémoire spatiale. Comme les niveaux de CBP sont présents dans des concentrations limitées dans les cellules (Vo et Goodman, 2001), la concurrence pour le recrutement de CBP pourrait fournir un mécanisme potentiel de diaphonie entre les différentes fonctions neuronales lors de la formation de la mémoire. Cette production de la hausse des niveaux de CBP - et éventuellement d'autres HATs - pourrait servir à mettre en œuvre la phase de consolidation de la formation de la mémoire soit en augmentant la robustesse de la réponse dans le temps, soit en participant à la transduction du signal à travers de multiples autres fonctions de CBP (coactivateur, pontage, ou le recrutement de l'ARN polymérase II au niveau des enhancers; Kim et al, 2010). En outre, l'acétylation de H2B, dont le niveau est considérablement modifiée dans l'hippocampe de souris mutantes CBP (Alarcon et al 2004; Chen et al, 2010; Valor et al, 2011) et semble donc être une cible de CBP in vivo, est augmentée dans les neurones de l'hippocampe tandis qu'une mémoire spatiale est formée à la fois au niveau de la chromatine et au niveau des promoteurs de plusieurs gènes de mémoire liés à la plasticité (Bousiges et al, 2010; Bousiges et al,

2013.). L'acétylation de H2B a également été associée à l'activité neuronale comme observé dans des coupes d'hippocampe dépolarisées (Sharma et al., 2010). Ainsi, l'induction d'un programme génétique dépendant de l'acétylation de H2B / CBP pourrait contribuer à la formation de la mémoire dépendante de l'hippocampe. Au total, ces études et données récentes du laboratoire établissent clairement que les acétyltransférases (la présence et l'activité) sont une composante essentielle de la formation de la mémoire.

Par conséquent, mon objectif pour la thèse était de 1 / mieux définir la fonction de CBP dans la mémoire spatiale en utilisant deux stratégies différentes: une stratégie pharmacologique (utilisation d'une petite molécule activant la fonction HAT de CBP dans le cerveau; en collaboration avec le Prof. Tapas Kundu, Bangalore, Inde) et une stratégie reposant sur un modèle de souris transgénique (modèle de souris avec une mutation du CBP dans le domaine KIX, de sorte que CBP ne puisse pas se lier avec phospho-CREB; collaboration avec le Dr Ted ABEL, Philadelphie, Etats-Unis) et 2 / examiner la pertinence de l'utilisation d'une molécule activateur des HAT comme nouvelle option thérapeutique pour les maladies liées à la mémoire telles que la maladie d'Alzheimer dans un modèle de souris Tau (collaboration avec les Drs. Luc BUEE et David BLUM, Lille, France).

Les inhibiteurs de HDAC augmentent l'acétylation des histones et ont montré des résultats prometteurs pour améliorer les processus mnésiques. Notre objectif était d'augmenter l'acétylation des histones dans une approche plus directe en activant directement l'activité enzymatique des acétyltransférases. Nous avons utilisé l'approche de la biologie chimique pour développer une petite molécule activant la fonction HAT de CBP / p300 (CSP-TTK21) qui induit l'acétylation des histones dans l'hippocampe dorsal et le cortex frontal des souris. Nous avons étudié les implications de l'activation de CBP / p300 dans deux fonctions

importantes: neurogenèse hippocampique adulte et la mémoire spatiale à long terme. L'objectif suivant était d'étudier la fonction co-activateur transcriptionnelle de CBP dépendant du domaine KIX dans la formation de la mémoire spatiale et de la rétention, ainsi que dans la régulation de l'expression de gènes cibles de CBP (c'est-à-dire des gènes pertinents de mémoire et de plasticité) lors de l'apprentissage spatial dans l'hippocampe dorsale et le cortex frontal des souris $CBP^{KIX/KIX}$. Enfin, nous avons exploré les implications thérapeutiques de l'activation pharmacologique de CBP dans un modèle de souris de la maladie d'Alzheimer (des souris THY-Tau22). Les résultats préalablement obtenus au sein de notre laboratoire suggèrent un dysfonctionnement de CBP dans l'hippocampe des souris THY-Tau22 et aussi de patients humains de la maladie d'Alzheimer. Par conséquent, notre hypothèse était de traiter des souris THY-Tau22 avec l'activateur de HAT CSP-TTK21 à un âge précoce (dès 3 mois), afin que nous puissions être en mesure non seulement d'améliorer les fonctions de la mémoire, mais aussi d'améliorer la neurogenèse adulte et peut être également de retarder l'apparition de la maladie.

Structure de la these

L'"Introduction générale" présente les concepts scientifiques fondamentaux qui ont jeté les bases de ma thèse. J'ai commencé avec les connaissances de base de l'apprentissage et de la mémoire où, je présente les différentes formes de mémoire. Ensuite, je me suis concentré sur l'hippocampe et est expliqué les fonctions importantes de l'hippocampe dans les processus mnésiques. Dans le chapitre suivant, j'ai expliqué brièvement les différentes voies moléculaires impliquées lors de la formation de la mémoire en partant des facteurs de croissance jusqu'aux facteurs de transcription et à l'expression des gènes précoces immédiats. J'ai cité des exemples d'un composant principal associé à

chacune des couches de la cascade de signalisation. Dans le chapitre suivant, j'ai introduit les mécanismes épigénétiques en mettant l'accent plus particulièrement sur la participation des acétylations dans les processus liés à la mémoire. Dans le dernier chapitre, j'ai décrit l'état pathologique de la maladie d'Alzheimer et décrit brièvement les facteurs importants impliqués dans la pathologie. Puis, j'ai insisté sur les implications de la modulation de l'acétylation des histones comme une approche thérapeutique possible pour le traitement de la maladie d'Alzheimer.

La « Contribution expérimentale » est divisée en trois chapitres basés sur les publications et les objectifs de la thèse:

Dans la publication 1, les implications de l'activation pharmacologique des HATs CBP/p300 avec CSP-TTK21 ont été décrites pour deux fonctions importantes: la neurogenèse adulte hippocampique et la formation de la mémoire spatiale. Il a jeté les bases d'un brevet de collaboration (WO2013 // 160885) entre l'UNISTRA (Strasbourg, France) et JNCASR (Bangalore, Inde). La publication 2 montre l'importance du domaine KIX de CBP dans le stockage de la mémoire spatiale à long terme. Dans la publication 3, nous avons montré les effets bénéfiques du traitement chronique de l'activateur de la HAT CSP-TTK21 chez la souris THY-Tau22 pour restaurer les déficits de mémoire spatiale.

La partie sur « Les résultats supplémentaires » présente les résultats de travaux de collaboration réalisées avec d'autres membres de mon laboratoire afin d'identifier les mécanismes moléculaires associés à l'activation de CBP/p300 par CSP-TTK21 chez la souris THY-Tau22 (description de la souche de souris THY-Tau22, effet du CSP-TTK21 sur la LTD (mesures électrophysiologique, en collaboration avec le Dr Patrick Dutar, Paris, France) et des études transcriptomiques (en collaboration avec la Plate-forme biopuce de l'IGBMC, Illkirch, France).

General Objectives and Summary (In French)

Dans la section « Discussion générale et perspective », j'ai décrit ce que nous avons appris sur la fonction de CBP dans la mémoire spatiale et ai suggéré les implications de ce travail de thèse dans le développement de médicaments épigénétiques pour le traitement des maladies de la mémoire comme la maladie d'Alzheimer, et probablement d'autres maladies neurodégénératives.

PUBLICATION 1.

A Novel Activator of CBP/p300 Acetyltransferases Promotes Neurogenesis and Extends Memory Duration in Adult Mice

Contexte de recherche et des objectifs

L'acétylation des histones est considérée comme essentielle pour la plasticité synaptique et la mémoire. La recherche réalisée par diverses équipes lors de cette dernière décennie a indiqué l'importance de l'acétylation des histones dans le fonctionnement du cerveau et l'altération de cette voie est responsable de déficits cognitifs. Le meilleur exemple de modulation de l'acétylation est l'utilisation d'inhibiteurs d'HDAC dans l'étude des processus de mémoire. Les chercheurs utilisent des inhibiteurs d'HDAC comme un outil pour cibler les HDAC et ainsi activer l'acétylation des histones. L'activation de l'acétylation des histones par les inhibiteurs HDAC impacts sur le maintien de la LTP et améliore également la mémoire à long terme comme cela a été démontré dans différentes formes de mémoire et différents contextes. De manière intéressante, l'activation de l'acétylation des histones par les inhibiteurs de HDAC est un processus plutôt indirecte et en dehors de l'activité de désacétylation, qui se produit également sur les protéines non histones, les HDAC sont associés à de nombreuses autres fonctions biologiques, en agissant par exemple comme des complexes co-répresseurs de la transcription de la chromatine.

Le rôle des HDAC dans la mémoire et les maladies est un domaine de recherche intense. Les chercheurs ont montré le rôle de plusieurs HDAC dans les processus de mémorisation. Cependant, nos connaissances sur le rôle des HATs dans les processus liés à la mémoire sont principalement basées sur CBP. La mutation de CBP est à l'origine du syndrome de Rubinstein Taybi, un état pathologique caractérisé par des déficits cognitifs (Petrij et al., 1995; Kalkhoven et al., 2003; Alarcón et al, 2004; Barco, 2007). La fonction de CBP dans l'apprentissage et dans les processus de mémorisation a été déchiffré avec

des modèles génétiques de knock-down et de suppression du gène (Barco, 2007; Oliveira et al., 2006; Barrett et al, 2011;. Oliveira et al, 2011;. Chen et al., 2010; Valor et al., 2011). L'apprentissage spatial induit l'expression de plusieurs HAT y compris CBP/p300 suggérant son importance pendant le processus de formation de la mémoire (Bousiges et al., 2010). De même, une libération virale de CBP dans l'hippocampe d'un modèle de souris de la maladie d'Alzheimer restaure les déficits d'apprentissage et de mémoire (Caccamo et al., 2010). L'ensemble de ces résultats appuie le fait que la stimulation de CBP peut être un potentiel outil thérapeutique pour le traitement des pathologies des troubles de la mémoire, tel que la maladie d'Alzheimer.

Ainsi quand j'ai commencé ma recherche au laboratoire du Dr K Tapas Kundu, Bangalore, en Inde, l'objectif était de cibler directement la fonction HAT de CBP par un moyen pharmacologique afin de moduler les niveaux d'acétylation des histones et d'étudier son effet sur les fonctions biologiques. Les recherches dans le laboratoire de Kundu étaient principalement axées sur la recherche sur le cancer. Après une collaboration avec le groupe du Dr AL Boutillier qui a commencé en 2003, un nouvel axe de recherche a été développé vers la réactivation des fonctions HAT de CBP dans les maladies neurodégénératives et dans les fonctions cognitives. L'activation des HAT pourrait permettre une meilleure compréhension de l'importance des HAT spécifiques dans différents processus, tels que la survie neuronale et la formation de la mémoire, et avec hypothétiquement moins d'acétylation des histones de manière non-spécifique et globale.

La recherche sur les activateurs KAT

Le domaine HAT est la région qui catalyse l'activité acétyltransférase des HAT. Le domaine HAT a été étudié minutieusement et la structure cristalline du domaine HAT de CBP et p300 a déjà été décrit. Le domaine HAT a été d'un

immense intérêt pour les chimistes pour moduler la fonction acétyltransférase des HAT. Plusieurs petites molécules (sondes chimiques synthétiques ou naturels) ont été conçues pour cibler ce domaine. L'utilisation de petites molécules qui peuvent activer la fonction enzymatique des HAT est un concept émergent et seulement quelques-unes d'entre elles ont été décrites. La première molécule activatrice de HAT rapportée est le N- (4-chloro-3-trifluorométhylphényl) -2-éthoxy-6-pentadécyle-Benzamide (CTPB) qui est dérivée à partir de l'acide anacardique obtenu à partir de la coquille de la noix de cajou. CTPB a été synthétisé dans le laboratoire du Dr Kundu en Inde (Balasubramanyam et al., 2003). CTPB active p300 mais pas fonction HAT de PCAF in vitro. L'analyse par spectroscopie Raman suggère que la liaison du CTPB sur le domaine HAT de p300 induit un changement de conformation qui aide au recrutement de plus d'acétyl-CoA et à l'auto-acétylation (Mantelingu et al., 2007). Dans le but d'avoir un activateur de HAT plus stable et plus puissant, CTPB a été dérivé en une série de petites molécules et une librairie de molécules a été créée. J'ai été associé au travail sur la modulation du domaine HAT par des petites molécules dans le laboratoire du Dr Kundu. Nous avons testé l'activité de ces molécules en utilisant un dosage de l'activité HAT faible débit. Parmi tous les dérivés, TTK21 a montré la meilleure activité et la meilleure spécificité envers CBP et p300. Le but principal à la synthèse de ces activateurs de HAT est de tester leurs fonctions dans le cerveau des animaux. Ainsi, la première étape avant de tester l'effet d'une molécule dans un modèle animal est de vérifier son activité dans des lignées cellulaires. Nous avons traité des lignées de cellules SHSY-5Y au TTK21 et nous avons trouvé que la molécule n'est pas capable de traverser la membrane cellulaire et est inactive dans les lignées cellulaires de mammifères.

Besoin d'un véhicule pour transporter l'activateur de HAT

La biologie moléculaire et la nanotechnologie ont travaillé main dans la main pendant la dernière décennie pour développer une approche thérapeutique pour la délivrance de la drogue. La science interdisciplinaire nous permet de partager les connaissances de chacune des disciplines de la science et de la technologie permettant de développer ce qui est impossible à faire seul. Nous avons appris que le groupe du Dr Eswaramoorthy dans JNCASR, en Inde avait développé un sucre dérivé de nanosphères de carbone (CSP) qui peut traverser la membrane des cellules de mammifères et peut également traverser la barrière hémato-encéphalique (BHE) chez la souris. Les premières études de la collaboration entre les deux groupes de recherche ont permis d'adsorber l'activateur de HAT CTPB sur CSP (CSP CTPB) de manière chimique. Ensuite, le composé adsorbé a pu être testé dans le laboratoire du Dr Boutillier et la molécule activateur de HAT a montré une activité dans le cerveau des souris et des rats (Selvi et al., 2008). Nous avons profité de la technologie disponible et on a commencé à enquêter sur les détails mécanistiques de l'entrée de CSP dans les cellules mammifères. Nous avons montré que l'entrée de CSP dans des cellules vivantes suit un processus d'endocytose dépendante de la clathrine. CSP a également montré une forte préférence pour les cellules avec des niveaux plus élevés de transporteurs de glucose (Selvi et al., 2012). Ainsi la molécule s'est avéré être un véhicule potentiel pour cibler différents organes comme le cerveau avec une grande spécificité.

La conjugaison de CSP-TTK21 et le début d'une approche fascinante pour stimuler la mémoire chez des souris non transgéniques

Nous avons réussi à conjuguer chimiquement CSP avec un activateur de HAT TTK21 (nommé comme CSP-TTK21) et à confirmer la conjugaison par

diverses méthodes biophysiques. CSP-TTK21 contrairement à la molécule TTK21 non conjuguée pourrait traverser la membrane des cellules de mammifères et aussi passer la barrière hémato-encéphalique (BHE) chez la souris. Le matériau conjugué prend environ 24 heures pour entrer dans le cerveau de rongeurs et dans les 72 heures après l'administration i.p., avec un suivi par la fluorescence intrinsèque de CSP. Comme CSP-TTK21 pourrait avoir un impact sur les niveaux d'acétylation des histones du cerveau, étudier ses conséquences dans un contexte neurobiologique est d'un immense intérêt. Cela établit les bases pour explorer les implications de l'activation CBP par l'activateur HAT CSP-TTK21 dans les processus liés à la mémoire. La collaboration avec le groupe du Dr Boutillier m'a permis de travailler dans son laboratoire pour un court séjour de 3 mois. Mes premiers résultats obtenus dans le laboratoire du Dr Boutillier portaient sur le rôle potentiel de l'activation de CBP grâce au CSP-TTK21 dans les processus de mémorisation. Nous avons constaté que CSP-TTK21 en activant l'acétylation des histones dans l'hippocampe dorsal a également favorisé la formation de neurones doublecortine positif très ramifiés dans le gyrus denté seulement après une dose unique d'injection (500 µg / souris). Ce fut la première série de données qui a suggéré que l'activation de la HAT pourrait également favoriser la maturation et la différenciation des progéniteurs neuronaux adultes. Enfin, nous avons également mis en évidence que CSP-TTK21 a amélioré la mémoire spatiale à long terme sans amélioration de la rétention d'une mémoire récente.

La première série de données obtenues à partir de ma courte visite dans le laboratoire du Dr Boutillier a en outre été soutenu par le CEFIPRA entre les laboratoires du Dr Kundu et du Dr Boutillier, y compris le financement de mon doctorat dans le laboratoire du Dr Boutillier à Strasbourg, France. Je suis entré dans le laboratoire du Dr Boutillier en Janvier 2013 comme un étudiant en doctorat.

Après avoir rejoint en tant que doctorant, nous avons étudié la distribution des CSP-TTK21 dans différentes régions du cerveau des souris et d'autres tissus du corps. Alors la grande question était le mécanisme par lequel CSP-TTK21 active la formation de la mémoire. Nous avons évalué les profils d'expression des gènes de la mémoire et nous avons également validé le statut d'acétylation de l'histone H2B sur les promoteurs de ces gènes après l'injection unique de CSP-TTK21.

Les données obtenues sur l'effet de la CSP-TTK21 chez les souris adultes en bonne santé ont été publiés dans le Journal of Neuroscience (Chatterjee et al., 2013) et la molécule (CSP-TTK21) a été breveté (W02013 / 160885).

Discussion

La présente étude a montré les implications de l'activation acétyltransférase CBP / p300 dans les processus liés à la mémoire. Contrairement à d'autres activateurs de HAT ne passant pas les membranes cellulaires, le nouvel activateur de HAT conjugué CSP-TTK21 traverse efficacement la barrière hémato-encéphalique et active l'acétylation des histones dans le cortex frontal et l'hippocampe dorsal de cerveau de souris. L'activation de l'acétylation des histones a été bénéfique car elle induit la différenciation et la maturation des jeunes neurones de l'hippocampe et l'amélioration de la rétention à long terme d'une mémoire spatiale. Cette étude est la première preuve directe pour l'activation de CBP / p300 dans le cerveau qui en soi est une grande réussite et ouvre une nouvelle option thérapeutique pour les maladies neurodégénératives.

Importance de l'amélioration de la maturation neuronale de la fonction cognitive

La neurogenèse hippocampique est considérée comme étant impliquée dans la persistance de la mémoire à long terme. Récemment, il a été montré que l'arrêt de la neurogenèse par rayonnement du cerveau entier un mois avant la tâche spatiale conduit à des déficits importants de la performance de la mémoire spatiale en piscine de Morris. En outre une diminution de la neurogenèse a aussi entraîné une expression réduite de BDNF en raison de la diminution des acétylations de H3 sur les promoteurs du BDNF (Ji et al., 2014). Ici, dans cette étude, nous avons montré que l'activation de HAT chez les souris non transgénique a amélioré la longueur dendritique et l'arborisation des neurones DCX-positifs et augmente l'expression du gène de marqueurs neuronaux de différenciation comme BDNF et NeuroD1 seulement après 3 jours d'injection. Nous avons observé une augmentation de l'occupation de l'histone H2B

acétylée sur les promoteurs de NeuroD1 et BDNF EI. Nous avons montré que l'expression induite de NeuroD1 par l'activateur de HAT a éventuellement contribué à la maturation dendritique stimulée. Il était déjà connu que NeuroD1 joue essentielle de la maturation dendritique et des souris dépourvues de NeuroD1 présentent une réduction de la maturation dendritique et de l'arborisation des progéniteurs granulaires de l'hippocampe (Schwab et al., 2000). Plus tard, une étude concluante du groupe de Claire Rampon a confirmé l'importance de NeuroD1 dans la maturation neuronale et l'intégration fonctionnelle de nouveaux neurones pendant la période de maturation (Richetin et al., 2015). Dans cette étude, les vecteurs rétroviraux codant le gène rapporteur pour la synthèse de NeuroD1 dans le gyrus denté montrent une grande complexité de ramification et une augmentation de la longueur dendritique totale des neurones à l'âge de 14 jours. Ainsi NeuroD1 fournit aux neurones nouvellement générés de nouvelles connexions. NeuroD1 est un gène cible CBP (Sun et al., 2001). Bien que les souris CBP mutées hétérozygote (+/-) ne montrent pas de défauts dans la neurogenèse adulte basale mais la neurogénèse adulte induit par un environnement enrichi était significativement altérée chez ces souris (Lopez-Atalaya et al., 2011). Ainsi, les résultats appuient l'idée que la présence de CBP contribue à la neurogenèse adulte peut-être par la maturation neuronale et la différenciation.

Rôle de l'activation de CBP / p300 dans la persistance de la mémoire à long terme

La recherche active de la dernière décennie a établi le rôle de CBP et p300 dans les processus de mémoire (Barco, 2007;. Oliveira et al., 2006; Barrett et al, 2011;. Oliveira et al, 2011). L'implication de CBP dans la mémoire spatiale dépend de sa liaison avec CREB à travers le domaine KIX (Chatterjee et al, non publié, Publication 3). L'activation de la voie de signalisation de la protéine

CREB augmente la force de la mémoire spatiale chez les animaux faiblement entraînés (Sekeris et al., 2010). Étonnamment, nous n'avons pas la preuve de l'influence de l'activation CBP sur les performances de la mémoire spatiale pour un délai court post acquisition. Cependant, l'activation dépendant de CSP-TTK21 des fonctions HAT de CBP / p300 augmente significativement la mémoire à long terme (16 jours après l'acquisition). Différentes souris mutantes CBP montrent une insuffisance dans certaines formes de la mémoire dépendante de l'hippocampe, en particulier la reconnaissance d'objet est affectée alors que la mémoire spatiale est soit peu ou pas impactée (Oike et al., 1999; Alarcón et al., 2004;. Korzus et al, 2004;. Valor et al, 2011). Notamment, la mémoire spatiale a été mesurée dans les études mentionnées ci-dessus avec peu de temps post-acquisition (24 h ou moins). Ainsi CBP semble être plus impliquée dans la formation de la mémoire spatiale à distance (remote memory) que pour la mémoire récente.

La consolidation de la mémoire implique une réorganisation synaptique et des systèmes où les interactions hippocampo-corticale coordonnés stabilise la mémoire (Frankland et Bontempi 2005; Winocur et al., 2010). Nous avons observé que CSP-TTK21 non seulement active l'acétylation des histones dans l'hippocampe dorsal mais active également l'acétylation des histones grâce à CBP / p300 dans le cortex frontal et certaines autres régions du cerveau. La fonction HAT de CBP est essentielle pour l'encodage à long terme dans le cortex préfrontal médial (CPFm). Des rapports récents suggèrent que la fonction réduite de CBP dans le CPFm se traduit par la perturbation la mémoire dépendant de la localisation d'objet (Vieira et Korzus, 2015). Ainsi, l'activation de la fonction HAT de CBP dans le CPFm pourrait compléter les mécanismes de la mémoire spatiale hippocampe-dépendante et améliorer le codage de la mémoire à long terme. Ces résultats suggèrent que l'augmentation de l'acétylation des histones grâce à CSP-TTK21 pourrait être la marque de neurones de certaines sous-régions corticales (marquage précoce), renforçant

ainsi un dialogue hippocampo-corticale pour former une mémoire persistante, comme décrit récemment (Lesburguères et al., 2011).

Activation de HAT, une nouvelle approche thérapeutique pour les troubles de la mémoire ?

HAT et HDAC présentent des résultats opposés dans le contexte de l'acétylation des niveaux globaux de chromatine, leur mode d'action est également différent. Les HAT sont les composantes essentielles des complexes co-activateur transcriptionnel et possèdent un Bromodomain permettant de recruter les histones acétylées de la chromatine (Yang, 2004). Considérant que les HDAC font partie de complexes corépresseurs qui dépendent de l'interaction protéine-protéine à cibler à la chromatine. Ainsi on peut présumer que l'activation des HAT conduirait à des conséquences différentes de celles de l'inhibition des HDAC. En outre, pendant la formation de la mémoire les marques spécifiques d'acétylation des histones sont activés par les HAT plutôt que bloqué par les HDAC (Bousiges et al, 2013;. Peixoto et Abel, 2013). Nos résultats suggèrent que CSP-TTK21 active la transcription des gènes liés à la différenciation (Neuro D1, DCX, TUC4, BDNF), l'excitabilité neuronale (cFos), ou de la mémoire (FOSL2, NR4A2), cependant, d'autres gènes cibles de CBP / p300 n'étaient pas activé comme Egr-1 ou Arc par une injection unique de CSPTTK21 dans des conditions basales. L'activation du BDNF est sensible à l'état d'acétylation de la chromatine et est une cible de la signalisation NR4A (Volpicelli et al, 2007;. Faucon et al, 2012). Les HDACi augmentent également l'expression du gène NR4A2, alors que le blocage de signalisation NR4A interfère avec l'amélioration de la mémoire induite par les HDACi. Ainsi CSP-TTK21 active éventuellement des cascades de signalisation spécifiques pour activer les processus de mémoire.

La déficience cognitive est souvent associée à un dysfonctionnement de la transcription comme en témoignent de diverses maladies neurodégénératives. Les inhibiteurs d'HDAC sont largement utilisés pour augmenter le statut d'acétylation des histones dans des modèles animaux afin de rétablir les programmes génétiques dans le cerveau (Kazantsev et Thompson, 2008; Gräff et al., 2011). Les HDACi ont montré un effet prometteur pour reconstituer les conditions pathologiques et les déficits de mémoire des modèles de souris de la maladie d'Alzheimer (MA) (Ricobaraza et al, 2009;. Kilgore et al, 2010;. Ricobaraza et al., 2011; Govindarajan et al, 2013.; Ricobaraza et al., 2012, Cuadrado-Tejedor et al., 2013).

CBP a été impliquée dans plusieurs maladies neuro-dégénératives. La mutation de CBP provoque le syndrome de Rubinstein Taybi, une affection neurodégénérative caractérisée par un retard mental (Petrij et al., 1995; Oike et al., 1999). Dans la maladie de Huntington, CBP interagit avec la protéine mutante et conduit à la dérégulation de l'expression du gène huntingtine (Steffan et al., 2000; Steffan et al., 2001). Des résultats non publiés de notre laboratoire suggèrent également que les niveaux de protéine CBP sont considérablement diminués dans l'hippocampe des patients atteints de la maladie d'Alzheimer (Bousiges et al, manuscrit en préparation) et dans un modèle de souris de Tauopathie (Cassel et al, manuscrit en cours de préparation). En outre, nous avons également observé que les niveaux de CBP ont diminué dans des cellules de l'hippocampe exprimant des niveaux élevés de protéine pathogène Tau phosphorylée dans un modèle de souris de Tauopathie. Ainsi la stratégie pour activer la fonction enzymatique de CBP dans un état pathologique pourrait effectivement se révéler bénéfique dans une perspective thérapeutique.

Points de vue

Un traitement unique du CSP-TTK21 chez les souris adultes en bonne santé a montré un effet prometteur pour améliorer la mémoire spatiale à long terme en renforçant la maturation neuronale et l'expression de gènes liés à la mémoire. Comme indiqué précédemment, les dysfonctionnements de la fonction HAT de CBP / p300 a été impliquée dans divers troubles neurodégénératifs comme la maladie d'Alzheimer. Par conséquent, la possibilité pour sauver les défauts cognitifs dans des modèles animaux de neurodégénérescence, par traitement CSP-TTK21 est très probable. Nous avons exploré la possibilité d'améliorer la perte de mémoire dans un modèle de souris de tauopathie (THY-Tau22) par le traitement chronique de CSP-TTK21 (Publication 3).

Pour utiliser l'activateur de HAT CSP-TTK21 nouvellement développé comme un médicament pour stimuler la mémoire, il serait nécessaire d'étudier son effet physiologique dans le corps de l'animal. CSP est préparé à partir de glucose et il est éliminé du cerveau après 7 jours après une injection ip. Bien que l'on n'ait pas mis en évidence d'effet toxique ou des phénotypes comportementaux anormaux chez les souris après une injection unique de CSP-TTK21, une caractérisation approfondie de la toxicité doit être effectuée. Pour développer CSP-TTK21 comme médicament thérapeutique, la dose mortelle doit également être déterminée dans différents modèles animaux. Lors de la publication 3, nous avons administré un traitement chronique de CSP-TTK21 chez la souris THY-Tau22 et avons essayé de répondre en partie à la question de la toxicité en mesurant les niveaux du marqueur pro-apoptotique caspase-3 dans différentes parties du corps comme le foie, la rate, les reins et le cœur. Pour répondre à la possibilité d'accumulation de la molécule dans ces parties du corps, le niveau d'acétylation des histones ont également été mesurées. Apparemment, la molécule ne montre pas d'effets secondaires toxiques (Publication 3).

Nous avons constaté que CSP-TTK21 active l'activité acétyltransférase de p300 / CBP, mais ne modifie pas l'activité de la HAT PCAF (données non présentées). Cependant, il a été démontré récemment que d'autres HAT comme GCN5 et Tip60 influencent les processus liés à la mémoire (Maurice et al, 2008;.. Stilling et al, 2014). Ainsi, il serait intéressant d'étudier si CSP-TTK21 agit sur d'autres HAT ou s'il améliore les processus de la mémoire liés uniquement par activation de CBP / p300. Comme l'acétylation des histones est liée à l'expression des gènes, nous avons également besoin d'effectuer une étude transcriptomique complète pour déterminer le profil d'expression différentielle des gènes lors du traitement par CSP-TTK21 des souris adultes en bonne santé. Dernier point mais pas des moindres; mettre au point un médicament pour le traitement, et l'effet de l'administration orale doit être contrôlé. Donc, nous devons aussi vérifier si CSP-TTK21 peut encore atteindre le cerveau et ainsi conserver sa propriété d'activation de la fonction HAT après administration orale.

PUBLICATION 2.

CREB-dependent CBP regulations of plasticity-related genes is required for long-term spatial memory formation

Contexte et objectifs scientifiques

CBP est une acétyltransférase de la lysine ainsi qu'un co-activateur transcriptionnel. L'interaction entre CBP et le facteur de transcription CREB est un événement essentiel dans le processus de formation de la mémoire. Depuis les dix dernières années, le rôle de CBP a été explorée au cours des différentes formes de formation de la mémoire à l'aide de la plupart des modèles de souris mutantes.

Dans la présente étude, nous avons utilisé un modèle de souris mutante de CBP (souris CBPKIX / KIX) qui contient une triple mutation dans le domaine KIX de CBP qui le rend incapable d'interagir avec phospho-CREB et c-myb. Woods et al ont déjà décrit que les souris CBP^{KIX / KIX} présentaient un déficit en mémoire à long terme, en conditionnement à la peur dépendant du contexte et en reconnaissance d'objet (Wood et al., 2006). Cependant, l'importance de l'interaction CBP-CREB n'a jamais été testé pour la consolidation de la mémoire spatiale dans la piscine de Morris (Morris water maze MWM) en utilisant des souris CBP^{KIX / KIX}.

Dans le présent chapitre, j'ai identifié que l'interaction entre CBP et les facteurs de transcription comme CREB grâce au domaine KIX est essentiel pour la conservation de la mémoire à long terme, mais pas pour la rétention à court terme. En outre, j'ai étudié les profils d'expression des gènes de la mémoire et de la plasticité liée après l'apprentissage spatial dans deux régions du cerveau

importantes pour la consolidation de la mémoire (hippocampe dorsal et cortex préfrontal) chez la souris $CBP^{KIX / KIX}$. Le profil d'expression des gènes a également été comparé à l'acétylation des histones de marques spécifiques liés à l'activation transcriptionnelle sur des promoteurs proximales de ces gènes. Par conséquent, cette étude fournit des preuves de l'interaction CBP-CREB par le domaine KIX pour la persistance de la mémoire spatiale à long terme.

PUBLICATION 3

Chronic treatment of a Tau mouse model with a HAT activator increases maturation of newly generated neurons and improves hippocampus-dependent memory

Contexte et objectifs scientifiques

Dans la publication 1, nous avons signalé un nouvel activateur de la fonction HAT de CBP / p300 (CSP-TTK21) qui peut traverser la barrière hémato-encéphalique et induire l'acétylation des histones dans le cerveau des souris. En atteignant le cerveau des souris adultes en bonne santé, il potentialise deux fonctions importantes: la neurogenèse hippocampique adulte et la mémoire spatiale à long terme (Chatterjee et al, 2013). Par conséquent, l'étape suivante était de déterminer si le traitement par cet activateur de la HAT CSP-TTK21 pourrait apporter un avantage dans un modèle de souris présentant une déficience cognitive. Pour cette étude, nous avons utilisé des souris THY-Tau22 qui expriment quatre répétitions de la protéine tau humaine mutés à des sites G272V et P301S sous un promoteur Thy1. Les souris THY-Tau22 montrent une pathologie Tau hippocampique et troubles de la mémoire dépendante de l'hippocampe que l'on retrouve dans la maladie d'Alzheimer (Schindowski et al., 2006;. Belarbi et al, 2011; Van der Jeugd et al, 2013.). Les THY-Tau22 montrent des déficits liée à l'âge tels que des déficits de l'apprentissage et de la mémoire dépendant de l'hippocampe (Van der Jeugd et al., 2013) et des déficits atténués en phase tardive de LTD pour la transmission synaptique (Van der Jeugd et al., 2011).

Les études de mon laboratoire ont montré qu'à l'âge de 8 mois les souris THY-Tau22 entraînées dans le MWM pendant cinq jours consécutifs afin de localiser une plate-forme cachée montrent des déficits dans la rétention de la mémoire spatiale à long terme (Schneider, Cassel, Chatterjee et al, manuscrit en préparation; Soutenir Résultats SR2). Un traitement sub-chronique de CSP-TTK21 (3 injections, une fois par semaine) chez les souris THY-Tau22 améliore les déficits de la mémoire avec parallèlement une restauration de l'expression de certains gènes dans des conditions d'apprentissage, comme évalué par des analyses du transcriptome (études de RNAseq). Particulièrement plusieurs gènes liés à la mémoire et la plasticité ont été trouvés dérégulés dans les souris Tau par rapport aux souris WT après l'apprentissage spatial, et de manière intéressante, un ensemble de gènes liés au transport d'ions et aux canaux ioniques voltage-dépendants ont été trouvés sur-régulée par un traitement CSPTTK21 (Schneider, Cassel, Chatterjee et al, manuscrit en préparation; Résultats Soutenir SR3). Cependant, un tel traitement sous-chronique n'a pas amélioré de façon significative la neurogenèse adulte qui est par ailleurs sévèrement altérée dans ce modèle de souris Tau (non représenté), ce qui suggère que les souris ne récupèrent pas pleinement avec le traitement.

Par conséquent, l'hypothèse de la présente étude était que si nous traitons les souris THY-Tau22 avec l'activateur de la HAT CSP-TTK21 à un temps précoce (dès 3 mois), nous pourrions être en mesure non seulement d'améliorer les fonctions de la mémoire, mais aussi d'améliorer la neurogenèse adulte et peut être retarder l'apparition de la pathologie de la maladie. Nous avons ensuite traité des souris THY-Tau22 de 3 mois avec CSP-TTK21 et nous avons poursuivi le traitement jusqu'à l'âge de 8 mois. Nous avons analysé les effets d'un traitement chronique de CSP-TTK21 dans deux fonctions importantes dépendantes de l'hippocampe: la neurogenèse adulte et la mémoire spatiale à long terme. Nous avons également étudié les profils d'expression de plusieurs gènes de mémoire et de plasticité (comme les gènes précoces immédiats, des

gènes de formation et de plasticité synaptique). Comme nous avons effectué le traitement chronique, nous avons cherché à évaluer les éventuels effets secondaires toxiques apparaissant en raison du traitement chronique. Enfin, nous avons également étudié l'anatomopathologie afin de déterminer si la molécule pourrait effectivement retarder la pathologie de la maladie.

Ce sont ces caractéristiques importantes qu'il faut déterminer, afin de tester si une telle molécule peut être une nouvelle opportunité thérapeutique pour les troubles liés à la mémoire tels que la maladie d'Alzheimer.

Role of Lysine Acetyltransferase (KAT) Activation in Spatial Memory: A New Therapeutic Approach for Memory Related Disorders such as Alzheimer's Disease

Résumé

La CREB Binding Protein (CBP) a une activité lysine acétyltransférase intrinsèque et fonctionne aussi comme un co-activateur transcriptionnel. L'activité acétyltransférase et la fonction de coactivateur transcriptionnel sont toutes deux essentielles pour la formation de mémoire à long terme. De plus, la dérégulation de CBP a été observée dans des maladies neurodégénératives comme la maladie d'Alzheimer et la maladie de Huntington. L'objectif de ma thèse était d'étudier le rôle de la CBP et de son activation pharmacologique dans le cadre de la formation de la mémoire spatiale, une forme de mémoire qui est démantelée très tôt dans la MA. Les données obtenues à partir de ma thèse montrent que l'activation de la fonction acétyltransférase CBP par l'activateur CSP-TTK21 améliore les processus mnésiques chez des souris adultes normales et aussi dans un modèle murin de MA (THY-Tau22). Ainsi, la stratégie d'activation pharmacologique de l'activité acétyltransférase de CBP a un énorme potentiel pour une utilisation en tant qu'agent thérapeutique pour le traitement des maladies liées à l'altération de la mémoire tel que la maladie d'Alzheimer.

Summary

CREB Binding Protein (CBP) has an intrinsic lysine acetyltransferase activity and also functions as a transcriptional co-activator. Both the acetyltransferase activity and the transcriptional co-activator function are critical for long-term memory formation. Importantly, CBP dysregulation has been observed in neurodegenerative conditions like in Alzheimer's disease and Huntington's disease. The focus of my thesis was to study the role of CBP and its activation by a new pharmacological tool, in the context of spatial memory formation, a form of memory that is very early dismantled in AD. Data obtained from my thesis clearly suggests that activation of CBP acetyltransferase function by small molecule activator CSP-TTK21 can improve memory related processes in healthy adult mice and also in a mouse model of AD, (THY-Tau22). Therefore, the strategy of pharmacological activation of CBP acetyltransferase activity has tremendous potential for use as therapeutics for the treatment of diseases related to memory impairment such as Alzheimer's disease.

Keywords: Epigenetics, Histone acetylation, Spatial memory, Transcription, Neurogenesis