



**HAL**  
open science

# La NADPH oxydase Nox4, approche topologique, modulation d'activité et impact dans l'arthrose

Francis Rousset

► **To cite this version:**

Francis Rousset. La NADPH oxydase Nox4, approche topologique, modulation d'activité et impact dans l'arthrose. Sciences agricoles. Université de Grenoble, 2014. Français. NNT : 2014GRENV001 . tel-01558890

**HAL Id: tel-01558890**

**<https://theses.hal.science/tel-01558890>**

Submitted on 10 Jul 2017

**HAL** is a multi-disciplinary open access archive for the deposit and dissemination of scientific research documents, whether they are published or not. The documents may come from teaching and research institutions in France or abroad, or from public or private research centers.

L'archive ouverte pluridisciplinaire **HAL**, est destinée au dépôt et à la diffusion de documents scientifiques de niveau recherche, publiés ou non, émanant des établissements d'enseignement et de recherche français ou étrangers, des laboratoires publics ou privés.

## THÈSE

Pour obtenir le grade de

## DOCTEUR DE L'UNIVERSITÉ DE GRENOBLE

Spécialité : **BIOLOGIE CELLULAIRE**

Arrêté ministériel : 7 août 2006

Présentée par

**Francis ROUSSET**

Thèse dirigée par **Françoise MOREL** et **Christian DROUET**  
codirigée par **Bernard LARDY**

préparée au sein du **Laboratoire GREPI AGIM FRE3405**  
**UJF/CNRS/EPHE/UPMF**

dans l'École Doctorale **CHIMIE ET SCIENCES DU VIVANT**

# La NADPH oxydase Nox4, approche topologique, modulation d'activité et impact dans l'arthrose

Thèse soutenue publiquement le 17 Janvier 2014,  
devant le jury composé de :

**Pr Philippe GAUDIN**

PU-PH, CHU de Grenoble, Président

**Dr Corinne DUPUY**

DR CNRS, Institut Gustave Roussy, Rapporteur

**Dr Pham My-Chan DANG**

CR CNRS, Institut Xavier Bichat, Rapporteur

**Pr Karl-Heinz KRAUSE**

Professeur, Université de Genève, Membre

**Dr Bernard LARDY**

MCU-PH, CHU de Grenoble, Membre

**Pr Françoise MOREL**

Professeur émérite, UJF, Grenoble, Membre





<b>SOMMAIRE</b> .....	<b>3</b>
<b>LEGENDE DES FIGURES</b> .....	<b>5</b>
<b>LISTE DES ABREVIATIONS</b> .....	<b>6</b>
<b>INTRODUCTION BIBLIOGRAPHIQUE</b> .....	<b>9</b>
<b>I. La genèse des dérivés réactifs de l'oxygène (ROS)</b> .....	<b>11</b>
<b>II. Les sources de ROS</b> .....	<b>12</b>
A. Mitochondrie et ROS.....	13
B. Xanthine oxydase et ROS.....	14
C. NO synthase et ROS .....	14
D. Les NADPH oxydases .....	14
1. Caractéristiques structurelles des Nox.....	15
2. Décryptage des mécanismes catalytiques .....	17
3. Biosynthèse des Nox.....	18
a) P22 <sup>phox</sup> , l'ancre des Nox1 à 4 au sein des membranes .....	18
b) Rôle de la molécule d'hème.....	20
4. Distribution tissulaire des Nox et rôles physiologiques.....	21
<b>III. Régulation de la concentration des ROS</b> .....	<b>23</b>
A. Les systèmes antioxydants.....	23
1. Neutralisation des ROS.....	23
2. Réduction des groupements thiols .....	24
3. L'hème oxygénase .....	25
a) Hème oxygénase 1.....	26
b) Hème oxygénase 2.....	26
c) Hème oxygénase et cytoprotection.....	26
B. Régulation de l'activité NADPH oxydase .....	27
1. Au niveau Transcriptionnel.....	27
2. Interactions protéines - protéines .....	28
3. Régulation spatiale du signal redox.....	30
4. Effet dominant négatif des isoformes des Nox .....	32
5. Hème oxygénase et activité NADPH oxydase .....	34
6. Les inhibiteurs synthétiques des NADPH oxydases.....	35
<b>IV. Rôles Physiologiques des ROS</b> .....	<b>36</b>
1. ROS et transduction du signal.....	36
a) Régulation redox de l'activité kinase et phosphatase .....	37
b) Régulation redox des facteurs de transcriptions.....	38
(1) Les facteurs de transcription contrôlant l'inflammation .....	38
(2) Rétrocontrôle des ROS par les ROS .....	39
c) Signalisation redox et épigénétique .....	40
2. ROS et mort cellulaire .....	41
<b>V. L'arthrose</b> .....	<b>42</b>
A. Le cartilage articulaire.....	43
1. Généralités.....	43
2. Structure et organisation du tissu cartilagineux .....	44
B. Composition du cartilage articulaire .....	45
1. Le chondrocyte.....	45
a) Généralités .....	45

b) Les ROS dans le chondrocyte .....	46
(1) Les sources de ROS dans le chondrocyte.....	46
(2) Rôle physiologique des ROS produits par le chondrocyte.....	47
(3) Initiation et propagation du signal redox dans les chondrocytes.....	48
2. La MEC du chondrocyte .....	48
a) Les protéoglycanes.....	49
b) Collagène et autres protéines de la MEC .....	50
3. Les métalloprotéases matricielles .....	51
C. Du cartilage sain à l'arthrose .....	53
1. L'interleukine-1 $\beta$ .....	53
2. Ethiopathogénie de l'arthrose et ROS .....	54
a) ROS, hypoxie et homéostasie matricielle .....	55
b) ROS et dégénérescence des fonctions chondrocytaires .....	55
(1) ROS et apoptose chondrocytaire.....	55
(2) ROS, sénescence et vieillissement du chondrocyte .....	56
c) ROS et catabolisme matriciel.....	57
(1) Oxydation non spécifique .....	57
(2) Signalisation redox et catabolisme matriciel .....	57
<b>VI. Argumentaire de l'étude et objectifs.....</b>	<b>59</b>
<b>TRAVAUX DE RECHERCHE.....</b>	<b>61</b>
Chapitre 1.....	63
Synopsis.....	65
Article 1.....	68
Chapitre 2.....	97
Synopsis.....	99
Article 2.....	102
Chapitre 3.....	119
Synopsis.....	121
Article 3.....	124
<b>DISCUSSION.....</b>	<b>155</b>
<b>REFERENCES BIBLIOGRAPHIQUES.....</b>	<b>167</b>
<b>ANNEXES ET PUBLICATIONS.....</b>	<b>187</b>

## LEGENDE DES FIGURES ET TABLEAUX

<b>Figure 1</b> : Statut électronique des principaux ROS.	9
<b>Figure 2</b> : Les principaux systèmes pourvoyeurs de ROS.	11
<b>Figure 3</b> : Topologie des NADPH oxydases.	14
<b>Figure 4</b> : Transfert des électrons du NADPH vers l'oxygène.	15
<b>Figure 5</b> : Maturation de Nox3.	17
<b>Figure 6</b> : Régulation de l'homéostasie redox.	20
<b>Figure 7</b> : Cycle redox du glutathion.	21
<b>Figure 8</b> : Catabolisme de l'hème par l'hème oxygénase.	23
<b>Figure 9</b> : Schématisation des mécanismes de cytoprotection relatifs au catabolisme de l'hème	24
<b>Figure 10</b> : Les principaux partenaires régulateurs de l'activation des NADPH oxydase 1 à 4.	26
<b>Figure 11</b> : Exemple de compartimentation redox initié par l'interleukine-1beta ou le TNFalpha.	29
<b>Figure 12</b> : Représentation linéaire putative des cinq isoformes décrites pour Nox4.	30
<b>Figure 13</b> : Régulation redox du facteur de transcription Nrf2.	37
<b>Figure 14</b> : Les ROS dans la transduction du signal.	39
<b>Figure 15</b> : Schématisation des quatre couches structurant le cartilage articulaire.	42
<b>Figure 16</b> : Principaux constituants de la matrice extracellulaire du cartilage synthétisés par le chondrocyte	47
<b>Figure 17</b> : Réseau collagénique constituant la MEC chondrocytaire.	48
<b>Figure 18</b> : Régulation de l'activité des MMP.	50
<b>Figure 19</b> : Profil d'hydrophobicité de la séquence de Nox4.	57
<b>Figure 20</b> : Application de la méthode ToDUFA à Nox4.	62
<b>Tableau I</b> : Distributions tissulaires et rôles physiologiques / pathologiques principaux des Nox	22

## ABREVIATIONS

1O <sub>2</sub>	Oxygène singulet
ADAMTS	A Disintegrin And Metalloproteinase with Thrombospondin motifs
ADN	Acide Désoxyribonucléique
ADNc	ADN complémentaire
ADP/ATP	Adénosine Diphosphate / Adénosine Triphosphate
AKT	sérine/ thréonine protéine kinase B
AP1	Activator protein 1
ARNm	Acide ribonucléique messenger
BMK1	Big mitogen-activated protein kinase 1
CGD	Granulomatose septique chronique
CO	Monoxyde de Carbone
CoPP	protoporphyrine à cobalt IX
DFP	Diisopropyl fluorophosphate
DMEM	Dubelcco's Modified Eagle's Medium
DMF	Diméthylformamide
DPI	Diphényliodonium
DUOX	Dual oxidase
EGF	Epidermal growth factor
ELISA	Enzyme- Linked Immunosorbent Assay
ERK	Extracellular signal-Regulated Kinase
FACS	Fluorescence Activated Cell Sorter
FAD	Flavin Adenine Dinucleotide
GFP	Green Fluorescent Protein
H <sub>2</sub> O <sub>2</sub>	Peroxyde d'hydrogène
HDAC	Histones Déacétylases
HEK	Human embryonic kidney
HIF	Hypoxia Inducible Factor
HO	Hème Oxygénase
HOCl-	Acide hypochloreux
HRPO	Horse Radish Peroxidase
Ig	Immunoglobuline
IκB	Inhibitor kappa B
IL-1β	Interleukine-1beta
JNK	Jun N-terminal Kinase
kDa	Kilodaltons
LDL	Low Density Lipoprotein
LPS	Lipopolysaccharide
mAb	monoclonal Antibody
MAPK	Mitogen Activated Protein Kinase
MEC	Matrice Extracellulaire
miARN	microARN
MMP	Métalloprotéase Matricielle
MPO	Myéloperoxydase
NADPH	Nicotinamide adénine dinucléotide phosphate (forme réduite)
NFκB	Nuclear factor kappa B
NO°	Monoxyde d'azote
NOS	Oxyde Nitrique Synthase
Nox	NADPH oxydase
NQO1	NAD(P)H quinone oxydoréductase 1
Nrf2	NF-E2-related Factor 2
O <sub>2</sub> •-	Anion superoxyde
OH•	Radical hydroxyle
ONOO-	Peroxynitrite

## Abréviations

PBS	Tampon phosphate isotonique « Phosphate Buffer Saline »
PCR	Polymerase chain reaction
PDGF	Platelet Derived Growth Factor
Phox	Phagocyte Oxidase
PKC	Protéine Kinase C
PMA	Phorbol 12-myristate 13-acétate
PRR	Prolin Rich Region
RLU	Relative luminescence unit
RFU	Relative fluorescence unit
ROS	Reactive Oxygen Species
SDS-PAGE	Electrophorèse en gel polyacrylamide en présence de SDS
SOD	Superoxyde dismutase
TGF- $\beta$	Transforming growth factor beta
TIMP	Tissue Inhibitor of Metalloprotéinase
TIR	Toll-interleukine receptor
TLR4	Toll-like récepteur 4
TNF- $\alpha$	Tumor Necrosis Factor
VEGF	Vascular Endothelial Growth Factor
VSMC	Cellules Musculaires Lisses Vasculaires
WT	Wild type ou sauvage





# Introduction



## I. La genèse des dérivés réactifs de l'oxygène (ROS)

Le dioxygène, gaz relativement inerte, apparut il y a environ 2,5 milliards d'années par le métabolisme photosynthétique des algues bleues est aujourd'hui indispensable au métabolisme énergétique d'un très grand nombre d'organismes. Ses métabolites appelés dérivés réactifs de l'oxygène (ROS « Reactive Oxygen Species ») sont en revanche hautement réactifs (Gardès-Albert 2003). Les ROS sont issus de la réduction univalente séquentielle de l'oxygène en eau par le transfert de 4 électrons successifs (Figure 1A). La première étape, la formation de l'anion superoxyde ( $O_2^{\circ-}$ ) est endothermique et nécessite l'intervention d'une enzyme. L'anion superoxyde donne ensuite spontanément naissance à d'autres ROS, par une série de réductions monoélectroniques.

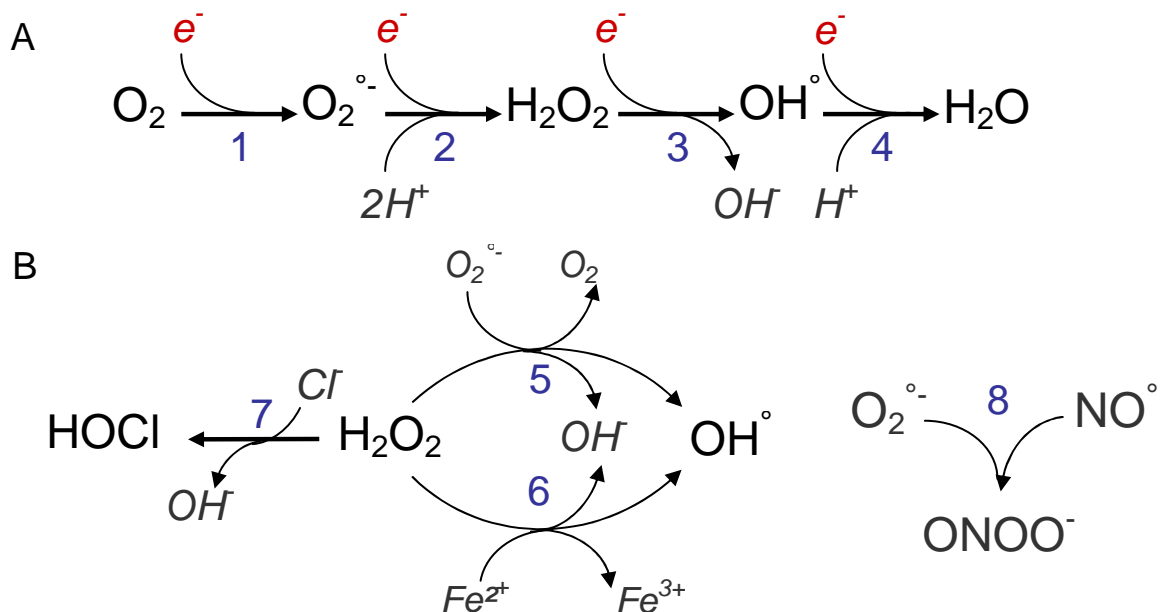

**Figure 1 : Statut électronique des principaux ROS.** **A-** L'oxygène moléculaire est réduit en anion superoxyde par un électron (1), puis en peroxyde d'hydrogène par un autre électron en présence de 2  $H^+$  (2). Le radical hydroxyle ( $OH^{\circ}$ ) est le produit issu de la réduction du peroxyde d'hydrogène ( $H_2O_2$ ) par un troisième électron s'accompagnant de la libération de 1 anion hydroxyle ( $OH^-$ ) (3). Enfin, la réduction par un autre électron en présence de l'ion  $H^+$  va donner de l'eau (4). **B-** Le peroxyde d'hydrogène peut également être transformé en radical hydroxyle par l'intermédiaire de la réaction de Harber-Weiss (5) ou de Fenton en présence de métaux de transition (6) ou en acide hypochlorique sous l'action de la myéloperoxydase (7). La combinaison de l'anion superoxyde et du monoxyde d'azote forme le peroxyde d'azote, à l'origine des RNS (« reactive nitrogen species ») (8).

Les ROS comprennent des composés radicalaires tels que le radical hydroxyle ( $OH^{\circ}$ ), l'alkoxyde ( $RO^{\circ}$ ), l'hydroperoxyde ( $HOO^{\circ}$ ) et l'oxyde ( $R-O_2^{\circ}$ ). De par leur orbitale déficitaire, ces composés possèdent une grande réactivité avec les molécules environnantes. D'autres composés non radicalaires comme le peroxyde d'hydrogène ( $H_2O_2$ ), l'acide hypochlorique ( $HOCl$ ), l'ozone ( $O_3$ ) et l'oxygène singulet ( $^1O_2$ ) appartiennent également à la famille des ROS. Dans la majorité des cas, les ROS réagissent spontanément mais leur transformation peut être facilitée par catalyse enzymatique. Par exemple, la superoxyde dismutase accélère

## Introduction

la dismutation de l'anion superoxyde en peroxyde d'hydrogène. Ce dernier sera lui-même transformé en molécule d'eau par la catalase. La toxicité du peroxyde d'hydrogène est potentialisée par le fer ferreux ( $\text{Fe}^{2+}$ ) ou l'anion superoxide ( $\text{O}_2^{\cdot -}$ ) qui vont générer le radical hydroxyle ( $\text{OH}^{\cdot}$ ) par l'intermédiaire des réactions de Fenton et de Harber-Weiss (Figure 1B).

Leur très grande instabilité confère aux ROS la capacité à réagir de manière spontanée avec les molécules composant leur environnement. A l'échelle du vivant, les ROS vont attaquer les lipides, les protéines ou encore les acides nucléiques, permettant par exemple la destruction de pathogènes. L'oxydation de certains acides aminés affecte les structures secondaires et tertiaires de certaines protéines, altérant leur stabilité et leur activité (Corcoran and Cotter 2013). Les ROS sont ainsi capables de moduler les fonctions catalytiques de certaines enzymes, de modifier l'affinité de certains facteurs de transcription pour leur séquence nucléotidique cible et de manière plus globale, de réguler l'expression de gènes (Nathan and Cunningham-Bussel 2013).

Au cours de l'évolution, les espèces vivantes ont parfaitement intégré l'oxygène et ses formes activées, les ROS, à leur métabolisme. Les ROS font partie intégrante de la physiologie (Krause 2007).

## II. Les sources de ROS

La plupart du temps, les ROS sont produits de manière fortuite par la cellule au cours de réactions biochimiques. Les principaux pourvoyeurs sont la chaîne respiratoire mitochondriale, la réaction catalysée par la xanthine oxydoréductase ou le fonctionnement détourné de certaines enzymes comme la NO synthase. Seules les NADPH oxydases ont pour fonction exclusive de produire les ROS (Figure 2).

Il est également à noter que le métabolisme de xénobiotiques par le cytochrome P450, la synthèse des leucotriènes et des prostaglandines par la lipoxigénase et la cyclo-oxygénase ainsi que la synthèse du glutathion par la gamma glutamyl transpeptidase peuvent aussi générer des ROS.

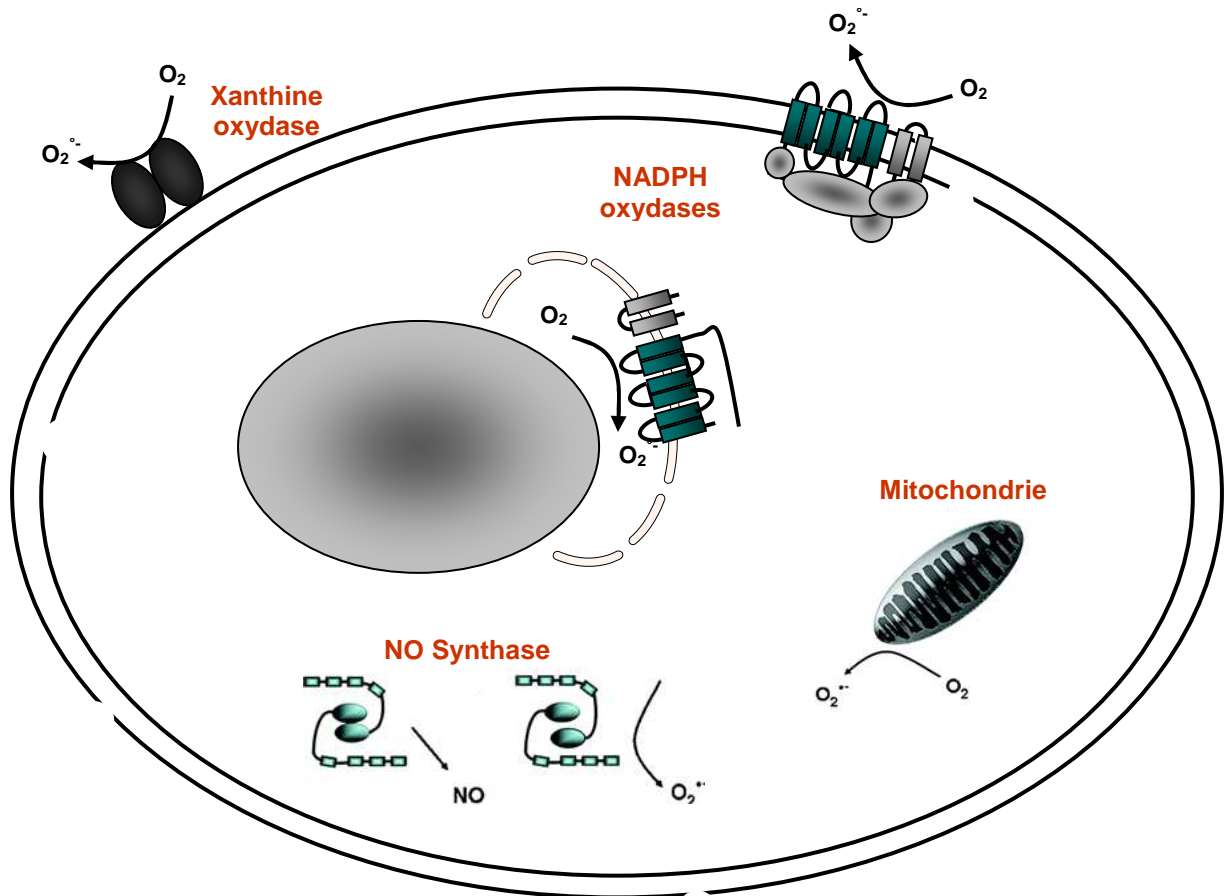

**Figure 2 : Les principaux systèmes pourvoyeurs de ROS.** Les ROS peuvent être produits au niveau de la chaîne respiratoire mitochondriale, par la xanthine oxydase, par la NOS découplée (en l'absence de son cofacteur la tétrahydrobioptérine) ou de façon professionnelle par les NADPH oxydase. Figure inspirée de Grienling et FitzGerald, 2003 et de Ray et Shah, 2005.

### **A. Mitochondrie et ROS**

La chaîne respiratoire des mitochondries est composée de 4 complexes (I, II, III et IV) au travers desquels circule un flux d'électrons fournis par le NADH et le FAD. Ce flux conduit à la réduction d'une molécule d'oxygène en molécule d'eau par 4 électrons et à un transfert de protons à travers la membrane interne, permettant la production d'ATP à partir d'ADP et de phosphate par l'ATP synthase. Il a été estimé qu'environ 1 à 2% des électrons sont détournés de ce flux, principalement au niveau des complexes I et III, provoquant la formation d'anions superoxyde. Cette proportion peut augmenter lorsque la chaîne respiratoire est déjà endommagée par les ROS, mais apparaît largement surestimée par des expériences réalisées sur des mitochondries en conditions hyperoxiques (Cadenas and Davies 2000).

## **B. Xanthine oxydase et ROS**

La xanthine oxydase est un homodimère fonctionnant avec une molécule de FAD et avec comme cofacteur du molybdène (Harrison 2002). Cette enzyme intervient dans le catabolisme des purines qu'elle va dégrader en acide urique avec dans certains cas une production d'ion superoxyde. Elle est présente sous deux formes distinctes : la xanthine deshydrogénase qui utilise préférentiellement le  $\text{NAD}^+$  comme substrat mais aussi l'oxygène moléculaire ce qui sera accompagné d'une production d'ions superoxyde. L'oxydation au niveau des résidus cystéine de l'enzyme la convertit en xanthine oxydase. Dans cet état réversible, la protéine ne pourra utiliser comme substrat que l'oxygène moléculaire, il y'aura alors une production d'ion superoxyde. Par conséquent, l'oxydation par les ROS de la xanthine oxydase la conduit elle-même à produire des ROS.

## **C. NO synthase et ROS**

La NO synthase (NOS) est une hémoprotéine homodimérique catalysant la transformation de l'arginine en citrulline avec une production du dérivé radicalaire  $\text{NO}^\bullet$ . La NOS, fonctionnant avec du FAD et du FMN, utilise comme cofacteur la tétrahydrobioptérine ( $\text{BH}_4$ ) qui coordonne les deux dimères. En son absence ou après oxydation de ce cofacteur par les ROS, la NOS fonctionne de manière découplée et produit des anions superoxyde. Le NO est une molécule hydrosoluble mais également liposoluble ce qui lui confère la capacité à diffuser librement de part et d'autre des membranes biologiques. Le monoxyde d'azote est un neuromédiateur très important et joue également un rôle dans la relaxation musculaire et l'immunité. Il existe deux isoformes constitutives de la NOS, une forme neuronale (nNOS) et une forme exprimée dans l'endothélium (eNOS). L'activité de ces deux isoformes est régulée par le calcium. Une NOS inductible (iNOS) peut aussi être exprimée en réponse à certaines cytokines ou endotoxines. Le  $\text{NO}^\bullet$  peut réagir très rapidement avec l'anion superoxyde pour former le peroxyde d'azote,  $\text{ONOO}^-$ . Ce dernier possède un très fort pouvoir oxydant, capable notamment d'induire des dommages à l'ADN et la lipopéroxydation des lipides membranaires (Carr et al. 2001).

## **D. Les NADPH oxydases**

Contrairement aux autres systèmes, produisant des ROS de manière fortuite, la génération des ROS est l'unique fonction des NADPH oxydases. Il existe 7 isoformes exprimées chez l'homme catalysant la réaction d'oxydation du NADPH, captant les électrons nécessaires à la réduction de l'oxygène moléculaire, accepteur final de la réaction, en anion superoxyde. Parmi ces isoformes, la NADPH oxydase phagocytaire Nox2, est la mieux caractérisée. Associée à la protéine  $\text{p22}^{\text{phox}}$ , elle forme un complexe membranaire, le cytochrome b558 en

référence à ses propriétés spectrales (Segal et al. 1978). Les mécanismes d'activation de Nox2 dépendent de la translocation des facteurs cytosoliques  $p47^{\text{phox}}$ ,  $p67^{\text{phox}}$  et  $p40^{\text{phox}}$ , régulateurs de l'activité du complexe, ainsi que des petites GTPases Rac1 et Rac2 (Volpp et al. 1988; Abo et al. 1991; Knaus et al. 1991; Wientjes et al. 1993). Il est maintenant connu depuis plusieurs décennies qu'un déficit d'un des composants de Nox2 conduit à un défaut de production de ROS à l'origine de la granulomatose septique chronique, une maladie génétique se traduisant par des infections bactériennes et fongiques graves et répétées (CGD, Chronic Granulomatous Disease) (Segal et al. 1978). Ainsi, la production de l'anion superoxyde par Nox2 dans les phagocytes est définie comme une « explosion respiratoire » nécessaire à la destruction de l'agent pathogène et donc à la défense immunitaire innée de l'hôte.

En 1999, deux équipes découvrent simultanément la première isoforme de Nox2 : baptisée initialement mitogenic oxydase puis renommée Nox1 (Suh et al. 1999; Banfi et al. 2000). Peu de temps après, les isoformes Nox3 (Kikuchi et al. 2000), Nox4 (Geiszt et al. 2000; Shiose et al. 2001) et Nox5 (Banfi et al. 2001) ainsi que les Duox1 et 2 sont clonées (De Deken et al. 2000; Dupuy et al. 2000). Au total, 7 isoformes de la NADPH oxydase, deux sous unités organisatrices ( $p47^{\text{phox}}$  et NoxO1), deux sous unités activatrices ( $p67^{\text{phox}}$  et NoxA1), deux facteurs de maturation nécessaires à l'activité des Duox (DuoxA1 et DuoxA2) sont aujourd'hui connus (Bedard and Krause 2007).

### **1. Caractéristiques structurales des Nox**

Leur ancrage membranaire rend difficile l'étude structurale des Nox par cristallisation. La partie C-terminale de Nox2 possède une homologie avec les protéines de la famille des Ferrédoxines NADP reductases, portant les domaines de fixation du NADPH et du FAD, tandis que la partie N-terminale serait composée de 6 hélices alpha délimitant les domaines transmembranaires (Cross and Segal 2004; Sumimoto 2008). Les Nox conservent en commun les domaines essentiels à leur fonction catalytique (Figure 3A et B). Sur le plan topologique, Nox2 est l'isoforme la mieux caractérisée (Lassegue et al. 2012). L'identification des épitopes des anticorps monoclonaux spécifiques de Nox2 par phage display a en effet permis de démontrer que les boucles C et E sont extracellulaire (Burritt et al. 2001; Yamauchi et al. 2001; Campion et al. 2007). La boucle B, impliquée dans l'interaction avec le facteur cytosolique  $p47^{\text{phox}}$ , a donc une localisation intracellulaire (DeLeo et al. 1995). Ainsi, il est maintenant admis que Nox2 est une protéine polytopique possédant 6 passages transmembranaires et des extrémités N et C-terminales orientées vers le cytosol (Imajoh-Ohmi et al. 1992; Paclat et al. 2004; Campion et al. 2009).



## Introduction

La topologie des autres isoformes est en revanche encore spéculative et repose en grande partie sur leurs homologues de séquence avec Nox2 ainsi que sur les prédictions *in silico* réalisées à partir de leur séquence peptidique (Figure 3C).

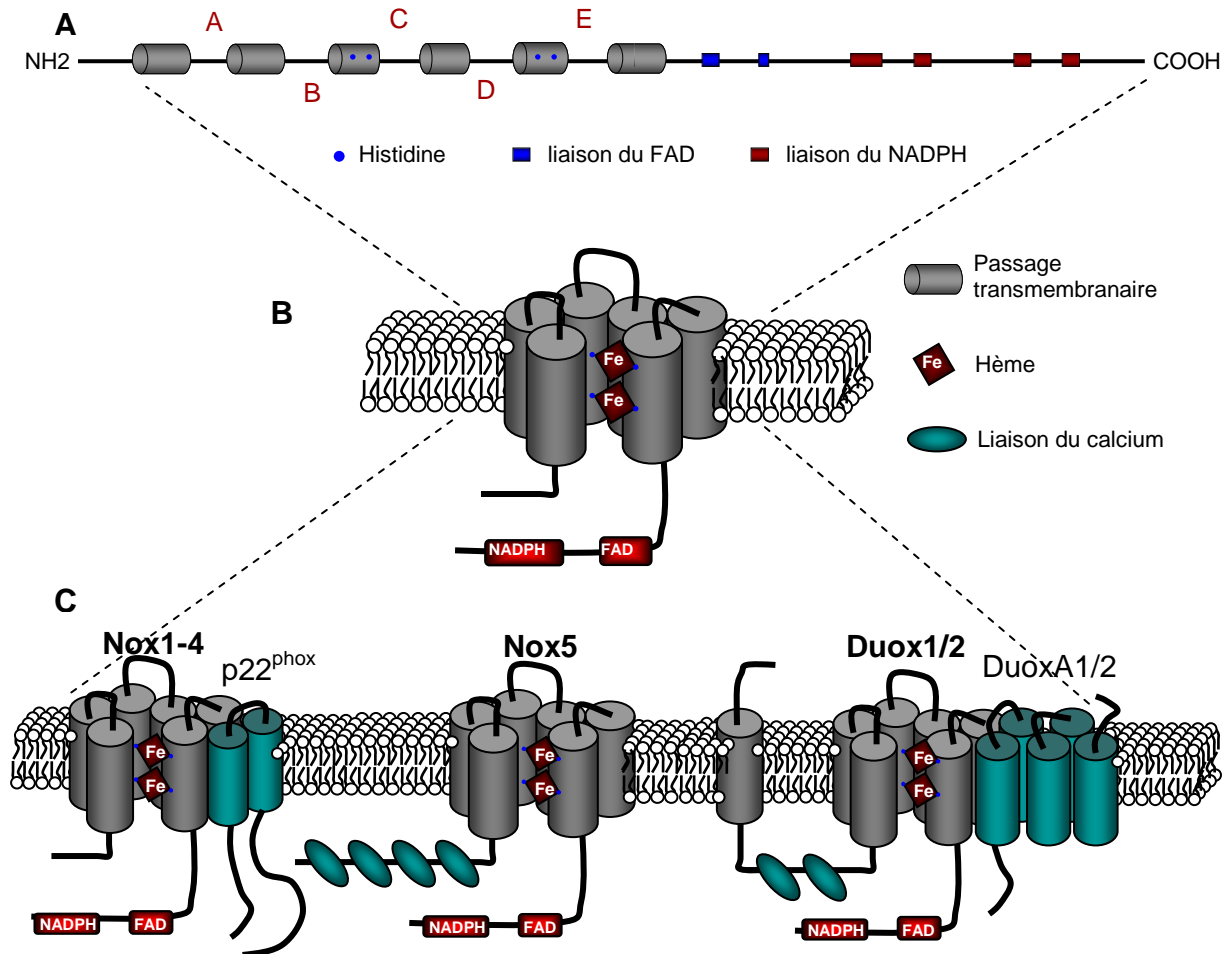

**Figure 3 : Topologie des NADPH oxydases.** Schématisation de la structure linéaire (A) ou tridimensionnelle (B) des domaines conservés par les Nox. La projection de la structure de Nox2 à l'ensemble des Nox, permet de supposer la présence en commun de quatre sites de fixation du NADPH, deux sites de fixation du FAD et six domaines transmembranaires entrecoupés de 5 boucles extra-membranaires (nommées A à E). De même les 4 histidines potentiellement impliquées dans la coordination des hèmes sont conservée entre les isoformes C- Des motifs structuraux additionnels comme des EF hands viennent se greffer sur Nox5 et les deux Duox. Ces dernières possèderaient également un domaine d'homologie avec la peroxydase situé à l'extrémité N-terminale ainsi qu'un septième passage transmembranaire. Les Nox 1 à 4 sont stabilisées par p22<sup>phox</sup>, les Duox par les Duox activators (Duox A), tandis que Nox5 fonctionne en l'absence de partenaires.

En excluant ces domaines N-terminaux, Nox5 et les Duox possèdent une séquence proche de celle de Nox2. Nox1 (564 acides aminés) et Nox3 (568 acides aminés) sont toutefois les isoformes les plus proches avec respectivement 60% et 58% d'homologie de séquence avec Nox2. La longueur des boucles liant les domaines transmembranaires est variable d'une isoforme à l'autre. Ces variations pourraient être à l'origine des caractéristiques propres à chaque isoforme. Selon ce principe, Nox4 se distingue par la longueur de sa boucle E portant 28 acides aminés surnuméraires, par rapport à la boucle E de Nox2. D'après Takac

et ses collaborateurs, cette boucle permettrait la génération du peroxyde d'hydrogène par Nox4, l'Histidine 222 agissant comme donneur de protons permettant la dismutation de l'anion superoxyde (Takac et al. 2011). Nox4 (578 acides aminés) est justement l'isoforme la plus distante de Nox2 avec seulement 39% d'homologie de séquence. Les premiers éléments expérimentaux concernant la topologie de Nox4 ont été acquis au sein de notre laboratoire, par l'identification des épitopes reconnus par trois anticorps monoclonaux développés contre la partie C-terminale de Nox4 (aa 206-578) (Zhang et al. 2011). Ainsi, la séquence H222-E241 est reconnue par l'anticorps 8E9 sans perméabilisation membranaire sur le modèle cellulaire HEK293, exhibant pour partie une expression de Nox4 à la membrane plasmique. En revanche, l'accès à la séquence S389-P416 reconnue par les anticorps 5F9 et 6B11 nécessite l'utilisation de détergents. La séquence H222-E241 prédite pour être localisée sur la boucle E est donc orientée vers le milieu extracellulaire tandis que la séquence S389-P416, proche de la partie N-terminale de Nox4 est cytosolique. De même, l'interaction de la région polybasique prédite pour appartenir à la boucle B (<sup>92</sup>RRTRR<sup>97</sup>) avec le domaine C-terminal déshydrogénase de Nox4 serait nécessaire à son fonctionnement constitutif (Jackson et al. 2010; von Lohneysen et al. 2012). Ce motif serait donc localisé du côté cytosolique.

En conclusion, même si la topologie de Nox2 est relativement claire aujourd'hui, il subsiste des interrogations concernant la topologie des autres Nox. Les maigres données expérimentales relatives à Nox4 ne permettent pas d'établir sa topologie avec certitude.

## 2. Décryptage des mécanismes catalytiques

Les mécanismes de transport des électrons au travers des membranes jusqu'à l'oxygène sont bien documentés pour Nox2 (Figure 4). L'activité diaphorase, étape initiale du transfert des deux électrons du NADPH vers le FAD serait limitante dans son turnover **(1)** (Cross and Segal 2004). Les électrons vont alors du FAD réduit vers l'hème interne qui ne peut accepter qu'un seul électron à la fois **(2)** conduisant à la formation transitoire d'un composé radicalaire semiquinone (FAD<sup>•</sup>). L'hème interne réduit donc l'hème externe **(3)** avant d'accepter le deuxième électron issu du radical FAD<sup>•</sup> **(5)**. L'oxygène, accepteur final de la réaction vient ensuite capter l'électron surnuméraire de l'hème externe pour former l'anion superoxyde **(4)**. Le cheminement du 2ème électron se poursuit comme précédemment de l'hème interne vers l'hème externe **(6)** puis vers l'oxygène **(7)**. Le transfert des électrons se fait par un gradient de potentiel redox globalement favorable à l'exception des étapes **(3)** et **(6)**. Ces dernières, sont rendues possibles par la fixation d'une molécule d'oxygène à proximité de l'hème externe créant des conditions énergétiques favorables pour la réduction de l'oxygène en ion superoxyde.

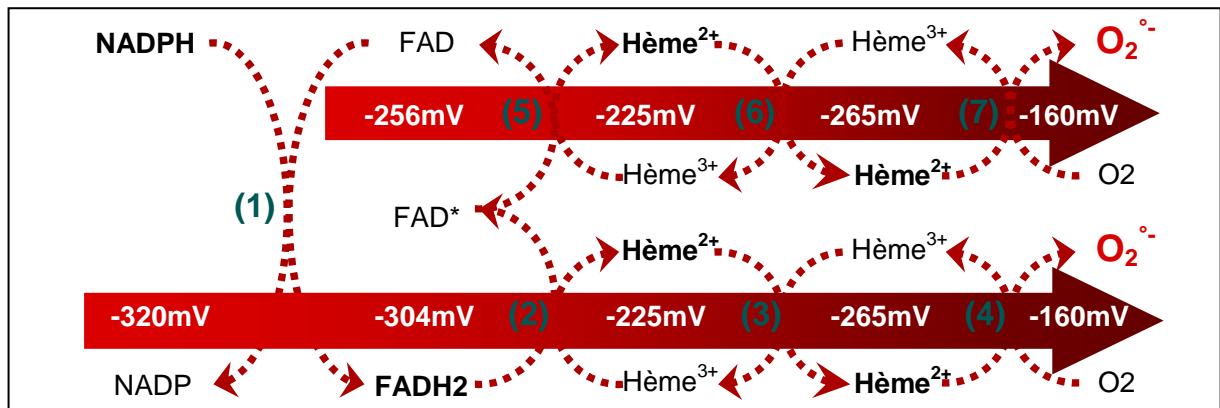

**Figure 4 : Transfert des électrons du NADPH vers l'oxygène.** Le transit des deux électrons captés à une molécule de NADPH nécessite sept étapes pour former deux molécules d'anion superoxyde. Voir le texte pour explications. Figure adaptée de la revue de Cross et Segal, 2004.

Dans des conditions optimales de fonctionnement, *in vitro*, le turnover du cytochrome b558 de Nox2 est de l'ordre de 200mol d'O<sub>2</sub><sup>•-</sup>/s/mol cyt b 558 (Paclat et al. 2000). Par comparaison, le turnover de Nox4, récemment déterminé par l'équipe de Lambeth n'est que de 3.3 mol H<sub>2</sub>O<sub>2</sub>/s/mol de Nox4 (Nisimoto et al. 2010). Bien évidemment, ces valeurs ayant été acquises dans des conditions expérimentales propres à chaque équipe ne peuvent pas être directement confrontées, mais sont cohérentes avec les rôles physiologiques respectifs des deux isoformes, Nox2 produisant une quantité bactéricide de ROS au cours de la phagocytose et Nox4 intervenant majoritairement dans la signalisation cellulaire.

### 3. Biosynthèse des Nox

La famille des NADPH oxydases est dissociable en deux sous groupes. Le premier sous groupe est constitué des Nox 1 à 4 dont la stabilité dépend de la sous unité stabilisatrice p22<sup>phox</sup>. Nox5 et les Duox forment le deuxième sous groupe.

#### a) P22<sup>phox</sup>, la protéine stabilisatrice des Nox1 à 4 au sein des membranes

Nox2 est lié à p22<sup>phox</sup> avec une stœchiométrie de 1:1 formant le cytochrome b558 (Huang et al. 1995). L'absence de l'un ou l'autre des partenaires compromet toutefois la stabilité et donc la fonctionnalité du complexe (Yu, 1997). Ce phénomène est illustré, chez certains patients atteints de CGD autosomales récessives, où la mutation du gène CYBA, codant pour p22<sup>phox</sup> abolit l'expression de Nox2 sans atteindre la quantité d'ARNm. La réciproque est également vraie dans les CGD liées à l'X où une mutation sur le gène CYBB, codant pour Nox2 produit une absence de p22<sup>phox</sup>, en dépit de la présence de son transcrit. En fait, les protéines Nox2 ou p22<sup>phox</sup> seules sont instables et dégradées par le protéasome (DeLeo et al. 2000; Block et al. 2007). Dans les cellules non phagocytaires, bien qu'il puisse exister

une certaine stabilité des monomères, Nox2 est inactive en l'absence de p22<sup>phox</sup> (Yu et al. 1998). De même, il a été rapporté une altération de la fonction des Nox1, 2, 3 et 4 après extinction de l'ARNm de p22<sup>phox</sup> par siRNA dans la lignée HEK293 (Kawahara et al. 2005; Martyn et al. 2006). p22<sup>phox</sup> est également impliqué dans la biosynthèse de Nox3 où il existe une stabilisation des deux monomères au niveau post traductionnel (Nakano et al. 2007) (Figure 5).

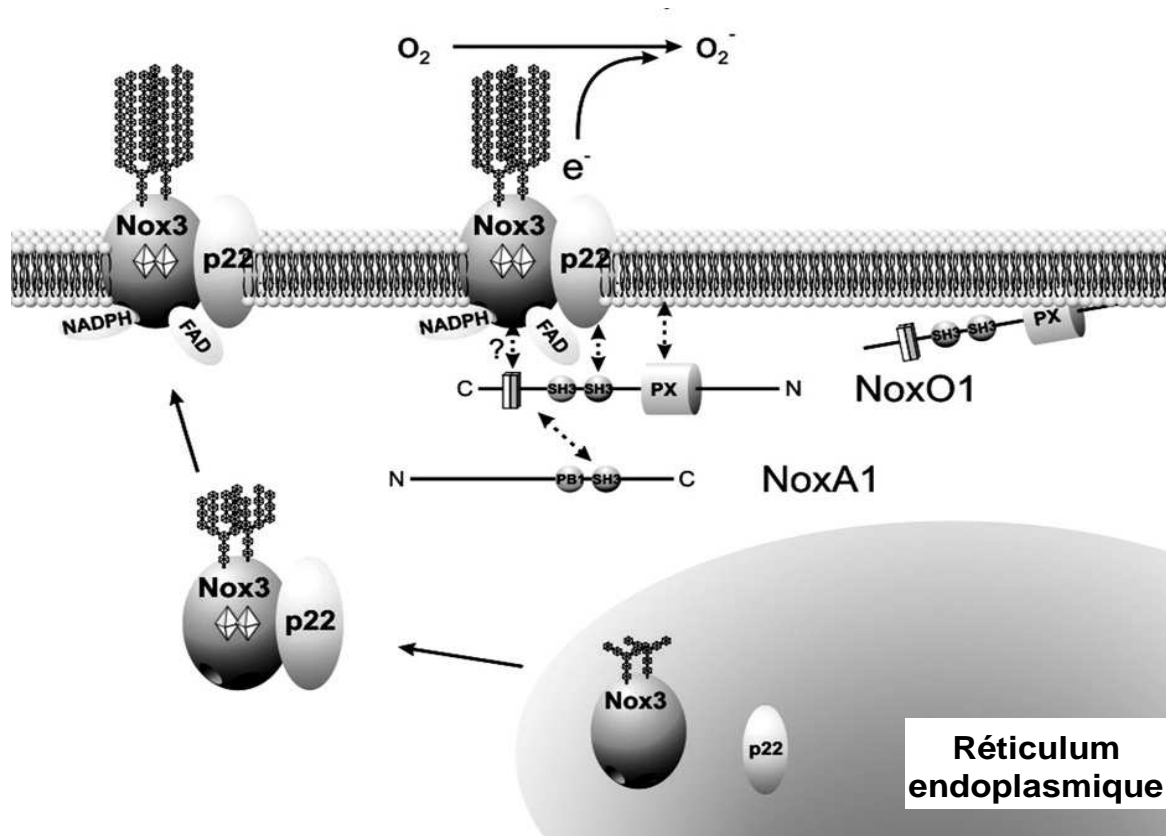

**Figure 5 : Maturation de Nox3.** Selon Nakano et al, 2007. Nox3 et p22<sup>phox</sup> sont synthétisés indépendamment dans le réticulum endoplasmique. La formation du dimère est un pré-requis nécessaire aux modifications post-traductionnelles réalisées dans le golgi et à l'adressage à la membrane plasmique. L'activité de Nox3 est indissociable des facteurs NoxO1 et NoxA1. Ce mécanisme de maturation pourrait être commun aux autres Nox dépendante de p22<sup>phox</sup>.

Ainsi, p22<sup>phox</sup> est nécessaire pour l'activité NADPH oxydase de Nox1, Nox2, Nox3 et Nox4. Il existe pourtant des zones d'interaction distinctes entre ces Nox et p22<sup>phox</sup> (Lassegue et al. 2012). Ainsi, à l'aide de formes tronquées de p22<sup>phox</sup>, l'équipe de Von Löhneysen a montré que les 11 acides aminés situés à l'extrémité N-terminale de p22<sup>phox</sup> sont impliqués dans la stabilisation, l'adressage et l'activité de Nox4 et Nox2. A l'inverse, la partie C-terminale 130-195 n'est pas indispensable pour Nox4 alors que la partie C-terminale 142-195 forme un complexe mature mais non fonctionnel avec Nox2 (Zhu et al. 2006; von Löhneysen et al. 2008). De surcroît, l'interaction entre Nox4 et p22 est indépendante du résidu Tyr 121 de p22<sup>phox</sup> alors que sa substitution empêche l'adressage et l'activité des isoformes 1, 2 et 3 (von Löhneysen et al. 2010). Kawahara et ses collaborateurs ont enfin montré que la région

polyproline de p22<sup>phox</sup> n'est pas utile pour l'activité de Nox4 puisqu'une mutation non fonctionnelle ou une délétion de cette région n'a pas de conséquence sur l'activité de Nox4 contrairement à celle de Nox1, Nox2 et Nox3 (Kawahara et al. 2005). Il est à noter que, l'activité des Duox 1 et 2 est respectivement dépendante des facteurs DuoxA1 et DuoxA2, nécessaires à leur adressage à la membrane plasmique (Morand et al. 2009). Une certaine homologie peut être faite avec p22<sup>phox</sup> vis-à-vis des Nox1 à 4.

### **b) Rôle de la molécule d'hème**

Nox2 est synthétisé au sein du réticulum endoplasmique, sous la forme d'un précurseur de 58kDa. Son poids moléculaire est alors porté à 65kDa (gp65<sup>phox</sup>) par une première série de glycosylations par des résidus mannoses. L'incorporation des molécules d'hème par gp65<sup>phox</sup> est ensuite une étape clé du processus de maturation de Nox2 (DeLeo et al. 2000). La démonstration nous vient de la lignée cellulaire PLB-985 qui peut être différenciée en « neutrophile-like » en présence de diméthylformamide (DMF), avec une augmentation de l'expression des protéines composant le complexe NADPH oxydase phagocytaire (Baillet et al. 2011). Lorsque cette différenciation est effectuée en présence de succinylacétone, un inhibiteur de la synthèse de l'hème, il y a une diminution conjointe de l'expression de gp91<sup>phox</sup> et de p22<sup>phox</sup> (Yu et al. 1997). En revanche, l'expression du précurseur glycosylé de gp91<sup>phox</sup> (gp65<sup>phox</sup>), ainsi que celle des facteurs cytosolique n'est pas affectée. Ces résultats sont réversibles par un apport exogène en hème. L'incorporation des hèmes permet donc à gp65<sup>phox</sup> de former un dimère avec la protéine p22<sup>phox</sup> puis d'acquérir, au sein du Golgi, les glycosylations portant son poids moléculaire à 91kDa (DeLeo et al. 2000). La glycosylation de Nox2 n'est pas essentielle à son activité catalytique, en revanche, elle augmenterait la résistance contre la digestion par les protéases cellulaires et pourrait jouer un rôle dans l'adressage de la protéine à la membrane plasmique (Pacllet et al. 2001; Murillo and Henderson 2005).

Le rôle de l'hème n'est pas aussi clairement démontré en ce qui concerne les autres isoformes. En 2004, Ambasta et ses collaborateurs ont montré par la technique de FRET une colocalisation entre les Nox1, 2 et 4 avec p22<sup>phox</sup> après surexpression dans la lignée HEK293 (Ambasta et al. 2004). Fait intéressant, la substitution d'un résidu histidine prédit comme étant impliqué dans la coordination des hèmes de Nox1 et Nox4, ne permet plus l'interaction de ces deux isoformes avec p22<sup>phox</sup>. Ces données suggèrent donc que, selon le schéma déjà décrit pour Nox2, l'incorporation des hèmes permette aussi la formation du dimère entre Nox1 et Nox4 avec p22<sup>phox</sup>. D'après les données disponibles, les mécanismes gouvernant la maturation des Nox1, 3 et 4 semblent comparables à ceux de Nox2. Mais la démonstration reste toujours à établir en ce qui concerne les Nox non phagocytaires.

## **4. Distribution tissulaire des Nox et rôles physiologiques**

### **(Tableau I)**

Originellement baptisée Mox1 (Mitogenic oxidase), Nox1 est majoritairement exprimée dans l'épithélium du colon où elle serait impliquée dans la prolifération cellulaire (Suh et al. 1999) et la défense immunitaire innée (Szanto et al. 2005). Elle est également retrouvée à un moindre niveau d'expression dans les macrophages, les mastocytes ou encore les VSMC (Katsuyama 2010). Nox1 pourrait contribuer à la migration des VSMC (Rodriguez et al. 2009), serait impliquée dans l'inflammation vasculaire (Haloui et al. 2003) et la régulation de la pression artérielle (Gavazzi et al. 2006).

Nox2 a été découverte dans les cellules phagocytaires et joue un rôle majeur dans l'immunité innée par la destruction des pathogènes ; son absence se caractérise par la CGD (Segal et al. 1978). Son expression est élevée dans les cellules de lignée myéloïde mais ne s'y limite pas. En effet Nox2 a été mis en évidence dans les neurones, les cardiomyocytes, les hépatocytes, les cellules endothéliales ou encore les cellules souches embryonnaires (Bedard and Krause 2007). Au contraire, l'expression de Nox3 se limite presque exclusivement à l'oreille interne (Paffenholz et al. 2004). Son rôle est essentiel dans la perception de la gravité. L'activité de Nox3 entraîne des dommages au sein des otoconies en réponse au cisplatine et a été associée à l'apoptose des cellules de la cochlée (Mukherjea et al. 2010).

Initialement baptisée Renox (oxydase rénale) suite à son identification dans le rein (Geiszt et al. 2000), l'expression de Nox4 s'est révélée par la suite être largement ubiquitaire (Chen et al. 2012; Lassegue et al. 2012). De façon non exhaustive, Nox4 est par exemple exprimée dans les cellules souches hématopoïétiques (Piccoli et al. 2005), dans les cellules souches embryonnaires (Bartsch et al. 2011), dans les kératinocytes (Chamulitrat et al. 2004), les neurones (Vallet et al. 2005; Kleinschnitz et al. 2010) les chondrocytes (Grange et al. 2006; Kim et al. 2010) et les podocytes (Piwkowska et al. 2011). L'ubiquité de la distribution tissulaire de Nox4 lui rend difficile l'attribution d'une fonction précise. Originellement, Nox4 a été décrite comme senseur de l'oxygène au niveau rénal (Geiszt et al. 2000; Shiose et al. 2001). Depuis, l'étude de Nox4 au travers de modèles murins invalidés a permis de suggérer son rôle dans la régulation de l'angiogénèse et de l'inflammation vasculaire (Schroder et al. 2012), de l'adipogénèse (Li et al. 2013) ou encore son implication dans la résorption osseuse et l'ostéoporose (Goettsch et al. 2013). Nox4 a été également associée à la prolifération cellulaire (Yamaura et al. 2009), à la différenciation (Mouche et al. 2007), à la sénescence (Lener et al. 2009) ou encore à l'apoptose (McKallip et al. 2006; Basuroy et al. 2009; Sancho

## Introduction

et al. 2009). Nox4 est enfin retrouvée exprimée dans certains cancers ou elle est souvent associée à la transformation tumorale (Brar et al. 2002; Vaquero et al. 2004; Choi et al. 2009; Zhang et al. 2013).

Nox5 est exprimée dans les organes lymphoïdes, les testicules et dans les VSMC (Banfi et al. 2001). La compréhension de son rôle physiologique a été rendu difficile par son absence d'expression chez le modèle murin. Nox5 intervient dans la prolifération des VSMC en réponse au PDGF (Jay et al. 2008). Elle est également exprimée de façon aberrante dans certains cancers. Les Duox, originellement identifiées dans la thyroïde sont aussi exprimées dans les cellules épithéliales, la prostate, les testicules, le pancréas ou encore le tractus digestif et les muqueuses (El Hassani et al. 2005; Katsuyama 2010). Les Duox interviennent dans la synthèse des hormones thyroïdiennes et l'immunité innée des muqueuses (Deken et al. 2013).

Isoforme	distribution tissulaire	Physiologie	Pathologie
<b>Nox1</b>	Epithélium du côlon	Défense immunitaire innée (1)	Transformation tumorale (2)
	Artères	Augmentation de la pression artérielle (3), athérosclérose (4)	
	Cellules musculaires lisses vasculaires	Migration (5) prolifération (2), hypertrophie (6)	
	Macrophages, mastocytes	Formation des cellules spumeuses (7)	
<b>Nox2</b>	Cellules phagocytaires (8)	Défense immunitaire innée	Granulomatose septique chronique
	Système nerveux central	Défense immunitaire innée	Dégénérescence (9), psychoses (10)
	Artères	Augmentation de la pression artérielle (11), angiogénèse (12), ischémie / reperfusion (13)	
	Cardiomyocytes	Différenciation (14)	
<b>Nox3</b>	Oreille interne (15)	Formation des otocognies	Troubles de l'équilibre
<b>Nox4</b>	Rein	Senseur de l'oxygène (16, 17)	Néphropathie Diabétique (18)
	Foie		Hépatite C, fibrose hépatique, apoptose (19, 20)
	Pancréas	Sécrétion de l'insuline (21)	Résistance à l'apoptose (22)
	Système nerveux central	Différenciation (23), Signalisation de l'angiotensine II (24)	
	Adipocytes	Différenciation (27), prévention obésité (28)	
	Cardiomyocytes	Différenciation (29)	
	Artères	Diminution de la pression artérielle, induction de la réponse aux oxydants (Nrf2), angiogénèse (30)	
	Tissus osseux (31)	Résorption osseuse	
	Cartilage	Chondrogénèse ? (32)	
<b>Nox5</b>	Organes lymphoïdes	Différenciation des lymphocytes ? (35)	
	Testicules	Motilité des spermatozoïdes (36)	
	Artères	Prolifération des VSMC (37)	
<b>Duox 1/2</b>	Thyroïde	Synthèse des hormones thyroïdiennes	
	(40) Muqueuses de épithélium pulmonaire	Défense immunitaire innée	
	Glandes salivaires	Défense immunitaire innée	

**Tableau I : Distribution tissulaire et rôles physiologiques / pathologiques principaux des Nox.**

(1) Szanto et al, 2005. (2) Suh et al, 1999. (3) Gavazzi et al, 2006. (4) Sheehan et al, 2011. (5) Rodriguez et al, 2010. (6) Lassègue et al, 2001. (7) Lee et al, 2009. (8) Segal et al, 1978). (9) Sorce et al, 2012. (10) Schiavone et al, 2012. (11) Wang et al, 2001. (12) Tojo et al, 2005. (13) Brait et al, 2010. (14) Nadworny et al, 2013. (15) Paffenholtz et al, 2004. (16) Geiszt et al, 2000. (17) Shiose et al, 2001. (18) Gorin, 2013. (19) Boudreau et al, 2009. (20) Sancho et al, 2012. (21) Crutzen et al 2012. (22) Vaquero et al, 2004. (23) Nayernia et al, 2013. (24) Case et al, 2013. (25) Suzuki et al, 2013. (26) Kallenborn-Gerhardt et al, 2013. (27) Mouche et al, 2007. (28) Li et al, 2013. (29) Li et al, 2006. (30) Schröder et al, 2012. (31) Goettsch et al, 2013. (32) Kim et al, 2010. (33) Grange et al, 2006. (34) Rousset et al, 2013. (35) Banfi et al, 2001. (36) Musset et al, 2012. (37) Jay et al, 2008. (38) Kamiguti et al, 2005. (39) Brar et al, 2003. (40) De Deken et al, 2013.

### III. Régulation de la concentration des ROS

Le rôle physiologique des ROS dépend de leur concentration (Figure 6). En deçà et au-delà de ces concentrations, l'homéostasie n'est plus respectée et les ROS entrent dans la genèse de processus pathologiques (Brieger et al. 2012).

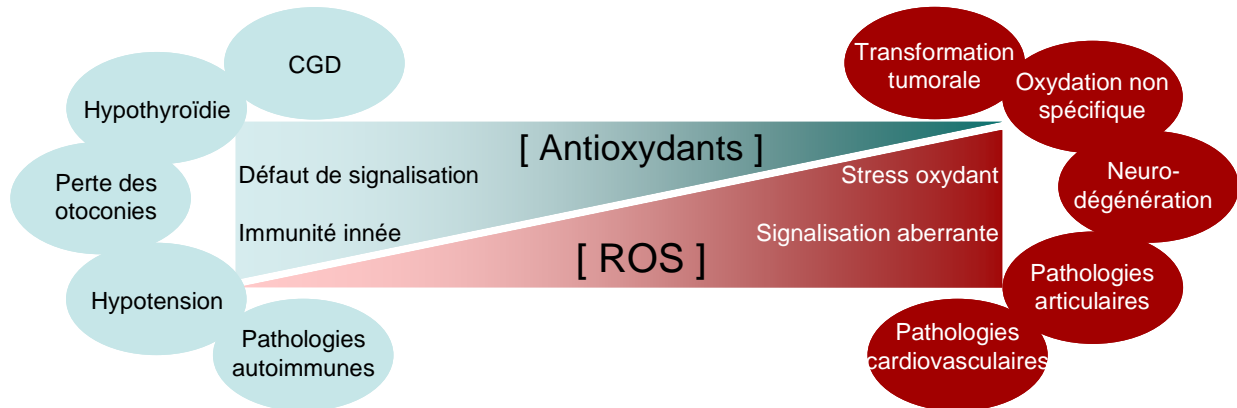

**Figure 6 : Régulation de l'homéostasie redox.** L'équilibre entre la production des ROS et leur contention par les systèmes antioxydants doit être finement contrôlée pour respecter l'homéostasie tissulaire tout en permettant aux ROS de produire leurs effets biochimiques. Voir le texte pour explications.

L'homéostasie redox naît d'un équilibre entre les pourvoyeurs de ROS et des systèmes de défense antioxydants. Une insuffisance dans la production de ROS entraîne par exemple un défaut de destruction des pathogènes, illustré par la Granulomatose Septique Chronique (CGD) (Morel 2007). A l'inverse, lorsque la concentration des ROS est supérieure au pouvoir tampon des systèmes antioxydants, il y a apparition d'un stress oxydant nuisible au fonctionnement de la cellule. Ce stress oxydant est à l'origine de la théorie radicalaire du vieillissement (Harman 1956) et entraîne notamment la mort cellulaire et la transformation tumorale (Beckman and Ames 1998). Au cours de l'évolution, les organismes vivants ont dû adapter leur métabolisme à l'oxygène. Ils ont développé un système de défense, capable de neutraliser ou diminuer, les effets délétères de l'oxygène activé sur les éléments les constituant. Ces mécanismes de défense peuvent être régis par des antioxydants ou par des systèmes enzymatiques, ainsi que par la régulation de la production des ROS, en particulier par les NADPH oxydases.

#### A. Les systèmes antioxydants

##### 1. Neutralisation des ROS

Les antioxydants sont des molécules capables d'exercer un pouvoir tampon sur les ROS en s'oxydant directement à leur contact, protégeant ainsi par compétition les molécules environnantes. Par leur rôle antioxydant, les vitamines A et C, le coenzyme Q, le glutathion ou encore les acides aminés jouent un rôle essentiel dans le maintien de l'homéostasie



redox. La vitamine E ( $\alpha$ -tocophérol), présente dans les fractions hydrophobes, empêche la peroxydation des lipides. Elle est ensuite régénérée par la vitamine C (acide ascorbique) ou le coenzyme Q. Ce dernier est enfin réduit par la NAD(P)H quinone oxydoréductase 1 (NQO1) (Faig et al. 2000). L'adaptation aux ROS comprend également des systèmes enzymatiques neutralisant directement les ROS. La superoxyde dismutase (SOD) est une enzyme facilitant la dismutation de l'anion superoxyde en peroxyde d'hydrogène. La SOD cytosolique (SOD1) et extracellulaire (SOD3) fonctionne avec un atome de cuivre et de Zinc. La SOD2, mitochondriale fonctionne quant à elle avec du manganèse. Le peroxyde d'hydrogène pourra être alors transformé en molécule d'eau sous l'action de la catalase au niveau des peroxysomes ou de la glutathion peroxydase en présence du glutathion.

## 2. Réduction des groupements thiols

Les propriétés antioxydantes du groupement thiol (SH) sont également largement utilisées pour réparer les attaques des ROS. Le glutathion est un tripeptide ubiquitaire de l'environnement intracellulaire composé de glutamate, de cystéine et de glycine synthétisé par la glutathion synthase. Ses propriétés antioxydantes lui sont essentiellement conférées par le groupement thiol (S-H) présent sur son résidu cystéine. La réaction catalysée par la glutathion peroxydase permet au glutathion de neutraliser directement les peroxydes. Le glutathion peut ainsi se lier aux groupements thiols d'autres protéines par glutathionylation les protégeant d'une oxydation irréversible (Chen et al. 2009) (Figure 7). La glutathionylation est réversible sous l'action des glutarédoxines (Grx) qui catalysent la réaction de réduction des ponts disulfures (Figure 7A). Le glutathion est ainsi oxydé en glutathion disulfide, puis à nouveau réduit par la glutathion réductase avec en contrepartie l'oxydation d'une molécule de NADPH (Figure 7B).

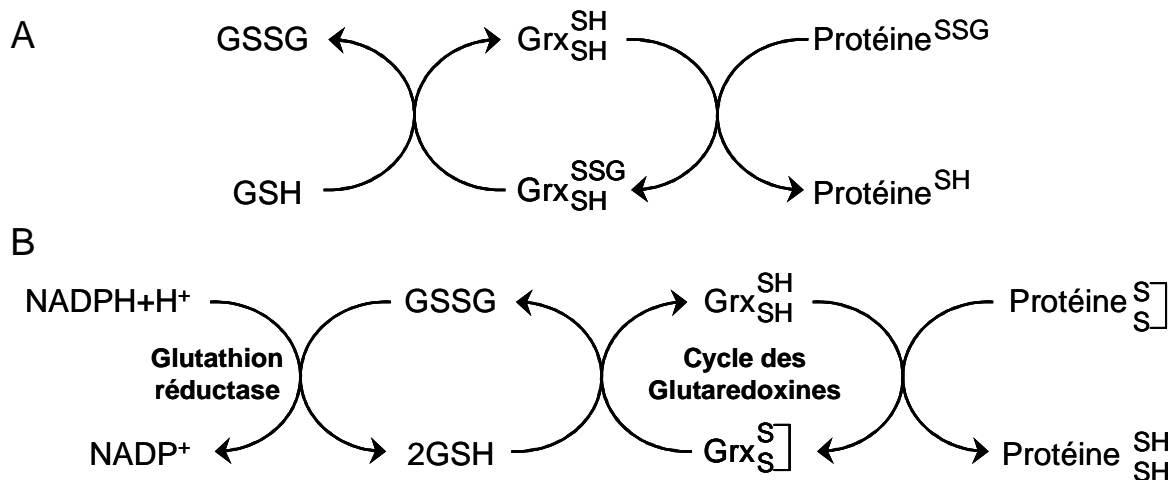
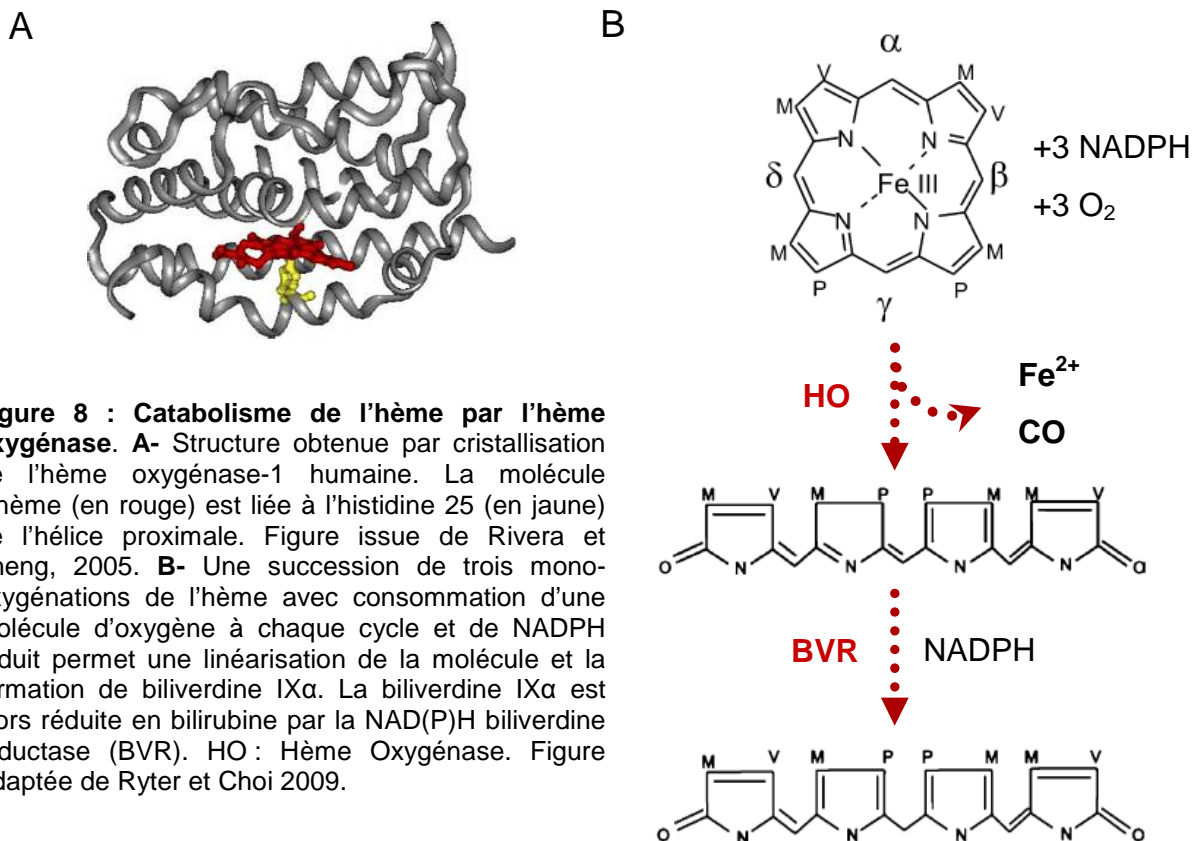

**Figure 7 : Cycle redox du glutathion. A-** Libération du glutathion du groupement thiol d'une protéine par les glutarédoxines. **B-** Réduction du groupement thiol oxydé d'une protéine via le cycle des glutarédoxines.

Les peroxyredoxines, famille comprenant 6 isoformes identifiées chez les mammifères, jouent également un rôle clé dans l'élimination du peroxyde d'hydrogène. Leur mécanisme catalytique dépend de deux résidus cystéines, oxydés en acide sulfénique (SOH) par H<sub>2</sub>O<sub>2</sub>. Le groupement acide sulfénique peut alors être réduit par les thioredoxines ou les glutaredoxines.

### 3. L'hème oxygénase

L'hème oxygénase (HO) est l'enzyme limitante intervenant dans le catabolisme de l'hème (Ryter and Choi 2009). Deux isoformes sont exprimées chez l'homme. La transcription de l'isoforme HO-1 est inductible, tandis que HO-2 est connue pour être constitutivement exprimée. HO-1 et HO-2 sont issus de deux gènes différents et ont des structures primaires relativement distinctes (Cruse and Maines 1988). Les deux isoformes conservent toutefois une forte homologie au sein de leur domaine catalytique.



L'hème oxygénase est formée de deux hélices, dites proximales et distales. L'histidine 25, placée sur l'hélice proximale est impliquée dans la liaison de l'hème via l'atome de fer qui sera ainsi pris en sandwich entre les deux hélices (Figure 8A). L'hélice distale va alors contrôler l'oxygénation du pont  $\alpha$ -méthène de l'hème, la réaction générant stoechiométriquement une molécule de monoxyde de carbone, une molécule de biliverdine-IX $\alpha$  et un atome de fer (Figure 8B). La réaction est réalisée en présence d'oxygène et

d'électrons fournis par le NADPH provenant du cytochrome P450 réductase. La biliverdine-IX $\alpha$ , produit de la réaction est elle-même réduite en biliverdine sous l'action de la NADPH biliverdine réductase.

### **a) Hème oxygénase 1**

HO-1 est une protéine de choc thermique de 32kDa (HSP-32), dont l'expression est inductible par le facteur de transcription Nrf2 (NF-E2-related Factor 2). Les stimuli engendrant un stress oxydant (ROS, toxines, métaux lourds, hypoxie, hème, protoporphyrine...) sont capables d'induire sa transcription. La protoporphyrine à cobalt IX (CoPP), mimant la structure de l'hème est couramment utilisée pour induire l'expression de HO-1 *in vitro* (Shan et al. 2006) et *in vivo* (Benallaoua et al. 2007). A l'exception de la rate et du foie, où HO-1 participe au renouvellement de l'hémoglobine et des cytochromes, son niveau d'expression est globalement faible dans les tissus en conditions physiologiques. Mais son expression peut être induite de manière ubiquitaire. HO-1 possède dans la partie C-terminale de sa séquence une région hydrophobe (très conservée également chez l'isoforme constitutive HO-2 lui permettant un ancrage membranaire au sein du réticulum endoplasmique lisse et plus particulièrement au niveau des microsomes. HO-1 est également exprimée au niveau des cavéoles de l'endothélium chez le rat (Kim et al. 2004), dans les mitochondries de l'épithélium pulmonaire (Slebos et al. 2007) ou encore peut transloquer au sein du compartiment nucléaire après clivage de la partie C-terminale hydrophobe. A ce niveau, elle pourrait réguler la transcription de certains gènes intervenant dans la réponse aux oxydants dans des fibroblastes (Lin et al. 2007).

### **b) Hème oxygénase 2**

HO-2 est exprimée constitutivement et présente environ 43% d'homologie de séquence avec l'isoforme inductible HO-1 (Cruse and Maines 1988). Il s'agit d'une protéine de 316 acides aminés pour un poids moléculaire de 34 kDa environ. La partie C-terminale hydrophobe ainsi que le site catalytique sont très conservés entre les deux isoformes. Sa distribution tissulaire est très ubiquitaire et dans des conditions normales, HO-2 est retrouvée au niveau de la rate, du foie, des reins, des testicules et du système cardiovasculaire. L'isoforme constitutive de l'hème oxygénase est également présente au niveau de l'endothélium du système nerveux où le monoxyde de carbone, produit de la réaction catalysée par l'enzyme, jouerait un rôle dans la neurotransmission (Basuroy et al. 2009).

### **c) Hème oxygénase et cytoprotection**

L'étude de Yachie et al, en 1999 rapporte le seul cas humain de mise en évidence d'une déficience en hème oxygénase-1 (Yachie et al. 1999). Le patient porteur de deux allèles

mutés souffrait d'une multitude de troubles associés à une anémie hémolytique, des dommages endothéliaux importants ou encore des troubles de la coagulation et décéda avant d'atteindre l'âge adulte. Les souris déficientes en HO-1 (*Hmox1*<sup>-/-</sup>) ont un phénotype caractérisé par une anémie et une susceptibilité accrue au stress endothélial. Dans ce type de modèle, l'importance de HO-1 a été mise en évidence lors de lésions artérielles, d'ischémie / reperfusion ou encore d'hypoxie. A l'inverse, plusieurs études sur des souris surexprimant HO-1 confirment le rôle cytoprotecteur de HO-1 sur l'apoptose des cardiomyocytes, l'hypertension pulmonaire, ou encore l'hypertrophie vasculaire (Ryter et Choi, 2009). Plus généralement, de nombreuses études démontrent aujourd'hui que l'hème oxygénase est un acteur clé de la cytoprotection. Ces propriétés sont étroitement liées aux produits de dégradation de l'hème, ainsi qu'à la diminution du pool d'hème biodisponible (Figure 9).

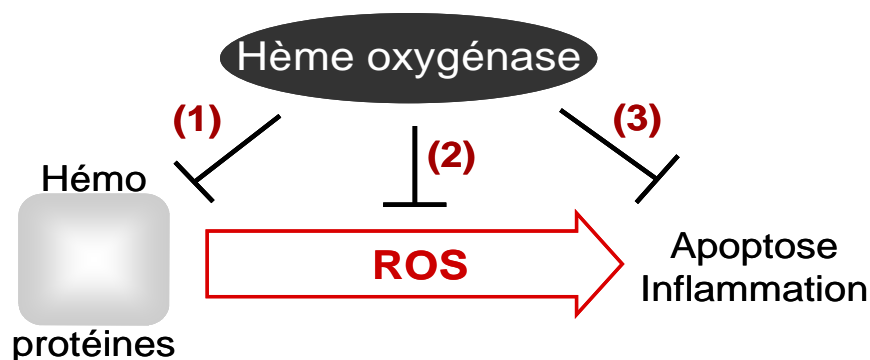

**Figure 9 : Schématisation des mécanismes de cytoprotection relatifs au catabolisme de l'hème.** Les hémoprotéines telles que la NO synthase, certaines protéines appartenant à la chaîne respiratoire des mitochondries ou encore les NADPH oxydases produisent de façon fortuite ou professionnelle des ROS. L'hème oxygénase peut intervenir directement ou non sur l'effet des ROS 1- Par une diminution du pool d'hème biodisponible pour la synthèse des hémoprotéines. 2- Par la production de biliverdine, puis de bilirubine possédant des propriétés antioxydantes ainsi que par l'induction de ferritine. 3- Par les effets anti-apoptotiques et anti-inflammatoires du monoxyde de carbone.

## **B. Régulation de l'activité NADPH oxydase**

Au même titre que les systèmes antioxydants, les différents niveaux de régulation de l'activité des NADPH oxydases sont un moyen de contrôler le statut redox de la cellule. Les mécanismes de régulation de l'activité NADPH oxydase sont propres à chaque isoforme.

### **1. Au niveau Transcriptionnel**

Contrairement aux Nox 1, 2 et 3, dont l'activité est régulée par l'assemblage de facteurs cytosoliques dans une interaction de type protéine-protéine, Nox4 est active constitutionnellement. Dans certains modèles cellulaires, la régulation de sa transcription est donc une étape limitant son activité (Serrander et al. 2007). Cependant, l'expression de Nox4 n'est pas toujours fonction du niveau d'expression de son ARNm (Meng et al. 2008) et

## Introduction

une traduction rapide de l'ARNm de Nox4 a pu être observée en réponse à certains stimuli, suggérant la présence de pools d'ARNm (Bondi et al. 2010; New et al. 2011).

Plusieurs études effectuées sur la séquence promotrice de Nox4 ont permis d'identifier les séquences régulatrices de sa transcription. En l'absence de stimulation, le facteur de transcription E2F1 (E2F transcription factor 1) régule le niveau basal d'expression du transcrit Nox4 (Zhang et al. 2008). En réponse à l'hypoxie, le facteur HIF-1 (Hypoxia Inducible Factor 1) accroît sa transcription ce qui permet à Nox4 la fonction de senseur de l'oxygène (Geiszt et al. 2000; Shiose et al. 2001; Diebold et al. 2010). Il a été rapporté une augmentation de la transcription de Nox4 de manière dépendante du TGF- $\beta$ , après l'infection d'hépatocytes par le virus de l'hépatite C (Boudreau et al. 2009). La transcription de Nox4 dépend également du NF $\kappa$ B (Nuclear Factor kappa B) et de façon plus surprenante, des sites ARE (antioxidant response element) pour lesquels Nrf2, à l'origine de la réponse antioxydante, possède une affinité (Lu et al. 2010; Pendyala et al. 2011). La régulation de la transcription des Nox est sensible à l'environnement épigénétique. La transcription de Nox4 est par exemple régulée par l'histone déacétylase HDAC3. L'inhibition de HDAC3 entraîne un relâchement de la chromatine, réprimant par une gêne stérique l'accès du facteur de transcription c-jun et de l'ARN polymérase à la région promotrice du gène codant pour Nox4 (Siuda et al. 2012).

## 2. Interactions protéines - protéines

Contrairement à Nox4, les Nox 1, 2 et 3 sont des isoenzymes dont l'activité est inductible. Leur activation requiert un assemblage avec les facteurs cytosoliques qui transloquent depuis le cytoplasme jusqu'au complexe membranaire formé avec p22<sup>phox</sup>. Ce mode de régulation est aujourd'hui très bien caractérisé pour Nox2 (Morel 2007). Le complexe Nox2 actif après assemblage est stabilisé par des interactions spécifiques de type protéine/protéine ou protéines/lipides initiées par des réactions de phosphorylations de p47<sup>phox</sup> (définie comme la sous unité organisatrice), suivi de p67<sup>phox</sup> et p40<sup>phox</sup>. L'activation de la NADPH oxydase phagocytaire dépend également de l'assemblage de la GTPase Rac couplée au GTP. Cette configuration active permet le transfert d'électrons du NADPH vers l'oxygène au travers de la membrane (Figure 10). La PKC (Protéine Kinase C), activée physiologiquement par le diacylglycérol ou *in vitro* par le PMA peut être à l'origine de la phosphorylation des facteurs cytosoliques.

Nox1 et Nox3 fonctionnent selon le même principe avec les homologues respectifs de p47<sup>phox</sup> et p67<sup>phox</sup>, NoxO1 et NoxA1. Illustrant ce principe, une phosphorylation du résidu serine 154 de NoxO1 par la PKC a été récemment rapporté comme activatrice de Nox1 sur

une lignée épithéliales du colon (Kroviarski et al. 2013). La phosphorylation de NoxA1 a au contraire un effet inhibiteur (Debbabi et al. 2010). Nox1 pourrait également fonctionner avec les facteurs cytosoliques de Nox2, p47<sup>phox</sup> et p67<sup>phox</sup> ; dans ce cas, son activité serait activable par le PMA (Banfi et al. 2003). La participation de NoxA1 dans l'activation de Nox3 est encore à démontrer.

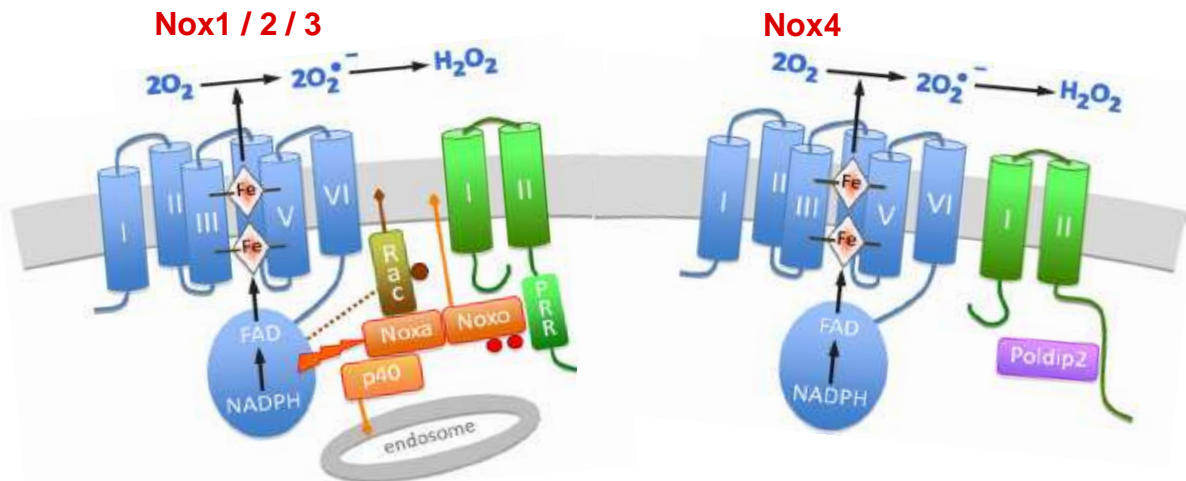

**Figure 10 : Les principaux partenaires régulateurs de l'activation des NADPH oxydase 1 à 4.** p22<sup>phox</sup> (en vert) est nécessaire à la stabilité et à l'adressage des Nox1-4 (en bleu). L'activité des Nox 1 à 3 est initiée par la translocation de facteurs cytosoliques (à gauche, en orange) formé d'une protéine organisatrice (NoxO1 ou p47<sup>phox</sup>), d'une protéine activatrice (NoxA1 ou p67<sup>phox</sup>) et de p40<sup>phox</sup> (uniquement avec p67<sup>phox</sup>). p22<sup>phox</sup> porte sur sa partie C-terminale un domaine riche en proline (PRR) permettant l'interaction avec la sous unité organisatrice du complexe. Cette interaction dépend de réactions de phosphorylation (points rouges) et de la GTPase Rac couplée au GTP (point marron). Au contraire, Nox4 est active constitutivement. Il a toutefois été rapporté un rôle de Poldip2 comme activateur de Nox4 via p22<sup>phox</sup>, mais les domaines d'interaction entre les deux partenaires ne sont pas encore connus. Figure adaptée de Lassègue et al, 2012.

A l'inverse de ses homologues isoenzymes 1-3, Nox4 n'est pas activable par les facteurs cytosoliques et présente une activité constitutive même en l'absence de stimulus et de façon indépendante de la GTPase Rac (Martyn et al. 2006). Cette particularité est due à sa partie C-terminale déshydrogénase, conférant une activité diaphorase spontanée à Nox4 (Nguyen et al. 2012). Ainsi, la protéine chimère composée de l'extrémité cytosolique de Nox4 fusionnée en C-terminal de la partie de séquence contenant les 6 passages transmembranaires de Nox2 (acides aminés 1-284 de Nox2 et 298-578 de Nox4) possède une activité constitutive (Nisimoto et al. 2010). De même, l'activité de la chimère inverse, composée de la queue cytosolique de Nox2 et des domaines transmembranaires de Nox4 (acides aminés 1-337 de Nox4 et 324-570 de Nox2) est stimuable par le PMA en présence des facteurs cytosoliques. Ces résultats ont été confirmés à l'aide d'autres chimères Nox2-Nox4 (von Lohneysen et al. 2010).

## Introduction

L'activité de Nox4 peut aussi être stimulée par des interactions protéines - protéines. Ainsi, en 2004, Park et al montrent par la technique du double hybride une interaction directe de la partie C-terminale de Nox4 avec le TLR4 dans les cellules HEK 293. Cette association a été confirmée par immunoprécipitation dans les cellules de l'endothélium tubulaire rénal (Ben Mkaddem et al. 2010). La fixation du LPS sur le TLR4 entraîne une augmentation de l'activité de Nox4 et une activation redox du facteur de transcription NFkB (Park et al. 2004; Park et al. 2006). Par la même technique, Lyle et al en 2009 ont décrit la Polymerase Delta Interacting Protein-2 (Poldip2) comme partenaire de p22<sup>phox</sup> dans les cellules musculaires lisses vasculaires (VSMC). Dans cette étude, la surexpression de Poldip2 accroît significativement l'activité de Nox4 et jouerait un rôle dans la migration des VSMC (Lyle et al. 2009). Au contraire, cette même étude suggère un effet inhibiteur de Poldip2 sur l'activité de Nox1, entraînant probablement une compétition avec la translocation des facteurs cytosoliques. Tks5, une protéine impliquée dans la formation des podosomes possède une forte homologie avec p47<sup>phox</sup> et serait un autre partenaire de p22<sup>phox</sup> (Diaz et al. 2009). Dans la lignée cellulaire B16-F10, issue de mélanome, la déplétion de Tks5 par ARN interférence, conduit à une diminution de l'activité de Nox4. Enfin, certains composés quinones sont capables de stimuler spécifiquement l'activité de Nox4 (Amara et al. 2007; Nguyen et al. 2013). Un mécanisme dépendant de la NQO1 a été récemment proposé au sein de notre laboratoire.

La biodisponibilité de p22<sup>phox</sup> permet également de réguler l'activité des Nox (Ambasta et al. 2004). L'expression de p22<sup>phox</sup> est régulée par le facteur de Von hippel Lindau (VHL), qui entraîne sa dégradation par le protéasome et conduit à une diminution de l'activité NADPH oxydase dans les cellules de carcinome rénal (Block et al. 2007). Ainsi, une mutation bi-allélique du facteur VHL se traduit par une surexpression de p22<sup>phox</sup> et une activité NADPH oxydase accrue. De même, l'IGF-1 entraîne une augmentation de l'expression de p22<sup>phox</sup>, et une stabilisation de l'expression de Nox4 conduisant à une augmentation de la production des ROS par les cellules cancéreuses pancréatiques (Edderkaoui et al. 2010).

En conclusion, les interactions de type protéine - protéine sont des éléments majeurs de régulation dans l'activation des NADPH oxydases. Elles sont le plus souvent initiées par des réactions de phosphorylations.

### **3. Régulation spatiale du signal redox**

Bien sûr, la propension des ROS à diffuser au travers des membranes biologiques ainsi que leur demi-vie constitue une première limite à leur diffusion. Mais, la notion de compartimentation physique des ROS par les membranes biologiques et les systèmes

antioxydants tend à émerger (Chen et al. 2009; Oakley et al. 2009b; Patel and Insel 2009). En particulier, les micro-domaines composés par les rafts lipidiques et les cavéoles permettent le regroupement des protéines associées à la membrane plasmique et jouent un véritable rôle de catalyseurs de la transduction du signal. Le terme de « redoxosome » à même été proposé par Oakley et ses collaborateurs (Oakley et al. 2009b). Les interactions protéines-protéines, protéines-lipides, ROS-protéines ou encore ROS-systèmes antioxydants y sont facilitées. Le rôle de la compartimentation endosomale des ROS a par exemple été démontré dans la translocation du facteur de transcription NFκB induite par l'IL-1β dans la lignée MCF-7 (Li et al. 2006; Mumbengegwi et al. 2008). Dans ces cellules, l'IL-1β induit une production d'anion superoxyde par Nox2 localisée au sein des endosomes ainsi qu'un recrutement de la SOD1. L'anion superoxyde produit diffuse alors au travers de la membrane des endosomes par l'intermédiaire de canaux à chlorures puis est dismuté par la SOD1 en H<sub>2</sub>O<sub>2</sub> permettant la translocation du NFκB au sein du noyau (Figure 11).

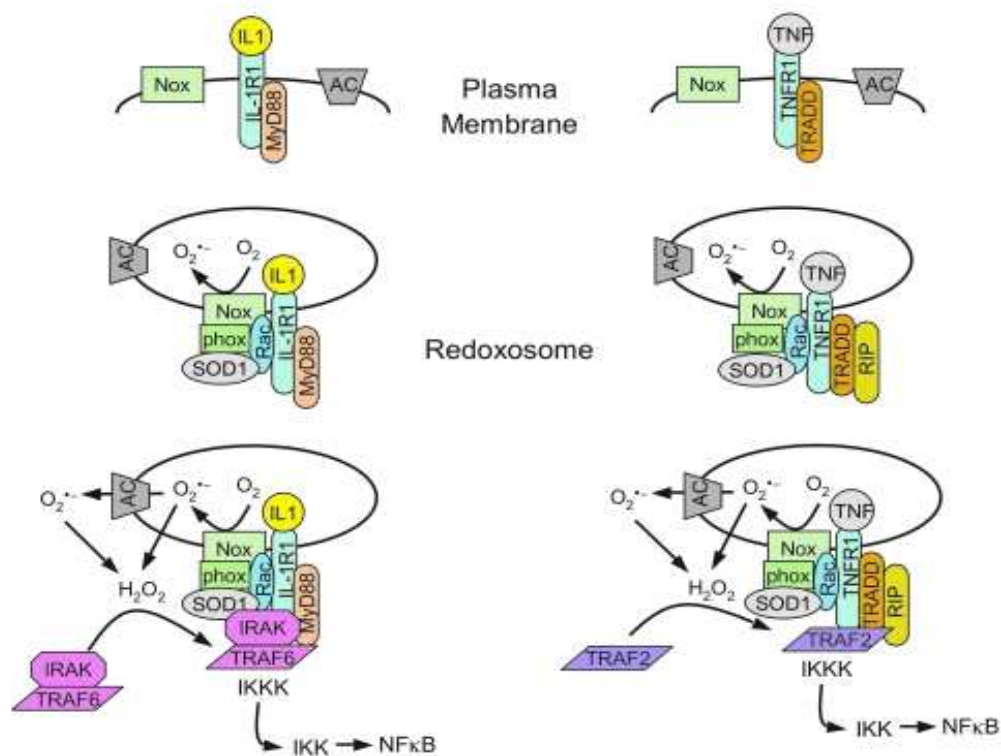

**Figure 11 : Exemple de compartimentation redox initié par l'interleukine-1beta ou le TNFalpha.** (1) Le ligand se lie à son récepteur, entraînant le recrutement de protéines adaptatrices et son internalisation. (2) Rac1 permet alors le recrutement de la NADPH oxydase au sein des endosomes à l'intérieur desquels elle va générer l'anion superoxyde, ce dernier diffusant au travers de la membrane des endosomes au travers de canaux à chlorures. (3) La SOD1 semble alors jouer un rôle déterminant, d'une part en maintenant la GTPase Rac1 sous forme active et d'autre part, dismutant l'anion superoxyde en H<sub>2</sub>O<sub>2</sub>, nécessaire à l'activation redox des kinases en amont du NFκB. Figure issue de la revue de Oakley et al, 2009.

La localisation subcellulaire des pourvoyeurs de ROS est une autre composante fondamentale de la compartimentation redox. En effet, la demie vie des ROS, en particulier



de l'anion superoxyde généré par les Nox est extrêmement courte ; le lieu de leur synthèse conditionnera donc directement le périmètre dans lequel ils pourront agir. Nox4 est exprimée dans le réticulum endoplasmique ou à la membrane plasmique des cellules HEK293 (Chen et al. 2008; Zhang et al. 2011), dans le compartiment nucléaire des VSMC (Hilenski et al. 2004) ou des cellules endothéliales (Kuroda et al. 2005) et au sein des mitochondries des cellules mésangiales (Block et al. 2009) et des cardiomyocytes (Ago et al. 2010). Le changement de la distribution subcellulaire de Nox4 d'une cellule à l'autre explique peut être ses fonctions distinctes sur le plan de la signalisation redox. Par exemple, en réponse à l'EGF les ROS générés par Nox4, localisée au sein du réticulum endoplasmique des VSMC inactivent spécifiquement la protéine phosphatase PTP1B et permettent la persistance de la signalisation liée à l'EGF (Chen et al. 2008).

Une étude récemment publiée a également montré pour la première fois que Nox4 est phosphorylable à la membrane plasmique des cellules musculaires lisses vasculaires (VSMC) (Xi et al. 2013). Dans ces cellules, la fixation de l'IGF-1 sur son récepteur entraîne la phosphorylation du résidu tyrosine 491 de Nox4 permettant l'interaction de la partie C-terminale cytosolique de Nox4 avec le domaine SH2 de Grb2 et un rapprochement physique avec la kinase src à la membrane plasmique. Fait intéressant, la disruption de l'interaction entre Nox4 et Grb2, soit par la mutation du résidu tyrosine 491 de Nox4 en phénylalanine, soit à l'aide d'un peptide, *in vivo*, inhibe l'activation de la kinase src par l'IGF-1 (Insulin Growth Factor-1) et la prolifération des VSMC aortiques dans un modèle murin.

#### **4. Effet dominant négatif des isoformes des Nox**

Les Nox 1, 2, 4 et 5 possèdent des isoformes résultant d'un épissage alternatif. Certaines de ces isoformes possèdent un effet dominant négatif sur la production des ROS. En 2001, Banfi et ses collaborateurs identifient plusieurs isoformes de Nox5 (Banfi et al. 2001). Nox5, correspond à l'isoforme Nox5 $\alpha$ , identifiée dans la rate et diffère par son extrémité N terminale des isoformes Nox5 $\beta$ , et Nox5 $\gamma$  Nox5 $\delta$  et Nox5S (BelAiba et al. 2007). Seules Nox5 $\alpha$ , Nox5 $\beta$  et Nox5S apparaissent comme fonctionnelles, mais contrairement aux deux premières isoformes, l'activité de Nox5S qui ne possède pas les domaines EF-Hand n'est pas régulée par le calcium. Au contraire des autres Nox, aucun partenaire n'est connu comme régulant l'activité de Nox5. En fait, il semblerait que Nox5 fonctionne en tétramères, les monomères étant associés de manière indépendante de la concentration en calcium par leur partie C-terminale déshydrogénase (Kawahara et al. 2012). De manière intéressante, la co-transfection du variant d'épissage Nox5S avec l'isoforme WT entraîne la formation d'oligomères inactifs et un effet dominant négatif.

L'activité de Nox4 est également sujette à ce type de régulation. Quatre variants d'épissage de Nox4 (désignés Nox4B, C, D et E) ont été identifiés par Goyal et al en 2005 (Figure 12). Nox4A désignant l'isoforme originelle.

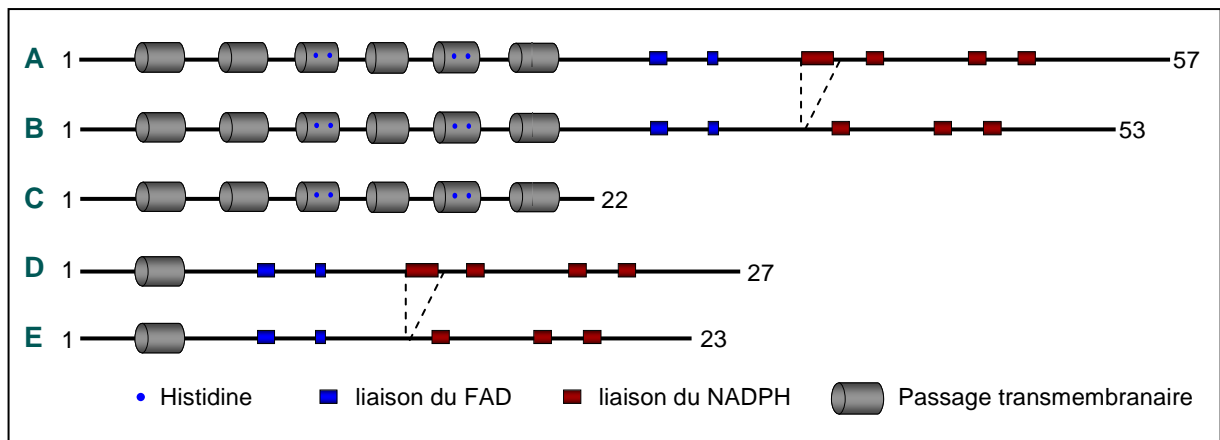

**Figure 12 : Représentation linéaire putative des cinq isoformes décrites pour Nox4.** Seul Nox4A et D seraient fonctionnels. Nox4 B et E jouent un rôle de dominant négatif, agissant vraisemblablement par compétition sur l'activité des isoformes fonctionnelles.

L'isoforme B diffère de Nox4A par un épissage de l'exon 14 entraînant une délétion du premier domaine de fixation du NADPH et donc la synthèse d'une isoforme dépourvue d'activité NADPH oxydase. Nox4B joue pourtant un rôle significatif dans la régulation de l'activité de Nox4A. En effet, la surexpression de Nox4B dans les cellules A549 a un effet dominant négatif et réduit l'activité oxydase endogène. Nox4C est le résultat de l'épissage des exons 9, 10 et 11. Cette délétion entraîne un changement du cadre de lecture et fait apparaître un codon stop sur l'exon 12, tronquant la queue cytosolique des sites de liaison du NADPH et rendant inactive cette isoforme. On remarque également comme pour l'isoforme Nox4B l'effet dominant négatif sur l'activité oxydase endogène. Le même constat est observé par la surexpression d'un mutant semblable ne contenant seulement que les 6 passages transmembranaires (Nox4 $\Delta$ FAD/NADPH) dans les adipocytes (Mahadev et al. 2004).

Nox4D et Nox4E résultent d'un épissage des exons 3 à 11 et ne possèderaient qu'un seul passage transmembranaire suivi de la queue cytosolique. De même que pour l'isoforme récemment décrite de Nox2, Nox2 $\beta$  (Harrison et al. 2012), il est surprenant de constater que l'isoforme Nox4D possède une activité oxydase équivalente à Nox4 dans les cellules A549, malgré l'absence des histidines prédites pour coordonner les deux hèmes. Pourtant, cette isoforme a également été retrouvée active dans les cellules tubulaires rénales ou plus récemment dans le compartiment nucléaire des VSMC (Ben Mkaddem et al. 2010; Anilkumar et al. 2013). Dans ces dernières, Nox4D est impliquée dans la transduction redox

conduisant à la phosphorylation de la kinase Erk1/2. Nox4D entraîne aussi des dommages à l'ADN, réprimés par une mutation ponctuelle sur l'un de ses sites de liaison du NADPH. De même, Nox4E est dépourvue de l'exon 14 et ne possède pas d'activité NADPH oxydase.

Enfin, la régulation de l'activité des Duox dépend de la présence des Duox activateurs (DuoxA1 pour la Duox1 et DuoxA2 pour la Duox2). L'existence de 4 variants d'épissage de DuoxA1 (DuoxA1 $\alpha$ ,  $\beta$ ,  $\gamma$  et  $\delta$ ) a été rapportée (Morand et al. 2009). Il est à noter que les isoformes  $\beta$  et  $\delta$  ne permettent pas l'adressage correct de la Duox1 qui est retrouvé dans le golgi.

Ainsi, les variants d'épissage des Nox ou des facteurs régulant leur activation permettent, par un effet dominant négatif, de réguler leur activité. L'activité de Nox4 peut être régulée par les isoformes Nox4B et E.

### **5. Hème oxygénase et activité NADPH oxydase**

Dans la lignée de macrophages RAW 264.7, l'induction de l'expression de l'hème oxygénase-1 par le CoPP-IX entraîne une diminution très significative de l'activité NADPH oxydase de Nox2 (Taille et al. 2004). Cette réduction d'activité s'accompagne également d'une diminution de l'expression de Nox2 et de p22<sup>phox</sup> et s'avère être réversible après addition exogène d'hème. Dans cette étude, les auteurs suggèrent donc que le catabolisme de l'hème par HO-1 amenuise sa biodisponibilité pour Nox2, altérant la stabilité du dimère avec p22<sup>phox</sup> et l'activité du complexe.

Le TNF- $\alpha$  entraîne une production de ROS par Nox4, responsable de l'apoptose des cellules issues de l'endothélium microvasculaire cérébral (Basuroy et al. 2009). La bilirubine, directement issue de l'activité enzymatique de HO-2 protège les cellules de cette apoptose par un effet antioxydant. De la même manière, Fujii et ses collaborateurs ont constaté que les rats hyperbilirubinémiques Gunn *j/j* étaient protégés de la fibrose rénale par un mécanisme impliquant une diminution de l'expression et de l'activité de Nox4 (Fujii et al. 2010). Des résultats similaires ont été obtenus par injection de biliverdine dans un modèle murin diabétique. Une autre étude, réalisée *in vivo* sur des souris déficientes en apolipoprotéine E, modèle d'étude du stress oxydant vasculaire démontre que l'induction de HO-1 par injection intra-péritonéale d'hémine (25mg/kg) réduit considérablement la génération de ROS par Nox2 et Nox4 de façon dépendante de la bilirubine (Datla et al. 2007).

Près de 85% du monoxyde de carbone (CO) produit de manière endogène provient du catabolisme de l'hème, dont environ 70% est issu de la dégradation de l'hémoglobine des

érythrocytes et 15% est issu des hémoprotéines (Kim et al. 2006). L'une des cibles biologiques privilégiées du CO est l'atome de fer constituant l'hème au sein des hémoprotéines. Il est ainsi un inhibiteur bien connu de la chaîne respiratoire des mitochondries (Taille et al. 2005) ou encore un activateur de la guanylate cyclase (Brune et al. 1990). Son rôle inhibiteur des NADPH oxydase, Nox1 et Nox2 a été suggéré (Taille et al. 2004; Nakahira et al. 2006; Rodriguez et al. 2009). D'après l'étude de Rodriguez et ses collaborateurs, le PDGF induit une production de ROS par Nox1 responsable de l'activation des voies ERK 1/2, JNK, AKT et p38 MAPK et entraîne la migration des VSMC (Rodriguez et al. 2009). Cette activation est réversible après induction de l'expression de HO-1 et de manière similaire à l'addition exogène de CO.

Ainsi, l'hème oxygénase possède 3 modes d'actions possibles pouvant altérer l'activité NADPH oxydase. Premièrement, par une diminution du pool d'hème biodisponible pour la néosynthèse des Nox. Deuxièmement, par la production d'antioxydants tels que la biliverdine ou la bilirubine, issus de son activité catalytique. Troisièmement, par l'inhibition directe ou non de leur activité consécutivement à la production de CO.

## 6. Les inhibiteurs synthétiques des NADPH oxydases

L'implication des NADPH oxydases a été décrite dans de nombreux mécanismes pathologiques (Lassegue et al. 2012). Pourtant, les molécules historiquement utilisées pour inhiber leur activité telles que l'Apocynine ou le Diphénylène Iodonium (DPI) manquent de spécificité ou sont toxiques *in vivo* (Jaquet et al. 2009; Kim et al. 2011). Un inhibiteur pharmacologique ciblant sélectivement l'activité des Nox1 et Nox4 a récemment été développé par la société GenKyoTex, le GKT136901 (Laleu et al. 2010). Cet inhibiteur a permis de confirmer l'impact de Nox4 dans des pathologies telles que le diabète de type II (Sedeek et al. 2013). Une autre stratégie consiste à développer des peptides compétiteurs des Nox ou de leur association avec les partenaires modulateurs de leur activité. Cette dernière approche a été abordée avec succès pour Nox2 mais requiert une parfaite connaissance des domaines fonctionnels de l'enzyme (Csanyi et al. 2011). Xi et al. ont récemment identifié un domaine de Nox4 intervenant dans l'interaction avec la protéine Grb2 (Xi et al. 2013). Cette interaction permet la production de ROS localisée de Nox4 à la membrane plasmique des VSMC. De manière intéressante, l'administration *in vivo* d'un peptide mimétique de ce domaine de Nox4 réprime l'activation redox de la kinase src et la prolifération des VSMC. De même, la boucle E de Nox4 a récemment été identifiée comme jouant un rôle clé dans la formation d' $H_2O_2$  par Nox4 (Takac et al. 2011). La fixation de l'anticorps 8E9, développé au laboratoire et dirigé contre cette boucle, inhibe partiellement la formation de l' $H_2O_2$  aux dépens de l' $O_2^-$  (Zhang et al. 2011). Cette synthèse de peptides

inhibiteurs n'est pourtant pas toujours couronnée de succès. La boucle B de Nox4 est connue pour interagir avec sa partie C-Terminale déshydrogénase, permettant son fonctionnement constitutif (Jackson et al. 2010). De même les 11 premiers acides aminés de p22<sup>phox</sup> sont essentiels à l'association avec Nox4 (von Lohneysen et al. 2008). Une série de peptides reproduisant la boucle B de Nox4 et la partie N-terminale de p22<sup>phox</sup> n'ont pourtant pas d'effet sur la formation des ROS par Nox4 (Csanyi and Pagano 2013).

## IV. Rôles Physiologiques des ROS

Outre leur rôle clé dans l'immunité innée et la synthèse des hormones thyroïdiennes (voir p. 21), les ROS sont des messagers seconds régulant de nombreux processus physiologiques. En contrôlant l'expression de certains gènes, ils jouent un rôle dans le développement embryonnaire, peuvent orienter la différenciation cellulaire, réguler la prolifération, ou encore entraîner la migration cellulaire. De façon non exhaustive, les ROS seraient par exemple impliqués dans la chondrogénèse à partir de cellules souches mésenchymateuses ou encore l'ossification endochondrale, processus par lequel le cartilage de croissance laisse place à l'os au cours de la croissance des organismes vertébrés (Morita et al. 2007; Kim et al. 2010). Les ROS sont également nécessaires à la différenciation des adipocytes, des cardiomyocytes et des ostéoblastes (Schroder et al. 2009; Crespo et al. 2010; Mandal et al. 2012). Ils sont également impliqués dans le maintien de la pluripotence des cellules souches de la moelle osseuse (à faible dose) ou leur différenciation (à plus forte doses) (Urao and Ushio-Fukai 2012). Les voies de signalisation activées par les ROS permettent également la migration et la prolifération des cellules musculaires lisses vasculaires ainsi que la synthèse de métalloprotéases matricielles (MMP) nécessaire au cours de l'angiogénèse (Meng et al. 2008; Rodriguez et al. 2009). La physiologie est ainsi régulée par une multitude de voies de signalisation contrôlées ou influencées par de très faibles quantités de ROS, orientant le comportement et l'homéostasie de la cellule.

### 1. ROS et transduction du signal

Les signaux transduits par certaines cytokines dépendent d'une production de ROS. Ainsi, l'IGF-1 et le PDGF (Platelet Derived Growth Factor) activent la production de ROS par les cellules musculaires lisses vasculaires (Meng et al. 2008 ; Rodriguez et al. 2009), le TGF- $\beta$  (Transforming Growth factor- $\beta$ ) par les hépatocytes (Sancho et al. 2009), le BMP-2 (Bone Morphogenetic Protein-2) par les ostéoblastes (Mandal et al. 2012), l'IL-1 $\beta$  (Interleukine-1 $\beta$ ) par les cellules MCF-7 (Mumbengegwi et al. 2008) et les chondrocytes (Grange et al. 2006), l'EGF (Endothelial Growth Factor) par les cellules endothéliales aortiques humaines ou encore le TNF- $\alpha$  (Tumor Necrosis Factor- $\alpha$ ) par les cellules endothéliales microvasculaires cérébrales (Basuroy et al. 2009). Dans ces cellules, les ROS agissent comme des

messagers secondaires régulant des fonctions aussi diverses que la migration cellulaire, la sécrétion de métalloprotéases matricielles, la différenciation, ou encore l'apoptose. Cette transduction redox du signal est la conséquence des modifications biochimiques apportées par les ROS sur les protéines kinases et phosphatases ou directement sur les facteurs de transcriptions. Les ROS impactent également certains phénomènes épigénétiques.

### **a) Régulation redox de l'activité kinase et phosphatase**

L'activité biologique des protéines phosphatases dépend d'un résidu cystéine présent au sein de leur site catalytique. L'oxydation de ce résidu en acide sulfénique (SOH) par le peroxyde d'hydrogène entraîne la formation d'un pont disulfure avec un résidu cystéine voisin et une inactivation (Corcoran and Cotter 2013). Cette oxydation est réversible par glutathionylation ou en présence des thioredoxines. Mais des concentrations supérieures en H<sub>2</sub>O<sub>2</sub> peuvent également inactiver définitivement les phosphatases par la formation irréversible de l'acide sulfinique (SO<sub>2</sub>H) et sulfonique (SO<sub>3</sub>H) (Brown and Griending 2009). De façon intéressante, la superoxyde dismutase est nécessaire à l'inactivation de la phosphatase PTP1B, suggérant l'importance du rôle du peroxyde d'hydrogène (Juarez et al. 2008). Ces données soulignent une certaine spécificité des différents types de ROS pour leurs cibles.

Contrairement aux protéines phosphatases, il n'existe pas de site consensus généralisé à toutes les protéines kinases susceptible d'être oxydées par les ROS. L'effet des ROS sur l'activité kinase sera donc fonction de l'emplacement du site qu'ils vont modifier sur la protéine (Corcoran and Cotter 2013). La mitogen-activated protein kinase kinase 1 (MEKK1) peut être par exemple glutathionylée sur son résidu cystéine 123, ce qui interfère de manière stérique avec l'entrée d'ATP sur son site actif (Cross and Templeton 2004). Ce mécanisme semble également être impliqué dans la régulation de l'activité de la protéine kinase C (PKC) et de l'AMPC kinase (Ward et al. 2000; Humphries et al. 2002). Les ROS ont au contraire un rôle activateur des kinases de la famille src en liant par un pont disulfure les cystéines 245 et 487 (Giannoni et al. 2005).

Les mitogen activated protein kinases (MAPK) sont également connues pour être sensibles au statut redox de la cellule (Torres 2003). Les MAPK sont des protéines sérine/thréonine kinases réparties en 4 groupes : ERK (« Extracellular signal Regulated Kinase »), JNK/SAPK (« c-Jun-N-terminal kinase/stress activated protein kinase »), p38 kinase et BMK1 (« Big mitogen activated protein kinase 1 »). Leur activité est régulée par une double phosphorylation au niveau du motif protéique thréonine-X-tyrosine (Mittelstadt et al. 2005). L'inhibition de l'activité phosphatase par les ROS est donc un mécanisme indirect

d'activation des MAP kinases (Lee et al. 2003). Mais, une oxydation sélective des MAPK, fonction de la concentration en  $H_2O_2$ , semble également dicter le comportement de la cellule (Galli et al. 2008). Ainsi, une concentration en  $H_2O_2$  voisine de  $0,1\mu M$  est capable d'oxyder deux résidus cystéines sur les cinq que comporte Erk2, induisant la transcription de gènes permettant la prolifération cellulaire. En revanche, une concentration supérieure ( $10\mu M$ ) va oxyder également les résidus cystéines présents sur les kinases JNK2 et p38, entraînant l'arrêt du cycle cellulaire. Les MAPK pourraient donc moduler la prolifération en fonction du statut redox de la cellule.

### **b) Régulation redox des facteurs de transcriptions**

#### ***(1) Les facteurs de transcription contrôlant l'inflammation***

Les ROS peuvent également moduler l'affinité des facteurs de transcription vis-à-vis de leurs répresseurs ou de leurs séquences cibles. Le NFkB (Nuclear Factor kappa B) est un complexe multiprotéique connu pour activer un grand nombre de gènes impliqués dans l'inflammation. Il est lié sous forme inactive à son répresseur Ikb qui le maintient dans le compartiment cytoplasmique. La phosphorylation de la sous unité Ikb entraîne la libération du NFkB qui peut alors transloquer dans le noyau et transcrire les gènes cibles. La chaîne légère de la dynéine (LC8) réprime la phosphorylation de Ikb. L'oxydation de LC8 va rompre l'interaction de LC8 et Ikb qui pourra alors être phosphorylé, entraînant la translocation du NFkB dans le noyau (Jung et al. 2008). Ainsi, l'oxydation de partenaires du NFkB va promouvoir sa translocation ; en revanche, l'oxydation directe du résidu cystéine présent sur le domaine de fixation à l'ADN en acide sulfénique va altérer sa capacité de fixation à l'ADN (Galter et al. 1994). Les ROS peuvent aussi agir en facilitant la phosphorylation de Ikb via les kinases situées en amont et en inhibant les phosphatases (Wang et al. 2002).

AP1 (Activator Protein 1) est un autre facteur de transcription régulé par l'état redox de la cellule. Il est composé du dimère d'oncogènes c-fos ou c-jun. Son activation se fait par l'intermédiaire des MAP kinase JNK actives qui vont phosphoryler les résidus sérines du domaine de transactivation de c-jun. L'activité de AP1 peut en revanche être inhibée par oxydation au niveau de deux résidus cystéines situées sur son domaine de fixation à l'ADN. La réponse AP1 est impliquée dans un large panel de signalisation conduisant à la prolifération, la survie, la différenciation, la migration, la transformation ou encore l'apoptose (Vesely et al. 2009).

## (2) Rétrocontrôle des ROS par les ROS

Lorsque les ROS produits excèdent les capacités des systèmes antioxydants disponibles, un rétrocontrôle se met en place via le facteur de transcription Nrf2. En l'absence de ROS, Keap1 (kelch-like ECH-associated protein 1) est lié à Nrf2 et le retient dans le cytosol où il sera ubiquitinylé et dégradé par le protéasome (Figure 13).

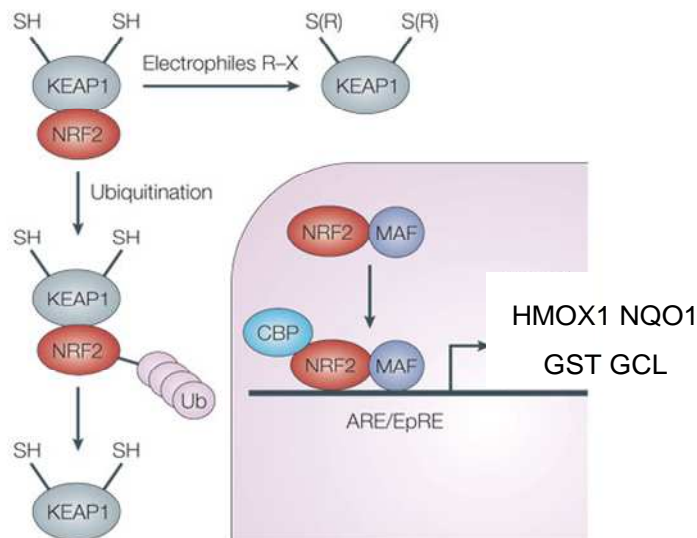

**Figure 13 : Régulation redox du facteur de transcription Nrf2.** L'oxydation de résidus spécifiques situés sur son répresseur, Keap1 (kelch-like ECH-associated protein 1) va rompre son interaction avec Nrf2 lui permettant d'échapper au protéasome et de transloquer au sein du noyau. Après association avec la protéine Maf Nrf2 va initier la transcription de gènes intervenant dans la réponse au stress oxydant (Liebler and Guengerich 2005).

Keap 1 contient deux résidus cystéines au sein de son site actif, l'oxydation de ces cystéines par les ROS va entraîner une baisse d'affinité pour Nrf2 et la libération du facteur de transcription qui pourra transloquer dans le noyau. Nrf2 va alors se lier à la protéine Maf et initier la machinerie transcriptionnelle sur la séquence promotrice ARE (Antioxydant Response Element). Au contraire, Bach-1, peut former un dimère avec Maf et réprimer la transcription par compétition avec Nrf2 (Shan et al. 2006). Nrf2 est impliqué dans la transcription d'un large panel de gènes codant pour des protéines impliquées dans la régulation de l'homéostasie du glutathion, le métabolisme et l'élimination des xénobiotiques et la réponse au stress oxydant (Boutten et al. 2011). La NAD(P)H quinone oxydoréductase 1 et son homologue, la NRH quinone oxydoréductase 2, impliquées dans la réduction des quinones, la glutathion S-transférase (GST) qui va permettre le couplage du glutathion aux composés oxydés, la glutamate cystéine ligase intervenant dans la synthèse du glutathion et l'hème oxygénase 1 (HO-1) enzyme clé du catabolisme de l'hème sont transcrites sous sa dépendance.

Les facteurs HIF (Hypoxia Inducible Factor), interviennent dans la transcription des gènes permettant l'adaptation de la cellule à un environnement hypoxique (Page et al. 2002). Les deux isoformes, HIF-1 et HIF-2 présentent des mécanismes d'activation comparables, ils fonctionnent sous forme de dimères (sous unité  $\alpha$  et  $\beta$ ). Les deux sous unités sont



## Introduction

constitutivement exprimées, la sous unité  $\alpha$  dans le cytosol et la sous unité  $\beta$  au sein du compartiment nucléaire. En conditions de normoxie, la sous unité  $\alpha$  est hydroxylée, accroissant son affinité pour le facteur de Von Hippel–Lindau (VHL) qui possède une activité E3 ubiquitine ligase et entraîne la dégradation de cette sous unité par le protéasome. L'activité prolyl hydroxylase est le facteur limitant de la dégradation de la sous unité  $\alpha$ , en effet, la réaction d'hydroxylation ne peut se faire qu'en présence d'oxygène, donc en normoxie. Ainsi, lorsque la concentration en oxygène vient à diminuer, la sous unité  $\alpha$  stabilisée peut transloquer au sein du noyau, former un dimère avec la sous unité  $\beta$  et se lier aux séquences HRE (hypoxia response element), au sein des séquences promotrices des gènes permettant l'adaptation à l'hypoxie (Henrotin et al. 2005; Haase 2013). Indépendamment des conditions d'hypoxie, l'activité prolyl hydroxylase dépendante d'un atome de Fer ferreux est inhibée par l'oxydation ; ainsi, HIF1 et 2 sont activés en réponse à certaines cytokines entraînant une transduction redox (IL-1 $\beta$ , TNF- $\alpha$ , PDGF, TGF- $\beta$ ...), ou par l'H<sub>2</sub>O<sub>2</sub> lui même (Gorlach et al. 2001; Yudoh et al. 2005a; Yang et al. 2010). Les facteurs HIF activent par exemple les gènes codants pour l'érythropoïétine (EPO), permettant la multiplication des érythrocytes et une amélioration du transport de l'oxygène sanguin, le VEGF, facteur majeur de l'angiogénèse ou encore certaines protéines de la glycolyse et du transport du glucose tels que Glut-1 (Haase 2013).

### **c) Signalisation redox et épigénétique**

L'épigénétique caractérise toute forme de modification de l'expression des gènes non codée par le génome. Parmi ces modifications, les acétylations et déacétylations des histones jouent un rôle majeur dans la compaction ou la décompaction de la chromatine. La fixation de facteurs de transcription tels que le NF $\kappa$ B ou AP1 sur leur séquence cible entraîne le recrutement de CBP (CREB-binding protein) qui va acétyler spécifiquement certains résidus lysine présents au sein des histones. Il en suit un relâchement de la chromatine qui devient accessible à l'ARN polymérase II entraînant la transcription des gènes cibles. Au contraire, les histones déacétylases (HDAC) vont induire une compaction de la chromatine et réprimer la transcription. La nitrosylation d'un résidu tyrosine présent sur HDAC2 inhibe son activité (Ito et al. 2004).

En somme, les ROS pourront d'abord agir sur le relâchement de la chromatine indirectement via l'activation de facteurs de transcription activables par le statut redox puis réprimer sa compaction par l'inactivation directe des HDAC (Rahman et al. 2004). Ils vont ainsi promouvoir la transcription des gènes cible du NF $\kappa$ B et de AP1 régulant la réponse inflammatoire (Figure 14).

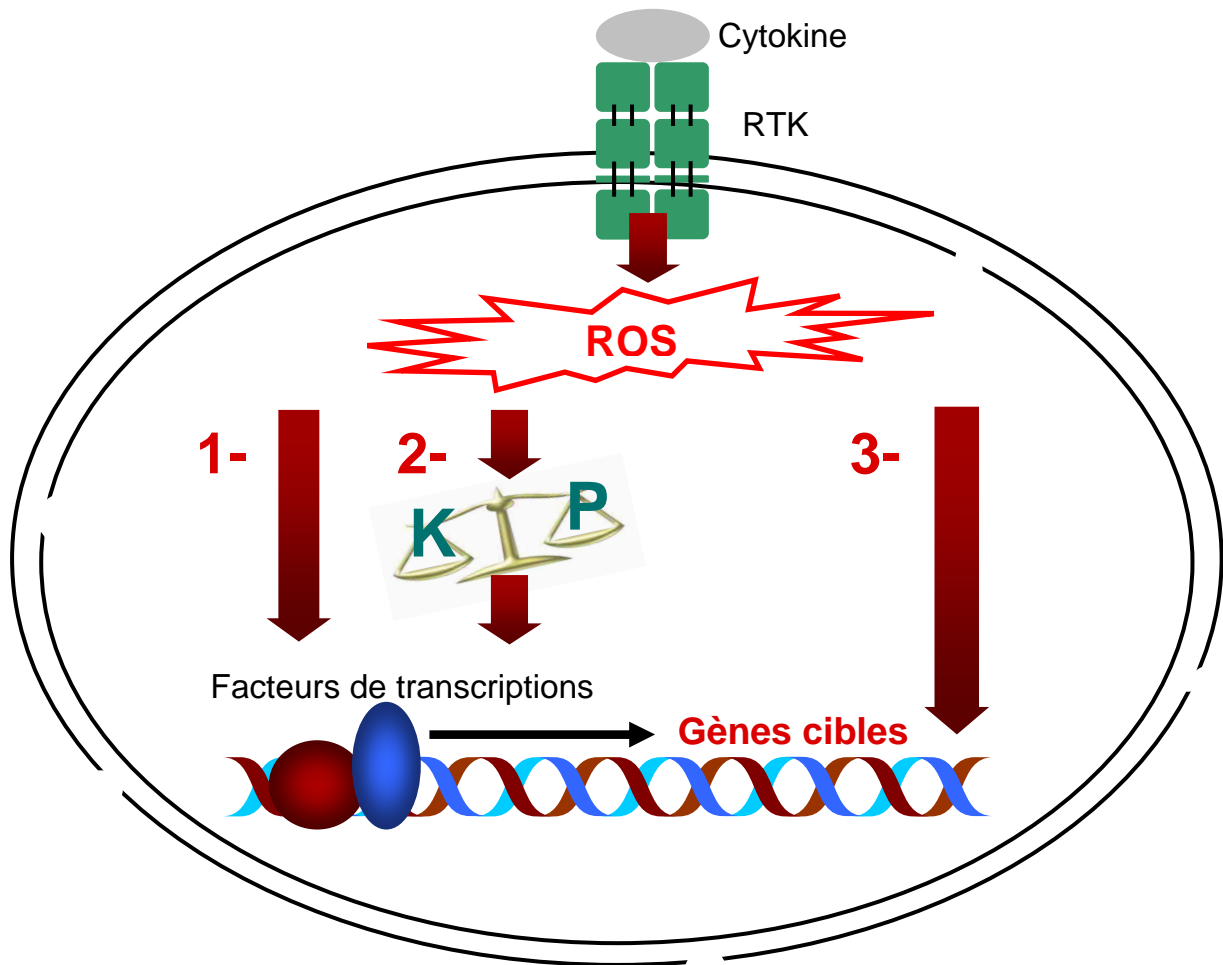

**Figure 14 : Les ROS dans la transduction du signal.** Après fixation de la cytokine sur son récepteur (RTK), la transduction du signal redox est régulée à 3 niveaux dans la cellule. 1- Les ROS produits peuvent moduler directement l'activité de certains facteurs de transcription. 2- Activer les protéines kinases et inhiber les phosphatases. 3- Entraîner des modifications épigénétiques par oxydation directe des acides nucléiques ou indirectement par l'intermédiaire d'acétylation ou méthylation de l'ADN. K : kinase ; P : phosphatase.

Il est également à noter que la transcription de certains gènes peut être régulée par l'oxydation directe de l'ADN par les ROS. En conditions d'hypoxie, la transcription du VEGF est par exemple induite par l'oxydation de bases azotées présentes au sein sa séquence promotrice, ce qui va accroître l'affinité de HIF1 $\alpha$  pour cette séquence (Ruchko et al. 2009). Enfin, il a été rapporté que l'expression du complexe protéique Dicer, impliqué dans la formation des miRNA, petits ARN non codants de 18-24 paires de bases, serait dérégulée par le peroxyde d'hydrogène (Ungvari et al. 2012).

## 2. ROS et mort cellulaire

Le processus d'apoptose, ou mort cellulaire programmée, s'oppose à la nécrose, définie par un arrêt pathologique et soudain du fonctionnement de la cellule. Au contraire de la nécrose, le processus d'apoptose sera donc transduit jusqu'à la cellule cible par une signalisation

adéquate. Certaines cytokines, en particulier, l'interleukine-1 $\beta$  (IL-1 $\beta$ ) ou le TNF- $\alpha$  (Tumor Necrosis Factor  $\alpha$ ) sont connues pour leur effet pro-apoptotique. Les ROS semblent occuper un rôle prépondérant dans l'initiation de ce processus de mort cellulaire programmée. En particulier, les ROS générés par Nox4 sont impliqués dans l'apoptose des hépatocytes en réponse au TGF- $\beta$  (Carmona-Cuenca et al. 2008), des cellules endothéliales microvasculaires cérébrales en réponse au TNF-  $\alpha$  (Basuroy et al. 2009), des cellules épithéliales en présence de concentration élevées en glucose (Eid et al. 2010), des cellules progénitrices de l'endothélium traitées par l'ostéoprotégérine (Kim et al. 2013) ou encore de différentes lignées de lymphocytes T leucémiques traitées par des cannabinoïdes (McKallip et al. 2006). Un excès d'apoptose caractérise d'ailleurs certaines pathologies dégénératives telles que l'arthrose, la maladie d'Alzheimer ou de Parkinson dans lesquelles les ROS sont impliqués. A l'opposé, les ROS induisent la transformation tumorale, se traduisant par l'acquisition d'une résistance à l'apoptose. Par exemple, les ROS générés par Nox4 confèrent une résistance à l'apoptose d'astrocytes malins en oxydant le résidu cystéine présent au sein du site actif de la caspase 3 active (Choi et al. 2009). Nox4 est également impliquée dans la résistance à l'apoptose des cellules pancréatiques (Vaquero et al. 2004; Lee et al. 2007).

## V. L'arthrose

L'arthrose est une pathologie ostéo-articulaire très fréquente touchant le cartilage articulaire. Sa prévalence est proche de 60% dans la population âgée en France ce qui entraîne des conséquences fonctionnelles et socio-économiques majeures. Sa physiopathologie est complexe car de nombreux facteurs (mécaniques, humoraux, cytokiniques, cliniques) interviennent dans son développement.

En 1994, l'OMS, (Organisation Mondiale de la Santé) et « l'American Academy of Orthopaedic Surgeons » ont proposé une définition officielle de cette pathologie : « L'arthrose est la résultante des phénomènes mécaniques et biologiques qui déstabilisent l'équilibre entre la synthèse et la dégradation du cartilage et de l'os sous-chondral. Ce déséquilibre peut être initié par de multiples facteurs : génétiques, de croissances, métaboliques et traumatiques. L'arthrose touche tous les tissus de l'articulation diarthrodiale et se manifeste par des modifications morphologiques, biochimiques, moléculaires et biomécaniques des cellules et de la matrice cartilagineuse conduisant à un ramollissement, une fissuration, une ulcération et une perte du cartilage articulaire, une sclérose de l'os sous-chondral avec production d'ostéophytes et de kystes sous-chondraux. Quand elle devient

symptomatique, l'arthrose entraîne douleur et raideur articulaires, un éventuel épanchement articulaire avec des degrés variables d'inflammation locale. »

Sur le plan biochimique, l'arthrose se caractérise par une dégradation de la matrice extracellulaire de l'articulation entraînant une perte des propriétés biomécaniques du cartilage et une réduction de la densité cellulaire due à une apoptose des chondrocytes.

L'arthrose a pour origine plusieurs facteurs connus. Parmi eux, la génétique, l'âge, l'ethnie, le surpoids et le sexe féminin de l'individu sont prépondérants.

### ***A. Le cartilage articulaire***

#### **1. Généralités**

Le cartilage articulaire est un tissu conjonctif translucide (nommé également cartilage hyalin), ferme, élastique et légèrement dépressible situé aux extrémités des os longs. Il a pour rôle d'amortir les chocs lors de mouvements et d'assurer le glissement des surfaces osseuses grâce à un coefficient de friction extrêmement faible.

Le cartilage articulaire est un tissu hautement différencié, structuré par un réseau de collagène très organisé au sein duquel vont se loger les protéoglycanes et les protéines non collagéniques. Il est avasculaire, non innervé et dépourvu de circulation lymphatique. La synthèse et le catabolisme de ses constituants sont assurés par le chondrocyte, seule cellule résidente au sein du cartilage articulaire. Le chondrocyte est ainsi responsable de la régulation de l'homéostasie d'une matrice extracellulaire très dense et du maintien de ses propriétés biomécaniques. Il se nourrit par imbibition à partir du liquide synovial et de l'os sous-chondral desquels sont puisés les nutriments. De par sa faible irrigation, le cartilage articulaire est un tissu hypoxique. La pression partielle en oxygène y varie de 7% environ dans la couche la plus superficielle à près de 1% dans la couche profonde (Strobel et al. 2010). En conséquence, le métabolisme énergétique du chondrocyte est essentiellement basé sur la glycolyse. Le cartilage articulaire est très peu renouvelé à l'âge adulte. En effet, le nombre de chondrocyte décroît des l'âge de 20 ans, de plus, le renouvellement des macromolécules composant la matrice extracellulaire du chondrocyte est très lent. Ainsi le collagène de type II n'est presque pas renouvelé et la demi-vie des agrécane est d'environ 20 ans (Hardingham 2012). L'épaisseur du cartilage est fonction de la charge qu'il doit supporter, ainsi, les pressions les plus importantes sont exercées sur les zones les plus épaisses et il est à noter que la pression hydrostatique résultante joue un rôle fondamental dans sa nutrition (Vignon et al. 1980).

## 2. Structure et organisation du tissu cartilagineux

De la surface articulaire, vers l'os sous chondral, le cartilage articulaire est composé de quatre couches distinctes sur le plan histologique. La surface articulaire est acellulaire, elle est essentiellement composée de fibrilles de collagène. La composition, l'organisation et les propriétés biomécaniques du tissu cartilagineux ainsi que la morphologie adoptée par le chondrocyte varie en fonction de la profondeur du cartilage (figure 15).

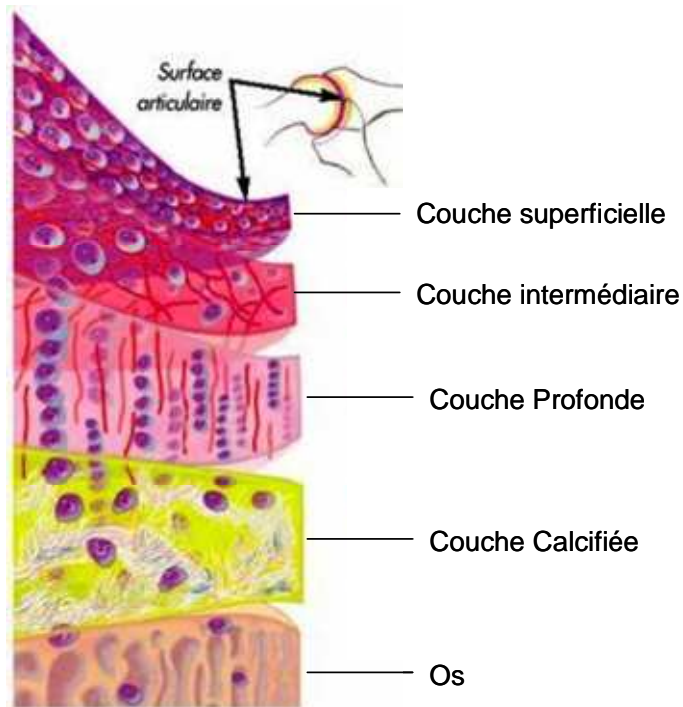

**Figure 15: Schématisation des quatre couches structurant le cartilage articulaire.** Figure issue du site [www.labrha.com](http://www.labrha.com).

La zone superficielle, représente 5 à 10% de la hauteur totale du cartilage et sa fonction principale constitue le glissement entre les pièces articulaires. En contact avec le liquide synovial, elle est composée de chondrocytes et de fibres de collagène de type I et III orientés parallèlement à la surface articulaire. Cette architecture apporte une grande résistance aux forces de compressions et permet la diffusion sélective des petites molécules et cytokines. Les chondrocytes ont une physionomie « aplatie », ils sont relativement nombreux mais métaboliquement peu actifs.

La zone intermédiaire, est riche en protéoglycanes, son épaisseur représente 40 à 45% de l'épaisseur totale du cartilage. Les chondrocytes sont arrondis, riches en organelles de synthèse et y sont plus actifs que dans la couche superficielle. Ils synthétisent du collagène de type II, IX et XI orienté obliquement à la surface.

La couche profonde est la plus riche en protéoglycanes et la plus pauvre en eau, les chondrocytes, abondamment présents, sont les plus actifs et présentent un aspect prolifératif

dans la partie supérieure (en colonne). Les chondrocytes synthétisent du collagène de type II, IX et XI, orienté perpendiculairement à la surface articulaire. Cette couche représente 40 à 45% de l'épaisseur totale du cartilage.

La couche calcifiée représentant environ 5 à 10% de l'épaisseur totale du cartilage constitue l'interface entre le cartilage et l'os sous chondral. Elle est séparée de la couche profonde par un front de minéralisation ou «*tidemark*» caractérisé par la présence de cristaux d'hydroxyapatite et d'amas calciques. Les chondrocytes présentent un phénotype hypertrophique et synthétisent du collagène de type X. Au contact des fibres de collagène, ces cristaux permettent un enchevêtrement extrêmement dense des fibres.

## ***B. Composition du cartilage articulaire***

### **1. Le chondrocyte**

#### **a) Généralités**

Le chondrocyte provient de la condensation et de la différenciation des cellules souches mésenchymateuses (Kronenberg 2003) ; il est l'unique type cellulaire présent au sein du cartilage articulaire et possède l'ensemble du répertoire génétique lui permettant de synthétiser les différents constituants de sa matrice. La synthèse des métalloprotéases matricielles (MMP) lui est également imputée. Dans des conditions physiologiques normales, il y'a un équilibre entre la synthèse des constituants de la matrice extracellulaire (MEC) et l'activité des MMPs, impliquées dans leur dégradation. Le chondrocyte est donc la cellule responsable de l'homéostasie de la matrice extracellulaire cartilagineuse. Il interagit directement avec celle-ci par l'intermédiaire du récepteur à l'acide hyaluronique (CD44), de l'annexine V liant le collagène de type II ou encore des intégrines (van der Kraan et al. 2002).

L'organisation structurale des intégrines, glycoprotéines transmembranaires associées sous forme d'hétérodimère (sous unité  $\alpha$  et  $\beta$ ), leur confère un rôle de mécanorécepteur (Blain 2009). Ces glycoprotéines sont d'une part associées spécifiquement aux composantes de la MEC et d'autre part au cytosquelette des chondrocytes de telle sorte qu'un stimulus extracellulaire soit directement retranscrit, au chondrocyte. Ainsi, une variation dans la composition qualitative ou quantitative de la matrice extracellulaire ou des contraintes mécaniques anormales sur la MEC auront un impact direct sur la signalisation du chondrocyte. En d'autres termes, son phénotype lui est dicté par la matrice extracellulaire,

qui conditionne en retour le maintien de sa propre homéostasie. On note par exemple que les chondrocytes issus d'explants de cartilage cultivés en 2D perdent très rapidement leur phénotype chondrocytaire. L'expression du collagène de type II, marqueur phénotypique diminue par exemple de près de 100 fois après deux passages en culture bidimensionnelle classique (Hardingham, 2012). Cette dédifférenciation est inhibée par la cytochalasine, un agent figeant le cytosquelette et bloquant toute information transmise par les intégrines. Les chondrocytes sont dépourvus de capacités de migration et leur prolifération est lente voir inexistante dans le cartilage normal (Chevalier 2003). Ils consomment toutefois une quantité importante de glucose qu'ils transforment en glucosamine, nécessaire à la synthèse des protéoglycanes.

Malgré leur rôle fondamental dans l'architecture du cartilage articulaire, le volume des chondrocytes n'excède pas 1% du volume total du cartilage. Cette densité est variable en fonction de la profondeur de la couche cartilagineuse. Ainsi la majeure partie du volume du cartilage articulaire est occupé par les constituants de la matrice extracellulaire.

### **b) Les ROS dans le chondrocyte**

#### ***(1) Les sources de ROS dans le chondrocyte***

Les chondrocytes sont capables de produire l'anion superoxyde, à l'origine des autres ROS (Henrotin et al. 2005). Ils produisent également le radical NO° par l'intermédiaire de la NO synthase inductible, qui par combinaison avec l'anion superoxyde, va donner le peroxyde nitrite (Yasuhara et al. 2005; Abramson 2008). L'acide hypochlorique généré par la myéloperoxydase, ainsi que le radical hydroxyle, issu de la réaction de Harber-Weiss seraient également produits par les chondrocytes (Tiku et al. 1998; Henrotin et al. 2005).

A la fin des années 1990, l'équipe de Mary Goldring a suggéré la présence d'une isoforme de la NADPH oxydase phagocytaire active dans la lignée de chondrocytes humain C-20/A4 ainsi que dans les chondrocytes porcins (Hiran et al. 1997; Moulton et al. 1997). Des travaux plus récents ont effectivement montré la présence des transcrits codant pour Nox2 et Nox4 dans les lignées de chondrocytes humains C-20/A4, C-28/I2 et T/C-28a2 (Goldring 2004; Grange et al. 2006). Le transcrit codant pour Nox5 serait également présent dans les lignées C-28/I2 et T/C-28a2. Dans les cellules chondrocytaires murines de la lignée ATDC5 les Nox 1, 2 et 4 seraient exprimées, en revanche la caractérisation des Nox présentes dans les chondrocytes primaires humains manque encore actuellement (Kim et al. 2010).

La présence de mitochondries à également été décrite dans les chondrocytes. Mais l'inhibition de l'ATP synthase par l'oligomycine n'entraîne pas de diminution significative de la

concentration en ATP, démontrant que la phosphorylation oxydative ne joue qu'un rôle mineur dans la production énergétique des chondrocytes (Martin et al. 2013). Néanmoins, selon les auteurs de cette étude, les mitochondries génèreraient un niveau basal de ROS nécessaire à l'équilibre redox du chondrocyte et au maintien de la production d'ATP par la glycolyse.

Il n'est enfin pas à exclure que d'autres systèmes, tels que la NOS ou la xanthine oxydase puissent contribuer à la génération des ROS par le chondrocyte. Dans ce contexte, il est à rappeler que l'oxydation de la tétrahydrobioptérine par les ROS, cofacteur essentiel au fonctionnement de la NOS, conduit à une production d'anion superoxyde (Li and Forstermann 2013).

### ***(2) Rôle physiologique des ROS produits par le chondrocyte***

Le rôle physiologique des ROS produits par le chondrocyte est encore débattu et très peu d'études ont été publiées sur le sujet. Des travaux effectués au sein de notre laboratoire sur les chondrocytes humains de la lignée C-20/A4 ont montré l'implication des ROS générés par Nox4, dans la synthèse de la collagénase MMP-1 (Grange et al. 2006). Sur le plan physiologique, les MMP jouent un rôle dans la dégradation des constituants de la MEC, permettant son remodelage ou son renouvellement. Cette activité protéolytique est nécessaire au développement ostéoarticulaire (Aiken and Khokha 2010). En revanche, leur surexpression est l'une des caractéristiques majeures conduisant au catabolisme matriciel observé dans l'arthrose.

Les ROS pourraient également guider le processus de chondrogenèse. Il est connu que la lignée ATDC5, cellules d'origine mésenchymateuse provenant d'un tératocarcinome murin, peut se différencier en cellules chondrocytaires. Dans cette lignée les ROS interviendraient dans la différenciation chondrogénique induite par l'insuline (Kim et al. 2010). Les ROS seraient également impliqués dans la différenciation hypertrophique des chondrocytes au cours de l'ossification endochondrale, processus par lequel le cartilage de croissance laisse place à l'os au cours de la croissance des organismes vertébrés (Drissi et al. 2005; Morita et al. 2007). Dans ce processus, les chondrocytes hypertrophiques, synthétisant la phosphatase alcaline, amorcent la minéralisation de la partie profonde du cartilage de croissance puis meurent par apoptose pour laisser place aux ostéoblastes.



Cette différenciation hypertrophique des chondrocytes a également été observée au cours de la progression arthrosique, se traduisant par un défaut de réparation ainsi qu'une minéralisation pathologique du cartilage articulaire (Tchetina et al. 2006).

### ***(3) Initiation et propagation du signal redox dans les chondrocytes***

La littérature rapporte plusieurs stimuli connus pour activer la production des ROS par les chondrocytes. L'IL-1 $\beta$  et le TNF- $\alpha$ , les LDL oxydées, certains produits de dégradation de la MEC tels que les fragments de fibronectine ou encore le LPS issu de la dégradation de la paroi des germes Gram négatif conduisent en effet à une production de ROS par le chondrocyte (Tiku et al. 1999; Nishimura et al. 2004; Del Carlo et al. 2007).

Les ROS activent les MAPK. L'IL-1 $\beta$  et le TNF- $\alpha$  activent les JNK dans les chondrocytes bovins. Les mêmes effets sont observés par l'utilisation directe de peroxyde d'hydrogène (Lo et al. 1996). La voie JNK, activée par le concours du NO et de l'anion superoxyde serait à l'origine de l'apoptose des chondrocytes bovins induite par l'IL-1 $\beta$  (Clancy et al. 2001). Les ROS activent également les voies ERK et p38MAPK (Henrotin et al. 2003). En 2005, l'équipe de Martin a montré un effet comparable de l'IL-1 $\beta$  et de l'H<sub>2</sub>O<sub>2</sub> sur l'activation du facteur de transcription AP-1, entraînant une augmentation de la transcription des MMP1 et 3 ainsi qu'une diminution de l'expression du collagène de type II et de la protéine core des aggrecanes sur des chondrocytes bovins (Martin et al. 2005). De manière coïncidente, l'activation du NF $\kappa$ B et de AP-1 consécutive à la signalisation déclenchée par l'IL-1 $\beta$  est réprimée par le DPI, un inhibiteur des flavoprotéines (Mendes et al. 2001). Il est à noter que ces deux facteurs de transcription dépendants du statut redox de la cellule sont à l'origine de la transcription de la plupart des métalloprotéases matricielles conduisant au catabolisme cartilagineux. Ils régulent notamment la transcription de la collagénase-1 (MMP-1) mais aussi de la collagénase-3 (MMP-13) (Kheradmand et al. 1998; Lo et al. 1998; Mengshol et al. 2000; Liacini et al. 2002; Ahmad et al. 2011).

## **2. La MEC du chondrocyte**

L'espace extracellulaire, responsable des propriétés physiques et biomécaniques du cartilage articulaire, occupe la plus grande partie de son volume. Ce volume est essentiellement conféré par l'eau (65 à 80% du poids du tissu), retenue par les protéoglycanes, molécules de nature polysaccharidiques extrêmement hydrophiles et enchevêtrées dans le réseau collagénique. Le collagène constitue quant à lui la majeure partie de la masse protéique de la MEC.

### a) Les protéoglycans

Les protéoglycans sont constitués d'une partie protéique sur laquelle sont fixées des chaînes de glycosaminoglycans. Ces derniers portent un ou plusieurs groupements sulfates, à l'origine des propriétés hydrophiles des protéoglycans (Figure 16A). Les agrécans représentent en poids sec les principaux protéoglycans de la matrice cartilagineuse, ils sont formés d'une protéine porteuse (core), sur laquelle sont ancrées les chaînes de kératane-sulfate et de chondroïtine-sulfate (Rannou 2010). Ils peuvent être assemblés sous forme de macro-agrégats dont la charpente est assurée par un polymère d'acide hyaluronique (Figure 16B). Gorgés d'eau, retenue par les glycosaminoglycans, ces macro-agrégats permettent au cartilage de répondre aux sollicitations mécaniques.

D'autres protéoglycans, de tailles plus modestes tels que la décorine, le biglycane ou la fibromoduline sont impliqués dans la formation et la coordination des fibres de collagène. En périphérie du chondrocyte, certains protéoglycans modulent par crinopexie l'activité et la biodisponibilité des protéases et cytokines.

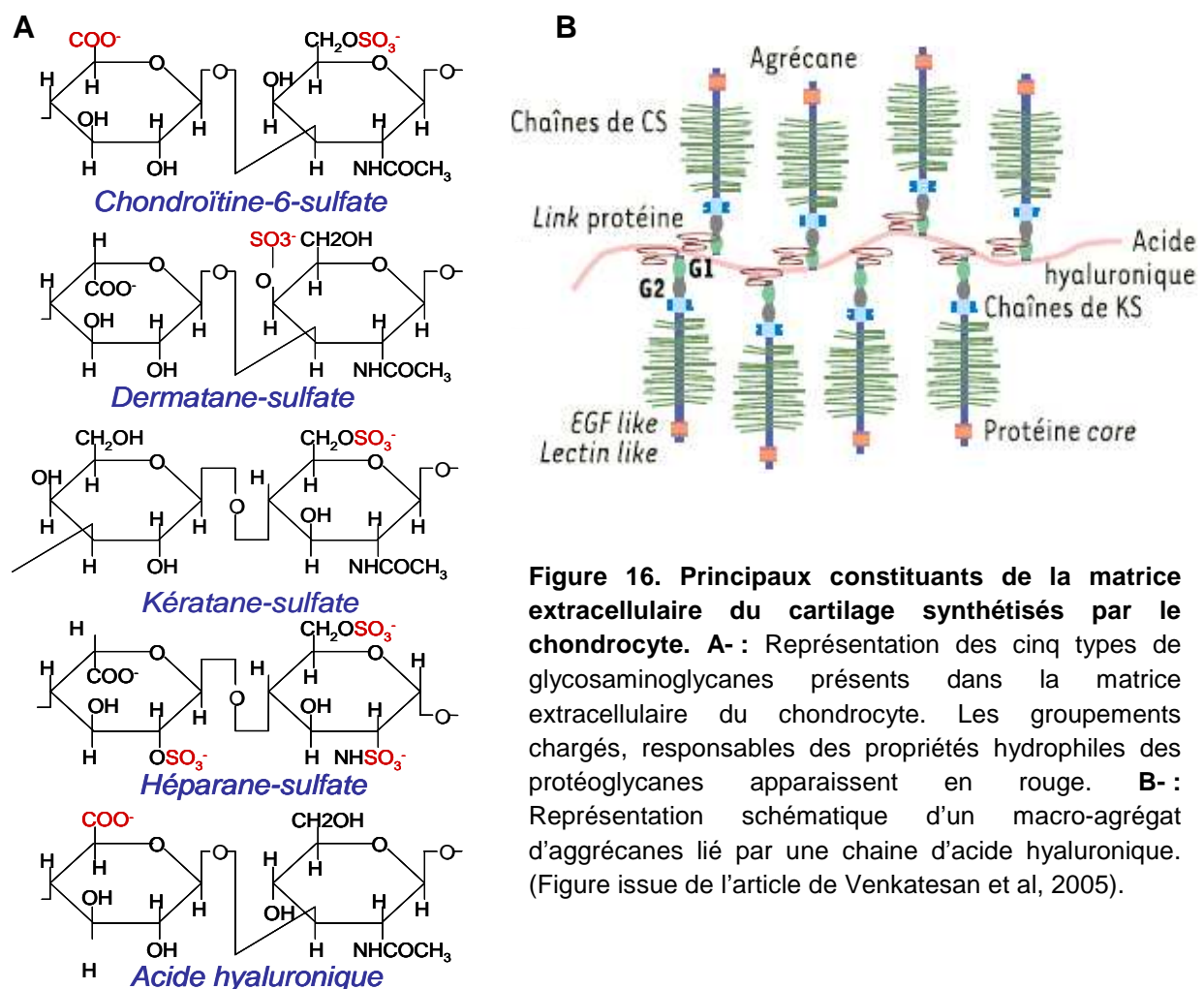

## b) Collagène et autres protéines de la MEC

L'essentiel du réseau structurant le cartilage articulaire est composé de collagène de type II, IX et XI (Rannou 2010). Le collagène de type VI est également retrouvé dans l'environnement immédiat du chondrocyte où il lie le récepteur à l'acide hyaluronique (CD44), les intégrines et l'annexine V, par l'intermédiaire du collagène de type II (Poole et al. 1992).

Le collagène de type II représente près de 95% du collagène total de la MEC chondrocytaire. Dans une association homotrimérique de chaînes  $\alpha 1$ , il permet la résistance aux forces d'étirement et de compression. Le collagène XI constitue une armature au sein du collagène II, le collagène IX, au contraire, est situé à la surface du collagène II et assure des liaisons avec les protéoglycanes (Figure 17).

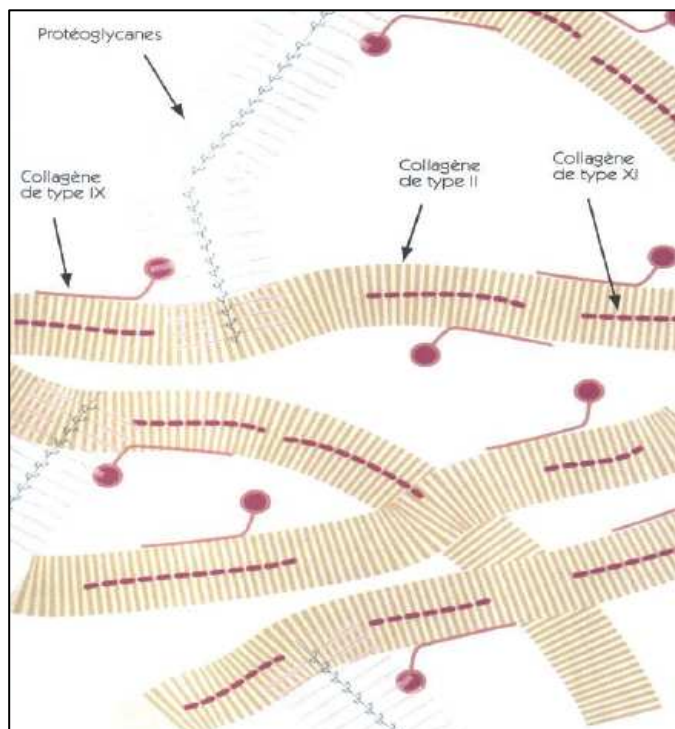

**Figure 17. Réseau collagénique constituant la MEC chondrocytaire.** Voir le texte pour explications. D'après « Atlas de l'arthrose » laboratoire NEGMA M. Lequesne & CJ Menkès, 1995.

Au cours de la différenciation hypertrophique, les chondrocytes se mettent à synthétiser du collagène de type X. Au contraire, les chondrocytes dédifférenciés produisent du collagène de type I, III et VI, au dépens du collagène de type II (Rannou et al, 2010). Le collagène de type I est également présent à la surface du cartilage. D'autres protéines, non collagéniques, telles que l'annexine V, la fibronectine ou la protéine COMP sont impliquées dans les interactions chondrocyte-MEC ou interviennent dans l'organisation du réseau macromoléculaire.

### 3. Les métalloprotéases matricielles

Les métalloprotéases matricielles (MMP) sont des protéases à zinc catalysant la dégradation d'au moins un constituant de la MEC. La somme des activités catalytiques des 25 MMP exprimées chez l'homme permet de dégrader intégralement les protéines de la MEC et de la membrane basale à pH physiologique (Nagase et al. 1999). Les MMP interviennent dans la morphogénèse, la cicatrisation, le remodelage tissulaire ou encore l'angiogénèse. De par leur activité protéolytique ces enzymes jouent aussi un rôle clé dans la signalisation de cytokines ou facteurs de croissance tels que le TNF- $\alpha$ , l'Interleukine-6, ou encore l'EGF. De manière plus générale, les MMP sont largement impliquées dans le processus inflammatoire (Khokha et al. 2013). Le rapport MMP/ TIMP (« tissue inhibitors of metalloproteinases », leurs inhibiteurs physiologiques) est en revanche souvent dérégulé dans les pathologies tels que les cancers, les ulcères, ou les pathologies ostéoarticulaires (Nagase et al. 2006). Dans l'arthrose, l'activité non contenue de certaines MMP synthétisées par le chondrocyte conduit à une altération des propriétés biomécaniques du cartilage articulaire.

Les MMP possèdent une organisation en domaines comparables avec un pré-domaine comportant le peptide signal permettant leur adressage (environ 20 résidus aa), un pro-domaine maintenant les metzincines sous forme latente (zymogène) par la présence d'un résidu cystéine interagissant avec l'atome de zinc (environ 80 aa) et un domaine catalytique d'environ 110 aa (Tocchi and Parks 2013). Une dernière région, longue de 200 aa environ, est impliquée dans la reconnaissance du substrat et la fixation des TIMP. Comme les MMP, les adamalysines (ADAM) et les ADAMTS appartiennent à la famille des metzincines. Ces dernières diffèrent seulement des MMP par leur partie C-terminale portant un domaine « disintegrin ». Les ADAMTS ont en plus des domaines d'homologie avec la thrombospondine tandis que les MMP possèdent un domaine d'homologie avec l'hémopexine (Murphy and Lee 2005). Certaines MMP (les MT-MMP) et les ADAM sont des protéases localisées à la membrane plasmique ; leur activité catalytique se limite ainsi à l'environnement immédiat de la cellule. Les autres protéases de la famille des metzincines sont sécrétées dans la MEC.

Bien que leur structure primaire soit différente, la conformation tertiaire des metzincines est globalement conservée (Murphy and Lee 2005). Leur activité est régulée par le clivage de leur pro-domaine, libérant le site catalytique et par l'intermédiaire des TIMP, leurs inhibiteurs physiologiques (Figure 18).

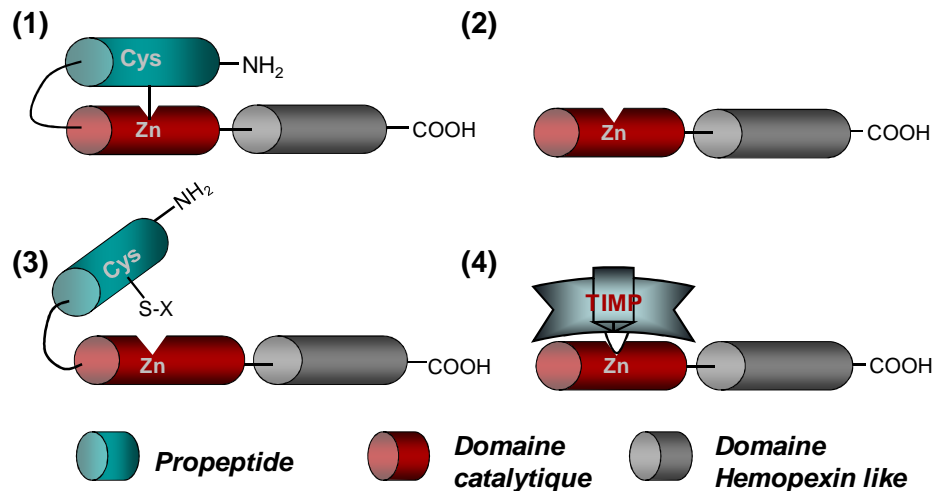

**Figure 18 : Régulation de l'activité des MMP.** (1) Les trois familles de metzincines (MMPs, ADAMs et ADAMTS) ont en commun un site catalytique impliquant un atome de zinc obstrué sous leur forme latente par le pro-domaine. La libération du site catalytique des MMP se fait soit par clivage protéolytique du pro-peptide par d'autres protéases (2) soit par activation chimique (3) (*in vivo* : les ROS tels que le peroxy-nitrite ou l'acide hypochlorique ; *in vitro* par les composés organomercuriels, les dénaturants protéiques ou encore par la chaleur). Enfin, une fois actives, les MMPs peuvent être inhibées par les TIMP (4).

Quatre TIMP sont exprimés chez l'homme. Chacun des TIMP peut obstruer le site catalytique de l'ensemble des MMP par son domaine N-terminal. Il existe cependant une certaine spécificité de chaque inhibiteur. Par exemple, la gélatinase MMP-2 est préférentiellement inhibée par les TIMP 2-4 alors que la gélatinase MMP-9 a plus d'affinité pour le TIMP-1. Il est à noter que les mécanismes d'activation des MT-MMP est différent. Elles sont activées de façon intracellulaire par la furine et exprimées sous leur forme active à la membrane plasmique. Ce mode d'activation est également valable pour la stromélysine 3 (MMP-11) (Woessner 2000). A l'exception de la gélatinase MMP-2, dont l'expression est constitutive, la transcription des MMP est largement dépendante des séquences AP-1 (site de fixation du dimère c-fos / c-jun) et de la fixation au NFκB. Ainsi, les ROS pourraient entraîner la transcription des MMP par l'intermédiaire de l'activation redox de ces facteurs de transcription. En effet, la transcription des MMP est induite par l'interleukine-1β ou le TNF-α, entraînant également la production de ROS par les chondrocytes (Goldring et al. 2008). Dans la littérature, il a déjà été rapporté que l'expression des MMP-1, 2, 3 et 9 est régulée par les ROS (Martin et al. 2005; Grange et al. 2006; Meng et al. 2008).

Les chondrocytes expriment les collagénases MMP-1, 3, 8 et 13. Ils expriment également la gélatinase MMP-9 et les ADAMTS-4 et 5, intervenant dans le clivage des agrécanes et dont le rôle dans la protéolyse matricielle est manifeste (Glasson et al. 2005). Ces dernières années, le développement d'inhibiteurs des MMP a suscité un engouement important sur le plan thérapeutique (Gargiulo et al. 2013). Mais, leur invalidation dans des modèles murins

ont démontré que les MMP jouent un rôle indispensable dans le développement ostéoarticulaire (Aiken and Khokha 2010). Par exemple, la couche de cartilage calcifiée des souris invalidées pour les gènes codant pour les MMP-9 et MMP-13, constituée des chondrocytes hypertrophiques, est significativement plus étendue que celle des souris sauvages. Ainsi, pour cibler les pathologies incriminant un rapport MMP / TIMP élevé, il semblerait falloir agir sur les acteurs intervenant en amont de la synthèse des MMP.

### ***C. Du cartilage sain à l'arthrose***

Sur le plan fonctionnel, l'obésité, la surcharge articulaire ou la sur-mobilisation sont des causes pouvant expliquer la survenue de l'arthrose. Mais, de façon non exhaustive, l'arthrose peut aussi avoir une origine génétique, traumatique, métabolique ou encore hormonale (Chevalier 2003; Dumond et al. 2003). L'arthrose n'est plus seulement considérée comme une usure d'origine mécanique du cartilage mais plutôt comme une pathologie micro-inflammatoire (Rannou 2010; Berenbaum 2013). Il est maintenant reconnu que les contraintes mécaniques s'exerçant sur le chondrocyte entraînent une activation du NFκB et la production de médiateurs de l'inflammation par les mêmes voies de transduction que celles initiées par l'IL-1β (Goldring et al. 2008; Nam et al. 2009). Le chondrocyte est donc capable de retranscrire un signal mécanique en signal biochimique, conduisant à la production d'IL-1β.

#### **1. L'interleukine-1β**

La synthèse de l'IL-1β peut être assurée de manière autocrine ou paracrine par le chondrocyte (Poole 2001). Cette synthèse est consécutive à une hyperpression sur un cartilage normal (arthroses mécaniques) ou à une pression normale s'exerçant sur un cartilage fragile (arthroses structurales). L'IL-1β a une double influence sur l'équilibre matriciel : elle accroît d'une part, la synthèse des métalloprotéases matricielles (MMP) et des adamalysines (ADAMTS) et altère d'autre part le métabolisme énergétique chondrocytaire et ses capacités de synthèse (Goldring et al. 2008; Kim et al. 2009; Rannou 2010). Le signal transduit par L'IL-1β est dépendant de messagers secondaires tels que les ROS, le NO produit par la NOS inductible, ou la prostaglandine E2 et entraîne l'activation des voies JNK, p38 MAPK, aboutissant à la translocation du NFκB et du facteur AP-1 au sein du compartiment nucléaire (Megias et al. 2009; Schmidt et al. 2009).

L'IL-1β est un inducteur de l'apoptose des chondrocytes (Heraud et al. 2000; Yasuhara et al. 2005). Elle entraîne une production de ROS, impliqués dans la différenciation hypertrophique des chondrocytes qui synthétisent et libèrent dans la MEC du collagène de type X, la collagénase MMP-13 ainsi que la phosphatase alcaline, tous trois considérés comme ses

## Introduction

marqueurs phénotypiques. La phosphatase alcaline participe à la minéralisation du cartilage articulaire par la libération de phosphate inorganique qui se lie au calcium pour former des cristaux d'hydroxyapatite. Dans le même temps, les chondrocytes hypertrophiques dégénèrent et meurent par apoptose (Drissi et al. 2005). La rupture de l'homéostasie de la MEC chondrocytaire entraîne enfin une altération de sa composition qualitative, à l'origine d'une dédifférenciation du chondrocyte. Celle-ci se manifeste par une augmentation de la production de collagène I, III et VI en lieu et place du collagène II (Rannou 2010).

En somme, la synthèse d'IL-1 $\beta$  conduit à :

- 1- Une augmentation de la production de MMP et d'ADAMTS
- 2- Une réduction des capacités anaboliques des chondrocytes
- 3- Une apoptose des chondrocytes arthrosiques
- 4- Un phénotype chondrocytaire aberrant

L'IL-1 $\beta$  est donc la principale cytokine impliquée dans la rupture de l'homéostasie matricielle du chondrocyte conduisant à l'arthrose. Une partie significative de ses effets biologiques pourrait être relayée par les ROS.

## 2. Ethiopathogénie de l'arthrose et ROS

Les ROS sont incriminés dans de nombreux mécanismes dégénératifs ou liés à l'âge. Il est aujourd'hui bien caractérisé que la maladie de Parkinson, la maladie d'Alzheimer ou les mécanismes du vieillissement dans leur globalité sont associés à une augmentation des marqueurs du stress oxydant (Zhang et al. 2000; Qin et al. 2006; Krause 2007). L'arthrose est une pathologie dégénérative liée à l'âge dont l'éthiopathogénie pourrait largement dépendre des ROS. En effet, il a été rapporté que les dérivés réactifs de l'oxygène (ROS) conduisent à la sénescence des chondrocytes (Yudoh et al. 2005b) et à une augmentation de l'expression des métalloprotéases matricielles à l'origine de la dégénérescence du cartilage (Gowen et al. 1984). En réponse à l'IL-1 $\beta$ , les chondrocytes articulaires vont activement produire des espèces réactives de l'oxygène. Ces ROS pourront directement promouvoir le catabolisme articulaire par l'oxydation non spécifique des constituants de la matrice extracellulaire et du chondrocyte ainsi que par l'activation des métalloprotéases matricielles. Ils agissent également de manière indirecte comme messagers secondaires dans la signalisation cellulaire. Les ROS ont une capacité d'interaction et un impact biochimique potentiel à différents niveaux d'organisation des constituants de l'articulation (Henrotin et al. 2005).

### **a) ROS, hypoxie et homéostasie matricielle**

Du fait de l'hypoxie régnant au sein de la matrice cartilagineuse, les facteurs de transcription HIF1 $\alpha$  et HIF2 $\alpha$ , senseurs de la pression partielle en oxygène, pourraient jouer un rôle dans l'homéostasie matricielle du chondrocyte. L'hypoxie et les ROS répriment de façon identique la dégradation des facteurs HIF. En revanche, la littérature récente suggère que HIF1 $\alpha$  et HIF2 $\alpha$  pourraient avoir des effets antagonistes au regard de l'homéostasie matricielle. Sur une même articulation, HIF1 $\alpha$  est par exemple surexprimé dans les chondrocytes issus de parties dégénérées du cartilage (chondrocytes arthrosiques) comparées aux chondrocytes issus des parties saines (Yudoh et al. 2005a). Dans cette étude, les auteurs ont également montré une stabilisation de HIF1 $\alpha$  après traitement des chondrocytes par IL-1 $\beta$  ou H<sub>2</sub>O<sub>2</sub> en conditions d'hypoxie (6% en O<sub>2</sub>). En fait, l'inhibition de HIF1 $\alpha$  dans les chondrocytes arthrosiques entraîne une diminution de leur activité glycolytique, de la synthèse des glycosaminoglycanes et une augmentation de l'apoptose. Outre sa fonction d'adaptation à l'hypoxie, HIF1 $\alpha$  pourrait donc agir en réponse au stress oxydant par le maintien des capacités de synthèse du chondrocyte (Pfander et al. 2006).

A l'inverse, HIF2 $\alpha$  pourrait jouer un rôle catabolique et pro-inflammatoire au sein du cartilage articulaire. Récemment Yang et ses collaborateurs ont mis en évidence le rôle de HIF2 $\alpha$  dans l'expression de MMPs et de prostaglandine E2 en réponse à l'IL-1 $\beta$  (Yang et al. 2010). De plus, la délétion du gène *Epas1*, codant pour HIF2 $\alpha$ , dans un modèle murin protège les animaux de l'arthrose survenant après méniscectomie. Ces résultats ne semblent pourtant pas totalement extrapolables au cartilage humain et sont controversés par plusieurs études (Murphy 2010; Clerigues et al. 2013).

Même si leur fonction précise reste à clarifier, les facteurs de transcription HIF pourraient ainsi jouer un rôle important dans la régulation de l'homéostasie matricielle du chondrocyte. Ils pourraient enfin réguler la production des ROS en entraînant la transcription de Nox4 (Diebold et al. 2010).

### **b) ROS et dégénérescence des fonctions chondrocytaires**

Les faibles capacités de renouvellement des chondrocytes à l'âge adulte, placent l'apoptose ou la sénescence comme une cause majeure conduisant à la rupture de l'homéostasie matricielle cartilagineuse.

#### **(1) ROS et apoptose chondrocytaire**

Le monoxyde d'azote à long terme a été considéré comme un inducteur majeur d'apoptose dans les chondrocytes (Pelletier et al. 2001). Son rôle apparaît aujourd'hui plus versatile et



## Introduction

pourrait dépendre de la présence d'autres ROS (Del Carlo and Loeser 2002). Ainsi, la combinaison du NO avec l'anion superoxyde est à l'origine de l'apoptose de la lignée chondrocytaire murine ATDC5 (Yasuhara et al. 2005). Ces résultats sont réversibles en présence du DPI, un inhibiteur des flavoprotéines utilisé comme inhibiteur des NADPH oxydases. En réalité, l'activation de Nox2 par l'IL-1 $\beta$  entraîne l'apoptose de la lignée ATDC5, de manière réversible en présence de N-acétyl-cystéine ou d'un inhibiteur du NF $\kappa$ B (Yoshimura et al. 2011). De même, les chondrocyte murins p47<sup>phox</sup>-/- sont protégés de l'apoptose induite par un modèle d'arthrite auto-immune (van Lent et al. 2005). Il apparaît donc que de la quantité d'anion superoxyde présente pourrait dépendre la quantité de peroxyde formée par combinaison avec le NO et le basculement ou non du chondrocyte vers l'apoptose.

Dans la lignée de chondrocyte humains C-20/A4, Nox2 est inactive, en l'absence de p47<sup>phox</sup> (Grange et al. 2006). Dans cette lignée, la surexpression de Nox4 conduit à la fragmentation de l'ADN après traitement par l'IL-1 $\beta$ , de manière réversible après surexpression de l'hème oxygénase-1 (Rousset et al. 2013). Coustry et ses collaborateurs ont également montré une surexpression de près de 100 fois de l'ARNm de Nox4 dans des cellules chondrocytaires de rat de la lignée RCS (Rat Chondrosarcoma Cells), reproduisant un modèle de pseudoachondroplasie (Coustry et al. 2012). Dans cette pathologie, caractérisée par une érosion articulaire et une arthrose précoce, la surexpression du transcrite Nox4 coïncide avec l'apparition d'un stress réticulaire et le déclenchement de la nécroptose des chondrocytes, un processus à mi chemin entre l'apoptose et la nécrose.

Il est enfin à noter que même si les ROS en excès sont délétères pour les fonctions que doit remplir le chondrocyte, un niveau basal de ROS semble nécessaire à leur survie et leur différenciation (Martin et al. 2013). La déplétion de l'ARNm codant pour Nox2 ou Nox4 par une approche de siRNA entraîne ainsi l'apoptose de la lignée chondrocytaire ATDC5 (Kim et al. 2010).

### **(2) ROS, sénescence et vieillissement du chondrocyte**

Bien que les chondrocytes puissent se diviser dans certaines circonstances, leur renouvellement est très lent, voir inexistant dans le cartilage articulaire adulte (Henrotin et al. 2005). Ils doivent donc, en dépit des attaques radicalaires et des sur-sollicitations mécaniques, maintenir leurs fonctions, tout au long de la vie du cartilage articulaire. Ainsi, s'ils ne sont pas sujet à la sénescence dite « répllicative », dépendante des télomérases, les modifications biochimiques induites par les ROS sur les lipides, les protéines ou les acides nucléiques s'accumulent dans le chondrocyte « adulte » et le conduisent lentement vers la

sénescence. Par exemple, l'anion superoxyde et le NO, produits en réponse au TNF- $\alpha$  ou à l'IL-1 $\beta$  conduisent à des dommages mitochondriaux, entraînant une diminution de la synthèse d'ATP et un ralentissement du métabolisme des chondrocytes, aboutissant à leur apoptose (Kim et al. 2009). Ces effets sont prévenus par surexpression mitochondriale de la 8-oxoguanine DNA glycosylase (hOGG1), une protéine impliquée dans la réparation de l'ADN.

### **c) ROS et catabolisme matriciel**

Les altérations biochimiques portées par les ROS aux molécules composant la MEC ainsi que la signalisation redox qu'ils propagent au travers du chondrocyte vont directement ou non conduire à une perte matricielle quantitative et qualitative.

#### **(1) Oxydation non spécifique**

Les ROS participent directement à la dégradation des collagènes et des aggrécans de la matrice cartilagineuse (Tiku et al. 1999). Les ROS générés par le système xanthine-xanthine oxydase sont par exemple capables de dépolymériser l'acide hyaluronique (Yamazaki et al. 2003). La collagénase du neutrophile, MMP-8 est également activable directement par l'acide hypochloreux (Burkhardt et al. 1986). Les attaques non spécifiques des ROS affectent aussi les capacités anaboliques du chondrocyte. L'oxydation de l'ADN mitochondrial par les ROS entraîne un dysfonctionnement de la chaîne respiratoire des mitochondries conduisant à une diminution de la production d'ATP diminuant les capacités du chondrocyte à produire des protéoglycanes et du collagène (Johnson et al. 2000; Kim et al. 2009).

#### **(2) Signalisation redox et catabolisme matriciel**

L'activation redox des facteurs de transcription NF $\kappa$ B, AP-1 ou encore HIF2 $\alpha$  conduisent à une augmentation de la synthèse et de la sécrétion des MMP-1, MMP-3, MMP-9, MMP12 et MMP-13 ainsi que des ADAMTS 4 et 5 par le chondrocyte (Martin et al. 2005; Yang et al. 2010). La signalisation redox entraîne également une diminution de l'expression du TIMP-1 (Shabani et al. 1998). L'IGF-1 stimule la synthèse des protéoglycanes par le chondrocyte. La S-nytroxylation de résidus tyrosine occupant la partie cytosolique de son récepteur par le peroxy-nitrite inhibe ainsi toute possibilité de phosphorylation et entraîne une perte de la sensibilité des chondrocytes à l'IGF-1 (Studer 2004). Le TGF- $\beta$  est également un stimulant de l'anabolisme chondrocytaire, le stress oxydant entraîne une diminution de l'expression de son récepteur à la surface des chondrocytes (Ayache et al. 2002). Les ROS régulent également la production chondrocytaire d'IL-1 $\beta$ , de prostaglandine E2 et de NO (Mathy-Hartert et al. 2002).

## Introduction

En amenuisant les capacités anaboliques des chondrocytes mais surtout en accroissant leur potentiel catabolique, les ROS participent donc directement et indirectement à la dégradation du cartilage articulaire.

## VI. Argumentaire de l'étude et objectifs

La NADPH oxydase Nox4 demeure méconnue sous bien des aspects. Sa topologie repose sur des analogies de séquences avec Nox2 et des prédictions informatiques. Renforçant l'incertitude relative à sa topologie, les données prédictives obtenues *in silico* sont discordantes (Figure 19).

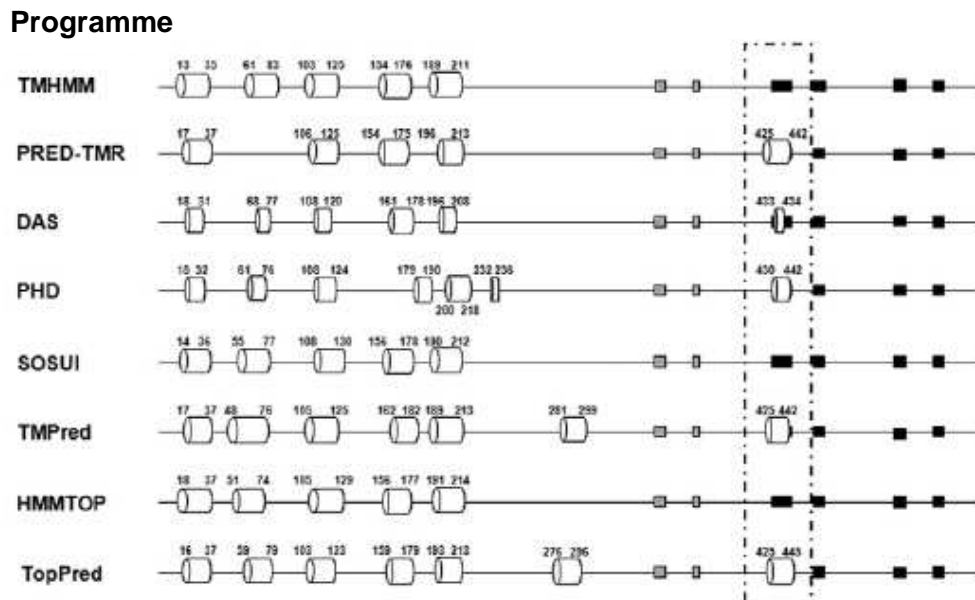

**Figure 19 : Profil d'hydrophobicité de la séquence de Nox4.** L'alignement des domaines hydrophobes prédits par 8 programmes indique la présence d'au moins 5 passages transmembranaires pour Nox4. Un seul programme indique une topologie à 6 passages transmembranaires et 5 programmes indiquent la présence d'une région fortement hydrophobe au niveau du quatrième domaine de fixation du NADPH. Il est à noter que 3 programmes prédisent une topologie à 7 domaines transmembranaires. Figure issue de l'article de Nguyen et al, 2012.

En effet, le profil d'hydrophobicité de sa séquence peptidique indique l'existence d'une région fortement hydrophobe proche du premier site de fixation du NADPH au sein de la queue cytosolique. Ces données, suggèrent que Nox4 pourrait posséder un septième passage transmembranaire (Nguyen et al. 2012). Au contraire, certains programmes n'indiquent que 5 passages transmembranaires pour Nox4.

L'expression de Nox4 est ubiquitaire mais son rôle physiologique n'est pas toujours clair. Dans les chondrocytes C-20/A4, Nox4 est impliquée dans la voie de transduction redox initiée par l'IL-1 $\beta$  et conduit à la synthèse de la collagénase MMP-1, l'une des principales protéases impliquées dans l'arthrose (Grange et al. 2006). Plus généralement, l'activité de Nox4 a été incriminée dans des pathologies tumorales ou liées au vieillissement. Son activité, au moins pour partie régulée au niveau transcriptionnel, est également stimuable par Poldip2, un partenaire nouvellement identifié dans les VSMC (Lyle et al. 2009). L'identification de nouveaux partenaires régulateurs de l'activité de Nox4 pourrait

## Introduction

représenter un enjeu thérapeutique important dans certaines pathologies. Cependant, l'absence de données disponibles sur le plan fondamental limite la mise en place de stratégies efficaces pour contrôler l'activité de Nox4. Dans ces travaux, développés en trois chapitres, nous nous sommes attachés du fondamental vers la physiopathologie à :

### 1 – Caractériser expérimentalement la topologie de Nox4.

L'étude de la topologie membranaire de Nox4 a été abordée en préparant des protéines de fusion avec l'ubiquitine marquée à la GFP.

### 2 – Décrypter les mécanismes de régulation de l'activité de Nox4.

L'hème oxygénase (HO-1) est l'enzyme limitante dans le catabolisme de l'hème, une molécule indispensable à l'activité catalytique de Nox4. Dans le but de contrôler l'activité de Nox4, nous avons surexprimé HO-1 dans la lignée de chondrocytes C-20/A4 et HEK293 TRex. De même, nous nous sommes intéressés au rôle potentiel de Poldip2 dans ces cellules.

### 3 - Mieux cerner le rôle de Nox4 dans les chondrocytes primaires humains.

L'expression de Nox4 a été décrite dans trois lignées de chondrocytes humain au sein de notre laboratoire (Grange et al. 2006). Mais aucune étude n'a encore permis d'identifier les Nox exprimées par les chondrocytes primaires humains. Les questions majeures auxquelles nous avons tenté de répondre sont les suivantes :

- Nox4 est elle exprimée dans les chondrocytes primaires humains ?
- Quel est le rôle des ROS produits par Nox4 dans ce type de cellules ?
- Y'a-t-il une différence d'expression ou d'activité de Nox4 dans les chondrocytes sains comparés aux chondrocytes arthrosiques ?

Et de manière plus générale, Nox4 peut elle être considérée comme une cible thérapeutique dans l'arthrose ?

# Travaux de recherche



# **CHAPITRE I**

## **Approche topologique de la NADPH oxydase Nox4**

### **Article 1**





## **Partie 1 : Approche expérimentale de la topologie de Nox4**

L'activité ou l'expression non contrôlée de Nox4 a été incriminée dans plusieurs pathologies parmi lesquelles la néphropathie diabétique (Gorin and Block 2013), la fibrose pulmonaire (Hecker et al. 2009) ou hépatique (Sancho et al. 2012), certains cancers (Zhang et al. 2013), ou encore l'ostéoporose (Goettsch et al. 2013). Nous suggérons également que Nox4 pourrait être une cible thérapeutique à atteindre dans l'arthrose (Grange et al. 2006; Rousset et al. 2013). Les données obtenues suggèrent que Nox4 pourrait être associée à la rupture de l'homéostasie redox contribuant à la dégénérescence tissulaire observée dans ces pathologies.

Une meilleure connaissance de la topologie de Nox4 pourrait non seulement permettre de mieux comprendre son fonctionnement mais également de mieux appréhender le développement d'inhibiteurs enzymatique, et donc une approche thérapeutique ciblée. Cependant, l'ancrage au sein des membranes rend compliqué l'obtention de structures protéiques par cristallisation ; de surcroît, les techniques disponibles pour caractériser le positionnement des protéines au sein des membranes sont limitées.

Les domaines fonctionnels de Nox2 sont relativement bien caractérisés et ont déjà permis le développement de peptides inhibiteurs ou compétiteurs de son activité (Csanyi et al. 2011). Chaque isoforme des Nox présente des caractéristiques structurales ou des modes de régulation qui leurs sont propres. En ce qui concerne Nox4, l'acquisition de données topologiques devrait permettre une localisation plus précise des domaines fonctionnels qu'elle porte ainsi que la caractérisation des compartiments subcellulaire dans lesquels les ROS sont produits.

Dans certaines cellules, les voies de transduction médiées par Nox4 dépendent de la localisation subcellulaire de l'enzyme, permettant en réponse à un stimulus, un rapprochement entre le site où les espèces réactives de l'oxygène sont formées et la cible redox (Chen et al. 2009; Xi et al. 2013). L'identification de l'emplacement où sont produits les ROS par Nox4 aura donc une importance critique pour comprendre la transduction redox en aval.

En l'absence de données de cristallisation, Nox4 est communément représentée avec 6 passages transmembranaires, selon le schéma déjà démontré par des approches immunologiques pour la NADPH oxydase phagocytaire Nox2. Cette hypothèse semble effectivement être la plus vraisemblable, mais, les données prédictives issues de différents

programmes informatiques indiquent que d'autres topologies sont possibles (Nguyen et al. 2012). Ainsi, à ce jour, aucune approche expérimentale ne permet de confirmer la topologie de Nox4 qui reste encore hypothétique.

Dans la méthode de détermination topologique de protéines membranaires (ToDUFA) que nous avons développée, la protéine de fusion ubiquitine-GFP (ubGFP) est associée à la partie C-terminale de la protéine de topologie inconnue. Le principe de la méthode repose ensuite sur l'activité protéolytique des déubiquitinasés, localisées au sein du compartiment cytosolique des cellules. Le relargage ou non de la GFP, conséquence du clivage de l'ubiquitine par les déubiquitinasés, servira d'indicateur de l'orientation topologique de la protéine d'intérêt et sera analysé simplement par des techniques usuelles de laboratoire (Western Blot, FACS ou microscopie à fluorescence).

La preuve de concept et la validité de cette approche ont été confirmées en utilisant deux protéines membranaires de topologie connue : le récepteur à l'IL-1 $\beta$  de type I (possédant une partie C-terminale cytosolique) et la protéine tronquée Nox2-N131 (131 premiers acides aminés) dont la partie C-terminale, correspondant à la 3<sup>ème</sup> boucle, est extracellulaire (Campion et al. 2007). La méthode a ensuite été appliquée à l'étude de la topologie de Nox4 (Figure 20).

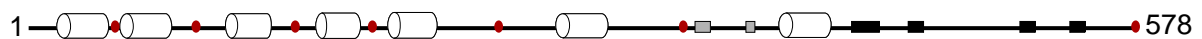

**Figure 20 : Application de la méthode ToDUFA à Nox4.** D'après les prédictions *in silico*, Nox4 pourrait compter 7 domaines transmembranaires (cylindres blanc). Des formes tronquées après chaque passage transmembranaire prédit de Nox4 (résidus 44, 98, 144, 184, 239, 341) ainsi que la forme entière (résidu 578) ont été fusionnées avec la protéine chimère ub-GFP et placées en C-terminal (points rouges), puis exprimées dans les cellules HEK 293.

Cette méthode originale, utilisant les protéines de fusion ubGFP comme outils de révélation de la topologie des protéines membranaires, apporte la première démonstration expérimentale de la topologie de Nox4. Nos données révèlent la présence de 6 passages transmembranaires liés par 5 boucles extramembranaires. Ces données confirment également l'orientation globale de Nox4, présentant les boucles A, C et E comme extracellulaires ou dirigées vers la lumière du RE et les boucles B et D ainsi que les extrémités N- et C-terminales vers le cytosol.

Dans ce travail, nous confirmons par l'expérimentation, l'hypothèse de 6 passages transmembranaire pour Nox4, formulée sur la base d'homologies de séquence avec Nox2.

D'autre part, tenant compte des différentes localisations subcellulaires que peut prendre Nox4 d'une cellule à l'autre, ces résultats pourraient avoir une résonance particulière dans la compréhension des voies redox dépendantes de la localisation de Nox4. Ces données pourraient faciliter la synthèse d'inhibiteurs peptidiques ou pharmacologiques.

Enfin, de manière générale, cette méthode devrait permettre l'analyse de la topologie de l'ensemble des protéines membranaires arborant une topologie complexe.

*J'ai contribué à la réalisation des plasmides codant pour l'IL1RI et une forme tronquée de Nox4 (N1-239) fusionnée à la GFP et ubGFP. J'ai également contribué à ce travail par la transfection, la sélection et la culture des cellules exprimant les différentes protéines de fusion, par la mise au point et la validation de la méthode par microscopie à fluorescence ainsi que par l'acquisition de résultats pour deux formes tronquées de Nox4. Enfin, j'ai confirmé par Western Blot et cytométrie en flux les résultats préliminaires déjà obtenus par Leilei Zhang et complété l'étude par l'obtention des résultats manquants.*

Article I: **Francis Rousset**, Leilei Zhang, Bernard Lardy, Françoise Morel and Minh Vu Chuong Nguyen. Nox4 topology revealed by Topological Determination by Ubiquitin Fusion Assay, a novel method to uncover membrane protein topology. Soumis à *Nature chemical biology*.

## **Nox4 topology revealed by Topological Determination by Ubiquitin Fusion Assay, a novel method to reveal membrane protein topology**

**Francis Rousset<sup>1</sup>, Leilei Zhang<sup>1</sup>, Bernard Lardy<sup>1, 2</sup>, Françoise Morel<sup>1</sup> and Minh Vu Chuong Nguyen<sup>1, 3 \*</sup>**

<sup>1</sup> Université Joseph Fourier, AGIM GREPI FRE CNRS 3405, Grenoble, France.

<sup>2</sup> Laboratoire de Biochimie des Enzymes et des Protéines - DBTP, Institut de Biologie et de Pathologie, Centre Hospitalier Universitaire (CHU), Grenoble, France.

<sup>3</sup> Calcium Signaling and Inflammation Group, Life Sciences Research Unit, University of Luxembourg, Luxembourg, Luxembourg.

\*Correspondence should be addressed to Minh Vu Chuong Nguyen, Université Joseph Fourier, AGIM GREPI FRE CNRS 3405, Grenoble, France and Calcium Signaling and Inflammation Group, Life Sciences Research Unit, University of Luxembourg, Luxembourg.  
Email: [mvchuong@yahoo.fr](mailto:mvchuong@yahoo.fr)

### **ABSTRACT**

Topological organization of integral membrane protein is a key feature that dictates the protein's function and its interaction with partners. Here, we developed a novel method, named Topological Determination by Ubiquitin Fusion Assay (ToDUFA), based on the proteolytic capacity of the ubiquitous deubiquitinase enzymes to process ubiquitin fusion proteins. This straightforward and reliable method, validated on two well-known topology proteins (IL1RI and Nox2), allowed us to discriminate rapidly the topological orientation of protein domains facing either the nucleocytosolic or the exterior/luminal compartments. We demonstrated its applicability and robustness in defining the undetermined yet topology of a multi-pass membrane protein NADPH oxidase Nox4. Considering the importance of protein topology knowledge in cell biology research and pharmacological development and the successful applicability of ToDUFA, we believe that this novel method will represent a widely useful technique to easily and unfailingly uncover complex membrane protein topology.

## INTRODUCTION

Membrane protein has a unique structural characterization involved in a wide range of basic and important cell biological functions, such as cell signaling, transport of membrane-impermeable molecules, signal transduction and cell-cell communication among others. Many of them are also the prime drug targets, and it has been estimated that more than half of all drugs currently on the market target are membrane proteins (Klabunde and Hessler 2002). Membrane proteins also make for ~70% of current drug development targets (Drews 2000). Cellular membranes act as barriers and scaffolds to separate different cellular environments. Consequently, it is important for membrane proteins to adopt appropriate orientations to communicate with their respective interacting partners and thus allowing their correct functioning in the cell.

Although an increasing number of membrane protein structures emerged recently over the past decade, the vast majority of those structures are of membrane proteins from prokaryotic sources and high resolution structural data of eukaryotic membrane proteins remains largely limited (Caffrey 2003). In the absence of crystallization data, the investigation of the membrane protein topology depends on the prediction according to their primary sequences. The computational prediction approaches examining the relative hydrophobicity of different polypeptide regions of a protein are not fully reliable, and different algorithms have led to different results (Wilkinson et al. 1996). In spite of the important role of topology in protein function, techniques available to estimate the membrane protein topology are limited, require substantial optimization and are often time consuming such as cystein substitution (Bogdanov et al. 2005), N-glycosylation scanning (Cheung and Reithmeier 2007), antibody mapping (Campion et al. 2007), protease protection (Imajoh-Ohmi et al. 1992), specific protease cleavage sequence (Wilkinson et al. 1996) or protease accessibility (Lorenz et al. 2006).

In this study, we developed a novel method, named ToDUFA (Topological Determination by Ubiquitin Fusion Assay), for determining the topological organization of transmembrane proteins in living cells. This novel method utilized the specific subcellular location combined to the enzymatic capability of Deubiquitinases proteins (DUBs) to process

ubiquitin (Ub) fusion proteins. This assay provides a fast and easy GFP fluorescence readout and do not require heavy optimization and chemical treatment or modification. Using this method, we can determine which domain of the transmembrane protein faces the extracellular/luminal or the nucleocytosolic side of the cell and therefore the number of integral transmembrane domains. ToDUFA method has been established and validated on two well-known topology proteins (IL1RI and Nox2) using different biochemical techniques (FACS, western blot, fluorescence microscopy) and was successfully applied to reveal the undetermined yet topology of a multi-pass membrane protein NADPH oxidase Nox4.

Nox4 belongs to the NADPH oxidase family (Nox) which unique function is to produce reactive oxygen species (ROS) (Chen et al. 2012). Under physiological conditions, the amount of ROS is adequately regulated and they represent essential cellular signaling molecules that regulate events such as phosphorylation, gene expression, cell differentiation and proliferation. However they are also responsible for tissues damages and oxidative stress in pathological states (Genestra 2007). Therefore, where ROS are produced, inside or outside of the cells, could lead to different cellular signaling pathways and therefore modify the cell fate. Moreover, a better knowledge of Nox4 topology could help the development of inhibitors. Nox4 generates ROS from NADPH substrate by successive electron transfers throughout the membrane environment. Thus, determining Nox4 membrane topology and consequently in which cellular compartment ROS are produced constitutes a key feature to understand its role in pathophysiological situations. So far, no data related to Nox4 topology have been reported in the literature and its membrane organization is predicted only through its amino acid sequence homology to Nox2. Using this new ToDUFA method we were able to provide first evidences that Nox4 possesses 6 transmembrane domains with its N- and C-terminus moieties facing the cytosol. ToDUFA appears thus to be a reliable and powerful method to determine the topology of membrane proteins.

## **EXPERIMENTAL**

### **Reagents**

Dulbecco's Modified Eagle's Medium (DMEM), fetal bovine serum, neomycin (G418, geneticin) were purchased from GIBCO; ECL Western Blotting Detection reagents were purchased from Amersham Biosciences; complete mini EDTA-free protease inhibitor

EASYpack, leupeptin, pepstatin, TLCK were purchased from Roche; GFP mAb was purchased from Santa Cruz; Goat anti-Mouse IgG-HRP was purchased from GE healthcare; X-treme GENE 9 Transfection Reagent was purchased from Roche; MassRuler DNA Marker was purchased from Euromedex. Alexa Fluor 488 labelled goat anti-mouse IgG and pCDNA 3.1 plasmid were from Invitrogen.

### **Plasmid constructions**

GFP sequence was obtained by PCR and inserted into the pCDNA 3.1 empty plasmid, using *XhoI* and *Apal* restriction sites, to generate the pCDNA GFP plasmid. The forward GFP primer sequence was designed to add a *Clal* restriction site between the *XhoI* site and GFP sequence. pCDNA Ub-GFP was constructed by inserting the ubiquitin sequence obtained by PCR between the *XhoI* and *Clal* restriction site in frame with the GFP sequence into the pCDNA GFP plasmid. Finally, Nox2N131, IL1RI and Nox4 full length or truncated sequences were obtained by PCR and inserted into either pCDNA GFP or pCDNA Ub-GFP plasmids using *KpnI* and *XhoI* restriction sites in frame with GFP or Ub-GFP sequences. The primers used in this study are indicated in the table 1.

### **Cell culture and transfection**

HEK293 cells were cultured in DMEM containing 4.5 g/L glucose and 0.11 g/L sodium pyruvate, supplemented with 10% (v/v) fetal bovine serum and 100 units/ml penicillin and 100 mg/ml streptomycin and 2 mM glutamine at 37°C in atmosphere containing 5% CO<sub>2</sub>. For transfections, 5×10<sup>5</sup> HEK293 cells were seeded in 6-well plates and allowed to grow for 24h to reach a 60% confluence in 2 ml of culture medium. Cells were transfected with 1 µg of vectors according to the manufacturing protocol (X-treme GENE 9, Roche). After 24h, transfected cells were stably selected with 500 µg/ml geneticin for 3 weeks before analysis.

### **Flow cytometry**

Cells were suspended in PBS (10<sup>7</sup>/ml), incubated with 0.01% saponin in PBS or PBS alone for 3 min on ice. After a centrifugation step, saponin treated cell supernatant was collected and stored for GFP western Blot. Meanwhile, cells were washed twice and suspended in PBS buffer. GFP fluorescence intensity of the cells (GMean) was measured on a FACScalibur (Becton Dickinson) cytometer. For the determination of the percentage of saponin necessary



to permeabilize cells, cells expressing GFP were suspended in PBS buffer and the fluorescence signal was followed every second by FACs. An initial period of 30 seconds served as a reference for the fluorescence and forward scatter (FSC) base line (discontinuous red line) then an increasing percentage of saponin (0.001 to 0.05%) was added to the cells while GFP the fluorescence and FSC parameters was continuously monitored during 5 additional minutes.

### **SDS/PAGE and Western Blotting**

Cells were suspended in PBS buffer containing 2  $\mu$ M leupeptin, 2  $\mu$ M pepstatin, 10  $\mu$ M TLCK and complete mini EDTA-free protease inhibitor. The cells were fractionated after sonication 3 $\times$ 10s at 4°C and 40W using a Branson sonifier. The homogenate was centrifuged at 1,000 g for 15 min at 4°C to remove unbroken cells and nuclei. The post-nuclear supernatant was centrifuged at 200,000 g for 1 h at 4°C. This high-speed centrifugation supernatant was referred to the cytosol, and the pellet consisting of crude membranes was suspended in the same buffer. The supernatant of saponin treated cells (collected before flow cytometry acquisition), membrane and cytosol fractions were loaded on a 10% SDS-PAGE and electro-transferred to nitrocellulose. Immunodetection was performed using primary monoclonal antibodies against GFP (dilution 1:1,000) (Santa Cruz). The immune complexes were detected with a secondary antibody combined with peroxidase. The bound peroxidase activity was detected using ECL reagents.

### **Fluorescence microscopy**

Cells were seeded on coverslips and grown in 12 wells plate for 24 h to reach a 60% confluence. Cells were then treated or not with 0.01% saponin for 3 min and washed with PBS buffer. Samples were then fixed with 4% (w/v) paraformaldehyde for 10 min and autofluorescence was quenched by 50 mM NH<sub>4</sub>Cl for 10 min, RT. The coverslips were immunostained with a mouse monoclonal antibody directed against GFP (1:200) followed by incubation with the appropriate secondary antibodies conjugated to Alexa 488 (1:200). Cells nuclei were stained with Hoechst 33258 (0.5  $\mu$ g/ml) and the coverslips were mounted in DABCO solution, sealed, and stored at 4°C in the dark. Images were collected on a fluorescence microscope.

## RESULTS

### General principle of the Topological Determination by Ubiquitin Fusion Assay (ToDUFA)

In this study, we have developed a stringent, easy and straightforward enzymatic assay to uncover the topology of membrane protein in living cells, named Topological Determination by Ubiquitin Fusion Assay (ToDUFA). This method is based on the properties of deubiquitinase enzymes to process ubiquitin fusion proteins. Deubiquitinases are exclusively expressed in the nucleocytoplasm and are involved in the synthesis and recycling of monomeric ubiquitin proteins by processing the polyubiquitin chain (Komander 2010), for example by hydrolyzing ester bond at the C terminus of Ub (Larsen et al. 1998). To determine the topology of transmembrane proteins, we attached a chimera protein, composed of a fluorescent protein fused to the C-terminus part of an ubiquitin molecule (UbGFP), to the C-terminus moiety of the reference protein (**Fig. 1**). They are then to possible scenarios: 1) if the C-terminus moiety of the reference protein is located in the extracellular or luminal side, the ubiquitin is not accessible to DUBs and therefore protected from their cleavage (**Fig. 1a**); 2) conversely, if the C-terminus moiety of the reference protein is exposed to the nucleocytoplasmic side, GFP protein will be released from the chimera UbGFP by the DUBs enzymes proteolytic activity (**Fig. 1b**). Consequently the release of “free” GFP molecule, evidenced by different laboratory techniques, will serve as an indicator for the orientation of the C-terminus moiety of the reference transmembrane protein.

### Establishment and proof-of-principle of the ToDUFA method

We first determine the percentage of saponin necessary to permeabilize the HEK293 cells. Saponin is a widely used natural compound derived initially from the soapwort plant *Saponaria* that can complex with cholesterol to form pores in cell membrane bilayers (Williams and Gong 2007). The cell membrane becomes permeable and cytosolic content as well as macromolecules such as proteins, like “free” GFP, diffuse out of the cell (**Supplementary Fig. S1a**). To estimate the percentage of saponin permitting the leakage of “free” GFP molecules, we treated cells expressing GFP with different concentration of saponin (**Supplementary Fig. S1b**). For this, cells were suspended in PBS and the fluorescence signal was followed every second by FACS. An initial period of 30 seconds served as a reference for the fluorescence base line and then an increasing percentage of

saponin was added to the cells while GFP fluorescence was monitored continuously. The permeabilization efficacy was evidenced by the decrease of the forward scatter (FSC) parameter, which reflects the volume of the cells and by the loss of GFP fluorescence intensity. We observed that 0.001% of saponin was unable to permeabilize the cell since both FSC and GFP fluorescence parameters were unchanged (**Supplementary Fig. S1b and S1c**). However, percentage of saponin starting from 0.01% was sufficient to permeabilize cellular membranes as shown by the rapid decrease of the FSC parameter as soon as the saponin was added (**Supplementary Fig. S1b and S1c**). Concomitantly, the release of the “free” GFP from the cell was evidenced by a quick decline of the fluorescent signal (**Supplementary Fig. S1b and S1c**). Therefore for the rest of the study, cells were treated or not with 0.01% of saponin before FACS analysis to evaluate the GFP leakage as shown for the GFP expressing cells (**Supplementary Fig. S1d and S1e**).

To establish the proof-of-principle of the ToDUFA method, we used two proteins of known membrane topology as models. The first corresponds to the Interleukin 1 Receptor Type I (IL1RI) which is a cytokine receptor presenting a single-pass transmembrane domain with its C terminus facing the cytoplasm (Wang et al. 2009) (**Fig. 1c, left panel**). The second is Nox2, the prototype of the NADPH oxidase family, which topology have been intensively studied leading to the model in which Nox2 is a type II polytopic membrane protein possessing 6 transmembrane domains (Imajoh-Ohmi et al. 1992; DeLeo et al. 1995; Biberstine-Kinkade et al. 1999; Burritt et al. 2001; Yamauchi et al. 2001; Burritt et al. 2003; Palet et al. 2004; Campion et al. 2007). A truncated form of Nox2 corresponding to its second extracellular loop, Nox2N131, have been chosen because its C-terminus faces the extracellular or luminal side (Burritt et al. 2001; Yamauchi et al. 2001; Campion et al. 2007) (**Fig. 1c, right panel**). IL1RI and Nox2N131 were tagged with UbGFP and expressed in HEK293 cells. To test whether the UbGFP tag exposed to the cytoplasm could be processed by DUBs, we expressed IL1RI-UbGFP proteins in HEK293 cells. Those cells were suspended in PBS buffer and treated or not with 0.01% saponin for 3 min on ice. After centrifugation, supernatant was collected and stored for further analysis by western blot. Meanwhile, cells were washed twice and suspended in PBS buffer. Then the fate of the GFP fluorescence was monitored on a FACScalibur cytometer (**Fig. 2a**). As shown in **Fig. 2b and 2c (left panels)**, fluorescence of IL1RI-UbGFP expressing cells was lost upon saponin treatment compared to

that of the untreated cells. These results suggest that the GFP attached to the IL1RI-Ub has been released by cleavage activity of DUBs present in the cytosol and that the saponin treatment permitted the leakage of the GFP out of the cell (**Fig. 2b, left panel cartoon**).

To investigate whether the release of the GFP is due to the presence of the ubiquitin tag, we performed similar experiments with cells expressing IL1RI linked to GFP alone (IL1RI-GFP) and found that the GFP fluorescence remained unchanged upon saponin treatment (**Supplementary Fig. S2a**), suggesting that GFP tag was not released. To further validate the method, we next examined the fate of the GFP fluorescence of cell expressing Nox2N131-UbGFP which C-terminus moiety faces the extracellular or luminal side. Theoretically, the UbGFP tag fused at the C-terminus part of Nox2N131 is not accessible to DUBs and should remain intact, leading to the maintenance of the GFP fluorescence intensity in the cells (**Fig. 2b, right panel cartoon**). Indeed, the addition of saponin did not decrease the GFP fluorescence of the Nox2N131-UbGFP cells (**Fig. 2b and 2c, right panels**) similarly to that of cells expressing Nox2N131-GFP (**Supplementary Fig. S2a**), indicating that ubiquitin tag is not subject to unspecific cleavage when exposed to the extracellular or luminal side.

To verify that GFP proteins were indeed released from the cells expressing IL1RI-UbGFP upon saponin permeabilization western blot experiments were performed on the supernatant collected after cell permeabilization using an antibody directed against GFP. The supernatant should contain the cytosolic content that has leaked out of the permeabilized cells. Consistent with the FACS data, the results confirmed that only supernatant from the cells expressing IL1RI-UbGFP contained GFP proteins compared to that of others control cells expressing IL1RI-GFP, Nox2N131-UbGFP and Nox2N131-GFP (**Fig. 2d**). This biochemical approach also confirmed the scenario in which the tag UbGFP, when exposed to the cytosolic side but not to the extracellular or luminal side, is processed by the DUBs enzymes allowing GFP proteins to “freely” diffused in the cytosol and thereafter into the extracellular compartment upon saponin permeabilization treatment (**Fig. 2b, left panel cartoon**).

We next corroborated these results by using a standard SDS-PAGE and western blot protocol on membrane and cytosol fractions of transfected cells (**Fig. 3**). In theory, if the UbGFP tag is not processed by DUBs, GFP fused protein location should remain in the

membrane fraction; and conversely, if the UbGFP tag is targeted by the DUBs enzymes, GFP should be released into the cytosol (**Fig. 3b cartoons**). IL1RI- and Nox2N131-UbGFP expressing cells were detached by scraping, centrifuged and lysed by sonication. Crude membrane and cytosolic fractions were then separated by ultracentrifugation (200,000 g for 1 h) and loaded onto 10% SDS-PAGE gel for GFP western blotting (**Fig. 3a**). In agreement with the data described above, “free” GFP molecules were found in the cytosolic fraction of cells expressing IL1RI-UbGFP at its predicted monomeric molecular weight ~28 kDa but not in cytosolic fraction of cells expressing Nox2N131-UbGFP (**Fig. 3b upper panel**). As expected, GFP labeling was found solely in the membrane fraction extracted from Nox2N131-UbGFP expressing cells (**Fig. 3b lower panel**).

We further evaluated the applicability of the ToDUFA method in a commonly laboratory used fluorescence microscopy technique. For this, cells expressing IL1RI- or Nox2N131-UbGFP were coated on coverslips and permeabilized or not with a saponin treatment. They were then washed with PBS buffer and the fluorescence of GFP was assessed on a fluorescence microscope (**Fig. 4**). Consistent with the FACS data, we observed a dramatic decrease of the fluorescence of cells expressing IL1RI-UbGFP upon saponin treatment (**Fig. 4 upper panel**) unlike that of cells expressing Nox2N131-UbGFP (**Fig. 4 lower panel**).

All together, results obtained from three different techniques (FACS, western blot and fluorescence microscopy) validate the fact that ToDUFA method could correctly determine the topology of membrane proteins.

#### **Application of ToDUFA method to reveal the membrane topology of NADPH oxidase 4 (Nox4) proteins.**

Nox4 belongs to the NADPH oxidase family which plays an essential role in cellular signaling pathway by generating reactive oxygen species. Nox4 has been chosen since even though it has been described as a transmembrane protein no experimental data concerning its topology are available in the literature so far. Computational analysis of Nox4 amino acid sequence led to inconsistent and conflicting topological models. Different algorithms

predicted 5 to 7 transmembrane domains with some at different locations (**Supplementary Fig. S3a**) (Nguyen et al. 2012). To reveal the topology of Nox4, we applied the ToDUFA method by attaching the UbGFP or GFP tags to the C-terminus side of full length or to the C-terminus-deleted Nox4 proteins according to the location of the predicted transmembrane domains (**Supplementary Fig. S3b**). All constructs were carefully designed to keep consistent the amino acid charges surrounding the transmembrane domain in order to not interfere with its orientation. As seen in **Fig. 5a** in the FACS experiments, fluorescence of Nox4FL-UbGFP, Nox4N341-UbGFP, Nox4N184-UbGFP and Nox4N98-UbGFP expressing cells quickly decreased upon saponin treatment, suggesting that their UbGFP moiety faces the cytoplasm. Meanwhile, as the negative control, fluorescence of Nox4FL-GFP, Nox4N341-GFP, Nox4N184-GFP and Nox4N98-GFP did not change (**Supplementary Fig. S2b**). By contrast, fluorescence intensity associated with Nox4N46-UbGFP, Nox4N144-UbGFP and Nox4N239-UbGFP expressing cells remained at the same level after the treatment (**Fig. 5a**) similarly to that of their negative control Nox4N46-GFP, Nox4N144-GFP and Nox4N239-GFP expressing cells (**Supplementary Fig. S2b**). These data suggest that in their case, the UbGFP moiety faces the cell exterior or luminal compartment. These results are consistent with the western blot analysis of GFP protein in the supernatant after saponin permeabilization (**Fig. 6a**).

This topological organization was confirmed by examining the GFP expression in the cytosol and crude membrane fractions by western blot. As in **Fig. 5b**, “free” GFP was detected only in the cytosol fraction of Nox4FL-UbGFP, Nox4N341-UbGFP, Nox4N184-UbGFP and Nox4N98-UbGFP expressing cells at its monomeric molecular weight. By contrast, the expression of Nox4N46-UbGFP, Nox4N144-UbGFP and Nox4N239-UbGFP protein was detected as their predicted fusion size with UbGFP tag in the crude membrane fraction. Finally, we tested Nox4N46 and Nox4FL topology by fluorescence microscopy and consistently found that the GFP fluorescence of the cells expressing Nox4FL-UbGFP was lost upon saponin permeabilization contrary to that of cells expressing Nox4N46-UbGFP (**Fig. 6b**).

All together, those data and particularly those of the FACS experiment summarized in **Fig.7a** permitted us to experimentally reveal Nox4 topology. In agreement with the topology of Nox2, we found that Nox4 consists of 6 transmembrane domains with its N- and C-

terminus moieties facing the cytosol (**Fig. 7a and 7b**). Furthermore, we were able to identify 5 intermembrane loops a, b, c, d, and e. Loops a, c and e are located in the extracellular or luminal side whereas loops b and d face the cytosol (**Fig. 7b**). This topological organization of the e loop and the C-terminus domain of Nox4 is confirmed by our previous study by characterizing the epitope of monoclonal antibodies targeting those domains (**Fig. 7b**) (Zhang et al. 2011). Thus, ToDUFA appears to be an original, easy, robust and suitable method to determine the topology of complex multi-spanning membrane proteins.

## DISCUSSION

Based on the range of predictions by the different methods more than 30% of the human proteome is dedicated to be membrane proteins (Ahram et al. 2006; Almen et al. 2009) which are considered to play a key role in cell's life by transducing and propagating signals from the surrounding to the cell. The proper function of these integral membrane proteins is dictated by their topological distribution throughout the cellular membrane. Development of inhibitors and basic knowledge on membrane protein functions are often limited by the difficulties to obtain their structure. In order to expand knowledge in the understanding of membrane protein function, we developed a new straightforward approach to uncover their topology. Our method based on the activity of native DUBs offers the advantage to study the membrane topology of proteins *in situ* without the need of performing biochemical modification of the reference protein or time consuming optimization steps prior the analysis. Indeed, techniques as simple as western blot experiments of the membrane and cytosol fractions or FACS analysis of saponin permeabilized cells are sufficient to determine reliably protein topology, saving time and effort. Only few amounts of proteins or transfected cells are necessary to perform topology analysis as demonstrated by fluorescence microscopy assay which could follow the fluorescence fate of single transfected cell. Therefore ToDUFA could be applied as well to determine the topology of membrane proteins that are difficult or weakly expressed. Based on the analysis of "free" GFP status, ToDUFA method may be applied in a variety routinely techniques utilized in laboratory. In this study, most frequently available techniques such as western blot, FACS and fluorescence microscopy have been successfully used open the possibility of a broad application of ToDUFA.

Although GFP tag allows an easy readout that do not require additional tools such as specific monoclonal antibodies (Campion et al. 2007), many other reporter system such as luciferase or Cre recombinase (Yang and Hughes 2001) could be used instead depending on the usage and tools availability in different laboratories. While GFP related tag most of the time does not affect the properties of the protein and retain native conformation of the untagged protein(Chudakov et al. 2010), rare case reported otherwise. To avoid those potential complications, the location of the attached UbGFP tag should be chosen with caution to avoid modification of the electronic charges surrounding the transmembrane domain (Kim et al. 1994). For some specific case, additional investigation such as enzyme activity or proper addressing of the tagged reference protein may be necessary to verify its correct conformation. Although GFP protein allowed an easy readout, its presence in our method based on the cleavage by DUBs enzymes is not mandatory. Indeed, smaller amino acid tag sequences could be substituted to the GFP proteins such as hemagglutinin or myc tags, which could reduce substantially the steric interference with the native topological distribution.

ToDUFA method is based on the protease activity of DUBs enzymes and is therefore applicable to cells that expressed endogenously DUBs proteins. DUBs which function is to generate active monomeric ubiquitin molecules from polyubiquitin chain are ubiquitously expressed, similarly to ubiquitin proteins, in all eukaryotic cells from *Saccharomyces cerevisiae* to *Homo sapiens* (Varshavsky 2006). Ubiquitous expression of DUBs opens a wide range of applicability of ToDUFA method to numerous cellular systems but excluding prokaryotic system though. Although we did not experimentally test this eventuality, it is conceivable that exogenous expression of DUBs enzymes in prokaryotic cells may overcome this limitation.

Finally, ToDUFA represents a powerful technique for topology determination of transmembrane proteins, which is performed on the protein in its cellular environment using native endogenous cellular tools such as DUBs. Its applicability and robustness have been successfully demonstrated in validating the topology of two know protein (IL1RI and Nox2) but also in defining the undetermined yet topology of a multi-pass membrane protein



NADPH oxidase Nox4. Regarding the relative importance of membrane proteins in cellular process and drug design and the technical difficulties to obtain membrane protein crystallization structure, the easy and straightforward ToDUFA method appears to be an attractive alternative approach that can be widely used to reveal topology of integral membrane proteins.

## ACKNOWLEDGEMENTS

This work was supported by grants from: the « Ministère de l'Enseignement supérieur de la recherche et la technologie », Paris, France; the « CNRS Institute »; the « Association pour la Recherche contre le Cancer » (ARC), Paris, France; the « Région Rhône-Alpes, programme ARCUS », France/Chine 2007–2008, « programme Emergence 2003–2006 »; the « CGD research Trust 2006–2007 », UK; the « Groupement des Entreprises Françaises de la Lutte contre le Cancer », délégation de Grenoble; the « Direction Régionale de la Recherche Clinique », Center Hospitalier Universitaire, Grenoble ; The « Etablissement Français du Sang EFS », Grenoble, the Fondation Arthritis Courtin and the « TRALI fellowship », EFS, Paris. We thank Dr M.H. Paclet for English language corrections and editing of the manuscript and Profs. J.L. Lenormand and C. Drouet for helpful discussions. AFR!

## AUTHOR CONTRIBUTIONS

M.V.C.N., F.R. and L.Z. designed and performed experiments, and analyzed data. B.L. contributed to experiments. M.V.C.N. and F.R. wrote the manuscript. F.M. contributed to discussions and editing of the manuscript. M.V.C.N. developed the concept and managed the project.

## FIGURE LEGENDS

**Figure 1 | General principle of Topological Determination by Ubiquitin Fusion Assay (ToDUFA) method.** C-terminus amino acid residue of transmembrane protein of unknown topology is tagged with Ubiquitin fused to GFP (UbGFP). **(a)** Cartoon representing a cell expressing membrane proteins tagged with an UbGFP that faces the extracellular or luminal compartment: ubiquitin is protected from DUBs processing and GFP proteins remain attached to the reference protein. **(b)** Cartoon representing a cell expressing membrane

proteins tagged with an UbGFP that faces the nucleocytoplasmic compartment: ubiquitin is cleaved by surrounding DUBs releasing the “free” GFP in the nucleocytoplasm. The release of “free” GFP molecule, evidenced by different laboratory techniques, will served as an indicator for the orientation of the C-terminus moiety of the reference transmembrane protein. **(c)** Schematic representation of two proteins of known topology used to demonstrate the proof-of-principle of the method. Left panel: Interleukin-1 Receptor Type I protein (IL1RI) which displays a C-terminus amino-acid residue exposed to the cytosol. Right panel: truncated Nox2 containing the first 131 amino acids displaying an extracellular C-terminus amino-acid residue.

**Figure 2 | ToDUFA proof-of-principle by FACS analysis.** **(a)** Scheme describing the FACS protocol. HEK293 cells expressing Ubiquitin fusion proteins were scraped, treated or not with 0.01% saponin and pelleted by centrifugation. Supernatants were collected for further western blot analysis and cells were washed and suspended in PBS buffer for FACS analysis **(b)** FACS measurement of GFP fluorescence intensity in IL1RI-UbGFP (left panel) and Nox2N131-UbGFP (right panel) expressing cells untreated or treated with saponin. The diffusion of the GFP out of the cell results in a loss of the measured fluorescence. In graphs, grey area indicates wild type HEK293 cells control fluorescence intensity. **(c)** Quantification of GFP fluorescence in IL1RI-UbGFP expressing cells (left panel) or Nox2N131ubGFP cells (right panel) treated or not with saponin. Data are expressed relatively to untreated cells. **(d)** GFP western blot from IL1RI-UbGFP, IL1RI-GFP, Nox2N131-UbGFP and Nox2N131-GFP cells supernatants after saponin treatment. Ctl, recombinant GFP positive control.

**Figure 3 | Establishment of the ToDUFA method by western blot.** **(a)** Scheme describing the protocol used for western blotting analysis of the ToDUFA method. Cells expressing UbGFP fusion proteins were scraped, lysed by sonication. Cytosol and membrane fractions were separated by ultracentrifugation 200,000 g for 1 hour at 4°C. 100 µg of proteins from each fraction were then loaded on 10% SDS-PAGE for GFP immunoblotting. **(b)** Upper panel: cartoon of a cell expressing ubiquitin fusion protein facing the nucleocytoplasm. Western blot from the cytosolic and membrane fraction of IL1RI-UbGFP transfected cells showing the presence of “free” GFP (27kDa) released in the cytosol fraction. Lower panel: cartoon of a

cell expressing ubiquitin fusion protein facing the exterior/luminal side. Western blot of the cytosolic and membrane fraction extracted from Nox2N131-UbGFP transfected cells showing the non cleaved fusion protein (41kDa) in the membrane fraction. Ctl: recombinant GFP positive control.

**Figure 4 | ToDUFA applied to fluorescence microscopy technique to reveal membrane protein topology.** HEK293 cells expressing ubiquitin fusion proteins were coated on coverslips and treated or not with 0.01% saponin. After a fixation step by 4% PFA, nuclei were stained with DAPI and GFP fluorescence was assessed by fluorescence microscopy (100X magnification). Results for IL1RI-UbGFP and Nox2N131-UbGFP expressing cells are displayed in the upper and lower part, respectively and show a drastic decrease of GFP fluorescence in the saponin treated IL1RI-UbGFP expressing cells indicating that “free” GFP proteins have diffused out of the cell.

**Figure 5 | ToDUFA reveals the topology of the membrane protein NADPH oxidase Nox4.** UbGFP tag (green dots) was added to the C-terminus moiety of the full-length (FL) or truncated forms of Nox4 corresponding to each putative loop (residues 46, 98, 144, 184, 239, 341) and expressed in HEK293 cells. The orientation of the each C-terminus residue was assessed by FACS after saponin treatment (as described in fig. 2b) and by GFP western blot after separation of the cytosolic and membrane fractions (as described in Fig. 3). For each panel: **(a)** the upper graph corresponds to untreated cells and the lower to 0.01% saponin treated cells. Grey area indicates wild type HEK293 cells. **(b)** GFP western blot of cytosol and membrane fractions from cells expressing ubiquitin fusion proteins.

**Figure 6 | Validation of Nox4 topology by ToDUFA using supernatants western blotting and fluorescence microscopy.** **(a)** HEK293 cells expressing UbGFP or GFP fusion proteins were scraped, treated or not with 0.01% saponin and pelleted by centrifugation. Supernatants were collected and analyzed by western blot. Ctl, recombinant GFP positive control. **(b)** HEK293 cells expressing Nox4N46-UbGFP and Nox4FL-UbGFP were coated on coverslips and treated or not with 0.01% saponin. After a fixation step by 4% PFA, nuclei were stained with DAPI and GFP fluorescence assessed by fluorescence microscopy (100X magnification).

Results show a drastic decrease of GFP fluorescence in the saponin treated Nox4FL-UbGFP expressing cells indicating that GFP proteins have been released and diffused out of the cell.

**Figure 7 | Topology of Nox4 revealed by ToDUFA method. (a)** Histogram summarizing fluorescence data obtained by FACS experiments of different forms of Nox4 fused to UbGFP. Fluorescence measured in the 0.01% saponin treated cells is expressed relatively to the fluorescence of untreated cells (100%). Red bars show a significant decrease in GFP fluorescence intensity indicating an intracytosolic orientation of the corresponding C-terminus amino acid residue. **(b)** Schematic representation of Nox4 topology, as determined by ToDUFA. Epitopes of monoclonal antibodies (6B11, 5F9 and 8E9) confirm the correct topological determination by ToDUFA of the corresponding Nox4 sequence (Zhang et al. 2011).

**Figure S1 |** Determination of the percentage of saponin necessary to permeabilized HEK293 cells expressing GFP proteins. **(a)** Cartoon showing the leakage of “free” GFP proteins out of the cell upon cell permeabilization by a saponin treatment. **(b)** Cells were suspended in PBS buffer and the fluorescence signal was followed every second by FACS. An initial period of 30 seconds served as a reference for the fluorescence and forward scatter (FSC) base line (discontinuous red line) then an increasing percentage of saponin (0.001 to 0.05%) was added (black arrow) to the cells while FL1 and FSC parameters was continuously monitored during 5 min additional. Efficiency of the permeabilization procedure was monitored by a decrease in the cell size (FSC) and a loss of GFP fluorescence. **(c)** Quantification of GFP fluorescence intensity obtained in (b) from saponin treated cells relative to unpermeabilized cells. **(d)** HEK293 cells expressing GFP were treated with 0.01% saponin for 3 min (lower panel) or left untreated (upper panel), washed with PBS buffer and analyzed by FACS. Grey area indicates wild type HEK293 cells. **(e)** Quantification of GFP fluorescence obtained in (d) of saponin treated cells relative to unpermeabilized cells.

**Figure S2 |** Fluorescence of GFP fusion proteins is not sensitive to saponin treatment. HEK293 cells expressing the GFP tagged form of IL1RI, Nox2N131 and Nox4 truncated or full-length were detached by scraping, treated or not with 0.01% saponin and washed with PBS buffer. GFP fluorescence was then assessed by FACS. **(a)** Histograms show GFP fluorescence

from IL1RI-GFP (left panel), Nox2N131-GFP (right panel) or **(b)** full-length and truncated Nox4-GFP forms.

**Figure S3** | Nox4 topology prediction and constructs designed for ToDUFA study. **(a)** Example of transmembrane prediction for Nox4 amino acid sequence by “DAS” and TMHMM” algorithms. **(b)** Schematic representation of Nox4 protein showing the location of 7 predicted transmembrane domains. A truncated form of Nox4 was designed for each putative loop (residues 46, 98, 144, 184, 239, 341) and attached to its C-terminus moiety to a GFP or UbGFP tag.

## REFERENCES

- Ahram, M., Litou, Z. I., Fang, R. and Al-Tawallbeh, G. (2006) Estimation of membrane proteins in the human proteome. *In Silico Biol.* 6, 379-386
- Almen, M. S., Nordstrom, K. J., Fredriksson, R. and Schioth, H. B. (2009) Mapping the human membrane proteome: a majority of the human membrane proteins can be classified according to function and evolutionary origin. *BMC Biol.* 7, 50
- Biberstine-Kinkade, K. J., Yu, L. and Dinauer, M. C. (1999) Mutagenesis of an arginine- and lysine-rich domain in the gp91(phox) subunit of the phagocyte NADPH-oxidase flavocytochrome b558. *J Biol Chem.* 274, 10451-10457
- Bogdanov, M., Zhang, W., Xie, J. and Dowhan, W. (2005) Transmembrane protein topology mapping by the substituted cysteine accessibility method (SCAM(TM)): application to lipid-specific membrane protein topogenesis. *Methods.* 36, 148-171
- Burritt, J. B., DeLeo, F. R., McDonald, C. L., Prigge, J. R., Dinauer, M. C., Nakamura, M., Nauseef, W. M. and Jesaitis, A. J. (2001) Phage display epitope mapping of human neutrophil flavocytochrome b558. Identification of two juxtaposed extracellular domains. *J Biol Chem.* 276, 2053-2061
- Burritt, J. B., Foubert, T. R., Baniulis, D., Lord, C. I., Taylor, R. M., Mills, J. S., Baughan, T. D., Roos, D., Parkos, C. A. and Jesaitis, A. J. (2003) Functional epitope on human neutrophil flavocytochrome b558. *J Immunol.* 170, 6082-6089
- Caffrey, M. (2003) Membrane protein crystallization. *J Struct Biol.* 142, 108-132
- Campion, Y., Paquet, M. H., Jesaitis, A. J., Marques, B., Grichine, A., Berthier, S., Lenormand, J. L., Lardy, B., Stasia, M. J. and Morel, F. (2007) New insights into the membrane topology of the phagocyte NADPH oxidase: characterization of an anti-gp91-phox conformational monoclonal antibody. *Biochimie.* 89, 1145-1158
- Chen, F., Haigh, S., Barman, S. and Fulton, D. J. (2012) From form to function: the role of Nox4 in the cardiovascular system. *Front Physiol.* 3, 412
- Cheung, J. C. and Reithmeier, R. A. (2007) Scanning N-glycosylation mutagenesis of membrane proteins. *Methods.* 41, 451-459
- Chudakov, D. M., Matz, M. V., Lukyanov, S. and Lukyanov, K. A. (2010) Fluorescent proteins and their applications in imaging living cells and tissues. *Physiol Rev.* 90, 1103-1163
- DeLeo, F. R., Nauseef, W. M., Jesaitis, A. J., Burritt, J. B., Clark, R. A. and Quinn, M. T. (1995) A domain of p47phox that interacts with human neutrophil flavocytochrome b558. *J Biol Chem.* 270, 26246-26251
- Drews, J. (2000) Drug discovery: a historical perspective. *Science.* 287, 1960-1964
- Genestra, M. (2007) Oxyl radicals, redox-sensitive signalling cascades and antioxidants. *Cell Signal.* 19, 1807-1819
- Imajoh-Ohmi, S., Tokita, K., Ochiai, H., Nakamura, M. and Kanegasaki, S. (1992) Topology of cytochrome b558 in neutrophil membrane analyzed by anti-peptide antibodies and proteolysis. *J Biol Chem.* 267, 180-184
- Kim, H., Paul, S., Gennity, J., Jennity, J. and Inouye, M. (1994) Reversible topology of a bifunctional transmembrane protein depends upon the charge balance around its transmembrane domain. *Mol Microbiol.* 11, 819-831
- Klabunde, T. and Hessler, G. (2002) Drug design strategies for targeting G-protein-coupled receptors. *Chembiochem.* 3, 928-944
- Komander, D. (2010) Mechanism, specificity and structure of the deubiquitinases. *Subcell Biochem.* 54, 69-87

- Larsen, C. N., Krantz, B. A. and Wilkinson, K. D. (1998) Substrate specificity of deubiquitinating enzymes: ubiquitin C-terminal hydrolases. *Biochemistry*. 37, 3358-3368
- Lorenz, H., Hailey, D. W. and Lippincott-Schwartz, J. (2006) Fluorescence protease protection of GFP chimeras to reveal protein topology and subcellular localization. *Nat Methods*. 3, 205-210
- Nguyen, M. V., Zhang, L., Lhomme, S., Mouz, N., Lenormand, J. L., Lardy, B. and Morel, F. (2012) Recombinant Nox4 cytosolic domain produced by a cell or cell-free base systems exhibits constitutive diaphorase activity. *Biochem Biophys Res Commun*. 419, 453-458
- Paquet, M. H., Henderson, L. M., Campion, Y., Morel, F. and Dagher, M. C. (2004) Localization of Nox2 N-terminus using polyclonal antipeptide antibodies. *Biochem J*. 382, 981-986
- Varshavsky, A. (2006) The early history of the ubiquitin field. *Protein Sci*. 15, 647-654
- Wang, X., Lupardus, P., Laporte, S. L. and Garcia, K. C. (2009) Structural biology of shared cytokine receptors. *Annu Rev Immunol*. 27, 29-60
- Wilkinson, B. M., Critchley, A. J. and Stirling, C. J. (1996) Determination of the transmembrane topology of yeast Sec61p, an essential component of the endoplasmic reticulum translocation complex. *J Biol Chem*. 271, 25590-25597
- Williams, J. R. and Gong, H. (2007) Biological activities and syntheses of steroidal saponins: the shark-repelling pavoninins. *Lipids*. 42, 77-86
- Yamauchi, A., Yu, L., Potgens, A. J., Kuribayashi, F., Nuno, H., Kanegasaki, S., Roos, D., Malech, H. L., Dinauer, M. C. and Nakamura, M. (2001) Location of the epitope for 7D5, a monoclonal antibody raised against human flavocytochrome b558, to the extracellular peptide portion of primate gp91phox. *Microbiol Immunol*. 45, 249-257
- Yang, Y. S. and Hughes, T. E. (2001) Cre stoplight: a red/green fluorescent reporter of Cre recombinase expression in living cells. *Biotechniques*. 31, 1036, 1038, 1040-1031
- Zhang, L., Nguyen, M. V., Lardy, B., Jesaitis, A. J., Grichine, A., Rousset, F., Talbot, M., Paquet, M. H., Qian, G. and Morel, F. (2011) New insight into the Nox4 subcellular localization in HEK293 cells: first monoclonal antibodies against Nox4. *Biochimie*. 93, 457-468

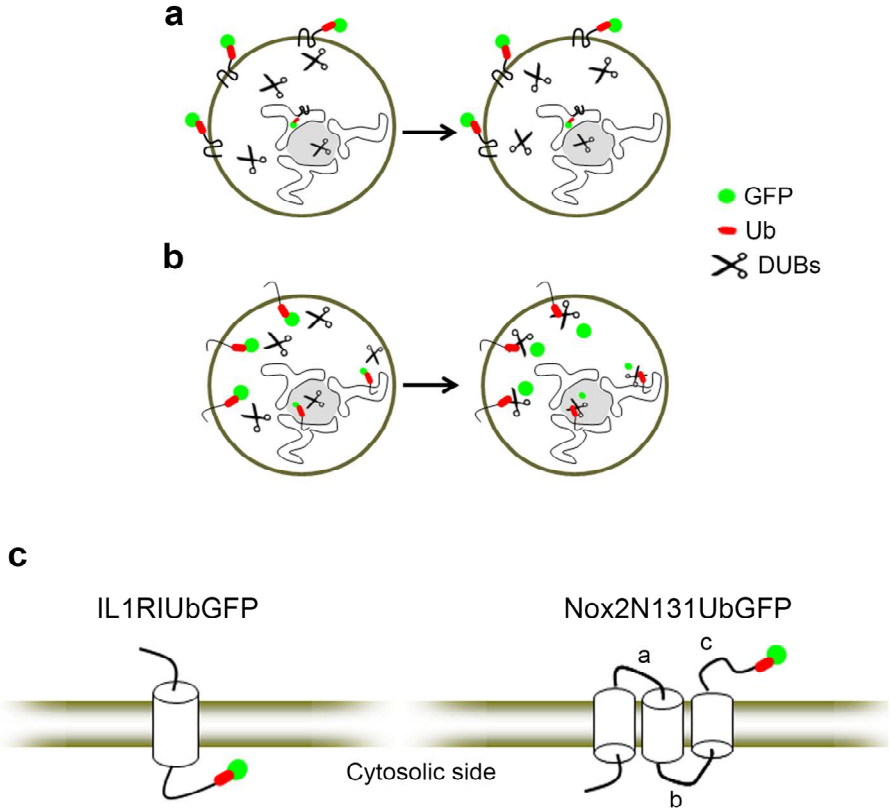

Figure 1



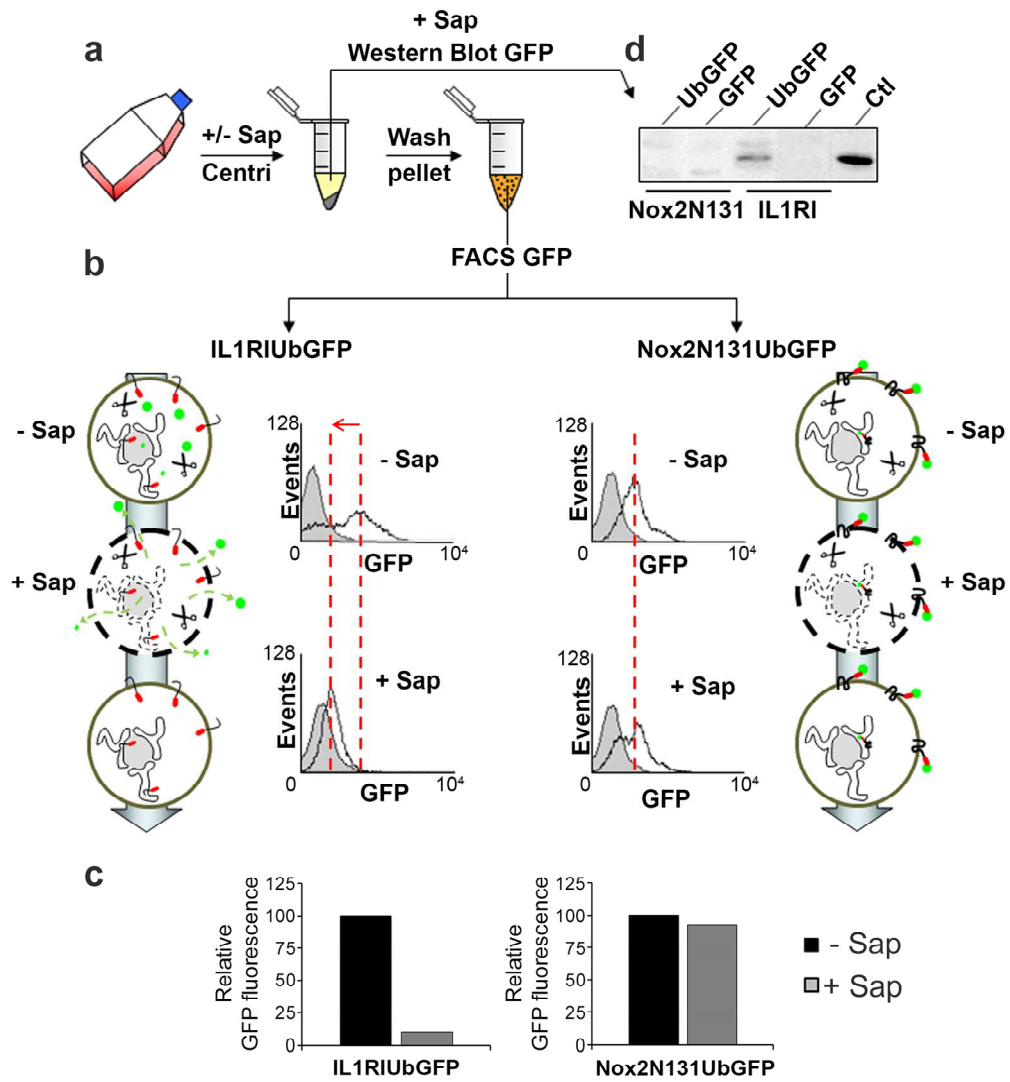

Figure 2

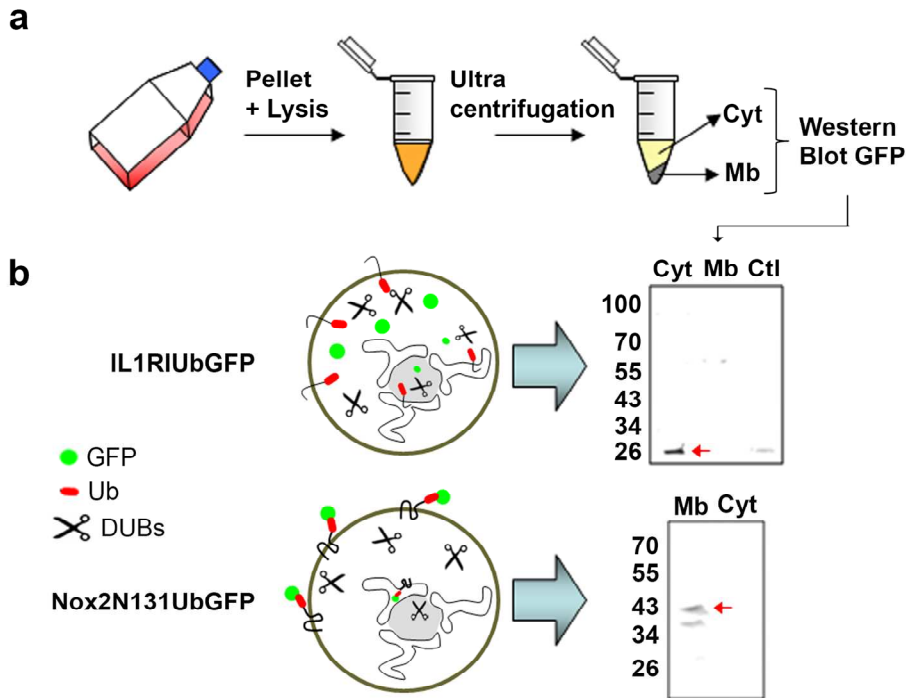
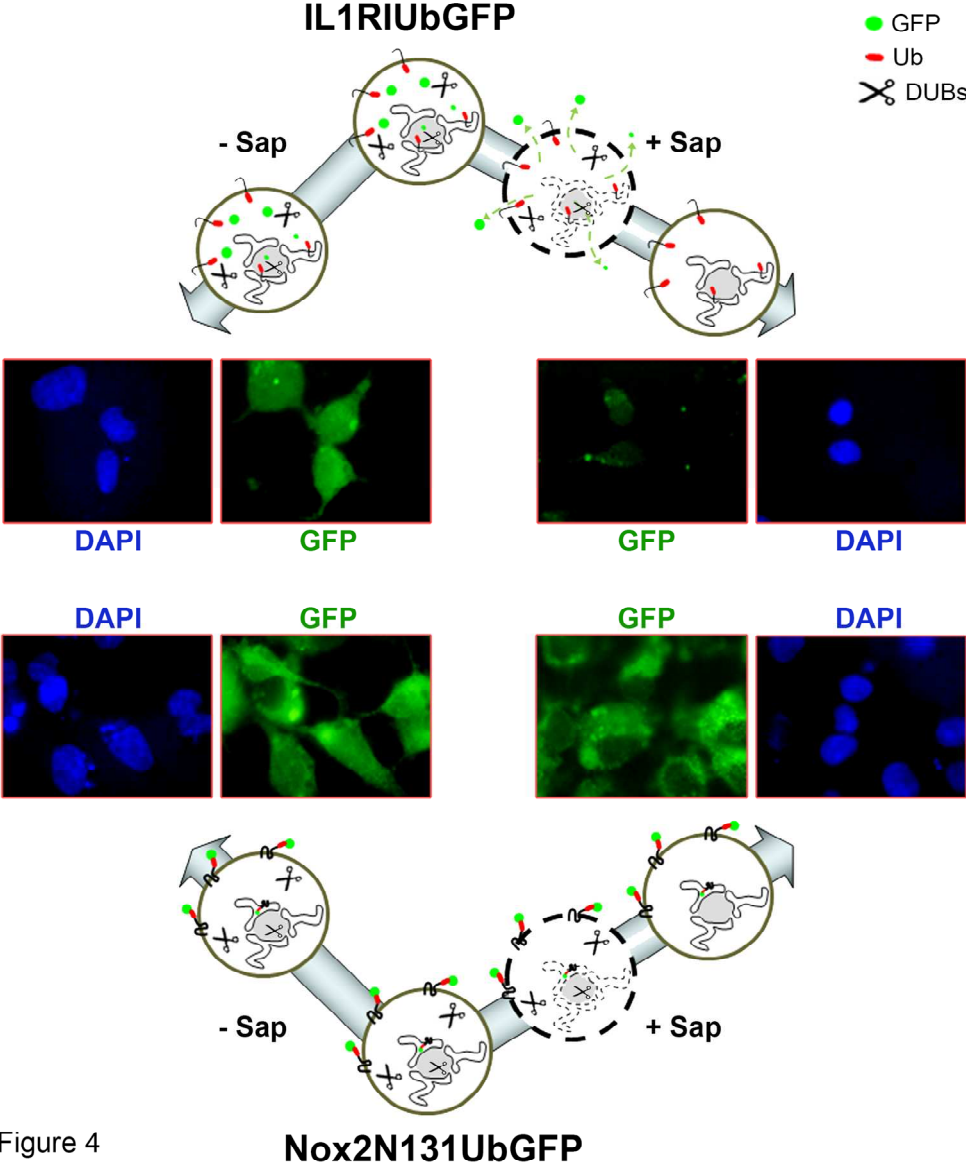

Figure 3



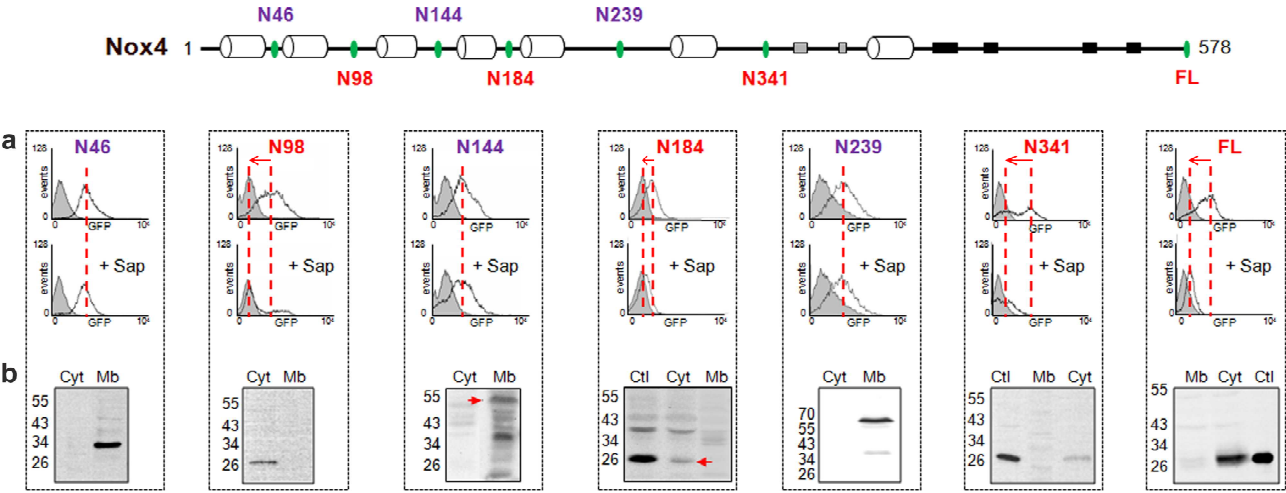

Figure 5

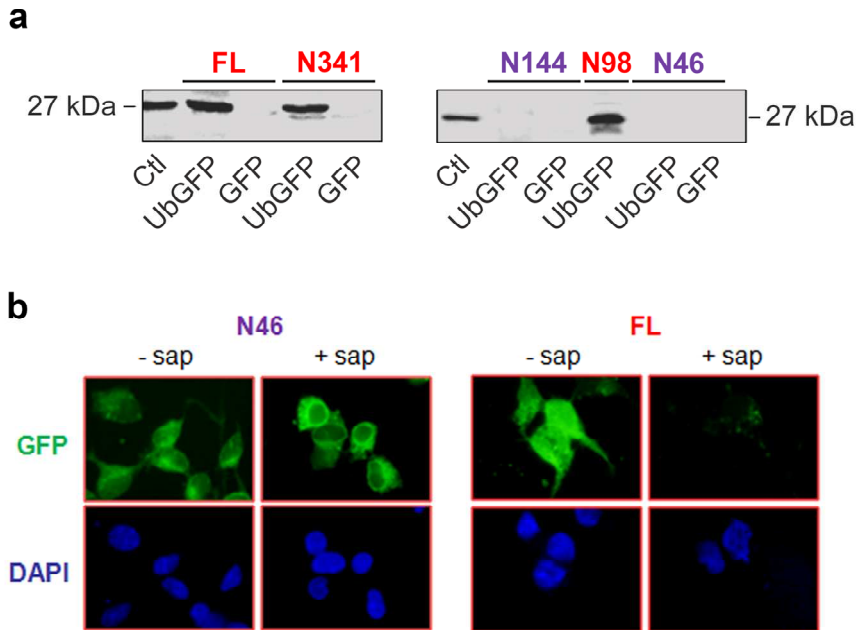

Figure 6

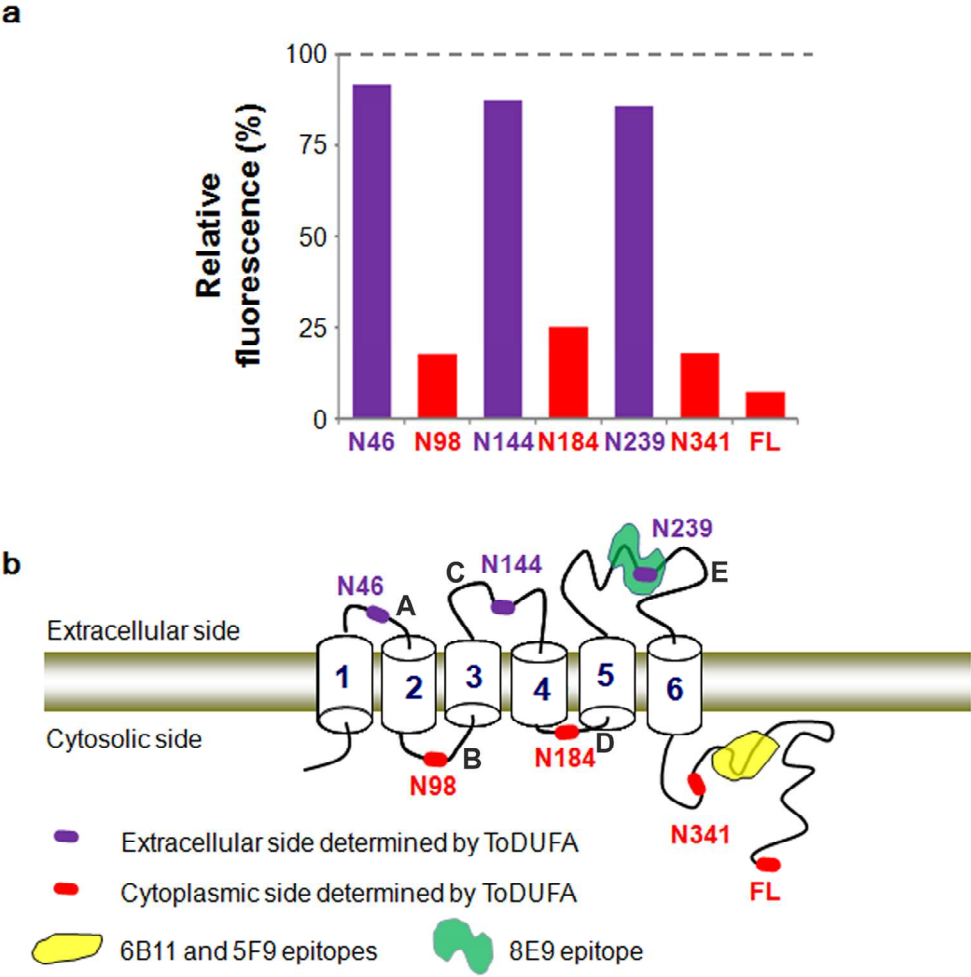
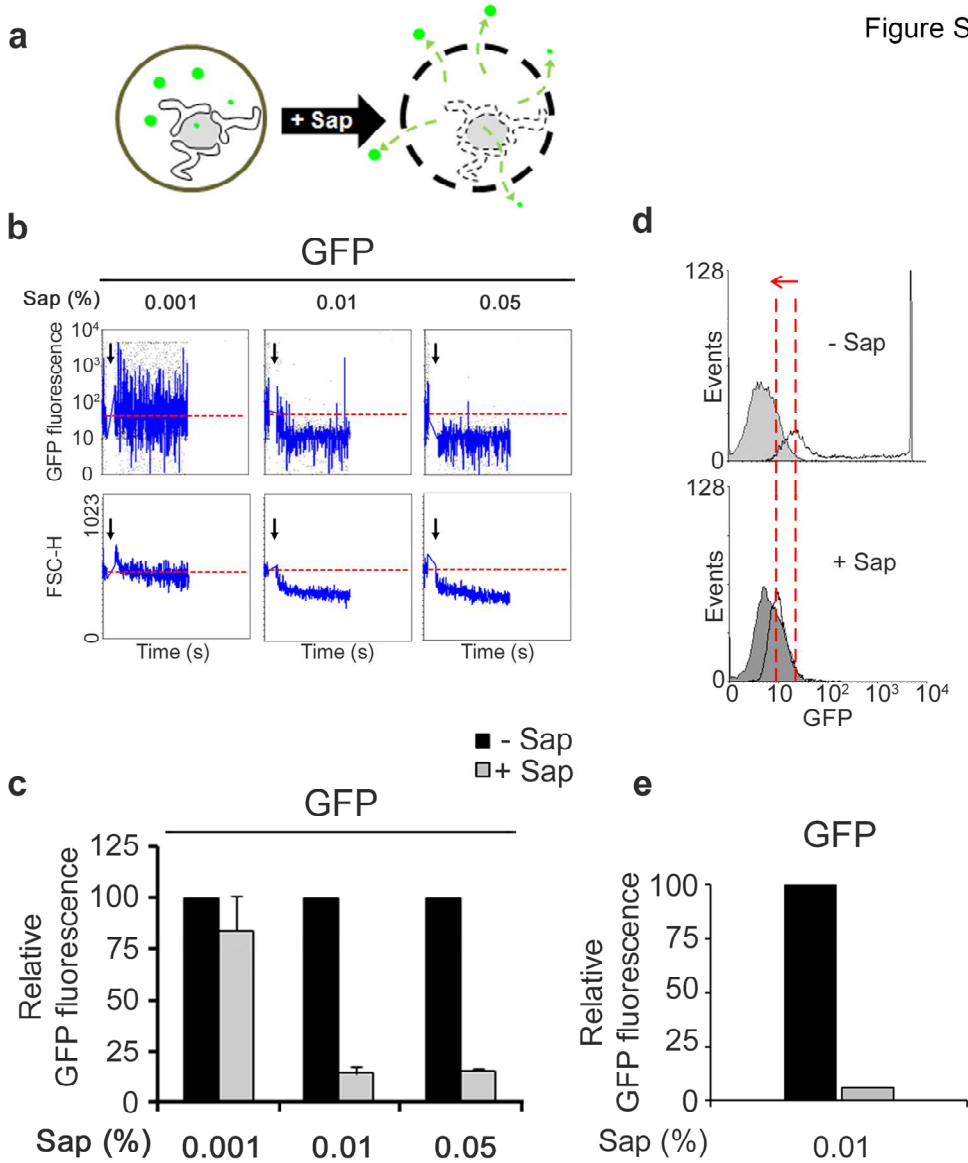

Figure 7

Figure S1



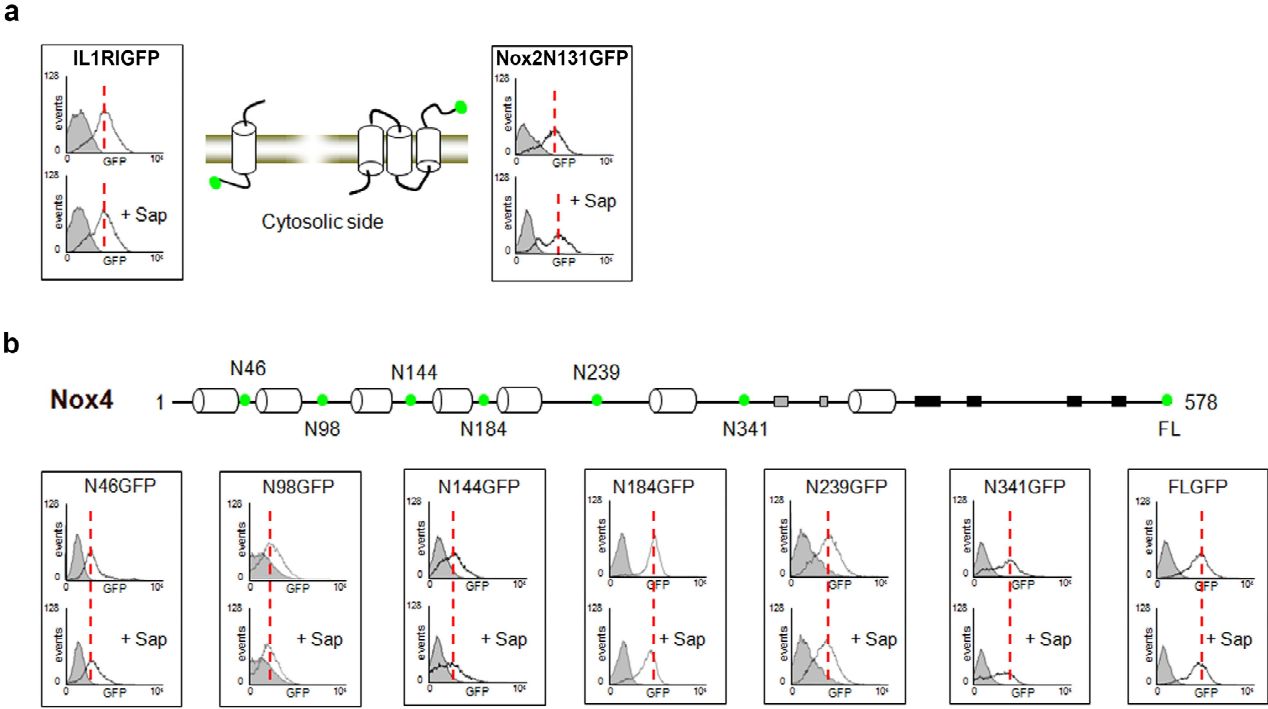

Figure S2



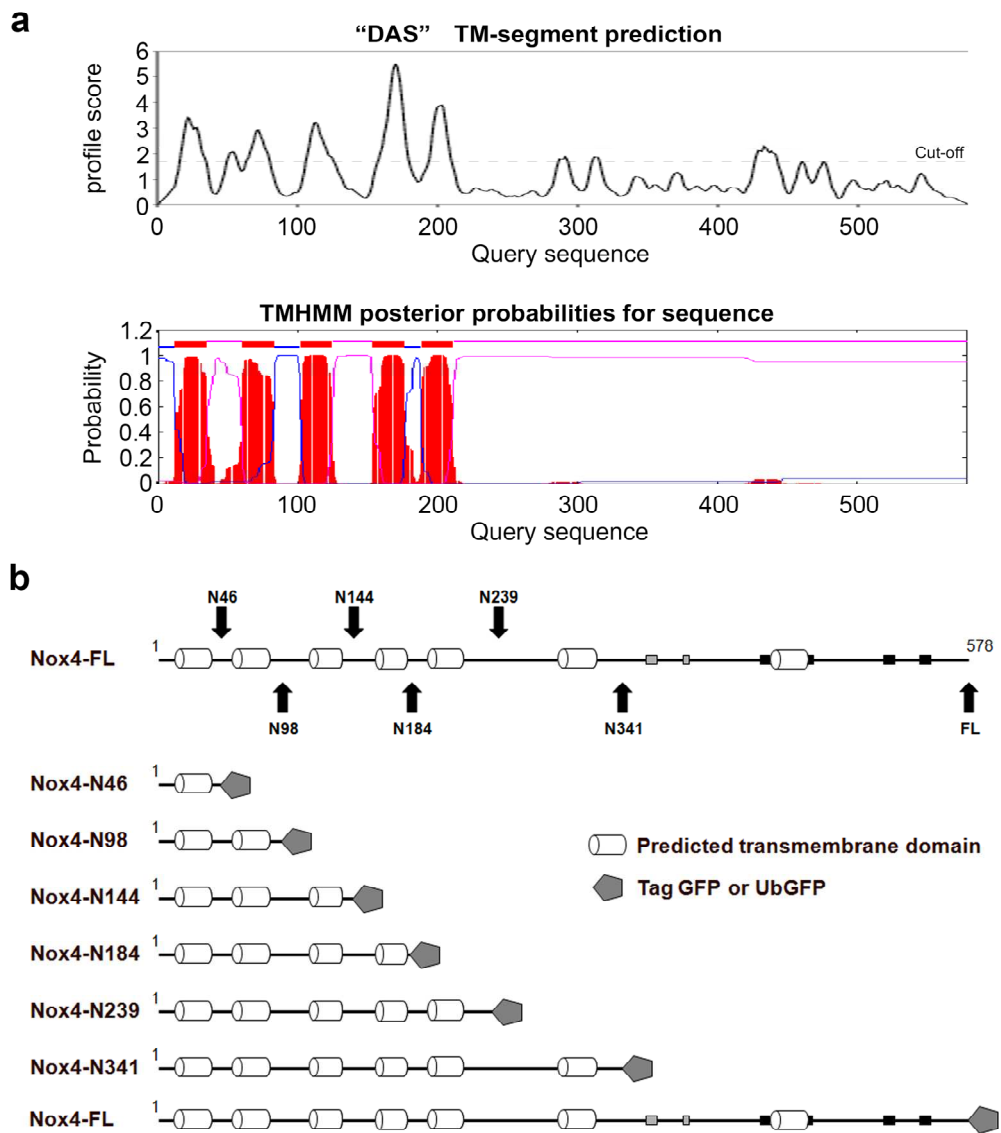

Figure S3

## **CHAPITRE II**

# **Régulation de l'activité NADPH oxydase de Nox4 par l'hème oxygénase-1**

## **Article 2**



**Partie II : Biosynthèse et régulation de l'activité NADPH oxydase de Nox4 ; conséquences dans les chondrocytes de lignée C-20/A4.**

Dans l'arthrose, la surexpression des métalloprotéinases matricielles ainsi que l'apoptose des chondrocytes conduisent à une altération irréversible des propriétés biochimiques et biomécaniques du cartilage. Les chondrocytes humains de la lignée C-20/A4 sont un modèle validé pour l'étude de cette pathologie (Goldring et al. 1994). Ils expriment Nox4, dont l'activité conduit à la synthèse de la MMP-1, responsable de la protéolyse du collagène, en réponse à l'IL-1 $\beta$  (Grange et al. 2006).

Nox4 fonctionne en dimère avec p22<sup>phox</sup>, sa sous unité stabilisatrice. Nox4 se distingue des autres isoformes de la famille des NADPH oxydases chez l'homme par sa capacité à fonctionner de manière constitutive, en l'absence de partenaires régulant son activité. Mais des données récentes de la littérature dévoilent par la technique du double hybride des interactions de l'hétérodimère Nox4/p22<sup>phox</sup> avec poldip2 et le TLR4 (Park et al. 2004; Lyle et al. 2009). Ces deux protéines ont été rapportées comme activant la production de ROS par Nox4. De même, la protéine NQO1 (NADPH Quinone Oxydoreductase-1) est capable d'activer spécifiquement Nox4 par un mécanisme impliquant des composés quinones (Nguyen et al. 2013).

Au contraire, Pandey et ses collaborateurs ont proposé un rôle inhibiteur de l'activité de Nox4 par SUMO-1 (Small Ubiquitin MODifier-1), protéine possédant une homologie avec l'ubiquitine (Pandey et al. 2011). Cependant, les mécanismes moléculaires n'ont pas pu être caractérisés dans cette étude.

Un inhibiteur pharmacologique de Nox4 a récemment été développé par la société GenKyoTex (Laleu et al. 2010). Cet inhibiteur est actuellement en cours d'évaluation dans le diabète de type 2 (Sedeek et al. 2013). Cependant, malgré l'intérêt potentiel que cela pourrait générer au plan thérapeutique, la recherche de partenaires réprimant physiologiquement l'activité de Nox4 est toujours en cours.

L'hème oxygénase est l'enzyme limitante dans le catabolisme de l'hème. Les effets de HO-1 sur l'activité des isoformes Nox1 et Nox2 ont déjà été rapporté dans la littérature (Taille et al. 2004; Datla et al. 2007; Rodriguez et al. 2009). En revanche, aucune étude ne s'est encore focalisée sur les effets de HO-1 sur l'activité de Nox4. L'expression de l'isoforme HO-1 est ubiquitaire en réponse à différents stimuli engendrant un stress oxydant. De par son

## Travaux de recherche

homologie avec la molécule d'hème, la protoporphyrine à Cobalt (CoPP), est un inducteur pharmacologique bien connu de HO-1 (Shan et al. 2006).

Les travaux précédents, effectués au laboratoire ont fait état de l'implication de Nox4 dans la signalisation initiée par l'IL-1 $\beta$  et conduisant à la synthèse de la collagénase MMP-1 dans la lignée C-20/A4 (Grange et al. 2006). Dans cette deuxième partie, L'objectif est d'induire l'expression de HO-1 par le CoPP ou par transfection afin d'étudier son impact sur l'activité de Nox4 ainsi que sur l'expression de la MMP-1 par le chondrocyte.

L'hème est une molécule indispensable à l'activité catalytique des NADPH oxydases. Son implication a été démontrée dans le processus de maturation de Nox2 où il permet notamment sa dimérisation avec p22<sup>phox</sup> et son adressage membranaire (Yu et al. 1997). Dans un deuxième temps, nous avons donc cherché à comprendre les mécanismes moléculaires de la régulation de l'activité de Nox4 par HO-1. Pour cela, les conséquences du catabolisme de l'hème par HO-1 sur Nox4 ont été comparées à l'inhibition de sa synthèse par le succinylacétone (SA). Les résultats obtenus sur la lignée C-20/A4 ont été validés sur la lignée HEK293-TRex, inductible pour l'expression de Nox4.

Les résultats obtenus s'articulent en 4 points et démontrent que :

- 1- Les radicaux oxydants produits par Nox4 contrôlent non seulement l'expression de la MMP-1, mais aussi entraînent la fragmentation de l'ADN et la mort des chondrocytes dans la lignée cellulaire C-20/A4 traitée par IL-1 $\beta$ .
- 2- L'inhibition de la synthèse de l'hème affecte profondément la maturation et la fonction de l'hétérodimère Nox4/p22 dans les lignées C-20/A4 et HEK293 TRex.
- 3- L'expression de HO-1 conduit à une diminution significative de l'activité de Nox4 mais de façon inattendue, n'affecte pas son niveau d'expression, ni sa localisation subcellulaire
- 4- Enfin, HO-1 semble réguler l'activité de Nox4 au niveau post traductionnel par l'intermédiaire du CO produit dans la réaction catalysée. De façon intéressante, HO-1 ou le CO entraînent une diminution significative et comparable de la quantité de MMP-1 sécrétée et de l'apoptose des chondrocytes.

## Chapitre II : Régulation de l'activité de Nox4

Il semble donc exister un équilibre entre l'activité de Nox4 et celle de HO-1. Intervenir sur cet équilibre dans le chondrocyte pourrait permettre de restaurer l'homéostasie de la matrice extracellulaire cartilagineuse. En conséquence, les molécules modulatrices de l'expression de HO-1 pourraient constituer une stratégie thérapeutique dans l'arthrose.

*Dans ce travail, j'ai transfecté, sélectionné et cultivé les chondrocytes C-20/A4, induit l'expression de HO-1 et mesuré l'activité de Nox4 par chimiluminescence et fluorescence. J'ai étudié les conséquences de la modulation de l'expression de Nox4 et de HO-1 sur la synthèse de MMP-1 et la fragmentation de l'ADN des chondrocytes C-20/A4. J'ai enfin comparé les effets du catabolisme de l'hème aux effets de l'inhibition de sa synthèse sur la maturation de Nox4 par Western Blot, par FACS, par microscopie confocale et par cytométrie en flux.*

Article 2 : **Francis Rousset**, Minh Vu Chuong Nguyen, Laurent Grange, Françoise Morel, Bernard Lardy (2013). Heme oxygenase-1 regulates matrix metalloproteinase MMP-1 secretion and chondrocyte DNA fragmentation via Nox4 NADPH oxidase activity. *PLoS ONE* 8(6): e66478. doi:10.1371/journal.pone.0066478

# Heme Oxygenase-1 Regulates Matrix Metalloproteinase MMP-1 Secretion and Chondrocyte Cell Death via Nox4 NADPH Oxidase Activity in Chondrocytes

Francis Rousset<sup>1\*</sup>, Minh Vu Chuong Nguyen<sup>1</sup>, Laurent Grange<sup>1,2</sup>, Françoise Morel<sup>1</sup>, Bernard Lardy<sup>1,3</sup>

**1** Université Joseph Fourier, AGIM GREPI FRE CNRS 3405, Grenoble, France, **2** Rheumatology Department, Grenoble Teaching Hospital, CHU Hôpital Sud, Grenoble, France, **3** Laboratoire de Biochimie Enzyme et Protéine-DBTP, Institut de Biologie et de Pathologie, Centre Hospitalier Universitaire (CHU), Grenoble, France

## Abstract

Interleukin-1 $\beta$  (IL-1 $\beta$ ) activates the production of reactive oxygen species (ROS) and secretion of MMPs as well as chondrocyte apoptosis. Those events lead to matrix breakdown and are key features of osteoarthritis (OA). We confirmed that in human C-20/A4 chondrocytes the NADPH oxidase Nox4 is the main source of ROS upon IL-1 $\beta$  stimulation. Since heme molecules are essential for the NADPH oxidase maturation and activity, we therefore investigated the consequences of the modulation of Heme oxygenase-1 (HO-1), the limiting enzyme in heme catabolism, on the IL-1 $\beta$  signaling pathway and more specifically on Nox4 activity. Induction of HO-1 expression decreased dramatically Nox4 activity in C-20/A4 and HEK293 T-REx<sup>TM</sup> Nox4 cell lines. Unexpectedly, this decrease was not accompanied by any change in the expression, the subcellular localization or the maturation of Nox4. In fact, the inhibition of the heme synthesis by succinylacetone rather than heme catabolism by HO-1, led to a confinement of the Nox4/p22<sup>phox</sup> heterodimer in the endoplasmic reticulum with an absence of redox differential spectrum highlighting an incomplete maturation. Therefore, the downregulation of Nox4 activity by HO-1 induction appeared to be mediated by carbon monoxide (CO) generated from the heme degradation process. Interestingly, either HO-1 or CO caused a significant decrease in the expression of MMP-1 and DNA fragmentation of chondrocytes stimulated by IL-1 $\beta$ . These results all together suggest that a modulation of Nox4 activity via heme oxygenase-1 may represent a promising therapeutic tool in osteoarthritis.

**Citation:** Rousset F, Nguyen MVC, Grange L, Morel F, Lardy B (2013) Heme Oxygenase-1 Regulates Matrix Metalloproteinase MMP-1 Secretion and Chondrocyte Cell Death via Nox4 NADPH Oxidase Activity in Chondrocytes. PLoS ONE 8(6): e66478. doi:10.1371/journal.pone.0066478

**Editor:** Yves St-Pierre, INRS, Canada

**Received:** March 18, 2013; **Accepted:** May 8, 2013; **Published:** June 20, 2013

**Copyright:** © 2013 Rousset et al. This is an open-access article distributed under the terms of the Creative Commons Attribution License, which permits unrestricted use, distribution, and reproduction in any medium, provided the original author and source are credited.

**Funding:** This work was supported by grants from the « Ministère de l'Enseignement Supérieur de la Recherche et Technologie, Paris, the « UFR de Médecine, Université Joseph Fourier, Grenoble the « Groupement des Entreprises Françaises dans la lutte contre le Cancer, délégation de Grenoble, the « Société Française de Rhumatologie and the « Délégation à la Recherche Clinique et à l'Innovation, Centre Hospitalier Universitaire, Grenoble. FR is supported by grants from the Fondation Arthritis Courtin. The funders had no role in study design, data collection and analysis, decision to publish, or preparation of the manuscript.

**Competing Interests:** The authors have declared that no competing interests exist.

\* E-mail: francisrousset@yahoo.fr

## Introduction

The pathogenesis of osteoarthritis involves an imbalance between anabolic and catabolic pathways in chondrocytes. The expression of matrix metalloproteinases (MMPs), chondrocyte hypertrophy and apoptosis are the main features of the pathology. Proinflammatory cytokines, such as interleukin-1 $\beta$  (IL-1 $\beta$ ) and tumor necrosis factor- $\alpha$  (TNF- $\alpha$ ) cause damages to cartilage via the synthesis and the secretion of MMPs, which in turn lead to matrix degradation [1,2,3,4,5]. Indeed, elevated levels of IL-1 $\beta$  were found in OA synovial fluid, and the expression of IL-1 $\beta$  gene is up-regulated in OA cartilage [6]. In response to IL-1 $\beta$ , articular chondrocytes actively produce reactive oxygen species (ROS). ROS have been suggested to act as secondary messengers in bovine chondrocytes and are involved in AP-1 and NF-kappaB activation pathways leading to the transcription of cytokine-induced MMP-1 and MMP-13 metalloproteinases [7,8,9,10]. The maturity-arrested differentiation state, also called hypertrophic differentiation that could promote OA progression, is observed among OA chondrocytes *in situ*. Indeed, hypertrophic chondrocytes undergo apoptosis leading to a dysregulation of matrix repair mechanism [11].

The role of ROS is nowadays well established in this terminal differentiation [12,13,14].

ROS are important regulators of redox-sensitive cell-signalling pathways and are involved in various biological processes including host defence, cell signalling, oxygen sensing, cell proliferation, differentiation and apoptosis. However, overproduction of ROS has been associated with many pathological conditions such as inflammation, vascular atherosclerosis, diabetes, hypertension, tumorigenesis, neurodegenerative pathologies and osteoarthritis [15,16]. NADPH oxidases (Nox) function of is solely dedicated to the production of ROS. Nox2 NADPH oxidase activity in phagocyte is well characterized and plays an essential role in innate immunity [17]. Nox family is composed of seven members who share specific structural homology regions [18]. Among them, Nox4 represents the major source of ROS in kidney and is widely expressed in many others tissues including the vascular system and bones [19,20]. For example, in osteoclasts, ROS production by Nox4 has been shown to directly contribute to bone resorption [20].

Despite evidences of ROS implication in OA, only few studies investigated the function of NADPH oxidase in human chondrocytes. Recently, Coustry and co-workers demonstrated that Nox4

mRNA is 100 fold upregulated in a chondrocyte model of pseudoachondroplasia characterized by abnormal joint architecture, joint erosion and osteoarthritis [21]. Our previous data showed that the oxidase complex Nox4/p22<sup>phox</sup> is expressed in the C-20/A4 human chondrocyte cell line and represents an important source of ROS generation [22]. In this cell line, Nox4 activity modulates MMP-1 expression and DNA fragmentation upon IL-1 $\beta$  treatment, events that are implicated in OA pathogenesis. Consequently, targeting Nox4 activity may represent a promising therapeutic strategy against osteoarthritis.

NADPH oxidase catalytic activity is dependent on two heme molecules which transfer electrons from the FAD to molecular oxygen to give rise to superoxide anion (O<sub>2</sub><sup>•-</sup>). Heme oxygenase-1 (HO-1) is the limiting enzyme in heme catabolism. HO-1 catalyzes the linearization of the heme molecule to produce an equimolar amount of biliverdin (BV) and carbon monoxide (CO). BV is subsequently converted to bilirubin (BR) by the NADPH biliverdin reductase. BV and BR are potent antioxidants [23] while CO has strong anti-inflammatory properties [24]. During Nox2 maturation, heme is incorporated into a 65 kDa precursor allowing its dimerization with the stabilizing subunit p22<sup>phox</sup> [25]. The complex called cytochrome *b<sub>558</sub>* (cyt *b<sub>558</sub>*) is then glycosylated and addressed to the plasma membrane. In presence of succinylacetone, a heme synthesis inhibitor, the maturation process was markedly reduced causing a significant decrease of NADPH oxidase activity [26].

In this study, we investigate whether the modulation of HO-1 expression could inhibit Nox4 activity and consequently reduce MMP-1 secretion and cell death. We first observed that the inhibition of heme synthesis by succinylacetone affected profoundly Nox4/p22<sup>phox</sup> heterodimer formation and subcellular localization emphasising the role of heme synthesis in the Nox4/p22<sup>phox</sup> maturation. Conversely, heme catabolism by HO-1 decreased Nox4 activity in the C-20/A4 chondrocytes and in the HEK293 T-REx<sup>TM</sup> Nox4 cells without affecting the Nox4/p22<sup>phox</sup> heterodimer formation and plasma membrane addressing. In fact, our results suggest that HO-1 inhibits Nox4 activity through carbon monoxide generated through the heme degradation process. Interestingly, in chondrocyte stimulated by IL-1 $\beta$ , inhibition of Nox4 activity by HO-1 led to a significant decrease in the expression of the MMP-1, DNA fragmentation and cell death. This suggests that the cartilage homeostasis provided by chondrocytes could depend on the balance between Nox4 and HO-1 expression, and may qualify Nox4 and HO-1 as potential therapeutic targets in osteoarthritis.

## Materials and Methods

### Material

Chemical reagents used in this study and their sources were the following: Dulbecco's modified Eagle's medium (DMEM), fetal bovine serum (FBS) and geneticin (G418) (life technologies, Saint Aubin, France); blasticidin (Funakoshi Co, Tokyo, Japan); AMV Reverse transcriptase (QBiogene, Illkirch, France); Zero Blunt TOPO PCR cloning kit, TRIzol<sup>®</sup> reagent, Taq polymerase, Alexa Fluor 488, 546 or 633 labelled goat anti-mouse IgG, Alexa Fluor 546 anti-rabbit, Alexa Fluor 546 anti-goat, Hoechst 33258, pEFb and pcDNA3.1 plasmids (Invitrogen, Cergy Pontoise, France); ECL Western Blotting detection reagents and Goat anti-Mouse IgG-HRP antibody (GE healthcare, Buckinghamshire, England); Na<sub>4</sub>P<sub>2</sub>O<sub>7</sub>, Na<sub>3</sub>VO<sub>4</sub>, PMSF, luminol, Horseradish Peroxidase (HRPO), Triton X-100, protoporphyrin-IX cobalt chloride (CoPP-IX), succinylacetone (SA), tricarbonylchlororutenium (II) dimer (CORM-II), ruthenium III chloride (RuCl) and bilirubin

(BR) (SIGMA, Saint Quentin Fallavier, France); Biliverdin hydrochloride (BV) (tebu-bio, Le Perray en Yvelines, France); Okadaic acid, leupeptin, pepstatin, trypsin inhibitor, TLCK, human interleukin-1 $\beta$ , complete mini EDTA-free protease inhibitor EASYpack, FuGENE transfection reagent and lactate dehydrogenase (LDH) optimized kits (Roche, Meylan, France); diisopropylfluorophosphate (DFP, Acros Organics, Halluin, France); polyclonal Ig from goat against HO-1 (sc-7695) or against actin (sc-1615) and control Ig (Santa Cruz Biotechnologies, Heidelberg, Germany); Lab-Tek chambered coverglass (Thermo scientific, Courtaboeuf, France); anti-MMP-1 monoclonal antibody (mAb 901) (R&D Systems, Lille, France); Rabbit polyclonal Ig against calnexin (ab10286) or against VDAC (ab28777) (Abcam, Paris, France); mammalian expression plasmid encoding for Nox4A or Nox4B (pEFb) [22]; pcDNA 3.1 Nox4GFP and Nox4 monoclonal antibodies (8E9 and 6B11) [27].

### Cell Lines and Culture

Human C-20/A4 chondrocyte cell line is a gift from Dr M.B. Goldring (Harvard Institute of Medicine, Boston, MA, USA) [5]. HEK293 T-REx<sup>TM</sup> Nox4 cells were provided by Pr KH. Krause (Geneva University, PATIM laboratory, Switzerland) [28]. Cells were cultured in DMEM containing 4.5 g/L glucose and 0.11 g/L sodium pyruvate, supplemented with 10% (v/v) fetal bovine serum, 100 units/ml penicillin, 100 mg/ml streptomycin and 2 mM glutamine at 37°C in atmosphere containing 5% CO<sub>2</sub> [27]. Blasticidin (5  $\mu$ g/ml) and G418 (400  $\mu$ g/ml) were used for HEK293 T-REx<sup>TM</sup> Nox4 cells. For experiments with IL-1 $\beta$ , complete cell culture medium was replaced by serum free DMEM. C-20/A4 chondrocytes were then stimulated with IL-1 $\beta$  supplemented or not with antioxidants during 48h for MMP-1 assay and 5 days for cell death assessment. All experiments were performed within cell passages 3 to 10 at 60–90% confluence.

### Generation of Plasmid Constructs for Heme Oxygenase-1 (HO-1) Expression

Human HO-1 cDNA was obtained by PCR after RNA extraction and cDNA amplification from CoPP-IX treated C-20/A4 chondrocytes. HO-1 sequence amplification was realized with the forward primer HO-1-F1 (5' **GTTTAAGCTTATG-GAGCGTCCGCAACCCGAC** 3') including a Hind III site (in bold type) and the reverse primer HO-1-R1 (5' **CTTTCTCGAGTCACATGGCATAAAGCCCTACAGC** 3') comprising a Xho I restriction site (in bold type). The purified HO-1 PCR product was subcloned into the pcR Blunt II-TOPO vector according to the manufacturing protocol (Zero Blunt TOPO PCR cloning kit, (Invitrogen)). pcR-Blunt II-TOPO plasmid containing HO-1 encoding sequence was digested by Hind III and Xho I, and HO-1 insert was ligated into linearized pcDNA 3.1 vector (Invitrogen). Plasmid encoding for HO-1 was checked by sequencing (Genome Express, Grenoble, France).

### Stable Transfection of Mammalian Expression Plasmids

C-20/A4 chondrocyte cells were trypsinized and counted. 4 $\times$ 10<sup>5</sup> C-20/A4 cells were seeded in 6-well plates and allowed to grow for 24h to reach a 60% confluence in 2 mL complete DMEM culture medium. Cells were transfected with 1  $\mu$ g of pEFb vectors encoding for Nox4A or Nox4B or 1  $\mu$ g pcDNA3.1 vector encoding for Nox4GFP or HO-1 according to the manufacturing protocol (FuGENE, Roche). After 24 h, transfected cells were selected for 3 weeks with 10  $\mu$ g/ml blasticidin for pEFb vector or 900  $\mu$ g/ml geneticin for pcDNA3.1.



### Measurement of NADPH Oxidase Activity in Intact Cells by Luminescence Assay

ROS production was measured as described by Grange et al [22]. Briefly, cells were detached with trypsin, washed twice with PBS and collected by centrifugation (400 g, 8 min, RT). The viability of the suspended cells was over 90%, as determined by the trypan blue exclusion method. In a 96-well plate,  $5 \times 10^5$  living cells resuspended in 50  $\mu$ l were added per well. Before the start of the assay, 200  $\mu$ l of a PBS solution containing 20  $\mu$ M luminol, and 10 units/ml of horseradish peroxidase was added in each well. Relative luminescence unit (RLU) counts were recorded every 30 s for a total of 45 min at 37°C using a Luminoscan® luminometer (Labsystems, Helsinki, Finland).

### Cell Extracts Preparation

Cells were treated with 3 mM DFP and lysed in Triton X-100 lysis buffer containing 20 mM Tris-HCl pH 7.4, 1% (v/v) Triton X-100, 150 mM NaCl, 1 mM EDTA, 10 mM  $\text{Na}_4\text{P}_2\text{O}_7$ , 10 nM okadaic acid, 2 mM  $\text{Na}_3\text{VO}_4$ , 2  $\mu$ g/ml leupeptin, 2  $\mu$ g/ml pepstatin, 10  $\mu$ g/ml trypsin inhibitor, 44  $\mu$ g/ml PMSF, 10  $\mu$ M TLCK and complete mini EDTA-free protease inhibitor (Triton X-100 cell extract). After 10 min incubation on ice, the mixture was centrifuged at 1000 g for 10 min at 4°C. The supernatant was then used for SDS-PAGE and Western Blotting or cytochrome *b* spectroscopy.

### Reduced Minus Oxidized Difference Spectra of Nox4

Reduced minus oxidized difference spectra were performed on Triton X-100 extract from C-20/A4 chondrocytes transfected or not with Nox4 and HMOX1 genes (HMOX1 encoded for HO-1). Reduction was achieved in the cuvette by addition of a few grains of sodium dithionite, and reduced minus oxidized difference spectra were recorded at room temperature with a DU 640 spectrophotometer (Beckman Coulter, Roissy, France). The amount of cyt *b* was determined by absorbance at 426 nm using the  $\epsilon$  value of the cytochrome  $b_{558}$  of Nox2 ( $106 \text{ mM}^{-1} \text{ cm}^{-1}$ ). A positive control was performed on cytochrome  $b_{558}$  purified from human neutrophils [29].

### SDS/PAGE and Western Blotting

Triton X-100 cell extract or centricon 10X concentrated cell culture supernatant were denatured at 60°C for 30 min or 4°C overnight and loaded on 10% or 12.5% (p/v) SDS-PAGE for migration and then electro-transfer to nitrocellulose. Immunodetection was performed using antibodies raised against Nox4 (mAb 8E9 or 6B11, 1:500) [27], MMP-1 (1:500), HO-1 (1:500), Actin (1:1000) or VDAC (1:1000). Secondary antibody was conjugated to peroxidase (1:5000). Peroxidase activity was detected using ECL reagents (GE Healthcare).

### Flow Cytometry

To assess the DNA fragmentation, C-20/A4 chondrocytes were fixed overnight in ice cold absolute ethanol, washed twice in PBS and  $2 \times 10^6$  cells were stained with 50  $\mu$ g/ml propidium iodide in presence of 100  $\mu$ g/ml RNase. After 30 min incubation on ice, propidium iodide emission of fluorescence (615 nm) was assessed by FACS. Plasma membrane localization of Nox4 was assessed on HEK293 T-REx™ Nox4 cells induced for Nox4 expression with tetracycline and treated or not with 25  $\mu$ M Cobalt Protoporphyrin-IX (CoPP-IX) or 25  $\mu$ g/ml succinylacetone during 48 h.  $10^6$  unpermeabilized cells were then suspended in 150  $\mu$ l PBS containing 0.2% (w/v) BSA and 0.5 mM  $\text{CaCl}_2$  (PBS/BSA/ $\text{CaCl}_2$  buffer) and incubated on ice for 30 min with 5  $\mu$ g of mouse

monoclonal Ig (irrelevant Ig or 8E9 mAb) [27]. Cells were washed twice and resuspended in 150  $\mu$ l of the Alexa Fluor 488 goat anti-mouse antibody diluted 1:200 in PBS/BSA/ $\text{CaCl}_2$  buffer. After 30 min incubation on ice, cells were washed twice and fluorescence intensity was assessed. All FACS experiments were performed on a FACSCanto II cytometer (Becton Dickinson).

### Confocal Microscopy

Nox4GFP overexpressing C-20/A4 chondrocytes were seeded on coverslips for 48 h and treated or not with 25  $\mu$ M Cobalt Protoporphyrin-IX or 25  $\mu$ g/ml succinylacetone. When confluence reached 60%, cells were fixed with 4% (w/v) paraformaldehyde (PFA) for 10 min and PFA fluorescence was quenched by 50 mM  $\text{NH}_4\text{Cl}$  for 10 min at RT. Nox4 subcellular localization in C-20/A4 chondrocytes was assessed by 1 h incubation at room temperature with 5  $\mu$ g of mouse monoclonal Ig (irrelevant Ig or 8E9 mAb) in 200  $\mu$ l of PBS containing 1% (w/v) BSA (PBS/BSA buffer). Cells were then washed twice with PBS/BSA buffer and permeabilized with 0.1% (v/v) Triton X-100 during 10 min at RT. Non treated and HO-1 induced chondrocytes were stained for 1 h at RT with a goat anti HO-1 antibody (1/50 in PBS/BSA buffer). Meanwhile, succinylacetone treated cells were incubated at RT with 5  $\mu$ g rabbit anti calnexin antibody in 200  $\mu$ l PBS/BSA buffer. After two washes with PBS/BSA buffer, 1 h incubation with anti-goat (for HO-1 labeled cells) or anti-rabbit (for calnexin) secondary antibodies conjugated to Alexa 546 (1/200) was performed at RT in PBS/BSA buffer. Finally, plasma membrane Nox4/8E9 mAb complex was revealed with 1 h incubation at RT with a goat anti-mouse antibody conjugated to Alexa 633 diluted 1/200 in PBS/BSA buffer. For Nox4/p22<sup>phox</sup> heterodimer formation study, C-20/A4 chondrocytes were permeabilized for 10 minutes with 0.1% (v/v) Triton X-100 and were stained for 1 h with 5  $\mu$ g of 16G6 mAb directed against p22<sup>phox</sup> [30] in 200  $\mu$ l PBS/BSA buffer. After two washes, p22<sup>phox</sup> staining was revealed with a goat anti mouse antibody labeled Alexa 546 (red). In all experiments, cell nuclei were stained with Hoechst 33258 (0.5  $\mu$ g/ml) and mounted in DABCO solution; they were sealed, and stored at 4°C in the dark. Confocal microscopy was carried out by using the Zeiss LSM510 NLO META. The pinhole was adjusted to 1 Airy unit resulting in 0.7  $\mu$ m thick slices. Hoechst fluorescence was visualized using a 2P excitation.

### Statistical Data

Data are presented as means  $\pm$  S.D., significance levels are assessed using Student's paired t test. A p-value of 0.05 or less between groups is considered to indicate a statistically significant difference.

### Results

#### Nox4 Mediates IL-1 $\beta$ -effects on MMP-1 Secretion and DNA Fragmentation in C-20/A4 Chondrocyte Cells

Our previous studies showed that Nox4 is involved in MMP-1 expression in C-20/A4 human chondrocyte cells [22]. To assess the role of Nox4 in chondrocytes, we generated a C-20/A4 chondrocyte cell line that provided a stable expression of Nox4A (Genbank No.AF254621), or Nox4B (Genbank No. AY288918) (Figure 1A). Nox4A correspond to the commonly described wild type Nox4. Nox4B is a splice variant in which the first NADPH binding site is missing and corresponds to a non functional enzyme. It has been described as a dominant negative variant in A549 cells [31]. Results showed a significant production of ROS by luminescence in Nox4A transfected cells compared with the cells that overexpress Nox4B (Figure 1B). Moreover, the ROS

produced was neutralized by Tiron, an antioxidant molecule. After 24 h stimulation by 2 ng/ml IL-1 $\beta$ , a 12 fold increase of MMP-1 expression was observed by Western Blot in the media supernatant of the Nox4A transfected C-20/A4 chondrocytes (Figure 1C). Interestingly, the addition of 5 mM Tiron completely inhibits the effect of IL-1 $\beta$  on MMP-1 expression, strengthening the role of ROS on MMP-1 induced expression. Contrary to Nox4A, Nox4B transfected chondrocytes slightly increased by 3 fold the secretion of MMP-1 upon IL-1 $\beta$  stimulation. These data confirmed our previous observation that MMP-1 synthesis in C-20/A4 chondrocytes upon IL-1 $\beta$  signalling is mediated by Nox4 oxidase activity [22]. As reported, IL-1 $\beta$  triggers chondrocyte apoptosis [32]. We next investigate the DNA fragmentation level and found a 80% increase of cell death (SubG1 population) of Nox4A transfected chondrocytes by flow cytometry after 5 days incubation with 10 ng/ml IL-1 $\beta$  compared to the control chondrocytes transfected with Nox4B gene (Figure 1D). The scavenging of ROS production by N-acetyl cystein prevented the observed cell death (Figure S1A). Consistently, the exposure of WT chondrocytes to either H<sub>2</sub>O<sub>2</sub> (Figure S1B left panel) or IL-1 $\beta$  (Figure S1B right panel) led to an increase of DNA fragmentation in a dose dependent manner that is inhibited by the addition of catalase PEG. All together, these data confirm that ROS and more specifically H<sub>2</sub>O<sub>2</sub> produced by Nox4A upon IL-1 $\beta$  stimulation induced C-20/A4 chondrocyte cell death and MMP-1 secretion.

### HO-1 Overexpression Decreases Nox4 Activity in C-20/A4 Chondrocytes

Heme molecules (heme A and B) are essential to NADPH oxidase activity [33]. Therefore, decreasing of heme availability by modulating of HO-1 expression may affect Nox4 activity. We found that HO-1 expression was dose-dependently induced in C-20/A4 chondrocytes (Figure S2A) and HEK293 T-REx<sup>TM</sup> (Figure S2C) cells after 48 h incubation with 10 or 25  $\mu$ M cobalt protoporphyrin-IX (CoPP-IX). Interestingly, incubation with CoPP-IX consequently decreased the ROS production in Nox4A chondrocytes (Figure 2A). Similar reduction (by 50%) of ROS production was obtained when HO-1 protein was overexpressed in Nox4A C-20/A4 chondrocytes (Figure 2B and S2B). To confirm that the observed effect of HO-1 was specifically related to Nox4 protein, we used another cellular model, HEK293 T-REx<sup>TM</sup> Nox4 cells, in which the expression of Nox4 is induced by the addition of tetracycline [28]. HO-1 expression was chemically induced by CoPP-IX in HEK293 T-REx<sup>TM</sup> Nox4 cells (Figure S2C) and the results confirmed a CoPP-IX dependent decrease of Nox4 activity up to 80% after 72 h HO-1 induction (Figure S3A). We confirmed those results by using the Amplex Red assay, another ROS detection method (Figure S3B). These data indicate that HO-1 act as a negative regulator of Nox4 activity in those two different cellular models.

### HO-1 Decreases MMP-1 Expression and Chondrocytes DNA Fragmentation

We have shown that ROS generated by Nox4 are directly involved in the expression of MMP-1 and cell death in the C-20/A4 chondrocyte cells. We next investigated whether the increase of HO-1 expression could affect MMP-1 secretion induced by IL-1 $\beta$ . HO-1 expression was induced by 48 h incubation with CoPP-IX or by stable HO-1 gene transfection in Nox4A transfected chondrocytes. The amount of MMP-1 secreted in the media supernatant was evaluated by Western Blot after 48h stimulation by IL-1 $\beta$ . The overexpression of HO-1 by transfection reduced 4 times the quantity of MMP-1 in the media supernatant of Nox4A

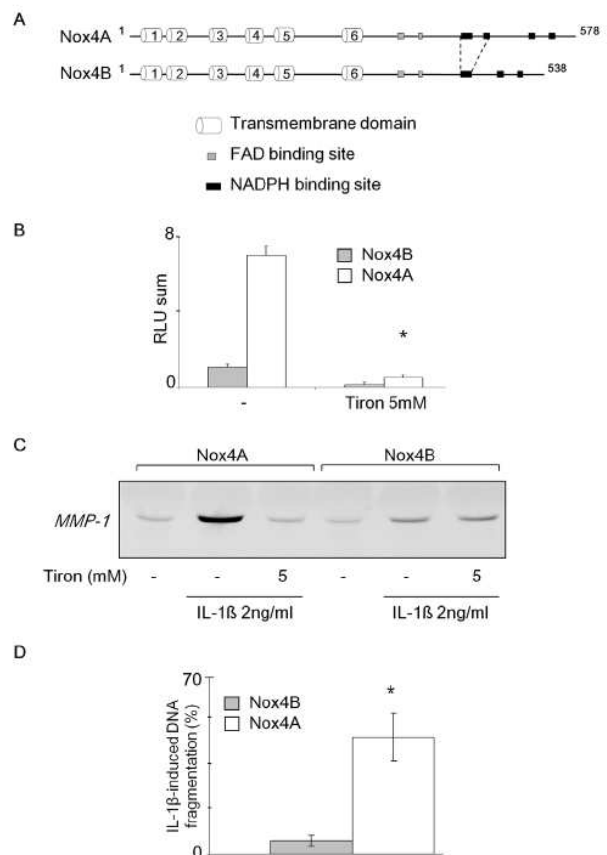

**Figure 1. Nox4 mediates IL-1 $\beta$ -effects on MMP-1 secretion and DNA fragmentation in C-20/A4 chondrocyte cells.** (A) Predicted linear domain structure of Nox4A, the functional isoform and Nox4B, deleted for a putative NADPH binding site. (B) ROS production was measured by chemiluminescence on  $5 \times 10^5$  intact C-20/A4 chondrocytes overexpressing Nox4A or Nox4B treated or not with 5 mM of Tiron. Results are expressed as the sum of all RLU measurements recorded every 30 s during 45 min. Values represent the mean  $\pm$  S.D. of four determinations obtained the same day. \*  $p < 0.05$  versus untreated Nox4A cells. (C) C-20/A4 chondrocytes transfected with genes encoding for Nox4A or Nox4B were stimulated or not with 2 ng/ml IL-1 $\beta$  with or without 5 mM Tiron. After 48h, supernatant was collected, concentrated 10 times by centrifugation and 10  $\mu$ g of proteins were loaded for MMP-1 immunodetection by Western Blot. Results are representative of three independent experiments. (D) C-20/A4 chondrocytes transfected with genes encoding for Nox4A or Nox4B were treated or not with 10 ng/ml IL-1 $\beta$ . After 5 days, cells were detached and fixed with ice cold absolute ethanol. Cells were then washed twice in PBS and stained with propidium iodide before flow cytometry acquisition. \*  $p < 0.05$  versus Nox4B cells. doi:10.1371/journal.pone.0066478.g001

chondrocytes compared to control EV transfected cells (Figure 3A). Consistently, the HO-1 induction by CoPP-IX totally abolished the MMP-1 secretion and DNA fragmentation mediated by Nox4A upon IL-1 $\beta$  treatment. Interestingly, similar but milder significant effects were also observed on WT cells, probably due to the presence of the endogenous Nox4 protein (Figure S4). By contrast, no significant effects of HO-1 were noticeable on MMP-1 secreted by cells expressing Nox4B suggesting a potential dominant negative effect of this splice variant (Figure 3B). Together, these data confirm that the regulation of Nox4 activity

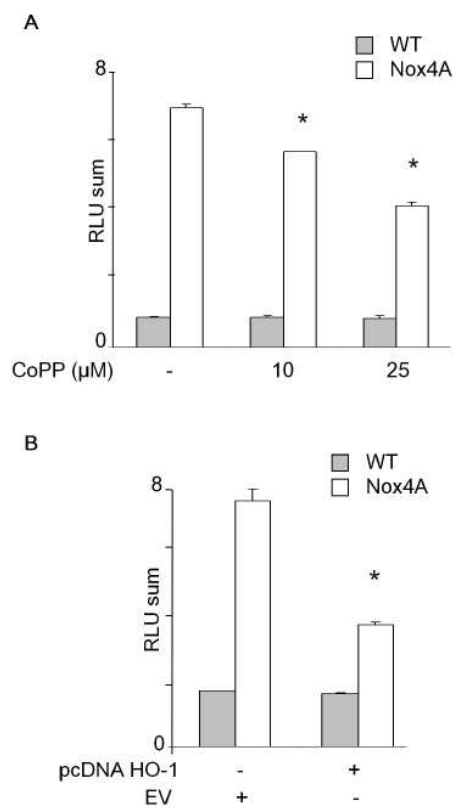

**Figure 2. HO-1 overexpression decreases Nox4 activity in C-20/A4 chondrocytes.** (A) C-20/A4 chondrocytes were treated or not with 10 or 25  $\mu\text{M}$  CoPP-IX for 48 h. Nox4 activity was then measured by chemiluminescence from  $5 \times 10^5$  WT or Nox4A transfected cells. RLU were recorded every 30 s for 45 min as described in material and methods. \*  $p < 0.05$  versus untreated Nox4 cells. (B) Similar experiments were also performed on chondrocytes (WT and Nox4A) stably transfected with HO-1 or the empty vector (EV) as described in material and methods. Values represent the mean  $\pm$  S.D. of three determinations obtained the same day and are representative of three independent experiments. \*  $p < 0.05$  versus EV Nox4 cells. doi:10.1371/journal.pone.0066478.g002

by HO-1 influences directly MMP-1 secretion as well as chondrocytes death.

#### Heme Availability does not Modify Nox4 Total Protein Expression but Affects Nox4 Subcellular Compartmentation

Heme molecules are necessary for Nox2 dimerization with its stabilizing subunit  $p22^{\text{phox}}$  and maturation, and for plasma membrane addressing of the mature heterodimer (cytochrome  $b_{558}$ ) in PLB-985 cells [25]. In the absence of hemes, Nox2 is unstable and is degraded by the proteasome [26]. Thus, we evaluated the molecular impact of heme catabolism by HO-1 on Nox4 expression. We did not observed significant changes in Nox4 expression when HO-1 was overexpressed either by transfection or by CoPP-IX induction in both C-20/A4 and HEK293 T-REx<sup>TM</sup> Nox4 cell types compared to untreated cells (Figure 4A, 4B and 4F). These results therefore demonstrate that HO-1 decreases Nox4 activity without affecting significantly its expression. Given the extremely short half-life of superoxide that dismutates quickly into  $\text{H}_2\text{O}_2$ , the site of its production determines its biological

impact. The effect of HO-1 on Nox4 subcellular localization was assessed in the C-20/A4 chondrocytes. Consistent with data shown in HEK293 cells [27], transfection of Nox4GFP fusion gene led to endoplasmic reticulum (ER) and plasma membrane localization of the fusion protein in C-20/A4 chondrocytes by confocal microscopy (Figure 4C). Plasma membrane localization of Nox4GFP was confirmed by using 8E9 antibody that recognizes an extracellular epitope of Nox4 protein [27] and that was added before cell permeabilization (Figure 4C, right panel). After 48h incubation with 25  $\mu\text{M}$  CoPP-IX, a clear induced expression of HO-1 was evidenced in C-20/A4 chondrocytes that was co-localized with Nox4GFP fusion protein (Figure 4C). We observed that upon 25  $\mu\text{M}$  CoPP-IX incubation, Nox4 remained expressed at the plasma membrane as illustrated by the 8E9 mAb staining (Figure 4C, right panel). Interestingly, after treatment with the heme synthesis inhibitor succinylacetone (SA), the total amount of Nox4 protein was not affected (Figure 4B) whereas its plasma membrane localization seemed compromised since a large majority of Nox4GFP proteins remained in the ER and were co-localized with calnexin, an endoplasmic reticulum marker (Figure 4D).

To confirm those observations, we used another cellular model HEK 293 T-REx<sup>TM</sup> (Figure 4E and 4F). Nox4 subcellular localization was assessed by flow cytometry using the 8E9 mAb on unpermeabilized tetracycline induced T-REx<sup>TM</sup> Nox4A cells. We observed that Nox4 expression at the plasma membrane after 48h tetracycline induction was not affected by the increase of HO-1 expression upon 48h CoPP-IX treatment (Figure 4E). On the contrary, 24h treatment with SA decreased by 60% the plasma membrane expression of Nox4 (Figure 4E) without affecting the total amount of Nox4 protein (Figure 4F). These data together suggest that the inhibition of heme synthesis by SA treatment rather than the catabolism of heme mediated by HO-1 affects plasma membrane localization of Nox4GFP which remains confined in the synthesis compartment (ER).

#### Inhibition of Heme Synthesis, Rather than Heme Catabolism by HO-1, Alters Nox4/ $p22^{\text{phox}}$ Dimer Formation and Heme Integration

Since cellular heme content influences Nox4 compartmentation and potentially its maturation, the consequence of a modulation of heme amount on Nox4/ $p22^{\text{phox}}$  heterodimer formation was investigated (Figure 5). In absence of HO-1, confocal images showed a strict co-localization of Nox4GFP fusion protein with  $p22^{\text{phox}}$  in C-20/A4 chondrocytes arguing in favour of the presence of a mature Nox4/ $p22^{\text{phox}}$  complex (Figure 5A). Interestingly, SA treatment abolished this co-localization whereas the induction of HO-1 by CoPP-IX did not (Figure 5A). We next assessed the spectral properties of Nox4/ $p22^{\text{phox}}$ . The Nox2/ $p22^{\text{phox}}$  heterodimer, named cytochrome  $b_{558}$  is characterized by a redox spectrum with three absorption bands at 426, 530 and 558 nm. Due to a high homology between Nox4 and Nox2, the Nox4/ $p22^{\text{phox}}$  heterodimer may display similar spectral properties [22]. 1% (v/v) Triton X-100 protein extracts from WT, Nox4A or Nox4A HO-1 transfected C-20/A4 chondrocytes were prepared. Reduced minus oxidized difference spectra were measured (Figure 5B). Similar to cyt  $b_{558}$ , results showed a slight peak at 426 nm (the Soret Band) in WT chondrocytes that was significantly enhanced (3.5 fold) in chondrocytes overexpressing Nox4A. To verify that this increase in absorbance at 426 nm was specific to Nox4 overexpression and not from a mitochondria contamination, we evaluated the expression level of VDAC, a mitochondria marker. We found that VDAC level was even in all samples, resulting in an increase of  $\text{Abs}_{426\text{nm}}/\text{VDAC}$  ratio in

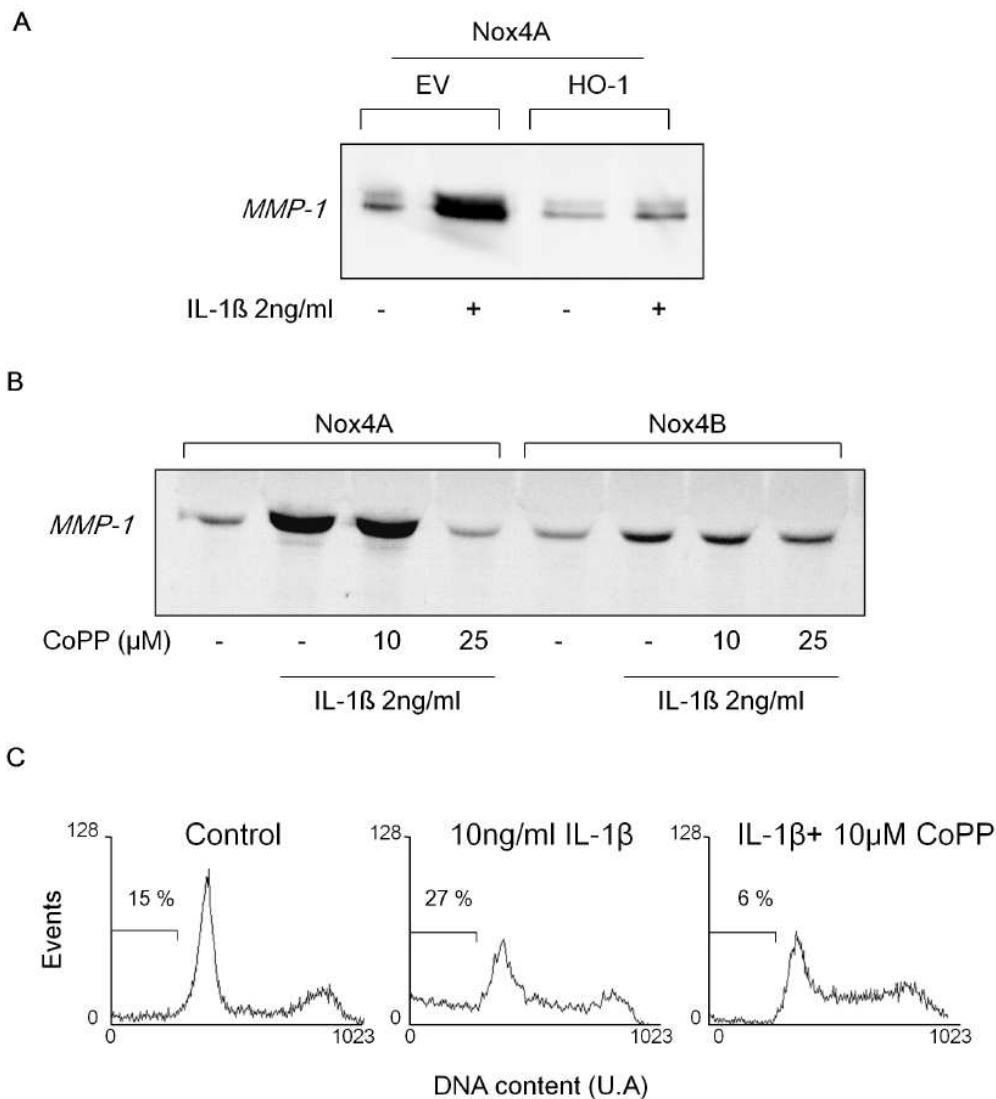

**Figure 3. HO-1 decreases MMP-1 expression and chondrocytes DNA fragmentation.** (A and B) C-20/A4 chondrocytes overexpressing Nox4A or Nox4B were induced or not for HO-1 expression with 10 or 25  $\mu$ M CoPP-IX for 48h (A). C-20/A4 Nox4A chondrocytes were stably transfected with HMOX1 gene (encoding for HO-1) or the empty vector (EV) (B). Cells were stimulated or not with 2 ng/ml IL-1 $\beta$ . After 48h, the media supernatant was collected, concentrated 10 times by centricon. 10  $\mu$ g of proteins were loaded on 10% SDS-PAGE for MMP-1 immunodetection by Western Blot. (C) C-20/A4 Nox4A chondrocytes were treated or not with 10 ng/ml IL-1 $\beta$  +/- 10  $\mu$ M CoPP-IX for 5 days in DMEM 2% fetal bovine serum. Cells were then washed, fixed with ice cold ethanol, stained with propidium iodide and  $5 \times 10^5$  cells fluorescence was assessed by FACS. Results are representative of three independent experiments.  
doi:10.1371/journal.pone.0066478.g003

protein extract from Nox4A chondrocytes compared with protein extracts from WT (Figure S5). In the absence of a known molar extinction coefficient at 426 nm ( $\epsilon_{426}$ ) value for Nox4, we estimated the amount of Nox4/p22<sup>phox</sup> dimer (cyt *b*) of Nox4 using the  $\epsilon_{426}$  value of the cytochrome *b*<sub>558</sub>. 22 pmol of cyt *b* per mg protein extract was initially found in WT cells and was increased up to ~70 pmol cyt *b* per mg of proteins in Nox4 transfected cells (Figure 5B and 5C). In addition, overexpression of HO-1 slightly decreased the cyt *b* amount (from 70 to 50 pmol/mg of protein). Conversely, no spectra were observed upon SA treatment (Figure 5B and 5C) which is correlated to an absence of ROS production under those conditions (unpublished data). Taken together, these data show that the presence of heme

molecules is necessary for the Nox4/p22<sup>phox</sup> heterodimerization. However, despite a significant inhibitory effect of HO-1 on Nox4 activity, the maturation of the Nox4/p22<sup>phox</sup> heterodimer appears not significantly affected by HO-1.

#### Carbon Monoxide Decreases Nox4 Activity and MMP-1 Expression

A possible mechanism of action of HO-1 on Nox4 activity could be mediated by heme degradation by-products (Carbon monoxide (CO), Biliverdin (BV) and Bilirubin (BR)). The consequences of CO have been studied on Nox1 and Nox2 activity [34,35,36] but not on that of Nox4 so far. In order to investigate whether CO

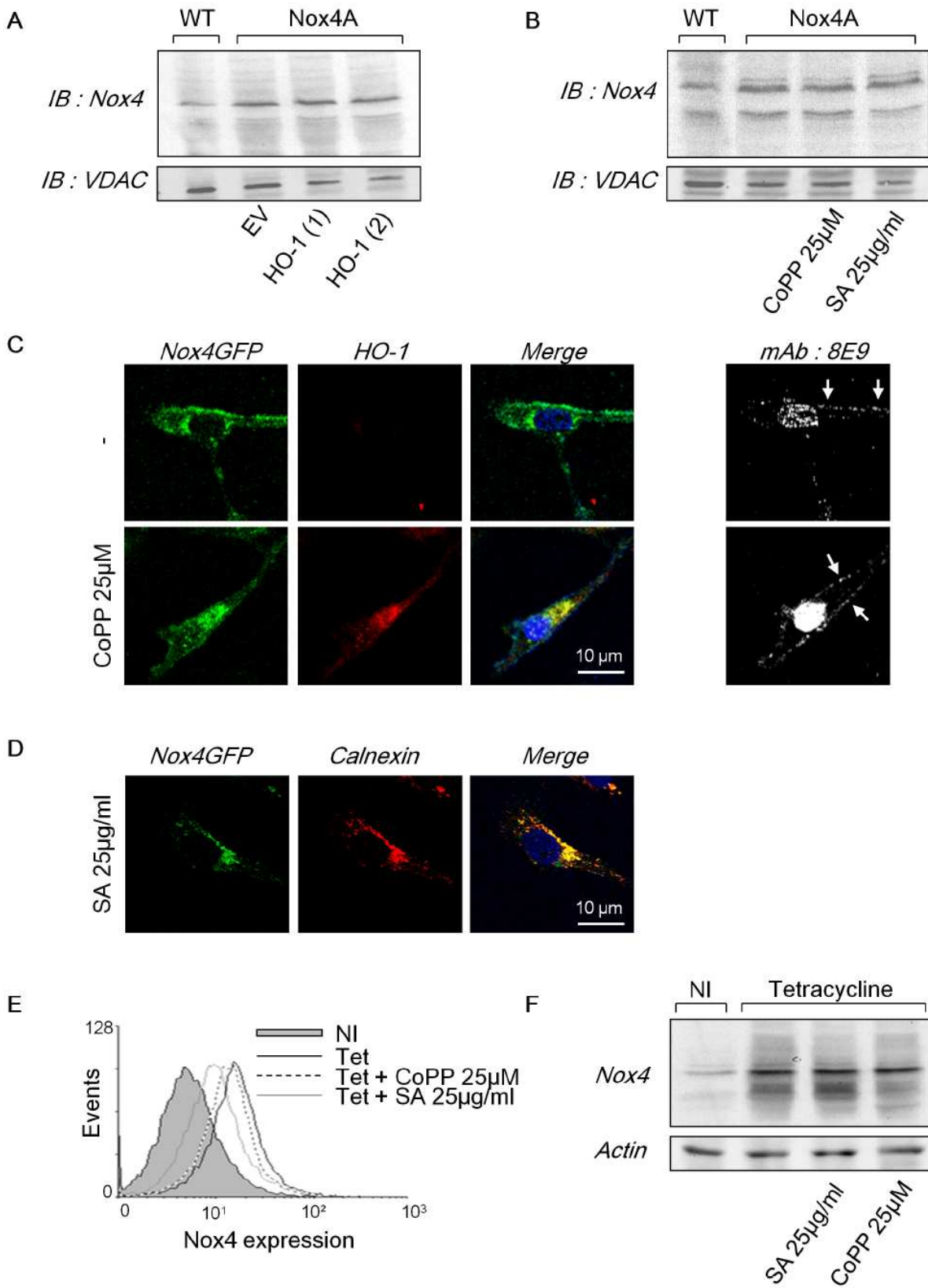

**Figure 4. Heme availability does not modify Nox4 total protein expression but affects Nox4 subcellular compartmentation.** (A and B) C-20/A4 Nox4A chondrocytes were transfected with HO-1 encoding vector or the empty vector (EV) ((1) and (2) are from two independent stable transfections) (A) or were treated with 25  $\mu$ M CoPP-IX or 25  $\mu$ g/ml SA during 48h (B). Nox4 expression was then assessed by Western Blot with 8E9 antibody on 150  $\mu$ g of protein from 1% (v/v) Triton X-100 extract. VDAC protein served as loading control. (C and D) Nox4GFP overexpressing C-20/A4 chondrocytes were treated or not with 25  $\mu$ M CoPP-IX (C) or 25  $\mu$ g/ml succinylacetone (D) for 48h. (C) Cells were fixed with 4% paraformaldehyde (PFA) and plasma membrane Nox4 was stained with 8E9 mAb before cell permeabilization. Cells were then permeabilized with 0.1% (v/v) Triton X-100 and immunostained for HO-1 (red). Right panels show the 8E9 mAb immunostaining (white arrows) with the nucleus. (D) SA treated Nox4GFP expressing chondrocytes were fixed with 4% PFA and permeabilized with 0.1% (v/v) Triton X-100. Cells were then immunolabelled with calnexin (red) and nucleus was stained with Hoechst 33258 (blue). (E and F) HEK293 T-REx<sup>TM</sup> cells were induced or not for Nox4 expression with tetracycline (Tet) and for HO-1 with 25  $\mu$ M CoPP-IX or were treated with 25  $\mu$ g/ml SA during 48 h. (E) Nox4 expressed at the plasma membrane was stained with 8E9 mAb (recognizing an extracellular epitope of Nox4). Plasma membrane Nox4 expression was then quantified by flow cytometry. Non-induced (NI) cells are displayed in grey solid line, tet-induced cells in black continuous line, tet-induced cells treated by CoPP-IX in black dotted line and tet-induced cells treated with SA in grey continuous line. (F) Total Nox4 expression was assessed by Western Blot with 8E9 antibody on 150  $\mu$ g of protein from a 1% (v/v) Triton X-100 extract. Actin protein served as loading control. Results are representative of three independent experiments. doi:10.1371/journal.pone.0066478.g004

interfere with Nox4 activity, we evaluated the effects of CORM-II, a CO donor [37], on tetracycline induced HEK293 T-REx<sup>TM</sup> Nox4 cells. CORM-II decreased significantly (by 75%) the production of ROS whereas the control RuCl compound which do not release CO had no effect (Figure 6A). To avoid a potential antioxidant property mediated by CORM-II itself independently of the presence of CO, CORM-II was prepared extemporaneously or 24 h before (time necessary to CO to totally volatilized) its supplementation to the cells. Indeed, a significant decrease of Nox4 activity was only observed with 50  $\mu$ M CORM prepared extemporaneously and not with those prepared 24 h earlier (Figure S6). The inhibitory effect of CO was confirmed on Nox4A transfected C-20/A4 chondrocytes in which CORM-II decreased significantly the ROS production by 50% (Figure 6B).

Finally, we tested whether the inhibition of Nox4 activity by CO could prevent the MMP-1 secretion induced by IL-1 $\beta$ . For this we treated IL-1 $\beta$ -induced Nox4A transfected C-20/A4 cells with 100  $\mu$ M of CORM-II or RuCl (control) and evaluated the amount of MMP-1 secreted. CORM-II reduced by approximately half the quantity of MMP-1 secreted in the media supernatant compared to the control RuCl (Figure 6C) strengthening the link in the IL-1 $\beta$  induced pathway between HO-1, CO, Nox4 activity, MMP-1 secretion and DNA fragmentation.

## Discussion

Physiological relevance of ROS in chondrocyte physiology remains elusive. ROS might play an important role in chondrogenesis [13,14]. Indeed, previous works have reported a role for ROS in mediating chondrocyte hypertrophy during endochondral ossification. However, hypertrophic phenotype is also observed among osteoarthritic chondrocytes which die by apoptosis [12] and NADPH oxidase Nox4 may contribute to this phenomenon [13]. Furthermore, pseudoachondroplasia, a genetic pathology caused by a mutation on the protein COMP (Cartilage Oligo Matrix Protein) is characterised by abnormal joint architecture, joint erosion and osteoarthritis. Interestingly, a recent study showed a 100 fold increase of Nox4 mRNA in Rat Chondrosarcoma Cells (RCS) expressing mutated COMP [21]. Necroptosis, a caspase independent cell death process was triggered in chondrocytes following DNA damages induced by ROS. Therefore, while the implication of ROS in chondrocyte pathologies has been suggested, no studies on the specific role of NADPH oxidase Nox4 was proposed until yet.

The extracellular matrix catabolism and chondrocyte death are the two main causes leading to cartilage degradation and osteoarthritis. In this study, we demonstrated for the first time the involvement of Nox4 derived ROS in DNA fragmentation and chondrocyte death under IL-1 $\beta$  cytokinic stress. Moreover, we identify a mechanism of regulation of Nox4 activity by HO-1

through CO generation as by-product of heme degradation validated in two different cellular models. Our findings indicate that the use of the CO generation compound (CORM-II) or the induced expression of HO-1 down-regulates the ROS production by Nox4 in human C-20/A4 chondrocytes that consequently reduce MMP-1 secretion and cell death, two main features in osteoarthritis. Those observations raise the prospect that targeting Nox4 activity and HO-1 may represent novel therapeutic strategies in OA.

It is well known that Nox2 expression, heterodimerization with p22<sup>phox</sup> and addressing to the plasma membrane are dependent on the presence of heme molecules [25]. In this work we studied the impact of heme metabolism on Nox4 expression, subcellular compartmentation and maturation by comparing the effect of HO-1 that catalyzes the degradation of heme to that of succinylacetone, a heme synthesis inhibitor. The localization at the plasma membrane is a good indication of the mature state for Nox2. Consistently with our previous observation in HEK293 T-REx<sup>TM</sup> cells [27], we found that functional Nox4 is partly expressed at the plasma membrane in C-20/A4 chondrocytes. Our data, showing that the inhibition of heme synthesis rather than heme degradation induces its retention in the endoplasmic reticulum and absence to the plasma membrane, indicate that heme incorporation by Nox4 is a prerequisite to its dimerisation and maturation. Indeed, a SA treatment eradicates totally the Nox4 redox differential spectrum measured indicating the absence of prosthetic heme group. A role of heme in Nox4/p22<sup>phox</sup> heterodimerization was suggested by Ambasta and coworkers by substituting the histidine 115 with a Leucine [38]. This mutation located on a putative heme coordination site disrupted the Nox4/p22<sup>phox</sup> heterodimer. Conversely, the induced expression of HO-1 is unable to remove significantly hemes incorporated in Nox4/p22<sup>phox</sup> complex characterized by an intact differential spectrum. Here, we demonstrate that in absence of heme, Nox4/p22<sup>phox</sup> maturation, plasma membrane addressing and NADPH oxidase activity are abolished without affecting the total expression of Nox4. This contrasts with the observation made by Taillé and coworkers showing that HO-1 decreases the heme bioavailability and consequently Nox2/p22<sup>phox</sup> expression in RAW264.7 macrophages [39]. Our data are consistent with previous findings in rat aortic tissue [40], where the production of ROS was decreased without any change in both Nox2 and Nox4 expression after HO-1 induction by hemin. However, this *in vivo* study could not discriminate whether the source of ROS production is Nox2 or Nox4.

In this work we demonstrate that HO-1 is able to modulate Nox4 activity and validate that effect in two different cellular models. Indeed, upon induction of HO-1 expression with CoPP-IX or plasmid overexpression, a significant decrease of Nox4 oxidase activity was observed in the HEK293 T-REx<sup>TM</sup> cells and

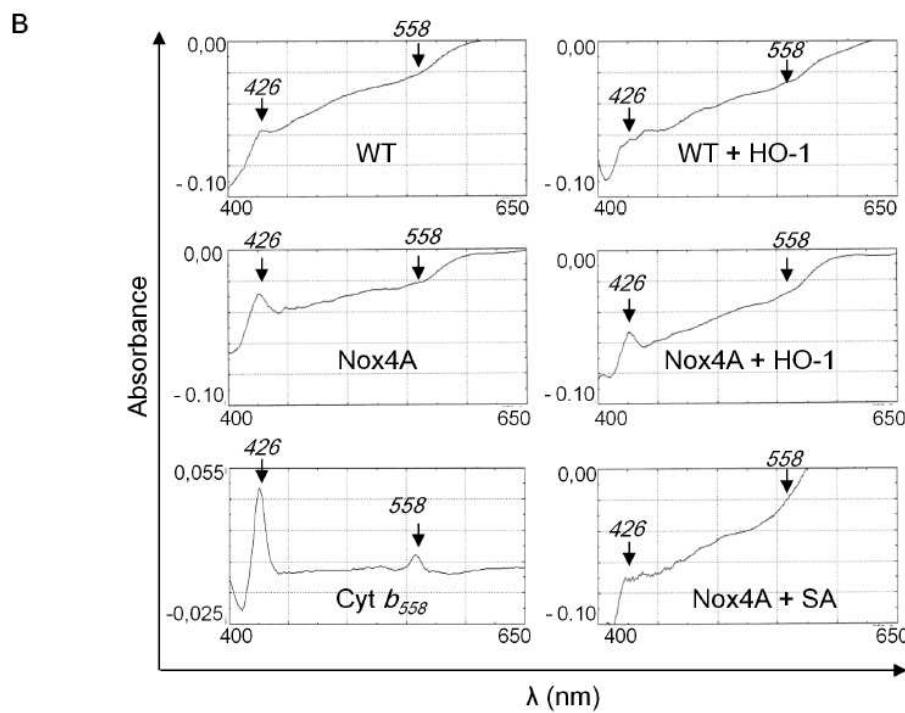
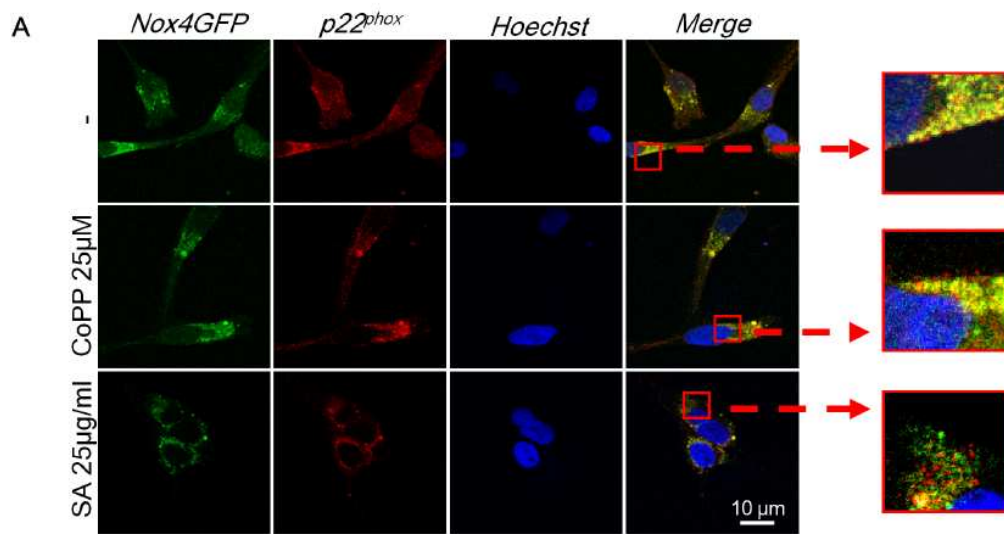

	WT	WT +HO-1	Nox4A	Nox4A +HO-1	Nox4A +SA
[cyt <i>b</i> ] (pmol /mg of proteins)	22±8	20	70±25	50±19	~0

**Figure 5. Inhibition of heme synthesis, rather than heme catabolism, affects Nox4/p22 dimer formation and heme integration.** (A) Nox4GFP C-20/A4 chondrocytes were treated with 25  $\mu$ M CoPP-IX or 25  $\mu$ g/ml SA during 48 h. Cells were then fixed with PFA, permeabilized and p22<sup>phox</sup> was stained with 16G7 mAb antibody (red). The nucleus was stained with Hoechst 33256 (blue). (B) WT and Nox4 chondrocytes were treated or not with succinylacetone (25  $\mu$ g/ml during 48 h) or were transfected with HO-1. Reduced minus oxidized difference spectra of Nox4 were assessed on 5 mg/ml of proteins from a 1% (v/v) Triton X-100 extracts. The positive control was obtained with cytochrome *b*<sub>558</sub> purified from human neutrophils. (C) Concentration of cytochrome *b* in the extract was calculated with a  $\epsilon_{426}$  nm value of 106  $\text{mM}^{-1} \text{cm}^{-1}$ . doi:10.1371/journal.pone.0066478.g005

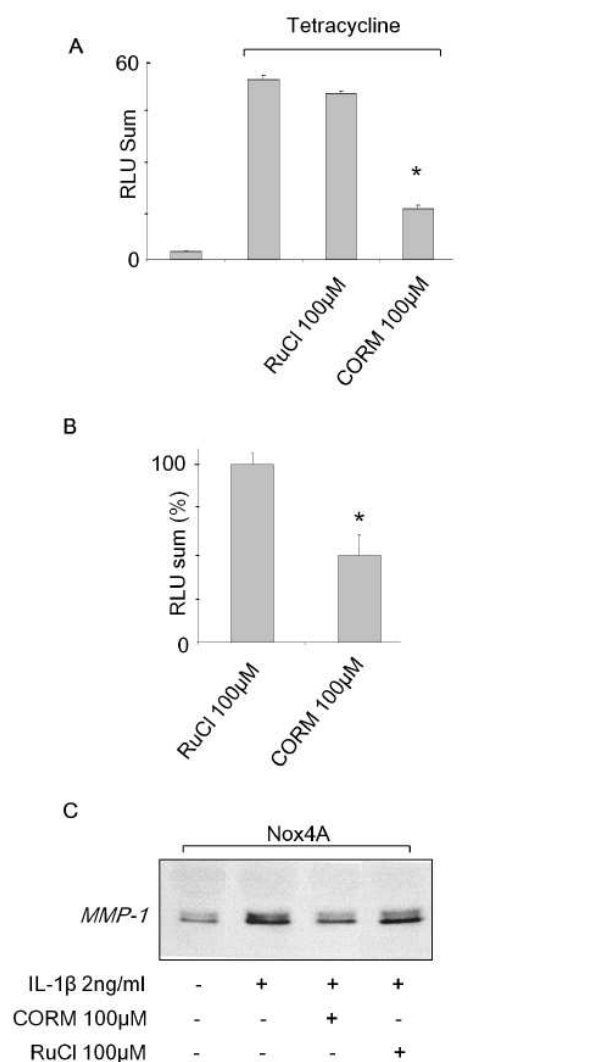

**Figure 6. Carbon monoxide (CO) decreases Nox4 activity and MMP-1 expression.** (A) Tet induced HEK293 T-REx<sup>TM</sup> Nox4 cells were treated for 1h with 100  $\mu$ M CORM (a CO donor) or RuCl (the control molecule). Histogram shows the RLU sum obtained from the 45 min kinetic of Nox4 activity from  $5 \times 10^5$  cells assessed by chemiluminescence. \*  $p < 0.05$  versus RuCl treated cells. (B)  $5 \times 10^5$  C-20/A4 chondrocytes were pre-treated for 1 h with 100  $\mu$ M CORM or RuCl. Nox4 activity was then assessed by chemiluminescence. Results are expressed as percentage of RuCl treated cells. Values represent the mean  $\pm$  S.D. of determinations in triplicate obtained the same day. \*  $p < 0.05$  versus RuCl treated cells. (C) C-20/A4 Nox4A chondrocytes were stimulated with 2 ng/ml IL-1 $\beta$  and treated with 100  $\mu$ M CORM or the control RuCl for 16 h. Medium supernatant was then collected and concentrated 10 times by centricon. 10  $\mu$ g of proteins were loaded on 10% SDS-PAGE for MMP-1 immunodetection by Western Blot. Results are representative of three independent experiments. doi:10.1371/journal.pone.0066478.g006

C-20/A4 chondrocytes. Similar data were previously reported in which the Heme oxygenase isoform HO-2 was shown to decrease Nox4 activity in microvasculature [41]. To our knowledge, it is the first time that HO-1 is reported as a regulator of Nox4 activity. We studied the HO-1 capability to inhibit Nox4 activity in the IL-1 $\beta$  pathway leading to events that participate to the progression of OA. We showed that inducing or overexpressing HO-1 proteins

strongly reduces the matrix metalloproteinase MMP-1 secretion and chondrocyte cell death, therefore acting potentially to prevent cartilage degradation.

Unlike the SA treatment that abolishes Nox4 activity by affecting its heterodimerization and maturation, it is intriguing to observe that the induced expression of HO-1 inhibits Nox4 activity without affecting Nox4 synthesis pathway. This raises the hypothesis that HO-1 could interfere directly or indirectly with Nox4 activity itself. The cellular concentration of heme is depending on the equilibrium between expression of hemoproteins, heme synthesis and heme degradation catalyzed by Heme oxygenase-1 to gives rise to carbon monoxide, biliverdin and bilirubin (CO, BV and BR) [24]. Among them, CO was shown to modulate Nox1 and Nox2 activity [34,35,36]. Moreover, CO may decrease both ROS and NO production in osteoarthritic chondrocytes stimulated by IL-1 $\beta$  [37]. This was associated to a weak expression of MMP-1, MMP-3, MMP-10 and MMP-13 [42]. In our study, we showed that CO reduces Nox4 activity. At least other 3 studies suggested a direct binding of CO on Nox1 and Nox2 [34,35,36]. However, it was demonstrated the absence of binding of CO on cytochrome *b*<sub>558</sub> [43]. Our data actually could not discriminate whether the impact of CO on Nox4 is direct or not; nevertheless, the CO donor CORM-II decreased significantly MMP-1 secretion and ROS production by IL-1 $\beta$  stimulated C-20/A4 chondrocytes.

Taken together, our results suggest that Nox4 is directly involved in MMP-1 expression and C-20/A4 chondrocyte death under IL-1 $\beta$  cytokinic stress. HO-1 is a negative modulator of Nox4 oxidase activity but does not significantly impact on its expression, subcellular localization and dimerization with its partner p22<sup>phox</sup>. On the other hand, inhibition of heme synthesis by succinylacetone affects profoundly maturation and function of Nox4. Therefore, inhibition of Nox4 activity by HO-1 is not due to the consequence of a decrease of heme bioavailability for Nox4, but mainly to CO production and its effect on oxidase activity.

These *in vitro* results highlight a possible role for Nox4 in OA, mediating pro-catabolic effect of IL-1 $\beta$ . Whether Nox4 is a physiological target or not in OA is currently under investigation in human primary chondrocytes. Nevertheless, homeostasis of the cartilage may depend on the balance between the expression of Nox4 and HO-1 and targeting those protein's functions may provide therapeutic benefits for the treatment of articular conditions.

### Supporting Information

**Figure S1 Nox4 derived ROS mediate IL-1 $\beta$  induced cell death.** (A) Pictures taken under inverted microscope of C-20/A4 chondrocytes transfected with Nox4A or Nox4B encoding genes. Cells were treated with 10 ng/ml IL-1 $\beta$ ,  $\pm$ 500 nM N-acetyl cysteine (NAC) during 5 days. Representative picture illustrating cell death by floating cell and low confluency compared to the untreated cells. (B) C-20/A4 WT chondrocytes were treated with increasing concentration of H<sub>2</sub>O<sub>2</sub> (0; 100; 250 or 500  $\mu$ M) or with IL-1 $\beta$  (0; 2 or 10 ng/ml)  $\pm$  catalase-PEG 200 U. After 5 days, cells were detached and fixed with ice cold absolute ethanol. Cells were then washed twice in PBS and stained with propidium iodide before FACS acquisition. (TIF)

**Figure S2 HO-1 is induced by CoPP-IX or plasmid transfection.** (A) C-20/A4 chondrocytes were treated 48 h with 10 or 25  $\mu$ M CoPP-IX or (B) were stably transfected with HO-1 encoding plasmid. (C) HEK 293 T-REx<sup>TM</sup> Nox4 cells were treated 48 h with 10 or 25  $\mu$ M CoPP-IX. (A, B and C) Cells were



then lysed by using a Triton X-100 extract. HO-1 expression was assessed by Western Blot. **(D)** Confocal microscopy shows HO-1 immunostaining (red) of C-20/A4 chondrocytes induced or not for HO-1 expression with 25  $\mu$ M CoPP-IX during 48 h. Results are representative of three independent experiments. (TIF)

**Figure S3 HO-1 decreases Nox4 activity in HEK293 T-REx<sup>TM</sup> Nox4 cells.** **(A)** Cells were treated or not with CoPP-IX in order to induce HO-1 expression. Incubation time (48 or 72 h) and dose effect (10 or 25  $\mu$ M) of CoPP-IX were assessed on ROS production by  $5 \times 10^5$  intact tet-induced cells. Results expressed the sum of all RLU measurements, acquired every 30s during 45 min. **(B)** Tet-induced HEK293 T-REx<sup>TM</sup> cells were incubated for 48 h with 10 or 25  $\mu$ M CoPP-IX and total H<sub>2</sub>O<sub>2</sub> production was assessed by the Amplex Red method on  $5 \times 10^5$  cells. Results expressed the sum of all RFU measurements, acquired every 2 min for 30 min. Values represent the mean  $\pm$  S.D. of four determinations obtained the same day and are representative of three independent experiments. (TIF)

**Figure S4 Effects of HO-1 overexpression on MMP-1 secretion and cell death in WT C-20/A4.** **(A)** WT chondrocytes were induced for HO-1 expression with 10 or 25  $\mu$ M CoPP-IX for 48h and stimulated or not with 2 ng/ml IL-1 $\beta$ . After 48h, the media supernatant was collected, concentrated 10 times by centricon. 10  $\mu$ g of proteins were loaded on 10% SDS-PAGE for MMP-1 immunodetection by Western Blot. **(B and C)** C-20/A4 WT cells were treated or not with 10 ng/ml IL-1 $\beta$   $\pm$  10  $\mu$ M CoPP-IX for 5 days in DMEM 2% fetal bovine serum. **(B)** Cells were then washed, fixed with ice cold ethanol, stained with propidium iodide and  $5 \times 10^5$  cells fluorescence was assessed by FACS. **(C)** Culture supernatant was collected to assess cellular membrane integrity by measuring the cytosolic LDH

## References

- Poole AR (2001) Cartilage in health and disease. In: Koopman WJ, editor. Arthritis and allied conditions: a textbook of rheumatology Philadelphia: Lippincott Williams & Wilkins. 226–284.
- Poole AR, Alini M, Hollander AR (1997) Cellular biology of cartilage degradation. In: Henderson B, Edwards JC, Pettipher ER, editors. Mechanisms and models in rheumatoid arthritis London: Academic Press. 163–204.
- Borden P, Solyman D, Sucharczuk A, Lindman B, Cannon P, et al. (1996) Cytokine control of interstitial collagenase and collagenase-3 gene expression in human chondrocytes. *J Biol Chem* 271: 23577–23581.
- Goldring MB (2000) The role of the chondrocyte in osteoarthritis. *Arthritis Rheum* 43: 1916–1926.
- Goldring MB, Birkhead JR, Suen LF, Yamin R, Mizuno S, et al. (1994) Interleukin-1 beta-modulated gene expression in immortalized human chondrocytes. *J Clin Invest* 94: 2307–2316.
- Poole AR, Howell DS (2001) Etiopathogenesis of osteoarthritis. In: Moskowitz RW, Howell DS, Altman RD, Buckwalter JA, Goldberg VM, editors. Osteoarthritis: diagnosis/surgical management Philadelphia: WB Saunders 29–47.
- Liacini A, Sylvester J, Li WQ, Zafarullah M (2002) Inhibition of interleukin-1-stimulated MAP kinases, activating protein-1 (AP-1) and nuclear factor kappa B (NF-kappa B) transcription factors down-regulates matrix metalloproteinase gene expression in articular chondrocytes. *Matrix Biol* 21: 251–262.
- Martin G, Bogdanowicz P, Domagala F, Ficheux H, Pujol JP (2003) Rhein inhibits interleukin-1 beta-induced activation of MEK/ERK pathway and DNA binding of NF-kappa B and AP-1 in chondrocytes cultured in hypoxia: a potential mechanism for its disease-modifying effect in osteoarthritis. *Inflammation* 27: 233–246.
- Mengshol JA, Vincenti MP, Coon CI, Barchowsky A, Brinckerhoff CE (2000) Interleukin-1 induction of collagenase 3 (matrix metalloproteinase 13) gene expression in chondrocytes requires p38, c-Jun N-terminal kinase, and nuclear factor kappaB: differential regulation of collagenase 1 and collagenase 3. *Arthritis Rheum* 43: 801–811.
- Vincenti MP, Brinckerhoff CE (2001) Early response genes induced in chondrocytes stimulated with the inflammatory cytokine interleukin-1beta. *Arthritis Res* 3: 381–388.
- Tchetina EV, Antoniou J, Tanzer M, Zukor DJ, Poole AR (2006) Transforming growth factor-beta2 suppresses collagen cleavage in cultured human osteoarthritic cartilage, reduces expression of genes associated with chondrocyte hypertrophy and degradation, and increases prostaglandin E(2) production. *Am J Pathol* 168: 131–140.
- Drissi H, Zuscik M, Rosier R, O'Keefe R (2005) Transcriptional regulation of chondrocyte maturation: potential involvement of transcription factors in OA pathogenesis. *Mol Aspects Med* 26: 169–179.
- Kim KS, Choi HW, Yoon HE, Kim IY (2010) Reactive oxygen species generated by NADPH oxidase 2 and 4 are required for chondrogenic differentiation. *J Biol Chem* 285: 40294–40302.
- Morita K, Miyamoto T, Fujita N, Kubota Y, Ito K, et al. (2007) Reactive oxygen species induce chondrocyte hypertrophy in endochondral ossification. *J Exp Med* 204: 1613–1623.
- Bedard K, Krause KH (2007) The NOX family of ROS-generating NADPH oxidases: physiology and pathophysiology. *Physiol Rev* 87: 245–313.
- Mendes AF, Carvalho AP, Caramona MM, Lopes MC (2001) Diphenyleioidonium inhibits NF-kappaB activation and iNOS expression induced by IL-1beta: involvement of reactive oxygen species. *Mediators Inflamm* 10: 209–215.
- Morel F (2007) [Molecular aspects of chronic granulomatous disease. "the NADPH oxidase complex"]. *Bull Acad Natl Med* 191: 377–390; discussion 390–372.
- Lambeth JD (2004) NOX enzymes and the biology of reactive oxygen. *Nat Rev Immunol* 4: 181–189.
- Geiszt M, Kopp JB, Varnai P, Leto TL (2000) Identification of renox, an NAD(P)H oxidase in kidney. *Proc Natl Acad Sci U S A* 97: 8010–8014.
- Yang S, Zhang Y, Ries W, Key L (2004) Expression of Nox4 in osteoclasts. *J Cell Biochem* 92: 238–248.
- Coustry F, Posey KL, Liu P, Alcorn JL, Hecht JT (2012) D469del-COMP retention in chondrocytes stimulates caspase-independent necroptosis. *Am J Pathol* 180: 738–748.
- Grange L, Nguyen MV, Lardy B, Derouazi M, Campion Y, et al. (2006) NAD(P)H oxidase activity of Nox4 in chondrocytes is both inducible and involved in collagenase expression. *Antioxid Redox Signal* 8: 1485–1496.

activity. Results are representative of three independent experiments. \*  $p < 0.05$  versus IL-1 $\beta$  treated cells. (TIF)

**Figure S5 HO-1 does not change Nox4 expression and heme integration.** The graph shows the ratio between the absorbance at 426nm of the differential redox spectra and densitometric value of VDAC expression obtained by Western Blot on the same soluble extracts used in the Figure 5B. Results were generated from three independent experiments. (TIF)

**Figure S6 CORM does not exhibit an antioxidant property.** The effect of 50  $\mu$ M CORM extemporaneously prepared (t0h) versus prepared 24h before the experiment (t24h) in which all the CO is volatilized, was investigated on Tet-induced HEK293 T-REx<sup>TM</sup> cells. Nox4 activity was measured by chemiluminescence. \*  $p < 0.05$  versus CORM t24h treated cells. Results are representative of three independent experiments. (TIF)

**Text S1.**  
(DOC)

## Acknowledgments

The authors thank Dr. Alexei Grichine for his support in confocal microscopy experiments, Pr. Karl-Heinz Krause for kindly providing Nox4 HEK293 T-REx<sup>TM</sup> Nox4 cells and Pr. Mary Goldring for the generous gift of the C-20/A4 cell line. The authors thank also Pr Xavier Ronot, Pr Bertrand Toussaint, Pr. François Rannou, Dr. Corinne Dupuy, Dr Marie Hélène Paclat and Dr. Patricia Sansilvestri-Morel for helpful discussion.

## Author Contributions

Conceived and designed the experiments: FR BL FM. Performed the experiments: FR MVCN LG. Analyzed the data: FR BL FM. Wrote the paper: FR MVCN BL FM.

23. Jansen T, Hortmann M, Oelze M, Opitz B, Steven S, et al. (2010) Conversion of biliverdin to bilirubin by biliverdin reductase contributes to endothelial cell protection by heme oxygenase-1-evidence for direct and indirect antioxidant actions of bilirubin. *J Mol Cell Cardiol* 49: 186–195.
24. Rytter SW, Choi AM (2009) Heme oxygenase-1/carbon monoxide: from metabolism to molecular therapy. *Am J Respir Cell Mol Biol* 41: 251–260.
25. DeLeo FR, Burritt JB, Yu L, Jesaitis AJ, Dinauer MC, et al. (2000) Processing and maturation of flavocytochrome b558 include incorporation of heme as a prerequisite for heterodimer assembly. *J Biol Chem* 275: 13986–13993.
26. Yu L, Zhen L, Dinauer MC (1997) Biosynthesis of the phagocyte NADPH oxidase cytochrome b558. Role of heme incorporation and heterodimer formation in maturation and stability of gp91phox and p22phox subunits. *J Biol Chem* 272: 27288–27294.
27. Zhang L, Nguyen MV, Lardy B, Jesaitis AJ, Grichine A, et al. (2011) New insight into the Nox4 subcellular localization in HEK293 cells: first monoclonal antibodies against Nox4. *Biochimie* 93: 457–468.
28. Serrander L, Cartier L, Bedard K, Banfi B, Lardy B, et al. (2007) NOX4 activity is determined by mRNA levels and reveals a unique pattern of ROS generation. *Biochem J* 406: 105–114.
29. Paclét MH, Coleman AW, Vergnaud S, Morel F (2000) P67-phox-mediated NADPH oxidase assembly: imaging of cytochrome b558 liposomes by atomic force microscopy. *Biochemistry* 39: 9302–9310.
30. Campion Y, Paclét MH, Jesaitis AJ, Marques B, Grichine A, et al. (2007) New insights into the membrane topology of the phagocyte NADPH oxidase: characterization of an anti-gp91-phox conformational monoclonal antibody. *Biochimie* 89: 1145–1158.
31. Goyal P, Weissmann N, Rose F, Grimminger F, Schafers HJ, et al. (2005) Identification of novel Nox4 splice variants with impact on ROS levels in A549 cells. *Biochem Biophys Res Commun* 329: 32–39.
32. Heraud F, Heraud A, Harmand MF (2000) Apoptosis in normal and osteoarthritic human articular cartilage. *Ann Rheum Dis* 59: 959–965.
33. Cross AR, Rae J, Curran JT (1995) Cytochrome b-245 of the neutrophil superoxide-generating system contains two nonidentical hemes. Potentiometric studies of a mutant form of gp91phox. *J Biol Chem* 270: 17075–17077.
34. Nakahira K, Kim HP, Geng XH, Nakao A, Wang X, et al. (2006) Carbon monoxide differentially inhibits TLR signaling pathways by regulating ROS-induced trafficking of TLRs to lipid rafts. *J Exp Med* 203: 2377–2389.
35. Rodriguez AI, Gangopadhyay A, Kelley EE, Pagano PJ, Zuckerbraun BS, et al. (2009) HO-1 and CO decrease platelet-derived growth factor-induced vascular smooth muscle cell migration via inhibition of Nox1. *Arterioscler Thromb Vasc Biol* 30: 98–104.
36. Taille C, El-Benna J, Lanone S, Bozowski J, Motterlini R (2005) Mitochondrial respiratory chain and NAD(P)H oxidase are targets for the antiproliferative effect of carbon monoxide in human airway smooth muscle. *J Biol Chem* 280: 25350–25360.
37. Guillen MI, Megias J, Clerigues V, Gomar F, Alcaraz MJ (2008) The CO-releasing molecule CORM-2 is a novel regulator of the inflammatory process in osteoarthritic chondrocytes. *Rheumatology (Oxford)* 47: 1323–1328.
38. Ambasta RK, Kumar P, Griendling KK, Schmidt HH, Busse R, et al. (2004) Direct interaction of the novel Nox proteins with p22phox is required for the formation of a functionally active NADPH oxidase. *J Biol Chem* 279: 45935–45941.
39. Taille C, El-Benna J, Lanone S, Dang MC, Ogier-Denis E, et al. (2004) Induction of heme oxygenase-1 inhibits NAD(P)H oxidase activity by down-regulating cytochrome b558 expression via the reduction of heme availability. *J Biol Chem* 279: 28681–28688.
40. Datla SR, Dusting CJ, Mori TA, Taylor CJ, Croft KD, et al. (2007) Induction of heme oxygenase-1 in vivo suppresses NADPH oxidase derived oxidative stress. *Hypertension* 50: 636–642.
41. Basuroy S, Bhattacharya S, Lefler CW, Parfenova H (2009) Nox4 NADPH oxidase mediates oxidative stress and apoptosis caused by TNF-alpha in cerebral vascular endothelial cells. *Am J Physiol Cell Physiol* 296: C422–432.
42. Megias J, Guillen MI, Bru A, Gomar F, Alcaraz MJ (2008) The carbon monoxide-releasing molecule tricarbonyldichlororuthenium(II) dimer protects human osteoarthritic chondrocytes and cartilage from the catabolic actions of interleukin-1beta. *J Pharmacol Exp Ther* 325: 56–61.
43. Morel F, Doussiere J, Stasia MJ, Vignais PV (1985) The respiratory burst of bovine neutrophils. Role of a b type cytochrome and coenzyme specificity. *Eur J Biochem* 152: 669–679.

Figure S1

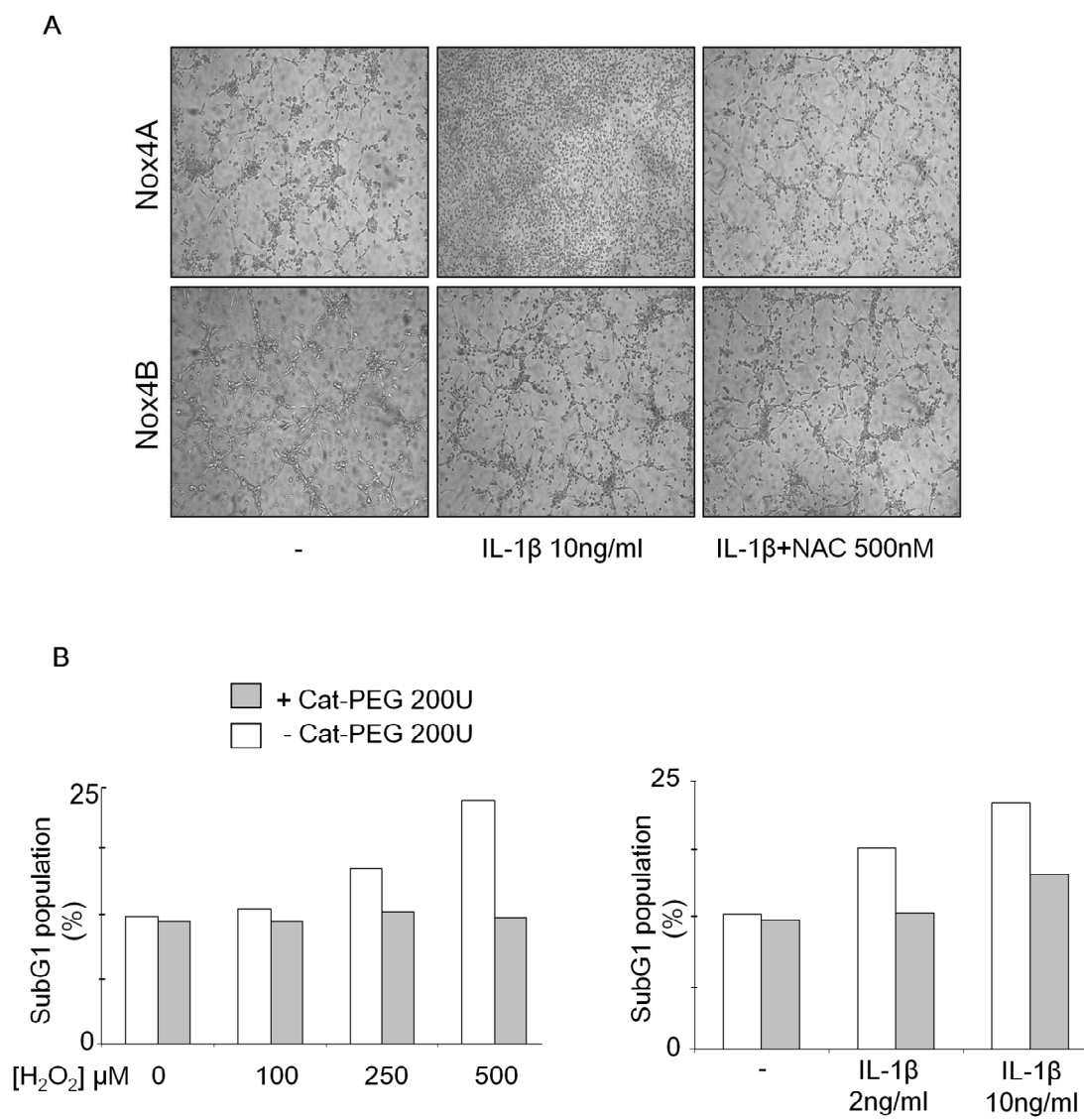

Figure S2

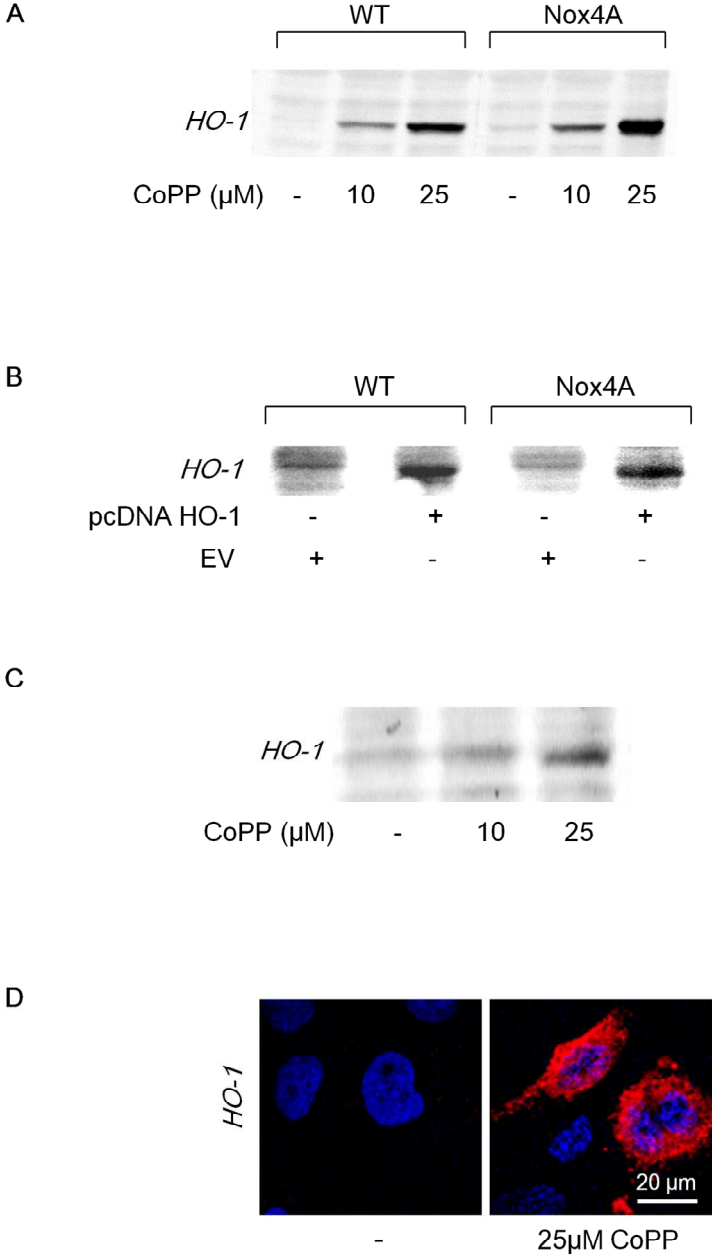

Figure S3

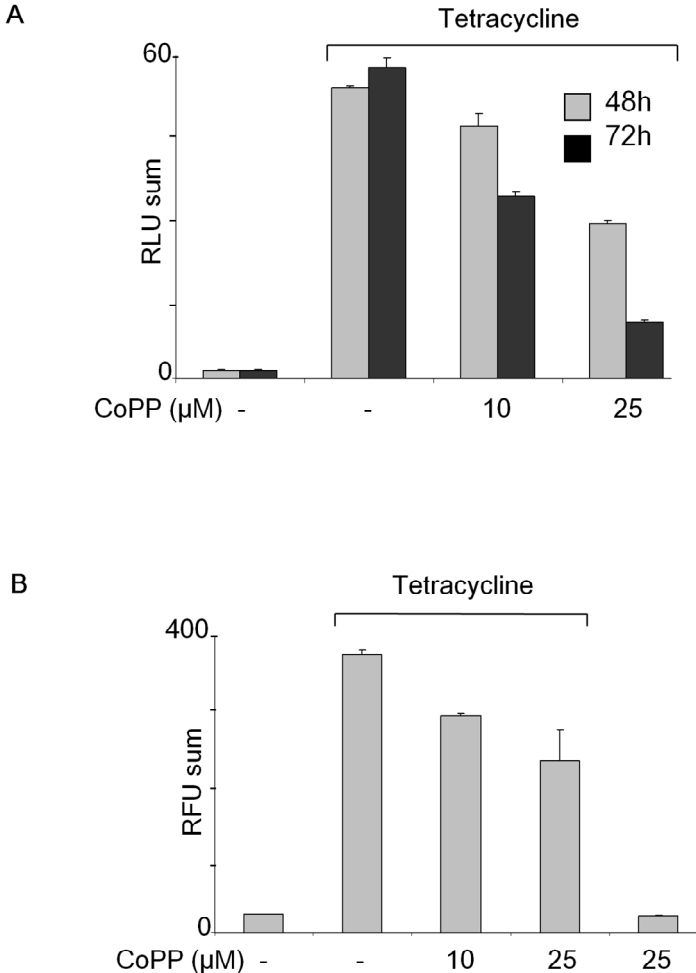

Figure S4

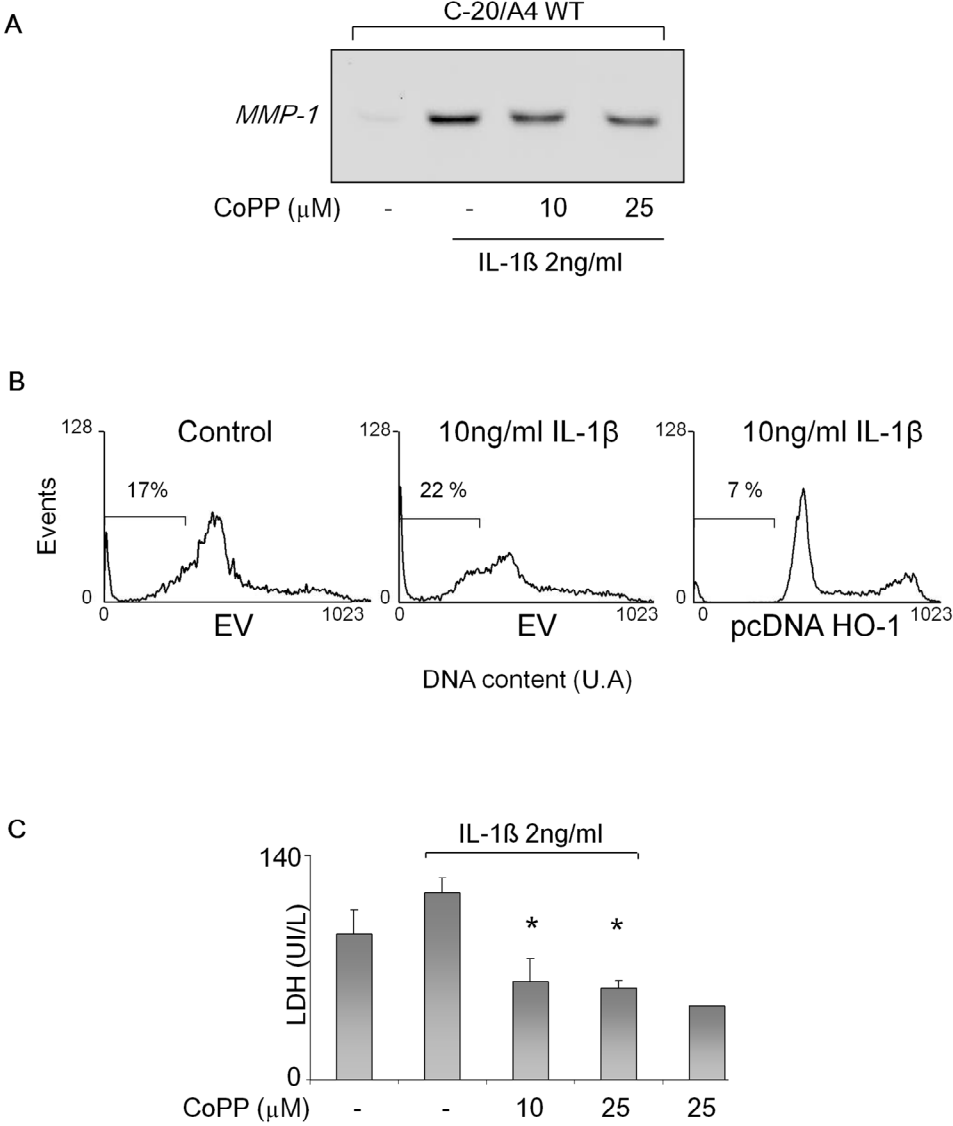

Figure S5

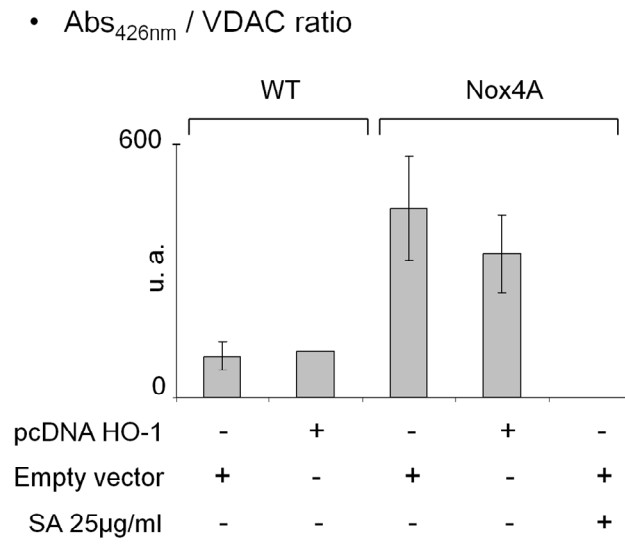
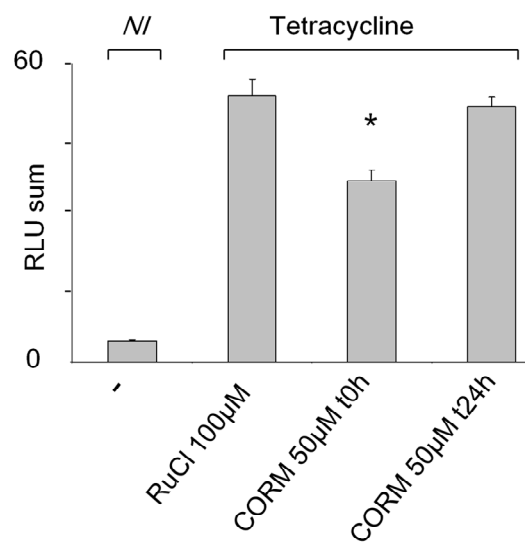

Figure S6



## **CHAPITRE III**

# **La NADPH oxydase Nox4 : nouvelle cible thérapeutique dans l'arthrose?**

## **Article 3**





### **Partie 3 : Nox4 dans le chondrocyte ; homéostasie matricielle et physiopathologie de l'arthrose**

L'arthrose est la résultante de phénomènes mécaniques et biologiques qui déstabilisent l'équilibre entre la synthèse et la dégradation du cartilage et de l'os sous-chondral. Le chondrocyte, unique type cellulaire présent dans le cartilage articulaire est responsable de l'homéostasie de la matrice extracellulaire cartilagineuse. En cas de stress mécanique, les chondrocytes articulaires augmentent la sécrétion d'interleukine-1 $\beta$ , la production de dérivés réactifs de l'oxygène (ROS) ainsi que la synthèse des métalloprotéases matricielles (MMP). Cela conduit à une rupture de l'équilibre entre les voies de synthèse et de dégradation de la matrice extracellulaire régulées par le chondrocyte.

L'utilisation de lignées permet de s'affranchir de certaines contraintes relatives aux cellules primaires. Les données expérimentales acquises à l'aide de la lignée de chondrocytes C-20/A4 ont permis de suggérer un rôle de Nox4 dans la médiation des effets pro-cataboliques initiés par l'IL-1 $\beta$ . En particulier, l'activité de Nox4 conduit à l'apoptose des chondrocytes C-20/A4 ainsi qu'à la synthèse de la collagénase MMP-1 ; deux phénomènes clés concourant *in fine* à l'arthrose.

Dans la troisième partie de ce travail, nous avons choisi de nous rapprocher de la physiologie. L'objectif est de confirmer l'impact de Nox4 dans les chondrocytes primaires humains et de déterminer si Nox4 est impliquée dans la physiopathologie de l'arthrose, comme le laisse suggérer le travail réalisé sur lignée.

L'implication de Nox4 a été abordée sous deux angles différents dans les chondrocytes issus de cultures primaires.

D'un point de vue mécanistique, nous nous sommes intéressés aux conséquences de l'activité de Nox4 dans le chondrocyte primaire sur les voies initiées par l'IL-1 $\beta$  et conduisant au catabolisme matriciel. Cette partie du travail a été abordé au travers des questions suivantes :

- 1- Quelles sont les Nox exprimées dans les chondrocytes primaires humains ? Nox4 est elle présente ?
- 2- Nox4 est-elle impliquée dans les voies de signalisation déclenchées par l'IL-1 $\beta$  ?
- 3- Quel est l'impact de la modulation de l'activité de Nox4 sur la synthèse des MMP par les chondrocytes primaires?

- 4- Comment la formation des ROS est elle régulée dans ce type de cellule ? Quelles sont les conséquences de leur régulation ?

Nos résultats montrent que Nox4 est la seule isoforme des Nox exprimée dans les chondrocytes primaires. L'expression de Nox4, son activité ainsi que l'expression de p22<sup>phox</sup>, son seul partenaire, sont accrus après stimulation des chondrocytes par IL-1 $\beta$ . De manière intéressante, l'utilisation d'antioxydants (Tiron) et d'inhibiteurs des NADPH oxydases (DPI et HO-1) inhibe la transcription et la sécrétion des MMP-1, 13 et de l'ADAMTS4 stimulées par l'IL-1 $\beta$ . Pour finir, nos résultats montrent que l'activité de Nox4 est impliquée dans la boucle autocrine conduisant à la néosynthèse de l'IL-1 $\beta$  et démontrent également un mode de régulation redox de p22<sup>phox</sup> dans les chondrocytes primaires.

De manière à enrichir nos résultats avec des données issues de la pathologie, nous avons ensuite cherché à déterminer s'il existe une corrélation entre la pathologie arthrosique, l'expression / l'activité de Nox4 ainsi que la synthèse des MMP, *ex vivo*.

Pour répondre à cet objectif, un projet de recherche clinique (ARTHRO-NOX), vise à comparer l'expression et l'activité de Nox4 entre chondrocytes issus de cartilage sain et arthrosique. Pour ce faire, sur chaque tête fémorale est prélevé une partie dite « saine » et une partie dite « arthrosique ». Le grade d'arthrose des deux parties prélevées est alors déterminé par les pathologistes du CHU de Grenoble, en accord avec les règles définies par l'OARSI (Pritzker et al. 2006). L'activité et l'expression de Nox4 et p22<sup>phox</sup> mais aussi la synthèse des MMP, du collagène II et de l'IL-1 $\beta$  sont comparés entre les zones saines et arthrosiques.

Les résultats, encore préliminaires à ce stade semblent confirmer le modèle mécanistique décrit. En effet, les premiers résultats montrent que les chondrocytes issus de la partie arthrosique expriment plus d'ARNm codant pour l'IL-1 $\beta$ , p22<sup>phox</sup> et les MMP-1, MMP-13 et ADAMTS4 par rapport aux chondrocytes prélevés sur la partie saine du cartilage.

En conclusion, les résultats démontrent que les ROS générés par Nox4 relayent et maintiennent l'activation des voies pro-cataboliques initiées par l'IL-1 $\beta$  dans les chondrocytes primaires. L'implication de Nox4 sur le plan clinique est encore en cours d'investigation mais les premiers éléments semblent conforter ces données.

*J'ai contribué à ce travail par l'isolement et la mise au point de la culture ex vivo des chondrocytes primaires au laboratoire, réalisés à partir de têtes fémorales humaines. J'ai caractérisé les Nox exprimées par les chondrocytes primaires en réalisant des expériences de RT-PCR, des immunoblots dirigés contre Nox4 et Poldip2 et des expériences de microscopie confocale. J'ai également mesuré l'impact de la stimulation des chondrocytes par l'IL-1 $\beta$  sur la formation des ROS ainsi que sur la production des MMP-1 et MMP-13 et tenté d'en décomposer les mécanismes. Les résultats du projet « ARTHRO-NOX », les expériences de RT-PCR quantitatives et d'immunohistochimie sont encore préliminaires.*

Article 3 : **Francis Rousset**, Florence Hazane-Puch, Chuong Nguyen, Laurent Grange, Clara Pinosa, Brice Rubens-Duval, Corinne Dupuy, Françoise Morel et Bernard Lardy. IL-1 $\beta$  mediates MMP secretion and IL-1 $\beta$  neosynthesis via upregulation of p22<sup>phox</sup> and Nox4 activity in human articular chondrocytes. En préparation.

## **IL-1 $\beta$ mediates MMP secretion and IL-1 $\beta$ neosynthesis via upregulation of p22<sup>phox</sup> and Nox4 activity in human articular chondrocytes**

Rousset F<sup>1</sup>, Hazane-Puch F<sup>2</sup>, Nguyen MVC<sup>1,3</sup>, Grange L<sup>1,2</sup>, Pinosa C<sup>1</sup>, Rubens-Duval B<sup>2</sup>, Dupuy C<sup>4</sup>, Morel F<sup>1</sup> and Lardy B<sup>1,2</sup>.

<sup>1</sup> Université Joseph Fourier, AGIM GREPI FRE CNRS 3405, Grenoble, France.

<sup>2</sup> Centre Hospitalier Universitaire (CHU), Grenoble, France.

<sup>3</sup> Calcium Signaling and Inflammation Group, Life Sciences Research Unit, University of Luxembourg, Luxembourg.

<sup>4</sup> UMR CNRS 8200, Institut de cancérologie Gustave Roussy, Villejuif, France

### **ABSTRACT**

Osteoarthritis (OA), the most common form of arthritis, results from the destabilization of the normal balance between the synthesis and the degradation pathways controlled by chondrocyte. That leads to a progressive degeneration of articular cartilage and subsequently to an alteration of the biochemical and biomechanical properties of the joint. Inflammation plays a major role in OA, particularly through the cytokine Interleukine-1 $\beta$ , promoting Reactive Oxygen Species (ROS) generation and Matrix Metalloproteinases (MMP) synthesis by the chondrocytes, which in turn orchestrate matrix proteolysis and catabolism. Nox4 belongs to the NADPH oxidase family whose function is to generate ROS. Nox4 associated with its stabilizing subunit p22<sup>phox</sup> is constitutively active. However, its activity has recently been shown to be stimulated by Poldip2. Given the critical role of oxidative stress in degenerative processes and in particular in OA, we assessed the role of NADPH oxidases in primary human articular chondrocytes (HAC) upon IL-1 $\beta$  stimulation. Our work demonstrates for the first time that Nox4 is expressed in HAC with p22<sup>phox</sup> and Poldip2 and is a major source of ROS upon IL-1 $\beta$  treatment. Moreover, results show that ROS produced by Nox4 are critical mediators of IL-1 $\beta$  induced MMP-1, MMP-13 and ADAMTS4 synthesis and release. Interestingly, Nox4 activity inhibition by the Heme Oxygenase-1 (HO-1), the rate limiting step in heme catabolism, but also by pharmacological inhibitors (DPI or GKT) led to a significant decrease in MMP synthesis by HAC. It has been shown that IL-1 $\beta$  acts in an autocrine / paracrine manner leading to its own neosynthesis by HAC. Our results demonstrate the

involvement of Nox4 in this autocrine loop and suggest that IL-1 $\beta$  stabilizes Nox4 expression/activity through an upregulation of p22<sup>phox</sup> in HAC and that upregulation of p22<sup>phox</sup> expression appears to be redox regulated in chondrocytes.

Finally, our data support a significant role for Nox4/p22<sup>phox</sup> in human articular chondrocytes mediating pro-catabolic pathways induced by IL-1 $\beta$ .

## INTRODUCTION

Reactive oxygen species (ROS) are small reactive molecules derived from molecular oxygen and are involved in various physiological processes such as innate immunity and cell signalling pathways controlling differentiation, adhesion, migration or apoptosis. Impairment of ROS homeostasis has been associated with pathological states such as cell tumoral transformation, fibrosis, osteoporosis or diabetes due to inappropriate cell signalling. Non controlled ROS production could also participate to the ageing process (Harman 1956). Indeed, most of the common ageing related degenerative pathologies such as Parkinson's disease, Alzheimer, cancer, osteoporosis or osteoarthritis are linked to oxidative stress (Henrotin et al. 2005; Krause 2007).

NADPH oxidase (Nox) catalyse the transfer of electron from NADPH across biological membranes via two heme molecules to generate superoxide anion, the first element of ROS (Lassegue et al. 2012). Nox family are transmembrane proteins composed of seven members who share specific structural homology regions (Lambeth 2004; Sumimoto 2008). Our recent data demonstrated that Nox4 possesses 6 transmembrane domains displaying N and C-terminus moieties facing the cytosolic side (Rousset et al. 2013b). Nox4 represents the major source of ROS in kidney and is widely expressed in many others tissues including the skeletal system (Geiszt et al. 2000; Yang et al. 2004; Mandal et al. 2012). The In contrast to other Nox enzymes, Nox4 is constitutively active when bound to p22<sup>phox</sup>; in fact its activity was shown to be regulated by the level of p22<sup>phox</sup> expression (Edderkaoui et al. 2010) through a mutual stabilization of the two partners at the protein level while monomers are inactive (Ambasta et al. 2004). However Nox4 activity has been shown to be upregulated by Poldip2, a protein making shuttle between nucleus and plasma membrane and by quinone compounds *in vitro* (Lyle et al. 2009; Nguyen et al. 2013). By contrast, the activity of Nox4 is negatively regulated by the Heme Oxygenase-1 (HO-1), the rate limiting enzyme in heme catabolism (Rousset et al. 2013).

Osteoarthritis (OA) is a common ageing related degenerative disease in which chondrocytes play a central role. In OA, chondrocytes exhibit reticular and oxidative stress markers, lack of proteasome recycling and decreased mitochondria dependent ATP generation that are common features of degenerative diseases (Kim et al. 2009; Loeser 2009). In OA, chondrocytes fail to maintain homeostasis between anabolic and catabolic pathways. The proinflammatory cytokine interleukin-1 $\beta$  (IL-1 $\beta$ ) is mainly responsible for this homeostasis breakdown (Goldring et al. 2008). Indeed, IL-1 $\beta$  leads to a production of ROS and the synthesis / release of matrix metalloproteinases (MMP) by articular chondrocytes causing extracellular matrix proteolysis and breakdown. In fact, many of biological effects of IL-1 $\beta$  appear to be mediated by a generation of ROS (Grange et al. 2006; Oakley et al. 2009a; Yoshimura et al. 2011). For example, IL-1 $\beta$  leads to the same biological effects as H<sub>2</sub>O<sub>2</sub> by activating the redox dependant transcription factors NF- $\kappa$ B and AP-1 (Martin et al. 2005) triggering a dramatic decrease in type II collagen transcription with, on the other hand a significant induction of MMP synthesis by bovine chondrocytes. Moreover, it has been reported a crucial role for ROS in mediating chondrocytes hypertrophic differentiation and apoptosis (Drissi et al. 2005; Morita et al. 2007). This process occurs physiologically during endochondral ossification, allowing vertebrates bone growth. However, in a pathological slope, IL-1 $\beta$  promotes this terminal differentiation leading to cartilage mineralization and repair defects observed in OA (Drissi et al. 2005). To summarize, non-controlled MMP proteolytic activity associated with chondrocytes terminal differentiation and apoptosis are the two main features of the pathology.

Nox2 and Nox4 mRNA have been identified in three human chondrocyte cell lines and in the murine chondrogenic cell line ATDC5 (Goldring 2004; Grange et al. 2006; Kim et al. 2010). In ATDC5 cell line, authors have suggested a role for Nox in chondrogenic differentiation upon insulin treatment. Nox2 was shown to mediate IL-1 $\beta$ -induced apoptosis in an NF- $\kappa$ B dependant fashion in those cells (Yoshimura et al. 2011). In the human C-20/A4 chondrocyte cell line, Nox2 is non functional due to the lack of p47<sup>phox</sup>, a critical organizer of Nox2 activation (Grange et al. 2006). In fact in this cell line, Nox4 is the sole active member of Nox family and its activity was shown to mediate MMP-1 synthesis and chondrocyte apoptosis under IL-1 $\beta$  cytokinic stimulation (Grange et al. 2006; Rousset et al. 2013). Interestingly, the inhibition of Nox4 activity by HO-1 prevents IL-1 $\beta$ -induced MMP-1 secretion and chondrocyte apoptosis; two pathways that *in fine* drive to OA.

Well characterized in chondrocyte cell lines, no data are currently available concerning the expression and function of Nox in primary human articular chondrocyte (HAC). In this study, we show that Nox4 is expressed in HAC primary cells and exhibits a constitutive oxidase activity. Similar to chondrocyte cell line, IL-1 $\beta$  drive MMP-1, MMP-13 and ADAMTS4 synthesis by HAC primary cells through an increase of Nox4 activity. Furthermore, our data suggest that IL-1 $\beta$  increases p22<sup>phox</sup> expression which in turn stabilizes Nox4 expression and therefore its oxidase activity in HAC. Moreover, our results point out the existence of an autocrine/paracrine loop in which Nox4 activity mediate IL-1 $\beta$  and p22<sup>phox</sup> neosynthesis, sustaining catabolic pathways. Interestingly the IL-1 $\beta$ -induced ROS production is prevented by NADPH oxidase inhibitors and particularly by GKT136901, a drug that inhibits specifically Nox4. These results suggest that targeting ROS generators and in particular Nox4 may have a promising potential for therapeutic strategy in the pathology of OA.

## MATERIAL AND METHODS

### 4. 2.1. Material

Chemical reagents used in this study and their sources were the following: Dulbecco's modified Eagle's medium (DMEM), fetal bovine serum (FBS) and SuperScriptIII first-strand synthesis (life technologies, Saint Aubin, France) ; AMV Reverse transcriptase (QBiogene, Illkirch, France); TRIzol<sup>®</sup> reagent, Taq polymerase, Alexa Fluor 546 or 633 labelled goat anti-mouse IgG, Hoechst 33258, (Invitrogen, Cergy Pontoise, France) ; ECL Western Blotting detection reagents, Goat anti-Mouse IgG-HRP antibody and IL-1 $\beta$  ELISA detection kit (GE healthcare, Buckinghamshire, UK); Na<sub>4</sub>P<sub>2</sub>O<sub>7</sub>, Na<sub>3</sub>VO<sub>4</sub>, PMSF, luminol, Horseradish Peroxidase (HRPO), Triton X-100, protoporphyrin-IX cobalt chloride (CoPP-IX), Collagenase type IA and Hyaluronidase (SIGMA, Saint Quentin Fallavier, France) ; LightCycler FastStart DNA Master plus SYBR Green I kit, Okadaic acid, leupeptin, pepstatin, trypsin inhibitor, TLCK, human interleukin-1 $\beta$ , complete mini EDTA-free protease inhibitor EASYpack (Roche diagnostics, Meylan, France) ; diisopropylfluorophosphate (DFP, Acros Organics, Halluin, France) ; polyclonal Ig from goat against HO-1 (sc-7695) or against actin (sc-1615) and control Ig (Santa Cruz Biotechnologies, Heidelberg, Germany) ; Lab-Tek chambered coverglass (Thermo scientific, Courtaboeuf, France) ; 100  $\mu$ m nylon cell strainer (BD Falcon, Pont de Claix, France) ; Decalcifier solution for histology SAKURA TDE 30 (Bayer Healthcare, Newbury, UK),



second antibody anti mouse conjugated to peroxidase (DAKO, Courtaboeuf, France); anti-MMP-1 (mAb 901) and anti-MMP-13 monoclonal antibody (R&D Systems, Lille, France) ; Rabbit polyclonal Ig against VDAC (ab28777) and Rabbit monoclonal Ig against Nox4 (UOTR1B492; Abcam, Paris, France); Nox4 monoclonal antibodies (8E9 and 6B11) (Zhang et al. 2011).

## **5. 2.2. Chondrocyte isolation and culture**

Cartilage specimens were obtained from patients undergoing femoral hip replacement. Samples were obtained under patient's consent according to the declaration of Helsinki. Cartilage slices were removed from the femoral head and cut into small pieces. The distinction between the "OA chondrocyte" group and the control chondrocytes was determined by pathologists, according to the OARSI guidelines (Pritzker et al. 2006). Chondrocytes were then isolated by sequential enzymatic digestion: 1 h with 0.1 mg/ml hyaluronidase in sterile PBS at 37°C, followed by 16h with 1 mg/ml collagenase (type IA) at 37°C in DMEM containing 10% FBS, penicillin (100 U/ml) and streptomycin (100 g/ml) at 37°C in 5% CO<sub>2</sub> atmosphere. The digested tissue was filtered through a 100 µm nylon mesh, washed and centrifuged. The isolated chondrocytes were finally seeded in 6-well plates until they reach confluence and cultured in DMEM containing 4.5 g/L glucose and 0.11 g/L sodium pyruvate, supplemented with 10% (v/v) fetal bovine serum, 100 units/ml penicillin, 100 mg/ml streptomycin and 2 mM glutamine at 37°C in atmosphere containing 5% CO<sub>2</sub>. For experiments with IL-1β, complete cell culture medium was replaced by serum free DMEM for 24h. Chondrocytes were then stimulated with IL-1β supplemented or not with antioxidants or inhibitors during 24h. To avoid chondrocyte dedifferentiation, MMP-1 and MMP-13 Western Blot and Real Time Quantitative PCR were performed before the first passage; other experiments were performed after a single passage (t75cm<sup>2</sup>). The expression of collagen type II, a marker of chondrocyte differentiation was checked for each patient before experiments.

## **2.3 RNA extraction and RT-PCR**

Cells were harvested and resuspended in TRIzol<sup>®</sup> at approximately 10<sup>8</sup> cells/ml as described in the manufacturer's instructions. RNA concentrations were determined spectroscopically at 260 nm. Reverse transcription reactions were performed from 5 µg of RNA with 20U of

AMV reverse transcriptase, as described by Grange and al. (Grange et al. 2006). All PCRs were processed during 35 cycles from 2.5 µl cDNA with 2.5 U of Taq polymerase. cDNA integrity and quantity were checked by amplification of a housekeeping gene Actin using commercial primers (BD Bioscience, Pont de Claix, France).

#### **2.4. Quantitative real time PCR**

Total RNA was extracted using a TRIzol1 reagent kit or RNeasy Mini Kit (Qiagen) according to the manufacturer's instructions. Total RNA was treated with RNase-free DNase I (Qiagen). One or 5 mg of RNA were converted to cDNA by reverse transcription with 20 U of AMV reverse transcriptase or SuperScriptIII first-strand synthesis (Life Technologies). Real time PCRs were performed with the LightCycler FastStart DNA Master plus SYBR Green I kit (Roche) or QuantiTect SYBR Green RT-PCR kit (Qiagen) as described (Grange et al. 2006). Real time RT-PCR was conducted using the LightCycler1 Carousel- Based System (Roche) or a Stratagene Mx3005P (Stratagene). Briefly, the expression levels of human IL-1 $\beta$ , COL2A1, CYBA, Nox4, HMOX1, MMP-1, MMP-13, ADAMTS4 and housekeeping GAPDH, RPL27 and RPL32 mRNAs were determined using specific primers chosen to include intron spanning (Table 2). PCR were carried out for each sample in triplicate. Gene expression was quantified using the comparative threshold cycle (Ct) method. The amount of target gene, normalized to three endogenous reference genes (RPL27, RPL32 and GAPDH) was expressed relative to the control cells, as indicated in Figures. The specificity of the products was confirmed for each fragment by a melting curve analysis and gel electrophoresis.

#### **2.5. Amplex Red assay**

After the first passage chondrocytes were grown in t75cm<sup>2</sup> at 90% confluency. After 24h serum starvation and treatment or not with 10µM CoPP to induce HO-1 expression, cells were stimulated with 2ng/ml IL-1 $\beta$  for additional 24h. Cells were then detached with 0.25 % (w/v) trypsin, washed twice with PBS and collected after 8 min centrifugation at 400 g at room temperature. The viability of the suspended cells was over 95%, as determined by the trypan blue exclusion method. In a 96-well plate, 5x10<sup>5</sup> living cells resuspended in 20 µl PBS were added per well. Nox4 inhibitors: DPI or GKT (10µM) or DMSO (0.1%) was added in wells, 20 min before starting the experiment and 100 µl of a PBS solution containing 5 µM Amplex Red and 10 mUnits/ml horseradish peroxidase was added in each well to begin the

reaction. Results are expressed as the sum of Relative Fluorescent Units (RFU) recorded every two minutes during 60 min on a fluostar omega spectrofluorimeter (BMG labtech).

## **2.6. Cell extracts preparation**

Cells were treated with 3 mM DFP and lysed in Triton X-100 lysis buffer containing 20 mM Tris-HCl pH 7.4, 1% (v/v) Triton X-100, 150 mM NaCl, 1 mM EDTA, 10 mM Na<sub>4</sub>P<sub>2</sub>O<sub>7</sub>, 10 nM okadaic acid, 2 mM Na<sub>3</sub>VO<sub>4</sub>, 2 µg/ml leupeptin, 2 µg/ml pepstatin, 10 µg/ml trypsin inhibitor, 44 µg/ml PMSF, 10 µM TLCK and complete mini EDTA-free protease inhibitor (Triton X-100 cell extract). After 10 min incubation on ice, the mixture was centrifuged at 1000 g for 10 min at 4°C. The supernatant was then used for SDS-PAGE and Western Blotting.

## **2.7. SDS/PAGE and immunolotting**

Triton X-100 cell extract or centricon 10x concentrated cell culture supernatant were denatured at 60°C for 30 min or 4°C overnight and loaded on 10 % (p/v) SDS-PAGE for migration and then electro-transfer to nitrocellulose. Immunodetection was performed using antibodies raised against Nox4 (mAb 8E9 or 5F9, 1:500 or UOTR 1:2000) (Zhang et al. 2011), MMP-1 (1:500), MMP-13 (1:1000); HO-1 (1:500) or Actin (1:1000). Secondary antibody was conjugated to peroxidase (1:5000). Peroxidase activity was detected using ECL reagents (GE Healthcare).

## **2.8. IL-1β assay**

C-20/A4 chondrocytes were treated with IL-1β in a 75 cm<sup>2</sup> flask containing serum free DMEM medium in presence or not of 10µM CoPP to induce HO-1 expression or with 5mM Tiron. After 24h incubation, 3 washes were performed with 1X PBS. Last wash was kept to assess residual IL-1β remaining in the flask. Medium was then replaced by serum free DMEM medium for additional 24h and was uptake for IL-1β neosynthesis measurement with a commercial ELISA assay.

## **2.9. Confocal microscopy**

Chondrocytes were seeded on coverslips at 60% confluency and fixed with 4% (w/v) paraformaldehyde (PFA) for 10 min, PFA fluorescence was quenched by 50 mM NH<sub>4</sub>Cl for 10 additional min at room temperature (RT). Cells were then washed twice with PBS containing 1 % (w/v) BSA (PBS/BSA buffer) and permeabilized with 0.1 % (v/v) Triton X-100 during 10

min at RT. Nox4 subcellular localization was assessed by 1 h incubation at room temperature with 5 µg of mouse monoclonal Ig (irrelevant Ig or 8E9 mAb) in 200 µl of PBS/BSA buffer. After two washes with PBS/BSA buffer, 1h incubation with anti-mouse secondary antibodies conjugated to Alexa 546 (1/200) was performed at RT. Cell nuclei were stained with Hoechst 33258 (0.5 µg/ml) and mounted in DABCO solution; they were sealed, and stored at 4°C in the dark. Confocal microscopy was carried out by using the Zeiss LSM510 NLO META. The pinhole was adjusted to 1 Airy unit resulting in 0.7 µm thick slices. Hoechst fluorescence was visualized using a 2P excitation.

### **2.10. Immunohistochemistry**

Human cartilage was decalcified (Decalcifier SAKURA TDE 30, Bayer-Tissue teck), washed in distilled water and included in paraffin. Four µm sections were then layered on polylysine coated slides and deparaffined with xylene treatment. Slides were then incubated for 40min at 98°C in EDTA solution pH8 to unmask antigen, treated with H<sub>2</sub>O<sub>2</sub> 3% for 10 min to inhibit endogenous peroxidases and were incubated over night with Nox4 8E9 mAb, 4°C. After 3 rinse in PBS 1x, slides were incubated for 45 min with second antibody conjugated to peroxidase before revelation. Nucleus was stained by hematoxilin and samples were mounted on coverslips.

### **2.11. Statistical data**

Data are presented as means +/- S.D., significance levels are assessed using Student's paired t test. A p-value of 0.05 or less between groups is considered to indicate a statistically significant difference.

## **RESULTS**

### **3.1. Nox4 is a major source of ROS upon IL-1β stimulation in human articular chondrocytes**

IL-1β is one of the main catabolic factors involved in osteoarthritis and many of its biological effects are mediated through a generation of ROS (Poole and Howell 2001 ; Grange et al. 2006). Given the importance of oxidative stress in age related diseases and in particular in osteoarthritis and our previous data from the chondrocyte cell line C-20/A4 (Grange et al. 2006; Brieger et al. 2012; Rousset et al. 2013), we decided to investigate the role of ROS in human articular chondrocytes. HAC were isolated and cultured from human femoral head according to the material and method section. We first assessed the impact of IL-1β on the

production of ROS by HAC. After 24h of stimulation by IL-1 $\beta$ , we observed a significant increase of the H<sub>2</sub>O<sub>2</sub> production by HAC (Figure 1A) with an optimum dose / response value at 2ng/ml IL-1 $\beta$  (Supp. Figure 1). We have previously shown that HO-1 has been shown to inhibit Nox4 activity in the C-20/A4 chondrocyte cell line (Rousset et al. 2013). In order to determine the role of Nox4 in the IL-1 $\beta$ -mediated pathway, we treated HAC cells with CoPP for 24h to induce the expression of HO-1 mRNA (Supp. Figure 2). Interestingly, induction of HO-1 expression dramatically decreased IL-1 $\beta$ -stimulated production of ROS by HAC (Figure 1B). Moreover, the addition of the DPI, an inhibitor of flavin enzyme, as well as that of the GKT, a pharmacological inhibitor of Nox4, led to a significant inhibition of the amount of ROS produced by HAC (Figure 1A). Together, these data suggest that Nox4 is a major source of ROS in HAC upon IL-1 $\beta$  stimulation.

To confirm the identity of the enzyme responsible for the ROS production by IL-1 $\beta$ , the presence NADPH oxidases (Nox1 to Nox5) and their partner p22<sup>phox</sup> was evaluated by RT-PCR (Figure 1B). Consistent to our previous data the C-20/A4 cell line (Grange et al. 2006), results have shown a robust transcription of Nox4 and p22<sup>phox</sup> in human primary chondrocyte. In contrast, Nox2 mRNA was not detected pointing Nox4 as the main source of ROS in HAC upon IL-1 $\beta$  stimulation. These results were confirmed by real time RT-PCR experiments (data not shown).

### **3.2. Nox4 is expressed and colocalized with Poldip2 in human articular cartilage**

To confirm that Nox4 is expressed *in vivo*, immunohistochemical experiments were performed on human cartilage sections (Figure 2A and 2B) and showed a gradual expression of Nox4 from the subchondral bone to the articular surface of the cartilage (Figure 2A). Accordingly, Nox4 proteins were also detected in *ex vivo* cultured HAC by Immunoblot (Figure 2C). Poldip2 was recently identified as an activator partner of Nox4 in Vascular Smooth Muscle Cells (VSMC). We found that Poldip2 is co-expressed with Nox4 by western blot in HAC cells (Figure 2C and 2D). We next assessed the subcellular localization of Nox4 in primary chondrocytes by confocal microscopy. Our results showed a clear expression of Nox4 in the perinuclear area and next to the plasma membrane of HAC. Interestingly, confocal experiments suggest that Poldip2 co-localizes with Nox4 in these cells (Figure 2E) suggesting a possible role of Poldip2 in the activation of the production of ROS by Nox4 in HAC cells.

### **3.3. Nox4 activity mediates MMP synthesis by chondrocytes**

We have previously shown that ROS generated by Nox4 regulate the MMP-1 synthesis pathway in the IL-1 $\beta$ -stimulated C-20/A4 chondrocyte cell line (Rousset et al. 2013). Moreover, in this cell line, IL-1 $\beta$  or exogenous addition of H<sub>2</sub>O<sub>2</sub> leads to a significant increase in MMP-1 secretion (Supp. Figure 3) confirming a role for IL-1 $\beta$  mediated production of ROS in MMP synthesis by chondrocytes. We therefore assessed the impact of ROS generated in response to IL-1 $\beta$  on MMP synthesis and release by primary human chondrocytes. We observed a strong increase in the mRNA level in HAC cell and in the amount of MMP-1 and MMP-13 proteins released in the culture supernatant after 24h stimulation with IL-1 $\beta$  (Figure 3). Similarly, a strong induction of the transcription of ADAMTS4 was detected by quantitative RT-PCR (Figure 4E). Interestingly, MMP-1 and MMP-13 transcription and secretion was reduced by 50% with an antioxidant treatment (Figure 3A-D) as well as with the NADPH oxidase inhibitors DPI and HO-1 induction by CoPP. ADAMTS4 mRNA was particularly affected with a decrease of over than 80% in presence of Nox4 inhibitors (Figure 3E).

Therefore data demonstrate that IL-1 $\beta$ -mediated MMP synthesis and release in HAC cells are triggered by a production of ROS. Interestingly, antioxidant treatment and Nox4 inhibitors were able to inhibit these deleterious pathways.

### **3.4. IL-1 $\beta$ regulates Nox4 activity through its protein level via p22<sup>phox</sup> mRNA upregulation.**

Data from the literature support the fact that Nox4 activity is constitutive and is mainly regulated at a transcriptional level (Serrander et al. 2007; Nguyen et al. 2012). However, partners such as Poldip2 have recently been shown to stimulate Nox4 activity independently of its level of expression (Lyle et al. 2009). Therefore, we assessed whether production of ROS induced by IL-1 $\beta$  results whether from Nox4 mRNA transcription and neosynthesis or from a direct Nox4 protein activation. For this, we used Cycloheximide (CHX), an inhibitor of the translation machinery, to prevent the neosynthesis of Nox4 proteins. CHX treatment abolished the increase of ROS production by chondrocytes observed in response to IL-1 $\beta$  exposure (Figure 4A). Thereby, production of ROS induced by IL-1 $\beta$  requires protein neosynthesis rather than post translational activation of Nox4 in HAC cells.

We therefore assessed the impact of IL-1 $\beta$  on Nox4 transcription. Unexpectedly, after 24h treatment with IL-1 $\beta$ , results obtained by quantitative RT-PCR showed a decrease in Nox4 mRNA (Figure 4B). It has been reported that Nox4 translation can be rapidly induced by stimuli due to the presence of a pool of Nox4 mRNA (Bondi et al. 2010; New et al. 2011) and that the level of Nox4 mRNA is not always correlated to the level of its protein expression (Meng et al. 2008). Similar to Nox2, Nox4 protein is stabilized in the presence of p22<sup>phox</sup> (Ambasta et al. 2004) therefore, IL-1 $\beta$  could upregulate Nox4 by increasing the expression of its partner p22<sup>phox</sup>. Indeed, results showed a 3.5 fold increase in p22<sup>phox</sup> mRNA content after stimulation by IL-1 $\beta$  (Figure 4C). Interestingly, the increase in p22<sup>phox</sup> mRNA level coincides with an upregulation of Nox4 protein level (Figure 4D). Together, these results suggest that the mechanism leading to an increase ROS production by IL-1 $\beta$  in HAC cells is mediated by an upregulation of p22<sup>phox</sup> that stabilize Nox4 proteins.

### 3.5. IL-1 $\beta$ induced ROS production is involved in inflammation persistence

It is well established that inflammatory process plays a significant role in the OA pathology (Goldring et al. 2008). Especially, IL-1 $\beta$  acts in an autocrine/paracrine manner and induces its own neosynthesis by the chondrocyte, maintaining the vicious circle leading to cartilage degradation (Poole et al. 1997; Towle et al. 1997). We next assessed whether the inhibition of Nox4 could impact the auto-induced IL-1 $\beta$  synthesis. Results obtained by quantitative RT-PCR showed that 24h IL-1 $\beta$  treatment strongly induced IL-1 $\beta$  mRNA (4000 fold increase) (Figure 5A). Interestingly, the use of antioxidants such as Tiron or the inhibition of Nox4 by DPI or HO-1-induction significantly reduced IL-1 $\beta$  mRNA neosynthesis leading to a reduction of the protein level of IL-1 $\beta$  assessed by ELISA assay in the culture supernatant of C-20/A4 chondrocytes (Figure 5B). Moreover, IL-1 $\beta$  induced p22<sup>phox</sup> transcription was also significantly reversed by antioxidants and Nox4 inhibitors treatment, suggesting the existence of a redox activated positive loop (Figure 5C).

To confirm the existence of this redox positive control loop, we compared effects of pre-incubation with IL-1 $\beta$  and H<sub>2</sub>O<sub>2</sub> on the ROS production by HAC and C-20/A4 chondrocytes (Figure 5D; Supp. Figure 4). For this, after 24h exposure to IL-1 $\beta$  or to H<sub>2</sub>O<sub>2</sub>, cells were washed and subject to ROS measurement. As expected, results showed a significant increase in ROS production after IL-1 $\beta$  treatment. Interestingly, production of ROS both by HAC and C-20/A4 chondrocytes was increased in a dose dependant fashion by H<sub>2</sub>O<sub>2</sub> treatment. This

enhanced production of ROS was coincident with MMP-1 secretion in the culture supernatant of C-20/A4 chondrocytes (Supp. Figure 3).

Taken together, these results demonstrate for the first time that p22<sup>phox</sup> transcription is upregulated by Nox4 activity, maintaining the formation of ROS by Nox4 in HAC. Nox4 activity mediates in turn IL-1 $\beta$  neosynthesis and sustains catabolic pathways.

### **3.6. IL-1 $\beta$ , p22<sup>phox</sup> and MMP related genes are upregulated in OA chondrocytes**

We next asked whether the IL-1 $\beta$  pathway through Nox4 activation and stabilization that we identified *ex vitro* is indeed implicated in osteoarthritis pathology. We therefore compared the expression of genes encoding for IL-1 $\beta$ , Nox4/p22<sup>phox</sup> complex and MMP in primary chondrocytes isolated from osteoarthritic parts versus healthy parts from the same articulation (Figure 6). Preliminary results obtained from 3 different patients are not yet significant at this time but an upregulation of IL-1 $\beta$  mRNA seems to occur in OA chondrocytes while at the same time Collagen II mRNA tended to decrease (Figure 6A; Supp. Figure 5) validating the results obtained in our experimental approach. Results also point out to a slight increase in CYBA mRNA in the "OA group" versus control cells despite the fact that Nox4 mRNA was not changed (Figure 6 B and 6C). Interestingly, MMP-1, MMP-13 and ADAMTS4 mRNA seems to be upregulated in the OA chondrocytes group (Figure 6D, 6E, 6F). Finally, these data point out a tendency in which p22<sup>phox</sup>, IL-1 $\beta$  and MMP encoding genes could be upregulated in OA chondrocytes compared to control cells. This is in agreement with the mechanistic model we suggest (Figure 7).

## **DISCUSSION**

Altogether, the data light on the role of ROS produced upon IL-1 $\beta$  stimulation in human primary chondrocytes. Given the critical role of oxidative stress in degenerative processes and in particular in OA, it is to note that actually no studies describe the presence of Nox in primary human chondrocytes. Our work demonstrates for the first time that Nox4 is a major source of ROS in HAC upon IL-1 $\beta$  treatment and mediates pro-catabolic pathways. These results are supported by preliminary clinic data.

Physiological relevance of ROS in chondrocytes is not well understood. Previous studies suggested a role of ROS during chondrogenesis or endochondral ossification (Drissi et al. 2005; Morita et al. 2007; Kim et al. 2010). Our results show for the first time the expression



of Nox4 in human articular cartilage slides with a clear gradient of Nox4 expression from the bone side to the articular surface of human cartilage. These data suggest an inverse correlation between Nox4 expression and hypertrophic chondrocytes location, next to the bone side and effectively raise the role of Nox4 in human chondrocyte differentiation.

However, in the inflammatory context mimicked in our study by the effects of IL-1 $\beta$  on HAC, ROS may play deleterious and pro-catabolic functions. Indeed, our data suggest that ROS generated by Nox4 activity are critical mediators of MMP-1, MMP-13 and ADAMTS4 synthesis and release by HAC. Interestingly, the use of Nox inhibitors such as DPI or HO-1 is able to prevent this release.

Unexpectedly, the results show that IL-1 $\beta$  has opposite effects on p22<sup>phox</sup> and Nox4 transcription. Indeed, CYBA mRNA, coding for p22<sup>phox</sup> was 4 fold upregulated in HAC while in the same time Nox4 mRNA was 5 fold downregulated. This raises the possibility that another Nox isoform dependent on p22<sup>phox</sup> such as Nox1-3 might be upregulated by IL-1 $\beta$  stimulation. However, after IL-1 $\beta$  treatment Nox4 was still the sole Nox isoform we could detect in HAC. Moreover, in contrast with the mRNA level, IL-1 $\beta$  seemed to increase Nox4 protein expression that was coincident with the enhanced ROS production. Finally our results suggest that IL-1 $\beta$  drive to an increase in Nox4 expression and activity via its stabilization at the post translational level by p22<sup>phox</sup>.

In contrast to Nox1-3, the activation process of which requires the translocation of cytosolic factors, Nox4 activity was shown to be regulated at the transcriptional level (Serrander et al. 2007). However, Nox4 mRNA level is not always representative of the protein amount expressed in the cell (Meng et al. 2008; Bondi et al. 2010; New et al. 2011). The recent report by Meng *et al.* demonstrate a rapid increase in Nox4 activity and expression without significant changes in the mRNA level (Meng et al. 2008). Moreover, actinomycin D, an inhibitor of the transcription process was not able to inhibit Nox4 increase in ROS production. Such hypothesis could explain the contrast between Nox4 mRNA and protein level after IL-1 $\beta$  treatment in HAC. However, a kinetic of Nox4 mRNA level earlier than 24h would be necessary to better understand this phenomenon in chondrocytes.

It is well known that IL-1 $\beta$  acts in an autocrine / paracrine manner and induces its own neosynthesis by chondrocytes (Poole et al. 1997). Results show indeed a clear induction of IL-1 $\beta$  mRNA upon IL-1 $\beta$  stimulation of HAC. Moreover, data demonstrate that this loop is redox mediated. In fact, p22<sup>phox</sup> upregulation upon IL-1 $\beta$  treatment may stabilize Nox4

generation of ROS, which in turn appears to be necessary to mediate IL-1 $\beta$  neosynthesis. Interestingly, antioxidants (Tiron) and Nox4 inhibitors (DPI or HO-1) abolished both the increase in p22<sup>phox</sup> and IL-1 $\beta$  mRNA, suggesting the importance of Nox4 in sustaining catabolic pathways in HAC.

Such transcriptional regulation of p22<sup>phox</sup> was also shown by Djordjevic et al. in EaHy926 endothelial cell line (Djordjevic et al. 2005). In this context, it is to remember that Poldip2, the recently identified activator of Nox4 in Vascular Smooth Muscle Cells is able to increase Nox4 activity via a binding to p22<sup>phox</sup> (Lyle et al. 2009). Interestingly, our preliminary results showed that poldip2 is expressed in HAC and may colocalize with Nox4. Further experiments need to be performed to clarify the role of Poldip2 in HAC.

Altogether, our results demonstrate for the first time the central role of Nox4/p22<sup>phox</sup> in human articular chondrocytes mediated expression of MMP and IL-1 $\beta$  autocrine loop (Figure 7). These results are supported by preliminary clinic data showing that IL-1 $\beta$ , p22<sup>phox</sup> and MMP mRNA expression tend to be upregulated in OA chondrocytes, compared to healthy cells. Finally, this study confirms that antioxidants or novel approaches to modulate Nox4 activity, such as HO-1 or GKT136901, could open new therapeutic strategies in osteoarthritis.

#### FIGURE LEGEND

**Figure 1. Nox4 is a major source of ROS upon IL-1 $\beta$  stimulation in human articular chondrocytes.** (A) HAC were induced or not for HO-1 expression by 24h treatment with 10 $\mu$ M CoPP. Cells were then stimulated with IL-1 $\beta$  for additional 24h and total H<sub>2</sub>O<sub>2</sub> production was assessed by the Amplex Red method by using 5x10<sup>5</sup> cells per well. Nox4 inhibitors: DPI or GKT (10 $\mu$ M) or DMSO (0.1%) was added in wells, 20 min before starting the experiment. Results are expressed as the percentage of non stimulated cells in Relative Fluorescence Units (RFU) and were acquired every minute during 60 min. Values represent the mean +/- S.D. of three determinations obtained the same day and are representative of three independent experiments. \*\* p<0.05 versus non stimulated cells. \* p<0.05 versus IL-1 $\beta$  alone treated cells. (B) RNA was extracted from HAC and transcribed to cDNA as described in the Material and Methods section. Specific primers were used to amplify cDNA encoding for Nox1 to Nox5 and p22<sup>phox</sup> (Table 1). The housekeeping actin gene was used as a positive control. Results are representative of three independent experiments.

**Figure 2. Nox4 is the chondrocyte NADPH oxidase.** (A) Nox4 is gradually expressed in human cartilage from the bone side to the articular surface. Immunohistochemical detection of Nox4 on human cartilage sections with purified mAb 8E9 (1:1250). (C) Poldip2 or (D) Nox4 expression was assessed by immunoblot upon SDS-PAGE on 150 µg of protein from 1% (v/v) Triton X-100 extract obtained from HAC. positive controls were obtained from HEK293-Trex Nox4 cells. (E) HAC were fixed with PFA, permeabilized and Poldip2 (green) and Nox4 (red) were respectively stained with a goat pAb or the 8E9 mAb antibody (red). The nucleus was coloured with Hoechst 33256 (blue).

**Figure 3. Nox4 activity regulates MMP synthesis.** HAC were cultured in absence of FBS and induced or not for HO-1 expression by CoPP. After 24h treatment with IL-1β and Nox4 inhibitors Total RNA was extracted from HAC and Real-time PCR analysis of MMP-1 (A), MMP-13 (C) and ADAMTS4 (D) mRNA expression were performed. In parallel, supernatant was uptake and 10 µg of proteins were loaded for MMP-1 (B) or MMP-13 (D) immunodetection by Western Blot. Results are representative of at least three independent experiments. \* p<0.05 versus IL-1β alone treated cells.

**Figure 4. IL-1β stabilizes Nox4 at the protein level through p22<sup>phox</sup> mRNA upregulation.** (A) Confluent HAC were cultured in absence of foetal bovine serum (FBS) and stimulated by IL-1β for 5h in presence or not of 100µg/mL cycloheximide, in order to stop *de novo* protein translation. Total H<sub>2</sub>O<sub>2</sub> production was then assessed by the Amplex Red method on 5x10<sup>5</sup> cells. Results are expressed as the percentage of non stimulated cells in Relative Fluorescence Units (RFU) and were acquired every minute during 60 min. Values represent the mean +/- S.D. of four determinations obtained the same day. \* p<0.05. NS: Non significant difference. (B and C) Total RNA was extracted from 24h IL-1β-treated HAC and Real-time PCR analysis of *Nox4* (B) and *CYBB* (C) mRNA expression were performed. (D) Nox4 protein expression in HAC. HAC were cultured in absence of foetal bovine serum (FBS) and stimulated by IL-1β for 24h. Nox4 expression was then assessed by Western Blot with a rabbit mAb on 75 µg of protein from 1% (v/v) Triton X-100 extract. Actin protein served as loading control.

**Figure 5. Nox4 activity sustains IL-1 $\beta$  autocrine/paracrine loop and p22<sup>phox</sup> upregulation.**

(A-C) HAC were cultured in absence of FBS and induced or not for HO-1 expression by CoPP. After 24h treatment with IL-1 $\beta$  and Nox4 inhibitors, total RNA was extracted from HAC and Real-time PCR analysis of *IL-1 $\beta$*  (A) and *CYBA* (C) were performed. (B) C-20/A4 chondrocytes were stimulated for 24h with 2ng/mL IL-1 $\beta$ . After 3 washes in PBS, serum free medium was replaced and was uptake 24h later to assess IL-1 $\beta$  neosynthesis by ELISA method. Values represent the mean +/- S.D. of three determinations obtained the same day and are representative of three independent experiments. (D) HAC were cultured in absence of FBS and treated by IL-1 $\beta$  or increasing amounts of H<sub>2</sub>O<sub>2</sub> (from 100 to 500 $\mu$ M). Cells were trypsinised, washed twice in PBS and total H<sub>2</sub>O<sub>2</sub> production was assessed by the Amplex Red method on 5x10<sup>5</sup> cells. Results are expressed as the percentage of non stimulated cells in Relative Fluorescence Units (RFU) and were acquired every minute during 60 min. Values represent the mean +/- S.D. of four determinations obtained the same day. \* p<0.05 versus IL-1 $\beta$  alone treated cells. \*\* p<0.05 versus non treated cells.

**Figure 6. IL-1 $\beta$ , p22<sup>phox</sup> and MMP are upregulated in OA chondrocytes.** Chondrocytes were isolated from damaged part (osteoarthritic) and undamaged part (control) of femoral heads from patients undergoing hip replacement and were grown in 6 wells plate until confluence. The amount of mRNA encoding for (A) IL-1 $\beta$ , (B) *CYBA*, (C) Nox4, (D) MMP-1, (E) MMP-13 and (F) ADAMTS-4 was then assessed by quantitative RT-PCR according to the material and methods section. Values represent the mean +/- S.D. obtained from three different patients.

**Figure 7. Nox4 mediated pathways in human chondrocytes.** IL-1 $\beta$  treatment of HAC leads to upregulation of p22<sup>phox</sup> mRNA, stabilization of Nox4 at the protein level and increasing production of H<sub>2</sub>O<sub>2</sub>. H<sub>2</sub>O<sub>2</sub> acts as a crucial mediator of MMP-1, MMP-13 and ADAMTS4 expression that are responsible for chondrocyte extracellular matrix catabolism. This work also point out the redox positive retrocontrol of p22<sup>phox</sup> and IL-1 $\beta$  highlighting that ROS production by Nox4 could sustain catabolic pathways in HAC.

**SUPPLEMENTARY FIGURES:**

**Supp. Figure 1: Impact of IL-1 $\beta$  concentration on the production of ROS by HAC.** HAC were cultured in absence of FBS and stimulated with increasing concentrations of IL-1 $\beta$  (from 0.5

to 10ng/mL). Total H<sub>2</sub>O<sub>2</sub> production was then assessed by the Amplex Red method on 5x10<sup>5</sup> cells. Results are expressed as the percentage of non stimulated cells in Relative Fluorescence Units (RFU) and were acquired every minute during 60 min. Values represent the mean +/- S.D. of four determinations obtained the same day.

**Supp. Figure 2: CoPP induces HO-1 transcription in HAC.** HAC were cultured 24h in presence of 10µM CoPP. Total RNA was then extracted and Real-time PCR analysis of *HMOX1* was performed. Values represent the mean +/- S.D. obtained from three different patients.

**Supp. Figure 3: Both IL-1β and H<sub>2</sub>O<sub>2</sub> activate MMP-1 secretion C-20/A4 chondrocytes.** Cells were cultured in absence of foetal bovine serum (FBS) and treated by IL-1β or by increasing amounts of H<sub>2</sub>O<sub>2</sub> (from 100 to 500µM) for 24h. Supernatant was then collected and 10 µg of proteins were loaded on SDS-PAGE for MMP-1 immunodetection by Western Blot. Results are representative of three independent experiments.

**Supp. Figure 4: Both IL-1β and H<sub>2</sub>O<sub>2</sub> activate the production of ROS by chondrocytes.** C-20/A4 chondrocytes were cultured in absence of FBS and treated by IL-1β or increasing amounts of H<sub>2</sub>O<sub>2</sub> (from 100 to 500µM). Cells were trypsinised, washed twice with PBS and total H<sub>2</sub>O<sub>2</sub> production was assessed by the Amplex Red method on 5x10<sup>5</sup> cells. Results are expressed as the percentage of non stimulated cells in Relative Fluorescence Units (RFU) and were acquired every minute during 60 min. Values represent the mean +/- S.D. of four determinations obtained the same day.

**Supp. Figure 5:**

Chondrocytes were isolated from damaged part (osteoarthritic) and undamaged part (control) of femoral heads from patients undergoing hip replacement and were grown in 6 wells plate until confluence. The amount of mRNA encoding for collagen II was then assessed by quantitative RT-PCR according to the material and methods section. Values represent the mean +/- S.D. obtained from three different patients.

## REFERENCES

- Ambasta RK, Kumar P, Griendling KK, Schmidt HH, Busse R et al. (2004) Direct interaction of the novel Nox proteins with p22phox is required for the formation of a functionally active NADPH oxidase. *The Journal of biological chemistry* 279(44): 45935-45941.
- Bondi CD, Manickam N, Lee DY, Block K, Gorin Y et al. (2010) NAD(P)H oxidase mediates TGF-beta1-induced activation of kidney myofibroblasts. *J Am Soc Nephrol* 21(1): 93-102.
- Brieger K, Schiavone S, Miller FJ, Jr., Krause KH (2012) Reactive oxygen species: from health to disease. *Swiss medical weekly* 142: w13659.
- Djordjevic T, Pogrebniak A, BelAiba RS, Bonello S, Wotzlaw C et al. (2005) The expression of the NADPH oxidase subunit p22phox is regulated by a redox-sensitive pathway in endothelial cells. *Free radical biology & medicine* 38(5): 616-630.
- Drissi H, Zuscik M, Rosier R, O'Keefe R (2005) Transcriptional regulation of chondrocyte maturation: potential involvement of transcription factors in OA pathogenesis. *Molecular aspects of medicine* 26(3): 169-179.
- Edderkaoui M, Nitsche C, Zheng L, Pandol SJ, Gukovsky I et al. (2010) NADPH oxidase activation in pancreatic cancer cells is mediated through Akt-dependent up-regulation of p22phox. *The Journal of biological chemistry* 286(10): 7779-7787.
- Geiszt M, Kopp JB, Varnai P, Leto TL (2000) Identification of renox, an NAD(P)H oxidase in kidney. *Proc Natl Acad Sci U S A* 97(14): 8010-8014.
- Goldring MB (2004) Immortalization of human articular chondrocytes for generation of stable, differentiated cell lines. *Methods in molecular medicine* 100: 23-36.
- Goldring MB, Otero M, Tsuchimochi K, Ijiri K, Li Y (2008) Defining the roles of inflammatory and anabolic cytokines in cartilage metabolism. *Annals of the rheumatic diseases* 67 Suppl 3: iii75-82.
- Grange L, Nguyen MV, Lardy B, Derouazi M, Champion Y et al. (2006) NAD(P)H oxidase activity of Nox4 in chondrocytes is both inducible and involved in collagenase expression. *Antioxidants & redox signaling* 8(9-10): 1485-1496.
- Harman D (1956) Aging: a theory based on free radical and radiation chemistry. *Journal of gerontology* 11(3): 298-300.
- Henrotin Y, Kurz B, Aigner T (2005) Oxygen and reactive oxygen species in cartilage degradation: friends or foes? *Osteoarthritis and cartilage / OARS, Osteoarthritis Research Society* 13(8): 643-654.
- Kim J, Xu M, Xo R, Mates A, Wilson GL et al. (2009) Mitochondrial DNA damage is involved in apoptosis caused by pro-inflammatory cytokines in human OA chondrocytes. *Osteoarthritis and cartilage / OARS, Osteoarthritis Research Society* 18(3): 424-432.
- Kim KS, Choi HW, Yoon HE, Kim IY (2010) Reactive oxygen species generated by NADPH oxidase 2 and 4 are required for chondrogenic differentiation. *The Journal of biological chemistry* 285(51): 40294-40302.
- Krause KH (2007) Aging: a revisited theory based on free radicals generated by NOX family NADPH oxidases. *Experimental gerontology* 42(4): 256-262.
- Lambeth JD (2004) NOX enzymes and the biology of reactive oxygen. *Nat Rev Immunol* 4(3): 181-189.
- Lassegue B, San Martin A, Griendling KK (2012) Biochemistry, physiology, and pathophysiology of NADPH oxidases in the cardiovascular system. *Circulation research* 110(10): 1364-1390.
- Loeser RF (2009) Aging and osteoarthritis: the role of chondrocyte senescence and aging changes in the cartilage matrix. *Osteoarthritis and cartilage / OARS, Osteoarthritis Research Society* 17(8): 971-979.

## Travaux de recherche

- Lyle AN, Deshpande NN, Taniyama Y, Seidel-Rogol B, Pounkova L et al. (2009) Poldip2, a novel regulator of Nox4 and cytoskeletal integrity in vascular smooth muscle cells. *Circulation research* 105(3): 249-259.
- Mandal CC, Ganapathy S, Gorin Y, Mahadev K, Block K et al. (2012) Reactive oxygen species derived from Nox4 mediate BMP2 gene transcription and osteoblast differentiation. *The Biochemical journal* 433(2): 393-402.
- Martin G, Andriamanalijaona R, Mathy-Hartert M, Henrotin Y, Pujol JP (2005) Comparative effects of IL-1beta and hydrogen peroxide (H<sub>2</sub>O<sub>2</sub>) on catabolic and anabolic gene expression in juvenile bovine chondrocytes. *Osteoarthritis and cartilage / OARS, Osteoarthritis Research Society* 13(10): 915-924.
- Meng D, Lv DD, Fang J (2008) Insulin-like growth factor-I induces reactive oxygen species production and cell migration through Nox4 and Rac1 in vascular smooth muscle cells. *Cardiovascular research* 80(2): 299-308.
- Morita K, Miyamoto T, Fujita N, Kubota Y, Ito K et al. (2007) Reactive oxygen species induce chondrocyte hypertrophy in endochondral ossification. *The Journal of experimental medicine* 204(7): 1613-1623.
- New DD, Block K, Bhandhari B, Gorin Y, Abboud HE (2011) IGF-I increases the expression of fibronectin by Nox4-dependent Akt phosphorylation in renal tubular epithelial cells. *American journal of physiology* 302(1): C122-130.
- Nguyen MV, Zhang L, Lhomme S, Mouz N, Lenormand JL et al. (2012) Recombinant Nox4 cytosolic domain produced by a cell or cell-free base systems exhibits constitutive diaphorase activity. *Biochemical and biophysical research communications* 419(3): 453-458.
- Nguyen MV, Lardy B, Rousset F, Hazane-Puch F, Zhang L et al. (2013) Quinone compounds regulate the level of ROS production by the NADPH oxidase Nox4. *Biochemical pharmacology* 85(11): 1644-1654.
- Oakley FD, Smith RL, Engelhardt JF (2009) Lipid rafts and caveolin-1 coordinate interleukin-1beta (IL-1beta)-dependent activation of NFkappaB by controlling endocytosis of Nox2 and IL-1beta receptor 1 from the plasma membrane. *The Journal of biological chemistry* 284(48): 33255-33264.
- Poole AR, Howell DS (2001) Etiopathogenesis of osteoarthritis. . In: Moskowitz RW, Howell DS, Altman RD, Buckwalter JA, Goldberg VM, editors. *Osteoarthritis: diagnosis/surgical management Philadelphia: WB Saunders* pp. 29–47.
- Poole AR, Alini M, Hollander AR (1997) Cellular biology of cartilage degradation. In: Henderson B, Edwards JC, Pettipher ER, editors. *Mechanisms and models in rheumatoid arthritis London: Academic Press*. pp. 163–204.
- Pritzker KP, Gay S, Jimenez SA, Ostergaard K, Pelletier JP et al. (2006) Osteoarthritis cartilage histopathology: grading and staging. *Osteoarthritis and cartilage / OARS, Osteoarthritis Research Society* 14(1): 13-29.
- Rousset F, Nguyen MV, Grange L, Morel F, Lardy B (2013) Heme Oxygenase-1 Regulates Matrix Metalloproteinase MMP-1 Secretion and Chondrocyte Cell Death via Nox4 NADPH Oxidase Activity in Chondrocytes. *PloS one* 8(6): e66478.
- Serrander L, Cartier L, Bedard K, Banfi B, Lardy B et al. (2007) NOX4 activity is determined by mRNA levels and reveals a unique pattern of ROS generation. *The Biochemical journal* 406(1): 105-114.
- Sumimoto H (2008) Structure, regulation and evolution of Nox-family NADPH oxidases that produce reactive oxygen species. *The FEBS journal* 275(13): 3249-3277.
- Towle CA, Hung HH, Bonassar LJ, Treadwell BV, Mangham DC (1997) Detection of interleukin-1 in the cartilage of patients with osteoarthritis: a possible autocrine/paracrine role in pathogenesis. *Osteoarthritis and cartilage / OARS, Osteoarthritis Research Society* 5(5): 293-300.
- Yang S, Zhang Y, Ries W, Key L (2004) Expression of Nox4 in osteoclasts. *Journal of cellular biochemistry* 92(2): 238-248.

### Chapitre III : Nox4, physiopathologie de l'arthrose

- Yoshimura K, Miyamoto Y, Yasuhara R, Maruyama T, Akiyama T et al. (2011) Monocarboxylate transporter-1 is required for cell death in mouse chondrocytic ATDC5 cells exposed to interleukin-1beta via late phase activation of nuclear factor kappaB and expression of phagocyte-type NADPH oxidase. *The Journal of biological chemistry* 286(17): 14744-14752.
- Zhang L, Nguyen MV, Lardy B, Jesaitis AJ, Grichine A et al. (2011) New insight into the Nox4 subcellular localization in HEK293 cells: first monoclonal antibodies against Nox4. *Biochimie* 93(3): 457-468.



Fig. 1

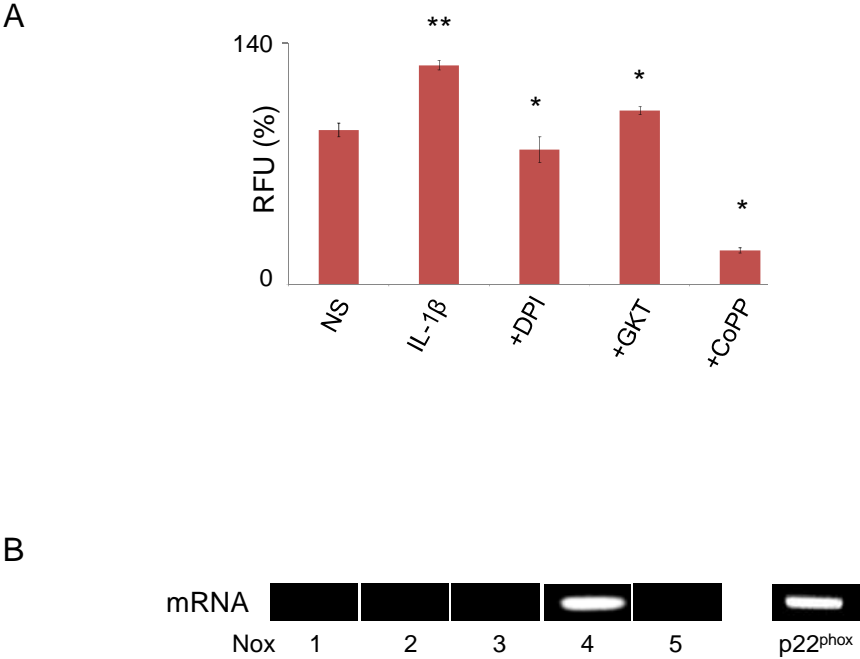

Fig. 2

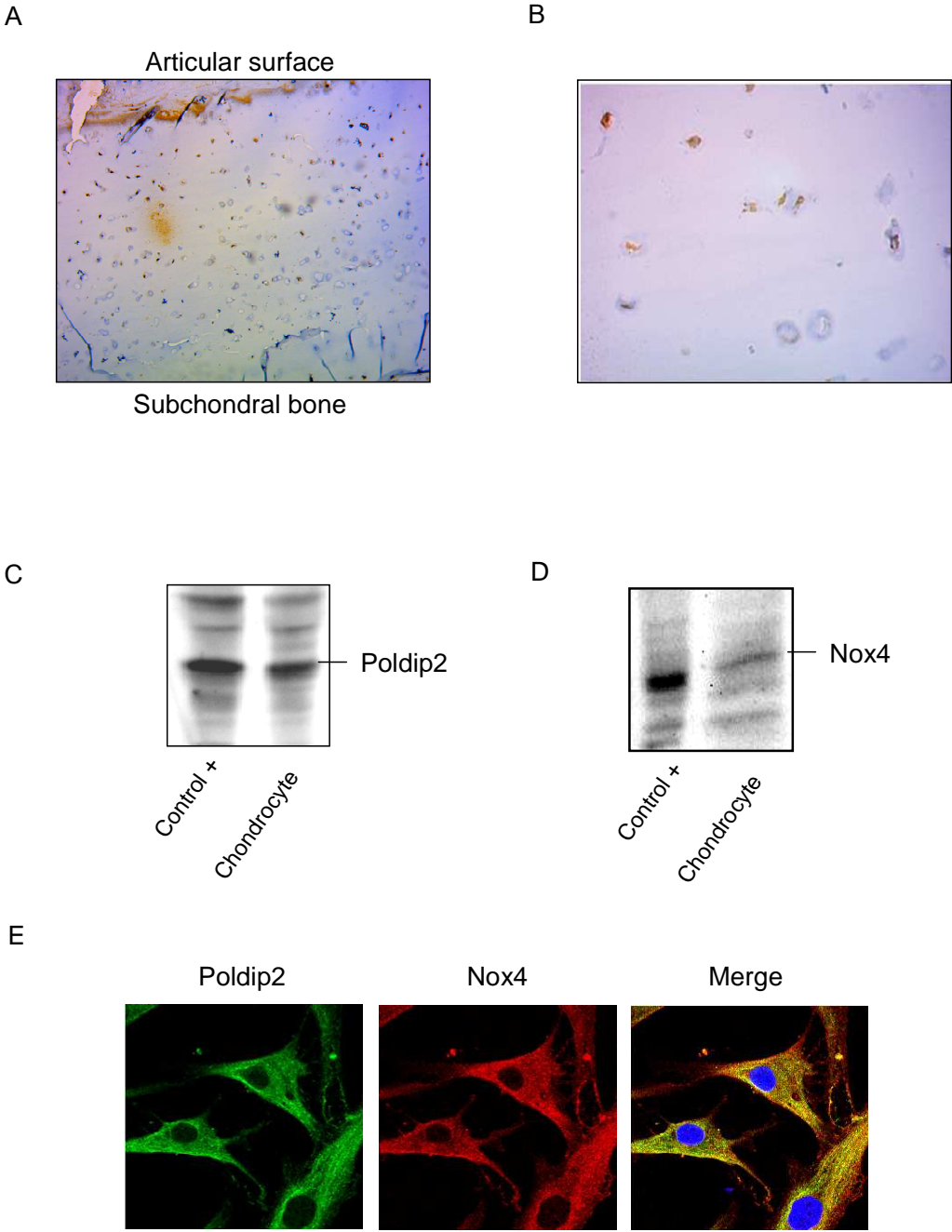

Fig. 3

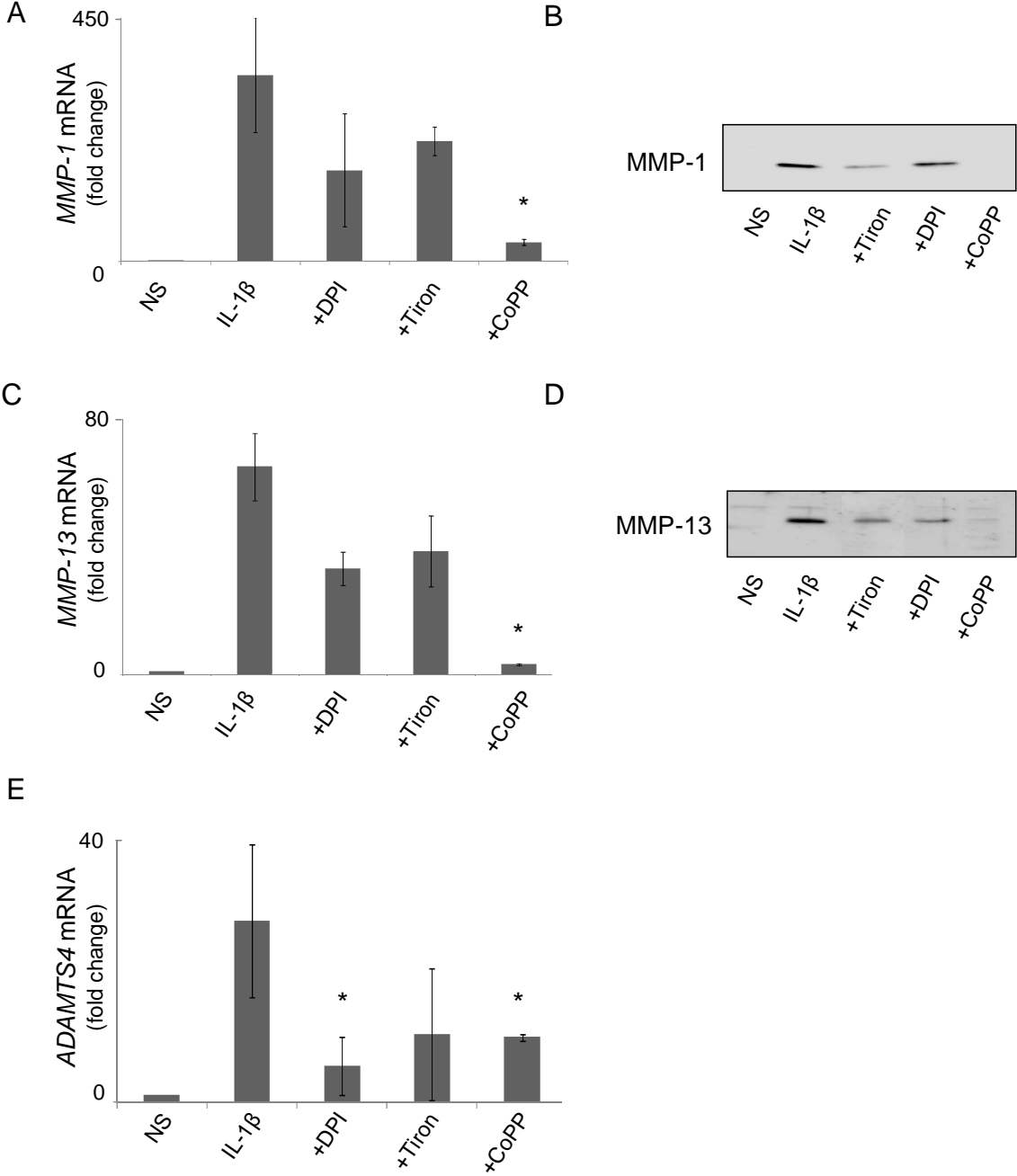

Fig. 4

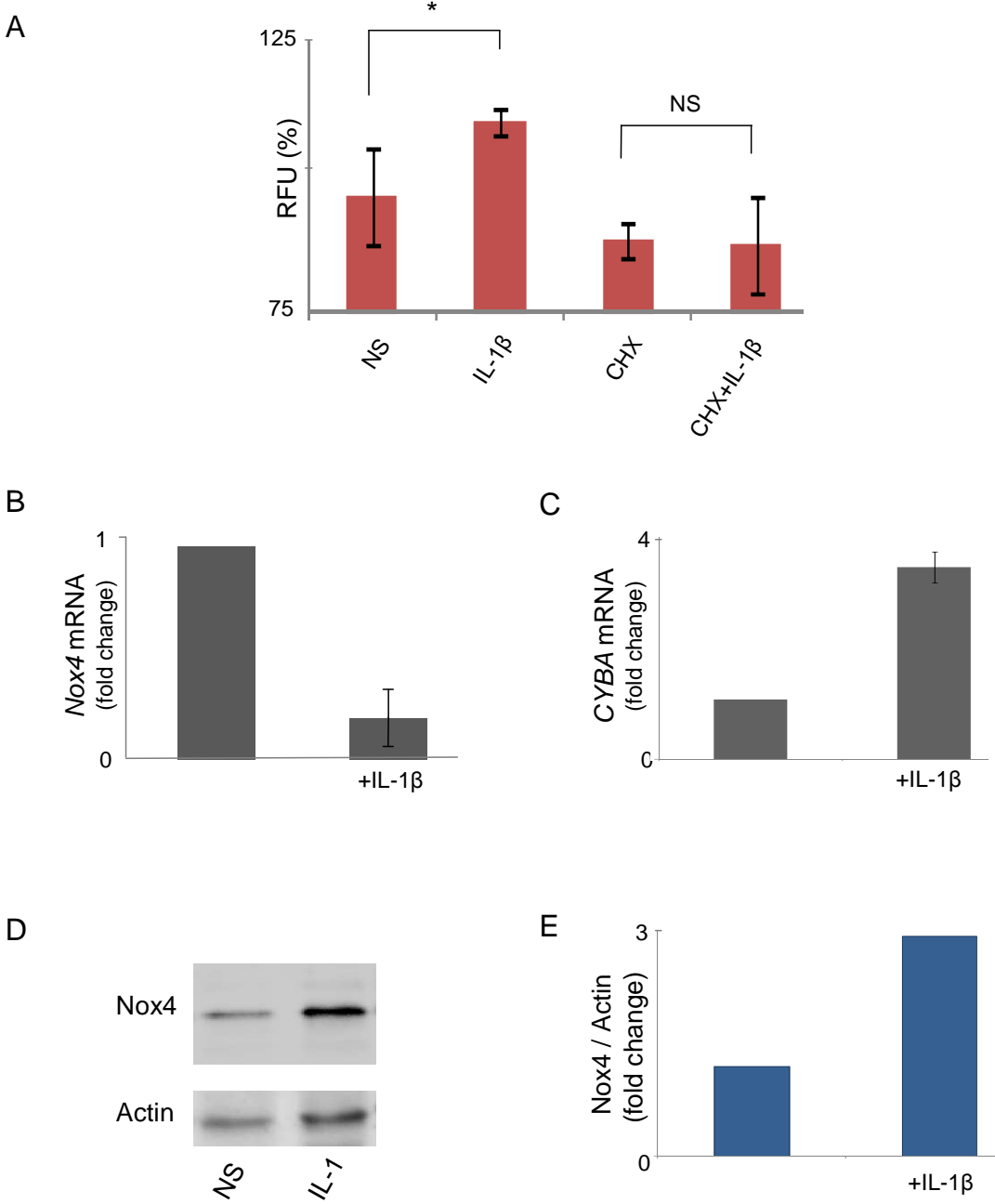

Fig. 5

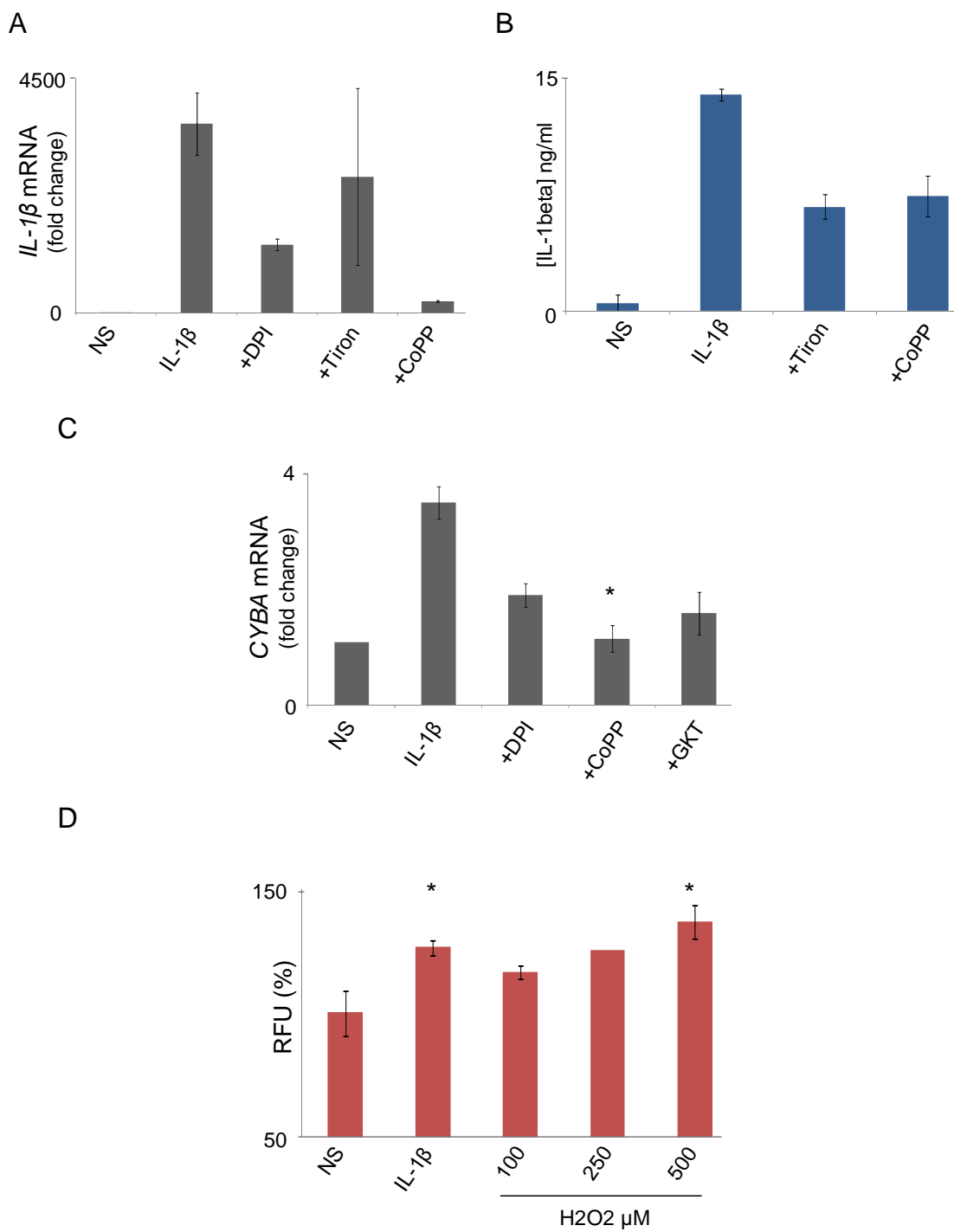

Fig. 6

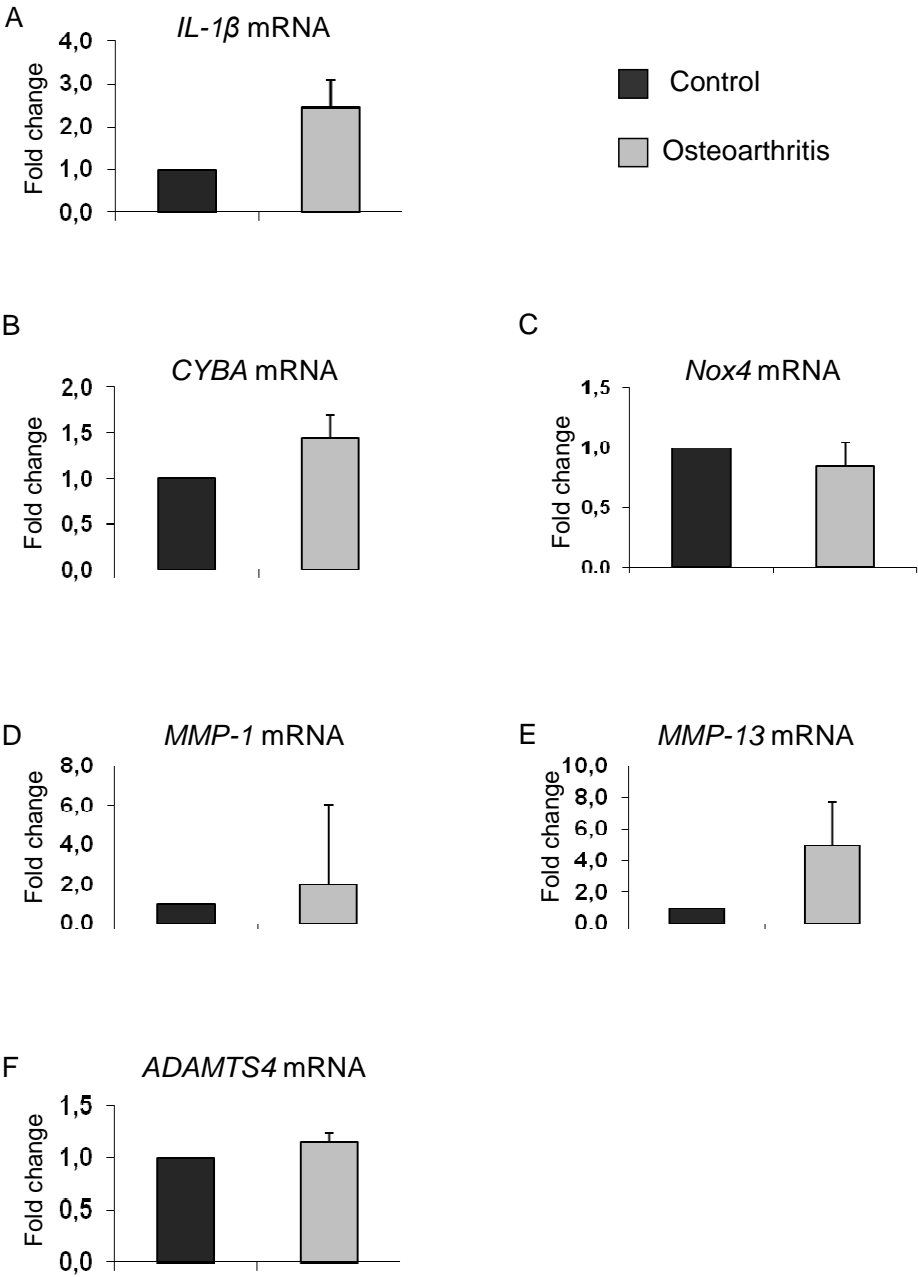
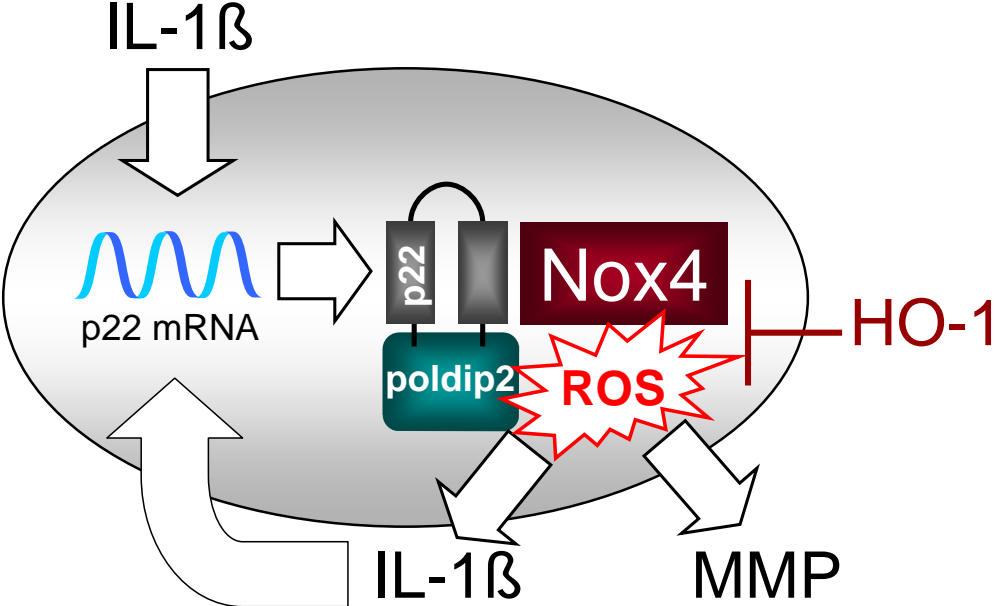
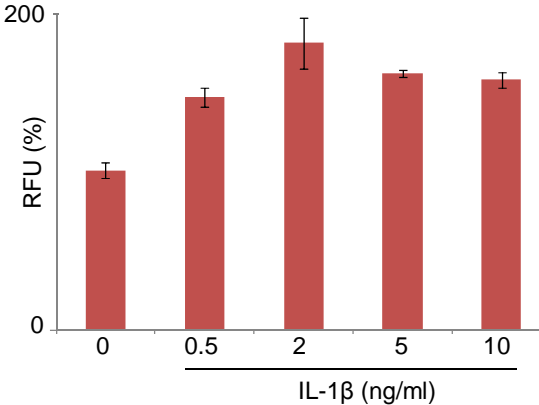

Fig. 7



Suppl. Data Fig. 1



Suppl. Data Fig. 2

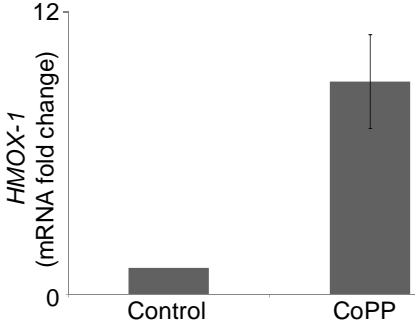

Suppl. Data Fig. 3

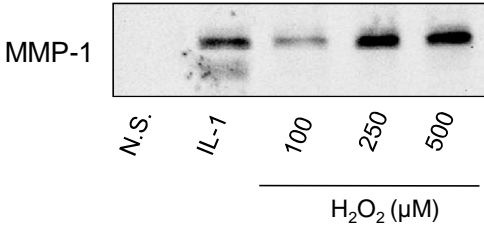



Suppl. Data Fig. 4

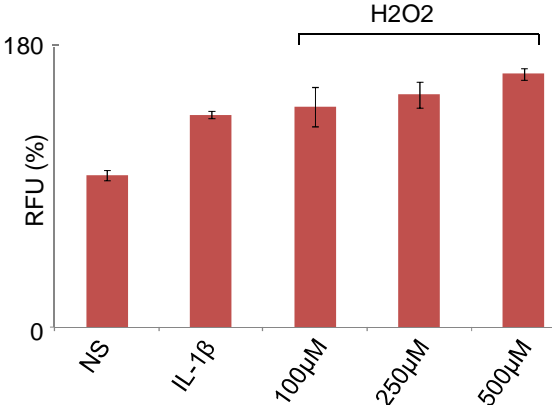

Suppl. Data Fig. 5

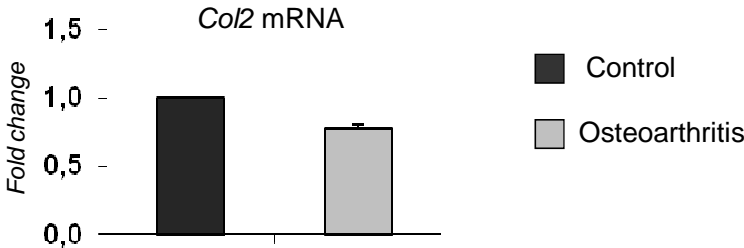

Table 1:

Gene	Forward sequence	Reverse sequence	Tm (°C)
NOX1	gtacaaattccagtggtgacaccac	agactggaatatcggtgacagca	58°C
NOX2	ataagcaggagttcaagat	gtttctagactgaagtttctgttgaaa	55°C
NOX3	atgaacacctctgggtcagctga	ggatcggagtcactccctcctctg	62°C
NOX4	cagcaagataccgagatg	ctggcttattgctccgga	60°C
NOX5	atcaagcggccccctttttcac	ctcattgtcacactcctcgac	60°C
CYBA	cagtgctccagccgggttcgtgtc	attgcaggtgggtgcacctgggtggag	70°C

Table 2:

HUGO names	Forward sequence	Reverse sequence	Tm (°C)	Concentration nM
<b>Genes of interest</b>				
ADAMTS4	gaggaggagatcggtttcca	ccagctctagtagcagcgtc	60	400
COL2A1	tggacgccatgaaggtttct	gctgcggatgctctcaatct	60	400
CYBA	cccagtggtactttgggtcc	gcggtcatgtacttctgtccc	60	400
CYBB	accgggttatgatattccacct	gatttcgacagactggcaaga	60	600
EPAS1	ggacttacacaggtggagcta	tctcacgaatctcctcctcatggt	60	400
HMOX1	agactgcgttctctgctcaacat	ggggcagaatcttgactttgt	60	400
IL1b	atgatggcttattacagtgga	gtcggagattcgtagctgga	60	400
MMP1	GCTTACGAATTTGCCGACAGAG	ttcctcagaaagagcagcatcg	57	400
MMP13	ccagacttcacgatggcattg	ggcatctcctccataaattggc	60	400
NOX4	CATTTACCCTCACAATGTGTCCA	GCAGAGGCTGACCTCATAGTT	60	600
TIMP1	AGAGTGTCTGCGGATACTTCC	CCAACAGTGTAGGTCTTGGTG	60	400
<b>House keeping genes</b>				
GAPDH	catgagaagtatgacaacagcct	agtcctccacgataccaaagt	60	400
RPL27	tgatggcacctcagatcgc	agagtacctgtgggcattagg	60	400
RPL32	TTAAGCGTAACTGGCGGAAAC	GAGCGATCTCGGCACAGTAA	60	400

Discussion

# Discussion

Discussion

### ***Nox4, du fondamental vers la physiopathologie de l'arthrose***

La NADPH oxydase Nox4 demeure énigmatique par bien des aspects. De par l'ubiquité de sa distribution tissulaire et son activité constitutive, Nox4 génère des espèces réactives de l'oxygène, les ROS, dans de nombreux tissus, au sein de l'organisme. Bien que le rôle physiologique de ces ROS soit bien souvent méconnu, leur production en excès est à l'origine de mécanismes pathologiques.

Les travaux présentés se sont tout d'abord attachés à décrypter la topologie de Nox4. Le manque de données concernant sa structure limite en effet la possibilité de développer des stratégies efficaces pour maîtriser son activité. Les résultats obtenus à l'aide d'une technique originale, mise au point au laboratoire « Topological Determination by Ubiquitin Fusion Assay », ont permis pour la première fois de confirmer la topologie transmembranaire de Nox4.

Nous avons ensuite abordé l'étude des mécanismes de régulation de l'activité de Nox4. Dans la lignée de chondrocytes humains C-20/A4, la surexpression de Nox4 conduit à une augmentation significative de la production de ROS et de métalloprotéase MMP-1, en réponse à l'IL-1 $\beta$  (Grange et al. 2006). Les données suggèrent également que l'activité de Nox4 serait impliquée dans l'apoptose chondrocytaire (Rousset et al. 2013). Nous avons ciblé nos travaux sur l'hème oxygénase-1 avec pour but d'étudier son effet sur l'activité catalysée par Nox4 et en particulier sur la synthèse des MMP, acteurs de la protéolyse matricielle dans le chondrocyte.

Enfin, dans le troisième chapitre de ce manuscrit, nous avons cherché à comprendre le rôle que joue Nox4 dans les chondrocytes primaires humains et plus particulièrement dans la physiopathologie de l'arthrose.

### ***Nox4 est la NADPH oxydase des chondrocytes humains***

Dans ce travail, nous montrons pour la première fois que Nox4 est exprimée dans les chondrocytes primaires humains, isolés et cultivés à partir de têtes fémorales. Nous avons également identifié p22<sup>phox</sup>, la sous unité stabilisatrice de l'hétérodimère, mais aussi Poldip2, le partenaire activateur de Nox4 exprimé dans les cellules musculaires lisses vasculaires. En fait les NADPH oxydases, Nox, ont déjà été décrites dans des lignées chondrocytaires (Hiran et al. 1997; Moulton et al. 1997; Grange et al. 2006; Kim et al. 2010). La présence des transcrits codant pour Nox2 et Nox4 a été rapportée dans les lignées de chondrocytes humaines C-20/A4, C-28/I2 et T/C-28a2 (Grange et al. 2006) ou dans la lignée ATDC5, issue de tératocarcinome murin (Kim et al. 2010). Nox5 serait également exprimée dans les

lignées C-28/12 et T/C-28a2 et Nox1 serait présente dans la lignée ATDC5. Mais contrairement à ces données, seule Nox4 semble exprimée dans les chondrocytes primaires. En effet, dans ces cellules, nous montrons une augmentation significative de la production d'H<sub>2</sub>O<sub>2</sub> en réponse à l'IL-1 $\beta$ .

Le lien entre l'IL-1 $\beta$ , la production de ROS et la protéolyse matricielle a déjà été suggéré dans les chondrocytes bovins (Martin et al. 2005). En 2001 déjà, Mendes et collaborateurs avaient montré que le DPI, un inhibiteur des flavoenzymes, réprimait l'activation du NF $\kappa$ B induite par l'IL-1 $\beta$  (Mendes et al. 2001). De la même manière, il a été observé que la transcription des MMP-1 et MMP-3 pouvait dépendre de facteurs de transcription régulés par les ROS (Kheradmand et al. 1998; Lo et al. 1998; Mengshol et al. 2000; Liacini et al. 2002; Ahmad et al. 2011). Dans ces travaux nous montrons que les inhibiteurs de Nox4 sont capables de réprimer la synthèse des MMP-1, MMP-13 et de l'ADAMTS4 induite par l'IL-1 $\beta$  dans les chondrocytes primaires. Par ailleurs, les résultats confirment l'existence d'un rétrocontrôle positif de l'IL-1 $\beta$  (Poole et al. 1997; Towle et al. 1997). Nous démontrons l'impact des ROS et suggérons l'implication de Nox4 dans ce phénomène, favorisant *in fine* la persistance de l'inflammation localisée au sein du cartilage et le catabolisme matriciel.

**Nos résultats suggèrent donc que les ROS générés par Nox4 seraient un relais des voies de signalisation initiées par l'IL-1 $\beta$  et conduiraient à la protéolyse matricielle. L'impact physiopathologique de ces résultats est conforté par des données préliminaires cliniques suggérant une surexpression du transcrit codant pour p22<sup>phox</sup> dans les chondrocytes arthrosiques par rapport aux chondrocytes issus de parties saines du cartilage. Fait intéressant, cette tendance semble corrélée à une surexpression des ARNm codant pour les MMP-1, MMP-13, ADAMTS4 et l'IL-1 $\beta$ .**

### ***Mécanismes de régulation de l'activité de Nox4 dans les chondrocytes***

L'activité des Nox1-4 dépend de leur association avec p22<sup>phox</sup> (Ambasta et al. 2004). En ce qui concerne Nox2, cette association est favorisée par la présence de molécules d'hèmes, indispensables à la stabilité du complexe et à son adressage membranaire (Yu et al. 1997). L'hème confère au cytochrome *b558* de Nox2 ses propriétés spectrales (Cross and Segal 2004). L'implication de molécules d'hèmes a également été suggérée par mutagenèse dirigée dans la formation de l'hétérodimère Nox4/p22<sup>phox</sup> (Ambasta et al, 2004) ; mais aucune étude n'a clairement démontré le rôle des hèmes dans le processus de maturation de Nox4.

#### **1- p22<sup>phox</sup>, sous unité stabilisatrice de Nox4**

## Discussion

La relation entre la quantité d'ARNm codant pour Nox4 et le niveau d'expression de la protéine n'est pas toujours linéaire (Meng et al. 2008). Dans certains types cellulaires, la quantité d'ARNm de Nox4 est en excès, permettant une traduction rapide de Nox4 en réponse à un stimulus. Ce phénomène a déjà été décrit dans la littérature et l'hypothèse de pools d'ARNm peut être formulée pour Nox4 (Bondi et al. 2010; New et al. 2011). Dans les chondrocytes primaires, l'IL-1 $\beta$  entraîne une augmentation de la quantité d'ARNm codant pour p22<sup>phox</sup> alors que dans le même temps, la transcription de Nox4 diminue. Cela conduit à penser que l'expression d'une autre isoforme des Nox telle que Nox1-3, dont l'activité catalytique dépendrait de p22<sup>phox</sup> pourrait être induite par l'IL-1 $\beta$ . Une telle diminution de la quantité d'ARNm de Nox4 a été rapportée dans la lignée murine ATDC5 stimulée par l'insuline (Kim et al. 2010). Dans cette étude, la diminution d'expression de Nox4 est compensée par une augmentation de la quantité d'ARNm codant pour Nox2. Dans les chondrocytes primaires, l'absence de Nox2 a été confirmée par RT-PCR quantitative et nous n'avons pas détecté d'autres Nox après stimulation par IL-1 $\beta$ . Dans le même temps, les résultats ont montré par immunoblot, une augmentation de l'expression de Nox4.

Cela nous conduit à penser que dans les chondrocytes primaires, Nox4 pourrait être traduite indépendamment du niveau d'expression de son ARNm. La quantité de protéine fonctionnelle serait alors déterminée par la biodisponibilité de p22<sup>phox</sup>.

Un tel mode de régulation de l'activité de Nox4, dépendant du niveau d'expression de p22<sup>phox</sup> a déjà été démontré dans les cellules cancéreuses pancréatiques (Edderkaoui et al. 2010). De manière intéressante, nos résultats suggèrent que la transcription de p22<sup>phox</sup> induite par l'IL-1 $\beta$  est sensible au statut redox. Par exemple, les inhibiteurs pharmacologiques de Nox4 (DPI et GKT) répriment la transcription de p22<sup>phox</sup> de façon similaire à l'induction de l'expression de HO-1. Un mode de régulation redox de l'expression de Nox4 a récemment été proposé par Fujii et collaborateurs dans le modèle de rats hyperbilirubinémiques (Gunn j/j). Par ailleurs, l'expression de p22<sup>phox</sup> induite par la thrombine dans une lignée endothéliale est réprimée par la vitamine C ou le DPI (Djordjevic et al. 2005). Afin d'étayer cette hypothèse, nous avons comparé les effets de l'IL-1 $\beta$  sur les chondrocytes à celui du peroxyde d'hydrogène. Les résultats ont effectivement montré une augmentation comparable de la production des ROS par les chondrocytes C-20/A4 et les chondrocytes primaires en réponse à la cytokine IL-1 $\beta$  et à H<sub>2</sub>O<sub>2</sub>.

Nos travaux suggèrent donc la présence d'un rétrocontrôle positif dans lequel les ROS entraineraient la néosynthèse de p22<sup>phox</sup> ; ce dernier stabiliserait en retour l'expression et l'activité de Nox4 et maintiendrait un niveau de production des ROS élevé dans les chondrocytes primaires.



## Discussion

Par ailleurs, nos expériences ont montré la présence de Poldip2 dans les chondrocytes primaires et suggèrent sa colocalisation avec Nox4. Poldip2 pourrait être un nouveau partenaire de Nox4 par l'intermédiaire de p22<sup>phox</sup> (Lyle et al. 2009). Ainsi, l'augmentation de l'expression de p22<sup>phox</sup> après stimulation des chondrocytes par l'IL-1 $\beta$  autoriserait l'interaction de Poldip2 avec le complexe oxydase de Nox4, stimulant son activité. Cette hypothèse est encore en cours d'étude.

### **2- Rôle de l'hème oxygénase-1**

De manière à caractériser et comprendre les mécanismes d'action de HO-1 sur l'activité de Nox4, nous avons mesuré l'impact du catabolisme de l'hème par HO-1 sur l'expression, la localisation subcellulaire et l'intégration des hèmes au sein de Nox4. L'effet de HO-1 a été comparé à celui de la succinylacétone (SA), un inhibiteur de la synthèse de l'hème. Dans les chondrocytes C-20/A4 et dans la lignée HEK293-TRex Nox4, la surexpression de Nox4 se traduit par une localisation subcellulaire, au moins pour partie à la membrane plasmique. Fait intéressant, la déplétion du pool d'hème par action de la SA conduit à une modification de la localisation de Nox4 qui se retrouve seulement au niveau du RE. Le traitement par SA abolit également le spectre redox de Nox4. L'hème oxygénase, HO-1, diminue de manière significative l'activité de Nox4 dans les modèles cellulaires que nous avons étudiés. Mais on observe aucun changement de localisation de Nox4, qui reste présente au niveau de la membrane plasmique des lignées C-20/A4 et HEK293-TRex. De plus, ni le spectre redox, ni l'expression de Nox4 ne sont significativement affectés par l'activité de HO-1 dans ces cellules.

En accord avec ces données, Datla et collaborateurs montrent que la production des ROS est réduite de près de 50% dans l'aorte murine après induction de HO-1 par l'hémine, alors que l'expression des isoformes Nox2 et Nox4 reste stable (Datla et al. 2007). Par contre, dans la lignée de macrophages Raw 264.7, Taillé et collaborateurs rapportent une diminution significative de l'expression de Nox2 après induction de l'expression de HO-1 (Taillé et al. 2004). Les auteurs justifient ces résultats par une diminution de la biodisponibilité de l'hème consécutive à l'activité de HO-1 ce qui entraîne un défaut de maturation de Nox2 qui est dégradé par le protéasome. Ces données rejoignent les études de l'équipe de Mary Dinauer obtenues par inhibition de la synthèse de l'hème sur Nox2 (Yu et al. 1997; Yu et al. 1999).

Dans les chondrocytes C-20/A4, les résultats mettent en avant un impact différentiel de la SA et de HO-1. Les données établissent en effet que HO-1 affecte l'activité de Nox4 et semblerait ne pas modifier les étapes clés de sa maturation. En revanche, l'inhibition de la synthèse de l'hème par la SA démontre la fonction essentielle qu'il joue dans l'adressage et la mise en place d'un hétérodimère mature avec p22<sup>phox</sup>.

**Dans leur intégralité, nos résultats suggèrent que p22<sup>phox</sup> serait la clé de voute d'un système redox initié par l'IL-1 $\beta$ , stabilisant l'activité de Nox4 et conduisant à la synthèse des MMP, effectrices de la protéolyse matricielle. Cette stabilité dépend également de la quantité d'hème biodisponible, permettant maturation et adressage du dimère dans les chondrocytes.**

### ***Nox4, cible thérapeutique dans les chondrocytes***

A l'heure actuelle, il n'est pas possible de traiter efficacement l'arthrose, ni même de ralentir significativement son évolution. Les thérapies existantes ne ciblent pas les causes de la pathologie et sont largement palliatives. Les inhibiteurs de MMP ont suscité de nombreux espoirs au cours de la dernière décennie, mais cette piste a été abandonnée à cause de leur manque de spécificité. Nox4 pourrait servir de nouvelle cible thérapeutique.

Poldip2 et le TLR4 ont été identifiés comme des partenaires d'activation de Nox4 (Park et al. 2004 ; Lyle et al. 2009). Nous avons également étudié l'impact que pourrait avoir l'hème oxygénase-1 sur l'activité de Nox4.

#### **1- HO-1 / CO**

L'ensemble des résultats, recueillis sur les lignées C-20/A4 et HEK293-TRex ainsi que sur les chondrocytes primaires, suggère que l'induction de l'expression de HO-1, en réprimant l'activité de Nox4, pourrait être une stratégie thérapeutique envisageable dans l'arthrose. L'activité de HO-1 conduit à la formation de bilirubine et biliverdine ainsi qu'à la libération de monoxyde de carbone (CO). La biliverdine, convertie par la biliverdine réductase et la bilirubine sont deux antioxydants à effets notoires (Jansen et al. 2010). Plusieurs études font état des effets de l'hème oxygénase, agissant par l'intermédiaire de ces métabolites de l'hème (Datla et al. 2007; Basuroy et al. 2009; Fujii et al. 2010). Le monoxyde de carbone également généré au cours de la dégradation de l'hème peut aussi altérer l'activité de certaines hémoprotéines (Ryter and Choi 2009).

Le dimère de tricarbonyldichlororuthénium (CORM2) est une molécule qui génère du monoxyde de carbone. Cette molécule a déjà été utilisée dans les cultures de chondrocytes primaires humains arthrosiques stimulés par IL-1 $\beta$  et conduirait à une diminution de l'activation du NF $\kappa$ B ainsi que de l'expression des MMP-1, 3, 10 et 13 (Guillen et al. 2008; Megias et al. 2008). Dans les chondrocytes C-20/A4 surexprimant Nox4, nous avons effectivement constaté que l'activité oxydase de Nox4 est significativement réprimée en présence de CORM2, tout comme nous l'avons observé après induction de l'expression de

## Discussion

HO-1. Par ailleurs cet apport exogène de CO conduit également à une diminution significative de la sécrétion de MMP-1.

La question qui se pose est le mode d'action du CO sur les Nox. Une inhibition des Nox1 et 2 par le CO a été rapportée dans la littérature (Taille et al. 2005; Nakahira et al. 2006; Rodriguez et al. 2009). Cependant, La fixation du CO sur les hèmes du cytochrome b558 de Nox2 a été étudié mais pas démontrée de manière absolue (Morel and Vignais, 1985 ; Lutter et al. 1985). Les données en notre possession ne permettent pas l'exclusion d'un effet indirect du CO sur Nox4. Sachant que la biliverdine et la bilirubine sont générés simultanément au CO, on ne peut pas exclure un effet antioxydant de ces produits de dégradation de l'hème (Datla et al. 2007; Basuroy et al. 2009; Fujii et al. 2010; Jansen et al. 2010)

Ainsi, dans les chondrocytes C-20/A4, les produits de dégradation de l'hème et en particulier le monoxyde de carbone seraient des éléments essentiels dans les effets biologiques de HO-1. Ces effets concernent Nox4 mais également la sécrétion des métalloprotéases, selon les travaux décrits par l'équipe de MJ Alcaraz (Guillen et al. 2008; Megias et al. 2008).

### **2- Nox4B**

Les résultats incriminent directement Nox4 dans les voies de signalisation conduisant à la synthèse des MMP. En particulier, la surexpression de Nox4A dans la lignée C-20/A4 entraîne une augmentation significative de la sécrétion de MMP-1 mesurée dans le surnageant de culture après stimulation par l'IL-1 $\beta$ .

L'effet dominant négatif de Nox4B a été initialement décrit par Goyal et collaborateurs, sur la lignée A546 (Goyal et al. 2005). Dans ces travaux, les auteurs ont identifié 4 autres isoformes de Nox4, dont trois d'entre elles, Nox4B, Nox4C et Nox4E seraient inactives. Encore actuellement, leur fonction demeure largement méconnue. L'isoforme Nox4B, utilisée comme contrôle dans nos expériences a été clonée à partir d'une banque d'ADNc de rein humain (Grange et al. 2006).

La présence endogène de l'ARNm de Nox4B n'a pas été mise en évidence dans les chondrocytes. En revanche, nos données suggèrent que la transfection de Nox4B pourrait réprimer les voies de signalisation dépendantes de Nox4A endogène, par un effet dominant négatif dans la lignée C-20/A4 (Rousset et al, 2013).

**A l'heure où des perspectives concrètes issues de la thérapie génique tendent à émerger dans certaines pathologies, la transduction de Nox4B ou de HO-1 de manière ciblée dans les chondrocytes pourrait être un outil prometteur dans le traitement de l'arthrose.**

En ce qui concerne l'hème oxygénase-1, des essais ont été réalisés sur le modèle murin d'arthrite inflammatoire K/BxN (Benallaoua et al. 2007). Dans ce modèle, l'induction systémique de l'expression de HO-1 par injection intrapéritonéale de CoPP entraîne une diminution significative de la libération de médiateurs de l'inflammation tels que l'IL-1 $\beta$ , l'IL-6 ou encore le TNF et la prostaglandine E2 induites dans la pathologie. Dans l'arthrose, la preuve du concept reste à établir.

Une autre stratégie consiste à développer des peptides inhibiteurs de Nox4 ou de son association avec p22<sup>phox</sup>. Cette dernière approche a été abordée avec succès pour Nox2 mais requiert une parfaite connaissance des domaines fonctionnels de l'enzyme (Csanyi et al. 2011). Une meilleure connaissance structure / fonction de Nox4 pourrait donc ouvrir de nouvelles pistes pour le développement d'inhibiteurs de son activité, actuellement freiné par le manque de données disponibles sur le plan fondamental.

### ***La topologie de Nox4***

Le cytochrome b558 des neutrophiles est maintenant connu depuis près de 30 ans (Segal and Jones 1978). Néanmoins, la nature de sa topologie n'a été établie que relativement récemment par une somme d'approches immunologiques et fonctionnelles (Imajoh-Ohmi et al. 1992; Paquet et al. 2004; Campion et al. 2009). L'isoforme Nox4 n'a été découverte que pendant le plein essor de la génomique, aux côtés de 5 autres isoformes, au début des années 2000. A l'heure actuelle, la seule approche immunologique de Nox4 a été conduite au sein de notre laboratoire. Cette étude a permis de définir l'orientation de Nox4 par la localisation de deux épitopes situés de part et d'autre de la membrane lipidique (Zhang et al. 2011).

La méthode ToDUFA que nous avons mise au point utilise les protéines de fusion Ubiquitine-GFP (Ub-GFP) comme outil pour révéler la topologie des protéines transmembranaires. L'utilisation de formes tronquées de Nox4 fusionnées en C-terminal à l'Ub-GFP nous a permis de révéler pour la première fois sa topologie. Nos données mettent en évidence la présence de 3 extrémités extracellulaires (aa 46, 144 et 239) et de 4 extrémités intracytosoliques (98, 184, 341 et 578), révélant la présence de 6 passages transmembranaires liés par 5 boucles extramembranaires. Ces données confirment également l'orientation globale de Nox4, présentant les boucles A, C et E comme

## Discussion

extracellulaires ou dirigées vers la lumière du RE et les boucles B et D ainsi que les extrémités N- et C-terminales vers le cytosol.

La localisation de la production des ROS est une composante fondamentale de laquelle dépend la spécificité de la transduction redox (Chen et al, 2009). Dans les chondrocytes C-20/A4 et la lignée HEK, Nox4 est localisée au sein du réticulum endoplasmique et à la membrane plasmique. Ainsi, de par l'orientation cytosolique des extrémités N et C-terminales de Nox4, nous démontrons que les ROS sont générés vers le milieu extracellulaire ou au sein d'endosomes (redoxosomes) lorsque Nox4 est à la membrane plasmique et dans la lumière du réticulum endoplasmique lorsque Nox4 est exprimée dans le compartiment réticulaire. Selon ce principe, Nox4 puiserait dans le pool de NADPH cytosolique sa source d'électrons.

Malgré sa relative inertie, la GFP présente un poids moléculaire important, limitant la pertinence de l'application de notre méthode à l'étude des petites protéines telles que p22<sup>phox</sup>. Pour contourner ce problème, plusieurs variantes de la technique pourraient être envisagées, notamment en intégrant l'ubiquitine au sein de la séquence protéique à étudier et non pas en son extrémité C-terminale, permettant de conserver l'intégrité de la protéine ainsi exprimée sous sa forme entière. L'action des DUB se traduirait alors par un clivage de la protéine cible visible par immunoblot ou par une perte de son activité enzymatique. Cette variante est également applicable avec les sites reconnus par d'autres protéases endogènes, pouvant être surexprimés ou ajoutées extemporanément sur les cellules. Enfin, la résolution de notre méthode est ajustable par le nombre d'acides aminés séparant deux formes tronquées. Il est donc possible d'établir des formes tronquées plus rapprochées dans les parties critiques de la protéine cible pour affiner sa topologie.

**En accord avec la topologie déjà établie pour Nox2, nos résultats démontrent pour la première fois expérimentalement une topologie à 6 passages transmembranaires de Nox4. De surcroît, en fonction de la localisation subcellulaire de Nox4, les résultats permettent de déterminer le compartiment où les ROS sont produits et pourront constituer un rationnel de départ pour le design et l'adressage d'inhibiteurs.**

### **Conclusions de l'étude et perspectives**

Dans ce travail, nous présentons Nox4 comme une cible thérapeutique potentielle dans l'arthrose.

Ce travail a tout d'abord porté sur la caractérisation de la topologie transmembranaire de Nox4. A l'aide d'une méthode originale, développée au laboratoire, nous établissons sa « trame topologique » et confirmons expérimentalement qu'il s'agit d'une protéine polytopique à 6 passages transmembranaires. La topologie transmembranaire de p22<sup>phox</sup> est encore matière à débat et les modèles *in silico* oscillent entre 2 et 4 passages transmembranaires (Heyworth et al. 2003; Taylor et al. 2004; Groemping and Rittinger 2005). Des résultats préliminaires ont déjà été obtenus avec la méthode ToDUFA (Thèse L. Zhang, 2011). Mais étant donné l'important poids moléculaire de la GFP en rapport à celui de p22<sup>phox</sup>, notamment pour ce qui concerne les formes tronquées courtes de p22<sup>phox</sup>, des variantes de la technique seront nécessaires pour établir avec certitude sa topologie.

De même, la co-transfection des plasmides codant pour des formes tronquées de Nox4 et de p22<sup>phox</sup> devrait nous permettre l'étude des domaines d'interaction entre les deux partenaires, couplant notre analyse topologique à une étude fonctionnelle de l'hétérodimère. Par cette approche nous pourrions également identifier les domaines d'interaction de Poldip2 avec p22<sup>phox</sup>, constituant une base pour le développement d'inhibiteurs ou de compétiteurs de l'activité de Nox4.

Pour déterminer si Poldip2 joue un rôle dans la production de ROS par Nox4 dans les chondrocytes, des approches de surexpression et d'inhibitions par shRNA, actuellement en cours de développement au laboratoire, devraient être utilisées. Ces outils permettront aussi d'étudier l'impact de Poldip2 sur la synthèse des MMP par les chondrocytes.

Dans les chondrocytes primaires, nous observons un décalage entre l'expression de l'ARNm et de la protéine Nox4 après 24h de stimulation avec l'IL-1 $\beta$ . Des expériences de RT-PCR quantitative et d'immunoblots devraient nous permettre à court terme de comprendre ce décalage.

Enfin, les résultats de cette étude démontrent que les ROS produits par Nox4 agissent comme des messagers seconds en réponse à l'IL-1 $\beta$  et conduisent à la transcription des MMP dans les chondrocytes primaires. De plus Nox4 semble impliquée dans une boucle autocrine conduisant à la synthèse d'IL-1 $\beta$  et de p22<sup>phox</sup> par les chondrocytes primaires. Sur le plan fondamental, nos résultats montrent également que la biodisponibilité de l'hème et

## Discussion

celle de p22<sup>phox</sup> sont deux paramètres conditionnant l'adressage et l'activité constitutive du complexe Nox4.

De manière à confirmer l'implication de Nox4 dans la physiopathologie de l'arthrose, un projet de recherche clinique (ARTHRO-NOX) a été récemment initié par notre laboratoire. En collaboration avec les services de rhumatologie, d'orthopédie et d'anatomopathologie du CHU de Grenoble, ce projet vise à mesurer l'expression et l'activité de Nox4 dans les chondrocytes prélevés sur du cartilage sain et à les comparer aux chondrocytes arthrosiques, prélevés sur la même articulation. La transcription et l'expression des MMP, du collagène de type II et de HO-1 seront également étudiés.

L'utilisation de modèles murins, permettant l'extinction de gènes codant pour Nox4 ou p22<sup>phox</sup> serait aussi un moyen de confirmer *in vivo* la pertinence physiopathologique de nos données. Du même coup, le potentiel thérapeutique d'inhibiteurs ou de compétiteurs de Nox4A tels que HO-1 ou Nox4B pourrait être confirmé avant d'envisager des perspectives plus concrètes, appliquées à la thérapie humaine.

# Références bibliographiques



## Références bibliographiques

## A

- Abo A, Pick E, Hall A, Totty N, Teahan CG et al. (1991) Activation of the NADPH oxidase involves the small GTP-binding protein p21rac1. *Nature* 353(6345): 668-670.
- Abramson SB (2008) Nitric oxide in inflammation and pain associated with osteoarthritis. *Arthritis research & therapy* 10 Suppl 2: S2.
- Ago T, Kuroda J, Pain J, Fu C, Li H et al. (2010) Upregulation of Nox4 by hypertrophic stimuli promotes apoptosis and mitochondrial dysfunction in cardiac myocytes. *Circulation research* 106(7): 1253-1264.
- Ahmad R, Sylvester J, Ahmad M, Zafarullah M (2011) Involvement of H-Ras and reactive oxygen species in proinflammatory cytokine-induced matrix metalloproteinase-13 expression in human articular chondrocytes. *Archives of biochemistry and biophysics* 507(2): 350-355.
- Ahram M, Litou ZI, Fang R, Al-Tawallbeh G (2006) Estimation of membrane proteins in the human proteome. *In Silico Biol* 6(5): 379-386.
- Aiken A, Khokha R (2010) Unraveling metalloproteinase function in skeletal biology and disease using genetically altered mice. *Biochimica et biophysica acta* 1803(1): 121-132.
- Almen MS, Nordstrom KJ, Fredriksson R, Schioth HB (2009) Mapping the human membrane proteome: a majority of the human membrane proteins can be classified according to function and evolutionary origin. *BMC Biol* 7: 50.
- Amara N, Bachoual R, Desmard M, Golda S, Guichard C et al. (2007) Diesel exhaust particles induce matrix metalloproteinase-1 in human lung epithelial cells via a NADP(H) oxidase/NOX4 redox-dependent mechanism. *American journal of physiology* 293(1): L170-181.
- Ambasta RK, Kumar P, Griendling KK, Schmidt HH, Busse R et al. (2004) Direct interaction of the novel Nox proteins with p22phox is required for the formation of a functionally active NADPH oxidase. *The Journal of biological chemistry* 279(44): 45935-45941.
- Anilkumar N, San Jose G, Sawyer I, Santos CX, Sand C et al. (2013) A 28-kDa splice variant of NADPH oxidase-4 is nuclear-localized and involved in redox signaling in vascular cells. *Arteriosclerosis, thrombosis, and vascular biology* 33(4): e104-112.
- Ayache N, Boumediene K, Mathy-Hartert M, Reginster JY, Henrotin Y et al. (2002) Expression of TGF-betas and their receptors is differentially modulated by reactive oxygen species and nitric oxide in human articular chondrocytes. *Osteoarthritis and cartilage / OARS, Osteoarthritis Research Society* 10(5): 344-352.

## B

- Baillet A, Xu R, Grichine A, Berthier S, Morel F et al. (2011) Coupling of 6-phosphogluconate dehydrogenase with NADPH oxidase in neutrophils: Nox2 activity regulation by NADPH availability. *Faseb J* 25(7): 2333-2343.
- Banfi B, Clark RA, Steger K, Krause KH (2003) Two novel proteins activate superoxide generation by the NADPH oxidase NOX1. *The Journal of biological chemistry* 278(6): 3510-3513.
- Banfi B, Molnar G, Maturana A, Steger K, Hegedus B et al. (2001) A Ca(2+)-activated NADPH oxidase in testis, spleen, and lymph nodes. *The Journal of biological chemistry* 276(40): 37594-37601.
- Banfi B, Maturana A, Jaconi S, Arnaudeau S, Laforge T et al. (2000) A mammalian H<sup>+</sup> channel generated through alternative splicing of the NADPH oxidase homolog NOH-1. *Science (New York, NY)* 287(5450): 138-142.
- Bartsch C, Bekhite MM, Wolheim A, Richter M, Ruhe C et al. (2011) NADPH oxidase and eNOS control cardiomyogenesis in mouse embryonic stem cells on ascorbic acid treatment. *Free radical biology & medicine* 51(2): 432-443.

## Références bibliographiques

- Basuroy S, Bhattacharya S, Leffler CW, Parfenova H (2009) Nox4 NADPH oxidase mediates oxidative stress and apoptosis caused by TNF- $\alpha$  in cerebral vascular endothelial cells. *American journal of physiology* 296(3): C422-432.
- Beckman KB, Ames BN (1998) The free radical theory of aging matures. *Physiological reviews* 78(2): 547-581.
- Bedard K, Krause KH (2007) The NOX family of ROS-generating NADPH oxidases: physiology and pathophysiology. *Physiological reviews* 87(1): 245-313.
- BelAïba RS, Djordjevic T, Petry A, Diemer K, Bonello S et al. (2007) NOX5 variants are functionally active in endothelial cells. *Free radical biology & medicine* 42(4): 446-459.
- Ben Mkaddem S, Pedruzzi E, Werts C, Coant N, Bens M et al. (2010) Heat shock protein gp96 and NAD(P)H oxidase 4 play key roles in Toll-like receptor 4-activated apoptosis during renal ischemia/reperfusion injury. *Cell death and differentiation* 17(9): 1474-1485.
- Benallaoua M, Francois M, Batteux F, Thelie N, Shyy JY et al. (2007) Pharmacologic induction of heme oxygenase 1 reduces acute inflammatory arthritis in mice. *Arthritis and rheumatism* 56(8): 2585-2594.
- Berenbaum F (2013) Osteoarthritis as an inflammatory disease (osteoarthritis is not osteoarthrosis!). *Osteoarthritis and cartilage / OARS, Osteoarthritis Research Society* 21(1): 16-21.
- Biberstine-Kinkade KJ, Yu L, Dinauer MC (1999) Mutagenesis of an arginine- and lysine-rich domain in the gp91(phox) subunit of the phagocyte NADPH-oxidase flavocytochrome b558. *J Biol Chem* 274(15): 10451-10457.
- Blain EJ (2009) Involvement of the cytoskeletal elements in articular cartilage homeostasis and pathology. *International journal of experimental pathology* 90(1): 1-15.
- Block K, Gorin Y, Abboud HE (2009) Subcellular localization of Nox4 and regulation in diabetes. *Proceedings of the National Academy of Sciences of the United States of America* 106(34): 14385-14390.
- Block K, Gorin Y, Hoover P, Williams P, Chelmicki T et al. (2007) NAD(P)H oxidases regulate HIF-2 $\alpha$  protein expression. *The Journal of biological chemistry* 282(11): 8019-8026.
- Bogdanov M, Zhang W, Xie J, Dowhan W (2005) Transmembrane protein topology mapping by the substituted cysteine accessibility method (SCAM(TM)): application to lipid-specific membrane protein topogenesis. *Methods* 36(2): 148-171.
- Bondi CD, Manickam N, Lee DY, Block K, Gorin Y et al. (2010) NAD(P)H oxidase mediates TGF- $\beta$ 1-induced activation of kidney myofibroblasts. *J Am Soc Nephrol* 21(1): 93-102.
- Boudreau HE, Emerson SU, Korzeniowska A, Jendrysik MA, Leto TL (2009) Hepatitis C virus (HCV) proteins induce NADPH oxidase 4 expression in a transforming growth factor beta-dependent manner: a new contributor to HCV-induced oxidative stress. *Journal of virology* 83(24): 12934-12946.
- Boutten A, Goven D, Artaud-Macari E, Bonay M (2011) La voie Nrf2 en pathologie respiratoire. *Médecine et Sciences* 27: 966-972.
- Brar SS, Kennedy TP, Sturrock AB, Huecksteadt TP, Quinn MT et al. (2002) An NAD(P)H oxidase regulates growth and transcription in melanoma cells. *American journal of physiology* 282(6): C1212-1224.
- Brieger K, Schiavone S, Miller FJ, Jr., Krause KH (2012) Reactive oxygen species: from health to disease. *Swiss medical weekly* 142: w13659.
- Brown DI, Griending KK (2009) Nox proteins in signal transduction. *Free radical biology & medicine* 47(9): 1239-1253.
- Brune B, Schmidt KU, Ullrich V (1990) Activation of soluble guanylate cyclase by carbon monoxide and inhibition by superoxide anion. *European journal of biochemistry / FEBS* 192(3): 683-688.
- Burkhardt H, Schwingel M, Menninger H, Macartney HW, Tschesche H (1986) Oxygen radicals as effectors of cartilage destruction. Direct degradative effect on matrix

## Références bibliographiques

components and indirect action via activation of latent collagenase from polymorphonuclear leukocytes. *Arthritis and rheumatism* 29(3): 379-387.

Burritt JB, DeLeo FR, McDonald CL, Prigge JR, Dinauer MC et al. (2001) Phage display epitope mapping of human neutrophil flavocytochrome b558. Identification of two juxtaposed extracellular domains. *J Biol Chem* 276(3): 2053-2061.

Burritt JB, Foubert TR, Baniulis D, Lord CI, Taylor RM et al. (2003) Functional epitope on human neutrophil flavocytochrome b558. *J Immunol* 170(12): 6082-6089.

## C

Cadenas E, Davies KJ (2000) Mitochondrial free radical generation, oxidative stress, and aging. *Free radical biology & medicine* 29(3-4): 222-230.

Caffrey M (2003) Membrane protein crystallization. *J Struct Biol* 142(1): 108-132.

Campion Y, Jesaitis AJ, Nguyen MV, Grichine A, Herenger Y et al. (2009) New p22-phox monoclonal antibodies: identification of a conformational probe for cytochrome b 558. *Journal of innate immunity* 1(6): 556-569.

Campion Y, Paclet MH, Jesaitis AJ, Marques B, Grichine A et al. (2007) New insights into the membrane topology of the phagocyte NADPH oxidase: characterization of an anti-gp91-phox conformational monoclonal antibody. *Biochimie* 89(9): 1145-1158.

Carmona-Cuenca I, Roncero C, Sancho P, Caja L, Fausto N et al. (2008) Upregulation of the NADPH oxidase NOX4 by TGF-beta in hepatocytes is required for its pro-apoptotic activity. *Journal of hepatology* 49(6): 965-976.

Carr AC, Decker EA, Park Y, Frei B (2001) Comparison of low-density lipoprotein modification by myeloperoxidase-derived hypochlorous and hypobromous acids. *Free radical biology & medicine* 31(1): 62-72.

Chamulitrat W, Stremmel W, Kawahara T, Rokutan K, Fujii H et al. (2004) A constitutive NADPH oxidase-like system containing gp91phox homologs in human keratinocytes. *The Journal of investigative dermatology* 122(4): 1000-1009.

Chen F, Haigh S, Barman S, Fulton DJ (2012) From form to function: the role of Nox4 in the cardiovascular system. *Front Physiol* 3: 412.

Chen K, Craige SE, Keaney JF, Jr. (2009) Downstream targets and intracellular compartmentalization in Nox signaling. *Antioxidants & redox signaling* 11(10): 2467-2480.

Chen K, Kirber MT, Xiao H, Yang Y, Keaney JF, Jr. (2008) Regulation of ROS signal transduction by NADPH oxidase 4 localization. *The Journal of cell biology* 181(7): 1129-1139.

Cheung JC, Reithmeier RA (2007) Scanning N-glycosylation mutagenesis of membrane proteins. *Methods* 41(4): 451-459.

Chevalier X (2003) Arthritis. *Rev Prat* 53(6): 665-673.

Choi K, Ryu SW, Song S, Choi H, Kang SW et al. (2009) Caspase-dependent generation of reactive oxygen species in human astrocytoma cells contributes to resistance to TRAIL-mediated apoptosis. *Cell death and differentiation* 17(5): 833-845.

Chudakov DM, Matz MV, Lukyanov S, Lukyanov KA (2010) Fluorescent proteins and their applications in imaging living cells and tissues. *Physiol Rev* 90(3): 1103-1163.

Clancy R, Rediske J, Koehne C, Stoyanovsky D, Amin A et al. (2001) Activation of stress-activated protein kinase in osteoarthritic cartilage: evidence for nitric oxide dependence. *Osteoarthritis and cartilage / OARS, Osteoarthritis Research Society* 9(4): 294-299.

Clerigues V, Murphy CL, Guillen MI, Alcaraz MJ (2013) Haem oxygenase-1 induction reverses the actions of interleukin-1beta on hypoxia-inducible transcription factors and human chondrocyte metabolism in hypoxia. *Clin Sci (Lond)* 125(2): 99-108.

Corcoran A, Cotter TG (2013) Redox regulation of protein kinases. *The FEBS journal* 280(9): 1944-1965.

## Références bibliographiques

- Coustry F, Posey KL, Liu P, Alcorn JL, Hecht JT (2012) D469del-COMP retention in chondrocytes stimulates caspase-independent necroptosis. *The American journal of pathology* 180(2): 738-748.
- Crespo FL, Sobrado VR, Gomez L, Cervera AM, McCreath KJ (2010) Mitochondrial reactive oxygen species mediate cardiomyocyte formation from embryonic stem cells in high glucose. *Stem cells (Dayton, Ohio)* 28(7): 1132-1142.
- Cross AR, Segal AW (2004) The NADPH oxidase of professional phagocytes--prototype of the NOX electron transport chain systems. *Biochimica et biophysica acta* 1657(1): 1-22.
- Cross JV, Templeton DJ (2004) Oxidative stress inhibits MEKK1 by site-specific glutathionylation in the ATP-binding domain. *The Biochemical journal* 381(Pt 3): 675-683.
- Cruse I, Maines MD (1988) Evidence suggesting that the two forms of heme oxygenase are products of different genes. *The Journal of biological chemistry* 263(7): 3348-3353.
- Csanyi G, Pagano PJ (2013) Strategies Aimed at Nox4 Oxidase Inhibition Employing Peptides from Nox4 B-Loop and C-Terminus and p22 (phox) N-Terminus: An Elusive Target. *International journal of hypertension* 2013: 842827.
- Csanyi G, Cifuentes-Pagano E, Al Ghoulah I, Ranayhossaini DJ, Egana L et al. (2011) Nox2 B-loop peptide, Nox2ds, specifically inhibits the NADPH oxidase Nox2. *Free radical biology & medicine* 51(6): 1116-1125.

## D

- Datla SR, Dusting GJ, Mori TA, Taylor CJ, Croft KD et al. (2007) Induction of heme oxygenase-1 in vivo suppresses NADPH oxidase derived oxidative stress. *Hypertension* 50(4): 636-642.
- De Deken X, Wang D, Many MC, Costagliola S, Libert F et al. (2000) Cloning of two human thyroid cDNAs encoding new members of the NADPH oxidase family. *The Journal of biological chemistry* 275(30): 23227-23233.
- Debbabi M, Kroviarski Y, Bournier O, Gougerot-Pocidallo MA, El-Benna J et al. (2010) NOXO1 phosphorylation on serine 154 is critical for optimal NADPH oxidase 1 assembly and activation. *Faseb J* 27(4): 1733-1748.
- Del Carlo M, Schwartz D, Erickson EA, Loeser RF (2007) Endogenous production of reactive oxygen species is required for stimulation of human articular chondrocyte matrix metalloproteinase production by fibronectin fragments. *Free radical biology & medicine* 42(9): 1350-1358.
- Del Carlo M, Jr., Loeser RF (2002) Nitric oxide-mediated chondrocyte cell death requires the generation of additional reactive oxygen species. *Arthritis and rheumatism* 46(2): 394-403.
- DeLeo FR, Nauseef WM, Jesaitis AJ, Burritt JB, Clark RA et al. (1995) A domain of p47phox that interacts with human neutrophil flavocytochrome b558. *The Journal of biological chemistry* 270(44): 26246-26251.
- DeLeo FR, Burritt JB, Yu L, Jesaitis AJ, Dinauer MC et al. (2000) Processing and maturation of flavocytochrome b558 include incorporation of heme as a prerequisite for heterodimer assembly. *The Journal of biological chemistry* 275(18): 13986-13993.
- Diaz B, Shani G, Pass I, Anderson D, Quintavalle M et al. (2009) Tks5-dependent, nox-mediated generation of reactive oxygen species is necessary for invadopodia formation. *Science signaling* 2(88): ra53.
- Diebold I, Petry A, Hess J, Gorchach A (2010) The NADPH oxidase subunit NOX4 is a new target gene of the hypoxia-inducible factor-1. *Molecular biology of the cell* 21(12): 2087-2096.
- Djordjevic T, Pogrebniak A, BelAiba RS, Bonello S, Wotzlaw C et al. (2005) The expression of the NADPH oxidase subunit p22phox is regulated by a redox-sensitive pathway in endothelial cells. *Free radical biology & medicine* 38(5): 616-630.

## Références bibliographiques

- Drews J (2000) Drug discovery: a historical perspective. *Science* 287(5460): 1960-1964.
- Drissi H, Zuscik M, Rosier R, O'Keefe R (2005) Transcriptional regulation of chondrocyte maturation: potential involvement of transcription factors in OA pathogenesis. *Mol Aspects Med* 26(3): 169-179.
- Dumond H, Presle N, Terlain B, Mainard D, Loeuille D et al. (2003) Evidence for a key role of leptin in osteoarthritis. *Arthritis and rheumatism* 48(11): 3118-3129.
- Dupuy C, Pomerance M, Ohayon R, Noel-Hudson MS, Deme D et al. (2000) Thyroid oxidase (THOX2) gene expression in the rat thyroid cell line FRTL-5. *Biochemical and biophysical research communications* 277(2): 287-292.

## E

- Edderkaoui M, Nitsche C, Zheng L, Pandol SJ, Gukovsky I et al. (2010) NADPH oxidase activation in pancreatic cancer cells is mediated through Akt-dependent up-regulation of p22phox. *The Journal of biological chemistry* 286(10): 7779-7787.
- Eid AA, Ford BM, Block K, Kasinath BS, Gorin Y et al. (2010) AMP-activated protein kinase (AMPK) negatively regulates Nox4-dependent activation of p53 and epithelial cell apoptosis in diabetes. *The Journal of biological chemistry* 285(48): 37503-37512.

## F

- Faig M, Bianchet MA, Talalay P, Chen S, Winski S et al. (2000) Structures of recombinant human and mouse NAD(P)H:quinone oxidoreductases: species comparison and structural changes with substrate binding and release. *Proceedings of the National Academy of Sciences of the United States of America* 97(7): 3177-3182.
- Fujii M, Inoguchi T, Sasaki S, Maeda Y, Zheng J et al. (2010) Bilirubin and biliverdin protect rodents against diabetic nephropathy by downregulating NAD(P)H oxidase. *Kidney international* 78(9): 905-919.

## G

- Galli S, Antico Arciuch VG, Poderoso C, Converso DP, Zhou Q et al. (2008) Tumor cell phenotype is sustained by selective MAPK oxidation in mitochondria. *PloS one* 3(6): e2379.
- Galter D, Mihm S, Droge W (1994) Distinct effects of glutathione disulphide on the nuclear transcription factor kappa B and the activator protein-1. *European journal of biochemistry / FEBS* 221(2): 639-648.
- Gardès-Albert M (2003) Espèce réactives de l'oxygène : comment l'oxygène peut-il devenir toxique ? *l'actualité chimique*: 91-96.
- Gargiulo S, Gamba P, Poli G, Leonarduzzi G (2013 ) Metalloproteinases and Metalloproteinase Inhibitors in Age-Related Diseases. *Curr Pharm Des* In press.
- Gavazzi G, Banfi B, Deffert C, Fiette L, Schappi M et al. (2006) Decreased blood pressure in NOX1-deficient mice. *FEBS letters* 580(2): 497-504.
- Geiszt M, Kopp JB, Varnai P, Leto TL (2000) Identification of renox, an NAD(P)H oxidase in kidney. *Proc Natl Acad Sci U S A* 97(14): 8010-8014.
- Genestra M (2007) Oxy radicals, redox-sensitive signalling cascades and antioxidants. *Cell Signal* 19(9): 1807-1819.
- Giannoni E, Buricchi F, Raugei G, Ramponi G, Chiarugi P (2005) Intracellular reactive oxygen species activate Src tyrosine kinase during cell adhesion and anchorage-dependent cell growth. *Molecular and cellular biology* 25(15): 6391-6403.
- Glasson SS, Askew R, Sheppard B, Carito B, Blanchet T et al. (2005) Deletion of active ADAMTS5 prevents cartilage degradation in a murine model of osteoarthritis. *Nature* 434(7033): 644-648.

## Références bibliographiques

- Goettsch C, Babelova A, Trummer O, Erben RG, Rauner M et al. (2013) NADPH oxidase 4 limits bone mass by promoting osteoclastogenesis. *The Journal of clinical investigation*.
- Goldring MB (2004) Immortalization of human articular chondrocytes for generation of stable, differentiated cell lines. *Methods in molecular medicine* 100: 23-36.
- Goldring MB, Otero M, Tsuchimochi K, Ijiri K, Li Y (2008) Defining the roles of inflammatory and anabolic cytokines in cartilage metabolism. *Annals of the rheumatic diseases* 67 Suppl 3: iii75-82.
- Goldring MB, Birkhead JR, Suen LF, Yamin R, Mizuno S et al. (1994) Interleukin-1 beta-modulated gene expression in immortalized human chondrocytes. *The Journal of clinical investigation* 94(6): 2307-2316.
- Gorin Y, Block K (2013) Nox4 and diabetic nephropathy: With a friend like this, who needs enemies? *Free radical biology & medicine* 61C: 130-142.
- Gorlach A, Diebold I, Schini-Kerth VB, Berchner-Pfannschmidt U, Roth U et al. (2001) Thrombin activates the hypoxia-inducible factor-1 signaling pathway in vascular smooth muscle cells: Role of the p22(phox)-containing NADPH oxidase. *Circulation research* 89(1): 47-54.
- Gowen M, Wood DD, Ihrie EJ, Meats JE, Russell RG (1984) Stimulation by human interleukin 1 of cartilage breakdown and production of collagenase and proteoglycanase by human chondrocytes but not by human osteoblasts in vitro. *Biochimica et biophysica acta* 797(2): 186-193.
- Goyal P, Weissmann N, Rose F, Grimminger F, Schafers HJ et al. (2005) Identification of novel Nox4 splice variants with impact on ROS levels in A549 cells. *Biochemical and biophysical research communications* 329(1): 32-39.
- Grange L, Nguyen MV, Lardy B, Derouazi M, Champion Y et al. (2006) NAD(P)H oxidase activity of Nox4 in chondrocytes is both inducible and involved in collagenase expression. *Antioxidants & redox signaling* 8(9-10): 1485-1496.
- Groemping Y, Rittinger K (2005) Activation and assembly of the NADPH oxidase: a structural perspective. *The Biochemical journal* 386(Pt 3): 401-416.
- Guillen MI, Megias J, Clerigues V, Gomar F, Alcaraz MJ (2008) The CO-releasing molecule CORM-2 is a novel regulator of the inflammatory process in osteoarthritic chondrocytes. *Rheumatology (Oxford, England)* 47(9): 1323-1328.

## H

- Haase VH (2013) Regulation of erythropoiesis by hypoxia-inducible factors. *Blood reviews* 27(1): 41-53.
- Haloui M, Meilhac O, Jandrot-Perrus M, Michel JB (2003) Atorvastatin limits the pro-inflammatory response of rat aortic smooth muscle cells to thrombin. *European journal of pharmacology* 474(2-3): 175-184.
- Hardingham T (2012) What makes chondrocyte special? *Osteoarthritis and cartilage / OARS, Osteoarthritis Research Society*.
- Harman D (1956) Aging: a theory based on free radical and radiation chemistry. *Journal of gerontology* 11(3): 298-300.
- Harrison CB, Selemidis S, Guida E, King PT, Sobey CG et al. (2012) NOX2beta: A novel splice variant of NOX2 that regulates NADPH oxidase activity in macrophages. *PloS one* 7(10): e48326.
- Harrison R (2002) Structure and function of xanthine oxidoreductase: where are we now? *Free radical biology & medicine* 33(6): 774-797.
- Hecker L, Vittal R, Jones T, Jagirdar R, Luckhardt TR et al. (2009) NADPH oxidase-4 mediates myofibroblast activation and fibrogenic responses to lung injury. *Nature medicine* 15(9): 1077-1081.

## Références bibliographiques

- Henrotin Y, Kurz B, Aigner T (2005) Oxygen and reactive oxygen species in cartilage degradation: friends or foes? *Osteoarthritis and cartilage / OARS, Osteoarthritis Research Society* 13(8): 643-654.
- Henrotin YE, Bruckner P, Pujol JP (2003) The role of reactive oxygen species in homeostasis and degradation of cartilage. *Osteoarthritis and cartilage / OARS, Osteoarthritis Research Society* 11(10): 747-755.
- Heraud F, Heraud A, Harmand MF (2000) Apoptosis in normal and osteoarthritic human articular cartilage. *Annals of the rheumatic diseases* 59(12): 959-965.
- Heyworth PG, Cross AR, Curnutte JT (2003) Chronic granulomatous disease. *Current opinion in immunology* 15(5): 578-584.
- Hilenski LL, Clempus RE, Quinn MT, Lambeth JD, Griendling KK (2004) Distinct subcellular localizations of Nox1 and Nox4 in vascular smooth muscle cells. *Arteriosclerosis, thrombosis, and vascular biology* 24(4): 677-683.
- Hiran TS, Moulton PJ, Hancock JT (1997) Detection of superoxide and NADPH oxidase in porcine articular chondrocytes. *Free radical biology & medicine* 23(5): 736-743.
- Huang J, Hitt ND, Kleinberg ME (1995) Stoichiometry of p22-phox and gp91-phox in phagocyte cytochrome b558. *Biochemistry* 34(51): 16753-16757.
- Humphries KM, Juliano C, Taylor SS (2002) Regulation of cAMP-dependent protein kinase activity by glutathionylation. *The Journal of biological chemistry* 277(45): 43505-43511.

## I

- Imajoh-Ohmi S, Tokita K, Ochiai H, Nakamura M, Kanegasaki S (1992) Topology of cytochrome b558 in neutrophil membrane analyzed by anti-peptide antibodies and proteolysis. *J Biol Chem* 267(1): 180-184.
- Ito K, Hanazawa T, Tomita K, Barnes PJ, Adcock IM (2004) Oxidative stress reduces histone deacetylase 2 activity and enhances IL-8 gene expression: role of tyrosine nitration. *Biochemical and biophysical research communications* 315(1): 240-245.

## J

- Jackson HM, Kawahara T, Nisimoto Y, Smith SM, Lambeth JD (2010) Nox4 B-loop creates an interface between the transmembrane and dehydrogenase domains. *The Journal of biological chemistry* 285(14): 10281-10290.
- Jansen T, Hortmann M, Oelze M, Opitz B, Steven S et al. (2010) Conversion of biliverdin to bilirubin by biliverdin reductase contributes to endothelial cell protection by heme oxygenase-1-evidence for direct and indirect antioxidant actions of bilirubin. *Journal of molecular and cellular cardiology* 49(2): 186-195.
- Jaquet V, Scapozza L, Clark RA, Krause KH, Lambeth JD (2009) Small-molecule NOX inhibitors: ROS-generating NADPH oxidases as therapeutic targets. *Antioxidants & redox signaling* 11(10): 2535-2552.
- Johnson K, Jung A, Murphy A, Andreyev A, Dykens J et al. (2000) Mitochondrial oxidative phosphorylation is a downstream regulator of nitric oxide effects on chondrocyte matrix synthesis and mineralization. *Arthritis and rheumatism* 43(7): 1560-1570.
- Juarez JC, Manuia M, Burnett ME, Betancourt O, Boivin B et al. (2008) Superoxide dismutase 1 (SOD1) is essential for H<sub>2</sub>O<sub>2</sub>-mediated oxidation and inactivation of phosphatases in growth factor signaling. *Proceedings of the National Academy of Sciences of the United States of America* 105(20): 7147-7152.
- Jung Y, Kim H, Min SH, Rhee SG, Jeong W (2008) Dynein light chain LC8 negatively regulates NF-kappaB through the redox-dependent interaction with IkappaBalpha. *The Journal of biological chemistry* 283(35): 23863-23871.



## K

- Katsuyama M (2010) NOX/NADPH oxidase, the superoxide-generating enzyme: its transcriptional regulation and physiological roles. *Journal of pharmacological sciences* 114(2): 134-146.
- Kawahara T, Ritsick D, Cheng G, Lambeth JD (2005) Point mutations in the proline-rich region of p22phox are dominant inhibitors of Nox1- and Nox2-dependent reactive oxygen generation. *The Journal of biological chemistry* 280(36): 31859-31869.
- Kawahara T, Jackson HM, Smith SM, Simpson PD, Lambeth JD (2012) Nox5 forms a functional oligomer mediated by self-association of its dehydrogenase domain. *Biochemistry* 50(12): 2013-2025.
- Kheradmand F, Werner E, Tremble P, Symons M, Werb Z (1998) Role of Rac1 and oxygen radicals in collagenase-1 expression induced by cell shape change. *Science (New York, NY)* 280(5365): 898-902.
- Khokha R, Murthy A, Weiss A (2013) Metalloproteinases and their natural inhibitors in inflammation and immunity. *Nature reviews* 13(9): 649-665.
- Kikuchi H, Hikage M, Miyashita H, Fukumoto M (2000) NADPH oxidase subunit, gp91(phox) homologue, preferentially expressed in human colon epithelial cells. *Gene* 254(1-2): 237-243.
- Kim H, Paul S, Gennity J, Jennity J, Inouye M (1994) Reversible topology of a bifunctional transmembrane protein depends upon the charge balance around its transmembrane domain. *Mol Microbiol* 11(5): 819-831.
- Kim HP, Ryter SW, Choi AM (2006) CO as a cellular signaling molecule. *Annual review of pharmacology and toxicology* 46: 411-449.
- Kim HP, Wang X, Galbiati F, Ryter SW, Choi AM (2004) Caveolae compartmentalization of heme oxygenase-1 in endothelial cells. *Faseb J* 18(10): 1080-1089.
- Kim J, Xu M, Xo R, Mates A, Wilson GL et al. (2009) Mitochondrial DNA damage is involved in apoptosis caused by pro-inflammatory cytokines in human OA chondrocytes. *Osteoarthritis and cartilage / OARS, Osteoarthritis Research Society* 18(3): 424-432.
- Kim JA, Neupane GP, Lee ES, Jeong BS, Park BC et al. (2011) NADPH oxidase inhibitors: a patent review. *Expert opinion on therapeutic patents* 21(8): 1147-1158.
- Kim JY, Park YJ, Kim KJ, Choi JJ, Kim WU et al. (2013) Osteoprotegerin causes apoptosis of endothelial progenitor cells by induction of oxidative stress. *Arthritis and rheumatism: NA*.
- Kim KS, Choi HW, Yoon HE, Kim IY (2010) Reactive oxygen species generated by NADPH oxidase 2 and 4 are required for chondrogenic differentiation. *J Biol Chem* 285(51): 40294-40302.
- Klabunde T, Hessler G (2002) Drug design strategies for targeting G-protein-coupled receptors. *Chembiochem* 3(10): 928-944.
- Kleinschnitz C, Grund H, Wingler K, Armitage ME, Jones E et al. (2010) Post-stroke inhibition of induced NADPH oxidase type 4 prevents oxidative stress and neurodegeneration. *PLoS biology* 8(9).
- Knaus UG, Heyworth PG, Evans T, Curnutte JT, Bokoch GM (1991) Regulation of phagocyte oxygen radical production by the GTP-binding protein Rac 2. *Science (New York, NY)* 254(5037): 1512-1515.
- Komander D (2010) Mechanism, specificity and structure of the deubiquitinases. *Subcell Biochem* 54: 69-87.
- Krause KH (2007) Aging: a revisited theory based on free radicals generated by NOX family NADPH oxidases. *Experimental gerontology* 42(4): 256-262.
- Kronenberg HM (2003) Developmental regulation of the growth plate. *Nature* 423(6937): 332-336.
- Kroviarski Y, Debbabi M, Bachoual R, Perianin A, Gougerot-Pocidallo MA et al. (2013) Phosphorylation of NADPH oxidase activator 1 (NOXA1) on serine 282 by MAP

## Références bibliographiques

- kinases and on serine 172 by protein kinase C and protein kinase A prevents NOX1 hyperactivation. *Faseb J* 24(6): 2077-2092.
- Kuroda J, Nakagawa K, Yamasaki T, Nakamura K, Takeya R et al. (2005) The superoxide-producing NAD(P)H oxidase Nox4 in the nucleus of human vascular endothelial cells. *Genes Cells* 10(12): 1139-1151.

## L

- Laleu B, Gaggini F, Orchard M, Fioraso-Cartier L, Cagnon L et al. (2010) First in class, potent, and orally bioavailable NADPH oxidase isoform 4 (Nox4) inhibitors for the treatment of idiopathic pulmonary fibrosis. *Journal of medicinal chemistry* 53(21): 7715-7730.
- Lambeth JD (2004) NOX enzymes and the biology of reactive oxygen. *Nat Rev Immunol* 4(3): 181-189.
- Larsen CN, Krantz BA, Wilkinson KD (1998) Substrate specificity of deubiquitinating enzymes: ubiquitin C-terminal hydrolases. *Biochemistry* 37(10): 3358-3368.
- Lassegue B, San Martin A, Griendling KK (2012) Biochemistry, physiology, and pathophysiology of NADPH oxidases in the cardiovascular system. *Circulation research* 110(10): 1364-1390.
- Lee JK, Edderkaoui M, Truong P, Ohno I, Jang KT et al. (2007) NADPH oxidase promotes pancreatic cancer cell survival via inhibiting JAK2 dephosphorylation by tyrosine phosphatases. *Gastroenterology* 133(5): 1637-1648.
- Lee YJ, Cho HN, Soh JW, Jhon GJ, Cho CK et al. (2003) Oxidative stress-induced apoptosis is mediated by ERK1/2 phosphorylation. *Experimental cell research* 291(1): 251-266.
- Lener B, Koziel R, Pircher H, Hutter E, Greussing R et al. (2009) The NADPH oxidase Nox4 restricts the replicative lifespan of human endothelial cells. *The Biochemical journal* 423(3): 363-374.
- Li H, Forstermann U (2013) Uncoupling of endothelial NO synthase in atherosclerosis and vascular disease. *Current opinion in pharmacology* 13(2): 161-167.
- Li Q, Harraz MM, Zhou W, Zhang LN, Ding W et al. (2006) Nox2 and Rac1 regulate H<sub>2</sub>O<sub>2</sub>-dependent recruitment of TRAF6 to endosomal interleukin-1 receptor complexes. *Molecular and cellular biology* 26(1): 140-154.
- Li Y, Mouche S, Sajic T, Veyrat-Durebex C, Supale R et al. (2013) Deficiency in the NADPH oxidase 4 predisposes towards diet-induced obesity. *International journal of obesity* (2005) 36(12): 1503-1513.
- Liacini A, Sylvester J, Li WQ, Zafarullah M (2002) Inhibition of interleukin-1-stimulated MAP kinases, activating protein-1 (AP-1) and nuclear factor kappa B (NF-kappa B) transcription factors down-regulates matrix metalloproteinase gene expression in articular chondrocytes. *Matrix Biol* 21(3): 251-262.
- Liebler DC, Guengerich FP (2005) Elucidating mechanisms of drug-induced toxicity. *Nat Rev Drug Discov* 4(5): 410-420.
- Lin Q, Weis S, Yang G, Weng YH, Helston R et al. (2007) Heme oxygenase-1 protein localizes to the nucleus and activates transcription factors important in oxidative stress. *The Journal of biological chemistry* 282(28): 20621-20633.
- Lo YY, Wong JM, Cruz TF (1996) Reactive oxygen species mediate cytokine activation of c-Jun NH<sub>2</sub>-terminal kinases. *The Journal of biological chemistry* 271(26): 15703-15707.
- Lo YY, Conquer JA, Grinstead S, Cruz TF (1998) Interleukin-1 beta induction of c-fos and collagenase expression in articular chondrocytes: involvement of reactive oxygen species. *Journal of cellular biochemistry* 69(1): 19-29.
- Loeser RF (2009) Aging and osteoarthritis: the role of chondrocyte senescence and aging changes in the cartilage matrix. *Osteoarthritis and cartilage / OARS, Osteoarthritis Research Society* 17(8): 971-979.

## Références bibliographiques

- Lorenz H, Hailey DW, Lippincott-Schwartz J (2006) Fluorescence protease protection of GFP chimeras to reveal protein topology and subcellular localization. *Nat Methods* 3(3): 205-210.
- Lu L, Wang YN, Sun WH, Liu ZH, Zhang Q et al. (2010) Two-dimensional fluorescence in-gel electrophoresis of coronary restenosis tissues in minipigs: increased adipocyte Fatty Acid binding protein induces reactive oxygen species-mediated growth and migration in smooth muscle cells. *Arteriosclerosis, thrombosis, and vascular biology* 33(3): 572-580.
- Lyle AN, Deshpande NN, Taniyama Y, Seidel-Rogol B, Pounkova L et al. (2009) Poldip2, a novel regulator of Nox4 and cytoskeletal integrity in vascular smooth muscle cells. *Circulation research* 105(3): 249-259.

## M

- Mahadev K, Motoshima H, Wu X, Ruddy JM, Arnold RS et al. (2004) The NAD(P)H oxidase homolog Nox4 modulates insulin-stimulated generation of H<sub>2</sub>O<sub>2</sub> and plays an integral role in insulin signal transduction. *Molecular and cellular biology* 24(5): 1844-1854.
- Mandal CC, Ganapathy S, Gorin Y, Mahadev K, Block K et al. Reactive oxygen species derived from Nox4 mediate BMP2 gene transcription and osteoblast differentiation. *The Biochemical journal* 433(2): 393-402.
- Mandal CC, Ganapathy S, Gorin Y, Mahadev K, Block K et al. (2012) Reactive oxygen species derived from Nox4 mediate BMP2 gene transcription and osteoblast differentiation. *The Biochemical journal* 433(2): 393-402.
- Martin G, Andriamanalijaona R, Mathy-Hartert M, Henrotin Y, Pujol JP (2005) Comparative effects of IL-1 $\beta$  and hydrogen peroxide (H<sub>2</sub>O<sub>2</sub>) on catabolic and anabolic gene expression in juvenile bovine chondrocytes. *Osteoarthritis and cartilage / OARS, Osteoarthritis Research Society* 13(10): 915-924.
- Martin JA, Martini A, Molinari A, Morgan W, Ramalingam W et al. (2013) Mitochondrial electron transport and glycolysis are coupled in articular cartilage. *Osteoarthritis and cartilage / OARS, Osteoarthritis Research Society* 20(4): 323-329.
- Martyn KD, Frederick LM, von Loehneysen K, Dinauer MC, Knaus UG (2006) Functional analysis of Nox4 reveals unique characteristics compared to other NADPH oxidases. *Cellular signalling* 18(1): 69-82.
- Mathy-Hartert M, Deby-Dupont GP, Reginster JY, Ayache N, Pujol JP et al. (2002) Regulation by reactive oxygen species of interleukin-1 $\beta$ , nitric oxide and prostaglandin E(2) production by human chondrocytes. *Osteoarthritis and cartilage / OARS, Osteoarthritis Research Society* 10(7): 547-555.
- McKallip RJ, Jia W, Schlomer J, Warren JW, Nagarkatti PS et al. (2006) Cannabidiol-induced apoptosis in human leukemia cells: A novel role of cannabidiol in the regulation of p22phox and Nox4 expression. *Molecular pharmacology* 70(3): 897-908.
- Megias J, Guillen MI, Bru A, Gomar F, Alcaraz MJ (2008) The carbon monoxide-releasing molecule tricarbonyldichlororuthenium(II) dimer protects human osteoarthritic chondrocytes and cartilage from the catabolic actions of interleukin-1 $\beta$ . *The Journal of pharmacology and experimental therapeutics* 325(1): 56-61.
- Megias J, Guillen MI, Clerigues V, Rojo AI, Cuadrado A et al. (2009) Heme oxygenase-1 induction modulates microsomal prostaglandin E synthase-1 expression and prostaglandin E(2) production in osteoarthritic chondrocytes. *Biochemical pharmacology* 77(12): 1806-1813.
- Mendes AF, Carvalho AP, Caramona MM, Lopes MC (2001) Diphenyleneiodonium inhibits NF-kappaB activation and iNOS expression induced by IL-1 $\beta$ : involvement of reactive oxygen species. *Mediators of inflammation* 10(4): 209-215.
- Meng D, Lv DD, Fang J (2008) Insulin-like growth factor-I induces reactive oxygen species production and cell migration through Nox4 and Rac1 in vascular smooth muscle cells. *Cardiovascular research* 80(2): 299-308.

## Références bibliographiques

- Mengshol JA, Vincenti MP, Coon CI, Barchowsky A, Brinckerhoff CE (2000) Interleukin-1 induction of collagenase 3 (matrix metalloproteinase 13) gene expression in chondrocytes requires p38, c-Jun N-terminal kinase, and nuclear factor kappaB: differential regulation of collagenase 1 and collagenase 3. *Arthritis and rheumatism* 43(4): 801-811.
- Mittelstadt PR, Salvador JM, Fornace AJ, Jr., Ashwell JD (2005) Activating p38 MAPK: new tricks for an old kinase. *Cell cycle (Georgetown, Tex)* 4(9): 1189-1192.
- Morand S, Ueyama T, Tsujibe S, Saito N, Korzeniowska A et al. (2009) Duox maturation factors form cell surface complexes with Duox affecting the specificity of reactive oxygen species generation. *Faseb J* 23(4): 1205-1218.
- Morel F (2007) [Molecular aspects of chronic granulomatous disease. "the NADPH oxidase complex"]. *Bulletin de l'Academie nationale de medecine* 191(2): 377-390; discussion 390-372.
- Morita K, Miyamoto T, Fujita N, Kubota Y, Ito K et al. (2007) Reactive oxygen species induce chondrocyte hypertrophy in endochondral ossification. *The Journal of experimental medicine* 204(7): 1613-1623.
- Mouche S, Mkaddem SB, Wang W, Katic M, Tseng YH et al. (2007) Reduced expression of the NADPH oxidase NOX4 is a hallmark of adipocyte differentiation. *Biochimica et biophysica acta* 1773(7): 1015-1027.
- Moulton PJ, Hiran TS, Goldring MB, Hancock JT (1997) Detection of protein and mRNA of various components of the NADPH oxidase complex in an immortalized human chondrocyte line. *British journal of rheumatology* 36(5): 522-529.
- Mukherjea D, Jajoo S, Kaur T, Sheehan KE, Ramkumar V et al. (2010) Transtympanic administration of short interfering (si)RNA for the NOX3 isoform of NADPH oxidase protects against cisplatin-induced hearing loss in the rat. *Antioxidants & redox signaling* 13(5): 589-598.
- Mumbengegwi DR, Li Q, Li C, Bear CE, Engelhardt JF (2008) Evidence for a superoxide permeability pathway in endosomal membranes. *Molecular and cellular biology* 28(11): 3700-3712.
- Murillo I, Henderson LM (2005) Expression of gp91phox/Nox2 in COS-7 cells: cellular localization of the protein and the detection of outward proton currents. *The Biochemical journal* 385(Pt 3): 649-657.
- Murphy CL (2010) HIF-2alpha--a mediator of osteoarthritis? *Cell research* 20(9): 977-979.
- Murphy G, Lee MH (2005) What are the roles of metalloproteinases in cartilage and bone damage? *Annals of the rheumatic diseases* 64 Suppl 4: iv44-47.

## N

- Nagase H, Visse R, Murphy G (2006) Structure and function of matrix metalloproteinases and TIMPs. *Cardiovascular research* 69(3): 562-573.
- Nagase H, Meng Q, Malinovskii V, Huang W, Chung L et al. (1999) Engineering of selective TIMPs. *Annals of the New York Academy of Sciences* 878: 1-11.
- Nakahira K, Kim HP, Geng XH, Nakao A, Wang X et al. (2006) Carbon monoxide differentially inhibits TLR signaling pathways by regulating ROS-induced trafficking of TLRs to lipid rafts. *The Journal of experimental medicine* 203(10): 2377-2389.
- Nakano Y, Banfi B, Jesaitis AJ, Dinauer MC, Allen LA et al. (2007) Critical roles for p22phox in the structural maturation and subcellular targeting of Nox3. *The Biochemical journal* 403(1): 97-108.
- Nam J, Aguda BD, Rath B, Agarwal S (2009) Biomechanical thresholds regulate inflammation through the NF-kappaB pathway: experiments and modeling. *PloS one* 4(4): e5262.
- Nathan C, Cunningham-Bussel A (2013) Beyond oxidative stress: an immunologist's guide to reactive oxygen species. *Nature reviews* 13(5): 349-361.

## Références bibliographiques

- New DD, Block K, Bhandhari B, Gorin Y, Abboud HE (2011) IGF-I increases the expression of fibronectin by Nox4-dependent Akt phosphorylation in renal tubular epithelial cells. *American journal of physiology* 302(1): C122-130.
- Nguyen MV, Zhang L, Lhomme S, Mouz N, Lenormand JL et al. (2012) Recombinant Nox4 cytosolic domain produced by a cell or cell-free base systems exhibits constitutive diaphorase activity. *Biochemical and biophysical research communications* 419(3): 453-458.
- Nguyen MV, Lardy B, Rousset F, Hazane-Puch F, Zhang L et al. (2013) Quinone compounds regulate the level of ROS production by the NADPH oxidase Nox4. *Biochemical pharmacology* 85(11): 1644-1654.
- Nishimura S, Akagi M, Yoshida K, Hayakawa S, Sawamura T et al. (2004) Oxidized low-density lipoprotein (ox-LDL) binding to lectin-like ox-LDL receptor-1 (LOX-1) in cultured bovine articular chondrocytes increases production of intracellular reactive oxygen species (ROS) resulting in the activation of NF-kappaB. *Osteoarthritis and cartilage / OARS, Osteoarthritis Research Society* 12(7): 568-576.
- Nisimoto Y, Jackson HM, Ogawa H, Kawahara T, Lambeth JD (2010) Constitutive NADPH-dependent electron transferase activity of the Nox4 dehydrogenase domain. *Biochemistry* 49(11): 2433-2442.

## O

- Oakley FD, Smith RL, Engelhardt JF (2009a) Lipid rafts and caveolin-1 coordinate interleukin-1beta (IL-1beta)-dependent activation of NFkappaB by controlling endocytosis of Nox2 and IL-1beta receptor 1 from the plasma membrane. *The Journal of biological chemistry* 284(48): 33255-33264.
- Oakley FD, Abbott D, Li Q, Engelhardt JF (2009b) Signaling components of redox active endosomes: the redoxosomes. *Antioxidants & redox signaling* 11(6): 1313-1333.

## P

- Paclet MH, Coleman AW, Vergnaud S, Morel F (2000) P67-phox-mediated NADPH oxidase assembly: imaging of cytochrome b558 liposomes by atomic force microscopy. *Biochemistry* 39(31): 9302-9310.
- Paclet MH, Coleman AW, Burritt J, Morel F (2001) NADPH oxidase of Epstein-Barr-virus immortalized B lymphocytes. Effect of cytochrome b(558) glycosylation. *European journal of biochemistry / FEBS* 268(19): 5197-5208.
- Paclet MH, Henderson LM, Champion Y, Morel F, Dagher MC (2004) Localization of Nox2 N-terminus using polyclonal antipeptide antibodies. *The Biochemical journal* 382(Pt 3): 981-986.
- Paffenholz R, Bergstrom RA, Pasutto F, Wabnitz P, Munroe RJ et al. (2004) Vestibular defects in head-tilt mice result from mutations in Nox3, encoding an NADPH oxidase. *Genes & development* 18(5): 486-491.
- Page EL, Robitaille GA, Pouyssegur J, Richard DE (2002) Induction of hypoxia-inducible factor-1alpha by transcriptional and translational mechanisms. *The Journal of biological chemistry* 277(50): 48403-48409.
- Pandey D, Chen F, Patel A, Wang CY, Dimitropoulou C et al. (2011) SUMO1 negatively regulates reactive oxygen species production from NADPH oxidases. *Arteriosclerosis, thrombosis, and vascular biology* 31(7): 1634-1642.
- Park HS, Chun JN, Jung HY, Choi C, Bae YS (2006) Role of NADPH oxidase 4 in lipopolysaccharide-induced proinflammatory responses by human aortic endothelial cells. *Cardiovascular research* 72(3): 447-455.
- Park HS, Jung HY, Park EY, Kim J, Lee WJ et al. (2004) Cutting edge: direct interaction of TLR4 with NAD(P)H oxidase 4 isozyme is essential for lipopolysaccharide-induced

## Références bibliographiques

- production of reactive oxygen species and activation of NF-kappa B. *J Immunol* 173(6): 3589-3593.
- Patel HH, Insel PA (2009) Lipid rafts and caveolae and their role in compartmentation of redox signaling. *Antioxidants & redox signaling* 11(6): 1357-1372.
- Pelletier JP, Fernandes JC, Jovanovic DV, Reboul P, Martel-Pelletier J (2001) Chondrocyte death in experimental osteoarthritis is mediated by MEK 1/2 and p38 pathways: role of cyclooxygenase-2 and inducible nitric oxide synthase. *The Journal of rheumatology* 28(11): 2509-2519.
- Pendyala S, Moitra J, Kalari S, Kleeberger SR, Zhao Y et al. (2011) Nrf2 regulates hyperoxia-induced Nox4 expression in human lung endothelium: identification of functional antioxidant response elements on the Nox4 promoter. *Free radical biology & medicine* 50(12): 1749-1759.
- Pfander D, Swoboda B, Cramer T (2006) The role of HIF-1alpha in maintaining cartilage homeostasis and during the pathogenesis of osteoarthritis. *Arthritis research & therapy* 8(1): 104.
- Piccoli C, Ria R, Scrima R, Cela O, D'Aprile A et al. (2005) Characterization of mitochondrial and extra-mitochondrial oxygen consuming reactions in human hematopoietic stem cells. Novel evidence of the occurrence of NAD(P)H oxidase activity. *The Journal of biological chemistry* 280(28): 26467-26476.
- Piwkowska A, Rogacka D, Audzeyenka I, Jankowski M, Angielski S (2011) High glucose concentration affects the oxidant-antioxidant balance in cultured mouse podocytes. *Journal of cellular biochemistry* 112(6): 1661-1672.
- Poole AR (2001) Cartilage in health and disease. In: Koopman WJ, editor. *Arthritis and allied conditions: a textbook of rheumatology* Philadelphia: Lippincott Williams & Wilkins. pp. 226–284.
- Poole AR, Howell DS (2001) Etiopathogenesis of osteoarthritis. . In: Moskowitz RW, Howell DS, Altman RD, Buckwalter JA, Goldberg VM, editors. *Osteoarthritis: diagnosis/surgical management* Philadelphia: WB Saunders pp. 29–47.
- Poole AR, Alini M, Hollander AR (1997) Cellular biology of cartilage degradation. In: Henderson B, Edwards JC, Pettipher ER, editors. *Mechanisms and models in rheumatoid arthritis* London: Academic Press. pp. 163–204.
- Poole CA, Ayad S, Gilbert RT (1992) Chondrons from articular cartilage. V. Immunohistochemical evaluation of type VI collagen organisation in isolated chondrons by light, confocal and electron microscopy. *Journal of cell science* 103 ( Pt 4): 1101-1110.
- Pritzker KP, Gay S, Jimenez SA, Ostergaard K, Pelletier JP et al. (2006) Osteoarthritis cartilage histopathology: grading and staging. *Osteoarthritis and cartilage / OARS, Osteoarthritis Research Society* 14(1): 13-29.

## Q

- Qin B, Cartier L, Dubois-Dauphin M, Li B, Serrander L et al. (2006) A key role for the microglial NADPH oxidase in APP-dependent killing of neurons. *Neurobiology of aging* 27(11): 1577-1587.

## R

- Rahman I, Marwick J, Kirkham P (2004) Redox modulation of chromatin remodeling: impact on histone acetylation and deacetylation, NF-kappaB and pro-inflammatory gene expression. *Biochemical pharmacology* 68(6): 1255-1267.
- Rannou FS, J. Berembaum, F. (2010) *Physiopathologie de l'arthrose : conceptions actuelles.* Presse Med 39: 1159-1163.

## Références bibliographiques

- Rodriguez AI, Gangopadhyay A, Kelley EE, Pagano PJ, Zuckerbraun BS et al. (2009) HO-1 and CO decrease platelet-derived growth factor-induced vascular smooth muscle cell migration via inhibition of Nox1. *Arterioscler Thromb Vasc Biol* 30(1): 98-104.
- Rousset F, Nguyen MV, Grange L, Morel F, Lardy B (2013) Heme Oxygenase-1 Regulates Matrix Metalloproteinase MMP-1 Secretion and Chondrocyte Cell Death via Nox4 NADPH Oxidase Activity in Chondrocytes. *PloS one* 8(6): e66478.
- Ruchko MV, Gorodnya OM, Pastukh VM, Swiger BM, Middleton NS et al. (2009) Hypoxia-induced oxidative base modifications in the VEGF hypoxia-response element are associated with transcriptionally active nucleosomes. *Free radical biology & medicine* 46(3): 352-359.
- Ryter SW, Choi AM (2009) Heme oxygenase-1/carbon monoxide: from metabolism to molecular therapy. *American journal of respiratory cell and molecular biology* 41(3): 251-260.

## S

- Sancho P, Bertran E, Caja L, Carmona-Cuenca I, Murillo MM et al. (2009) The inhibition of the epidermal growth factor (EGF) pathway enhances TGF-beta-induced apoptosis in rat hepatoma cells through inducing oxidative stress coincident with a change in the expression pattern of the NADPH oxidases (NOX) isoforms. *Biochimica et biophysica acta* 1793(2): 253-263.
- Sancho P, Mainez J, Crosas-Molist E, Roncero C, Fernandez-Rodriguez CM et al. (2012) NADPH oxidase NOX4 mediates stellate cell activation and hepatocyte cell death during liver fibrosis development. *PloS one* 7(9): e45285.
- Schmidt N, Pautz A, Art J, Rauschkolb P, Jung M et al. (2009) Transcriptional and post-transcriptional regulation of iNOS expression in human chondrocytes. *Biochemical pharmacology* 79(5): 722-732.
- Schroder K, Wandzioch K, Helmcke I, Brandes RP (2009) Nox4 acts as a switch between differentiation and proliferation in preadipocytes. *Arteriosclerosis, thrombosis, and vascular biology* 29(2): 239-245.
- Schroder K, Zhang M, Benkhoff S, Mieth A, Pliquett R et al. (2012) Nox4 is a protective reactive oxygen species generating vascular NADPH oxidase. *Circulation research* 110(9): 1217-1225.
- Sedeek M, Gutsol A, Montezano AC, Burger D, Nguyen Dinh Cat A et al. (2013) Renoprotective effects of a novel Nox1/4 inhibitor in a mouse model of Type 2 diabetes. *Clin Sci (Lond)* 124(3): 191-202.
- Segal AW, Jones OT, Webster D, Allison AC (1978) Absence of a newly described cytochrome b from neutrophils of patients with chronic granulomatous disease. *Lancet* 2(8087): 446-449.
- Serrander L, Cartier L, Bedard K, Banfi B, Lardy B et al. (2007) NOX4 activity is determined by mRNA levels and reveals a unique pattern of ROS generation. *The Biochemical journal* 406(1): 105-114.
- Shabani F, McNeil J, Tippet L (1998) The oxidative inactivation of tissue inhibitor of metalloproteinase-1 (TIMP-1) by hypochlorous acid (HOCl) is suppressed by anti-rheumatic drugs. *Free radical research* 28(2): 115-123.
- Shan Y, Lambrecht RW, Donohue SE, Bonkovsky HL (2006) Role of Bach1 and Nrf2 in up-regulation of the heme oxygenase-1 gene by cobalt protoporphyrin. *Faseb J* 20(14): 2651-2653.
- Shiose A, Kuroda J, Tsuruya K, Hirai M, Hirakata H et al. (2001) A novel superoxide-producing NAD(P)H oxidase in kidney. *The Journal of biological chemistry* 276(2): 1417-1423.
- Siuda D, Zechner U, El Hajj N, Prawitt D, Langer D et al. (2012) Transcriptional regulation of Nox4 by histone deacetylases in human endothelial cells. *Basic research in cardiology* 107(5): 283.

## Références bibliographiques

- Slebos DJ, Ryter SW, van der Toorn M, Liu F, Guo F et al. (2007) Mitochondrial localization and function of heme oxygenase-1 in cigarette smoke-induced cell death. *American journal of respiratory cell and molecular biology* 36(4): 409-417.
- Strobel S, Loparic M, Wendt D, Schenk AD, Candrian C et al. (2010) Anabolic and catabolic responses of human articular chondrocytes to varying oxygen percentages. *Arthritis research & therapy* 12(2): R34.
- Studer RK (2004) Nitric oxide decreases IGF-1 receptor function in vitro; glutathione depletion enhances this effect in vivo. *Osteoarthritis and cartilage / OARS, Osteoarthritis Research Society* 12(11): 863-869.
- Suh YA, Arnold RS, Lassegue B, Shi J, Xu X et al. (1999) Cell transformation by the superoxide-generating oxidase Mox1. *Nature* 401(6748): 79-82.
- Sumimoto H (2008) Structure, regulation and evolution of Nox-family NADPH oxidases that produce reactive oxygen species. *The FEBS journal* 275(13): 3249-3277.
- Szanto I, Rubbia-Brandt L, Kiss P, Steger K, Banfi B et al. (2005) Expression of NOX1, a superoxide-generating NADPH oxidase, in colon cancer and inflammatory bowel disease. *The Journal of pathology* 207(2): 164-176.

## T

- Taille C, El-Benna J, Lanone S, Boczkowski J, Motterlini R (2005) Mitochondrial respiratory chain and NAD(P)H oxidase are targets for the antiproliferative effect of carbon monoxide in human airway smooth muscle. *The Journal of biological chemistry* 280(27): 25350-25360.
- Taille C, El-Benna J, Lanone S, Dang MC, Ogier-Denis E et al. (2004) Induction of heme oxygenase-1 inhibits NAD(P)H oxidase activity by down-regulating cytochrome b558 expression via the reduction of heme availability. *The Journal of biological chemistry* 279(27): 28681-28688.
- Takac I, Schroder K, Zhang L, Lardy B, Anilkumar N et al. (2011) The E-loop is involved in hydrogen peroxide formation by the NADPH oxidase Nox4. *The Journal of biological chemistry* 286(15): 13304-13313.
- Taylor RM, Burritt JB, Baniulis D, Foubert TR, Lord CI et al. (2004) Site-specific inhibitors of NADPH oxidase activity and structural probes of flavocytochrome b: characterization of six monoclonal antibodies to the p22phox subunit. *J Immunol* 173(12): 7349-7357.
- Tchetina EV, Antoniou J, Tanzer M, Zukor DJ, Poole AR (2006) Transforming growth factor-beta2 suppresses collagen cleavage in cultured human osteoarthritic cartilage, reduces expression of genes associated with chondrocyte hypertrophy and degradation, and increases prostaglandin E(2) production. *The American journal of pathology* 168(1): 131-140.
- Tiku ML, Yan YP, Chen KY (1998) Hydroxyl radical formation in chondrocytes and cartilage as detected by electron paramagnetic resonance spectroscopy using spin trapping reagents. *Free radical research* 29(3): 177-187.
- Tiku ML, Gupta S, Deshmukh DR (1999) Aggrecan degradation in chondrocytes is mediated by reactive oxygen species and protected by antioxidants. *Free radical research* 30(5): 395-405.
- Tocchi A, Parks WC (2013) Functional interactions between matrix metalloproteinases and glycosaminoglycans. *The FEBS journal* 280(10): 2332-2341.
- Torres M (2003) Mitogen-activated protein kinase pathways in redox signaling. *Front Biosci* 8: d369-391.
- Towle CA, Hung HH, Bonassar LJ, Treadwell BV, Mangham DC (1997) Detection of interleukin-1 in the cartilage of patients with osteoarthritis: a possible autocrine/paracrine role in pathogenesis. *Osteoarthritis and cartilage / OARS, Osteoarthritis Research Society* 5(5): 293-300.



## U

- Ungvari Z, Tucsek Z, Sosnowska D, Toth P, Gautam T et al. (2012) Aging-Induced Dysregulation of Dicer1-Dependent MicroRNA Expression Impairs Angiogenic Capacity of Rat Cerebromicrovascular Endothelial Cells. *The journals of gerontology* 68(8): 877-891.
- Urao N, Ushio-Fukai M (2012) Redox regulation of stem/progenitor cells and bone marrow niche. *Free radical biology & medicine* 54: 26-39.

## V

- Vallet P, Charnay Y, Steger K, Ogier-Denis E, Kovari E et al. (2005) Neuronal expression of the NADPH oxidase NOX4, and its regulation in mouse experimental brain ischemia. *Neuroscience* 132(2): 233-238.
- van der Kraan PM, Buma P, van Kuppevelt T, van den Berg WB (2002) Interaction of chondrocytes, extracellular matrix and growth factors: relevance for articular cartilage tissue engineering. *Osteoarthritis and cartilage / OARS, Osteoarthritis Research Society* 10(8): 631-637.
- van Lent PL, Nabbe KC, Blom AB, Sloetjes A, Holthuysen AE et al. (2005) NADPH-oxidase-driven oxygen radical production determines chondrocyte death and partly regulates metalloproteinase-mediated cartilage matrix degradation during interferon-gamma-stimulated immune complex arthritis. *Arthritis research & therapy* 7(4): R885-895.
- Vaquero EC, Edderkaoui M, Pandol SJ, Gukovsky I, Gukovskaya AS (2004) Reactive oxygen species produced by NAD(P)H oxidase inhibit apoptosis in pancreatic cancer cells. *The Journal of biological chemistry* 279(33): 34643-34654.
- Varshavsky A (2006) The early history of the ubiquitin field. *Protein Sci* 15(3): 647-654.
- Vesely PW, Staber PB, Hoefler G, Kenner L (2009) Translational regulation mechanisms of AP-1 proteins. *Mutation research* 682(1): 7-12.
- Vignon E, Arlot M, Hartman D, Noyer D (1980) [Microdurimetric and biochemical study of human articular cartilage. Comparison of different joints]. *Revue du rhumatisme et des maladies osteo-articulaires* 47(12): 715-718.
- Volpp BD, Nauseef WM, Clark RA (1988) Two cytosolic neutrophil oxidase components absent in autosomal chronic granulomatous disease. *Science (New York, NY)* 242(4883): 1295-1297.
- von Lohneysen K, Noack D, Jesaitis AJ, Dinauer MC, Knaus UG (2008) Mutational analysis reveals distinct features of the Nox4-p22 phox complex. *The Journal of biological chemistry* 283(50): 35273-35282.
- von Lohneysen K, Noack D, Hayes P, Friedman JS, Knaus UG (2010) Constitutive NADPH oxidase 4 activity resides in the composition of the B-loop and the penultimate C terminus. *The Journal of biological chemistry* 287(12): 8737-8745.
- von Lohneysen K, Noack D, Hayes P, Friedman JS, Knaus UG (2012) Constitutive NADPH oxidase 4 activity resides in the composition of the B-loop and the penultimate C terminus. *The Journal of biological chemistry* 287(12): 8737-8745.

## W

- Wang T, Zhang X, Li JJ (2002) The role of NF-kappaB in the regulation of cell stress responses. *International immunopharmacology* 2(11): 1509-1520.
- Wang X, Lupardus P, Laporte SL, Garcia KC (2009) Structural biology of shared cytokine receptors. *Annu Rev Immunol* 27: 29-60.
- Ward NE, Stewart JR, Ioannides CG, O'Brian CA (2000) Oxidant-induced S-glutathiolation inactivates protein kinase C-alpha (PKC-alpha): a potential mechanism of PKC isozyme regulation. *Biochemistry* 39(33): 10319-10329.

## Références bibliographiques

- Wientjes FB, Hsuan JJ, Totty NF, Segal AW (1993) p40phox, a third cytosolic component of the activation complex of the NADPH oxidase to contain src homology 3 domains. *The Biochemical journal* 296 ( Pt 3): 557-561.
- Wilkinson BM, Critchley AJ, Stirling CJ (1996) Determination of the transmembrane topology of yeast Sec61p, an essential component of the endoplasmic reticulum translocation complex. *J Biol Chem* 271(41): 25590-25597.
- Williams JR, Gong H (2007) Biological activities and syntheses of steroidal saponins: the shark-repelling pavoninins. *Lipids* 42(1): 77-86.
- Woessner JFN, H (2000) *Matrix Metalloproteinase and TIMPs*. oxford university press.

## X

- Xi G, Shen XC, Wai C, Clemmons DR (2013) Recruitment of Nox4 to a plasma membrane scaffold is required for localized reactive oxygen species generation and sustained Src activation in response to insulin-like growth factor-I. *The Journal of biological chemistry* 288(22): 15641-15653.

## Y

- Yachie A, Niida Y, Wada T, Igarashi N, Kaneda H et al. (1999) Oxidative stress causes enhanced endothelial cell injury in human heme oxygenase-1 deficiency. *The Journal of clinical investigation* 103(1): 129-135.
- Yamauchi A, Yu L, Potgens AJ, Kuribayashi F, Nunoi H et al. (2001) Location of the epitope for 7D5, a monoclonal antibody raised against human flavocytochrome b558, to the extracellular peptide portion of primate gp91phox. *Microbiol Immunol* 45(3): 249-257.
- Yamaura M, Mitsushita J, Furuta S, Kuniwa Y, Ashida A et al. (2009) NADPH oxidase 4 contributes to transformation phenotype of melanoma cells by regulating G2-M cell cycle progression. *Cancer research* 69(6): 2647-2654.
- Yamazaki K, Fukuda K, Matsukawa M, Hara F, Matsushita T et al. (2003) Cyclic tensile stretch loaded on bovine chondrocytes causes depolymerization of hyaluronan: involvement of reactive oxygen species. *Arthritis and rheumatism* 48(11): 3151-3158.
- Yang S, Zhang Y, Ries W, Key L (2004) Expression of Nox4 in osteoclasts. *Journal of cellular biochemistry* 92(2): 238-248.
- Yang S, Kim J, Ryu JH, Oh H, Chun CH et al. (2010) Hypoxia-inducible factor-2alpha is a catabolic regulator of osteoarthritic cartilage destruction. *Nature medicine* 16(6): 687-693.
- Yang YS, Hughes TE (2001) Cre stoplight: a red/green fluorescent reporter of Cre recombinase expression in living cells. *Biotechniques* 31(5): 1036, 1038, 1040-1031.
- Yasuhara R, Miyamoto Y, Akaike T, Akuta T, Nakamura M et al. (2005) Interleukin-1beta induces death in chondrocyte-like ATDC5 cells through mitochondrial dysfunction and energy depletion in a reactive nitrogen and oxygen species-dependent manner. *The Biochemical journal* 389(Pt 2): 315-323.
- Yoshimura K, Miyamoto Y, Yasuhara R, Maruyama T, Akiyama T et al. (2011) Monocarboxylate transporter-1 is required for cell death in mouse chondrocytic ATDC5 cells exposed to interleukin-1beta via late phase activation of nuclear factor kappaB and expression of phagocyte-type NADPH oxidase. *The Journal of biological chemistry* 286(17): 14744-14752.
- Yu L, Zhen L, Dinauer MC (1997) Biosynthesis of the phagocyte NADPH oxidase cytochrome b558. Role of heme incorporation and heterodimer formation in maturation and stability of gp91phox and p22phox subunits. *The Journal of biological chemistry* 272(43): 27288-27294.
- Yu L, Quinn MT, Cross AR, Dinauer MC (1998) Gp91(phox) is the heme binding subunit of the superoxide-generating NADPH oxidase. *Proceedings of the National Academy of Sciences of the United States of America* 95(14): 7993-7998.

## Références bibliographiques

- Yu L, DeLeo FR, Biberstine-Kinkade KJ, Renee J, Nauseef WM et al. (1999) Biosynthesis of flavocytochrome b558 . gp91(phox) is synthesized as a 65-kDa precursor (p65) in the endoplasmic reticulum. *The Journal of biological chemistry* 274(7): 4364-4369.
- Yudoh K, Nakamura H, Masuko-Hongo K, Kato T, Nishioka K (2005a) Catabolic stress induces expression of hypoxia-inducible factor (HIF)-1 alpha in articular chondrocytes: involvement of HIF-1 alpha in the pathogenesis of osteoarthritis. *Arthritis research & therapy* 7(4): R904-914.
- Yudoh K, Nguyen v T, Nakamura H, Hongo-Masuko K, Kato T et al. (2005b) Potential involvement of oxidative stress in cartilage senescence and development of osteoarthritis: oxidative stress induces chondrocyte telomere instability and downregulation of chondrocyte function. *Arthritis research & therapy* 7(2): R380-391.

## Z

- Zhang B, Liu Z, Hu X (2013) Inhibiting cancer metastasis via targeting NADPH oxidase 4. *Biochemical pharmacology* 86(2): 253-266.
- Zhang L, Sheppard OR, Shah AM, Brewer AC (2008) Positive regulation of the NADPH oxidase NOX4 promoter in vascular smooth muscle cells by E2F. *Free radical biology & medicine* 45(5): 679-685.
- Zhang L, Nguyen MV, Lardy B, Jesaitis AJ, Grichine A et al. (2011) New insight into the Nox4 subcellular localization in HEK293 cells: first monoclonal antibodies against Nox4. *Biochimie* 93(3): 457-468.
- Zhang Y, Dawson VL, Dawson TM (2000) Oxidative stress and genetics in the pathogenesis of Parkinson's disease. *Neurobiology of disease* 7(4): 240-250.
- Zhu Y, Marchal CC, Casbon AJ, Stull N, von Lohneysen K et al. (2006) Deletion mutagenesis of p22phox subunit of flavocytochrome b558: identification of regions critical for gp91phox maturation and NADPH oxidase activity. *The Journal of biological chemistry* 281(41): 30336-30346.

# Annexes et publications



# Annexe 1

## Liste de publications et communications scientifiques



## LISTE DES PUBLICATIONS

---

**Rousset F**, Nguyen MVC, Grange L, Hazane-Puch F, Talbot M, Morel F, Lardy B. IL-1 $\beta$  mediates MMP secretion and IL-1 $\beta$  neosynthesis via upregulation of p22<sup>phox</sup> and Nox4 activity in human articular chondrocytes. **(En preparation)**.

**Rousset F**, Lardy B, Grange L, Morel F. Differential impact of glucosamine sulphate and cuivramine on the IL-1 $\beta$  stimulated C-20/A4 chondrocyte cell line. **(En preparation)**.

**Rousset F**, Zhang L, Lardy B, Morel F, Nguyen MVC. Nox4 topology revealed by Topological Determination by Ubiquitin Fusion Assay, a novel method to uncover membrane protein topology **(Soumis)**.

**Rousset F**, Nguyen MVC, Grange L, Morel F, Lardy B **(2013)**. Heme oxygenase-1 regulates matrix metalloproteinase MMP-1 secretion and chondrocyte DNA fragmentation via Nox4 NADPH oxidase activity. *PLoS ONE* 8(6): e66478. doi:10.1371/journal.pone.0066478

Nguyen MVC, Lardy B, **Rousset F**, Hazane-Puch F, Zhang L, Trocmé C, Serrander L, Krause KH, Morel F **(2013)**. Quinone compounds regulate the level of ROS production by the NADPH oxidase Nox4. *Biochem Pharmacol.* 85(11):1644-54.

Zhang L, Nguyen MVC, Lardy B, Jesaitis AJ, Grichine A, **Rousset F**, Paclet MH, Qian GX, Morel F. **(2010)**. New insight into the Nox4 subcellular localization in HEK293 cells: First monoclonal antibodies against Nox4. *Biochimie.* 93: 457-468.

Frédéric MY, Clot F, Cif L, Blanchard A, Dürr A, Vuillaume I, Lesca G, Kreisler A, Davin C, Besnard T, **Rousset F**, Thorel D, Saquet C, Mechin D, Ozelius L, Agid Y, Barroso B, Chabrol B, Chan V, Clanet M, Coubes C, Destee A, Nguyen K, Vial C, Vidailhet M, Xie J, Sablonniere B, Calender A, Brice A, Roubertie A, Coubes P, Claustres M, Tuffery-Giraud S, Collod-Beroud G. **(2008)**. Is the early-onset torsion dystonia (EOTD) linked to TOR1A gene as frequent as expected in France? *Neurogenetics.* 9(2):143-50.

## COMMUNICATIONS ORALES

---

**Rousset F**, Hazane-Puch F, Nguyen MVC, Grange L, Pinosa C, Talbot M, Morel F, Lardy B. La NADPH oxidase Nox4, nouvelle cible thérapeutique dans l'arthrose. 7<sup>ème</sup> journée Jacques Courtin, Paris, 18 Novembre **2013**.

**Rousset F**, Nguyen MVC, Grange L, Hazane-Puch F, Talbot M, Morel F et Lardy B. La NADPH oxydase Nox4, nouvelle cible thérapeutique dans l'arthrose. 8<sup>ème</sup> Club Oxydase, Paris, 30- 31 Mai **2013**.



**Rousset F**, Nguyen MVC, Grange L, Morel F, Lardy B. La NADPH oxidase Nox4, nouvelle cible thérapeutique dans l'arthrose. 6<sup>ème</sup> journée Jacques Courtin, Paris, 22 Octobre **2012**.

**Rousset F**, Lardy B, Zhang L, Grange L, Grichine A, Morel F. La NADPH oxydase Nox4 dans l'arthrose, régulation par l'Hème Oxygénase-1, perspectives thérapeutiques. 7<sup>ème</sup> Club Oxydase, Grenoble, 26-27 Mai **2011**.

### **ABSTRACT / POSTER COMMUNICATIONS :**

---

**Rousset F**, Zhang L, Lardy B, Morel F, Nguyen MVC. Détermination topologique de la NADPH oxydase Nox4 par la méthode **ToDUFA** «**T**opological **D**etermination by **U**biqutin **F**usion **A**ssay». 8<sup>ème</sup> Club Oxydase, Paris, 30-31 Mai **2013**.

**Rousset F**, Lardy B, Zhang L, Grange L, Morel F. The Nox4 NADPH oxidase in cartilage homeostasis, regulation by heme oxygenase-1 and therapeutic perspectives. Redox and Inflammation signaling 2012. Luxembourg, 25-27 Janvier **2012**.

**Rousset F**, Lardy B, Grange L, Morel F. Differential impact of glucosamine sulphate and cuivramine on the IL-1 $\beta$  stimulated C-20/A4 chondrocyte cell line. International congress of Rheumatology OARSI 2012. Barcelona, 26-30 Avril **2012**.

**Rousset F**, Zhang L, Grange L, Morel F, Lardy B. Nox4 activity is induced by IL-1 $\beta$  in human chondrocytes. Effects on collagenase expression and chondrocyte apoptosis. Ernst Klenk Symposium Nox Family NADPH Oxidases as Therapeutic Targets, Cologne, 4-6 Novembre **2010**.

**Rousset F**, Lardy B, Zhang L, Grange L, Morel F. Stress oxydant et arthrose, stratégie d'inhibition de Nox4 dans les chondrocytes. Journées de la Recherche Médicale 2010, Grenoble, Mai **2010**.

**Rousset F**, Lardy B, Grange L, Heraud F, Kurkdjian E, Gouze JN, Trocme C, Juvin R, Gaudin P, Morel F. Effect of bovine chondroitin sulfate on IL-1 $\beta$  stimulated human chondrocyte C-20/A4 cell line. International congress of Rheumatology OARSI 2009, Montreal, 10-13 Septembre **2009**.

**Rousset F**, Lardy B, Grange L, Heraud F, Kurkdjian E, Gouze JN, Trocme C, Juvin R, Gaudin P, Morel F. Effect of bovine chondroitin sulfate on IL-1 $\beta$  stimulated human chondrocyte C-20/A4 cell line. European congress of Rheumatology EULAR 2009, Copenhagen, 10-13 Juin **2009**.

**Rousset F**, Lardy B, Zhang L, Grange L, Morel F. Effet du chondroïtine sulfate dans l'arthrose: Approche moléculaire, rôle de la NADPH oxydase Nox4. Journées de la Recherche Médicale 2009, Grenoble, Mai **2009**.

# Annexe 2

Article publié dans la newsletter de la  
fondation Arthritis Courtin

## EN DIRECT D'UN LABO

### › ARTHROSE ‹

# La NADPH OXYDASE 4, nouvelle cible thérapeutique dans l'arthrose ?

**Le GREPI est un laboratoire qui s'intéresse aux mécanismes du processus inflammatoire depuis de nombreuses années. Ce laboratoire créé par le Pr Françoise Morel est focalisé plus particulièrement sur l'étude de la famille des NADPH oxydase (Nox).**

Les Nox sont des enzymes qui produisent des dérivés réactifs de l'oxygène (ROS). Les ROS sont de petites molécules extrêmement réactives, capables de modifier les propriétés biochimiques des constituants de la cellule et de produire à fortes doses un stress oxydant. En outre, les ROS semblent jouer un rôle important dans certaines pathologies rhumatismales. En partenariat avec le service de rhumatologie du CHU de Grenoble, le groupe s'est focalisé sur l'impact des Nox autour de deux pathologies rhumatologiques majeures ; la polyarthrite rhumatoïde et l'arthrose. Francis Rousset, étudiant en thèse subventionné par la Fondation Arthritis, nous explique son projet de recherche.

#### L'arthrose : une maladie peu connue

L'arthrose est une affection rhumatologique chronique extrêmement fréquente touchant plus de 60% de la population âgée en France soit plus de 9 à 10 millions de patients. Compte tenu du vieillissement de la population et de l'augmentation de la prévalence de l'obésité, ce chiffre ne fera qu'augmenter dans les années à venir. Malgré l'importance de cette pathologie, les traitements médicamenteux actuellement

disponibles sont relativement peu efficaces, et ne s'attaquent qu'aux symptômes et non à la cause de l'arthrose. Ainsi, une connaissance plus approfondie des mécanismes physiopathologiques conduisant à la destruction du cartilage permettrait de proposer des thérapies innovantes et plus efficaces.

La médecine considère actuellement l'arthrose comme « la maladie du chondrocyte ». Le chondrocyte, est l'unique cellule présente au sein du cartilage articulaire. Dans des conditions physiologiques normales, cette cellule assure l'équilibre entre la synthèse des constituants de la matrice extracellulaire et l'activité protéolytique des métalloprotéases matricielles (MMP), qui dégradent cette matrice. Une sollicitation anormale du cartilage articulaire va entraîner la synthèse de médiateurs de l'inflammation tels que les ROS et l'Interleukine-1 $\beta$  (IL-1 $\beta$ ) par le chondrocyte, ce qui va déclencher le processus pathologique à l'origine de l'arthrose.

#### Nox4 : Acteur de la dégénérescence du cartilage

Au laboratoire, des résultats ont montré que l'expression de Nox4 dans des chondrocytes humains (C-20/A4) conduit à une synthèse accrue de MMP-1, une

métalloprotéase matricielle impliquée dans la protéolyse du collagène (Grange et al. 2006). Nox4 est également à l'origine du processus de mort cellulaire de cette lignée chondrocytaire en réponse à l'IL-1 $\beta$  (Rousset et al. 2013). L'activité non contenue des MMP et la mort des chondrocytes sont les deux principales causes conduisant à l'arthrose. Nous avons donc émis l'hypothèse que Nox4 pourrait être un acteur de la dégénérescence cartilagineuse (Figure 1).

Le projet de thèse de Francis Rousset, financé par la Fondation Arthritis, a donc deux objectifs principaux : Premièrement, de valider le rôle de Nox4 dans les chondrocytes primaires directement issus de patients. Deuxièmement, de développer des stratégies pour inhiber l'activité de Nox4 dans les chondrocytes.

Pour tenter d'inhiber l'activité de Nox4, Francis Rousset s'est intéressé à l'Hème Oxygénase-1 (HO-1). HO-1 est l'enzyme permettant la dégradation de l'hème ; une molécule indispensable à l'activité catalytique de Nox4. De façon intéressante, le contrôle de l'activité de Nox4 par HO-1 conduit à une diminution significative de l'expression de la collagénase MMP-1 et de l'apoptose des chondrocytes C-20/A4 stimulés par IL-1 $\beta$ . Ces résultats décrivent un nouveau

60 000 €

Grâce à vos dons,  
la Fondation Arthritis  
finance le travail  
de thèse de cet  
étudiant pendant  
deux ans.



www.fondation-arthritis.org  
ACTUALITÉS RECHERCHE

## L'équipe

**Unité :** Laboratoire AGIM, GREPI, Université Joseph Fourier, FRE3405 CNRS-EPHE, Grenoble, France.

**Equipe :** Groupe de Recherche et d'Etude du Processus Inflammatoire (GREPI), équipe « phox-nox » (Phagocyte oxydase - NADPH oxydase).

**Composition de l'équipe :** Le groupe « phox nox » est dirigé par le Professeur Françoise Morel. Bernard Lardy est tuteur scientifique du projet. Laurent Grange est correspondant clinicien. Francis Rousset effectue sa thèse sur Nox4 dans l'arthrose, financée par la Fondation Arthritis.

**De gauche à droite :** Chuong Nguyen (post doctorant), Kathy Koy (Interne, Doctorante), Alhan Baillet (AUH), Françoise Morel (Professeur émérite), Marc André Hograindleur (étudiant EPHE), Sylvie Berthier (Ingénieur), Francis Rousset (Doctorant), Marie-Hélène Paclet (MCU PH) et Bernard Lardy (MCU PH).

**Thématique :** Etude des NADPH oxydase 2 et 4 dans la polyarthrite rhumatoïde et l'arthrose.



mode de régulation possible de l'activité de Nox4 par la protéine HO-1.

Aucune étude n'a encore permis d'identifier les Nox exprimées par les chondrocytes directement issus de patients. A l'aide d'une collaboration avec le service d'orthopédie du CHU de Grenoble qui fournit les prélèvements biologiques, les chondrocytes ont été isolés et cultivés à partir de têtes fémorales humaines. Confortant les données obtenues sur les lignées cellulaires, les résultats préliminaires du laboratoire ont montré que Nox4 est la seule isoforme des NADPH oxydases exprimée dans ces chondrocytes.

La production de ROS stimulée par l'IL-1 $\beta$  est sensible aux antioxydants mais également aux inhibiteurs des NADPH oxydases et en particulier de Nox4. De plus, l'induction de l'expression de HO-1 dans les chondrocytes primaires entraîne une diminution très significative de l'activité de Nox4 et de la synthèse des MMP1 et 13, deux des principales MMP impliquées dans l'arthrose. En fait, ces résultats ont démontré que l'activité de Nox4 conduit aussi à la néosynthèse de l'IL-1 $\beta$  par les chondrocytes primaires et par conséquent à l'emballement des voies de signalisation concourant à la dégradation du cartilage (figure 1).

De manière à confirmer l'implication de Nox4 dans cette pathologie, un projet de recherche clinique (ARTHRO-NOX) a été récemment initié par le laboratoire, en collaboration avec les services de rhumatologie, d'orthopédie et d'anatomopathologie du CHU de Grenoble. Ce projet vise à mesurer l'expression et l'activité de Nox4 dans les chondrocytes prélevés sur du cartilage sain et de les comparer au chondrocytes arthrosiques. L'approche sera validée à l'aide d'un modèle murin dont le gène codant pour Nox4 a été supprimé (collaboration avec le laboratoire du Pr. Krause, à l'université de Genève).

En conclusion, les résultats directement obtenus à partir du cartilage humain confortent l'hypothèse selon laquelle Nox4 serait une cible thérapeutique dans l'arthrose. La confirmation in vivo de cette hypothèse permettra d'envisager de nouveaux traitements. L'identification de nouveaux partenaires contrôlant l'activité de Nox4, tels que l'hème oxygénase-1, ou encore le développement d'inhibiteurs de Nox4 pourrait ainsi ouvrir de nouvelles stratégies thérapeutiques dans cette pathologie à incidence élevée

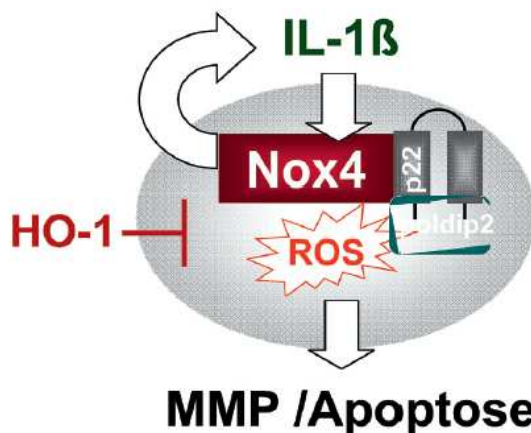

**Figure 1 :** Nox4 fonctionne en association avec p22 et Poldip2. Dans notre modèle, l'IL-1 $\beta$  stimule la production de ROS par Nox4. L'activité de Nox4 conduit également à une synthèse de novo de l'IL-1 $\beta$  par les chondrocytes. Nox4 serait donc le pivot central de voies de signalisation médiatrices de la dégénérescence cartilagineuse. Ces voies sont réprimées par les inhibiteurs de l'activité de Nox4.

**Références bibliographiques :** Grange L, Nguyen MV, Lardy B, Derouazi M, Campion Y et al. (2006) NAD(P)H oxidase activity of Nox4 in chondrocytes is both inducible and involved in collagenase expression. Antioxidants & redox signaling 8(9-10): 1485-1496.

Rousset F, Nguyen MV, Grange L, Morel F, Lardy B (2013) Heme Oxygenase-1 Regulates Matrix Metalloproteinase MMP-1 Secretion and Chondrocyte Cell Death via Nox4 NADPH Oxidase Activity in Chondrocytes. PloS one 8(6): e66478.



# Annexe 3

Article 4 : Quinone compounds  
regulate the level of ROS  
production by the NADPH oxidase  
Nox4





Contents lists available at SciVerse ScienceDirect

## Biochemical Pharmacology

journal homepage: [www.elsevier.com/locate/biochempharm](http://www.elsevier.com/locate/biochempharm)

## Quinone compounds regulate the level of ROS production by the NADPH oxidase Nox4



Minh Vu Chuong Nguyen<sup>a,1,\*</sup>, Bernard Lardy<sup>a,d,1</sup>, Francis Rousset<sup>a</sup>,  
 Florence Hazane-Puch<sup>e</sup>, Leilei Zhang<sup>a</sup>, Candice Trocmé<sup>d</sup>, Lena Serrander<sup>b</sup>,  
 Karl-Heinz Krause<sup>c</sup>, Françoise Morel<sup>a</sup>

<sup>a</sup> Université Joseph Fourier, GREPI AGIM FRE 3405, CNRS, EPHE, Grenoble, France

<sup>b</sup> Department of Clinical Microbiology, University Hospital, Linköping, Sweden

<sup>c</sup> Department of Pathology and Immunology, Medical Faculty and University Hospital, Geneva, Switzerland

<sup>d</sup> Laboratoire de Biochimie Enzyme et Protéine-DBTP, Institut de Biologie et de Pathologie, University Hospital CHU-Grenoble, Grenoble, France

<sup>e</sup> Laboratoire de Biochimie Hormonale et Nutritionnelle-DBTP, Institut de Biologie et de Pathologie, University Hospital CHU-Grenoble, Grenoble, France

## ARTICLE INFO

## Article history:

Received 3 February 2013

Accepted 29 March 2013

Available online 9 April 2013

## Keywords:

NADPH oxidase Nox4

NAD(P)H:quinone oxidoreductase NQO1

Quinones

Redox regulation of Nox

Reactive oxygen species (ROS)

## ABSTRACT

NADPH oxidase Nox4 is expressed in a wide range of tissues and plays a role in cellular signaling by providing reactive oxygen species (ROS) as intracellular messengers. Nox4 oxidase activity is thought to be constitutive and regulated at the transcriptional level; however, we challenge this point of view and suggest that specific quinone derivatives could modulate this activity. In fact, we demonstrated a significant stimulation of Nox4 activity by 4 quinone derivatives (AA-861, tBuBHQ, tBuBQ, and duroquinone) observed in 3 different cellular models, HEK293E, T-REX<sup>TM</sup>, and chondrocyte cell lines. Our results indicate that the effect is specific toward Nox4 versus Nox2. Furthermore, we showed that NAD(P)H:quinone oxidoreductase (NQO1) may participate in this stimulation. Interestingly, Nox4 activity is also stimulated by reducing agents that possibly act by reducing the disulfide bridge (Cys226, Cys270) located in the extracellular E-loop of Nox4. Such model of Nox4 activity regulation could provide new insight into the understanding of the molecular mechanism of the electron transfer through the enzyme, *i.e.*, its potential redox regulation, and could also define new therapeutic targets in diseases in which quinones and Nox4 are implicated.

© 2013 Elsevier Inc. All rights reserved.

### 1. Introduction

Quinone derivative compounds induce a broad spectrum of effects in humans and represent a class of toxicological intermediates, which may induce acute cytotoxicity, immunotoxicity,

and carcinogenesis, and lead to cellular damage [1]. They can be formed from benzene or polycyclic aromatic hydrocarbons and are toxicologically important components of air pollution [2] and cigarette smoke [3]. Among the enzymes that modulate quinone toxicity, the NAD(P)H quinone oxidoreductase type 1 (NQO1; EC 1.6.99.2) is one of the most important enzymes. NQO1 is a homodimeric flavoenzyme that catalyses the obligatory two-electron reduction of quinones to hydroquinones [4]. NQO1 activity can protect animal cells from the deleterious and carcinogenic effects of quinones by preventing the one-electron reduction of quinones by other reductases; however, prolonged exposure to environmental contamination, which contains quinones, damages pulmonary tissue and leads to airway inflammation and pathologies through an oxidative stress mechanism [5,6]. NQO1 is mainly cytosolic but it has been described to be expressed at plasma membrane [7]. Semiquinone radicals of inhaled airborne particulate matter are believed to cause oxidative stress by generating reactive oxygen species (ROS), as reported in the lung [8]. Furthermore, diesel exhaust particles composed of polycyclic

**Abbreviations:** AA-861, 2-(12-hydroxydodeca-5,10-dienyl)-3,5,6-trimethyl-*p*-benzoquinone; BQ, benzoquinone; CGD, chronic granulomatous disease; CHX, cycloheximide; DPI, diphenyliodonium; Duroquinone, 2,3,5,6-tetramethyl-1,4-benzoquinone; HQ, hydroquinone; tMetBQ, 2,5-dimethyl-1,4-benzoquinone; LDH, lactate dehydrogenase; 5-LO, 5-lipoxygenase; NQO1, NAD(P)H:quinone oxidoreductase 1; PMA, phorbol 12-myristate 13-acetate; PMN, polymorphonuclear cells; RLU, relative light unit; ROS, reactive oxygen species; tBuBHQ, 2,5-di-tert-butyl-1,4-benzo-hydroquinone; and tBuBQ, 2,5-di-tert-butyl-1,4-benzoquinone.

\* Corresponding author at: GREPI AGIM FRE 3405, CNRS, Université Joseph Fourier, EPHE, CHU Albert Michallon, BP217, 38043 Grenoble, France.

Tel.: +33 4 76 76 57 52; fax: +33 4 76 76 62 51.

E-mail address: [mvchuong@yahoo.fr](mailto:mvchuong@yahoo.fr) (M.V.C. Nguyen).

<sup>1</sup> Equal contributors.

0006-2952/\$ – see front matter © 2013 Elsevier Inc. All rights reserved.  
<http://dx.doi.org/10.1016/j.bcp.2013.03.023>



aromatic hydrocarbons and quinones are involved in a cellular ROS production associated with lung function impairment via a Nox4 redox-dependent mechanism [9].

Nox4 belongs to the NADPH oxidase family that contains 7 members [10–12]. The function of those enzymes is exclusively dedicated to the production of ROS, which are essential signaling molecules. Primary discovered in kidney tissue [13], Nox4 appears to be ubiquitously distributed. Its dysfunction has been linked to several pathologies including hypertension [14], diabetes [15], atherosclerosis [16], cancer [17], osteoarthritis [18] and inflammation [19], and Nox4 represent a potential therapeutic target [20]. Despite its wide distribution, its activation mechanisms at the molecular level are unclear. It is of therapeutic interest to elucidate the mechanism of Nox4 NADPH oxidase activity. While activity of Nox1, Nox2, and Nox3 largely depends on the presence of cytosolic activator or organizer subunits, no well-known NADPH oxidase partners, beside p22<sup>phox</sup>, have been identified or shown to activate Nox4 [21–23]. However, two partners of Nox4 have been described recently: the protein disulfide isomerase (PDI) and the polymerase DNA directed-delta-interacting protein (Poldip2). Nox4 is unique among other Nox isoenzymes in that its activity is constitutive and may depend on a specific conformation of the dehydrogenase DH domain that should allow a spontaneous transfer of electrons from NADPH to FAD and to the hemes [24,25]. Data from various studies indicated clearly that Nox4 activity is regulated at the mRNA level, implying that an increase or decrease of ROS production by Nox4 is correlated to an up regulation [9,16,26–33] or to a decline [34] of Nox4 transcripts. Although it has not been reported yet, post-translational regulation of Nox4 oxidase activity cannot be excluded.

In this study, we provide the first evidence that Nox4 activity can be modulated independently of both transcriptional and translational processes. We showed a dual effect of quinone compounds, as being activators or inhibitors of Nox4 ROS production depending on their redox potential (*E*). We suggest that quinones derivatives could modulate Nox4 activity by a redox regulation pathway. Moreover, NQO1 is introduced as an intermediate between quinones and Nox4 activation, suggesting a functional interaction between Nox4 and NQO1. The results argue in favor of a modulation of Nox4 activity by a new family of chemical compounds and suggest a potential role of Nox4 in pathologies implying quinone toxicity.

## 2. Materials and methods

### 2.1. Materials

Polyclonal antibody against 5-lipoxygenase (5-LO) (Cayman, Ann Arbor, USA) was a generous gift from F. Stanke (Grenoble, France). pEF6V5/HisB vector, penicillin, streptomycin, L-glutamine, Dulbecco's modified Eagle's medium (DMEM), fetal bovine serum (FBS), trypsin, Earle's balanced salts (EBSS), geneticin, Fluo-3/AM, BAPTA/AM, and TRIzol<sup>®</sup> were purchased from Invitrogen (Cergy Pontoise, France). Blasticidin was from Funakoshi Co. (Japan); AMV reverse transcriptase was from QBiogene (Illkirch, France). Effectene transfection reagent was from Qiagen (Courtaboeuf, France). Luminol, ionomycin, horseradish peroxidase, thapsigargin, diphenyleneiodonium chloride (DPI), rotenone, N $\omega$ -nitro-L-arginine methyl ester hydrochloride (L-NAME), tiron, xanthine, benzoquinone (BQ), hydroquinone (HQ), 2,5-dimethyl-1,4-benzoquinone (tMetBQ), duroquinone, 2,5-di-tert-butyl-1,4-benzo-hydroquinone (tBuBHQ), 2,5-di-tert-butyl-1,4-benzoquinone (tBuBQ), 2-(12-hydroxydodeca-5,10-diynil)-3,5,6-trimethyl-p-benzoquinone (AA-861), 3,3'-methylene-bis-4-hydroxycoumarin (Dicoumarol), cycloheximide (CHX) compounds were purchased from Sigma (Saint Quentin Fallavier, France).  $\beta$ -Mercaptoethanol was purchased from

Carlo Erba (Val de Reuil, France). LightCycler FastStart DNA Master plus SYBR Green I kit, protease inhibitors cocktail tablet, tosyllysine-chloromethyl ketone (TLCK), NADPH, NADH, xanthine oxidase, and lactate dehydrogenase (LDH) optimized kits were purchased from Roche (Meylan, France). Leupeptin, pepstatin, and ECL reagents were from GE Healthcare (Orsay, France). UNI-ZAP human kidney lambda cDNA library was purchased from Stratagene (La Jolla, CA). Housekeeping gene GAPDH was purchased from BD Bioscience (Pont de Claix, France). SuperScriptIII first-strand synthesis was obtained from Life Technologies (Saint Aubin, France).

### 2.2. Cell culture

Nox4 T-REx<sup>TM</sup> cells were a generous gift from K.H. Krause (Department of Pathology and Immunology, Genève, Suisse) and were generated from HEK293 cell (Invitrogen). The HEK293E cell line was purchased from Invitrogen (Cergy Pontoise, France). PLB-985 human myeloid cell lines (wild type PLB-985 WT) or knock out for Nox2 (PLB-985 KO-Nox2) were a generous gift from M. Dinanuer (Department of Pediatrics, St. Louis, USA). PLB-985 cells were cultured at 37 °C under a 5% CO<sub>2</sub> atmosphere in RPMI 1640 medium containing 2 mM L-glutamine supplemented with 10% fetal bovine serum and with 1% penicillin/streptomycin. The HEK293E cell line was maintained in DMEM supplemented with 10% (v/v) fetal bovine serum (FBS), 100 units/mL penicillin, 100  $\mu$ g/mL streptomycin, 2 mM L-glutamine at 37 °C in a 5% CO<sub>2</sub> humidified atmosphere. Five  $\mu$ g/mL Blasticidin was added to the culture medium of cells transfected with the mammalian expression plasmid pEF6V5/HisB.

The T-REx<sup>TM</sup> system was used for Tetracycline-inducible expression of the genes of interest. T-REx<sup>TM</sup> cells stably expressing Tet repressor were selected by 5  $\mu$ g/mL Blasticidin and maintained in DMEM supplemented with 10% (v/v) FBS, 2 mM L-glutamine at 37 °C in a 5% CO<sub>2</sub> humidified atmosphere. T-REx<sup>TM</sup> Nox4 cells as compared to T-REx<sup>TM</sup> WT are able to induce Nox4 expression. Both cells were selected with 5  $\mu$ g/mL blasticidin and 400  $\mu$ g/mL G418. Nox4 expression was induced by the addition of 1  $\mu$ g/mL tetracycline in the culture medium. Experiments were performed after the incubation at set times.

### 2.3. Isolation of human neutrophils

As previously reported [35], human neutrophils were isolated from citrated venous blood of healthy volunteers. Blood samples were diluted twice in PBS (137 mM NaCl, 2.7 mM KCl, 1.5 mM KH<sub>2</sub>PO<sub>4</sub>, 8 mM Na<sub>2</sub>HPO<sub>4</sub> pH 7.3) containing 1% (w/v) tri-sodium citrate, using a 33% (v/v) Hypaque-Ficoll gradient. After 20 min of centrifugation at 800  $\times$  g at 20 °C, the pellet was submitted to a hypotonic lysis for 5–15 min in ice. After 5 min of centrifugation at 350  $\times$  g at 4 °C, the neutrophil pellet was collected and washed once in PBS. Neutrophils were suspended in PBS containing 0.2% (w/v) BSA and 0.5 mM CaCl<sub>2</sub> at a concentration of 10<sup>7</sup> cells/mL and used for superoxide measurement by chemiluminescence and protein extraction.

### 2.4. Generation of plasmid constructs for Nox4 and NQO1 isoforms expression

Two Nox4 cDNAs were characterized by PCR using UNI-ZAP human kidney lambda cDNA library (Stratagene) as template. Nox4A corresponds to the full length Nox4 usually described (Genbank<sup>TM</sup> accession number: AF254621), and Nox4B is the 14 spliced exon isoform (Genbank<sup>TM</sup> accession number: AY288918). Two NQO1 cDNAs were characterized by RT-PCR from mRNA extracts of Nox4 T-REx<sup>TM</sup> cells, NQO1A (no. access NP\_000894.1) and NQO1C (no. access NP\_001020605.1). Nox4A, Nox4B, NQO1A,

and NQO1C were cloned into pEF6V5/HisB for mammalian expression as described [18].

### 2.5. Stable transfection of mammalian expression plasmids

HEK293E cells were trypsinized and counted;  $4 \times 10^5$  HEK293E cells were seeded in 6-well plates and allowed to grow for 24 h to reach a 60% confluence in 2 mL of culture medium. Cells were transfected with 0.4  $\mu$ g of vectors containing Nox4A or Nox4B according to the manufacturing protocol (Effectene transfection reagent, Qiagen). After 24 h of culture, stable transfected cells were selected by 5  $\mu$ g/mL blasticidin for 3 weeks before analysis.

### 2.6. Real time RT-PCR

Total RNA was extracted using a TRIzol<sup>®</sup> reagent kit or RNeasy Mini Kit (Qiagen) according to the manufacturer's instructions. Total RNA was treated with RNase-free DNase I (Qiagen). One or 5  $\mu$ g of RNA were converted to cDNA by reverse transcription with 20 U of AMV reverse transcriptase or SuperScriptIII first-strand synthesis (Life Technologies). Real time PCRs were performed with the LightCycler FastStart DNA Master plus SYBR Green I kit (Roche) or QuantiTect SYBR Green RT-PCR kit (Qiagen) as described [18]. Real time RT-PCR was conducted using the LightCycler<sup>®</sup> Carousel-Based System (Roche) or a Stratagene Mx3005P (Stratagene). Briefly, the expression levels of human Nox4, NQO1 and housekeeping GAPDH, RPL27 and RPL32 mRNAs were determined using specific primers chosen to include intron spanning (Table 1). PCRs were carried out for each sample in triplicate. Gene expression was quantified using the comparative threshold cycle (Ct) method. The amount of target gene, normalized to three endogenous reference genes (RPL27, RPL32 and GAPDH) was expressed relative to the control cells, as indicated in Figures. The specificity of the products was confirmed for each fragment by a melting curve analysis and gel electrophoresis.

### 2.7. Protein extraction

Two methods were used. First, HEK293E cells were harvested and lysed on ice in 1% (p/v) Triton X-100 buffer (20 mM Tris-HCl,

150 mM NaCl, 1 mM EDTA, pH 7.6), containing a protease inhibitor cocktail containing 2  $\mu$ M leupeptin, 2  $\mu$ M pepstatin, and 10  $\mu$ M TLCK I, for 20 min at 4 °C. The lysate was then centrifuged at  $10,000 \times g$  for 10 min at 4 °C and supernatant was used for Western blotting experiments. Second, human neutrophils were suspended at a concentration of  $5 \times 10^8$  cells/mL in PBS containing the protease inhibitor cocktail. The cells were sonicated for  $3 \times 10$  s at 4 °C and 40 W using a Branson sonifier. The homogenate was centrifuged at  $1000 \times g$  for 15 min at 4 °C to remove unbroken cells and nuclei. The post-nuclear supernatant was centrifuged at  $200,000 \times g$  for 1 h at 4 °C. The pellet consisting of crude membranes was suspended in the same buffer.

### 2.8. SDS-PAGE and Western blot

The Triton X-100 soluble extract, membrane or cytosol fractions were loaded on a 7% or 10% SDS-PAGE and electro-transferred to nitrocellulose, as previously described. Immunodetection was performed using primary polyclonal antibodies against 5-lipoxygenase (dilution 1:2000) following by a secondary antibody combined with horseradish peroxidase. The bound peroxidase activity was measured using ECL reagents.

### 2.9. Determination of ROS production by chemiluminescence

ROS production was measured as previously described [18]. Cells were washed twice with PBS, detached with trypsin, and collected by centrifugation (250 g, 5 min at 20 °C). The cell viability was superior to 90%, as determined by the trypan blue exclusion method. For measurement of Nox4 activity that is constitutive,  $5 \times 10^5$  living cells per well (96-well plate) were resuspended in 250  $\mu$ l of PBS containing 20  $\mu$ M luminol and 10 U/mL horseradish peroxidase. The phagocyte oxidase (Nox2) activity was initiated by 0.13  $\mu$ M PMA or by 0.15  $\mu$ M fMLP in medium containing 0.9 mM CaCl<sub>2</sub>, 0.5 mM MgCl<sub>2</sub>, and 20 mM glucose. Relative luminescence unit (RLU) counts were recorded every minute for a total of 60 min using a Luminoscan<sup>®</sup> luminometer (Labsystems, Helsinki, Finland). In some experiments, chemical compounds (quinones) were added just before luminescence measurement (Nox4) or before the addition of

**Table 1**  
Primers used in this study for RT-PCR experiments. tot, total and exo, exogenous.

Name	Primers (5'...3')	Gene	TM
<b>Real time RT-PCR</b>			
Nox4 Forward	CTGAATGCAGCAAGATACCGAGAT	Nox4	66 °C
Nox4 Reverse	CTGGCTTATTGCTCCGGA	Nox4	66 °C
NQO1 Forward a	GAAGAGCACTGATCGTACTGGC	NQO1 tot	60 °C
NQO1 Reverse a	GGATACTGAAAGTTCGCAGGG	NQO1 tot	60 °C
NQO1 Forward b	GCAAGTCCATCCCAACTGACA	NQO1 exo	60 °C
NQO1 Reverse b	CTAGAAGGCACAGTCGAGGC	NQO1 exo	60 °C
RPL27 Forward	TGATGGCACTCAGATCCG	RPL27	60 °C
RPL27 Reverse	AGAGTACCTTGTGGGCATTAGG	RPL27	60 °C
RPL32 Forward	TAAAGCGTAACTGGCGGAAAC	RPL32	60 °C
RPL32 Reverse	GAGCGATCTCGGCACAGTAA	RPL32	60 °C
GAPDH Forward a	CATGAGAAGTATGACAACAGCCT	GAPDH	60 °C
GAPDH Reverse a	AGTCTTCCACGATACCAAAGT	GAPDH	60 °C
GAPDH Forward b	GTTGGTGGACCTGACCTGC	GAPDH	70 °C
GAPDH Reverse b	CCCTGTTGCTGTAGCCAAATTCG	GAPDH	70 °C
<b>Semi-quantitative RT-PCR</b>			
GAPDH Forward	BD Bioscience	GAPDH	55 °C
GAPDH Reverse	BD Bioscience	GAPDH	55 °C
Actin Forward	Clontech	Actin	55 °C
Actin Reverse	Clontech	Actin	55 °C
NQO1 Forward	GTTGGTACCATGGTCGGCAGAAGAGC	NQO1	55 °C
NQO1 Reverse	GTACTAGTTCATTTCTAGCTTTGATCTGG	NQO1	55 °C
5-LO Forward	CAAATGCCACAAGGATTTACCCCG	5-Lipoxygenase	55 °C
5-LO Reverse	CGTATTTTCATCCGAAGGGAGGA	5-Lipoxygenase	55 °C

stimulating agents (Nox2). For the xanthine-xanthine oxidase assay, ROS production was measured as previously in a medium containing luminol and horse radish peroxidase plus 1 mM Xanthine and 0.75 mUI Xanthine oxidase in the presence or not of quinones.

### 2.10. Intracellular free $Ca^{2+}$ measurement

Intracellular free  $Ca^{2+}$  levels were measured by flow cytometry (FACSCalibur, Becton Dickinson cytometer) using Fluo-3/AM. The fluorescence intensity of Fluo-3/AM dye was detected in the gated cell population at 526 nm (FL1 channel), which is proportional to the intracellular free calcium level. Cells were harvested and then counted.  $10^7$  cells/mL, suspended in Tyrode's «free» buffer (10 mM HEPES, 145 mM NaCl, 2.5 mM KCl, 10 mM glucose, 1.2 mM  $MgCl_2$ , pH 7.3) were incubated in a light free environment with 10  $\mu$ M of Fluo-3/AM for 30 min at 37 °C before analysis. After washing cells with the Tyrode's «free» buffer containing 1.5 mM  $CaCl_2$  or 1 mM EGTA, basal fluorescence was measured at 526 nm for 1 min. Chemical compounds were added to the tubes containing  $5 \times 10^6$  cells per 500  $\mu$ l, and measurement was continued for 5 more minutes. The data analysis was performed as follow: gates (5 s) were created along the time axis of the dot plots windows at defined time points, and the mean fluorescence intensity was statistically analyzed for every gate (WinMDI 2.8 software).

### 2.11. Lactate dehydrogenase (LDH) activity measurement

The activity of LDH was measured in the incubation medium as an index of plasma membrane integrity. Cells were washed twice with PBS, detached with trypsin, collected by centrifugation (250 g, 5 min at 20 °C), and counted. In a 96-well plate,  $5 \times 10^5$  cells per well were resuspended in 250  $\mu$ l of PBS. Cells were incubated with quinone compounds at different concentrations for 60 min. At the end of the treatment period, supernatants were collected and assessed for LDH activity on a Hitachi/MODULAR automated analyzer using the Roche optimized kit. The cell viability was expressed as the percentage of LDH released into the incubation medium versus total cell activity measured after cell lysis with 1% (v/v) Triton-X 100.

### 2.12. Statistical analysis

Data were expressed as the mean  $\pm$  SD. Statistical analysis was performed using Mann and Whitney or Kruskal and Wallis tests. The results are reported when significantly different ( $p < 0.05$ ) from control.

## 3. Results

### 3.1. Overexpression of Nox4 in HEK293E cell line and constitutive NADPH oxidase activity

Nox4 was identified for the first time in tubular cells of adult kidney and its oxidase activity was shown to be constitutive [13]. We, therefore, performed the functional characterization of Nox4 in HEK293E (human embryonic kidney) cell line which expresses Nox4 mRNA but not Nox1 and Nox2, (unpublished data). The oxidase activity of these cells was very low and was not sensitive to PMA (unpublished data). We stably overexpressed two isoforms of Nox4, Nox4A the active isoform (Genbank™ accession number: AF254621), and a splicing variant Nox4B (Genbank™ accession number: AY288918) that is unable to produce ROS due to the absence of one NADPH binding sites [36]. The results showed a significant increase of mRNA expression encoding both Nox4 isoforms compared to WT cells (Fig. 1A). While the overexpression of Nox4B failed to produce ROS, Nox4A demonstrated a spontaneous ROS generation compared to WT-HEK293E cells (Fig. 1B) and that corresponded to a NADPH oxidase activity since it was solely inhibited by DPI (inhibitor of flavoproteins) and Tiron (superoxide scavenger) but not by rotenone (mitochondrial respiratory chain inhibitor) and L-NAME (competitive inhibitor of NO synthase) (Fig. 1C).

### 3.2. Stimulation of Nox4 activity by two quinone derivatives

Next, we evaluated the effect of two quinone compounds, AA-861 and tBuBHQ on Nox4 constitutive activity. Incubation of Nox4A-HEK293E cells with AA-861 or tBuBHQ led to an increase of ROS production (Fig. 2A). The stimulated activity reached its optimum level at 10 min or 20 min after AA-861 or tBuBHQ incubation respectively. The incubation with WT-HEK293E cells did not lead to a high level of ROS production. In fact, only small increase of ROS was observed reflecting the stimulation of the endogenous Nox4 by those two quinones (Fig. 2A, inset). The specificity of a NADPH oxidase activity was confirmed by using DPI which had an inhibitory effect whereas rotenone and L-NAME did not (Fig. 2A).

To confirm that the observed effect of AA-861 and tBuBHQ was specifically related to Nox4 proteins, we used two other characterized cell lines that over-expressed Nox4: human chondrocyte C-20/A4 [18] and Nox4 T-REx™ in which Nox4 expression could be temporally induced by the addition of tetracycline [27]. Consistently, the constitutive ROS production in Nox4 C-20/A4 cells or in 4 h-induced Nox4 T-REx cells was enhanced after the addition of AA-861 or tBuBHQ (Fig. 2B and C). It is noticeable that

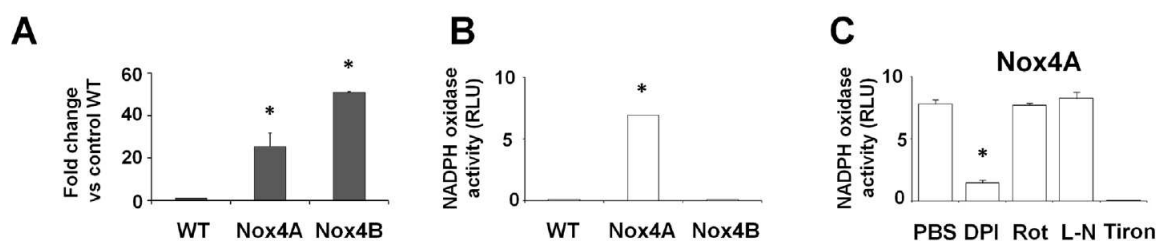

**Fig. 1.** Characterization of Nox4 expression and constitutive activity in HEK293E transfected cells. (A) Real-time RT-PCR analysis of Nox4 mRNA. Total RNA was extracted from non-transfected WT-, Nox4A-, or Nox4B-HEK293E transfected cells. (B) Measurement of constitutive ROS production by HEK293E cells. The ROS production was measured by chemiluminescence on  $5 \times 10^5$  intact WT-, Nox4A-, or Nox4B-HEK293E transfected cells. (C) The specificity of constitutive NADPH oxidase activity of HEK293E cells overexpressing Nox4A was confirmed by using several inhibitors: DPI (10  $\mu$ M), rotenone (Rot, 1  $\mu$ M), L-NAME (L-N, 100  $\mu$ M), tiron (0.5 mM). Results are expressed as the sum of RLU measurements for 90 min. Values represent the mean  $\pm$  SD of triplicate determinations of at least 3 independent experiments, \* $p < 0.05$  versus cells without transfection (A and B), or cells without inhibitors (C).

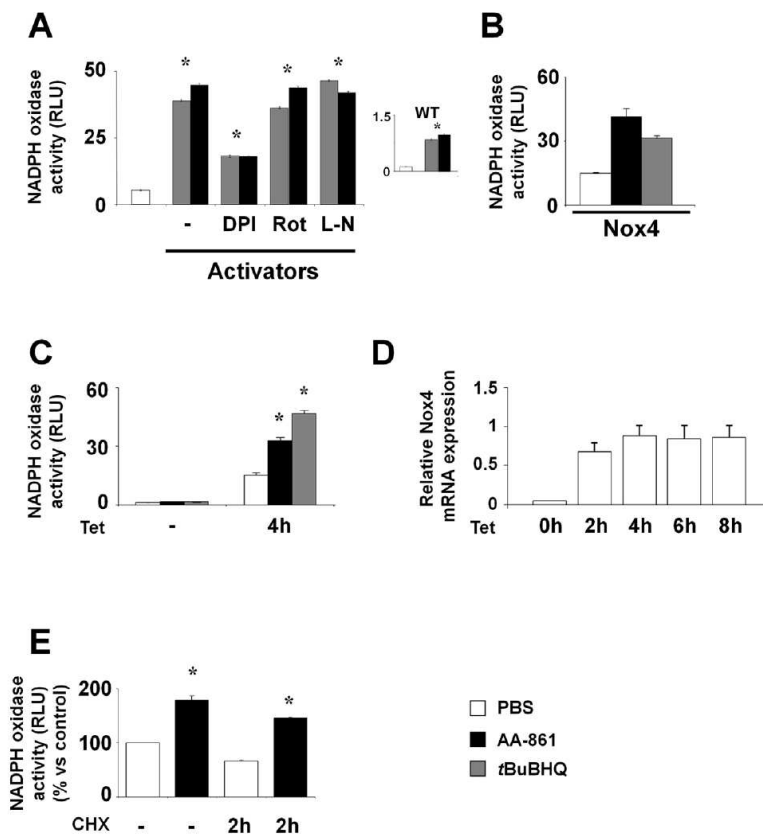

**Fig. 2.** AA-861 and tBuBHQ stimulate ROS production by Nox4A-HEK293E cells and two other cellular models. (A) Stimulation of ROS generation by the endogenous Nox4 (inset) in WT-HEK293E cells or Nox4A-HEK293E cells with 50  $\mu$ M tBuBHQ or 10  $\mu$ M AA-861. The ROS production was measured by chemiluminescence on  $5 \times 10^5$  intact cells and results are expressed as the sum of RLU measurements for 90 min. The specificity of NADPH oxidase activity stimulation by tBuBHQ or AA-861 was demonstrated by using several inhibitors: DPI (10  $\mu$ M); rotenone (Rot, 1  $\mu$ M) and L-NAME (L-N, 100  $\mu$ M). Values represent the mean  $\pm$  SD of triplicate determinations of at least 3 independent experiments, \* $p < 0.05$  versus cells without activators. ROS production by human chondrocyte cell line C-20/A4 (B) or Nox4 T-REx<sup>TM</sup> cells (C) [27] induced 4 h or not with 1 mg/mL tetracycline (tet-induced) was measured after the addition or not of 10  $\mu$ M AA-861 or 50  $\mu$ M tBuBHQ. Results are expressed as the sum of RLU measurements for 90 min for each condition. Values represent the mean  $\pm$  SD of triplicate determinations and are representative of at least 3 independent experiments, \* $p < 0.05$  versus cells without activators. (D) Real-time RT-PCR analysis of Nox4 mRNA time course expression. Total RNA was extracted from Nox4 T-REx<sup>TM</sup> exposed to tetracycline from 0 to 8 h. (E) In order to stop *de novo* protein translation, tet-induced Nox4 T-REx<sup>TM</sup> cells were treated with cycloheximide (CHX). After 2 h of tetracycline induction, tet-induced Nox4 T-REx<sup>TM</sup> cells were incubated with CHX (100  $\mu$ g/mL) or not for 2 more hours and then ROS measurements by chemiluminescence of  $5 \times 10^5$  intact cells was performed. Results are expressed as the sum of RLU measurements for 90 min and are shown as percentage of ROS produced by Nox4 T-REx<sup>TM</sup> cells after 4 h of tet-induction without CHX treatment. Values represent the mean  $\pm$  SD of triplicate determinations of at least 3 independent experiments, \* $p < 0.05$  versus cells without AA-861 in same conditions.

the ROS production of uninduced T-REx<sup>TM</sup> cells, which do not express Nox4, was not affected by AA-861 or by tBuBHQ indicating that those two quinones do not produce ROS spontaneously in the presence of cells (Fig. 2C). Considering the short time course of AA-861 and tBuBHQ stimulation, it is unlikely that the augmentation of Nox4 activity observed was correlated to an increase of its protein expression. However, to rule out this eventuality, we inhibited Nox4 protein synthesis by using cycloheximide (CHX), an inhibitor of protein translation. The time course of the Nox4 mRNA expression induced by tetracycline indicated that the maximum level was reached at 4 h and then remained constant until 8 h (Fig. 2D). After 2 h of Nox4 induction by tetracycline, time point when the Nox4 mRNA synthesis is still increasing, CHX was added in the medium of Nox4 T-REx<sup>TM</sup> cell line and oxidase activity was measured after two additional hours of incubation. As expected, CHX-treated cells exhibited a lower constitutive oxidase activity (66%), indicating a lower amount of induced Nox4 proteins, compared to non-CHX-treated cells (Fig. 2E, white bars). Although an increase of Nox4 protein was abolished under CHX treatment, Nox4 activity was still stimulated by AA-861 incubation (Fig. 2E, black bars compared to white). These results support our above

consideration that AA-861 specifically increases Nox4 activity independently of its protein level.

### 3.3. Molecular mechanism and significance of Nox4 activity stimulation by quinone compounds AA-861 and tBuBHQ: 5-lipoxygenase and calcium flux are not involved in the activation of Nox4

Since AA-861 was described as a 5-lipoxygenase (5-LO) inhibitor, we investigated whether 5-LO could be implicated in the stimulation of Nox4 activity. 5-LO was originally reported to be expressed in leucocytes and some epithelial cells [37], but no data concerning 5-LO expression in the HEK293E cell line are available. We found that neither 5-LO mRNA nor 5-LO protein was expressed in HEK293E cells (Fig. 3A and B), which excludes the involvement of 5-LO in Nox4 activation by AA-861. Furthermore, MK-886, another 5-LO inhibitor did not modulate Nox4 activity (unpublished observations).

The relationship between calcium ion flux and Nox4 activity has not been clearly described. Pedruzzi et al. [16] reported that Nox4 activity located in the endoplasmic reticulum was

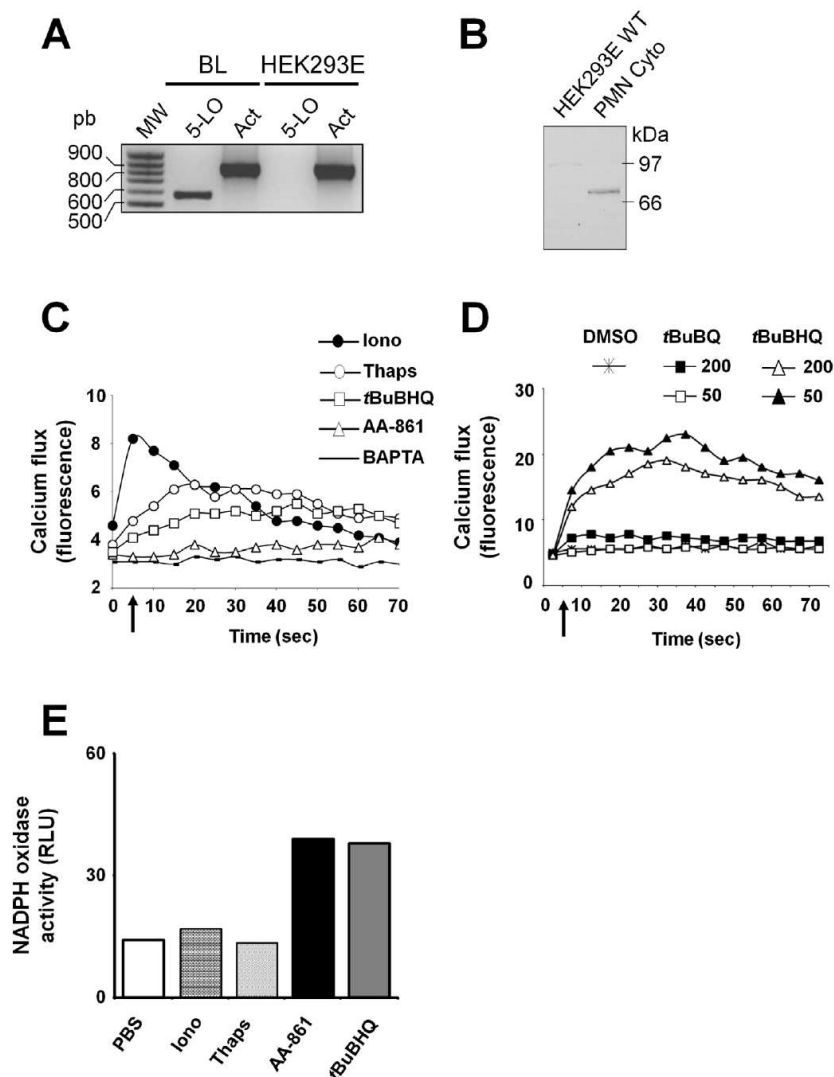

**Fig. 3.** AA-861 or *t*BuBHQ NADPH oxidase activity stimulation is independent of 5-lipoxygenase and of calcium flux. (A) 5-lipoxygenase mRNA expression in HEK293E cells. Total RNA was extracted from HEK293E and B lymphocytes (BL), a semi-quantitative RT-PCR was performed using specific primers for 5-lipoxygenase (5-LO). The housekeeping actin gene (Act) was used as a positive control. (B) 5-lipoxygenase protein expression in HEK293E cells. 150  $\mu$ g of total proteins from HEK293E WT, and 75  $\mu$ g of cytosolic (Cyto) protein fraction (positive control) from neutrophils (PMN) were loaded on a 7% SDS-PAGE gel. 5-lipoxygenase proteins were characterized with a specific monoclonal antibody against 5-LO. (C) and (D) Calcium flux measurement was assessed by a fluorescent probe in Nox4A-HEK293E cells. Intact cells were incubated with 10  $\mu$ M Fluo3/AM with or without 20  $\mu$ M BAPTA, during 30 min at 37  $^{\circ}$ C, washed and resuspended at  $10^6$  cells/mL. Calcium flux visualization was performed by flow cytometry. The arrow indicates the time of the addition of ionomycin (Iono, 10  $\mu$ M), AA-861 (10  $\mu$ M), *t*BuBHQ (50  $\mu$ M), or thapsigargin (Thaps, 10  $\mu$ M) in presence of 1 mM EGTA (C); or that of *t*BuBQ (50–200  $\mu$ M) and *t*BuBHQ (50–200  $\mu$ M) (D). Results are expressed as the mean of the fluorescence intensity (FL1 change) measured every 5 s (E).  $5 \times 10^5$  intact HEK293E cells overexpressing Nox4A were incubated or not with ionomycin (Iono, 10  $\mu$ M), thapsigargin (Thaps, 10  $\mu$ M), AA-861 (10  $\mu$ M), or *t*BuBHQ (50  $\mu$ M) in presence of 1 mM EGTA and then the ROS production was measured by chemiluminescence. Results are expressed as the sum of RLU measurements for 90 min.

concomitant to  $\text{Ca}^{2+}$  oscillation after exposure to 7-ketocholesterol. However in a previous study, we showed that ionomycin (calcium ionophore) had no effect on the Nox4 activity in chondrocytes C-20/A4 cells over-expressing Nox4A [18]. Since *t*BuBHQ was described as a SERCA pump inhibitor, it is necessary to evaluate the potential contribution of the  $\text{Ca}^{2+}$  flux on Nox4 stimulation. To this purpose, we measured the calcium flux in Nox4-HEK293E cells by FACs using a fluorescent Fluo-3/AM probe and compared the calcium changes to Nox4 activation. As illustrated in the figure 3 (Fig. 3C and D), an increase of cytosolic calcium from intracellular stores was observed in the presence of extracellular EGTA after adding ionomycin, thapsigargin or *t*BuBHQ whereas the addition of AA-861 or *t*BuBQ, two compounds that stimulate Nox4 activity were unable to modify

$\text{Ca}^{2+}$  level. Furthermore, thapsigargin or ionomycin could not modulate the constitutive activity of Nox4 in Nox4-HEK293E cells (Fig. 3E). Same experiments were performed in the presence of 1.5 mM  $\text{CaCl}_2$  in the extracellular medium without EGTA and led to the same results (unpublished observations). These data strongly suggest that there is no correlation between  $\text{Ca}^{2+}$  flux and Nox4 activity.



#### 3.4. Quinone structure may be responsible for the modulation of Nox4 activity

AA-861 and *t*BuBHQ share the same quinone moiety. To evaluate whether quinone structure was responsible for Nox4 activation, the ROS production by Nox4-HEK293E cells was

1650

M.V.C. Nguyen et al. / Biochemical Pharmacology 85 (2013) 1644–1654

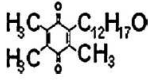
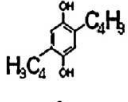
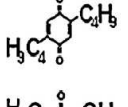
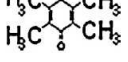
**Table 2**Quinone effect on Nox4 ROS production of Nox4A-HEK293 cells. Data were expressed as the mean  $\pm$  SD.

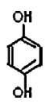
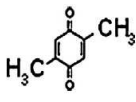
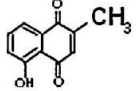
Effect	Structure	[C] $\mu$ M	ROS production
<b>None</b>			
PBS			9.01 $\pm$ 0.8
<b>Activators</b>			
AA-861		1 5 10 50	24.26 $\pm$ 0.91* 34.40 $\pm$ 1.16* 45.70 $\pm$ 0.77* 37.20 $\pm$ 2.14*
<i>t</i> BuBHQ		1 10 50 100	14.20 $\pm$ 0.76 36.01 $\pm$ 0.68* 61.74 $\pm$ 0.78* 38.90 $\pm$ 1.82*
<i>t</i> BuBQ		1 10 50 100	13.58 $\pm$ 0.42 32.70 $\pm$ 0.22* 36.50 $\pm$ 0.63* 34.99 $\pm$ 1.22*
Duroquinone		1 10 50	35.69 $\pm$ 1.65* 30.21 $\pm$ 1.70* 29.30 $\pm$ 1.80*
<b>Inhibitors</b>			
Benzoquinone		0.01 0.5 1 3 30	7.88 $\pm$ 0.36 8.09 $\pm$ 0.37 7.69 $\pm$ 0.51 3.63 $\pm$ 0.15* 1.01 $\pm$ 0.11*
Hydroquinone		0.01 0.5 1 3 30	7.65 $\pm$ 0.50 8.09 $\pm$ 0.37 8.70 $\pm$ 0.52 4.18 $\pm$ 0.34* 0.12 $\pm$ 0.07*
<i>t</i> MetBQ		1 10 50 100 200	10.09 $\pm$ 1.68 12.70 $\pm$ 0.43 12.87 $\pm$ 0.82 1.32 $\pm$ 0.20* 0.38 $\pm$ 0.01*
Plumbagine		0.01 0.5 1 5 10	7.40 $\pm$ 0.67 6.64 $\pm$ 0.27 4.00 $\pm$ 0.22* 1.93 $\pm$ 0.29* 1.34 $\pm$ 0.09*

\*  $p < 0.01$  versus PBS treated cells.

measured after incubation with various quinone derivatives that differ with respect to their reduced or oxidized state and substitution levels. The results shown in Table 2 illustrate two opposite effects. Duroquinone as well as *t*BuBHQ, *t*BuBQ (the oxidative form of *t*BuBHQ), and AA-861, stimulated Nox4 activity at a starting concentration of 1  $\mu$ M, whereas BQ (30  $\mu$ M), HQ (30  $\mu$ M) and *t*MetBQ (100  $\mu$ M) inhibited this activity in a dose dependent manner. We also confirmed the inhibitory effect of the naphthoquinone, plumbagin, on Nox4 activity as reported [38,39].

To exclude a non-specific spontaneous ROS production by quinone compounds in contact with membrane phospholipids as described for *t*BuBHQ [40], we measured the ROS synthesis in the presence of 25  $\mu$ g phosphatidylcholine. The results illustrated in Table 3 show that there was no ROS enhancement by quinones after addition of phospholipids versus control, except for a slight increase observed as expected with *t*BuBHQ, as previously reported [40]. Furthermore, quinone concentrations used in this study were not cytotoxic as examined by the LDH activity (Table 3).

### 3.5. Effect of quinones on Nox2

We next evaluated whether those quinones could affect Nox2 oxidase activity in isolated human neutrophils which express only

**Table 3**

Cytotoxicity of quinones and ROS production in the presence of phosphatidylcholine.

Structure	[C] $\mu$ M	Toxicity %LDH <sup>a</sup>	ROS production <sup>b</sup>	
			PBS	PC
–	–	10.80 $\pm$ 0.29	1.9 $\pm$ 0.1	2.7 $\pm$ 0.2
Benzoquinone	1 30	11.37 $\pm$ 0.53 10.72 $\pm$ 0.53	ND 2.0 $\pm$ 0.1	ND 2.3 $\pm$ 0.2
Hydroquinone	1 30	10.73 $\pm$ 0.53 10.99 $\pm$ 0.80	ND 2.1 $\pm$ 0.1	ND 2.3 $\pm$ 0.1
<i>t</i> MetBQ	50 200	12.79 $\pm$ 0.97 12.66 $\pm$ 1.00	2.3 $\pm$ 0.3 ND	2.4 $\pm$ 0.1 ND
<i>t</i> BuBQ	50	12.44 $\pm$ 0.42	2.3 $\pm$ 0.1	2.2 $\pm$ 0.2
<i>t</i> BuBHQ	50	11.93 $\pm$ 1.41	4.4 $\pm$ 0.9	6.8 $\pm$ 0.4
Duroquinone	50	11.03 $\pm$ 1.13	2.3 $\pm$ 0.1	2.8 $\pm$ 0.2
AA-861	10	12.00 $\pm$ 0.84	2.3 $\pm$ 0.1	2.4 $\pm$ 0.3

<sup>a</sup> Cytotoxicity evaluation of quinone compounds on HEK293E cell line.  $5 \times 10^5$  intact HEK293E were incubated with chemical compounds and lactate dehydrogenase (LDH) activity was assessed 60 min later in the culture medium. Values represent the mean percentage of LDH activity compared to total LDH enzymatic activity (cells lysed by a treatment with 1% triton X-100).

<sup>b</sup> Luminol chemiluminescence measurements of quinone alone (PBS column) or with only 25  $\mu$ g of phosphatidylcholine (PC column) demonstrated no spontaneous ROS production. Values represent the mean percentage of NADPH oxidase activity compared to constitutive ROS production by Nox4A-HEK293E alone.

Nox2, the redox core of phagocyte NADPH oxidase. Compared to the well known activator PMA, no NADPH oxidase activation was observed when neutrophils were incubated with AA-861, *t*BuBQ, or duroquinone (Fig. 4A) as opposed to what was previously observed in Nox4 T-REX<sup>TM</sup> cells (Table 2). However, slight oxidase activation was observed upon the addition of *t*BuBHQ, probably due to its effect on the calcium flux since thapsigargin, another SERCA pump inhibitor, or ionomycin gave similar results (unpublished data). On the contrary, the quinones BQ, HQ, *t*MetBQ, and plumbagin also inhibited the PMA stimulated neutrophil oxidase activity (Fig. 4B). By using an *in vitro* xanthine/xanthine oxidase superoxide production system, we observed that the ROS production was abolished in the presence of 30  $\mu$ M BQ, 30  $\mu$ M HQ, and 100  $\mu$ M *t*MetBQ while no effect on the xanthine/xanthine oxidase ROS production was noticeable with 50  $\mu$ M duroquinone, 50  $\mu$ M *t*BuBHQ, 50  $\mu$ M *t*BuBQ, or 10  $\mu$ M AA-861 (unpublished data). Using differentiated PLB-985 as another cellular model, we obtained similar results than those observed with human PMN (Fig. 4C). We, next, evaluated whether quinones could increase Nox2 activity already activated by the physiological agonists (the formylated peptide fMLP) in differentiated PLB-985 cells and found that AA-861, *t*BuBQ, and duroquinone did not stimulate Nox2 activity (Fig. 4D).

These results suggest that BQ, HQ, and *t*MetBQ inhibit ROS production through an antioxidant property. On the contrary, duroquinone, *t*BuBHQ, *t*BuBQ, and AA-861 appear to stimulate specifically NADPH oxidase activity of Nox4.

### 3.6. Putative quinone binding site (Q site) on Nox4

Quinones compounds bind to its target proteins through well described ubiquinone binding sites [41]. Based on computational prediction, a consensus sequence for a predictable quinone binding site or Q site was suggested: “**aliphatic**-(X)<sub>3</sub>-**H**-(X)<sub>2-3</sub>-(**Leu/Thr/Ser**)” [42]. The analysis of the Nox4 protein sequence showed a similar putative motif in the fifth transmembrane domain (“<sup>203</sup>**LTLHVS**<sup>209</sup>”) that is missing in Nox2 sequence (Fig. 5A). Therefore, quinones could regulate Nox4 activity by binding directly to the protein through this putative domain. To investigate the relevance of this potential Q site in Nox4 protein, we mutated

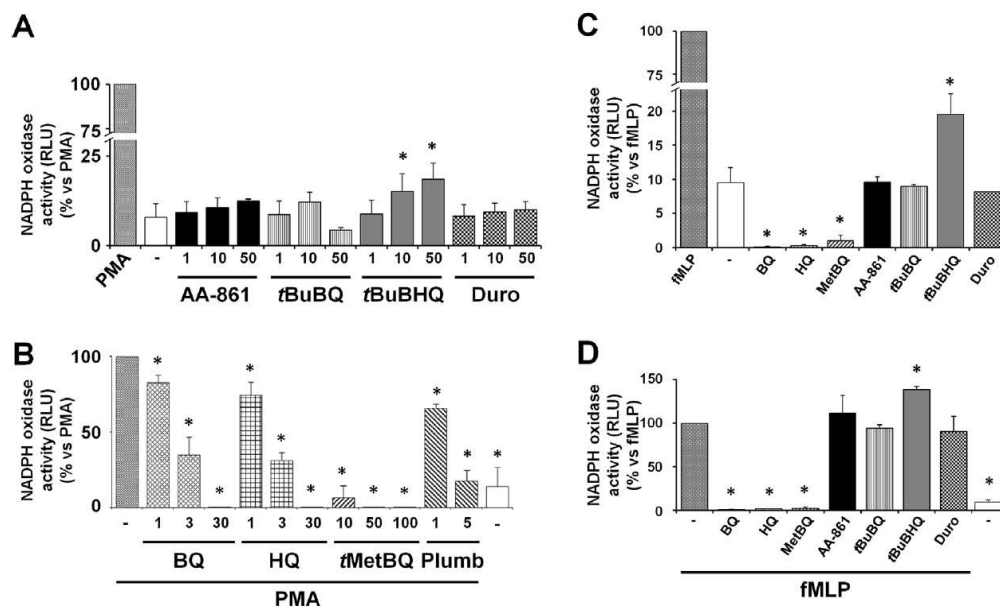

**Fig. 4.** Effect of quinone derivatives on the activation of Nox2 oxidase activity. (A) The reactive oxygen species production was measured by chemiluminescence on  $5 \times 10^5$  intact PMN cells in the presence of an increasing concentration (1  $\mu\text{M}$ , 10  $\mu\text{M}$ , or 50  $\mu\text{M}$ ) of AA-861, tBuBQ, tBuBHQ, or duroquinone. Results are expressed as the sum of RLU measurements for 60 min and are shown as percentage of ROS produced by PMN stimulated by PMA (0.13  $\mu\text{M}$ ). Values represent the mean  $\pm$  SD of triplicate determinations of at least 3 independent experiments,  $^*p < 0.05$  versus cells without PMA activation and quinones. (B) PMN ( $5 \times 10^5$  cells) were stimulated by PMA (0.13  $\mu\text{M}$ ) in the presence or not of BQ (1  $\mu\text{M}$ , 3  $\mu\text{M}$ , and 30  $\mu\text{M}$ ), HQ (1  $\mu\text{M}$ , 3  $\mu\text{M}$ , and 30  $\mu\text{M}$ ), tMetBQ (10  $\mu\text{M}$ , 50  $\mu\text{M}$ , and 100  $\mu\text{M}$ ) or plumbagin (1  $\mu\text{M}$  and 5  $\mu\text{M}$ ). Results are expressed as the sum of RLU measurements for 90 min and are reported as a percentage of ROS produced by PMN stimulated by PMA (0.13  $\mu\text{M}$ ). Values represent the mean  $\pm$  SD of triplicate determinations of at least 3 independent experiments,  $^*p < 0.05$  versus cells activated by PMA without quinones. (C) The reactive oxygen species production was measured by chemiluminescence on  $5 \times 10^5$  intact differentiated PLB-985 cells in the presence of 30  $\mu\text{M}$  BQ, 30  $\mu\text{M}$  HQ, 50  $\mu\text{M}$  tMetBQ, 10  $\mu\text{M}$  AA-861, 50  $\mu\text{M}$  tBuBQ, 50  $\mu\text{M}$  tBuBHQ, or 50  $\mu\text{M}$  duroquinone. Results are expressed as the sum of RLU measurements for 60 min and are shown as percentage of ROS produced by differentiated PLB-985 cells stimulated by fMLP (0.15  $\mu\text{M}$ ). Values represent the mean  $\pm$  SD of triplicate determinations of at least 3 independent experiments,  $^*p < 0.05$  versus cells without fMLP activation and quinones. (D) Differentiated PLB-985 ( $5 \times 10^5$  cells) were stimulated by fMLP (0.15  $\mu\text{M}$ ) in the presence or not of 30  $\mu\text{M}$  BQ, 30  $\mu\text{M}$  HQ, 50  $\mu\text{M}$  tMetBQ, 10  $\mu\text{M}$  AA-861, 50  $\mu\text{M}$  tBuBQ, 50  $\mu\text{M}$  tBuBHQ, or 50  $\mu\text{M}$  duroquinone. Results are expressed as the sum of RLU measurements for 60 min and are reported as a percentage of ROS produced by differentiated PLB-985 cells stimulated by fMLP (0.15  $\mu\text{M}$ ). Values represent the mean  $\pm$  SD of triplicate determinations of at least 3 independent experiments,  $^*p < 0.05$  versus cells activated by fMLP without quinones.

key amino acid residues of that sequence, *i.e.*, substitutions of L203G and S209A (Fig. 5A). Our results showed that those mutations did not modify the stimulatory effect of the quinone tBuBHQ on Nox4 activity which remained similar to WT Nox4 (Fig. 5B). Since our data showed that quinones did not activate Nox2 activity nor enhance its activity (Fig. 4), we therefore exchanged the sequence  $^{201}\text{Y}..^{215}\text{Y}$  of Nox4, which contains the putative Q binding of Nox4, with the homologous sequence of Nox2  $^{216}\text{F}..^{230}\text{G}$ . This Nox4/2 chimera protein remained still stimulated by tBuBHQ (Fig. 5B). Those results suggest that this putative Q site domain on Nox4 is not involved in the stimulation of Nox4 activity by quinone compounds.

### 3.7. Redox regulation of Nox4 activity

A recent study [43] showed that structural modifications of the E-loop, by deletion or exchange of cysteine, had an impact on the production rate and nature of ROS generated. The authors hypothesized that extracellular cysteines C226 and C270 might form a disulfide bridge that modulates Nox4 ROS production. Quinones compounds are highly reducing molecules capable of breaking disulfide bridges and, therefore, could modulate Nox4 activity through a redox regulation. To test this hypothesis, we measured the effect of known reducing agents on Nox4 activity and found that in tet-induced Nox4 T-REX<sup>TM</sup> cells, the addition of 80  $\mu\text{M}$  NADPH, NADH, or  $\beta$ -mercaptoethanol increased significantly the ROS production compared to non-induced and untreated Nox4 T-REX<sup>TM</sup> cells (Fig. 5C). These results suggest that reducing agents stimulate Nox4 activity and point out a possible

mechanism by which quinones might regulate Nox4 activity by reducing the E-loop disulfide bridge.

### 3.8. Involvement of NQO1 on Nox4 activation by quinone

Quinone compounds are metabolized through different pathways and one of them involves the NAD(P)H oxidoreductase 1 (NQO1). By RT-PCR and sequencing, we revealed that Nox4 T-REX<sup>TM</sup> cells expressed two types of mRNA encoding for NQO1: NQO1A, the active form and NQO1C, the inactive form, which lacks 2 essential amino acid residues (Tyrosine-126 and -128) necessary for its quinone binding capacity [4]. To investigate the potential role of NQO1 in the stimulation of Nox4 activity by quinone compounds, we used dicoumarol to inhibit NQO1. Pre-incubation of the tetracycline induced Nox4 T-REX<sup>TM</sup> cells with 100  $\mu\text{M}$  dicoumarol inhibited Nox4 constitutive activity as well as its stimulation by tBuBHQ (Fig. 6A). To further investigate the role of NQO1, we stably overexpressed NQO1A and NQO1C in Nox4-HEK293 and confirmed the presence of the exogenous NQO1A and NQO1C mRNA in the corresponding transfected cells compared with the empty vector control transfected cells (Fig. 6B). Furthermore, by real time RT-PCR we showed the mRNA level of NQO1A and NQO1C increased 2 and 8 fold, respectively, compared to the control Nox4-HEK293 cells (Fig. 6B). We then investigated the consequences of these overexpressions on Nox4 activity. Results showed that overexpression of NQO1A enhanced twice the stimulatory effect of tBuBHQ on Nox4 activity compared to the control empty vector cells. This is consistent with the increase level of NQO1A mRNA observed previously (Fig. 6B). On the contrary,

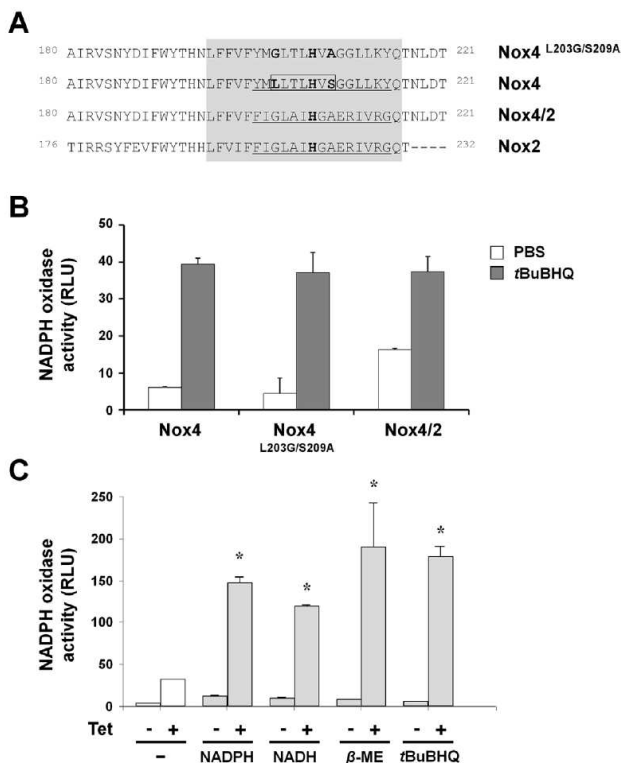
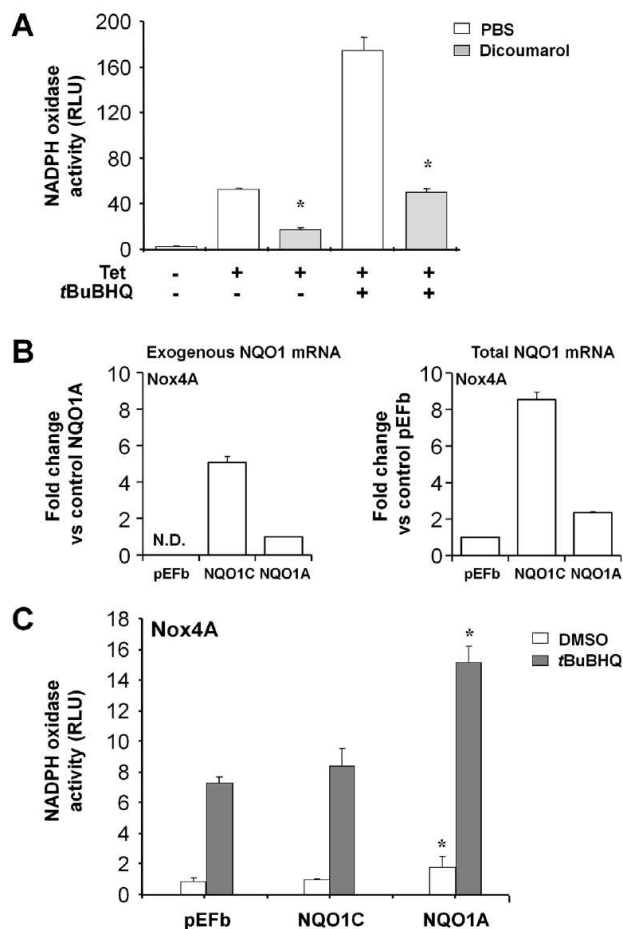

**Fig. 5.** Putative Q site and redox regulation of Nox4 activity. (A) Schematic representation of the alignment of partial sequences of Nox4, Nox2 and Nox4 mutants (Nox4<sup>L203G/S209A</sup> and Nox4/2). Gray box represents the predicted 5th transmembrane domain. Boxed amino acids on Nox4 sequence correspond to the putative Q site and bold letters are key amino acids described for the Q site [42]. Underlined amino acids represent amino acids that have been exchanged from Nox2 sequence to produce the chimera Nox4/2. (B) Measurement of ROS generation by chemiluminescence on  $5 \times 10^5$  intact transfected Nox4-, Nox4<sup>L203G/S209A</sup>- and Nox4/2-HEK293 cells with or without 50  $\mu$ M tBuBHQ. (C) Measurement of ROS generation by chemiluminescence on  $5 \times 10^5$  intact cells. ROS production by Nox4 T-REx™ cell induced 4 h or not with 1 mg/mL tetracycline (tet-induced) was measured after the addition or not of NADPH, NADH,  $\beta$ -mercaptoethanol ( $\beta$ -ME) (80  $\mu$ M of each), or tBuBHQ (50  $\mu$ M). Results are expressed as the sum of RLU measurements for 90 min for each condition. Values represent the mean  $\pm$  SD of triplicate determinations of at least 3 independent experiments, \* $p < 0.05$  versus cells without redox compounds.

although the overexpression of NQO1C is higher than that of NQO1A, it did not modify the stimulatory effect which is comparable to that observed with the control empty plasmid (Fig. 6C). Together, these data suggest the implication of NQO1 enzymes in quinone-stimulated Nox4 activity.

#### 4. Discussion

Our study focuses on the capacity of quinone compounds to modulate the NADPH oxidase activity of Nox4. Quinones are important toxic compounds present in air pollution and abundant in all burnt organic material, including urban air particles, cigarette smoke, and diesel exhaust particles (DEP) [44]. DEP were reported to increase Nox4 ROS production after 1 h of incubation, suggesting the implication of Nox4 in the quinone metabolism [9]. Considering the structure/function relationship of the quinones used in this study (Table 2), we observed a dual stimulation/inhibition effect that depends on their substitution state: Nox4 activity was stimulated by AA-861, duroquinone, tBuBQ, and tBuBHQ whereas other less substituted derivatives such as BQ, HQ,



**Fig. 6.** Effect of NQO1 on tBuBHQ activation of ROS production by Nox4. (A) Nox4 T-REx™ cells were induced (or not) with 1 mg/mL tetracycline for 4 h. Dicoumarol was added in the culture medium 2 h before ROS measurements. Chemiluminescence assay was done on  $10^6$  intact cells per well, activated or not by 50  $\mu$ M tBuBHQ. Results are expressed as the sum of RLU measurements for 90 min. Values represent the mean  $\pm$  SD of triplicate determinations of at least 3 independent experiments, \* $p < 0.05$  versus cells in same condition without dicoumarol. (B) Real-time RT-PCR analysis of exogenous and total NQO1 mRNA in Nox4A-, Nox4A/NQO1C- and Nox4A/NQO1A-HEK293 cells. Left panel, real time RT-PCR showing the presence of exogenous NQO1 mRNA in Nox4A/NQO1C- and Nox4A/NQO1A-HEK293 cells and not in Nox4A-HEK293 transfected with the control pEFb empty plasmid. N.D., not detected. Right panel, real time RT-PCR showing the increase of NQO1 mRNA level in Nox4A/NQO1C- and Nox4A/NQO1A-HEK293 cells compared to Nox4A-HEK293 transfected with the control pEFb empty plasmid. (C) Nox4A-HEK293E cells were transfected with the empty vector pEFb (Control) or containing NQO1A or NQO1B. The reactive oxygen species production was measured by chemiluminescence on  $5 \times 10^5$  intact cells after the addition of 50  $\mu$ M tBuBHQ or the same volume of vehicle (DMSO). Results are expressed as the sum of RLU measurements for 90 min. Values represent the mean  $\pm$  SD of triplicate determinations of at least 3 independent experiments, \* $p < 0.005$  versus cells transfected with the control empty vector in same conditions.

tMetBQ, and plumbagin, developed antioxidant properties (Table 2). The specificity of AA-861, duroquinone, and tBuBQ for Nox4 over Nox2, suggests either a direct effect of quinone derivatives in the molecular dynamics of electron transfer mediated by Nox4, or an indirect role on a quinone sensitive functional partner of Nox4. In this work, we suggest a new aspect of Nox4 oxidase activity regulation that takes place not only at a transcriptional level as usually described [13,27,45] but also at a post-translational level as described above with quinone molecules.



Quinones are bioreactive molecules that are sensitive to redox mechanism. Ubiquinone, for example, is a mobile electron carrier of mitochondria and a highly hydrophobic molecule that diffuses into the core of inner membrane where the electron transfer proceeds through a Q cycle on either side of membrane [41,46]. A predictable quinone binding site has been suggested [42] and we identified a similar domain in Nox4 protein sequence “<sup>203</sup>LLTLHVS<sup>209</sup>”. However, the implication of such domain was not confirmed since the ability of quinones to stimulate Nox4 activity was not abolished when appropriate residues of this sequence were mutated (Fig. 5A and B).

Alternatively, Takac and his colleagues [43] have shown that disulfide bridges formed by two cysteines C226 and C270 may be involved in the maintenance of the extracellular E-loop integrity. Indeed, the disruption of the bridge by mutagenesis modified notably Nox4 ROS production [43]. Disulfide bridges with a standard redox potential ( $E_0$ ) of  $-180$  mV [47] could be reduced by NADPH, NADH and  $\beta$ -mercaptoethanol that possess a lower  $E_0$  ( $-324$ ,  $-320$ , and  $-253$  mV, respectively) [48]. Our results using those reducing agents indicated that Nox4 activity could be stimulated by extracellular redox modifications, possibly through the reduction of its disulfide bridge. Interestingly, duroquinone, which enhances Nox4 activity, has a low  $E_0$  ( $-260$  mV) [49] and then could theoretically reduce disulfide bridge. Conversely, compounds such as BQ, HQ and *t*MetBQ that do not stimulate Nox4 exhibit a higher  $E_0$ ,  $78$  mV,  $78$  mV and  $-67$  mV, respectively, compared to that of the disulfide bridge. Thus, it is possible that quinones exhibiting an  $E_0$  lower than that of disulfide bridge are able to stimulate Nox4 activity.

NAD(P)H-quinone oxidoreductase-1 (NQO1) is a broadly distributed FAD-dependent flavoprotein that catalyses the reduction of a wide variety of quinone compounds. It reduces quinones, by the transfer of 2 electrons, to the corresponding hydroquinones which are the electron donor state capable to initiate reductive reactions. We showed that NQO1 is expressed in uninduced or tet-induced Nox4 T-REX<sup>TM</sup> cells; however, the stimulation of ROS production by quinones occurs only when Nox4 expression was induced. Moreover, the increase of Nox4 ROS production by quinones was inhibited by a well known inhibitor of NQO1, dicoumarol. Noticeably, dicoumarol also decreases Nox4 constitutive activity in quinone-untreated Tet-induced Nox4 T-REX<sup>TM</sup> cells (Fig. 6A), possibly by inhibiting the endogenous NQO1 enzymes. More specifically, only the functional NQO1 enzyme, NQO1A, enhanced the ROS production of Nox4 induced by quinone compounds (Fig. 6C). Interestingly, NQO1 has been described to partition between cytosol and plasma membrane [7] where Nox4 is also located in HEK293 cells [50]. These observations suggest a potential link between NQO1 and Nox4. Such potential link could be illustrated in pancreatic cancer. Pancreatic cancer is very aggressive and unresponsive to treatments due to a resistance of cells to apoptosis. Vaquero et al. [51] reported that ROS produced by Nox4 are prosurvival and antiapoptotic for human pancreatic adenocarcinoma cell lines, MIA PaCa-2 and PANC-1. In the MIA PaCa-2 cell line, Lewis et al. [52] showed that inhibition of NQO1 by dicoumarol suppresses the malignant phenotype of pancreatic cancer cells and induces cell apoptosis.

Finally, our study described 4 quinones derivatives especially AA-861 and *t*BuBHQ capable of enhancing Nox4 ROS production. We showed that NQO1 may be involved in the stimulation of Nox4 ROS production induced by quinones. We further observed that Nox4 activity is also stimulated in the presence of reducing agents that may possibly act by reducing the disulfide bridge located in the extracellular E-loop of Nox4. All together, we hypothesize that in the presence of quinones, NQO1 may generate hydroquinone forms, providing, therefore, potential reducing agents near Nox4 protein. Depending on the quinone redox potential, Nox4 E-loop

disulfide bridge could be disrupted consequently leading to the increase of its oxidase activity. However, the direct implication of the E-loop disulfide bridge needs further investigations. The proposed model could provide new insight into the understanding of molecular mechanism of the electron transfer through Nox4 and also define new therapeutic targets in diseases in which quinones and Nox4 are implicated.

#### Acknowledgments

This work was supported by grants from: the ‘Ministère de l’Enseignement supérieur de la recherche et la technologie’, Paris, France; the ‘CNRS Institute’; the Association pour la Recherche contre le Cancer (ARC), Paris, France; the Région Rhône-Alpes, programme ARCUS, France/Chine 2007–2008, programme Emergence 2003–2006; the ‘CGD research Trust 2006–2007’, UK; the ‘Groupement des Entreprises Françaises de la Lutte contre le Cancer’, délégation de Grenoble; the ‘UFR de Médecine, Université Joseph Fourier, Grenoble’; and the ‘Direction Régionale de la Recherche Clinique, Center Hospitalier Universitaire, Grenoble’. We thank Prof. Stanke (Grenoble, France) for kindly providing the 5-lipoxygenase polyclonal antibody, Prof. P.E. Cole, Drs M.H. Huynh and M.H. Pacllet for English language corrections, S. Berthier for FACS measurements, A. Dariz-Soldini for real time RT-PCR experiments and Prof. A. Maitre and Prof. R. Brandes for helpful reading and discussions.

#### References

- [1] Bolton JL, Trush MA, Penning TM, Dryhurst G, Monks TJ. Role of quinones in toxicology. *Chem Res Toxicol* 2000;13:135–60.
- [2] Ghio AJ, Carraway MS, Madden MC. Composition of air pollution particles and oxidative stress in cells, tissues, and living systems. *J Toxicol Environ Health B Crit Rev* 2012;15:1–21.
- [3] Rodgman A, Smith CJ, Perfetti TA. The composition of cigarette smoke: a retrospective, with emphasis on polycyclic components. *Hum Exp Toxicol* 2000;19:573–95.
- [4] Faig M, Bianchet MA, Talalay P, Chen S, Winski S, Ross D, et al. Structures of recombinant human and mouse NAD(P)H:quinone oxidoreductases: species comparison and structural changes with substrate binding and release. *Proc Natl Acad Sci U S A* 2000;97:3177–82.
- [5] Kovacic P, Somanathan R. Pulmonary toxicity and environmental contamination: radicals, electron transfer, and protection by antioxidants. *Rev Environ Contam Toxicol* 2009;201:41–69.
- [6] Auerbach A, Hernandez ML. The effect of environmental oxidative stress on airway inflammation. *Curr Opin Allergy Clin Immunol* 2012;12:133–9.
- [7] Gray JP, Eisen T, Cline GW, Smith PJ, Heart E. Plasma membrane electron transport in pancreatic beta-cells is mediated in part by NQO1. *Am J Physiol Endocrinol Metab* 2011;301:E113–21.
- [8] Squadrito GL, Cueto R, Dellinger B, Pryor WA. Quinoid redox cycling as a mechanism for sustained free radical generation by inhaled airborne particulate matter. *Free Radic Biol Med* 2001;31:1132–8.
- [9] Amara N, Bachoual R, Desmard M, Golda S, Guichard C, Lanone S, et al. Diesel exhaust particles induce matrix metalloproteinase-1 in human lung epithelial cells via a NAD(P)H oxidase/NOX4 redox-dependent mechanism. *Am J Physiol Lung Cell Mol Physiol* 2007;293:L170–81.
- [10] Morel F. Molecular aspects of chronic granulomatous disease, the NADPH oxidase complex. *Bull Acad Natl Med* 2007;191:377–90 [discussion 90–2].
- [11] Lardy B, Bof M, Aubry L, Pacllet MH, Morel F, Satre M, et al. NADPH oxidase homologs are required for normal cell differentiation and morphogenesis in *Dictyostelium discoideum*. *Biochim Biophys Acta* 2005;1744:199–212.
- [12] Bedard K, Krause KH. The NOX family of ROS-generating NADPH oxidases: physiology and pathophysiology. *Physiol Rev* 2007;87:245–313.
- [13] Geiszt M, Kopp JB, Varnai P, Leto TL. Identification of renox, an NAD(P)H oxidase in kidney. *Proc Natl Acad Sci U S A* 2000;97:8010–4.
- [14] Djordjevic T, BelAiba RS, Bonello S, Pfeilschifter J, Hess J, Gorlach A. Human urotensin II is a novel activator of NADPH oxidase in human pulmonary artery smooth muscle cells. *Arterioscler Thromb Vasc Biol* 2005;25:519–25.
- [15] Mahadev K, Motoshima H, Wu X, Ruddy JM, Arnold RS, Cheng G, et al. The NAD(P)H oxidase homolog Nox4 modulates insulin-stimulated generation of H<sub>2</sub>O<sub>2</sub> and plays an integral role in insulin signal transduction. *Mol Cell Biol* 2004;24:1844–54.
- [16] Pedrucci E, Guichard C, Ollivier V, Driss F, Fay M, Prunet C, et al. NAD(P)H oxidase Nox-4 mediates 7-ketocholesterol-induced endoplasmic reticulum stress and apoptosis in human aortic smooth muscle cells. *Mol Cell Biol* 2004;24:10703–17.

- [17] Fitzgerald JP, Nayak B, Shanmugasundaram K, Friedrichs W, Sudarshan S, Eid AA, et al. Nox4 mediates renal cell carcinoma cell invasion through hypoxia-induced interleukin 6- and 8- production. *PLoS ONE* 2012;7:e30712.
- [18] Grange L, Nguyen MV, Lardy B, Derouazi M, Campion Y, Trocme C, et al. NAD(P)H oxidase activity of Nox4 in chondrocytes is both inducible and involved in collagenase expression. *Antioxid Redox Signal* 2006;8:1485–96.
- [19] Park HS, Chun JN, Jung HY, Choi C, Bae YS. Role of NADPH oxidase 4 in lipopolysaccharide-induced proinflammatory responses by human aortic endothelial cells. *Cardiovasc Res* 2006;72:447–55.
- [20] Bonner MY, Arbiser JL. Targeting NADPH oxidases for the treatment of cancer and inflammation. *Cell Mol Life Sci* 2012;69:2435–42.
- [21] Ambasta RK, Kumar P, Griendling KK, Schmidt HH, Busse R, Brandes RP. Direct interaction of the novel Nox proteins with p22phox is required for the formation of a functionally active NADPH oxidase. *J Biol Chem* 2004;279:45935–41.
- [22] Hilenski LL, Clempus RE, Quinn MT, Lambeth JD, Griendling KK. Distinct subcellular localizations of Nox1 and Nox4 in vascular smooth muscle cells. *Arterioscler Thromb Vasc Biol* 2004;24:677–83.
- [23] Martyn KD, Frederick LM, von Loehneysen K, Dinauer MC, Knaus UG. Functional analysis of Nox4 reveals unique characteristics compared to other NADPH oxidases. *Cell Signal* 2006;18:69–82.
- [24] Nguyen MV, Zhang L, Lhomme S, Mouz N, Lenormand JL, Lardy B, et al. Recombinant Nox4 cytosolic domain produced by a cell or cell-free base systems exhibits constitutive diaphorase activity. *Biochem Biophys Res Commun* 2012;419:453–8.
- [25] Nisimoto Y, Jackson HM, Ogawa H, Kawahara T, Lambeth JD. Constitutive NADPH-dependent electron transferase activity of the Nox4 dehydrogenase domain. *Biochemistry* 2010;49:2433–42.
- [26] Ellmark SH, Dusting GJ, Fui MN, Guzzo-Pernell N, Drummond GR. The contribution of Nox4 to NADPH oxidase activity in mouse vascular smooth muscle. *Cardiovasc Res* 2005;65:495–504.
- [27] Serrander L, Cartier L, Bedard K, Banfi B, Lardy B, Plastre O, et al. NOX4 activity is determined by mRNA levels and reveals a unique pattern of ROS generation. *Biochem J* 2007;406:105–14.
- [28] Cucoranu I, Clempus R, Dikalova A, Phelan PJ, Ariyan S, Dikalov S, et al. NAD(P)H oxidase 4 mediates transforming growth factor-beta1-induced differentiation of cardiac fibroblasts into myofibroblasts. *Circ Res* 2005;97:900–7.
- [29] McKallip RJ, Jia W, Schlomer J, Warren JW, Nagarkatti PS, Nagarkatti M. Cannabidiol-induced apoptosis in human leukemia cells: A novel role of cannabidiol in the regulation of p22phox and Nox4 expression. *Mol Pharmacol* 2006;70:897–908.
- [30] Moe KT, Aulia S, Jiang F, Chua YL, Koh TH, Wong MC, et al. Differential upregulation of Nox homologues of NADPH oxidase by tumor necrosis factor-alpha in human aortic smooth muscle and embryonic kidney cells. *J Cell Mol Med* 2006;10:231–9.
- [31] Murillo MM, Carmona-Cuenca I, Del Castillo G, Ortiz C, Roncero C, Sanchez A, et al. Activation of NADPH oxidase by transforming growth factor-beta in hepatocytes mediates up-regulation of epidermal growth factor receptor ligands through a nuclear factor-kappaB-dependent mechanism. *Biochem J* 2007;405:251–9.
- [32] Touyz RM, Chen X, Tabet F, Yao G, He G, Quinn MT, et al. Expression of a functionally active gp91phox-containing neutrophil-type NAD(P)H oxidase in smooth muscle cells from human resistance arteries: regulation by angiotensin II. *Circ Res* 2002;90:1205–13.
- [33] Wingler K, Wunsch S, Kreutz R, Rothermund L, Paul M, Schmidt HH. Upregulation of the vascular NAD(P)H-oxidase isoforms Nox1 and Nox4 by the renin-angiotensin system in vitro and in vivo. *Free Radic Biol Med* 2001;31:1456–64.
- [34] Park HS, Jin DK, Shin SM, Jang MK, Longo N, Park JW, et al. Impaired generation of reactive oxygen species in leprechaunism through downregulation of Nox4. *Diabetes* 2005;54:3175–81.
- [35] Campion Y, Pacllet MH, Jesaitis AJ, Marques B, Grichine A, Berthier S, et al. New insights into the membrane topology of the phagocyte NADPH oxidase: characterization of an anti-gp91-phox conformational monoclonal antibody. *Biochimie* 2007;89:1145–58.
- [36] Goyal P, Weissmann N, Rose F, Grimminger F, Schafers HJ, Seeger W, et al. Identification of novel Nox4 splice variants with impact on ROS levels in A549 cells. *Biochem Biophys Res Commun* 2005;329:32–9.
- [37] Luo M, Lee S, Brock TG. Leukotriene synthesis by epithelial cells. *Histol Histopathol* 2003;18:587–95.
- [38] Ding Y, Chen ZJ, Liu S, Che D, Vetter M, Chang CH. Inhibition of Nox-4 activity by plumbagin, a plant-derived bioactive naphthoquinone. *J Pharm Pharmacol* 2005;57:111–6.
- [39] Rossary A, Arab K, Steghens JP. Polyunsaturated fatty acids modulate NOX 4 anion superoxide production in human fibroblasts. *Biochem J* 2007;406:77–83.
- [40] Tsukii K, Nakahata N, Watanabe K, Tsurufuji S, Ohizumi Y. Comparison of tBuHQ with chemotactic peptide and phorbol ester in O<sub>2</sub>- production in HL-60 cells. *Eur J Pharmacol* 1996;298:87–95.
- [41] Lenaz G, Fato R, Genova ML, Bergamini C, Bianchi C, Biondi A. Mitochondrial complex I: structural and functional aspects. *Biochim Biophys Acta* 2006;1757:1406–20.
- [42] Fisher N, Rich PR. A motif for quinone binding sites in respiratory and photosynthetic systems. *J Mol Biol* 2000;296:1153–62.
- [43] Takac I, Schroder K, Zhang L, Lardy B, Anilkumar N, Lambeth JD, et al. The E-loop is involved in hydrogen peroxide formation by the NADPH oxidase Nox4. *J Biol Chem* 2011;286:13304–13.
- [44] Schuetzle D, Lee FS, Prater TJ. The identification of polynuclear aromatic hydrocarbon (PAH) derivatives in mutagenic fractions of diesel particulate extracts. *Int J Environ Anal Chem* 1981;9:93–144.
- [45] Shiose A, Kuroda J, Tsuruya K, Hirai M, Hirakata H, Naito S, et al. A novel superoxide-producing NAD(P)H oxidase in kidney. *J Biol Chem* 2001;276:1417–23.
- [46] Mitchell P. Protonmotive redox mechanism of the cytochrome b-c1 complex in the respiratory chain: protonmotive ubiquinone cycle. *FEBS Lett* 1975;56:1–6.
- [47] Siedler F, Rudolph-Bohner S, Doi M, Musiol HJ, Moroder L. Redox potentials of active-site bis(cysteiny) fragments of thiol-protein oxidoreductases. *Biochemistry* 1993;32:7488–95.
- [48] Crans DC, Zhang B, Gaidamauskas E, Keramidias AD, Willsky GR, Roberts CR. Is vanadate reduced by thiols under biological conditions? Changing the redox potential of V(V)/V(IV) by complexation in aqueous solution. *Inorg Chem* 2010;49:4245–56.
- [49] Schultz TW. Influence of the energy relationship of organic compounds on toxicity to the cladoceran *Daphnia magna* and the fish *Pimephales promelas*. *Ecotoxicol Environ Saf* 1997;38:336–8.
- [50] Zhang L, Nguyen MV, Lardy B, Jesaitis AJ, Grichine A, Rousset F, et al. New insight into the Nox4 subcellular localization in HEK293 cells: first monoclonal antibodies against Nox4. *Biochimie* 2011;93:457–68.
- [51] Vaquero EC, Edderkaoui M, Pandol SJ, Gukovsky I, Gukovskaya AS. Reactive oxygen species produced by NAD(P)H oxidase inhibit apoptosis in pancreatic cancer cells. *J Biol Chem* 2004;279:34643–54.
- [52] Lewis A, Ough M, Li L, Hinkhouse MM, Ritchie JM, Spitz DR, et al. Treatment of pancreatic cancer cells with dicumarol induces cytotoxicity and oxidative stress. *Clin Cancer Res* 2004;10:4550–8.



# Annexe 4

Article 5 : New insight into the Nox4 subcellular localization in HEK293 cells: First monoclonal antibodies against Nox4





Contents lists available at ScienceDirect

Biochimie

journal homepage: [www.elsevier.com/locate/biochi](http://www.elsevier.com/locate/biochi)

Research paper

## New insight into the Nox4 subcellular localization in HEK293 cells: First monoclonal antibodies against Nox4

Leilei Zhang<sup>a,b</sup>, Minh Vu Chuong Nguyen<sup>a</sup>, Bernard Lardy<sup>a</sup>, Algirdas J. Jesaitis<sup>c</sup>, Alexei Grichine<sup>d</sup>, Francis Rousset<sup>a</sup>, Monique Talbot<sup>e</sup>, Marie-Hélène Paclét<sup>a</sup>, GuanXiang Qian<sup>b</sup>, Françoise Morel<sup>a,\*</sup>

<sup>a</sup> GREPI TImc-Imag UMR-CNRS 5525, Enzymologie/CHU Albert Michallon, BP 217, 38043 Grenoble, France

<sup>b</sup> Department of Biochemistry and Molecular Biology, Research Center for Human Gene Therapy, School of Medicine, Shanghai Jiao Tong University, Shanghai 200025, PR China

<sup>c</sup> Department of Microbiology, Montana State University, Bozeman, MT 59717, USA

<sup>d</sup> Platform 'Optical Microscopy – Cell Imaging' – UJF, Inserm U823, Institut Albert Bonniot, 38076 La Tronche, France

<sup>e</sup> UMR-CNRS 8200, Institut de cancérologie Gustave Roussy, 94805 Villejuif, France

### ARTICLE INFO

#### Article history:

Received 7 June 2010

Accepted 3 November 2010

Available online 12 November 2010

#### Keywords:

NADPH oxidase 4

Monoclonal antibodies

Subcellular localization

O<sub>2</sub><sup>-</sup>

### ABSTRACT

Nox4, a member of Nox family of NADPH oxidase expressed in nonphagocytic cells, is a major source of reactive oxygen species in many cell types. But understanding of the role of Nox4 in the production of ROS and of regulation mechanism of oxidase activity is largely unknown. This study reports for the first time the generation and characterization of 5 mAbs against a recombinant Nox4 protein (AA: 206–578). Among 5 novel mAbs, 3 mAbs (8E9, 5F9, 6B11) specifically recognized Nox4 protein in HEK293 transfected cells or human kidney cortex by western blot analysis; mAb 8E9 reacted with intact tet-induced T-REx™ Nox4 cells in FACS studies. The other 2 mAbs 10B4 and 7C9 were shown to have a very weak reactivity after purification. Immunofluorescence confocal microscopy showed that Nox4 localized not only in the perinuclear and endoplasmic reticulum regions but also at the plasma membrane of the cells which was further confirmed by TIRF-microscopy. Epitope determination showed that mAb 8E9 recognizes a region on the last extracellular loop of Nox4, while mAbs 6B11 and 5F9 are directed to its cytosolic tail. Contrary to mAb 6B11, mAb 5F9 failed to detect Nox4 at the plasma membrane. Cell-free oxidase assays demonstrated a moderate but significant inhibition of constitutive Nox4 activity by mAbs 5F9 and 6B11. In conclusion, 5 mAbs raised against Nox4 were generated for the first time. 3 of them will provide powerful tools for a structure/function relationship of Nox4 and for physiopathological investigations in humans.

© 2010 Elsevier Masson SAS. All rights reserved.

### 1. Introduction

NADPH oxidase, Nox4, belongs to the Nox family which could generate reactive oxygen species (ROS) by transferring an electron to molecular oxygen. All these members contain six putative transmembrane helices, conserved binding sites for FAD and

NADPH, and four heme-binding histidines in the third and fifth transmembrane domain [1]. Nox2 is the prototype of the Nox family [2]: it is essentially present in phagocytes and a well studied characterized source for ROS production. By interacting with the membrane-bound p22<sup>phox</sup>, it becomes the heterodimer flavocytochrome b<sub>558</sub>. This core unit assembles with various cytosolic regulating and activating factors p47<sup>phox</sup>, p67<sup>phox</sup>, p40<sup>phox</sup>, and Rac 1/2 being recruited upon activation, at the membrane level from cytosol [3–5].

Nox4 is a ubiquitous protein with 39% identity to Nox2 [6–8]. Although originally identified and highly expressed in the kidney, Nox4 mRNA was also reported in many human and murine tissues [6,8,9]. Nox4 is a p22<sup>phox</sup>-dependent enzyme which co-immunoprecipitates with p22<sup>phox</sup>, and stabilizes the p22<sup>phox</sup> protein [10]; Contrary to Nox2, the activity of Nox4, is constitutive: it is active without the need for cell stimulation [6,7,11,12] and does not require the assembly of cytosolic factors. P22<sup>phox</sup> is the only component necessary for its activity. Recently, Poldip2 (polymerase

*Abbreviations:* IPTG, Isopropyl β-D-1-thiogalactopyranoside; ER, endoplasmic reticulum; ROS, reactive oxygen species; DFP, Diisopropylfluoro-phosphate; eGFP, enhanced Green Fluorescent Protein; SOD, Superoxide dismutases; CAT, catalase; TIRF, Total Internal Reflection Fluorescence; HEK, human embryonic kidney; VSMC, vascular smooth muscle cell; FAD, flavin adenine dinucleotide.

\* Corresponding author. Tel.: +33 (0) 4 76 76 57 52; fax: +33 (0) 4 76 76 56 08.

*E-mail addresses:* zll1981@hotmail.com (L. Zhang), mvchuong@yahoo.fr (M.V.C. Nguyen), blardy@chu-grenoble.fr (B. Lardy), umbaj@montana.edu (A.J. Jesaitis), alexei.grichine@ujf-grenoble.fr (A. Grichine), francisrousset@yahoo.fr (F. Rousset), Talbot@igr.fr (M. Talbot), MHPaquet@chu-grenoble.fr (M.-H. Paclét), qiangx@shsmu.edu.cn (GuanXiang Qian), FrMorel.enzymo@chu-grenoble.fr (F. Morel).

0300-9084/\$ – see front matter © 2010 Elsevier Masson SAS. All rights reserved.  
doi:10.1016/j.biochi.2010.11.001

DNA-directed delta-interacting protein 2) was introduced as a novel Nox4/p22<sup>phox</sup>-interacting protein: it is a potent positive regulator of Nox4 activity in VSMC [13].

Despite its ubiquitous expression and activity, the primary function of Nox4 derived ROS is not clear. It has been proposed to have a role in oxygen sensing, growth, senescence and differentiation [14]. The abnormal expression and activation of Nox4 may induce tumorigenesis, tumor angiogenesis [15], and be related with the occurrence and development of other diseases, such as hypertension [16,17], atherosclerosis [18], fibrosis [19] and osteoarthritis [20]. Although the reasons for these differences are not quite clear, an important clue to the biological function of Nox4 links to its subcellular localization [21]. Localization studies of Nox4 remain controversial. Nox4 was shown primarily to be located in perinuclear and endoplasmic reticulum regions of COS7, HEK293 and endothelial cells [11], but it was also detected at the plasma membrane [22], focal adhesion and within the nucleus [8]. It may not be surprising that the same protein displays distinct localization in different cell types. However, different Nox4 localization was also reported in human vascular endothelial cells [21,23]. It will be interesting to know whether these different localizations could be due to the specificity between different Nox4 antibodies used. It may also come from the different physiological and pathological state of cells, as different intracellular localization of Nox4 was reported in normal and pathological human thyroid tissues [24].

Although the knowledge of gene expression and Nox4 association with pathologies is rapidly growing, understanding of the role of Nox4 in the production of reactive oxygen species and of regulation mechanism of oxidase activity has been hindered by the lack of specific monoclonal antibodies which are also essential tools to provide direct evidence to topology models and to identify structural features of heterodimer with p22<sup>phox</sup>.

In this present study, we report for the first time the generation and characterization of 5 novel monoclonal antibodies raised against a truncated recombinant protein (residues 206–578) of Nox4, which were then used to clarify the subcellular localization of Nox4 in human embryonic kidney cell lines. These Nox4-reactive mAbs were epitope mapped by phage-display analysis or by immunodetection of recombinant Nox4 truncated constructions and were examined for effects on Nox4 oxidase activity. Due to their respective properties, these mAbs reported in this study will be valuable in characterizing the regulation of Nox4 activity, the subcellular localization/function relationship of Nox4, therefore to provide new drug targets for the effective prevention of diseases related to ROS.

## 2. Materials and methods

### 2.1. Materials

DMEM, fetal bovine serum, neomycin (G418, geneticin) were purchased from GIBCO; Alexa Fluor 488 F(ab') fragment of goat anti-mouse IgG(H + L) was purchased from Invitrogen; ECL Western Blotting Detection reagents were purchased from Amersham Biosciences; complete mini EDTA-free protease inhibitor EASYpack, Atto-565-concanavalin A, Na<sub>4</sub>P<sub>2</sub>O<sub>7</sub>, Na<sub>3</sub>VO<sub>4</sub>, PMSE, luminol, isoluminol, Triton X-100, Chaps, Isopropyl β-D-1-thiogalactopyranoside(IPTG) and monoclonal antibody anti-poly-Histidine-peroxidase were purchased from SIGMA; okadaic acid, leupeptin, pepstatin, trypsin inhibitor, TLCK, and protein G Agarose were purchased from Roche; Hoechst 33258 was purchased from Molecular Probes; DFP was purchased from Acros Organics; GFP mAb and isotype antibodies were purchased from Santa Cruz; Lab-Tek II chamber slide and Lab-Tek chambered coverglass were purchased from Thermo; Goat anti-Mouse IgG-HRP was purchased

from GE healthcare; HiPerFect Transfection Reagent was purchased from QIAGEN; HEK293 T-REX™ Nox4 cells, siRNA a and c were generous gifts from PATIM laboratory, Pr KH. Krause, Geneva university, Switzerland; pET15b ΔT/Stop ZEBRA/MD4-eGFP plasmid was obtained from TheREx laboratory, Pr JL. Lenormand (TIMC-Imag, UMR-CNRS 5525, Grenoble, France).

### 2.2. Cell culture

All cells were cultured in DMEM containing 4.5 g/L glucose and 0.11 g/L sodium pyruvate, supplemented with 10% (v/v) fetal bovine serum and 100 units/ml penicillin and 100 μg/ml streptomycin and 2 mM glutamine at 37 °C in air with 5% CO<sub>2</sub>. Selecting antibiotics, blasticidin (5 μg/ml) and neomycin (400 μg/ml) were used with HEK293 T-REX™ Nox4 cells, while neomycin (500 μg/ml) was used with HEK293 Nox4GFP cells.

### 2.3. Generation of plasmids for the expression of recombinant Nox4 proteins

#### 2.3.1. Truncated Nox4 proteins coupled with a His-tag at the N terminus

pET30b plasmid (Novagen) was used to express NHS-Nox4-1TM protein corresponding to the amino acid 206–578 of Nox4. PCR fragments corresponding to the Nox4 (206–578)-truncated form were obtained by using pEF/Nox4 plasmid as a matrix with the forward primer 5'-GGA AIT CTC CAT GGT CTT GCA TGT TTC AGG AGG GCT GC-3' including a *Nco*I site (underlined) and the reverse primer 5'-GCG TTA CTC GAG TCA GCT GAA AGA CTC TTT ATT GTA TTC-3'. The *Xho*I restriction site of the reverse primers is underlined. The purified PCR product was digested with *Nco*I and *Xho*I and ligated into linearized pET30b plasmid to obtain a plasmid encoding for NHS-Nox4-1TM protein. PCR fragments corresponding to the other various Nox4 truncated forms 1–10 (Table S1) were obtained by using pET30b Nox4-1TM as a matrix with each forward primers and reverse primers (Table S1) including a *Nco*I and *Xho*I restriction site (underlined). The purified PCR products were digested with *Nco*I and *Xho*I and ligated into linearized pET30b plasmid to obtain plasmids encoding for various Nox4 truncated forms (Table S1).

#### 2.3.2. Truncated Nox4 proteins coupled with a His-tag at the C-terminus

pIVEX2.3MCS plasmid (Roche) was used to express Nox4-1TM-CH (AA: 206–578) and Nox4qc-CH (AA: 309–578). PCR fragments corresponding to the Nox4 (206–578) or (309–578)-truncated forms were obtained by using pEF/Nox4 plasmid as a matrix with the forward primer 5'-GGA TGA GCG GCC GCG CCT TGC ATG TTT CAG GAG GGC TGC-3' for Nox4 (206–578) or with the forward primer 5'-GGA TGA GCG GCC GCG CAG TCA CCA TCA TTT CGG TC-3' for Nox4 (309–578) and the reverse primer 5'-GCG TTA CTC GAG TTG CTG AAA GAC TCT TTA TTG TAT TC-3'. The *Xho*I restriction site of the reverse primers is underlined. The purified PCR product was digested with *Not*I and *Xho*I and ligated into linearized pIVEX2.3MCS plasmid.

### 2.4. Nox4 truncated proteins produced by in vitro translation (RTS, rapid translation system)

Expression for each protein was performed using the RTS™ HY100 (Roche Applied Science) according to the manufacturer's instructions. 5 μl of the reaction was used for western blot experiments [25,26].

## 2.5. Generation of monoclonal antibodies raised against Nox4 truncated protein (AA: 206–578)

Mice immunization and monoclonal antibody production were carried out by Biotem Co. Briefly, Balb/c mice were immunized by three intraperitoneal injections of 50 µg NHS-Nox4-1TM (AA: 206–578) used as antigen and diluted with adjuvant. 12 days later, mice received a last injection of antigen. Three days after the last injection, the spleen cells were fused with myeloma cells. Hybrids producing specific monoclonal antibodies which were positive for the antigen and negative for ZEBRA/MD4-GFP protein by ELISA were selected. ELISA-positive hybridoma clones (Biotem Co) were cloned twice. Monoclonal antibodies were produced in the ascite of nude mice. Monoclonal antibodies were purified from ascitic fluid after isotype identification. The isotype for 8E9 and 7C9 is IgM, the isotype for 10B4 is IgG1, the one for 5F9 and 6B11 is IgG2a and IgG2b respectively (Biotem Co.).

## 2.6. Purification of immunoglobulins from ascitic fluids

Ascitic fluids were centrifuged at 10,000g for 10 min at 4 °C. IgG were purified from the supernatant of centrifugation on protein G Sepharose. Depending on the Ig isotype, protein G Sepharose was equilibrated with 100 mM H<sub>3</sub>BO<sub>3</sub> pH8.9 containing 3M NaCl for IgG1 purification or 20 mM Na<sub>2</sub>HPO<sub>4</sub> pH7 for IgG2 purification. After extensive washes, IgG were eluted with 0.1 M glycine pH3 [27]. Purified Ig were dialyzed against PBS and stored at –20 °C. IgG purification was controlled by SDS-PAGE. IgM was purified on Sephacryl S300 by gel filtration [28]. Purified antibodies were dialyzed against PBS and stored at –20 °C.

## 2.7. Expression of various Nox4 truncated forms 1–10 (Table S1)

BL21(λDE3) Codon Plus-RIL bacteria (Stratagen) transformed with different recombinant plasmids were grown in LB medium supplemented with Kanamycin (50 µg/ml) and Chloramphenicol (40 µg/ml) and allowed to grow to reach an OD<sub>600</sub> of 0.7–1, then bacteria were induced by IPTG at a final concentration of 1 mM at 16 °C overnight. Bacteria pellets were lysed by sonication in lysis buffer (50 mM Tris pH7.5, 100 mM NaCl, 15 mM DTT, 0.1% Chaps, 2 µg/ml leupeptin, 2 µg/ml pepstatin, 10 µM TLCK) and the lysates were centrifuged at 10,000g at 4 °C for 10 min to obtain total protein. Supernatant was collected and stored at –80 °C until further use.

## 2.8. Cell-free oxidase assay

Whole cell extracts were prepared using the Chaps lysis buffer. Cells were treated with 3 mM DFP and then lysed in Chaps lysis buffer containing 20 mM Tris–HCl pH7.4, 1% (v/v) Chaps, 150 mM NaCl, 1 mM EDTA, 10 mM Na<sub>4</sub>P<sub>2</sub>O<sub>7</sub>, 10 nM okadaic acid, 2 mM Na<sub>3</sub>VO<sub>4</sub>, 2 µg/ml leupeptin, 2 µg/ml pepstatin, 10 µg/ml trypsin inhibitor, 44 µg/ml PMSF, 10 µM TLCK and complete mini EDTA-free protease inhibitor. After 10 min incubation on ice, the mixture was centrifuged at 10,000g for 10 min at 4 °C and the supernatant was collected. An appropriate amount of cell lysates (50 µg of protein) were pre-incubated with Nox4-specific or irrelevant mAb (40 µg) for 30 min on ice. Then 10 µM FAD was added to the cell lysates in a final volume of 50 µl. After 5 min incubation on ice, cell lysates were transferred to the Corning Costar 96 well Assay Plate. The reaction was initiated by addition of 200 µl PBS containing 20 µM luminol, 10 units/ml horseradish peroxidase, 10 µM FAD and 150 µM NADPH. Photon emission was recorded at 37 °C for 1 h with a luminiscan (LabSystem, Pontoise, France).

## 2.9. SDS/PAGE and Western Blotting

### 2.9.1. In vitro experiments

Mammalian cells were treated with 3 mM DFP and then lysed in Triton lysis buffer containing 20 mM Tris–HCl pH7.4, 1% (v/v) Triton X-100, 150 mM NaCl, 1 mM EDTA, 10 mM Na<sub>4</sub>P<sub>2</sub>O<sub>7</sub>, 10 nM okadaic acid, 2 mM Na<sub>3</sub>VO<sub>4</sub>, 2 µg/ml leupeptin, 2 µg/ml pepstatin, 10 µg/ml trypsin inhibitor, 50 mM NaF, 20 µg/ml aprotinin, 44 µg/ml PMSE, 10 µM TLCK and complete mini EDTA-free protease inhibitor. After 10 min incubation on ice, the mixture was centrifuged at 10,000g for 10 min at 4 °C. Supernatant was collected and stored at –80 °C until further use.

### 2.9.2. In vivo experiments

Homogenate from human renal cortex was prepared in the following Triton lysis buffer containing 20 mM Tris–HCl pH7.4, 1% (v/v) Triton X-100, 150 mM NaCl, 5 mM EDTA, 2 mM Na<sub>3</sub>VO<sub>4</sub>, 10 mM

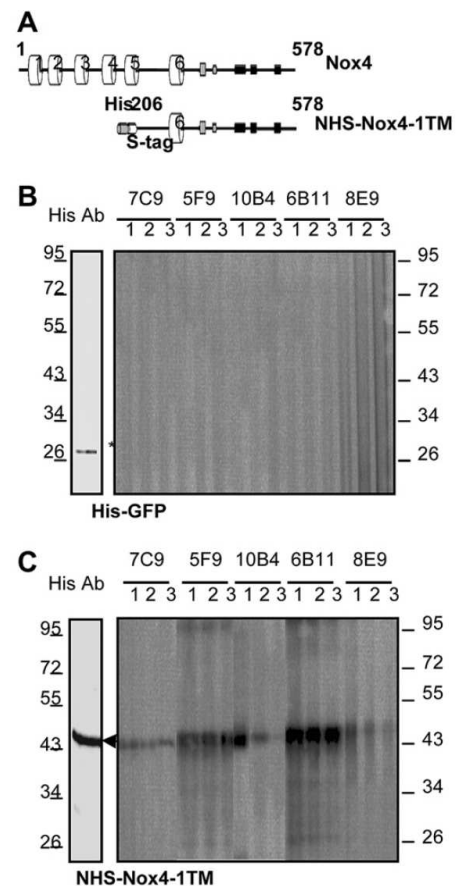

**Fig. 1.** Specificity of novel mAbs directed against the antigen. (A) Schematic representation of the antigen used to develop Nox4 mAbs. Full-length Nox4 is presented at the top of the diagram: transmembrane domains (1–6) are shown in cylindrical. FAD and NADPH binding sites are represented by rectangles, filled gray and black, respectively. The antigen NHS-Nox4-1TM (AA: 206–578, 48 kDa) is a Nox4 truncated form expressed as an N terminal His-tagged protein; (B) Specificity of Nox4 mAbs to the antigen. NHS-Nox4-1TM was produced by IPTG induction and a His-tagged GFP (H-GFP) was synthesized by in vitro translation assay (RTS); they were used to evaluate the specificity of novel mAbs against Nox4. Asterisk indicates the position of H-GFP and arrow indicates the position of NHS-Nox4-1TM added as 1 µl from 1 ml elution fraction. The dilution of the antibodies (ascite) in PBS is indicated as follows: 1, 1/100; 2, 1/500 and 3, 1/1000. Immune complexes were detected by ECL after binding with peroxidase. These pictures are representative of 2 experiments.



Na<sub>4</sub>P<sub>2</sub>O<sub>7</sub>, 10 nM okadaic acid, 20 µg/ml leupeptin, 2 µg/ml pepstatin, 10 µg/ml trypsin inhibitor, 50 mM NaF, 1 mM PMSF, 10 µM TLCK and 20 µg/ml aprotinin using a Dounce homogenizer (Kontes Glass Co., Vineland, N. J.). Homogenate was incubated for 1 h on ice and centrifuged at 10,000g for 15 min at 4 °C. Supernatant was collected and stored at –80 °C until further use.

A fraction aliquot of 10,000g soluble extracts supernatant of HEK293 Nox4GFP cells (200 µg) or of T-REx™ Nox4 cells (200 µg) or of human kidney homogenates (60 µg) or of bacteria (5 µg) was denatured at 60°C for 1 h or 4°C overnight or 95°C for 5 min and loaded on a 10% or 12.5% (p/v) SDS-PAGE for migration and then electro-transferred to nitrocellulose, as previously described [29]. Immunodetection was performed using primary monoclonal antibodies against Nox4 (dilution 1:500) or monoclonal antibody directed against the cytosolic domain of p22<sup>phox</sup> (16G7) (dilution 1:5000) [30] or monoclonal GFP antibody (dilution 1:1000). The immune complexes were detected with a secondary antibody combined with peroxidase (1:5000). The bound peroxidase activity was detected using ECL reagents.

Human kidney sections (5 µm thick) were prepared from paraffin embedded tissues. Briefly, sections were deparaffined with xylene, dehydrated by ethanol and rehydrated with water. After pretreatment, antigen retrieval was done by EDTA pH8 at 98 °C for 40 min. Sections were incubated for 10 min with 3% (v/v) H<sub>2</sub>O<sub>2</sub> in water to quench the endogenous peroxidase activity. Primary antibodies were diluted 1/100, incubated for 60 min at room temperature and thereafter rinsed with PBS. The EnVision (K4007, Dako) signal enhancement system was used to develop the bound antibodies. Sections were counterstained with Mayer's haematoxylin, dehydrated, mounted and examined by light microscope (Leica DMRXA).

### 2.10. Flow cytometry

HEK293 T-REx™ Nox4 cells suspended in PBS/BSA/CaCl<sub>2</sub> (PBS containing 0.2% (w/v) BSA and 0.5 mM CaCl<sub>2</sub>) were neither fixed nor permeabilized, or cells suspended in PBS were fixed with 1% (w/v) paraformaldehyde for 15 min on ice and resuspended at the concentration of 10<sup>7</sup> cells/ml in PBS/BSA/CaCl<sub>2</sub> containing 0.1% (v/v) Triton X-100 for the permeabilization. 10<sup>6</sup> cells were then incubated on ice for 30 min with 5 µg of mouse monoclonal Ig (irrelevant Ig or specific Ig) diluted in 100 µl of PBS/BSA/CaCl<sub>2</sub> buffer. Cells were washed twice and resuspended in 150 µl of the Alexa Fluor 488 goat anti-mouse antibody diluted 1:200 in PBS/BSA/CaCl<sub>2</sub> buffer. After 30 min incubation on ice, cells were washed. Fluorescence intensity (FL1) of the cells was measured on a FACScalibur (Becton Dickinson) cytometer [31].

### 2.11. Phage-display epitope mapping

Monoclonal antibodies 5F9 and 10B4 were epitope mapped by selecting peptide sequences from J404 nonapeptide library [32] by 3 successive rounds of affinity purification on antibodies covalently coupled to Sepharose followed by amplification on bacterial lawns on nutrient media, as previously described [33]. After selection, high affinity mAb-binding clones were identified after replica-plate on nitrocellulose and immunoblot analysis, then purified and sequenced. 24 to 33 nonapeptide sequences were obtained for the 2 mAbs selections and were aligned visually as well as by the EPIMAP algorithm [34].

### 2.12. Confocal microscopy

3 × 10<sup>4</sup> HEK293 T-REx™ Nox4 cells were seeded on chamber slide. When the cells reached ~60% confluence, they were

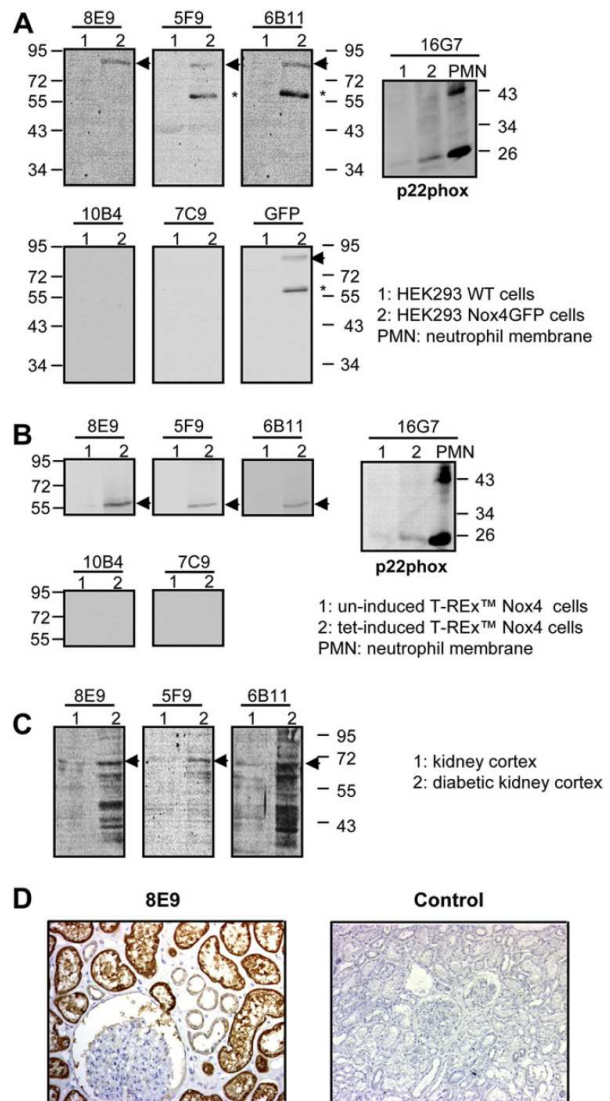

**Fig. 2.** Immunodetection of Nox4 expression in human embryonic kidney cell lines and human kidney cortex. (A) Immunodetection of Nox4GFP or p22<sup>phox</sup> in HEK293 Nox4GFP cells. Total lysates of HEK293 WT cells and HEK293 Nox4GFP cells (200 µg/lane) were analyzed by western blot to evaluate the capacity of Nox4 mAbs (1:500) to bind to Nox4GFP. Proteins were denatured at 4 °C overnight. Control of expression was performed with anti-GFP mAb (1:1000). The expression of p22<sup>phox</sup> was detected by monoclonal antibody anti-p22 (16G7, 1:5000). 1: HEK293 WT cells, 2: HEK293 Nox4GFP cells, PMN: Neutrophil membrane. Arrow indicates full-length Nox4GFP protein (85 kDa), asterisk indicates degraded Nox4GFP protein (58 kDa); (B) Immunodetection of Nox4 or p22<sup>phox</sup> in tet-induced HEK293 T-REx™ Nox4 cells. Total lysates of un-induced and tet-induced HEK293 T-REx™ Nox4 cells (200 µg/lane) were analyzed by western blot using 5 Nox4 mAbs (1:500) or monoclonal antibody anti-p22 (16G7, 1:5000). Arrow indicates full-length Nox4 protein (58 kDa). 1: un-induced T-REx™ Nox4 cells, 2: tet-induced T-REx™ Nox4 cells, PMN: Neutrophil membrane. Immune complexes were detected by ECL after binding with peroxidase. These pictures are representative of at least 5 experiments; (C) Immunodetection of Nox4 in human kidney cortex. Homogenates were prepared in Triton X-100 lysis buffer using a Dounce homogenizer from human renal cortex as described in materials and methods; they were incubated for 1 h on ice and centrifuged at 10,000g for 15 min at 4 °C. Proteins presented in the soluble fraction (supernatant) were denatured at 4 °C overnight and analyzed by western blot (60 µg/lane). Expression of Nox4 was checked by 3 purified Nox4 mAbs 8E9 (1:500), 5F9 (1:500), 6B11 (1:500). 1: normal kidney cortex, 2: diabetic kidney cortex. Immune complexes were detected by ECL after binding with peroxidase. Immunodetection of Nox4 by mAbs 8E9 and 5F9 was repeated twice. (D) Immunohistochemical detection of Nox4 on human kidney sections by purified mAb 8E9 (1:100) or without 8E9 (control). Photographed and printed to a final magnification of ×100 for the left picture, and ×50 for the right (control).

incubated for 16 h with tetracycline to induce Nox4 expression. Un-induced and induced HEK293 T-REx™ Nox4 cells were fixed with 4% (w/v) paraformaldehyde for 10 min at room temperature. Paraformaldehyde fluorescence was then quenched by 50 mM NH<sub>4</sub>Cl for 10 min at room temperature. After two washes with PBS, cells were unpermeabilized or permeabilized with 0.1% (v/v) Triton X-100 for 5 min at room temperature, followed by two washes with PBS containing 1% (w/v) BSA; Then cells were incubated for 1 h at room temperature with 5 µg of mouse monoclonal Ig (irrelevant Ig or specific Ig) diluted in 200 µl of PBS/BSA/CaCl<sub>2</sub> buffer. Following washes, a secondary Alexa Fluor 488 goat anti-mouse antibody (1:1000 in PBS containing 1% (w/v) BSA) were added. After a 1 h-incubation, cells were then washed with PBS containing 1% (w/v) BSA.

$1 \times 10^5$  HEK293 Nox4GFP cells were seeded on chamber slide. When the cells reached ~80% confluence, they were fixed with 4% (w/v) paraformaldehyde for 10 min at room temperature. Paraformaldehyde fluorescence was quenched by 50 mM NH<sub>4</sub>Cl for 10 min at room temperature. Cells were then washed with PBS.

Cell nuclei were stained with Hoechst 33258 (0.5 µg/ml). Samples were then mounted in DABCO solution, sealed, and stored at 4 °C in the dark. Confocal microscopy was carried out by using the Zeiss LSM 510 NLO META. In the green channel, the pinhole was

adjusted to 1 Airy unit resulting in 0.7 µm thick slices. Hoechst fluorescence was visualised using a 2P excitation.

### 2.13. Total internal reflection fluorescence microscopy TIRF

$2 \times 10^4$  HEK293 T-REx™ Nox4 cells were seeded on chambered coverglass. When the cells reached ~60% confluence, they were incubated for 16 h with tetracycline to induce Nox4 expression. Un-induced and induced HEK293 T-REx™ Nox4 cells were fixed with 4% (w/v) paraformaldehyde for 10 min at room temperature. Paraformaldehyde fluorescence was then quenched by 50 mM NH<sub>4</sub>Cl for 10 min at room temperature. After two washes with PBS, cells were incubated with concanavalin A atto-565 conjugated (6 µg/ml) for 30 min. After washing with PBS once, cells were unpermeabilized or permeabilized with 0.1% (v/v) Triton X-100 for 5 min at room temperature, followed by two washes with PBS containing 1% (w/v) BSA; Then following with the incubation of primary antibodies against Calnexin (1:500) or Nox4 (5 µg) and 2nd antibodies (1:1000) as confocal microscopy. Samples were incubated with PBS containing 1% (w/v) BSA and stored at 4 °C in the dark, then observed with a TIRF microscope Axiovert 200M (Carl Zeiss) equipped with the 100×/1.46 plan-apochromat objective. The evanescent field was excited with 488

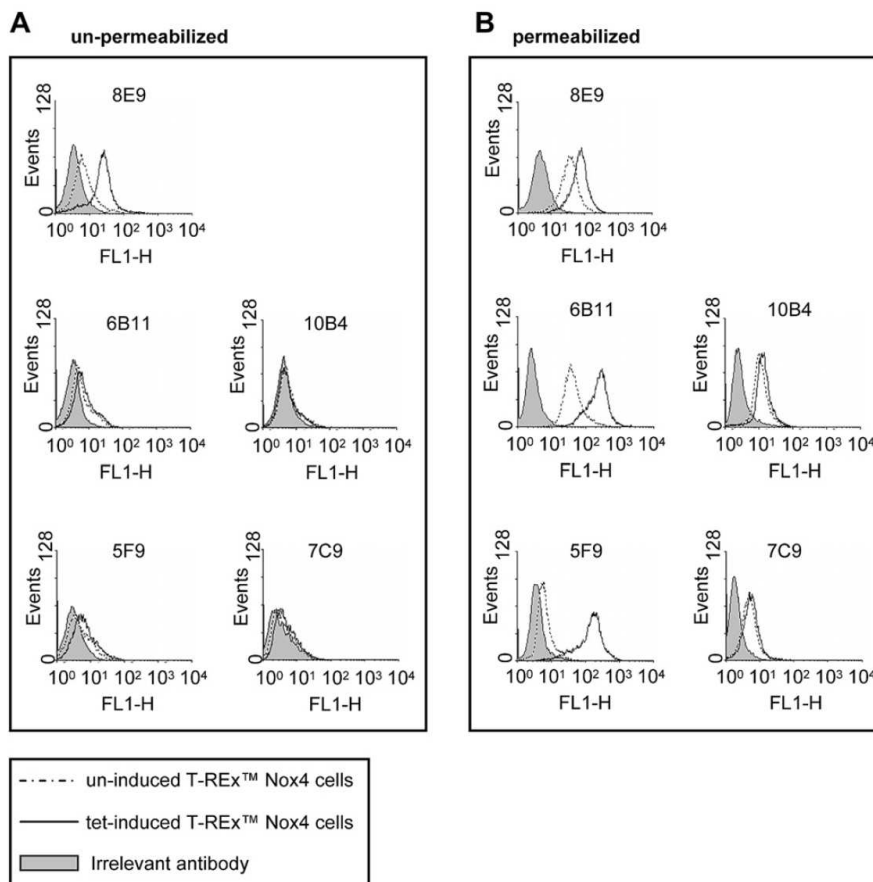

**Fig. 3.** Flow-cytometry analysis of Nox4 expression in tet-induced T-REx™ Nox4 cells. Un-induced (dotted line) and tet-induced (solid line) T-REx™ Nox4 cells ( $10^6$  cells) were unpermeabilized (A) or fixed with 1% (w/v) paraformaldehyde and permeabilized (B) with 0.1% Triton X-100 and labelled with specific and purified Nox4 mAbs (5 µg) (white area) or irrelevant (IR) mAb (5 µg) (gray area) for 30 min on ice as described in materials and methods. The antibody-labelled cells were stained with the second antibody (Alexa Fluor 488 goat anti-mouse, 1:200), and the fluorescence (FL1) was measured by FACS. These pictures are representative of at least 3 experiments.

or 514 nm Ar laser lines and fluorescence was detected in green or red channel respectively.

#### 2.14. Statistical data

Data are presented as means  $\pm$  S.D., significance levels are assessed using Student's *t*-test. A *p*-value of 0.05 or less between groups is considered to indicate a statistically significant difference.

### 3. Results

#### 3.1. Production of a recombinant NADPH oxidase truncated Nox4

In order to investigate subcellular localization and topology of Nox4, 5 novel monoclonal antibodies, named 5F9, 6B11, 8E9, 10B4, 7C9, were developed. The antigen used for the immunization of the mice corresponds to a Nox4 truncated protein from the amino acid 206 to 578 and named NHS-Nox4-ITM (Fig. 1A). This truncated protein contained the cytosolic part of Nox4 plus the 6th potential transmembrane helix, the last extracellular loop between the 5th and 6th transmembrane helices and a poly-histidine tag at the N terminal position. BL21( $\lambda$ DE3) Codon Plus-RIL bacteria were transformed with the plasmid encoding for NHS-Nox4-ITM protein and the protein was produced upon IPTG induction. The overexpressed protein was mainly insoluble (Fig. S1A, lane 3). Denatured protein (urea 8 M) was purified from inclusion bodies and partially refolded in column by a decreasing gradient of urea (from 8 M to 2 M) (Fig. S1B). In order to avoid the selection of antibody directed against the histidine tag, a negative control antigen, ZEBRA/MD4-eGFP protein which contains the same poly-histidine tag, was expressed (Fig. S1B, right panel). After immunization, sera and hybridoma supernatants were both controlled and shown to be positive with the antigen and negative with ZEBRA/MD4-GFP by ELISA (Biotem company).

#### 3.2. Validation and characterization of 5 novel monoclonal antibodies raised against recombinant Nox4

The specificity of these antibodies was first validated by western blot using the antigen NHS-Nox4-ITM and a recombinant eGFP

protein containing a histidine tag. All of the ascitic fluids of mAbs recognized the antigen (Fig. 1B, lower panel) by western blot but did not bind to the histidine tagged eGFP at different concentrations (Fig. 1B, upper panel), excluding the possibility of the recognition of mAbs to the histidine tag.

Next, we investigated the ability of the 5 purified mAbs to bind the full-length Nox4 *ex vivo* by using 2 cell lines: HEK293 cells overexpressing Nox4 fused with a GFP tag at the C-terminus and HEK293 T-REx<sup>TM</sup> Nox4 cells which overexpress Nox4 upon tetracycline (tet) induction. In both models, Nox4 protein expressed upon tet-induction or fused with a GFP tag were fully functional, an O<sub>2</sub><sup>-</sup> generating, SOD-sensitive Nox4 activity was detected compared to HEK293 WT cells and to un-induced HEK293 T-REx<sup>TM</sup> Nox4 cells (Fig. S2). First, GFP mAb was used as a positive control to detect Nox4GFP in HEK293 Nox4GFP cells (Fig. S3). The protein denaturation at 4 °C overnight allowed the detection of two forms: an 85 kDa form (arrows), corresponding to the predicted molecular weight of the full-length Nox4GFP (58 kDa plus 27 kDa for GFP) and a 58 kDa form (asterisk) that may be a degraded form of Nox4GFP (31 kDa for the degraded Nox4 plus 27 kDa for GFP). In contrast, the 60 °C denaturation protocol leads to the only detection of the 58 kDa form suggesting a high sensitivity of Nox4 to heat degradation. Therefore, all samples were treated at 4 °C for further western blot experiments. The intact Nox4GFP protein was recognized by only three purified Nox4 mAbs (8E9, 5F9, 6B11) and GFP mAb in HEK293 Nox4GFP cell lysates compared to the wild type cell lysates (Fig. 2A, arrows). To confirm the specificity of the signal observed, we used a RNA interference (RNAi) approach with small interfering RNA (siRNA) targeting Nox4 mRNA (Nox4 siRNA) (Fig. S4). One of the two siRNAs, siRNA a decreased the expression of Nox4GFP by ~80% compared to the cells transfected with scrambled siRNA (Fig. S4A). This is consistent with the decrease tendency of the NADPH oxidase activity observed with these siRNAs (Fig. S4B). Similar results were observed by using HEK293 T-REx<sup>TM</sup> Nox4 cells. Upon tet-induction, a band at about 58 kDa was recognized by the same three purified Nox4 mAbs 8E9, 5F9 and 6B11 compared to un-induced T-REx<sup>TM</sup> Nox4 cells (Fig. 2B). Furthermore, Nox4 proteins were also able to interact with p22<sup>phox</sup> and stabilized its expression as shown by the increase of p22<sup>phox</sup> expression in HEK293 Nox4GFP cells and tet-induced HEK293

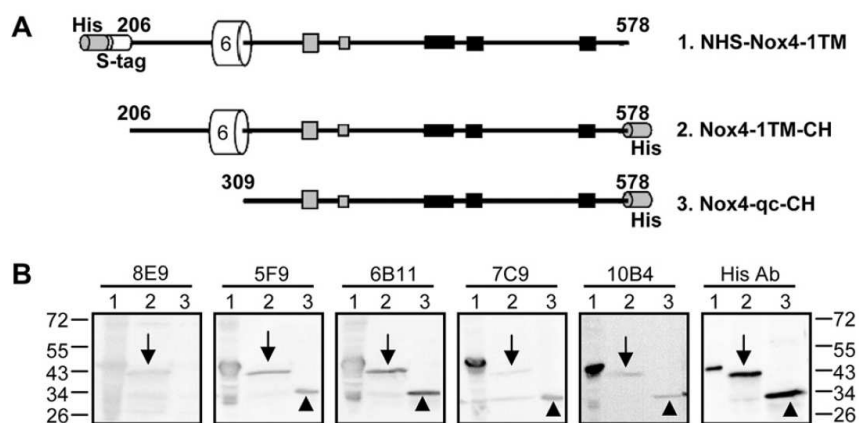

**Fig. 4.** Evaluation of novel mAbs binding to Nox4 truncated recombinant proteins. (A) Schematic representation of Nox4 truncated recombinant proteins. NHS-Nox4-ITM: residue 206–578 with His-tag and S-tag at N terminal (48 kDa) was expressed in bacteria by IPTG induction; Nox4-ITM-CH (residue 206–578 with His-tag at C-terminal (45 kDa)) and Nox4qc-CH (residue 309–578 with His-tag at C-terminal (32 kDa)) were synthesized by *in vitro* translation assay (RTS); (B) Western blot analysis of Nox4 truncated recombinant proteins. (1): NHS-Nox4-ITM (1  $\mu$ l from 1 ml of elution fraction); (2): Nox4-ITM-CH; (3): Nox4qc-CH, 5  $\mu$ l from 30  $\mu$ l of reaction medium for (2) and (3). Expression of all truncated recombinant proteins was checked by using the monoclonal antibody anti-polyhistidine (1:5000). The binding of the 5 mAbs (1:500), ascite except for 8E9, to Nox4 truncated forms was analyzed to determine their epitope regions. Immune complexes were detected by ECL after binding with peroxidase. Arrow indicates the position of truncated form Nox4-ITM-CH, arrow head indicates the position of truncated form Nox4qc-CH. These pictures are representative of 2 or 3 experiments.

T-REx™ Nox4 cells compared to their respective negative controls by western blot (Fig. 2A and B). Since Nox4 is widely expressed in kidney, we investigated the expression of Nox4 in human kidney cortex by using the 3 functional purified Nox4 monoclonal antibodies. A positive band at about 68 kDa was detected both in diabetic and non-diabetic kidney cortex. Moreover, the expression of Nox4 was increased in diabetic kidney cortex compared with non-diabetic controls (Fig. 2C, arrows) as described by Gorin et al. [35]. Meanwhile, commassie blue staining of the gel was used to assess the loading quantity of each well (data not shown). We confirmed the presence of Nox4 in kidney tissues by immunohistochemistry (Fig. 2D).

The specificity of these mAbs raised against Nox4 was tested against purified cytochrome *b*<sub>558</sub>. The results show no cross reaction with Nox2 (data not shown).

The binding of the 5 purified mAbs to native antigen was further investigated by flow cytometry on intact and Triton X-100 permeabilized T-REx™ Nox4 cells. The results showed that 3 purified mAbs (5F9, 6B11 and 8E9) bound to Nox4 upon permeabilization (Fig. 3B) while only mAb 8E9 recognized Nox4 in intact cells (Fig. 3A). These data suggested that 8E9 recognized an extracellular epitope on Nox4 whereas 5F9 and 6B11 bound to an intracellular domain.

### 3.3. Determination of mAb epitope regions using different truncated forms of Nox4

Protein alignments of different NADPH oxidases revealed that the last extracellular loop of Nox4 (E loop) contains a more extended amino acid sequence than the other Nox family members. To determine if some of these mAbs could recognize the E loop, we evaluated the immunoreactivity of these mAbs against the cytosolic tail of Nox4, Nox4qc-CH (Fig. 4A). As we can see in Fig. 4B, the ascites of 5F9, 6B11, 7C9 and 10B4 recognized Nox4qc-CH suggesting a cytosolic epitope on Nox4 while mAb 8E9 did not. The data favor a localization of the mAb 8E9 epitope on the extracellular E loop, consistent with the results of FACS (Fig. 3A). Furthermore, since NHS-Nox4-1TM possesses an S-tag sequence, by using a recombinant protein (Nox4-1TM-CH) sharing the same amino acid sequence of Nox4 (amino acid 206–578) but without S-tag, we ruled out the possibility that mAbs could be directed against this sequence and demonstrated their specificity towards Nox4 (Fig. 4B).

Then, different Nox4 truncated forms containing a poly-histidine tag at the N-terminal position (Fig. 5A, Table. S1) were used to further determine the epitope regions of these novel purified Nox4 mAbs. As results shown by Fig. 5C, mAb 8E9 could recognize the Nox4 truncated form 10 but not 7 and 3; combined with previous results that mAb 8E9 failed to recognize Nox4qc-CH (Fig. 4B), these data together showed that its epitope region was on the extracellular E loop of Nox4 (222H–E241). Both mAbs 6B11 and 5F9 recognized a region at the C-terminal part of Nox4 (389S–P416). As mAbs 10B4 and 7C9 could not label Nox4 in two cell lines by western blot and FACS, the reactivity difference between ascite and mAb was studied. By using the same recombinant proteins (NHS-Nox4-1TM and Nox4-1TM-CH), we found that neither mAb 10B4 nor mAb 7C9 could bind these two recombinant proteins when using the same dilution of their ascites (Fig. S5A). This is contrary to what is obtained with both mAb 5F9 and its ascite (Fig. S5). The binding of mAb 10B4 to NHS-Nox4-1TM but not to NHS-Nox4qc was observed only when its concentration was increased up to 1:50. For mAb 7C9, different concentrations of this antibody were used to detect the recombinant protein NHS-Nox4-1TM. As seen in Fig. S5B, the signal of specific band (NHS-Nox4-1TM, arrow) recognized by mAb 7C9 was stronger than unspecific band (asterisk) until the dilution was increased up to 1:25. Due to the weak reactivity of mAbs 10B4 and 7C9, mAb 10B4

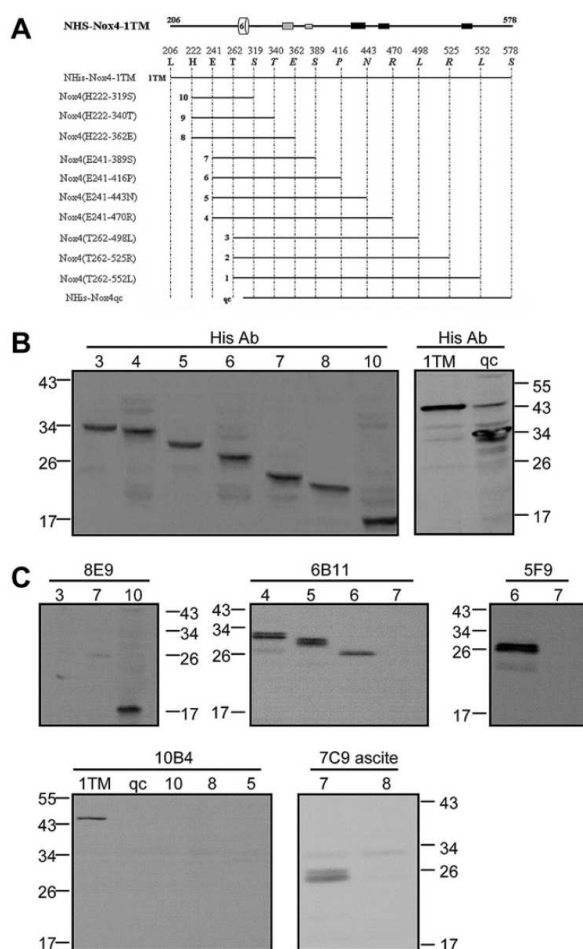

**Fig. 5.** Determination of mAb epitope regions by using Nox4 truncated recombinant proteins. (A) Schematic representation of Nox4 truncated recombinant proteins expressed in bacteria by IPTG induction. 1–10 indicate the number of each different truncated recombinant protein, the letters in non-italic and italic indicate the beginning and ending AA of each truncated recombinant protein, respectively; (B) Western blot analysis of Nox4 truncated recombinant proteins. Expression of the truncated recombinant proteins (1  $\mu$ l from 1 ml of elution fraction) was checked by using the monoclonal antibody anti-polyhistidine (1:5000); (C) Determination of mAb epitope regions by using different truncated Nox4 recombinant proteins. 8E9(1:500), 5F9 (1:500), 6B11(1:500) and 10B4(1:50) used here were purified mAbs, while 7C9(1:500) used here was ascite. Immune complexes were detected by ECL after binding with peroxidase. These pictures are representative of 2 or 3 experiments.

(dilution: 1:50) and ascite 7C9 were used to study their epitope regions. As seen in Fig. 5C, mAb 10B4 recognized only Nox4-1TM but neither Nox4qc nor Nox4 truncated form 10, this result suggesting that its epitope region was on the extracellular E loop of Nox4 (206L–H222); for the ascite 7C9 which could recognize the Nox4 truncated form 7 but not 8, the result showed that it bound a region at the C-terminal part of Nox4 (362E–S389). The expression of all these Nox4 truncated forms used was confirmed by histidine antibody at each right size (Fig. 5B).

### 3.4. Determination of mAb epitopes by phage display

To define the antibody epitopes, phage-display analysis was applied as previously reported [27,30]. After immunopurification

on mAb affinity matrices, several unique peptide sequences were identified for mAbs 5F9 and 10B4 (Fig. 6). Alignments of the peptide sequences recognized by mAbs 5F9 and 10B4 revealed the amino acid residues <sup>392</sup>DSEILPF<sup>398</sup> which are present in the cytosolic tail of Nox4 and <sup>210</sup>GLLKYQTNL<sup>219</sup> which are present on the extracellular E loop of Nox4, respectively (Fig. 6A and B, lower panel). To gain a more comprehensive understanding of the mAbs 5F9 and 10B4 epitopes, an extensive analysis of the peptide sequences obtained by phage display was performed by using the computer program EPIMAP in order to map the epitopes to discontinuous segments of the protein that are distant in the primary sequence, but are in close spatial proximity in the structure. Histograms resulting from EPIMAP software analysis confirmed a matching of the mAbs 5F9 and 10B4 consensus sequences on the region of Nox4 <sup>392</sup>DSEILPF<sup>398</sup> and <sup>210</sup>GLLKYQTNL<sup>219</sup> (Fig. 6A and B, upper panel).

### 3.5. Subcellular localization of Nox4

The immunoreactivity of mAb 8E9 on non-permeabilized cells (Fig. 3A) suggests that Nox4 could be expressed at the plasma membrane of tet-induced T-REX<sup>TM</sup> Nox4 cells. To provide a direct evidence of this specific subcellular localization, we looked at Nox4 subcellular distribution by confocal microscopy. As 8E9 recognized an extracellular epitope on Nox4 whereas 5F9 and 6B11 bound to an intracellular domain (Fig. 3), 8E9 or 5F9 and 6B11 were used to observe the localization of Nox4 in intact or permeabilized cells

respectively. When cells were not permeabilized, by using mAb 8E9, Nox4 was observed only at the plasma membrane of tet-induced T-REX<sup>TM</sup> Nox4 cells compared to un-induced T-REX<sup>TM</sup> Nox4 cells (Fig. 7A). After permeabilization, Nox4 was detected as well at the plasma membrane than in the perinuclear and endoplasmic reticulum regions (Fig. 7B, lower panel) by mAb 6B11. This multi-cellular distribution was confirmed by the same fluorescence localization of Nox4GFP protein (Fig. 7C). Interestingly, the labelling of mAb 5F9 was mainly intracellular and no clear signal could be observed at the plasma membrane (Fig. 7B, upper panel).

The localization of Nox4 at the plasma membrane in tet-induced T-REX<sup>TM</sup> Nox4 cells was further confirmed by Total Internal Reflection Fluorescence (TIRF) microscopy, in which the plasma membrane close to the glass surface is visualised preferentially due to the small penetration depth of the evanescent excitation field (<150 nm). Concanavalin A, a plasma membrane marker and calnexin, an endoplasmic reticulum marker, were used as a positive and a negative control respectively. Thus, only the fluorescence signal of concanavalin A at the plasma membrane could be seen but not that of calnexin by TIRF (Fig. 8A). As shown in the Fig. 8B, a positive signal was obtained by using mAbs 8E9 and 6B11 only in tet-induced HEK293 T-REX<sup>TM</sup> Nox4 indicating a localization of Nox4 at the plasma membrane. On the contrary, no fluorescence could be observed by TIRF with mAb 5F9 showing that this antibody is unable to bind to Nox4 at the plasma membrane (Fig. 8B). This result is consistent with the absence of fluorescence observed with

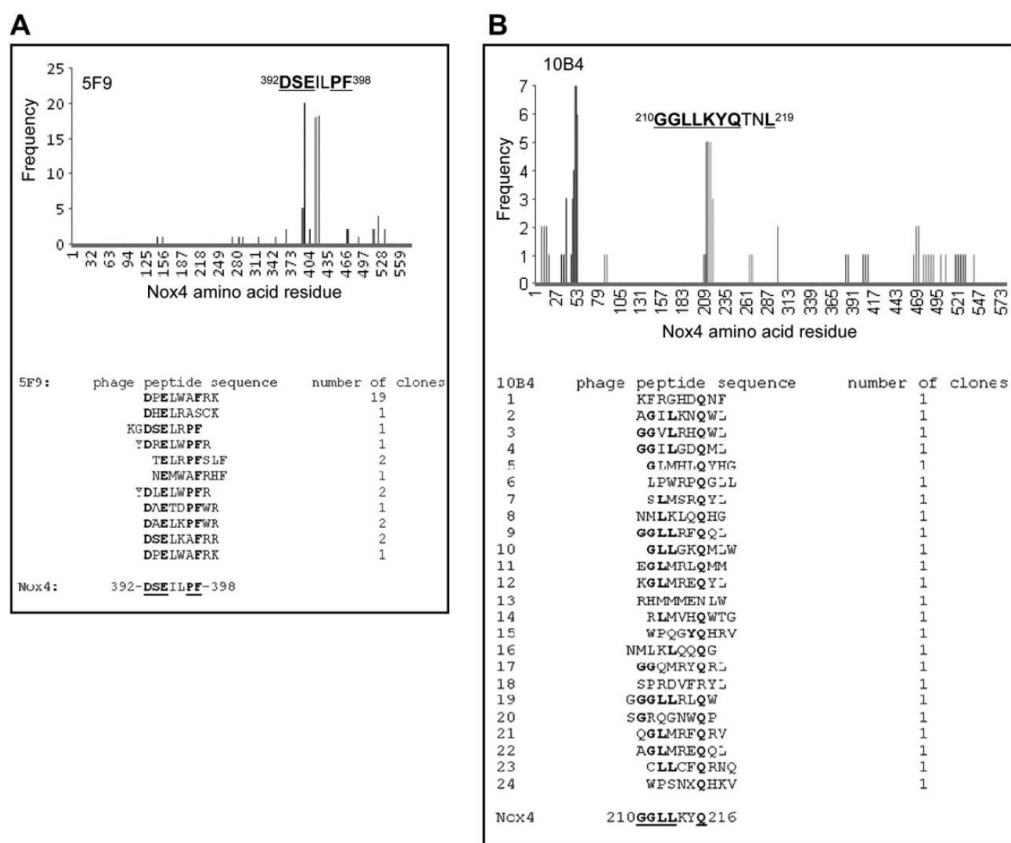

**Fig. 6.** EPIMAP analysis for mAbs 5F9 and 10B4. Alignment of phage sequences of mAbs 5F9(A) and 10B4(B) to discontinuous protein regions of Nox4 by using the program EPIMAP. Histograms presented the frequency of phage-peptide amino acids recovered in the target protein sequence (upper panel); the potential epitope is presented in frame with amino acids belonging to Nox4 (lower panel).

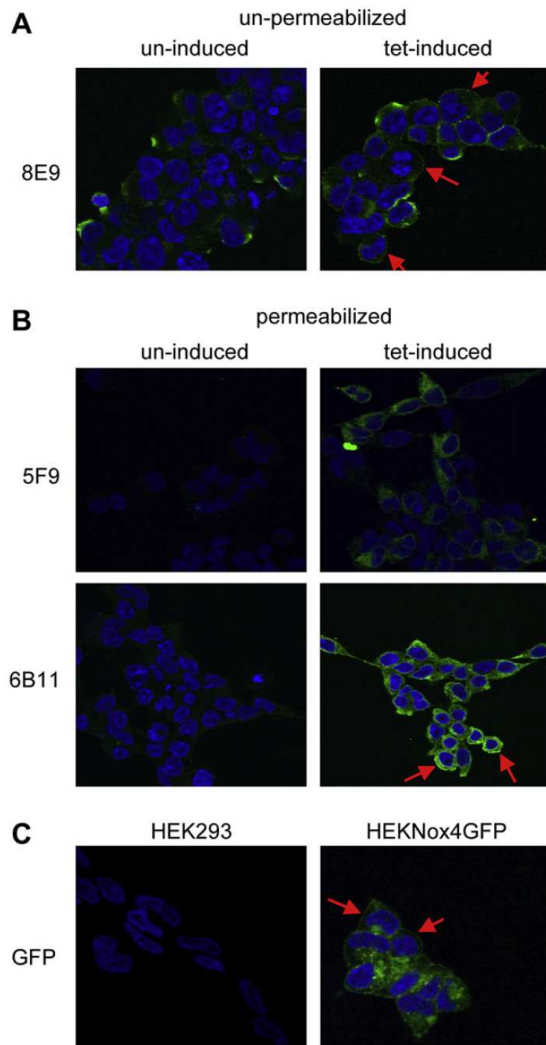

**Fig. 7.** Subcellular localization of Nox4 by confocal microscopy. Un-induced and tet-induced HEK293 T-REX<sup>TM</sup> Nox4 cells ( $1 \times 10^5$  cells) were fixed, unpermeabilized(A) or permeabilized(B) with 0.1% Triton X-100 and labelled with Nox4 mAbs 8E9, 5F9, 6B11 (5  $\mu$ g) for 1 h at room temperature as described in Methods. The second antibody (Alexa Fluor 488 goat anti-mouse, 1:1000) was used to detect mAb binding by confocal microscopy. (C) HEK293 wild type cells and HEK293 Nox4GFP were fixed, GFP fluorescence was detected by confocal microscopy. Arrows indicated the plasma membrane of the cells. These pictures are representative of 2 or 3 experiments.

the same antibody at the plasma membrane by confocal microscopy (Fig. 7B, upper panel).

### 3.6. Effect of Nox4 mAbs on the constitutive NADPH oxidase activity *in vitro*

In order to identify specific inhibitors of Nox4 activity, the effect of mAbs on the NADPH oxidase activity in a cell-free system was analyzed. In this experiment, total lysates of tet-induced T-REX<sup>TM</sup> Nox4 cells were pre-incubated with an excess of mAb for 30 min on ice before adding reaction mixture which contained 20  $\mu$ M luminol, 10 units/ml horseradish peroxidase, 10  $\mu$ M FAD and 150  $\mu$ M NADPH. A control experiment was performed with an irrelevant antibody.

Contrary to 8E9, the presence of mAb 6B11 or 5F9 in the assay resulted in a moderate but significant inhibition of the NADPH oxidase activity of  $\sim 25\%$  compared to the activity measured in the presence of an irrelevant mAb (Fig. 9).

## 4. Discussion

Five monoclonal antibodies specific to Nox4 were raised for the first time and characterized in the present work. Among these mAbs, 3 of them, 8E9, 6B11 and 5F9, could recognize native over-expressed Nox4 in HEK293 cells, tet-induced T-REX<sup>TM</sup> Nox4 cells and C20/A-4 human chondrocyte cell lines (unpublished data). The current findings focus on distinct properties of these mAbs referring to identification and subcellular localization of Nox4 as NADPH oxidase activity.

The theoretical size of Nox4 is 66.9 kDa (expasy, proteomic server), as shown for the first time by Shiose et al. [7]. By consequence, the fused protein Nox4-GFP should appear at a size of 93.9 kDa. It has been reported that Nox4 antibodies recognize two kinds of bands: one of 75–80 kDa and a second of 55–65 kDa from endogenous Nox4 expressing cells and/or Nox4-overexpressing cells by Martyn et al. [11], Kawahara et al. [12], and Hilenski et al. [36]. As for us, Nox4 was detected using two different cell lines (HEK293 overexpressing Nox4GFP and the Tet-induction model HEK293 T-RexNox4) at the size of 58 kDa instead of 66.9 kDa. This size, for Nox4 was also observed by Ambasta et al. [10], Martyn et al. [11], Kawahara et al. [12], and Von Löhneysen et al. [22]. 68 kDa is the size of Nox4 detected in kidney cortex, which has also been reported by [35,37,38]. Immunohistochemical experiments highlighted the presence of Nox4 in kidney (Fig. 2D) as well as in thyroid tissues (data not shown). The difference of size of Nox4 might suggest that the protein is more glycosylated in the tissues or less degraded. The degradation process of Nox4 may depend on the modalities of storage and freezing and thawing, and on the procedure of cell homogenization and protein extraction. In this paper we emphasized also (Fig. S3) the great sensitivity of Nox4 to the temperature and the necessary addition to sample fraction not only of an anti-protease cocktail but also of vanadate and okadaic acid reagents that inhibit phosphatases; moreover the SDS solubilisation procedure has to be carried out at 4 °C.

As reported recently [11,39], Nox4 was shown to be located in the ER of HEK293 transfected cells. In our study, the binding of mAb 8E9 to intact tet-induced T-REX<sup>TM</sup> Nox4 cells in FACS analysis favors a plasma membrane localization of Nox4 (Fig. 3A). By confocal microscopy, we confirmed its localization in ER, but we demonstrated that Nox4 is also present in the plasma membrane of tet-induced T-REX<sup>TM</sup> Nox4 cells (Fig. 7) and C20/A-4 human chondrocyte cells (unpublished data) by using mAbs 8E9 and 6B11. The data were further confirmed by total internal reflection fluorescence microscopy (TIRF) (Fig. 8). Nox4 has been detected in several cellular compartments: in transfected cells. Nox4 was localized in the ER [11,21] or plasma membrane [22,40]; in endothelial cells [23] and smooth muscle cells [36], the localization of Nox4 was reported within the nucleus; in vascular smooth muscle cells, a localization close to focal adhesion was reported [36]. Moreover, in somatic cells, Nox4 was detected in mitochondria [41]. It is uncertain whether these contradicting findings are a consequence of so-far unknown partner of Nox4 changing the localization of Nox4 or of potential problems arising from the overexpression of a membrane protein per se or of the specificity of the different Nox4 antibodies used. It is also possible that the localization of Nox4 changes with the functional or pathological state of the cells [24]. In fact, in vascular smooth muscle cells, Nox4 relocates from focal adhesions to stress fibers during differentiation [42]. This also reflects the cell-specific targeting of Nox4 or the different

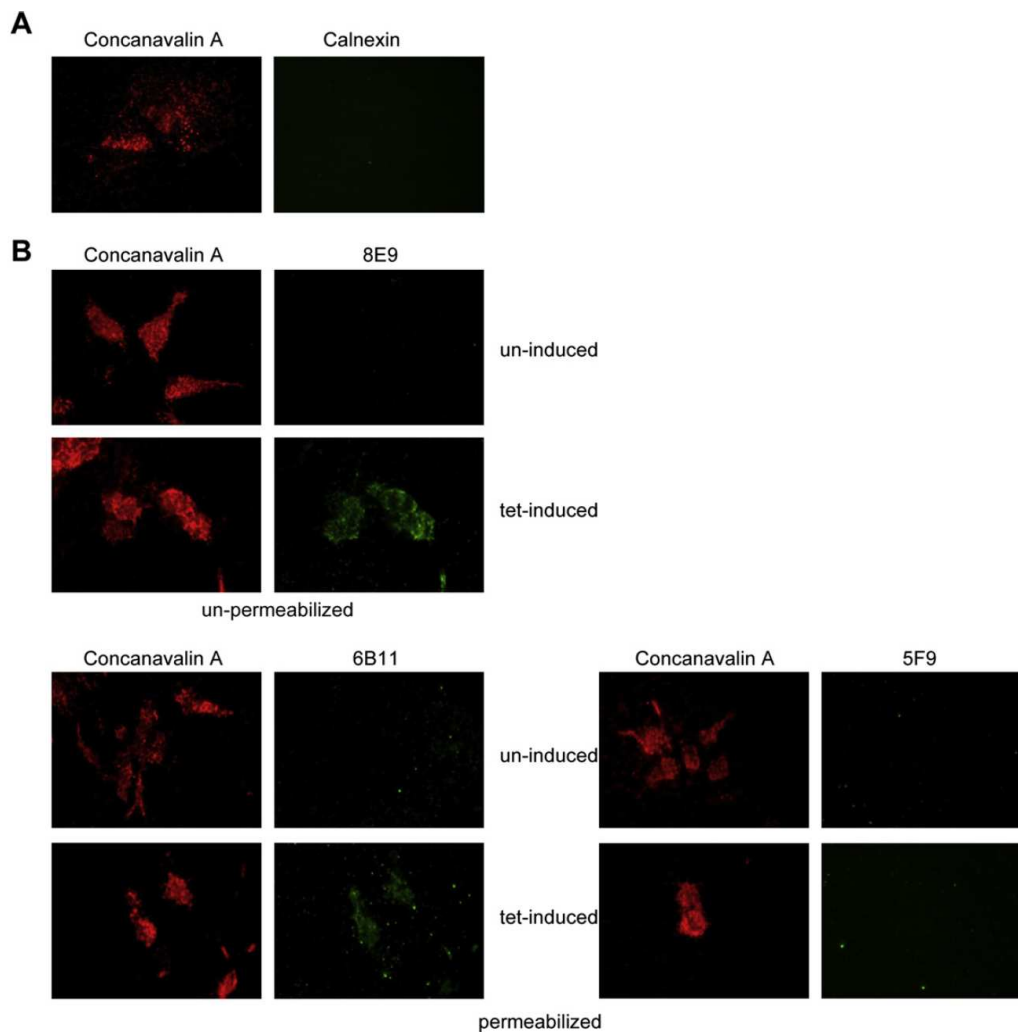

**Fig. 8.** Subcellular localization of Nox4 by total internal reflection fluorescence microscopy. (A) TIRF signals of plasma membrane and ER in permeabilized tet-induced HEK293 T-REx™ Nox4 cells. Cells were labelled with concanavalin A atto-565 conjugated (plasma membrane marker, red) (6 µg/ml) and mouse anti-calnexin monoclonal antibody (ER marker, 1:500) following with Alexa Fluor 488 goat anti-mouse (green) (1:1000); (B) TIRF signals of concanavalin A and Nox4 in un-induced and tet-induced HEK293 T-REx™ Nox4 cells, unpermeabilized (upper panel) or permeabilized (lower panel). Red indicates the concanavalin A (6 µg/ml) on the plasma membrane, green indicates the Nox4 expression detected by Nox4 mAbs (5 µg). These pictures are representative of 2 experiments. (For interpretation of the references to colour in this figure legend, the reader is referred to the web version of this article).

specificity of Nox4 antibodies [43]. Plasma membrane localization of Nox4 is in favor of a ROS production directly in the extracellular medium. Most studies showed that  $H_2O_2$  is the principal source of ROS detected outside of cells [11,21,37]; However, Boudreau et al. [19] recently reported that  $O_2^-$  is synthesized in the extracellular medium of hepatocytes. We also detected the  $O_2^-$  release from tet-induced T-REx™ Nox4 cells and HEK293 Nox4GFP cells (Fig. S2).

Surprisingly, mAb 5F9 was not able to label Nox4 at the plasma membrane. Phage-display epitope mapping suggested that mAb 5F9 interacts with ( $^{392}D-F^{398}$ ) region of Nox4. Three possibilities could explain such a result: (1) Nox4 may change its conformation once transferred to the plasma membrane and therefore could hide the epitope of 5F9; (2) additional Nox4 partner such as Poldip2 [13] which influence Nox4 subcellular localization in VSMC may bind to this epitope region; (3) the permeabilization process could alter the epitope of 5F9. We are working on directed mutagenesis in this

region to study strategic AA residues referring to the localization and activity of Nox4.

The inability of mAbs against Nox4 (except mAb 8E9) to bind intact tet-induced T-REx™ Nox4 cells in FACS analysis provides support for topology models localizing these respective regions to the cytoplasmic portion of Nox4, while the epitope of mAb 8E9 is accessible on the E loop. But this could not completely rule out the possibility of extracellular regions of Nox4 being masked on the cell surface. In fact, the epitope determination by using different truncated forms of Nox4 and by phage display showed that the epitope of 10B4 was on the E loop of Nox4 ( $^{210}GLLKYQTNL^{219}$ ), although the frequency of consensus sequence is low (Fig. 6B). The failing of 10B4 and 7C9 mAbs to recognize Nox4 in native cells may be due to a low sensitivity of mAbs; interaction forces between mAbs and native or recombinant antigen remain to be addressed.

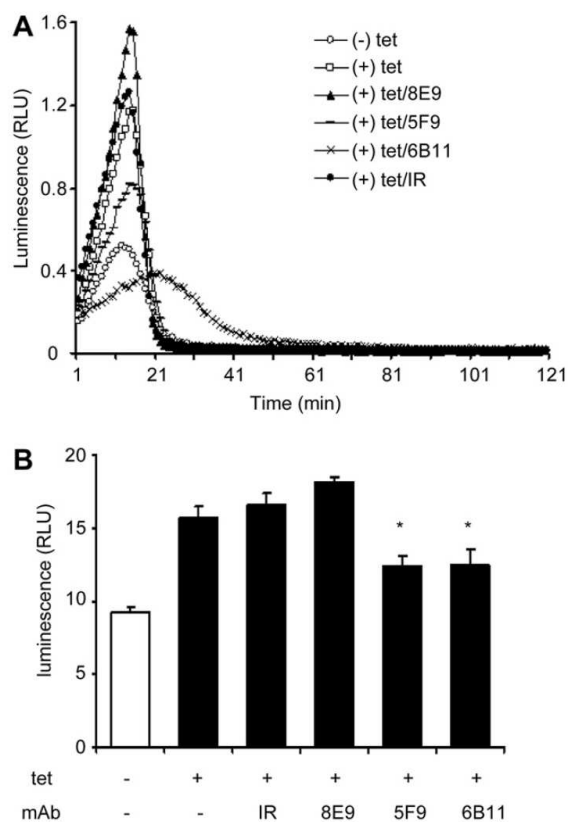

**Fig. 9.** Effect of Nox4 mAbs on the NADPH oxidase activity in a cell-free system. Cell lysates (50  $\mu$ g) of tet-induced HEK293 T-REx<sup>TM</sup> Nox4 cells were pre-incubated with Nox4-specific mAbs (8E9, 5F9, 6B11) (40  $\mu$ g) or irrelevant antibody (40  $\mu$ g) for 30 min on ice. Then 10  $\mu$ M FAD was added to the cell lysates in a final volume of 50  $\mu$ l. After 5 min incubation on ice, cell lysates were transferred to the Corning Costar 96 well Assay Plate. The reaction was initiated by addition of 200  $\mu$ l PBS containing 20  $\mu$ M luminol, 10 units/ml horseradish peroxidase, 10  $\mu$ M FAD and 150  $\mu$ M NADPH. (A) Representative traces from each treatment; (B) Means  $\pm$  S.D. from accumulated signals after 1 h. Values are presented as the average of three experiments  $\pm$  S.D. \* indicates  $P < 0.05$ .

For mAbs 8E9 and 6B11, the epitope region was not clearly determined. However, immunodetection of Nox4 truncated forms suggested that the epitope of mAb 8E9 was on the extracellular E loop of Nox4 (<sup>222</sup>H–E<sup>241</sup>) and mAb 6B11 bound a region at the

**Table 1**  
Summary of characteristics of monoclonal antibodies directed against Nox4.

Nox4 mAbs	Reactivity of mAbs against Nox4	Epitope	Localization of Nox4	Effect on NADPH oxidase activity
8E9	+	<sup>221</sup> H–E <sup>241</sup>	Plasma membrane	No effect
5F9	+	<sup>392</sup> D–F <sup>398</sup>	Perinuclear and endoplasmic reticulum regions	Inhibition
6B11	+	<sup>389</sup> S–p <sup>416</sup>	Plasma membrane, perinuclear and endoplasmic reticulum regions	Inhibition
10B4	–	<sup>210</sup> G–L <sup>219</sup>	ND	ND
7C9	–	<sup>362</sup> E–S <sup>389</sup>	ND	ND

ND: non determined.

C-terminal part of Nox4 (<sup>389</sup>S–p<sup>416</sup>). Pre-incubation of total lysates of tet-induced T-REx<sup>TM</sup> Nox4 cells with either mAb 6B11 or mAb 5F9 leads to a moderate but significant inhibition of Nox4 activity, indicating that they interact with a region important for the electron transfer. Furthermore, this result also suggested that the cytosolic tail of Nox4 could be responsible for its constitutive activity. In fact, as previously reported by Lambeth team [38], the constitutive activity of Nox4 resides in the dehydrogenase domain. This domain is located immediately C-terminal to the TM domain. It is constitutively “turned on” compared with the DH domain of other Nox 1–3. Of note, we have produced and purified a recombinant protein NHS-Nox4qc (AA: 309–578); a constitutive activity was measured at 550 nm as the SOD-sensitive reduction of cytochrome c (unpublished data).

Unlike Nox2, p22<sup>phox</sup> is the only known partner that interacts with Nox4 [10–12]. In our study, results obtained by flow cytometry (data not shown) and western blot confirmed that Nox4 is a p22<sup>phox</sup>-dependent enzyme. Both in tet-induced T-REx<sup>TM</sup> Nox4 cells and HEK293 Nox4GFP cells, the expression of Nox4 is consistent with the increase of p22<sup>phox</sup> (Fig. 2). Recently, Lyle et al. [13] reported in VSMC the association of Poldip2 (polymerase, DNA-directed, delta-interacting protein 2) with heterodimer Nox4/p22<sup>phox</sup> and Poldip2 was introduced as a positive regulator of Nox4. The isolation of Nox4 with additional partners such as Poldip2 as a complex from HEK293 cells and the capacity of 5F9 to specifically map this putative complex should be addressed further.

In conclusion, among 5 novel mAbs described in this study, 3 mAbs (8E9, 5F9, 6B11) could specifically recognize Nox4 protein in human kidney cortex and HEK293 cell lines and chondrocytes cell line (Table 1). These mAbs display distinct and specific properties: mAb 8E9 recognizes an epitope on the last extracellular loop of Nox4 (<sup>222</sup>H–E<sup>241</sup>), while mAb 6B11 and mAb 5F9 are directed to cytosolic tail of Nox4 (<sup>389</sup>S–p<sup>416</sup>) and both of them interact with a region involved in Nox4 constitutive activity, but mAb 5F9 could not detect Nox4 at the plasma membrane. More work is necessary to further determine the epitope of mAbs 8E9 and 6B11. Monoclonal antibodies developed against Nox4 described in this study will be a valuable set of probes specific to Nox4 and will provide powerful tools for a structure/function relationship investigation and physiopathological studies.

#### Acknowledgments

We greatly appreciate the gift of human renal cortex from Dr. Nicole Pinel (Département d'Anatomie et Cytologie Pathologiques, CHU Albert Michallon; BP 217, 38043 Grenoble, France). We would like to give our thanks to Thiru Ramaraj (Department of Computer Science, Montana State University) for running the EPIMAP programs and to Sylvie Berthier (GREPI Timc-Imag UMR-CNRS 5525, Enzymologie/CHU Albert Michallon, BP 217, 38043 Grenoble, France) for technical assistance. We thank Pr Karl-Heinz Krause (Department of Pathology and Immunology, Geneva Medical Faculty and University Hospital) for providing Nox4 siRNAs and for the helpful advice or comments on the results. We also thank Dr Bernard Caillou (Department of Pathology, Institut Gustave Roussy, Villejuif, France) for Immunohistochemical experiments.

This work was supported by grants from the “ministère de l'Enseignement Supérieur de la Recherche et Technologie, Paris”, the “UFR de Médecine, Université Joseph Fourier, Grenoble”, the “Region Rhône-Alpes, programme Emergence 2003”, the “association nationale de défense contre l'Arthrite Rhumatoïde, délégation de l'Isère, ANDAR”, the “Groupement des Entreprises Françaises dans la Lutte contre le Cancer, GEFLUC, délégation de Grenoble”, the “Société Française de Rhumatologie”, and the “Délégation Régionale de la Recherche Clinique, DRRCC” CHU Grenoble.



Leilei Zhang was supported by “the Region Rhône-Alpes, programme ARCUS”, “the National Key Program for Basic Research of China (2010CB529902)”, “the Science and Technology Commission of Shanghai (S30205, 06SR07110)”, “the National Natural Science Foundation of China (30973663)”, “L’Ambassade de France en Chine”. Algirdas J. Jesaitis was supported by USPHS grant RO1-AI26711.

#### Appendix. Supplementary material

Supplementary material related to this article can be found at doi:10.1016/j.biochi.2010.11.001.

#### References

- Cheng, Z., Cao, X., Xu, E.G.V., Meir, J.D., Lambeth, Homologs of gp91phox: cloning and tissue expression of Nox3, Nox4, and Nox5. *Gene* 269 (2001) 131–140.
- D. Rotrosen, C.L. Yeung, J.P. Katkin, Production of recombinant cytochrome b558 allows reconstitution of the phagocyte NADPH oxidase solely from recombinant proteins. *Journal of Biological Chemistry* 268 (1993) 14256–14260.
- W.M. Nauseef, Assembly of the phagocyte NADPH oxidase. *Histochemistry and Cell Biology* 122 (2004) 277–291.
- S. Berthier, M.H. Pacllet, S. Lerouge, F. Roux, S. Vergnaud, A.W. Coleman, F. Morel, Changing the conformation state of cytochrome b558 initiates NADPH oxidase activation. *Journal of Biological Chemistry* 278 (2003) 25499–25508.
- M.H. Pacllet, S. Berthier, L. Kuhn, J. Garin, F. Morel, Regulation of phagocyte NADPH oxidase activity: identification of two cytochrome b558 activation states. *FASEB Journal* 21 (2007) 1244–1255.
- M. Geiszt, J.B. Kopp, P. Várnai, T.L. Leto, Identification of Renox, an NAD(P)H oxidase in kidney. *Proceedings of the National Academy of Sciences of the United States of America* 97 (2000) 8010–8014.
- A. Shiose, J. Kuroda, K. Tsuruya, M. Hirai, H. Hirakata, S. Naito, M. Hattori, Y. Sakaki, H. Sumimoto, A novel superoxide-producing NAD(P)H oxidase in kidney. *Journal of Biological Chemistry* 276 (2001) 1417–1423.
- K. Bedard, K.H. Krause, The NOX family of ROS-generating NADPH oxidases: physiology and pathophysiology. *Physiological Reviews* 87 (2007) 245–313.
- M. Geiszt, T.L. Leto, The Nox family of NAD(P)H oxidases: host defense and beyond. *Journal of Biological Chemistry* 279 (2004) 51715–51718.
- R.K. Ambasta, P. Kumar, K.K. Griendling, H.H.H.W. Schmidt, R. Busse, R.P. Brandes, Direct interaction of the novel Nox proteins with p22phox is required for the formation of a functionally active NADPH oxidase. *Journal of Biological Chemistry* 279 (2004) 45935–45941.
- K.D. Martyn, L.M. Frederick, K. von Löhneysen, M.C. Dinauer, U.G. Knaus, Functional analysis of Nox4 reveals unique characteristics compared to other NADPH oxidases. *Cellular Signalling* 18 (2006) 69–82.
- T. Kawahara, D. Ritsick, G. Cheng, J.D. Lambeth, Point mutations in the proline-rich region of p22phox are dominant inhibitors of Nox1- and Nox2-dependent reactive oxygen generation. *Journal of Biological Chemistry* 280 (2005) 31859–31869.
- A.N. Lyle, N.N. Deshpande, Y. Taniyama, B. Seidel-Rogol, L. Pounkova, P. Du, C. Papaharalambus, B. Lassegue, K.K. Griendling, Poldip2, a novel regulator of Nox4 and cytoskeletal integrity in vascular smooth muscle cells. *Circulation Research* 105 (2009) 249–259.
- F.J. Miller Jr., NADPH oxidase 4: walking the walk with Poldip2. *Circulation Research* 105 (2009) 209–210.
- C. Xia, Q. Meng, L.Z. Liu, Y. Rojanasakul, X.R. Wang, B.H. Jiang, Reactive oxygen species regulate angiogenesis and tumor growth through vascular endothelial growth factor. *Cancer Research* 67 (2007) 10823–10830.
- T. Akasaki, Y. Ohya, J. Kuroda, K. Eto, I. Abe, H. Sumimoto, M. Iida, Increased expression of gp91phox homologues of NAD(P)H oxidase in the Aortic media during chronic hypertension: involvement of the renin–angiotensin system. *Hypertension Research* 29 (2006) 813–820.
- M. Sedeek, R.L. Hébert, C.R. Kennedy, K.D. Burns, R.M. Touyz, Molecular mechanisms of hypertension: role of Nox family NADPH oxidases. *Current Opinion in Nephrology and Hypertension* 18 (2009) 122–127.
- D. Sorescu, D. Weiss, B. Lassegue, R.E. Clempus, K. Szocs, G.P. Sorescu, L. Valppu, M.T. Quinn, J.D. Lambeth, J.D. Vega, W.R. Taylor, K.K. Griendling, Superoxide production and expression of Nox family proteins in human atherosclerosis. *Circulation* 105 (2002) 1429–1435.
- H.E. Boudreau, S.U. Emerson, A. Korzeniowska, M.A. Jendrysiak, T.L. Leto, Hepatitis C Virus (HCV) proteins induce NADPH oxidase 4 expression in a transforming growth factor [beta]-dependent manner: a new contributor to HCV-induced oxidative stress. *The Journal of Virology* 83 (2009) 12934–12946.
- L. Grange, M.V.C. Nguyen, B. Lardy, M. Derouazi, Y. Campion, C. Trocme, M.H. Pacllet, P. Gaudin, F. Morel, NAD(P)H oxidase activity of Nox4 in chondrocytes is both inducible and involved in collagenase expression. *Antioxidants & Redox Signaling* 8 (2006) 1485–1496.
- K. Chen, M.T. Kirber, H. Xiao, Y. Yang, J.F. Keaney, Regulation of ROS signal transduction by NADPH oxidase 4 localization. *The Journal of Cell Biology* 181 (2008) 1129–1139.
- K. von Löhneysen, D. Noack, A.J. Jesaitis, M.C. Dinauer, U.G. Knaus, Mutational analysis reveals distinct features of the Nox4-p22phox complex. *Journal of Biological Chemistry* 283 (2008) 35273–35282.
- J. Kuroda, K. Nakagawa, T. Yamasaki, K.I. Nakamura, R. Takeya, F. Kuribayashi, S. Imajoh-Ohmi, K. Igarashi, Y. Shibata, K. Sueishi, H. Sumimoto, The superoxide-producing NAD(P)H oxidase Nox4 in the nucleus of human vascular endothelial cells. *Genes to Cells* 10 (2005) 1139–1151.
- U. Weyemi, B. Caillou, M. Talbot, R. Ameziane-El-Hassani, L. Lacroix, O. Lagent-Chevallier, A. Al Ghuzlan, D. Roos, J.M. Bidart, A. Virion, M. Schlumberger, C. Dupuy, Intracellular expression of reactive oxygen species-generating NADPH oxidase NOX4 in normal and cancer thyroid tissues. *Endocrine-Related Cancer* 17 (2010) 27–37.
- B. Marques, L. Liguori, M.H. Pacllet, A. Villegas-Méndez, R. Rothe, F. Morel, J.L. Lenormand, Liposome-mediated cellular delivery of active gp91<sup>phox</sup>. *PLoS ONE* 2 (2007) e856.
- L. Liguori, B. Marques, A. Villegas-Méndez, R. Rothe, J.L. Lenormand, Production of membrane proteins using cell-free expression systems. *Expert Review of Proteomics* 4 (2007) 79–90.
- Y. Campion, M.H. Pacllet, A.J. Jesaitis, B. Marques, A. Grichine, S. Berthier, J.L. Lenormand, B. Lardy, M.J. Stasia, F. Morel, New insights into the membrane topology of the phagocyte NADPH oxidase: characterization of an anti-gp91-phox conformational monoclonal antibody. *Biochimie* 89 (2007) 1145–1158.
- G. Batot, C. Martel, N. Capdeville, F. Wientjes, F. Morel, Characterization of neutrophil NADPH oxidase activity reconstituted in a cell-free assay using specific monoclonal antibodies raised against cytochrome b558. *European Journal of Biochemistry* 234 (1995) 208–215.
- H. Towbin, T. Staehelin, J. Gordon, Electrophoretic transfer of proteins from polyacrylamide gels to nitrocellulose sheets: procedure and some applications. *Proceedings of National Academy of Sciences* 9 (1979) 4350–4354.
- Y. Campion, A.J. Jesaitis, M.V.C. Nguyen, A. Grichine, Y. Herenger, A. Baillet, S. Berthier, F. Morel, M.H. Pacllet, New p22-phox monoclonal antibodies: identification of a conformational probe for cytochrome b 558. *Journal of Innate Immunity* 1 (2009) 556–569.
- M.H. Pacllet, L.M. Henderson, Y. Campion, F. Morel, M.C. Dagher, Localization of Nox2 N-terminus using polyclonal antipeptide antibodies. *Biochemical Journal* 382 (2004) 981–986.
- J.B. Burritt, C.W. Bond, K.W. Doss, A.J. Jesaitis, Filamentous phage display of oligopeptide libraries. *Analytical Biochemistry* 238 (1996) 1–13.
- J.B. Burritt, M.T. Quinn, M.A. Jutila, C.W. Bond, A.J. Jesaitis, Topological mapping of neutrophil cytochrome b epitopes with phage-display libraries. *Journal of Biological Chemistry* 270 (1995) 16974–16980.
- B.M. Mumeey, B.W. Bailey, B. Kirkpatrick, A.J. Jesaitis, T. Angel, E.A. Dratz, A new method for mapping discontinuous antibody epitopes to reveal structural features of proteins. *Journal of Computational Biology* 10 (2004) 555–567.
- Y. Gorin, K. Block, J. Hernandez, B. Bhandari, B. Wagner, J.L. Barnes, H.E. Abboud, Nox4 NAD(P)H oxidase mediates hypertrophy and fibronectin expression in the diabetic kidney. *Journal of Biological Chemistry* 280 (2005) 39616–39626.
- L.L. Hilenski, R.E. Clempus, M.T. Quinn, J.D. Lambeth, K.K. Griendling, Distinct subcellular localizations of Nox1 and Nox4 in vascular smooth muscle cells, atherosclerosis, thrombosis, and vascular biology. *Journal of Cellular Biochemistry* 24 (2004) 677–683.
- L. Hecker, R. Vittal, T. Jones, R. Jagirdar, T.R. Luckhardt, J.C. Horowitz, S. Pennathur, F.J. Martinez, V.J. Thannickal, NADPH oxidase-4 mediates myofibroblast activation and fibrogenic responses to lung injury. *Nat Med* 15 (2009) 1077–1081.
- Y. Nisimoto, H.M. Jackson, H. Ogawa, T. Kawahara, J.D. Lambeth, Constitutive NADPH-dependent electron transferase activity of the Nox4 dehydrogenase domain. *Biochemistry* 49 (2010) 2433–2442.
- I. Helmcke, S. Heumüller, R. Tikkanen, K. Schröder, R.P. Brandes, Identification of structural elements in Nox1 and Nox4 controlling localization and activity. *Antioxidants & Redox Signaling* 11 (2008) 1279–1287.
- Y.M. Lee, B.J. Kim, Y.S. Chun, I. So, H. Choi, M.-S. Kim, J.W. Park, NOX4 as an oxygen sensor to regulate TASK-1 activity. *Cellular Signalling* 18 (2006) 499–507.
- K. Block, Y. Gorin, H.E. Abboud, Subcellular localization of Nox4 and regulation in diabetes. *Proceedings of the National Academy of Sciences* 106 (2009) 14385–14390.
- R.E. Clempus, D. Sorescu, A.E. Dikalova, L. Pounkova, P. Jo, G.P. Sorescu, B. Lassegue, K.K. Griendling, Nox4 is required for maintenance of the differentiated vascular smooth muscle cell phenotype. *Arteriosclerosis, Thrombosis, and Vascular Biology* 27 (2007) 42–48.
- C. Goettsch, W. Goettsch, G. Muller, J. Seebach, H.J. Schnittler, H. Morawietz, Nox4 overexpression activates reactive oxygen species and p38 MAPK in human endothelial cells. *Biochemical and Biophysical Research Communications* 380 (2009) 355–360.