



**HAL**  
open science

# Identification des descripteurs macroscopiques de la dérive pour sa modélisation

Majid Hazim Alheidary

► **To cite this version:**

Majid Hazim Alheidary. Identification des descripteurs macroscopiques de la dérive pour sa modélisation. Sciences agricoles. Montpellier SupAgro, 2016. Français. NNT: 2016NSAM0002. tel-01567823

**HAL Id: tel-01567823**

**<https://theses.hal.science/tel-01567823>**

Submitted on 24 Jul 2017

**HAL** is a multi-disciplinary open access archive for the deposit and dissemination of scientific research documents, whether they are published or not. The documents may come from teaching and research institutions in France or abroad, or from public or private research centers.

L'archive ouverte pluridisciplinaire **HAL**, est destinée au dépôt et à la diffusion de documents scientifiques de niveau recherche, publiés ou non, émanant des établissements d'enseignement et de recherche français ou étrangers, des laboratoires publics ou privés.

# THÈSE

Pour obtenir le grade de  
**Docteur**

**Délivré par le**  
**Centre international d'études supérieures en**  
**sciences agronomiques**  
**Montpellier**

**Préparée au sein de l'école doctorale**  
**Sciences des Procédés - Sciences des Aliments**  
**Et de l'unité de recherche IRSTEA-UMR-ITAP**

**Spécialité : Génie des procédés**

**Présentée par Majid Hazim Reshaq Alheidary**

**Identification des descripteurs  
macroscopiques de la dérive pour sa  
modélisation**

**Soutenue le 07 Mars 2016 devant le jury composé de**

Marie-France Destain, Prof., Université de Liège  
Christelle Gée, Prof., AgroSup / Dijon  
Gilles Belaud, Prof., SupAgro / Montpellier  
Santiago Planas de Marti, Prof., ETSEA/Lleida  
Carole Sinfort, Prof., SupAgro / Montpellier  
Jean-Paul Douzals, IR / IRSTEA-Montpellier

Rapportrice  
Rapportrice  
Président  
Examinateur  
Directrice  
Co-directeur

## **Acknowledgement**

I address special thanks to Prof. Marie-France DESTAIN and Prof. Christelle Gée for spending their precious time in reviewing my thesis manuscript and for their valuable suggestions. And, I am grateful to Prof. Santiago Planto de Marti, Prof. Gill BELAUD for their acceptance to participate in the jury committee.

I thank my supervisor Prof. Carole SINFORT and my grateful thanks to co-supervisor Dr. Jean-Paul DOUZALS who support and encourage me to success this study. Thanks to PEPS team and the laboratory technicians in IRSTEA-Montpellier who gave so generously of their time for wind tunnel testing in particular Xavier, Cyril, Jean-Philippe. Thanks to the University of Montpellier, GAIA; Campus France; Iraqi Government (ministry of high education) for awarding me a Dissertation Completion Fellowship, providing me with the financial means to complete this thesis. Many thanks to all my colleagues at IRSTEA Montpellier for their smiles and kindness that made my PhD work much enjoyable. Many thanks to my children (Fatemah & Zainab) who have accompanied me on this hardly journey. Thank for my wife who has always been my great helper. Great thanks to my family in Iraq my mother and my brothers who shared me morally this hard duration.

Finally, I thank my God for giving me strength and good health during this thesis work.

Highest regards

Majid

## Résumé en français

# Identification de descripteurs macroscopiques de la dérive de pulvérisation pour sa modélisation

## 1. Contexte de la thèse

### 1.1. La dérive

Plusieurs études ont porté sur la dérive de pulvérisation en agriculture et il est démontré qu'une certaine quantité du liquide pulvérisé n'atteint pas la zone cible. Ce phénomène, connu sous le nom de la dérive de pulvérisation, est défini par la norme NF ISO 22866, 2005 comme le mouvement physique d'un spray en dehors de la zone cible sous l'effet du vent au moment de l'application. Selon le type d'application, les pertes en dérive de pulvérisation peuvent être extrêmement variables. La dérive est en partie responsable de la pollution des cours d'eau, de dégâts occasionnés sur des parcelles adjacentes, mais également de nuisances pour les riverains et le voisinage. Ainsi une réglementation européenne vise à limiter la pollution des cours d'eau en instaurant des zones non traitées combinées à des moyens physiques de réduction de la dérive des sprays (Directive cadre sur l'eau citée par Sinfort and Bonicelli, 2010). Des mesures telles que la mise en place de ZNT de 5 mètres au voisinage des points d'eau identifiés en trait bleu continu ou pointillé sur une carte IGN au 1/25000 ont déjà été prises dès 2006 (Arrêté du 12/09/2006). Selon leur toxicité, les produits de protection des plantes sont donc affectés d'une distance maximale de traitement au bord des cours d'eau. L'utilisation d'un moyen officiellement reconnu de réduction de la dérive permet de réduire la distance de 20m ou 50m à 5m.

Les facteurs influençant la dérive sont nombreux et il est possible de les classer en trois catégories.

(i) Les facteurs liés au spray : Les technologies d'atomisation utilisées (ex. buses) produisent un spray composé de gouttes dont la taille et la vitesse varient selon une dimension spatiale qui peut être cartographiée et selon une dimension temporelle liée à la perte d'énergie et à l'évaporation des gouttes lors du transfert atmosphérique. Plus les gouttes sont fines, plus elles sont sujettes à la dérive (Salyani and Farooq, 2004). De plus, l'angle principal du spray peut influencer sur la taille des gouttes et également sur la dérive. Pour une buse de calibre 03 à 3 bar, le passage d'un angle de 110° à 65° entraîne une augmentation du  $Dv_{0.5}$  de 260 à

340  $\mu\text{m}$  (Miller et al., 2011). De plus, la composition physico-chimique de la bouillie peut jouer un rôle important sur la taille des gouttes. D'une manière générale, la formulation des produits phytosanitaires peut également limiter les pertes dans l'atmosphère grâce à l'utilisation d'adjuvants ex-temporanes ou de coformulants (Stainier et al., 2006). Parmi les facteurs physico-chimiques d'importance, la tension de surface et la viscosité interviennent dans le processus d'atomisation et peuvent aussi influencer sur la dérive (Hilz and Wermeer, 2013).

(ii) Les facteurs liés aux réglages et aux conditions atmosphériques : La hauteur de la rampe, l'orientation des buses, la vitesse d'avancement ainsi que les conditions climatiques (température & humidité de l'air, vitesse et orientation du vent) sont des grandeurs d'influence.

Par exemple, l'effet de la hauteur de la rampe sur la dérive des sprays a été étudiée au champ (De Jong et al., 2000 ; De Schampheleire *et al.*, 2008) ou en soufflerie (Taylor et al., 2004; Miller et al., 2011). Dans tous les cas, une hauteur de rampe plus importante entraîne une augmentation de la dérive et ce d'autant plus que les gouttelettes produites sont fines.

L'intensité du vent et sa direction sont les paramètres externes au spray les plus influents. Si ces paramètres sont difficilement maîtrisables et reproductibles au champ, leurs effets peuvent être plus facilement étudiés en soufflerie avec des conditions atmosphériques contrôlées.

(iii) Les facteurs liés à la végétation et son stade de développement: La dérive peut être influencée par le type de cultures et le système d'application associé, la densité du feuillage et le stade végétatif (Van de Zande et al., 2014). Par exemple, la taux de pertes au moment de l'application dépend directement de la configuration du pulvérisateur et du stade végétatif (Fig.1) (source: J. Van de Zande et al., 2014)

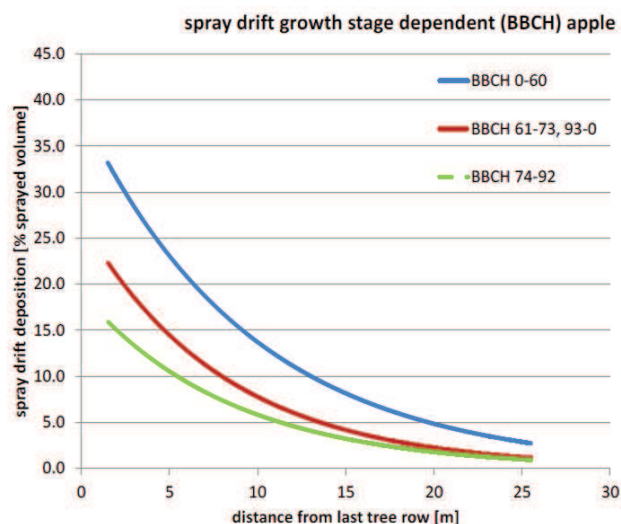

**Figure 1: Evolution de la dérive en verger selon le stade végétatif (verger pomme)**

Comme le montre la figure 1, les stades précoces sont caractérisés par une porosité plus importante et une surface foliaire plus faible; la dérive est donc plus importante.

La vitesse et l'orientation des flux d'air, le volume d'application, le spectre de taille de gouttes et la vitesse de l'application doivent en général être adaptés à la configuration de la végétation (taille, forme et densité) afin de réduire la dérive dans les vergers (Fox et al., 2008).

La dérive de pulvérisation peut être mesurée au champ dans le cas d'un appareil complet de pulvérisation selon la norme NF ISO 22866, 2005. Cependant compte tenu des contraintes météorologiques, ces mesures sont coûteuses et difficilement répétables.

Ainsi, l'utilisation d'une soufflerie expérimentale permet de fixer et de contrôler les conditions météorologiques telles que la vitesse du vent, la température et l'humidité relative de l'air limitant ainsi la variabilité des résultats.

De nombreuses études ont porté sur l'étude de la dérive en soufflerie et l'article suivant tente d'en faire une synthèse bibliographique (Alheidary et al., 2014)



*Cet article correspond à une compilation des données publiées qui a permis de faire ressortir les grandes tendances en matière de facteurs influençant la dérive. Ainsi, si l'influence de la taille des gouttes sur la dérive est connue depuis longtemps et confirmée par toutes les données, l'influence de la vitesse des gouttes semble plus contradictoire. Les effets combinés de la tailles de gouttes, du calibre, de l'angle des buses et de la pression d'alimentation rend difficile la généralisation des phénomènes. En particulier, cette étude a notamment montré que selon la technologie des buses (jet plat, pré-orifice ou induction d'air), la relation entre la taille et la vitesse des gouttes était spécifique. L'influence physico-chimie de la bouillie est elle-aussi importante même si, ici aussi, les phénomènes sont difficilement généralisables. En particulier, l'effet d'adjuvants peut être visible avec de l'eau mais peut se retrouver masqué lorsque l'adjuvant est utilisé avec une substance active. Enfin des pistes de recherche sont*

*ouvertes sur la question de la distribution spatiale des tailles et vitesses de gouttes mais relativement peu de données ont été publiées sur ce point.*

D'une manière générale les études ayant porté sur la mesure de la dérive de pulvérisation en soufflerie ont généralement utilisé le protocole normalisé NF ISO 22856, 2008. Dans ce cas, une seule buse est placée en position frontale et soumise à une vitesse de vent de  $2 \text{ m s}^{-1}$ . Les mesures sont généralement réalisées avec des sprays courts (5 à 10 s) et l'analyse nécessite le dosage d'un traceur sur des collecteurs (fils nylon de 2 mm de diamètre) placés à différentes hauteurs ou distances.

Dans ce contexte, la soufflerie d'IRSTEA Montpellier est originale car elle permet de travailler avec une mini rampe allant jusqu'à 4 buses. Différentes positions de la rampe par rapport à l'axe du vent peuvent être testées et notamment les positions frontales et latérales. Enfin cette soufflerie est capable de générer des vitesses de vent de 0 à  $12 \text{ m.s}^{-1}$  et la mesure de la dérive fait appel à un banc de répartition permettant une évaluation quantitative des dépôts tous les 5 cm sur une distance totale de 9m.

## **1.2. Objectif de la thèse**

L'objectif principal de ce travail est d'identifier des descripteurs macroscopiques de la dérive de pulvérisation en soufflerie sur la base de l'étude des courbes de dépôt et de modéliser l'effet de différents paramètres d'influence. S'il existe plusieurs modèles de dérive de pulvérisation au champ (Driftsim, Agdrift, IDEFICS, CFD), ceux-ci sont très dépendants des conditions atmosphériques qui brouillent l'effet des conditions de réglage telles que la vitesse d'avancement ou la hauteur de la rampe. Par ailleurs, il n'existe pas vraiment de modélisation de la dérive en soufflerie qui mette clairement en évidence l'effet de la vitesse du vent, de l'orientation du vent et de la hauteur de la rampe.

Pour réaliser cette étude, la démarche employée a été la suivante:

Tout d'abord, l'état de l'art en matière de facteurs physiques influençant la dérive des sprays a été investigué notamment pour mettre en évidence l'effet de la taille et de la vitesse des gouttes, la composition physico-chimique des bouillies et l'influence des facteurs atmosphériques.

Ensuite, une étude expérimentale dans la soufflerie d'IRSTEA a permis de définir différents descripteurs sur la base de courbes de dérive avec un nombre suffisamment important de modalités entre le type de buse, la vitesse du vent, la hauteur et la position de la rampe.

Enfin, l'analyse des résultats a conduit à l'identification d'au moins un descripteur de dérive qui réponde à la variation de la vitesse du vent, de la position et de la hauteur de la rampe. Idéalement, la modélisation du comportement de ce descripteur, corroborée par des mesures de granulométrie *in situ*, a permis de développer un simulateur de dérive pertinent.

### 1.3. La soufflerie et le banc de mesure

Les données utilisées dans ce travail ont été obtenues lors de mesures réalisées dans la soufflerie d'IRSTEA–Montpellier entre les mois d'Octobre 2012 et Janvier 2015. Cette soufflerie à recirculation d'air a une section de 3 x 2m sur une longueur de 9m. A l'étage supérieur se trouve le module de génération et de contrôle des conditions de vent avec 6 ventilateurs à entraînement hydraulique, un groupe frigorifique et des résistances thermiques. La vitesse de vent est contrôlée avec un anémomètre situé à la hauteur de la rampe et qui peut être réglée de 0 à 12 m s<sup>-1</sup>, la température est maintenue à 20°C et l'humidité relative de l'air doit être de 90% minimum. 3 vitesses de vent caractéristiques ont été retenues pour cette étude : 2, 4 et 7.5 m s<sup>-1</sup>. La vitesse de 7,5 m s<sup>-1</sup> (25 km/h) est supérieure à la vitesse maximale de vent autorisée pour la pulvérisation en France (19 km/h). Elle a été choisie car elle permet d'obtenir le même taux de réduction de la dérive entre 3 buses candidates (AVI 02 – 2.5 bar, AVI 02 – 3.5 bar et ADI 02 - 2.5 bar) et la buse de référence (AXI 02 – 2.5 bar) à partir de mesures au champ entre 5 et 50m et de mesures en soufflerie entre 5 et 8 m (Liet et Polveche, 2009). La vitesse de 2 m s<sup>-1</sup> est la vitesse utilisée avec un protocole d'exposition courte (Allemagne, Angleterre, Belgique, cf. §1.3.3.2 – Tableau 4). La vitesse de 4 m s<sup>-1</sup> a été choisie car elle correspond à une vitesse intermédiaire entre les deux précédentes.

La partie inférieure de la soufflerie comprend une rampe équipée de 4 buses espacées de 50 cm et d'un capteur de pression. L'alimentation des buses se fait via un débitmètre électromagnétique. Cette rampe peut être orientée de manière parallèle à la direction du vent (dérive latérale) ou perpendiculaire (dérive frontale) ou de manière intermédiaire (ex. 15°, 30°, 45°, 60° et 75°). La hauteur de la rampe est réglable de 0.10m à 1.20m. La pulvérisation issue de la rampe est captée par un banc de répartition horizontale composé de 180 gouttières



de 0,05 m de large et 3 m de long. La longueur totale du banc d'essai de répartition est de 9 m et inclut une zone de spray direct sous la rampe et une zone de dérive.

Le liquide pulvérisé correspond à de l'eau adoucie. A l'heure actuelle, la soufflerie n'est compatible avec l'usage d'adjuvant ou de produits de protection des plantes. Le liquide collecté aux différentes distances par le banc de répartition est mesuré par un dispositif mobile comprenant 60 tubes de 500 ml de capacité placés sur un banc individuel de pesée. La portée du banc mobile étant de 3m, le banc se déplace selon un incrément de 1m afin de couvrir la zone de mesure (Fig. 2). Au total, 7 positions sont nécessaires pour investiguer la plage de mesure de 9m du tunnel.

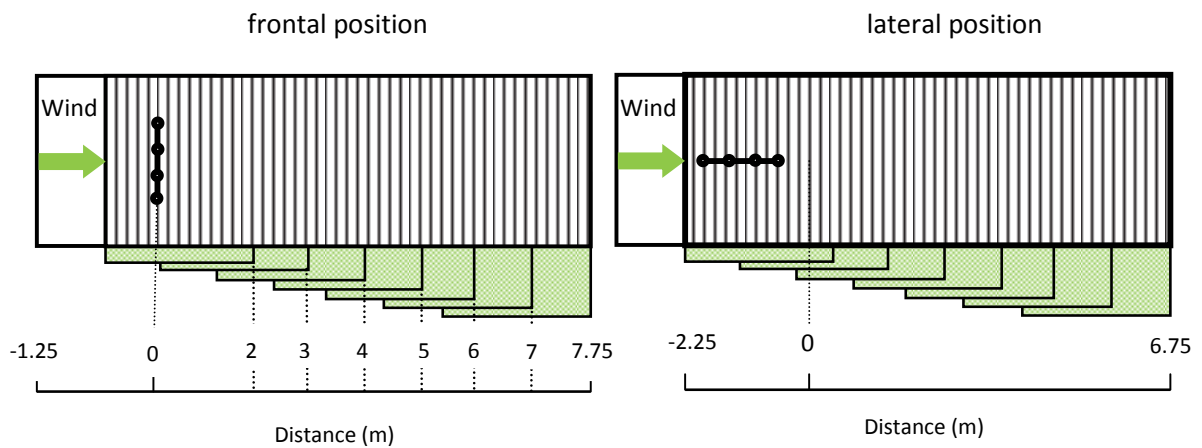

**Figure 2: Différentes positions de la rampe**

Selon la Fig.3, chaque gouttière est donc mesurée de 1 à 3 fois selon sa position par rapport à la rampe (axe des abscisses Fig. 3). Seuls le premier et le dernier mètre n'est mesuré qu'une seule fois.

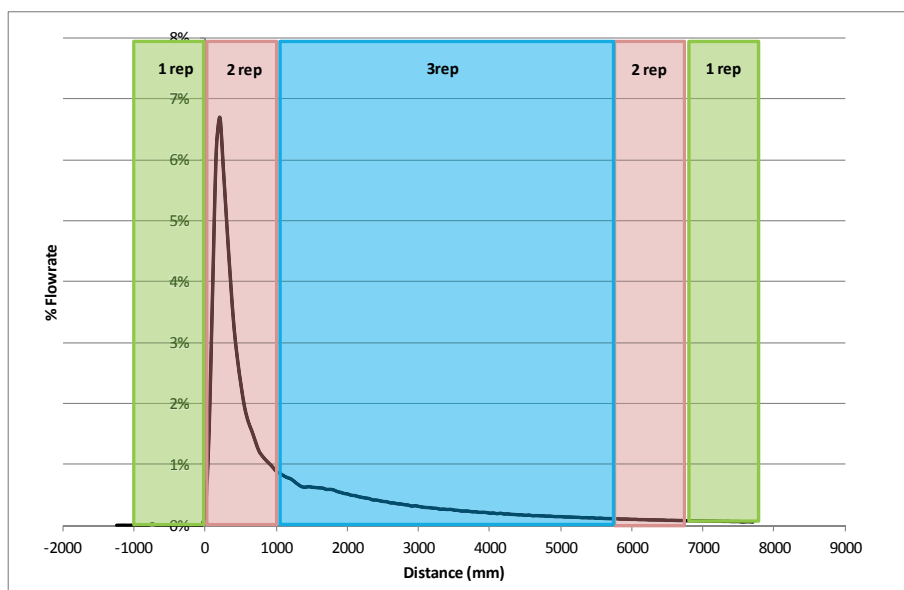

**Figure 3: Répétition des mesures par gouttière en fonction de la distance- rampe en position.**

#### **1.4. Caractéristiques des buses**

Trois technologies de buses ont été utilisées dans cette étude et sont présentées dans le Tableau1 ci-dessous. Tout d’abord, le calibre des buses (02) à une pression d’injection de 2,5 bar est considéré comme la situation de référence en France et conduit à un volume d’application de 110 l ha<sup>-1</sup> en considérant une vitesse d’avancement de 8 km h<sup>-1</sup>. La buse AXI est une buse à jet plat (Flat Fan) et correspond à la buse de référence pour la dérive de pulvérisation en France. La buse CVI est une buse à inclusion d’air (AI) et est inscrite comme moyen de limitation de la dérive. Par contre, la buse CVI Twin 02 est également une buse à inclusion d’air, double jet, mais n’est pas inscrite comme moyen de limitation de la dérive. Ces dernières buses ont été développées notamment pour améliorer l’efficacité de traitement sur les épis de céréales. Ces buses ont été intégrées au protocole afin d’étudier l’effet de la configuration des sprays sur la performance anti-dérive.

**Table 1: Caractéristiques des buses**

Buse	Type	Angle/calibre	VMD $\mu\text{m}$	Débit $\text{L min}^{-1}$	Pression bar
AXI Jaune	Flat Fan	110/02	164.9	0.73	2.5
CVI Jaune	Flat Fan-inclusion d'air	110/02	434.6	0.73	2.5
CVI Twin Jaune	Flat Fan- inclusion d'air double jet	110/02	380.0	0.73	2.5

VMD : Diamètre Volumétrique Médian

La taille de gouttes a été mesurée avec un appareil Malvern Spraytec en considérant le scan d'un spray de pulvérisation complet.

### **1.5. Mesure des dépôts de dérive sédimentaire**

Les tubes (éprouvettes) situés sous les gouttières du banc de répartition se remplissent avec un certain débit selon la distance à la rampe, le calibre des buses et la pression d'alimentation, la hauteur de la rampe et de la vitesse du vent. Lorsque la première éprouvette est pleine, l'arrêt des mesures est commandé et une pesée finale est effectuée. Les données brutes correspondent pour chaque distance par rapport à la rampe, à une masse acquise selon un certain temps. Lorsque plusieurs mesures sont effectuées à la même distance par des éprouvettes différentes, la courbe de dérive est construite sur la base de la moyenne des mesures.

### **1.6. Analyse des dépôts de dérive sédimentaire**

Les données brutes sont converties en débit collecté en tenant compte du temps d'acquisition pour chaque position du banc (cf Fig. 2). Le débit collecté au niveau de chaque gouttière est normalisé par le débit total injecté au niveau de la rampe et est exprimé en pourcentage (% de débit ou débit relatif). Le débit relatif est ensuite cumulé le long du banc de répartition. Enfin, la valeur opposée au débit relatif cumulé, appelé taux de dérive (ou Drift ratio  $Dr$ ), est calculé selon l'équation 1 (Douzals et Alheidary, 2014).

$$Dr_i = 1 - \sum_i q_i \quad (1)$$

Où  $Dr_i$  est le taux de dérive en % à une position  $i$ ,  $q_i$ , est le % de débit (débit relatif) à la position  $i$  en %.

## 2. Modalités

Ce travail comporte 99 modalités différentes qui ont été réalisées dans la soufflerie d'IRSTEA- Montpellier. Le plan expérimental est basé sur un inventaire réaliste des pratiques courantes de pulvérisation et comprend 3 types de buses, 3 vitesses de vent, 3 hauteurs de la rampe et deux orientations principales de la rampe (Figure 4).

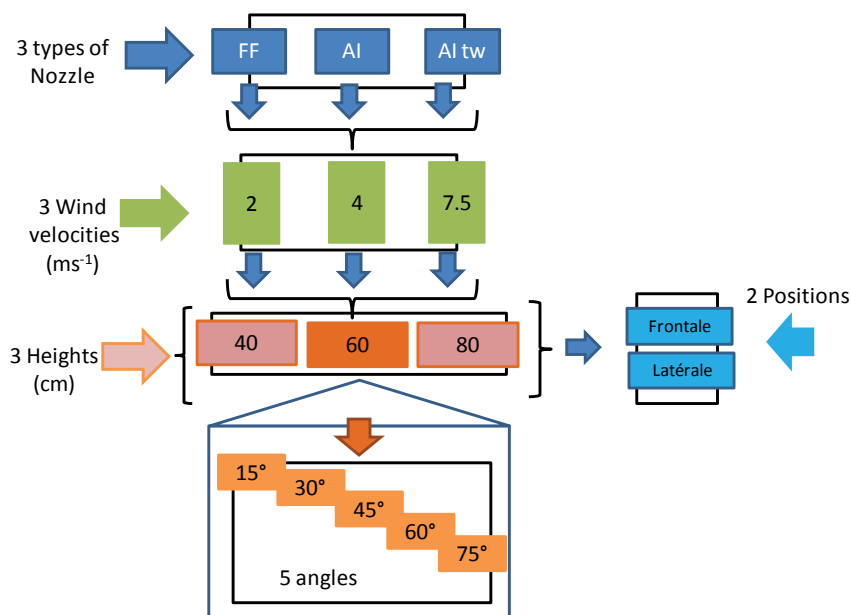

Figure 4: Plan expérimental

## 3. Résultats

Ce chapitre Résultats comporte 4 parties correspondant à des publications différentes.

La première partie correspond à des tests préliminaires sur l'effet du nombre de buses dans les deux positions de la rampe (3 buses – 3 vents – 60 cm) (Douzals and Alheidary, 2014).

La deuxième partie décrit l'ensemble des résultats obtenus en soufflerie (3 buses, 3 vents, 3 hauteurs, 2 positions + essais angles de rampe) et une discussion autour du choix des descripteurs de la dérive (Alheidary et al., 2016-1, *soumis*)

La troisième partie définit les relations entre les paramètres d'influence (vitesse du vent et la hauteur de la rampe) et le taux de dérive à travers le temps de vol (ToF) pour chaque type de buse. (Alheidary et al., 2016-2, *soumis*)

La quatrième partie permet de valider la représentation en temps de vol (ToF) grâce à des mesures de taille des gouttes in situ. (Alheidary et al., 2016-3, *soumis*).

### **3.1. Partie 1: Effet du nombre de buses dans les deux positions de la rampe**

Différentes configurations expérimentales sont testées en soufflerie pour étudier l'effet de la vitesse du vent de 2 à 7.5 m s<sup>-1</sup>, le nombre de buses de 1 à 4 buses et la position de la rampe par rapport à la direction du vent (position frontale ou latérale de la rampe). Une seule hauteur de rampe (60 cm) a testée dans cette étude.

Les résultats ont montré (Fig.5) qu'en position frontale, tous les sprays sont dans la même position par rapport à la direction du vent et génèrent des courbes de dépôt identiques. Ainsi le nombre de buses n'influe pas sur la forme des courbes de dérive. Aucune interaction entre sprays n'a pu être mise en évidence pour des vitesses de vent de 2, 4 et 7.5 m s<sup>-1</sup>. À l'inverse, en position latérale (Fig. 6), le nombre et la position des sprays sur la rampe joue un grand rôle sur la courbe de dérive générée (débit relatif et taux de dérive). Le premier et le second spray proches de la source de vent sont les plus impactés et tendent à « protéger » les autres sprays situés derrière eux. En position latérale, la distance de référence évolue avec le nombre de buses mais est définie comme étant la demi-inter-distance après la dernière buse de la rampe (EN ISO 16119-2).

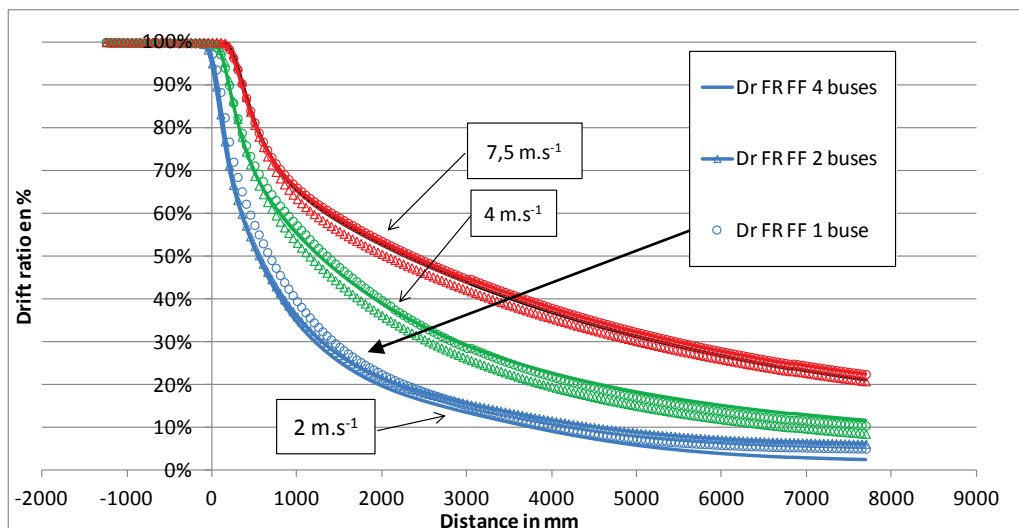

Figure 5: Effet du nombre de buses et de la vitesse de vent en position frontale sur le taux de dérive (Dr), (FF: buses Flat Fan) - Hauteur 60 cm. Les points en légende illustrent les différentes configurations de rampe à la vitesse de 2 m.s<sup>-1</sup>.

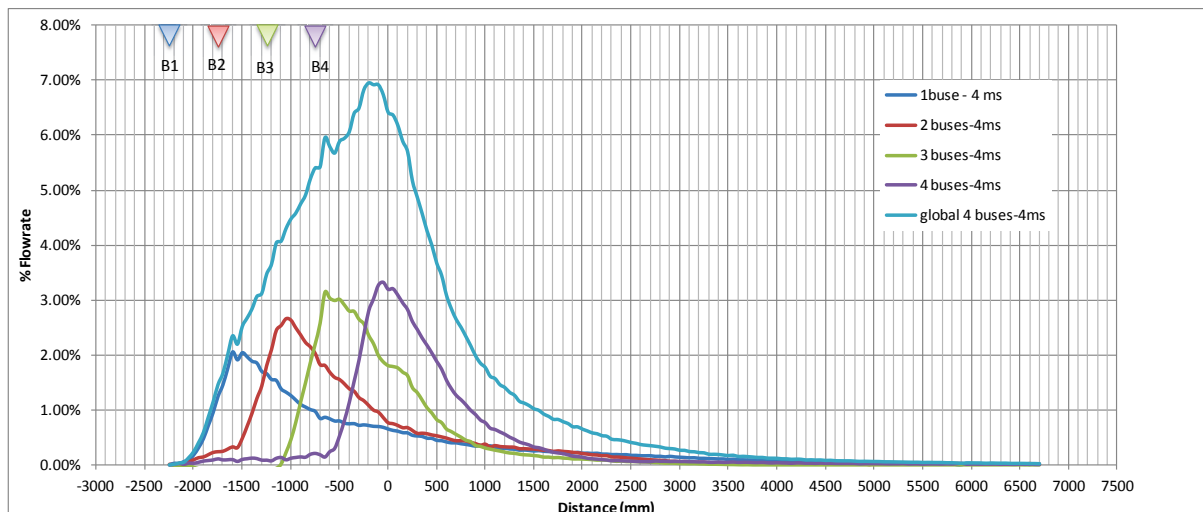
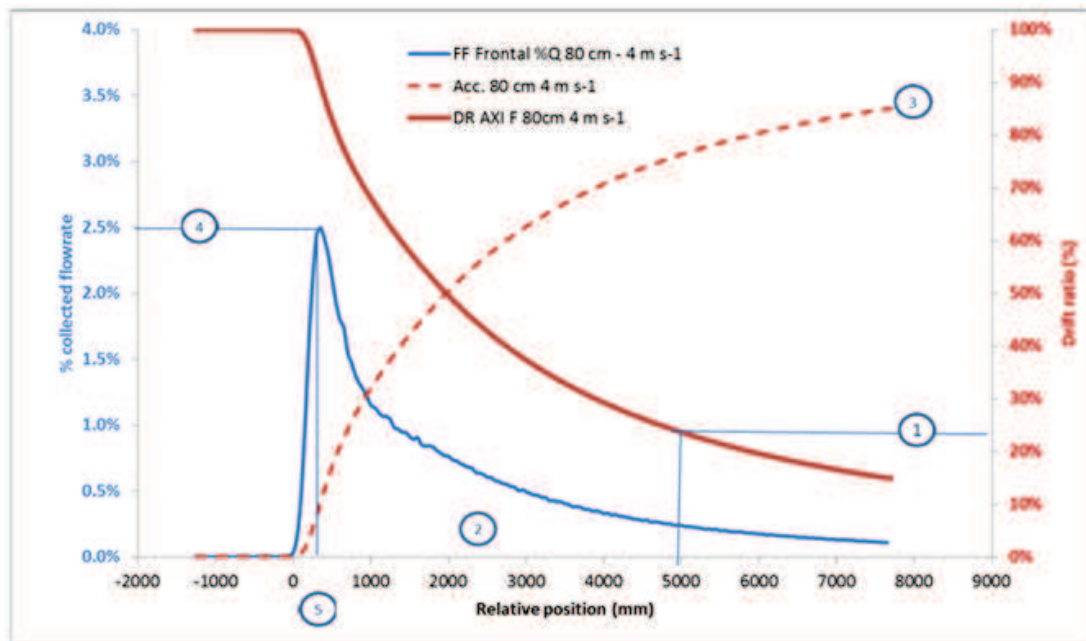

Figure 6: Effet du nombre de buses sur le débit relatif en position latérale – vent 4 m s<sup>-1</sup> et buses FF - Hauteur 60 cm

### 3.2. Partie 2 : Identification et validation de descripteurs de la dérive

99 modalités ont été testées pour mesurer la dérive en soufflerie. Différents descripteurs ont été identifiés (Fig. 7) sur les courbes de dérive brute (\_\_\_), de la dérive cumulée (- - -) et du taux de dérive (\_\_\_).



**Figure 7: Identification des indicateurs de la dérive, (1) le taux de dérive à 5m ; (2) barycentre des dépôts; (3) le taux de récupération ; (4) l'intensité du pic de dépôt; (5) la position du pic de dépôt**

Les résultats ont rapidement montré que l'intensité et la position du pic de dépôt sont inadaptées pour différentes raisons :

- Les gouttières ayant une largeur de 5 cm, des mesures de précision ne sont pas envisageables,
- En position latérale, chaque buse génère un pic ce qui limite l'interprétation des résultats

Le barycentre des courbes de dérive traduit la répartition spatiale des dépôts selon la distance mais ne tient pas réellement compte de l'intensité des dépôts. Deux courbes peuvent donc générer des barycentres identiques alors que les valeurs de dépôts sont quantitativement très différentes.

Enfin, le taux de dérive à 5 m ( $Dr_5$ ) correspond à l'inverse du taux de récupération à 5m sous le vent. Ces deux indicateurs sont apparus pertinents dans toutes les situations et notamment dans toutes les positions de la rampe. Pour des raisons pratiques de comparaison des résultats avec les données existantes issues du protocole développé à IRSTEA, le taux de dérive à 5m a été finalement choisi. L'évolution de cet indicateur avec la vitesse de vent et la hauteur de la rampe a été étudiée avec des régressions linéaires multiples. Celles-ci ont montré l'effet prédominant de la hauteur de la rampe sur la vitesse du vent avec un rapport H/V de 11 à 38 selon les modalités.

### 3.3. Partie 3 : Approche cinématique selon le temps de vol

Les résultats précédents, fonction de la distance, ont été exprimés en fonction du temps de vol des gouttes (Time-of-Flight, ToF) en prenant l'hypothèse que la vitesse de vent prédomine sur la vitesse initiale des gouttes issue du processus d'atomisation. Le temps de vol est alors

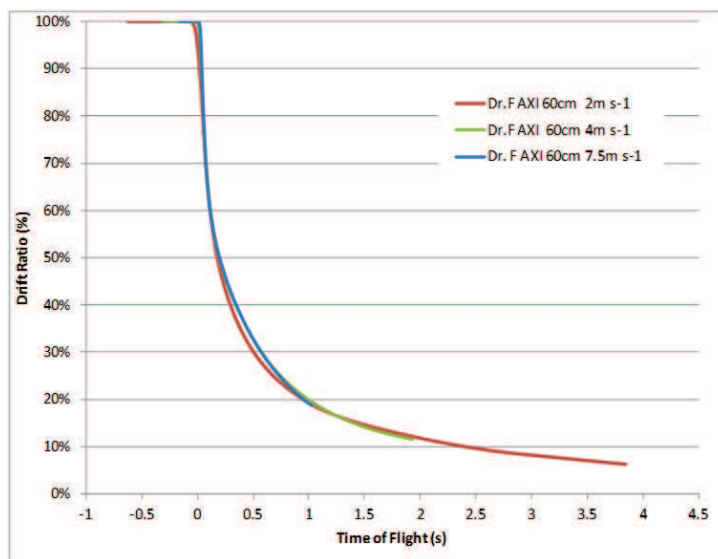

défini comme le rapport entre la distance de sédimentation et la vitesse du vent. En utilisant cette approche, les courbes de taux de dérive pour différentes vitesses de vent se retrouvent superposées (Fig. 8).

**Figure 8: Taux de dérive en fonction du temps de vol (ToF) selon différentes vitesses de vent - Position frontale**

Ce changement d'échelle permet une meilleure superposition des courbes de dérive ( $Dr_5$ ) en position frontale (Fig. 8) qu'en position latérale.



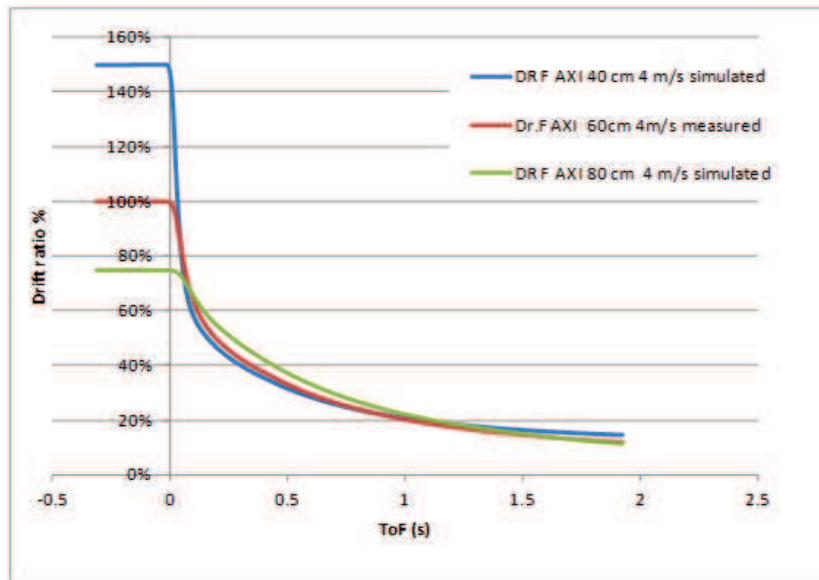

De même, il est possible de simuler l'effet de la hauteur de la rampe dans différentes positions en appliquant la représentation par temps de vol et une transformation proportionnelle selon la hauteur (Fig. 9).

**Figure 9: Comparaison du taux de dérive entre des valeurs mesurées (60 cm) et des valeurs simulées à partir des hauteurs 40 et 80 cm. Buses AXI - Position frontale**

### **3.4. Partie 4 : Validation du modèle de temps de vol par des mesures de granulométrie *in situ*.**

Des mesures de taille de gouttes ont été réalisées en utilisant un granulomètre Malvern Spraytec à différentes distances et différentes vitesses de vent pour les 3 types de buses en position frontale et latérale. Les résultats montrent une bonne corrélation entre la taille des gouttes ( $D_{v0.5}$ ) et le temps de vol (ToF) (par exemple ToF = 1 seconde, Fig. 10).

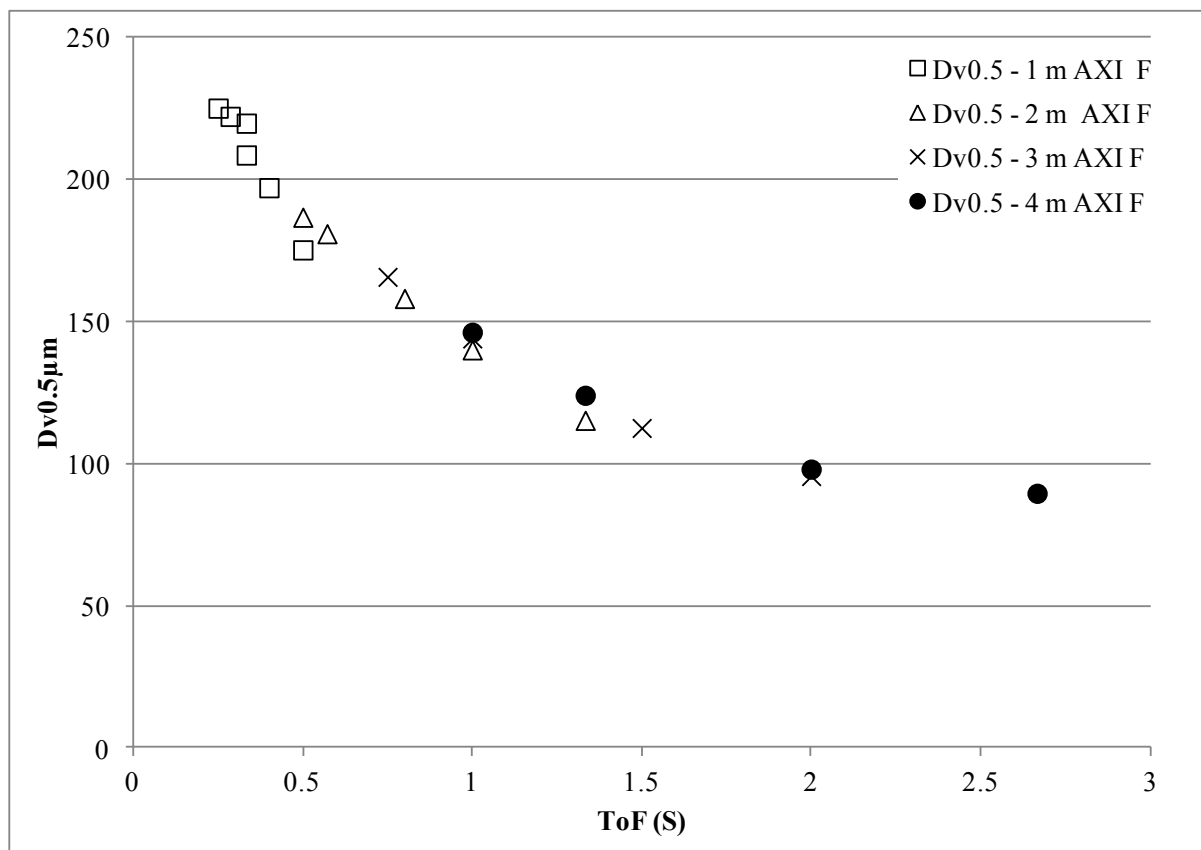

**Figure10: Relation entre la taille de gouttes et le temps de vol (ToF) – buse jet plat en position frontale**

Ces premiers résultats ont été obtenus principalement en position frontale. Dans ce cas, les courbes obtenues sont assez différentes pour la buse à jet plat et les buses à induction d'air. L'hypothèse avancée serait que la vitesse respective des gouttes à l'éjection de la buse serait différente entre ces buses et induirait des pentes spécifiques. En position latérale, peu de données ont pu être acquises du fait d'une densité de gouttes trop faible pour réaliser une mesure. Cependant, dans les cas où une mesure a pu être réalisée, les résultats confirment ceux obtenus en position frontale.

Par ailleurs, ces résultats préliminaires ont été comparés à ceux issus de certains modèles (Ex. Driftsim) ou issus de données existantes avec une bonne correspondance.

## 4. Conclusions

Ce travail visait à définir des descripteurs macroscopiques de la dérive des sprays sur la base de mesures en soufflerie équipée d'un banc de répartition. Différentes conditions expérimentales ont été testées telles que le nombre de buses, le type de buse, la hauteur de la rampe, l'orientation de la rampe et la vitesse du vent.

Le premier résultat correspond à la définition du taux de dérive à 5m ( $Dr_5$ ) comme étant l'indicateur de dérive le plus pertinent lorsque l'on considère les multiples combinaisons de la hauteur de la rampe, de la vitesse du vent et de la position de la rampe. La robustesse de cet indicateur a permis de modéliser, pour chaque buse et pour chaque position de la rampe, les paramètres d'influence (vitesse de vent et hauteur de rampe) avec un modèle de premier ordre à travers la notion de temps de vol (ToF). Ce changement de repère permet maintenant de comparer des essais qui n'étaient pas comparables auparavant et pourra également trouver des applications dans l'analyse des essais au champ où les conditions de vent sont par nature très variables.

Le deuxième résultat correspond à la relation trouvée entre le temps de vol et la taille des gouttes mesurées in situ. Ce résultat montre la prédominance du transport horizontal des gouttes selon leur taille par le vent sur la trajectoire des gouttes à l'éjection. Les quelques comparaisons effectuées avec des modèles de dérive existants (ex Driftsim) démontrent la pertinence de ce résultat. Par contre les différences de résultat entre la buse à jet plat et les buses à induction d'air dans l'espace ToF restent à élucider.

## 5. Perspectives

Ce travail pourra être poursuivi sur le plan de la recherche expérimentale, de la modélisation et sur le plan appliqué. La pertinence de la représentation ToF pour des essais au champ pourrait être testée dans le but de mieux comparer des conditions de vent distinctes.

De plus, l'effet de la pression n'a pas été considéré comme prioritaire lors ce travail, compte tenu du nombre important de variables étudiées. Pour être exhaustive, cette étude nécessiterait d'intégrer la pression dans les modèles prédictifs de la dérive.

Les potentialités d'extension du domaine d'étude (hauteur – vitesse de vent – pression) mériteraient d'être définies. Par exemple, la validité du simulateur de hauteur pour des valeurs de 1.20 m ou 0.3m pourrait être vérifiée.

Enfin, ces travaux offrent des perspectives en matière d'harmonisation des mesures de dérive potentielle en soufflerie (future révision de la norme NF ISO 22856) et notamment pour la comparaison de protocoles à exposition de longue et de courte durée.

## Contents

## Sommaire

<b>Acknowledgement</b> .....	2
<b>Résumé en français</b> .....	3
1. Contexte de la thèse.....	3
1.1. La dérive .....	3
1.2. Objectif de la thèse .....	6
1.3. La soufflerie et le banc de mesure .....	7
1.4. Caractéristiques des buses .....	9
1.5. Mesure des dépôts de dérive sédimentaire .....	10
1.6. Analyse des dépôts de dérive sédimentaire .....	10
2. Modalités .....	11
3. Résultats .....	11
3.1. Partie 1: Effet du nombre de buses dans les deux positions de la rampe .....	12
3.2. Partie 2 : Identification et validation de descripteurs de la dérive.....	14
3.3. Partie 3 : Approche cinématique selon le temps de vol.....	15
3.4. Partie 4 : Validation du modèle de temps de vol par des mesures de granulométrie <i>in situ</i> . 16	
4. Conclusions .....	18
5. Perspectives .....	18
Contents.....	20
List of figures .....	22
List of Tables.....	23
List of symbols and abbreviations.....	24
Chapter 1: General introduction .....	25
1.1. Efficacy criteria of a spray application .....	26
1.2. Spray drift .....	28
1.2.1. Definition and typology .....	28
1.2.2. Causes.....	31
1.2.3. Methods for drift measurement .....	32
1.2.4. Spray drift sampling techniques for field tests.....	34
1.3. Context and objectives.....	42
1.3.1. General problem statement.....	42
1.3.2. Objectives of this study .....	42

Chapter 2: Literature Review .....	43
Abstract .....	43
Conclusions and perspectives.....	55
Chapter 3: Materials and Methods .....	56
1. Introduction .....	56
2. Description of IRSTEA Montpellier wind tunnel .....	56
2.1. Air control .....	57
2.2. Pressure liquid control .....	58
3. Boom setup.....	59
4. Distribution test bench .....	60
5. Nozzle characteristics.....	62
6. Sedimentation flowrate measurements.....	63
7. Droplet size measurements.....	63
8. Modalities setup .....	65
Chapter 4: Results .....	67
Abstract .....	67
Abstract .....	77
Abstract .....	77
Chapter 5: General conclusions and perspectives .....	77
Perspectives.....	79
Bibliography.....	82
Appendix .....	89
Publications .....	89
Oral communications .....	89
Posters .....	90
Abstract .....	91
Résumé .....	91

## List of figures

Figure 1: Evolution de la dérive en verger selon le stade végétatif (verger pomme).....	4
Figure 2: Différentes positions de la rampe .....	8
Figure 3: Répétition des mesures par gouttière en fonction de la distance- rampe en position.	9
Figure 4: Plan expérimental .....	11
Figure 5: Effet du nombre de buses et de la vitesse de vent en position frontale sur le taux de dérive (Dr), (FF: buses Flat Fan) - Hauteur 60 cm. Les points en légende illustrent les différentes configurations de rampe à la vitesse de $2 \text{ m s}^{-1}$ .....	13
Figure 6: Effet du nombre de buses sur le débit relatif en position latérale – vent $4 \text{ m s}^{-1}$ et buses FF - Hauteur 60 cm .....	13
Figure 7: Identification des indicateurs de la dérive, (1) le taux de dérive à 5m ; (2) barycentre des dépôts; (3) le taux de récupération ; (4) l'intensité du pic de dépôt; (5) la position du pic de dépôt .....	14
Figure 8: Taux de dérive en fonction du temps de vol (ToF) selon différentes vitesses de vent- Position frontale .....	15
Figure 9: Comparaison du taux de dérive entre des valeurs mesurées (60 cm) et des valeurs simulées à partir des hauteurs 40 et 80 cm. Buses AXI - Position frontale .....	16
Figure10: Relation entre la taille de gouttes et le temps de vol (ToF) – buse jet plat en position frontale .....	17
Figure 11: Pesticide transfer process.....	26
Figure 12: Mass balance approach applied to banana crop spray application .....	27
Figure 13: Mass balance indicators during a spray application .....	27
Figure 14: Sedimentation time in a still air as a function of droplet size.....	29
Figure 15: Vapor drift phenomena .....	30
Figure 16: factors associated spray drift.....	31
Figure 17: Methods for measuring spray drift .....	32
Figure 21: Belgian protocol.....	41
Figure 22: IRSTEA-Montpellier wind tunnel .....	57
Figure 23: 2D Wind profiles in IRSTEA wind tunnel for expected wind speeds of 1, 3 and $6 \text{ m s}^{-1}$ .....	58
Figure 24: Main measuring devices found in the wind tunnel .....	59
Figure 25: Different boom positions in the wind tunnel (A): Frontal position; (B): Lateral position; (C): Boom with an angle of $45^\circ$ .....	60
Figure 26: Collecting plan with grooves .....	61
Figure 27: A mobile device wind tunnel.....	61
Figure 28: Weight cells .....	62
Figure 29: Set-up of the Malvern Spraytec in the wind tunnel (A) Testing Malvern (B) Measuring droplet size in frontal position (C) Measuring droplet size in lateral position.....	64

## List of Tables

Table 1: Caractéristiques des buses.....	10
Table 2: Comparison of spray drift sampling techniques .....	35
Table 3: Method applied for measuring spray drift in the wind tunnel.....	37
Table 4: Classification of drift reduction for LERAP and ISO 22369-1 depending on reduction of the candidate system compared to reference system .....	39
Table 5: Albuz nozzles characteristics .....	63
Table 6: Summary of some technical definitions used for describing droplet size.....	65
Table 7: Modalities settings .....	66



## List of symbols and abbreviations

Agdrift	<i>Agricultural Drift model</i>
AI	<i>Air Induction nozzle</i>
AI Twin jet	<i>Air Induction Twin Jet nozzle</i>
CFD	<i>Computational Fluid Dynamics</i>
DIX	<i>Drift Index Scheme</i>
DR <sub>5</sub>	<i>Drift Ratio at 5 m</i>
Driftsim	<i>Drift Computer Simulation Software</i>
Dv0.5	<i>Volume Median Diameter (μm)</i>
EPA	<i>Environmental Protection Agency</i>
FAO	<i>Food and Agriculture Organization</i>
FF	<i>Flat Fan nozzle</i>
H	<i>Boom Height (cm)</i>
HV	<i>High Volume</i>
IDEFICS	<i>IMAG program for Drift Evaluation for Field sprayers by Computer Simulation</i>
IRSTEA	<i>Institut National de Recherche en Science et Technologies pour l'Environnement et l'Agriculture</i>
ISO	<i>International Organization for Standardization</i>
JKI	<i>Julius Kühn Institute</i>
LERAP	<i>Local Environmental Risk Assessment for Pesticides</i>
LV	<i>Low Volume</i>
PSI	<i>Pounds per Square Inch</i>
ToF	<i>Time of Flight (s)</i>
ULV	<i>Ultra Low Volume</i>
V	<i>Wind velocity (m/s)</i>
WSP	<i>Water Sensitive Paper</i>

## Chapter 1: General introduction

The supply of agricultural products in quantity and quality is considered as an important issue to human life because of the worldwide food demand that is increasing (FAO, 2012). To achieve this aim, the improvement of agricultural production yield is necessary. On the other hand and in parallel with the increasing needs for food production, public health issues are to be solved (ex. vectorial diseases carried by insects, mosquitoes, etc). For the moment, both agriculture and public health issues are managed considering the use of pesticides. However the pesticide use involved controversies due to human health and safety as well as environmental contamination.

Generally, pesticide is a chemical or biological product used to protect a biological target site (plants or animals) from pests or diseases.

Pesticides can be classified (i) by the target pest group into different types (i.e. herbicides, insecticides, fungicides, rodenticides, and pediculicides), (ii) by their biological mode of action (contact, systemic) or (iii) by their mode of application (fog, mist, spray, powder).

The need in pesticide use in agriculture is a worldwide necessity, as an unavoidable way to control the impact of pest, diseases, weeds that affect the crop yield. Pesticide use is also a necessity when more food is expected from the same or a reduced agricultural surface area.

(Eurostat, 2013) reported that approximately 67.3 million tones of pesticides are applied in France for agricultural applications. France is considered as the third top pesticide consumer country in the world and the second in Europe.

Most of pesticides are applied in liquid formulations and require spraying equipment. Agronomical specifications of a spray application have evolved during these last 20 years. Advices and practices in the 80' and 90' were mostly focused on a uniform distribution of small and numerous impacts per cm<sup>2</sup> (Prokop and Veverka, 2006). Nowadays, due to environmental considerations and the more systematic use of drift mitigation equipments, a smaller number of bigger impacts per cm<sup>2</sup> is accepted and seeked.

The use of systemic active ingredients (ex. Glyphosate) was promoted by such strategy. However, the question of the ideal distribution of impacts is still open for contact mode of action products.

## 1.1. Efficacy criteria of a spray application

The purpose of a spraying application in agriculture is to place an effective and uniform product amount on the intended target zone. The quality of a spray application can be assessed through different time scales. Shortly after the application, deposition amount, impact size and number on targets can be evaluated by using dye tracer or image analysis techniques. On a longer time scale, the quality assessment is achieved by evaluating the biological efficacy.

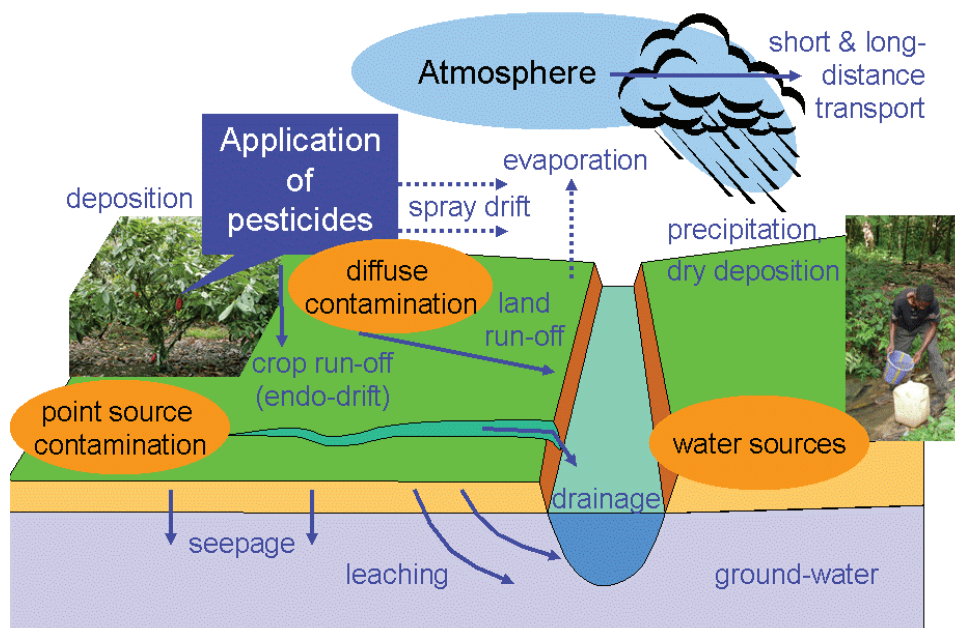

**Figure 11: Pesticide transfer process**

Source: [https://en.wikipedia.org/wiki/Pesticide\\_application](https://en.wikipedia.org/wiki/Pesticide_application)

Figure 11 describes the phenomenon occurring during and after a spray application. Apart from the deposition on targets, several types of pesticide losses can be identified like point source contamination (ex. during sprayer filling and cleaning) and diffuse sources related to the transfer of pesticide due to atmospheric conditions (ex. drift). As a result, Fig.11 explains why water is one the environmental compartment that might be the most impacted by pesticides.

In general, spray applications are evaluated considering either deposition on targets or drift or soil deposition, etc. Another approach considers the global efficacy of the application in terms of mass balance. In this case, the sprayed volume fraction collected in different compartments

is taken into account (Fig 12). The intention is both to maximize the deposition on the targets and to minimize ground and aerial losses.

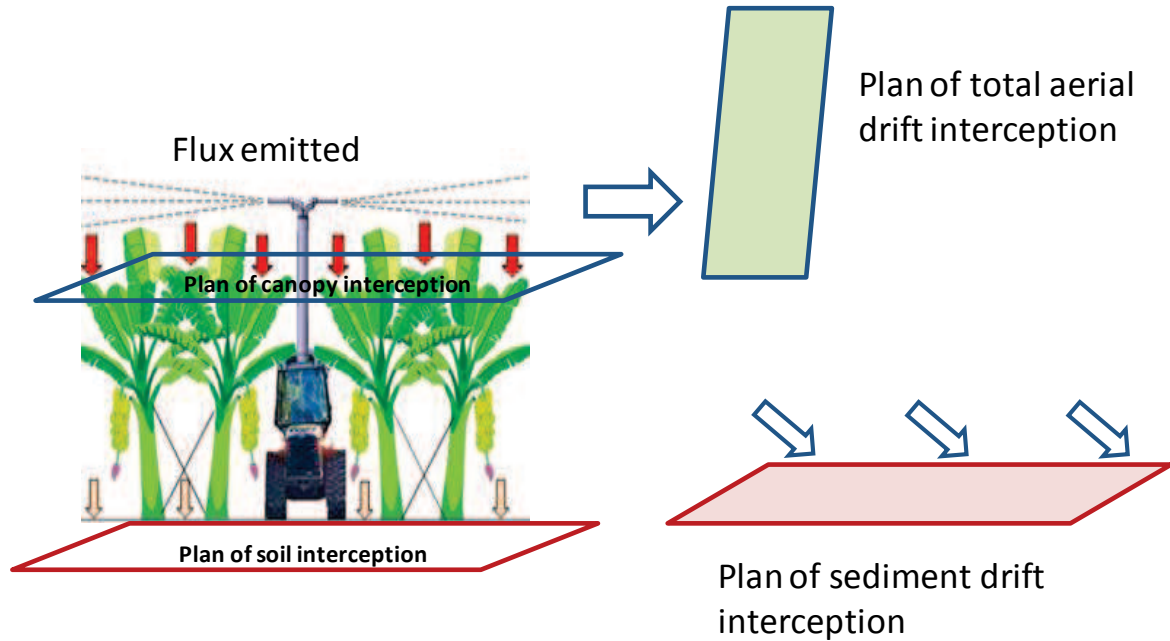

**Figure 12: Mass balance approach applied to banana crop spray application (Cotteux et al., 2013)**

Several indicators can then be calculated from the previous figure as illustrated by figure 13.

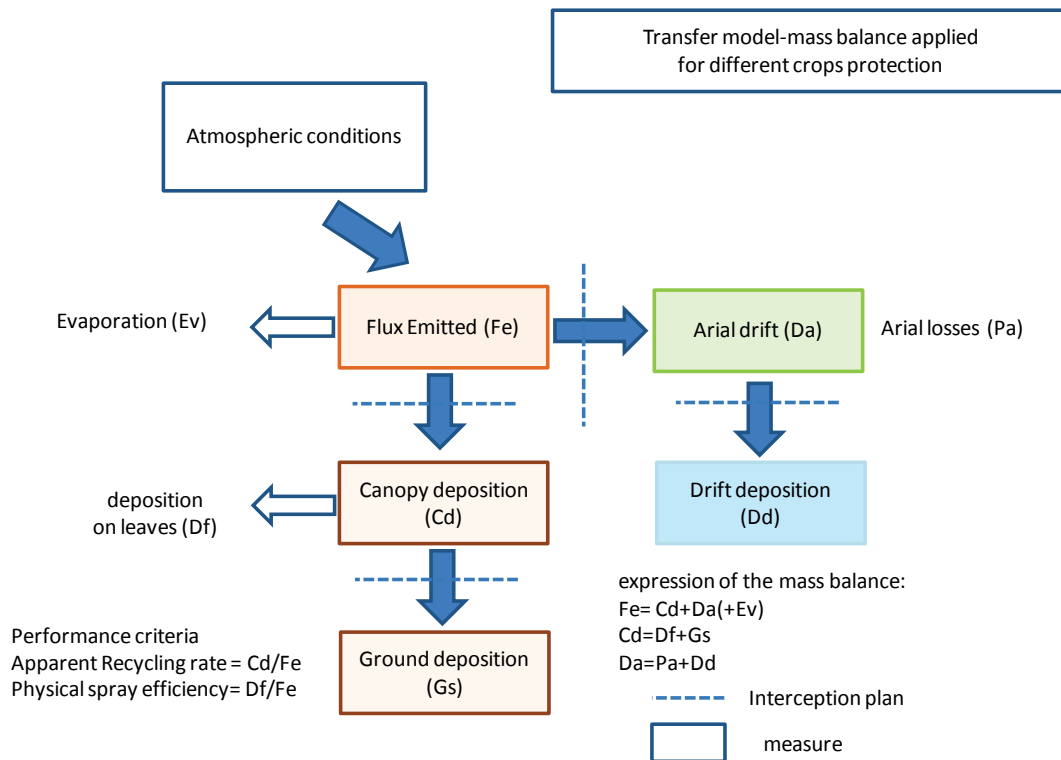

**Figure 13: Mass balance indicators during a spray application**

During pesticide applications, there are more than 80% of the pesticide may be derive-away from the target site as spray drift (up to 15%), rebound (up to 30%), run-off (up to 20%) and other processes (up to 15%) including evaporation or photolysis which play an important factor with side effect on the human health and environmental contamination (Knowles, 2001; Pimentel and Burgess, 2012; Minov et al., 2015).

The starting point of this mass balance corresponds to the emitted flux of plant protection products that is carried out by spray application equipment introduced in the next paragraph.

## **1.2. Spray drift**

### **1.2.1. Definition and typology**

According to the Environmental Protection Agency (EPA) and the International Organization for Standardization (ISO), spray drift can be defined as the amount of spray liquid that is carried out of the sprayed (treated) area by the action of the air currents during the application process. Spray drift can consist of droplets, vapors or dry particles (Gil and Sinfort, 2005). It is expressed as a percentage of the application volume.

Pesticide spray drift is an important issue and is considered of great concern in the European Union because of the environmental consequences of agricultural practices and the sustainable use of pesticides. In practice, some amount of the spray liquid may deposit on the ground nearby the sprayed field and may potentially harm sensitive crops, water courses, workers, residents (Miller et al. 1993; Butler Ellis & Bradley, 2002; Taylor et al, 2004; Miller et al., 2011).

Several studies have shed light on spray drift phenomenon and the most influential factors affecting its magnitude (Nuyttens et al, 2007; Nuyttens et al, 2011; Douzals, 2012). The protection of surface water in Europe has led to the development of drift mitigation measures combining buffer zones and low drift nozzles. At the present time more than 100 nozzle references are registered as low drift in France.

All agricultural chemicals can drift away from the target site when applied and the prevention from all types of drift (droplets, vapors, particles) is important regarding to the human health and environmental impacts. Pesticide spray drift can be evaluated according to two protocols: sedimentation (ground) drift and airborne (aerial) drift. Sedimentation drift is generally considered when the impact of a chemical on surface water or sensitive adjacent crop is

studied. Airborne drift is generally considered when the impact of a chemical on bees, residents, workers or bystanders is studied (cf Fig 11).

### 1.2.1.1. *Liquid or solid particle spray drift:*

Particle spray drift is defined as the movement of solid particles from the intended treatment zone during spraying application into non target zone. Solid particles can correspond to particles generated by depression seeders with coated seeds or evaporated droplets from liquid sprays. Compared to liquid droplets generated by flat fan nozzles, the range of solid particle size can be much lower involving higher drift distances (Manzone et al., 2015).

Larger (coarser) droplets may sediment at a short distance from the nozzle orifice and fall close to the point of release according to their energy. But smaller droplet sizes (finer droplets less than 100 $\mu$ m) remain in suspension in the air for a long time and may eventually be transported by air currents. Fig. 14 shows the effect of droplet size on the drift potential by affecting on the rate of fall (Ross and Lembi, 1985).

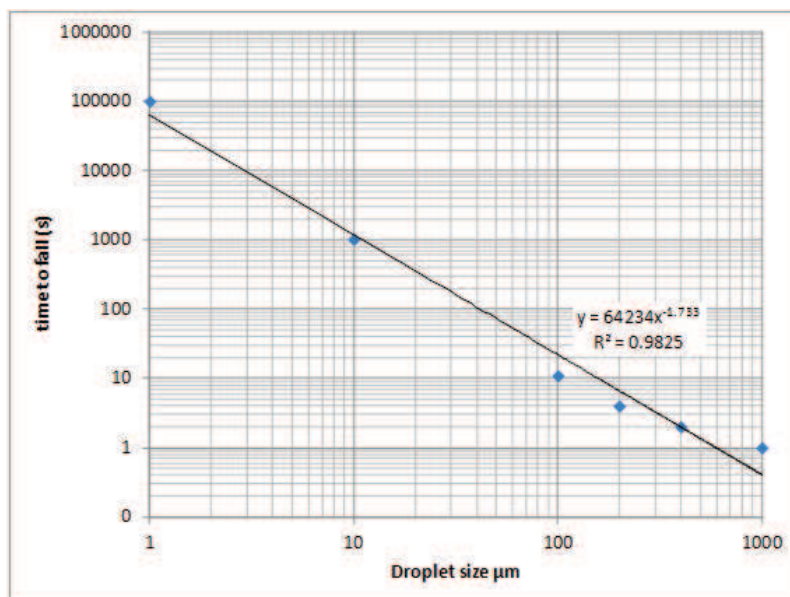

**Figure 14: Sedimentation time in a still air as a function of droplet size**

Results as shown in Fig. 14 introduced the relationship between droplet size and the time of transport for different droplet size. Increasing the falling time corresponds to a greater drift potential.

### 1.2.1.2. Vapor drift:

Vapor drift is defined as the movement or transfer of pesticide spray vapors from the soil surface or plant into the atmosphere outside of the treatment zone during or soon thereafter the time of application as a form of gas. This type of drift is invisible and can have a considerable impact on residents, workers located close to the sprayed field.

Vapor drift occurs when the finer pesticide molecules from the target surfaces or soil evaporated in the air during or after the application. Vapor form particles are moved more than 12 hours after the application especially when the air temperature is high and the relative humidity is low (Matthews, 2006).

Vapor drift is mainly depending on the chemicals properties of spray liquid or formulation (i.e. esters content, vapor pressure values and chemical's Henry's law constant) and environmental conditions (high temperature and low relative humidity). Chemical molecules are then moving away as a gas rather than as liquid droplets.

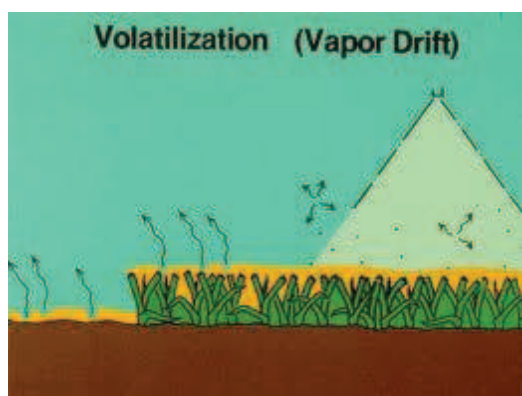

**Figure 15: Vapor drift phenomena**

([www.personal.psu.edu/faculty/a/s/asm4/turfgrass/education/turgeon/modules/07\\_pestmanagement/pesticides/volatilization.html](http://www.personal.psu.edu/faculty/a/s/asm4/turfgrass/education/turgeon/modules/07_pestmanagement/pesticides/volatilization.html) )

Many modern formulations registered to use have a low vapor pressure (Miller, 2003) in order to mitigate of droplets evaporation to the atmosphere. (Korbara et al., 1999) developed the plastic film to prevent methyl bromide mission to the atmosphere by the action of air. The film is composed of gas-barrier layer, Tio2 photocatalytic layer and support layer. As a result methyl bromide was dramatically reduced with this film without the production of vapor drift.

The equilibrium between the liquid and the gas forms may be highly different depending on the pesticide type.

For example the drift form of pendimethalin and trifluralin is generally gas as alachlor and metolachlor was in the particle form. Thiobencarb was indicated in both forms (gas and particle forms) (Yogo, 2009).

### 1.2.2. Causes

Several factors have a great influence on pesticide spray drift (Alheidary et al., 2014) including i) physical factors (droplet size, droplet velocity, droplet evaporation, and properties of spray liquid) ii) technological factors (nozzle type, nozzle size, boom height and orientation, operating pressure, and forward speed); iii) meteorological factors (wind velocity, air stability, air ambient temperature, and relative humidity) and iv) other factors such as topography of the terrain, the crop vegetation stage, application equipment and methods, and decisions of the applicator.

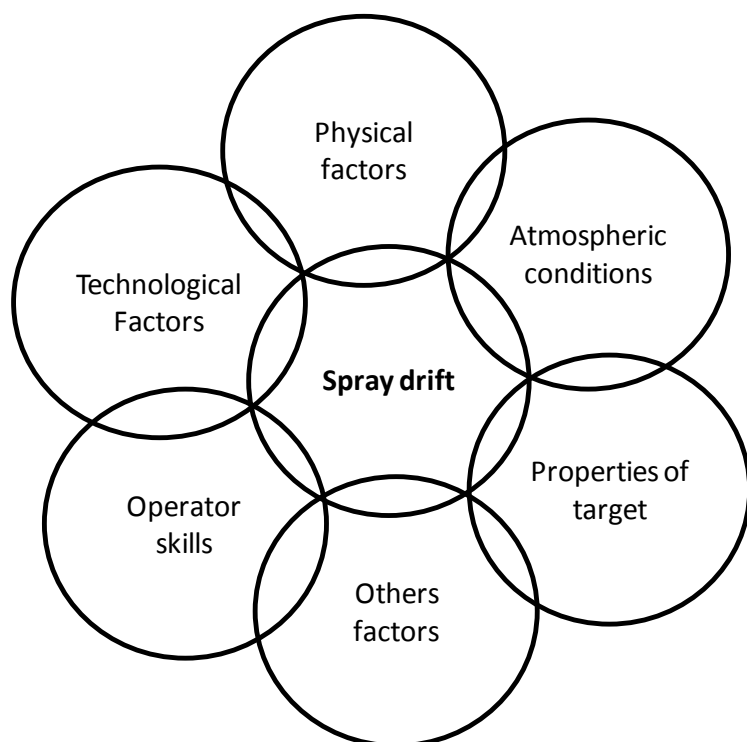

**Figure 16: factors associated spray drift**

(Inspired by <http://www.omafra.gov.on.ca/french/index.html> )

#### Boom height

A majority of field studies carried out on spray drift from boom sprayers showed clear quantitative results and found high variation in spray drift according to boom height (Teske and Thistle, 1999; De Jong et al., 2000).



Moreover, the results showed the importance of minimizing the boom height particularly when the nozzle produces fine or medium droplet sizes (Miller et al., 2011).

Droplet size

Several experimental studies are conducted from different authors in the field and in the wind tunnel concerned droplet sizes. The results showed droplet size is one of the major important characteristics that related to droplet velocity. Furthermore, both of droplet size and droplet velocity have affected on biological efficacy and environmental contamination as spray drift values (Matthews, 2000, Taylor et al., 2004, Alheidary et al., 2014). On the other hand, droplet size and droplet velocity are related to nozzle type and nozzle size.

**1.2.3.Methods for drift measurement**

Spray drift can be evaluated through field measurements or wind tunnel experiments by using different protocols (Fig. 17).

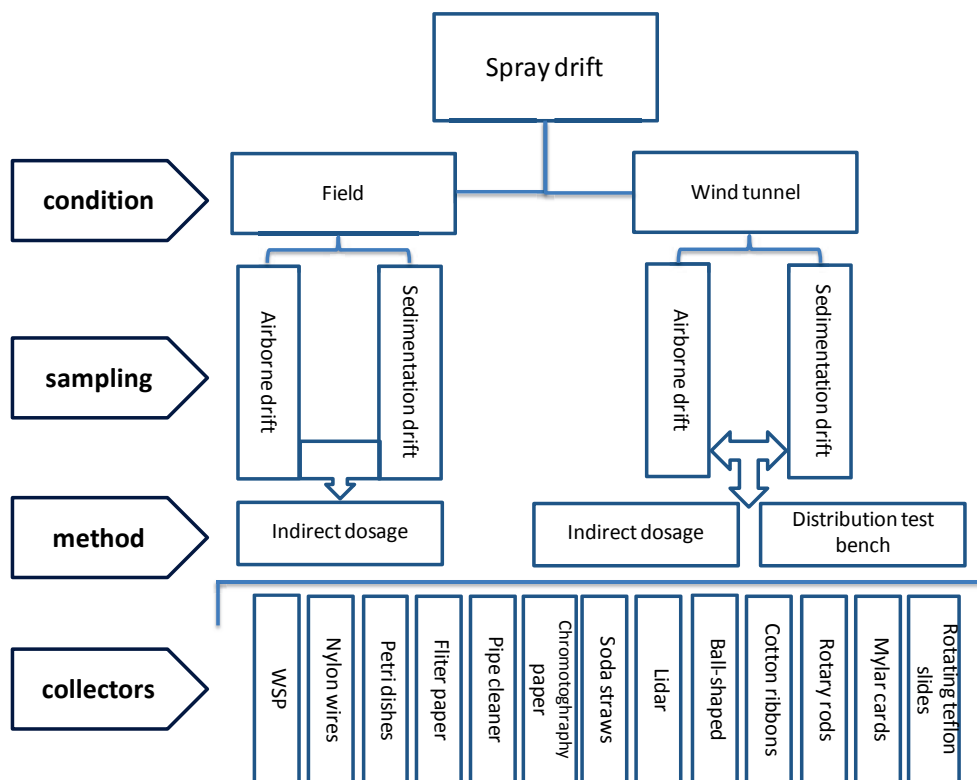

**Figure 17: Methods for measuring spray drift**

### 1.2.3.1. Field test

Spraying equipments are devoted to apply a certain amount of a pesticide on an intended target. However it appears that a volume fraction is deflected outside the target area to the ground, surface water, or other sensitive area as spray drift by the action of wind speed and spraying conditions.

Field experimental is appropriate to obtain realistic estimates of spray drift values using sprayers under different working conditions.

In most cases, spray drift measurements in the field are carried out according to ISO 22866: 2005 (sprayed area and wind velocity criteria) in conjunction with ISO 22369-2 that defines the sampling distances (ex 5m, 10m, 20m, 30m, 50m, etc.) (Fig.18).

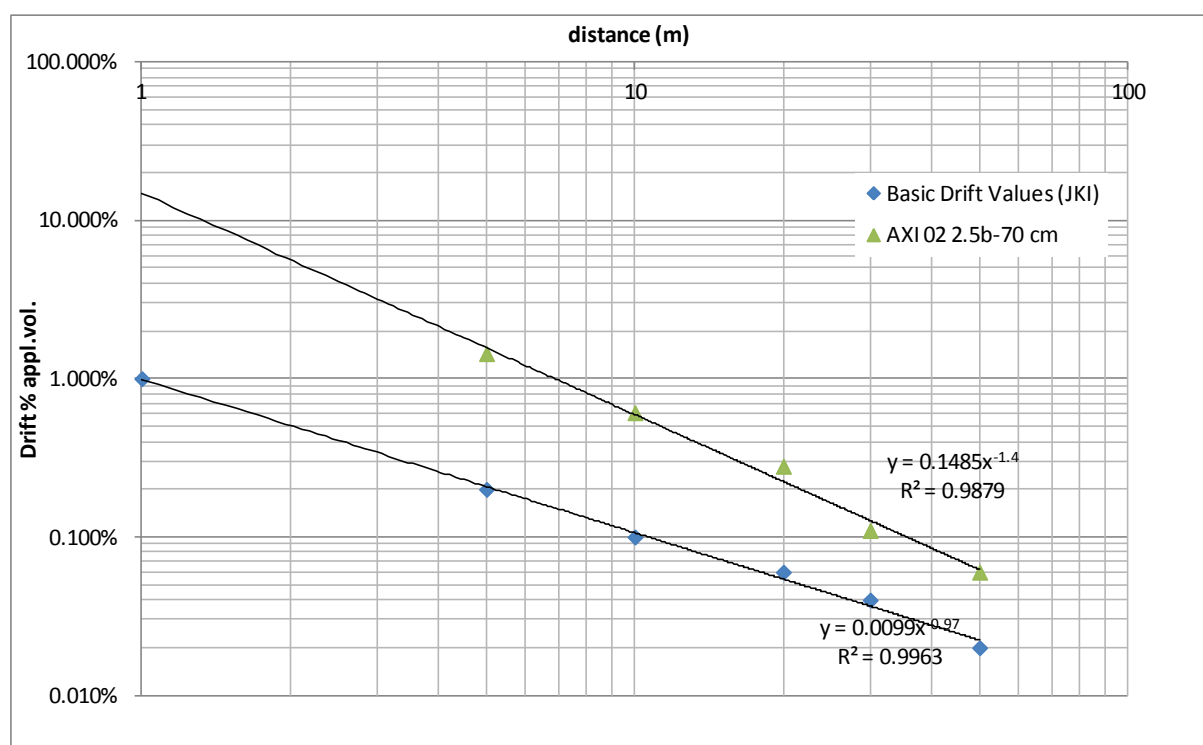

**Figure 18: Comparison of reference drift values (average values) for France (Liet and Polveche, 2009) and Germany (Rautmann et al., 2001).**

Due to wind speed and wind direction specifications, this method is applicable with difficulty because it is extremely time-consuming and costly (Carlsen et al, 2006; Rimmer et al., 2009).

In addition, field measurement has a high dependence on meteorological conditions and repetitions are not really possible. In this case, results can only be interpreted in terms of statistics based on a relatively high number of repetitions (ex percentile).

Typically, sedimentation spray drift is a result of the droplets that move away and falling on the surface as air-borne droplets (Miller et al., 2011). The use of sampling to measure sedimentation spray drift is can be supported either vertically or horizontally position depending on the measuring type. Measuring sedimentation spray drift is always requiring a tracer for capturing sedimentation spray drift which fall on the sampling surface.

Several methods are available for quantifying sedimentation spray drift including Petri dishes, chromatography paper, wire string nylon, etc that located on the surface depending on the planning of test (protocol).

#### **1.2.4.Spray drift sampling techniques for field tests**

Many spray drift sampling techniques have been used in different studies in both field and wind tunnel measurements (Salyani et al., 2006; Ferreira et al., 2010, Nuyttens et al., 2010, Donkersley and Nuyttens, 2011). There are two types existing of the collectors: passive and active collectors. Passive collectors which have used in various studies to determine the sedimentation and airborne spray drift using tracers. Passive sampling techniques are mostly used for spray drift measurements and are introduced in Table 2.

The collected amount of spray is generally determined by dosing the quantity of tracer on collectors by using spectrometry (Tartrazine) or spectrofluorometry (Brillant Sulflo Flavine, Fluoresceine, Rhodamine). In the Table 2 showed several studies that concern environmental aspect have been carried out in the world to stimulate the quantity of drift using different techniques. These passive techniques can be completed with active sampling techniques such as low or high volume air samplers, rotary rod sampler (rotorod), etc. Each technique that showed in Table 2 has advantages and disadvantages dependent on different conditions to be more effective to measure drift value at the time of spraying as weather conditions at the time of application (temperature and relative humidity), forward speed, type of equipment, and the type of tracer. One of the most disadvantages for sampling spray drift techniques, it has a great variety into estimate of spray drift values between them when it is tested at the same operating conditions.

At field conditions, there are various techniques have been developed to evaluate spray drift and coverage such as passive samplers (e.g. water sensitive paper) and active samplers (e.g. air samplers and rotorods). Several studies were conducted to compare the collecting efficiency of collectors while estimating the spray drift values.

Good relationship between airborne spray drift and the risk that required an understanding. From this fact, several studies were conducted to develop sampling airborne spray drift which consider difficult phenomena that related with micro metrological conditions (Fox et al., 2004, Fritz and Hoffmann, 2008, Wolter et al., 2008, Arvidsson et al., 2011). So, airborne spray drift has a great importance since it can be carried over long distances from the target site by the action of the air.

Measuring spray drift technique to evaluate airborne drift involve sampling of droplets less than 100µm together with dry particles of substances originating from volatilization of the pesticide carrier (normally water).

**Table 2: Comparison of spray drift sampling techniques**

References	Active samplers				Passive samplers															
	Air sampler	Rotorods	Rotating ribbon	Rotating Teflon slides	WSP	Alpha cellulose	Nylon string	LIDAR	Soda straws	Pipe cleaners	Petri dishes	Filter paper	Ball-shaped	Mylar cards	Cotton ribbons	Glass tube	Patterntors	Synthetic cloths	Canfil CM 360	
Cooper et al., 1996			X				X													
Bui et al., 1998	X					X	X													
Miller & Butler Ellis, 2000	X						X			X										
Briand et al., 2002a	X															X				
Hoffmann et al., 2003	X	X			X									X						
Barber et al, 2004				X																
Balsari et al., 2005							X													
Fritz & Hoffmann, 2008							X		X											
Wolter et al., 2008							X				X									
Farooq et al., 2009			X	X							X				X					
Arvidsson et al., 2011							X			X	X	X								
Fritz et al., 2011							X							X						
Llorens et al., 2012								X			X									
Kasiotis et al., 2014							X				X	X								
Zhao et al., 2014										X										
Gregorio et al., 2014					X		X	X												
Gil et al., 2014											X									
Van de Zande et al., 2014																		X	X	
Wenneker et al., 2014													X							X
Reichard et al., 1992											X									
Herbst and Ganzelmeier,2000							X													
Taylor et al., 2004							X													
Fritz et al., 2006							X							X						
Stainier et al., 2006							X				X									
Nuyttends et al, 2007							X													
Dorr, 2009							X													
Nuyttens et al, 2009							X													
Miller et al., 2011							X													
Douzals & Alheidary, 2014																		X		

(White lines: filed tests – Grey lines wind tunnel)

In conclusion, all samplers above are depending on the air velocity at the time of measuring in collection the quantity of spray airborne that found in atmosphere space. Normally, each type of collector has an advantages and disadvantages. The main advantages of using these collectors to sample airborne spray drift that link to the high collection efficiencies with small particles sizes. Conversely, the disadvantages are related to high power requirements and the complexity of constructor (Miller, 2003)

#### Conclusion on collector efficacy

Airborne drift can be evaluated both in the field and in wind tunnel by using static and/or dynamic samplers. Comparatively, the results showed significant differences between both types of collectors depending on several factors such as sampler place, sampler height, etc. In high wind velocity situations, static collectors showed a better efficiency compared to dynamic samplers.

When used, pipe cleaners appeared as suitable samplers for measuring airborne spray drift. Sedimentation drift is usually evaluated by using Petri dishes, filter papers or WSP.

Drift measurement techniques are used to assess spray equipments but also to classify their drift reducing efficacy. When considering a reference sprayer or a reference spray application technique or a nozzle, it is possible to classify the drift reducing technologies compared to this reference as suggested by ISO 22369-1.

#### ***1.2.4.1. Simplified methods in a wind tunnel***

Wind tunnel experiments were used by researchers to evaluate pesticide spray drift in controlled conditions (Miller et al., 1993; Butler Ellis and Bradley, 2002; Taylor, 2002; Miller et al., 2011; Nuyttens et al., 2007; Nuyttens et al., 2009; Douzals, 2012; Douzals and AlHeidary, 2014). The advantage of using a the wind tunnel is an efficient way for supporting and complementing the data derived and can be a valuable alternative to field experiments by controlling wind speed and direction, air temperature, relative humidity, air stability, and turbulence that occur at the time of measuring (Nuyttens et al., 2011).

Spray drift in the wind tunnel experimental is often evaluated by using different methods sometimes with polythene lines, filter paper, water sensitive paper, Petri dishes, etc (ISO 22856). As the drift from one nozzle is generally measured on short sprays, wind tunnel experiments lead to the definition of a so-called potential drift compared to drift values collected form field measurements with a complete sprayer.

Spray drift potential can be evaluated considering either a vertical sampling framework as DIX in Germany (Herbst and Ganzelmeier, 2000) or a horizontal sampling framework as in the LERAP scheme (Gilbert, 2000). In both cases the minimum collection distance is 2m from the nozzle outlet and wind velocity is 2 m s<sup>-1</sup>. Globally, wind tunnels are used for measuring the potential spray drift of nozzles in the following European countries: Belgium, Germany, UK and France.

Therefore, several studies carried out on potential spray drift measurements showed a certain level of variability in the results depending on type of protocol applied and the operating conditions (Walklate et al., 2000; Nuyttens et al., 2007; Douzals and Alheidary, 2014).

Generally, measuring sedimentation spray drift in the wind tunnel is dependent on various factors as nozzle type, operating pressure, boom height and their orientation, and wind velocity.

To evaluate the quantities of spray drift that could not reach to their target (particle or vapour drift), several testing protocols carried out in the world using a wind tunnel experimental in order to estimate potential spray drift at different distance from the nozzle (Table 3) .

**Table 3: Method applied for measuring spray drift in the wind tunnel**

Country	Wind tunnel working section (W*H*L)(m)	Wind velocity (ms <sup>-1</sup> )	Sampling plane	NB of nozzle	Collectors	Reference
UK	3x2x9	2	Horizontal	1	Horizontal nylon lines	Miller et al., 1995b
Germany	3x2x6	2	Vertical	1	Horizontal nylon lines	<u>Helck and Herbst, 1998</u>
Belgium	2x2x3	2	Horizontal	1	Horizontal nylon lines	<u>Stainier et al., 2006</u>
France	3x2x9	2-7.5	Horizontal	1-4	Distribution test bench	Douzals and Alheidary, 2014
USA	0.9x0.9x9.6	2	Horizontal	1	Horizontal nylon lines	Fritz et al, 2009
<u>Australia</u>	1.75x1.75x10	2	Horizontal	1	Horizontal nylon lines	Dorr, 2009

Several protocols have been developed in the European Union to evaluate spray drift potential and drift mitigation performance of nozzles used on field crop sprayers.

#### 1.2.4.2. DIX protocol (Drift Index scheme- Germany)

The DIX scheme (Herbst and Ganzelmeier, 2000) that developed in Germany in order to define the risk associated to spray drift potential. DIX scheme is based on the airborne drift profile measured in the Julius Kühn-Institut JKI wind tunnel. To evaluate spray drift in a wind tunnel by using the DIX protocol, a vertical array of horizontal polythene wires of 1.98 mm diameter is placed across the wind direction. The polythene lines are placed every 0.1 m from 0.1m to 1 m in order to quantify the total volume that may be lost downwind (Fig. 19). The tested nozzle is placed at a distance of 2m from the sampling zone upwind. All measurements

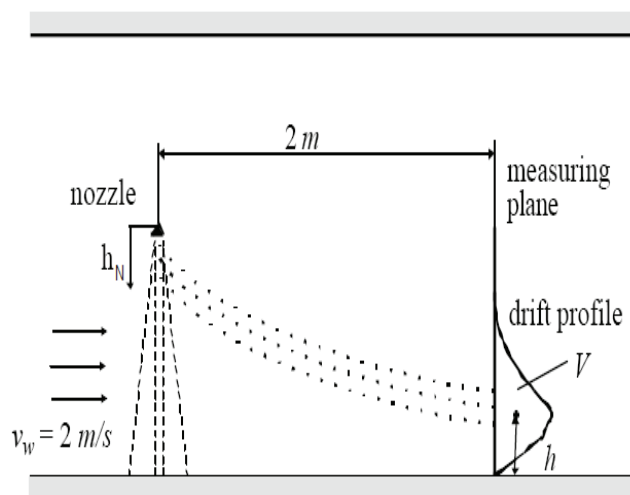

are conducted at wind speed of  $2 \text{ ms}^{-1}$ . The DIX value of a nozzle corresponds to the quantity of airborne volume flux ( $V$ ) multiplied by the weighted value of the drift vertical profile ( $h$ ), (Herbst and Ganzelmeier 2000) Fig. 19 normalized by the reference values of weighted height  $h_{st}$  and volume  $V_{st}$  from the reference nozzle as given by Eq. 2.

**Figure 19: Germany's DIX scheme for measuring spray drift potential**

$$\text{DIX} = \frac{h \cdot v}{h_{st} \cdot v_{st}} \times 100 \quad (2)$$

Drift reducing classes of 50%, 75% and 90% are directly calculated from the DIX values for different injection pressures.

#### 1.2.4.3. LERAP protocol (Local Environmental Risk Assessment for Pesticides in UK)

LERAP scheme stands for “Local Environmental Risk Assessment for Pesticides” (LERAP, 2001, Gilbert, 2000) and was introduced in the UK in 1999. LERAP scheme also implies buffer zones of 5m from the water edge, non-intended crops or other sensitive area.

Compared to the DIX methodology, LERAP scheme takes into account the droplets that fall onto the horizontal surfaces outside the treated zone and focuses on sedimentation drift profiles (Fig. 20).

The results of LERAP system to express on low drift with three star rating showed a level of sedimentation drift ratio in the wind tunnel (Fig. 20) that less than 25% of the reference system at a defined range of operating conditions such as (operating pressure, forward speed, boom height).

LERAP classification scheme uses a star rating to define the level of drift reduction of a given technology compared to a reference system. The using of rating level is to evaluate the size of spray buffer mitigation which can be used with a spray technology. Compared to the ISO classification scheme that includes 6 classes (A to F), LERAP scheme includes only 3 levels (\* to \*\*\*) as shown in the Table 4, (Hoffmann et al., 2010)

**Table 4: Classification of drift reduction for LERAP and ISO 22369-1 depending on reduction of the candidate system compared to reference system**

Drift reduction, % (1)	25≤50	50≤75	75≤90	90≤95	95≤99	≥99
LERAP drift classification	*	**	***	***	***	***
ISO drift classification	F	E	D	C	B	A

(1) Drift reduction is the percentage of drift reduction achieved by a technology as comared to a standard reference

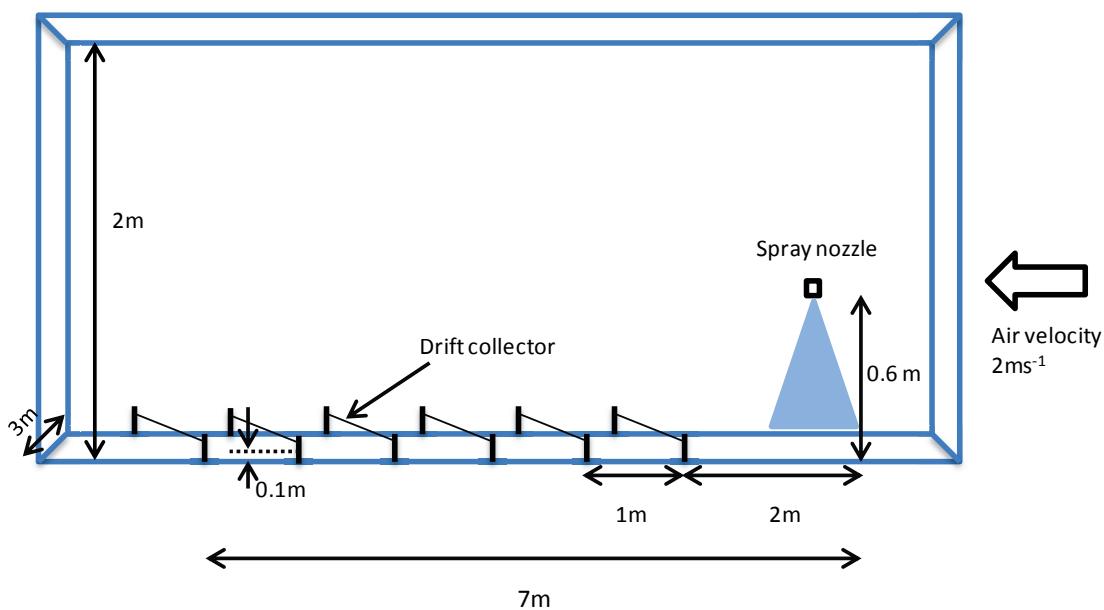
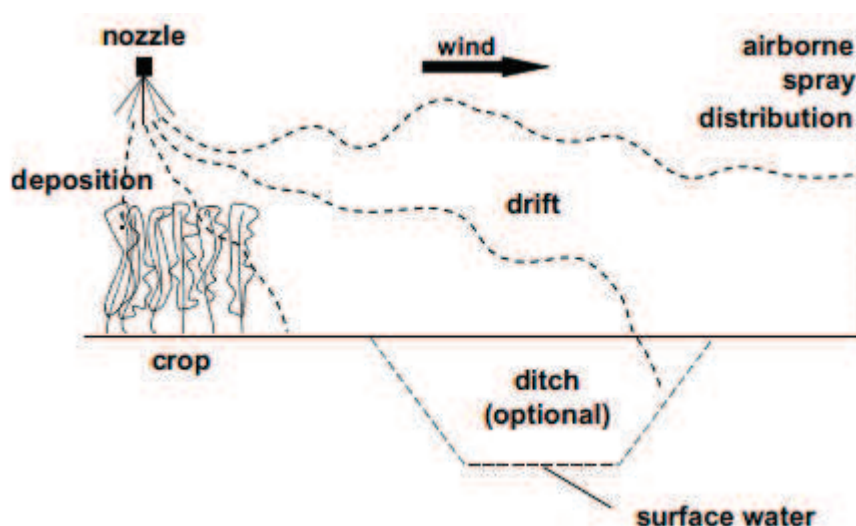

**Figure 20: LERAP scheme-ISR wind tunnel (Walklate et al., 2000).**



#### 1.2.4.4. IDEFICS model

IDEFICS drift model (IMAG program for Drift Evaluation for Field sprayers by Computer Simulation) is a one of the different computer models that used to quantify the extent of spray drift which affects the surface of water. In reality all these models are depending on the weather conditions (usually expressed in the wind velocity), properties of spraying equipment including (droplet size spectrum, and droplet velocity), and the geometry of the agricultural field. Generally the contamination of surface water and ditches surrounding crop fields has shed light in the Netherlands. Because the measurement of spray drift in the field is very difficult, a prediction of spray deposition onto the water surface was developed by using a computer model (IDEFICS: Holterman et al., 1997). Basically, IDEFICS model mixes 2D/3D random-walk model to describe the trajectories of a large number of individual droplets that are produced from a single nozzle (Fig. 21).



**Figure 21: Typical field lay-out for the simulation model (Holterman et al., 1998)**

IDEFICS drift model was calibrated by considering a single nozzle in a cross wind and extended to different nozzle types, liquid pressure, boom height, and forward speed. Weather conditions were measured at the experimental site and integrated into the model.

This system considers data from a reference nozzle that are issued from both laboratory (droplet size) and spray drift measured at field level. Reference data allow the set of drift reducing classes of 50%, 75%, 90% and 95%.

With this model, the droplet size spectrum and droplet velocity were measured using Phase Doppler Anemometry (PDA).

The results of this model and field experiments revealed all boom height, wind velocity and nozzle types are considered the most important parameters that affecting spray drift.

**1.2.4.5. Wind tunnel Gembloux**

Measuring spray drift protocol in Belgium was conducted by using wind tunnel experimental located at Gembloux Agricultural University. In this case the position of the spray corresponds to a lateral drift measurement. The internal working section of the wind tunnel is 2 x 2 x 6 m width, height, and length respectively. During the application, the nozzle is moved horizontally and perpendicularly to the wind direction by using a computer controlled with a servo-motor at forward velocity of 2 ms<sup>-1</sup>. The spray drift deposition is collected on the glass fibre collectors of 25mm x 25mm using a type of the tracer. Measuring spray deposit on the collectors carried out at each 1m from 2m to 6m downwind from nozzle with five sampling positions (Stainier et al., 2006) (Fig. 21)

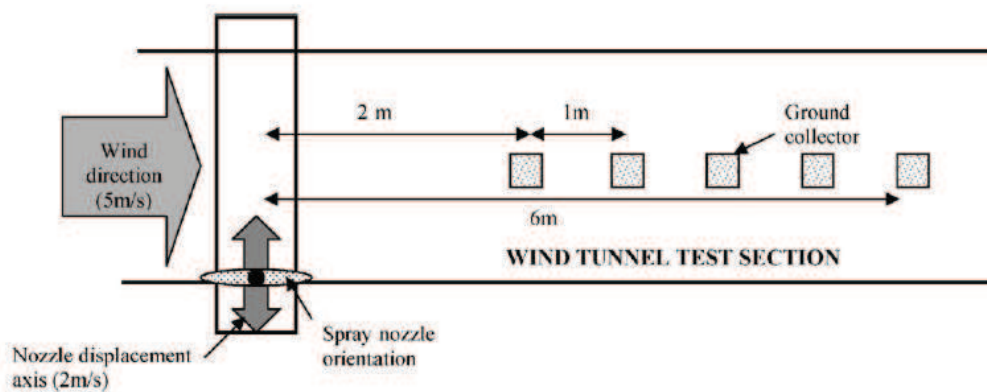

**Figure 18: Belgian protocol**

The integer of the spray drift curve was used to calculate of the spray drift with this protocol (Stainier et al., 2006) using the (Eq. 4)

$$Dp = \frac{100vD((\frac{d_{2m}}{2})+d_{3m}+d_{4m}+d_{5m}+(\frac{d_{6m}}{2}))}{q} \tag{3}$$

Where Dp is the spray drift percentage; d<sub>im</sub> is the spray drift sediment on the collector at position i m (ml m<sup>-2</sup>); v is the nozzle forward velocity (m s<sup>-1</sup>); D is the distance between two collectors (m); and q is the nozzle flowrate (ml s<sup>-1</sup>)

#### **1.2.4.6. French scheme for assessing drift reducing nozzles**

French scheme for assessing the drift reduction capacity of nozzles were set up in 2007 after a series of field tests comparing a reference spray situation (FF 02 2.5 bar and 70 cm height) with several drift reducing nozzles (pre orifice and air induction) on the same 24 m boom sprayer. Forward speed was 8 km/h and average lateral wind speed was 12 km/h.

Drift reducing rates between nozzles tested with field tests were used to set IRSTEA wind tunnel parameters with an appropriate wind speed of 7.5 m/s.

As it will be explained further on in this document (cf. chapter 3), IRSTEA wind tunnel is equipped with a distribution test bench allowing spray deposition measurements starting 1m before the boom up to 8m after the boom. Frontal and lateral positions of the boom are tested and the drift ratio obtained at 5m downwind is considered to calculate the final drift reduction between the candidate and the reference nozzle.

### **1.3. Context and objectives**

#### **1.3.1. General problem statement**

At the present time, the direct comparison between field and wind tunnel measurements is not really possible. Indeed, wind tunnel protocols (ISO 22856) generally consider only one nozzle placed frontally, one (low) wind speed and short sprays of about 5s. The sensitivity of those parameters to wind speed, boom height was not really demonstrated

Conversely, long duration exposure protocol in a wind tunnel, i.e. by using a distribution test bench, might avoid the problem of the saturation of collectors according to nozzle flowrate and might mitigate the effect of turbulences while smoothing drift deposition data.

Finally, as field tests are generally based on the evaluation of off target ground deposition as wind tunnel protocols are rather oriented to the evaluation of airborne drift. Ideally this study aims at combining the evaluation of sedimentation drift and airborne drift through the remaining volume fraction still in the air (DR calculation) at a certain distance.

#### **1.3.2. Objectives of this study**

Wind tunnels offer the possibility to measure spray drift with reproducible and reliable results compared to field tests. Assuming that existing spray drift models are generally not based on wind tunnel measurements, is it possible to identify spray drift descriptors from drift curves in order to develop a specific and simplified drift model?

## Chapter 2: Literature Review

The current chapter is a literature review that focused on the most important factors that affect on spray drift potential. This chapter is based on the paper N°1 entitled “Influence of spray characteristics on spray drift potential of field crop sprayers: a literature review”. This chapter discusses the influence of spray characteristics on spray drift potential that represented all the physical factors affecting spray drift in the wind tunnel measurements.

### Abstract

Spray drift is a practical consequence of agricultural spraying operations. Because of the agronomical and environmental impacts of this phenomenon, drift has been widely studied and extensive information is available. Here we present a literature review on the relationships between global physical descriptors of agricultural sprays, air conditions and resulting drift, generally studied in wind tunnels. Basic physical factors are droplet size, droplet velocity, and the physicochemical characteristics of the sprayed product. When possible, data available in the literature are collated to draw trends. Contradictory information sometimes appears especially regarding droplet velocity and drift control. The main physical factors consist generally of medians such as Volume Median Diameter (VMD or  $Dv0.5$ ) that do not always represent the heterogeneity of a spray and especially the spatial distribution of particle size and velocity. Technological parameters such as nozzle height, spray angle, travel speed are then related to initial physical factors and their contribution to drift-ability of sprays.



## Influence of spray characteristics on potential spray drift of field crop sprayers: A literature review



M. Al Heidary<sup>a</sup>, J.P. Douzals<sup>a,\*</sup>, C. Sinfort<sup>b</sup>, A. Vallet<sup>a</sup>

<sup>a</sup> Unité Mixte de Recherche Information & Technologies for AgroProcess, IRSTEA, 361 rue Jean-François Breton, BP 9505, F-34196 Montpellier Cedex, France  
<sup>b</sup> Montpellier SupAgro, 2 place Viala, F-34060 Montpellier, France

### ARTICLE INFO

**Article history:**  
 Received 18 December 2013  
 Received in revised form  
 9 May 2014  
 Accepted 10 May 2014  
 Available online xxx

**Keywords:**  
 Spray drift  
 Physical factors  
 Spray descriptors

### ABSTRACT

Spray drift is a practical consequence of agricultural spraying operations. Because of the agronomical and environmental impacts of this phenomenon, drift has been widely studied and extensive information is available. Here we present a literature review on the relationships between global physical descriptors of agricultural sprays, air conditions and resulting drift, generally studied in wind tunnels. Basic physical factors are droplet size, droplet velocity, and the physicochemical characteristics of the sprayed product. When possible, data available in the literature are collated to draw trends. Contradictory information sometimes appears especially regarding droplet velocity and drift control. The main physical factors consist generally of medians such as Volume Median Diameter (VMD or Dv50) that do not always represent the heterogeneity of a spray and especially the spatial distribution of particle size and velocity. Technological parameters such as nozzle height, spray angle, travel speed are then related to initial physical factors and their contribution to driftability of sprays.

© 2014 Elsevier Ltd. All rights reserved.

### 1. Introduction

Pesticides were extensively used in farmland after the discovery of DDT (Dichloro Diphenyl Trichloroethane) in 1939. About 3 billion kg of pesticides are applied each year with a purchase price of nearly 40 billion US \$/year (Pimentel, 2005). Pesticides are used to increase both productivity and quality of cultivated crops. On the other hand, they can cause serious environmental and public health problems. Consequences of pesticide application may cause persistent problems in rural and urban areas due to the transport of polluting agents from the crop-growing areas to air, water and other natural resources, via different pathways (Gil and Sinfort, 2005). Spray drift may involve exposure of bystanders, residents, livestock, terrestrial and aquatic ecosystems to pesticides (Hilz and Vermeer, 2013).

Spray drift has always been one of the major concerns in the spray application industry. A common definition of spray drift is given through several organizations including the US Environmental Protection Agency (EPA), British Crop Protection Council (BCPC) and International Organization for Standardization (ISO).

Spray drift can then be defined as the physical movement of pesticide droplets or particles through the air at the time of pesticide application or soon thereafter from the target site to any non- or off-target site due to wind conditions (EPA, 2001; ISO 22856-1, 2008; BCPC, 1986). Spray drift may take several forms as droplet, dry particles or vapor. Particle drift increases when water and other pesticide carriers evaporate quickly from the droplet leaving tiny particles of concentrated pesticide. Vapour may arise directly from the spray or by evaporation of pesticide from sprayed surfaces (William and Smith, 2004). However many registered formulations are characterized by a low vapor pressure limiting the evaporation of active ingredients (Miller, 2003).

Spray drift is a complex phenomenon due to the combination effect of spraying equipment design, crop architecture, atmospheric conditions and the physicochemical properties of the spray mix. As such, the concomitant study of the influence of all parameters cited above appears unrealistic and literature mostly focuses on the influence of few parameters at a time. Main studies refer to (a) spray characteristics such as droplet size, spray shape and angle (Foqué et al., 2012), physicochemical properties of spray liquid (Butler Ellis and Tuck, 1999; Miller and Butler Ellis, 2000; Butler Ellis and Bradley, 2002; Herbst, 2003; Heinlein et al., 2007), (b) operating conditions : spray application technique (Van de Zande et al., 2003), boom height (De Jong et al., 2000; Baetens et al., 2009), operating

\* Corresponding author. Tel.: +33 467166503.  
 E-mail address: [jean-paul.douzals@irstea.fr](mailto:jean-paul.douzals@irstea.fr) (J.P. Douzals).

pressure (Nuyttens et al., 2007b) and driving speed (Miller and Smith, 1997; Ghosh and Hunt, 1998; Womac et al., 2001) and (c) meteorological conditions (Threadgill and Smith, 1975; Miller, 1993; Miller et al., 2000; Gil and Sinfort, 2005).

Typical evaluation of spray drift is achieved through field tests with a complete sprayer (Ravier et al., 2005) whereas drift potential assessment generally requires a wind tunnel where generally only one nozzle is tested. Both methods are based on sampling process through a large variety of artificial collectors (Salyani, 2000; Salyani et al., 2006; Ferreira et al., 2010). Each method has its own advantages and disadvantages in terms of significance of drift data and repeatability due to atmospheric condition control (Hewitt and Wolf, 2004; Carlsen et al., 2006; Nuyttens, 2007; De Schampheleire et al., 2008; Donkersley and Nuyttens, 2011). Wind tunnel experiments provide an efficient method for supporting and complementing the data derived from field experiments. They allow the use of driftability indices, relative drift factors or drift potential factors to be developed for spray equipment (Walklate et al., 2000).

The objective of this paper is to draw a synthetical literature review on comprehensive works about spray drift to identify which physical factors were analyzed and when possible, compare the results. This paper focuses on experimental approaches developed in wind tunnels bringing some theoretical considerations, additionally. Modeling aspects are not covered in the scope of this paper.

A systemic representation of drift physical factors was adopted in this study as given in Fig. 1. In this figure three main systems are identified: (i) droplets, (ii) the spray pattern and (iii) external conditions. Drift potential can be attributed to a combination of these systems. It is obvious that the system “droplets” is a sub-system of the system “spray” but this representation was

chosen to evidence that external conditions can interact both with individual droplets and their characteristics but also with the spray in its globality. The measurable characteristics of each system are indicated in boxes. This paper investigates how some measurable characteristics can be linked with spray drift as measured in a wind tunnel considering data present in the literature.

2. Droplet characteristics

At the droplet level, drift corresponds to a modification of droplet trajectory induced by the drag force due to external air velocity. The expression of the drag force  $F_d$  is given by Eq. (1):

$$F_d = \frac{1}{2} \rho_a C_d A (V_d - V_a)^2 [N] \tag{1}$$

where  $F_d$  is the drag force,  $C_d$  is the drag factor depending on the shape of the droplet (usually supposed spherical) and the Reynolds number,  $A$  is the frontal interaction area ( $\pi D^2/4$ ) in  $m^2$ ,  $V_a$  and  $V_d$  the velocities of air and droplet respectively, in  $m s^{-1}$  and  $\rho_a$  the air density in  $kg m^{-3}$ .

The drag force is then directly proportional to the square diameter and this factor is, by far, the most investigated parameter at the laboratory level. However, it also appears in this expression that the droplet relative velocity is an influential factor. In a first approach, one can consider that  $C_d$  is constant. The last influencing factor might then correspond to the density of the fluid.

Eq. (1) corresponds to a dynamic process: diameter ( $A$ ) may change with evaporation,  $V_a$  is not constant (neither in time nor in

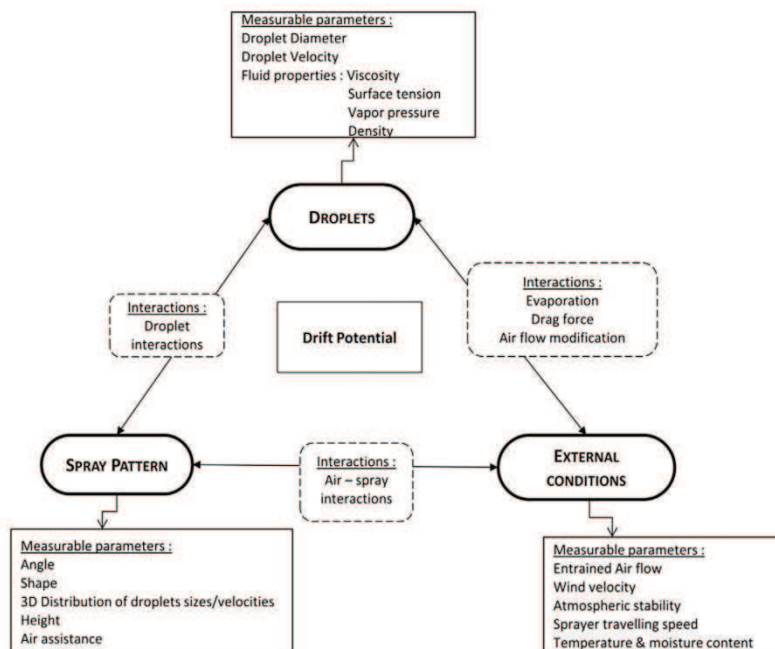

Fig. 1. Systemic representation of spray components contributing to drift potential. Interactions between components and components measurable parameters are indicated in dash and solid rectangles respectively.

**Table 1**  
Methods used for droplet size and drift potential measurements.

Reference	Droplet size measurement device	Distance from nozzle	Wind velocity	Nozzle number and position	Collecting method	Drift potential value
(1)	Oxford Laser VisiSize	350 mm	2 m s <sup>-1</sup>	1 nozzle-fixed	Ground deposition on polythene wires 2 mm φ from 2 to 7 m – each m	Average deposition
(2)	Malvern Mastersizer	150 mm	2 m s <sup>-1</sup>	1 nozzle – 2 m s <sup>-1</sup> lateral speed	Ground deposition on filter papers (25 * 100 mm) from 2 to 6 m – each m	Integrated deposition
(3)	Oxford Laser VisiSize	350 mm	2 m s <sup>-1</sup>	2 nozzles – 2.78 m s <sup>-1</sup> lateral speed	Ground deposition on polythene wires 2 mm φ from 2 to 7 m – each m	Average deposition
(4)	Malvern Spraytec	Not specified	2 m s <sup>-1</sup>	1 nozzle – fixed	Ground deposition on polythene wires 2 mm φ from 2 to 7 m – each m	Average deposition

(1) Butler Ellis et al., 2002; (2) Stainier et al., 2006; (3) Miller et al., 2011; (4) Taylor et al., 2004.

**Table 2**  
Effect of nozzle type, nozzle size, injection pressure, nozzle angle (°), nozzle height (cm), and Dv50 (µm) on spray drift potential (% applied volume).

Reference	Nozzle type	Nozzle size	Pressure, Bar	Nozzle angle, °	Nozzle height, cm	Dv50, µm	Spray drift% wind tunnel
(1)	AI	03	3	110	50	539	1.7
	AI	03	3	110	50	545	1.57
	AI	03	3	110	50	747	0.67
	AI	03	3	110	50	790	0.67
(2)	FF	01	4.5	110	50	107	22
	FF	03	3	110	50	163	8
	FF	06	2	120	50	244	6
	FF	08	2.5	80	50	365	2.5
	FF	10	3	65	50	434	2
(3)	FF	03	3	110	50	259	8
	FF	03	3	80	50	272	5
(4)	FF	02	3	120	50	142	9.4
	FF	02	3	120	50	293	6.47
	FF	02	3	120	50	118	14.03
	FF	02	3	120	50	124	13.37
	FF	02	3	120	50	215	12.4
	FF	02	3	120	50	253	7.2
	FF	02	3	120	50	243	8.63
	FF	02	3	120	50	184	8.9
	FF	02	3	120	50	220	7.53
	FF	02	3	120	50	239	7.29
	FF	02	3	120	50	195	14.47
	FF	02	3	120	50	195	15.33
	FF	02	3	120	50	185	15.94
	FF	02	3	120	50	175	15.06
	FF	02	3	120	50	178	15.44
	HC	02	3	80	50	114	14.24
	HC	02	3	80	50	190	9.15
	HC	02	3	80	50	107	16.32
	HC	02	3	80	50	105	16.44
	HC	02	3	80	50	204	14.69
	HC	02	3	80	50	191	9.93
	HC	02	3	80	50	168	11.78
	HC	02	3	80	50	153	11.84
	HC	02	3	80	50	170	11.81
	HC	02	3	80	50	160	11.52
	HC	02	3	80	50	150	18.33
	HC	02	3	80	50	160	16.41
	HC	02	3	80	50	143	16.31
	HC	02	3	80	50	152	16.06
	HC	02	3	80	50	147	17.18
	AI	02	3	120	50	470	1.23
	AI	02	3	120	50	552	1.32
	AI	02	3	120	50	412	2.98
	AI	02	3	120	50	422	1.67
	AI	02	3	120	50	523	1.26
	AI	02	3	120	50	527	1.44
	AI	02	3	120	50	487	1.45
	AI	02	3	120	50	451	2.23
	AI	02	3	120	50	476	1.87
	AI	02	3	120	50	492	1.55
	AI	02	3	120	50	457	2.36
	AI	02	3	120	50	469	2.65
	AI	02	3	120	50	476	2.65
	AI	02	3	120	50	451	2.38
	AI	02	3	120	50	438	2.75

(1) Butler Ellis et al., 2002; (2) Miller et al., 2011; (3) Taylor et al., 2004; (4) Stainier et al., 2006. FF: Flat Fan, AI: Air Injection and HC: Hollow Cone nozzles.

space) and  $V_d$  changes during the droplet travel from the nozzle output to the target (Hinkle, 1991).

2.1. Droplet size

Spray nozzles are known to produce different droplet quality in sizes. Size distribution is usually described by statistical descriptors (ASABE, 2009; BCPC, 1986; Doble et al., 1985) whilst an ISO standard is in preparation. In general the description of droplet distribution refers to the median value of the distribution related to total number of droplets (Number Median Diameter: NMD) or to the total volume: Volume Median Diameter (VMD) or Dv50 (Lefebvre, 1989). Other descriptors such as Sauter Mean Diameter can be also found (Butler Ellis and Tuck, 1999; Vallet and Tinet, 2011). These descriptors are integrative as they consider cumulative data but they cannot directly represent the whole distribution span.

From a practical point of view, droplet diameter is strongly affected by nozzle type and operating pressure. All technologies generating larger droplets will benefit drift mitigation: low pressure, pre-orifice, deflector, induction chamber, air inclusion.

Several experimental studies in wind tunnels concerned the effect of Dv50 on drift. Being rigorous, these measurements do not only relate droplet diameter effect but also the global distribution of droplets within the spray as well as interactions between air flow and spray that will be discussed in part 3. Among the existing results in the literature, several papers were using comparable methodologies as presented in Table 1. Table 2 introduces data extracted from these previous papers. Note that other wind velocities were tested i.e.  $4 \text{ m s}^{-1}$  (2) and  $4\text{--}8 \text{ m s}^{-1}$  (3) but represented only a few cases and were not considered in the present paper.

Data from Table 2 plotted in Fig. 2 were mainly obtained by integration of collected deposits using horizontal collectors (filter papers or strings) placed at minimum 2 m downwind with a wind velocity from  $2 \text{ m s}^{-1}$ . In all cases, drift potential values are expressed in percentage of the applied volume. An exponential fits these data with acceptable correlation ( $R^2 = 0.93$ ). The population of nozzles with Dv50 below  $300 \mu\text{m}$  corresponds either to Flat fan nozzles –  $110^\circ$  top angle and Hollow Cone nozzles with corresponding pressures. The population of nozzles with Dv50 above  $300 \mu\text{m}$  corresponds to Flat Fan –  $65^\circ$  and  $80^\circ$  top angles and Air Injection nozzles.

In addition to Dv50 criteria, other droplet size distribution parameters are known to be strongly related to drift. Arnold (1990) focused on the volumetric fraction of particles less than  $50 \mu\text{m}$  in diameter and an extensive number of authors promoted the volumetric fraction of particles less than  $100 \mu\text{m}$  diameter (Wolf, 2000; Landers and Schupp, 2001; Osborne et al., 2002; Van de Zande et al., 2002; Hobson et al., 1993). For other authors there is a need to extend the limit to the volumetric fraction of particles less than  $200 \mu\text{m}$  (Hewitt et al., 1998). If those parameters are usually considered as thresholds, they do not totally reflect the droplet distribution itself and its spatial heterogeneity in the spray.

2.2. Droplet velocity

In general, droplets have their maximum velocity close to the nozzle orifice and eventually slow down during transport to the target. Referring to Bernoulli's equation, the conversion of pressure into initial liquid velocity is given by the Eq. (2):

$$V = C \sqrt{2 \cdot \frac{\Delta P}{\rho_L}} \text{ [ms}^{-1}\text{]} \tag{2}$$

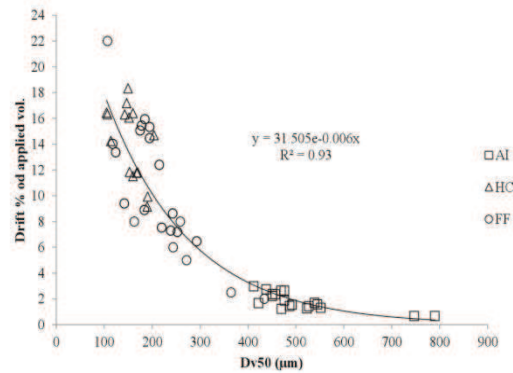

Fig. 2. Percentage of applied volume collected in wind tunnel vs. Dv50 of various nozzles. AI: air Injection nozzle; FF: Flat Fan and HC: Hollow Cone (Butler Ellis et al., 2002; Taylor et al., 2004; Stainier et al., 2006; Müller et al., 2011).

where  $V$  is the initial velocity,  $\Delta P$  is the injection pressure in Pa and  $\rho_L$  is the liquid density in  $\text{kg m}^{-3}$ .  $C$  is a discharge coefficient that depends on the shape of the orifice.

Within static air, droplet velocity quickly decreases and reaches a constant value, the terminal velocity is obtained considering the balance of forces on Stokes regime's condition (i.e. the drag force is balanced by friction forces) giving Eq. (3):

$$V_t = \frac{\rho_L \cdot g \cdot D^2}{18 \cdot \eta_a} \text{ [m s}^{-1}\text{]} \tag{3}$$

where  $V_t$  is the terminal velocity,  $\rho_L$  is the density of droplet ( $\text{kg m}^{-3}$ ),  $g$  is the gravitational acceleration ( $\text{m s}^{-2}$ ),  $D$  is the diameter of droplet (m), and  $\eta_a$  is the dynamic viscosity of air ( $\text{kg m}^{-1} \text{ s}^{-1}$ ).

Very few papers have been published on the effect of droplet velocity on spray drift. Depending on authors, methodologies and parameters of influence, the relationship between droplet size, droplet velocity and drift mitigation capability is variable. As for the studies related in section 2.1, the results depend on the global distribution of velocities that will be discussed in section 3. Nuyttens et al. (2007a,b) studied the effect of the droplet size and velocity characteristics with different nozzle – pressure

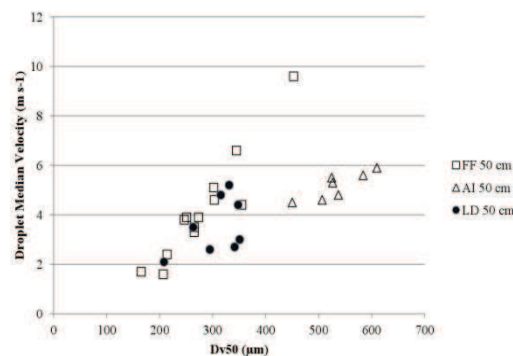

Fig. 3. Distribution of droplet median velocity depending on droplet size for various Flat Fan (FF) Air Injection (AI) and Low Drift (LD) nozzles – 3 bar–50 cm (Nuyttens et al., 2007a,b, 2009).



combinations; they measured and compared the results with the results obtained by other researchers using different measuring techniques and procedures. The relationship they obtained between Dv50 and droplet median velocity (V50) is given by Fig. 3 for different nozzle types. The results showed the effect of nozzle type, size and pressure on the droplet size and velocity spectra.

Liu et al. (2006) studied four nozzle types at different operating pressures. In any cases, droplets generated by a flat fan nozzle with narrow spray angle (i.e. 80°) were found to have the highest velocity as estimated through travel time between the ejection point of the nozzle to the target.

Data found in the literature are introduced in Table 3 where V50 indicates median droplet velocities for various hydraulic driven nozzles and measurement conditions.

When focusing on droplet size expressed in terms of Dv50 with median velocities measured at 50 cm from the nozzle outlet (Table 3), different behaviors are observed depending on the nozzle technology (Fig. 3). Flat Fan and Air Injection nozzles show a linear dependence of the median velocity with droplet size but with

different slopes. In contrast, no real trends are visible for Pre-orifice (LD) nozzles.

Both droplet size and velocity contribute to droplet kinetic energy ( $E_k$ ) and its value was also introduced in Table 3 by using the following Eq. (4):

$$E_k = \frac{1}{2} m V_{50}^2 \text{ [J]} \tag{4}$$

With  $m$ , the median droplet mass as given by Eq. (5), from the Dv50 value:

$$m = \rho_L \frac{\pi}{6} D_v 50^3 \text{ [kg]} \tag{5}$$

V50 the median velocity ( $\text{m s}^{-1}$ ),  $E_k$  is the estimated kinetic energy of droplets in J assuming the same liquid density for all droplets including those generated by air injection nozzles.

Median velocity is found to vary from 1 to 12  $\text{m s}^{-1}$  but with a high dependence on the measurement distance from the nozzle outlet.

**Table 3**  
Droplet size, droplet velocity and median kinetic energy for various nozzles and operating pressures.

Reference	Distance (mm)	Nozzle	Pressure (bar)	Dv50	V50	Est. Drift %	$E_k$ (μJ)		
(1)	350	FF 110 01	4.5	172.9	3.35	13.29	1.52E-02		
		FF110 03	3	257.3	6.72	5.65	2.01E-01		
		FF 120 06	2	349.8	6.51	2.91	4.75E-01		
		LU 120 03	3	256	6.91	5.71	2.10E-01		
		XR 110 03	3	262	5.22	5.43	1.28E-01		
		Bubblejet 03	3	431	6.08	1.86	7.75E-01		
		IDK 120 03	3	489	5.85	1.42	1.05E+00		
		AI 110 03 VS	3	628	6.03	0.83	2.36E+00		
		LU 120 03	5	231	8.2	7.12	2.17E-01		
		XR 110 03	5	240	6.36	6.56	1.46E-01		
		Bubblejet 03	5	359	6.71	2.76	5.45E-01		
		IDK 120 03	5	406	6.51	2.11	7.43E-01		
		AI 110 03 VS	5	546	7.14	1.12	2.17E+00		
		FF80 08	2.5	391.8	12.01	2.28	2.27E+00		
		(2), (3)	500	FF 110 01	4.5	165.4	1.7	14.62	3.42E-03
				FF110 03	3	251	3.9	5.95	6.30E-02
FF 120 06	2			355	4.4	2.82	2.27E-01		
80 08	2.5			453	9.6	1.67	2.24E+00		
80 15	2			561	6.6	1.05	2.01E+00		
AXI 110 02	3			207	1.6	9.02	5.94E-03		
AXI 110 04	3			265.5	3.5	5.28	6.00E-02		
AXI 110 06	3			302.2	5.1	3.99	1.88E-01		
API 110 02	3			208.3	2.1	8.90	1.04E-02		
API 110 04	3			263.6	3.5	5.36	5.87E-02		
API 110 06	3			315.4	4.8	3.64	1.89E-01		
Hardi ISO F110 02	3			214.2	2.4	8.38	1.48E-02		
Hardi ISO F110 03	4			246.5	3.8	6.19	5.66E-02		
Hardi ISO F110 03	3			273.6	3.9	4.95	8.16E-02		
Hardi ISO F110 03	2			265.4	3.3	5.28	5.33E-02		
Hardi ISO F110 04	3			303.4	4.6	3.96	1.55E-01		
Hardi ISO F110 06	3	345.1	6.6	3.00	4.69E-01				
(2), (3)	500	ATR 80 blue	3	298.6	3.5	4.10	8.54E-02		
		ATR 80 green	3	256	2.6	5.71	2.97E-02		
		ATR 80 orange	3	191.1	1.2	10.71	2.63E-03		
		Hardi LD F110 02	3	294.9	2.6	4.21	4.54E-02		
		Hardi LD F110 03	3	348.2	4.4	2.94	2.14E-01		
		Hardi LD F110 04	3	331.2	5.2	3.28	2.57E-01		
		ADI 110 02	3	341.7	2.7	3.06	7.61E-02		
		ADI 110 04	3	351.1	3	2.89	1.02E-01		
		Hardi Injet 110 02	3	506.8	4.6	1.31	7.21E-01		
		Hardi Injet 110 03	3	537.4	4.8	1.16	9.36E-01		
		Hardi Injet 110 04	3	584	5.6	0.97	1.64E+00		
		Hardi Injet 110 06	3	610	5.9	0.88	2.07E+00		
		AVI 110 02	3	450.4	4.5	1.69	4.84E-01		
		AVI 110 04	3	526.5	5.3	1.21	1.07E+00		
		AVI 110 06	3	524.8	5.5	1.22	1.14E+00		

(1) Miller et al., 2008; (2) Nuyttens et al., 2007a,b; (3) Nuyttens et al., 2009. Drift % is estimated from Fig. 2 correlation curve.

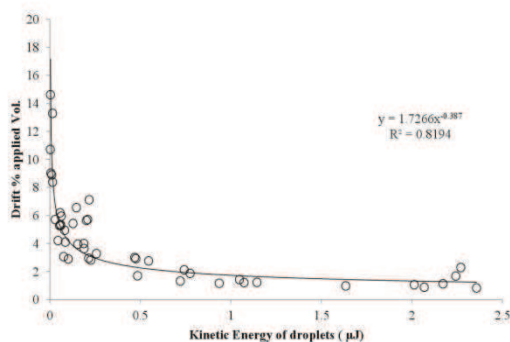

Fig. 4. Percentage of applied volume collected in wind tunnel vs. kinetic energy of various nozzles from several literature references (Nuyttens et al., 2007a,b, 2009; Miller et al., 2008).

A simulation of drift values (Drift est.) was introduced in Table 2 from Dv50 values obtained with the correlation shown in Fig. 2, for various nozzles and operating conditions. Estimated drift values are plotted vs. Kinetic energy ( $E_k$ ) on Fig. 4 and an acceptable correlation is observed. Lower kinetic energy may be due to both low diameter and velocity. As a general statement,  $E_k$  is proportional to  $V50^2$  and  $Dv50^3$  and the last parameter is the most influential. When AI nozzles are used, the variation of droplet density (due to air inclusion) might also be taken into account. However the determination of droplet density inside a spray is still very difficult.

Finally Giles and Ben-Salem (1992) investigated the effects of intermittent flow on the droplet velocity and kinetic energy within spray clouds from flat-fan nozzles. Droplet velocity and energy were slightly reduced and median diameter increased as the frequency of intermittency increased under identical operating conditions. However, Pulse Modulation Width (PWM) control systems are still poorly represented in the literature.

### 2.3. Physicochemical properties of spray liquid

The effect of the physicochemical properties of spray liquid on drift potential in the wind tunnel was studied over a long period (Maas and Krasel, 1988; Western et al., 1999; Hewitt et al., 2001). Parameters such as the surface tension coefficient and viscosity are considered as the most important factors affecting spray drift (Hilz and Vermeer, 2013). Modifying the physical properties of spray liquids to lower surface tension or higher viscosity with additives may sometimes affect spray droplet size with a direct consequence on drift control. However combined effects of nozzle technology with *ad hoc* operating conditions and chemical properties of a spray mix were questioned in the past (Rizk and Lefebvre, 1989) and still appears unpredictable.

Table 4  
Effect of additives on Dv50 with an FF 110 03 nozzle at 3 bars as measured with PDPA (Butler Ellis et al., 1997).

Spray liquid	Composition	Concentration	Dv50 µm	% Vol < 100 µm
Water	–		256	2.9
Ethokem	Cationic surfactant	0.50%	234	4.8
Li 700	Soybean phospholipids	0.50%	275	1.6
Agral	Non ionic wetting agent	0.10%	247	3.6
Axiom	Mineral oil	1%	260	2.6
Codacid oil	Vegetable oil	1%	268	2.0
Silwett L-77	Organo-silicone	0.15%	276	1.5

In many cases, surfactants may improve pesticide application in terms of wetting effect, sticking properties, drift retardant, etc. (Hoffmann et al., 2003; Carlsen et al., 2006; Celen, 2010) but effects on drift mitigation cannot hardly be proven without either droplet size or drift measurements.

Most research work which has been done on drift-reducing effects of surfactants has considered water solutions but De Schampheleire et al. (2009) stated that the physicochemical characteristics of the complete spray mixture including active ingredient(s), co-formulants and surfactant shall be considered. It is also known that physical and chemical properties can be affected by the sprayer circuit due to shear in the pump, in the agitation circuit and in the pressure control valve (Hilz and Vermeer, 2013).

Effects of additives on water and their impact on droplet size and drift potential were measured in a wind tunnel with a FF 110 03 nozzle by (Butler Ellis et al., 1997). As shown in Table 4, mineral or vegetable oils did not modify the Dv50 significantly. When compared to water, cationic surfactant (Ethokem) and non-ionic wetting agent (Agral) are found to produce smaller droplets. In the meantime, soybean phospholipids (Li 700) and organo-silicone (Silwett L-77) involved the production of larger droplets.

Sanderson et al. (1997) measured the combined effect of chemical formulation (EC, WDG and LF) and surfactant composition on droplet size (Malvern 3000 and in-field potential drift values (from artificial collectors placed along a 10 m mast) for aerial spraying. Great differences appeared between chemical formulations but also due to surfactant composition. In general and as already seen on Table 4, the use of a non-ionic surfactant leads to a decrease in the size of droplets and an increase in drift values. Similar results are shown on Table 5. In contrast to non-ionic surfactants, crop oils induce no significant modification in droplet size (compared to EC solo) as well as in drift values.

An extract from (Stainier et al., 2006) exhaustive study is proposed in Fig. 5 where the effect of nozzle type, chemical formulation and adjuvant on droplet size is introduced. Two formulations of phenmediphan (SC and EC) were compared with pure water and several adjuvants: Actirob B is an esterified crop oil – 0.4% w/v, Tensiofix D03: a non-ionic surfactant 0.2% w/v, Break-Thru S-240 : organo-silicones surfactant (trisiloxane), 0.15% w/v and Silwett L-77: organo – silicones (heptamethyltrisiloxane) – 0.1% w/v. Three main situations can be considered. (a) With pure water, Actirob B and Silwett L-77 induce greater droplets as Tensiofix D03 and Break-Thru S-240 generate smaller droplet sizes. This phenomenon occurs for the three nozzles. (b) When a suspension concentrate formulation (SC) is used, water always generates greater droplet size compared to any of the tested adjuvants. Tensiofix D03 and Break-Thru S-240 modalities generate smaller droplets compared to Actirob B and Silwett L-77 but the distribution in droplet size is

Table 5  
Effect of chemical formulation and additives on Dv50 and drift potential as measured in field conditions (aerial application with D8-46 nozzle at 1.52 bar).

Spray liquid	Dv50 (µm)	Drift % in-field
Propanil (EC)	177	19.8
EC + non ionic surf.	174	21.5
EC + Crop Oil	177	20.6
Propanil (WDG)	219	14.4
WDG + non ionic surf.	208	14.7
WDG + crop oil	220	13.9
Propanil (LF)	236	11.5
LF + non ionic surf.	212	13.4
LF + crop oil	238	11.4

EC: Emulsifiable Concentrate, WDG: Water Dispersible Granular, LF: Liquid Flowable (from Sanderson et al., 1997).

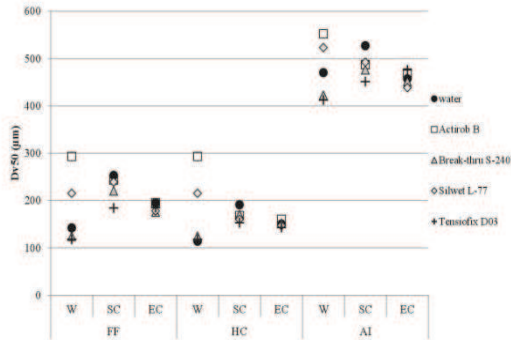

Fig. 5. Effect of nozzle type, adjuvant and phenmediphan formulation – 4.45%w/v (W, SC or EC) on droplet size (Dv50). FF: Flat Fan, HC: Hollow Cone and AI: Air Injection. From Stainer et al. (2006).

much reduced compared to pure water conditions (a), (c) With an EC formulation, the amplitude of droplet size is drastically reduced whatever the adjuvant. In this case the standard deviation in droplet size is less than 5%.

In general, the effect of the combination of nozzle type, adjuvant and chemical is not easily predictable: indeed the effect of an adjuvant as seen with pure water is totally modified when spraying EC or SC formulation of phenmediphan. Whatever the combination of chemical and adjuvant, the effect of nozzle type is rather predominant.

Moreover, the effects of additives are often rate sensitive. The main practical consequence of surfactant overdosage may be revealed by strong modifications of the spray pattern, angle, flow distribution homogeneity as shown by Douzals et al. (2012).

2.4. Droplet evaporation

Evaporation of a spray droplet is a common physical phenomenon that occurs during or after the application of the pesticide. Evaporation of solvent (usually water) and solute (dissolved or suspended chemicals) is an important issue but barely studied in the literature. When the solvent is water, the capability of air to absorb water vapor is given by the psychrometric diagram, linking vapor content, temperature and air enthalpy value (kJ g<sup>-1</sup> of dry air). Increasing the temperature as well as decreasing the relative humidity both involve a higher capacity for evaporation of eventual surrounding droplets. The air volume under the boom of a working sprayer can be considered as an infinite reservoir for evaporation. Indeed, considering a 18 m boom width, at 50 cm height and at 8 km h<sup>-1</sup>, the air flow interacting with sprays is about 20 m<sup>3</sup> s<sup>-1</sup>. Depending on the wind direction, these previous numbers may probably increase. Comparatively, liquid flowrate generated by FF 02 nozzles on the 18 m boom generates a liquid flow of about 4.8 × 10<sup>-4</sup> m<sup>3</sup> s<sup>-1</sup>.

The quantification of the effect of evaporation on spray drift is not an obvious issue as evaporation is time dependent. Evaporation has been integrated in many models such as AgDisp or random walk model studied by Miller and Hadfield (1989). In the spray drift model IDEFICS, (Holterman et al., 1997; Holterman, 2003) assumed that only water would evaporate during the application and all solutes would be chemically inert. This seems reasonable for short distance downwind drift (until 10–20 m from the edge of the crop). The droplet that moves through the air, or floats in the air, is subjected to evaporation and will decrease in size. Due to the difference in vapor pressure between droplet and air, the droplet cools

down due to evaporation, until it reaches its wet-bulb temperature. At the same time, a thin layer of saturated vapor has formed around the droplet. The temperature of the droplet is lower than that of the ambient air, heat flows toward the droplet and feeds the evaporation process.

The rate of decrease of the diameter *D* of a spherical droplet in the air due to evaporation described by (Williamson and Threadgill, 1974), which is somehow analogous to the so called *D*<sup>2</sup> law described by (Mokeba et al., 1997) in the following Eq. (6) :

$$\frac{dD}{dt} = \frac{-4 \cdot M_l \cdot D_f \cdot \Delta P}{D \cdot \rho_L \cdot R \cdot T_f} \left( 1 + 0.27 \cdot Re^{1/2} \cdot Sc^{1/3} \right) [m] \quad (6)$$

where *D* is the droplet diameter, *t* the time of variation (s), *M<sub>l</sub>* is the molecular weight of the evaporating liquid (water 0.018 kg mol<sup>-1</sup>), *ρ<sub>L</sub>* is the liquid density (kg m<sup>-3</sup>), *D<sub>f</sub>* is the average diffusion coefficient for vapor molecules in the saturated film around the droplet (m<sup>2</sup> s<sup>-1</sup>), *T<sub>f</sub>* is the average absolute temperature (K), *Re* is Reynolds number, *Sc* is Schmidt's number, *ΔP* is the difference between the vapour pressure near the droplet and that in the ambient atmosphere (atm), and *R* is the gas constant. Schmidt number is a dimensionless quantity relating viscous transport of material to diffusive transport.

Reynolds (*Re*) and Schmidt's (*Sc*) numbers should both be evaluated for the saturated film, at temperature *T<sub>f</sub>*.

Reynolds number and Schmidt's numbers are calculated from Eq. (7) and Eq. (8) :

$$Re = \frac{\rho_a \cdot V \cdot D}{\mu_a} \quad (7)$$

$$Sc = \frac{\nu_a}{K_v} \quad (8)$$

where *V* is the relative velocity of droplet in the surrounding air (m s<sup>-1</sup>), *D* is the diameter (m), *ρ<sub>a</sub>* is the air density (kg m<sup>-3</sup>), *μ<sub>a</sub>* is the air dynamic viscosity (kg m<sup>-1</sup> s<sup>-1</sup>), *ν<sub>a</sub>* is the kinematic viscosity of air (m<sup>2</sup> s<sup>-1</sup>), *K<sub>v</sub>* is the coefficient diffusion of the liquid sprayed into air. Evaporation is then closely related to atmospheric conditions but also to droplet initial size as well as to physicochemical characteristics as described by Eq. (6). Practical consequences are shown in Fig. 6 where the kinetic of partial evaporation is represented by a 66% reduction in diameter as a function of initial diameter of spray droplets. Considering a nozzle with a range of droplet initial velocities between 1 and 12 m s<sup>-1</sup> (Table 3) and a

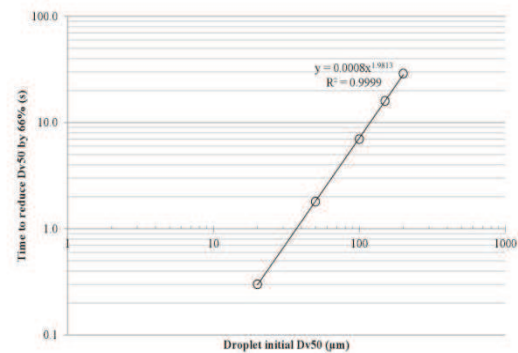

Fig. 6. Evaporation kinetic of evaporation from spray droplet according to initial diameter from Hofman and Solseng (2001). Conditions assumed: Temperature 32 °C (90 °F), Relative humidity 36%, spray pressure 1.72 bar, pesticide solution 3.75%.

8

M. Al Heidary et al. / Crop Protection 63 (2014) 1–11

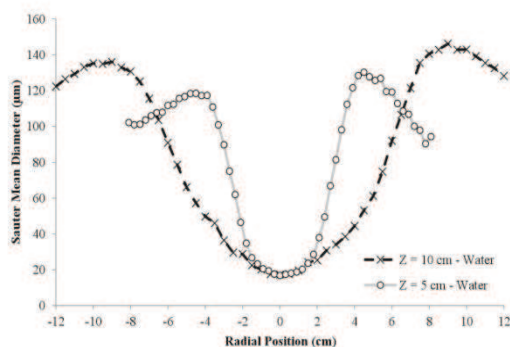

Fig. 7. Radial distribution of Sauter Mean Diameter of spray droplets – Hollow cone nozzle ATR Lilac – 7 bar – 5 cm and 10 cm from the nozzle outlet. From Vallet and Tinet (2011).

typical travel distance of 50 cm, estimated travel times of spray droplets are 0.5 s and 0.04 s, respectively. According to Fig. 6 such short travel times will preferably affect droplets with a  $Dv50$  lower than  $40\ \mu\text{m}$ . However, very few data are published on the effect of evaporation on the modification of pesticide concentration into residual droplets with regards to vapor tension or physicochemical characteristics of the spray mix.

### 2.5. Conclusions on droplet characteristics

As seen in the previous section, many studies have focused on the relationship between spray drift and droplet characteristics in terms of droplet size, droplet velocity and physicochemical properties. However these studies do not explicitly consider the distribution of droplets in a spray organization as a significant factor influencing spray drift. The following section introduces the main macroscopic factors related to spray organization and their relationship with spray drift.

## 3. Spray characteristics

### 3.1. Droplet diameter distribution

NMD as well as  $Dv50$  are not homogenous in a spray as the spatial distribution of droplet size may certainly interfere with spray behavior in working conditions (Belhadef et al., 2012; Vallet and Tinet, 2013). Fig. 7 introduces the radial distribution of droplet size of an HC ATR Lilac nozzle at 7 bar from Vallet and Tinet (2011). Smaller droplets ( $20\ \mu\text{m}$ ) are mostly located in the center of the spray and surrounded by larger droplets ( $140\ \mu\text{m}$ ) (Fig. 7). As seen previously, the velocity drop and the extension of the spray sheet with the travel distance induce a greater sensitivity to spray drift for smaller droplets. Furthermore, similar  $Dv50$  can be obtained with various nozzle technologies. This may involve peculiar behavior regarding drift (i.e. FF vs. HC vs. deflector nozzles) but updated data seems rather poor in the literature (Murphy et al., 2000).

Finally, most of low drift accreditation methods used in Europe are based on the performance of a single nozzle either in terms of droplet size (IDEFICS in The Netherlands, Van de Zande et al., 2002) or potential drift profile in a wind tunnel (DIX in Germany, Herbst and Ganzelmeier, 2000; LERAP in the UK, Guilbert, 2000). In those cases, interactions between several nozzles/sprays are then not considered and relationship with in-field drift data is not always possible. Drift accreditation used in France is also based on the

evaluation of potential drift in a wind tunnel but for a small boom of 4 nozzles. Frontal and lateral drift mitigation performances are then evaluated in comparison with a small boom fitted with reference nozzles (Douzals and Al Heidary, 2014). Lateral and frontal drift conditions give different results that can not directly be explained by the cumulated spray surface in interaction with the wind (Douzals, 2012).

### 3.2. Spray height

Nozzle height is known to have a great influence on drift considering the cumulative effects of higher transport time and evaporation (Fig. 8). The effect of nozzle type and nozzle size (FF nozzles only) on velocity is introduced with similar injection pressure conditions. In order to compare homogeneous data, a velocity rate was defined as the ratio between the median velocity at a given distance and the initial velocity of droplets. Initial velocity was estimated from its theoretical value (Eq. (1)).

The velocity rate for different 03 nozzles measured at 35 and 50 cm is depending on nozzle type and measuring distance (Fig. 8). Compared to an FF, an AIF nozzle at 35 cm generates droplets with a lower velocity rate. This phenomenon is generally attributed to a difference in droplet inertia between pure liquid droplets (Standard FF) and liquid/air bubble inclusions contained in droplets ejected by an FF AI. As a consequence, AI nozzles generate larger sized droplets but with relatively lower velocity when measured close to the ejection point (Fig. 8). However, an opposite behavior is observed at 50 cm where droplet velocity from an AI nozzle is still relatively high.

As a general trend, increasing the nozzle/boom height will increase susceptibility to drift for both nozzles. Miller et al. (2011) showed that the total airborne spray collected in a wind tunnel issued from an FF 110 nozzle is increasing from about 2 to  $27\ \mu\text{l}$  for respective nozzle heights of 350–850 mm. The practical consequence is that boom height is a parameter that is not always considered by authorities or that some spray drift reduction recommendations appear unrealistic (ex. boom height lower than 40 cm but with forward speed up to  $12\ \text{km h}^{-1}$ ).

### 3.3. Nozzle size

The effect of nozzle size on droplet size and velocities was highlighted in several studies. Most visible effects were shown on

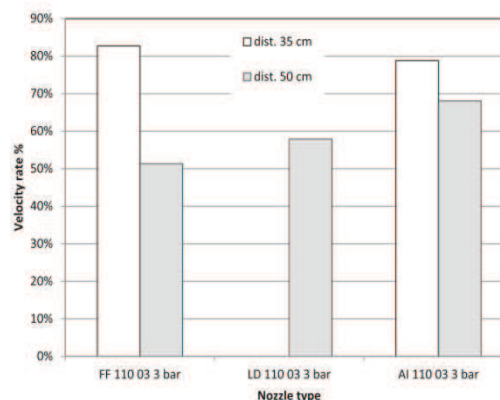

Fig. 8. Velocity rate of various nozzles – effect of nozzle type and measurement distance. FF: Flat Fan; LD: Pre orifice; AI: Air Injection nozzle. 100% corresponds to theoretical initial velocity with data from Nuyttens et al. (2007a,b, 2009) and Miller et al. (2008).

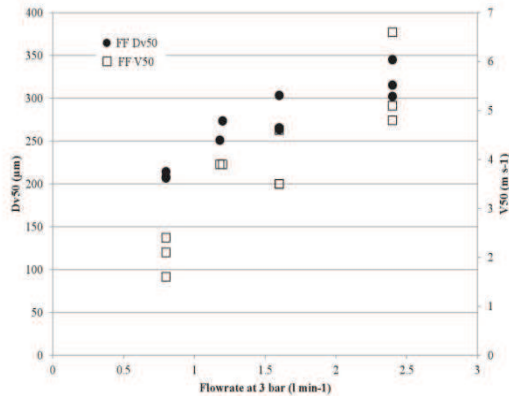

Fig. 9. Effect of flowrate on Dv50 and V50 for different sized FF nozzles at 3 bar. Dv50 and V50 were measured at 50 cm from nozzle outlet. Data from Nuytens et al. (2007a,b, 2009).

Flat Fan nozzles (Fig. 9) extracted from Table 3. When plotting droplet sizes and velocities of different FF nozzles at the same pressure (Fig. 9), both parameters are directly dependant on flowrate. However there is only a slight influence of nozzle size to drift values (Table 2).

#### 3.4. Spray top angle

Several studies have shown an interesting effect of spray angle with identical nozzle sizes. When comparing FF nozzles spray angle, drift was reduced by a factor 2 between a 110° and a 80° and by a factor 5 between a 110° and a 65° at 1100 mm nozzle height although droplet sizes were respectively increased by 5% and 30% (Miller et al., 2011). These macroscopic results might be explained by the spatial distribution of droplets size and velocity in the spray as well as droplet velocity modifications during travel period. To a greater extent than droplet size, spray angle might also be strongly affected by physicochemical composition of the spray mix (Douzals, 2012). In some cases the spray angle can be reduced from 110 to 65° involving drastic changes in cross distribution CV for a given height.

#### 3.5. Air-spray interactions

Air velocity interacts with sprays because of the wind and the driving speed of the sprayer. Generally two cases are considered: when wind and driving speed are collinear and when they are perpendicular.

Wind is a complex phenomenon, varying with different magnitudes and frequencies in time and space as has been widely studied by bio-meteorologists. The role of wind and its description was the focus point on most drift modeling approaches (Gil et al., 2007). From an experimental point of view, the main interest of wind tunnels is to produce stable air flow compared to field conditions. Nevertheless the mode of production of this air flow and the shape features of the tunnels influence the air flow field and describing this flow by its mean velocity is a poor approach that could lead to different results in different equipments.

The effect of traveling speed involves a modification of the air velocity (relative wind) and one should consider this relative wind to analyze air speed influence. It can be pointed out that forward speed is generally not restricted by national regulations as it is for wind conditions during spraying operations.

The influence of the air velocity is directly visible on drift values for several reasons. When frontal, it counteracts the greatest surface area of the spray. In this case all the spray plume along the boom is affected. Quantitatively, frontal drift is generally about two times more important than lateral drift for a wide range of Flat Fan nozzles considering a small boom of 4 nozzles placed in a wind tunnel at 7.5 m s<sup>-1</sup> (Douzals, 2012). In the case of lateral wind conditions, front sprays are greatly affected but sprays situated behind appear protected. The blooming development of “high speed” nozzles, mostly twin jets, among nozzle manufacturers shows the practical interest to higher productivity for farmers.

A comprehensive work on the interaction of spray with a frontal air flow is given by Ghosh and Hunt (1998). Depending on the position of the droplet in the spray plume, three vertical domains are defined in the spray plume whereas the air flow interferes more or less severely with regards to droplet velocity. Each domain is described in terms of entrainment velocity and air currents around droplets generated by weak and strong cross winds of respectively 1.0 and 10 m s<sup>-1</sup>. The capability of droplet extraction from the spray is found to be dependent on the air/droplet velocity ratio vs. cross wind velocity. Until now this point has never been exploited within experimental approaches in wind tunnels.

Many studies realized in wind tunnel exploit the effect of front wind to generate drift. Most protocols in wind tunnels in Europe use polythene wires to collect a tracer and use short spray emissions (generally less than 10 s). Wind speed is about 2 m s<sup>-1</sup>. Less data are available on the effect of wind velocity in conditions of lateral drift. Cumulative effects of forward speed and side wind can be easily obtained and simulated in a wind tunnel by placing the nozzle with an angle representing the vectorial sum of both wind direction and forward speed.

## 4. Conclusion

Spray physical factors described in the literature are related to droplet size, droplet velocity and physicochemical composition.

Droplet size is one of the major characteristics that have been widely studied and it appears closely related to droplet velocity. Although less studied than droplet size, droplet velocity might play an important role in the final spray characteristics and its susceptibility to drift. Unless there are other indications, it can be considered that droplet driftability is a consequence of droplet kinetic energy that involves both droplet size and velocity.

Regarding the evaporation process, knowledge of air conditions is essential. From a practical point of view, optimum air conditions for spraying operations are generally prescribed by authorities or advisors, but on-board meteorological equipments on tractors or sprayers are still not a generality on the market.

Chemical composition of the spray mix becomes more and more studied as drift retardant or drift control properties may involve a profitable market for the chemical industry. Although all previous parameters are generally studied independently, they do not represent the whole complexity of a spray with its spatial variation. Further work is then envisaged on (i) the definition of the macroscopic behavior of agricultural sprays based on physical parameters (droplet size and velocities) but also considering their spatial distribution. As a result, the potential gain in drift reduction might be generated by optimizing spray pattern for example. (ii) From a practical use, this research may also lead to the development of on-board controllers including local atmospheric conditions and spray pattern adjustment.

## References

- Arnold, A.C., 1990. Comparative study of drop sizing equipment for agricultural fan-spray atomizers. *Aer. Sci. Tech.* 12, 431–445.

- ASAE S572.1, 2009. Spray Nozzle Classification by Droplet Spectra. Am. Soc. Agric. Eng., St. Joseph, MI, p. 4.
- Baetens, K., Ho, Q.T., Nuyttens, D., De Schampheleire, M., Melese Endalew, A., Hertog, L.A.T.M., Nicolai, B., Ramon, H., Verboven, P., 2009. A validated 2-D diffusion-advection model for prediction of drift from ground boom sprayers. *Atmos. Environ.* 43 (9), 1674–1682.
- BCPC, 1986. Nozzle Classification Scheme. British Crop Protection Council.
- Belhadef, A., Vallet, A., Amielh, M., Anselmet, F., 2012. Pressure-swirl atomization: modeling and experimental approaches. *Int. J. Multiph. Flow* 39, 13–20.
- Butler Ellis, M.C., Tuck, C.R., Miller, P.C.H., 1997. The effect of some adjuvants on sprays produced by agricultural flat fan nozzles. *Crop Prot.* 16, 41–50.
- Butler Ellis, M.C., Tuck, C.R., 1999. How adjuvants influence spray formation with different hydraulic nozzles. *Crop Prot.* 18, 101–109.
- Butler Ellis, M.C., Bradley, A., 2002. The influence of formulation on spray drift. *Asp. Appl. Biol.* 66, 251–258.
- Butler Ellis, M.C., Swan, T., Miller, P.C.H., Waddelow, S., Bradley, A., Tuck, C.R., 2002. Design factors affecting spray characteristics and drift performance of air induction nozzles. *Biosyst. Eng.* 82 (3), 289–296.
- Carlsen, S., Splid, N., Svensmark, B., 2006. Drift of 10 herbicides after tractor spray application. 2. Primary drift (droplet drift). *Chemosphere* 64, 778–786.
- Celen, I.H., 2010. The effect of spray mix adjuvants on spray drift. *Bulg. J. Agric. Sci.* 16, 105–110.
- De Jong, A., Michielson, J., Stallinga, H., Van De Zande, J., 2000. Effect of sprayer boom height on spray drift. *Medelingen Univ. Gent* 65 (2b), 919–930.
- De Schampheleire, M., Nuyttens, D., Dekeyser, D., Verboven, P., Spanoghe, P., Cornelis, W., Gabriels, D., Steurbaut, W., 2009. Deposition of spray drift behind border structures. *Crop Prot.* 28, 1061–1075.
- De Schampheleire, M., Baetens, K., Nuyttens, D., Spanoghe, P., 2008. Spray drift measurements to evaluate the Belgian drift mitigation measures in field crops. *Crop Prot.* 27, 577–589.
- Doble, S.J., Matthews, G.A., Rutherford, I., Southcombe, E.S.E., 1985. A system for classifying hydraulic and other atomizers into categories of spray quality. *Proc. Br. Crop Prot. Conf. Weeds* 3, 1125–1133.
- Donkersley, P., Nuyttens, D., 2011. A meta analysis of spray drift sampling. *Crop Prot.* 30 (7), 931–936.
- Douzals, J.P., 2012. Asymmetric classification of drift reducing nozzles considering frontal or lateral wind conditions. *Proceedings of CIGR – Ag. Eng meeting 2012 Valencia, Spain*. [http://wcigr.ageng2012.org/images/fotosg/tabla\\_137\\_C1501.pdf](http://wcigr.ageng2012.org/images/fotosg/tabla_137_C1501.pdf), 4.
- Douzals, J.P., Al Heidary, M., 2014. How spray characteristics may influence spray drift in a wind tunnel. *Asp. Appl. Biol.* 122, 271–278.
- Douzals, J.P., Porte, A., Fernandez, P., 2012. Simulating CoV from nozzle spray distribution: a necessity to investigate spray distribution quality with drift reducing surfactants. *Proceedings of CIGR – Ag. Eng meeting 2012 Valencia, Spain*. <http://hal.archives-ouvertes.fr/hal-00764634>, 6.
- EPA, 2001. Pesticide Registration (PR) Notice 2001-X draft: spray and dust drift label statement for pesticide products. [http://www.epa.gov/PR\\_Notices/prdraft-spraydrift801.htm](http://www.epa.gov/PR_Notices/prdraft-spraydrift801.htm).
- Ferreira, M., Miller, P.C.H., Tuck, C.R., O'Sullivan, C., 2010. Comparison of sampling arrangements to determine airborne spray profiles in wind tunnel conditions. *Asp. Appl. Biol. Int. Adv. Pest. Appl.*, 291–296.
- Foqué, D., Baekman, P., Pieters, J.G., Nuyttens, D., 2012. A vertical spray boom application technique for conical bay laurel (*Laurus nobilis*) plants. *Crop Prot.* 41, 113–1121.
- Ghosh, S., Hunt, J., 1998. Spray jets in a cross-flow. *J. Fluid Mech.* 365, 109–136.
- Gil, Y., Sinfort, C., 2005. Emission of pesticides to the air during sprayer application: a bibliographic review. *Atmos. Environ.* 39 (28), 5183–5193.
- Gil, Y., Sinfort, C., Brunet, Y., Polveche, V., Bonicelli, B., 2007. Atmospheric loss of pesticides above an artificial vineyard during air-assisted spraying. *Atmos. Environ.* 41, 2945–2957.
- Giles, D.K., Ben-Salem, E., 1992. Spray droplet velocity and energy in intermittent flow from hydraulic nozzles. *J. Agric. Eng. Res.* 51, 101–112.
- Guilbert, A.J., 2000. Local environmental risk assessment for pesticides (LERAP) in the UK. *Asp. Appl. Biol.* 57, 83–90.
- Heinlein, J., Schulte, G., Fritching, U., Guardani, R., 2007. Mapping the structure of a liquid spray by means of neural networks. *Chem. Eng. Process* 46, 1357–1364.
- Herbst, A., 2003. Pesticide formulation and drift potential. The BCPC conference, 255–260.
- Herbst, A., Ganzelmeier, H., 2000. Classification of sprayers according to drift risk – a German approach. *Asp. Appl. Biol.* 57, 35–40.
- Hewitt, A., Wolf, T., 2004. An international database on pesticide drift. *Asp. Appl. Biol.* 165–168.
- Hewitt, A.J., Valcore, D.L., Teske, M.E., Schick, R.J., 1998. Droplet size classification for agricultural spray. *Proceedings 11th Annual conference on liquid Atomization and spray systems*, Sacramento, CA, May 1998.
- Hewitt, A.J., Miller, P.C.H., Dexter, R.W., Bagley, W.E., 2001. The influence of tank mix adjuvants on the formation, characteristics and drift potential. *Pesticide Formulations and Application Systems: 21st volume, ASTM STP1414*, American Society for Testing and Materials, West Conshohocken, PA, USA.
- Hilz, E., Vermeer, A.W.P., 2013. Spray drift review: the extent to which a formulation can contribute to spray drift reduction. *Crop Prot.* 44, 75–83.
- Hinkle, S.E., 1991. A modified empirical drag coefficient for water drop ballistics. *pdf. Appl. Eng. Agric.* 7 (1), 75–80.
- Hobson, P.A., Miller, P.C.H., Walklate, P.J., Tuck, C.R., Western, N.M., 1993. Spray drift from hydraulic spray nozzles: the use of a computer simulation model to examine factors influencing drift. *J. Agric. Eng. Res.* 54 (4), 293–305.
- Hoffmann, W.C., Hewitt, A.J., Barber, J.A.S., Kirk, I.W., Brown, J.R., 2003. Field swath and drift analyses techniques. *ASAE Paper No. AA032007*. St. Joseph, Mich. ASAE.
- Hofman, V., Solseng, E., 2001. Reducing Spray Drift. North Dakota State University Extension. <http://hdl.handle.net/10365/5111>.
- Holterman, H.J., 2003. Kinetics and evaporation of water drops in air, IMAG report, Wageningen UR, July 2003.
- Holterman, H.J., Van de Zande, J.C., Porskamp, H.A.J., Huijismans, J.F.M., 1997. Modelling spray drift from boom sprayers. *Comp. Elect. Agric.* 19, 1–22.
- ISO 22856, 2008. Equipment for crop protection-Laboratory measurement of spray drift-part 1: wind tunnel.
- Landers, A.J., Schupp, J.R., 2001. Improving deposition and reducing drift in orchards. *N.Y. Fruit Q.* 9 (1), 3–6.
- Lefebvre, A.H., 1989. *Atomization and Sprays*. Hemisphere Publishing Corporation, New York.
- Liu, Q., Cooper, S.E., Qi, L., Fu, Z., 2006. Experimental study of droplet transport time between nozzles and target. *Biosyst. Eng.* 95 (2), 151–157.
- Maas, G., Krasel, G., 1988. Direct drift of herbicides using various nozzle types and additives. *Zeitsch. Pflanzenkrankh. Pflanzensch.* 11, 241–247.
- Miller, P.C.H., 1993. Spray drift and its measurement. In: Matthews, G.A., Hislop, E.C. (Eds.), *Application Technology for Crop Protection*. E.C., CABL.
- Miller, P.C.H., 2003. The measurement of spray drift. *Pest Outlook* 14 (5), 205–209.
- Miller, P.C.H., Butler Ellis, M.C., 2000. Effects of formulation on spray nozzle performance for applications from ground-based boom sprayers. *Crop Prot.* 19, 609–615.
- Miller, P.C.H., Hadfield, D.J., 1989. A simulation model of the spray drift from hydraulic nozzles. *J. Agric. Eng. Res.* 42 (2), 135–147.
- Miller, P.C.H., Smith, R., 1997. The effects of forward speed on the drift from boom sprayers. *The 1997 Brighton Crop Protection Conference-weeds*, 399–406.
- Miller, D.R., Stoughton, T.E., Steinke, W.E., Huddleston, E.W., Ross, J.B., 2000. Atmospheric stability effects on pesticide drift from an irrigated orchard. *Trans. ASAE* 43 (5), 1057–1066.
- Miller, P.C.H., Tuck, C.R., Murphy, S., Da Costa Ferreira, M., 2008. Measurements of the droplet velocities in sprays produced by different designs of agricultural spray nozzles. In: *Proceedings of 22nd European Conference on Liquid Atomization and Spray Systems (LIASS Europe)*, Como Lake, Italy, pp. 1–8. Paper ID LIASS08-8-5.
- Miller, P.C.H., Ellis, M.C.B., Lane, A.G., Tuck, C.R., 2011. Methods for minimising drift and off-target exposure from boom sprayer applications. *Asp. Appl. Biol.* 106, 281–288.
- Mokeba, M.L., Salt, D.W., Lee, B.E., Ford, M.G., 1997. Simulating the dynamics of spray droplets in the atmosphere using ballistic and random-walk models combined. *J. Wind Eng. Indus Aerodyn.* 67–68, 923–933.
- Murphy, S.D., Miller, P.C.H., Parkin, C.S., 2000. The effect of boom section and nozzle configuration on the risk of spray drift. *J. Agric. Eng. Res.* 75, 127–137.
- Nuyttens, D., 2007. Drift from Field Crop Sprayers: The Influence of Spray Application Technology Determined Using Direct and Indirect Assessment Means. PhD dissertation NR.772. Katholieke University Leuven, p. 291.
- Nuyttens, D., Baetens, K., De Schampheleire, M., Sonck, B., 2007a. Effect of nozzle type, size and pressure on spray droplet characteristics. *Biosyst. Eng.* 97 (3), 333–345.
- Nuyttens, D., De Schampheleire, M., Baetens, K., Sonck, B., 2007b. The influence of operator controlled variables on spray drift from field crop sprayers. *Trans. ASABE* 50 (4), 1129–1140.
- Nuyttens, D., Taylor, W.A., De Schampheleire, M., Verboven, P., Dekeyser, D., 2009. Influence of nozzle type and size on drift potential by means of different wind tunnel evaluation methods. *Biosyst. Eng.* 103 (3), 271–280.
- Osborne, J.L., Landers, A.J., Schupp, J., 2002. Efficacy of Apogee on McIntosh Apples comparing two pesticide application technologies, a disc-core type cone nozzle and air induction nozzle. In: *Proc.23rd Symposium on Pesticide Formulations and Application System: Surviving the Change in the Agrochemical Industry*, October 15–16, Norfolk, Va. ASTM International, West Conshohocken, PA, pp. 213–220.
- Pimentel, D., 2005. Environmental and economic costs of the application of pesticides primarily in the United States. *Environ. Dev. Sustain.* 7 (2), 229–252.
- Ravier, I., Houisee, E., Clement, M., Seux, R., Briand, O., 2005. Field experiments for the evaluation of pesticide spray-drift on arable crops. *Pest Manag. Sci.* 61 (8), 728–736.
- Rizk, N.K., Lefebvre, A.H., 1989. Influence of liquid film thickness on airblast atomization. *J. Eng. Power* 102, 706–710.
- Salyani, M., 2000. Optimization of deposition efficiency for airblast sprayers. *Trans. ASAE* 43 (5), 247–253.
- Salyani, M., Sweeb, R.D., Farooq, M., 2006. Comparison of string and ribbon samplers in orchard spray application. *Trans. ASABE* 49, 1705–1710.
- Sanderson, R., Hewitt, A.J., Huddleston, E.W., Ross, J.B., 1997. Relative drift potential and droplet size spectra of aerially applied Propanil formulations. *Crop Prot.* 16, 717–721.
- Stainier, C., Destain, M.F., Schiffers, B., Lebeau, F., 2006. Droplet size spectra and drift effect of two phenmedipham formulations and four adjuvants mixtures. *Crop Prot.* 25 (12), 1238–1243.

- Taylor, W.A., Womac, A.R., Miller, P.C.H., Taylor, B.P., 2004. An attempt to relate drop size to drift risk. *International conference on pesticide Application for drift management October 27–29, Waikola, Hawaii*, 210–223.
- Threadgill, E., Smith, D., 1975. Effects of physical and meteorological parameters on the drift of controlled-size droplets. *Trans. ASAE* 18 (S.1), 51–56.
- Vallet, A., Tinet, C., 2011. Surfactant influence on droplet size and velocity spectra from hollow cone and air induced sprays. *J. Agric. Sci. Technol.* 11, 718–727.
- Vallet, A., Tinet, C., 2013. Characteristics of droplets from single and twin jet air induction nozzles: a preliminary investigation. *Crop Prot.* 48, 63–68.
- Van de Zande, J.C., Holterman, H.J., Porskamp, H.A.J., 2002. Influence of reference nozzle choice on spray drift classification. *Asp. Appl. Biol.* 66, 49–56. *International advances in pesticide application*.
- Van de Zande, J., Parkin, C., Gilbert, A., 2003. Application technologies. In: Wilson, M. (Ed.), *Optimizing Pesticide Use*. Wiley, Chichester, UK, pp. 23–44. S.I.
- Walldate, P.J., Miller, P.C.H., Gilbert, A., 2000. Drift classification of boom sprayers based on single nozzle measurements in a wind tunnel. *Asp. Appl. Biol.* 57, 49–57. S.I.
- Western, N., Hislop, E.H., Bieswal, M., Holloway, P.J., Coupland, D., 1999. Drift reduction and droplet-size in sprays containing adjuvant oil or emulsions. *Extended Summaries: IUPAC Congress. Pest. Sci.* 55, 633–675.
- William, E., Smith, 2004. *Reducing Herbicide Spray Drift*. New Agriculture, Tamworth Agricultural Institute.
- Williamson, R.E., Threadgill, E.D., 1974. A simulation for dynamics of evaporating spray droplets in agricultural spraying. *Trans. ASAE* 17, 254–261.
- Wolf, R.E., 2000. *Strategies to Reduce Spray Drift*. Kansas State University Agricultural Experiment Station and Cooperative Extension Service.
- Womac, A., Etheridge, R., Seibert, A., Hogan, D., Ray, S., 2001. Sprayer speed and venturi nozzle effects on broadcast application uniformity. *Trans. ASAE* 44, 1437–1444.

## Conclusions and perspectives

Spray drift is an involuntary consequence of spray applications. By using wind tunnels, several factors affect spray drift intensity. In this literature review, the influence of some physical factors such as droplet size, droplet velocity and physicochemical properties of spray liquid are discussed. Droplet size is one of the most important factors that have been widely studied conversely to droplet velocity. In this study, these two factors were merged in the expression of the droplet kinetic energy that involves both droplet size and its velocity and show a high correlation with spray drift. Physico-chemical properties of the spray mix may affect spray drift through the evolution of the surface tension and the viscosity of the spray liquid. However all the physical factors highlighted in this literature review provide only partial information on the characterization of macroscopic descriptors of spray drift such as the sedimentation rate at a certain distance and its susceptibility to the wind speed and the boom height. Many studies in wind tunnels are based on short sprays collected on nylon strings of 2 mm diameter. This study will take the occasion to test a long duration exposure protocol based on the use of a distribution test bench inside a wind tunnel.



## **Chapter 3: Materials and Methods**

### **1. Introduction**

This chapter describes the methodology that was carried out in order to measure the sedimentation spray drift from various nozzles and conditions in an IRSTEA Montpellier wind tunnel. The sedimentation spray drift was measured by using a horizontal distribution test bench. Compared to other studies conducted in other wind tunnels, the experiments developed in this study are specific in terms of measurement method itself and the analysis of the results.

The measurement of the sedimentation spray volume in the wind tunnel is achieved through a distribution test bench of 9m long including the direct spray and the drift area. Considering the volumetric measurement of the spray deposition at distance up to 9m, the experiments are based on a long duration exposure principle. The analytical process is based on the collection recovery of the sprayed volume at different distances.

### **2. Description of IRSTEA Montpellier wind tunnel**

All experimental measurements in this study were carried out in IRSTEA-Montpellier wind tunnel from October 2013 until January 2015. As shown in Fig. 22 the circular wind tunnel has an internal working section of 3m x 2m x 9m height, width, and length respectively.

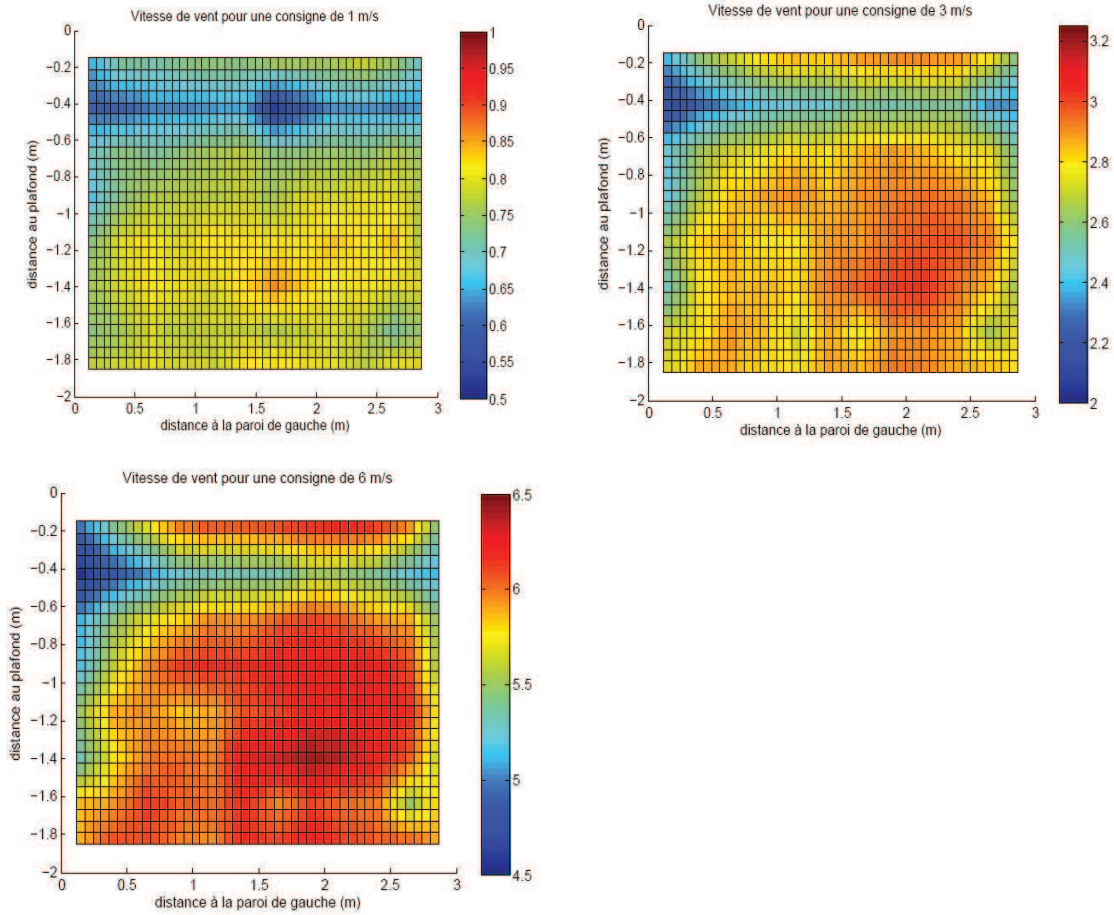

**Figure 19: IRSTEA-Montpellier wind tunnel**

### **2.1. Air control**

Air generators are located on the upper floor of the wind tunnel with 6 fans hydraulically driven as well as the air conditioning by using a refrigeration unit and thermal resistances. The wind speed is controlled and can be adjusted from 0 to 12 m s<sup>-1</sup> with a precision of ± 0.2 m.s<sup>-1</sup>. The homogeneity of the wind velocity was checked across the working section (Fig. 23) with a sampling grid of 0.25 x 0.2m (Cemagref internal report 2006) i.e. 99 sampling points on a 2m x 3m cross section for wind velocities 1, 3 and 6ms<sup>-1</sup>.

The temperature was maintained at 20 °C and relative humidity up to 90 %. The temperature and relative humidity were measured using VAISALA, HMT337 (Fig.24B). The wind speed is controlled with an anemometer located at the boom height (Fig.24C).



**Figure 20: 2D Wind profiles in IRSTEA wind tunnel for expected wind speeds of 1, 3 and 6 m s<sup>-1</sup>.**

## 2.2. Pressure liquid control

The water injected to the boom is controlled in terms of flowrate by using an electromagnetic flowmeter (4000 pulses/L) (SIKA, N° VMZ081, Germany) with a precision  $\pm 0.1 \text{ l min}^{-1}$ . The operating pressure is controlled during the measurements by using a pressure gauge Keller (Type, PR-33/80794-30, Germany) with a precision  $\pm 0.1 \text{ bar}$  (Fig.24A).

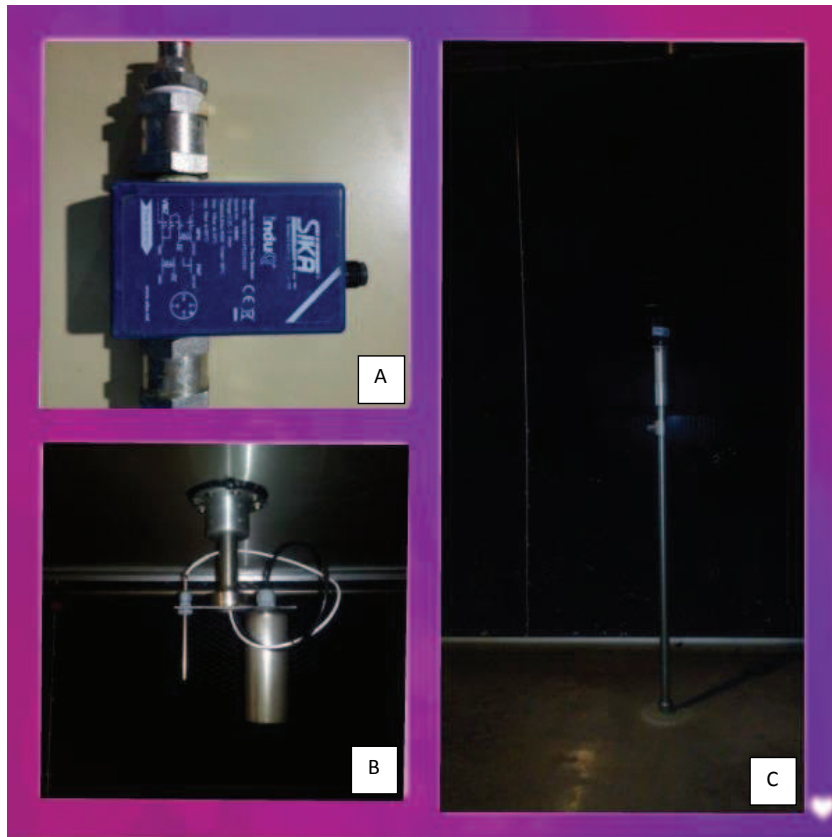
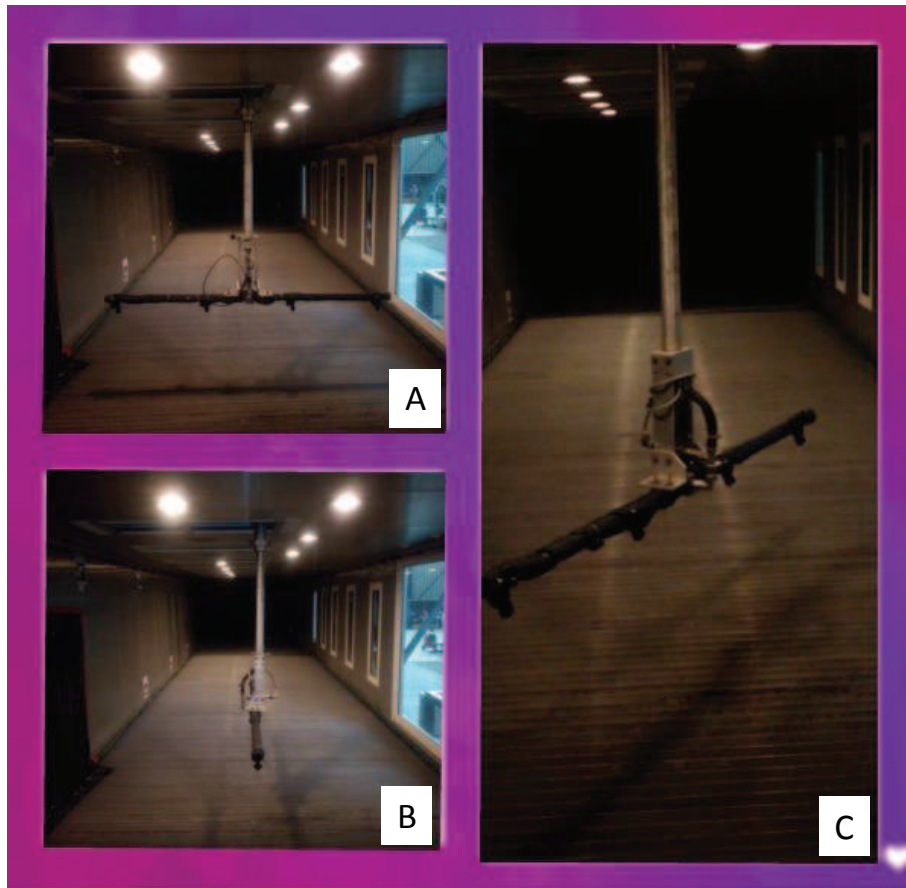

**Figure 21: Main measuring devices found in the wind tunnel**

(A) Magnetic Inductive flow sensor SIKA Type VMZ081. (B) Temperature and relative humidity sensors (C) VAISALA, HMT337 Ultrasonic sensor with RS-232.

### 3. Boom setup

Wind tunnel is supplied with a short boom of 4 nozzles, with 50cm nozzle spacing, placed in the central axis of the wind tunnel. The position of the boom towards the wind direction is adjustable from a frontal position (perpendicular to the wind direction) to a lateral position (parallel to the wind direction). Any intermediate angle between frontal and lateral position can be set (Fig. 25) for example to 15°, 30°, 45°, 60°, and 75° depending on the objective of each test with an accuracy  $\pm 1^\circ$ .



**Figure 22: Different boom positions in the wind tunnel (A): Frontal position; (B): Lateral position; (C): Boom with an angle of 45°**

In addition, the boom height can be set from 0.1 to 1.2m. Boom height was adjusted for the measurements at 40, 60, and 80cm with an accuracy  $\pm 2$ cm.

#### **4. Distribution test bench**

IRSTEA-Montpellier wind tunnel has a horizontal patternator which consists of 180 grooves of 0.05m width (Fig. 26). The total length of the distribution test bench is 9 m.

The grooves are rinsed with water before measurements in order to allow an immediate flow of sediments.

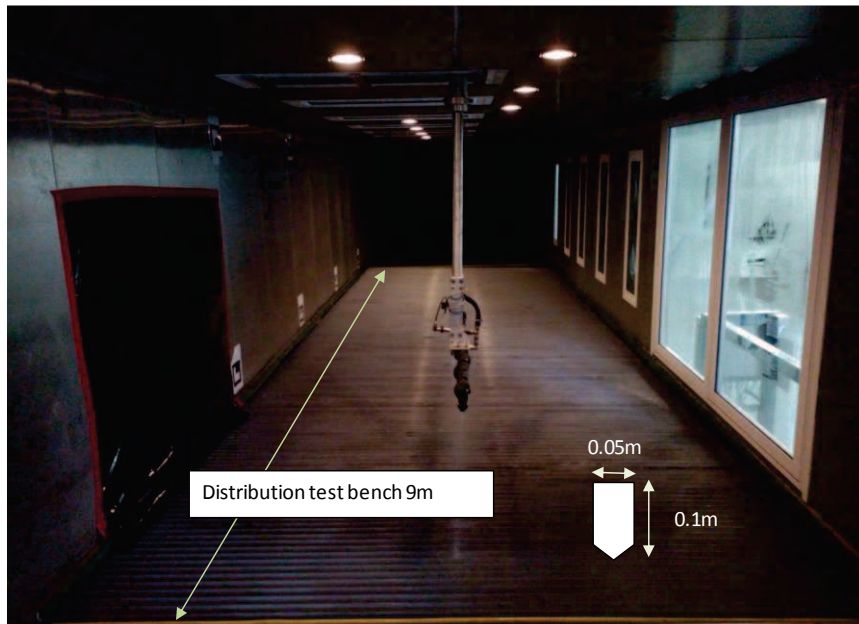

**Figure 23: Collecting plan with grooves**

A mobile device including 60 tubes (Fig. 27) is connected to the grooves in order to collect the deposition volume. A portion of 3m length (60 grooves) in the wind tunnel is then measured at the same time with increments of 1m. 7 positions are necessary to cover the total distance of 9m.

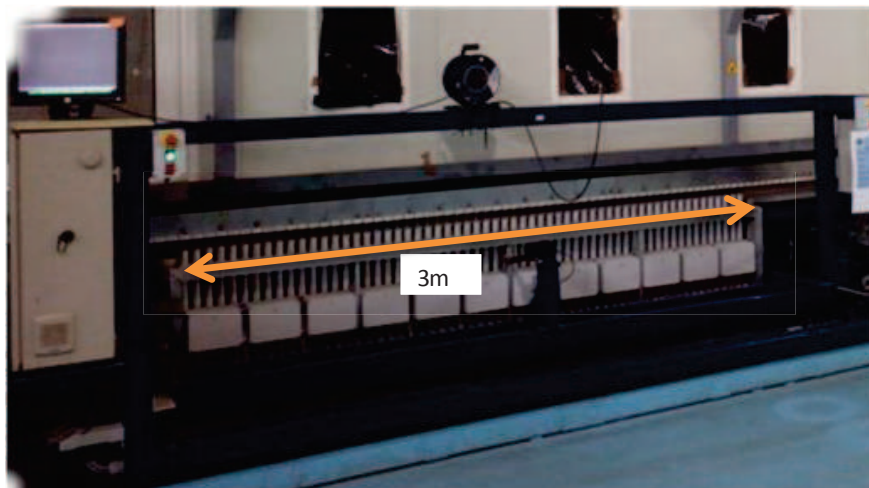

**Figure 24: A mobile device wind tunnel**

Each measuring tube is placed on a weight cell (Fig. 28)

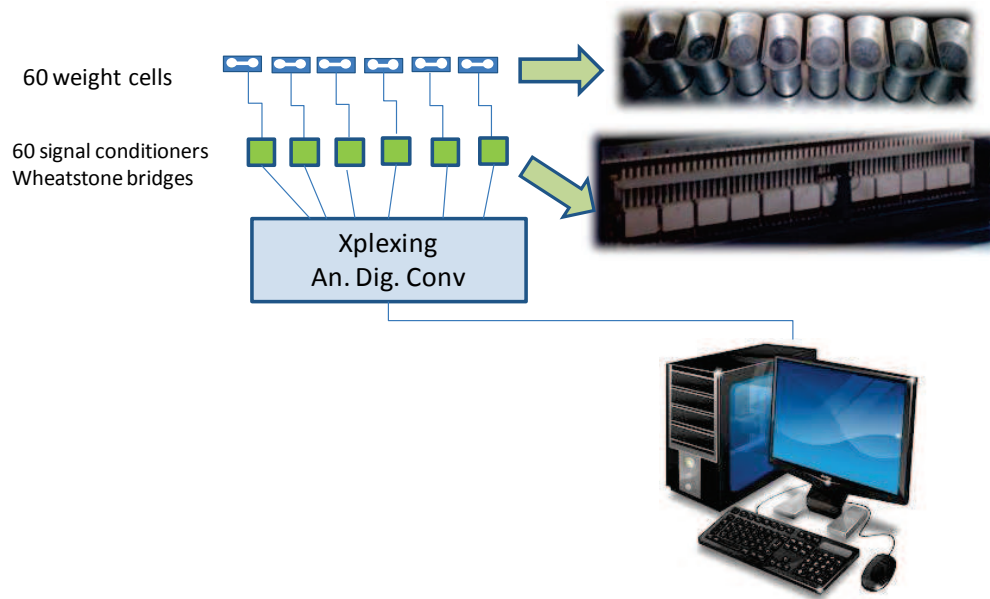

**Figure 25: Weight cells**

The maximum tube capacity is 500ml but can be adjusted as necessary through the setting of the filling rate. A typical filling rate of 80% is used to stop the measurement in the direct spray area where flowrate is high. In the drift area up to 9m, measurements are stopped on the basis of a maximum acquisition time (ex. 1500s). The duration of a complete measurement is about 2 to 3 hours depending on the number of nozzles, the nozzle size and the injection pressure.

## 5. Nozzle characteristics

Three nozzle types were tested according to Table 5. These nozzle types are considered as common in agriculture applications with boom sprayers. The flat fan nozzle corresponds to the reference drift situation (50% drift reduction). The air injection monojet represents a 66% drift reduction and the air injection twin jet did not achieve the 66% drift reduction. All nozzles were 110° that is recommended by the manufacturer with 50cm nozzle spacing and 50cm boom height. The nozzle size of 02 means 0.2 US gallons per min at a pressure of 43.5 PSI (ISO 10625). The conversion to usual units gives 0.8 l min<sup>-1</sup> at 3 bar.

All these nozzles at the same size and angles and tested at the same operating pressure of 2.5bar that corresponds to an application rate of 110 l ha<sup>-1</sup> at 8 km h<sup>-1</sup>.

**Table 5: Albus nozzles characteristics**

nozzle	Nozzle type	Nozzle angle/size	VMD $\mu\text{m}$	Nozzle flowrate $\text{Lmin}^{-1}$	Operating pressure (bar)
AXI	Flat Fan	110/02	164.9	0.73	2.5
CVI	Flat Fan-air induction	110/02	434.6	0.73	2.5
CVITwin	Flat Fan- air induction twin jet	110/02	380.0	0.73	2.5

Note : VMD was measured with a Malvern Spraytec

## 6. Sedimentation flowrate measurements

During spray drift measurements in the wind tunnel, the sedimentation drift is collected in the grooves and connected to the filling tubes. At the end of the measurement, a data file is obtained indicating the groove position, the local collected volume, the working pressure and the duration of the measurement. Depending on the sampling strategy, the same groove can be measured by up to 3 different tubes. A cross table is drawn considering the average sedimentation volume in each groove. First, all data are converted to relative flowrate considering the emission flowrate by the entire boom.

Second, the relative flowrate data for each distance are cumulated according to the distance. Finally, the opposite of the accumulated value, called drift ratio (DR) is calculated along the sedimentation distance as presented in the equation 4 (Douzals and Alheidary, 2014).

$$Dr_i = 1 - \sum_i q_i \quad (4)$$

Where  $Dr_i$  is the spray drift ratio % at a position  $i$ ,  $q_i$  is the relative flowrate (total collected flowrate normalized by the injected flowrate) at the position  $i$  in %.

## 7. Droplet size measurements

Droplet size spectra were characterized by the volume median diameter (VMD or  $Dv_{0.5}$ ) by using a Malvern Spraytec 2680 (Spraytec instrument Ltd., Spring Lane South, Malvern. Worcestershire.UK). Static measurements were conducted to determine the droplet size given in Table 6. Dynamic measurements were also achieved in the wind tunnel considering different measuring distances from the nozzle depending on the wind velocity.



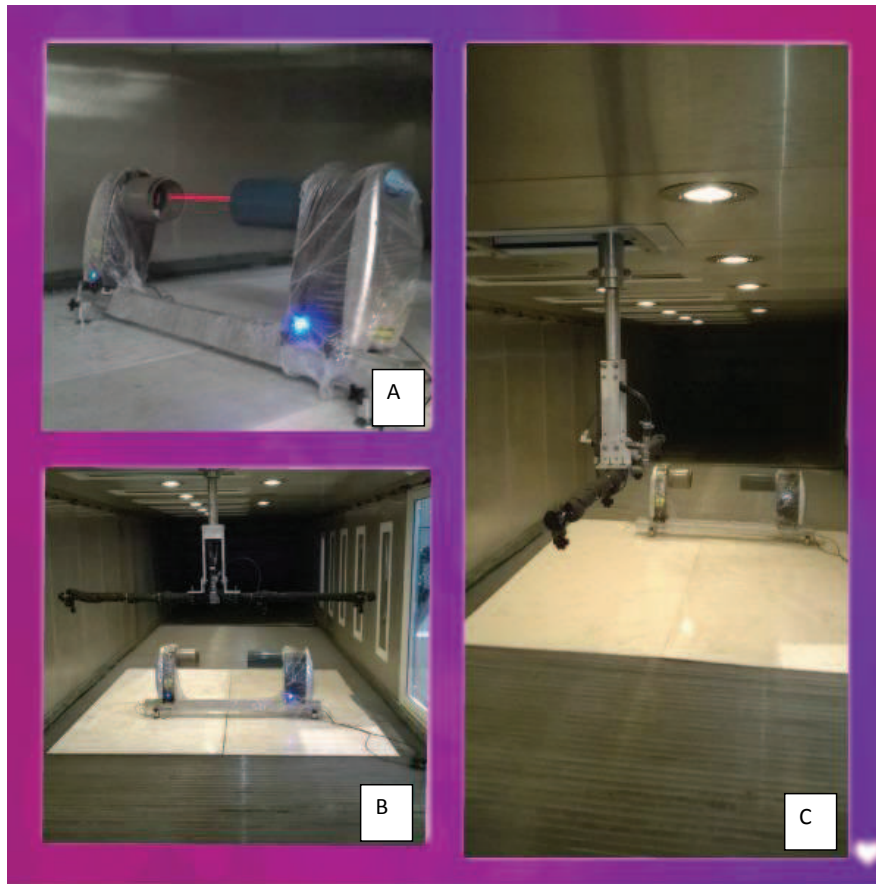

**Figure 26: Set-up of the Malvern Spraytec in the wind tunnel (A) Testing Malvern (B) Measuring droplet size in frontal position (C) Measuring droplet size in lateral position**

Spraytec device is fitted with 750 mm lens corresponding to a range of droplet size from 1 to 2500  $\mu\text{m}$ . The acquisition frequency is 1 Hz including a time of 100 ms for exposure. 30 photoreceptors intercept the diffracted light produced by a laser beam (632.8 nm). Results are expressed considering 60 droplet size classes distributed on a log scale. A number of at least 20 measurements were averaged to calculate the droplet size distribution data.

The nozzle sprays vertically downwards and is positioned approximately at 50cm from the laser beam. The distance between the emission and reception lenses was 100cm and the actual measuring the distance through the spray was 75cm due to use of polythene tubes to prevent the deposition of droplets on both emitter and receiver optics.

As the droplet diameter is known to be variable across the spray. 30 cm underneath the orifice of nozzle, perpendicular to the main nozzle axis for the elliptical spray of nozzle tested. The measurements of spray droplet size distributions are analyzed in order to calculate the volume median diameter (VMD), DV0.1, and DV0.9 (Table 6).

**Table 6: Summary of some technical definitions used for describing droplet size**

Parameters	Definition	Units	Comments
VMD or Dv0.5	50% of the total volume of the liquid sprayed is made up of droplets with diameters larger than the stated value and 50% is made up of droplets with diameters smaller than the stated value.	µm	Most commonly used value for describing droplet size distribution
Dv0.1	10% of the total volume is contained in droplets of a smaller diameter	µm	Useful indication for fine droplets which are more prone to drift.
Dv0.9	10% of the total volume is contained in droplets of a greater diameter	µm	Useful indication for coarse droplets to avoid the waste of chemical.
Relative span factor	Relative distribution span $RSF = \frac{Dv0.9 - Dv, 0.1}{Dv0.5}$	**	The lower the span, the more uniform the droplet spectrum is. For monosize droplets, span=0
%V<100 µm	Volume fraction of droplets below 100 µm	%	Useful indication for small droplets which are more prone to drift.

- µm or micrometer = 1/1000mm or 10<sup>-6</sup>m
- \*\* dimensionless

Droplet size measurements were repeated at least three times on a separate occasion to check for consistency and are presented in the final results of the paper part 3 as means.

## 8. Modalities setup

99 different modalities were tested in IRSTEA-Montpellier wind tunnel as introduced in Table7. Different combinations of parameters were selected corresponding to series identified as A, B and C for frontal, lateral and angular measurements respectively. Each series comprises sub modalities for each nozzle type (ex A1: FF nozzle, A2, AI nozzle, etc.). Each sub series corresponds to 3 wind speeds and 3 boom heights. Finally the C series were operated at 60cm only but with different angular positions of the boom as 15°, 30°, 45°, 60°, 75° for the 3 different nozzles.

**Table 7: Modalities settings**

Modalities	Nozzle type	Boom height (cm)	Boom angle (°)	Operating pressure (bar)	Wind velocity (ms <sup>-1</sup> )
A1 series	FF	40/60/80	0 (Frontal)	2.5	2/4/7.5
A2 series	AI	40/60/80	0 (Frontal)	2.5	2/4/7.5
A3 series	AI Tw	40/60/80	0 (Frontal)	2.5	2/4/7.5
B1 series	FF	40/60/80	90 (Lateral)	2.5	2/4/7.5
B2 series	AI	40/60/80	90 (Lateral)	2.5	2/4/7.5
B3 series	AI Tw	40/60/80	90 (Lateral)	2.5	2/4/7.5
C1 series	FF	60	15/30/45/60/75°	2.5	2/4/7.5
C2 series	AI	60	15/30/45/60/75°	2.5	2/4/7.5
C3 series	AI Tw	60	15/30/45/60/75°	2.5	2/4/7.5

Some parameters were not considered in this study as the effect of: i) the operating pressure, ii) the nozzle size or iii) other types of nozzles (ex. deflector, pre-orifice or rotary nozzles) mainly because of a lack of time.

## **Chapter 4: Results**

The main objective of this chapter was to present the results that were obtained from wind tunnel experimental in accordance with different parameters as nozzles type, boom heights, boom positions, and wind velocities that would define key- elements for spray drift modeling. In this chapter, all these results are introduced in four articles. The paper N°2 is entitled “How spray characteristics and orientation may influence spray drift in a wind tunnel”

### **Abstract**

Different experimental setups are conducted in IRSTEA-Montpellier wind tunnel to study the effect of wind velocity from 2 to 7.5ms<sup>-1</sup>, the number of nozzles from 1 to 4 nozzles mounted on the boom, and the position of spray nozzles towards the wind direction (frontally and laterally position) that related to boom position. One boom height of 60cm is tested in this study. All these experimental carried out at operating pressure of 2.5bar. The results showed that in frontal position, all spray nozzles at the same position thereby gave the equally of sedimentation flowrate. On the same position, no significant effect on spray drift ratio was observed when using 1, 2, or 4 nozzles were mounted on the boom. Conversely, in the lateral position the effect of the number of nozzles on spray drift was demonstrated especially with the first or second spray close to wind source with a higher protective impact compared to the other sprays behind. Also, the results showed increasing the number of nozzles led to decrease in spray drift ratio at the reference point. As well as, the effect of wind velocity was visible for both frontal and lateral positions.

Author-produced version of the article published in *Aspects of Applied Biology*, 2014, 122, 271-278.  
The original publication is available at [www.blackwell-synergy.com](http://www.blackwell-synergy.com)  
Congrès International Advances in Pesticide Application 2014, 08-10/01/2014,Oxford, GBR

*Aspects of Applied Biology*

## How Spray Characteristics and orientation may influence spray drift in a wind tunnel

J P DOUZALS and M AL HEIDARY

*IRSTEA – UMR ITAP 361, Rue JF Breton 361 F-34196 Montpellier, France*

### Summary

Crop protection product application may be subjected to drift. This paper aims at studying the effect of wind direction on drift and nozzle classification accordingly to [ISO 22369-1]. Experiments were realized in Irstea wind tunnel with wind speeds varying from 2 to 7.5 m.s<sup>-1</sup> oriented in frontal or lateral position to a narrow spray boom including from 1 to 4 nozzles.

A first set of experiments were conducted with the reference nozzle in frontal or lateral position and with 1 to 4 nozzles. A second set of experiments were conducted with a wide range of low drift nozzles (19 Flat Fan Air injection and 8 Twin jets Flat Fan Air Injection) with 4 nozzles at 7.5 m.s<sup>-1</sup> wind speed. The results showed that DR<sub>F</sub> and DR<sub>L</sub> classification was significantly different depending on the nozzle type and working conditions. A global discussion is proposed for methodological aspects and practical conclusions for nozzle classification.

**Key words** : Frontal, Lateral drift, Wind tunnel, Nozzle Classification

### Introduction

Wind tunnels represent a convenient tool to study spray application behavior in windy environment with controlled atmospheric conditions. A comprehensive modeling work on the interaction of spray with a frontal air flow is given by (Ghosh and Hunt ,1998) but a lot of experimental data were produced by (Miller et al, 2011; Taylor et al, 2004; Nuyttens et al, 2009) and (Walklate et al, 2000) as well.

This paper aims at studying the effect of artificial wind on two main experimental conditions in IRSTEA wind tunnel. A first series of experiments were conducted in order to show the effect of wind speed, orientation of the boom and the number of nozzles (from 1 to 4) by using the French reference nozzle for drift measurements. A second series of experiments were conducted with a fixed wind speed but with several air injection (AI) nozzles either single or twin jets.

### Material and method

#### *Wind tunnel settings*

Experiments were conducted within Irstea circular wind tunnel. Internal dimensions are 3m x 2m and distribution test bench is 9 m (180 grooves of 5 cm width). Distribution test bench is rinsed before measurements in order to allow immediate and permanent flow into measuring tubes.

Author-produced version of the article published in *Aspects of Applied Biology*, 2014, 122, 271-278.  
The original publication is available at [www.blackwell-synergy.com](http://www.blackwell-synergy.com)  
Congrès International Advances in Pesticide Application 2014, 08-10/01/2014, Oxford, GBR

Wind is generated by 6 fans and wind speed is controlled at the height of the boom. Possible wind speeds are from 0 up to 12 m.s<sup>-1</sup> +/- 0.2 m.s<sup>-1</sup>. National drift assessment scheme is usually conducted with wind speed of 7.5 m.s<sup>-1</sup>. Wind speed homogeneity through working section has been checked. Temperature is maintained between 19.5°C and 20.5 °C and relative humidity is typically above 90 % by spraying in the circular tunnel for 1 hour before experiments.

#### *Boom settings*

A short boom of 4 nozzles (50 cm spacing) is placed in the axial axis of the wind tunnel at height between 0.20 m up to 1.60 m. Boom positions can be frontal (perpendicular to the wind direction) or lateral (parallel to the wind direction). Typical working heights for nozzle accreditation are between 50 to 70 cm. Flowrate is controlled by an electromagnetic flowmeter (4000 pulses/L) and operating pressure is estimated by a pressure gauge Keller (+/- 0.01 bar). The input flowrate of the boom is maintained at +/- 2 % s.d. Before wind tunnel measurement, nozzles are checked in flowrate. Droplet size of reference nozzle was measured with a laser PDPA with a VMD of 226 µm - % Volume lower than 100 µm is 8.9%.

#### *Distribution test bench*

A horizontal patternator consists of fixed 180 grooves of 5 cm width (9 m width in total). A mobile device includes 60 collecting tubes, each of them placed on an individual weight cell (precision of 1/- mg). Maximum collected volume can be adjusted either considering the filling rate of 500 ml tubes (high flowrate zone underneath the boom) or considering a maximum collecting time (low flowrate zone in the drifting area). Ordinary values when testing four nozzles are 80 % filling and/or 2800 s.

#### *Experimental setup*

Different experimental setups were conducted. Tests A aim at showing either the effect of wind speed and the number & position of nozzles mounted on the boom in frontal and lateral positions with the reference nozzle FF 110 02 at 2.5 bar injection pressure and 60 cm boom height.

Table 1. *Experimental setups with reference nozzles*

Modality	Nozzle type	Wind speed (m.s <sup>-1</sup> )	Boom height (cm)	Nozzles position on the boom	Modality	Nozzle type	Wind speed (m.s <sup>-1</sup> )	Boom height (cm)	Nozzles position on the boom
Frontal position	FF 02 – 2.5 bar	2	60 cm	1-2-3-4	Lateral position	FF 02 – 2.5 bar	2	60 cm	1-2-3-4
				1-2-3-0					1-2-3-0
				1-2-0-0					1-2-0-0
		0-2-3-0		1-0-3-0					
		0-0-3-4		1-0-0-0					
		1-0-3-0		1-2-3-4					
	0-2-0-0	1-2-3-0							
	4	60 cm	1-2-3-4	1-2-0-0					
			1-2-3-0	1-0-3-0					
			0-2-3-0	1-0-0-0					
			0-2-0-0	1-2-3-4					
			1-2-3-4	1-2-3-0					
1-2-3-0			1-2-0-0						
7.5	60 cm	60 cm	1-2-3-4	1-2-3-0					
			1-2-3-0	1-0-3-0					
			0-2-3-0	1-0-0-0					
			0-2-0-0	1-2-3-4					
			1-2-3-4	1-2-3-0					
			1-2-3-0	1-2-0-0					

Nozzle position : 0 means absence of nozzle.

Author-produced version of the article published in *Aspects of Applied Biology*, 2014, 122, 271-278.  
The original publication is available at [www.blackwell-synergy.com](http://www.blackwell-synergy.com)  
Congrès International Advances in Pesticide Application 2014, 08-10/01/2014,Oxford, GBR

Tests B were realized with a constant wind speed of  $7.5 \text{ m.s}^{-1}$ . Deposition data obtained for lateral and frontal positions were compared for the twenty-eight following nozzles with *ad hoc* settings. These nozzles were satisfying the minimum 66 % drift reduction that is adopted by Law in France (Table 2).

Table 2. *Experimental setups with Air Injection nozzles at constant wind speed ( $7.5 \text{ m.s}^{-1}$ ).*

Nozzle	Type	Size	Pressure (bar)	Nozzle Height (cm)	Angle1 (°)	Angle2 (°)	Material
Albuz AXI (Ref.)	FF	02	2.5	70	110 °	-	Ceramic
Agrotop Airmix	FF AI	015	2	50	110°		Polymer
		02	2	50			
		025	2	50			
Albuz CVI	FF AI	02	2	60	110		Ceramic
		03	2	60			
		04	2	60			
		05	2	60			
Lechler IDKT	Twin FF AI	03	2	50	120	60	Polymer
		04	2	50			
Lechler IDKT	Twin FF AI	02	2	50	120	60	Ceramic
		025	2	50			
		03	2	50			
		04	2	50			
		05	2	50			
Albuz AVI Twin	Twin FF AI	02	4	60	110	65	Ceramic
		025	4	60			
		03	4	60			
Albuz CVI Twin	Twin FF AI	04	4	60	110	65	Ceramic
		025	2	60			
		03	2	60			
		04	2	60			
Nozal ARX	FF AI	05	5	70	120		Ceramic
		02	5	70			
		03	5	70			
		04	5	70			

Note : Working height and pressure are given by manufacturers.

#### *Analysis of deposition values*

Data from distribution test bench correspond to deposition volume in ml. Collected volume are converted into flowrate while taking into account the acquisition time and the effective pressure. Deposition flowrates are then normalized with the input flowrate. Normalized deposition flowrates are then cumulated along the distance and the complementary curve is then obtained. As a result, a drift ratio (Dr) curve is obtained starting from direct spraying zone up to about 8 m downwind (Douzals, 2012).

Author-produced version of the article published in Aspects of Applied Biology, 2014, 122, 271-278.  
 The original publication is available at www.blackwell-synergy.com  
 Congrès International Advances in Pesticide Application 2014, 08-10/01/2014,Oxford, GBR

**Results**

*Test A : Frontal drift with reference nozzles*

Raw deposits of frontal drift measurements with four nozzles are introduced in Fig.1 for different wind speeds. Reference distance (X = 0) corresponds to the vertical to the position of nozzles when the boom is in frontal position.

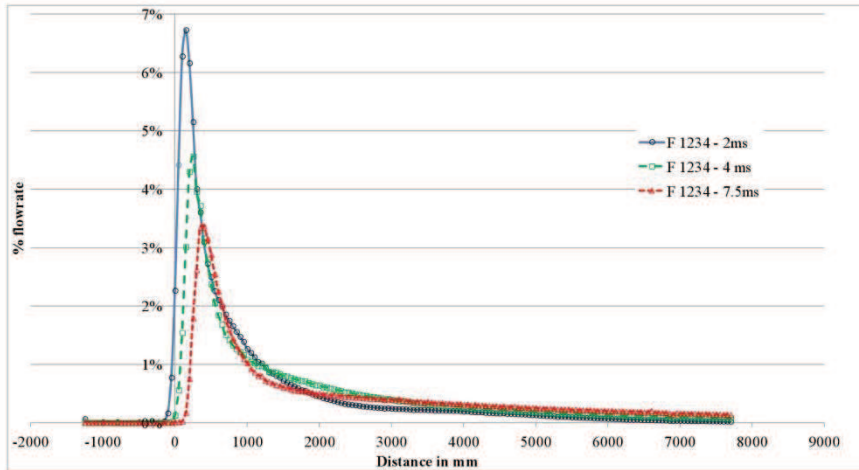

Fig. 1. Effect of wind speed on sedimentation flowrate of a 4 nozzle boom fitted with FF 02 – 2.5 bar – 60 cm height – Frontal position.

As shown on Fig. 1, wind speed increase involved a decrease in the peak value and a shift in peak position. Total recoveries on the distribution test bench were respectively 97%, 88% and 79 % for wind speed of 2, 4 and 7.5 m.s<sup>-1</sup>. The effect of the number of nozzles is introduced in Fig. 2.

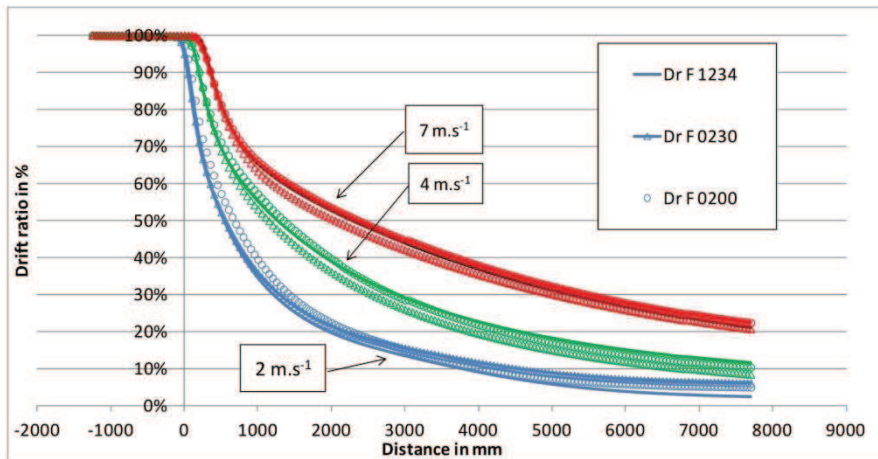

Fig. 2. Evolution of Drift Ratio depending on the number of nozzles and wind speed – FF 02 – 2.5 bar – 60 cm – Frontal position

As shown on Fig. 2, increasing the number of nozzles induced only slight variations in drift ratio compared to wind speed effect. Flowrate data analysis (not represented here) showed that drift



Author-produced version of the article published in *Aspects of Applied Biology*, 2014, 122, 271-278.  
The original publication is available at [www.blackwell-synergy.com](http://www.blackwell-synergy.com)  
Congrès International Advances in Pesticide Application 2014, 08-10/01/2014, Oxford, GBR

ratio were quite similar between 1234 – 0230 and 0200 configurations with a standard deviation range of 1.13% to 1.62%. The number of nozzles induced a cumulative effect on raw flowrate depositions but variations between nozzle configurations did not involve significant differences when drift curves are normalized according to the input flowrate.

#### *Test A : Lateral drift with reference nozzles*

The evolution of sedimentation flowrates in lateral position is presented on Fig. 3 for different boom configurations. The reference position ( $X = 0$ ) corresponds to the half nozzle spacing distance (250 mm) after the last nozzle mounted on the boom:

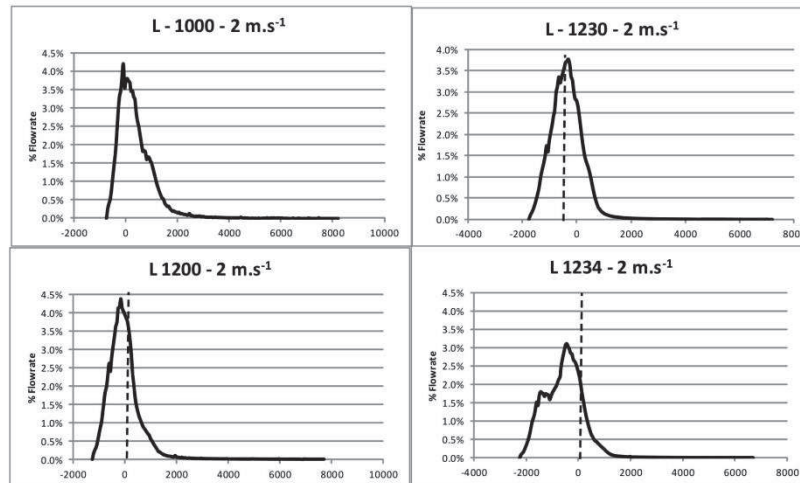

Fig. 3. Sedimentation flowrates for different boom configuration with 2 m.s<sup>-1</sup> wind speed – lateral position.

As shown on Fig. 3, flowrate values at the reference position (0) and beyond distances downwind are dependent on the number of nozzles. As a result, drift ratios will be modified accordingly. In lateral position, the first spray appears strongly modified by the wind shear compared to subsequent sprays behind that are more protected. When the number of nozzles increases, the drift ratio at the reference point decreases because the impacted spray is located at a greater distance.

#### *Effect of wind speed – lateral position*

Following Fig. 4 shows a comparison of deposition flowrates at 2, 4 and 7.5 m.s<sup>-1</sup> for (1-2-3-4) configuration of nozzles.

Author-produced version of the article published in Aspects of Applied Biology, 2014, 122, 271-278.  
 The original publication is available at www.blackwell-synergy.com  
 Congrès International Advances in Pesticide Application 2014, 08-10/01/2014,Oxford, GBR

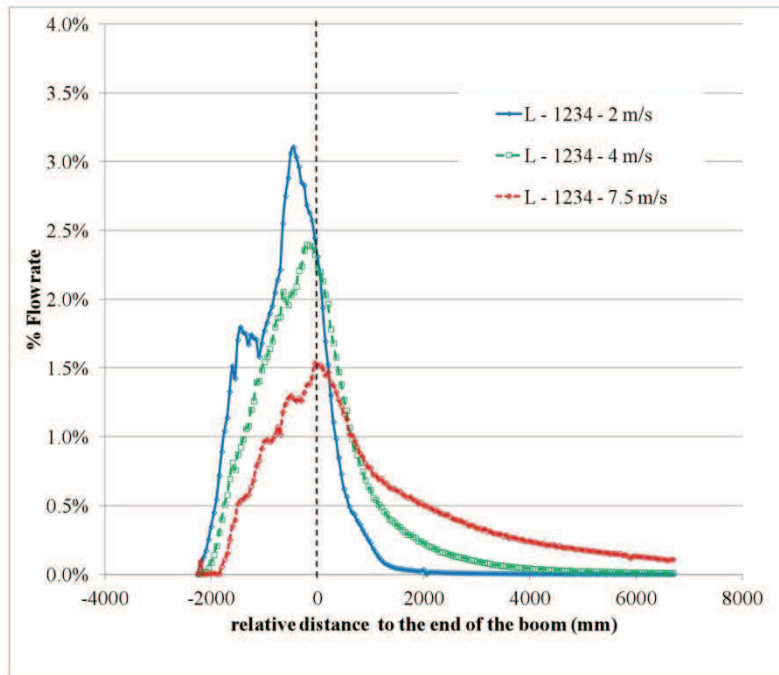

Fig. 4. Effect of wind speed on sedimentation flowrate for a 4 nozzles configuration with FF 02 – 2.5 bar – 60 cm – Lateral position.

As found in frontal position, the effect of wind speed is visible either on the deposition peak value and position. Recovery rates were 98%, 97.4 and 91.2% for 2,4 and 7.5 m.s<sup>-1</sup> wind speed respectively.

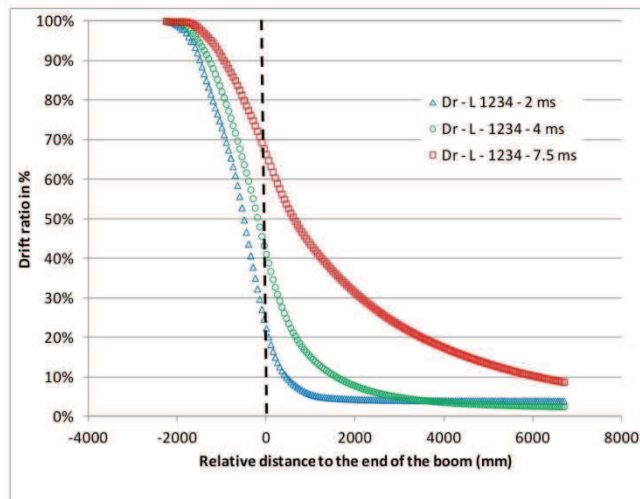

Fig. 5. Evolution of drift ratio of a 4 nozzle boom (1-2-3-4) configuration with different wind speeds – Lateral position.

Author-produced version of the article published in *Aspects of Applied Biology*, 2014, 122, 271-278.  
The original publication is available at [www.blackwell-synergy.com](http://www.blackwell-synergy.com)  
Congrès International Advances in Pesticide Application 2014, 08-10/01/2014, Oxford, GBR

The effect of wind speed on a complete set of nozzles drift ratio is given in Fig. 5 after normalization of flowrates and distances. Increasing wind speed involved increasing values of deposit at all distances.

#### *Partial conclusion*

In frontal position, an additive effect is observed on deposition flowrates. All nozzles are at the same position and contribute equally to the sedimentation. When raw data are normalized with flowrates, no significant difference was observed when 1, 2 or 4 nozzles were mounted on the boom with similar air speed.

In lateral position, a protective effect is observed as the first spray is much more disturbed by the air flow. In this case, raw curves are hardly comparable but the effect of the reference distance tends to minimize drift values with equal air speed. With a given configuration of nozzles in lateral position, the effect of air speed is also visible.

#### *Test B : Low drift nozzle classification*

A second set of experiments were exclusively realized with a standard wind speed of  $7.5 \text{ m.s}^{-1}$ . Frontal and Lateral drift were measured in wind tunnel with a complete set of four nozzles.

Table 2. Drift results for *different Air Injection Nozzles – wind speed  $7.5 \text{ m.s}^{-1}$* .

Test	pressure	height	DR Frontal 5 m	DR Lateral 5 m	drift reduc frontal	drift reduc lateral	F/L ratio
AXI 02 (ref.)	2.5	70	36.9	17.1	0.00%	0.00%	
AVI twin 02	4	60	9.8	4	73.44%	76.61%	2.45
AVI twin 025	4	60	11.2	5	69.65%	70.76%	2.24
AVI twin 03	4	60	10.3	4	72.09%	76.61%	2.58
AVI twin 04	4	60	10.7	5.1	71.00%	70.18%	2.10
CVI 03	2	60	8.3	5.2	77.51%	69.59%	1.60
CVI 02	2	60	8.9	4.5	75.88%	73.68%	1.98
ARX 015	5	70	11.3	5.7	69.38%	66.67%	1.98
ARX 02	5	70	9	4.3	75.61%	74.85%	2.09
ARX 025	5	70	11.7	5.2	68.29%	69.59%	2.25
ARX 03	5	70	11.6	4.5	68.56%	73.68%	2.58
CVI 04	2	60	9.9	4.1	73.17%	76.02%	2.41
CVI 05	2	60	11.2	4.8	69.65%	71.93%	2.33
IDKT 02	2	50	9.3	3	74.80%	82.46%	3.10
IDKT 025	2	50	7.9	5.1	78.59%	70.18%	1.55
IDKT 03 K	2	50	6.2	3.4	83.20%	80.12%	1.82
IDKT 03 POM	2	50	6.8	4.7	81.57%	72.51%	1.45
IDKT 04 POM	2	50	8.9	5.1	75.88%	70.18%	1.75
IDKT 05 POM	2	50	8.9	5	75.88%	70.76%	1.78
IDKT 04	2	50	6.3	3.5	82.93%	79.53%	1.80
IDKT 05	2	50	8.1	4	78.05%	76.61%	2.03
Airmix 015	2	50	10.3	7	72.09%	59.06%	1.47
Airmix 02	2	50	11	5.8	70.19%	66.08%	1.90
Airmix 025	2	50	10.2	5.2	72.36%	69.59%	1.96
CVI Twin 025	2	60	7.5	4.7	79.67%	72.51%	1.60
CVI Twin 03	2	60	8.5	5.3	76.96%	69.01%	1.60
CVI Twin 04	2	60	5.8	4.6	84.28%	73.10%	1.26

Note : Injection pressure as well as boom height were set accordingly to manufacturer requirements.

As seen in Table 2, ranges of drift ratio at 5 m downwind varied from 5.8% to 11.7% (frontal) and from 3% to 5.8% (Lateral). Drift reduction was calculated on the basis of the reference (FF 02 at 2.5 bar and 70 cm height) for lateral and frontal positions.

Author-produced version of the article published in *Aspects of Applied Biology*, 2014, 122, 271-278.  
The original publication is available at [www.blackwell-synergy.com](http://www.blackwell-synergy.com)  
Congrès International Advances in Pesticide Application 2014, 08-10/01/2014,Oxford, GBR

The ratio between Frontal and Lateral drift values at 5 m were calculated and named F/L ratio. ANOVA made upon data showed no significant difference between single and twin jets regarding drift values in frontal and lateral positions (not represented here), drift reduction or F/L ratio. F/L ratio was related to the combined effect of boom height and operating pressure on frontal drift values (Table 3).

Table 3. *Influence of boom height and operating pressure on F/L ratio of air injection nozzles*

Height (cm)	F/L ratio (Nb of values)			
	Pressure (bar)			
	2	4	5	Average
50	1.87 - (11)			1.87
60	1.82 - (7)	2.34 - (4)		2.01
70			2.23 - (4)	2.23
<b>Average</b>	<b>1.85</b>	<b>2.34</b>	<b>2.23</b>	<b>1.99</b>

#### *Impact on drift reduction classification of low drift nozzles*

When comparing the drift reducing performance in frontal or lateral position with the reference in the same conditions, a double classification can be drawn (Fig. 7).

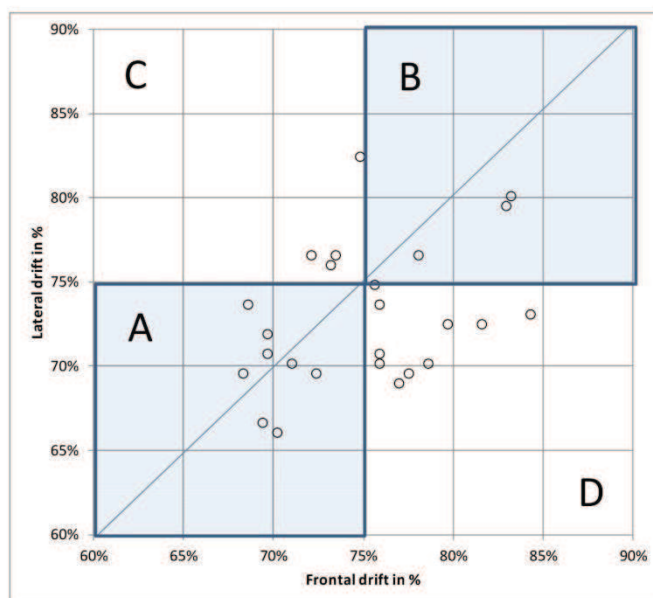

Fig. 7. Classification of nozzles according to frontal or lateral position.

Using frontal or lateral protocol three different cases can be found. In square A and B in Fig. 7, all points are situated in the same range 60% to 75 % or 75 to 90 %. In square C, drift reduction is overestimated in lateral position. In the square D, drift reduction in frontal position is overestimated. In total 14 points (50 % of 28) are not equally classified depending on the protocol.

Author-produced version of the article published in *Aspects of Applied Biology*, 2014, 122, 271-278.  
The original publication is available at [www.blackwell-synergy.com](http://www.blackwell-synergy.com)  
Congrès International Advances in Pesticide Application 2014, 08-10/01/2014,Oxford, GBR

### **Conclusion**

This paper introduces different aspects of drift measurement in a wind tunnel. Measurements with the reference nozzles showed the effect of wind speed as well as boom configuration in terms of number of nozzles and of the orientation of the boom. Measurements made with low drift nozzles in a reduced number of configurations (4 nozzles only) showed different drift reducing classifications for half of samples when considering lateral or frontal drift values.

### **Acknowledgements**

Authors would like to thank the French Ministry of Agriculture as well as nozzles manufacturers cited in this study.

### **References**

**Douzals J P, 2012.** Asymmetric Classification of Drift Reducing Nozzles considering Frontal or Lateral Wind Conditions. Proceedings of CIGR – Ag. Eng meeting 2012 Valencia, Spain. 4p. [http://wcigr.ageng2012.org/images/fotosg/tabla\\_137\\_C1501.pdf](http://wcigr.ageng2012.org/images/fotosg/tabla_137_C1501.pdf)

**Ghosh S, Hunt J, 1998.** Spray jets in a cross-flow. *Journal of Fluid Mechanics*, **365**: 109-136

**Miller P C H, Butler Ellis M C, Lane A G, O’Sullivan C M, Tuck C R, 2011.** Methods for minimizing drift and off-target exposure from boom sprayer applications *Aspects of Applied Biology* **106** : 281-288 .

**Nuyttens D, Taylor W A, De Schampheleire M, Verboven P, Dekeyser D. 2009.** Influence of nozzle type and size on drift potential by means of different wind tunnel evaluation methods. *Biosystems Engineering*, **103** (3), 271–280.

**Taylor W A, Womac A R, Miller P C H, Taylor B P. 2004.** An attempt to relate drop size to drift risk , International conference on pesticide application for drift management October 27<sup>th</sup> - 29<sup>th</sup>, Waikola, Hawaii : 210-223.

**Walklate, P., Miller, P., Gilbert, A., 2000.** Drift classification of boom sprayers based on single nozzle measurements in a wind tunnel. S.I., *Aspects of Applied Biology*, **57**, 49-57.

## **Chapter 5: General conclusions and perspectives**

This chapter reports the main conclusions of this thesis and proposes future work related to the modeling of spray drift in a wind tunnel. The initial objective of this work was to define macroscopic spray drift descriptors from drift curves obtained in IRSTEA wind tunnel. The study of such descriptors gave the opportunity to evaluate drift behavior in a tunnel with a large set of variables and to find innovative ways enabling to decrease the number of necessary experiments to evaluate nozzle drift behavior.

### **Main results**

The first novelty of this work lies on the use of a long duration exposure protocol using a distribution test bench compared to traditional wind tunnels methods, based on short sprays. Such protocol enables to increase significantly test repeatability and to define macroscopic drift indicators with a good reliability.

Five macroscopic indicators were identified: drift ratio at 5m, weighted distance method, recovery rate, deposition peak value and deposition peak position. They were tested on 99 combinations of type and number of nozzles, boom height, boom position and wind velocity. Drift ratio and recovery rate were shown to be the most interesting values because they are usable for any orientation of the boom (frontal or lateral) and they take into account both quantitative (deposition value) and qualitative information (spatial distribution). Finally drift ratio at 5m ( $DR_5$ ) was selected as the macroscopic indicator for drift behavior in the tunnel. The robustness of this indicator was used to analyze spray drift in the wind tunnel, for each nozzle type, varying wind speed, boom position toward the wind direction and the number of nozzles mounted on the boom. One of the main results of this work was that the position of the boom relatively to the air flow has a great influence on spray drift ratio. The wind speed has a visible effect on spray drift for both frontal and lateral position especially in the peak amplitude and the shift in the peak position. But statistically, in the frontal position no significant difference was observed on the spray drift ratio measured with 1, 2 and 4 nozzles

mounted on the boom. On the other hand, in the lateral boom position the results showed that the patterns of the first or the second nozzle mounted on the boom near to the wind are highly modified by the wind comparing to other sprays behind that are more protected. Then, in the lateral position increasing the number of nozzles lead to reduce the spray drift ratio. It appeared that the frontal position generally gave the highest drift values and the lateral position the lowest drift values. Application of this is that forward speed has more importance on drift than lateral wind during spraying. Both drift tests and regulations should take this point into account.

Results observed in the wind tunnel showed that it was possible to predict wind velocity effect through the concept of Time of Flight (ToF). ToF was obtained by dividing the distance (in wind direction) by wind velocity. When expressing drift ratio curves with this variable (instead of the distance), the curves corresponding to varying wind velocities (all other variable remaining the same) have a good superposition. In a same way it was possible to describe the effect of boom height with a simple homothetic transformation of the curves. These results showed that droplets behave as if they were alone in a constant velocity field and that no other factor than wind velocity modify their trajectory. Few comparisons with a spray drift model based on trajectory computation (Driftsim) demonstrated the relevance of such result. This concept was never used until now for experimental purposes: the expression of the drift curves according to the ToF allows the comparison of experimental conditions that were not comparable before. It makes possible to simulate several settings from only one initial condition with an acceptable accuracy.

Finally the relationship between the time of flight and the median volumetric droplet size (*DV50*) for a given nozzle type was investigated. For this the *DV50* was measured in situ at several distances and with several wind velocities. As a result, a good correspondence was found between the *DV50* and the ToF in frontal and lateral position of the boom: the *DV50* of a droplet population acts more or less as a single droplet of equivalent diameter. However, significant differences appeared between flat fan nozzles and air induction nozzles in the ToF representation: the method is not applicable for air injection nozzles for the moment

Globally, the method used in this study induced a new approach for assessing spray drift in measurements carried out in a wind tunnel through repeatable measurements based on a long duration exposure protocol. One of the most important interest of this method is its great

potential for the evaluation of spray drift at different setting conditions as nozzle type, wind speed, boom position, boom angle or boom height, from a reduce number of tests. Coupling this method with the Time-of-Flight concept provides a good way to evaluate the drift potential of a nozzle – or a series of nozzles – in a large set of conditions with an optimal number of tests.

## Perspectives

This preliminary work would lead to several follow-ups in terms of experimental research, modeling and practical applications. Perspectives can be drawn to i) better understand drift behavior in the wind tunnel, ii) apply the method for field measurements and iii) coupling with modelling approaches.

The behaviour in the wind tunnel relies first on the air velocity field in the tunnel. Some air velocity measurements were made upon transversal sections, showing that the measurement area could be considered as homogeneous, but this work has to be done for all the velocities used during measurements. In the transversal sections, homogeneity of the wind speed profile in wind tunnel should be checked at different wind speed from  $0 \text{ m s}^{-1}$  to  $12 \text{ m s}^{-1}$  at different distances from the boom position. The homogeneity of the longitudinal air profile has also to be check as sedimentation flowrate figures observed with laser facilities could be due to artificial turbulent frequencies. The influence of the patternator, at the bottom of the tunnel, should be also checked by comparing the longitudinal wind profile with a smooth bottom surface.

The relation of DV50 with ToF for air injection nozzles is based on fewer points and have significantly different slopes than for flat fan nozzles. Some hypotheses were formulated: worse droplet sampling due to fewer droplets, measurement difficulties, significant difference in droplet liquid density, difference in droplet ejection velocities. These hypotheses must be deeply investigated to conclude and validate the relation for such nozzles.

The atomization process, converting any liquid into spray droplets, is dependent on several factors such as working pressure. Several studies investigated the effects of liquid spray pressure on droplets. These studies showed that the range of droplet sizes tended to narrow



and that relatively smaller droplets were formed with higher operating pressure thereby increasing the amount of spray prone to drift especially with undesirable weather conditions at the time of applications. In the present study, operating pressure was not considered as a priority, considering the already large number of variables. To be exhaustive, this variable should be investigated too so as to find a way to get a superposition of curves: it is expected than homothetic transformations with the square root of pressure ratio would ensure this result.

The potential extension of the experimental domain to larger boom heights-wind velocities—operating pressures is to be validated. For example, the simulation of boom heights of 0.30m or 1.2m shall be verified in link with wind field velocity homogeneity controls in the tunnel. From a global perspective these results provide stand points on the harmonization of potential spray drift in the wind tunnel (revision of the ISO22856), in particular for comparison with long and short exposure protocols.

Additional factors affecting spray drift are the physico-chemical properties of spray liquid (surface tension, viscosity, evaporation rate and density): controlling their effect is an excellent way to minimize spray drift and spray additives are commercially available to increase spray droplet size. Both tunnel and field experiments report that drift control additives can reduce downwind drift deposits. Nevertheless, many of these products are very rate sensitive. Increased rates may further reduce spray drift, but can also cause nozzle distribution patterns to become non-uniform. The relationship between physicochemical properties of liquid and the atomization characteristics of liquids are far from simple and could not be predicted from simple measurements of surface tension or viscosity. Few studies have been done on the influence of physicochemical parameters on spray drift. Most researchers who have examined the drift-reducing effects of adjuvants have used solutions of adjuvant in water, even though it is accepted that not the physico-chemical properties of the adjuvant itself but the physico-chemical characteristics of the complete spray mixture (pesticide formulation and adjuvant) are drift determining. A large field of studies must be investigated to understand the effects of the physico-chemical properties of pesticide complexes but the use of pesticides in wind tunnels involve safety precautions that are not easy to ensure and in most cases, are not feasible.

Another perspective of this work is to take advantage of the opportunity suggested by the use of Time-of-Flight (ToF) representation, to decrease the number of necessary tests in field conditions. The difficulty arises from the variability of atmospheric stability, wind velocity and wind direction in natural conditions. The first step could be to check the superposition of drift ratio curves (expressed relatively to ToF) with uniform wind and atmospheric stable conditions, e.g. at the night and in the predawn hours. Then, it could be interesting to compare the results with more variable conditions and evaluate at which point this variability is allowable to predict drift potential. Influence of soil cover must be investigated also.

Finally, modelling spray drift is an important issue because models are used to analyse the abilities of some practices or techniques to decrease spray exposure of water courses, bystanders, or sensible crops. A large number of models have been developed in order to predict downwind spray movement from droplet size as potential spray drift. Nevertheless most of them are not validated in field conditions or only for very specific conditions. Relationships shown in this work could be investigated in a modelling perspective. This approach might be particularly appropriate once relationships will be adapted to field.

## Bibliography

- Al Heidary, M., Douzals, J. P., Sinfort, C., Vallet, A. 2014. Influence of spray characteristics on potential spray drift of field crop sprayers: A literature review. *Crop Protection*, 63, 120–130.
- Alves, G.S., Rodrigues da Cunha, J.P.A., 2014. Field data and prediction models of pesticide spray drift on coffee crop. *Pesq. Agropec. Bras.*, Brasília, 49(8), 622-629
- Arvidsson, T., Bergström, L., Kreuger, J., 2011. Comparison of collectors of airborne spray drift. Experiments in a wind tunnel and field measurements. *Pest management science*, 67(6), 725–33.
- Balsari, P., Marucco, P., Tamagnone, M., 2005. A system to assess the mass balance of spray applied to tree crops. *Trans. of the ASAE* 48, 1689-1694.
- Barber, J., Greer, M., Hewitt, A., 2004. A field measurement device for the aerosols used in mosquito control. An ASAE Meeting Presentation, Paper AA04-0010.
- Briand, O., Bartrand, F., Seux, R., Millet, M., 2002a. Comparison of different sampling techniques for the evaluation of pesticide spray drift in apple orchards. *The science of the Total Environment* 288. 199-213.
- Bui, Q. D., Womac, A. R., Howard, K. D., Mulrooney, J. E., Amin, M.D., 1998. Evaluation of samplers for spray drift. *Trans. of the ASAE* 41(1): 37-41.
- Butler Ellis, M. C., Bradley, A., 2002. The influence of formulation on spray drift. *Aspects of Applied Biology*, 66, 251–258.
- Carlsen, S. C. K., Spliid, N. H., Scensmark, B., 2006. Drift of 10 herbicides after tractor spray application: 2. Primary drift (droplet drift). *Chemosphere* 64(5): 778-786.
- Cooper, J.F., Smith, D.N., Dobson, H.M., 1996. An evaluation of two field samplers for monitoring spray drift. *Crop Protection*, 15(3), 249-257.
- Cotteux, E., Rombaut, M., Douzals, J.P., 2013. Comparison of vertical and horizontal collecting methods for spray deposits in crop canopy and airborne spray drift assessment. 12<sup>th</sup> Workshop on Spray application Techniques in Fruit Growing. 26-28 June, Valencia, Spain.
- De Jong, A; Michielsen, J. M. G .P; Stallinga, H.; Van De Zande, J. C., 2000. Effect of Sprayer Boom Height on Spray Drift. *52nd International Symposium on Crop Protection Pts I and II Proceedings*, 65, 919–930.
- De Schampheleire, M., Baetens, K., Nuyttens, D., Spanoghe, P., 2008. Spray drift measurements to evaluate the Belgian drift mitigation measures in field crops. *Crop Protection*. 27, 577-589.

- Donkersley, P., Nuyttens, D., 2011. A meta analysis of spray drift sampling. *Crop Protection*, 30, 931-936.
- Dorr, G.J., 2009. Minimising environmental and public health risk of pesticide application through understanding the droplet-canopy interface. PhD thesis, University of Queensland, Australia.
- Douzals, J.P., 2012. Asymmetric classification of drift reducing nozzles considering frontal or lateral wind conditions. Proceedings of AgEng meeting 2012 Valencia, Spain. DOI: 10.13140/RG.2.1.3343.2804
- Douzals, P.J., AlHeidary, M., 2014. How spray characteristics and orientation may influence spray drift in a wind tunnel. *Aspect of Applied Biology* 122, 271-278.
- EC/128, 2009, European Directive on the sustainable use of pesticide. Official Journal, L 309, 24.11.2009, 71–86.
- EPA. Types of Pesticides. <http://www.epa.nsw.gov.au>
- Eurostat, 2013. [http://ec.europa.eu/eurostat/statistics-explained/index.php/Agri-environmental\\_indicator\\_consumption\\_of\\_pesticides](http://ec.europa.eu/eurostat/statistics-explained/index.php/Agri-environmental_indicator_consumption_of_pesticides)
- FAO, 2012. [www.fao.org](http://www.fao.org)
- Farooq, M., Hoffmann, W.C., Walker, T.W., Smith, V.L., Robinson, C.A., Dunford, J.C., Sutherland, I.W., 2009. Samplers for avaluation and quantification of ultra-low volume space sprays. *Journal of the American Mosquito Control Association*, 25(4), 521-524.
- Ferreira, M.C., Miller, P.C.H., Tuck, C.R., O’Sullivan, C.M., 2010. Comparison of sampling arrangements to determine airborne spray profiles in wind tunnel conditions. *Aspects of Applied Biology*, 291-296.
- Fritz, B.K., Hoffmann, W.C., 2008. Collection efficiencies of various airborne spray flux samplers used in aerial application research. *Journal of ASTM international* 5(1), Paper ID JAI 101493.
- Fritz, B. K., Hoffmann, W. C., Bagley, W.E., Hewitt, A., 2011. Field scale evaluation of spray drift reduction technologies from ground and aerial application systems. *Journal of ASTM International*, 8(5), paper ID JAI103457.
- Fritz, B.K., Hoffmann, W.C., Parker, C., Lopez, J., 2009. Development and testing of a laboratory spray table methodology to bioassay simulated levels of aerial spray drift. *J. ASTM International*. 6(6), Paper ID JAI102125.
- Fritz, B. K., Kirk, I. W., Hoffmann, W. C., Martin, D. E., Hofman, Hollingsworth, V. L., McMullen, C. M., Halley, S., 2006. Aerial application methods for increasing spray deposition on wheat heads. *Applied Engineering in Agriculture*, 22(3): 357-364.

- Foqué, D., Nuyttens, D., 2011. effect of nozzle type and spray angle on spray deposition in ivy pot plants. *Pest Manag. Sci.* 67, 199-208.
- Fox, R.D., Derksen, R.C., Zhu, H., Downer, R.A., Brazee, R.D., 2004. Airborne spray collection efficiency of nylon screen. *Applied Engineering in Agriculture* 20, 147–152.
- Fox, R. D., Derksen, R.C., Zhu, H., Brazee, R.D., Svensson, S.A., 2008. A history of air-blast sprayer development and future prospects. *Tran. of the ASABE* 51(2): 405-410.
- Gil, E., Balsari, P., Gallart, M., Llorens, J., Marucco, P., Andersen, P. G., Llop, J., 2014. Determination of drift potential of different flat fan nozzles on a boom sprayer using a test bench. *Crop Protection*, 56, 58–68.
- Gil, Y., Sinfort, C. 2005. Emission of pesticides to the air during sprayer application: A bibliographic review. *Atmospheric Environment*, 39(28), 5183–5193.
- Gilbert, A. J., 2000. Local Environmental Risk Assessment for Pesticides (LERAP) in the UK. *Aspects of Applied Biology* 57. *Pestic. Appl.* 83-90.
- Gregorio, E., Rosell-Polo, J.R., Sanz, R., Rocadenbosch, F., Solanelles, F., Garcerà, C., Chueca, P., Arno, J., Moral, I., Masip, J., Camp, F., Viana, R., Escolà, A., Gràcia, F., Planas, S., Molto, E., 2014. Lidar as an alternative to passive collectors to measure pesticide spray drift. *Atmospheric Environment* 82, 83-93.
- Helck, C., Herbst, A., 1998. Drift potential index-a new parameter for the evaluation of pesticide application nozzles regarding their drift potential. *Nachrichtenblatt des Deutschen Pflanzenschutzdienstes* 50, 225–232.
- Herbst, A., Ganzelmeier, H., 2000. Classification of sprayers according to drift risk – a German approach. *Aspects of Applied Biology*, 57, 35-40.
- Hilz, E., Vermeer, A.W.P., 2013. Spray drift review: the extent to which a formulation can contribute to spray drift reduction. *Crop Protection*, 44, 75-83.
- Hoffmann, W.C., Fritz, B.K., Thornburg, J.W., Bagley, W.E., Birchfield, N.B., Ellenberger, J., 2010. Spray drift reduction evaluations of spray nozzles using a standardized testing protocol. *Journal of ASTM International*. 7(6):JAI102820.
- Hoffmann, W. C., Hewitt, A. J., Barber, J. A. S., Kirk, I. W., Brown, J. R., 2003. Field swath and drift analyses techniques. *ASAE Paper No. AA032007*. St. Joseph, Mich.: ASAE.
- Holterman, H. J., Van De Zande, J. C., Porskamph, A. J., Huijsmans, J. F. M. 1997. Modeling spray drift from boom sprayers. *Computers and Electronics in Agriculture* 19(1), 1–22.

- Holterman, H.J., Van de Zande, J.C., Porskamp, H.A.J., Michielsen, J.M.G.P., 1998. IDEFICS: a physical model of spray drift from boom sprayers in agriculture. In: ILASS-Europe 98.
- ISO 22866:2005. Equipment for crop protection-Methods for the field measurement of spray drift 17p.
- ISO 22369-1, 2006. Crop protection equipment drift classification of spraying equipment Part 1: Classes. Switzerland.
- ISO 22856, 2008. Equipment for crop protection-Laboratory measurement of spray drift-part 1: wind tunnel, 14p.
- ISO 22369-2, 2010. Crop protection equipment - Drift classification of spraying equipment - Part 2: Classification of field crop sprayers by field measurements.
- ISO 16119-2. Agricultural and forestry machinery-environmental requirements for sprayers-part 2: horizontal boom sprayers; 2013c.
- Kasiotis, K.M., Glass, C.R., Tsakirakis, A.N., Machera, K., 2014. Spray drift reduction under southern European conditions: A pilot study in the Ecopest project in Greece. *Science of the Total Environment* 479-480, 132-137.
- Kim, K.Y., Marshall, W.R., 1971. Drop-size distributions from pneumatic atomizers. *AIChE J.*, 17, 575-584.
- Knowles, A., 2001. Adjuvants for agrochemicals. *Pesticide Outlook* 12, 183-184.
- Korbara, Y., Ishii, Y., Ishihara, S., Inao, K., 1999. Reducing MeBr emission with a sheet containing titanium dioxide, methyl bromide alternative newsletter, United state Department of Agriculture .(<http://ars.usda.gov/is/np/mba/july99/dioxide.htm>).
- Kruger, G.R., Klein, R.N., Ogg, C.L., 2013. Spray drift of pesticides. University of Nebraska-Lincoln Extension, Institute of Agriculture and Natural Resources. USA.
- Langenakens, J. J., Clijmans, L., Ramon, H., De Baerdemaeker, J., 1999. The Effects of Vertical Sprayer Boom Movements on the Uniformity of Spray Distribution. *J. agric. Eng. Res.* 74, 281-291.
- LERAP, 2001. Horizontal boom sprayers: a step-by-step guide to reducing aquatic buffer zones in the arable sector (DEFRA, PSD) ,9p [http://www.pesticides.gov.uk/uploadedfiles/Web\\_Assets/PSD/LERAP\\_Horizontal\\_boom\\_sprayers\(1\).pdf](http://www.pesticides.gov.uk/uploadedfiles/Web_Assets/PSD/LERAP_Horizontal_boom_sprayers(1).pdf).
- Liet O. and Polveche, 2009. Etude pour l'optimisation de l'usage des pesticides et des fertilisants, etude DGAL 07.F4.01 – Ministère de l'Agriculture, de l'Alimentation et de la Forêt, 152p.

- Llorens, J., Gil, E., duarte, S., Liop, J., 2012. First results using terrestrial lidar sensor for drift detection in vineyard spraying. Proceedings of AgEng meeting 2012 Valencia, Spain. p. C-1391.
- Mahalinga Iyer, I., Wills, B.M.D., 1978. Factors determining the design of tractor-mounted sprayer booms-sprayer nozzle characteristics. *Journal of Agricultural Engineering Research*, 23(1), 37–43.
- Manzone, M., Balsari, P., Marucco, P., Tamagnone, M., 2015. Potential external contamination of pneumatic seed drills during sowing of dressed maize seeds. *Pest Manag. Sci.* [wileyonlinelibrary.com/journal/ps](http://wileyonlinelibrary.com/journal/ps).
- Matthews, G.A. 2000. *Pesticide application methods*. Blackwell Science Ltd, Oxford, pp.432.
- Matthews, G., 2006. *Pesticide: Health, Safety and the Environment*. Wiley-Blackwell. ISBN: 978-1-4051-3091-2, p 130.
- Miller, P.C.H., 2003. The measurement of spray drift. *Pesticide. Outlook* 14, 205-209.
- Miller, P.C.H., Butler Ellis, M.C., 2000. Effects of formulation on spray nozzle performance for applications from ground-based boom sprayers. *Crop Protection* 19, 609–615.
- Miller, P.C.H., Butler Ellis, M.C., Lane, A.G., O’Sullivan, C.M., Tuck, C.R., 2011. Methods for minimizing drift and off-target exposure from boom sprayer applications. *Aspect of Applied Biology* 106, 281-288.
- Miller, P.C.H., Hislop, E.C., Parkin, C.S., Matthews, G.A., Gilbert, A.J., 1993. The classification of spray generator performance based on wind tunnel assessments of spray drift. *Proceedings of the International Symposium on Pesticide Application*. Strasbourg, 1, 109-116.
- Miller, P. C. H., Smith, R. W., Tuck, C. R., Walklate, P. J., 1995b. The classification of agricultural spray based on droplet size distributions and the results from wind tunnel tests. *Proceedings Brighton Crop Protection Conference*.
- Minov, J., Karadzinska- Bislimovska, J., Vasilevska, K., Risteska-Kuc, S., Stoleski, S., Mijakoski, D., 2015. Distribution of sensitizer-induced occupational asthma in R. Macedonia in the period 2005-2014 by occupattion. *Glob J. Allergy* 1(1), 19-23.
- Nuyttens, D., De Schampheleire, M., Brusselman, E., Dekeyser, D., Verboven, P., 2011. Drift from Field Crop Sprayers using an Integrated Approach: Results of a 5 Year Study. *Trans. of the ASABE*. 54(2), 403-408.
- Nuyttens, D., Baetens, K., De Schampheleire, M., Sonck, B. 2007a. Effect of nozzle type, size and pressure on spray droplet characteristics. *Biosys. Eng.* 97(3), 333-345.
- Nuyttens, D., De Schampheleire, M., Baetens, K., Sonck, B., 2007. The influence of operator controlled variables on spray drift from field crop sprayers. *Trans. of the ASABE American Society of Agricultural and Biological Engineers* 50(4) , 1129-1140.

- Nuyttens, D., De Schampheleire, M., Steurbaut, W., Baetens, K., Verboven, P., Nicolai, B., Ramon, H., Sonck, B., 2006. Characterization of agricultural sprays using laser techniques. *Aspects of Applied Biology* 77, 1–8.
- Nuyttens, D, Taylor, W. A., De Schampheleire, M., Verboven, P., Dekeyser, D., 2009. Influence of nozzle type and size on drift potential by means of different wind tunnel evaluation methods. *Biosyst. Eng.* 103(3), 271–280.
- Nuyttens, D., De Schampheleire, M., Verboven, P., Sonck, B., 2010. Comparison between indirect and direct spray drift assessment methods. *Biosystems Engineering*. 105(1), 2–12.
- Pimentel, D., Burgess, M. 2012. Small amounts of pesticides reaching target insects. *Environment Development and Sustainability Journal*, 14, 1-2.
- Prokop, M., Veverka, K., 2006. Influence of droplet spectra on the efficiency of contact fungicides and mixture of contact and systemic fungicides. *Plant Protect. Sci.*, 42, 26–33.
- Rautmann, D., Streloke, M., Winkler, R. 2001. New basic drift values in the authorization procedure for plant protection products. *Mitteilungen aus der Biologische Bundesanstalt für Land- und Forstwirtschaft*. No. 383. Berlin.
- Reichard, D. L., Zhu, H., Fox, R. D., Brazee, R. D., 1992. Computer Simulation of Variables that Influence Spray Drift. *Trans. Of the ASAE*, 35: 1401-1407.
- Rimmer, D. A., Johnson, P. D., Kelsey, A., Warren, N. D., 2009. Field experiments to assess approaches for spray drift incident investigation. *Pest Manag. Sci.* 65(6): 665-671.
- Ross, M.A., Lembi, C.A., 1985. *Applied weed science*. Burgess Publishing Company, Minneapolis, Minn.
- Sinfort, C., Bonicelli, B., 2010. Mesure et modélisation de la dispersion des pesticides dans l'air au voisinage des parcelles agricoles. *Bulletin de veille scientifique n° 14. Santé/Environnement*. P.18-21.
- Salyani, M., Farooq, M., 2004. Drift potential of citrus air-carrier sprayers. *Proc. Fla. State Hort. Soc.* 117, 130-135.
- Salyani, M., Sweeb, R.D., Farooq, M., 2006. Comparison of string and ribbon samplers in orchard spray applications. *Transactions of the ASABE* 49, 1705-1710.
- Stainier, C., Destain, M.F., Schiffers, B., Lebeau, F., 2006. Droplet size spectra and drift effect of two phenmedipham formulations and four adjuvants mixtures. *Crop Protection*. 25 (12), 1238-1243.
- Taylor, B.P., 2002. Defining the swath edge: some further considerations towards the establishment of a robust wind tunnel-based drift predictive protocol. *Aspects of Applied Biology* 66, 209-216.



- Taylor, W. A., Womac, A.R., Miller, P.C.H., Taylor, B. P., 2004. An attempt to relate drop size to drift risk. International Conference on Pesticide Application for Drift Management Octobre 27-29, 210–223.
- Teske, M. E., Thistle, H. W., 1999. A simulation of release height and wind speed effects for drift minimization. Trans. of the ASAE 42(3): 583-591.
- Thornhill, E.W., Matthews, G.A., 1995. Pesticide application equipment for use in agriculture. Vol.2. Mechanically Powered Equipment.
- Van De Zande, J.C., Butler Ellis, M.C., Wenneker, M., Walklate, P.J., Kennedy, M., 2014. Spray drift and bystander risk from fruit crop spraying. Aspects of Applied Biology 122, 177-185.
- Van De Zande, J. C., Huijsmans, J. F. M., Porskamp, H. A. J., Michielsen, J.M.G.P., Stallinga, H., Holterman, H. J., De Jong, A., 2008. Spray techniques: How to optimise spray deposition and minimise spray drift. Environmentalist 28(1): 9–17.
- Walkalate, P.J., Miller, P.C.H., Gilbert, A.J., 2000. Drift classification of boom sprayers based on single nozzle measurements in a wind tunnel. Aspects of Applied Biology 57, 49-56.
- Wenneker, M., Van de Zande, J.C., Stallinga, H., Michielsen, J.M.P.G., Van Velde, P., Nieuwenhuizen, A.T., 2014. Emission reduction in orchards by improved spray deposition and increased spray drift reduction of multiple row sprayers. Aspects of Applied Biology 122, 195-202.
- Wolters, A.; Linnemann, V., Van de Zande, J.C., Vereecken, H., 2008. Field experiment on spray drift : Deposition and airborne drift during application to a wheat crop. Science of the Total Environment 405: 269-277.
- Yogo, Y., 2009. Approaches to the Problem on Pesticide Residues in Crops and Soils in Japan. Food and Fertilizer Technology Center, 3-1-3, Kannondai, Tsukuba, Ibaraki, 305-8608, Japan.
- Zhao, H., Xie, C., Liu, F., He, X., Zhang, J., Song, J., 2014. Effect of sprayers and nozzles on spray drift and terminal residues of imidacloprid on wheat. Crop Protection 60, 78-82.

## Appendix

### Publications

**Al Heidary, M.**, Douzals, J. P., Sinfort, C., Vallet, A. 2014. Influence of spray characteristics on potential spray drift of field crop sprayers: A literature review. *Crop Protection*, 63, 120–130.

Douzals, P.J., **Al Heidary, M.**, 2014. How spray characteristics and orientation may influence spray drift in a wind tunnel. *Aspect of Applied Biology* 122, 271-278.

**Al Heidary, M.**, Douzals, J. P., Sinfort, C., Vallet, A. 2015. Sedimentation spray drift assessment in a wind tunnel. Part 1: Comparison of Analytical Methods and the definition of drift indicators. *submitted to Crop Protection*.

**Al Heidary, M.**, Douzals, J. P., Sinfort, C., Vallet, A. 2015. Sedimentation spray drift assessment in a wind tunnel. Part 2: Development of a kinematic approach based on droplets Time-of-Flight. *submitted to Crop Protection*.

**Al Heidary, M.**, Douzals, J. P., Sinfort, C., Vallet, A. 2015. Sedimentation Spray Drift Assessment in a Wind Tunnel. Part 3: Validation of Time-of-flight model with *in situ* Droplet Size measurements. *submitted to Crop Protection*.

Douzals, J.P., **Alheidary, M.**, Sinfort, C., 2015 Spray deposition in a wind tunnel: a kinetic approach of wind speed effects. *Aspects of Applied Biology*, *to be published*.

### Oral communications

**Al Heidary, M.**, 2013. Identification of nozzles macroscopic descriptors for spray drift modeling. Séminaire la journée de l'UMR-ITAP-IRSTEA. 19 Juin, 2013. Montpellier. France.

Douzals, JP; **Al Heidary, M.**, 2014. How Spray Characteristics and orientation may influence spray drift in a wind tunnel. International Advances in pesticide application 2014, Oxford: Aspects of Applied Biology, 122, 271-278.

**Al Heidary, M.**, 2014. Identification of nozzles macroscopic descriptors for spray drift modeling. Séminaire la journée de l'UMR-ITAP-IRSTEA. 20 Juin, 2013. Montpellier. France.

**Al Heidary, M.**, Douzals, JP.; Sinfort, C.; Vallet, A., 2014. Influence of nozzle type, nozzle arrangement and side wind speed on spray drift as measured in a wind tunnel. Proceedings of AgENg 2012 Zurich, Switzerland.

**Al Heidary, M.**, Douzals, J.P., Vallet, A., Sinfort, C., 2014. Evaluation of spray drift in frontal and lateral position in a wind tunnel by using different nozzle types, wind speeds and

boom orientation. International Workshop of Plant Protection Machinery and Application Techniques 20-21 September.

Douzals, J.P., **Al Heidary, M.**, Bakache, A., Kempf, J., Rocha, M., 2014. Measurement of potential drift by using a test bench in a wind tunnel. ISO TC 23 SC 6 WG, workshop Montpellier 16 March, 2014.

**Al Heidary, M.**, 2015. Identification of nozzles macroscopic descriptors for spray drift modeling. Séminaire sur l'écriture des publications scientifiques. 16-17 March 2014. Chaudes Aigues. France.

**Al Heidary, M.**, 2015. Identification of nozzles macroscopic descriptors for spray drift modeling. Séminaire du TR INSPIRE. 15-16 Juin 2015. IRSTEA- Clermont-Ferrand. France.

**Al Heidary, M.**, 2015. Identification of nozzles macroscopic descriptors for spray drift modeling. Séminaire la journée de l'UMR-ITAP-IRSTEA. 29 Juin, 2013. Montpellier. France.

## Posters

**Al Heidary, M.**, 2014. Identification of nozzles macroscopic descriptors for spray drift modeling. Séminaire la journée de l'ED. 24 Juin 2014. SupAgro-Montpellier. France.

**Al Heidary, M.**, Douzals, J.P., Vallet, A., Sinfort, C., 2014. Evaluation of spray drift in frontal and lateral position in a wind tunnel by using different nozzle types, wind speeds and boom orientation. CIGR E-Journal - abstract 0618-096; 2014, Beijing, CHN, 10 p.

**Al Heidary, M.**, 2014. Identification of nozzles macroscopic descriptors for spray drift modeling. Séminaire du TR INSPIRE. 19-20 May 2014. Lyon. France.

## Abstract

Spray drift might be measured either infield or in a wind tunnel through specific sampling strategies. Paradoxically field tests are subjected to a high variability due to the atmospheric conditions but can be more easily conducted in the absence of a wind tunnel. The result is that most of spray drift models are based on infield measurements. Conversely very few models were developed on the basis of wind tunnel measurements. The objective of this work was to define spray drift descriptors from the analysis of drift curves in IRSTEA wind tunnel. Compared to the majority of existing wind tunnels, a long duration exposure protocol was applied with a high sampling density. A large experimental plan of 99 modalities were conducted including nozzle types (FF, AI, AI Twin jet), boom heights from 40 to 80cm, boom positions (frontal, lateral, and intermediate angles) and wind velocities from 2 to 7.5ms<sup>-1</sup>. Results showed that the drift ratio at 5m (DR<sub>5</sub>) was the most robust drift indicator considering the wide range of parameters and operations conditions (wind velocity, boom height). First order models were drawn for the expression of the effect of the wind velocity and the boom height according to the droplet time of flight (ToF). As a result it was possible to compare data from different experimental conditions and to simulate the effect of the wind velocity and the boom height for a given type of nozzle. *In situ* droplet size measurements confirmed the relevance of the time of flight expression.

Key words: Spray drift, nozzles, wind tunnel, time of flight

## Résumé

La dérive de pulvérisation peut être mesurée au champ ou en soufflerie. Paradoxalement, les tests au champ sont sujets à de grandes variations dues aux conditions atmosphériques mais peuvent être plus facilement réalisés contrairement aux tests en soufflerie. Ainsi les principaux modèles de dérive sont basés sur des mesures au champ alors que peu de modèles s'inspirent de mesures en soufflerie. L'objectif de ce travail a été de définir un ou des descripteurs de la dérive sur la base de l'analyse de courbes de dépôts obtenues dans la soufflerie d'IRSTEA Montpellier. Par rapport aux souffleries existantes, un protocole d'exposition de longue durée a été utilisé avec une forte densité d'échantillonnage. Un plan expérimental comprenant 99 modalités a été réalisé en prenant compte 3 différents types de buses (FF, AI, AI Twin jet), 3 différentes hauteurs de rampe de 40 à 80cm, différentes positions de rampe (frontale, latérale et angles intermédiaires) et 3 différentes vitesses de vent entre 2 et 7.5m s<sup>-1</sup>. Les résultats ont montré que le taux de dérive à 5m sous le vent (DR<sub>5</sub>) correspond au descripteur le plus robuste si l'on tient compte du large spectre de paramètres et de réglages. Des modèles de premier ordre ont été définis pour l'expression de l'effet de la vitesse du vent ainsi que de la hauteur de rampe selon le temps de vol des gouttes (ToF). Ainsi il est possible de comparer des résultats issus de conditions expérimentales différentes et de simuler l'effet de la vitesse du vent et la hauteur de la rampe pour un type donné de buse. Des mesures *in situ* de taille de gouttes ont confirmé la pertinence du temps de vol comme base de l'expression des résultats.

Mots clés : Dérive de pulvérisation, buses, soufflerie, temps de vol