



HAL
open science

Vowel length in Egyptian Arabic: a different view

Radwa Fathi

► **To cite this version:**

Radwa Fathi. Vowel length in Egyptian Arabic: a different view. Linguistics. Université Paris 7 - Denis Diderot, 2013. English. NNT: . tel-01587465

HAL Id: tel-01587465

<https://theses.hal.science/tel-01587465v1>

Submitted on 14 Sep 2017

HAL is a multi-disciplinary open access archive for the deposit and dissemination of scientific research documents, whether they are published or not. The documents may come from teaching and research institutions in France or abroad, or from public or private research centers.

L'archive ouverte pluridisciplinaire **HAL**, est destinée au dépôt et à la diffusion de documents scientifiques de niveau recherche, publiés ou non, émanant des établissements d'enseignement et de recherche français ou étrangers, des laboratoires publics ou privés.

Université Paris Diderot (Paris 7)
École Doctorale : Sciences du Langage
UFR Linguistique

N° attribué par la bibliothèque

| | | | | | | | | | |
|--|--|--|--|--|--|--|--|--|--|
| | | | | | | | | | |
|--|--|--|--|--|--|--|--|--|--|

Thèse de Doctorat
Discipline : Linguistique Théorique

Radwa Fathi

**La longueur vocalique en arabe égyptien: une nouvelle
conception**

Vowel length in Egyptian Arabic: a different view

Thèse dirigée par : Jean Lowenstamm

Soutenue le 6 Septembre 2013

Composition du jury :

Sabrina Bendjaballah, CNRS – LLF
Monik Charette, SOAS, University of London (pré-rapporteur)
Mohand Guerssel, Université du Québec à Montréal (pré-rapporteur)
Jean Lowenstamm, Université Paris Diderot (Paris 7)
Shohei Yoshida, Yokohama National University (pré-rapporteur)

Table of Contents

| | |
|--|-------------|
| List of Tables | vii |
| List of Charts | xi |
| Abbreviations | xii |
| Acknowledgments | xiii |
| Introduction | 1 |
| 0.1 Purpose of the study | 1 |
| 0.2 Research design | 4 |
| | |
| Chapter 1 | |
| The Formal Representation of Cardinal Vowels in Egyptian Arabic | 6 |
| 1.1 Introduction..... | 6 |
| 1.2 Outlines of the vowel system | 8 |
| 1.2.1 The surface vowel inventory: Quality and Quantity | 8 |
| 1.2.2 Vowel distribution | 9 |
| 1.2.3 The underlying vowel phonemes..... | 12 |
| 1.3 Problem statement..... | 14 |
| 1.3.1 Abnormal long vowel distribution..... | 14 |
| 1.3.2 The limitation of vowel length contrasts to specific positions | 15 |
| 1.3.3 The limitation of vowel length contrasts to specific qualities | 16 |
| 1.4 How distinctive is vowel length in Egyptian Arabic? | 17 |
| 1.5 Reinterpreting vowel length in Egyptian Arabic..... | 22 |
| 1.5.1 The vocalization device of Classical Arabic and Moroccan Arabic..... | 22 |
| 1.5.2 The vocalization device of Egyptian Arabic | 28 |
| 1.5.3 What final vowels can reveal | 34 |
| 1.5.4 When allomorphy gets involved: the “singular feminine nominal marker” | 38 |

| | |
|-----------------------------|----|
| 1.7 Concluding remarks..... | 42 |
|-----------------------------|----|

Chapter 2

| | |
|--|-----------|
| The Formal Representation of Mid-vowels in Egyptian Arabic..... | 45 |
|--|-----------|

| | |
|-----------------------|----|
| 2.1 Introduction..... | 45 |
|-----------------------|----|

| | |
|--|----|
| 2.2 Considering the “loss of brevity thesis” | 46 |
|--|----|

| | |
|--------------------------------|----|
| 2.2.1 In Moroccan Arabic | 46 |
|--------------------------------|----|

| | |
|-------------------------------|----|
| 2.2.2 In Egyptian Arabic..... | 47 |
|-------------------------------|----|

| | |
|------------------------------------|----|
| 2.3 Statement of the problem | 49 |
|------------------------------------|----|

| | |
|--|----|
| 2.4 The organization of the vowel system of Egyptian Arabic..... | 52 |
|--|----|

| | |
|---------------------------|----|
| 2.4.1 The parameters..... | 52 |
|---------------------------|----|

| | |
|--------------------------------------|----|
| 2.4.2 Interpreting empty nuclei..... | 57 |
|--------------------------------------|----|

| | |
|---------------------|----|
| 2.5 Mid-vowels..... | 69 |
|---------------------|----|

| | |
|---|----|
| 2.5.1 Missing short mid-vowel phonemes..... | 69 |
|---|----|

| | |
|---|----|
| 2.5.2 Previous accounts of long mid-vowels in Egyptian Arabic | 72 |
|---|----|

| | |
|---|----|
| 2.5.3 Reanalyzing long mid-vowels | 74 |
|---|----|

| | |
|------------------------------------|----|
| 2.5.4 Glide-medial segholates..... | 76 |
|------------------------------------|----|

| | |
|-----------------------------|----|
| 2.6 Concluding remarks..... | 80 |
|-----------------------------|----|

Chapter 3

| | |
|--|-----------|
| Ablaut in Egyptian Arabic | 81 |
|--|-----------|

| | |
|-----------------------|----|
| 3.1 Introduction..... | 81 |
|-----------------------|----|

| | |
|---|----|
| 3.2 A general view of the Egyptian Arabic verbal organization | 83 |
|---|----|

| | |
|--------------------------------|----|
| 3.2.1 The verbal measures..... | 83 |
|--------------------------------|----|

| | |
|---|----|
| 3.2.2 The formal representation of the verb in Egyptian Arabic..... | 85 |
|---|----|

| | |
|--|----|
| 3.3 The strategies for understanding the Egyptian Arabic verb..... | 88 |
|--|----|

| | |
|---|----|
| 3.4 The perfective of Egyptian Arabic | 91 |
|---|----|

| | |
|-----------------------|----|
| 3.4.1 Vocalisms | 91 |
|-----------------------|----|

| | |
|---|----|
| 3.4.2 The characteristics of the AV (CaCaC) and NAV (CeCeC) patterns..... | 95 |
|---|----|

| | |
|---|-----|
| 3.4.3 The organization of the perfective vocalic material..... | 105 |
| 3.5 The imperfective of Egyptian Arabic | 110 |
| 3.5.1 The apophonic mechanism in Classical Arabic..... | 110 |
| 3.5.2 Towards an apophony-based account of aspectual alternations in Egyptian Arabic | 114 |
| 3.5.3 The predictability of certain imperfective melodies | 127 |
| 3.5.4 The lexical vowel Ø | 129 |
| 3.5.5 More evidence for “frontness” | 138 |
| 3.6 Concluding remarks..... | 143 |

Chapter 4

| | |
|---|------------|
| The Vocalization of Hollow and Deaf Verbs in Egyptian Arabic | 144 |
| 4.1 Introduction..... | 144 |
| 4.2 Identifying the problem..... | 145 |
| 4.3 Hollow (Glide-medial) verbs..... | 148 |
| 4.3.1 Expected vocalisms..... | 148 |
| 4.3.2 The attested vocalisms | 156 |
| 4.4 Deaf (Bilateral) verbs | 159 |
| 4.4.1 The aspectual melodic alternations | 159 |
| 4.4.2 The arrangement of the vocalic material in deaf perfectives..... | 161 |
| 4.4.3 Why deaf verbs implement lexical vowels Ø and <i>a</i> | 163 |
| 4.5 Concluding remarks..... | 173 |

Chapter 5

| | |
|---|------------|
| Word Stress in Egyptian Arabic | 174 |
| 5.1 Introduction..... | 174 |
| 5.2 Outlines of stress assignment in Egyptian Arabic | 176 |
| 5.2.1 The characteristics of Egyptian Arabic stress | 176 |
| 5.2.2 Stress placement in Egyptian Arabic, generalizations and challenges | 180 |

| | |
|--|------------|
| 5.3 Towards a new view of stress assignment | 187 |
| 5.3.1 Phonological Length / Phonetic Duration | 187 |
| 5.3.2 Stressed epenthetic vowels | 189 |
| 5.3.3 The proposal | 190 |
| 5.3.4 The phonetic correlates of stress in Egyptian Arabic | 193 |
| 5.3.5 Stress and vowel length, correlation undone | 195 |
| 5.4 Accentuation on a skeletal level | 200 |
| 5.4.1 Stressed antepenultimate vowels | 200 |
| 5.4.2 Stressed final short vowels | 208 |
| 5.4.3 Stressed final long vowels | 211 |
| 5.4.4 Stressed long vowels in absolute final position..... | 213 |
| 5.5 Concluding remarks..... | 217 |
| Conclusion | 218 |
| References | 221 |
| Appendices | 232 |
| Résumé de la Thèse..... | 249 |

List of Tables

| | |
|---|----|
| Table 1.1 Surface vowel qualities | 8 |
| Table 1.2 Vowel distributions within the syllable | 9 |
| Table 1.3 Distribution of short vowels | 9 |
| Table 1.4 Distribution of long vowels | 11 |
| Table 1.5 Length contrasts and the three cardinal vowels..... | 12 |
| Table 1.6 Minimal contrasts and mid-vowels..... | 13 |
| Table 1.7 Lack of ideal correspondence between vowel length and contrasting length..... | 15 |
| Table 1.8 Vowel length contrast in CEA | 17 |
| Table 1.9 Final long vowels alternating with final [h] in free variation | 18 |
| Table 1.10 mesektu: ‘you (PL) caught it (MASC)’ + l ‘to, for PREP’ + IOP (1SING). | 19 |
| Table 1.11 mesektu: ‘you (PL) caught it (MASC)’ /mesek-tu + hu/..... | 20 |
| Table 1.12 Every long vowel in a final open syllable is followed by a latent /hu/ morpheme | 20 |
| Table 1.13 The vocalic equipment of MA compared to CA | 23 |
| Table 1.14 The CEA vocalization compared to CA | 28 |
| Table 1.15 Branching vowels in CEA and differential phonetic length..... | 30 |
| Table 1.16 Branching vowels in CEA and differential phonetic length due to stress | 32 |
| Table 1.17 CA labis- /CEA lebes- √lbs ‘put (clothes) on’ perfective paradigm..... | 34 |
| Table 1.18 Subject inflectional morphemes..... | 34 |
| Table 1.19 The Feminine singular nominal marker in CEA..... | 39 |
| Table 1.20 The role of epenthesis in the allomorphy..... | 40 |
| Table 2.1 Delinking of short {i, u, a} vowels in MA..... | 46 |
| Table 2.2 Delinking of short {i, u, a} vowels in CEA | 48 |
| Table 2.3 The epenthetic vowel [o] | 65 |

| | |
|--|-----|
| Table 2.4 Identifying the default epenthetic vowel | 66 |
| Table 2.5 Stressed short mid-vowels | 68 |
| Table 2.6 Long mid-vowels vs. long high vowels | 71 |
| Table 2.7 The origins of long mid-vowels in CEA..... | 72 |
| Table 2.8 Mirror image segholates | 77 |
| Table 3.1 Ablaut in CA: verbal Measure I (3 _{SING.MASC})..... | 83 |
| Table 3.2 Ablaut in CEA: verbal Measure I (3 _{SING.MASC}) | 84 |
| Table 3.3 Verbal measures found in both CA and CEA (3 _{SING.MASC}) | 84 |
| Table 3.4 The perfective/imperfective alternation patterns in CA: (3 _{SING.MASC}) forms | 88 |
| Table 3.5 <i>Four</i> verbal classes in CA vs. <i>two</i> classes in CEA: the perfective | 89 |
| Table 3.6 The perfective/imperfective alternation patterns in CEA..... | 89 |
| Table 3.7 The perfective: CA vs. MA | 91 |
| Table 3.8 Unexpected retention of short vowel {a} by CEA | 93 |
| Table 3.9 Neutralization of CA (a _ i) and (a _ u) into (e _ e) in CEA | 94 |
| Table 3.10 CEA katab vs. selem : perfective verbal paradigms | 96 |
| Table 3.11 Stable second stem vowel in -katab- but not in -selem-..... | 96 |
| Table 3.12 CEA katab vs. selem: perfective and negation..... | 97 |
| Table 3.13 Stable first stem vowel in -katab- but not in -selem-..... | 98 |
| Table 3.14 The CoCoC ~ CeCeC variants in the perfective of CEA | 106 |
| Table 3.15 Perfective/Imperfective alternating patterns in CA..... | 110 |
| Table 3.16 The vocalic material involved in the aspectual alternations in CA.... | 110 |
| Table 3.17 Apophony, established in CA..... | 113 |
| Table 3.18 Perfective/Imperfective alternating patterns in CEA | 115 |
| Table 3.19 Two perfective and three imperfective patterns in CEA | 115 |
| Table 3.20 Absent possible systems of aspectual alternations in CEA | 116 |
| Table 3.21 Perfective/imperfective CEA melodies reformulated in Elements ... | 116 |
| Table 3.22 The variant (o _ o) considered | 117 |

| | |
|--|-----|
| Table 3.23 Factoring out the predictable A Element from the perfective melody | 118 |
| Table 3.24 The CA Active and Passive | 118 |
| Table 3.25 The imperfective prefixes in je-msek and jo-xrog..... | 124 |
| Table 3.26 The imperfective prefix in je-slam..... | 124 |
| Table 3.27 Factoring out the predictable A Element from the imperfective melody..... | 126 |
| Table 3.28 The lexical perfective and imperfective melodies..... | 126 |
| Table 3.29 A selection of apophony-based alternations | 127 |
| Table 3.30 Predictable imperfective patterns | 128 |
| Table 3.31 Identifying the phonologically conditioned imperfective melody | 129 |
| Table 3.32 The I → A step in semeʃ/je-smaʃ alternation pattern | 131 |
| Table 3.33 The step (∅ → I), established | 132 |
| Table 3.34 Subset of the class katab/je-kteb with lowering R ₁ and/or R ₂ | 133 |
| Table 3.35 Identifying “frontness” in the imperfective..... | 135 |
| Table 3.36 The class mesek/je-msek | 136 |
| Table 3.37 Identifying the perfective managed by epenthesis..... | 137 |
| Table 3.38 Apophony, established in CEA | 138 |
| Table 3.39 Input (U ⇒ I) in CEA..... | 139 |
| Table 3.40 Output A, indicator of input I..... | 139 |
| Table 3.41 Perfective entry /U/ vs. perfective entry (U transforming to ⇒ I)..... | 140 |
| Table 3.42 Output (∅ _ e) ~ output (∅ _ o) | 141 |
| Table 3.43 Future fusions due to the mounting influence of “ambient I” | 142 |
| Table 3.44 The apophonic derivation of CEA imperfective | 142 |
| Table 4.1 Root types and vocalic patterns in CEA Measure I: Perfective (3 _{SING.MASC}) | 147 |
| Table 4.2 The absence of <i>Non A-Vocalization</i> in CEA hollow and deaf verbs | 147 |
| Table 4.3 The vocalic equipment of glide-medial roots if it replicated the set of options available to verbs from strong roots (3 _{SING.MASC})..... | 149 |

| | |
|--|-----|
| Table 4.4 Expected vocalizations of w-medial verbs, e.g. $\sqrt{\text{mwt}}$ 'die' (3 _{SING.MASC}) | 153 |
| Table 4.5 Expected vocalizations of j-medial verbs, e.g. $\sqrt{\text{mjl}}$ 'lean' (3 _{SING.MASC})... | 155 |
| Table 4.6 CEA hollow verbs: attested melodies (3 _{SING.MASC})..... | 156 |
| Table 4.7 CEA deaf verbs: aspectual alternation patterns..... | 159 |
| Table 4.8 CEA deaf verbs: rough underlying representation | 160 |
| Table 4.9 The perfective of deaf verbs vs. their sane counterparts | 164 |
| Table 4.10 Deaf verb: root $\sqrt{\text{gr}}$ 'pull' whose perfective lexical entry is A..... | 170 |
| Table 4.11 Glide-medial roots: $\sqrt{\text{mjl}}$ 'lean' and $\sqrt{\text{mwt}}$ 'die': perfective | 171 |
| Table 4.12 Glide-final roots: $\sqrt{\text{rmj}}$ 'throw' and $\sqrt{\text{dʃw}}$ 'pray': perfective..... | 172 |
| Table 5.1 Manifestations of stress shift in CEA..... | 176 |
| Table 5.2 Stress location and clitics bearing stress..... | 177 |
| Table 5.3 Long vowels and stress in CEA..... | 178 |
| Table 5.4 Stress and the structure of stressed syllable | 181 |
| Table 5.5 Stressed epenthetic vowels..... | 189 |

List of Charts

| | |
|---|----|
| Chart 1.1 The surface vowel inventory | 8 |
| Chart 1.2 The underlying vowel phonemes..... | 13 |
| Chart 1.3 The surface vowel inventory vs. the underlying inventory | 16 |
| Chart 1.4 The CA and MA vowel inventories..... | 22 |
| Chart 2.1 The attested MA vowel inventory and the predicted CEA vowel inventory..... | 49 |
| Chart 2.2 CEA and MA vowel inventories | 49 |
| Chart 2.3 The surface vowel inventory of Ge'ez | 60 |
| Chart 2.4 The MA, Ge'ez and CEA vowel qualities in terms of Elements... | 63 |
| Chart 2.5 The surface vs. the underlying vowel inventories in CEA | 69 |

Abbreviations

| | | | |
|----------------|---------------------------|---------|-------------------------|
| 1 | First person | NEG | Negation |
| 2 | Second person | PREP | Preposition |
| 3 | Third person | PRO | Pronoun |
| SING | Singular | SUB | Subject |
| PL | Plural | OBJ | Object |
| MASC | Masculine | POSS | Possessive |
| FEM | Feminine | GEN | Genitive |
| CS | Construct State | NOM | nominative |
| GP | Government Phonology | INSTRUM | instrumental |
| ECP | Empty Category Principle | DOP | Direct Object Pronoun |
| PG | Proper Government | IOP | Indirect Object Pronoun |
| *PG | Lack of Proper Government | Ø | zero marker for nothing |
| <i>perf.</i> | Perfective | v/V | vowel |
| <i>imperf.</i> | Imperfective | C | consonant |

Acknowledgments

Jean Lowenstamm, this dissertation is dedicated to you.

Sabrina Bendjaballah, my gratitude for your impressive continuous support and your availability, as a scholar whom I hold the highest esteem and especially as a friend, is simply inexpressible.

Nicola Lampitelli, Nora Arbaoui and Noam Faust, thanks for the valuable discussions, for the helpful feedback and for your company all through the last five years.

Philippe Ségéral, thank you for having welcomed me into your fascinating seminars and thanks for having taught me a lot and for the advice whenever I needed one.

George Boulakia, thanks for letting me enjoy your guidance, patience, generosity and warmth ever since I came to Paris 7.

Anne Abeillé, thanks to you and to the members of Laboratoire de Linguistique Formelle for welcoming me in the lab, and for generously sharing with me its intellectual and material resources.

Prof. Shohei Yoshida, thank you so much for your support and guidance, and for sponsoring my application for a post-doctoral position in Japan.

I am grateful to Dr. Sabrina Bendjaballah, Prof. Monik Charette, Prof. Mohand Guerssel and Prof. Shohei Yoshida for having agreed to participate in the evaluation of my work and for having accepted to be my jury.

Thanks to all my colleagues and friends at Paris 7, the fellows with whom I shared as much worries and stresses as fun.

Sheikh Emad Effat, Mina Daniel, Ahmed Ihab, Sally Zahran, Anas Mohyi Ed-Din, Ahmed Harara, Mohamed Yousri Salama, Gika, Eg-Gendy, Christy, Abu El-Hassan and so many others, too numerous to name, thanks for the lives you have been giving to establish social justice.

Introduction

0.1 Purpose of the study

This dissertation is devoted to the study of the vowel system of my native language, a variety of Arabic spoken in Cairo and in the major urban centers in northern Egypt, known under the generic term “Egyptian Arabic.”

Although Egyptian Arabic has received special attention over the past five decades, it can be clearly seen that research efforts aimed at understanding the phonology of this language squarely fall into two distinct categories: a) descriptive, and b) theoretical. Unfortunately, the boundaries between these two categories seem to have remained unchanged over the years. This can most clearly be seen when the results of theoretically-oriented studies are examined. Here, it seems that these studies’ main preoccupation has been mostly limited to checking whether the proposals provided therein could handle the challenging generalizations proposed by earlier descriptive works. It is also possible that the descriptions themselves are problematic, as most of the data has not been updated for a long period of time (with scarce exceptions).

One of the goals of this study is therefore to meet the compelling need to refresh the debate on Egyptian Arabic phonology and to shrink the size of the unfortunate gulf that divides the two research blocks, the descriptive on one side and theoretical on the other side.

The first common thread that runs through all chapters of the dissertation is thus to establish descriptive generalizations on issues that have not yet received enough attention, descriptions that constitute true linguistic generalizations of a type likely to feed theoretical elaboration. New relevant information will be adduced and a detailed analysis of a

comprehensive fragment of fresh data dealt with through analytical tools different from those used previously by my predecessors, will be offered.

By introducing new terms of analysis into the discussion of Egyptian Arabic, specific predictions will be made and several crucial interrelations, unavailable in earlier works, will be brought to light.

The main argument of the dissertation is that the key to the interpretation of the most prominent vowel-related events in this language lies in the interdependence of vowel quality and vowel quantity. I establish a transparent relationship between these two, only phonologically long vowels in Egyptian Arabic can maintain their quality on the phonetic level, otherwise they become incapable of surfacing. They are, in this case, phonetically replaced either by an epenthetic vowel or by nothing at all. I thus construe vowel length in strictly phonological terms.

The development of this thesis was made possible by utilizing theoretical tools that recognize a skeletal tier. These tools allow for the redefinition of vowel length, not as a phonetic difference between short and long vowels as is usually the case, but rather, in terms of the number of nuclear positions to which a vowel is attached. Length is no longer represented as an inherent feature of vowels; the segmental string therefore becomes unspecified for length features that are instead represented on the CV level. A long vowel becomes the expression of a vocalic object attached to *two* nuclear positions whereas a vowel is deemed short when associated with one skeletal position. Once vowel length in Egyptian Arabic is reinterpreted in such a way and the principles managing the economy of the vowel system are determined, a wide range of explanations for repeatedly reported problematic issues such as the vocalization of verbs and the stress pattern, etc. immediately falls out.

The establishment of the new construal of vowel length in Egyptian Arabic was also made possible through comparison with other varieties of Arabic whose diachrony and parameters are relatively well understood, namely Classical Arabic and the Arabic spoken in the Maghreb. With the proliferation of valuable research on contemporary varieties of spoken Arabic, the prospect of defining the parameters responsible for the identification and

stabilization of each language or dialect, appears to be within reach. This is the other common thread running through the dissertation. The comparative examination carried out between Egyptian Arabic and the other Arabic varieties reveals how they are even more tightly related than had been surmised. The relationship that binds the spoken varieties of Arabic can be articulated in such a way that they can be viewed as being true dialects of one language, rather than different languages.¹ Indeed, what might seem indeterminable in Egyptian Arabic can be possibly retrieved and ascertained on the basis of Maghribi Arabic and vice-versa.

The dissertation in this respect aims at extensively contributing to the enhancement of the study of Arabic dialectology. But, my ultimate goal is to give a deductive structure to my results and to draw conclusions that can go beyond the case of Egyptian Arabic or Arabic dialectology, indeed to contribute to the elaboration of Linguistic Theory.

¹ Of course, I use “dialect” in the modern technical sense; not in the sense of XIXth century scholars who used to view vernacular forms of speech as degenerate versions of Classical Arabic.

0.2 Research design

The dissertation is in the form of a theme and four variations. The central theme is put forth in the first chapter. The examination of the major characteristics of the Egyptian Arabic vowel system through a pure structuralist approach calls into question the too widely accepted concept that vowel length is contrastive in this language. The central objective of this chapter is therefore to reconsider vowel length in Egyptian Arabic. The closer examination of vowel length using different theoretical tools which recognize a skeletal level leads to developing a new concept of vowel length in Egyptian Arabic. A specific correlation between a vowel's surface quality and the number of templatic positions to which it is attached is endorsed; a vowel maintains its quality on the phonetic level only when attached to two nuclear positions.

An extended elaboration of the correlation between vowel quality and vowel quantity covers all the material of the dissertation. In chapter two, I show how the emerging view of vowel length can lay the foundation for determining the parameters involved in deriving the vowel system. I subsequently make use of these parameters to understand and redefine mid-vowels of Egyptian Arabic. Consequently, the new analysis of long mid-vowels makes it possible to explain an intriguing distributional lacuna in glide-medial segholate nouns.

My rejection of the traditional conceptions of vowel length brings forth rich consequences. Indeed, my novel construal of vowel length is shown to be the essential tool for resolving a number of challenging issues in the verbal system, issues that have not been seriously addressed until now. This is firstly seen in chapter three where the allegedly unpredictable aspectual vocalic alternations are explained; then in chapter four where the invariable perfective melody of hollow and deaf verbs is finally understood.

The investigation into verbal vocalizations is followed by a final return to the main theme in the fifth chapter in the form of a comprehensive examination of the stress phenomenon. Here, I offer an alternative system of stress assignment that emphasizes – again – the role of the economy of the vowel system. Two main theoretical procedures are

fundamental for establishing this alternative view of stress: a) the representation of vowel length on the CV skeletal level, and b) the implementation of the CVCV model. The main argument of this chapter is that the prosodic features are not specified in the vowel segments themselves, the assignment of prominence perceived as “stress” can be rather expressed by means of government relations affecting particular positions on the skeletal level.

Chapter 1

The Formal Representation of Cardinal Vowels in Egyptian Arabic

1.1 Introduction

Vowel length is often assumed to play a contrastive role in Egyptian Arabic. But, contrary to what would be expected for a language in which vowel length is presumably distinctive, long vowels in Egyptian Arabic have a very limited distribution in relation to short ones. Indeed, length contrasts appear to be restricted to particular word positions as well as particular vowel qualities. This calls into question the view that vowel length is distinctive. When the bases upon which vowel contrasts have been established are examined, an important result is reached: these bases are far from being reliable. This leads to a closer examination of vowel length with different tools than those employed earlier in structuralist phonology; these tools are the theoretical resources that recognize a skeletal tier. This chapter discusses how these resources are utilized for developing a novel construal of vowel length in Egyptian Arabic.

Vowel length cannot be seen as only a phonetic difference between short and long vowels (i.e. as inherent property of vowels), but rather must be defined in terms of the number of nuclear positions to which a vowel is attached. I argue that {i, u, a} vowels maintain their surface quality only when they are attached to two templatic positions. The difference between the *phonetically* short series [i, u, a] and the *phonetically* long series [i:, u:, a:] is a mere consequence of stress: a vowel {i, u, a} exhibits explicit *phonetic* length only under stress.

The discussion is organized as follows: it begins in section 2 with an outline of the general characteristics of the vowel system. The problems arising from the observation of these characteristics are then specified in section 3. In section 4, the reasons that could lead to the assumption of a contrastive role of vowel length are reconsidered. This reconsideration leads to a more restrictive analysis of the distribution of long vowels: long vowels are exclusively penultimate. In section 5, the different vocalic manifestations in Egyptian Arabic are examined in comparison with two well-studied vowel systems, Classical Arabic and Moroccan Arabic. This comparative examination lays the groundwork for a new view of vocalic length in Egyptian Arabic. The redefinition of vocalic length in terms of templatic space is further supported by two cases, the final empty nuclei and the allomorphy displayed by the feminine singular nominal marker.

1.2 Outlines of the vowel system

1.2.1 The surface vowel inventory: Quality and Quantity

Colloquial Egyptian Arabic (from here on CEA) displays an array of surface vocalic qualities including both short and long counterparts: [i], [i:], [u], [u:], [a], [a:], [e], [e:], [o], [o:].² This range of surface qualities is documented (underscored) in Table 1.1 and presented in Chart 1.1.

Table 1.1 Surface vowel qualities

| a. Short vowels | | | | b. Long vowels | | |
|-----------------|-----|------------------|------------|----------------|--------------|---------|
| i. | [i] | kor <u>s</u> i | 'chair' | [i:] | ni: <u>l</u> | 'Nile' |
| ii. | [u] | du: <u>l</u> a:b | 'wardrobe' | [u:] | su: <u>r</u> | 'fence' |
| iii. | [a] | š <u>a</u> ms | 'sun' | [a:] | ba: <u>b</u> | 'door' |
| iv. | [e] | se <u>l</u> k | 'wire' | [e:] | be: <u>t</u> | 'house' |
| v. | [o] | do <u>r</u> g | 'drawer' | [o:] | mo: <u>t</u> | 'death' |

Chart 1.1 The surface vowel inventory

| | a. Short | | b. Long | |
|------|----------|------|---------|------|
| | Front | Back | Front | Back |
| High | i | u | i: | u: |
| Mid | e | o | e: | o: |
| Low | a | | a: | |

² Consonants are usually considered to be the cause of vowel's allophonic variations other than those covered in this and further chapters of this work. For example, Ammar and Morsi (2006) note that in [ʕædd] 'he counted' and [ʕædd] 'he bit,' the [æ] changes into [ɑ] because of the influence of the neighboring emphatic consonant [d]. In this study, I use the notation [ɑ] for all of the allophonic variations of /a/.

1.2.2 Vowel distribution

In CEA, as in all other forms of Arabic, vowels do not occur in syllable-initial position. Short vowels can be found in: a) open syllables (CV), and b) syllables closed by one or two consonants (CVC and CVCC). Long vowels, on the other hand, can exist in: a) open syllables (CVV), b) syllables closed by one consonant (CVVC), but not in syllables closed by two consonants (*CVVCC). This is recapitulated in Table 1.2.

Table 1.2 Vowel distributions within the syllable

| | a. Short vowels | b. Long vowels |
|--|-----------------|----------------|
| i. Open syllable | CV | CVV |
| ii. Syllable closed by one consonant | CVC | CVVC |
| iii. Syllable closed by two consonants | CVCC | *CVVCC |

The exact distribution of syllables capable of accommodating short vowels in CEA can be identified by examining the underlined sequences in Table 1.3. In the table, two verbs suffixed with different pronominal clitics are presented; *mesekt* ‘I caught’ in set I and *mesket* ‘she caught’ in set II.

Table 1.3 Distribution of short vowels

| Set I: <i>mesekt</i> ‘I caught’ | | |
|---|----------------------------------|---------------------------------|
| a. Syllables | b. Distribution within the word | Gloss |
| i. <i>mesekt</i> CV <u>CVCC</u> | CVCC: ultimate | <i>‘I caught’</i> |
| ii. <i>mesektu</i> <u>CV</u> CVC <u>CV</u> | CV: ultimate and antepenultimate | <i>‘I caught him/it (MASC)’</i> |
| iii. <i>mesektaha</i> CV CVC <u>CV</u> CV | CV: penultimate | <i>‘I caught her/it (FEM)’</i> |
| iv. <i>mesektohom</i> <u>CV</u> CVC CV CVC | CV: preantepenultimate | <i>‘I caught them’</i> |

| Set II: mesket <i>'she caught'</i> | | |
|-------------------------------------|---------------------------------|-----------------------------------|
| a. Syllables | b. Distribution within the word | Gloss |
| i. mesket <u>CVC</u> CVC | CVC: penultimate | <i>'she caught'</i> |
| ii. mesketu <u>CVC</u> CV CV | CVC: antepenultimate | <i>'she caught him/it (MASC)'</i> |
| iii. mesketha CVC <u>CVC</u> CV | CVC: penultimate | <i>'she caught her/it (FEM)'</i> |
| iv. meskethom CVC CVC <u>CVC</u> | CVC: ultimate | <i>'she caught them'</i> |

Syllables with short nuclei are recognized in the following word positions:

1. (CV) and (CVC) exist in the ultimate, penultimate as well as the antepenultimate positions of the word.
2. (CV) exists in the preantepenultimate position.
3. (CVCC) only exists in the word-final position.

These findings can be summed up as follows:

- (1.1) Short vowels in CEA can occur in any position of the word. Short vowels are freely distributed.

As for long vowels, a basic idea of their distribution can be gathered from the observation of the underlined syllables in Table 1.4. The table shows the verb *mesekna* 'we caught' affixed by different pronominal, prepositional and negative clitics.

Table 1.4 Distribution of long vowels

| mesekna 'we caught' | | |
|---|---------------------------------|-----------------------------------|
| a. Syllables | b. Distribution within the word | Gloss |
| i. mesekna: CV CVC <u>CVV</u> | CVV: ultimate | 'we caught him/it (MASC)' |
| ii. mesekna:ha CV CVC <u>CVV</u> CV | CVV: penultimate | 'we caught her/it (FEM)' |
| iii. meseknaha:li CV CVC CV <u>CVV</u> CV | CVV: penultimate | 'we caught it (FEM) for me' |
| iv. mamseknahali:š CVC CVC CV CV <u>CVVC</u> | CVVC: ultimate | 'we didn't catch it (FEM) for me' |

We therefore see that:

1. Only one long vowel can exist for a single utterance.
2. (CVV) can be found in either the final or the pre-final positions of the word.
3. (CVVC) is only found in the word-final position.

The distribution of long vowels can be stated as follows:

- (1.2) Long vowels in CEA are not freely distributed. Long vowels are limited to either the ultimate or the penultimate position of the word.

1.2.3 The underlying vowel phonemes

The existing quantitative contrasts involving the three cardinal vowels {i, u, a}, as seen (underscored) in Table 1.5, led most investigators concerned with the makeup of the vowel system of CEA to: a) assume a contrastive role played by vowel length, and b) consider /i/, /i:/, /u/, /u:/, /a/ and /a:/ as six different vowel phonemes.³

Table 1.5 Length contrasts and the three cardinal vowels

| a. [u] vs. [u:] | | |
|--------------------------|-----|--|
| i. [mesekt <u>u</u>] | vs. | ii. [mesekt <u>u:</u>] |
| <i>'you (PL) caught'</i> | | <i>'you (PL) caught him/it (MASC)'</i> |
| b. [i] vs. [i:] | | |
| i. [kors <u>i</u>] | vs. | ii. [kors <u>i:</u>] |
| <i>'chair'</i> | | <i>'his chair'</i> |
| c. [a] vs. [a:] | | |
| i. [maʕ <u>a</u>] | vs. | ii. [maʕ <u>a:</u>] |
| <i>'with'</i> | | <i>'with him'</i> |

However, careful inspection of the pairs displayed in Table 1.5 leads to a curious finding:

- (1.3) The only word position where a vowel length contrast can be identified is the final position.

In addition, the existence of qualitative contrasts between the long high vowels [i:], [u:] and the long mid-vowels [e:], [o:] prompted investigators to posit the latter as two more vowel phonemes in CEA. Consider the pairs displayed (underlined) in Table 1.6.

³ Studies on Egyptian Arabic include Harrell (1957), Mitchell (1956), Tomiche (1964), Broselow (1976), Yoshida (1999), Gadalla (2000) and Watson (2002) among others.

Table 1.6 Minimal contrasts and mid-vowels

| a. [i:] vs. [e:] | | |
|--|-----|----------------------|
| i. [mi:] | vs. | ii. [me:] |
| <i>'incline! Imperative (2_{SING.MASC})'</i> | | <i>'inclination'</i> |
| b. [u:] vs. [o:] | | |
| i. [mu:] | vs. | ii. [mo:] |
| <i>'die! Imperative (2_{SING.MASC})'</i> | | <i>'death'</i> |

Short mid-vowels were, on the contrary, barred from the phonological vowel inventory due to the absence of minimal pairs opposing short [e], [o] to short [i], [u].

In view of that, the list of vowel phonemes has consistently been defined as follows: /i/, /i:/, /u/, /u:/, /a/, /a:/, /e:/, /o:/; this is seen in Chart 1.2.

Chart 1.2 The underlying vowel phonemes

| | a. Short | | b. Long | |
|------|----------|------|---------|------|
| | Front | Back | Front | Back |
| High | i | u | i: | u: |
| Mid | | | e: | o: |
| Low | | a | | a: |

1.3 Problem statement

The vowel system that has just been described is challenging in many respects. In this chapter, we will focus on only one problematic aspect of this system, that of “vowel length” and its related intriguing manifestations. In particular, the following three points will be the main object of our inquiry:

1. The limited distribution of long vowels.
2. The limited positions wherein vowel length contrasts can be established.
3. The limited range of qualities for which vowel length distinctions can be recognized.

1.3.1 Abnormal long vowel distribution

The distributional study of short and long vowels in CEA revealed some noteworthy findings; the most relevant ones are:

1. Short vowels occur in any word position.
2. Long vowels are restricted to the final and the pre-final positions of the word.

These two findings are essentially paradoxical because languages in which vowel length is presumably “distinctive” usually exhibit a free distribution of long vowels, or the distribution of long vowels at least tends to be equivalent to that of short vowels.⁴ The comparatively restricted distribution of long vowels with respect to short ones in CEA does not conform to the attested trends and will need to be addressed.

⁴ Arguments in this respect are provided in Clements (1990).

1.3.2 The limitation of vowel length contrasts to specific positions

Long vowels in CEA have been argued to exist in both the ultimate and penultimate positions of the word. If the relationship between long vowels and contrasting length is construed as in (1.4), then a vowel length contrast is expected to be recognizable in both final and pre-final positions of the word.

(1.4) Where long vowels are identified, a vowel length contrast can be established.

And yet, the minimal pairs that show quantitative vocalic distinctions reveal something else; a vowel length contrast is not identifiable but word-finally. This directly raises the question: if long vowels have been shown to exist in both final and pre-final word positions, why can a length contrast not be established in the penultimate position of the word?

In other words, what keeps the distribution of “vowel length contrasts” even more restricted than the distribution of “long vowels” themselves? Consider the lack of perfect correspondence between the distribution of long vowels and the word positions where length contrasts can be established (Table 1.7).

Table 1.7 Lack of ideal correspondence between vowel length and contrasting length

| | a. Long vowels | b. Vowel length contrast |
|-------------------------------|----------------|--------------------------|
| i. Ultimate word position | + | + |
| ii. Penultimate word position | + | – |

As we will see in section 1.4, the purported length contrast in word-final position is a mere illusion.

1.3.3 The limitation of vowel length contrasts to specific qualities

A quick comparison between the surface vowel inventory and the underlying vowel phonemes reiterated in Chart 1.3 reveals the following: length contrasts exclusively hold of the set of cardinal vowels. This is due to the simple fact that short mid-vowels are absent from the phonemic level.

Chart 1.3 The surface vowel inventory vs. the underlying inventory

| a. Surface vowel inventory | | b. Underlying vowel phonemes | |
|----------------------------|-------|------------------------------|-------|
| i, i: | u, u: | i, i: | u, u: |
| e, e: | o, o: | e: | o: |
| a, a: | | a, a: | |

The absence of the short mid-vowel phonemes, */e/ and */o/, raises two important questions:

- 1) Did the length contrast get lost in the course of the evolution of the CEA vowel system?
- 2) Why can a length contrast be established for cardinal vowels and not for mid-vowels? In other words, is contrasting length “quality-dependent”?

The proliferation of these types of problems indicates the following fact: we do not know enough about vowel length in CEA. The main objective of this chapter is therefore to enhance our understanding of vowel length and to determine whether or not it is distinctive in CEA.

In order to address this query, I move away from the conventional structuralist approach, and I implement different theoretical tools, namely those that recognize a skeletal tier. The rich consequences this decision brings forth will be seen progressively as we proceed. Let us begin by raising the core question of this chapter of how distinctive vowel length is in CEA.

1.4 How distinctive is vowel length in Egyptian Arabic?

Assessing vowel length contrasts in CEA basically relies upon minimal pairs like those seen in Table 1.8. Let us closely examine those pairs and carefully consider each (i) form versus its (ii) correspondent.

Table 1.8 Vowel length contrast in CEA

| a. [u vs. u:] | | |
|--|-----|--|
| i. [mesekt <u>u</u>] | vs. | ii. [mesekt <u>u:</u>] |
| /mesek-tu/ | | /mesek-tu + ??/ |
| mesek ‘catch’ -(2 _{SUBJ.PL}) | | mesek - _{SUBJ} (2 _{PL}) + ‘it (OBJ·MASC)’ |
| <i>‘you (PL) caught’</i> | | <i>‘you (PL) caught it (.MASC)’</i> |
| b. [i vs. i:] | | |
| i. [korsi] | vs. | ii. [korsi:] |
| /korsi/ | | /korsi + ??/ |
| korsi (noun _{SING.MASC}) | | korsi + ‘his (POSS)’ |
| <i>‘chair’</i> | | <i>‘his chair’</i> |
| c. [a vs. a:] | | |
| i. [maʕa] | vs. | ii. [maʕa:] |
| /maʕa/ | | /maʕa + ??/ |
| maʕa (PREP) | | maʕa + ‘him (GEN)’ |
| <i>‘with’</i> | | <i>‘with him’</i> |

In addition to the fact that a length contrast is only recognizable in ultimate word position, the pairs of words displayed above reveal another specific feature that casts great doubt on the entire list and renders it far from reliable. It is conspicuous that the series in (ii) are morphologically far more complex than those in (i). The final vowel lengthening necessarily indicates a certain morphological process that consistently involves (3_{SING.MASC}).

Consequently, two important questions arise:

- 1) Do forms ending with final long vowels regularly involve the (3_{SING.MASC})?
- 2) What is the nature and where exactly is the concrete pronominal material signaling (3_{SING.MASC})?

If we return to series (ii) in Table 1.8 (a) through (c), two assumptions can be made regarding the phantomlike (3_{SING.MASC}) pronoun (indicated by the two question marks “??” in the rough underlying structure):

1. The (3_{SING.MASC}) morpheme is a “contentless” morpheme, an empty appendix which permits the spreading of any neighboring vowel on its left, thus yielding the lengthening effect.
2. The morpheme is present but for some reason it cannot explicitly materialize. The presence of the morpheme can only be inferred by its lengthening effect on the preceding vowel.

Here, I would like to point out that the (ii) series in Table 1.8, the forms that exhibit a final long vowel, are commonly found in free variation with forms ending in [h] like what appears in Table 1.9. The variety ending in an audible [h] is not infrequent; it is conditioned by personal stylistic factors or contextual factors like slow speech or rhetorical emphasis.

Table 1.9 Final long vowels alternating with final [h] in free variation

| | a. Variants ending in long vowels | | b. Variants ending in [h] | Gloss |
|------|-----------------------------------|---|---------------------------|------------------------------------|
| i. | [mesektu:] | ~ | [mesektu:h] | <i>'you (PL) caught it (MASC)'</i> |
| ii. | [korsi:] | ~ | [korsi:h] | <i>'his chair'</i> |
| iii. | [maʕa:] | ~ | [maʕa:h] | <i>'with him'</i> |

This would be one reason to dismiss the pairs in Table 1.8 as reliable ground for the establishment of length contrast. The final [h] in column (b) of Table 1.9 provides the first solid clue that the underlying makeup of series (ii) of Table 1.8 is very different from that of series (i).

If evidence for the occurrence of long vowels in final open syllables (CVV#) were mainly based upon words like those in series (ii) in Table 1.8, a simple test can disprove it. Let us take *mesektu*: ‘you (PL) caught it (MASC)’ as an example; further addition of suffixes to *mesektu*: obligatorily activates the dormant (3_{SING.MASC}) pronoun that finally materializes as *-hu*. This test is demonstrated in Table 1.10. As pointed out in the right-hand side column in (c) in Table 1.10 below, **mesektu:li* ‘you (PL) caught it (MASC) for me’ is completely ungrammatical.

Table 1.10 *mesektu*: ‘you (PL) caught it (MASC)’ + *l* ‘to, for (PREP)’ + IOP (1_{SING})

| a. verb + clitics | b. Attested | c. Expected |
|--|---|------------------------------|
| i. <i>mesektu</i> : + <i>l</i> + <i>i</i> <i>ʔu</i> (PL) <i>caught it</i> (MASC)’ + <i>for</i> + <i>me</i> | <i>mesektu</i> <u><i>hu</i></u> : <i>li</i> | * <i>mesektu</i> : <i>li</i> |
| ii. <i>mesektu</i> : + <i>l</i> + <i>ha</i> <i>ʔu</i> (PL) <i>caught it</i> (MASC)’ + <i>for</i> + <i>her</i> | <i>mesektu</i> <u><i>hol</i></u> <i>ha</i> | * <i>mesektul</i> <i>ha</i> |

Once the (3_{SING.MASC}) morpheme is no longer found in an absolute final word position, the elided material is unmistakably recovered as *hu* (which alternates with *ho* in closed syllables).⁵ The underlying structures in column (b) of Table 1.11 can thus be posited for the utterances in column (a).

⁵ In Egyptian Arabic, high vowels undergo lowering in closed syllables. Consider the final high vowels in the imperfective *tektebi* ‘you (SING.FEM) write’ and *tektebu* ‘you (PL) write’ when they get concatenated by different clitics (the vowels in question are underscored below).

| a. | b. |
|---|---|
| i. <i>tektebi</i> <u><i>i</i></u> <i>ʔu</i> (SING.FEM) <i>write</i> ’ | <i>tektebu</i> <u><i>u</i></u> <i>ʔu</i> (PL) <i>write</i> ’ |
| ii. <i>tektebi</i> <u><i>ih</i></u> <i>al</i> <i>na</i> <i>ʔu</i> (SING.FEM) <i>write it</i> (FEM) <i>to us</i> ’ | <i>tektebu</i> <u><i>uh</i></u> <i>al</i> <i>na</i> <i>ʔu</i> (PL) <i>write it</i> (FEM) <i>to us</i> ’ |
| iii. <i>tektebu</i> <u><i>el</i></u> <i>ha</i> <i>ʔu</i> (SING.FEM) <i>write to her</i> ’ | <i>tektebu</i> <u><i>ol</i></u> <i>ha</i> <i>ʔu</i> (PL) <i>write to her</i> ’ |

Vowels *i* and *u* above are subject to *lowering* in *closed* syllables; short {*i*, *u*} can only survive in an *open* syllable.

Table 1.11 mesektu: ‘you (PL) caught it (MASC)’ /mesek-tu + hu/

| a. | b. | Gloss |
|------------------------------|--------------------------------|-------------------------------------|
| i. [mesektu: ~ mesektu:h] | /mesek-tu + hu / | ‘you (PL) caught it (MASC)’ |
| ii. [mesektu hu :li] | /mesek-tu+ hu + l + i/ | ‘you (PL) caught it (MASC) for me’ |
| iii. [mesektu hol ha] | /mesek-tu+ hu + l + ha/ | ‘you (PL) caught it (MASC) for her’ |

Essentially, all long vowels in final open syllables involve (3_{SING.MASC}). In view of this argument, a drastic consequence immediately ensues for the distribution of long vowels. If all long vowels in final open syllables (CVV#) are followed by a latent morpheme like that shown in Table 1.12, then the claim articulated in (1.5) can be put forth.

Table 1.12 Every long vowel in a final open syllable is followed by a latent /hu/ morpheme

| a. | b. | Gloss |
|---------------------------|-------------------------|-----------------------------|
| i. [mesektu: ~ mesektu:h] | /mesek-tu + hu / | ‘you (PL) caught it (MASC)’ |
| ii. [korsi: ~ korsi:h] | /korsi+ hu / | ‘his chair’ |
| iii. [maʕa: ~ maʕa:h] | /maʕa+ hu / | ‘with him’ |

(1.5) Long vowels in CEA are not ‘final or penultimate’; they are exclusively penultimate.

Following from all what precedes, two conclusions can be drawn:

- (1.6) a. In CEA, vowel length must be conditioned
 b. In CEA, vowel length cannot be distinctive.

According to these conclusions, all of the previously observed problems will be resolved; namely the abnormal distribution of long vowels compared to short ones, the abnormal restrictiveness of length contrasts to a set of positions and a set of qualities.

However, if the conclusions in (1.6) are correct and if the assumption that “vowel length is contrastive in CEA” is rejected, then how can the relationship between {i and i:}, {u and u:}, {a and a:} be interpreted? Are they just allophonic variations?

Providing a satisfactory answer to this question, or at least the preliminary essential keys to a satisfactory answer, is the main objective of the next section. The discussion will be pursued in order to determine the implications of the difference in “vowel length” between {i and i:}, {u and u:}, {a and a:}.

Before doing so, we will stop briefly to consider the case of Moroccan Arabic (from now on MA) that will enhance our understanding of vowel length in CEA. The case of MA will be discussed in comparison with the Classical variety of Arabic (from now on CA). First, the basic aspects of the CA and MA vowel systems will be quickly reviewed. This is followed by a detailed analysis of the CEA data which reveals some striking similarities underlying both modern dialects. This will gradually lay the ground for a redefinition of vowel length in CEA.

Note that the point is not whether or not MA or CEA have CA as an input language. Rather, the comparative examination that will be provided is primarily intended to investigate the way in which the two contemporary dialects manage their vocalic material in comparison with each other and with the Classical variety.

1.5 Reinterpreting vowel length in Egyptian Arabic

1.5.1 The vocalization device of Classical Arabic and Moroccan Arabic

CA is well known for its three-vowel system which includes short and long cardinal vowels; this is seen in Chart 1.4 (a). If the CA vowel inventory is compared to that of MA in Chart 1.4 (b), two evident differences are revealed:

1. While a length contrast can be recognized for the three vowels {i, u, a} in CA, no clear phonetic length contrasts can be discerned for these three same vowels in MA. As a result, it does not seem possible to establish an underlying vowel length distinction in MA.
2. A fourth central high vowel *i* which does not exist in CA appears in the MA system.

Chart 1.4 The CA and MA vowel inventories

| a. CA | | b. MA | |
|-------|-------|-------|---|
| i, i: | u, u: | i | u |
| | | i | |
| | a, a: | a | |

In view of these divergences, a series of important questions have repeatedly been raised:

- 1) MA supposedly lost one series of vowels; why does this result in a four-vowel system, not in a three-vowel system?
- 2) Could there be any relationship between the loss of one series of vowels and this unexpected fourth vowel?

The set of data in Table 1.13 sheds light on the issue and leads up to the generalization in (1.7).⁶

⁶ The data – initially supplied by Mohand Guerssel – is adapted from Lowenstamm (1991, 2011), Kabbaj (1990) and Arbaoui (2002).

Table 1.13 The vocalic equipment of MA compared to CA

| | CA | MA | Gloss |
|-------|----------|--------|--------------------------------|
| i. | taktubu | tiktib | <i>'you (SING.MASC) write'</i> |
| ii. | katabna: | ktibna | <i>'we wrote'</i> |
| iii. | ħima:r | ħmar | <i>'donkey'</i> |
| iv. | kari:m | krim | <i>'generous'</i> |
| v. | ba:b | bab | <i>'door'</i> |
| vi. | labisu: | libsū | <i>'they put (clothes) on'</i> |
| vii. | muslim | mislim | <i>'muslim'</i> |
| viii. | kattaba | kittib | <i>'he made X write'</i> |

- (1.7) a. Where a word is attested in both Classical and Moroccan Arabic, the latter does not realize the short vowels of the Classical Arabic version, but retains the long vowels present therein.⁷
- b. More concretely, where CA has a short vowel, MA displays either the high central vowel *i* or no vowel at all.

In earlier structuralist views of vowel length, it was not possible to interpret the aforementioned differences between the CA and MA vocalizations seen in Table 1.13. Vowel length was construed as an inherent property of individual segments and thus represented at the phonemic level. In this view, both vowels in e.g. MA *ktibna* 'we wrote' are the same length; both are "short." However, with the emergence of theories that distinguish a skeletal tier, length was conceived of differently. Vowel length, under the prosodic theory in e.g. McCarthy (1981) is viewed as a consequence of the number of skeletal positions to which a vocalic expression is attached; a short or a long vowel by itself is no more recognized. A short vowel is a result of the mapping of the vocalic material onto a single V slot in the

⁷ The generalization articulated in (1.7a) appears in Lowenstamm (1991, 2011) following previous works that have brought forward very important aspects of the vowel systems of both Classical Arabic and Moroccan Arabic. The reader is referred to the following resources for further discussion: McCarthy (1979a, 1981), Kaye, Ech-chadli and El Ayachi (1986), Heath (1987, 2002, 2003), Kaye, Lowenstamm and Vergnaud (1990), Guerssel and Lowenstamm (1990, 1996), Kaye (1990b), Kabbaj (1990), McCarthy and Prince (1990b), Caubet (1993), El Medlaoui (1998, 2000), Arbaoui (2002), Benbraham (2004), Lampitelli (2005), Boueddine (2011), and references therein.

CV-skeleton whereas a long vowel is a result of linking the vocalic substance to two V skeletal positions.

(1.8) Vowel length reformulated in the prosodic theory

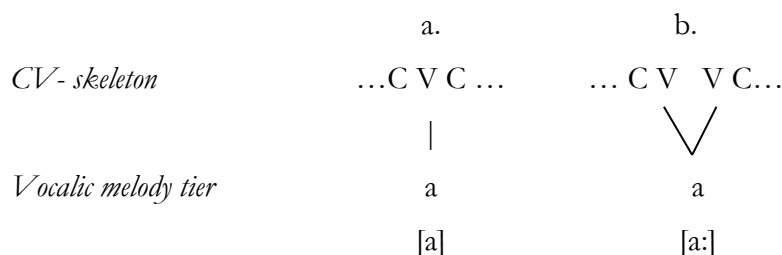

Within the subsequent CVCV model initiated in Lowenstamm (1996), a notable reduction of the number of the classical arboreal syllabic constituents is posited; syllable structure is reduced to CV. The model assumes a systematic alternation between *non-branching onsets* and *non-branching nuclei*, with one-to-one correspondence between syllabic constituents and skeletal slots. The constituent coda is excluded from the structure, or rather construed as the onset of a following CV unit. Two adjacent consonants (two Onsets) on the surface must, in this view, be separated by a phonetically empty nucleus, and an empty onset can be either straddled by a long vowel, or it can intervene between two adjacent vowels in languages allowing hiatus.⁸ Length is represented in this framework as a segmental expression linked to two units of the same type separated by an empty unit of a different type. A geminate results from the identification of two C units surrounding an empty V unit in-between; see (1.9b).

(1.9)

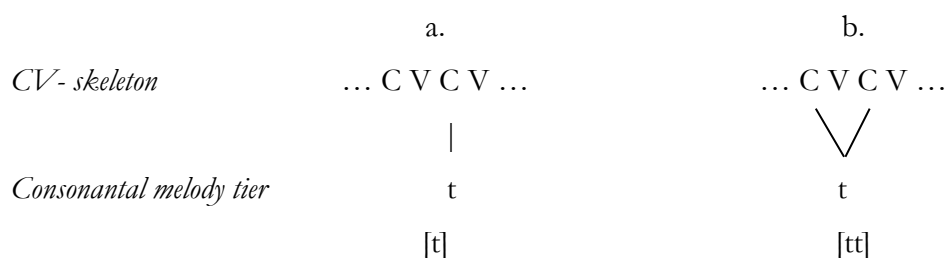

⁸ For a detailed discussion of this model and the motivations behind its development, cf. Lowenstamm (1996) and Scheer (2004).

Similarly, a long vowel is represented as two identified V units (two Nuclei) flanking a non-identified C unit (an empty onset); this is seen in (1.10b).

(1.10) Vowel length in the CVCV model

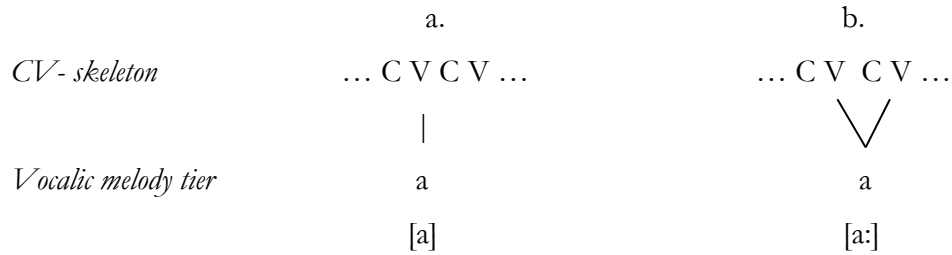

With the availability of these theoretical resources, the difference between e.g. the CA word *ħima:r* vs. MA *ħmar* ‘donkey’ can be readily accounted for as in (1.11). Peripheral vowels are maintained if and only if two vocalic units are available. If not, delinking ensues.

(1.11)

a. Classical Arabic

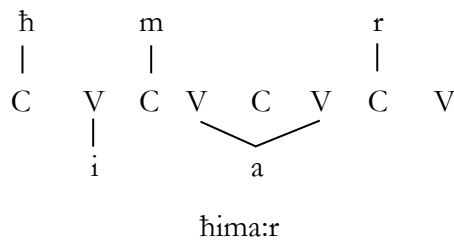

b. Moroccan Arabic

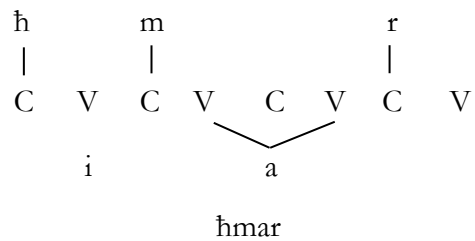

Peripheral vowels thus never ceased to be “long” in MA. As for short peripheral vowels, they have not necessarily been lost; rather, MA lost the ability to *attach* short peripheral vowels to single skeletal positions, i.e. non-branching nuclei in the conventional syllabic terms. This situation is referred to in Lowenstamm (1991, 2011) as the “*loss of brevity of peripheral vowels thesis*.” This thesis can be formally expressed as in (1.12) and its consequences are specified in (1.13).⁹

⁹ For further details, cf. Lowenstamm (1991, 2011).

(1.12) *i, u* and *a* must branch.

(1.13) a. A vowel delinks unless attached to two Vs (i.e. it is long).

b. Delinking does not necessarily entail vowel loss.

c. Templatic structure is unaffected by delinking. (i.e. everything being equal, MA inherits the templatic structure of CA for the relevant items)

Delinking, as just described, entails massive proliferation of consonantal sequences in MA. CA *taktubu* ‘you (SING.MASC) write’ for example will yield **tktb* in MA, as sketched out in (1.14).

(1.14)

| | | | | | | | | | |
|----|--------------------------|---|---|---|---|---|---|---|---|
| CA | | t | a | k | | t | u | b | u |
| | | | | | | | | | |
| | | C | V | C | V | C | V | C | V |
| | <i>delinked material</i> | | a | | | | u | | u |
| MA | | t | | k | | t | | b | |

CA *taktubu* vs. hypothetical MA **tktb*

However, the actual form is *tiktib*, some consonant sequences are allowed while others are broken in well-determined points; the high central vowel *i* appears to the left of empty nuclei. Clearly, the intervention of vowel *i* is purely phonotactic. The alternation {*i*/empty nucleus} reflects the economy of MA’s epenthetic system (Kaye, 1990b). According to the postulates of standard Government Phonology developed in Kaye, Lowenstamm and Vergnaud (1990), government is defined as a binary asymmetric relation between two skeletal positions, one of which is the governor while the other is the governee. Good governors must have phonetic content.¹⁰ A nuclear position is said to be licensed to remain empty if it is properly governed (PG). In other words, an empty nucleus always requires government from the following contentful one; otherwise, epenthetic material is inserted. This situation is

¹⁰ The reader is referred to Kaye (1990b), Kaye, Lowenstamm and Vergnaud (1990), Charette (1990), Yoshida (1990, 1996), Scheer (1998a) for further discussion of Government Phonology.

expressed under the Empty Category Principle (ECP) in Kaye, Lowenstamm and Vergnaud (1990) as follows:

- (1.15) Empty skeleton positions are subject to a special form of government, they must be properly governed.

The ECP accounts for the vowel/zero alternations in MA, i.e. the alternations {*i*/empty nucleus} where the zero variant appears under proper government. An empty nuclear position (a V skeletal slot) is licensed if and only if properly governed. Consequently, if one nucleus can supposedly govern another and the direction of government is defined from right to left, it will be possible to characterize the contexts in which an empty nucleus is or is not realized phonetically; this is illustrated in (1.16). Note that proper government (PG) is hereafter indicated by non-interrupted lines and lack of proper government (*PG) is indicated by interrupted lines.

- (1.16) MA *tiktib* and the distribution of vowel *i*

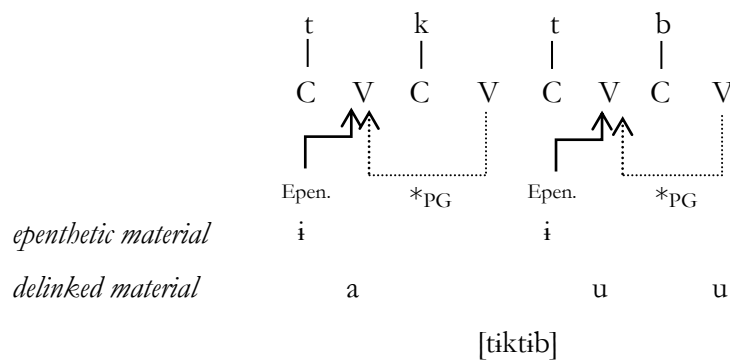

As a result and in terms of templatic space, the two vowels in the MA *kt**ib**na* will be of different lengths. Consider in this view the comparative analysis between CA *katabna*: and MA *kt**ib**na* ‘we wrote’ demonstrated in (1.17). The peripheral vowel *a* in MA *kt**ib**na* is a vocalic expression occupying two nuclear positions while the high central vowel *i* identifies a single V position.

The comparative analyses of CA *taktubu* vs. CEA *tekteb* ‘you (SING.MASC) write’ and CA *labisu:* vs. CEA *lebsu* ‘they put (clothes) on’ reveal a clear case of the dissociation of short {i, u, a} vowels in the modern Egyptian variety. That is, {i, u, a} vowels delink if they are not attached to two V positions; this is illustrated in (1.18).

(1.18)

| | | | | | | | | |
|-----|----|---|----|---|---|---|---|---|
| | a. | | b. | | | | | |
| CA | t | a | k | t | u | b | u | |
| | | | | | | | | |
| | C | V | C | V | C | V | C | V |
| | | | | | | | | |
| CEA | t | e | k | t | e | b | | |

| | | |
|---------------------------|--|--------------------------|
| CA taktubu vs. CEA tekteb | | CA labisu: vs. CEA lebsu |
|---------------------------|--|--------------------------|

The representations above point to the following facts:

1. CA peripheral vowels are not manifested in the CEA parallel forms unless they branch.
2. Non-branching vowels are systematically substituted in CEA by *e* or by nothing at all.
3. The distribution of vowel *e* (to the left of empty nuclei) is government-dependent.

Accordingly, the following principle can be identified as one of the keys for understanding the CEA system:

(1.19) *i, u* and *a* must branch.

b.

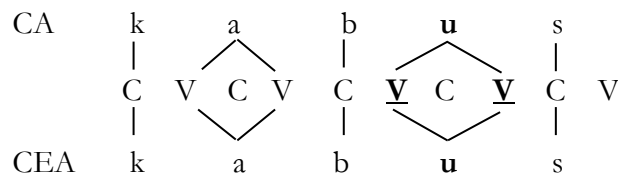

CA ka:bu:s vs. CEA kabu:s

c.

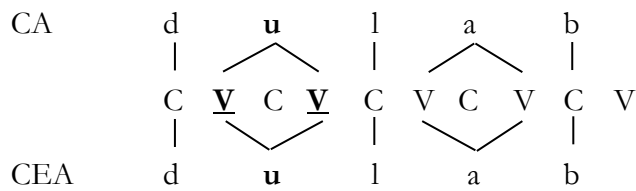

CA du:la:b vs. CEA dula:b

The problem can be stated as follows:

1. All of the three *u* vowels in CEA correspond to long ones in CA.
2. The two templatic V slots permit the explicit expression of the three *u* vowels in CEA, i.e. they are all phonologically long.
3. Although all are similarly branching, the *u* in CEA *kabu:s* compared to those in *lebsu* and *dula:b* is phonetically much longer.
4. Although similarly branching, *u* and *a* in CEA *kabu:s* and *dula:b* (see 1.21b and c) exhibit different phonetic length.

Two questions ensue:

- 1) Why do the three *u* vowels in CEA *kabu:s*, *lebsu* and *dula:b* not exhibit identical phonetic length although they are endowed (per hypothesis) with identical phonological length?
- 2) Why does *u* not exhibit the same phonetic length as *a*, as in CEA *kabu:s* and *dula:b*, although both are endowed (per hypothesis) with similar phonological length?

The answer to these two questions will immediately follow once the “stress position” in the utterances under investigation is considered. When the workings of stress are understood, we can determine why the *u* in *kabú:s* displays “phonetic length” contrary to the *u* in *lébsu* and *dulá:b* in CEA. The *u* in *kabú:s* is simply “stressed” differently from the other two; consider Table 1.16.

Table 1.16 Branching vowels in CEA and differential phonetic length due to stress

| | a. Vowel <u> </u> | b. Stress | b. Phonological length (i.e. 2 V slots) | c. Phonetic length | Gloss |
|------|---------------------|------------|--|-----------------------|--------------------------------|
| i. | [lébs <u>u</u>] | unstressed | + | - | <i>‘they put (clothes) on’</i> |
| ii. | [kab <u>ú</u> :s] | stressed | + | + | <i>‘nightmare’</i> |
| iii. | [d <u>u</u> láb] | unstressed | + | - | <i>‘wardrobe’</i> |

Likewise, when the CEA *kabú:s* and *dulá:b* are considered, it becomes obvious that the vowel perceived as phonetically longer than the other is the one under stress.

This result is documented under (1.22) and formally expressed afterward in (1.23).

(1.22) “Stress” phonetically validates the length of an already “phonologically long” vowel.

(1.23)

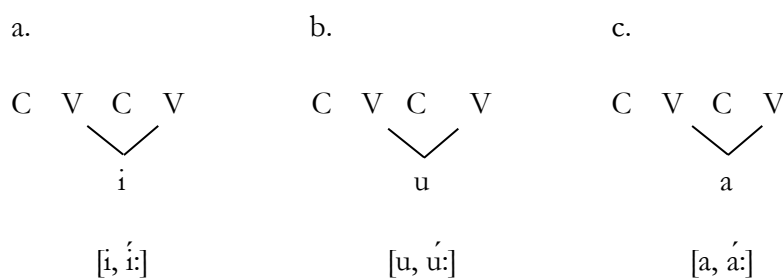

Phonological length, phonetic duration and the influence of stress are discussed in detail in chapter 5, section 5.3.

To conclude:

1. In CEA, {i, u, a} vowels must *branch* in order to overtly surface.
2. Non-branching {i, u, a} *dissociate* and the corresponding templatic nuclear position either remains unidentified or is phonetically interpreted by means of {e}.
3. Only under stress is a *phonologically* long {i, u, a} vowel realized with explicit *phonetic* length. All of the following vowels [i, í:], [u, ú:], [a, á:] exhibit identical *phonological* length; their *phonetic* length differs according to whether or not they bear stress.

It seems, for the first time, quite possible to characterize vowel length in CEA in terms other than as “an inherent property of vowels.” According to a vowel’s surface quality, the number of templatic nuclear positions to which it is attached can be inferred.

In light of the afore-stated conclusions, one last yet important issue will require to be addressed, that is the dissociated vocalic material. The loss of brevity thesis implies a proliferation of unrealized vowels, the ones that are phonetically interpreted as [Ø] or [e] in CEA.¹¹ If delinked vowels are present on the phonological level, the question that naturally follows is whether this phonetically unrealized material can be detected. In the remaining part of this chapter, I will present two cases that show concrete evidence of this “covert” material. First, final empty nuclei in CEA are brought into discussion to illustrate how a delinked vowel can be inferred by its impact on neighboring ones. Then a brief consideration of the singular feminine nominal marker, where a dissociated latent vowel can be completely recovered, is provided.

¹¹ [Ø] is the zero marker for nothing.

1.5.3 What final vowels can reveal

The status of final vowels in CEA can be accurately illustrated by means of the subject inflectional morphemes appearing on verbs in the perfective aspect. Consider the representative piece of data in Table 1.17.

Table 1.17 CA labis- /CEA lebes- √lbs ‘put (clothes) on’ perfective paradigm

| | | CA | CEA |
|------|-----------------------|----------|---------|
| i. | 1 _{PL} | labisna: | lebesna |
| ii. | 1 _{SING} | labistu | lebest |
| iii. | 3 _{SING.FEM} | labisat | lebset |

Factoring out the perfective stems CA labis- and CEA lebes- in Table 1.17, the following inflectional endings can be established:

Table 1.18 Subject inflectional morphemes

| | | CA | CEA |
|------|-----------------------|-------|------|
| i. | 1 _{PL} | – na: | – na |
| ii. | 1 _{SING} | – tu | – t |
| iii. | 3 _{SING.FEM} | – at | – et |

Consideration of the above inflectional suffixes leads to the following outcome:

(1.24)

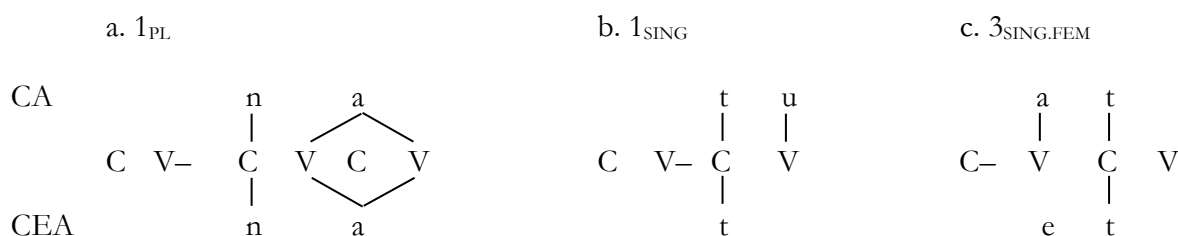

delinked material

–na: vs. –na

–tu vs. –t

–at vs. –et

Two categorical distinctions can be established for final closed syllables in CEA:

1. Closed syllables followed by silent nuclei *emptied* from their phonetic vocalic content (i.e. a nuclear vacuity resulting from delinking); this is exemplified by the underlined V in (1.27a).
2. Closed syllables followed by empty nuclei that never had any vocalic content in the first place, neither in CA nor in CEA; this is exemplified by the underlined V in (1.27b).

The contrast depicted in (1.27) indicates that not all final “phonetically silent” nuclei in CEA necessarily stem from “phonologically contentless” ones. This distinction can be further specified as follows:

1. Some final consonants can be reanalyzed as onsets of virtually open syllables.
2. Some final consonants are onsets of empty nuclei.

An important piece of evidence that stands in support of this asymmetry is vowel *e* intervening between the verbal stem and the feminine marker in CEA *lebs-et* ‘she put (clothes) on,’ contrary to its absence in the case of (1_{SING}) in CEA *lebes-t* ‘I put (clothes) on.’ According to Government Phonology, this divergence automatically results from the ECP:

(1.28)

a.

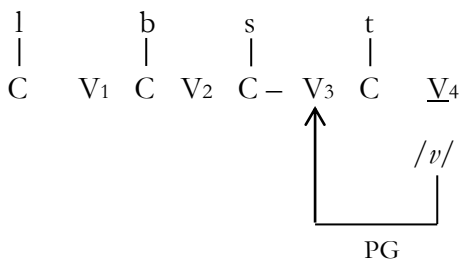

lebest

b.

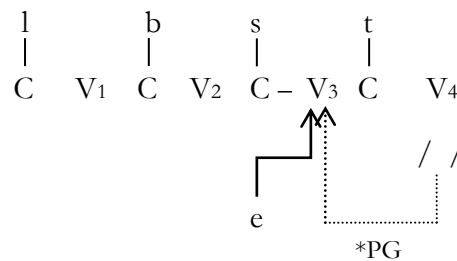

lebset

The emptiness of the vocalic position separating the verbal stem -lebes- and the morpheme -t in (1.28a) indicates a perfect condition of well-formedness. The unbreakable {...s-t} sequence suggests a dormant governor occupying V₄ (underscored). If the latter V position was phonologically empty, the {...s-t} sequence would have been split up by

epenthetic material to repair two empty nuclei occurring in a row, hence {...set}. This is exactly what happens in (1.28b). The phonetic interpretation of V₃ as *e* in *lebs-et* indicates the absence of any governor and therefore witnesses the true emptiness of the nuclear position on its right.

Thus, two important conclusions can be drawn:

1. In CEA, not all final vocalic positions projected as “zero” on the surface are structurally dead (i.e. phonologically empty).
2. CEA presents two types of final governors:
 - a. Governors that enjoy explicit phonetic and phonological content (i.e. conventional governors); let us call them Governor Type 1. This type of governors is exemplified by the final *a* in *lebesna* ‘we put (clothes) on’; see (1.29a).
 - b. Governors that were evacuated from their concrete phonetic vocalic content (*v* in 1.29b). These governors involve a latent, yet structurally active nucleus. They are exemplified by the final silent nucleus in *lebest* ‘I put (clothes) on’ where two empty nuclei “appear” to occur in a row. We will call them Governor Type 2.
 - c. In CEA, there is a category of final nuclei that can be characterized as both phonologically and phonetically “contentless.” This type is exemplified by the final empty nucleus in *lebset* ‘she put (clothes) on.’ These nuclei are not governors; see (1.29c).

(1.29)

a. Governors Type 1

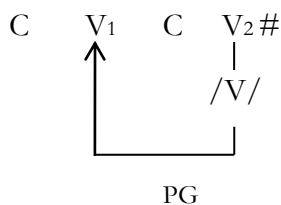

Epenthesis: not required

CCV# *lebesna*

b. Governors Type 2

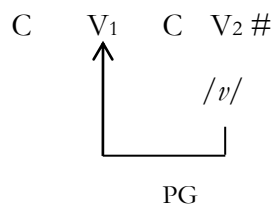

CC# *lebest*

c. Non-governors

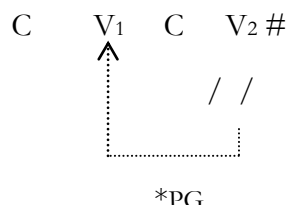

Epenthesis: required

*CC# → C_vepenC# *lebset*

Understanding the status of *final* phonetically silent nuclei, and to which class of governors they belong, can therefore be inferred from the *impact* those final nuclei have on the *pre-final* ones. This is expressed as follows:

(1.30) CEA is a language that permits two types of final phonetically content-empty governors. CEA is a language in which the sequence CC# is grammatical.

In the next section, another case will be brought to light just to show the following: unrealized vowels can explicitly reveal themselves. They can overtly materialize under favorable circumstances.

1.5.4 When allomorphy gets involved: the “singular feminine nominal marker”

CEA maintains a noun inventory divided into two different genders, according to the different agreement they trigger, masculine and feminine. No other gender can be discerned. The diagnostic suffix of feminine gender on nouns as well as on adjectives in CEA is [a]. However, once feminine nouns are realized as first members of a construct state configuration (CS), this suffix seemingly disappears and is replaced by [(e)t].¹² In Table 1.19 the feminine noun *ga:ra* ‘neighbor (FEM),’ which has been chosen for allowing all of the variations that can be presented by the feminine suffix, is displayed in the free state, in the CS (where the second term of the genitive construct may be either a noun or a possessive pronoun), as well as in the dual.

¹² The construct state is a characteristic feature of Semitic languages. It simply consists of the juxtaposition of two nouns and indicates a possessive or limiting relationship between the two (Thackston, 1994).

Table 1.19 The feminine singular nominal marker in CEA

| | Feminine noun | Gloss | Isolated feminine marker |
|----------------------|------------------|------------------------|--------------------------|
| a. Free state (SING) | i. ga:ra | 'neighbor (FEM)' | -a |
| b. CS | ii. ga:ret ma:ma | 'mom's neighbor (FEM)' | -et |
| | iii. Garetha | 'her neighbor (FEM)' | -et |
| | iv. garti | 'my neighbor (FEM)' | -t |
| c. Dual | v. garte:n | 'two neighbors (FEM)' | -t |

The pattern illustrated in Table 1.19 exhausts all the distributional possibilities for the feminine marker on nouns in CEA. It is clear that no noun can be spelled out with the bare *-a* morpheme in any CS. The [a] allomorph is limited to the free state. Conversely, no noun can end with *-(e)t* in the free state. Hypothetical combinations like *g:ara ma:ma 'mom's neighbor (FEM)', *gara:ha 'her neighbor (FEM)' or *ga:ret 'neighbor (FEM)' are out of the question. In other words, *-a* and *-(e)t* are in strict complementary distribution.

(131)

| | Construct state | Free state |
|-------|-----------------|------------|
| -a | - | + |
| -(e)t | + | - |

This complementary distribution can, in fact, be directly accounted for through the following key principle: surface vowel quality is entirely dependent on the underlying templatic architecture. Only under this principle can it be explained that one single morpheme */-at/* is substantiated in two or even three different guises. Details concerning the derivation of the CS lie beyond the scope of this study, and I will immediately offer my proposal in the analysis sketched out in (1.32).

(1.32)

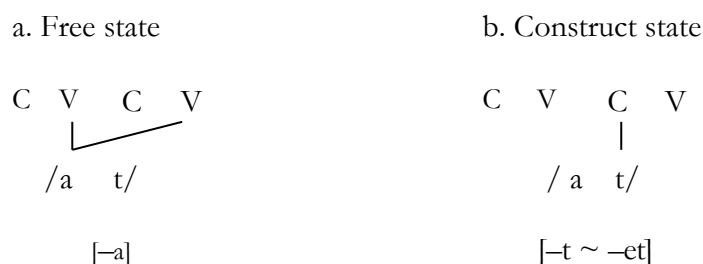

The configurations depicted above show why the vocalic component [a] and the consonantal component [t] of a unique morpheme /at/ are never realized conjointly. No space is sufficient for both ingredients of the conjectured morpheme to be actualized simultaneously. In (1.32), two possible options can result from an underlying material /at/ that tries to saturate fix-sized template:

- a. Option 1: the /a/ component branches and therefore preserves its melody; this is seen in (1.32a), or
- b. Option 2: the attachment of the component /t/ in the CS renders the delinking of /a/ inevitable; this is seen in (1.32b).

Any malformations resulting from illegitimate consonant clusters in Option 2 are directly handled by the epenthetic mechanism. To clarify this point, a piece of data seen earlier is reiterated in Table 1.20 below. The morpheme /at/ can be actualized as *-et* as in *garetha* ‘her neighbor’ to break the 3-consonant {...rth...} sequence, or as *-t* as in *garti* ‘my neighbor’ where epenthesis is not required.

Table 1.20 The role of epenthesis in the allomorphy

| | Feminine noun | Gloss | Isolated feminine marker |
|----------------------|---------------|----------------------|--------------------------|
| a. Free state (SING) | i. ga:ra | ‘neighbor (FEM)’ | -a |
| b. CS | ii. garetha | ‘her neighbor (FEM)’ | -et |
| | iii. garti | ‘my neighbor (FEM)’ | -t |

The epenthetic scenario is illustrated in (1.33) with the dissociated component indicated between brackets.

(1.33)

a.

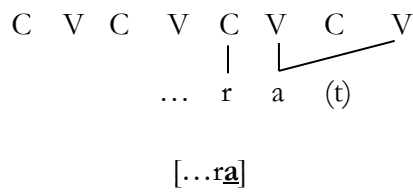

b.

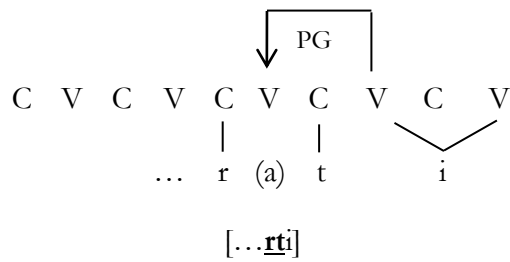

c.

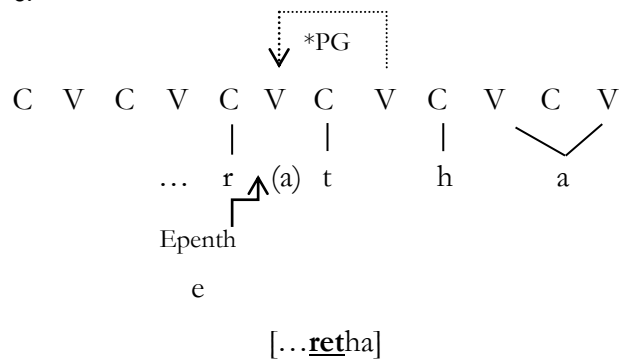

Endorsing the previous representation of the nominal feminine singular morpheme carries an evident consequence; the delinking of a short vowel does not necessarily entail its loss from the lexical level. A dissociated vowel due to insufficient templatic space might reappear whenever the favorable conditions are present.¹³

¹³ Evidence of a different kind (the case of (3_{SING.FEM}) subject pronoun in Moroccan Arabic) is provided in Lowenstamm (2011).

1.7 Concluding remarks

In this chapter, I have examined vocalic length in Egyptian Arabic. The need for this examination stemmed from the following observations:

1. In languages exhibiting vowel length contrast, the distribution of long vowels tends to be equivalent to that of short vowels. In Egyptian Arabic, a language in which vowel length appears to be contrastive, the distribution of long vowels is in fact much more restricted than that of short vowels. While the latter are freely distributed, long vowels are limited to the ultimate and penultimate positions of the word.
2. In languages with a vowel length contrast, length distinctions are usually possible in the word positions capable of accommodating long vowels. In Egyptian Arabic, a language in which vowel length is reputed to be contrastive, vowel length distinctions are possible in word final position only.
3. In languages with vowel length contrast, length distinctions are usually not quality-related. In Egyptian Arabic, a language in which vowel length appears to be contrastive, the establishment of length contrasts seems to be reserved to the set of cardinal vowels.

The assessment of the position in which a vowel length contrast can be recognized led to following conclusions:

1. In Egyptian Arabic, vowel length must be conditioned.
2. In Egyptian Arabic, vowel length cannot be distinctive.

These results raised the important question of how to define the difference between {i, u, a} and {i:, u:, a:}. This difference was the initial motive for assuming the contrastive role of vowel length.

The comparison of Egyptian Arabic and Moroccan Arabic laid the ground for the redefinition of vocalic length in the former. In both modern dialects, it can be argued that it is not (anymore) the vowel that possesses length or shortness per se. Rather, vowel length can

be defined in terms of the number of nuclear positions to which a vowel is attached. This occurs through the following conditions:

1. Peripheral vowels {i, u, a} must be attached to two nuclear positions in order to explicitly express their peripheral quality, otherwise they delink. (i.e. *i, u, a* must branch)
2. Peripheral vowels {i, u, a} associated to one templatic position are interpreted, according to the phonotactics of the language by means of:
 - a. An empty nucleus (hence nothing).
 - b. An epenthetic vowel, the high central vowel in Moroccan Arabic and the short anterior mid-vowel in Egyptian Arabic.

The difference between the series {i, u, a} and {i:, u:, a:} that was previously interpreted as motivating a length contrast in Egyptian Arabic was redefined as the effect of stress. Arguments have been presented to show that both the “short” and “long” series exhibit the same phonological length. Specifically, both branch to identify two nuclear positions. It is due to stress that “phonological length” in the {i:, u:, a:} series is implemented as “phonetic length.”

(1.34)

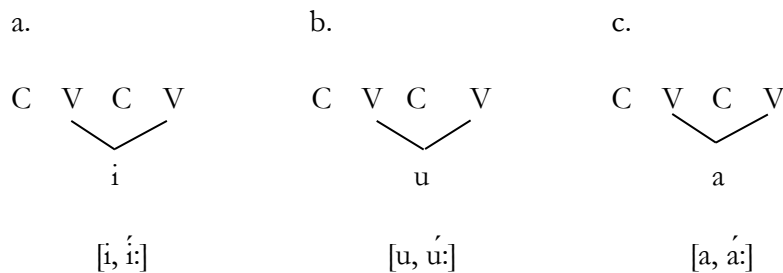

This view of vocalic length motivated our discussion of final nuclei in Egyptian Arabic. The most important results are the following:

1. The distinction of two types of final empty nuclei.
2. The identification of two types of final governors.

The endorsement of the “loss of brevity thesis” in Egyptian Arabic can further be supported by the repeatedly reported case of allomorphy concerning the singular feminine nominal marker that alternates between [a] and [(e)t]. Arguments demonstrated that both allomorphs involve the same underlying morpheme /at/.

Chapter 2

The Formal Representation of Mid-vowels in Egyptian Arabic

2.1 Introduction

As we just saw in the preceding chapter, Egyptian Arabic presents much evidence for the loss of brevity thesis established for Moroccan Arabic. While the loss of brevity thesis can successfully account for the rise of the high central vowel in the vocalic inventory of Moroccan Arabic, it is also apparent that Egyptian Arabic manages its emptied nuclei without the help of such a vowel. This is due to the simple reason that, contrary to Moroccan Arabic, Egyptian Arabic has short vowels, *e* and *ø*. Two main issues therefore lead to the need for studying the organization of the Egyptian Arabic vowel system. First, why would Egyptian Arabic employ the anterior mid-vowel in an epenthetic capacity and not a high central vowel like in Moroccan Arabic? Second, why would Egyptian Arabic employ the anterior mid-vowel for that purpose and not the posterior mid-vowel (or any other vowel)?

The main aim of this chapter is therefore to determine the parameters involved in deriving the vowel system of Egyptian Arabic. This is possible through the Theory of Elements proposed in Kaye, Lowenstamm and Vergnaud (1985), which provides basic principles for interpreting the makeup of vowels and how vowels form systems.

The chapter is organized as follows: in section 2, the consequences of “loss of brevity” are considered in both Moroccan Arabic and Egyptian Arabic, which will help sharpen the questions in section 3. In section 4, the parameters underlying the organization of the vowel system of Egyptian Arabic are discussed and the strategies through which Egyptian Arabic interprets empty nuclei are brought to light. This will finally introduce the discussion of the Egyptian Arabic mid-vowels in section 5.

2.2 Considering the “loss of brevity thesis”

2.2.1 In Moroccan Arabic

The comparative analysis of MA and relevant CA data led to the loss of brevity thesis for MA as we saw in sections 1.5.1 and 1.5.2 of the preceding chapter. Peripheral vowels in MA must be attached to two vocalic positions in the template; otherwise they delink and cannot overtly surface. Delinking in MA entails a proliferation of empty nuclei which are filled in (or left empty) according to the phonotactics of the language, specifically the ECP.¹⁴ Let us focus once more on the consequences of delinking in MA by examining the series of data shown in Table 2.1 and represented in (2.1).¹⁵ It is important to note the phonetic alternatives to the three peripheral vowels {i, u, a}.

Table 2.1 Delinking of short {i, u, a} vowels in MA

| | CA | MA | Gloss |
|------|---------|--------|--------------------------------|
| i. | taktubu | tiktib | <i>'you (SING.MASC) write'</i> |
| ii. | labisu: | libsu | <i>'they put (clothes) on'</i> |
| iii. | muslim | mislīm | <i>'muslim'</i> |
| iv. | kattaba | kittib | <i>'he made X write'</i> |

(2.1)

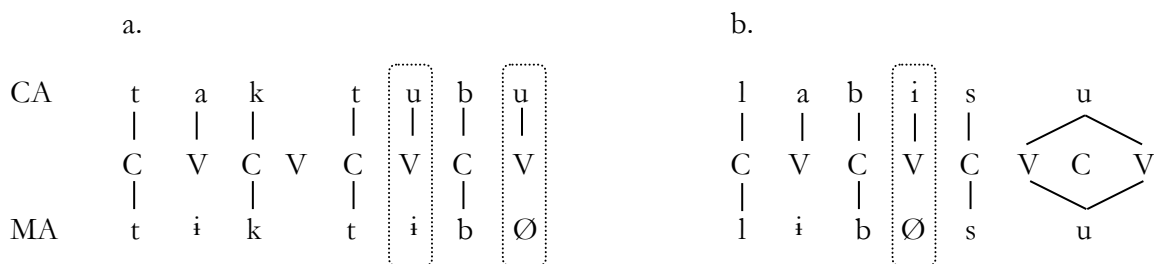

CA labisu: vs. MA libsu

¹⁴ See the brief discussion of the Empty Category Principle in chapter 1, section 1.5.1.

¹⁵ The whole set of data was previously seen in Table 1.13 in section 1.5.1.

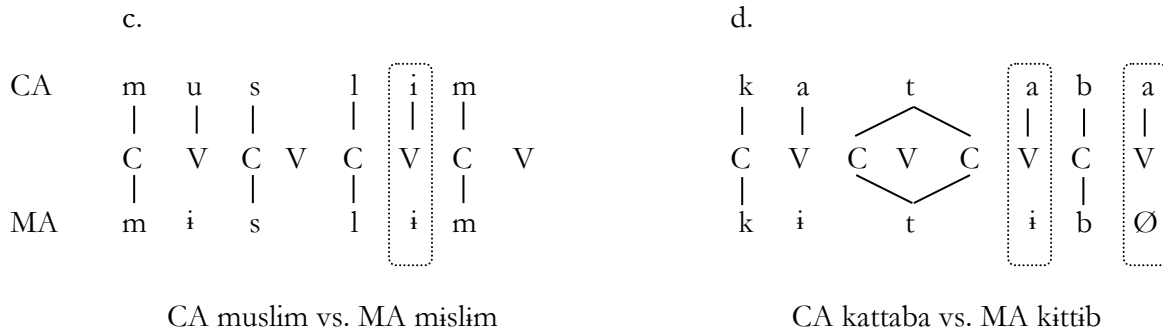

The analyses in (2.1) lead to the following conclusion: the phonetic alternatives to each of the non-branching peripheral vowels are either [i] or [Ø]. This result can be ascertained for the delinked /i/ in (b) and (c), for the delinked /u/ in (a), and for the delinked /a/ in (d), the boxed portions in the representations in (2.1). This can be summarized as follows:

(2.2) In MA: non-branching {i, u, a} → {i/Ø}

(2.3)

| | |
|-----------|---|
| C | V |
| /i, u, a/ | |
| [i/Ø] | |

2.2.2 In Egyptian Arabic

The comparative analysis of the CEA and the equivalent CA data suggests that the Egyptian variant is also consistent with the loss of brevity thesis. To become audible in CEA, {i, u, a} vowels must branch. Delinking of {i, u, a} in CEA also entails a systematic replacement by either an empty nucleus or a noise interpreting an empty nucleus. Let us focus now on the consequences of delinking in CEA by examining the data in Table 2.2 and represented in (2.4). We will examine the phonetic alternatives to {i, u, a} when the latter cannot meet the branching requirement.

Table 2.2 Delinking of short {i, u, a} vowels in CEA

| | CA | CEA | Gloss |
|------|---------|--------|-------------------------|
| i. | taktubu | tekteb | 'you (SING.MASC) write' |
| ii. | labisa | lebes | 'he put (clothes) on' |
| iii. | laʕib | leʕb | 'playing (verbal noun)' |

(2.4)

| | a. | b. | c. | | | | | | | | | | | | | | | | | | | | | | | | | | | | | | | | | | | | | | | | | | | | | | | | | | | | | | | | | | | | | | | | | | | | | | | | |
|-----|--|-------------------------|-----------------------|---|---|---|---|---|--|---|---|---|---|---|---|--|---|---|---|---|---|---|--|--|--|--|--|--|--|--|---|---|---|---|---|---|--|--|--|--|--|--|---|---|---|---|---|---|--|--|--|--|--|--|--|---|---|---|---|---|--|--|--|--|--|---|---|---|---|---|--|--|--|--|--|
| CA | <table style="margin: auto;"> <tr><td>t</td><td>a</td><td>k</td><td>t</td><td>u</td><td>b</td><td>u</td></tr> <tr><td> </td><td> </td><td> </td><td> </td><td> </td><td> </td><td> </td></tr> <tr><td>C</td><td>V</td><td>C</td><td>V</td><td>C</td><td>V</td><td>C</td></tr> <tr><td> </td><td> </td><td> </td><td> </td><td> </td><td> </td><td> </td></tr> </table> | t | a | k | t | u | b | u | | | | | | | | C | V | C | V | C | V | C | | | | | | | | <table style="margin: auto;"> <tr><td>l</td><td>a</td><td>b</td><td>i</td><td>s</td><td>a</td></tr> <tr><td> </td><td> </td><td> </td><td> </td><td> </td><td> </td></tr> <tr><td>C</td><td>V</td><td>C</td><td>V</td><td>C</td><td>V</td></tr> <tr><td> </td><td> </td><td> </td><td> </td><td> </td><td> </td></tr> </table> | l | a | b | i | s | a | | | | | | | C | V | C | V | C | V | | | | | | | <table style="margin: auto;"> <tr><td>l</td><td>a</td><td>ʕ</td><td>i</td><td>b</td></tr> <tr><td> </td><td> </td><td> </td><td> </td><td> </td></tr> <tr><td>C</td><td>V</td><td>C</td><td>V</td><td>C</td></tr> <tr><td> </td><td> </td><td> </td><td> </td><td> </td></tr> </table> | l | a | ʕ | i | b | | | | | | C | V | C | V | C | | | | | |
| t | a | k | t | u | b | u | | | | | | | | | | | | | | | | | | | | | | | | | | | | | | | | | | | | | | | | | | | | | | | | | | | | | | | | | | | | | | | | | | | | | |
| | | | | | | | | | | | | | | | | | | | | | | | | | | | | | | | | | | | | | | | | | | | | | | | | | | | | | | | | | | | | | | | | | | | | | | | | | | | |
| C | V | C | V | C | V | C | | | | | | | | | | | | | | | | | | | | | | | | | | | | | | | | | | | | | | | | | | | | | | | | | | | | | | | | | | | | | | | | | | | | | |
| | | | | | | | | | | | | | | | | | | | | | | | | | | | | | | | | | | | | | | | | | | | | | | | | | | | | | | | | | | | | | | | | | | | | | | | | | | | |
| l | a | b | i | s | a | | | | | | | | | | | | | | | | | | | | | | | | | | | | | | | | | | | | | | | | | | | | | | | | | | | | | | | | | | | | | | | | | | | | | | |
| | | | | | | | | | | | | | | | | | | | | | | | | | | | | | | | | | | | | | | | | | | | | | | | | | | | | | | | | | | | | | | | | | | | | | | | | | | | |
| C | V | C | V | C | V | | | | | | | | | | | | | | | | | | | | | | | | | | | | | | | | | | | | | | | | | | | | | | | | | | | | | | | | | | | | | | | | | | | | | | |
| | | | | | | | | | | | | | | | | | | | | | | | | | | | | | | | | | | | | | | | | | | | | | | | | | | | | | | | | | | | | | | | | | | | | | | | | | | | |
| l | a | ʕ | i | b | | | | | | | | | | | | | | | | | | | | | | | | | | | | | | | | | | | | | | | | | | | | | | | | | | | | | | | | | | | | | | | | | | | | | | | |
| | | | | | | | | | | | | | | | | | | | | | | | | | | | | | | | | | | | | | | | | | | | | | | | | | | | | | | | | | | | | | | | | | | | | | | | | | | | |
| C | V | C | V | C | | | | | | | | | | | | | | | | | | | | | | | | | | | | | | | | | | | | | | | | | | | | | | | | | | | | | | | | | | | | | | | | | | | | | | | |
| | | | | | | | | | | | | | | | | | | | | | | | | | | | | | | | | | | | | | | | | | | | | | | | | | | | | | | | | | | | | | | | | | | | | | | | | | | | |
| CEA | <table style="margin: auto;"> <tr><td>t</td><td>e</td><td>k</td><td>t</td><td>e</td><td>b</td><td>∅</td></tr> </table> | t | e | k | t | e | b | ∅ | <table style="margin: auto;"> <tr><td>l</td><td>e</td><td>b</td><td>e</td><td>s</td><td>∅</td></tr> </table> | l | e | b | e | s | ∅ | <table style="margin: auto;"> <tr><td>l</td><td>e</td><td>ʕ</td><td>∅</td><td>b</td></tr> </table> | l | e | ʕ | ∅ | b | | | | | | | | | | | | | | | | | | | | | | | | | | | | | | | | | | | | | | | | | | | | | | | | | | | | | | |
| t | e | k | t | e | b | ∅ | | | | | | | | | | | | | | | | | | | | | | | | | | | | | | | | | | | | | | | | | | | | | | | | | | | | | | | | | | | | | | | | | | | | | |
| l | e | b | e | s | ∅ | | | | | | | | | | | | | | | | | | | | | | | | | | | | | | | | | | | | | | | | | | | | | | | | | | | | | | | | | | | | | | | | | | | | | | |
| l | e | ʕ | ∅ | b | | | | | | | | | | | | | | | | | | | | | | | | | | | | | | | | | | | | | | | | | | | | | | | | | | | | | | | | | | | | | | | | | | | | | | | |
| | CA taktubu vs. CEA tekteb | CA labisa vs. CEA lebes | CA laʕib vs. CEA leʕb | | | | | | | | | | | | | | | | | | | | | | | | | | | | | | | | | | | | | | | | | | | | | | | | | | | | | | | | | | | | | | | | | | | | | | | | |

The analyses in (2.4) reveal the following: the phonetic alternatives to each of the non-branching {i, u, a} vowels are either [e] or [∅]. This result can be established for the delinked /i/ in (b) and (c), for the delinked /u/ in (a), and for the delinked /a/ in (b) and (c). Therefore, regardless of the quality of the delinked vowel, the phonetic interpretation of an empty nucleus is [e] or zero. These findings can be summarized as follows:

(2.5) In CEA: non-branching {i, u, a} → {e/∅}

(2.6)

C V
/i, u, a/
[e/∅]

In sum, the two modern dialects show great uniformity in the way they deal with the underlying vocalic material that is not able to be explicitly expressed due to lack of templatic space.

2.3 Statement of the problem

If all non-branching vowels in CEA were realized as [e] or [∅] as indicated in (2.4) through (2.6), this would result in a four-vowel system. Consider the hypothetical CEA vowel system in Chart 2.1 (a), illustrated in parallel with the MA system in (b).

Chart 2.1 The attested MA vowel inventory and the predicted CEA vowel inventory

| a. Hypothetical CEA | | b. MA | |
|---------------------|---|-------|---|
| i | u | i | u |
| e | | i | |
| a | | a | |

The hypothetical CEA system illustrated above raises two questions:

- 1) Is it true that CEA is characterized by a four-vowel system like its Moroccan analogue?
- 2) Why would the same process of delinking of non-branching {i, u, a} lead to two different phonetic outputs, i.e. two different audible interpretations of empty nuclei, a high central vowel [i] in MA and a mid-vowel [e] in CEA?

The first question can be rapidly answered based on a quick look on the factual surface qualities featuring in CEA; consider Chart 2.2 (a).

Chart 2.2 CEA and MA vowel inventories

| a. Attested CEA | | b. MA | |
|-----------------|-------|-------|---|
| i, i: | u, u: | i | u |
| e, e: | o, o: | i | |
| a, a: | | a | |

We can clearly see that CEA possesses a surface vowel inventory richer than that which appears above in Chart 2.1 (a). Accordingly, the answer is “No”; CEA is not characterized by a four-vowel system as might be expected.

What can Chart 2.2 tell us, however, about the second question of why delinking would result in *i* in MA and in *e* in CEA? The only explanation provided by the chart is that the opposite is not possible. The high central vowel [ɨ] is not featured in CEA so that it can be employed in case of delinking, nor is the mid-vowel [e] featured among the list of vowels that characterizes MA.

What other conclusions can be drawn from Chart 2.2?

Under the loss of brevity thesis, we can conclude with certainty that [ɨ] will be the only audible interpretation for empty nuclei in MA and there are no other alternatives; however, a similar conclusion cannot be drawn for CEA. In addition to the mid-quality [e], CEA exhibits another mid-quality, [o]. It is not clear why CEA uses [e] as a phonetic alternative for delinked vowels and not [o] or any other vowel.

Another glance at the vowel inventory of CEA reveals the presence of two series of vowels, a short series and a long series, [i, u, a, e, o] and [i:, u:, a:, e:, o:]. In the preceding chapter, it has been argued that the three short [i, u, a] vowels and their long counterparts [i:, u:, a:], all possess the same “phonological length.” The perceived “phonetic length” in the long series is a mere consequence of “stress,” the relationship that affects the two sets of vowels has been therefore defined as “phonetic length validated by stress” in the case of the latter series, which results in [í:, ú:, á:]. The question that directly follows is whether the same is true for mid-vowels. Specifically, whether the relationship that holds between short mid-vowels [e, o] and long mid-vowels [e:, o:] can be defined in the same terms, i.e. short and long mid-vowels have the same phonological length but their different phonetic length is due to stress.

To summarize, the two main objects of our inquiry in this chapter can be listed as follows:

1. The interpretation of empty nuclei in CEA.
2. The status of mid-vowels in CEA.

As we will see, the answer to the abovementioned issues mainly rests with the parameters involved in deriving the CEA vowel system. The central objective of the coming discussion is therefore to determine those parameters.

2.4 The organization of the vowel system of Egyptian Arabic

2.4.1 The parameters

The vowel qualities featured in MA and CEA can be readily interpreted in terms of the Theory of Elements proposed in Kaye, Lowenstamm and Vergnaud (1985). According to this theory, the ultimate phonological units are not features; rather they are “Elements.” Vowel segments, in this view, can be broken down into these ultimate constituents, Elements, which are phonetically pronounceable due to a fully specified feature matrix.¹⁶ The three Elements relevant to any vowel system are I, U and A, which occur in all natural languages and are phonetically realized as [i, u, a]. Hence, they are considered to be the basic vocalic constituents and the least marked ones. Elements display properties of an autosegmental nature and are accordingly represented as residing on autosegmental lines. Autosegmental lines are labeled by the hot features of Elements occupying them. Hot features are features whose values are marked; they are underlined in the matrices constituting Elements I, U, A in (2.7).

(2.7)

| I | U | A |
|--|--|--|
| $\left(\begin{array}{c} - \text{Round} \\ - \underline{\text{Back}} \\ + \text{High} \\ - \text{Low} \end{array} \right)$ | $\left(\begin{array}{c} + \underline{\text{Round}} \\ + \text{Back} \\ + \text{High} \\ - \text{Low} \end{array} \right)$ | $\left(\begin{array}{c} - \text{Round} \\ + \text{Back} \\ - \underline{\text{High}} \\ + \text{Low} \end{array} \right)$ |
| [i] | [u] | [a] |

Lines together with positions form a two-dimensional grid from which phonological representations may be plotted. Positions on the autosegmental lines not occupied by Elements host what is referred to as the cold vowel *v* whose feature matrix contains no hot

¹⁶ Cf. Kaye, Lowenstamm and Vergnaud (1990), Harris (1990, 1994), Harris and Lindsey (1995) and Scheer (1996) for proposals concerning the internal representation of consonantal segments within this framework.

features. This two-dimensional grid is illustrated in (2.8) where the objects (x) that constitute the skeletal tier are undifferentiated skeletal positions; they can either be V or C positions.¹⁷

(2.8)

| | | | | | | | | | | | |
|-----------------------|-------|----------|-------|---|-------|---|-------|----------|-------|----------|-------|
| <i>Back</i> | | I | | I | | I | | I | | <i>v</i> | |
| <i>High</i> | | A | | A | | A | | <i>v</i> | | | |
| <i>Round</i> | | <i>v</i> | | U | | U | | U | | <i>v</i> | |
| <i>Skeletal tier</i> | x | x | x | x | x | x | x | x | x | x | x |
| <i>Segmental tier</i> | | | | | | | | | | | |

The cold vowel *v* whose feature matrix is represented in (2.9) is phonetically realized as [i̤].

(2.9)

$$\begin{array}{c}
 v \\
 \left(\begin{array}{c}
 - \text{Round} \\
 + \text{Back} \\
 + \text{High} \\
 - \text{Low}
 \end{array} \right) \\
 [i̤]
 \end{array}$$

The model endorses the idea that vowels are either Elements themselves (primitive vowels), or combinations of Elements (derived vowels). Combinations of Elements depend in the first place on whether the autosegmental lines are fused or separated. Elements residing on the same autosegmental tier cannot combine.

Compound Elements are derived through an operation called “fusion,” which is defined as involving two Elements: *Head* and *Operator*. In the “fusion” operation, the value of the hot

¹⁷ This is discussed later in this chapter, section 2.5.3.

feature of the operator substitutes that of the corresponding feature of the head. For example, the fusion of Elements (A.I) would be as follows:

(2.10)

$$\begin{array}{ccc}
 \begin{array}{c} \textit{Operator} \\ \left(\begin{array}{c} - \text{Round} \\ + \text{Back} \\ - \underline{\text{High}} \\ + \text{Low} \end{array} \right) \\ \text{A} \end{array} & \cdot & \begin{array}{c} \textit{Head} \\ \left(\begin{array}{c} - \text{Round} \\ - \underline{\text{Back}} \\ + \text{High} \\ - \text{Low} \end{array} \right) \\ \text{I} \end{array} \rightarrow \begin{array}{c} \left(\begin{array}{c} - \text{Round} \\ - \underline{\text{Back}} \\ - \underline{\text{High}} \\ - \text{Low} \end{array} \right) \\ [\text{e}] \end{array}
 \end{array}$$

The fusion operation is asymmetric, as (A.I) is not equivalent to (I.A), (A.I) → [e], whereas (I.A) → [æ], (A.U) → [o] whereas (U.A) → [a] and so on.

Since the feature matrix of the cold vowel *v* is void of any hot features, this vowel behaves as a neutral Element in the fusion operations. As *Operator*, the cold vowel has no hot feature to inject into the matrix of the *Head*; no modifications in the feature matrix of the *Head* Element will thus result.

(2.11)

$$\begin{array}{ccc}
 \begin{array}{c} \textit{Operator} \\ \left(\begin{array}{c} - \text{Round} \\ + \text{Back} \\ + \text{High} \\ - \text{Low} \end{array} \right) \\ \textit{v} \end{array} & \begin{array}{c} \text{No hot features to} \\ \text{introduce} \\ \cdot \end{array} & \begin{array}{c} \textit{Head} \\ \left(\begin{array}{c} \underline{+ \text{Round}} \\ + \text{Back} \\ + \text{High} \\ - \text{Low} \end{array} \right) \\ \text{U} \end{array} \rightarrow \begin{array}{c} \left(\begin{array}{c} \underline{+ \text{Round}} \\ + \text{Back} \\ + \text{High} \\ - \text{Low} \end{array} \right) \\ [\text{u}] \end{array}
 \end{array}$$

If the cold vowel takes on the role *Head*, it behaves mostly as a neutral Element. Reversing the *Operator/Head* roles in the fusion operation illustrated in (2.11) will have no impact on the output vowel (hence (U.v) → [u] just as (v.U) → [u]).

(2.12)

$$\begin{array}{ccc}
 \begin{array}{c} \textit{Operator} \\ \left(\begin{array}{c} \underline{+Round} \\ + Back \\ + High \\ - Low \end{array} \right) \\ U \end{array} & \cdot & \begin{array}{c} \textit{Head} \\ \left(\begin{array}{c} - Round \\ + Back \\ + High \\ - Low \end{array} \right) \\ v \end{array} \rightarrow \begin{array}{c} \left(\begin{array}{c} \underline{+Round} \\ + Back \\ + High \\ - Low \end{array} \right) \\ [u] \end{array}
 \end{array}$$

The only instance in which the cold vowel does not behave as a neutral Element is the fusion operation involving v as a *Head* and Element A as an *Operator*. In this case, the feature Low participates in the operation, which results in a low central vowel (hence $(v.A) \rightarrow [a]$ while $(A.v) \rightarrow [ə]$).¹⁸ These asymmetric results are illustrated in (2.13) and (2.14).

(2.13)

$$\begin{array}{ccc}
 \begin{array}{c} \textit{Operator} \\ \left(\begin{array}{c} - Round \\ + Back \\ + High \\ - Low \end{array} \right) \\ v \end{array} & \begin{array}{c} \text{No hot features to} \\ \text{introduce} \\ \cdot \end{array} & \begin{array}{c} \textit{Head} \\ \left(\begin{array}{c} - Round \\ + Back \\ \underline{- High} \\ + Low \end{array} \right) \\ A \end{array} \rightarrow \begin{array}{c} \left(\begin{array}{c} - Round \\ + Back \\ \underline{- High} \\ + Low \end{array} \right) \\ [a] \end{array}
 \end{array}$$

(2.14)

$$\begin{array}{ccc}
 \begin{array}{c} \textit{Operator} \\ \left(\begin{array}{c} - Round \\ + Back \\ \underline{- High} \\ + Low \end{array} \right) \\ A \end{array} & \cdot & \begin{array}{c} \textit{Head} \\ \left(\begin{array}{c} - Round \\ + Back \\ + High \\ - Low \end{array} \right) \\ v \end{array} \rightarrow \begin{array}{c} \left(\begin{array}{c} - Round \\ + Back \\ \underline{- High} \\ - Low \end{array} \right) \\ [ə] \end{array}
 \end{array}$$

¹⁸ For further discussion, cf. Kaye, Lowenstamm and Vergnaud (1985).

Under the Theory of Elements, the four-vowel system that characterizes MA, seen in Chart 2.2 (b), can be described as involving the fusion of the three autosegmental lines labeled *Round*, *Back* and *High*. This rules out any possible combinations between Elements I, U and A, hence the generation of any anterior rounded vowels or mid-vowels. This one-line system is illustrated in (2.15).¹⁹

(2.15)

| | | | | |
|-------------------------|---------------|---------------|---------------|----------------------|
| | a. | b. | c. | d. |
| <i>Round/Back/ High</i> | I | U | A | <i>v</i> |
| <i>Segmental tier</i> | i | u | a | ɨ |

The parameters that derive the vowel system of MA can thus be defined as follows:

1. The cardinal vowels *i*, *u*, *a* directly express Elements I, U, A.
2. The high central vowel *ɨ* is the cold vowel *v*.

Similarly, the five-vowel system that characterizes CEA, seen earlier in Chart 2.2 (a), can be described as involving the fusion of the two autosegmental lines labeled *Round* and *Back*. Residing on the same line, combinations involving both Elements I and U together are excluded; the generation of anterior rounded vowels cannot occur. This two-line system is illustrated in (2.16); the heads of combinations are underscored.

(2.16)

| | | | | | |
|-----------------------|----------------------|----------------------|----------------------|----------------------|----------------------|
| | a. | b. | c. | d. | e. |
| <i>Round/Back</i> | <u>I</u> | <u>U</u> | <i>v</i> | <u>I</u> | <u>U</u> |
| | | | | | |
| <i>High</i> | <i>v</i> | <i>v</i> | <u>A</u> | A | A |
| <i>Segmental tier</i> | i | u | a | e | o |

¹⁹ For the formal representation of the MA vowel system, the reader is referred to Lowenstamm (1991).

The parameters underlying the vowel system of CEA can therefore be defined as follows:

1. Vowels *i*, *u*, *a* result from the combination of the three Elements I, U, A with the cold vowel *v*. The Element carries the role *Head* whilst the cold vowel is the *Operator*, hence (*v*.I), (*v*.U) and (*v*.A) respectively.
2. Mid-qualities *e*, *o* result from the combination of the two Elements (A.I) and (A.U), respectively.
3. Vocalic expressions involving Elements I and U are necessarily headed by these Elements.

2.4.2 Interpreting empty nuclei

Under the loss of brevity thesis, vowels {*i*, *u*, *a*} must branch. In terms of phonological Elements, the thesis will be formally expressed as in (2.17).

(2.17) Elements I, U, A must branch.

The loss of brevity thesis as articulated in (2.17) will consequently be represented in MA as follows:²⁰

(2.18) Elements must branch in MA

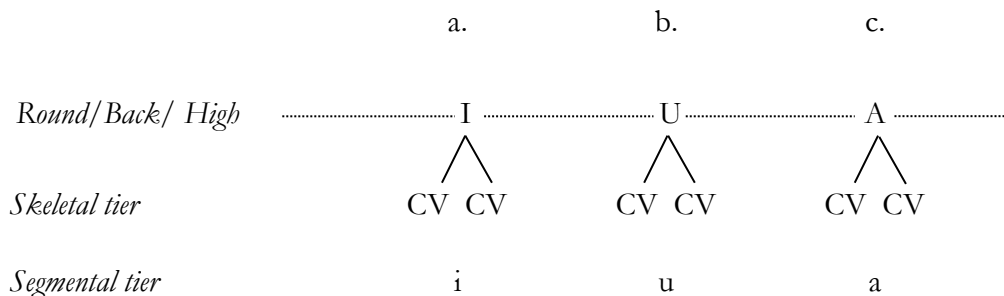

²⁰ The picture in (2.18) is very similar to what we saw earlier in (1.20) in chapter 1.

Delinking of non-branching Elements in MA will be depicted in these terms:

(2.19) Delinking and {Ø/i} alternation in MA

| | a. Option 1: Nothing | b. Option 2: Epenthesis |
|--------------------------|--|--|
| <i>delinked material</i> | I U A | I U A |
| <i>Round/ Back/ High</i> | <i>v</i> <i>v</i> <i>v</i> | <i>v</i> <i>v</i> <i>v</i> |
| <i>Skeletal tier</i> | CV CV CV | CV CV CV |
| <i>Segmental tier</i> | [] [] [] | [i] [i] [i] |

The question therefore raised is how the same process could be represented for CEA? Consider (2.20) and recall that the case of CEA is rather complicated due to the role that stress plays. Stress authorizes “phonetic length” for branching Elements. Branching Elements in CEA can surface as: a) phonetically “short” *i*, *u*, *a* when non stressed or b) phonetically “long” *i*:, *u*:, *a*: under stress.

(2.20) Elements must branch in CEA

| | a. | b. | c. | d. | e. | f. |
|-----------------------|----------------------|----------------------|----------------------|----------------------|----------------------|----------------------|
| <i>Round/ Back</i> | <u>I</u> | <u>U</u> | <i>v</i> | <u>I</u> | <u>U</u> | <i>v</i> |
| | | | | | | |
| <i>High</i> | <i>v</i> | <i>v</i> | <u>A</u> | <i>v</i> | <i>v</i> | <u>A</u> |
| <i>Skeletal tier</i> | ∧ | ∧ | ∧ | ∧ | ∧ | ∧ |
| | CVCV | CVCV | CVCV | CVCV | CVCV | CVCV |
| <i>Segmental tier</i> | i | u | a | i: | u: | a: |

Under loss of brevity, what occurs if the condition “Elements must branch” is not met in CEA? How would {e/empty nucleus} be formally represented? According to what we saw, regardless of the melody of the delinked Element in CEA, the language mobilizes *e* as a filling material whenever the “nothing” alternative is not allowed; this is illustrated in (2.21).

(2.21) Delinking and {Ø/e} alternation in CEA

| | a. Option 1: Nothing | | | b. Option 2: Epenthesis | | |
|--------------------------|----------------------|---------|---------|-------------------------|---------|---------|
| <i>delinked material</i> | I | U | A | I | U | A |
| <i>Round/Back</i> | v | v | v | I | I | I |
| <i>High</i> | v | v | v | A | A | A |
| <i>Skeletal tier</i> | CV | CV | CV | CV | CV | CV |
| <i>Segmental tier</i> | [] | [] | [] | [e] | [e] | [e] |

The first glance at epenthesis as it appears in Option 2 in (2.21) confirms the categorical elimination of the possibility depicted in (2.22a) by the CEA system. This is in contradistinction to the case of MA in (2.22b) where this possibility is in fact permitted.

(2.22)

| | a. CEA: Unaccepted | | | b. MA: Accepted | | |
|--------------------------|--------------------|---------|---------|------------------------------|---------|---------|
| <i>delinked material</i> | I | U | A | I | U | A |
| <i>Round/Back</i> | v | v | v | | | |
| <i>High</i> | v | v | v | <i>Round/Back/high</i> | v | v |
| <i>Skeletal tier</i> | CV | CV | CV | CV | CV | CV |
| <i>Segmental tier</i> | [i] | [i] | [i] | [i] | [i] | [i] |

The rejection of epenthesis through [i] in CEA suggests the introduction of an additional parameter into the list of parameters that derive its vowel system. This parameter appears in (2.23).

(2.23) In CEA, vocalic expressions must involve at least one Element. This rules out the presence of a high central vowel in the CEA system.

Moreover, the configuration in (2.22b) supports the following for MA:

(2.24) All the predictions made by a one-line system can be established.

While the strategy in (2.22b) above is mobilized by MA to address the consequences of a delinked Element, nothing of the kind occurs in CEA. Clearly, CEA does not tolerate delinking in its most radical sense as is the case in MA. The question that must be asked is whether the configuration depicted in (2.22a) is excluded by the predictions of the theory in regard to two-line systems.

This is not the case; the configuration in (2.22a) could be implemented in a two-line system. One such system is found in Ge'ez (an Ethiopian Semitic language).²¹ Ge'ez is characterized by a two-line system that derives the high central vowel [ɨ] in addition to other six vowel qualities; see Chart 2.3.

Chart 2.3 The surface vowel inventory of Ge'ez

| | | |
|----|----|----|
| i: | i | u: |
| e: | ə | o: |
| | a: | |

The vowel qualities displayed in the chart above result from the fusion of the two lines labeled *Round* and *Back* as illustrated in (2.25) where the heads of combinations have been underscored.

²¹ This example is in addition to other Ethiopic languages such as Tigrinya and Amharic; these languages are characterized by two-line systems within which the generation of the high central vowel is permitted.

(2.25)

| | | | | | | | |
|-----------------------|----------------------|----------------------|----------------------|---------------|---------------|----------------------|----------------------|
| | a. | b. | c. | d. | e. | f. | g. |
| <i>Round/ Back</i> | I | U | <i>v</i> | I | U | <i>v</i> | <i>ɥ</i> |
| | | | | | | | |
| <i>High</i> | <i>v</i> | <i>v</i> | A | A | A | <i>v</i> | A |
| <i>Segmental tier</i> | i | u | a | e | o | i | ə |

Most of the parameters that characterize the vowel system of Ge'ez therefore appear to be very similar to those of CEA, namely:

1. The cardinal vowels *i*, *u*, *a* result from the combination of the three Elements I, U, A with the cold vowel *v*. The Element is *Head* and the cold vowel is *Operator*.
2. Mid-qualities *e*, *o* result from the combination involving the two Elements (A.I) and (A.U) respectively.
3. Vocalic expressions involving the Elements residing on the autosegmental line labeled *Round* and *Back* must be headed by these Elements.

Furthermore, the phonological system of Ge'ez presents much evidence that supports the following principle:²²

(2.26) Vocalic expressions headed by an Element must be attached to two skeletal positions.

According to the principle posited in (2.26), *i* and *u* attached to one nuclear position are subject to delinking, they are either replaced by an empty nucleus [Ø] or by [ị]. Non-branching *a* is replaced either by [Ø] or by [ə].²³ These circumstances are represented in the following manner:

²² For a detailed view of this principle in Ethiopic, cf. Lowenstamm (1991), Ségéral (1995, 1996).

²³ In the literature addressing Ge'ez, this vowel is often written [ä].

(2.27) Loss of brevity in Ge'ez

| | | | | | | | | |
|--------------------------|------|------|----------|----------|----------|----------|----------|----------|
| | a. | b. | c. | d. | e. | f. | g. | h. |
| <i>delinked material</i> | | | | | | I | U | |
| <i>Round/Back</i> | I | U | I | U | <i>v</i> | <i>v</i> | <i>v</i> | <i>v</i> |
| <i>High</i> | A | A | <i>v</i> | <i>v</i> | A | <i>v</i> | <i>v</i> | A |
| <i>Skeletal tier</i> | ∧ | ∧ | ∧ | ∧ | ∧ | | | |
| | CVCV | CVCV | CVCV | CVCV | CVCV | CV | CV | CV |
| <i>Segmental tier</i> | [e:] | [o:] | [i:] | [u:] | [a:] | ∅/[i] | ∅/[i] | ∅/[ə] |

The configurations in (2.27f and g) reveal the same strategy as was previously seen in MA. By contrast, in the configuration in (2.27h), another maneuver allowed by the theory can be identified, the “reversal of the *Head/Operator* roles.” Element A attached to one skeletal position does not result in {∅/ɪ}, as is the case for Elements I and U, but in {∅/ə}. If (*v*.A) derives [a] which cannot fit into one nuclear position, the reversal of the roles, hence (A.*v*), derives [ə] which meets the condition specified in (2.26). Evidently, the “reversal of *Head/Operator* roles” strategy is ineffective in the case of Elements I and U. Indeed, the combinations (I.*v*) and (U.*v*) result in [i] and [u] which will not, in any circumstances, be linked to one V position in the skeleton. As such, the Ge'ez system resorts to the same strategy as MA (a one-line system), that being the insertion of *i* whenever the reversal of roles is sterile.

This overview of the case of Ge'ez brings up a particularity of the CEA system: the absence of strategies similar to the “reversal of roles” in the latter. As a result, the following additional parameter can be identified:

(2.28) No combinations headed by the cold vowel *v* are permitted. This rules out the presence of a low central vowel in the CEA system.

The strategies seen in Options 1 and 2 in (2.29) that are excluded by the CEA system reveal a marked intolerance for central vowels.

(2.29) The CEA system

| | a. Option 1: Not permitted | | | b. Option 2: Not permitted | | |
|--------------------------|-------------------------------|----------------------|----------------------|-------------------------------|----------------------|----------------------|
| <i>delinked material</i> | I | U | A | I | U | |
| <i>Round/Back</i> | <i>v</i> | <i>v</i> | <i>v</i> | <i>v</i> | <i>v</i> | <i>ʔ</i> |
| <i>High</i> | <i>v</i> | <i>v</i> | <i>v</i> | <i>v</i> | <i>v</i> | A |
| <i>Skeletal tier</i> | CV | CV | CV | CV | CV | CV |
| <i>Segmental tier</i> | ∅/[i] | ∅/[i] | ∅/[i] | ∅/[i] | ∅/[i] | ∅/[ə] |

Therefore the question should be asked: how does the CEA system manage to interpret its emptied nuclei? Before I suggest an answer to this question, let us observe Chart 2.4. The chart contains the MA, Ge'ez and CEA vowel systems reformulated in terms of Elements.

Chart 2.4 The MA, Ge'ez and CEA vowel qualities in terms of Elements

| a. MA | b. Ge'ez | | | c. CEA | | | |
|-------|----------|---|-------------|---------------------|-------------|-------------|-------------|
| I | <i>v</i> | U | <i>v</i> .I | <i>v</i> . <i>v</i> | <i>v</i> .U | <i>v</i> .I | <i>v</i> .U |
| | | | A.I | A. <i>v</i> | A.U | A.I | A.U |
| | A | | <i>v</i> .A | | | <i>v</i> .A | |

The above chart reemphasizes the following fact: unlike MA and Ge'ez, the CEA system maintains two principles *simultaneously* in every single instance of a vowel derivation:

1. Vocalic expressions must involve at least one Element.
2. Vocalic expressions must be headed by an Element.

Vocalic expressions headed by Elements and whose *Operators* are the cold vowel *v* will not be able to interpret empty nuclei, as *i*, *u*, *a* must branch. Vocalic expressions headed by the cold vowel cannot deal either with empty nuclei, as their derivation is not permitted in the first place. The process in (2.30) appears in that case to be the only remaining possibility:

- (2.30) Interpret an empty nucleus by means of a vocalic expression whose *Head* and *Operator* do not involve the cold vowel (i.e. a vocalic expression that involves two elements).

The autonomy of the line labeled *High* with respect to the fused *Round* and *Back* lines entails the following:

- (2.31) Element A is necessarily involved in every vocalic expression resulting from the operation specified in (2.30). Element A is the default ingredient in any vocalic expression utilized to interpret an ungoverned empty nucleus. Element A is the basic constituent in any epenthetic vowel.

On the other hand, the second ingredient cannot be uniquely determined; the fusion of the lines labeled *Round* and *Back* does not favor one element over the other. Residing on the same line, both Elements I and U can possibly be involved in the operation proposed in (2.30), hence an ungoverned empty nucleus could be filled either by means of [e] or [o] (recall that a vocalic expression in which I or U is involved is necessarily headed by these elements). This conclusion is immediately challenged by our recurrent finding that empty nuclei are materialized by means of [e] whenever [Ø] is not allowed. The following question is consequently raised: are there no occurrences where Element U is used as the *Head* of an epenthetic expression?

Close examination of the data in Table 2.3 aptly reveals that [o] can be distinguished as filler in CEA. The table presents two verbs, *mesekt* 'I/ you (SING.MASC) caught' and *mesek* 'he caught' cliticized by different direct object pronouns.

Table 2.3 The epenthetic vowel [o]

| a. mesekt 'I/you (SING.MASC) caught' (...CC#) | | b. mesek 'he caught' (...VC#) | | |
|---|---|--|------------------------------------|---|
| i. | [mesekt <u>e</u> na] 'you (SING.MASC) caught us' | /mesek-t + na/ caught-2 _{SING.MASC} + us | [mesekna] 'he caught us' | /mesek + na/ caught-3 _{SING.MASC} + us |
| ii. | [mesekt <u>o</u> kom] 'I caught you (PL)' | /mesek-t + kom/ caught-1 _{SING} + you (PL) | [mesekkom] 'he caught you (PL)' | /mesek + kom/ caught-3 _{SING.MASC} + you (PL) |
| iii. | [mesekt <u>o</u> hom] 'I caught them' | /mesekt + hom/ caught-1 _{SING} + them | [mesekhom] 'he caught them' | /mesek + hom/ caught-3 _{SING.MASC} + them |

In the above table, let us consider the space separating the suffixed object pronouns and the inflected verbal bases. A vowel is seen intervening between the verbal bases and the object pronoun in column (a), but not in column (b). In CEA, whenever a series of three consonants (or more) are juxtaposed within the word, epenthesis intervenes to break this string between the second and the third consonants. This fact is confirmed in column (a) where the consonant sequences resulting from the suffixation of a verb ending in two consonants ...CC# by a C-initial suffix is immediately repaired by the insertion of a vowel to break the 3-consonant chain. Thus, /mesekt + na/ yields *mesektena* 'you (SING.MASC) caught us,' /mesekt + kom/ yields *mesektokom* 'I caught you (PL)' and /mesekt + hom/ yields *mesektohom* 'I caught them.' In column (b), epenthesis is not required, /mesek + na/ therefore yields *mesekna* 'he caught us' and /mesek + kom/ results in *mesekkom* 'he caught you (PL).'

Now, regarding the quality of the vowel inserted to break the 3-consonant chain, the conspicuous harmony between the inserted vowels in *mesektokom* 'I caught you (PL)' and *mesektohom* 'I caught them' and the vowels realizing the object pronouns suggests the following: these vowels are a mere *copy* of the subsequent ones. This claim will be validated once we consider the data displayed in Table 2.4.

Table 2.4 Identifying the default epenthetic vowel

| a. Verb + Preposition / 'for' + IOP | b. Attested | c. Excluded |
|---|---|---|
| i. /mesek-t + l + na/ caught-2 _{SING.MASC} + for + us | [mesekt <u>e</u> lna] <i>'you (SING.MASC) caught X for us'</i> | |
| ii. / mesek-t + l + kom/ caught-1 _{SING} + for + you (PL) | [mesekt <u>e</u> lkom] <i>'I caught X for you (PL)'</i> | *[mesekt <u>o</u> lkom] <i>'I caught X for you (PL)'</i> |
| iii. /mesekt + l + hom/ caught-1 _{SING} + for + them | [mesekt <u>e</u> lhom] <i>'I caught X for them'</i> | *[mesekt <u>o</u> lhom] <i>'I caught X for them'</i> |

The observation of the above data reveals two findings:

1. The vowel inserted to repair the consonant clusters formed upon the suffixation of the verbal bases by different clitics is invariably *e*.
2. Once the pronominal suffix and the epenthetic vowel are separated by two consonants, they do not maintain harmonized vocalizations.

To resume, the back mid-vowel [o] is allowed to interpret empty nuclei but under particular conditions. When these particular conditions are not met, [e] is used instead. The following deduction can therefore be made:

(2.32) Epenthesis is one instance when the Egyptian system shows a particular preference for Element I.

Yet, the following question arises: for what exact reason does the epenthetic system favor Element I to U and not the opposite?

Here, I would like to point out the fact that this very same question will be repeatedly raised as we proceed. The proliferation of instances when the Egyptian system shows a special tendency to the implementation of Element I and not U motivates (2.33).²⁴

²⁴ See chapter 3, sections 3.4.3, 3.5.4 and 3.5.5.

(2.33) The Egyptian system evidences a special attraction for “frontness”; CEA is a language whose phonology can be characterized by the presence of an “ambient Element I.”

“Ambient I” is not meant in any way to eliminate Element U from CEA, despite the fact that the system shows many signs that it is actually shifting toward this outcome. “Ambient I” is basically assumed to express the system’s general tendency to “frontness” by employing front vowels more than back vowels. Epenthesis is one of the situations in which the system demonstrates this tendency.

At any rate, reaching the conclusion that [o] can, as much as [e], interpret an empty nucleus (i.e. one skeletal position) brings us back to the following issue: the relationship that affects short [e, o] on one side and long [e:, o:] on the other side.

It was previously argued that the “phonetic length” distinguishing short and long cardinal vowels is a consequence of “stress.”²⁵ Could the difference between short and long mid-vowels be interpreted along the same lines? If *e* and *o* can be attached to one nuclear position, does this mean that *e:* and *o:* can occupy one skeletal position? Can the phonetic difference between the two series of mid-vowels be just a consequence of stress as shown in the hypothetical representations in (2.34)?

(2.34)

| | | | |
|-----|-----|-----|-----|
| a. | b. | c. | d. |
| C V | C V | C V | C V |
| | | | |
| A.I | A.I | A.U | A.U |
| e | e: | o | ó: |

The hypothetical representations in (2.34) are rapidly refuted on a quick glance at the stress position in the data in Table 2.5, previously seen in Table 2.3.

²⁵ See the discussion in chapter 1, section 1.5.2.

Table 2.5 Stressed short mid-vowels

| a. mesekt 'I/you (SING.MASC) caught' | | b. mesek 'he caught' | | |
|--------------------------------------|--------------|------------------------------------|------------|-----------------------------|
| i. | [mesekténa] | <i>'you (SING.MASC) caught us'</i> | [mesékna] | <i>'he caught us'</i> |
| ii. | [mesektókom] | <i>'I caught you (PL)'</i> | [mesékkom] | <i>'he caught you (PL)'</i> |
| iii. | [mesektóhom] | <i>'I caught them'</i> | [mesékhom] | <i>'he caught them'</i> |

Short *e* and *o* can bear stress with no signs of phonetic lengthening, i.e. *mesekté:na, *mesektó:kom and *mesektó:hom are clearly excluded.

If the difference between {e, e:} and {o, o:} owes nothing to “stress,” how can this difference be defined? To answer this question, the next section provides a comprehensive analysis of long mid-vowels in CEA.

2.5 Mid-vowels

2.5.1 Missing short mid-vowel phonemes

Once more, the surface vowel inventory of CEA is presented together with the underlying vowel phonemes, as seen through a purely structuralist approach, in Chart 2.5. We will focus on mid-vowels. Clearly, short mid-vowels are not posited as two vowel phonemes, contrary to long mid-vowels.

Chart 2.5 The surface vs. the underlying vowel inventories of CEA

| a. Surface vowel inventory | | b. Underlying vowel phonemes | |
|----------------------------|-------|------------------------------|-------|
| i, i: | u, u: | i, i: | u, u: |
| e, e: | o, o: | e: | o: |
| | a, a: | | a, a: |

The absence of short */e/ and */o/ from the phonemic level raises two important questions:

- 1) Why would CEA generate only three short vowel phonemes (of cardinal qualities): /i/, /u/, /a/ when it is capable of generating five long ones (cardinal as well as mid-qualities), /i:/, /u:/, /a:/, /e:/, /o:/?
- 2) According to universal tendencies (see universal (2.35) in Greenberg, 1978); the expectancy of less marked phonemes to occur in natural languages is greater than the expectancy of marked ones.

(2.35) In general, the number of phonemes exhibiting a marked feature is less than or equal to the number of those characterized for the unmarked feature. Length in vowels exhibits in general the characteristics of a marked feature.

If the presence of the “marked feature” implies the presence of the “unmarked” one, then the relation between long and short vowels can be stated as follows:

(2.36) The presence of long vowels implies the presence of short vowels.

And if most of the structuralist accounts for length distinction explicitly and implicitly rely upon the recognition of a length contrast for vowels of the same quality, then (2.36) can be reinterpreted as follows:

(2.37) The presence of a given long vowel implies the presence of a short vowel of the same quality.

Consequently, three possible hypotheses can account for the presence of /e:/ and /o:/ (the vowels characterized by the marked feature) in the absence of /e/ and /o/ (the less marked phonemes) in a language in which length is supposedly contrastive; they are:

1. CEA is endowed with an underlying vowel generator that operates contrary to universal tendencies.
2. The inclusion of long /e:/ and /o:/ into the phonemic inventory of CEA is misleading.
3. Excluding short */e/ and */o/ from the phonemic inventory is not correct.

Under structuralist assumptions, short mid-vowels are not phonemes due to lack of minimal contrasts opposing [e], [o] to [i], [u]. Now, having seen that vowel length can be redefined in CEA in a different way (in terms of nuclear positions), the exclusion of short mid-vowels as two vowel phonemes can in fact be accounted for by a different type of argument; consider (2.38).

(2.38)

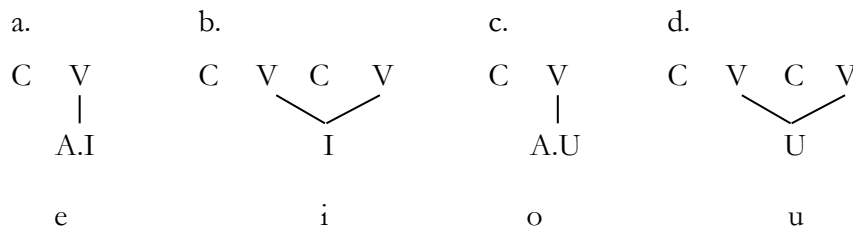

Short mid-vowels [e] and [o] simply interpret a single nuclear position, i.e. Elements involved in these mid-qualities do not branch as they do in the case of high vowels [i] and [u]. In other terms, high vowels do not share the same underlying templatic architecture with mid-vowels. This can account for the fact that high vowels are never found in opposition to mid-vowels.

On the other hand, it has continuously been assumed that long mid-vowels [e:] and [o:] are two vowel phonemes due to the presence of minimal contrasts opposing them to long high vowels [i:] and [u:]. Consider the pairs displayed in Table 2.6.

Table 2.6 Long mid-vowels vs. long high vowels

| a. [i:] vs. [e:] | | |
|--|-----|---------------------|
| i. [š <u>i</u> :l] | vs. | ii. [š <u>e</u> :l] |
| <i>‘carry! Imperative (2_{SING.MASC})’</i> | | <i>‘carrying’</i> |
| b. [u:] vs. [o:] | | |
| i. [ʔ <u>u</u> :l] | vs. | ii. [ʔ <u>o</u> :l] |
| <i>‘say! Imperative (2_{SING.MASC})’</i> | | <i>‘saying’</i> |

It has been noted on several occasions that two branching Elements, I and U, underlie long high vowels such as the ones realizing the imperatives ši:l ‘carry!’ and ʔu:l ‘say!.’ The question now is what representation could better account for the long mid-vowels of še:l ‘carrying’ and ʔo:l ‘saying’?

Under the hypothetical structure sketched out earlier in (2.34), one V position was conjectured for long mid-vowels in analogy with short mid-vowels. This representation will lead us to a situation similar to that of short mid-vowels:

(2.39)

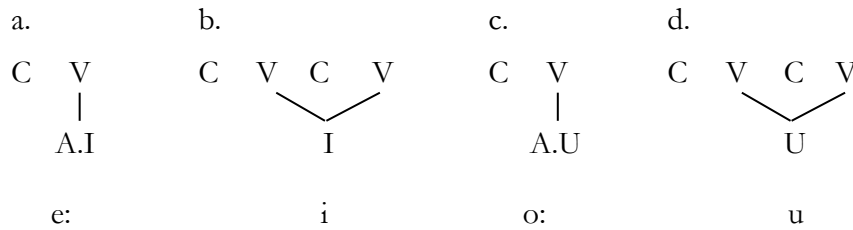

In this case, the same argument that led to the refutation of the phonemic status of short mid-vowels would refute once more the phonemic status of long mid-vowels. The latter do not share a similar-sized templatic architecture with high vowels.

How would mid-vowels be represented if not as depicted in (2.39)? This is the main concern of the next two sections. First, we will rapidly review how long mid-vowels were described in previous frameworks. This brief review will form the foundation of my proposal regarding long mid-vowels.

2.5.2 Previous accounts of long mid-vowels in Egyptian Arabic

There is a general consensus about the nature of long mid-vowels in the literature on CEA. A long mid-vowel is known to stem from an underlying diphthong.²⁶ This view primarily relies on cases such as those displayed in Table 2.7. Gadalla (2000) notes that CEA systematically changes the CA sequences *aj* and *aw* into *e:* and *o:* respectively.

Table 2.7 The origins of long mid-vowels in CEA

| | a. CA | b. CEA | Gloss |
|------|-------|--------|----------------|
| i. | bajt | be:t | <i>'house'</i> |
| ii. | zajt | ze:t | <i>'oil'</i> |
| iii. | lawn | lo:n | <i>'color'</i> |
| iv. | ṣawt | ṣo:t | <i>'voice'</i> |

²⁶ Cf. Broselow (1976), Gadalla (2000), Watson (2002) for instance.

To account for the change from a /diphthong/ to a [long mid-vowel], Broselow (1976) proposes a phonological rule of “coalescence” wherein the backness of the glide lowered by the vowel *a* on its left is preserved in the long mid-vowel quality. The rule of “coalescence” is expressed as follows (X and Y represent segmental sequences):

$$(2.40) \quad \begin{array}{cccccc} 1 & 2 & 3 & 4 & 5 & \rightarrow & 1 & 2 & 3 & 4 & 5 \\ X & [+syll] & \left(\begin{array}{c} - \text{syll} \\ - \text{cons} \\ + \text{high} \\ \alpha \text{ back} \end{array} \right) & [+ \text{cons}] & Y & \rightarrow & X & \left(\begin{array}{c} + \text{syll} \\ - \text{low} \\ \alpha \text{ back} \\ + \text{long} \end{array} \right) & \emptyset & [+ \text{cons}] & Y \end{array}$$

Gadalla (2000) has afterwards suggested another rule that he calls “monophthongization” to account for these alternations. This rule is laid out in (2.41).

$$(2.41) \quad \{aj, aw\} \rightarrow \{e:, o:\} / \text{when sharing syllable rime and stem-final}$$

Apart from the description of the alternations (CA *aj* / CEA *e:*) and (CA *aw* / CEA *o:*) offered by the different phonological rules, no real explanation was provided to explain the occurrence of such alternations. Obviously, most of the accounts for the (diphthong / long mid-vowel) correspondences are essentially based on the prior assumption that CEA forms are formed on the same pattern as CA. I will test this hypothesis in the next section. I will present an alternative analysis for long mid-vowels that confirms the hypothesis that CEA maintains the same vocalic equipment as CA, but implements it differently. The argument will therefore reach the same conclusion, but by means of a different method – a method that successfully explains and *synchronically* the corresponding cases of (diphthong / long mid-vowel).

2.5.3 Reanalyzing long mid-vowels

Far beyond phonological rules, now that we have the theoretical tools that make possible the revision of what are known as “diphthongs,” I will explain that this remarkable analogy between a diphthong in CA and a long mid-vowel in CEA is not merely related to a historical process. Nonlinear models and the Theory of Elements offer the means to account for such situations. The assumptions of the Theory of Elements imply that a glide is a possible phonetic manifestation of an underlying primitive Element. In such cases, the Element is not associated with a V slot in the skeleton (as usual occurs in order to result in a vowel), but to a C slot instead. The glide [j] and the vowel [i] thus become two phonetic realizations of an underlying /Element I/; see (2.42a). The glide [w] and the vowel [u] also become two phonetic expressions of the same underlying phoneme, /Element U/; see (2.42b).

(2.42)

| | | | | | |
|----|-----|-----|----|-----|-----|
| a. | | | b. | | |
| | V | C | | V | C |
| | | | | | |
| | /I/ | /I/ | | /U/ | /U/ |
| | [i] | [j] | | [u] | [w] |

In this way, both a diphthong in CA and a long mid-vowel in CEA will involve the same segmental ingredients. The principal distinction, however, would depend on the differential internal organization of this material with respect to the skeletal plane. Specifically, the type of the relevant skeletal positions determines the type of the output in the following way:

1. The output is a diphthong when a V and a C slot are involved; this is illustrated in (2.43b and d).
2. The output is a long mid-vowel when two V units are involved; this is illustrated in (2.43a and c).

(2.43)

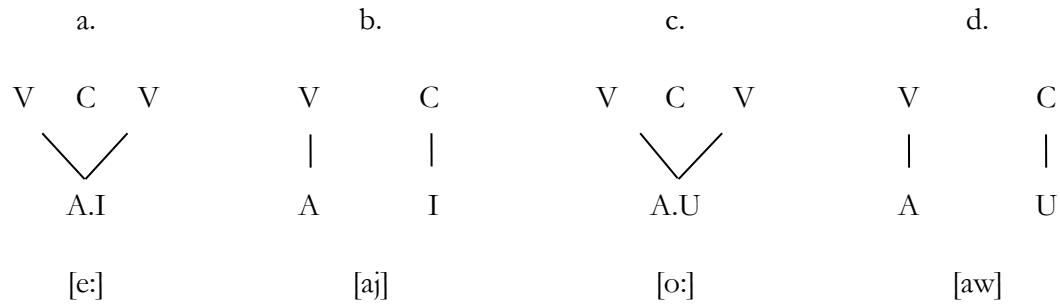

Along these lines where [aj] and [e:] involve underlying /A/ and /I/ and [aw] and [o:] involve underlying /A/ and /U/, cases like CA *bajt* vs. CEA *be:t* ‘house’ and CA *lawn* vs. CEA *lo:n* ‘color’ can be straightforwardly represented as follows:

(2.44)

a. CA

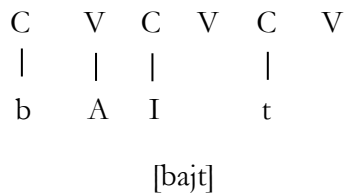

b. CEA

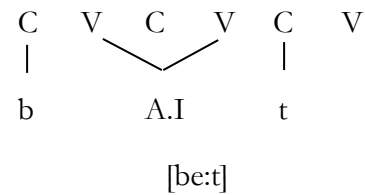

(2.45)

a. CA

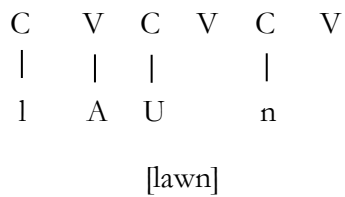

b. CEA

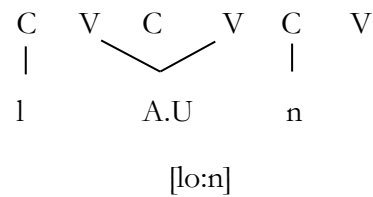

In view of this analysis, the question of why CEA exhibits long mid-vowels whereas CA exhibits diphthongs can finally be addressed. Unlike CA, Elements must spread in CEA. The “branching” seen in (2.44b), (2.45b) and re-emphasized in (2.46b) reflects a fundamental principle of the CEA phonology: *Elements must branch*.

(2.46)

a. CA

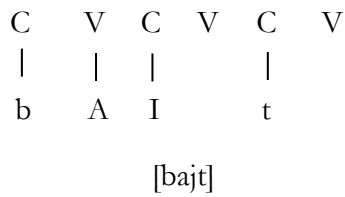

b. CEA

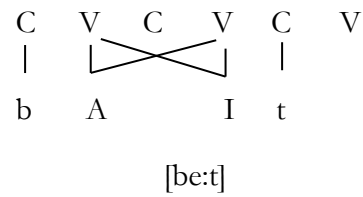

In conclusion, the input phonological material underlying every long mid-vowel in CEA actually includes *two* phonemes and *not only one*. /A/ and /I/ underlie [e:] and /A/ and /U/ underlie [o:]. This belies the phonemic status attributed to /e:/ and /o:/. If long mid-vowels are to be excluded from the phonemic inventory of CEA, this would not be because they are able to attach to one nuclear position (unlike long high vowels). Elements involved in both long mid-vowels and long high vowels are, indeed, branching to two nuclear positions. The difference is that in the case of long high vowels, only one Element is involved, while in the case of long mid-vowels, two Elements branch simultaneously. To further highlight this fact, an additional argument based on the nominal class known as “segholates” is immediately provided. The endorsement of this view of long mid-vowels contributes to account for the absence of glide-medial segholates from the CEA noun inventory.

2.5.4 Glide-medial segholates

Segholates constitute the class of nouns whose makeup exclusively involves: a) a root, b) a lexical vowel, and c) a CV₁C[V₂]C template where V₂ is locked. CEA shows a rich repertoire of segholates with various vocalizations and consonant arrangements. As for the vocalic patterns characterizing the segholates of CEA, [CaCC] such as *šams* ‘sun,’ [CeCC] such as *wedn* ‘ear’ and [CoCC] such as *dorg* ‘drawer’ occur whereas *[CiCC] and *[CuCC] do not. On the other hand, the most prominent feature of the consonant organizations of segholates is the presence of pairs that show a mirror-image distribution of the final two consonants. A sample of those pairs is seen (underlined> in Table 2.8.



Table 2.8 Mirror image segholates

| | a. CVC _α C _β | | Root | | b. CVC _β C _α | | Root |
|------|------------------------------------|-------------|------|-----|------------------------------------|-----------|------|
| i. | ba <u>d</u> r | 'full moon' | √bdr | vs. | ba <u>r</u> d | 'cold' | √brd |
| ii. | ħe <u>m</u> l | 'burden' | √ħml | vs. | ħe <u>l</u> m | 'dream' | √ħlm |
| iii. | ro <u>s</u> b | 'horror' | √rʕb | vs. | ro <u>b</u> ʕ | 'quarter' | √rbʕ |

The segmental organization CVC_αC_β has been shown to exist as a mirror-image counterpart of the CVC_βC_α configuration. The phenomenon is clearly distinguished for segholates derived from trilateral strong roots like those in the above table. Interestingly, CEA exhibits segholates with final glides: CVCj and CVCw. If so, CVjC and CVwC can be expected to occur as mirror-image structures. Specifically, if CaCj and CaCw can be reported for final weak roots such as in √rʕj *raʕj* 'chatter' and √ħšw *ħašw* 'stuffing,' then hypothetical mirror-images CajC and CawC would be expected to occur. Conversely, these latter configurations are totally absent where Ce:C and Co:C emerge instead. The segholate derived from the glide-medial root √mj_l is *me:l* 'inclination' not *majl and the segholate involving the root √mwt is *mo:t* 'death' not *mawt.

In a system capable of dismantling the vocalic qualities like Elements theory, the mid-quality in *me:l* and *mo:t* can be further broken down into the two fused Elements (A.I) and (A.U) respectively. Unraveling the Elements that constitute [e:] and [o:] reflects the exact phonological segments in the missing forms *mawt and *majl; this is seen in (2.47).

(2.47) CEA

| a. Actual | b. Hypothetical | c. Actual | d. Hypothetical |
|---|-----------------|---|-----------------|
| V C V | V C | V C V | V C |
|  | |  | |
| A.I | A I | A.U | A U |
| me:l | *majl | mo:t | *mawt |

Therefore, glide-medial segholates can be represented as follows:

(2.48) $\sqrt{\text{mwt}}$ -derived segholate

a. Expected

| | | | | | |
|---|---|---|---|---|---|
| C | V | C | V | C | V |
| | | | | | |
| m | A | U | | t | |

*mawt

b. Attested

| | | | | | |
|---|-----|---|---|---|---|
| C | V | C | V | C | V |
| | \ | | / | | |
| m | A.U | | | | t |

[mo:t]

(2.49) $\sqrt{\text{mjl}}$ -derived segholate

a. Expected

| | | | | | |
|---|---|---|---|---|---|
| C | V | C | V | C | V |
| | | | | | |
| m | A | I | | l | |

*majl

b. Attested

| | | | | | |
|---|-----|---|---|---|---|
| C | V | C | V | C | V |
| | \ | | / | | |
| m | A.I | | | | l |

[me:l]

This argument explains the distributional lacuna resulting from the absence of CajC and CawC nouns. Additionally, it reconfirms the following conclusion:

- (2.50)
- a. Long mid-vowels in CEA are not autonomous phonemes, they stem from two underlying phonemes.
 - b. The realization of these two underlying phonemes as a long mid-vowels is determined by their internal organization in relation to the skeleton.
 - c. In terms of Elements, the famous minimal oppositions [e:] vs. [i:] and [o] vs. [o:] actually contrast Element A to the cold vowel ν . Specifically, /**A**.I/ vs. / ν .I/ and /**A**.U/ vs. / ν .U/.

Accordingly, the question raised earlier of why the CEA system would engender long mid-vowels and not short mid-vowels is automatically answered. The system generates neither long nor short mid-vowels on the phonemic level. The CEA vowel system is not as

irregular or asymmetric as it might appear. It is not a system that includes phonemes characterized by marked features (long mid-vowels) in the absence of unmarked ones (short mid-vowels). The crucial distinction between short mid-vowels [e], [o] and long mid-vowels [e:] and [o:] can be defined in different terms. Unlike short and long cardinal counterparts that share a similar templatic architecture, two nuclear positions, short and long mid-vowels do not. Short mid-vowels can attach to one nuclear position; long mid-vowels on the other hand require two positions. We can conclude, in consequence, that a long mid-vowel is not a short mid-vowel lengthened under stress.

To resume, if vowel length can be represented at the skeletal level and as a function of timing units, then the CEA system can be described as follows:

(2.51)

| | a. | b. | c. | d. | e. | f. | g. | h. |
|-----------------------|---|----------------------|----------------------|----------------------|----------------------|--|----------------------|----------------------|
| <i>Round/Back</i> | <u>I</u> | <u>U</u> | <i>v</i> | <u>I</u> | <u>U</u> | <u>I</u> | <u>U</u> | <i>v</i> |
| | | | | | | | | |
| <i>High</i> | <i>v</i> | <i>v</i> | <u>A</u> | <u>A</u> | <u>A</u> | <i>v</i> | <i>v</i> | <u>A</u> |
| | ∧ | ∧ | ∧ | ∧ | ∧ | | | |
| <i>Skeletal tier</i> | CVCV | CVCV | CVCV | CVCV | CVCV | CV | CV | CV |
| <i>Segmental tier</i> | [i] | [u] | [a] | [e:] | [o:] | ∅/Epenthetic vowel | | |
| | <i>alternate with [iː, uː, aː] resp. under stress</i> | | | | | <i>[e] by default, [o] under particular conditions</i> | | |

2.6 Concluding remarks

The study of the Egyptian Arabic five-vowel system in light of the Theory of Elements (Kaye, Lowenstamm and Vergnaud, 1985) led to the establishment of the following parameters:

1. The fusion of the two autosegmental lines labeled *Round* and *Back* excludes any combinations involving Elements I and U together.
2. *i*, *u*, *a* are the expressions of Elements I, U, A combined to the cold vowel *v*, hence (*v*.I), (*v*.U), and (*v*.A) respectively.
3. *e*, *o* are the combination of two elements, (A.I) and (A.U) respectively.
4. Vocalic expressions involving the Elements I and U must be headed by these Elements.
5. Vocalic expressions must involve at least one Element; this rules out the presence of a high central vowel in the Egyptian system.
6. No combinations headed by the cold vowel *v* are permitted; this rules out the presence of a low central vowel in the Egyptian system.

These parameters consequently led us to discover the principle implemented by the language to interpret empty nuclei, that being the insertion of a vocalic expression that does not involve the cold vowel. In the two Elements involved in the latter vocalic expression, A is necessarily implicated. The grammar of the language resorts by default to Element I as the second ingredient in this process; hence, [e] is the default epenthetic material. The identification of [o] as a quality capable of interpreting empty nuclei, however, subsequently allowed for the introduction of a novel analysis of mid-vowels in Egyptian Arabic. This analysis has marked the difference between short and long mid-vowels. Unlike the set of cardinal qualities wherein the difference between {i, u, a} and {i:, u:, a:} is defined as the appearance of the latter series under stress, the relation between the set of mid-qualities is defined in other terms. Vowels {e:, o:} are not the stressed alternatives to {e, o}; the main difference between the two series is found in the different underlying templatic architecture. The proposed analysis of long mid-vowels has afterward opened a window of explanation for the distributional lacuna identified for glide-median segholates.

Chapter 3

Ablaut in Egyptian Arabic

3.1 Introduction

The main argument of this chapter is that the aspectual vowel alternations in the Egyptian Arabic Measure I verbs are not determined arbitrarily. Firstly, studying the perfective in Egyptian Arabic leads to the identification of two major vocalic patterns, CaCaC, and CeCeC. The comparative examination of these two patterns with their Classical Arabic analogues leads to a very important generalization. The perfective in Egyptian Arabic is equipped with the same vocalic material present in the Classical variety, but organized differently.

Secondly, the alternation patterns attested between perfectives and imperfectives in Egyptian Arabic do not initially reveal the conditions that allow them to be predicted. Both perfective classes, CaCaC and CeCeC, alternate in similar fashion with the three possible imperfective melodies, (\emptyset _ a), (\emptyset _ e), (\emptyset _ o). Analysis of these alternations, however, leads to the following result: the perfective melody is mapped onto the imperfective according to the regular formula of apophony proposed in Guerssel and Lowenstamm (1996) to account for the aspectual vowel alternations of Classical Arabic.

Both characteristics of Egyptian Arabic phonology, namely “phonological Elements must branch” and the mounting tendency to “frontness” (to which I refer in this study as the influence of “ambient I”), are crucial to understanding the vowel organization, in both the perfective and imperfective.

The chapter is organized as follows: in section 2, the general verbal organization in Egyptian Arabic is briefly reviewed. The specific strategies that help understand the Egyptian Arabic verb are then explored in section 3. This is followed by a comprehensive examination of the perfective vocalisms that occur in Egyptian Arabic in section 4. Finally, the six attested aspectual vowel alternations in Egyptian Arabic (perfective/imperfective) are analyzed in section 5.

3.2 A general view of the Egyptian Arabic verbal organization

3.2.1 The verbal measures

CEA shares many common features with CA as well as with other Semitic languages in general. The most prevalent characteristic common throughout the Semitic branch is its non-concatenative morphology. This morphology is expressed by means of pairing a *consonantal root* that encapsulates the lexical semantics of the verb and *vocalic patterns* that determine different grammatical values; the stem emerges following the interdigitation of these two ingredients.

A wide range of morphological alternations internal to the stem can take place in a non-concatenative system. Some phenomena involve consonants but not vowels; others involve vowels but not consonants, e.g. the systematic vowel alternation that is observed in the stem of the active voice of the first verbal measure of CA. This regular vowel alternation, known as “Ablaut in Classical Arabic,” can be roughly seen in the list of examples provided in Table 3.1. Perfectives with (a _ a) vocalic pattern may alternate with *u* or *i* in the imperfective (see i and ii). An imperfective with *a* melody corresponds to (a _ i) in the perfective (see iii). The alternating vowels are underscored.

Table 3.1 Ablaut in CA: verbal Measure I (3_{SING.MASC})

| | <i>perf.</i> | <i>imperf.</i> | | Root |
|------|----------------|------------------|------|---------------------|
| i. | ka <u>ta</u> b | ja-kt <u>u</u> b | √ktb | ‘write’ |
| ii. | ṣa <u>ba</u> r | ja-ṣb <u>i</u> r | √ṣbr | ‘act with patience’ |
| iii. | sa <u>l</u> im | ja-sl <u>a</u> m | √slm | ‘be safe’ |

The phenomenon of “ablaut” is encountered in CEA too; the far from exhaustive sample displayed in Table 3.2 documents this fact. According to the verb, a perfective with (e _ e) melody may alternate with either *o* or *a* in the imperfective (see ii and iii). A vowel *e* in the imperfective corresponds to (a _ a) in the perfective (see i). This is in addition to a number of other alternations that will be discussed in detail in a while.

Table 3.2 Ablaut in CEA: verbal Measure I (3_{SING.MASC})

| | <i>perf.</i> | <i>imperf.</i> | | Root |
|------|--------------|----------------|------|---------------------|
| i. | katab | je-kteb | √ktb | 'write' |
| ii. | ṣeber | jo-ṣbor | √ṣbr | 'act with patience' |
| iii. | selem | je-slam | √slm | 'be safe' |

Regarding its verbal system in general, CEA parallels CA in two ways: a) CEA successfully derives the most common verbal measures found in the Classical variety, and b) just like CA, CEA distinguishes between Measure I and the rest of the verbal measures in the sense that Measure I exhibits various patterns of “ablaut” but not the rest of the measures. These two shared particularities are documented in Table 3.3.

Table 3.3 Verbal measures found in both CA and CEA: (3_{SING.MASC})

| a. Measure | b. Root | c. CA | | d. CEA | | |
|------------|---------|---------------------|------------------|--------------|----------------|------------|
| | | <i>perf.</i> | <i>imperf.</i> | <i>perf.</i> | <i>imperf.</i> | |
| M. I | √ktb | 'write' | i. katab | ja-ktub | katab | je-kteb |
| | √ṣbr | 'act with patience' | ii. ṣabar | ja-ṣbir | ṣeber | jo-ṣbor |
| | √slm | 'be safe' | iii. salim | ja-slam | selem | je-slam |
| M. II | √drs | 'teach, learn' | iv. darras | ju-darris | darres | je-darres |
| M. III | √sfr | 'travel' | v. sa:far | ju-sa:fir | sa:fer | je-sa:fer |
| M. IV | √hrg | 'embarrass' | vi. ḥrag | ju-ḥrig | ḥrag | je-ḥreg |
| M. V | √klm | 'speak' | vii. takallam | ja-takallam | ḥetkalle | je-tkalle |
| M. VI | √wad | 'date' | viii. tawa:ʕad | ja-tawa:ʕad | ḥetwa:ʕed | je-twa:ʕed |
| M. VII | √fsl | 'split up' | ix. (ʔi)nfaʕal | ja-nfaʕil | ḥenfʕal | je-nfeʕel |
| M. VIII | √ʕmd | 'depend on' | x. (ʔi)ʕtamad | ja-ʕtamid | ḥeʕtamad | je-ʕtemed |
| M. IX | √hmr | 'become red' | xi. (ʔi)hmarr | ja-ḥmarr | ḥehmarr | je-ḥmarr |
| M. X | √hlk | 'consume' | xii. (ʔi)stahlak | ja-stahlak | ḥestahlek | je-stahlek |

3.2.2 The formal representation of the verb in Egyptian Arabic

The structural representation of the verb in Arabic has always been a concern for semiticists. In the earlier prosodic models (e.g. McCarthy, 1979a, 1981, 1984), the organization of the ingredients *root* and *vocalic pattern* with respect to each other is orchestrated by a “prosodic template”; this is the CV skeleton that determines the shape of the stem. The consonantal and the vocalic components of the verbal stem are associated to the template in autonomous fashion. This association occurs in a multi-tiered structure according to the Universal Association Conventions of autosegmental phonology (Goldsmith, 1976, Clements and Ford, 1979). Accordingly, the perfective of the CA and CEA Measure I verb *katab* √ktb ‘write’ is represented as appears in (3.1) where the radical consonants and the vocalic pattern have been mapped onto a CVCVC template.

(3.1) Measure I *katab* (CA and CEA)

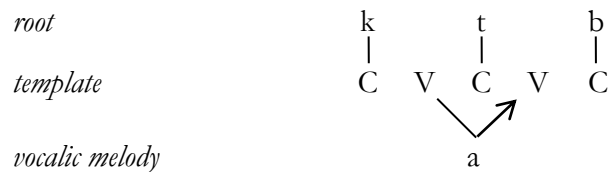

All the other verbal measures are represented in a similar way where the mapping of the roots and the vocalic patterns involves more complex templates, for example Measure II associates to CVCCVC, Measure III associates to CVVCVC, et cetera. The different morphemes of the CA Measure II verb *darras* √drs ‘teach’ and its CEA equivalent *darres* are seen each organized in their relevant templates in (3.2).²⁷

²⁷ For more details on this theory, the reader is referred to McCarthy (1979a, 1981).

(3.2) Measure II

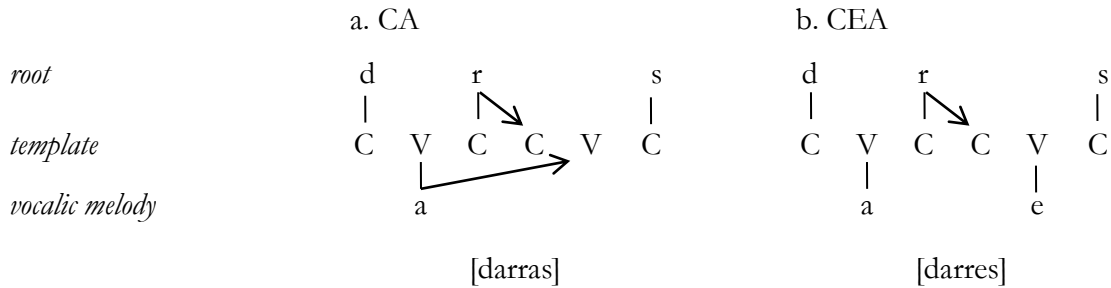

Another approach to the morpheme “template” was developed afterwards in Guerssel and Lowenstamm (1990). The crux of this model calls into question McCarthy’s (1979a, 1981) prior postulate that the whole template should be considered as a morpheme. Guerssel and Lowenstamm propose that only certain positions in the template can be sites for morphological operations. As such, their approach aims to identify these positions and to determine their morpho-syntactic role. In so doing, Guerssel and Lowenstamm (1990) offer an alternative account for the derivation of the verbal system of CA. In their analysis, Guerssel and Lowenstamm insist that each measure is identified by its own head.

The core of their proposal is articulated in such a way that the structure underlying the derivational morphology of the CA verb is a template consisting of: a) what they refer to as a “Nuclear Base” which consists of three CV syllables, together with b) prosodic units to which they refer as “derivational heads” that are expressed by an additional [CV]. These heads are either *internal* to the Nuclear base, in which case the additional CV is known as the “_{DS}, Derivational Syllable,” or *prefixed* to the Nuclear Base (both in italics in (3.3).) These ingredients constitute the unique Verbal Template from which all the verbal forms are derived:²⁸

(3.3) *CV* – *CV* [_{DS} *CV*] *CVCV*

²⁸ Another recent ambitious analysis of the ten verbal forms in Classical Arabic is provided in Arbaoui (2010). Arbaoui shows that each of the CV units of the unique Verbal Template proposed by Guerssel and Lowenstamm in (3.3) above is generated in a particular syntactic projection. The distinction between the ten measures is a reflex of their different derivations.

The derivation of the CA and CEA Measure I verb *katab* within this model is illustrated in (3.4), as is the derivation of the CA Measure II verb *darras* and its CEA counterpart *darres* in (3.5).

(3.4) Measure I

a. CA

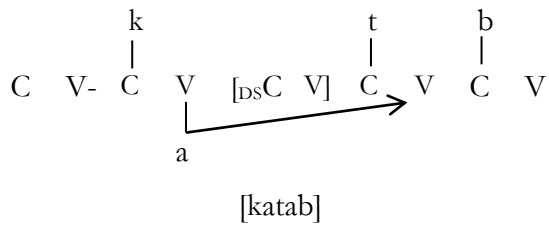

b. CEA

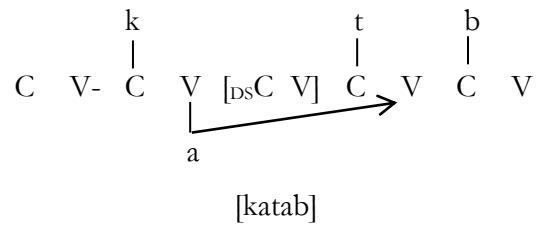

(3.5) Measure II

a. CA

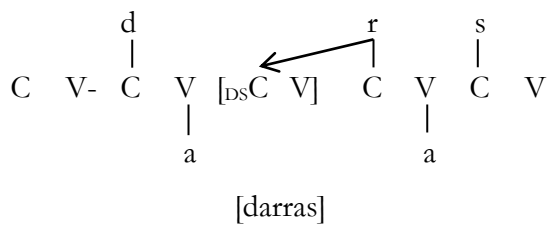

b. CEA

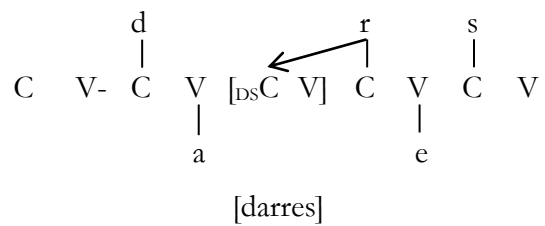

As we can see in (3.4), the derivation of the first verbal measure within this model is achieved through the identification of only the three CV units that make up the Nuclear Base. This is the “template” that I will, from here on, use as a base for my demonstration of Measure I verbs.

(3.6) CV- CV [Ds CV] CV CV

While CEA shares this common general verbal organization with CA, it does so within a certain framework and according to specific strategies. The aim of the next section is to bring to light some of the major similarities and differences between the two languages, more precisely on the subject of the vocalization of Measure I verbs.

3.3 The strategies for understanding the Egyptian Arabic verb

Measure I verbs in CA are classified into four categories according to the vocalic alternations attested between the perfective and the imperfective; this is illustrated in Table 3.4. The perfective stem (a _ a) pattern alternates with either *i* or *u* in the imperfective (see i and ii). The perfective (a _ i) alternates with an imperfective *a* (see iii) and the perfective (a _ u) alternates with an imperfective *u* melody (see iv). A Measure I verb in CA necessarily belongs to one of these four classes.²⁹

Table 3.4 The perfective/imperfective alternation patterns in CA: (3_{SING.MASC}) forms

| | a. | b. | c. | d. | e. |
|------|--------------|----------------|--|--|----------------|
| | <i>perf.</i> | <i>imperf.</i> | <i>perf.</i> stem melody (V ₁ _ V ₂) | <i>imperf.</i> stem melody (V ₁ _ V ₂) ³⁰ | Root |
| i. | ḍarab | ja-ḍrib | (a _ a) | (Ø _ i) | √ḍrb 'hit' |
| ii. | katab | ja-ktub | (a _ a) | (Ø _ u) | √ktb 'write' |
| iii. | salim | ja-slam | (a _ i) | (Ø _ a) | √slm 'be safe' |
| iv. | kabur | ja-kbur | (a _ u) | (Ø _ u) | √kbr 'grow up' |

The comparison of the perfective in these four classes with their corresponding forms in CEA leads us to an important observation. Consider Table 3.5. CA verbs with (a _ a) vocalization maintain the same stem melody in CEA (see i and ii). On the other hand, CA (a _ i) and (a _ u) perfective patterns converge into (e _ e) in CEA (see iii and iv).

²⁹ Two additional classes have been identified: CaCaC/ja-CCaC (such as *qaraʔ/ja-qrʔ* √qrʔ 'read') and CaCiC/ja-CCiC (such as *watiq/ja-wtiq* √wtiq 'rely on'); see Guerssel and Lowenstamm (1996) and Guerssel (2003) for discussion.

³⁰ "Ø" is the zero-marker for nothing.

Table 3.5 *Four* verbal classes in CA vs. *two* classes in CEA: the perfective

| | a. | b. | c. | d. | e. | |
|------|-------|-------|--|---|------|-----------|
| | CA | CEA | CA <i>perf.</i> stem (V ₁ _ V ₂) | CEA <i>perf.</i> stem (V ₁ _ V ₂) | | Root |
| i. | ḍarab | ḍarab | (a _ a) | (a _ a) | √ḍrb | 'hit' |
| ii. | katab | katab | (a _ a) | (a _ a) | √ktb | 'write' |
| iii. | salim | selem | (a _ i) | (e _ e) | √slm | 'be safe' |
| iv. | kabur | keber | (a _ u) | (e _ e) | √kbr | 'grow up' |

There would have been a huge number of logically possible alternatives to those seen in the above table. The fact that such a striking generalization as appears in Table 3.5 is possible, strongly suggests that a comparison with CA is worth pursuing.

The comparative examination of the different aspectual vocalic patterns in CEA and CA reveals another intriguing fact. Contrary to CA where the existing alternation patterns prompt a classification of verbs into *four* classes (see Table 3.4), careful assessment of CEA verbs yields a classification of aspectual vocalizations into *six* major alternation patterns as indicated in Table 3.6. Each of the two perfective patterns attested in CEA, (a _ a) and (e _ e), alternates with three imperfective melodies, {a, e, o}.

Table 3.6 The perfective/imperfective alternation patterns in CEA

| | a. (a _ a) class | | | b. (e _ e) class | | |
|----|---|---|---------------|---|---|--------------------------|
| | <i>perf.</i> stem (V ₁ _ V ₂) | <i>imperf.</i> stem (V ₁ _ V ₂) | Root | <i>perf.</i> stem (V ₁ _ V ₂) | <i>imperf.</i> stem (V ₁ _ V ₂) | Root |
| 1. | ḍarab (a _ a) | je-ḍrab (Ø _ a) | √ḍrb 'hit' | 4. selem (e _ e) | je-slam (Ø _ a) | √slm 'be safe' |
| 2. | katab (a _ a) | je-kteb (Ø _ e) | √ktb 'write' | 5. mesek (e _ e) | je-msek (Ø _ e) | √msk 'catch' |
| 3. | xarag (a _ a) | jo-xrog (Ø _ o) | √xrg 'go out' | 6. šeber (e _ e) | jo-šbor (Ø _ o) | √šbr 'act with patience' |

In view of the melodic alternations presented in the above table:

1. Two verbs with different perfective vocalic patterns such as *katab* and *meseK* are found sharing the same imperfective vocalization; see slots (2) and (5).
2. Verbs sharing the same perfective (a _ a) pattern such as *ḍarab*, *katab* and *xarag* alternate with different imperfective melodies, *a*, *e* and *o*; see column (a).
3. Verbs exhibiting the same perfective (e _ e) pattern such as *selem*, *meseK* and *ṣeber* also alternate with different imperfective melodies, *a*, *e* and *o*; see column (b).

Numerous other alternations between two perfective vocalizations, (a _ a) and (e _ e), and three imperfective melodies, {a, e, o}, could have been possible. The fact that only the alternation patterns shown in Table 3.6 are attested suggests – again – a robust underlying regularity.

Accordingly, the main objectives of our forthcoming inquiry can be stated as follows:

1. To explore the relationship between the respective vocalic equipment of CEA and CA Measure I verbs.
2. To determine the mechanism underlying the aspectual vocalic alternations in CEA.

For the sake of gaining perspective, CEA will be compared, where necessary, to CA and MA. This comparative examination will help pinpoint the strategies selected by CEA.

Our discussion begins in the next section with verbs in the perfective aspect. The special features that characterize the two main perfective vocalization patterns in CEA, (a _ a) and (e _ e), will be identified. This will lead up to a very important generalization: CEA perfectives, as their CA counterparts, are divided into a small number of vocalization classes.

3.4 The perfective of Egyptian Arabic

3.4.1 Vocalisms

We noted that four distinct classes of Measure I verbs are recognized in CA; they can be seen anew in column (a) in Table 3.7 below. The comparative examination of these four classes with their MA equivalents in column (b) confirms the loss of brevity thesis established for MA. Where a word is attested in both CA and MA, the latter does not realize the short (non-branching) vowels of the CA version, they are replaced by either: a) the high central vowel *i*, or by b) nothing at all.

Table 3.7 The perfective: CA vs. MA³¹

| | a. | b. | c. | d. | e. | |
|------|-------|------|--|--|------|-----------|
| | CA | MA | CA <i>perf.</i> stem (V ₁ _ V ₂) | MA <i>perf.</i> stem (V ₁ _ V ₂) | | Root |
| i. | ḍarab | ḍrib | (a _ a) | (Ø _ i) | √ḍrb | 'hit' |
| ii. | katab | ktib | (a _ a) | (Ø _ i) | √ktb | 'write' |
| iii. | salim | slim | (a _ i) | (Ø _ i) | √slm | 'be safe' |
| iv. | kabur | kbir | (a _ u) | (Ø _ i) | √kbr | 'grow up' |

Under the “delinking of non-branching vowels” premise, the dramatic convergence of the perfective of the four CA classes into one single class in MA is just what we expect; consider (3.7).

³¹ The Moroccan Arabic data is supplied by Nora Arbaoui.

(3.7)

| | | | | | | | | | | | | | | | |
|----------------------|--|---------------------------|---|---|---|---|----------------------|---------------------------|----|---|---|---|---|---|---|
| | | a. Predicted and attested | | | | | | b. Predicted and attested | | | | | | | |
| CA | | ḏ | a | r | a | b | | | | k | a | t | a | b | |
| | | | | | | | | | | | | | | | |
| | | C | V | C | V | C | V | | | C | V | C | V | C | V |
| | | | | | | | | | | | | | | | |
| MA | | ḏ | | r | i | b | | | MA | k | | t | i | b | |
| CA ḏarab vs. MA ḏriḏ | | | | | | | CA katab vs. MA kṭiḏ | | | | | | | | |
| | | c. Predicted and attested | | | | | | d. Predicted and attested | | | | | | | |
| CA | | s | a | l | i | m | | | CA | k | a | b | u | r | |
| | | | | | | | | | | | | | | | |
| | | C | V | C | V | C | V | | | C | V | C | V | C | V |
| | | | | | | | | | | | | | | | |
| MA | | s | | l | i | m | | | MA | k | | b | i | r | |
| CA salim vs. MA slim | | | | | | | CA kabur vs. MA kbir | | | | | | | | |

The previous examination of the CEA vowel system in chapter 1, section 1.5.2 uncovered a comparable tendency towards the dissociation of non-branching {i, u, a}. Everything being equal, a similar convergence of the perfective of the four CA verb classes into one class in CEA would be expected, parallel to what happens in MA. However, the inspection of the CEA perfective compared to that of CA reveals a different kind of vowel arrangement. Verbs with (a _ a) pattern in CA *maintain* their melody in CEA while those with (a _ i) and (a _ u) seem to have had their vowels dissociated. Consider the schemes in (3.8a and b) first vs. (c and d), then vs. (e and f). Note that, unlike MA, CEA is a language in which a word-initial sequence of two consonants is not permitted. Word-initial *#CC is immediately repaired by an epenthetic content that breaks this 2-consonant cluster.

(3.8)

| | | | | | | | | | | | | | | | |
|-------------------------|--|----------------------------|---|---|---|---|-------------------------|----------------------------|-----|---|---|---|---|---|---|
| | | a. Predicted, non-attested | | | | | | b. Predicted, non-attested | | | | | | | |
| CA | | ḏ | a | r | a | b | | | | k | a | t | a | b | |
| | | | | | | | | | | | | | | | |
| | | C | V | C | V | C | V | | | C | V | C | V | C | V |
| | | | | | | | | | | | | | | | |
| CEA | | ḏ | e | r | e | b | | | CEA | k | e | t | e | b | |
| CA ḏarab vs. CEA *ḏereb | | | | | | | CA katab vs. CEA *keteb | | | | | | | | |

c. Not predicted, attested

| | | | | | | |
|-----|---|---|---|---|---|---|
| CA | ḍ | a | r | a | b | |
| | | | | | | |
| | C | V | C | V | C | V |
| | | | | | | |
| CEA | ḍ | a | r | a | b | |

CA ḍarab vs. CEA ḍarab

d. Not predicted, attested

| | | | | | | |
|-----|---|---|---|---|---|---|
| CA | k | a | t | a | b | |
| | | | | | | |
| | C | V | C | V | C | V |
| | | | | | | |
| CEA | k | a | t | a | b | |

CA katab vs. CEA katab

e. Predicted, attested

| | | | | | | |
|-----|---|---|---|---|---|---|
| CA | s | a | l | i | m | |
| | | | | | | |
| | C | V | C | V | C | V |
| | | | | | | |
| CEA | s | e | l | e | m | |

CA salim vs. CEA selem

f. Predicted, attested

| | | | | | | |
|-----|---|---|---|---|---|---|
| CA | k | a | b | u | r | |
| | | | | | | |
| | C | V | C | V | C | V |
| | | | | | | |
| CEA | k | e | b | e | r | |

CA kabur vs. CEA keber

If CEA simply dissociates non-branching {i, u, a}, then the shaded slots in Table 3.8 raise an interesting challenge.

Table 3.8 Unexpected retention of short vowel {a} by CEA

| | a. CA | b. CEA | | Gloss |
|------|-------|----------|-------------------------|----------------------|
| | | Attested | Expected with delinking | |
| i. | ḍarab | ḍarab | *ḍereb | <i>'he hit'</i> |
| ii. | katab | katab | *keteb | <i>'he wrote'</i> |
| iii. | salim | selem | selem | <i>'he was safe'</i> |
| iv. | kabur | keber | keber | <i>'he grew up'</i> |

While CEA *selem* and *keber* comply with the conjecture under scrutiny, *ḍarab* and *katab* apparently do not. Rather, *ḍereb and *keteb would be expected. However, another look at Table 3.8 duplicated in Table 3.9 directly leads to the identification of perfect vowel harmony in CEA. Unlike the CA verbal stem which exhibits two different vowels, (a _ i) and (a _ u), CEA sturdily displays two identical stem vowels, either (a _ a) or (e _ e).

Table 3.9 Neutralization of CA (a _ i) and (a _ u) into (e _ e) in CEA

| | a. CA | | b. CEA | | c. CEA vocalization |
|------|-------|------------------|--------|------------------------------------|---------------------|
| i. | ḍarab | | ḍarab | | |
| ii. | katab | → | katab | → A-vocalization | CaCaC |
| iii. | salim | Neutralization → | selem | → Non-A-vocalization ³² | CeCeC |
| iv. | kabur | | keber | | |

The vowel patterns seen in the above table show the following:

1. CA (a _ i) and (a _ u) patterns undergo neutralization into one single class in CEA, (e _ e).
2. Unlike CA, a stem containing different vowel qualities, (a _ i) or (a _ u), is not possible in CEA. Both stem vowels must be *identical*.

These observations are summarized through the generalization articulated in (3.9) and further illustrated in (3.10):

- (3.9) A CEA verbal stem maintains a vocalization similar to CA when:
- a. The stem contains two identical vowels.
 - b. These two vowels are *a*.

³² The reason for which I am referring to this type of vocalization as “Non-A-vocalization” and not “E-vocalization” will become clear in section 3.4.3 of this chapter.

(3.10)

| | | | | | | | | | | | | | | | | | | | | | | | | | | | | | | | | | | | | | | | | | | | | | | | | | | | | | | | | | | | | | | | | | | | | | | | | | | | | | | | | | | | | | | | | | | | | | | | | | | | | | | | | | | | | | | |
|---|---|---|-------------------------------------|---|---|--|--|--|--|--|--|--|---|---|---|---|---|---|--|--|--|--|--|--|--|--|---|-------------------------------------|---|--|---------|--|--|--|--|--|---|---|--|---|--|---|--|--|--|--|--|--|--|---|---|---|---|---|---|--|--|--|--|--|--|--|--|---|-------------------------------------|---|--|---------|--|--|--|--|--|---|---|--|---|--|---|--|--|--|--|--|--|--|---|---|---|---|---|---|--|--|--|--|--|--|--|--|---|-------------------------------------|---|--|---------|--|--|--|--|--|
| <p>a.</p> <table style="width: 100%; border-collapse: collapse;"> <tr> <td style="text-align: center;">k</td> <td></td> <td style="text-align: center;">t</td> <td></td> <td style="text-align: center;">b</td> <td></td> </tr> <tr> <td style="text-align: center;"> </td> <td></td> <td style="text-align: center;"> </td> <td></td> <td style="text-align: center;"> </td> <td></td> </tr> <tr> <td style="text-align: center;">C</td> <td style="text-align: center;">V</td> <td style="text-align: center;">C</td> <td style="text-align: center;">V</td> <td style="text-align: center;">C</td> <td style="text-align: center;">V</td> </tr> <tr> <td></td> <td></td> <td style="text-align: center;"> </td> <td></td> <td style="text-align: center;"> </td> <td></td> </tr> <tr> <td></td> <td></td> <td style="text-align: center;">a</td> <td style="text-align: center;"><input checked="" type="checkbox"/></td> <td style="text-align: center;">a</td> <td></td> </tr> <tr> <td colspan="6" style="text-align: center; padding-top: 10px;">[katab]</td> </tr> </table> | k | | t | | b | | | | | | | | C | V | C | V | C | V | | | | | | | | | a | <input checked="" type="checkbox"/> | a | | [katab] | | | | | | <p>b.</p> <table style="width: 100%; border-collapse: collapse;"> <tr> <td style="text-align: center;">s</td> <td></td> <td style="text-align: center;">l</td> <td></td> <td style="text-align: center;">m</td> <td></td> </tr> <tr> <td style="text-align: center;"> </td> <td></td> <td style="text-align: center;"> </td> <td></td> <td style="text-align: center;"> </td> <td></td> </tr> <tr> <td style="text-align: center;">C</td> <td style="text-align: center;">V</td> <td style="text-align: center;">C</td> <td style="text-align: center;">V</td> <td style="text-align: center;">C</td> <td style="text-align: center;">V</td> </tr> <tr> <td></td> <td></td> <td></td> <td></td> <td></td> <td></td> </tr> <tr> <td></td> <td></td> <td style="text-align: center;">a</td> <td style="text-align: center;"><input checked="" type="checkbox"/></td> <td style="text-align: center;">i</td> <td></td> </tr> <tr> <td colspan="6" style="text-align: center; padding-top: 10px;">[selem]</td> </tr> </table> | s | | l | | m | | | | | | | | C | V | C | V | C | V | | | | | | | | | a | <input checked="" type="checkbox"/> | i | | [selem] | | | | | | <p>c.</p> <table style="width: 100%; border-collapse: collapse;"> <tr> <td style="text-align: center;">k</td> <td></td> <td style="text-align: center;">b</td> <td></td> <td style="text-align: center;">r</td> <td></td> </tr> <tr> <td style="text-align: center;"> </td> <td></td> <td style="text-align: center;"> </td> <td></td> <td style="text-align: center;"> </td> <td></td> </tr> <tr> <td style="text-align: center;">C</td> <td style="text-align: center;">V</td> <td style="text-align: center;">C</td> <td style="text-align: center;">V</td> <td style="text-align: center;">C</td> <td style="text-align: center;">V</td> </tr> <tr> <td></td> <td></td> <td></td> <td></td> <td></td> <td></td> </tr> <tr> <td></td> <td></td> <td style="text-align: center;">a</td> <td style="text-align: center;"><input checked="" type="checkbox"/></td> <td style="text-align: center;">u</td> <td></td> </tr> <tr> <td colspan="6" style="text-align: center; padding-top: 10px;">[keber]</td> </tr> </table> | k | | b | | r | | | | | | | | C | V | C | V | C | V | | | | | | | | | a | <input checked="" type="checkbox"/> | u | | [keber] | | | | | |
| k | | t | | b | | | | | | | | | | | | | | | | | | | | | | | | | | | | | | | | | | | | | | | | | | | | | | | | | | | | | | | | | | | | | | | | | | | | | | | | | | | | | | | | | | | | | | | | | | | | | | | | | | | | | | | | | | |
| | | | | | | | | | | | | | | | | | | | | | | | | | | | | | | | | | | | | | | | | | | | | | | | | | | | | | | | | | | | | | | | | | | | | | | | | | | | | | | | | | | | | | | | | | | | | | | | | | | | | | | | | | | | | | | |
| C | V | C | V | C | V | | | | | | | | | | | | | | | | | | | | | | | | | | | | | | | | | | | | | | | | | | | | | | | | | | | | | | | | | | | | | | | | | | | | | | | | | | | | | | | | | | | | | | | | | | | | | | | | | | | | | | | | | |
| | | | | | | | | | | | | | | | | | | | | | | | | | | | | | | | | | | | | | | | | | | | | | | | | | | | | | | | | | | | | | | | | | | | | | | | | | | | | | | | | | | | | | | | | | | | | | | | | | | | | | | | | | | | | | | |
| | | a | <input checked="" type="checkbox"/> | a | | | | | | | | | | | | | | | | | | | | | | | | | | | | | | | | | | | | | | | | | | | | | | | | | | | | | | | | | | | | | | | | | | | | | | | | | | | | | | | | | | | | | | | | | | | | | | | | | | | | | | | | | | |
| [katab] | | | | | | | | | | | | | | | | | | | | | | | | | | | | | | | | | | | | | | | | | | | | | | | | | | | | | | | | | | | | | | | | | | | | | | | | | | | | | | | | | | | | | | | | | | | | | | | | | | | | | | | | | | | | | | |
| s | | l | | m | | | | | | | | | | | | | | | | | | | | | | | | | | | | | | | | | | | | | | | | | | | | | | | | | | | | | | | | | | | | | | | | | | | | | | | | | | | | | | | | | | | | | | | | | | | | | | | | | | | | | | | | | | |
| | | | | | | | | | | | | | | | | | | | | | | | | | | | | | | | | | | | | | | | | | | | | | | | | | | | | | | | | | | | | | | | | | | | | | | | | | | | | | | | | | | | | | | | | | | | | | | | | | | | | | | | | | | | | | | |
| C | V | C | V | C | V | | | | | | | | | | | | | | | | | | | | | | | | | | | | | | | | | | | | | | | | | | | | | | | | | | | | | | | | | | | | | | | | | | | | | | | | | | | | | | | | | | | | | | | | | | | | | | | | | | | | | | | | | |
| | | | | | | | | | | | | | | | | | | | | | | | | | | | | | | | | | | | | | | | | | | | | | | | | | | | | | | | | | | | | | | | | | | | | | | | | | | | | | | | | | | | | | | | | | | | | | | | | | | | | | | | | | | | | | | |
| | | a | <input checked="" type="checkbox"/> | i | | | | | | | | | | | | | | | | | | | | | | | | | | | | | | | | | | | | | | | | | | | | | | | | | | | | | | | | | | | | | | | | | | | | | | | | | | | | | | | | | | | | | | | | | | | | | | | | | | | | | | | | | | |
| [selem] | | | | | | | | | | | | | | | | | | | | | | | | | | | | | | | | | | | | | | | | | | | | | | | | | | | | | | | | | | | | | | | | | | | | | | | | | | | | | | | | | | | | | | | | | | | | | | | | | | | | | | | | | | | | | | |
| k | | b | | r | | | | | | | | | | | | | | | | | | | | | | | | | | | | | | | | | | | | | | | | | | | | | | | | | | | | | | | | | | | | | | | | | | | | | | | | | | | | | | | | | | | | | | | | | | | | | | | | | | | | | | | | | | |
| | | | | | | | | | | | | | | | | | | | | | | | | | | | | | | | | | | | | | | | | | | | | | | | | | | | | | | | | | | | | | | | | | | | | | | | | | | | | | | | | | | | | | | | | | | | | | | | | | | | | | | | | | | | | | | |
| C | V | C | V | C | V | | | | | | | | | | | | | | | | | | | | | | | | | | | | | | | | | | | | | | | | | | | | | | | | | | | | | | | | | | | | | | | | | | | | | | | | | | | | | | | | | | | | | | | | | | | | | | | | | | | | | | | | | |
| | | | | | | | | | | | | | | | | | | | | | | | | | | | | | | | | | | | | | | | | | | | | | | | | | | | | | | | | | | | | | | | | | | | | | | | | | | | | | | | | | | | | | | | | | | | | | | | | | | | | | | | | | | | | | | |
| | | a | <input checked="" type="checkbox"/> | u | | | | | | | | | | | | | | | | | | | | | | | | | | | | | | | | | | | | | | | | | | | | | | | | | | | | | | | | | | | | | | | | | | | | | | | | | | | | | | | | | | | | | | | | | | | | | | | | | | | | | | | | | | |
| [keber] | | | | | | | | | | | | | | | | | | | | | | | | | | | | | | | | | | | | | | | | | | | | | | | | | | | | | | | | | | | | | | | | | | | | | | | | | | | | | | | | | | | | | | | | | | | | | | | | | | | | | | | | | | | | | | |

Although the neutralization outlined in Table 3.9 above has been reported by previous investigators, to my knowledge, it has never been explained. Gadalla (2000) for example states that the conditions governing the correspondence between the CA (a _ i) and (a _ u) patterns and the CEA (e _ e) are still unknown. For my part, I will offer a proposal that accounts for these correspondences. In order to do so, I must first adduce important additional information concerning the two perfective vocalic patterns of CEA.

3.4.2 The characteristics of the AV (CaCaC) and NAV (CeCeC) patterns

As we have just seen in the last section, two vocalic patterns only are attested in the CEA perfective verbal stem. They are either: a) *A-Vocalization*, the CaCaC pattern, or b) *Non-A-Vocalization*, the CeCeC pattern. I will henceforth refer to these two classes by the initials *AV* and *NAV*, respectively. When these two patterns are closely examined, one interesting finding is revealed. Let us observe the following two verbal paradigms in Table 3.10; the verb *katab* √ktb ‘write’ in column (a) and *selem* √slm ‘be safe’ in column (b).

Table 3.10 CEA katab vs. selem: perfective verbal paradigms

| | | katab √ktb ‘write’ | selem √slm ‘be safe’ |
|-------|------------------------|--------------------|----------------------|
| i. | 3 _{SING.MASC} | katab | selem |
| ii. | 3 _{SING.FEM} | katabet | selmet |
| iii. | 2 _{SING.MASC} | katabt | selemt |
| iv. | 2 _{SING.FEM} | katabti | selemti |
| v. | 1 _{SING} | katabt | selemt |
| vi. | 3 _{PL} | katabu | selmu |
| vii. | 2 _{PL} | kababt | selemtu |
| viii. | 1 _{PL} | katabna | selemnna |

Table 3.10 shows the following fact: compared to the stable vocalization of the *AV* class, the vocalization of the *NAV* class is very unstable. Consider Table 3.11 for a clearer idea; let us focus on the second stem vowel in *selem-tu* compared to *selm-u* in set (a) and the second stem vowel in *katab-tu* compared to *katab-u* in set (b). The vowels under investigation are underlined.

Table 3.11 Stable second stem vowel in -katab- but not in -selem-

| | | Stem V ₂ | Gloss |
|----------------------------|-----------------|---------------------|--|
| a. <i>NAV</i> stem -selem- | | | |
| i. | 2 _{PL} | [se <u>l</u> emtu] | Present /se <u>l</u> em-tu/ ‘you (PL) were safe’ |
| ii. | 3 _{PL} | [sel_mu] | Absent /se <u>l</u> em-u/ ‘they were safe’ |
| b. <i>AV</i> stem -katab- | | | |
| i. | 2 _{PL} | [katab <u>a</u> tu] | Present /katab <u>a</u> -tu/ ‘you (PL) wrote’ |
| ii. | 3 _{PL} | [katab <u>a</u> bu] | Present /katab <u>a</u> -u/ ‘they wrote’ |

While the second vowel of the *AV* stem is stable, the second stem vowel in the *NAV* class is not. It is present with a C-initial suffix (the 2_{PL} *-tu* in *selemtu*), and it disappears where the stem is suffixed with a V-initial pronoun (the *-u* marking the plural in *selmu*). The second stem *e* in the *NAV* category is therefore dependent on the phonological shape of the suffix. On the contrary, the phonological makeup of the suffixed material has no effect whatsoever on the stability of the second stem *a* in the *AV* class, hence *katabtu* and *katabu*.

In terms of Government Phonology and under the ECP, this can be expressed as follows: when the second V position of the *-selem-* template (the underscored V_2 in (3.11)) is properly governed by a subsequent content-packed nucleus, it is licensed to remain empty, hence *selmu*.

(3.11)

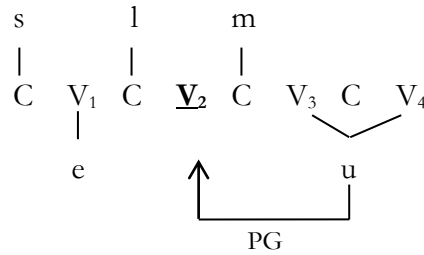

[selmu]

Now, let us consider the negation forms of the two verbs given earlier in Table 3.10. A look at Table 3.12 reveals the instability of the *NAV* first stem vowel in certain negation forms compared to the affirmative ones, namely (3_{SING.MASC}), (2_{SING.MASC}), (2_{SING.FEM}), (1_{SING}), (2_{PL}) and (1_{PL}).

Table 3.12 CEA *katab* vs. *selem*: perfective and negation

| | | <i>katab</i> | Negation | <i>selem</i> | Negation |
|-------|------------------------|----------------|--------------------|----------------|-------------------|
| | | √ktb 'write' | | √slm 'be safe' | |
| i. | 3 _{SING.MASC} | <i>katab</i> | <i>makatabš</i> | <i>selem</i> | <i>maslemš</i> |
| ii. | 3 _{SING.FEM} | <i>katabet</i> | <i>makatabetš</i> | <i>selmet</i> | <i>maselmetš</i> |
| iii. | 2 _{SING.MASC} | <i>katabt</i> | <i>makatabteš</i> | <i>selemt</i> | <i>maslemteš</i> |
| iv. | 2 _{SING.FEM} | <i>katabti</i> | <i>makatabti:š</i> | <i>selemti</i> | <i>maslemti:š</i> |
| v. | 1 _{SING} | <i>katabt</i> | <i>makatabteš</i> | <i>selemt</i> | <i>maslemteš</i> |
| vi. | 3 _{PL} | <i>katabu</i> | <i>makatabu:š</i> | <i>selmu</i> | <i>maselmu:š</i> |
| vii. | 2 _{PL} | <i>kabtu</i> | <i>makabtu:š</i> | <i>selemtu</i> | <i>maslemtu:š</i> |
| viii. | 1 _{PL} | <i>kabna</i> | <i>makabna:š</i> | <i>selemn</i> | <i>maslemn:š</i> |

The volatility of the *NAV* first stem vowel (seen in *selemtu* vs. the negation form *maselemtu:š* in set (a) in Table 3.13) can this time be distinguished. This is in contrast with the *AV* first stem vowel (seen in *katab-tu* vs. *makatabtu:š* in set (b)) which appears to be entirely stable. The vowels in question are underscored.

Table 3.13 Stable first stem vowel in -katab- but not in -selem-

| | | Stem V ₁ | Gloss | | |
|----------------------------|---------------------|-------------------------|---------|---------------------------|--------------------------|
| a. <i>NAV</i> stem -selem- | | | | | |
| i. | 2 _{PL} | [s <u>e</u> lemtu] | Present | /s <u>e</u> lem-tu/ | 'you (PL) were safe' |
| ii. | 2 _{PL.NEG} | [mas_ <u>e</u> lemtu:š] | Absent | /ma+s <u>e</u> lem-tu +š/ | 'you (PL) were not safe' |
| b. <i>AV</i> stem -katab- | | | | | |
| i. | 2 _{PL} | [k <u>a</u> tabtu] | Present | /k <u>a</u> tab-tu/ | 'you (PL) wrote' |
| ii. | 2 _{PL.NEG} | [mak <u>a</u> tabtu:š] | Present | /ma+k <u>a</u> tab-tu +š/ | 'you (PL) didn't write' |

A cursory comparison between the verbal stem -selem- before and after the cliticization by the (ma – š) negation morpheme shows that the appearance or disappearance of the first stem vowel *e* is conditioned by the presence or absence of the V-final negative proclitic *ma*-.³³

Under the assumptions of Government Phonology, this can be interpreted as follows: whenever the first V position of the -selem- verbal template (the underlined V₃ in (3.12)) is properly governed by the subsequent nucleus, and *when it is non-initial within the word domain*, its phonetic materialization is no longer required.

³³ The negation morpheme attested in most contemporary dialects of spoken Arabic (including Colloquial Egyptian Arabic) is composed of the pre-verbal morpheme *ma*:- together with a post-verbal enclitic –š which has been grammaticalized from the word for *šaj?* in Classical Arabic. Literally, both clitics (ma: + *šaj?*) make up the word (no + thing).

(3.12)

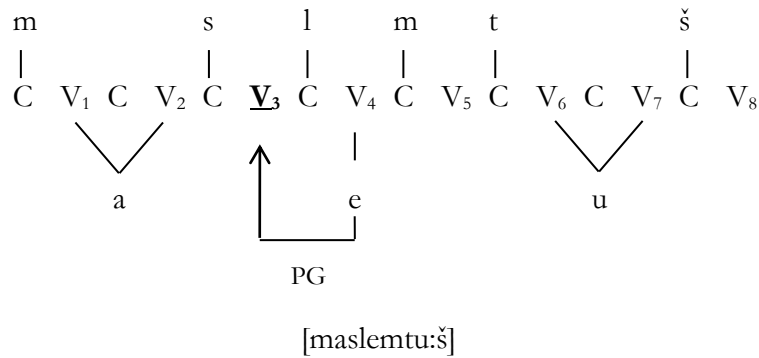

By contrast, the first stem vowel in -katab-, whether preceded by a V-final proclitic or not, remains stable.³⁴ Consequently, it can be plausibly presumed that the vocalization of the *NAV* class is managed by the “epenthetic system.” If this is the case, it can be surmised that the vocalic equipment of *selem* ‘he was safe’ and all *NAV* verbs is *null*.

Based on what precedes, two hypotheses will be pursued:

1. Hypothesis 1:

- a. The *AV* class is equipped with an underlying lexical *a* which, *for some reason*, manages to resist dissociation under space requirement, apparently contra the loss of brevity thesis.
- b. The *NAV* class is characterized by its underlying “null” vocalic equipment.

2. Hypothesis 2: both *AV* and *NAV* classes are equipped with vocalic material similar to that of CA where:

³⁴ The volatility of the *NAV* stem vowels (i.e. the stem alternation -slem ~ selm- according to the nature of the affixed material) presents a serious challenge to the prosodic model proposed in e.g. McCarthy (1979a, 1981). A template of a CVCVC structure can only account for the stable *AV* stem but not the *NAV* stem which varies between CCVC in -slem- (e.g. *maslemš* ‘he was not safe’) and CVCC in -selm- (e.g. *selmu* ‘they were safe’). Only a template that rigidly comprises three consecutive CV units like the one proposed in Guerssel and Lowenstamm (1990) can interpret such alternations.

- a. The *AV* class maintains its melody *modulo* the generalization in (3.9) which states that a CEA verbal stem maintains a vocalization similar to that of CA when the stem contains two identical vowels, and when these two vowels are *a*.
- b. The *NAV* class demonstrates a clear case of delinking of non-branching {i, u, a} vowels which goes in line with the general tendency of the language. The consonantal string resulting from delinking is, as usual, managed through the economy of the epenthetic system.

These two possibilities are depicted in (3.13) and (3.14), respectively.

(3.13) Hypothesis 1: *AV* with underlying /a/ and *NAV* with underlying “null” vocalic material

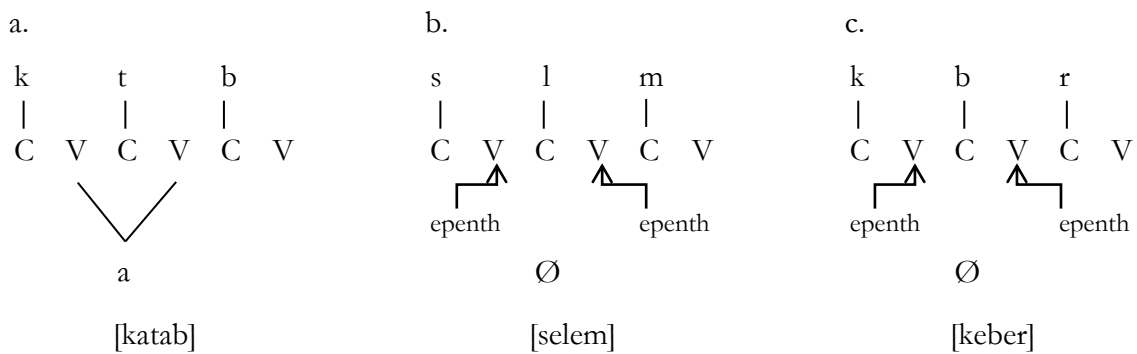

(3.14) Hypothesis 2: *AV* and *NAV* with underlying material similar to CA. Only *NAV* complies with “loss of brevity”

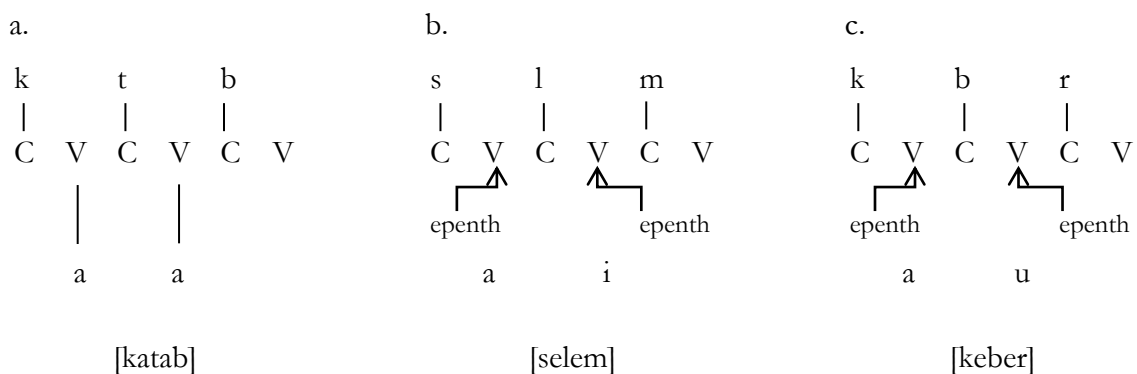

Endorsing Hypothesis 1 implies an inevitable dichotomy of roots: a class of roots implements a lexical /a/ whereas another class employs /Ø/. In other words, the vocalic material underlying the perfective stem is unrelated to that of CA.

Endorsing Hypothesis 2 seems more attractive for the following reasons:

1. The vocalic material underlying a given CEA perfective can be retrieved through the observation of its CA equivalent.
2. Two thirds of CEA verbs conform to the loss of brevity thesis (i.e. *selem* and *keber*).

And yet, “loss of brevity” is still challenged in one third of the cases, i.e. the *AV* class (why is **keteb* not attested?).

A rapid examination of nominal stems is relevant here. In (3.15), three CEA nouns are compared to their CA analogues; these are the verbal noun CA *ḍāḥik* vs. CEA *ḍeḥk* √ḍḥk ‘laughter’ in (a), CA *ḥulm* vs. CEA *ḥelm* √ḥlm ‘dream’ in (b), and CA *qalam* vs. CEA *ʔalam* √qlm ‘pen’ in (c).³⁵ Let us focus on two things: a) what vowels have remained and what vowels have not remained, and b) whether or not the stem exhibits identical vowels.

(3.15)

| | a. | b. | c. |
|-----|-----------------------|-----------------------|-------------------------|
| CA | ḍ a ḥ i k | ḥ u l m | q a l a m |
| | | | |
| | C V C V C V | C V C V C V | C V C V C V |
| | | | |
| CEA | ḍ e ḥ k | ḥ e l m | ʔ a l a m |
| | | | |
| | C V C V C V | C V C V C V | C V C V C V |
| | | | |
| | C V C V C V | C V C V C V | C V C V C V |
| | | | |
| | C V C V C V | C V C V C V | C V C V C V |
| | | | |
| | C V C V C V | C V C V C V | C V C V C V |
| | | | |
| | C V C V C V | C V C V C V | C V C V C V |
| | | | |
| | C V C V C V | C V C V C V | C V C V C V |
| | | | |
| | C V C V C V | C V C V C V | C V C V C V |
| | | | |
| | C V C V C V | C V C V C V | C V C V C V |
| | | | |
| | C V C V C V | C V C V C V | C V C V C V |
| | | | |
| | C V C V C V | C V C V C V | C V C V C V |
| | | | |
| | C V C V C V | C V C V C V | C V C V C V |
| | | | |
| | C V C V C V | C V C V C V | C V C V C V |
| | | | |
| | C V C V C V | C V C V C V | C V C V C V |
| | | | |
| | C V C V C V | C V C V C V | C V C V C V |
| | | | |
| | C V C V C V | C V C V C V | C V C V C V |
| | | | |
| | C V C V C V | C V C V C V | C V C V C V |
| | | | |
| | C V C V C V | C V C V C V | C V C V C V |
| | | | |
| | C V C V C V | C V C V C V | C V C V C V |
| | | | |
| | C V C V C V | C V C V C V | C V C V C V |
| | | | |
| | C V C V C V | C V C V C V | C V C V C V |
| | | | |
| | C V C V C V | C V C V C V | C V C V C V |
| | | | |
| | C V C V C V | C V C V C V | C V C V C V |
| | | | |
| | C V C V C V | C V C V C V | C V C V C V |
| | | | |
| | C V C V C V | C V C V C V | C V C V C V |
| | | | |
| | C V C V C V | C V C V C V | C V C V C V |
| | | | |
| | C V C V C V | C V C V C V | C V C V C V |
| | | | |
| | C V C V C V | C V C V C V | C V C V C V |
| | | | |
| | C V C V C V | C V C V C V | C V C V C V |
| | | | |
| | C V C V C V | C V C V C V | C V C V C V |
| | | | |
| | C V C V C V | C V C V C V | C V C V C V |
| | | | |
| | C V C V C V | C V C V C V | C V C V C V |
| | | | |
| | C V C V C V | C V C V C V | C V C V C V |
| | | | |
| | C V C V C V | C V C V C V | C V C V C V |
| | | | |
| | C V C V C V | C V C V C V | C V C V C V |
| | | | |
| | C V C V C V | C V C V C V | C V C V C V |
| | | | |
| | C V C V C V | C V C V C V | C V C V C V |
| | | | |
| | C V C V C V | C V C V C V | C V C V C V |
| | | | |
| | C V C V C V | C V C V C V | C V C V C V |
| | | | |
| | C V C V C V | C V C V C V | C V C V C V |
| | | | |
| | C V C V C V | C V C V C V | C V C V C V |
| | | | |
| | C V C V C V | C V C V C V | C V C V C V |
| | | | |
| | C V C V C V | C V C V C V | C V C V C V |
| | | | |
| | C V C V C V | C V C V C V | C V C V C V |
| | | | |
| | C V C V C V | C V C V C V | C V C V C V |
| | | | |
| | C V C V C V | C V C V C V | C V C V C V |
| | | | |
| | C V C V C V | C V C V C V | C V C V C V |
| | | | |
| | C V C V C V | C V C V C V | C V C V C V |
| | | | |
| | C V C V C V | C V C V C V | C V C V C V |
| | | | |
| | C V C V C V | C V C V C V | C V C V C V |
| | | | |
| | C V C V C V | C V C V C V | C V C V C V |
| | | | |
| | C V C V C V | C V C V C V | C V C V C V |
| | | | |
| | C V C V C V | C V C V C V | C V C V C V |
| | | | |
| | C V C V C V | C V C V C V | C V C V C V |
| | | | |
| | C V C V C V | C V C V C V | C V C V C V |
| | | | |
| | C V C V C V | C V C V C V | C V C V C V |
| | | | |
| | C V C V C V | C V C V C V | C V C V C V |
| | | | |
| | C V C V C V | C V C V C V | C V C V C V |
| | | | |
| | C V C V C V | C V C V C V | C V C V C V |
| | | | |
| | C V C V C V | C V C V C V | C V C V C V |
| | | | |
| | C V C V C V | C V C V C V | C V C V C V |
| | | | |
| | C V C V C V | C V C V C V | C V C V C V |
| | | | |
| | C V C V C V | C V C V C V | C V C V C V |
| | | | |
| | C V C V C V | C V C V C V | C V C V C V |
| | | | |
| | C V C V C V | C V C V C V | C V C V C V |
| | | | |
| | C V C V C V | C V C V C V | C V C V C V |
| | | | |
| | C V C V C V | C V C V C V | C V C V C V |
| | | | |
| | C V C V C V | C V C V C V | C V C V C V |
| | | | |
| | C V C V C V | C V C V C V | C V C V C V |
| | | | |
| | C V C V C V | C V C V C V | C V C V C V |
| | | | |
| | C V C V C V | C V C V C V | C V C V C V |
| | | | |
| | C V C V C V | C V C V C V | C V C V C V |
| | | | |
| | C V C V C V | C V C V C V | C V C V C V |
| | | | |
| | C V C V C V | C V C V C V | C V C V C V |
| | | | |
| | C V C V C V | C V C V C V | C V C V C V |
| | | | |
| | C V C V C V | C V C V C V | C V C V C V</ |

The comparative analysis in (3.15) reveals the following:

- (3.16) A CEA nominal stem maintains a vocalization similar to CA when:
- a. The stem contains two identical vowels.
 - b. These two vowels are *a*.

In light of these additional findings, an important question must be asked: what makes a nominal stem like *ʔalam* ‘pen’ and a verbal stem like *katab* ‘he wrote’ viable in CEA?

If the two major characteristics of the CEA phonology are recalled, namely {i, u, a} must branch, and stems tend to exhibit harmonized vowels, then the viability of *katab* and *ʔalam* will be indicative of the *branching* of vowel *a* realizing these stems. Under the CVCV approach, a branching vowel is a vocalic object associated to two V units flanking an “empty” C slot; this is shown in (3.17a). On the other hand, if the stability of the vocalization of *katab* and *ʔalam* is considered, another structural representation of a branching vowel can be contemplated, this being a vocalic object that branches *and* straddles an “identified” C slot as appears in (3.17b). The pair of vowels implemented in *katab* and *ʔalam* is counted by the system as one single object.

(3.17)

a. Branching vowel in CVCV model

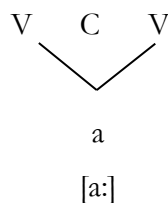

b. Possible branching vowel in CEA

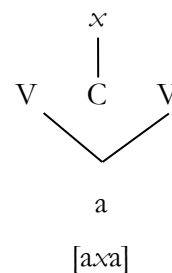

The proposal developed above is that vowel *a* in CEA has the capacity to flank a C slot occupied by a consonant; this consonant is represented by *x* in (3.17b). I argue that the two configurations in (3.17) are equivalent; both have the same value, a “phonologically long” vowel.

Reconsidering the generalizations posited earlier in (3.9) and (3.16) leads to a preliminary distinction between vowel *a* on one side and *i* and *u* on the other side. In CEA, *a* can spread across a consonant whereas *i* and *u* cannot.

(3.18) CEA

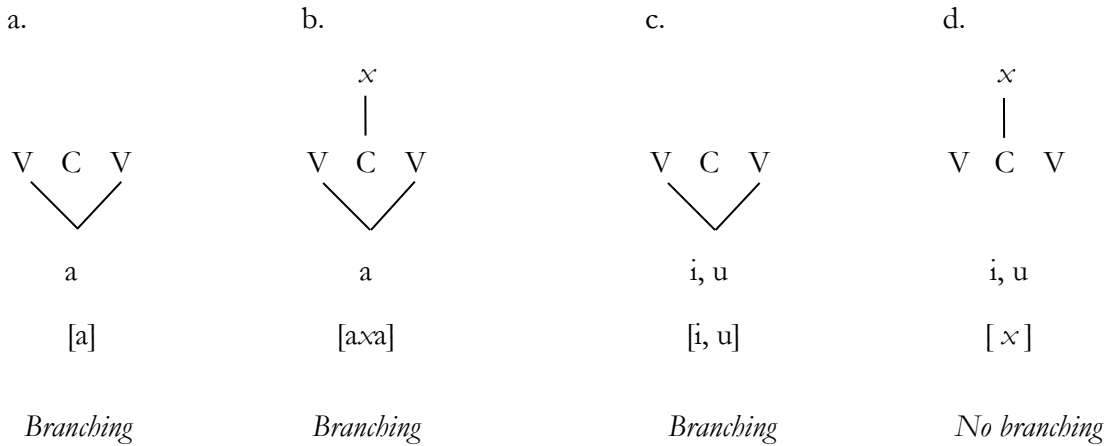

Generally speaking, the representation in (3.17b) can also define one of the basic differences between the grammars of CEA and MA: whereas a “full” vowel *a* in CEA can branch and straddle a consonant, vowel *a* in MA cannot.

(3.19)

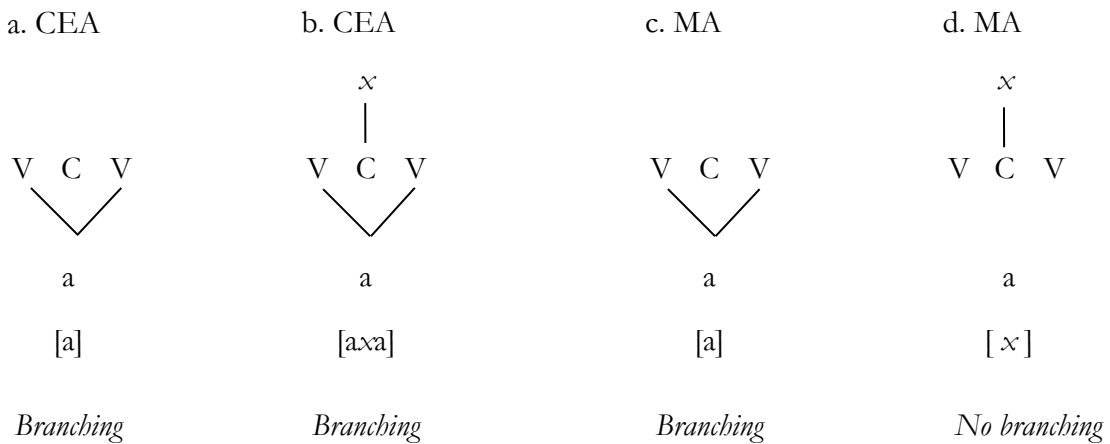

For this reason, CEA is capable of maintaining the stem vowels in *katab* (**keteb* is therefore excluded) contrary to the MA *ktib* which obviously had its stem vocalization dissociated (hence **katab* is not an option for MA).

(3.20)

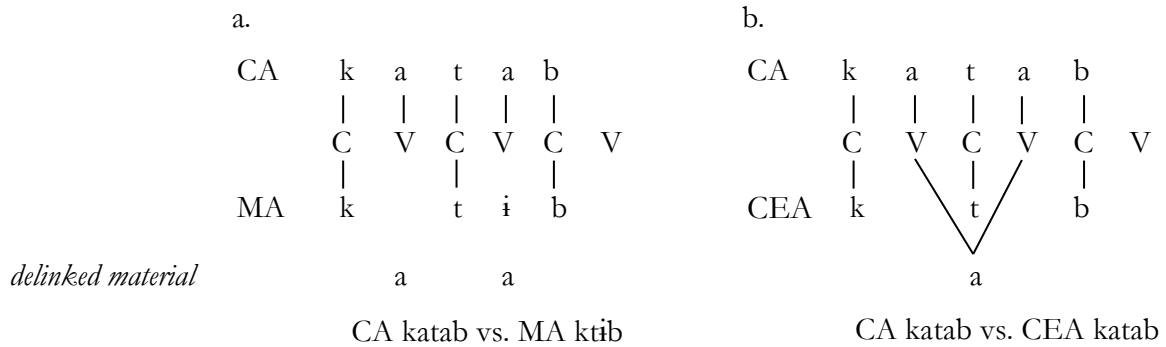

In view of this proposal, let us now reassess the two hypotheses contemplated earlier in (3.13) and (3.14). Between Hypothesis 1 where no relationship whatsoever can be discerned between the perfectives of CEA and CA, and Hypothesis 2 whereby both CEA and CA perfectives are equipped with the same vowels, I would opt for the second choice even though a “special status” will be assigned in this case to vowel *a*. Indeed, surmising a split in the performance of vowel *a* on one side and *i* and *u* on the other side is not that uncommon, similar distinctions can also be found in other Afro-Asiatic languages.³⁶

(3.21) The CEA perfective is equipped with the same vowels as CA

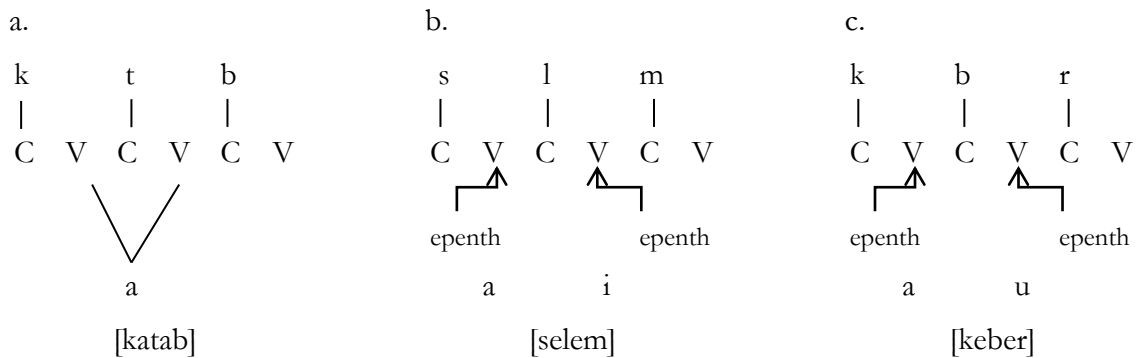

³⁶ Cf. Lowenstamm (1991), Ségéral (1995, 1996) and the detailed discussions therein for evidence supporting this view. Additionally, the case of Ge’ez is briefly reviewed in chapter 2, section 2.4.2 of the present study.

3.4.3 The organization of the perfective vocalic material

Now, if the preliminary conclusion just put forth is correct, CEA maintains (a _ a), (a _ i), (a _ u) as (a _ a) and (e _ e) due to the capacity of vowel *a* to spread across a consonant, and if *i* and *u* are not endowed (per hypothesis) with the same capacity, then what prevents the *a* in *salim* and *kabur* from branching as depicted in (3.22b and c)?

(3.22) Predictable non-attested representations

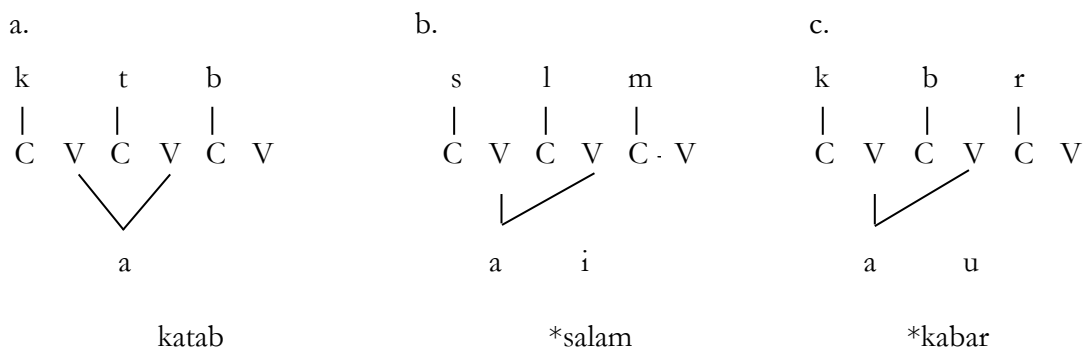

The delinking of *i* and *u* in (3.22b and c) should certainly create favorable circumstances for the *a* ingredient to branch. Why are **salam* and **kabar* not attested?

Indeed, in a parallel hypothetical system where “phonologically full” *i* and *u* also had the potential of spreading across an identified consonantal position, verbs like *katab*, *selem* and *kobor* would certainly be found. Consider (3.23) where (by hypothesis) all of {*i*, *u*, *a*} have the capacity to branch *and* straddle a consonant.

(3.23)

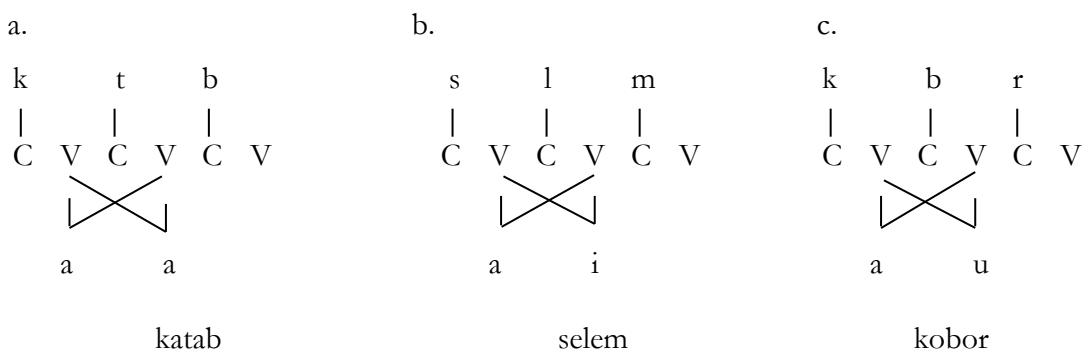

The above representations raise the question of whether hypothetical outputs like *selem* and *kobor* are present in CEA.

Close examination of the CEA verbal repertoire interestingly shows that over forty verbs with (o _ o) vocalization can be readily listed.³⁷ Almost all of those relatively few verbs are found in free variation with verbs vocalized by means of (e _ e); consider the sample given in Table 3.14.³⁸ These forty verbs in free variation will help us uncover a remarkable dynamic aspect of contemporary CEA.

Table 3.14 The CoCoC ~ CeCeC variants in the perfective of CEA

| | a. Frequent | | b. Infrequent | | c. Root |
|------|-------------|---|---------------|------|---------------------------|
| i. | keber | ~ | kobor | √kbr | 'increase in size or age' |
| ii. | šeber | ~ | šobor | √šbr | 'decrease in size or age' |
| iii. | rexeş | ~ | roxoš | √rxş | 'cheapen' |
| iv. | sexen | ~ | soxon | √sxn | 'become hot' |
| v. | xeser | ~ | xosor | √xsr | 'lose' |
| vi. | keḏeb | ~ | koḏob | √kḏb | 'become angry' |

Careful examination of one of the verbs displayed in Table 3.14 in terms of Elements reveals two important findings: a) elements other than Element A can spread *across* a consonant, and b) crucially, neither Element I nor Element U is capable of branching all by itself, Element A must be present. Consider the verb *keber* ~ *kobor* in (3.24).

³⁷ Badawi and Hinds (1986) provide a list of 43 trilateral verbs with (u _ u) vocalization, 41 of which alternate in free variation with (i _ i). Badawy and Hinds note that their transcription of *i* and *u* in these verbs does not phonetically involve the high vowels, rather vowels with a lower quality. I write them *xeser*, *kobor*, etc.

³⁸ Variants with (e _ e) melody are far more frequent than (o _ o); this might be the reason for which verbs with (o _ o) vocalization have never been taken into account by previous investigators.

(3.24)

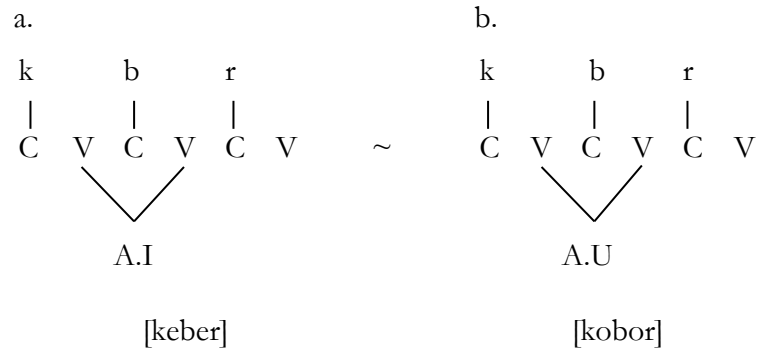

Accordingly, the distinction previously established between vowel *a* (i.e. Element A) on one side and vowels *i* and *u* (i.e. Elements I and U) on the other side can be further refined. The introduction of Element A into I and U *enables* them to branch across a content-packed C slot; this can be seen in (3.25d) when compared to (3.26b and d).

(3.25)

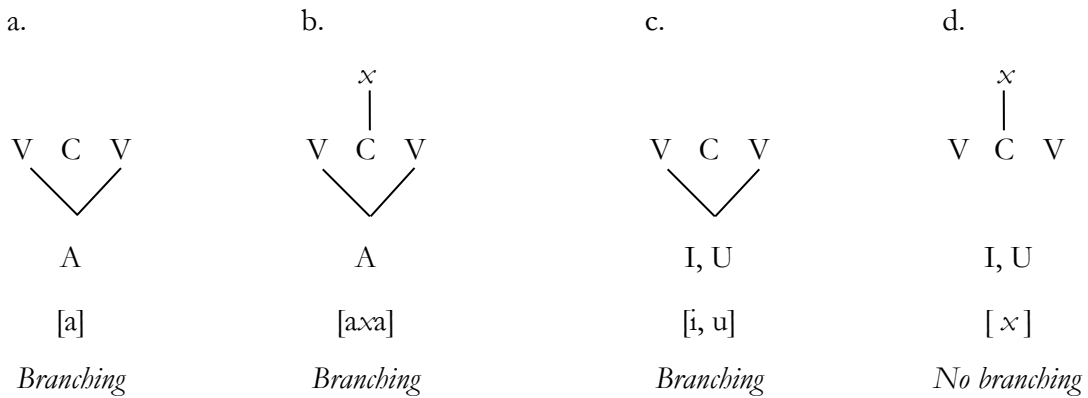

(3.26)

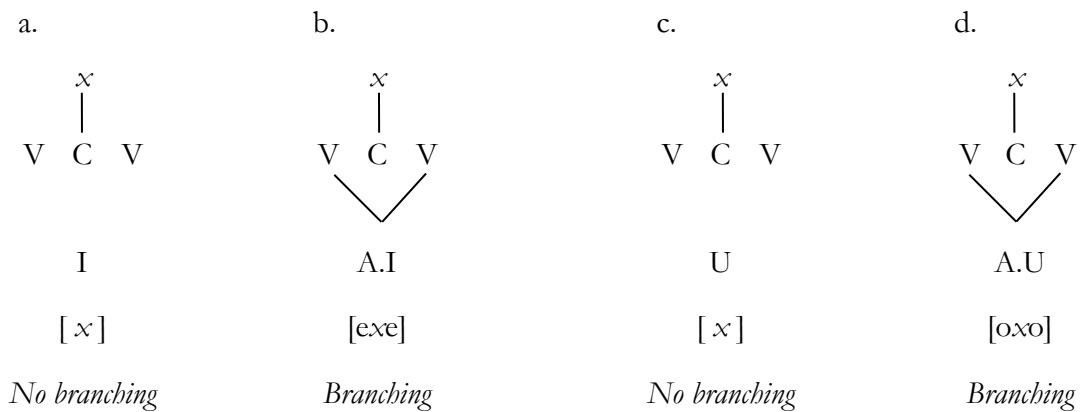

It is therefore by virtue of the special capacity attributed to Element A in the first place that this peculiar type of branching can also be executed by Elements I and U when accompanied by A. Elements other than A need the latter as a vehicle or a mediator to achieve successful spreading to harmonize a stem.

This being the case, the harmonized perfective vocalizations in CEA will be finally expressed as in (3.27).³⁹ Indeed, the reinterpretation of harmony in such a way gives expression to the general tendency of CEA to implement the branching of its elements.

(3.27)

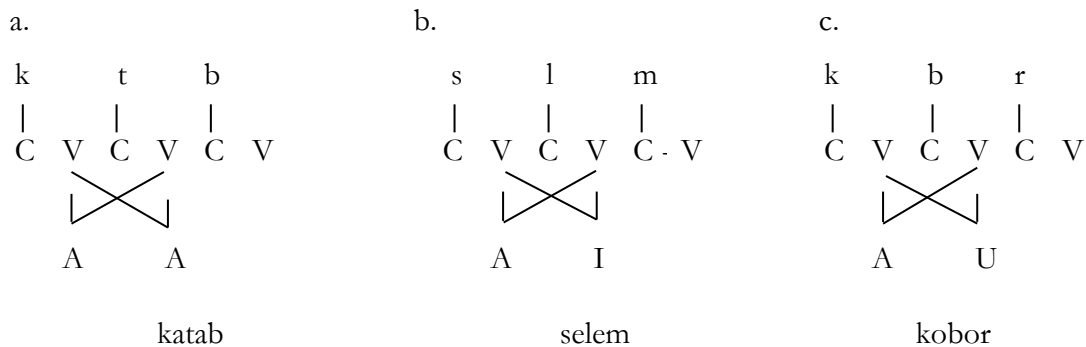

Now, if CEA's attraction for "frontness" is recalled, the realization of Element U underlying *kobor* as I in the variant *keber* will be no more puzzling. The favored variant is a mere reflex of an ambient I element pushing for the implementation of front vowels.

(3.28)

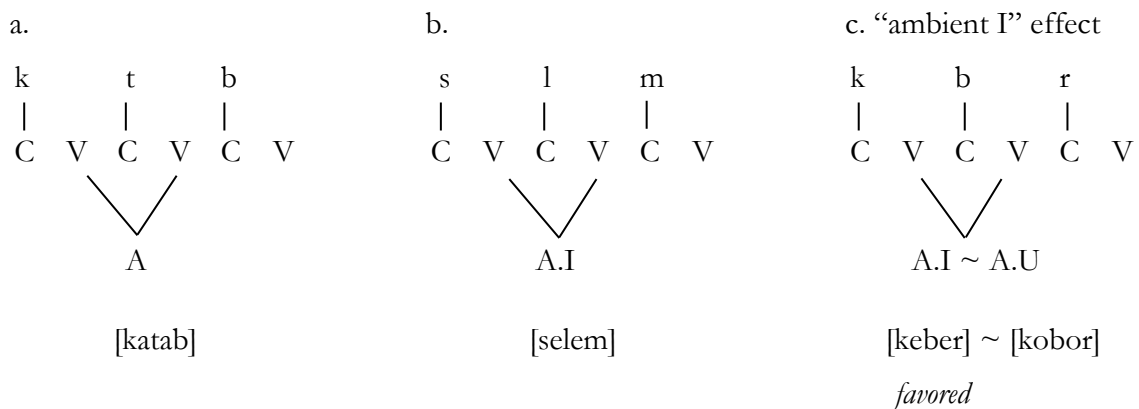

³⁹ The hypothetical system conjectured in (3.23) above is therefore retained.

In view of all what precedes, the following conclusion can be finally drawn:

- (3.29) CEA perfectives maintain the same vowels as CA, but organized differently. The method whereby CEA would realize a given CA vocalic pattern rests on two major principles:
- a. {i, u, a} must branch in CEA.
 - b. The tendency towards frontness characteristic of CEA causes the shift of *u* to *i* in many cases.

It is of great importance here to point out that this conclusion does not in any way imply the pairing of every root found in both languages with a similar vocalic pattern. Indeed, the choice of one pattern or another to vocalize a given root in CEA remains as arbitrary as it is in CA.

3.5 The imperfective of Egyptian Arabic

3.5.1 The apophonic mechanism in Classical Arabic

In CA, the relationship between the aspectual melodies of Measure I verbs can be expressed in such a way that the imperfective vocalization is derived from that of the perfective via *apophony* as proposed in Guerssel and Lowenstamm (1996). It was noted earlier that Measure I verbs in CA are classified into four main categories according to the perfective/imperfective vocalic alternations; see Table 3.15.

Table 3.15 Perfective/Imperfective alternating patterns in CA

| | a. <i>perf.</i> | b. <i>imperf.</i> | c. <i>perf.</i> stem V ₁ – V ₂ | d. <i>imperf.</i> stem V ₁ – V ₂ | e. Root |
|------|-----------------|-------------------|---|---|----------------|
| i. | ḍ <u>a</u> rab | ja-ḍrib | (<u>a</u> _ a) | (Ø _ i) | √ḍrb 'hit' |
| ii. | ka <u>a</u> tab | ja-ktub | (<u>a</u> _ a) | (Ø _ u) | √ktb 'write' |
| iii. | sa <u>i</u> lim | ja-slam | (<u>i</u> _ i) | (Ø _ a) | √slm 'be safe' |
| iv. | ka <u>u</u> bur | ja-kbur | (<u>u</u> _ u) | (Ø _ u) | √kbr 'grow up' |

Note that the first *a* vowel of the perfective stem is an invariable ingredient in all the perfective forms, so is the *a* vocalizing the prefix in the imperfective. For this reason, these two invariable components (underscored in the above table) were considered as being the least probable elements involved in the aspectual alternations. Putting them aside, the variable second stem vowel (the vowel vocalizing the second radical) was accordingly posited as the ingredient most likely to be involved in this ablaut process; this vowel is isolated below.

Table 3.16 The vocalic material involved in the aspectual alternations in CA

| | <i>perf.</i> | <i>imperf.</i> |
|------|--------------|----------------|
| i. | a | i |
| ii. | a | u |
| iii. | i | a |
| iv. | u | u |

The restrictiveness displayed in Table 3.16, where many other logically possible alternations are excluded, points to the fact that those vocalic changes are not by any means accidental, in other terms, just lexically determined. The two main factors that often hindered the establishment of any kind of regularity in those alternations are pointed out by Guerssel and Lowenstamm (1996) as follows:

1. Opacity:

- a. If the derivation goes from perfective to imperfective, then an imperfective output *u* can correspond to two different perfective inputs, *a* and *u*; and a perfective input *a* will have two different imperfective outputs, *i* and *u*.

(3.30)

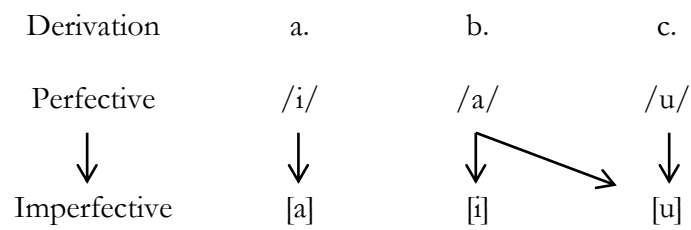

- b. Similarly, if the derivation goes from imperfective to perfective, an output *a* can simultaneously correspond to two different imperfective inputs, *i* and *u*; and an input *u* corresponds to two different perfective outputs, *a* and *u*.

(3.31)

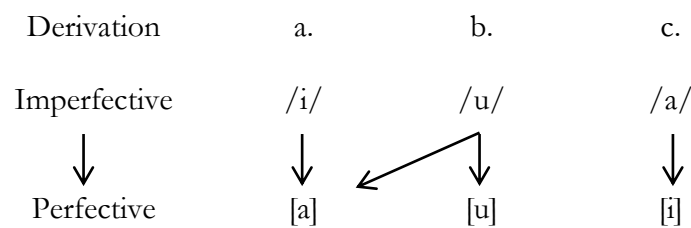

2. Partial polarity: Regardless of the direction of the derivation, an input *a* can have an output *i* and an input *i* can have an output *a*.

(3.32) a ↔ i

Guerssel and Lowenstamm attributed the puzzle posed by the aforementioned opacity to a failure to detect a fourth input object. They call it X. Conjecturing a fourth object X gives rise to four possibilities and a system free from ambiguity, two for each version of directionality.

(3.33)

| | | | | |
|--------------|-----|-----|-----|-----|
| | a. | | b. | |
| Perfective | /i/ | /a/ | /X/ | /u/ |
| | ↓ | ↓ | ↓ | ↓ |
| Imperfective | [a] | [i] | [u] | [u] |

(3.34)

| | | | | |
|--------------|-----|-----|-----|-----|
| | a. | | b. | |
| Imperfective | /i/ | /u/ | /X/ | /a/ |
| | ↓ | ↓ | ↓ | ↓ |
| Perfective | [a] | [a] | [u] | [i] |

Seeing that the shaded possibility in (3.33b) not only resolves the problem of opacity, but also settles the question of polarity (that is still attested in the other three possibilities), Guerssel and Lowenstamm have chosen this option to complete the missed step in the derivational sequence, which entails that the derivation goes from *perfective* to *imperfective*. Further, the possibility in (3.33b) has finally put a demarcation between verbs with opaque perfective *a* vocalization (i.e. *katab* and *darab*) as illustrated in (3.35).

(3.35)

| | | | | | | | |
|-----|-----------|--|---------|--|----|---|----|
| | a. | | b. | | c. | | d. |
| i. | katab | | ja-ktub | | a | → | u |
| | └───┬───┘ | | ↑ | | | | |
| ii. | darab | | ja-drib | | X | → | i |
| | └───┬───┘ | | ↑ | | | | |

$$(3.38) \quad \emptyset \rightarrow i \rightarrow a \rightarrow u \rightarrow u$$

If the principle in (3.39) – proposed in Ségéral (1995) – is adopted, the apophonic formula could be revised as in (3.40).

(3.39) Apophony manipulates Elements rather than segments.

$$(3.40) \quad \emptyset \rightarrow I \rightarrow A \rightarrow U \rightarrow U$$

Under this apophonic path, the aspectual vocalic alternations in CA are no more considered as arbitrary; rather, they are a component of a grammatical operation, the derivation of the phonetic form of the imperfective.⁴⁰

3.5.2 Towards an apophony-based account of aspectual alternations in Egyptian Arabic

Bearing the outlines of the apophonic mechanism in mind, let us now examine the case of CEA. Six main types of aspectual vowel alternations are identified in CEA; these are seen anew in Table 3.18 and isolated afterward in Table 3.19. Each perfective class, *AV* (CaCaC) and *NAV* (CeCeC), alternates with {a, e, o} imperfective stem melodies.

⁴⁰ Cf. Guerssel and Lowenstamm (1990, 1996), Ségéral (1995, 1996, 2000), Ségéral and Scheer (1998), Bendjaballah (1998, 1999, 2005) amongst others for arguments for the apophonic path.

Table 3.18 Perfective/Imperfective alternating patterns in CEA

| a. <i>AV</i> (CaCaC) class | | | b. <i>NAV</i> (CeCeC) class | | |
|---------------------------------|---------------------------------|-----------------------|---------------------------------|---------------------------------|----------------------------------|
| <i>perf.</i> stem | <i>imperf.</i> stem | Root | <i>perf.</i> stem | <i>imperf.</i> stem | Root |
| V ₁ – V ₂ | V ₁ – V ₂ | | V ₁ – V ₂ | V ₁ – V ₂ | |
| 1. <u>ḍarab</u> | je- <u>ḍrab</u> | √ <u>ḍrb</u> 'hit' | 4. <u>selem</u> | je- <u>słam</u> | √ <u>slm</u> 'be safe' |
| (a _ a) | (Ø _ a) | | (e _ e) | (Ø _ a) | |
| 2. <u>katāb</u> | je- <u>kṭeb</u> | √ <u>ktb</u> 'write' | 5. <u>mešek</u> | je- <u>mseq</u> | √ <u>mšk</u> 'catch' |
| (a _ a) | (Ø _ e) | | (e _ e) | (Ø _ e) | |
| 3. <u>xarag</u> | jo- <u>xrog</u> | √ <u>xrg</u> 'go out' | 6. <u>seber</u> | jo- <u>sbor</u> | √ <u>sbr</u> 'act with patience' |
| (a _ a) | (Ø _ o) | | (e _ e) | (Ø _ o) | |

Table 3.19 Two perfective and three imperfective patterns in CEA

| a. <i>AV</i> | | b. <i>NAV</i> | |
|--------------|----------------|---------------|----------------|
| <i>perf.</i> | <i>imperf.</i> | <i>perf.</i> | <i>imperf.</i> |
| | je-CCaC | | je-CCaC |
| CaCaC | je-CCeC | CeCeC | je-CCeC |
| | jo-CCoC | | jo-CCoC |

The establishment of any meaningful generalizations upon the aspectual alternations displayed in Table 3.19 is considerably hindered by the same two factors (previously pointed out by Guerssel and Lowenstamm in the case of CA), those being opacity and partial polarity:

1. It is not clear whether the derivation goes from perfective to imperfective where two different input patterns (a _ a) and (e _ e) have the same set of output melodies {a, e, o}, or whether the derivation goes from imperfective to perfective where three input melodies {a, e, o} converge to two perfective patterns, (a _ a) and (e _ e).
2. Perfective (a _ a) pattern can alternate with imperfective (Ø _ e) and perfective (e _ e) pattern can alternate, in turn, with imperfective (Ø _ a).

Even though a mechanism like apophony might seem incapable of accounting for the alternation patterns attested in CEA, yet the striking regularity cannot be missed in just a first

glance at those existing alternations. Indeed, with two perfective patterns, (a _ a) and (e _ e), and three imperfective melodies, {a, e, o}, why are logically possible systems, like that appearing in Table 3.20 for example, so evidently absent?

Table 3.20 *Absent* possible systems of aspectual alternations in CEA

| a. <i>AV</i> | | b. <i>NAV</i> | |
|--------------|----------------|---------------|----------------|
| <i>perf.</i> | <i>imperf.</i> | <i>perf.</i> | <i>imperf.</i> |
| | | | je-CCaC |
| CaCaC | je-CCeC | CeCeC | |
| | jo-CCoC | | jo-CCoC |

This question has not, up to this point, been answered. Broselow (1976) for example, indicates that the choice of the imperfective vowel melodies in CEA is totally unpredictable. I will show that this is not true. Let us reconsider those intriguing perfective and imperfective vocalizations recast this time in terms of Elements.

Table 3.21 Perfective/imperfective CEA melodies reformulated in Elements

| a. <i>AV</i> | | b. <i>NAV</i> | |
|-------------------|---------------------|-------------------|---------------------|
| <i>perf.</i> stem | <i>imperf.</i> stem | <i>perf.</i> stem | <i>imperf.</i> stem |
| A A | A | A.I | A |
| A A | A.I | A.I | A.I |
| A A | A.U | A.I | A.U |

According to the combinations present in the above table, two observations can be made:

1. The ubiquitous presence of Element A.
2. The absence of Element U in the perfective.

First, regarding the absence of U from the perfective vocalizations, it was pointed out earlier in section 3.4.3 that over forty CEA (e _ e) perfectives are found in free variation with

(o _ o) melody. Counting those (o _ o) variants, although they are infrequent, would induce the modification in the shaded cell of Table 3.22.

Table 3.22 The variant (o _ o) considered

| a. AV | | | b. NAV | | |
|-------|-------------------|---------------------|--------|-------------------|---------------------|
| | <i>perf.</i> stem | <i>imperf.</i> stem | | <i>perf.</i> stem | <i>imperf.</i> stem |
| i. | A A | A | i. | A.I | A |
| ii. | A A | A.I | ii. | A.I | A.I |
| iii. | A A | A.U | iii. | A.I ~ A.U | A.U |

Then, as for the overwhelming Element A detected in all of the perfective melodies, this element can be straightforwardly attributed to the first stem vocalic ingredient. Recall that CEA maintains CA ***katab*** /k(A)t(A)b/, ***salim*** /s(A)l(I)m/ and ***kabur*** /k(A)b(U)r/ as ***katab*** /k(A)t(A)b/, ***selem*** /s(A.I)l(A.I)m/ and ***kobor*** /k(A.U)b(A.U)r/ ~ ***keber*** /k(A.I)b(A.I)r/.

This is once more shown in (3.41) where the element in question is squared.

(3.41)

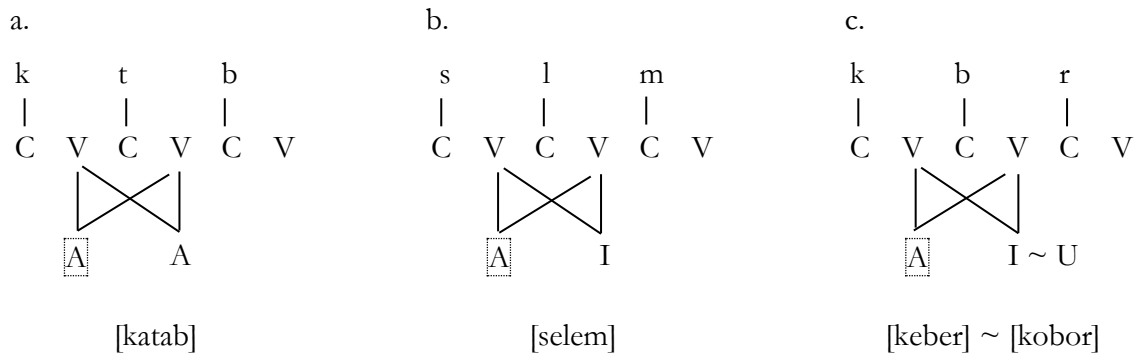

This predictable Element A can accordingly be filtered out from Table 3.22. The quality of the second stem vowel of the CEA ***perfective***, free from any impurities, can therefore be isolated as shown in the grayed slots in the table below.

Table 3.23 Factoring out the predictable A Element from the perfective melody

| a. <i>AV</i> | | | b. <i>NAV</i> | | |
|--------------|-------------------|---------------------|---------------|-------------------|---------------------|
| | <i>perf. stem</i> | <i>imperf. stem</i> | | <i>perf. stem</i> | <i>imperf. stem</i> |
| i. | ⊖ A | A | i. | ⊖ A.I | A |
| ii. | ⊖ A | A.I | ii. | ⊖ A.I | A.I |
| iii. | ⊖ A | A.U | iii. | ⊖ A.I ~ A.U | A.U |

Now, as for the prevalent Element A in the imperfective melodies, let us first observe the sample of CA data presented in Table 3.24, with special attention to the alternations involving the squared vowels.

Table 3.24 The CA Active and Passive

| | a. <i>perf.</i> | b. <i>imperf.</i> | c. Root |
|-------------|--|---|--------------|
| i. Active | k a t a b | j a- k t u b | √ktb ‘write’ |
| ↓ | | | |
| ii. Passive | k u t i b | j u- k t a b | |
| | katab vs. kutib | ja-ktub vs. ju-ktab | |
| | ‘he wrote’ vs. ‘it (MASC) was written’ | ‘he writes’ vs. ‘it (MASC) is written’ | |

A simple comparison between the CA perfective active vs. perfective passive and imperfective active vs. imperfective passive reveals alternations of a similar nature; the vocalic alternation $a \rightarrow u$ characterizes the transition from active to passive. The a vocalizing the *prefix* in the CA active imperfective is, thus, the *equivalent* of the first a component of the perfective stem; both signify [Active].⁴¹

As we have just seen, CEA keeps this a ingredient within its perfective vocalic equipment (the squared element in (3.41).) In parallel, I will make the hypothesis that the “equivalent” of this ingredient is also present in the CEA imperfective, underlying the prefix, and infiltrating the stem vowel as is the case of the perfective. This is demonstrated for verb *mesek/je-msek*

⁴¹ Cf. Guerssel and Lowenstamm (1990, 1996) for discussion of the active/passive vocalic alternations in CA.

√msk ‘catch’ in (3.42), where the acute brackets “>>” indicate the permeation of the stem vowel by Element A.

(3.42)

a. Perfective

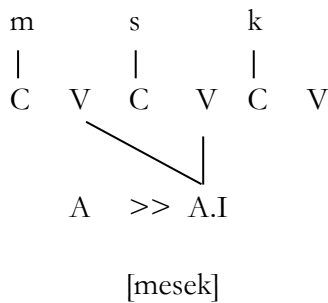

b. Imperfective

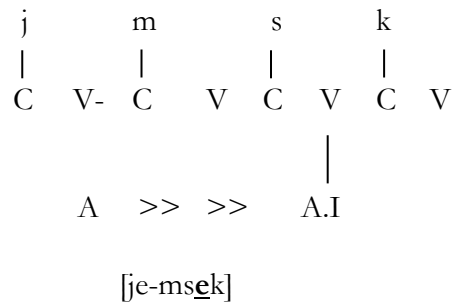

Additionally, it can be assumed that the vowel harmony characterizing the *prefix* and the *stem* is the consequence of a branching (A.I) expression; this is in perfect analogy with what occurs in the perfective; consider (3.43).

(3.43)

a. Perfective

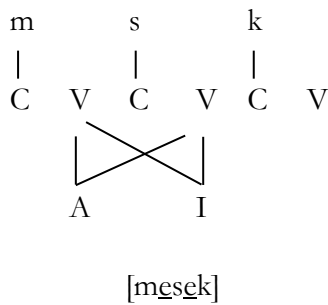

b. Imperfective

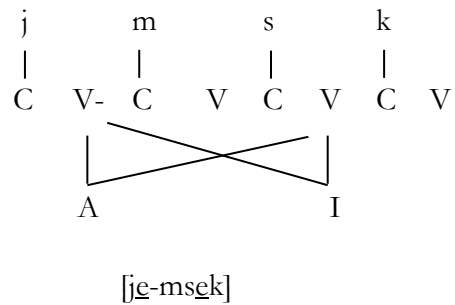

The claim underlying (3.43b) is especially interesting for two main reasons:

1. It is corroborated by harmonic imperfectives, e.g. **je-xrog** √xrg ‘go out’ (and not *je-xrog); see (3.44a).
2. But it is challenged by the lack of vowel propagation towards the prefix in imperfectives with stem A melody, e.g. **je-slam** √slm ‘be safe’ (and not *ja-slam); see (3.44b) with dotted lines indicating absence of harmony.

(3.44)

a. Harmony (jo-CCoC)

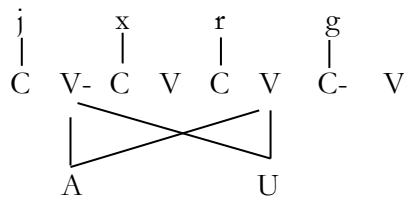

jo-xrog

b. No harmony (je-CCaC)

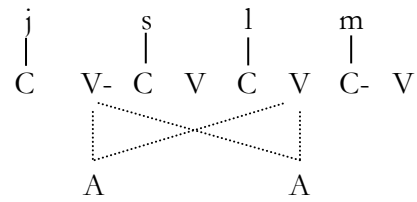

je-slam (*ja-slam)

Why would vowel harmony be allowed in imperfectives whose underlying stem melodies are I and U (i.e. *je-msek* and *jo-xrog*), but not A (i.e. *je-slam*)? Let us examine these imperfectives this time as outlined in (3.45), here, the arrow indicates the sliding of Element A on its autosegmental line to permeate the element underlying the stem.

(3.45)

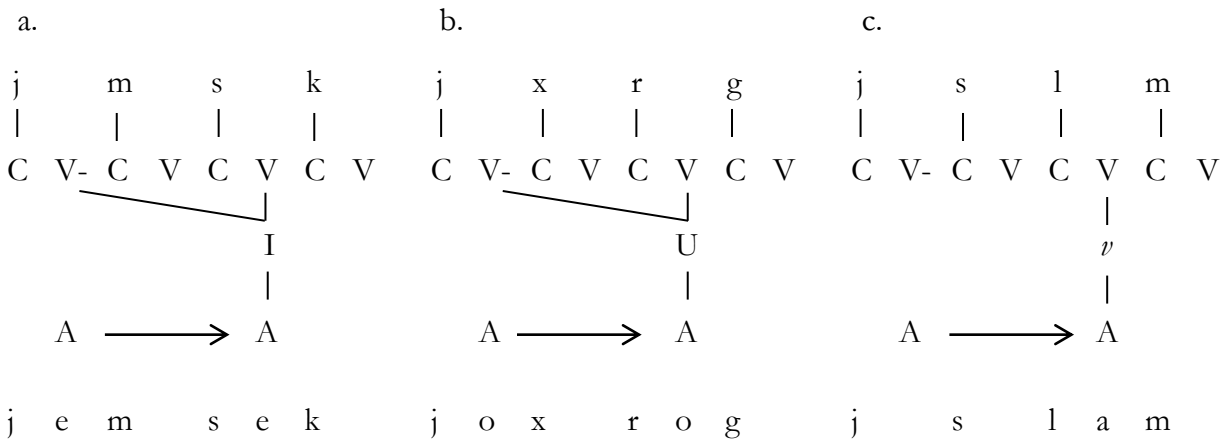

What can we conclude from the above structures?

1. We can discern for the first time a type of harmony that goes *beyond* the stem (in (3.45a and b).) As far as we saw, vowel spreading has shown to be limited to the stem boundaries. Why would harmony be manifested in such a way? In other words, why would the nuclear position vocalizing the prefix in (a) and (b) be involved in a copy process triggered within the stem?
2. If the system still complies with the principle “Elements must branch,” then the *a* melody of the stem –slam would be definitely diagnostic of one thing: Element A underlying the

stem must be *somehow* branching, though it is not immediately clear exactly how branching is implemented. The nature of that putative branching configuration will be returned to momentarily.

To better understand the puzzling findings drawn from (3.45), I suggest a second consideration of the CA imperfective. As reviewed in the last section, the CA imperfective is derived from the perfective through the regular apophonic mechanism. However, that is not everything; as the derivation of the imperfective proceeds, the identification of the V position separating the first and second radicals of the verb becomes no longer permitted. The verbal stem manifests a leftward shift of the vowel vocalizing the first radical, which instead vocalizes the prefix. Recall that both squared Elements A in (3.46) below are equivalents in CA. We can, therefore, conclude that the vocalic position separating the first two radicals (the underscored V in (3.46)) is the *original* site of Element A and that its leftward shift into the prefix is yet another grammatical manifestation of the derivation of the imperfective.

(3.46) The imperfective derivation in CA, e.g. katab/ja-ktub

a. Perfective

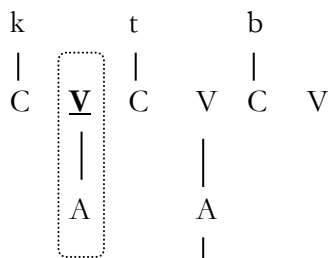

[katab]

b. Imperfective

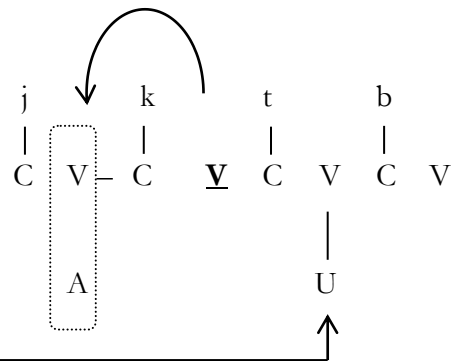

[ja-ktub]

Bearing in mind that the first V position in the imperfective stem (i.e. the V separating the first two radicals) is the “original site” of Element A, let us once again examine the CEA imperfectives.

In (3.47) below, I will make the following hypothesis:

1. Element A (used to vocalize the prefix in CA) is part of the underlying ingredients *retained* by the CEA imperfective.
2. In CEA, this Element A occupies its *original* site (i.e. V separating the first two radicals).
3. The identification of V separating R₁ and R₂ in the CEA imperfective is *allowed*.

Let us consider the outcome of this hypothesis as depicted in (3.47), focusing on the imperfective *stem* (indicated between squared brackets).

(3.47)

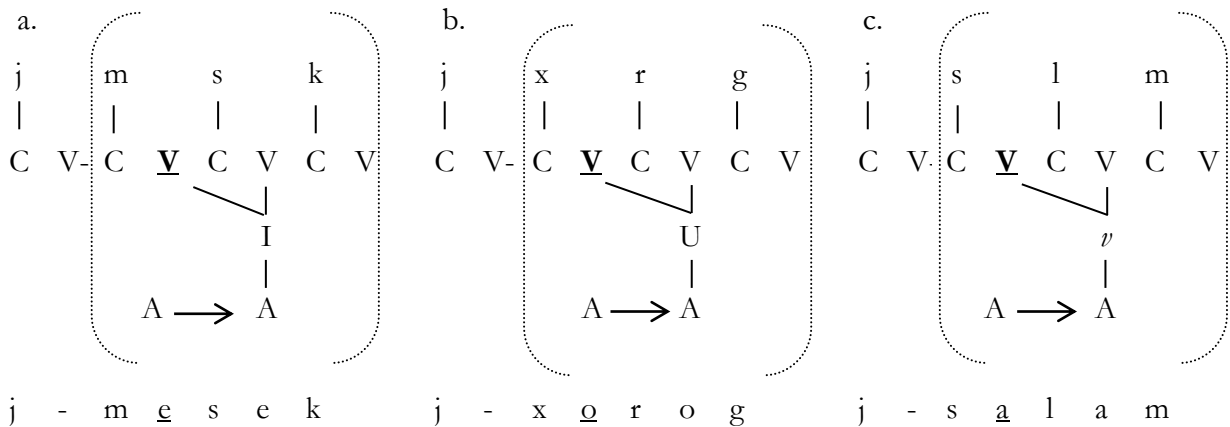

In the above schemes, both “branching” and “harmony” take place the same way they do in the case of CEA perfective. The hypothetical output of these structures would be as follows: imperfective stems realized by means of two *identical* vowels (hence *–mesek, *–xorog, and *–salam).

One question follows: what would ensue if the hypothetical step demonstrated above was correct (i.e. branching and harmony take place), so that when under a constraint imposing “emptiness” on the V separating the first two radicals the vowel occupying this V shifts leftwards (as indicated by the curved arrows in (3.48)) just as in CA? Of course, a perfect vowel harmony between the stem and the prefix would obtain je-msek, jo-xrog and *ja-slam.

(3.48)

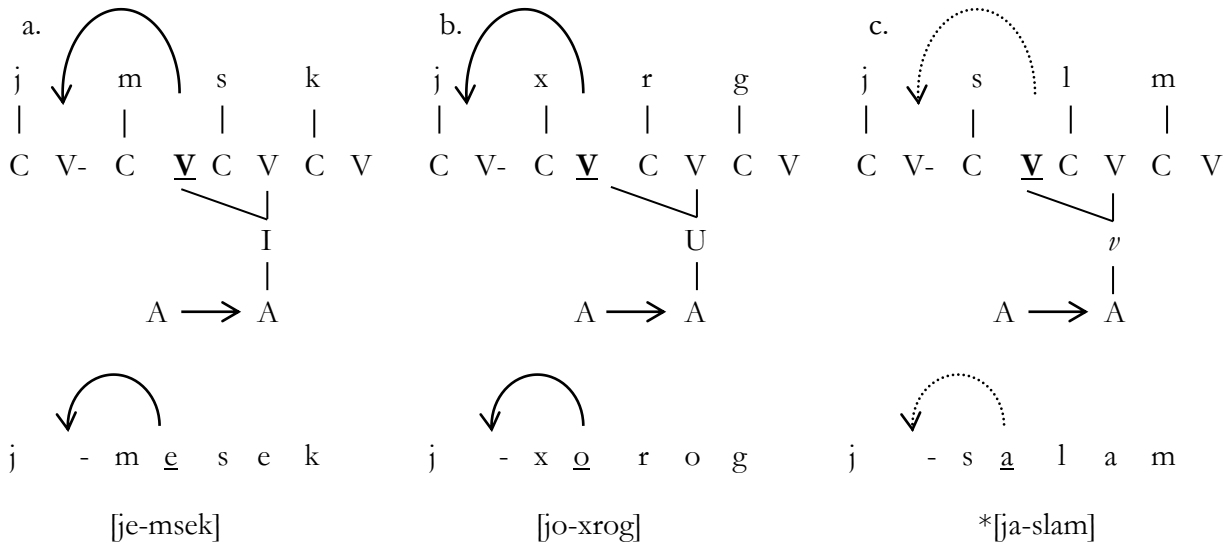

Therefore, this is exactly what occurs in *je-msek* and *jo-xrog*, but why not in **ja-slam*?

A quick comparison between the first two cases in (3.48a and b) where leftward propagation takes place and the third case in (3.48c) where harmony is blocked directly reveals the following. Only in (a) and (b) is the available vocalic material sufficient for triggering the process of interpreting an empty nucleus whereby a vocalic expression whose *Head* and *Operator* do not involve the cold vowel can be inserted. As we saw in section 2.4.2 of the preceding chapter, this process was identified as the main strategy whereby CEA generally manages empty nuclei. I argue that the type of vocalic material present in (a) and (b) motivates the leftward vowel shift under the call for interpreting the empty nucleus underlying the prefix (i.e. the initial empty nucleus within the word domain). This makes the vowel realizing the prefix in *je-msek* and *jo-xrog* a mere copy of the one realizing the stem.

Another argument for this view might be the remarkable similarity observed in the vowels actualizing the different subject inflectional morphemes prefixed to the imperfective verbal stem. A sample of these morphemes is displayed (in italics) in the table below.

Table 3.25 The imperfective prefixes in *je-msek* and *jo-xrog*

| | | a. $\sqrt{\text{msk}}$ 'catch' | b. $\sqrt{\text{xrg}}$ 'go out' |
|------|------------------------|--------------------------------|---------------------------------|
| i. | 3 _{SING.MASC} | <i>je-msek</i> | <i>jo-xrog</i> |
| ii. | 3 _{PL} | <i>je-msek-u</i> | <i>jo-xrog-u</i> |
| iii. | 2 _{SING.FEM} | <i>te-msek-i</i> | <i>to-xrog-i</i> |
| iv. | 2 _{PL} | <i>te-msek-u</i> | <i>to-xrog-u</i> |
| v. | 1 _{PL} | <i>ne-msek</i> | <i>no-xrog</i> |

For each of the above imperfectives, regardless of the subject's person, gender or number, all of the prefixes exhibit vowels with identical quality. These vowels are in addition identical to the one vocalizing the stem. The identicalness of the vowels realizing the prefixes indicates that they share a similar origin. Only under the assumption that these vowels have the stem vocalization as their common source can the harmony detected between the prefix and the stem be immediately explained.

Yet, this is not the case in *je-slam*. Whereas – again – regardless of the subject's person, gender or number, all of the imperfective prefixes exhibit identical vowels, this material vocalizing the prefixes is different from the stem vocalization. Consider the following table.

Table 3.26 The imperfective prefix in *je-slam*

| | | $\sqrt{\text{slm}}$ 'be safe' |
|------|------------------------|-------------------------------|
| i. | 3 _{SING.MASC} | <i>je-slam</i> |
| ii. | 3 _{PL} | <i>je-slam-u</i> |
| iii. | 2 _{SING.FEM} | <i>te-slam-i</i> |
| iv. | 2 _{PL} | <i>te-slam-u</i> |
| v. | 1 _{PL} | <i>ne-slam</i> |

The following question arises accordingly: if the *a* underlying the parenthesized (**V**) in (3.49c) has not undergone any leftward shift, and if the presence of an explicit *a* quality in the stem *je-slam* is, as such, strongly indicative of a branching Element A, why does the parenthesized (**V**) result nevertheless in an *inaudible* nucleus?

Table 3.27 Factoring out the predictable A Element from the imperfective melody

| a. <i>AV</i> class | | | b. <i>NAV</i> class | | |
|--------------------|--------------|----------------|---------------------|--------------|----------------|
| | <i>perf.</i> | <i>imperf.</i> | | <i>perf.</i> | <i>imperf.</i> |
| i. | A | A | i. | I | A |
| ii. | A | A.I | ii. | I | A.I |
| iii. | A | A.U | iii. | I ~ U | A.U |

The following verbs exemplify the above melodic patterns:

Table 3.28 The lexical perfective and imperfective melodies

| a. <i>AV</i> (CaCaC) class | | | b. <i>NAV</i> (CeCeC) class | | |
|----------------------------|------------------|------------------------------|-------------------------------------|------------------|---|
| <i>perf.</i> | <i>imperf.</i> | Root | <i>perf.</i> | <i>imperf.</i> | Root |
| 1. ḍarab | je-ḍrab | $\sqrt{\text{ḍrb}}$ 'hit' | 4. selem | je-slam | $\sqrt{\text{slm}}$ 'be safe' |
| A | A | | I | A | |
| 2. katab | je-kteb | $\sqrt{\text{ktb}}$ 'write' | 5. mesek | je-msek | $\sqrt{\text{msk}}$ 'catch' |
| A | I | | I | I | |
| 3. xarag | jo-xrog | $\sqrt{\text{xrg}}$ 'go out' | 6. $\text{ṣeber} \sim \text{ṣobor}$ | jo-ṣbor | $\sqrt{\text{ṣbr}}$ 'act with patience' |
| A | U | | I ~ U | U | |

Now that we have a reasonable idea of the pure lexical melodies underlying both the perfective and imperfective in CEA, a crucial question must be asked: can this vocalic equipment open a window of explanation for perfective/imperfective alternations?

If the perfective melody is mapped into the imperfective via *apophony*, then at least half of the alternation patterns attested in CEA will immediately fall out. Consider the grayed cells in Table 3.29; they follow a regular apophonic path, specifically steps: I \rightarrow A in (4), A \rightarrow U in (3) and U \rightarrow U in (6).

Table 3.29 A selection of apophony-based alternations

| a. <i>AV</i> class | | | b. <i>NAV</i> class | | |
|--------------------|--------------|----------------|---------------------|----------------------------|----------------|
| | <i>perf.</i> | <i>imperf.</i> | | <i>perf.</i> | <i>imperf.</i> |
| 1. | ḍarab A | -ḍrab A | 4. | selem I | -slam A |
| 2. | katab A | -kteb I | 5. | mesek I | -msek I |
| 3. | xarag A | -xrog U | 6. | (šeber) ~ šobor (I) ~ U | -šbor U |

It is quite promising that half of the aspectual alternations implemented in CEA follow a regular path of derivation. The next section aims at providing finer analysis of the less clear cases in order to show that they too resort to the same general mechanism, the derivation of the imperfective stem melody from that of the perfective by means of apophony.

3.5.3 The predictability of certain imperfective melodies

The consonantal makeup of the sample of verbs presented in Table 3.30 is particularly interesting; their roots contain at least one of the following consonants: a guttural, an emphatic, a uvular or an *r* (i.e. {z, ʒ, t, ḍ, ʕ, ʔ, h, ḥ, ʁ, x, r}). The verbs in set (a), whose **first** radical is one of these consonants, allow various imperfective melodies, *o* as well as *e*. In contrast, the only imperfective melody that can be identified for the verbs in set (b) is *a*, these verbs contain roots that exhibit a guttural, an emphatic, a uvular or an *r* as their **second and/or third** radical. These consonants are well known for their natural *lowering* effect on the neighboring vowels.⁴³

⁴³ Cf. McCarthy (1991, 1994), Scheer (1998b) and Guerssel (2003) for discussion.

Table 3.30 Predictable imperfective patterns⁴⁴

| a. R ₁ = {z, s, t, d, ʕ, ʔ, h, ħ, ʁ, x, r} | | | | b. R ₂ and/or R ₃ = {z, s, t, d, ʕ, ʔ, h, ħ, ʁ, x, r} | | | |
|---|----------------|---------|--------------------|---|----------------|---------|-----------------|
| <i>perf.</i> | <i>imperf.</i> | Root | | <i>perf.</i> | <i>imperf.</i> | Root | |
| i. | rasam | je-rsem | √rsm 'draw' | i. | kasar | je-ksar | √ksr 'break' |
| ii. | ʕagab | je-ʕgeb | √ʕdʒb 'impress' | ii. | baʕat | je-bʕat | √bʕθ 'send' |
| iii. | ħasad | je-ħsed | √ħsd 'envy' | iii. | ħaraʔ | je-ħraʔ | √ħrq 'burn' |
| iv. | ʔatal | je-ʔtel | √ʔtl 'kill' | iv. | garaħ | je-graħ | √dʒrħ 'hurt' |
| v. | habal | je-hbel | √hbl 'drive mad' | v. | nahab | je-nhab | √nhb 'loot' |
| vi. | xazal | je-xzel | √xðl 'let down' | vi. | xataf | je-xtaf | √xtf 'kidnap' |
| vii. | ʁasal | je-ʁsel | √ʁsl 'wash' | vii. | ħafaʒ | je-ħfaʒ | √ħfð 'memorize' |
| viii. | zalam | je-zlem | √ðlm 'be unfair' | viii. | ʔabað | je-ʔbað | √qbd 'cash' |
| ix. | ʕalab | jo-ʕlob | √ʕlb 'ask' | ix. | nasax | je-nsax | √nsx 'copy' |
| x. | ʕalab | jo-ʕlob | √ʕlb 'set upright' | x. | ladaʁ | je-ldaʁ | √ldʁ 'sting' |
| | | | | xi. | zaraʕ | je-zraʕ | √zrʕ 'plant' |
| | | | | xii. | masaħ | je-msaħ | √msh 'sweep' |
| | | | | xiii. | zahaʕ | je-zhaʕ | √ðhr 'appear' |
| | | | | xiv. | lazaʔ | je-lzaʔ | √lzq 'glue' |

It is not surprising that the lowering effect of those peculiar consonants confines vocalization to *a*, what is far more significant is that the subset of verbs given in column (b) of Table 3.30 is part of a bigger list of verbs to which *darab/je-drab* belongs. Consequently, if the six perfective/imperfective alternation patterns of CEA are revisited, another slot can be readily understood; this is the slot of the *predictable* imperfective vocalization displayed in slot (1) in Table 3.31.

⁴⁴ Where a root is present in both Classical Arabic and Egyptian Arabic, the following consonantal alternations are attested:

- a θ in CA is realized as {t or s} in CEA,
- a ð in CA is realized as {d or z} in CEA,
- a ð in CA is regularly realized as ʒ in CEA, and
- a dʒ in CA is regularly realized as g in CEA.

Table 3.31 Identifying the phonologically conditioned imperfective melody

| a. <i>AV</i> class | | | b. <i>NAV</i> class | | |
|--------------------|--------------|----------------|---------------------|--------------------------|----------------|
| | <i>perf.</i> | <i>imperf.</i> | | <i>perf.</i> | <i>imperf.</i> |
| 1. | ḍarab ? | -ḍrab A | 4. | selem I | -slam A |
| 2. | katab A | -kteb I | 5. | mesek I | -msek I |
| 3. | xarag A | -xrog U | 6. | ṣeber ~ ṣobor (I) ~ U | -ṣbor U |

3.5.4 The lexical vowel Ø

The conclusion just put forward implies that the imperfective stem vowel of *je-ḍrab* is phonologically conditioned by the natural lowering effect of the second radical *r*. If the apophonic mechanism is maintained, three possible perfective entries for *je-ḍrab* can be conjectured:

1. Perfective input I, in which case its output A would not result from the lowering potential of the *r* of $\sqrt{\text{ḍrb}}$, i.e. *input* I \rightarrow *output* A.
2. Perfective input A, in which case its output U assimilates with the adjacent lowering consonant *r*, i.e. *input* A \rightarrow *output* U (eventually A).
3. Perfective input Ø, in which case its output I is lowered by the neighboring *r*, i.e. *input* Ø \rightarrow *output* I (eventually A).

The first of the above prospects is rapidly refuted: the perfective is *ḍarab*, not *ḍereb. So is the second prospect by the presence of *jo-xrog* as a viable imperfective (see slot (3) in

roots that contain {z, s, t, d, ʕ, ʔ, h, ħ, ʁ, x, r} as second and/or third radical. If the imperfective *je-smaʕ*, in line (i), has a perfective **samaʕ*, then the *a* of *je-smaʕ* – just like the *a* of *je-ḍrab* – would reflect the influence of the guttural ʕ in $\sqrt{\text{smʕ}}$. But, if *je-smaʕ* has a perfective *semeʕ* (which is the actual case), then the *a* of *je-smaʕ* is the direct result of apophony, much as the *a* of *je-slam* in the alternation *selem/je-slam*.

Table 3.32 The I → A step in *semeʕ/je-smaʕ* alternation pattern

| R ₂ and/or R ₃ = {z, s, t, d, ʕ, ʔ, h, ħ, ʁ, x, r} | | | | |
|--|--------------|----------------|---------------------|----------------|
| | <i>perf.</i> | <i>imperf.</i> | | Root |
| i. | <i>semeʕ</i> | <i>je-smaʕ</i> | $\sqrt{\text{smʕ}}$ | 'bear' |
| ii. | <i>seher</i> | <i>je-shar</i> | $\sqrt{\text{shr}}$ | 'stay up late' |
| iii. | <i>ʕeʕeʕ</i> | <i>je-ʕtaʕ</i> | $\sqrt{\text{ʕtʕ}}$ | 'be thirsty' |
| iv. | <i>neʕem</i> | <i>je-nʕam</i> | $\sqrt{\text{nʕm}}$ | 'be soft' |
| v. | <i>teʔel</i> | <i>je-tʔal</i> | $\sqrt{\text{tʔl}}$ | 'be heavy' |
| vi. | <i>fedel</i> | <i>je-fdal</i> | $\sqrt{\text{fdl}}$ | 'remain' |
| vii. | <i>bered</i> | <i>je-brad</i> | $\sqrt{\text{brd}}$ | 'become cold' |
| viii. | <i>ʕeleʕ</i> | <i>je-ʕlaʕ</i> | $\sqrt{\text{ʕlʕ}}$ | 'ascend' |
| ix. | <i>fehem</i> | <i>je-fham</i> | $\sqrt{\text{fhm}}$ | 'understand' |
| x. | <i>fereʕ</i> | <i>je-fraʕ</i> | $\sqrt{\text{frʕ}}$ | 'be empty' |
| xi. | <i>ʕereʔ</i> | <i>je-ʕraʔ</i> | $\sqrt{\text{ʕrʔ}}$ | 'sweat' |
| xii. | <i>ʕeref</i> | <i>je-ʕraf</i> | $\sqrt{\text{ʕrf}}$ | 'know' |

Now that the mechanism underlying the alternation *ḍarab/je-ḍrab* has been established as involving step $\emptyset \rightarrow \text{I}$ (eventually A), the question that is consequently raised is whether the same alternating pattern can be recognized for roots which do not exhibit any lowering radicals. In the latter case, an explicit imperfective *e* will be rather expected.

In fact, the two remaining cases in our list of melodic alternations, namely *katab/je-kteb* and *meseḳ/je-mseḳ* (slots (2) and (5) in Table 3.33), display both an imperfective vowel *e*, and roots free from any lowering radicals. How could these two cases be interpreted?

Table 3.33 The step ($\emptyset \rightarrow I$), established

| a. <i>AV</i> class | | | b. <i>NAV</i> class | | |
|--------------------|---------------|------------------|--------------------------------|---------------|----------------|
| <i>perf.</i> | | <i>imperf.</i> | <i>perf.</i> | | <i>imperf.</i> |
| 1. <i>ḍarab</i> | | - <i>ḍrab</i> | 4. <i>selem</i> | | - <i>slam</i> |
| \emptyset | | I (eventually A) | I | \rightarrow | A |
| 2. <i>katab</i> | | - <i>kteb</i> | 5. <i>mesek</i> | | - <i>msek</i> |
| A | | I | I | \rightarrow | I |
| 3. <i>xarag</i> | | - <i>xrog</i> | 6. <i>ṣeber</i> ~ <i>ṣobor</i> | | - <i>ṣbor</i> |
| A | \rightarrow | U | (I) ~ U | \rightarrow | U |

First, regarding the *katab/je-kteb* alternation pattern, under the apophonic mechanism, it can be assumed that the imperfective vocalization of *je-kteb* is the apophonic output of \emptyset (much as *ḍarab/je-ḍrab*, i.e. $\emptyset \rightarrow I$). The only difference would be the absence of any lowering influence of the consonantal makeup of $\sqrt{\text{ktb}}$ on the output I (which overtly surfaces as *e* in *je-kteb*). According to this hypothesis, the perfective (a _ a) vocalization of *katab* can also be accounted for along the same lines proposed for *ḍarab*: Element A (the first vocalic component underlying CEA perfectives) propagates to vocalize the second radical as shown in (3.51).

(3.51)

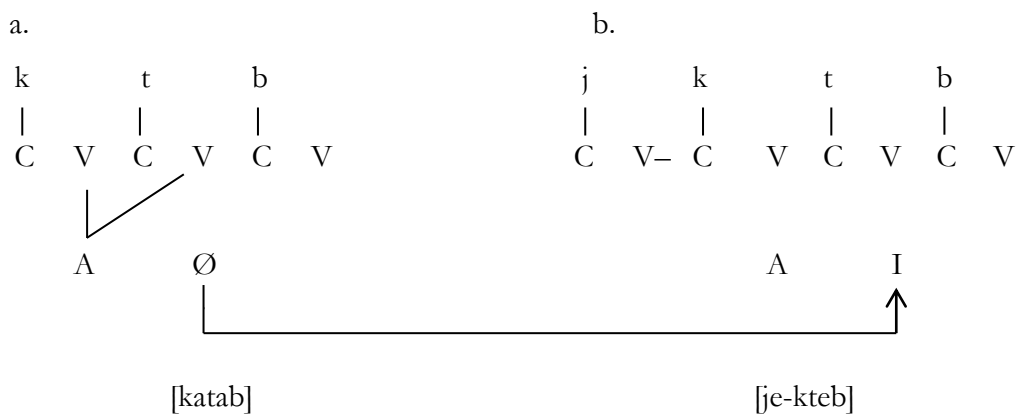

Careful examination of the set of verbs given in Table 3.34, however, immediately disproves this assumption. These verbs are part of the same class to which *katab/je-kteb* belongs, their roots exhibit a lowering consonant as their second and/or third radical (just as *darab*), even though, they display an imperfective *e*.

Table 3.34 Subset of the class *katab/je-kteb* with lowering R₂ and/or R₃

| R ₂ and/or R ₃ = {z, ʒ, t, d, ʕ, ʔ, h, ħ, ʁ, x, r} | | | | |
|--|--------------|----------------|------|-----------------------------|
| | <i>perf.</i> | <i>imperf.</i> | | Root |
| i. | ʃaraf | je-ʃref | √ʃrf | 'spend (money)' |
| ii. | šaʕal | je-šʕel | √šʕl | 'occupy' |
| iii. | ʕaʃab | je-ʕʃeb | √ʕʃb | 'oblige' |
| iv. | waʕad | je-wʕed | √wʕd | 'promise' |
| v. | zaħam | je-zħem | √zħm | 'crowd' |
| vi. | haras | je-hres | √hrs | 'crush, mash' |
| vii. | haḍam | je-hḍem | √hḍm | 'digest' |
| viii. | laxam | je-lxem | √lxm | 'overtax, fluster, confuse' |
| ix. | naʃaf | je-nʃef | √nʃf | 'relieve of injustice' |

If verb *ʃaraf* √ʃrf 'spend money,' in line (i), has a perfective entry Ø like *darab*, then by analogy with *je-ḍrab*, an imperfective **je-ʃraf* would be expected (i.e. an output I lowered to *a* under the influence of the *r* of √ʃrf). However, *r* proves unable to lower the *e* of *je-ʃref*, so do gutturals, emphatics and uvulars with respect to the imperfective melody of the rest of the verbs in the above table. The viability of output I in the adjacency of a lowering consonant results in an interesting problem to which I propose the solution in (3.52) below. In the preceding section, we have seen that the output U in *xarag/jo-xrag* proves resistant to any kind of assimilation from adjacent lowering consonants, just like the *e* in *je-ʃref*. Accordingly, only under the hypothesis that the imperfective output of *je-ʃref* is not I, rather, it is U *coated in I* can the alternation pattern *ʃaraf/je-ʃref* be explained.

(3.52)

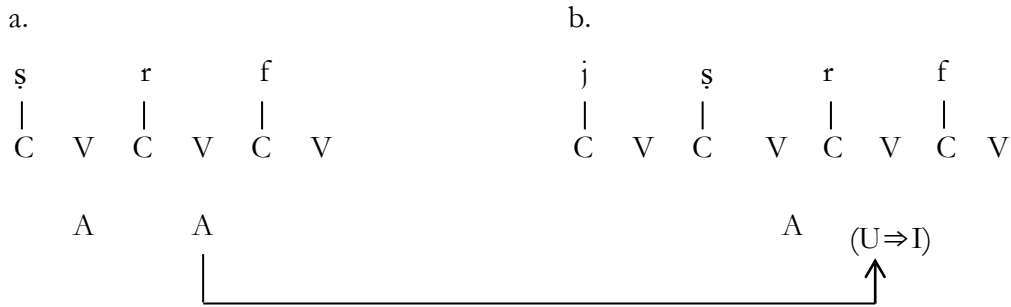

This account implies: a) perfective lexical entry *A* underlying *şaraf*, and b) the transformation of the imperfective /*jo-şrof*/ into [*je-şref*]. Indeed, the same kind of shift where the system implements a front vowel *e* instead of the back vowel *o* has previously been identified for the perfective; see the transition from (a) to (b) in (3.53). The potential of this tendency to frontness can certainly go far beyond the case of perfective.

(3.53)

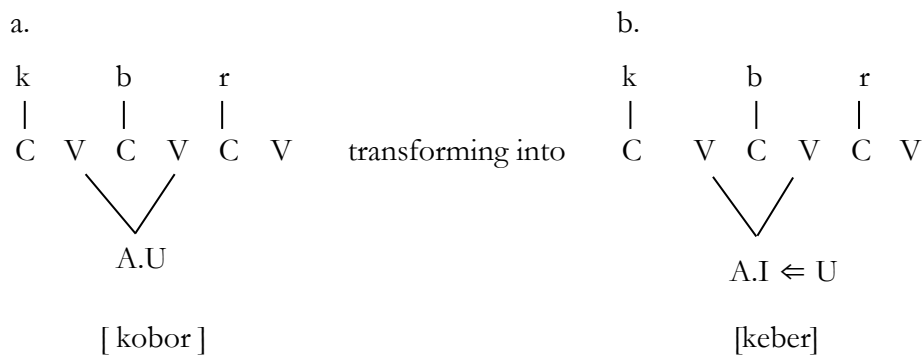

In view of that, another problematic alternation pattern has been understood; this is the case *şaraf/je-şref*, which is part of the class exemplified by *katab/je-kteb* (slot (2) in our table of melodic alternations). This alternation involves a lexical entry *A* which initiates the step $A \rightarrow U$ where the output emerges eventually in the form of *I*.

Table 3.35 Identifying “frontness” in the imperfective

| a. <i>AV</i> class | | | b. <i>NAV</i> class | | |
|--------------------|-------|------------------|---------------------|---------------|----------------|
| <i>perf.</i> | | <i>imperf.</i> | <i>perf.</i> | | <i>imperf.</i> |
| 1. | ḍarab | -ḍrab | 4. | selem | -slam |
| | ∅ | I (eventually A) | | I | A |
| | | | | → | |
| 2. | katab | -kteb | 5. | mesek | -msek |
| | A | U ⇒ I | | I | I |
| | | | | → | |
| 3. | xarag | -xrog | 6. | šeber ~ šobor | -šbor |
| | A | → U | | (I) ~ U | U |
| | | | | → | |

Now, regarding the remaining case of *mesek/je-msek* in slot (5) which displays an imperfective *e* melody, if the perfective (e _ e) melody can be indicative of lexical vowel I (such as *selem*), then *mesek* will be expected to have **je-msak* as imperfective (by analogy with *je-slam*). This account cannot be upheld due to the evident absence of **je-msak*. On the other hand, if the *e* melody of *je-msek* can be diagnostic of a lexical input ∅, then why is perfective **masak* not attested (parallel to *ḍarab* which is also equipped with the null lexical vowel)?

Indeed, only under the assumption that the material vocalizing *mesek* involves the epenthetic vowel *e*, can apophony provide an immediate account for this case, as proposed in (3.55).

Accordingly, the last intriguing aspectual alternation pattern has finally been interpreted, this is slot (5) in Table 3.37.

Table 3.37 Identifying the perfective managed by epenthesis

| a. <i>AV</i> class | | | b. <i>NAV</i> class | | |
|--------------------|--------------|---------------------------|---------------------|--------------------------|----------------|
| | <i>perf.</i> | <i>imperf.</i> | | <i>perf.</i> | <i>imperf.</i> |
| 1. | ḡarab ∅ | -ḡrab I (eventually A) | 4. | selem I | -slam A |
| 2. | katab A | -kteb U ⇒ I | 5. | mesek ∅ | -msek I |
| 3. | xarag A | -xrog U | 6. | ṣeber ~ ṣobor (I) ~ U | -ṣbor U |

Based on what precedes, the following conclusions can be finally reached:

1. The alternation patterns involving:

- a. (a _ a) → a
b. (e _ e) → e
- } are diagnostics of $\emptyset \rightarrow I$ (slots (1) and (5) of Table 3.38).

2. The alternation patterns involving:

- a. (a _ a) → e
b. (a _ a) → o
- } are diagnostics of $A \rightarrow U$ (slots (2) and (3) of Table 3.38).

3. The alternation pattern involving:

- (e _ e) → a → indicates $I \rightarrow A$ (slot (4) of Table 3.38).

4. The alternation pattern involving:

(e _ e) → o → points to ***U (coated in I)*** → ***U*** (slot (6) of Table 3.38).

Table 3.38 Apophony, established in CEA

| a. <i>AV</i> class | | | b. <i>NAV</i> class | | |
|--------------------|---|----------------------------|----------------------------|---|----------------|
| <i>perf.</i> | | <i>imperf.</i> | <i>perf.</i> | | <i>imperf.</i> |
| 1. ḍarab | | -ḍrab | 4. selem | | -slam |
| ∅ | → | I _{lowered} ⇒ A | I | → | A |
| 2. katab | | -kteb | 5. mesek | | -msek |
| A | → | U _{coated in} ⇒ I | ∅ | → | I |
| 3. xarag | | -xrog | 6. ṣeber ~ (ṣobor) | | -ṣbor |
| A | → | U | I ⇐ _{coated in} U | → | U |

3.5.5 More evidence for “frontness”

Before wrapping up our discussion, I would like to shed some more light on the peculiar class of verbs whose perfective swings between (o _ o) and (e _ e) in free variation. This is the class exemplified by the verb in cell (6) in Table 3.38 above. These verbs will help us discover more about the dynamic process of fronting characterizing the CEA system. Let us consider the sample of verbs displayed in Table 3.39. Note that all of the verbs below contain roots that exhibit a lowering consonant as their second and/or third radical.

Table 3.39 Input (U ⇒ I) in CEA

| | <i>perf.</i> | | <i>imperf.</i> | | Root |
|------|--------------|---------|----------------|------|-------------------------|
| | a. | b. | c. | | |
| i. | keber | ~ kobor | je-kbar | √kbr | 'grow' |
| ii. | šeʕeb | ~ ʕoʕob | je-ʕʕab | √ʕʕb | 'become more difficult' |
| iii. | zeheʔ | ~ zohoʔ | je-zhaʔ | √zhq | 'get bored' |
| iv. | ʕeʕeb | ~ ʕoʕob | je-ʕʕab | √ʕʕb | 'get angry' |
| v. | texen | ~ toxon | je-txan | √θxn | 'fatten' |
| vi. | keter | ~ kotor | je-ktar | √kθr | 'become numerous' |
| vii. | ʕemeʔ | ~ ʕomoʔ | je-ʕmaʔ | √ʕmq | 'darken' |

According to our conclusions outlined earlier in Table 3.38, the imperfective melody in the list of verbs given above suggests two hypotheses regarding the vocalic material underlying the perfective:

1. Perfective input \emptyset just as the case of *darab/je-drab*.
2. Perfective input I just as the case of *selem/je-slam*. Recall that the list to which *selem* belongs contains some verbs whose roots exhibit a lowering consonant as R₂ and/or R₃; we have seen this already in Table 3.32.

The presence of imperfectives of the kind displayed in column (c) of Table 3.40 can in fact provide a hint as to whether the perfective is equipped with \emptyset or I. This is because neither R₂ nor R₃ is characterized by any lowering effect. Those imperfectives are good indicators of a perfective input I (hence like *selem/je-slam*).

Table 3.40 Output A, indicator of input I

| | <i>perf.</i> | | <i>imperf.</i> | | Root |
|------|--------------|---------|----------------|------|--------------------|
| | a. | b. | c. | | |
| i. | ʕeleb | ~ ʕolob | je-ʕlab | √ʕlb | 'suffer hardship' |
| ii. | ʔedem | ~ ʔodom | je-ʔdam | √qdm | 'grow old' |
| iii. | ʔenef | ~ ʔonof | je-ʔnaf | √qnf | 'become disgusted' |

The existence of the variants in column (a) with perfective melody (e _ e) supports this deduction. And yet, how would the variants with (o _ o) vocalization, in column (b), be interpreted? The question can be reformulated differently, why would these perfectives with (e _ e) ~ (o _ o) not yield imperfectives with *o* (like in *šeber* ~ *šo**o**r*/*jo-š**o**r*)? Why would *keleb* ~ *kolob* yield *je-**k**lab* and not **jo-**k**lob*?

Obviously, perfectives with (e _ e) ~ (o _ o) show the dichotomy outlined in the following table.

Table 3.41 Perfective entry /U/ vs. perfective entry /U transforming to ⇒ I/

| <i>perf.</i> | | <i>imperf.</i> | Root |
|--------------|---|----------------|------------------|
| a. U → U | | | |
| šeber | ~ | šo o r | jo-š o r |
| | | └──────────┘ | ↑ |
| b. I → A | | | |
| keleb | ~ | kolob | je- k lab |
| | | └──────────┘ | ↑ |

The above table reveals the following:

1. Some (e _ e) ~ (o _ o) verbs evidence a lexical entry U such as (*šo**o**r*) ~ *šeber* → *je-š**o**r* (i.e. U → U); this would be the original perfective melody.
2. Some other verbs have squarely adopted a perfective I that derives an output A (hence *kolob* ~ (*ke**l**eb*) → *je-**k**lab* and not **jo-**k**lob*).

This dynamic transition from U ⇒ I can be seen once more in the list of verbs in Table 3.42.⁴⁵ The table presents a number of (a _ a) perfectives which alternate with fluctuating U ~ I imperfectives. I argue that this would be the *intermediate* class between *xarag*/*jo-xrog*

⁴⁵ Adapted from Badawi and Hinds (1986).

and *katab/jektab* (\Leftarrow /jo-ktob/); this is the class where the transition to a “front” vowel is still actively taking place.

Table 3.42 Output (\emptyset _ e) ~ output (\emptyset _ o)

| | <i>perf.</i> | | <i>imperf.</i> | | Root | |
|-------|--------------|--|----------------|----|---------|---------------------------|
| | a. | | b. | c. | | |
| i. | kanas | | je-knes | ~ | jo-knos | √kns ‘sweep’ |
| ii. | rabak | | je-rbek | ~ | jo-rbok | √rbk ‘confuse’ |
| iii. | ʕafar | | je-ʕfer | ~ | jo-ʕfor | √ʕfr ‘forgive’ |
| iv. | naʔaš | | je-nʔeš | ~ | jo-nʔoš | √nqš ‘engrave, inscribe’ |
| v. | ħašar | | je-ħšer | ~ | jo-ħšor | √ħšr ‘cram’ |
| vi. | farak | | je-frek | ~ | jo-frok | √frk ‘rub’ |
| vii. | šadam | | je-šdem | ~ | jo-šdom | √šdm ‘shock’ |
| viii. | ħabak | | je-ħbek | ~ | jo-ħbok | √ħbk ‘to cause to fit’ |
| ix. | ʕaʔad | | je-ʕʔed | ~ | jo-ʕʔod | √ʕqd ‘knot’ |
| x. | ʔalaʔ | | je-ʔleʔ | ~ | jo-ʔloʔ | √ʔlq ‘release, set loose’ |
| xi. | ħaras | | je-ħres | ~ | jo-ħros | √ħrs ‘safeguard, ward’ |
| xii. | ʕabad | | je-ʕbed | ~ | jo-ʕbod | √ʕbd ‘worship’ |

If it is the case that (o _ o) perfectives are shifting towards (e _ e) as do imperfectives (\emptyset _ o) towards (\emptyset _ e) this could be a critical point. This would entail future fusions of certain verbal classes as indicated in Table 3.43.

Table 3.43 Future fusions due to the mounting influence of “ambient I”

| a. <i>AV</i> class | | | b. <i>NAV</i> class | | |
|--------------------|--------------|----------------|---------------------|------------------------|----------------|
| | <i>perf.</i> | <i>imperf.</i> | | <i>perf.</i> | <i>imperf.</i> |
| 1. | ḍarab ∅ | -ḍrab A | 4. | selem I | -slam A |
| 2. | katab A | -kteb U ⇒ I | 5. | mesek ∅ | -msek I |
| 3. | xarag A | -xrog U | 6. | ṣeber ~ ṣobor I ⇐ U | -ṣbor U |

At any rate, the actual CEA aspectual alternations attested at this point of its history show that the mechanism underlying the aspectual alternations is the apophonic path. The perfective melody is regularly mapped into the imperfective as summed up in the following table:

Table 3.44 The apophonic derivation of CEA imperfective

| | <i>perf.</i> | | <i>imperf.</i> | Examples |
|------|--------------|---|----------------|------------------------------|
| i. | ∅ | → | i | ḍarab/je-ḍrab, mesek/je-msek |
| ii. | i | → | a | selem/je-slam |
| iii. | a | → | u | xarag/jo-xrog, katab/je-kteb |
| iv. | u | → | u | (ṣeber) ṣobor/jo-ṣbor |

3.6 Concluding remarks

The Egyptian Arabic aspectual vowel alternations (perfective/imperfective) are a problem that has not been seriously addressed until now. This is not because they have drawn little attention, but because of the massive opacity whereby both perfective patterns (a _ a) and (e _ e) alternate with the three possible imperfective melodies {a, e, o}. Investigators have consistently described these alternations as unpredictable. I argued for a different position. The purpose of this chapter was thus not only to shed some light on this obscure aspect of the Egyptian Arabic verbal system and perhaps search some meaningful generalizations but also to account for these alternations.

The harmony characterizing the perfective stem was the key to understanding the perfective. Unlike the perfective in Classical Arabic wherein stems can exhibit mixed vocalizations in addition to harmonic ones, such as (a _ a), (a _ i), (a _ u), Egyptian Arabic robustly rejects perfective stems with mixed vocalizations. Only two harmonized perfective melodies are maintained by Egyptian Arabic, (a _ a) and (e _ e). This harmony is achieved under the “Elements must branch” principle implemented by the Egyptian Arabic phonology. Bearing in mind the general attraction of Egyptian Arabic for frontness, it was possible to argue that it maintains perfective vocalic equipment similar to that of Classical Arabic. However, this vocalic material surfaces in Egyptian Arabic according to the language-specific strategies. Contrary to Classical Arabic, which is capable of projecting two different non-branching vowels (Elements) separately, Elements do branch in Egyptian Arabic and spread to harmonize the stem. This is one crucial difference between the grammars of both languages. This result, specifically, the Egyptian Arabic’s ability to maintain the perfective vocalizations found in Classical Arabic, helped understand the “apparently” unpredictable imperfective vocalization. Close examination of the (perfective/imperfective) alternation patterns revealed the following: the perfective vocalic melody in Egyptian Arabic is ablauted into the imperfective by means of the regular apophonic path. The fact that this path can be so evidently established in Egyptian Arabic further enforces the general idea that $\emptyset \rightarrow I \rightarrow A \rightarrow U \rightarrow U$.

Chapter 4

The Vocalization of Hollow and Deaf Verbs in Egyptian Arabic

4.1 Introduction

Egyptian Arabic hollow (glide-medial) and deaf (biliteral) verbs share a number of challenging features, most notably the invariable perfective *a* melody they exhibit. Unlike other types of Measure I perfectives that evidence both *A-vocalization* and *Non A-Vocalization* patterns, hollow and deaf perfectives exclusively display a-vocalizations. The regular absence of non a-vocalization in these two verb classes is definitely intriguing. Indeed, in a Semitic language, roots and vocalic patterns are independent of each other.

The central aim of this chapter is thus to account for the phenomenally consistent *a* melody realizing hollow and deaf perfectives, and to explain the absence of non a-vocalization.

Close examination of the aspectual melodic alternations attested in Egyptian Arabic hollow and deaf verbs shows that only two steps of the regular apophonic chain are maintained, ($\emptyset \rightarrow \text{I}$) and ($\text{A} \rightarrow \text{U}$). Implementing lexical entries that only involve \emptyset and *a* might describe the fact that hollow and deaf perfectives display *a*-vocalization, but does not explain *why* they call for this specific melody. I claim that this particular vocalization is the direct result of a process that addresses the qualitative root defect of hollow verbs and the quantitative root defect of deaf verbs.

The chapter is organized as follows: in section 2, the problem is presented. In section 3, hollow verbs are taken apart. This is followed by a detailed treatment of deaf verbs in section 4.

4.2 Identifying the problem

CEA, as other Semitic languages, exhibits three main classes of verbs:

1. Class I: Sane verbs

This class is characterized by roots free from defects, i.e. roots with perfect quantity and quality. Perfect quantity is typically conceived as three radical consonants and perfect quality indicates that none of those radicals is a glide or a glottal stop. A CEA sane (or strong or sound) verb exhibits the entirety of its radical equipment at all times. *katab* from the root \sqrt{ktb} ‘write’ is an example: no form of the verb fails to exhibit all three consonants. This is in sharp contrast with weak verbs as we soon will see.

2. Class II: Weak verbs

This class is characterized by roots with qualitative defects whereby one of the three radical consonants is weak: {w, j, or ?}. Depending on the position of the weak radical, weak verbs are classified, in turn, into three sub-classes:

- a. Initial-weak or assimilated verbs which exhibit a weak first radical, e.g. *?amar* whose root is $\sqrt{?mr}$ ‘command.’
- b. Medial-weak or hollow verbs which exhibit a weak second radical, e.g. *ma:t* whose root is \sqrt{mwt} ‘die.’
- c. Final-weak or defective verbs which exhibit a weak third radical, e.g. *rama* whose root is \sqrt{rmj} ‘throw.’

3. Class III: Deaf verbs

This class is characterized by roots with a defective quantity. The root in deaf verbs comprises two consonants, not the usual three, e.g. *madd* whose root is \sqrt{md} ‘extend.’ Verbs with this doubling of the second radical are also known as doubled verbs.⁴⁶

⁴⁶ On the biconsonantality of deaf verbs, cf. Lambert (1897), Greenberg (1950), Frajzyngier (1979), Voigt (1988), Bohas (1990), Zaborski (1991), Goldenberg (1998, 2005) and Lowenstamm (2010).

The CEA verbal system displays the following vocalic patterns:

1. Strong verbs: Two vocalic patterns are distinguished as we saw in the preceding chapter.
 - a. CaCaC, such as *katab* √ktb ‘write,’ which is referred to as *AV* (A-vocalization) in this study.
 - b. CeCeC, such as *selem* √slm ‘be safe,’ which is referred to as *NAV* (Non A-vocalization).

2. Initial-weak verbs: The same two vocalizations are attested.⁴⁷
 - a. CaCaC, such as *wazan* √wzn ‘weigh.’
 - b. CeCeC, such as *jebes* √jbs ‘dry up.’

3. Final-weak verbs: The same two vocalic patterns are found.
 - a. CaCa, such as *rama* √rmj ‘throw.’
 - b. CeCi, such as *nesi* √nsj ‘forget.’

4. Median-weak verbs: Contrary to the two recurrent patterns, these verbs show an invariable *a* melody regardless of the type of medial glide:
 - a. Ca:C, such as *ma:t* with medial *w* radical √mwt ‘die.’
 - b. Ca:C, such as *ma:l* with medial *j* radical √mjł ‘lean.’

5. Deaf verbs: Reveal the same phenomenally persistent *a* melody as hollow verbs, thus CaC_iC_i. A biliteral root like √md ‘extend’ can be realized as in *madd* and nothing else.

The set of recognized combinations between root types and vocalic patterns is recapitulated in the following table:

⁴⁷ In general, initial weak verbs almost always show a behavior similar to sane verbs with very few exceptions, e.g. the two ?-initial verbs *ʔakal* √ʔkl ‘eat’ and *ʔaxad* √ʔxð ‘take’ which alternate in free variation with *kal* and *xad* respectively.

Table 4.1 Root types and vocalic patterns in CEA Measure I: Perfective (3_{SING.MASC})

| a. Class | | b. Roots | | c. Vocalic patterns | d. Actualization |
|-------------------------------|-------|----------|-----------|---------------------|------------------|
| 1. Sane (sound/strong) | i. | √ktb | 'write' | CaCaC | katab |
| | ii. | √slm | 'be safe' | CeCeC | selem |
| 2. Initial-weak (assimilated) | iii. | √wzn | 'weigh' | CaCaC | wazan |
| | iv. | √jbs | 'dry up' | CeCeC | jebes |
| 3. Medial-weak (hollow) | v. | √mwt | 'die' | Ca:C | ma:t |
| | vi. | √mjl | 'lean' | | ma:l |
| 4. Final-weak (defective) | vii. | √rmj | 'throw' | CaCa | rama |
| | viii. | √nsj | 'forget' | CeCi | nesi |
| 5. Doubled (deaf) | ix. | √md | 'extend' | CaCiCi | madd |

The invariable perfective vocalization of hollow and deaf verbs is reemphasized by means of the shaded cells in Table 4.2. By analogy with *selem*, *jebes* and *nesi*, *me:t, *me:l and *medd would be logically expected. The systematic absence of Non A-vocalization is truly puzzling. Indeed, everything we have seen up to this point indicates that roots and vocalic melodies are independent of each other in CEA as in other Semitic languages.

 Table 4.2 The absence of *Non A-Vocalization* in CEA hollow and deaf verbs

| a. Class | | b. Root | | c. Vocalic melody | d. Unattested | |
|-------------------------------|-------|---------|-----------|-------------------|---------------|--------------|
| 1. Sane (sound/strong) | i. | √ktb | 'write' | katab | AV | |
| | ii. | √slm | 'be safe' | selem | NAV | |
| 2. Initial-weak (assimilated) | iii. | √wzn | 'weigh' | wazan | AV | |
| | iv. | √jbs | 'dry up' | jebes | NAV | |
| 3. Medial-weak (hollow) | v. | √mwt | 'die' | ma:t | AV | *me:t (*NAV) |
| | vi. | √mjl | 'lean' | ma:l | AV | *me:l (*NAV) |
| 4. Final-weak (defective) | vii. | √rmj | 'throw' | rama | AV | |
| | viii. | √nsj | 'forget' | nesi | NAV | |
| 5. Doubled (deaf) | ix. | √md | 'extend' | madd | AV | *medd (*NAV) |

It is the main objective of this chapter to identify the factors imposing the persistent *A-Vocalization* pattern in CEA hollow and deaf verbs.

4.3 Hollow (Glide-medial) verbs

4.3.1 Expected vocalisms

The treatment in chapter 3 of the CEA perfective and imperfective vocalization patterns rests on two major claims:

- (4.1) a. CEA is equipped with vocalic material similar to that of CA (albeit managed in different fashion). This includes Element A, a remnant of the morphological marker of active voice in CA, and lexical vowels { \emptyset , A, I, U}.
- b. The perfective lexical vowel is ablauted into that of the imperfective via the following apophonic formula: $\emptyset \rightarrow I \rightarrow A \rightarrow U \rightarrow U$.

Accordingly, glide-medial roots are expected to be paired with four possible perfective vowel entries as well as with four imperfective output patterns; this is shown in Tables 4.3. The ubiquitous left-hand side Element A (in italics) is the first vocalic constituent used to signal voice in CA. In section 3.5.2 of the preceding chapter, the original site of this element was determined as being the V separating the first two radicals. The right-hand side elements (in the perfectives) are the lexical inputs to apophony and their outputs appear as the right-hand side elements of the imperfectives melodies (at the end of the arrow in Table 4.3). These elements underlie the vocalic position separating the second and third radical. Root $\sqrt{\text{mwt}}$ ‘die’ has been used as a token representative of w-medial roots and $\sqrt{\text{mjl}}$ ‘lean’ as a representative of j-medial roots.

Table 4.3 The vocalic equipment of glide-medial roots if it replicated the set of options available to verbs from strong roots (3_{SING.MASC} forms)

| a. √mwt ‘die’ | | b. √mjl ‘lean’ | |
|-----------------|-----------------|-----------------|-----------------|
| <i>perf.</i> | <i>imperf.</i> | <i>perf.</i> | <i>imperf.</i> |
| 1. m_w_t A Ø | j -m_w_t A I | 5. m_j_l A Ø | j -m_j_l A I |
| 2. m_w_t A I | j -m_w_t A A | 6. m_j_l A I | j -m_j_l A A |
| 3. m_w_t A A | j -m_w_t A U | 7. m_j_l A A | j -m_j_l A U |
| 4. m_w_t A U | j -m_w_t A U | 8. m_j_l A U | j -m_j_l A U |

How are the above morphemes supposed to interact with each other? In addition, what kind of phonetic outcome is expected from these interactions?

The main tools that will help us answer these two questions are:

First, the general principles that underlie the CEA vowel system, which are: a) Elements must branch, otherwise they delink, and b) Elements I and U can spread across a consonant when accompanied by Element A. The consequence is that CEA tends to maintain stems with harmonized vocalizations, as established in the previous chapter.

Second, the general characteristics of the second radical involved in this class (i.e. the *glide*); these are:

1. A glide in CEA proves unable to hold between two identical vowels, $\text{Glide} \rightarrow \emptyset / V_{\alpha} - V_{\alpha}$.

This phenomenon can be seen in nouns as in verbs, for example:

- a. The disappearance of the glide-medial radical in nouns such as *ba:b* √bwb ‘door’ (where the medial *w* can be recovered in the plural *ʔebwa:b* ‘doors’), as well as in *ʕa:r* √ʕjr ‘shame’ (where the medial *j* reappears in the related verb *ʕa:jer* ‘to shame someone’), etc.
 - b. Similarly, the medial glides *w* and *j* in verbs such as *ma:t* √mwt ‘die’ and *ma:l* √mjl ‘lean’ can be retrieved once they undergo gemination in the second verbal measure (hence *mawwet* ‘kill’ and *majjel* ‘bend’).
2. The glide is a “primitive Element.” The phonetic realization of an underlying Element depends on whether it is attached to a vocalic position or a consonantal position. Hence, [w] and [u] are two different phonetic manifestations of an underlying /U/; *w* when it associates to C and *u* when it associates to V. Likewise, [j] and [i] are two different phonetic manifestations of an underlying /I/, depending on how it is organized with respect to the skeleton.⁴⁸

Bearing these elements in mind will be necessary while we test the range of interactions that might take place between the different morphemes displayed in Table 4.3. We will start by considering the w-medial root √mwt ‘die’ when paired with different vocalic patterns.

⁴⁸ Cf. Kaye, Lowenstamm and Vergnaud (1985) for details. Also, evidence for this view is provided in chapter 2, section 2.5.3 (the case of long mid-vowels in Egyptian Arabic).

(4.2) Glide-medial root $\sqrt{\text{mw}t}$ ‘die’: expected vocalizations for (3SING.MASC)

a. Input $\emptyset \rightarrow$ Output I

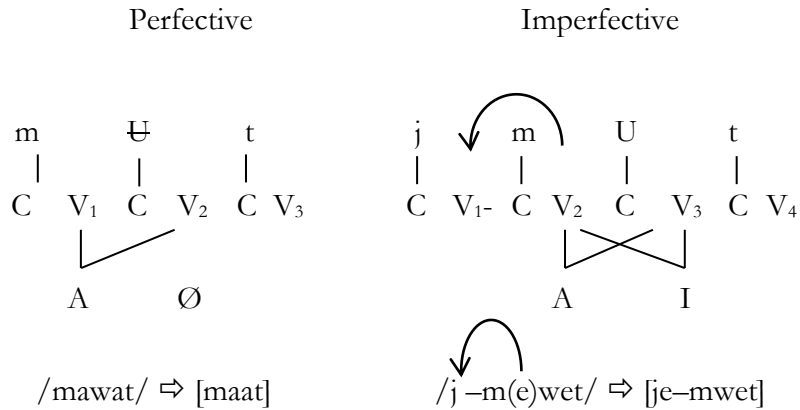

The glide is crushed between two identical *a* vowels.

- The vowel occupying V_2 shifts to the left to keep the first two radicals adjacent.⁴⁹
- (A.I) can interpret the prefix's empty nucleus.

b. Input I \rightarrow Output A

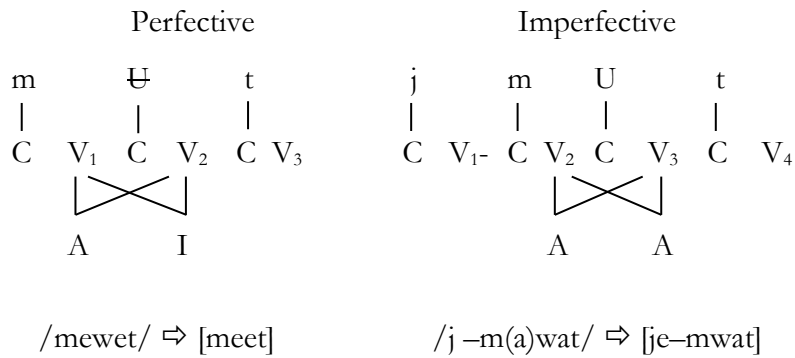

The glide is sandwiched between two identical *e* vowels, it cannot hold.

V_2 remains silent and V_1 is handed over to epenthesis, no leftward shift of the vowel occupying V_2 as A cannot interpret the prefix's empty nucleus.

⁴⁹ The imperfective derivation imposes phonetic adjacency of the first two radicals. For discussion, cf. section 3.5.2 of the preceding chapter.

c. Input A → Output U

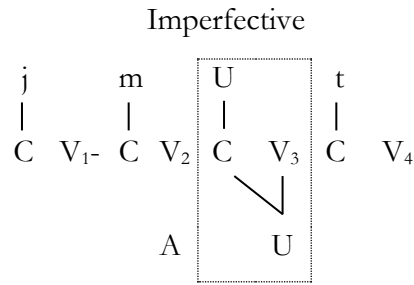
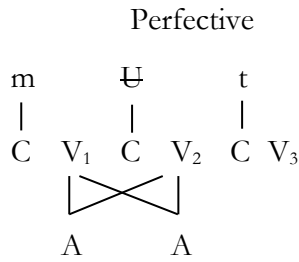

The glide is squeezed between two identical *a* vowels.

- Two Elements U occurring in a row satisfy the branching requirements of U.
- Element A underlying V₂ delinks.
- V₁ is managed by epenthesis.

d. Input U → Output U

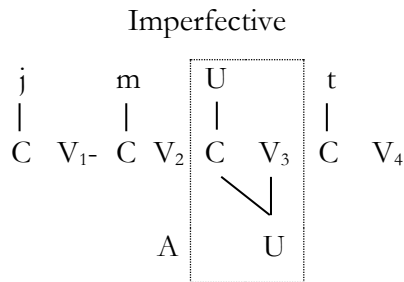
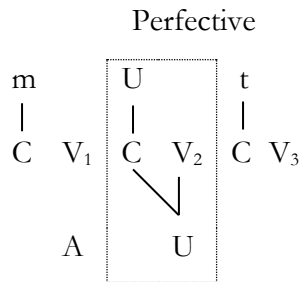

- Two consecutive U's satisfy the branching requirements of the lexical vowel.
- Element A delinks.

- Here – again – two successive U's satisfy the branching requirements of U.
- Element A delinks.
- V₁ is filled in by epenthesis.

In short, the above scenarios are expected to result in the following range of options:

Table 4.4 Expected vocalizations of w-medial verbs, e.g. $\sqrt{\text{mw}}t$ ‘die’ (3_{SING.MASC})

| | | <i>perf.</i> | <i>imperf.</i> |
|----|--|--------------|----------------|
| a. | Input $\emptyset \rightarrow$ Output I | maat | je-mwet |
| b. | Input I \rightarrow Output A | meet | je-mwat |
| c. | Input A \rightarrow Output U | maat | je-muut |
| d. | Input U \rightarrow Output U | muut | je-muut |

Now, in (4.3), we will proceed along the same lines for the j-medial root $\sqrt{\text{mj}}l$ ‘lean.’

(4.3) Glide-medial root $\sqrt{\text{mj}}l$ ‘lean’: expected vocalizations for (3_{SING.MASC})

a. Input $\emptyset \rightarrow$ Output I

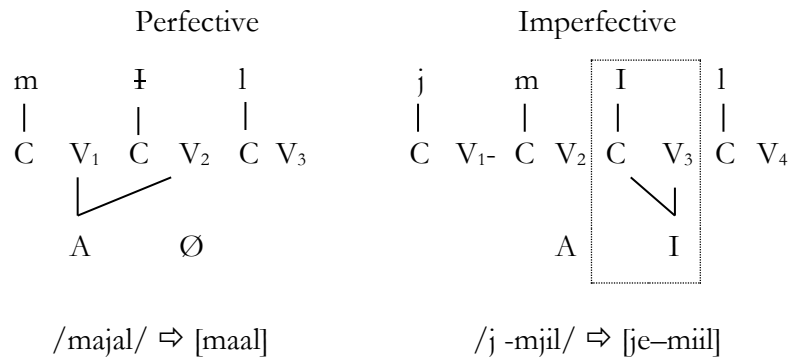

The glide is crushed between two identical *a* vowels.

- Two Elements I occurring in a row satisfy the branching requirements of I.
- Element A delinks and the nucleus of the prefix is managed by epenthesis.

b. Input I → Output A

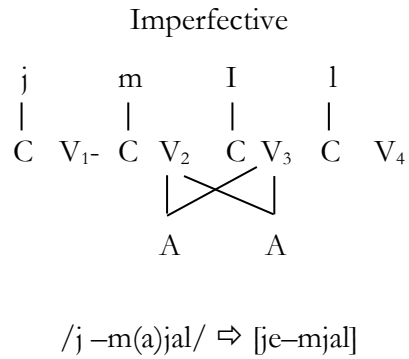
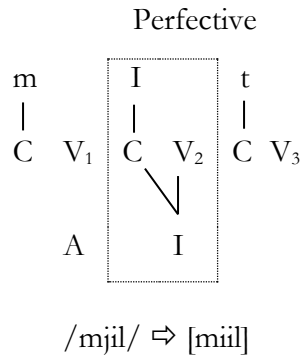

- Two consecutive I's satisfy the branching requirements of I.
- Element A delinks.

V₂ remains silent and the prefix's nucleus is handed over to epenthesis.

c. Input A → Output U

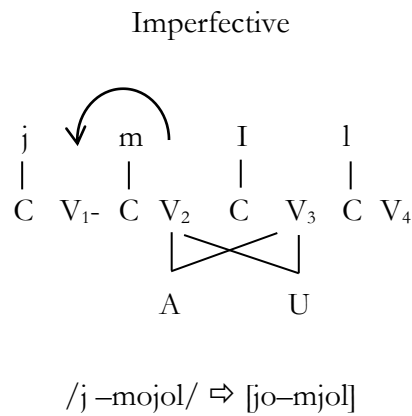
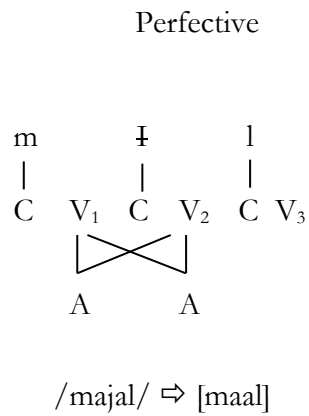

The glide is squeezed between two identical *a* vowels.

Leftward shift of the vowel occupying V₂ occurs towards the prefix. (A,U) is capable of interpreting an empty nucleus.

d. Input U → Output U

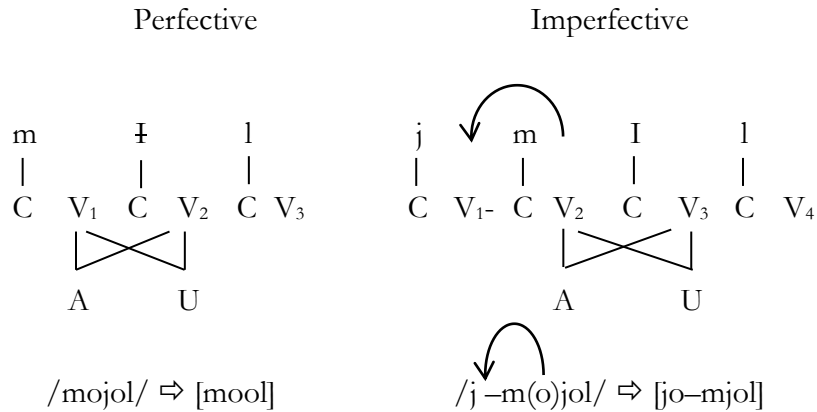

The glide cannot hold between two identical *o* vowels.

Leftward shift of the vowel occupying V₂ occurs to satisfy the constraint imposed to keep R₁ and R₂ adjacent. (A.U) is capable of interpreting the prefix's empty nucleus.

Consequently, the phonetic realizations of (4.3) can be summed up as follows:

Table 4.5 Expected vocalizations of j-medial verbs, e.g. √mjl 'lean' (3_{SING.MASC})

| | | <i>perf.</i> | <i>imperf.</i> |
|----|--------------------|--------------|----------------|
| a. | Input ∅ → Output I | maal | je-miil |
| b. | Input I → Output A | miil | je-mjal |
| c. | Input A → Output U | maal | jo-mjol |
| d. | Input U → Output U | mool | jo-mjol |

The actually attested forms of CEA hollow verbs reviewed in Table 4.6 leads to the validation of only two of the above options. Those are *ma:t/je-mu:t* for √mwt 'die' and *ma:l/je-mi:l* for √mjl 'lean.' These two possibilities appear in the shaded cells in Tables 4.4 and 4.5 above.

Table 4.6 CEA hollow verbs: attested melodies (3_{SING.MASC})

| | Root | <i>perf.</i> | <i>imperf.</i> |
|-----|-------------|--------------|----------------|
| i. | √mwt ‘die’ | ma:t | je-mu:t |
| ii. | √mjł ‘lean’ | ma:l | je-mi:l |

4.3.2 The attested vocalisms

Our examination of the full set of options expected for glide-medial verbs led to the identification of only two valid combinations, one for each root type; they can be seen anew in (4.4).

(4.4) Glide-medial roots: attested vocalisms

| <p>a. √mwt: Input A → Output U</p> <table border="1" style="width: 100%; border-collapse: collapse; text-align: center;"> <thead> <tr> <th style="border: none;"><i>perf.</i></th> <th style="border: none;"><i>imperf.</i></th> </tr> </thead> <tbody> <tr> <td style="border: none;">m_w_t</td> <td style="border: none;">j-m_w_t</td> </tr> <tr> <td style="border: none;">A A</td> <td style="border: none;">A U</td> </tr> <tr> <td style="border: none;">↓</td> <td style="border: none;">↓</td> </tr> <tr> <td style="border: none;">[ma:t]</td> <td style="border: none;">[je-mu:t]</td> </tr> </tbody> </table> | <i>perf.</i> | <i>imperf.</i> | m_w_t | j-m_w_t | A A | A U | ↓ | ↓ | [ma:t] | [je-mu:t] | <p>b. √mjł: Input Ø → Output I</p> <table border="1" style="width: 100%; border-collapse: collapse; text-align: center;"> <thead> <tr> <th style="border: none;"><i>perf.</i></th> <th style="border: none;"><i>imperf.</i></th> </tr> </thead> <tbody> <tr> <td style="border: none;">m_j_l</td> <td style="border: none;">j-m_j_l</td> </tr> <tr> <td style="border: none;">A Ø</td> <td style="border: none;">A I</td> </tr> <tr> <td style="border: none;">↓</td> <td style="border: none;">↓</td> </tr> <tr> <td style="border: none;">[ma:l]</td> <td style="border: none;">[je-mi:l]</td> </tr> </tbody> </table> | <i>perf.</i> | <i>imperf.</i> | m_j_l | j-m_j_l | A Ø | A I | ↓ | ↓ | [ma:l] | [je-mi:l] |
|--|----------------|----------------|-------|---------|-----|-----|---|---|--------|-----------|--|--------------|----------------|-------|---------|-----|-----|---|---|--------|-----------|
| <i>perf.</i> | <i>imperf.</i> | | | | | | | | | | | | | | | | | | | | |
| m_w_t | j-m_w_t | | | | | | | | | | | | | | | | | | | | |
| A A | A U | | | | | | | | | | | | | | | | | | | | |
| ↓ | ↓ | | | | | | | | | | | | | | | | | | | | |
| [ma:t] | [je-mu:t] | | | | | | | | | | | | | | | | | | | | |
| <i>perf.</i> | <i>imperf.</i> | | | | | | | | | | | | | | | | | | | | |
| m_j_l | j-m_j_l | | | | | | | | | | | | | | | | | | | | |
| A Ø | A I | | | | | | | | | | | | | | | | | | | | |
| ↓ | ↓ | | | | | | | | | | | | | | | | | | | | |
| [ma:l] | [je-mi:l] | | | | | | | | | | | | | | | | | | | | |

In view of the above, two generalizations can be made:

- (4.5) a. Only two perfective lexical entries, Ø and *a*, are implemented for CEA hollow verbs.
- b. Lexical vowel Ø only goes with roots whose medial glide is *j* and lexical vowel *a* only goes with roots whose medial glide is *w*. In other words, Ø is impossible with √R₁wR₃, so is *a* with √R₁jR₃.

A quick look at the boxed material in the schemes depicted below in (4.6) and (4.7) makes it possible to deduce the following: the presence of a *glide* rules out the choice of lexical vowels *i* and *u*.

(4.6) ma:t/je-mu:t

a. Perfective [maat]

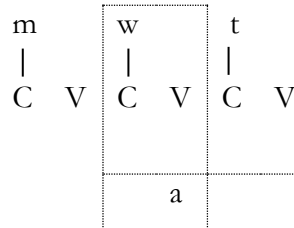

b. Imperfective [j -muut]

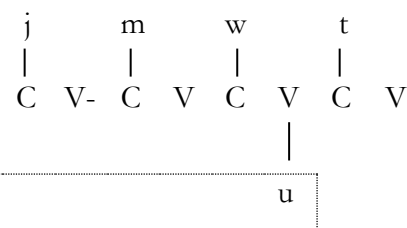

(4.7) ma:l/je-mi:l

a. Perfective [maal]

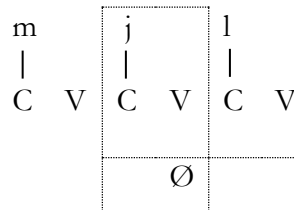

b. Imperfective [j -miil]

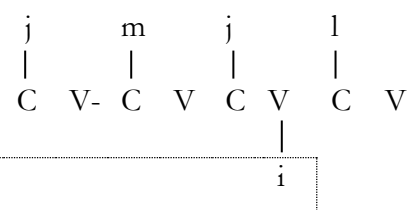

The system therefore seems not to implement combinations such that the root and the lexical vowel would both be high vocoids, I or U. Thus, all combinations of type $R_1j/wR_3 - i/u$ are excluded. This complementary distribution explains the absence of forms like *me:t /m(A)U(I)t/, *mo:t /m(A)U(U)t/, *me:l /m(A)I(I)l/ or *mo:l /m(A)I(U)l/.

Moreover, the restriction of ∅ to j-medial roots and of a to w-medial roots is too specific to be accidental. My answer to this challenge is the following: the hollowness of the roots under discussion has to be interpreted literally. That is, \sqrt{mwt} is in reality $\sqrt{m\emptyset t}$ and $\sqrt{mj l}$ is in

reality $\sqrt{m\emptyset l}$. The medial glides *j* and *w* are the direct result of apophony operating on the lexical vowels \emptyset and *a*.⁵⁰ Consider the analysis in (4.8) and (4.9).

(4.8) ma:t/j -mu:t

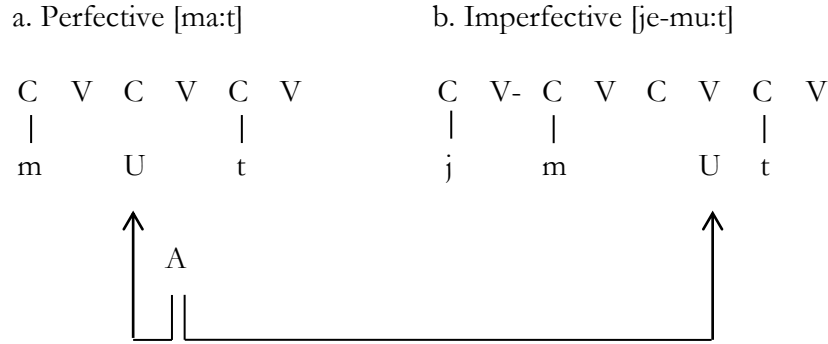

(4.9) ma:l/j -mi:l

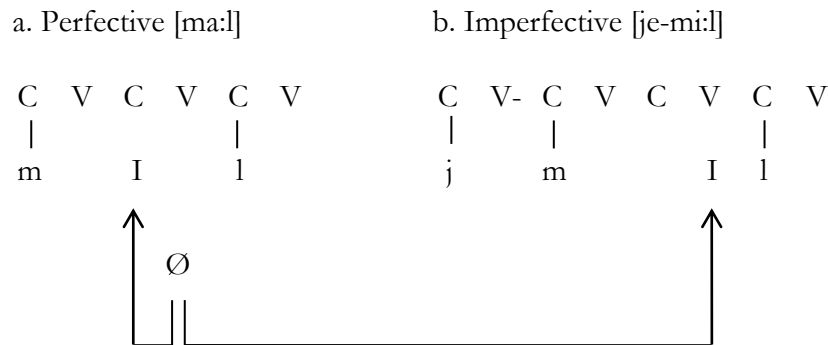

If the account developed above is endorsed, where the medial radical of hollow verbs (i.e. *j* or *w*) is generated from the verb's lexical vowel by means of apophony, then a lexical entry that specifically involves \emptyset and *a* will be essentially required. The consequence is that hollow perfectives maintain an invariable *a*-vocalization.

Now that the reason for which glide-median verbs exhibit a consistent *a* melody has been revealed, let us move on to the examination of the second intriguing case, the vocalization of deaf verbs.

⁵⁰ Cf. Chekayri and Scheer (1996) for arguments of a different kind but a similar conclusion for the apophonic origin of medial glides in Classical Arabic.

4.4 Deaf (Bilateral) verbs

4.4.1 The aspectual melodic alternations

CEA deaf verbs can be classified into two distinct classes according to the aspectual vocalic alternations they exhibit; this is illustrated in Table 4.7. The invariable perfective *a* melody may alternate with *e* or *o* in the imperfective. The first melodic alternation can be discerned in *madd/je-medd* on top of set (a), while the second can be discerned in *garr/je-gorr* on top of set (b).

Table 4.7 CEA deaf verbs: aspectual alternation patterns

| | a. <i>perf.</i> | b. <i>imperf.</i> | c. Root | |
|-------------|-----------------|-------------------|---------|------------|
| I. Set (a) | | | | |
| i. | madd | je-medd | √md | 'extend' |
| ii. | ħabb | je-ħebb | √ħb | 'love' |
| iii. | hadd | je-hedd | √hd | 'demolish' |
| iv. | ball | je-bell | √bl | 'wet' |
| II. Set (b) | | | | |
| v. | garr | je-gorr | √gr | 'pull' |
| vi. | rašš | je-rošš | √rš | 'sprinkle' |
| vii. | radd | je-rodd | √rd | 'reply' |
| viii. | bašš | je-bošš | √bš | 'look' |

Under the apophonic mechanism, the attested two imperfective melodies, *e* and *o*, are diagnostics of two perfective lexical entries, \emptyset and *a* (hence $\emptyset \rightarrow I$ and $A \rightarrow U$). The rough underlying representations displayed in Table 4.8 can be consequently accepted for the above verbs.

Table 4.8 CEA deaf verbs: rough underlying representation

| | a. <i>perf.</i> | b. <i>imperf.</i> | c. Root | |
|-------|-----------------|-------------------|---------|------------|
| Ø → I | | | | |
| i. | /mØdd/ | /-midd/ | √md | 'extend' |
| ii. | /hØbb/ | /-hibb/ | √hb | 'love' |
| iii. | /hØdd/ | /-hidd/ | √hd | 'demolish' |
| iv. | /bØll/ | /-bill/ | √bl | 'wet' |
| A → U | | | | |
| v. | /garr/ | /-gurr / | √gr | 'pull' |
| vi. | /rašš/ | /-rušš/ | √rš | 'sprinkle' |
| vii. | /radd/ | /-rudd / | √rd | 'reply' |
| viii. | /bašš/ | /-bušš / | √bš | 'look' |

Accordingly, the following configurations can be posited for the two existing alternating patterns, *madd/je-medd* in (4.10), and *garr/je-gorr* in (4.11).

(4.10) *madd/je-medd*

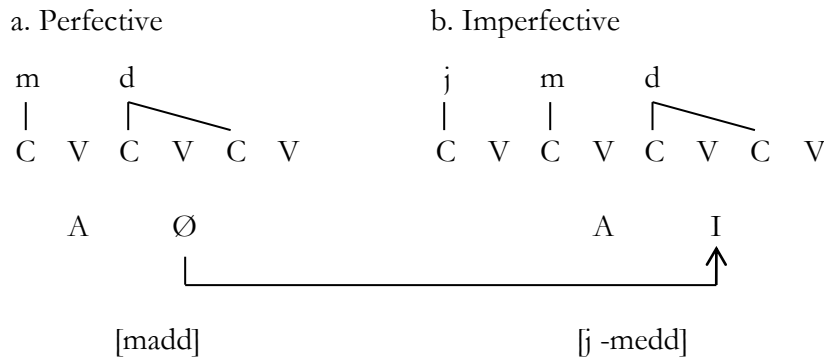

(4.11) *garr/je-gorr*

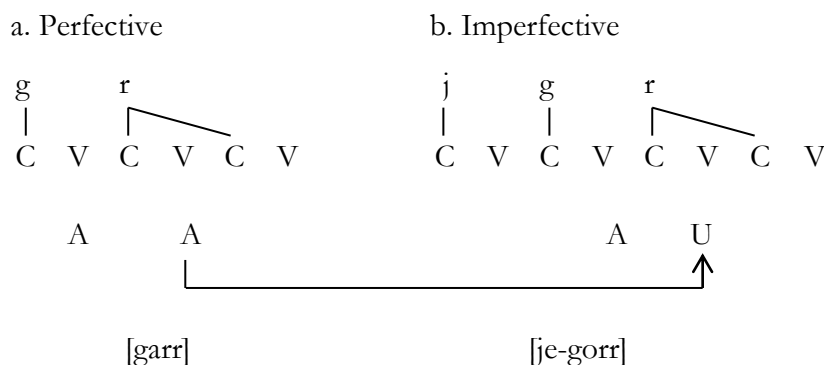

When the above structures are observed, a very curious finding is revealed: the perfective lexical entries implemented by the system managing deaf verbs – just as hollow verbs – uniquely involve \emptyset and *a*. The elimination of the choice of lexical vowels *i* and *u* efficiently accounts for the absence of melodic alternations of the kind **medd* /midd/ → **je-madd* /j -madd/ and **modd* /mudd/ → **je-modd* /j -mudd/.

The reason for which biliteral roots – just as glide-medial roots – specifically employ lexical vowels \emptyset and *a* and excludes *i* and *u*, though a crucial point, will not be uncovered immediately. The organization of the vocalic material depicted in (4.10) and (4.11) with respect to the root must be first addressed.

4.4.2 The arrangement of the vocalic material in deaf perfectives

As we repeatedly saw, deaf verbs display one single invariable perfective vocalization, that is *a*. In light of the “Elements I, U, A must branch” principle, the viability of the peripheral *a* melody of *madd* ‘he extended’ and *garr* ‘he pulled’ will be indicative of the branching of Element A underlying these perfectives. Consider in this respect (4.12).

(4.12)

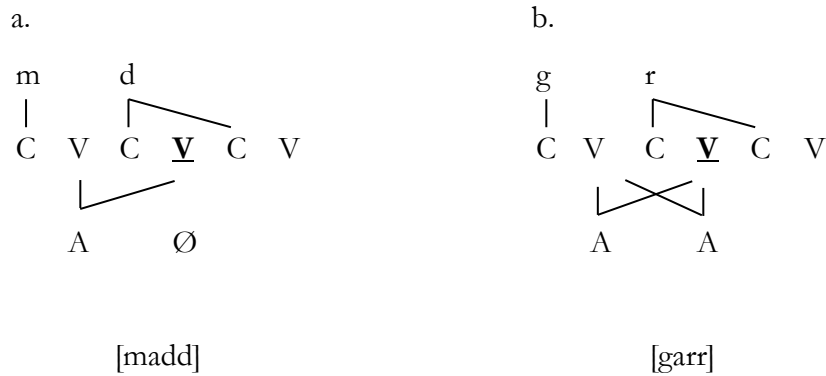

Obviously, this analysis entails one complication. Although the underscored nuclei in the above schemes do possess phonological content, they are phonetically interpreted as “inaudible.” Perfectives **madad* and **garar* are therefore intolerable in CEA.

In the preceding chapter, the two sane verbs *ḍarab* ‘he hit’ and *xarag* ‘he went out’ have been shown to be equipped with similar vocalic material as the two deaf verbs depicted in (4.12), *ḍarab* ‘he hit’ implements lexical entry Ø (like *madd*), and *xarag* ‘he went out’ implements lexical entry A (like *garr*). The major difference between sane verbs and deaf verbs can be articulated in such a way that the V vocalizing the second radical receives phonetic content in the former class of verbs but not in the latter. In order to see that, compare the two sane verbs *ḍarab* and *xarag* in (4.13) and *madd* and *garr* in (4.12). Clearly, a geminate in CEA cannot be separated “phonetically” by any short vowels.

(4.13)

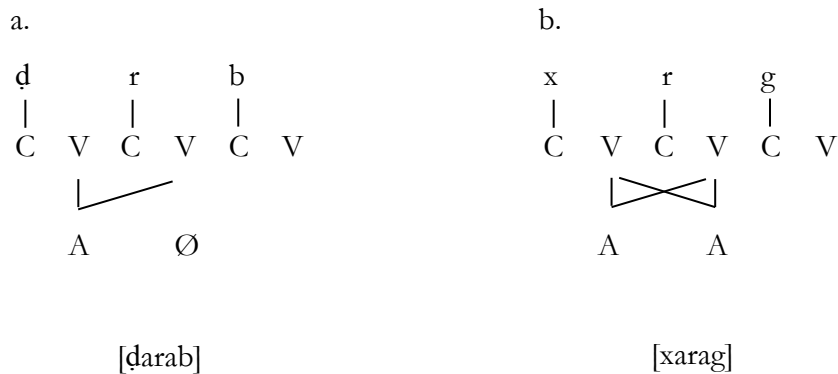

Now that the fashion whereby the vocalic material underlying deaf perfectives is arranged has been revealed, it will be appropriate to return to our pending question of why biliteral verbs specifically implement lexical vowels \emptyset and a .

4.4.3 Why deaf verbs implement lexical vowels \emptyset and a

We noted that CEA deaf verbs display only two types of aspectual melodic alternations; these are $\emptyset \rightarrow I$ such as *madd/je-medd* (/mad \emptyset d/ → /j-mdid/), and $A \rightarrow U$ such as *garr/je-gorr* (hence /garar/ → /j-grur/). The absence of alternation patterns of any other nature led to the deduction that biliteral verbs will necessarily exhibit invariable perfective a melody mainly due to the exclusion of lexical vowels i and u . The same conclusion was previously drawn for hollow verbs. However, in the latter class, this was reinterpreted in terms of a tight relationship that affects the medial glides and the lexical vowels implemented by the system. The medial glides have the lexical vowels as their apophonic antecedents, the medial radical in hollow verbs is thus derived according to the nature of the existing lexical vowel, j is the result of lexical vowel \emptyset , so is w with respect to A .

The primary examination of deaf verbs did not reveal any evidence that can help us assume a similar relationship between the root and the perfective lexical vowels. This is why I suggest a secondary examination of deaf perfectives considering this time the entire verbal paradigm, not only the (3_{SING.MASC}) forms that we have been treating up to this point. Indeed, a remarkable fact that will enable the establishment of the relationship we are surmising between biliteral roots and lexical vowels will immediately follow if another concurrent challenge presented by deaf verbs is considered.

Let us examine the two verbal paradigms shown in Table 4.9. Contrary to the perfect regularity exhibited by sane verb *ḍarab* in column (a), deaf verb *madd*, in column (b), exhibits an unexpected long mid-vocalic stretch, [e:], between the verbal stem and the pronominal suffixes involving the first and second person. The vowel under investigation is underscored.

Table 4.9 The perfective of deaf verbs vs. their sane counterparts

| | | a. Sound verbs | b. Deaf verbs |
|-------|------------------------|--------------------|----------------------|
| | | √ <i>ḏrb</i> ‘hit’ | √ <i>md</i> ‘extend’ |
| i. | 1 _{SING} | ḏarab <u>t</u> | madde <u>t</u> |
| ii. | 1 _{PL} | ḏarabna | madde <u>na</u> |
| iii. | 2 _{SING.MASC} | ḏarab <u>t</u> | madde <u>t</u> |
| iv. | 2 _{SING.FEM} | ḏarab <u>ti</u> | madde <u>ti</u> |
| v. | 2 _{PL} | ḏarab <u>tu</u> | madde <u>tu</u> |
| vi. | 3 _{SING.MASC} | ḏarab | madd |
| vii. | 3 _{SING.FEM} | ḏarabet | maddet |
| viii. | 3 _{PL} | ḏarabu | maddu |

The unexpected presence of the long mid-vowel *e:* as appears in the above table is intriguing for two reasons:

1. Contrary to the third person forms, which fit into the three CV units involved in the derivation of Measure I verbs, the first and second person forms seem to exceed this 3-CV-sized template. An extra CV-sized templatic chunk of unknown origin appears wedged between the stem and the pronoun (underscored in (4.14).)

(4.14)

a. Third person : deaf verbs

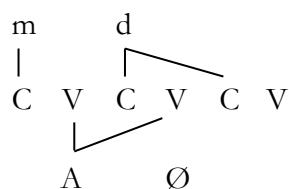

[madd]

b. First and second person : deaf verbs

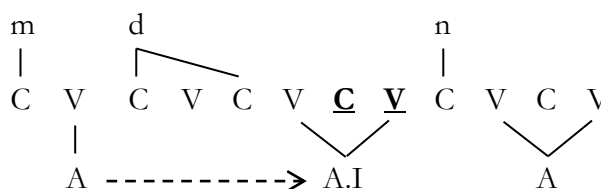

[madde:na]

2. Inside the mid-quality of the surprising vowel [e:] that separates the stem and the first and second person suffixes, two essential ingredients can be disentangled: a) Element A, which reflects the influence of the obligatory *a* melody of this class (indicated by the interrupted arrow in (4.14)), and b) Element I.

Three important questions accordingly ensue:

- 1) How could the origin of the extra CV unit underscored in (4.14b) be possibly identified, and for what exact reason has it been inserted in this particular position?
- 2) How could the influence of the obligatory *a* melody characterizing this class on the vowel [e:] separating the stem and the pronoun be interpreted?
- 3) What could possibly be the source of Element I implemented in the complex quality of the puzzling [e:]?

Any answer to the abovementioned queries should first of all address the motivation behind the insertion of an extra CV between the stem and the suffix. Let us examine the situation of the 1_(PL) form *madde:na* ‘we extended’ **before** the introduction of this extra CV unit. In (4.15a), the morphemes making up *madde:na* are arranged along the lines of what was proposed earlier for deaf perfectives. The expected outcome of linearizing the segmental material will be **maddna* as seen in (4.15b).

(4.15)

a. Association of morphemes

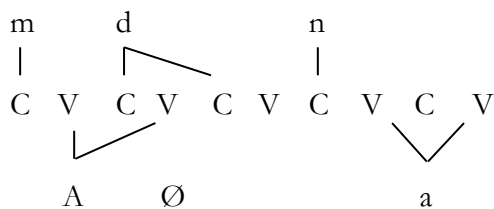

b. Linearization

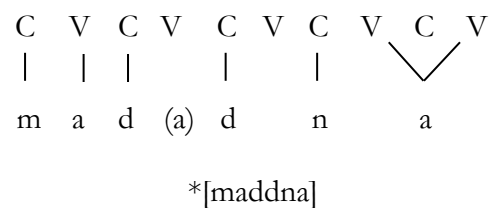

As a string of three consonants occurring in a row is not allowed in CEA, a form like *maddna should be directly handed over to epenthesis. An epenthetic vowel is expected to

break this ill-formed sequence, /...ddn.../, between the second and third consonant (hence ***maddena** would be the expected repaired form). Why is ***maddena** not attested? Careful examination of the particular position that rejects epenthesis, that is V₃ in (4.16), will at once reveal why it is not.

(4.16)

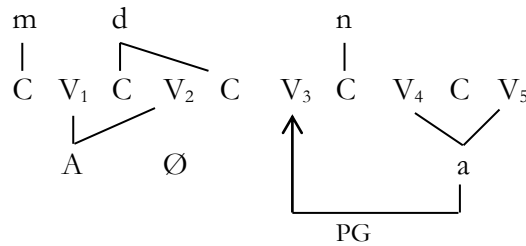

Under proper government of vowel *a* realizing the suffix, (V₃) is licensed to remain empty; explicit phonetic content in the preceding nucleus will be consequently required. But, the preceding nucleus (i.e. V₂) cannot exhibit any phonetic content under any circumstances; it is straddled by a geminate. Two constraints being imposed simultaneously to keep two consecutive phonetically unrealizable nuclei (i.e. V₂ and V₃), the transition to the phonetic level risks to crash. How could the system deal with such a dilemma? It cannot separate the geminate nor can it insert an epenthetic vowel in a licensed nucleus.

The answer to this problem will immediately fall out if only one aspect of (4.16) is recalled. The three CV units onto which the verbal stem of *madde:na* seems to be mapped are only one part of a greater-sized structure, that is the unique Verbal Template underlying the derivational morphology of CEA verbs. This 3-CV templatic portion is known as the Nuclear Base (in italics in (4.17)).

(4.17) CV – CV_[DS CV] CV CV

The configuration in (4.18a) has in effect (4.18b) as its actual underlying representation.

With R₂ propagating towards the derivational syllable, the source of the A component included by the (A.I) material of the intriguing [e:] has been finally revealed. This account immediately corroborates our prior conjecture to the effect that Element A was branching underneath the geminate, even though it was “phonetically” inaudible.

Based on what precedes, the need to recognize an “extra CV chunk” in *madde:na* ‘we extended’ vanishes. Consider the formerly identified position in (4.20a) where an extra syllable of unknown origin (underscored) has presumably been “inserted” between the stem and the pronoun, opposed to the actual position in (4.20b) where the extra syllable is already *part* of the unique Verbal Template.

(4.20)

a. An extra CV of unknown origin

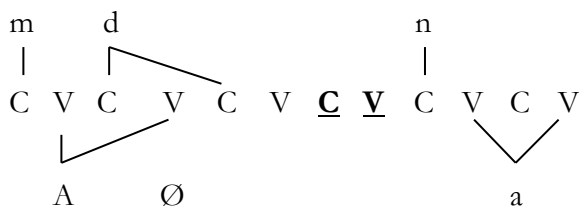

b. Activation of the already existing [dsCV]

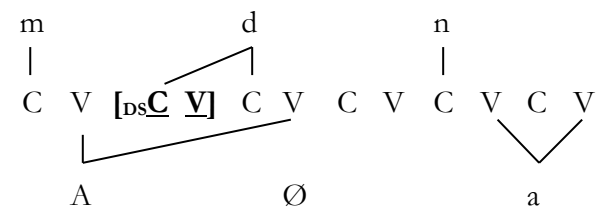

What else can follow from the leftward branching of the second radical towards the derivational syllable? The third consonantal position in the nuclear base (i.e. the canonical C slot that typically hosts the third verbal *radical*) remains unidentified, indeed demanding identification.

In the analysis demonstrated in (4.21a) I propose a possible scenario. The identification of the third C slot of the nuclear base is achieved by means of *j* (i.e. I), which is the apophonic output of the lexical vowel underlying the perfective.

(4.21)

a. Apophony: set off

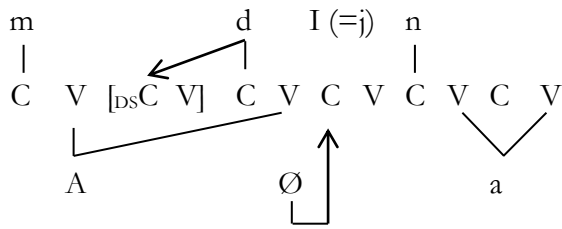

b. Linearization

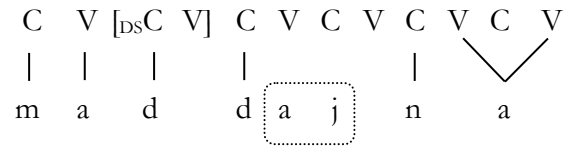

[madde:na]

Definitely, the result of linearizing the boxed segmental material in (4.21b) precisely yields the mysterious vocalic expression that separates the verbal stem and the suffix. Both the boxed segmental material /aj/ and the mid-vowel [e:] involve the same ingredients, Elements A and I.

However, if this account is endorsed, then deaf verbs whose lexical vowel is A will be expected to manifest a long mid-vowel [o:] between the verbal stem and the pronominal material of the first and second person (hence *garro:na ‘we pulled’ for instance).

(4.22)

a. Apophony: set off

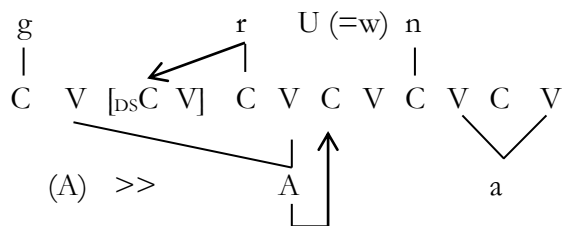

b. Linearization

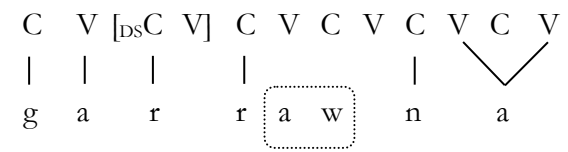

*[garro:na]

Contrary to what might be expected, the examination of the first and second person forms of verb *garr* reveals something else. A quick comparison between the actual forms in column (b) of Table 4.10 and the expected (non-attested) ones in column (a) shows that the system favors the surfacing of the apophonic output of A underlying *garr* as I.

Table 4.10 Deaf verb: root $\sqrt{\text{gr}}$ ‘pull’ whose perfective lexical entry is A

| | | $\sqrt{\text{gr}}$ ‘pull’ | |
|-------|------------------------|---------------------------|-------------|
| | | a. Predicted | b. Attested |
| i. | 1 _{SING} | *garro:t | garre:t |
| ii. | 1 _{PL} | *garro:na | garre:na |
| iii. | 2 _{SING.MASC} | *garro:t | garre:t |
| iv. | 2 _{SING.FEM} | *garro:ti | garre:ti |
| v. | 2 _{PL} | *garro:tu | garre:tu |
| vi. | 3 _{SING.MASC} | garr | garr |
| vii. | 3 _{SING.FEM} | garret | garret |
| viii. | 3 _{PL} | garru | garru |

This situation is documented in (4.23).

(4.23)

a.

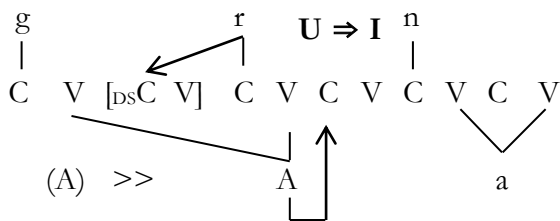

b.

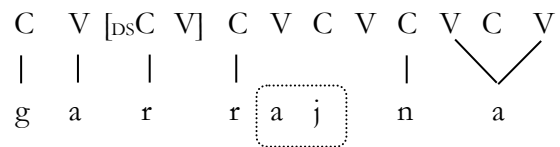

[garre:na]

This being the case, one question should be directly raised: are the apophonic outputs of lexical vowels \emptyset and a liable to undergo similar convergence in hollow verbs? The question put differently, can the opacity identified for *madde:na* and *garre:na* (as to whether the extra radical j is the direct apophonic output of \emptyset or the apophonic output of A *coated in j*) be also encountered in glide-medial verbs?

To answer this question, we need to refer back to the totality of the perfective paradigms of hollow verbs; these are reviewed in Table 4.11.

Table 4.11 Glide-medial roots: $\sqrt{mj}l$ 'lean' and $\sqrt{mw}t$ 'die': perfective

| | | a. $\sqrt{mj}l$ 'lean' | b. $\sqrt{mw}t$ 'die' |
|-------|------------------------|-----------------------------|----------------------------|
| i. | 1 _{SING} | <u>m</u> elt | m <u>o</u> tt |
| ii. | 1 _{PL} | <u>m</u> elna | m <u>o</u> tna |
| iii. | 2 _{SING.MASC} | <u>m</u> elt | m <u>o</u> tt |
| iv. | 2 _{SING.FEM} | <u>m</u> el ⁱ ti | m <u>o</u> tt ⁱ |
| v. | 2 _{PL} | <u>m</u> eltu | m <u>o</u> ttu |
| vi. | 3 _{SING.MASC} | ma:l | ma:t |
| vii. | 3 _{SING.FEM} | ma:let | ma:tet |
| viii. | 3 _{PL} | ma:lu | ma:tu |

According to the information available in the above table, two generalizations can be made:

1. The verbal stem of the third person exhibits a bare *a* melody, this is in contradistinction to a vocalic expression of mid-quality that vocalizes the stem of the first and second person.
2. The medial radical (i.e. the glide) can be easily distinguished within the substance of the mid-vowel displayed by the first and second person.

Obviously, no convergence of the kind we just saw in *madde:na* and *garre:na* can be recognized for glide-medial verbs. The ability of *w* to surface in the mid quality vocalizing the hollow verb *motna* 'we died' (where **metna* 'we died' is not an option), but not in the mid-vowel realizing the deaf verb **garro:na* points to the following fact:

(4.24) Glide *w* is impossible in a stem final position, *w* necessarily converges to *j*.

Another argument for this view would be the inability of *w* to surface in the verb class known as final-weak (or defective verbs), this class contains roots that exhibit a glide as *third*

radical. In Table 4.12, the perfective of two glide-final verbs is displayed, *rama* √rmj ‘throw’ in column (a) and *daʕa* √dʕw ‘pray’ in column (b).⁵¹

Table 4.12 Glide-final roots: √rmj ‘throw’ and √dʕw ‘pray’: perfective

| | | a. √rmj ‘throw’ | b. √dʕw ‘pray’ | |
|-------|------------------------|-----------------|----------------|------------|
| | | | Attested | Unattested |
| i. | 1 _{SING} | rame:t | daʕe:t | *daʕo:t |
| ii. | 1 _{PL} | rame:na | daʕe:na | *daʕo:na |
| iii. | 2 _{SING.MASC} | rame:t | daʕe:t | *daʕo:t |
| iv. | 2 _{SING.FEM} | rame:ti | daʕe:ti | *daʕo:ti |
| v. | 2 _{PL} | rame:tu | daʕe:tu | *daʕo:tu |
| vi. | 3 _{SING.MASC} | rama | daʕa | |
| vii. | 3 _{SING.FEM} | ramet | daʕet | |
| viii. | 3 _{PL} | ramu | daʕu | |

The inspection of the above table reveals that regardless of the type of the *final* glide, it consistently surfaces as *j*. This can be clearly seen in the invariable quality of the long mid-vowel [e:] displayed in the first and second person forms (hence *rame:na* ‘we threw’ and *daʕe:na* ‘we prayed,’ not **daʕo:na*). It is therefore confirmed that a glide *w* is impossible in a stem final position in CEA.

To wrap our discussion, deaf verbs – just as hollow verbs – have part of their radical material produced by means of apophony operating on the verb’s lexical vowel. As this radical material involves a glide, *j* or *w*, only two lexical entries are implemented by the system managing the two verb classes, these are \emptyset and *a*. The exclusion of lexical vowels *i* and *u*, in consequence, makes impossible any perfective vocalizations other than *a*. The main difference between glide-median verbs and doubled verbs can be expressed in such a way that the radical material *w* (the apophonic output of the lexical vowel *a*) is realized as *j* in the stem final position.

⁵¹The final *j* in *rama* can be recovered in other related derivatives of the same root such as *ramja* ‘the nomen unitatis of throw,’ also, the final *w* of *daʕa* can be retrieved in e.g. the nomen unitatis *daʕwa* ‘prayer.’

4.5 Concluding remarks

In this chapter, one of the most interesting phenomena presented by the Egyptian Arabic Measure I verbs was investigated, that is the absence of any perfective melodies in hollow and deaf verbs other than *a*. Close examination of the nature of the aspectual alternations attested in these groups of verbs revealed the following: hollow and deaf perfectives maintain lexical entries that uniquely involve \emptyset and A.

The analysis of hollow perfectives showed that part of the radical material of this class (the medial glide) is generated from the perfective lexical vowels by apophony. The analysis of deaf perfectives led to the same result; part of the radical material of this class (an extra final glide) is generated from the perfective lexical material via apophony. This explained the persistent need for perfective lexical vowels \emptyset and *a*. Indeed, the exclusion of perfective lexical vowels *i* and *u* could aptly account for the absence of any perfective vocalizations other than *a*.

Chapter 5

Word Stress in Egyptian Arabic

5.1 Introduction

Stress has always occupied an eminent position in the major developments of the phonological theory because, in many cases, it literally kicks phonology into action and brings to light rich and complex allophonic alternations. A familiar but spectacular example from English is the shift from *parent* *pærənt* to *parental* *pərəntəl*. Despite decades of the recurrence of stress in descriptive studies as well as being a subject of analysis within different frameworks, issues like what stress is, what a stress rule could be and why/how it operates warrant further investigation.

Egyptian Arabic exhibits word stress.⁵² Stress-related phenomena in Egyptian Arabic have received special attention, perhaps more than any other Arabic variant.⁵³ The location of stress in Egyptian Arabic is generally viewed as a function of both syllable weight and syllable position. The stress pattern is hence often described as predictable on the basis of syllabic structure.

Two main features made Egyptian Arabic stress especially interesting. First, stress assigning rules do not completely conform to universal tendencies, especially in the treatment of heavy syllables of type CVC. The stress pattern shows an abnormal distinction between

⁵² One of the syllables of the word is necessarily assigned stress in Egyptian Arabic, hence perceived as more prominent than the others. One or more of the remaining syllables might receive secondary stress. In this study, secondary stress will not be discussed. In any case, this will be of no consequence for the proposals put forth in this chapter.

⁵³ Cf. Watson (2011).

final and antepenultimate syllables of this particular type. Second, stress rules operate from left to right unlike Classical Arabic and other colloquial varieties.⁵⁴

In this chapter, I aim at introducing new elements to the discussion of Egyptian Arabic stress which for over half a century revolved around the main developments of research on syllabification. The implementation of a theoretical tool of analysis, in which no syllable weight distinctions are posited, like the CVCV model, advanced by Lowenstamm (1996), enables me to propose a new non syllable-weight based view of word stress in Egyptian Arabic.

The discussion proceeds as follows. First, the main outlines of Egyptian Arabic stress placement are presented in section 2. The descriptive generalizations that have repeatedly provided the challenging input material for previous scholars are then discussed and the reasons for which I propose to change the analytical tools in handling these generalizations are laid out. In section 3, the basic insight behind my proposal is put forth. Stress uniformly targets the penultimate vowel and applies on a skeletal level. The formal representation of this non syllable-weight based system leads to a very important conclusion: vowel length owes nothing to stress. Vowel “length” and “stress” must be dealt with independently from one another. The clear distinction made between “phonological length” and “phonetic length” helps characterize the main phonetic property associated with stress in Egyptian Arabic that is *pitch*. The details of this emerging system are subsequently discussed in section 4. The discussion emphasizes the role of morphology in explaining challenging cases where stress appears to be lodged on a vowel other than the penultimate vowel.

⁵⁴ Cf. McCarthy (1979b) for instance.

5.2 Outlines of stress assignment in Egyptian Arabic

5.2.1 The characteristics of Egyptian Arabic stress

One of the most interesting accentual phenomena of Arabic is found in the Egyptian dialect. This is due to the fact that stress assignment rules seem to handle every word, no matter how morphologically complex, as a single chunk of segments. This leads to the perception that stress shifts as different affixes and clitics are added, much as with Level I affixes in English,⁵⁵ e.g. the shift from *parent* pærənt to *parental* pərəntəl; this can be seen in the set of examples in Table 5.1. Consider the series of inflected verbs in line (i) as they get progressively cliticized in lines (ii) through (iv).

Table 5.1 Manifestations of stress shift in CEA

| | a. 3 _{PL} | b. 3 _{SING.FEM} | c. 2 _{SING.MASC} |
|--|--------------------|--------------------------|---------------------------|
| i. Verb-3 _{PL} /3 _{SING.FEM} /2 _{SING.MASC} /katab (-u/-et/-t)/ 'they/she/you (SING.MASC) wrote' | kátabu | kátabet | katabábt |
| | ↓ | ↓ | ↓ |
| ii. Verb-3 _{PL} /3 _{SING.FEM} /2 _{SING.MASC} + DOP (3 _{SING.FEM}) /katab (-u/-et/-t) + ha/ 'they/she/you (SING.MASC) wrote it (FEM)' | katabú:ha | katabétha | katabtáha |
| | ↓ | ↓ | ↓ |
| iii. Verb-3 _{PL} /3 _{SING.FEM} /2 _{SING.MASC} + DOP (3 _{SING.FEM}) + PREP + IOP (1 _{SING}) /katab (-u/-et/-t) + ha + l + i/ 'they/she/you (SING.MASC) wrote it (FEM) to me' | katabuhá:li | katabethá:li | kababtahá:li |
| | ↓ | ↓ | ↓ |
| iv. NEG + Verb-3 _{PL} /3 _{SING.FEM} /2 _{SING.MASC} + DOP (3 _{SING.FEM}) + PREP + IOP (1 _{SING}) + NEG /ma + katab (-u/-et/-t) + ha + l + i + š/ 'they/she/you (SING.MASC) didn't write it (FEM) to me' | makatabuhá:š | makatabethá:š | makababtahá:š |

⁵⁵ Cf. Newman (1946), Siegel (1974) and Kiparsky (1982a, 1982b) for discussion.

Close examination of additional data in Table 5.2 allows for the identification of some basic information concerning the location of stress in CEA.

Table 5.2 Stress location and clitics bearing stress

| | a. 3 _{PL} | b. 3 _{SING.FEM} | c. 2 _{SING.MASC} /1 _{SING} |
|---|---------------------------------|--------------------------------|--|
| i. Verb-SUBJ | kátabu | kátabet | katábt |
| /katab (-u/-et/-t)/ | 'they wrote' | 'she wrote' | 'you (SING.MASC)/I wrote' |
| ii. Verb-SUBJ + DOP (2 _{SING.MASC}) | katabú:k | katabétak | katábtak |
| /katab (-u/-et/-t)+ k~ak/ | 'they wrote you (SING.MASC)' | 'she wrote you (SING.MASC)' | 'I wrote you (SING.MASC)' |
| iii. Verb-SUBJ + DOP (3 _{SING.MASC}) | katabú: | katabétu | katábtu |
| /katab-(u/et/t) + 3 _{SING.MASC} / | 'they wrote it (MASC)' | 'she wrote it (MASC)' | 'you (SING.MASC) wrote it (MASC)' |

In CEA:

1. Stress is confined to one of the last three syllables of the word.
2. Clitics are perfectly capable of bearing stress.

Further dissection of some of the previous examples reveals additional stress-related events. Consider Table 5.3.

Table 5.3 Long vowels and stress in CEA

| | a. | b. | Gloss |
|------|------------------|-------------------------------------|---|
| i. | [kátabu] | /katab-u/ | <i>'they wrote'</i> |
| ii. | [katabú:k] | /katab-u + k/ | <i>'they wrote you (SING.MASC)'</i> |
| iii. | [katabú:ha] | /katab-u + ha/ | <i>'they wrote it (FEM)'</i> |
| iv. | [katabuhá:li] | /katab-u + ha + l + i/ | <i>'they wrote it (FEM) to me'</i> |
| v. | [makatabuháli:š] | /ma + katab-u + ha + l + i + š/ | <i>'they didn't write it (FEM) to me'</i> |
| vi. | [katabú:] | /katab-u + 3 _{SING.MASC} / | <i>'they wrote it (MASC)'</i> |

According to the above table, a number of stress-related generalizations can be made:

1. Only one long vowel can be present per utterance.
2. This long vowel is located either in the ultimate or the penultimate position of the word.
3. Only one primary word stress can be perceived.
4. Long vowels are always stressed.
5. Stressed vowels are not always long.
6. Once a vowel-final base (i.e. a stem + a subject agreement) is concatenated by a consonant-initial enclitic, the final vowel of the base lengthens; this is usually described as “pre-suffix vowel lengthening.”
7. When suffixes are further added and stress moves rightwards, the stem final vowel shortens once deprived of stress. This phenomenon is commonly known as “unstressed long vowel shortening.”

“Pre-suffix vowel lengthening” and “unstressed long vowel shortening” can be clearly seen in the final *-u* of *kátabu* ‘they wrote’ and the final *a* of the clitic *-ha* of *katabú:ha* ‘they wrote it (FEM)’ displayed (in italics) in (5.1).

(5.1) a. b. c. d.

kátabu → *katabú:ha* → *katabuhá:li* → *makatabuháli:š*

This combination of length and stress, i.e. “lengthening under stress” and “return to brevity once stress has moved away further to the right” can have one of two interpretations:

1. Vowels lengthen under stress, or
2. For some reason, suffixation triggers lengthening of the preceding vowel, in which case vowel length owes nothing to stress. Instead, long vowels attract stress.

Two questions arise:

- 1) Which of the previous two interpretations can better account for the data adduced up to this point? Is vowel length stress-dependant? Or are stress rules length-sensitive?
- 2) In English, a language which manifests stress shift, stress displacement is reportedly triggered by certain types of affixes (Level I and not Level II). Does CEA make similar distinctions between affix types?

Contrary to possible anticipation, in my treatment of this combination of length and stress, I will show that:

1. Vowel length is not stress dependant.
2. Stress rules are not length-sensitive.
3. Vowel length and stress, indeed, must be dealt with independently from one another.
4. It is not the type of the affix that determines whether stress shifts in CEA or not.
5. What are crucial about the affix is its phonological makeup and the size of its relevant template.

5.2.2 Stress placement in Egyptian Arabic, generalizations and challenges

In a number of languages, a syllable bears stress not by virtue of its own makeup but simply due to its position in the word. In Polish for example, stress is regularly associated with the penultimate syllable of the word. As different suffixes are combined to a base, stress appears to shift accordingly; see (5.2).⁵⁶

- (5.2)
- | | | |
|----|--------------------|--------------------------------|
| a. | rozpra <u>wa</u> | <i>'discussion (NOM.SING)'</i> |
| b. | ro <u>z</u> praw | <i>'discussion (GEN.PL)'</i> |
| c. | rozpra <u>wami</u> | <i>'discussion (INSTR.PL)'</i> |

This is apparently not the case in CEA as stress can dock on one of the last three syllables of the word: the ultimate, the penultimate and the antepenultimate; see Table 5.2 above. The multiplicity of positions eligible for bearing stress shows a simple fact:

- (5.3) The position of a syllable in the word cannot be the only determinant factor in the process of stress placement in CEA.

If the makeup of the words previously presented in Tables 5.1 and 5.2 is re-inspected, some regularity is detectable. Besides position, the structure of a given syllable is also relevant as to whether it is assigned stress or not. Consider the underlined sequences in Table 5.4.

⁵⁶ The examples are adapted from Garde (1968).

Table 5.4 Stress and the structure of stressed syllable

| | a. 3 _{PL} | b. 3 _{SING.FEM} | c. 2 _{SING.MASC} |
|------|--|--|--|
| i. | kátabu <u>CÝ</u> CV CV | kátabet <u>CÝ</u> CV CVC | katábt CV <u>CÝCC</u> |
| ii. | katabú:ha CV CV <u>CÝV</u> CV | katabétha CV CV <u>CÝC</u> CV | katábtáha CV CVC <u>CÝ</u> CV |
| iii. | katabuhá:li CV CV CV <u>CÝV</u> CV | katabethá:li CV CV CVC <u>CÝV</u> CV | katábtahá:li CV CVC CV <u>CÝV</u> CV |
| iv. | makatabuháli:š CV CV CV CV CV <u>CÝVC</u> | makatabetháli:š CV CV CV CVC CV <u>CÝVC</u> | makábtaháli:š CV CV CVC CV CV <u>CÝVC</u> |
| v. | katabú:k CV CV <u>CÝVC</u> | katabétak CV CV <u>CÝ</u> CVC | katábtak CV <u>CÝC</u> CVC |
| vi. | katabú: CV CV <u>CÝV</u> | katabétu CV CV <u>CÝ</u> CV | katábtu CV <u>CÝC</u> CV |

Specifically:

1. A final syllable is stressed if and only if it exhibits one of the following shapes: a) CVV, b) CVVC, or c) CVCC. Notably, the last two do not occur elsewhere in the word.
2. The penult can be stressed regardless of its syllable shape, hence CV, CVC and CVV can all be assigned stress.
3. The antepenult is not able to bear stress unless it is of a CV type. An antepenultimate syllable of type CVC rejects stress; see Table 5.4 (c.ii) *katábtáha* ‘you (SING.MASC) wrote it (FEM)’ and not *katábtaha.

Thus, although the position of the syllable as well as its structure can largely contribute to the definition of the stress location, a finer description of the stress pattern cannot be achieved until the composition of the entire utterance has been taken into account:

- (5.4) The stress placement device of CEA is sensitive not only to the position and the makeup of the stressed syllable, but also to the structure of the neighboring syllables.

The CEA stress pattern was described accordingly in a number of different systems. Harrell (1957) defines the following three principal stress rules:⁵⁷

- (5.5) a. The last syllable is stressed when it is of principle structure CVV(C) or CVCC. Thus, *katábt* ‘you (SING.MASC) wrote’; see Table 5.4 (c.i), *katabú:k* ‘they wrote you (SING.MASC)’; see Table 5.4 (a.v), *katabú:* ‘they wrote it (MASC)’; see Table 5.4 (a.vi).
 b. The antepenult is stressed if the last three syllables are of the structure CVCVCV(C), unless the preantepenult is CV. Thus, *kátabu* ‘they wrote,’ *kátabet* ‘she wrote’; see Table 5.4 (a.i and b.i. resp.) and *katabétu* ‘she wrote it (MASC)’ with preantepenult CV; see Table 5.4 (b.vi), but not **katábetu*.
 c. The penult is stressed in all circumstances not included in the previous two conditions.

Broselow (1976) endorses Harrell’s generalizations as shown in (5.6):⁵⁸

- (5.6) a. *Condition A*: A final strong syllable, which contains either a long vowel or a vowel followed by two consonants, is always stressed.
 b. *Condition B*: When the last two syllables are weak and no sequence of two consonants follows the antepenultimate vowel, stress falls on the antepenult.

⁵⁷ To avoid confusion, some of the examples originally given in Harrell are replaced by familiar equivalents previously seen by the reader in Table 5.1 through Table 5.4.

⁵⁸ Additional descriptive accounts for Egyptian Arabic include Mitchell (1952, 1956, 1960, 1975), Harrell (1957), Tomiche (1964), Behnstedt and Woidich (1985) and Woidich (2006).

c. *Condition C*: In all other cases, the penultimate syllable is stressed.

Although these descriptive syllable structure-based systems can cover a good deal of the CEA data, they are subject to a number of exceptions. Harrell (1957) for example points out the following:

- (5.7) a. When a particle of structure CV is prefixed to CVCVCV(C) in close transition, the stress remains on the antepenult. Thus: di+báladī ‘this is my country’ remains *dibáladī* and not **dibaládi* contrary to the prediction made by Rule (5.5b).
- b. When a particle of structure CV is prefixed to CVCV(C), the stress is on the penult, not the antepenult. Thus be+ʔálam ‘with a pen,’ remains *beʔálam* and not **béʔalam*, again contrary to what is dictated by Rule (5.5b).
- c. In the perfective of the (3_{SING.FEM}) of hollow verbs that has the structure /CV(V)Cit/ *šá:fet* ‘she saw,’ the penult receives the stress in forms with a suffix of structure V(C). Thus *šá:fet+ek* ‘she saw you (SING.FEM),’ becomes *šafétek* and *šafétu* ‘she saw him,’ not **šáfetek* and **šáfetu* as expected with the application of Rule (5.5b).
- d. A handful of lexical items, all plural nouns of the type CeCéCa violate Rule (5.5b), e.g. *sebéta* ‘baskets’ instead of **sébeta*.

Besides this set of unexplained exceptions, previously mentioned systems fail to handle common cases like CVC CV CÝ CV, e.g. *kattébétu* ‘she made him write.’ This string is quite frequent in CEA. Harrell’s Rule (5.5b) predicts a stressed antepenult in this case, hence *CVC CÝ CV CV, i.e. **kattébetu*.

While these exceptional cases require explanation, another advance in the investigation of stress was introduced, the syllable-weight oriented systems. According to most phonological theories concerned with accentuation, stress rules are often shown to be dependent on the distinction between light and heavy syllables. McCarthy (1979b), emphasizing this relation affirms: “Of all the diverse properties of segmental strings, syllable structure is the one that stress rules most often refer to. In fact, they refer to a quite specific

aspect of syllable structure: syllable weight. Generally, it is this distinction between heavy and light syllables that affects the placement of stress.”

Typologically, CEA generally recognizes three syllable weights: light, heavy and superheavy. Syllables in CEA, like in other “rhyme-weight languages,” are considered heavy if they contain a long vowel or a rhyml consonant.⁵⁹ Hence, both (CVV) and (CVC) are of equal weight in CEA, both are heavy syllables. A superheavy syllable is characterized either by a closed syllable which contains a long vowel or a syllable closed by two consonants, (CVVC) and (CVCC).

One system within which the stress algorithm for CEA is determined by referring to the weight of the syllables is found in Langendoen (1968). Langendoen proposes the following three generalizations:

- (5.8) a. Stress a superheavy ultima.
 b. Otherwise stress a heavy penult.
 c. Otherwise stress the penult or antepenult, whichever is separated by an even number of syllables from the rightmost non-final heavy syllable or, if there is no non-final heavy syllable, from the left boundary of the word.

The generalization in (5.8c) can be exemplified by *kátabu* ‘they wrote’; the latter contains no heavy syllables so the counting of parity starts at the left boundary of the word. The antepenult then receives the stress because zero syllables – an even number – separate it from the left boundary. In Langendoen’s proposals, the choice between the penult and the antepenult can only be achieved by checking the whole string for the number of its syllables and their weight. This confirms once more the following deduction:

- (5.9) Stress placement is dependent on the syllabic profile of the entire word.

⁵⁹ Cf. Hayes (1995) for discussion.

Despite being more encompassing than its predecessors (Harrell's (1957) and Mitchell's (1952, 1956, 1960) for instance) Langendoen's rules remain unable to cover the same set of exceptions, e.g. *šafétek* 'she saw you (SING.FEM)' and *šafétu* 'she saw him.' In these cases:

1. The penultimate syllable is not "heavy" enough to attract stress as generalization (5.8b) states.
2. There is no non-final heavy syllable, so the counting of parity starts from the left, the antepenult is then expected to bear stress being separated from the left boundary of the word by an even number as condition (5.8c) specifies, hence **šáfetek* and **šáfetu* would be expected.

Furthermore, this weight-based system fails to handle cases like *katabtí:* 'you (SING.FEM) wrote it (MASC).' In the absence of a superheavy ultima, condition (5.8b) predicts **katábtí:* much as *katábtak* 'I wrote you (SING.MASC).' Yet, it is the final heavy syllable that is stressed and not the heavy penult. Langendoen's proposals cannot predict in any way the stress docking on a final heavy syllable. In this system, a superheavy syllable is the only type of syllable capable of bearing stress at the final position of the word.

Thus, although CEA makes a clear weight distinction between light vs. heavy syllables, there are further complications. If stress rules have to check the weight of the syllables of the entire string, then this characteristic rejection of stress by heavy antepenults (which can be seen in *katabtáha* 'you (SING.MASC) wrote it (FEM)') will be puzzling. Since stress can go as far back as the antepenult as in *kátabu* 'they wrote' and *kátabet* 'she wrote' and since heavy syllables are stressed in penult position, this rejection of stress on the part of heavy antepenults is truly odd. Indeed, it goes against the universal tendencies of stress assignment where the general trend is that a short vowel in an open syllable rebuffs stress which may be passed on to another neighboring eligible heavy syllable. This appears not to be the case in *katabtáha* (and not **katábtaha*), the light penultimate syllable maintains stress. This atypical behavior has been referred to in McCarthy (1979a) as *ternary distinction*. This ternary distinction is seen once more in the case of *kátabet* 'she wrote.' Word-finally, stress is assigned to a superheavy syllable (CVVC, CVCC), thus *makatabú:š* 'they didn't write' and *katábt* 'I wrote.'

Word-internally, the stress rule contrasts light syllables (CV) with heavy syllables (CVC, CVV), hence *katabétna* ‘she wrote us’ and *katabú:li* ‘they wrote to me.’ While heavy syllables of the (CVV) type are always stressed in final position as in *katabú:* ‘they wrote it (MASC),’ a word-final (CVC) fails, by contrast, to attract stress as in *kátabet* ‘she wrote.’

The constantly reported exceptional cases, the odd rejection of stress by a heavy antepenult in favor of a light penult, the reduction of unstressed long vowels and the lengthening of stressed ones, the avoidance of stress by a heavy final closed syllable, the direction of counting of stress rules, etc., all these challenges have exercised researchers endeavoring to deal with the question of stress in CEA over the years. This can obviously be seen in the various proposals made in Broselow (1976), McCarthy (1979a, 1979b), Angoujard (1981), Hayes (1981), Halle and Vergnaud (1987), and Watson (2002), amongst others.

The central objective of this study is, thus, to present some novel relevant facts about CEA stress and to put forth predictions with respect to data lying beyond the original set tapped by Mitchell and Harrell. I attempt to refresh the discussion on CEA stress by introducing new terms of analysis that are totally weight-independent. I will turn to different tools than what have usually been implemented, the CVCV model. Within the latter model, no weight distinctions (light, heavy or super-heavy) are posited; all the syllables are fundamentally light. This is a crucial turning point as relative prominence distinctions will have to be redefined according to a non syllable-weight based model. In the absence of arboreal constituents, a redefinition of the stress-bearing unit will be required.

In the next section, the major principles that govern the CEA vowel system will be rapidly recalled; this will lay the ground for the presentation of my view of stress in CEA.

5.3 Towards a new view of stress assignment

5.3.1 Phonological Length / Phonetic Duration

One of the most important results of chapters 1 and 2 concerning the vowel system of CEA can be seen again in (5.10).

(5.10) Elements must branch.

{i, u, a} vowels can maintain their quality only when *phonologically long*. A vowel is deemed phonologically long, i.e. “full,” only if it successfully spreads over two V templatic positions. The reader is reminded that I construe length in strictly phonological – not phonetic – terms.

Subsequently, I was led to propose the following:

- (5.11) a. Element A can straddle an identified templatic C slot.
 b. It is only in the company of Element A can Elements I and U do the same.

Hence, (5.12b) below is the equivalent of (5.12a). Both are identified by the system as one phonological “long” vowel where *x* in (5.12b) is a consonant.

(5.12)

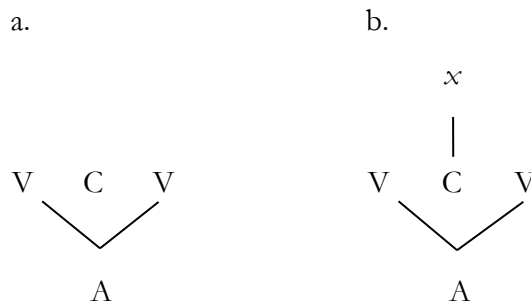

A simple comparison between the phonetic forms in (5.13) and the phonological representations in (5.14) results in a paradox. Despite being all phonologically “long,” only one of the three *u* vowels (the one in 5.14b) is perceived as being *phonetically* longer than the other two (in 5.14a and c).

No adequate explanation can be provided for this problem until one important detail about the phonetic forms given in (5.13) is taken into account: unlike the two “short” *u* vowels in (a) and (c), the phonetically “long” *u* vowel in (b) is stressed. This phonetic length can, thus, be interpreted as an auditory attribute of stress. Yet, it is also obvious that stress must target something other than “length” since the three *u* vowels are all equally “long” as seen in (5.14). Before proceeding with the discussion, a related issue must be immediately mentioned, stressed epenthetic vowels, an odd feature of CEA.

5.3.2 Stressed epenthetic vowels

Consider the data in Table 5.5 with vowel *e* occasionally appearing before the clitic *-na*. The vowel under scrutiny is underscored.

Table 5.5 Stressed epenthetic vowels

| | | | |
|------|-----------------------|---------------------|-------------------------------|
| a. | | | |
| i. | [katabt <u>e</u> na] | /katab-t + na/ | 'you (SING.MASC) wrote us' |
| ii. | [katab <u>e</u> tna] | /katab-et + na/ | 'she wrote us' |
| b. | | | |
| iii. | [katabt <u>e</u> lna] | /katab-t + l + na/ | 'you (SING.MASC) wrote to us' |
| iv. | [kabet <u>e</u> lna] | /katab-et + l + na/ | 'she wrote to us' |

The underscored *e* vowels in (a) and (b) above share an interesting characteristic, they both display typical epenthetic behavior:

1. They are inserted in contexts where they are not part of the corresponding underlying representation.
2. They disappear the moment they are no longer required.

However, the very same vowels display an uncommon feature for epenthetic material: they can bear stress.

5.3.3 The proposal

The two issues just reviewed, the fact that: a) vowels with equal phonological length do not always exhibit equal phonetic duration, and b) epenthetic vowels are assigned stress, suggest that:

1. Vowel length owes nothing to stress.
2. The stress assigning mechanism is blind to the origin of the stressed vowel, whether lexical or epenthetic.

With these two points in mind, I propose the following stress assigning principles:

- (5.15)
- a. Stress in CEA is a purely nuclear process. The stress-bearing unit is the vowel.
 - b. The mechanism of its identification involves the projection of all [+ syll] segments.⁶⁰
 - c. Stress assignment rules refer neither to the makeup of the stressed syllable nor to that of its neighbors.
 - d. Stress assignment consists in assigning high pitch (henceforth noted H) to a penultimate vowel.⁶¹

⁶⁰ In Egyptian Arabic, only vocalic segments are identified as [+ syll].

⁶¹ The identification of this penultimate vowel will be further refined shortly.

Under these assumptions, the previous two problems can be handled and all the cases seen earlier can be accounted for as in (5.16) below (the three problematic *u* vowels as well as the problematic epenthetic vowel *e* are underscored).

(5.16)

a.

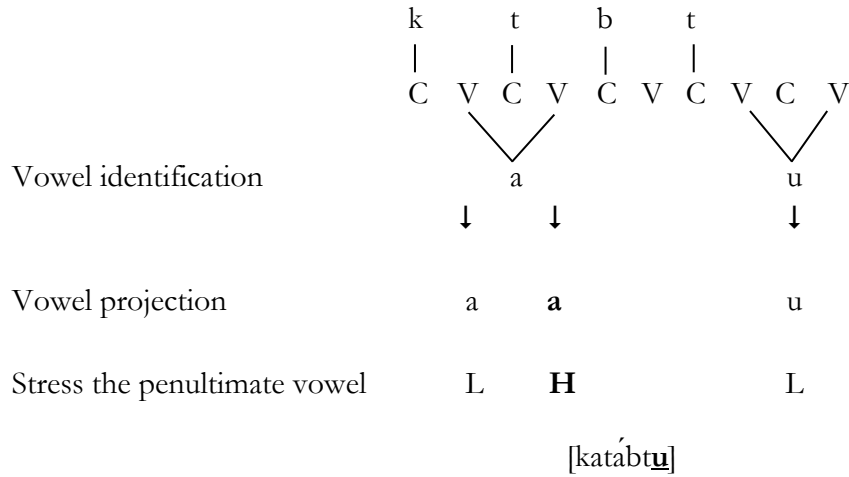

b.

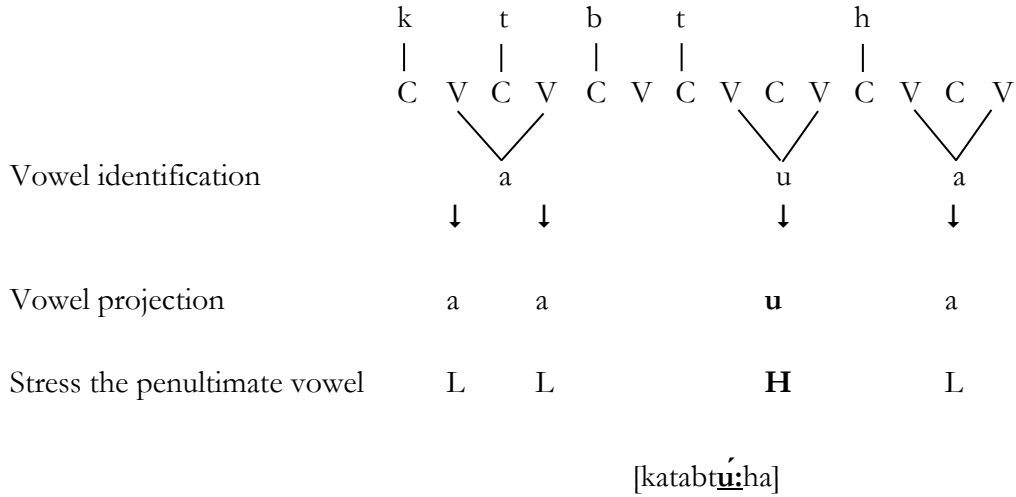

c.

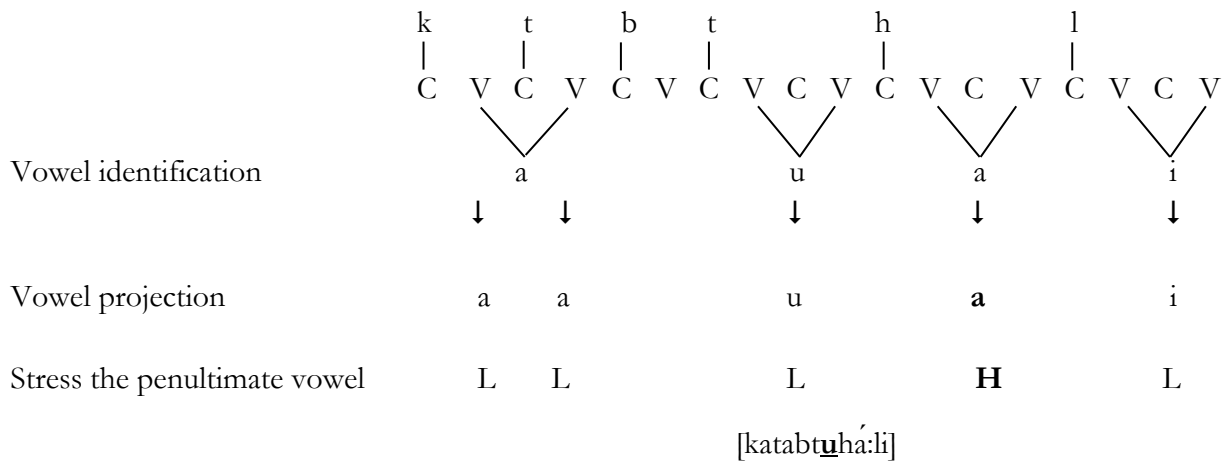

d.

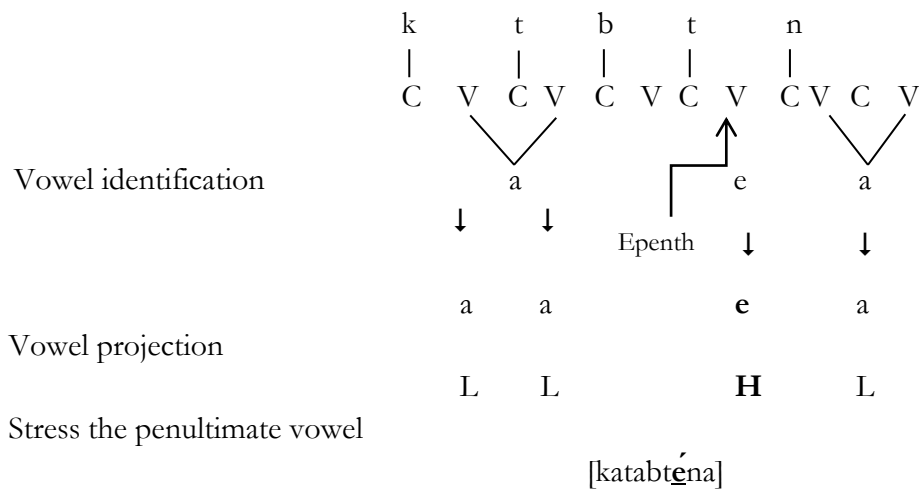

This can be summed up as in (5.17) below where:

1. Steps (i) and (ii) show both the underlying representations and the phonetic forms respectively.
2. Step (iii) roughly shows the projection of [+ syll] segments.
3. The final step (iv) represents the targeting of the penultimate vowel in this vowel string regardless of its nature, be it epenthetic or lexical. The notation *L* is used for low-pitch, *H* for the imposed high-pitch.

(5.17)

| | | | | |
|------|---------------|-------------------|------------------------|-------------------|
| | a. | b. | c. | d. |
| i. | / katab-tuu / | / katab-tuu-haa / | / katab-tuu-haa-l-ií / | / katab-t- -naa / |
| ii. | [katabtu] | [katabtu:ha] | [katabtuhá:li] | [katabténá] |
| iii. | (a a) u | (a a) u a | (a a) u a i | (a a) e a |
| iv.. | L H L | L L H L | L L L H L | L L H L |

In the extracted string in step (iii) in (5.17), it is essential to note that the vowels between brackets constitute two members of the same “branching” vowel; the system recognizes them as a single unit. The analyses given in (5.16a and 5.17a) consequently raise a question. Although the system has identified the bracketed “branching *a*” as the penultimate vowel of the string, stress has only been assigned to the second member of this pair. On what basis have the stress calculations recognized the rightmost member as the stress-bearing unit?

Before moving on to an illustration of how the proposed principles deal with this question and additional more opaque cases, the point of the phonetic correlates of CEA stress has to be addressed. Some clarification as to why “pitch” has been introduced is also required.

5.3.4 The phonetic correlates of stress in Egyptian Arabic

Stress is frequently characterized by three phonetic features that increase the prominence of a syllable; a pitch change, a greater duration and a greater intensity. Fry (1955, 1958) notes: “In fact, despite its intuitive status as the most natural correlate of stress, intensity has the least influence on stress perception. Indeed, duration changes have a greater effect; longer syllables are more likely to be perceived as stressed. The strongest effects on stress perception were however achieved by altering the pitch contours.” Thus, pitch, then duration rather than intensity seem to be the principal cues for stress. Many subsequent studies (Bolinger (1958), Morton and Jassem (1965) amongst others) provide further support for Fry’s findings.

It also happens that stress is phonetically realized on language-specific bases. Berinstein (1979), for instance, presents arguments that point out the following: “languages with phonemic vowel length contrasts have been shown to avoid using duration as a correlate for stress.”

CEA presents two arguments that would suggest pitch to be the main phonetic correlate of stress. First, it was shown that both stressed and non-stressed {i, u, a} vowels do have similar phonological length; see (5.13) and (5.14) above. Second, the treatment of “vocalic length” generally motivates the establishment of underlying length distinction in function of templatic space. If Berinstein (1979) is correct, duration should not be the preferred correlate of stress in CEA.

The comparison of the two stressed vowels demonstrated in (5.18a and b) consequently shows an important difference. The stressed *u* in (a) is perceived as much “longer” than the stressed *e* in (b). If stress is only about changes in pitch level and not in duration, what is the source of that difference?

(5.18)

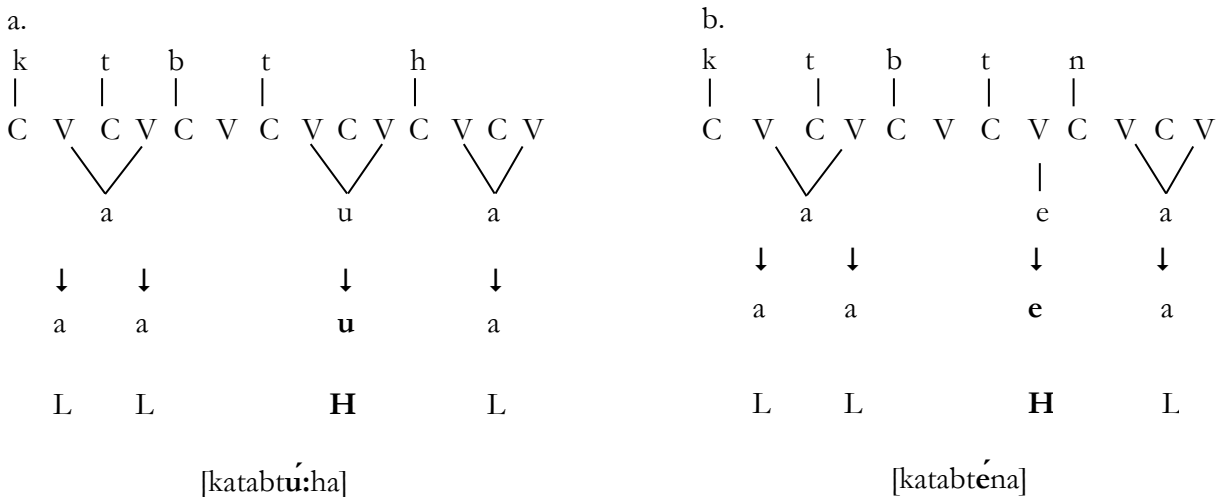

The crucial difference between the stressed *u* in (a) and the stressed *e* in (b) entirely and exclusively stems from the difference in the *size of the respective templatic chunks occupied by the objects under discussion*. This is indicated by the superior vertical arrows in (5.19).

underlying representation (hence /katabtu/ in the example above) and there is a process of lengthening before a C-initial suffix. Proponents of this view for CEA include Watson (2002) and Broselow (1976) who describe the process as “pre-suffix vowel lengthening.” Some other investigators embrace the view that these stem-final vowels are underlying long (hence /katabtu:/) with vowel shortening in absolute final word position. This approach was endorsed in Abu-Salim (1982) for the Lebanese and Palestinian dialects.

As noted earlier, this “pre-suffix long vowel” is characterized by bearing the main stress of the word. When suffixes are further concatenated and hence stress moves forwards, the vowel immediately “shortens.” This was also described in Watson (2002) amongst others as “unstressed long vowel shortening.” Consider the stem-final *u* when stress shifts rightward:

| | | | | | |
|--------|-------------------------|---|----------------------------------|---|--|
| (5.21) | a. katabtu | | b. katabtu + ha | | c. katabtu + ha + l + i |
| | katab <u>tu</u> | → | katab <u>tu</u> :ha | → | katab <u>tu</u> há:li |
| | <i>‘you (PL) wrote’</i> | | <i>‘you (PL) wrote it (FEM)’</i> | | <i>‘you (PL) wrote it (FEM) to me’</i> |

Two alternative hypotheses can account for this state of affairs:

1. “Long” vowels attract stress, or
2. Vowels “lengthen” as stress shifts forwards.

Definitely, the second hypothesis can better justify the existence of the “short” version of vowels once they become unstressed. As duration has been recognized as the second most frequent phonetic characterization of stress besides pitch changes, the situation of these “stressed long” vowels vs. “non-stressed short” ones in CEA becomes strongly evocative of Fant’s generalization (1958). Fant notes: “The tendency towards lengthening is the most obvious feature observed as a physiological correlate to stress.”

The conventional view is that only in languages with no vowel length contrast are short vowels free to lengthen. The speaker is not perceptually motivated to draw stress away from short vowels to avoid convergence with the corresponding long ones and maintain a

phonemic contrast. Thus, if CEA allows tonic lengthening, this would go against the fact that the language does distinguish length on a phonological level.

Moreover, if stress caused vowels to lengthen in open syllables,⁶² what makes *katabt́ena* ‘you (SING.MASC) wrote us’ and *kátab* ‘he wrote,’ among countless other examples where “stressed short” vowels in open syllable can be identified, viable as such? Indeed, if vowels really lengthened under stress, **katabt́:na* and **ká:tab* would rather be expected.

Now I will show how the alternative system I am proposing can solve this puzzle. I assume that only the penultimate of the extracted string of vowel is targeted by the stress assigning mechanism. Bearing this in mind, let us re-examine the three *u* vowels in (5.22).

(5.22)

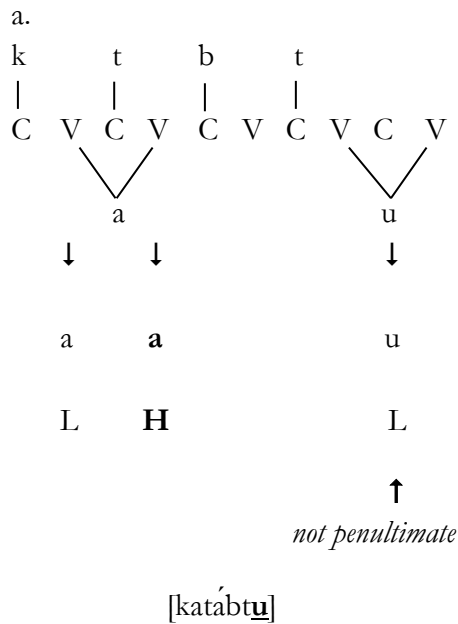

(that is two V slots), thus perceived “longer” than usual. As suffixation proceeds and the newly formed *katabtú:ha* in (b) is joined by the portion *-li* this yields *katabtuhá:li* in (c), the *u* in *-tu* is no more “penultimate” hence no longer recognized as the stress-bearing unit, it does not consequently manifest any particular auditory prominence.

Therefore, regarding the “pre-suffix vowel lengthening” and “unstressed long vowel shortening” phenomena, I claim the following:

- (5.23)
- a. These phenomena are neither about “lengthening” nor “shortening” of vowels.
 - b. Stress does not manipulate the “length” of vowels in any way.
 - c. Vowels are either “long” or “short” from the very beginning.
 - d. Length is a function of the available templatic space, long vowel = two V positions, short vowel = 1 V slot.

My speculation that stress is a persistent penultimate event does not only explain these pervasive events but also makes a very important prediction which confirms the results established in an earlier discussion:⁶³

- (5.24) So called “long” vowels in CEA are exclusively penultimate. It is only in the penultimate position that *phonological* length can coincide with *high pitch*.

Now that the core concepts of the proposal are settled and their preliminary benefits motivated, I will move to recalcitrant cases. In the next section, various exceptions that might challenge this alternative construal of stress in CEA will be discussed. This will lead to further refinements of this non weight-based approach.

⁶³ The claim that “long vowels are exclusively penultimate” was first introduced in chapter 1, section 1.4.

5.4 Accentuation on a skeletal level

The drastic simplification I am advocating – stress is penultimate – is apparently challenged by cases such as *kátabet* ‘she wrote’ and *kátabu* ‘they wrote’ which exhibit apparent *antepenultimate* stress, also by cases such as *katábt* ‘I wrote,’ *makatabná:š* ‘we didn’t write’ and *katabná:* ‘we wrote it (MASC)’ with apparent *final* stress.

The main concern of the forthcoming discussion is to precisely determine on which level accentuation applies. I assume that the basic mechanism of accentuation occurs on the skeletal CV plane whilst making allowance for the morphological composition of utterances. I begin this investigation with the examination of antepenultimate stress, e.g. *kátabu* ‘they wrote,’ followed by stressed final “short” vowels, e.g. *katábt* ‘I wrote.’ Then I will move on to address more perplexing cases which exhibit both “final stress” and “final long” vowels such as *makatabná:š* ‘we didn’t write’ and *katabná:* ‘we wrote it (MASC).’

5.4.1 Stressed antepenultimate vowels

Consider the pair of CEA verbs given in (5.25); both are compatible with the system I propose. Stress identifies the penultimate of the extracted string of vowels and marks it more prominent, hence *H*.

| | | | | |
|--------|---------|------------------|--------|----------------------|
| (5.25) | a. | | b. | |
| | katabtu | ‘you (PL) wrote’ | selmtu | ‘you (PL) were safe’ |

| | | | | |
|--------|------------------|--|--------------|--|
| (5.26) | a. | | b. | |
| | i. / katab-tuu / | | / selem-tuu/ | |
| | ii. [katabtu] | | [selmtu] | |
| | iii. a a u | | e e u | |
| | iv. L H L | | L H L | |

In section 3.4.2 of chapter 3, the respective characteristics of A-vocalized vs. non A-vocalized perfectives were discussed. The vocalization of the *NAV* verb in (5.25b and 5.26b) has been shown to be totally unstable in sharp contradistinction with the *AV* counterpart in (5.25a and 5.26a). The vocalization of a *NAV* verbal stem has shown to be largely dependent on the phonological makeup of the affixed clitics. Hence, -selm- before a V-initial suffix, e.g. *selmu* ‘they were safe,’ -selem- before a C-initial suffix, e.g. *selemtu* ‘you (PL) were safe’ and -slem- after a V-final prefix, e.g. *maslemteš* ‘I wasn’t safe.’ This dependency was interpreted in terms of government. An *AV* stem such as -katab- is, on the contrary, always stable.

In view of that, let us now consider (5.27).

(5.27)

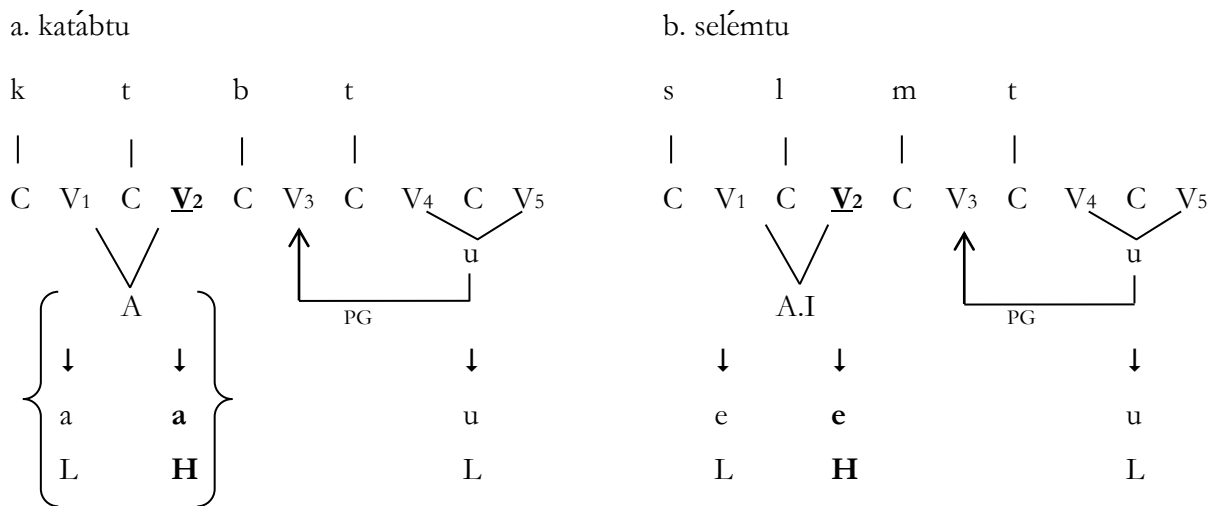

Close examination of these two representations yields a number of simple yet valuable observations:

1. The proper government of V₃ in both templates by the suffix *u* licenses this position to remain empty. The identification of the nucleus to the left of V₃ becomes, consequently, a must, i.e. V₂ in the template above requires vocalic content.
2. The identification of V₂ in the *AV* group in (a) is achieved by the branching of the underlying A material.

3. The identification of the V_2 in the NAV class is taken care of by the branching (A.I) material.
4. As the word-initial two consonants cluster $*\#CC\dots$ is banned in CEA, the identification of V_1 in both templates also becomes inevitable despite being properly governed.

The following can be therefore deduced:

- (5.28) The projected series of vowels correspond in one-to-one fashion to the “must-identify” templatic nuclear positions.

At this point, the stress pattern displayed in (5.27) turns our attention back to an unsettled issue. Let us focus again on the structure in (a). It is only the second member of the “pair” constituting the penultimate vowel A (the branching vowel straddling the radical t and marked in between curled brackets) that has been identified by stress calculations as a stress-bearing unit, hence assigned more prominence. Two questions arise accordingly:

- 1) For what reason has the second member been targeted by the stressing mechanism if the system identifies the branching vowel as a whole “single” unit; as illustrated below in (5.29a)?
- 2) Under what condition would the first member of the pair be eligible to bear stress; as shown in (5.29b)?

(5.29)⁶⁴

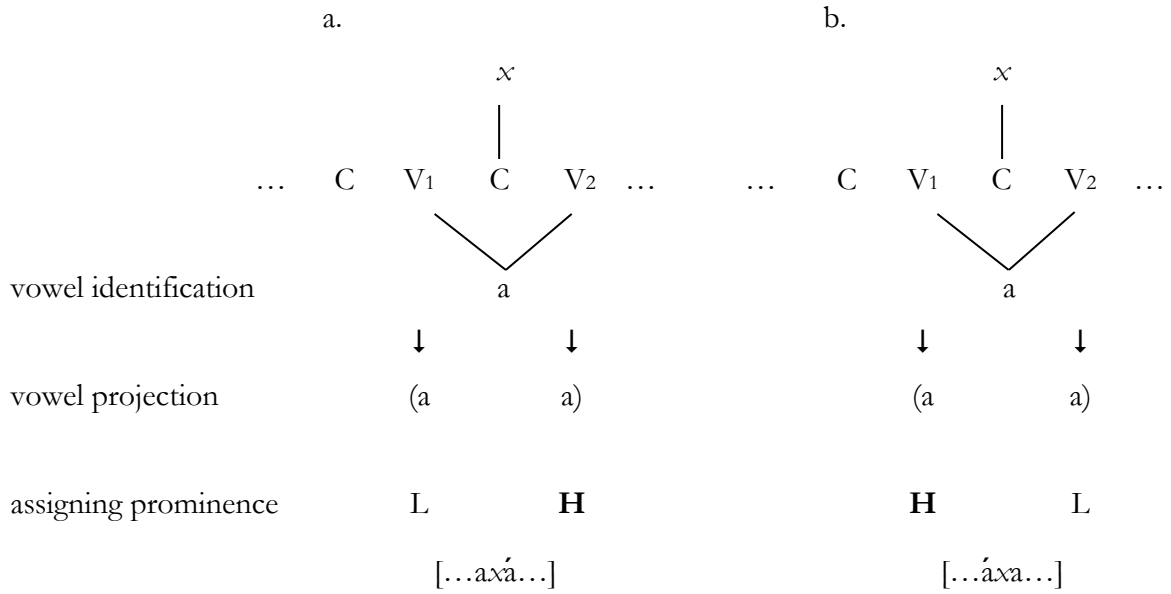

A second consideration of the representation previously given in (5.27) and reproduced below shows the following key point: the second member of the pair that has been assigned stress occupies the *first ungoverned nucleus* in the template.

(5.30)

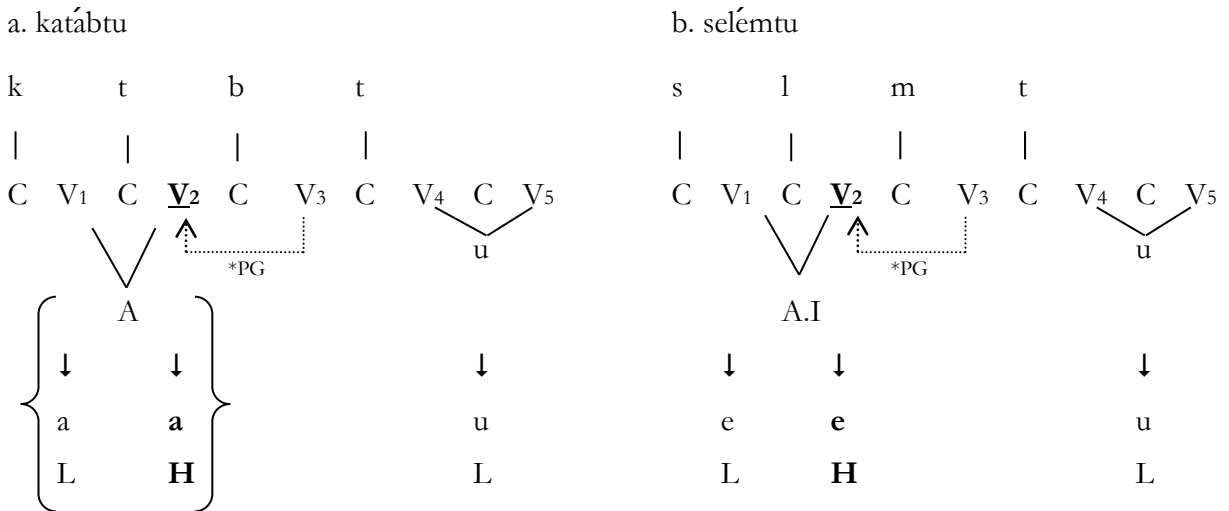

⁶⁴ A quick reminder: (a) is a penultimate vowel; (x) is an intervening consonant and (...) is a segmental sequence.

- (5.34) a. A vowel primarily associates to an *ungoverned* nuclear position (this is indicated in the case of *a* in (5.33) by the non-interrupted association line).
 b. A vowel propagates towards a *governed* nuclear position (this is indicated in the case of *a* in (5.33) by the interrupted association line).

Stress calculations are particularly interested in the site of “primary association” of the branching vowel. This is the crucial idea behind my proposal. Furthermore, this idea presents a good argument in favor of a more restrictive mechanism of identification of stress-bearing units; this is seen under (5.35).

(5.35)

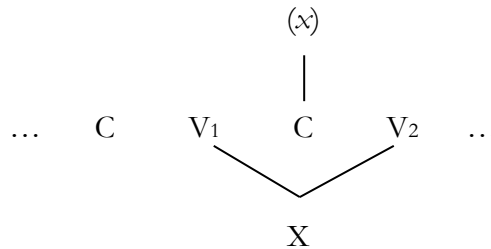

- a. X is the penultimate of a series of projected [+ syll] segments.
 b. In case the position straddled by X is identified by consonantal material, V₂ is stressed if and only if it is not governed.
 c. Otherwise, stress falls on V₁.

This very same mechanism can account for all the branching penultimate vowels either: a) straddling a consonant like the *e* in *sélemu* ‘they were safe’ (a possible free variant of *sélmú* in slow speech) or b) not straddling any consonants like the *u* in *selmú:li* ‘may they remain safe for me.’ In general, a branching vowel associates first to an ungoverned position then propagates to a governed one. Stress targets afterwards the stress-bearing unit specified in (5.35). Consider the following analysis (and recall that primary association is marked by non-interrupted association line while the copy is marked by the interrupted association line):

katabú:ha ‘they wrote it (FEM).’ Indeed, whether or not the penultimate stressed vowel evidences phonetic length will depend in the first place on the size of its relevant template.⁶⁵

On the other hand, the prediction in (5.37) does not in any way imply the opposite; cases with penultimate stress do not necessarily entail a configuration in which the stressed vowel and the vowel preceding it are the same. This is clearly seen in *katabétak* ‘she wrote you (SING.MASC),’ or in *šagarétna* ‘our tree,’ *šafétu* ‘she saw him,’ *šafétek* ‘she saw you (SING.FEM),’ etc. where stressing the penultimate vowel does not imply that the antepenultimate one should be identical.

Now that the main features of antepenultimate stress have been revealed, another type of stress will be revisited in the next section. This is final stress assigned to: a) what is conventionally conceived as superheavy syllables (C \acute{V} CC and C \acute{V} VC) such as *katábt* ‘I wrote’ and *makatabná:š* ‘we didn’t write,’ and b) final syllables with long vowels (CVV#) such as *katabná:* ‘we wrote it (MASC).’ These two cases will be explored successively. The treatment of final stress emphasizes the role played by the morphology in the accentuation process.

5.4.2 Stressed final short vowels

Our previous examination of “the status of final nuclei” in CEA led to the identification of three types of final governors; to facilitate reading, they are reiterated in (5.38) below.⁶⁶ In (a) the final nucleus enjoys both phonological and phonetic content; it embodies typical final governors. In (b) the insufficient templatic space keeps the phonetic substance unexpressed. And yet, the nucleus remains phonologically active. In (c), the nucleus is both phonologically and phonetically vacuous; it cannot govern the preceding position for total lack of content.

⁶⁵ Plural nouns such as *sebéta* ‘baskets’ where stress targets the penultimate vowel and not the antepenultimate one even though both vowels are identical suggests that the stressed penultimate vowel in *sebéta* is the phonetic interpretation of the *first ungoverned nucleus*. Indeed, if this nuclear position was properly governed by the suffix –a, it would have been licensed to remain empty (hence, the expected form would be rather *sebta* much as *sélmu*).

⁶⁶ See the discussion in chapter 1, section 1.5.3.

(5.39)

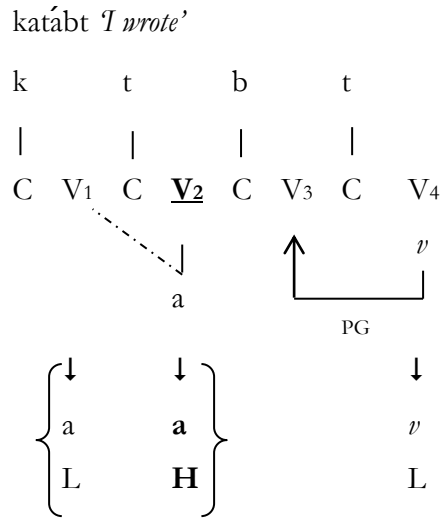

penultimate

All the signs point to the presence of a phonologically existent phonetically non-permitted final vowel in the *-t* morpheme of *katábt*, which is recognized by stress as the *ultimate* of the projected series of vowels. Indeed, this phonetically inaudible final nucleus has the capacity to accommodate explicit vocalic material on further addition of enclitics; consider (5.40).

- | | | |
|--------|--------------------------|-----------------------------------|
| (5.40) | a. | b. |
| | i. [katabt ó hom] | [katabt é na] |
| | ii. /katab-t + hom/ | /katab-t + na/ |
| | <i>'I wrote them'</i> | <i>'you (SING.MASC) wrote us'</i> |

Thus, if every final CVCC# sequence is followed by a vowel of the kind seen in V₄ of (5.39) above (hence reanalyzed as CVCCV#), then what was previously considered as stressed final vowel in superheavy syllable ([CVCC]#) can be now construed as another instance of penultimate stress (i.e. /CVCCV/#).

5.4.3 Stressed final long vowels

Cases which display a stressed final long vowel such as *makatabná:š* ‘we didn’t write’ and *katabná:* ‘we wrote it (MASC)’ are especially upsetting. This is because they challenge the system I am proposing in two respects:

1. While the system predicts penultimate stresses, these forms display “final” stress.
2. While the system predicts exclusive “penultimate long” vowels, these forms display “final long” vowels instead.

Let us start with the final superheavy syllable (CVVC#). The explanation I offer for this case directly follows from the idea proposed for final (CVCC#). The final consonant in the series ...CVVC# in *makatabná:š* can be reanalyzed as follows: ...CVVC**V**#, hence *makatabná:š(v)*. This final nucleus “phonetically” evacuated from its content is what permits the *a* of *-na* to be identified as being the penultimate vowel, hence receives more prominence. An immediate illustration of the situation is provided in (5.41):

(5.41)

makatabná:š ‘we didn’t write’

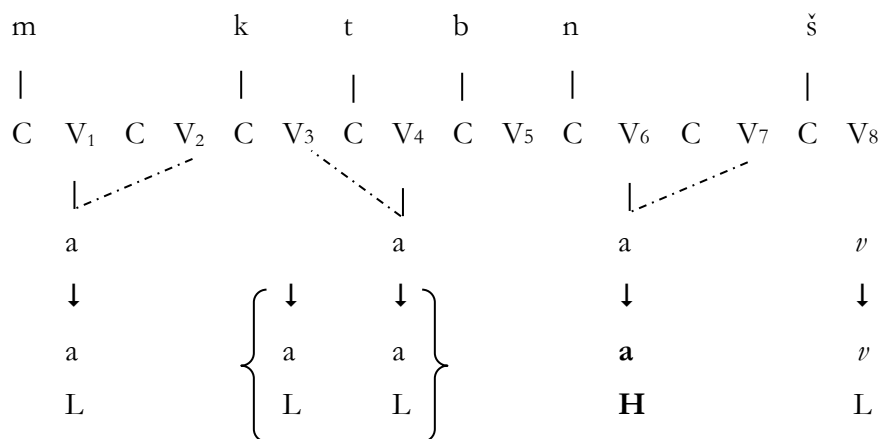

penultimate

In effect, evidence of the final *v* vowel that is recognized by stress calculations as ultimate in (5.41), i.e. V_8 , can be retrieved in the free variant *makatabná:ši*. The latter variant is either stylistically conditioned or contextually conditioned such as in slow emphatic speech.

In view of that, final silent nuclei can be classified into the following two categories:

| (5.42) | a. Type 1 | b. Type 2 |
|---------------------------------|-----------|-----------|
| i. Phonetic content | - | - |
| ii. Phonological content | + | - |
| iii. Governors | Yes | No |
| iv. Final grammatical CVCC# | + | - |
| v. Final grammatical CVVC# | + | - |
| vi. Counts in stress assignment | Yes | No |

To sum up, only under the hypothesis that speculates the presence of an inaudible final nucleus that has phonological content can the system distinguish the stress-bearing unit in [...CVCC]# and [...CVVC]#. Stress systematically docks on the penultimate vowel of /CVCCV/ and /CVVCV/. Further evidence for the view of considering more than mere visible phonetic material is provided in the next section. We will proceed with the discussion of the final case that challenges my proposed system of stress assignment, stressed long vowels in absolute final position of the word (i.e. CVV#).

This shows that *katabná*: is in reality /katabna + hu/ and that the *a* of *-na* is recognized after all by the stress operation as *penultimate* and hence receives more prominence, as illustrated in (5.45). Once again, only by considering the morphological makeup of the word can the vowel in what appears as CVV# be recognized as penultimate stress, hence stressed (i.e. /CVV + CV/).

(5.45)

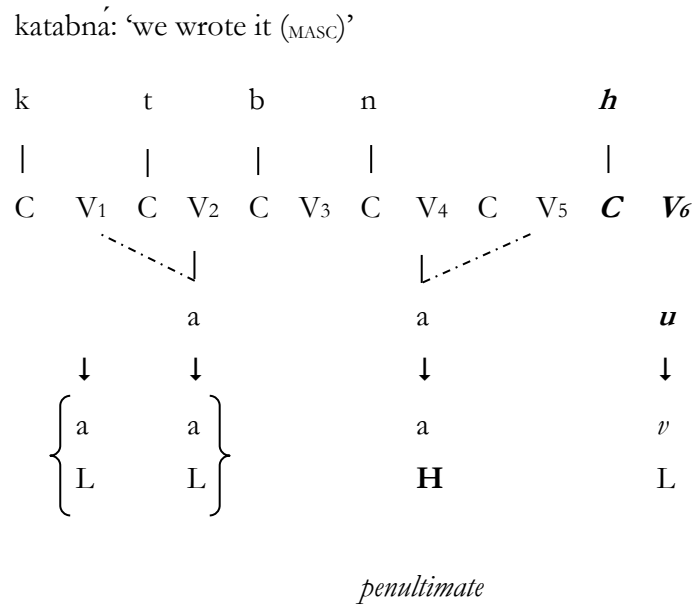

Here, it is of great significance to note that in CEA, stressed long vowels in absolute final position of the word essentially involve the (3_{SING.MASC}) non-subject pronoun.

An interesting argument for the view of inaudible material that has impact on the accentual process is provided in Godon’s (1998) account for tonal accent of Somali. In Somali, the displacement of tonal accent can be the marker that distinguishes the two genders – masculine and feminine – in the singular in the absolutive (i.e. non-subject) case. Masculine absolutive nouns, which usually receive the accent on the penultimate mora alternate with feminine absolutive nouns, which receive the tonal accent on the ultimate mora (Puglielli and Siyaad, 1984).

5.5 Concluding remarks

My reconsideration of stress in Egyptian Arabic aims at unraveling the factors that work together to dictate the placement of stress. I argue that stress is a purely nuclear process that is consistently lodged on the *penultimate* of the series of vowels extracted by the projection of all that is [+syll]. Some cases appear to contravene this principle. But, I showed how such apparent problems can be reduced, eventually leading to an even more restrictive proposal. In the relevant template of a given stem, stress assigning mechanisms target the *first ungoverned nuclear position*.

Equipped with a theoretical toolkit that exclusively recognizes light syllables, I was able to separate syllable weight and stress. A fundamentally different view of stress was put forth. With this correlation undone, a range of explanations for the various intriguing cases previously reported in syllable weight-based models of stress assignment were finally examined. In my view of the stress assigning operation, stress directly applies on the CV tier. Hence, whether a syllable is inserted, a vowel is deleted or even morphological material is elided as with (3_{SING.MASC}), this has no impact on the stress placement.

This more restrictive construal leads to specific predictions with respect to other aspects of the Egyptian Arabic system, namely the source of vowel length. My attempt to offer a totally independent theory of length in Egyptian Arabic leads me to reject stress as the source of vowel length. Vowels neither “lengthen” nor “shorten” as in the alleged two stress-related events, pre-suffix vowel lengthening and unstressed long vowel shortening. I argue that vowels maintain their “length” under all circumstances. Vocalic length is a function of templatic space and phonetic length is a result of adding more prominence to an already phonologically long vowel that happens to be identified as a stress-bearing unit. In other words, it is only in the penultimate position that a phonologically long vowel can also display phonetic length.

Conclusion

The material discussed in this dissertation supports the general idea that Egyptian Arabic is one of the languages in which vocalic quantity can be predicted through the vowel's surface quality. Viewing vowel length as mere phonetic difference between short and long vowels constitutes the main obstacle in decoding the vocalic organization. This is simply the reason for which most of the vocalic patterns in Egyptian Arabic have remained unexplained and often viewed as arbitrary.

Through exhaustive treatment of the data, I have presented the arguments that allow for the redefinition of vowel length in different terms. Vowel length must be defined in terms of the number of nuclear positions to which a vowel is attached. This reinterpretation of vowel length emphasized the principal concept that phonological Elements must branch in Egyptian Arabic, or else they delink. A phonological Element attached to one nuclear position is interpreted according to the phonotactics of the language by means of a silent nucleus or an epenthetic vowel. The principle according to which a phonological Element must spread to two nuclear positions to maintain its quality is known as “loss of brevity thesis.”

Determining this key characteristic allowed us to provide a range of explanations for various intriguing features of the Egyptian Arabic phonology.

Firstly, it has been shown that the phonetic difference between long and short cardinal vowels that was previously conceived as expressing a vowel length contrast, was reinterpreted as the mere consequence of stress. This substantiates the argument that “vowel length” in Egyptian Arabic, phonetically speaking, is conditioned.

Secondly, under the same view that Elements must branch, an important distinction between phonetically “silent” nuclei was put forth. Some silent nuclei have phonological

content that is prevented from materializing for lack of templatic space; some are truly void of any phonological content.

Next, the phonetic interpretation of empty nuclei (resulting either from an Element attached to one nuclear position or true underlying phonological emptiness) was the beginning of a study of the parameters involved in deriving the vowel system of Egyptian Arabic. Through a methodical comparison with the Moroccan Arabic and Ge'ez vowel systems, two systems which comply with the loss of brevity thesis, it has been shown that the Egyptian Arabic vowel system is derived according to the following parameters:

1. The two autosegmental lines labeled *Round* and *Back* are fused, hence a two-line system wherein both lines are consistently involved.
2. Vocalic expressions *i*, *u*, *a* are the results of fusion operations involving Elements I, U, A and the cold vowel *v*, hence (*v*.I), (*v*.U), and (*v*.A) respectively.
3. Vocalic expressions *e*, *o* are the results of fusion operations involving two Elements, (A.I) and (A.U) respectively.
4. Vocalic expressions involving the Elements residing on the autosegmental line labeled *Round* and *Back* must be headed by these Elements.
5. Vocalic expressions must involve at least one Element. The derivation of the high central vowel is not permitted.
6. No combinations headed by the cold vowel *v* are permitted. The derivation of the low central vowel is excluded.

The identification of the parameters underlying the Egyptian Arabic vowel system has therefore contributed to:

1. The determination of the strategy employed by Egyptian Arabic to interpret empty nuclei, i.e. to generate a vocalic expression that does not involve any cold vowel, neither as *Head* nor as *Operator*.
2. The identification of the characteristic tendency of the Egyptian Arabic to frontness, to which I refer as “ambient I” effect.
3. Reanalyzing and formally representing mid-vowels, which consequently contributed to the explanation of the distributional lacuna identified for glide-medial segholates.

It follows that one of the most important implications of the principle “Elements must branch” can be seen in the treatment of phenomena related to the verbal system. Through investigating exhaustive lists of Egyptian Arabic Measure I sane verbs in the perfective aspect, a very important generalization was reached: Egyptian Arabic is equipped with the same vocalic material that characterizes the Classical variety of Arabic but under a different organization.

This being the case, another intriguing issue, the apparently unpredictable aspectual alternations, was examined. It has been shown that though characterized by a great deal of surface opacity, the aspectual melodic alternations in Egyptian Arabic follow a regular apophonic mechanism enforcing the general idea that $\emptyset \rightarrow I \rightarrow A \rightarrow U \rightarrow U$.

Next, the major principle identified for the Egyptian Arabic vowel system, namely “Elements must branch,” along with results from the study of sane verbs, were shown to be the main tools that made it possible to explain the invariable perfective bare *a* melody characterizing medial-weak verbs and deaf verbs. It has been argued that the persistent need for a perfective lexical vowel capable of generating a glide (\emptyset and A) is due to the following fact: part of the radical material of these two atypical classes of verbs is constructed via the process of apophony.

Finally, the recognition of the principle “Elements must branch” allowed for the unraveling of the factors responsible for stress placement. Stress has been excluded as a source of vowel length as has always been assumed. I argued that vocalic length is a function of templatic space and that phonetic length is a result of adding more prominence to an already phonologically long vowel that happens to be stress-bearing. Adopting a non syllable-weight framework of analysis, I have shown that stress assignment rules apply on the CV skeletal level. A novel interpretation of stress assignment in Egyptian Arabic was reached: in the template of any given stem, stress-assigning mechanisms target the first ungoverned nuclear position.

References

- Abu-Salim, I.M. (1982). A Reanalysis of Some Aspects of Arabic Phonology: A Metrical Approach. Doctoral dissertation, University of Illinois.
- Allen, W.S. (1973). *Accent and Rhythm*. Cambridge: Cambridge University Press.
- Ammar, W. and Morsi, R. (2006). Phonological Development and Disorders: Colloquial Egyptian Arabic, in Zhu Hua and B. Dodd (eds.), *Phonological Development and Disorders in Children: A Multilingual Perspective*. Multilingual Matters Ltd.
- Angoujard, J.P. (1978). Le Cycle en Phonologie? L'accentuation en Arabe Tunisien. *Analyses, Théorie*, 3 : 1-39.
- Angoujard, J.P. (1981). Contribution à l'Analyse Prosodique (Parlers de Tunis, du Caire et de Damas). *Analyses, Théorie*, 1: 66-121.
- Angoujard, J.P. (1990). *Metrical Structure of Arabic*. Dordrecht: Foris.
- Arbaoui, N. (2002). Aspects du Système Verbal de l'Arabe Marocain. Mémoire de DEA, Université Paris 7.
- Arbaoui, N. (2010). Les Dix Formes de l'Arabe Classique à l'Interface Syntaxe/Phonologie – pour une Déconstruction du Gabarit. Thèse de doctorat, Université Paris 7.
- Aronoff, M. (1976). *Word Formation in Generative Grammar*. Cambridge, MA: MIT press.
- Bachra, B. (2000). *The Phonological Structure of the Verbal Roots in Arabic and Hebrew*. Leiden: Brill.
- Badawi, E. and Hinds, M. (1986). *A Dictionary of Egyptian Arabic*. Librairie du Liban.
- Barillot, X. (2002). Morphologie Gabaritique et Information Consonantique Latente en Somali et dans les langues est-Couchitiques. Thèse de doctorat, Université Paris 7.
- Bat-El, O. (1994). Stem Modification and Cluster Transfer in Modern Hebrew. *Natural Language and Linguistic Theory*, 12: 572-596.
- Bat-El, O. (2003). Semitic Verb Structure within a Universal Perspective, in J. Shimron (ed.), *Language Processing and Acquisition in Languages of Semitic, Root-based, Morphology*: 29-59. Amsterdam: John Benjamins.

- Behnstedt, P. and Woidich, M. (1985). *Die Ägyptische-Arabischen Dialekt*. Wiesbaden: Ludwig Riechert.
- Benbraham, S. (2004). Site Interne et Morphologie Non-concaténative en Arabe Maghrébin. Mémoire de DEA, Université Paris 7.
- Bendjaballah, S. (1998). Aspects Apophoniques de la Vocalisation du Verbe Berbère (Dialecte Kabyle), in Sauzet P. (ed.), *Langue et grammaire II & III – Phonologie*. Université Paris 8, Paris.
- Bendjaballah, S. (1999). Trois Figures de la Structure Interne des Gabarits. Thèse de doctorat, Université Paris 7.
- Bendjaballah, S. (2005). Apophony, in K. Versteegh (ed.), *Encyclopedia of Arabic Language and Linguistics*. Leiden : Brill.
- Berinstein, A.E. (1979). A Cross-linguistic Study on the Perception and Production of Stress. *Working Papers in Phonetics*, 47. University of California, Los Angeles.
- Bohas, G. (1990). A Diachronic Effect of the OCP. *Linguistic Inquiry* 21, 2: 298-301.
- Bolinger, D.L. (1958). A Theory of Pitch Accent in English. *Word*, 14: 109-149.
- Boueddine, M. (2011). Les Ségholés des Racines Faibles en Arabe Marocain. MA Thesis, Université Paris 7.
- Broselow, E. (1976). The phonology of Egyptian Arabic. Doctoral dissertation, University of Massachusetts, Amherst.
- Broselow, E. (1992). Parametric Variation in Arabic Dialect Phonology, in E. Broselow, M. Eid and J. McCarthy (eds.), *Perspectives on Arabic linguistics IV*: 7-47. Amsterdam and Philadelphia: John Benjamins.
- Broselow, E. (2008). Stress-Epenthesis Interactions, in B. Vaux and A. Nevins (eds.), *Rules, Constraints, and Phonological Phenomena*: 121-148. Oxford: Oxford University Press.
- Cantineau, J. (1950a). La notion de “Schème” et son Altération dans Diverses Langues Sémitiques. *Semitica*, 3: 73-83.
- Cantineau, J. (1950b). Racines et Schèmes, in *Mélanges offert à William Marçais* : 119-124. Paris: G.P. Maisonneuve.
- Caubet, D. (1993). *L'Arabe Marocain. Tome 1, Phonologie et Morphosyntaxe*. Louvain: Editions Peeters.
- Charette, M. (1990). License to Govern. *Phonology*, 7: 233-253.

- Chekayri, A. and Scheer, T. (1996). The Apophonic Origin of Glides in the Verbal System of Classical Arabic, in J. Lacarme, J. Lowenstamm and U. Shlonsky (eds.), *Studies in Afroasiatic Grammar*, 62-76. The Hague: Holland Academic Graphics.
- Chomsky, N. and Halle, M. (1968). *The Sound Pattern of English*. New York: Harper and Row.
- Clements, N. (1990). The Role of the Sonority Cycle in Core Syllabification, in J. Kingston and M. Beckman (eds.), *Papers in Laboratory Phonology I*. Cambridge: Cambridge University Press.
- Clements, N. and Ford, K. (1979). Kikuyu Tone Shift and its synchronic consequences. *Linguistic Inquiry*, 10: 179-210.
- Cowell, M. (1964). *A Reference Grammar of Syrian Arabic (Based on the Dialect of Damascus)*. Washington, DC: Georgetown University Press.
- El Medlaoui, M. (1998). Le Substrat Berbère en Arabe Marocain: Un Système de Contraintes. *Langues et Littératures. Vol. 16*: 137-165. Rabat: Publications de la Faculté des Lettres et des Sciences Humaines.
- El Medlaoui, M. (2000) L'Arabe Marocain, Un Lexique Sémitique Inséré Sur Un Fond Grammatical Berbère, in S. Chaker and A. Zaborski (eds.), *Etudes Berbères et Chamito-Sémitiques, Mélanges Offerts à Karl Prasse*: 155-188. Louvain: Editions Peeters.
- Fant, C. (1958). Modern Instruments and Methods for Acoustic Studies of Speech. *Acta Polytechnica Scandinavica*, 1: 1-81.
- Firth, J. (1948). Sounds and Prosodies. *Transactions of the Philological Society*: 127-152.
- Fischer, W. and Jastrow, O. (1980). *Handbuch der Arabischen Dialekte*. Wiesbaden: Harassowitz.
- Fleisch, H. (1961/1979). *Traité de Philologie Arabe, I et II*. Beirut: Imprimerie Catholique 1961 (Vol. I); Beirut: Dar al-Machreq 1979 (Vol. II).
- Frajzyngier, Z. (1979). Notes on the R₁R₂R₂ Stems in Semitics. *Journal of Semitic Studies*, 24: 1-13.
- Fry, D.B. (1955). Duration and Intensity as Physical Correlates of Linguistic Stress. *Journal of the Acoustical Society of America*, 27: 765-768.
- Fry, D.B. (1958). Experiments in the Perception of Stress. *Language and Speech*, 1: 126-152.
- Gadalla, H. (2000). *Comparative Morphology of Standard and Egyptian Arabic*. Muenchen: Lincom Europa.
- Gafos, A. (2003). Greenberg's Asymmetry in Arabic: A Consequence of Stems in Paradigms. *Language* 79, 2: 317-355.

- Garde, P. (1968). *L'accent*. Paris: Presses Universitaires de France.
- Gelb, I. (1969). *Sequential Reconstruction of Proto-Akkadian*. Chicago: The University of Chicago Press.
- Godon, E. (1998). Aspects de la Morphologie Nominale du Somali: La Formation du Pluriel. Mémoire de DEA, Université Paris 7.
- Goldenberg, G. (1994). Principles of Semitic Word-Structure, in G. Goldenberg and S. Raz (eds.), *Semitic and Cushitic Studies*: 29-64. Wiesbaden: Harrassowitz Verlag.
- Goldenberg, G. (1998). Principles of Semitic Word Structure, in G. Goldenberg (ed.), *Studies in Semitic Linguistics*: 10-45. Jerusalem: The Magnes Press.
- Goldenberg, G. (2005). Semitic Triradicalism and the Biradical Question, in G. Kahn (ed.), *Semitic Studies in Honour of Edward Ullendorff*: 9-25. Leiden: Brill.
- Goldsmith, J. (1976). Autosegmental Phonology. Doctoral dissertation, MIT.
- Greenberg, J. (1950). The Patterning of Root Morphemes in Semitic. *Word*, 6: 162-81.
- Greenberg, J. (1966). Synchronic and Diachronic Universals in Phonology. *Language*, 42: 508-517.
- Greenberg, J. (1978). *Universals of Human Language. Vol. 3: Word Structure*. Stanford, California: Stanford University Press.
- Guerssel, M. (2003). Why Arabic guttural assimilation is not a phonological process, in S. Ploch (ed.), *Living on the Edge, 28 papers in honour of Jonathan Kaye*: 581-598. Berlin, New York: Mouton de Gruyter.
- Guerssel, M. and Lowenstamm, J. (1990). The Derivational Morphology of the Verbal System of Classical Arabic. Ms. Université du Québec à Montréal and Université Paris 7.
- Guerssel, M. and Lowenstamm, J. (1996). Ablaut in Classical Arabic Measure I Active Verbal Forms, in J. Lecarme, J. Lowenstamm and U. Shlonsky (eds.), *Studies in Afroasiatic Grammar*: 123-134. The Hague: Holland Academic Graphics.
- Haile, A. and Mtenje, A. (1988). In Defence of Autosegmental Treatment of Nonconcatenative Morphology. *Journal of Linguistics*, 24: 433-455.
- Halle, M. (1990). Respecting Metrical Structure. *Natural Language and Linguistic Theory*, 8: 149-76.
- Halle, M. and Kenstowicz, M. (1991). The Free Element Condition and Cyclic versus Noncyclic stress. *Linguistic Inquiry*, 22: 457-501.
- Halle, M. and Vergnaud, J.R. (1979). Metrical Phonology. Unpublished Ms., MIT.

- Halle, M. and Vergnaud, J.R. (1980). Metrical Structure in Phonology. Unpublished paper, MIT.
- Halle, M. and Vergnaud, J.R. (1987). *An Essay on Stress*. Cambridge, MA: MIT press.
- Harms, R. (1981). A Backwards Metrical Approach to Cairo Arabic Stress. *Linguistic Analysis*, 7: 429-450.
- Harrell, R. (1957). *The Phonology of Colloquial Egyptian Arabic*. New York: American Council of Learned Societies.
- Harris, J. (1990). Segmental Complexity and Phonological Government. *Phonology*, 7: 255-300.
- Harris, J. (1994). *English Sound Structure*. Oxford: Blackwell.
- Harris, J. and Lindsey, G. (1995). The Elements of Phonological Representation, in J. Durand and F. Katamba (eds.), *Frontiers of Phonology: Atoms, Structures, Derivations*: 34-79. Harlow, Essex: Longman.
- Hayes, B. (1979). Extrametricality. *MIT working papers in Linguistics*, 1: 77-86.
- Hayes, B. (1981). A Metrical Theory of Stress Rules. Doctoral dissertation, MIT.
- Hayes, B. (1989). Compensatory Lengthening in Moraic Phonology. *Linguistic Inquiry*, 13: 227-276.
- Hayes, B. (1995). *Metrical Stress Theory: Principles and case Studies*. Chicago: University of Chicago Press.
- Hayward, R. (1988). In Defence of the Skeletal Tier. *Studies in African Linguistics*, 19: 131-172.
- Heath, J. (1987). *Ablaut and Ambiguity, Phonology of a Moroccan Arabic Dialect*. Albany: State University of New York.
- Heath, J. (2002). *Jewish and Muslim Dialects of Moroccan Arabic*. Oxford: Routledge.
- Heath, J. (2003). Arabic Derivational Ablaut, Processing Strategies, and Consonantal Roots, in J. Shimron (ed.), *Language Processing and Acquisition in Languages of Semitic, Root-based, Morphology*: 115-129. Amsterdam: John Benjamins.
- Hockett, F. (1958). *A Course in Modern Linguistics*. New York: Macmillan.
- Hyman, L. (1977). On The Nature of Linguistics Stress, in L. Hyman (eds.), *Studies in Stress and Accent*, Southern California Occasional Papers in Linguistics 4, University of Southern California, Los Angeles, California.
- Jakobson, R., Fant, C. and Halle, M. (1951). *Preliminaries to Speech Analysis*. Cambridge, MA: MIT Press.

- Kabbaj, O. (1990). La Structure Syllabique de l'Arabe Marocain: le Cas des Verbes Creux. Mémoire de Maîtrise, Université du Québec à Montréal.
- Kager, R. (1995). The Metrical Theory of Word Stress, in J. Goldsmith (ed.), *The handbook of Phonological Theory*: 367-402. Oxford: Basil Blackwell.
- Kaye, J. (1990a). 'Coda' Licensing. *Phonology Yearbook*, 7: 301-330.
- Kaye, J. (1990b). Government in Phonology: The Case of Moroccan Arabic. *The Linguistic Review*, 6: 131-159.
- Kaye, J., Ech-chadli, M. and El Ayachi, S. (1986). Les Formes Verbales de l'Arabe Marocain. La Phonologie des Langues Sémitiques. *Revue Québécoise de Linguistique*, 16 : 61-99.
- Kaye, J., Lowenstamm, J. and Vergnaud, J.R. (1985). The Internal Structure of Phonological Representations: A Theory of Charm and Government. *Phonology Yearbook*, 2: 305-328.
- Kaye, J., Lowenstamm, J. and Vergnaud, J.R. (1990). Constituent Structure and Government in Phonology. *Phonology Yearbook*, 7: 193-231.
- Kiparsky, P. (1982a). Lexical Phonology and Morphology, in I.S. Yang (ed.), *Linguistics in the Morning Calm: Selected Papers from SICOL-1981*: 3-91. Seoul: Hanshin.
- Kiparsky, P. (1982b). From Cyclic Phonology to Lexical Phonology. In H. Van Der Hulst and N. Smith (eds.), *The Structure of Phonological Representations*: 131-175. Dordrecht: Foris.
- Kiparsky, P. (2002). Syllables and Moras in Arabic, in C. Féry and R. Van Der Vijver (eds.), *The Syllable in Optimality Theory*: 147-182. Cambridge: Cambridge University Press.
- Kuryłowicz, J. (1972). *Studies in Semitic Grammar and Metrics*. Wrocław: Wydawbućtwi Polskiej Akademii Nauk.
- Lambert, M. (1897). De la Formation des Racines Trilitères Fortes, in G.A. Kohut (ed.), *Semitic Studies in Memory of Rev. Dr. Alexander Kohut* : 354-362. Berlin : S. Calvary.
- Lampitelli, N. (2005). L'Arabe Marocain: Vocalisme, Schwa et Epenthèses. Mémoire de Maîtrise, Université Paris 7.
- Langendoen, D.T. (1968). *The London School of Linguistics: A Study of the Linguistic Theories of B. Malinowski and J.R. Firth*. Cambridge, MA: MIT Press.
- Larsen, U.B. (1994). Some Aspects of Vowel Length and Stöd in Modern Danish. M.A. Thesis, Université Paris 7.
- Larsen, U.B. (1998). Italian Vowel Length, Raddoppiamento Sintattico and the Definite Article, a Unified Analysis in Government Phonology, in P. Sauzet (ed.), *Actes des Colloques Langues et Grammaire 2 et 3, Phonologie*: 87-102. Université Paris 8, Paris.

- Leben, W. (1973). Suprasegmental Phonology. Doctoral dissertation, MIT.
- Lecerf, J. (1974). L'Accent de Mot en Arabe d'Orient, in A. Caquot and D. Cohen (eds.), *Actes de Premier Congrès International de Linguistique Sémitique et Chamito-sémitique*. The Hague: Mouton.
- Lieberman, M. and Prince, A. (1977). On Stress and Linguistic Rhythm. *Linguistic Inquiry*, 8: 249-336.
- Lowenstamm, J. (1991). Vocalic Length and Centralization in Two Branches of Semitic (Ethiopic and Arabic), in A.S. Kaye (eds.), *Semitic Studies in Honor of Wolf Leslau on the Occasion of His eighty-fifth Birthday*: 949-965. Wiesbaden: Otto Harrassowitz.
- Lowenstamm, J. (1996). CV as the Only Syllable Type, in J. Durant and B. Laks (eds.), *Current Trends in Phonology, Models and Methods*: 419-441. European Studies Research Institute, University of Salford, Manchester: ESRI.
- Lowenstamm, J. (1999). The beginning of the Word, in J. Renison and K. Kühnammer (eds.), *Phonologika 1996: Syllables !?:* 153-166. The Hague: Thesus.
- Lowenstamm, J. (2006). La Phonologie Métrique, in S. Auroux, K. Koerner, H. J. Niederehe, K. Versteegh (eds.), *History of the Language Sciences*. Berlin : Walter de Gruyter.
- Lowenstamm, J. (2011). The Phonological Pattern of Phi-features in the Perfective Paradigm of Moroccan Arabic. *Brill's Annual of Afroasiatic Languages and Linguistics*, 3: 140-201.
- Lowenstamm, J. and Kaye, J. (1986). Compensatory Lengthening in Tiberian Hebrew, in L. Wetzels and E. Sezer (eds.), *Studies in Compensatory Lengthening*: 97-146. Dordrecht: Foris.
- Lucas, C. (2009). The Development of Negation in Arabic and Afro-Asiatic. Doctoral dissertation, Emmanuel College, University of Cambridge.
- Marantz, A. (1981). Re-reduplication. *Linguistic Inquiry*, 13: 435-482.
- Matthews, P. (1974). *Morphology: An Introduction to the Theory of Word-Structure*. Cambridge: Cambridge University Press.
- McCarthy, J. (1979a). Formal Problems in Semitic Phonology and Morphology. Doctoral dissertation, MIT.
- McCarthy, J. (1979b). On Stress and Syllabification. *Linguistic Inquiry*, 10: 443-466.
- McCarthy, J. (1980). A Note on the Accentuation of Damascene Arabic. *Studies in the Linguistic Sciences* 10: 77-98.
- McCarthy, J. (1981). A Prosodic Theory of Nonconcatenative Morphology. *Linguistic Inquiry*, 12: 373-418.

- McCarthy, J. (1982). Prosodic Templates, Morphemic Templates, and Morphemic Tiers, in H. Van Der Hulst and N. Smith (eds.), *The Structure of Phonological Representations*: 191-223. Dordrecht: Foris.
- McCarthy, J. (1984). Prosodic Structure in Morphology, in M. Aronoff and R. Oehrle (eds.), *Language Sound Structure*. Cambridge, MA: MIT press.
- McCarthy J. (1986). OCP Effects: Gemination and Antigemination. *Linguistic Inquiry*, 17: 207-263.
- McCarthy, J. (1991). Semitic Gutturals and Distinctive Feature Theory, in B. Comrie and M. Eid. (eds.), *Perspectives on Arabic Linguistics III*: 63-91. Amsterdam: John Benjamins.
- McCarthy, J. (1994). The Phonetics and Phonology of Semitic Pharyngeals, in P. Keating (ed.), *Papers in Laboratory Phonology III: Phonological Structure and Phonetic Form*: 191-233. Cambridge: Cambridge University Press.
- McCarthy, J. (2005). The Length of Stem-final Vowels in Colloquial Arabic. *Linguistics Department Faculty Publication Series, Paper 85*. University of Massachusetts, Amherst.
- McCarthy, J. and Prince, A. (1986). Prosodic morphology. Ms. [revised 1996] http://rucss.rutgers.edu/tech_rpt/pm86all.pdf
- McCarthy, J. and Prince, A. (1990a). Foot and Word in Prosodic Morphology: the Arabic Broken Plural. *Natural Language and Linguistic Theory*, 8: 209-283.
- McCarthy, J. and Prince, A. (1990b). Prosodic Morphology and Templatic Morphology, in M. Eid and J. McCarthy (eds.), *Perspectives on Arabic Linguistics II: Papers from the Second Annual Symposium on Arabic linguistics*. Amsterdam: John Benjamins.
- McGuirk, R. (1986). *Colloquial Arabic of Egypt*. London: Routledge.
- Mitchell, T. F. (1952). The Active Participle in an Arabic Dialect of Cyrenaica. *Bulletin of the School of Oriental and African Studies*, 14: 11-33.
- Mitchell, T. F. (1956). *An Introduction to Colloquial Egyptian Arabic*. London: Oxford University Press.
- Mitchell, T. F. (1960). Prominence and Syllabification in Arabic. *Bulletin of the School of Oriental and African Studies*, 23: 369-389.
- Mitchell, T. F. (1975). *Principles of Firthian Linguistics*. London: Longman.
- Mitchell, T. F. (1990). *Pronouncing Arabic*. Oxford: Clarendon Press.

- Moore, J. (1990). Doubled Verbs in Modern Standard Arabic, in M. Eid and J. McCarthy (eds.), *Perspectives on Arabic Linguistics, II*: 55-93. Amsterdam: John Benjamins.
- Morgenbrod, H. and Serifi, E. (1981). The Sound Structure of Verb Roots in Modern Hebrew. *Journal of Linguistics*, 17: 11-16.
- Morton, J. and Jassem, W. (1965). Acoustic Correlates of Stress. *Language and Speech*, 8: 148-158.
- Moscato, S., Anton S., Edward U. and Wolfram V.S. (1964). *An Introduction to the Comparative Grammar of the Semitic languages: Phonology and Morphology*. Wiesbaden: Harrassowitz.
- Newman, S. (1946). On the Stress System of English, *Word*, 2: 171-187.
- Nöldeke, T. (1911). Semitic Languages. *Encyclopedia Britannica (11th Edition)*, 24: 617-630.
- Owen, J. (1997). The Arabic Grammatical Tradition, in R. Hetzron (ed.), *Semitic languages*: 46-58. London: Routledge.
- Petráček, K. (1963). Die Innere Flexion in den Semitischen Sprachen. *Archiv Orientální*, 31: 577-624.
- Puglielli, A. and Siyaad, C.M. (1984). La Flessione del Nome, In Annarita Puglielli (ed.), *Studi Somali 5: Aspetti Morfologici, Lessicali e della Focalizzazione*: 53-112. Roma: Ministero Affari Esteri, Direzione Generale per la Cooperazione allo Sviluppo.
- Saeed, J.I. (1993). *Somali Reference Grammar*. Kensington, Maryland: Dunwoody Press.
- Scheer, T. (1994). The status of Consonant Clusters blocking Proper Government: a Unified Model of Government. Paper presented at the Workshop on Government Phonology, Vienna.
- Scheer, T. (1996). Une Théorie de l'Interaction Directe entre Consonnes. Thèse de doctorat, Université Paris 7.
- Scheer, T. (1997). Vowel-Zero Alternations and their Support for a Theory of Consonantal Interaction, in P.M. Bertinetto, L. Gaeta, G. Jetchev and D. Michaels, *Certamen Phonologicum III*: 67-88. Torino: Rosenberg and Sellier.
- Scheer, T. (1998a). A Unified Model for Proper Government. *The Linguistic Review*, 15: 41-67.
- Scheer, T. (1998b). La Structure Interne des Consonnes, in P. Sauzet (ed.), *Langues et Grammaire II-III, Phonologie* : 140-172. Université Paris 8, Paris.
- Scheer, T. (2004). *A Lateral Theory of Phonology. Vol.1: What is CVCV, and Why It Should Be?* Berlin: Mouton de Gruyter.

- Scheer, T. and Szigetvári, P. (2005). Unified Representations for Stress and the Syllable. *Phonology*, 22: 37-75.
- Ségéral, P. (1995). Une Théorie Généralisée de l'Apophonie. Thèse de doctorat, Université Paris 7.
- Ségéral, P. (1996). L'Apophonie en Ge'ez, in J. Lecarme, J. Lowenstamm and U. Shlonsky (eds.), *Studies in Afroasiatic Grammar*, 360-391. La Hague: Holland Academic Graphics.
- Ségéral, P. (2000). Théorie de l'Apophonie et Organisation des Schèmes en Sémitique, in J. Lecarme, J. Lowenstamm and U. Shlonsky (eds.), *Research in Afroasiatic Grammar*. 263-299. Amsterdam: John Benjamins.
- Ségéral, P. and Scheer, T. (1998). A Generalized Theory of Ablaut: the Case of Modern German Strong Verbs, in A. Ortman, R. Fabri and T. Parodi (eds.), *Models of Inflection*: 28-59. Tübingen: Niemeyer.
- Ségéral, P. and Scheer, T. (2001). La Coda-Miroir. *Bulletin de la Société de Linguistique de Paris*, 96: 107-152.
- Ségéral, P. and Scheer, T. (2008). The Coda Mirror, Stress and Positional Parameters, in J.B. de Carvalho, T. Scheer and P. Ségéral, *Lenition and Fortition*: 483-518. Berlin and New York: Mouton de Gruyter.
- Selkirk, E. (1984). *Phonology and Syntax: The Relation between Sound and Structure*. Cambridge, MA: MIT Press.
- Shimron, J. (2003). Semitic Languages: Are they Really Root-based?, in J. Shimron (ed.), *Language Processing and Acquisition in Languages of Semitic, Root-Based, Morphology*: 1-28. Amsterdam: John Benjamins.
- Siegel, D. (1974). Topics in English Morphology. Doctoral dissertation, MIT. Published (1979), New York: Garland.
- Thackston, W. (1994). *An Introduction to Koranic and Classical Arabic. An Elementary Grammar of the Language*. Iranbooks: IBEX Publishers.
- Tobin, Y. (1990). A Combinatory Phonology of the Hebrew Triconsonantal (CCC) Root System. *La Linguistique*, 26: 99-114.
- Tomiche, N. (1964). *Le Parler Arabe du Caire*. The Hague: Mouton.
- Trubetzkoy, N. (1939). *Principles of Phonology*. Originally published in German, Grundzüge der Phonologie, Vandenhoeck und Ruprecht, Göttingen. Translated (1969) by C.A.M. Baltaxe. Berkley and Los Angeles: University of south California Press.

- Ussishkin, A. (1999). The inadequacy of the consonantal root: Modern Hebrew Denominal Verbs and Output-Output Correspondence. *Phonology* 16: 401-442.
- Ussishkin, A. (2006). Semitic Morphology: Root-based or Word-based? *Morphology*, 16: 37-40.
- Vergnaud, JR. (1976). Formal Properties of Phonological Rules, in R. Butts and J. Hintikka (eds.), *Basic Problems in Methodology and Linguistics*: 299-318. Dordrecht: Reidel.
- Voigt, R. (1988). *Die Infirmen Verbaltypen des Arabischen und das Biradikalismus Problem*. Stuttgart: Franz Steiner.
- Wahrmund, A. (1898). *Lesebuch in Neu-arabischer Sprache*. Giessen: Ricker.
- Watson, J. (2002). *The Phonology and Morphology of Arabic*. Oxford: Oxford University Press.
- Watson, J. (2011). Word Stress in Arabic, in M.V. Oostendrop, C. Ewen, E. Hume and K. Rice (eds.), *The Blackwell Companion to Phonology*: 2990-3017. Oxford: Blackwell Publishing Ltd.
- Weitzman, M. (1987). Statistical Patterns in Hebrew and Arabic Roots: Corrected Diagram. *Journal of the Royal Asiatic Society*, 119: 306-306.
- Welden, A. (1980). Stress in Cairo Arabic. *Studies in the Linguistic Sciences*, 10: 99-120.
- Woidich M. (1999). Grammatik des Kairenisch-Arabischen. MS. University of Amsterdam.
- Woidich, M. (2006). *Das Kairenisch-Arabisch: Grammatik*. Wiesbaden: Harrassowitz.
- Wright, W. (1986): *A Grammar of the Arabic Language*, Translated from the German of Caspari and edited with numerous additions and corrections. Cambridge: Cambridge University Press.
- Yip, M. (1988). Templatic Morphology and the Direction of Association. *Natural Language and Linguistic Theory*, 6: 551-577.
- Yoshida, S. (1990). Some Aspects of Governing Relations in Japanese Phonology. Doctoral dissertation, School of Oriental and African Studies, University of London.
- Yoshida, S. (1993). Licensing of Empty Nuclei: the Case of Vowel Harmony in Palestinian Arabic. *The Linguistic Review*, 10: 127-159.
- Yoshida, S. (1996). *Phonological Government in Japanese*. Australia: Australian National University.
- Yoshida, S. (1999). Inter-nuclear Relations in Arabic, in J. Denison and K. Kühnammer (eds.), *Phonologica 1996: Syllables !?:* 379-398. The Hague: Thesus.
- Zaborski, A. (1991). Biconsonantal Roots and Triconsonantal Root Variation in Semitic: Solutions and Prospect, in A.S. Kaye (ed.), *Semitic Studies in Honor of Wolf Leslau on the Occasion of his 85th Birthday*: 1675-1703. Wiesbaden: Otto Harrassowitz.

Appendices

1. The consonant inventory of Egyptian Arabic.
2. Vowel distributions within the syllable.
3. Measure I: perfective and negation.
4. Measure I: perfective and imperfective.
5. Verbal Measure I suffixed with direct object pronouns (DOP).

1 The consonant inventory of Egyptian Arabic

| | Bilabial | Labiodental | Dental | Palatal | Velar | Uvular | Pharyngeal | Glottal |
|--------------|----------|-------------|--------|---------|-------|--------|------------|---------|
| Plosive/Stop | b | | t d | | k g | q | | ʔ |
| | | | ʈ ɖ | | | | | |
| Fricative | | f (v) | s z | ʃ (ʒ) | | x ʁ | ħ ʕ | h |
| | | | ʂ ʐ | | | | | |
| Nasal | m | | n | | | | | |
| Lateral | | | l | | | | | |
| Trill/Flap | | | r | | | | | |
| Semi-vowel | | | | j | w | | | |

The consonant sounds between brackets occur in loan words such as *garaʒ* ‘garage’ and *mo:ʐ* ‘mauve.’

2 Vowel distributions within the syllable

2.1 Stressed syllables

| Vowel | CV | | CVC | | CVV | | CVVC# | CVCC# |
|-------|----|-----|-----|------|------------|------|-------|-------|
| | CV | CV# | CVC | CVC# | CVV PreFin | CVV# | | |
| i | | | | | | | | |
| i: | | | | | i: | i: | i: | |
| e | e | | e | | | | | e |
| e: | | | | | e: | e: | e: | |
| a | a | | a | | | | | a |
| a: | | | | | a: | a: | a: | |
| u | | | | | | | | |
| u: | | | | | u: | u: | u: | |
| o | o | | o | | | | | o |
| o: | | | | | o: | | o: | |

2.2 Non-stressed syllables

| Vowel | CV | | CVC | | CVV | | CVVC# | CVCC# |
|-------|----|-----|-----|------|------------|------|-------|-------|
| | CV | CV# | CVC | CVC# | CVV PreFin | CVV# | | |
| i | i | i | | | | | | |
| i: | | | | | | | | |
| e | e | | e | e | | | | |
| e: | | | | | | | | |
| a | a | a | a | a | | | | |
| a: | | | | | | | | |
| u | u | u | | | | | | |
| u: | | | | | | | | |
| o | o | | o | o | | | | |
| o: | | | | | | | | |

3 Verbal Measure I: perfective and negation

3.1 Strong roots

| √ktb 'write' | | √msk 'catch' | | |
|------------------------|---------|-----------------|---------|------------|
| 1 | 2 | 3 | 4 | |
| <i>negation</i> | | <i>negation</i> | | |
| 3 _{SING.MASC} | kátab | makatábš | mése | mamsékš |
| 3 _{SING.FEM} | kátabet | makatabétš | mésket | mameskétš |
| 2 _{SING.MASC} | katábt | makatábteš | mesékt | mamsékteš |
| 2 _{SING.FEM} | katábtí | makatabtí:š | mesékti | mamsékti:š |
| 1 _{SING} | katábt | makatábteš | mesékt | mamsékteš |
| 3 _{PL} | kátabu | makatabú:š | mésku | mameskú:š |
| 2 _{PL} | katábtu | makatabtú:š | meséktu | mamséktú:š |
| 1 _{PL} | katábna | makatabná:š | mesékna | mamsékná:š |

3.2 Glide-final roots

| √bnj 'build' | | √nsj 'forget' | | √nsj 'forget' | | |
|------------------------|---------|-----------------|---------|-----------------|---------|-----------|
| 5 | 6 | 7 | 8 | 7' | 8' | |
| <i>negation</i> | | <i>negation</i> | | <i>negation</i> | | |
| 3 _{SING.MASC} | bána | mabaná:š | nési | mansí:š | nési | mansí:š |
| 3 _{SING.FEM} | bánet | mabanétš | nésjet | manesjétš | nésjet | manesjétš |
| 2 _{SING.MASC} | bané:t | mabanétš | nisi:t | mansétš | nesé:t | mansétš |
| 2 _{SING.FEM} | bané:ti | mabanetí:š | nisi:ti | mansití:š | nesé:ti | mansetí:š |
| 1 _{SING} | bané:t | mabanétš | nisi:t | mansétš | nesé:t | mansétš |
| 3 _{PL} | bánu | mabanú:š | nésju | manesjú:š | nésju | manesjú:š |
| 2 _{PL} | bané:tu | mabanetú:š | nisi:tu | mansitú:š | nesé:tu | mansetu:š |
| 1 _{PL} | bané:na | mabanená:š | nisi:na | mansiná:š | nesé:na | mansená:š |

3.3 Glide-medial roots

| | √šwf 'see' | | √mjł 'lean, incline' | |
|------------------------|------------|-----------------|----------------------|-----------------|
| | 9 | 10 | 11 | 12 |
| | | <i>negation</i> | | <i>negation</i> |
| 3 _{SING.MASC} | šá:f | mašáfš | má:l | mamáłš |
| 3 _{SING.FEM} | šá:fet | mašafetš | má:let | mamalétš |
| 2 _{SING.MASC} | šóft | mašófteš | mélt | mamélteš |
| 2 _{SING.FEM} | šófti | mašofti:š | mélti | mamelti:š |
| 1 _{SING} | šóft | mašófteš | mélt | mamélteš |
| 3 _{PL} | šá:fu | mašafu:š | má:lu | mamalú:š |
| 2 _{PL} | šóftu | mašoftu:š | méltu | mameltu:š |
| 1 _{PL} | šófna | mašofná:š | mélna | mamelná:š |

3.4 Biliteral roots

| | √md 'extend' | |
|------------------------|--------------|-----------------|
| | 13 | 14 |
| | | <i>negation</i> |
| 3 _{SING.MASC} | mádd | mamáddeš |
| 3 _{SING.FEM} | máddet | mamaddétš |
| 2 _{SING.MASC} | maddé:t | mamaddétš |
| 2 _{SING.FEM} | maddé:ti | mamaddeti:š |
| 1 _{SING} | maddé:t | mamaddétš |
| 3 _{PL} | máddu | mamaddú:š |
| 2 _{PL} | maddé:tu | mamaddetu:š |
| 1 _{PL} | maddé:na | mamaddená:š |

4 Verbal Measure I: perfective and imperfective

4.1 Strong roots

| | √ktb 'write' | | √ḍrb 'hit' | | √xrg 'go out' | |
|------------------------|--------------|----------------|--------------|----------------|---------------|----------------|
| | 1 | 2 | 3 | 4 | 5 | 6 |
| | <i>perf.</i> | <i>imperf.</i> | <i>perf.</i> | <i>imperf.</i> | <i>perf.</i> | <i>imperf.</i> |
| 3 _{SING.MASC} | kátab | jékteb | ḍárab | jéḍrab | xárag | jóxrog |
| 3 _{SING.FEM} | kátabet | tékteb | ḍárabet | téḍrab | xáraget | tóxrog |
| 2 _{SING.MASC} | katábt | tékteb | ḍarábt | téḍrab | xarágt | tóxrog |
| 2 _{SING.FEM} | katábtí | tektebí | ḍarábtí | teḍrábí | xarágtí | toxrógí |
| 1 _{SING} | katábt | ʔákteb | ḍarábt | ʔáḍrab | xarágt | ʔáxrog |
| 3 _{PL} | kátabu | jektebu | ḍárabu | jéḍrabu | xáragu | joxrógu |
| 2 _{PL} | katábtu | tektebu | ḍarábtu | teḍrábu | xarágtu | toxrógu |
| 1 _{PL} | katábna | nékteb | ḍarábna | néḍrab | xarágna | nóxrog |

| | √msk 'catch' | | √rkb 'mount, ride' | | √şbr 'act with patience' | |
|------------------------|-----------------------|-----------------------|-----------------------|-----------------------|--------------------------|-----------------------|
| | 7 | 8 | 9 | 10 | 11 | 12 |
| | <i>perf.</i> | <i>imperf.</i> | <i>perf.</i> | <i>imperf.</i> | <i>perf.</i> | <i>imperf.</i> |
| 3 _{SING.MASC} | mése [́] sek | jé [́] msek | ré [́] keb | jér [́] kab | şé [́] ber | jó [́] şbor |
| 3 _{SING.FEM} | més [́] ket | tém [́] sek | rék [́] bet | tér [́] kab | şéb [́] ret | tó [́] şbor |
| 2 _{SING.MASC} | mesé [́] kt | tém [́] sek | reké [́] bt | tér [́] kab | şebé [́] rt | tó [́] şbor |
| 2 _{SING.FEM} | mesé [́] kti | temsé [́] ki | reké [́] bti | terká [́] bi | şebé [́] rti | toş [́] bóri |
| 1 _{SING} | mesé [́] kt | ʔám [́] sek | reké [́] bt | ʔár [́] kab | şebé [́] rt | ʔaş [́] bor |
| 3 _{PL} | més [́] ku | jemsé [́] ku | rék [́] bu | jerká [́] bu | şé [́] bru | joş [́] bóru |
| 2 _{PL} | mesé [́] ktu | temsé [́] ku | reké [́] btu | terká [́] bu | şebé [́] rtu | toş [́] bóru |
| 1 _{PL} | mesé [́] kna | ném [́] sek | reké [́] bna | nér [́] kab | şebér [́] na | noş [́] bor |

4.2 Glide-final roots

| | √bnj 'build' | | √nsj 'forget' | | √mšj 'walk' | |
|------------------------|--------------|----------------|---------------|----------------|--------------|----------------|
| | 13 | 14 | 15 | 16 | 17 | 18 |
| | <i>perf.</i> | <i>imperf.</i> | <i>perf.</i> | <i>imperf.</i> | <i>perf.</i> | <i>imperf.</i> |
| 3 _{SING.MASC} | bána | jébni | nési | jénsa | méši | jémši |
| 3 _{SING.FEM} | bánet | tébni | nésjet | ténsa | méšjet | témši |
| 2 _{SING.MASC} | bané:t | tébni | niší:t | ténsa | miší:t | témši |
| 2 _{SING.FEM} | bané:ti | tébni | niší:ti | ténsi | miší:ti | témši |
| 1 _{SING} | bané:t | ʔábni | niší:t | ʔánsa | miší:t | ʔámši |
| 3 _{PL} | bánu | jébnu | nésju | jénsu | méšju | jémšu |
| 2 _{PL} | bané:tu | tébnu | niší:tu | ténsu | miší:tu | témšu |
| 1 _{PL} | bané:na | nébni | niší:na | nénsa | miší:na | némši |

4.3 Glide-medial roots

| | √mjl 'lean, incline' | | √šwf 'see' | |
|------------------------|----------------------|----------------|--------------|----------------|
| | 19 | 20 | 21 | 22 |
| | <i>perf.</i> | <i>imperf.</i> | <i>perf.</i> | <i>imperf.</i> |
| 3 _{SING.MASC} | má:l | jemí:l | šá:f | ješú:f |
| 3 _{SING.FEM} | má:let | temí:l | šá:fet | tešú:f |
| 2 _{SING.MASC} | mélt | temí:l | šóft | tešú:f |
| 2 _{SING.FEM} | mélti | temí:li | šófti | tešú:fi |
| 1 _{SING} | mélt | ʔamí:l | šóft | ʔašú:f |
| 3 _{PL} | má:lu | jemí:lu | šá:fu | ješú:fu |
| 2 _{PL} | méltu | temí:lu | šóftu | tešú:fu |
| 1 _{PL} | mélna | nemí:l | šófna | nešú:f |

4.4 Biliteral roots

| | √md 'extend' | | √rd 'reply' | |
|------------------------|--------------|----------------|--------------|----------------|
| | 23 | 24 | 25 | 26 |
| | <i>perf.</i> | <i>imperf.</i> | <i>perf.</i> | <i>imperf.</i> |
| 3 _{SING.MASC} | mádd | jemédd | rádd | jeródd |
| 3 _{SING.FEM} | máddet | temédd | ráddet | teródd |
| 2 _{SING.MASC} | maddé:t | temédd | raddé:t | teródd |
| 2 _{SING.FEM} | maddé:ti | teméddi | raddé:ti | teróddi |
| 1 _{SING} | maddé:t | ʔamédd | raddé:t | ʔaródd |
| 3 _{PL} | máddu | jeméddu | ráddu | jeróddu |
| 2 _{PL} | maddé:tu | teméddu | raddé:tu | teróddu |
| 1 _{PL} | maddé:na | nemédd | raddé:na | neródd |

5 Verbal Measure I suffixed with direct object pronouns (DOP)

5.1 Strong roots

5.1.1 kátab √ktb 'write' perfective

| Subject | 3 _{SING.MASC} | 3 _{SING.FEM} | 2 _{SING.MASC} /1 _{SING} | 2 _{SING.FEM} | 3 _{PL} | 2 _{PL} | 1 _{PL} |
|---------|------------------------|-----------------------|---|-----------------------|-----------------|-----------------|-----------------|
| | kátab | káabet | katábt | katábtí | kátabu | katábtu | katábna |

| DOP | 1 | 2 | 3 | 4 | 5 | 6 | 7 |
|------------------------|----------|------------|------------|-------------|------------|-------------|-------------|
| 3 _{SING.MASC} | kátabu | katabétu | katábtu | katabtí: | katabú: | katabtú: | katabná: |
| 3 _{SING.FEM} | katábha | katabéthha | katabtáha | katabtí:ha | katabú:ha | katabtú:ha | katabná:ha |
| 2 _{SING.MASC} | kátabak | katabétak | katábtak | | katabú:k | | katabná:k |
| 2 _{SING.FEM} | kátabek | katabétek | katábték | | katabú:ki | | katabná:ki |
| 1 _{SING} | katábni | katabétni | katabténi | katabtí:ni | katabú:ni | katabtú:ni | |
| 3 _{PL} | katábhom | katabéthom | katabtóhom | katabtí:hom | katabú:hom | katabtú:hom | katabná:hom |
| 2 _{PL} | katábkú | katabétku | katabtóku | katabtí:ku | katabú:ku | | katabná:ku |
| 2 _{PL'} | katábkom | katabétkom | katabtókom | | katabú:kom | | katabná:kom |
| 1 _{PL} | katábna | katabétna | katabténa | katabtí:na | katabú:na | katabtú:na | |

5.1.2 mések $\sqrt{\text{msk}}$ 'catch' perfective

| | | | | | | | |
|---------|------------------------|-----------------------|---|-----------------------|-----------------|-----------------|-----------------|
| Subject | 3 _{SING.MASC} | 3 _{SING.FEM} | 2 _{SING.MASC} /1 _{SING} | 2 _{SING.FEM} | 3 _{PL} | 2 _{PL} | 1 _{PL} |
| | mések | mésket | mesékt | mesékti | mésku | meséktu | mesékna |

| | | | | | | | |
|------------------------|----------|-----------|------------|-------------|-----------|-------------|-------------|
| DOP | 8 | 9 | 10 | 11 | 12 | 13 | 14 |
| 3 _{SING.MASC} | mésku | meskétu | meséktu | mesekti: | meskú: | mesektú: | mesekná: |
| 3 _{SING.FEM} | mesékha | meskétha | mesektáha | mesekti:ha | meskú:ha | mesektú:ha | mesekná:ha |
| 2 _{SING.MASC} | méskak | meskétak | meséktak | | meskú:k | mesektú:k | mesekná:k |
| 2 _{SING.FEM} | méskek | meskéték | meséktek | | meskú:ki | mesektú:ki | mesekná:ki |
| 1 _{SING} | mesékni | meskétni | mesekténi | mesekti:ni | meskú:ni | mesektú:ni | |
| 3 _{PL} | mesékhom | meskéthom | mesektóhom | mesekti:hom | meskú:hom | mesektú:hom | mesekná:hom |
| 2 _{PL} | mesékku | meskétku | mesektóku | | meskú:ku | mesektú:ku | mesekná:ku |
| 2 _{PL'} | mesékkom | meskétkom | mesektókom | | meskú:kom | mesektú:kom | mesekná:kom |
| 1 _{PL} | mesékna | meskétna | mesekténa | mesekti:na | meskú:na | mesektú:na | |

5.2 Glide-final roots

5.2.1 bána √bnj 'build' perfective

| Subject | 3 _{SING.MASC} | 3 _{SING.FEM} | 2 _{SING.MASC} /1 _{SING} | 2 _{SING.FEM} | 3 _{PL} | 2 _{PL} | 1 _{PL} |
|---------|------------------------|-----------------------|---|-----------------------|-----------------|-----------------|-----------------|
| | bána | bánet | bané:t | bané:ti | bánu | bané:tu | bané:na |

| DOP | 15 | 16 | 17 | 18 | 19 | 20 | 21 |
|------------------------|----------|----------|----------|------------|----------|------------|------------|
| 3 _{SING.MASC} | baná: | banétu | bané:tu | banetí: | banú: | banetu: | banená: |
| 3 _{SING.FEM} | baná:ha | banéthha | banéthha | banetí:ha | banú:ha | banetu:ha | banená:ha |
| 2 _{SING.MASC} | baná:k | banétak | bané:tak | | banú:k | | banená:k |
| 2 _{SING.FEM} | baná:ki | banétek | bané:tek | | banú:ki | | banená:ki |
| 1 _{SING} | baná:ni | banétni | banétni | banetí:ni | banú:ni | banetu:ni | |
| 3 _{PL} | baná:hom | banéthom | banéthom | banetí:hom | banú:hom | banetu:hom | banená:hom |
| 2 _{PL} | baná:ku | banétku | banétku | banetí:ku | banú:ku | banetu:ku | banená:ku |
| 2 _{PL} ' | baná:kom | banétkom | banétkom | banetí:kom | banú:kom | banetu:kom | banená:kom |
| 1 _{PL} | baná:na | banétna | banétna | banetí:na | banú:na | banetu:na | |

5.2.2 nési √nsj ‘forget’ perfective

| | | | | | | | |
|---------|------------------------|-----------------------|---|-----------------------|-----------------|-----------------|-----------------|
| Subject | 3 _{SING.MASC} | 3 _{SING.FEM} | 2 _{SING.MASC} /1 _{SING} | 2 _{SING.FEM} | 3 _{PL} | 2 _{PL} | 1 _{PL} |
| | nési | nésjet | nisi:t | nisi:ti | nésju | nisi:tu | nisi:na |

| | | | | | | | |
|------------------------|----------|-----------|----------|------------|-----------|------------|------------|
| DOP | 22 | 23 | 24 | 25 | 26 | 27 | 28 |
| 3 _{SING.MASC} | nisi: | nesjétu | nisi:tu | nesiti: | nesjú: | nesitu: | nesiná: |
| 3 _{SING.FEM} | nisi:ha | nesjétha | nesétha | nesiti:ha | nesjú:ha | nesitu:ha | nesiná:ha |
| 2 _{SING.MASC} | nisi:k | nesjétak | nisi:tak | | nesjú:k | | nesiná:k |
| 2 _{SING.FEM} | nisi:ki | nesjétek | nisi:tek | | nesjú:ki | | nesiná:ki |
| 1 _{SING} | nisi:ni | nesjétni | nesétni | nesiti:ni | nesjú:ni | nesitu:ni | |
| 3 _{PL} | nisi:hom | nesjéthom | neséthom | nesiti:hom | nesjú:hom | nesitu:hom | nesiná:hom |
| 2 _{PL} | nisi:ku | nesjétku | nesétku | | nesjú:ku | | nesiná:ku |
| 2 _{PL} ' | nisi:kom | nesjétkom | nesétkom | | nesjú:kom | | nesiná:kom |
| 1 _{PL} | nisi:na | nesjétna | nesétna | nesiti:na | nesjú:na | nesitu:na | |

5.3 Glide-medial roots

5.3.1 ša:f √šwf 'see' perfective

| Subject | 3 _{SING.MASC} | 3 _{SING.FEM} | 2 _{SING.MASC} /1 _{SING} | 2 _{SING.FEM} | 3 _{PL} | 2 _{PL} | 1 _{PL} |
|---------|------------------------|-----------------------|---|-----------------------|-----------------|-----------------|-----------------|
| | ša:f | ša:fet | šoft | šofti | ša:fu | šoftu | šofna |

| DOP | 29 | 30 | 31 | 32 | 33 | 34 | 35 |
|------------------------|--------|----------|---------|-----------|----------|-----------|-----------|
| 3 _{SING.MASC} | ša:fu | šafétu | šoftu | šofti: | šafú: | šoftú: | šofná: |
| 3 _{SING.FEM} | šáfha | šaféthha | šoftáha | šofti:ha | šafú:ha | šoftú:ha | šofná:ha |
| 2 _{SING.MASC} | ša:fak | šafétak | šoftak | | šafú:k | | šofná:k |
| 2 _{SING.FEM} | ša:fek | šafétek | šofterk | | šafú:ki | | šofná:ki |
| 1 _{SING} | šáfni | šafétni | šofétni | šofti:ni | šafú:ni | šoftú:ni | |
| 3 _{PL} | šáfhom | šaféthom | šofohom | šofti:hom | šafú:hom | šoftú:hom | šofná:hom |
| 2 _{PL} | šáfku | šafétku | šofoku | | šafú:ku | | šofná:ku |
| 2 _{PL'} | šáfkom | šafétkom | šofokom | | šafú:kom | | šofná:kom |
| 1 _{PL} | šáfna | šafétna | šofétna | šofti:na | šafú:na | šoftú:na | |

5.3.2 ša:l √šjl 'carry' perfective

| Subject | 3 _{SING.MASC} | 3 _{SING.FEM} | 2 _{SING.MASC} /1 _{SING} | 2 _{SING.FEM} | 3 _{PL} | 2 _{PL} | 1 _{PL} |
|---------|------------------------|-----------------------|---|-----------------------|-----------------|-----------------|-----------------|
| | ša:l | ša:let | šełt | šełti | ša:lu | šełtu | šełna |

| DOP | 36 | 37 | 38 | 39 | 40 | 41 | 42 |
|------------------------|--------|----------|----------|-----------|----------|-----------|-----------|
| 3 _{SING.MASC} | ša:lu | šalētu | šełtu | šełti: | šalú: | šełtú: | šełná: |
| 3 _{SING.FEM} | šálha | šaléthha | šełtáha | šełti:ha | šalú:ha | šełtú:ha | šełná:ha |
| 2 _{SING.MASC} | ša:lak | šalétak | šełtak | | šalú:k | | šełná:k |
| 2 _{SING.FEM} | ša:lek | šalétek | šełtek | | šalú:ki | | šełná:ki |
| 1 _{SING} | šálni | šalétni | šełétni | šełti:ni | šalú:ni | šełtú:ni | |
| 3 _{PL} | šálhom | šaléthom | šełtóhom | šełti:hom | šalú:hom | šełtú:hom | šełná:hom |
| 2 _{PL} | šálku | šalétku | šełtóku | | šalú:ku | | šełná:ku |
| 2 _{PL'} | šálkom | šalétkom | šełtókom | | šalú:kom | | šełná:kom |
| 1 _{PL} | šálna | šalétna | šełétna | šełti:na | šalú:na | šełtú:na | |

5.4. Biliteral roots

5.4.1 *ħabb* √*ħb* 'love' perfective

| Subject | 3 _{SING.MASC} | 3 _{SING.FEM} | 2 _{SING.MASC} /1 _{SING} | 2 _{SING.FEM} | 3 _{PL} | 2 _{PL} | 1 _{PL} |
|---------|------------------------|-----------------------|---|-----------------------|-----------------|-----------------|-----------------|
| | ħább | ħábbet | ħabbé:t | ħabbé:ti | ħábbu | ħabbé:tu | ħabbé:na |

| DOP | 43 | 44 | 45 | 46 | 47 | 48 | 49 |
|------------------------|----------|-----------|-----------|-------------|-----------|-------------|-------------|
| 3 _{SING.MASC} | ħábbu | ħabbétu | ħabbé:tu | ħabbeti: | ħabbú: | ħabbetú: | ħabbená: |
| 3 _{SING.FEM} | ħabbáha | ħabbéthha | ħabbéthha | ħabbeti:ha | ħabbú:ha | ħabbetú:ha | ħabbená:ha |
| 2 _{SING.MASC} | ħábbak | ħabbétak | ħabbé:tak | | ħabbú:k | | ħabbená:k |
| 2 _{SING.FEM} | ħábbek | ħabbétek | ħabbé:tek | | ħabbú:ki | | ħabbená:ki |
| 1 _{SING} | ħabbéni | ħabbétni | ħabbétni | ħabbeti:ni | ħabbú:ni | ħabbetú:ni | |
| 3 _{PL} | ħabbóhom | ħabbéthom | ħabbéthom | ħabbeti:hom | ħabbú:hom | ħabbetú:hom | ħabbená:hom |
| 2 _{PL} | ħabbóku | ħabbétku | ħabbétku | | ħabbú:ku | | ħabbená:ku |
| 2 _{PL'} | ħabbókom | ħabbétkom | ħabbétkom | | ħabbú:kom | | ħabbená:kom |
| 1 _{PL} | ħabbéna | ħabbétna | ħabbétna | ħabbeti:na | ħabbú:na | ħabbetú:na | |

Résumé de la Thèse

1. L'objectif de la thèse

Cette thèse est consacrée a) à l'étude du système vocalique de l'arabe parlé dans les grands centres urbains du Nord de l'Égypte, et connu dans la documentation sous l'étiquette générique "arabe égyptien" ou "Egyptian Arabic"; b) à l'élaboration des conséquences théoriques de cette étude.

Bien que l'arabe égyptien ait été l'objet d'une certaine attention au cours des cinq dernières décennies, on voit bien que les efforts de recherche visant à comprendre la phonologie de cette langue tombent carrément dans deux catégories bien distinctes: a) descriptive, et b) théorique. De plus, les frontières entre ces deux catégories semblent être restées inchangées, à vrai dire étanches, au fil des années. Ceci peut être clairement perçu lorsque l'on examine les résultats des études d'orientation théorique. Ici, il semble que la principale préoccupation de ces études ait été limitée à vérifier si les propositions qu'elles incluent sont compatibles avec les généralisations émanant des travaux descriptifs. Le résultat en est que les données n'ont été ni renouvelées ni mises à jour, ou très peu seulement. Ce qui a fait défaut, c'est le type d'interaction classique selon lequel les prédictions des théories sont rendues précises, puis les faits linguistiques interrogés en conséquence directe des prédictions en question. Il n'existe pas d'autre façon de "faire sortir" des données nouvelles ou de "rafraîchir" les données classiques.

L'un des objectifs de cette étude est donc de tenter en toute modestie de répondre à l'impérieuse nécessité d'actualiser le débat sur la phonologie de l'arabe égyptien et de contribuer à réduire le fossé qui sépare les deux blocs de recherche, le descriptif d'un côté et le théorique de l'autre côté.

Deux fils conducteurs traversent chacun des chapitres. Le premier consiste à établir des généralisations descriptives sur des questions n'ayant pas encore retenu l'attention des linguistes, de véritables généralisations linguistiques du type capable de nourrir une élaboration théorique. De nouvelles données sont présentées et traitées par des outils d'analyse différents de ceux utilisés par mes prédécesseurs. Ce même fil conducteur consiste également à réviser des généralisations établies par mes prédécesseurs, notamment sur le système accentuel et la cliticisation étudiés, tous les deux, en détail.

L'introduction de nouveaux termes d'analyse dans la discussion de l'arabe égyptien permet de faire des prédictions spécifiques et d'établir plusieurs corrélations cruciales, et non disponibles dans les travaux antérieurs.

L'argument principal de la thèse est que la clé de l'interprétation des manifestations vocaliques les plus importantes en arabe égyptien se trouve dans la définition de la corrélation entre qualité vocalique et quantité vocalique. Dans la thèse, j'établis une corrélation entre ces deux notions: seules les voyelles phonologiquement longues en arabe égyptien peuvent maintenir leur qualité au niveau phonétique. Si le maintien de la longueur *phonologique* est contrarié, ces voyelles deviennent incapables de se manifester en surface. Elles sont, alors, remplacées soit par une voyelle épenthétique ou par rien du tout. Ainsi, je conçois la longueur vocalique en termes strictement *phonologiques*. L'accent, lui, peut affecter *la durée* (phonétique) certes, mais pas la longueur (phonologique).

Le développement de cette thèse a été rendu possible grâce à l'utilisation d'outils théoriques aujourd'hui classiques, au nombre desquels le niveau du squelette fourni par les gabarits. Ces outils permettent la redéfinition de la longueur vocalique, non comme une différence intrinsèque, phonémique, entre voyelles courtes et voyelles longues, mais au contraire en termes du nombre de positions nucléaires auxquelles une voyelle est attachée. La longueur vocalique n'est donc plus représentée comme une caractéristique inhérente aux voyelles: la chaîne segmentale est non-spécifiée pour le trait de longueur; la longueur est représenté au niveau du support gabaritique. Spécifiquement, une voyelle longue devient l'expression d'un objet vocalique attaché à deux positions nucléaires tandis qu'une voyelle est dite courte lorsqu'elle est associée à une seule position squelettale.

Une fois que la longueur vocalique en arabe égyptien est réinterprétée de cette manière, les principes qui gèrent l'économie du système vocalique peuvent être déterminés et un large éventail d'explications pour des problématiques fréquemment signalées, comme les alternances aspectuelles, les règles qui sous-tendent le système accentuel, et bien d'autres problèmes, peut en découler presque immédiatement.

L'élaboration de la nouvelle conception de la longueur vocalique soumise dans cette thèse pour l'arabe égyptien a également été rendue possible par la comparaison avec d'autres parlers arabes. Une large place est faite à la comparaison avec d'autres variétés de l'arabe dont les paramètres et la diachronie sont relativement bien compris, notamment l'arabe classique, ou l'arabe parlé au Maghreb. Avec l'existence d'importantes recherches sur les variétés contemporaines de l'arabe (y compris égyptien), la perspective de dégager les paramètres responsables de l'identification et de la stabilisation de chaque langue ou dialecte, semble se rapprocher sinon être à portée de main. Ceci est le deuxième fil conducteur qui traverse la thèse.

La thèse, à cet égard, vise à contribuer au progrès de l'étude de la dialectologie arabe comparée. Ultimement, l'objectif est de donner une structure déductive à mes résultats et d'en tirer les conséquences – au-delà du cas de l'arabe égyptien ou de la dialectologie arabe – pour la théorie linguistique elle-même.

2. L'organisation de la thèse

L'importance attachée à la *durée* (phonétique) induite par l'accent comme fondement de la distinction entre voyelles courtes et voyelles longues a constitué, selon l'argumentation développée dans ce travail, le principal obstacle à la détection de l'organisation du système vocalique. Il est soutenu ici, au contraire, par le matériel présenté et les analyses proposées que l'arabe égyptien est l'une des langues dans lesquelles la quantité vocalique (distincte de la durée) peut être déduite de la qualité de surface de la voyelle.

La thèse se présente sous la forme d'un thème et de quatre variations. Le thème central est lancé dans le premier chapitre. L'observation des caractéristiques majeures du système vocalique de l'arabe égyptien, même dans une optique purement structuraliste, jette un doute sur l'idée largement admise que la longueur vocalique est contrastive dans cette langue. Les raisons sont les suivantes:

1. Dans les langues dans lesquelles la longueur vocalique est considérée comme étant distinctive, la distribution des voyelles longues a tendance à être équivalente à celle des voyelles courtes. En arabe égyptien, une langue dans laquelle la longueur vocalique semble être contrastive, la distribution des voyelles (réputées) longues est en fait beaucoup plus restreinte que celle des voyelles courtes: alors que ces dernières sont librement distribuées, les voyelles longues sont limitées à la position ultime et pénultième du mot.
2. Dans les langues dans lesquelles la longueur vocalique est considérée comme étant distinctive, les distinctions de longueur peuvent généralement être établies dans les positions du mot capables d'accueillir les voyelles longues. En arabe égyptien, une langue dans laquelle la longueur vocalique est réputée contrastive, les distinctions de longueur sont uniquement possibles en position finale de mot, et non dans la position ultime et pénultième du mot comme on s'y serait attendu.
3. Dans les langues dans lesquelles la longueur vocalique est considérée comme étant distinctive, les distinctions de longueur ne sont généralement pas liées à la qualité des

voyelles. En arabe égyptien, une langue dans laquelle la longueur vocalique est réputée contrastive, la mise en place des contrastes de longueur semble être réservée à l'ensemble des voyelles cardinales, et non aux voyelles moyennes.

L'objectif fondamental du premier chapitre est par conséquent de reconsidérer la nature de ce que l'on appelle "longueur vocalique" en arabe égyptien. L'observation plus approfondie des données en utilisant des outils d'analyse qui reconnaissent le niveau squelettal conduit à l'élaboration d'une vision différente – de fait, d'un nouveau concept - de la longueur vocalique pour l'arabe égyptien. Une corrélation précise entre la qualité de surface d'une voyelle et le nombre de positions gabaritiques à laquelle elle est associée est établie; une voyelle conserve sa qualité sur le niveau phonétique si et seulement si elle est attachée à deux positions nucléaires.

Ainsi, les voyelles périphériques {i, u, a} doivent être associées à deux positions vocaliques afin de pouvoir explicitement exprimer leur qualité périphérique (c.à.d. *i, u, a* doivent être branchants); sinon elles se dissocient. Une voyelle périphérique, {i, u, a}, associée à une seule position gabaritique sera phonétiquement interprétée, selon les contraintes phonotactiques de la langue, au moyen de: a) un noyau vide (rien), ou b) une voyelle épenthétique.

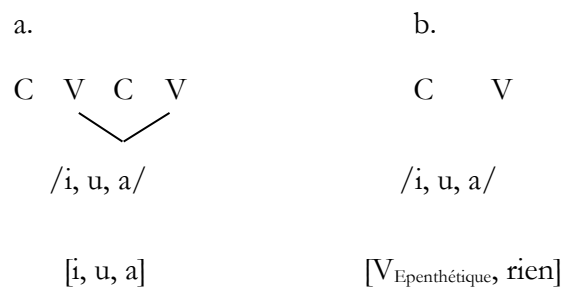

La différence entre la série courte {i, u, a} et la série longue {i:, u: a:}, qui a toujours été interprétée comme un contraste de longueur en arabe égyptien, a été redéfinie comme l'effet de l'accent. Des arguments sont présentés pour montrer que les deux séries, "courte" et "longue," présentent, en fait, la même longueur phonologique, sinon la même durée. Plus

précisément, les deux branchent pour identifier deux positions vocaliques. L'accent ne fait donc qu'augmenter la durée de voyelles *déjà phonologiquement longues*.

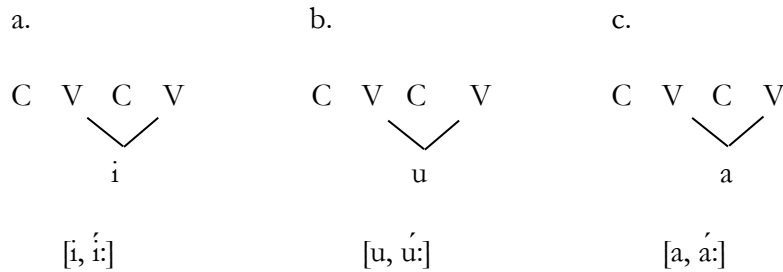

Une élaboration détaillée de la corrélation entre la qualité et la quantité d'une voyelle couvre tout le matériel de la thèse. Dans le chapitre deux, je montre comment ce point de vue permet de déterminer les paramètres impliqués dans la dérivation du système vocalique. L'identification des paramètres, qui sous-tendent le système vocalique de l'arabe égyptien, permet:

1. La détermination de la stratégie employée par l'arabe égyptien pour interpréter les noyaux vides.
2. La compréhension et la redéfinition des voyelles moyennes de l'arabe égyptien, {e/eː, o/oː}.
3. L'explication d'une lacune distributionnelle intrigante dans la classe nominale dite des ségholés à glide médian.

Mon rejet des conceptions traditionnelles de la longueur vocalique entraîne bien d'autres conséquences. En effet, ma nouvelle conception de la longueur vocalique se révèle être l'outil indispensable pour résoudre un certain nombre de questions difficiles dans le système verbal. Il s'agit de questions qui n'ont pas réellement été abordées jusqu'à présent. Cela est d'abord montré dans le chapitre trois, où les alternances vocaliques aspectuelles prétendument imprédictibles sont expliquées, puis dans le chapitre quatre où la mélodie invariable du perfectif des verbes creux et des verbes sourds reçoit une explication.

L'étude des vocalisations verbales est suivie d'un retour final au thème principal dans le cinquième chapitre sous la forme d'un examen exhaustif du phénomène de l'accent. Ici, je propose un système alternatif de l'assignation de l'accent qui souligne - à nouveau - le rôle du système vocalique. Deux outils principaux jouent un rôle fondamental pour établir cette vision alternative de l'accent: a) la représentation de la longueur vocalique au niveau squelettal, et b) la mise en œuvre du modèle CVCV.

L'argument principal du cinquième chapitre est que les caractéristiques prosodiques ne sont pas spécifiées dans les segments vocaliques eux-mêmes; la proéminence perçue comme "accent" peut être plutôt exprimée par des relations de gouvernement affectant des positions particulières du gabarit. J'argumente que les mécanismes d'assignation de l'accent opèrent de manière à cibler la première position non-gouvernée du gabarit.

Cette conception plus restrictive conduit à des prédictions précises en ce qui concerne les autres aspects du système de l'arabe égyptien, à savoir la "source" de la longueur vocalique. Ma tentative de proposer une théorie totalement indépendante de la longueur en arabe égyptien m'amène à rejeter l'accent comme source de la longueur vocalique. Les voyelles ne "s'allongent" ni ne "raccourcissent," comme il est généralement supposé ("allongement vocalique pré-suffixal" et "raccourcissement d'une voyelle non-accentuée"). J'argumente que les voyelles maintiennent leur "longueur" en toutes circonstances. La longueur vocalique est fonction de l'espace gabaritique réservé au matériel vocalique, et la durée phonétique n'est qu'un surcroît de proéminence attribué à une voyelle déjà phonologiquement longue. En d'autres termes, ce n'est que dans la position pénultième du mot qu'une voyelle phonologiquement longue peut également manifester une longueur phonétique (strictement parlant: une durée).